



HAL
open science

FloodProBE Project WP 3: Reliability of Urban Flood Defences. Guidebook for Using Helicopter-Borne Lidar to Contribute to Levee Assessment – Experiment on “Val d’Orléans” Pilot Site

L. Auriau, P. Mériaux, P. Royet, R. Tourment, S. Lacombe, J. Maurin, A. Boulay

► To cite this version:

L. Auriau, P. Mériaux, P. Royet, R. Tourment, S. Lacombe, et al.. FloodProBE Project WP 3: Reliability of Urban Flood Defences. Guidebook for Using Helicopter-Borne Lidar to Contribute to Levee Assessment – Experiment on “Val d’Orléans” Pilot Site. [Research Report] irstea. 2012, pp.77. hal-02600693

HAL Id: hal-02600693

<https://hal.inrae.fr/hal-02600693>

Submitted on 16 May 2020

HAL is a multi-disciplinary open access archive for the deposit and dissemination of scientific research documents, whether they are published or not. The documents may come from teaching and research institutions in France or abroad, or from public or private research centers.

L’archive ouverte pluridisciplinaire **HAL**, est destinée au dépôt et à la diffusion de documents scientifiques de niveau recherche, publiés ou non, émanant des établissements d’enseignement et de recherche français ou étrangers, des laboratoires publics ou privés.

WP 3: Reliability of Urban Flood Defences Guidebook for Using Helicopter-Borne Lidar to Contribute to Levee Assessment – Experiment on “Val d’Orléans” Pilot Site

Date: October 2012

Report Number: WP03-01-12-03

Version Number: V2_Irstea

Deliverable Number:

Due Date for Deliverable:

Actual Submission date:

Task Leader: Irstea (previously Cemagref)

**FloodProBE is co-funded by the European Community
Seventh Framework Programme for European Research and
Technological Development (2009-2013)
FloodProBE addresses “Technologies for Improved Safety of the Built
Environment in Relation to Flood Events”
Start date: November 2009, duration: 4 Years**

Document Dissemination Level PU

PU = Public

PP = Restricted to other programme participants (including the Commission Services).

RE = Restricted to a group specified by the consortium (including the Commission Services).

CO = Confidential, only for members of the consortium (including the Commission Services).

CL restricted = Classified with the mention of the classification level restricted "Restraint UE"

CL confidential = Classified with the mention of the classification level confidential "Confidential UE"

CL secret = Classified with the mention of the classification level secret "Secret UE"

Document Information

Title	Final Report V2 - Action 3.2.2: Remote Sensing Guidebook for Using Helicopter-Borne Lidar to Contribute to Levee Assessment – Experiment on “Val d’Orléans” Pilot Site
Lead Author	L. Auriou, P. Mériaux
Contributors	P. Royet, R. Tourment, S. Lacombe, J. Maurin, A. Boulay
Distribution	"[Click here and list Distribution]"
Report Number	"[Click here and enter Report Number]"

Document History

Date	Version	Prepared by	Organisation	Approved by	Notes
12/02/03	V1	LA and PM	Irstea		
12/10/18	V2	LA and PM	Irstea	P. Royet	

Acknowledgement

The work described in this publication was supported by the European Community’s Seventh Framework Program through the grant to the budget of the FloodProBE project, Grant Agreement Number 243401.

Disclaimer

This document reflects only the authors’ views and not those of the European Community. This work may rely on data from sources external to the members of the FloodProBE project Consortium. Members of the Consortium do not accept liability for loss or damage suffered by any third party as a result of errors or inaccuracies in such data. The information in this document is provided “as is” and no guarantee or warranty is given that the information is fit for any particular purpose. The user thereof uses the information at its sole risk and neither the European Community nor any member of the FloodProBE Consortium is liable for any use that may be made of the information.

© **Members of the FloodProBE Consortium**

Guidebook for Using Helicopter-Borne Lidar to Contribute to Levee Assessment

Experiment on “Val d’Orléans” Pilot Site

Chapter I: Topographical data is essential to levee assessment p. 5

I.1 Levee Break or Damage Mechanisms p. 5

I.2 Purpose of the Assessment and Levee Methodology p. 7

I.3 High Resolution Topographical Data Required p. 7

- a) Levee Top Longitudinal Profiles Against Maximum Headwater Level During Floods
- b) Cross-sections
- c) Topographic Plan
- d) Flood Plains Topography

Chapter II: Remote Sensing Technologies Contributing To Levee Assessment p. 11

II.1 Remote Sensing Overview p. 11

II.2 LiDAR p.11

- a) Definition
- b) Airborne Lidar
- c) Helicopter-Borne Lidar
 - a) Land Lidar
 - b) Bathymetric LiDAR
 - c) Examples of Applications on Levees

II.3 Summary Table p. 16

Chapter III: Methodology for Using High Resolution Lidar Data and imageries p. 17

III.1 Val d’Orléans Pilot Operation – Overview p. 17

- a) Pilot Site Selection
- b) Specifications Preparation and Lidar Acquisition
- c) Acquired Data Overview
 - i. *Raw Laser Points*
 - ii. *High Resolution Photographs and Ortho-Mosaic*
 - iii. *High Resolution Videos*
 - iv. *Digital Elevation Model*
 - v. *Digital Terrain Model*
 - vi. *Topographic Material*
- d) Work Preparation and Completion Time on Pilot Site

III.2 Three Experimental Test Areas – Overview p. 29

- a) Sites With Woodland
 - i. *Background*
 - ii. *Problem*

- iii. *Goals*
- iv. *Main Results*
- b) Capucins Levee
 - i. *Background*
 - ii. *Problem*
 - iii. *Goals*
 - iv. *Main Results*
- c) Town of Jargeau
 - i. *Background*
 - ii. *Problem*
 - iii. *Goals*
 - iv. *Main Results*

III.3 Proposed Method to Contribute to a Levee Assessment

p. 46

- a) Operating Aerial Photographs and Videos to Explore the Levee, Pre-Identify the Areas of Interest and Pre-Split them into Sections
 - i. *Initial Levee Zoning*
 1. Various Types of Works: embankment, masonry
 2. Woodland, Embedded Buildings
 3. “Levee Toe/Watercourse” Junction
 4. Potential Former Breaches Identification
 - ii. *Cross-Checking Against Historical Data*
 1. Breach Identification
 2. Reinforced Area Identification
 3. Comparison with Former Aerial Photographs
- b) Topographic Plan
- c) Using Lidar Data to Assess Levee Sensitivity to Various Break or Damage Risks
 - i. *Internal Erosion Risk*
 1. Embedded Constructed Entities
 2. Crossing Works
 3. Ligneous Vegetation
 4. Transition Structures
 - ii. *Overflow Risk*
 1. Levee Top Longitudinal Profile
 2. Comparison between Flow Lines during Floods and Levee Longitudinal Profile
 3. Settlement Monitoring through Regular Lidar Acquisitions
 - iii. *Instability Risk*
 1. Low Levee Width and Steep Slope
 2. Irregularities and Ancillary Works
 3. Topographic Plan Contribution
 - iv. *External Erosion and Scouring*
 1. Levee Close to Watercourse
 2. Levee Far from Watercourse

III.4 Conclusion

p. 77

- a) Relevance to Practice
- b) Remaining gaps in Knowledge

Chapter I: Topographical data is essential to levee assessment

This chapter first outlines four main break¹ or damage mechanisms observed on flood protection dikes and the typical assessment methodology (or diagnostic methodology) as recommended by the French good engineering practices.

I.1 Levee Break or Damage Mechanisms

In rural or suburban areas, flood protection dikes are generally built as embankments (and are most commonly referred to as “levees”). Such design has always been widely accepted by hydraulic work designers as it helps highlight the watertight (clay or silt) or semi-permeable (silty sand) ground deposits frequently observed in alluvial valleys: it specifically complies with the technical and financial optimum for levees by minimizing earthmoving constraints (cut and fill construction).

Embankment flood dikes are subjected to four main damages or break mechanisms [Mériaux, Royet, 2007]² that are more or less associated with the action of water these structures are supposed to retain or contain:

- ❑ Internal erosion;
- ❑ Overflow: when the levee top is exceeded by the river water level (overflowing) or waves (overtopping);
- ❑ Sliding slope;
- ❑ Slope external erosion on the watercourse side from the action of flow or waves.

These mechanisms are not independent: they may be sequenced and/or maintain each other until they induce the levee break (total or partial breach with release of a flood wave). For example: current-driven erosion results in the slope getting steeper on the watercourse side of a waterway levee, with the said slope sliding upon the fall in the water level (mechanical “break” in so-called rapid outlet-down conditions) and, at the next flood, the embankment – with a narrower profile, thereby supporting an increased hydraulic gradient – is subjected to internal erosion that will lead to a breach.

Of all such four mechanisms, internal erosion stands out as hardly identifiable as, by essence, it is produced at the heart of the structure and its foundation thereof and develops at a more or less slow pace:

¹ “Levee break” shall be understood as a “breach in the levee”

² Mériaux, Royet, 2007 - Surveillance, Maintenance and Diagnosis of Flood Protection Dikes: A Practical Handbook for Owners and Operators, Edition Quae, ISBN 978-2-7592-0036-8, France, 162p.

- ❑ From the one part, through visual observation which, by nature, only helps identify indications displayed outside the structure;
- ❑ From the other part, through geophysical or geotechnical methods since the event may be extremely local and internal erosion is only proven when the dragging of ground particles from the work or the foundation thereof has taken place and led to the formation of under-dense areas, voids or ducts.

Thus, internal erosion will rather be identified by reviewing its initiating events or indirect effects, including the specific construction or behavioral features of the structure or foundation thereof from which such internal erosion may arise: permeable areas, ground/rigid structure interfaces, internal flow development, etc.

Levees in Urban Areas

In urban areas liable to flooding and riparian to a watercourse, an insufficient right-of-way usually led to the building of flood protection dikes immediately next to the river. Such levees are then protected on the watercourse side by **a wall or a masonry facing** made of stones or concrete and based on a secant or sheet pile cut off. This type of composite work (embankment and masonry) is subjected to the same pathological mechanisms as previously described; the rigid structure on the watercourse side is itself exposed to specific break mechanisms (e.g.: sloughing, overturning, etc.) or damage mechanisms (e.g.: slump, cracking, wear, erosion, ...) that undermine its protective function.

In a number of towns riparian to watercourses, some districts are built, sheltered from floods, down a higher land or on a topographically high area of the flood plains (such area is referred to as “mound” in the Loire Valley). In front of such areas, the levee is often replaced by **a quay wall**. Although this structure remains subjected to specific pathological mechanisms (overturning on the river side at fall of the water level, erosion or face cracking, undercutting or under-sampling of fillers within the foundation, etc.), it no longer works as a water retaining structure but rather as a protective or supporting structure for the bank and infrastructures located thereupon (road, harbor facilities, buildings, etc.). It appears difficult to draw up an assessment process (or in-depth diagnostic) for this type of hydraulic works in urban areas since the high level of density in terms of housing and construction often precludes a clear understanding of the actual work: a levee, strictly speaking, a composite structure or a mere quay wall. In addition, transition areas between the levee and the quay wall - located up and down the topographically high area(s) and sometimes hardly identifiable, as indicated above - are just so many structural weak spots with regard to pathological mechanisms, including internal erosion. Indeed, most of these areas - which shall hereinafter be referred to as interfaces or transitions – have been settled a very long time ago, and no specific construction plans thereof are available.

I.2 Purpose of the Assessment and Levee Methodology

A civil engineering structure assessment aims at assessing the structure's state (that is, its capability to function) and ability to resist all pathological mechanisms, such as ageing, damage, failure or break, that may affect it, and at defining and prioritizing all necessary measures to improve this state or make it last: monitoring, maintenance, repair, reinforcement, etc. The French regulation (December 11th, 2007 Decree) mainly relies on the definition above to specify the so-called "risk analysis" assessment of a hydraulic structure.

With regard to flood protection dikes – long alignment hydraulic structures that are singularly subjected to a temporary hydraulic head – the literature [Lino et al., 2000]³, [Mériaux, Royet, 2007], suggests and provides for a 9-step assessment (or diagnostic) methodology that includes topographical data collection and/or acquisition as a critical process:

1. Historical Approach
2. Topographical Data Acquisition (levee, river bed)
3. Morphodynamic Approach
4. Hydraulic Study
5. Visual Inspection
6. Geotechnical Explorations
7. Numerical Modeling
8. Map Prioritization of Break-Driven Risks
9. Reinforcement Solutions

It is recommended that the topographical data acquisition step should be completed at the beginning of this assessment process so that the results may be used for all subsequent steps.

I.3 – High Resolution Topographical Data Required

All four damages or break mechanisms, as outlined above under Section I.1, are more or less strongly connected to topographical items in relation to the levee (See Table 1 below):

- From the one part, because topographical irregularities have produced them, contribute to them or make them worse;
- From the other part, because they change the structure topography or environment due to their direct or indirect effects.

³ Lino, Meriaux, Royet, 2000, *Méthodologie de diagnostic des digues appliquée aux levées de la Loire moyenne*, Cemagref Editions, ISBN 2-85362-524-9, 224 p.

Topographical Items Damage Mechanisms	Aggravating Topographical Irregularities	Effects On Topography
Internal Erosion	<ul style="list-style-type: none"> . Narrow levee cross-section (too high height/width right-of-way ratio at levee bottom). . Crossing works in operation or disused within the levee body or foundation: identified by their inlets, gates, sight holes or adjoining pumping stations. . Embedded buildings. . Interface or transition areas between two different types of levees. . Trees⁴. 	<ul style="list-style-type: none"> . Sink hole. . Slump on the top or slope. . Potential temporary leak sealing works (e.g.: stacked sandbags).
Overflowing	<ul style="list-style-type: none"> . Points or lower areas on the levee top longitudinal profile. . Irregularities of levee top. . Tightening of levee-limited flood plains (raising the flow line during floods). 	<ul style="list-style-type: none"> . Levee top, slope or toe erosion on the land side (in the event of a proven overflow). . Temporary raising or shut-off works on top.
Slope Sliding	<ul style="list-style-type: none"> . Steep slope. . Narrow levee cross-section. 	<ul style="list-style-type: none"> . Slope irregularities, widening or slides. . Wall tilting.
External Erosion	<ul style="list-style-type: none"> . Steep slope on the river side. . No protection wall on the river side. . Irregularities, structures sticking out of the face. 	<ul style="list-style-type: none"> . Eroded bends (vegetation gone). . Sliding slope (see above). . Undercuttings (only visible from underwater topography or from a low-water LiDAR acquisition).
Proven Breach (background)	/	<ul style="list-style-type: none"> . Depression or pond at levee bottom on the land side (former breach scour hole).

Table 1: Connections between Topography and Levee Damage or Break Mechanisms

⁴ Trees and wood vegetation are typically identified and localized on topographic plans (except for large digging animal lairs which are also a major cause of internal erosion).

Acquiring, and subsequently analyzing, an accurate and exhaustive topography of the levee and its environment will efficiently contribute to producing an in-depth, valuable and reliable assessment.

Topographic campaign deliverables typically include:

- Longitudinal profiles;
- Cross-sections with uniform screen density on specific areas;
- Topographic plans;
- Topographical items related to flood plains.

These will be consecutively reviewed hereafter, and their contribution to the assessment process will be pointed out.

a) Levee Top Longitudinal Profiles Against Maximum Headwater Level During Floods

Overflow often leads to the formation of breaches. Such a risk may be assessed by comparing flow lines during floods and the levee top profile.

Therefore, an accurate topographical survey of the levee top will help determine the freeboard available against the flood from which a protection is sought (a so-called protection project flood), and highlight all sections where the freeboard would be inappropriate. For lack of any hydraulic study, an analysis of the levee longitudinal profile will be sufficient to identify, in a first step, all points and lower areas where the overflow should start in the event of a major flood. Such a piece of information is important to define potential protective or preventive measures.

If there is a raising linear earthridge or parapet (called “banquette” in the Loire Valley) on the crest of the dike, the longitudinal profile should also be surveyed on the same basis as previously indicated.

b) Cross-sections

During floods, the levee is designed for maintaining the difference in water level between the levee-limited bed and the land. Apart from the overflow, the break mechanisms to watch out for are piping (internal erosion) and instability of the slope on the land side during flood and on the river side when the water level falls. In either case, the risk analysis requires good knowledge of the levee cross-sections so as to build up their geometrical model. Geophysical and geotechnical explorations aiming to identify and quantify any material, mechanical strength and permeability heterogeneities within the levee and its close foundation shall indeed provide for the essential and complementary information on the structure internal construction, that are necessary as digital models for calculating the stability or resistance to internal erosion (see D3.1).

Ideally, the cross-sections should overflow by about twenty meters on both sides of the levee toes, including underwater on the river side if the levee touches the low-water bed. The latter would then require specific survey techniques: sonar bathymetry, bathymetric Lidar, etc.

Cross-sections also provide basic data for potentially necessary reinforcement study (stability calculations with reinforced levee, representation of reinforcement works).

c) Topographic Plan

Drawing up a topographic plan on a large scale (typically 1:500) proves to be particularly useful when the levee comprises a great number of irregular points. Such a document, for which one shall ensure the limits will overflow by at least twenty meters on both sides of the levee toes, may be used according to the following stages:

1. Highly detailed preliminary identification of the levee, especially when no high resolution aerial photographs are available;
2. Visual inspection preparation: the levee external construction and spatial variables are pre-identified and thereby will help plan for the field study stage and the material to be carried along (type and number of survey sheets, selection of small equipment, etc.);
3. Accurate location of geophysical and geotechnical explorations **before and after** prospecting and sounding;
4. Reporting all information from field study stages (visual inspection, geotechnical investigations).

Topographical data is also useful for:

- Performing a cartographic summary of the assessment process (plan view) ;
- Locating the reinforcement works: on cross-sections and plan view ;
- Checking whether new levee or reinforcement of levee was constructed according to design plans.

d) Flood Plains Topography

The levee-limited flood plains topography is required for performing hydraulic calculations of flow lines during floods. With regard to the geomorphological study, such topography will help calculate the flow velocity along the levees, and thereby assess hydraulic loadings on the river side faces, and contribute to calculating the potential undermining depths. It shall also prove to be useful to describe alluvial deposits and islets found in the levee-limited waterbed. However, the change in such deposits – which is important for drawing up a geomorphological diagnostic - may be assessed only using consecutive aerial photography campaigns or by repeating topographic campaigns several years apart.

As for the protected flood plains topography, it should provide basic data for performing hydraulic calculations of a slow flooding by backing up or spillway (existing or to be created) or of a flood wave resulting from a simulated breach, with the results thereof being subsequently made available on GIS as public information material. It will also help the geomorphologists identify and specify all topographically high areas or mounds.

Decimeter precision is usually sufficient for acquiring and using topographical data in flood plains.

Topographical data is essential to any levee assessment; mostly when the survey technique used helps produce large scale or high resolution documents: theodolite land survey with high point density or high resolution Lidar. This study shall later describe the existing remote sensing techniques that may be used to acquire accurate topographical data on large surfaces and with high-level output on the field.

Chapter II: Remote Sensing Technologies Contributing To Levee Assessment

II.1 Remote Sensing Overview

Remote sensing, in its broadest sense, refers to measuring or acquiring information on a specific object or event, using a measurement instrument that is separated from the object. It refers to the use, from a distance (for instance an aircraft, a spacecraft, a satellite or a boat), of any type of instrument capable of acquiring information on the environment. Instruments such as still cameras, lasers, radars, sonars, seismographs or gravimeters are frequently used [source: techno-science.net].

For the study of alluvial valley environments and structures, the most frequently used techniques include:

- Aerial photography or satellite imagery;
- Mono- or multispectral photogrammetry;
- Traditional Lidar and bathymetric Lidar;
- Radar;
- High resolution infrared thermography;
- Sonar.

These various techniques, either passive (photography, thermography) or active (Lidar, Radar, Sonar), and their potential applications to levee assessment shall be outlined in a summary table at the end of this chapter (§ II.3) and Lidar technologies shall subsequently be described in further details.

II.2 LiDAR

a) Definition

LiDAR (Light Detection And Ranging) is an “active” remote sensing technique based on light transmission from a transmitter/receiver. The light is partly radiated or absorbed into the target environment while the remaining light is backscattered towards the receiver. The technique is based on measuring the lengths between the laser source and the object or environment (typically the earth surface). The signal is transmitted from a laser fitted on an airborne (helicopter or airplane) or ground platform. The signal wavelength ranges, depending on applications, from 500 nm (e.g.: bathymetric Lidar) to 1,550 nm, that is with a close infrared signal (e.g.: Airborne Laser Scanning).

The Lidar technique is efficiently used in various applications: for instance to study river valleys [Comes-Pereira & Wicherson, 1999]⁵, woodlands or farming areas [Haugerud &

⁵ Comes-Pereira L.M., Wicherson R.J., 1999 – Suitability of laser data for deriving geographical information: a case study in the context of management of fluvial zones. *Journal of Photogrammetry and Remote Sensing* 54 (1999) 105-114.

Harding, 2001]⁶, the changing coastline [Collins & Sitar, 2005]⁷, slope stability [Collins & Sitar, 2004]⁸, linear works or infrastructures (access roads, electric lines, levees) or to perform explorations on volcanoes [Kayen et al, 2004]⁹.

b) Airborne Lidar

The laser system is carried onboard an airplane. Traditional ground resolutions are provided in decimeters with densities amounting to a few points per square meter. This type of Lidar survey is now commonly used in France for acquiring topographical data on river valleys, and gradually for studying coastal areas.

Very high over-flights (up to 6,000 m) were impossible until recently. They help cover very large surfaces although the point density on the ground (< 1 point/m²) and measurement precision are far lower than at lower altitudes. In addition, at such an altitude, the airplane velocity is usually higher and the signal greatly reduced from crossing the atmosphere.

c) Helicopter-Borne Lidar

Specifically in mountain areas where low altitude over-flight by plane proved difficult, airplanes have been gradually replaced with helicopters to take the Lidar system on board. Generally speaking, helicopters offer the advantage of flying at lower altitudes and slower paces, allowing the measurement of high point densities on the ground (> 50 points/m²). On the contrary, the scan swath (that is, strip or corridor width as measured on the ground) is narrower and, if necessary, several adjoining return flights are to be planned to cover a given surface according to the flight height: the helicopter-borne Lidar technique is indeed particularly suitable for performing surveys or following up linear infrastructures such as access roads, electric lines or levees.

Finally, at least in France, flight clearance procedures are less restrictive for helicopters than airplanes from the moment that the flight altitude above the ground remains under visual flight conditions ($< 1,000$ feet). However, it should be noted that flying over built-up areas, may be subject to local restrictions.

In the Lidar-Flimap (Fugro-Geoid©) high resolution technique as implemented on FloodProBE pilot site in Val d'Orléans, the laser performs three scans forward, nadir and backward, respectively, on the helicopter (Figure 1). This scanning feature provides for an improved coverage of the overflowed area; the signal may indeed reach items on the ground

⁶ Haugerud, Harding (2001) R.A. Haugerud and Harding : *Some algorithms for virtual deforestation of lidar topographic survey data*, ISPRS Workshop on Airbone Laserscanning, Annapolis, October 2001

⁷ Collins, B.D. and Sitar, N. (2005). Monitoring of Coastal Bluff Stability Using High Resolution 3D Laser Scanning, *ASCE Geo-Frontiers Special Publication 138: Site Characterization and Modeling, Remote Sensing in Geotechnical Engineering*, E.M. Rathje, ed., ASCE, Austin, Texas, Jan 24-26, 2005.

⁸ Collins, B.D. and Sitar, N. (2004) Application of High Resolution 3D Laser Scanning to Slope Stability Studies. *39th Symposium on Engineering Geology and Geotechnical Engineering*, Butte, Montana, pp. 79-92.

⁹ Kayen, R., Barhardt, W., Carkin, B., Collins, B.D., Grossman, E.E., Minasian, D., Thompson, E. (2004) Imaging the M7.9 Denali Fault Earthquake 2002 Rupture at the Delta River Using LiDAR, RADAR, and SASW. *Surface Wave Geophysics, Eos Trans. AGU, 85(47), Fall Meet. Suppl, Abstract S11A-0999*.

that are partially covered (for instance by vegetation), which would otherwise be impossible with a unique vertical scan plane. The Flimap system offers a specific feature which consists in the Lidar acquisition being associated with high resolution aerial photography and high definition video recording.

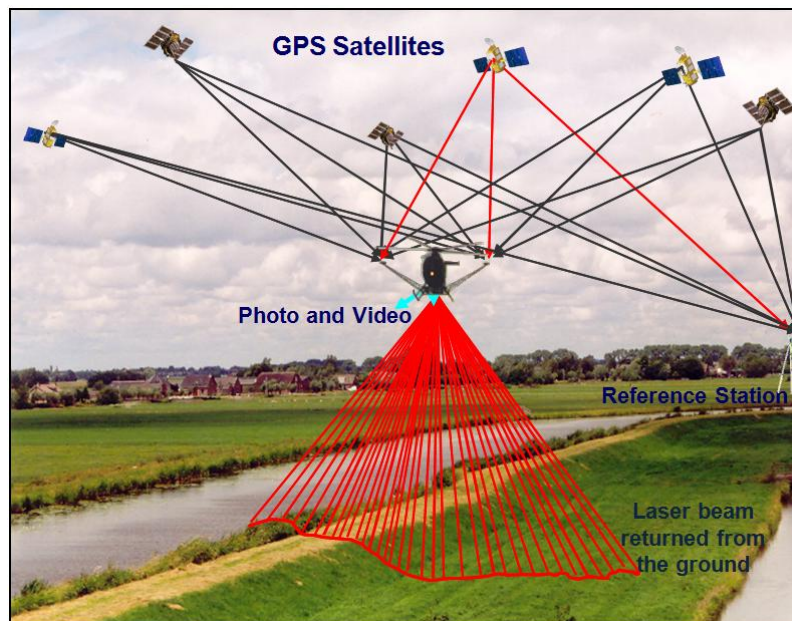

Figure 1: Helicopter-Borne LiDAR Acquisition Principle [source: Fugro-Geoid©]

The flight path and laser source position can be known using onboard GPS systems. Therefore, coordinates for each point surveyed on the earth surface may be calculated by determining the helicopter position and the distance and direction between the scanner and the measured point. Thanks to an inertial unit, helicopter movements may be recorded and induce subsequent post-process corrections.

This laser system comprises three key items: a laser scanner, a GPS and an inertial unit.

Laser Scanner

It is also referred to as laser radar. Indeed, this system is similar to any conventional radar (Radio Detecting And Ranging) system although, as the name implies, it sends out fine pulses - or light beams - instead of radio waves. Most systems operate within near infrared wavelengths (from 1,000 to 1,500 nm).

The measurement principle is based on recording all data stemming from the first pulse or first echo, and from the last pulse or last echo. First echo data will show, for instance, the vegetation top whereas last echo data will show the ground underneath this vegetation (Figure 2).

GPS System

An onboard GPS will indicate the helicopter position at any time, and more specifically the scanner position. This will then provide X, Y and Z coordinates for each post-processed point. It is also recommended to have at least one GPS station set up on the ground, near the flight area, for improving sensor's geographical precision.

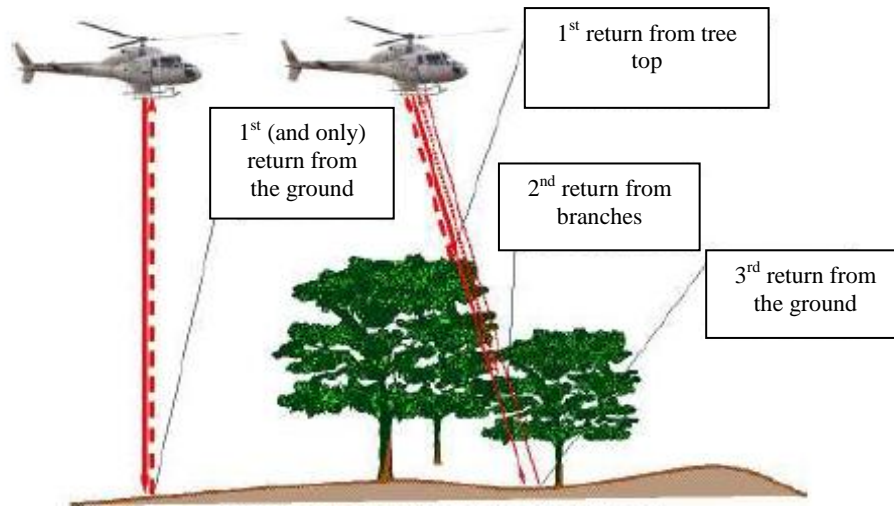

Figure 2: Laser Multiple Return Principle [source: Fugro-Geoid©]

Inertial Unit

An inertial unit is a device featuring gyroscopes, accelerometers and a computer that will calculate the helicopter's attitude and acceleration.

The point density per square meter is contingent upon acquisition frequency and flight height. With the FliMap 400 device as implemented in this study, acquisition frequency is 375 kHz. The point density is then higher than 80 points per square meter for a 150 m high flight. Such a high laser point density makes sure that beams will cross the vegetation cover and reach the ground for exploring the topography underneath the canopy.

d) Land Lidar

It is a 3D laser scanning technique operated from a scanning station fitted on the ground. This method consists in transmitting and collecting laser signals to and from surface objects in order to create a file compiling all three dimension points.

The technique may be used in horizontal or oblique sighting from multiple separate stations to survey mountain slopes, caves, tunnels, walls, etc.

e) Bathymetric LiDAR

The goal is to achieve underwater and land topography.

There are only a couple of bathymetric Lidar systems in the world. All of them transmit a laser beam with two frequencies: one is in the green (532 nm), so that the signal is not blocked by water, and the other frequency is reflected from the water or the ground. Thereby, both the river/sea bottom and bed bank/coast topographies are obtained, and the water level is measured.

Measurement vertical precision ranges from 10 to 50 cm, according to the flight conditions or the overflowed environment.

The bathymetric Lidar remains scarcely implemented on continental watercourses [Feurer & al., 2008]¹⁰, since laser beams hardly ever enter turbid water; however it is used on clean water coastal areas for 3D mapping at 2-30 m depths.

f) Examples of Applications on Levees

As part of levee follow-up procedures, Lidar techniques were first used in the United States and the Netherlands. In France, the first experimental application dates back to 2006, to the best of our knowledge.

- **In the Netherlands: Helicopter-Borne Lidar**

As an archetypal home to levees, the Netherlands have been implementing for many years the high resolution helicopter-borne Lidar at regular time intervals so as to monitor physical changes in levee tops. Indeed, levee managers are required to regularly provide the State Control department with their levee top longitudinal profiles in order to confirm, for instance, that no settlement has occurred.

- **New Orleans Levees (USA): Land Surveys**

A land Lidar survey was performed on a number of levees in New Orleans [Coll. 2006]¹¹ following Katrina hurricane in 2005. Data acquisition was performed over 5 days, from October 9th to 14th, 2005. Such Lidar acquisition campaign was meant to achieve precise earth surface measurements for mapping any ground movements on each site, any inconsistent levee heights, erosion areas and damages on rigid structures.

The instrument used to do so was fitted on a three-legged stand. In order to improve the imagery and make it easier to carry the instrument, the tripod was attached to a platform set on a car roof. Raising the device height by 4 m would reduce the shadow areas and increase the acquisition surface. In some cases however, the tripod was directly set on the ground or on a wall.

- **Levees in Lower Rhône River Valley (France): Recent Helicopter-Borne Surveys**

In March 2006, as part of an experimental research project funded by the Provence-Alpes-Côte d'Azur Region, a high resolution LiDAR helicopter-borne flight along a corridor was performed by Fugro-Geoid design office in the lower Rhône river valley over 50 km levees and banks covered with more or less dense a vegetation [Clément & Mériaux, 2007]¹².

¹⁰ Feurer D., Bailly J-S, Puech C., Le Coarer Y. & Viau A. (2008) – Very high resolution mapping of river immersed topography by remote sensing. *Progress in Physical Geography*, 32(4):1-17.

¹¹ Collective (2006) <http://www.ce.berkeley.edu/projects/neworleans/> Investigation of the Performance of the New Orleans Flood Protection Systems in Hurricane Katrina on August 29, 2005 – Appendix A: Terrestrial Lidar imagery of New Orleans levees affected by hurricane Katrina. *Independent Levee Investigation Team Final Report*.

¹² Clément A., Mériaux P., 2007 - Apports de la télédétection LiDAR hélicoptérée pour la reconnaissance des digues françaises: premiers résultats. *Revue Française de Photogrammétrie et Télédétection*, n° 186, p. 87-91

Overflowed works included:

- some of the Petit Rhône levees, managed by SYMADREM (*Inter-regional Syndicate for Camargue Delta Levees*);
- the hydroelectric installation levee by CNR (*Rhône National Company*) in Vallabrègues on the Rhône river, downstream Avignon;
- the Palière levee on the Durance river, in Avignon, managed by the City of Avignon and the SMAVD (*Syndicate for Land Planning in the Durance River Valley*).

During the following year (summer 2007), the SYMADREM, since they were confident that such technique was relevant, had their entire levee fleet (about 250 km, including 5 km of urban levees and docks in Arles) surveyed by the Flimap 400 system: flying 275 m high above the ground, 30 points/m² density, 5 cm precision.

- **Mid-Loire Valley: Airborne Lidar**

From 2002 to 2003, the DREAL Centre had a medium resolution topographical survey performed by airborne laser over the Mid-Loire Valley, with 1 point for 4 square meters as minimum point density, each DTM grid pixel being 1 m by 1 m.

Thereby, the DREAL Centre may perform, among others, a GIS mapping of areas liable to flooding, improve hydraulic modeling and understanding of the Loire river flood plains and low-water bed, and design information material for the general public with regard to floods spreading into dales that are protected by levees.

- **Bès Mountain Stream, Near Digne: Airborne Lidar Connected with Photogrammetry**

This braided mountain river was subjected to a comparative study between photogrammetric data obtained from an orthophotograph acquisition campaign carried out in 2000 and data stemming from an airborne Lidar survey performed in 2008 in order to identify geomorphological changes, including changes in torrential deposit volume [Génin, 2009]¹³.

This site does not comprise any levees but appeared of interest in this study since it shows how relevant repeated Lidar acquisitions can be for studying geomorphological changes in watercourses with high sediment transport [Cavalli & al., 2008]¹⁴: this type of study may be transposed into the assessment process for flood protection dikes located along torrential rivers.

II.3 Summary Table

See Chart in **Appendix 1**.

¹³ Génin J.-R., 2009 – Application de la télédétection pour la caractérisation des changements géomorphologiques d'une rivière en tresses. *Master Thesis in Land Environment Science, under the supervision of Dufour S. (CEREGE) and Liébault F. (Cemagref)*.

¹⁴ Cavalli M., Tarolli P., Marchi L. & Dalla Fontana G., 2008 – The effectiveness of airborne LiDAR data in the recognition of channel-bed morphology. *Catena*, 63, pp. 249-260.

Chapter III: Methodology for Using High Resolution Lidar Data and imageries

III.1 Val d'Orléans Pilot Operation - Overview

a) Pilot Site Selection

As part of FloodProBE WorkPackage 3 (Task 3.2), the very high resolution helicopter-borne laser remote sensing technology has been identified as suitable for contributing to the assessment process (topography, determination of embedded structures and vegetation) of urban and suburban levees. Such technology is not in common use until now in France and in most of European countries.

The French pilot site selected for performing and operating an experimental helicopter-borne survey over levees and related works in urban and suburban environments is Val d'Orléans. This is one of the most challenging dales along the Loire River, with several Orléans districts or boroughs located on areas liable to flooding by the river (65,000 inhabitants).

On the selected pilot site, a railway embankment in the Loire flood plains was also an opportunity to extend the project research to linear infrastructures other than levees.

Two types of dikes stand out on Val d'Orléans left bank:

- ◆ Levees or embankment dikes, in rural and suburban areas (50 km), either touching the low-water bed (10 km), or more or less distant from the said low water-bed (40 km) with a "franc-bord" (*freeboard*) covering the area between the low-water bed and the levee. Compared to traditional dikes, Loire river levees typically feature a "banquette" (earth ridge or parapet) on top, either on the river side or on the land side (and sometimes on both sides) and a drainage blanket on the land side of the levee

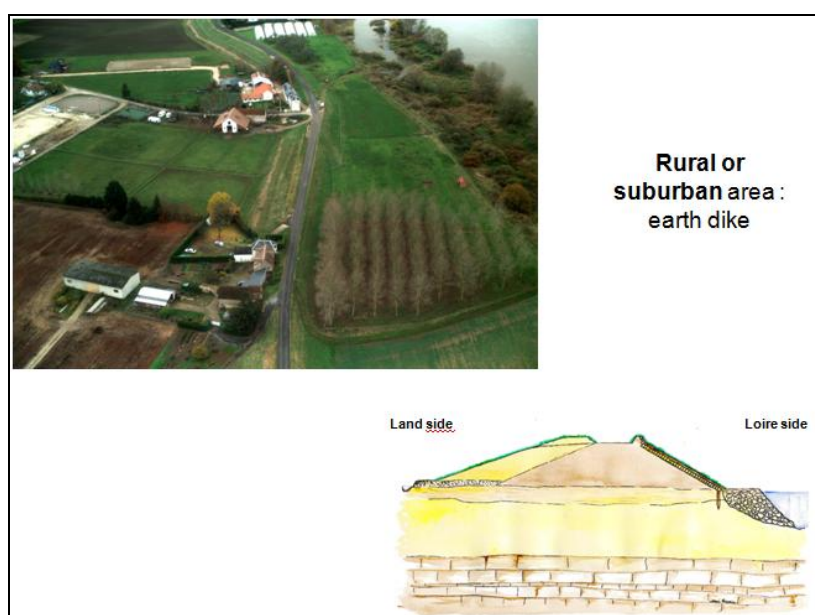

Figure 3: Example of Rural or Suburban Area Levee. Constructions Embedded in the Landside Slope

- ◆ Embedded stone or embankment-masonry composite dikes or docks in urban areas (4 km), either topped or not with parapets or curbs and including or not many singular works (flashboards, wedges, pipes or sluices)

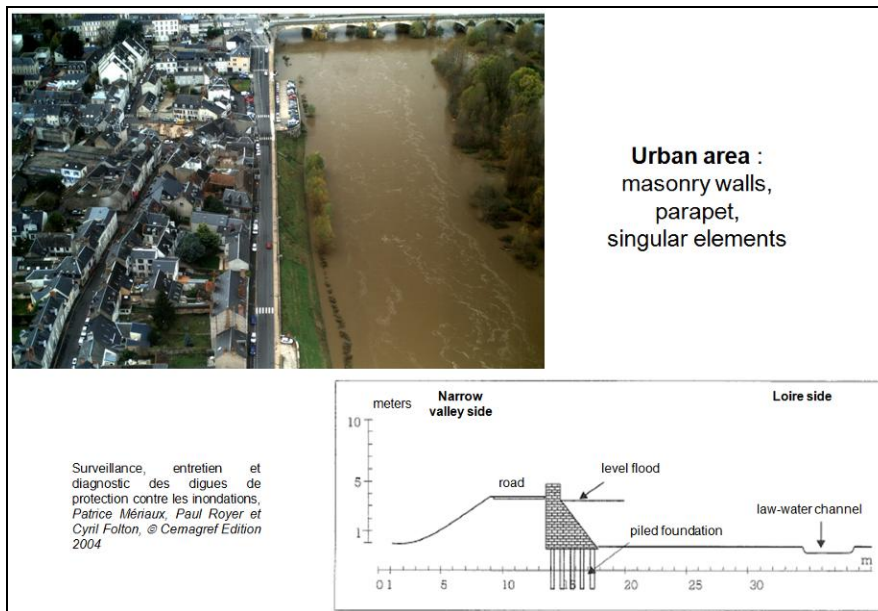

Figure 4: Example of Urban Area Levee. Wall and Irregular Works in the Loire River Side Slope

Furthermore, other hydraulic works or embankment structures are involved in the dale operation in the event of a flood:

- Jargeau spillway, located upstream the town of Jargeau;
- Orléans-Vierzon railway embankment, including several singular works.

b) Specifications Preparation and Lidar Acquisition

Our proposed methodology of using Lidar and high-resolution imagery concerns levee safety assessment in “dry” conditions (e.g.: not during a flood, river side slope of the levee visible, not under water). In order to complete such diagnostic objectives, flight instructions were to acquire data in autumn season (trees without leaves, dry weather) and to avoid flood event.

On November 17th and 18th, 2010, Fugro-Geoid’s Lidar Flimap 400 system flew over 70 km levees in Val d’Orléans (including 60 km on the left bank and 4 km in urban environment) and 6.5 km over Orléans–Vierzon railway to acquire laser topographical data and high resolution remote sensing images along a 105 m-wide corridor (that is 52.5 m on both sides of the flight axis, typically the levee axis) mainly lined up with the works right-of-way.

As this was a pilot operation, the specifications drafted for this specific assignment during summer 2010 were made relevant for all assignments and translated into English for use in other helicopter-borne laser operations as part of waterway levee in-depth diagnostics. This document (e.g. “**Technical Specifications Template for LiDAR aerial acquisition on dike**”) is a deliverable of our task 3.2.2 of the FloodProBE project.

The map below shows Flimap flight coverage by mid-November 2010.

Cover of flight for LiDAR acquisition on Orleans pilote site
the 17th and 18th of Novembre, 2010

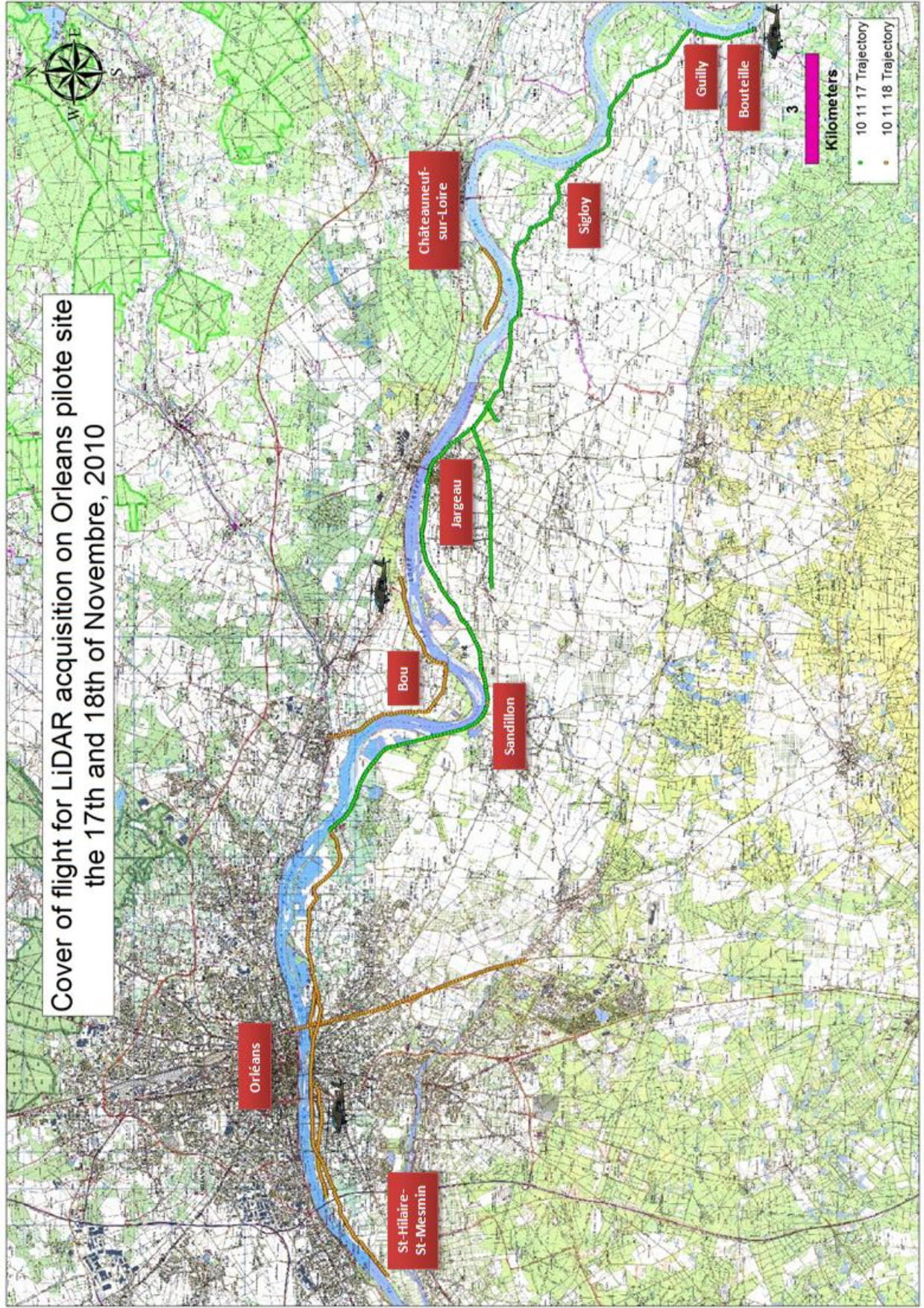

Planimetry and altimetry control surveys were performed on November 19th, 2010. All paths have been compared with those requested per the specifications thanks to flight videos and the path recorded by the GPS onboard the helicopter and to be read with a GIS. Thereby, compliance with all flight axis instructions as provided in the specifications is ensured.

Flight Parameters

Considering the corridor mapping width (105 m, that is 52.5 m on both sides of the flight axis, typically the levee axis) and the final deliverables specific characteristics, including DSMs and DTMs, the following flight instructions were adopted:

- Acquisition system: FLI-MAP 400;
- Flight altitude: 150 m high above ground level;
- Maximum speed: 65 km/h (35 knots);
- Flimap Lidar system with three scanning angles (7° forward, nadir, 7° backward) to reduce shadowing in the flight direction;
- Two high resolution video cameras 0.4 Mpixels (forward and nadir view);
- Two high resolution digital still cameras 16 Mpixels (forward and nadir view);
- Point density: > 80 points per square meter.

These flight parameters will eventually help achieve a 5 cm accuracy for planimetry and 3 cm accuracy for altimetry, in good surface conditions, regarding the surveyed points.

c) Acquired Data Overview

FliMap assignment deliverables include the performance and provision of digital elevation and terrain models, high resolution geo-referenced and ortho-corrected photographs and videos pertaining to works located in the corridors flown over by helicopters and, for some outstanding levee sections, a set of topographic plans on a scale of 1:500 and longitudinal profiles or cross-sections. The topographical dataset is drawn up using RGF 93 map projection system LAMBERT 93. The related altimetry baseline system is NGF IGN 69 (namely “standard” altitude).

i. Raw Laser Points

The raw laser point density higher than 80 points per square meter helps display all visible and identifiable topographical items with an image size that is more than 1 mm on a scale of 1:500. The FliMap system features a camera built in the laser for real-time coloring of all measured laser points. Laser point color is the natural color of the object obstructing the first laser return path. There is no need to wait for ortho-photographs to read into the laser points.

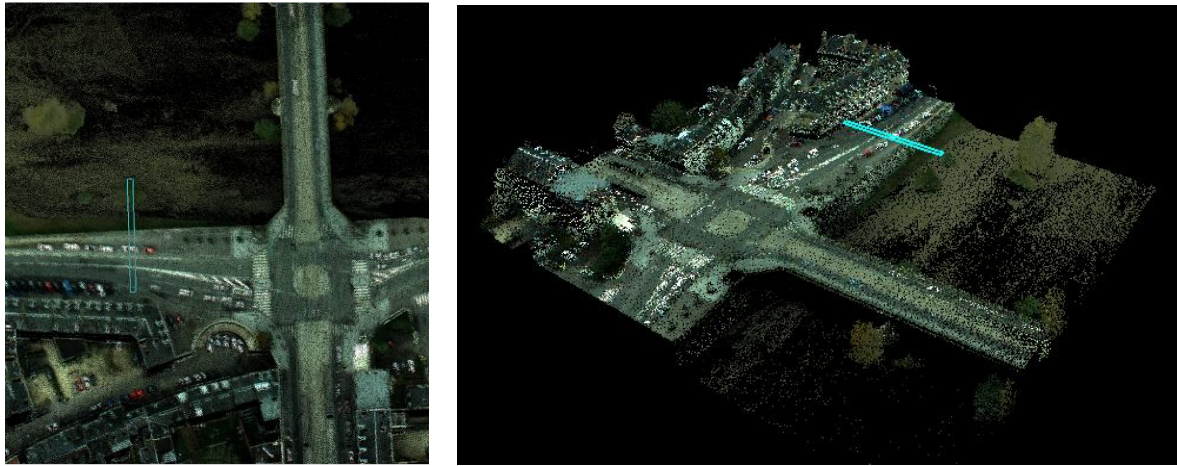

Figure 5: Plan and 3D Views of Natural Colored Raw Points of Left Bank Abutment Area

ii. High Resolution Photographs and Ortho-Mosaic

Taking aerial photographs is very helpful to identify and specify any visually indicated damages (external erosion, etc.), specific works (walls, water discharge or intake, etc.) and irregular surfaces (woodlands), and to map them on a large scale plan. These are taken with 50 % overlap and are provided as JPEG files. Pixel size is 25 mm on ground. The still camera front-end set-up helps visualize the ground in perspective, which is very useful to project managers trying to analyze specific objects that otherwise might be “squeezed” under vertical view.

Each pair of pictures under nadir view includes a photograph that is slightly tilted leftward from the flight axis, and another one tilting rightward (Figure 6).



Left Raw Picture



Right Raw Picture



Oblique Picture of Same Area as Above

Figure 6: *Upstream Capucins Levee Raw Aerial Pictures*

Based on raw vertical aerial photographs and laser data, a geo-referenced and ortho-corrected photo mosaic was drawn up for levees (Figure 7), docks and Orléans-Vierzon railway embankment. An index chart displays slab outlines with their identification number (Figure 8). Ortho-mosaics ground resolution is rounded to 25 mm. Files are in ECW format. Photographs may be viewed from a conventional image reading or editing software and on ArcGis through FliMap Analyst plug-in.



Figure 7: *Example of Ortho-corrected Photograph (Produced from Raw Picture Pairs)*

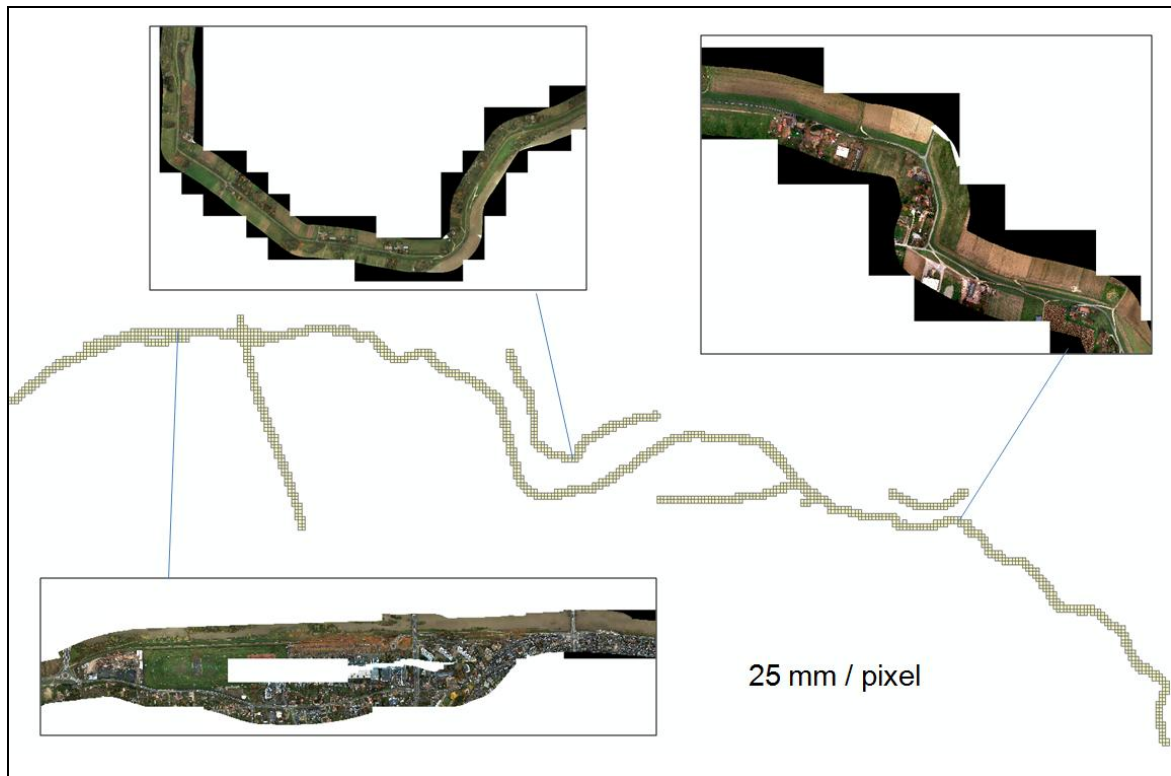

Figure 8: Ortho-Mosaic Index Charts

iii. High Resolution Videos

Geo-referenced videos of levees, docks and railway embankment were produced as MPEG files. Geo-referencing may be done using FliMap Analyst software. In the manner of front-end photographs, front-end videos help identify and assess all objects in perspective.

In raw version, these videos are geo-referenced from the recording hours and may be viewed on Windows Media Player and on ArcGis through FliMap Analyst plug-in.



Figure 9: Examples of High Resolution Videos Taken During Flight: Oblique and Nadir Views

iv. Digital Elevation Model

General definition reminder: a Digital Elevation Model (DEM), a Digital Surface Model (DSM) or a Digital Terrain Model (DTM) is an image of a ground area topography that is adjusted as required for using such representation on a computer. A DEM or DTM (usually) uses a square regular mesh that is referred to as a grid.

The digital elevation model (DEM or DSM) contains information transmitted by the radar first echo from the vegetation and frame cover. Items such as cars and people are filtered and removed from those datasets. Underwater topography is not shown on the DSM as this type of laser does not reflect water.

For the sake of FloodProBE experiment, other DSM products were created: a no-vegetation DSM to show only the constructions; and conversely a no-construction DSM to show only the vegetation (Figure 10). This will enable the constructions and vegetation analyses with a GIS.

Following tests performed on three types of grids (0.5 m, 0.2 m and 0.1 m screen densities) to measure information display time on a GIS, a grid scale of 0.10 meter screen density was finally maintained for all three DSM products.

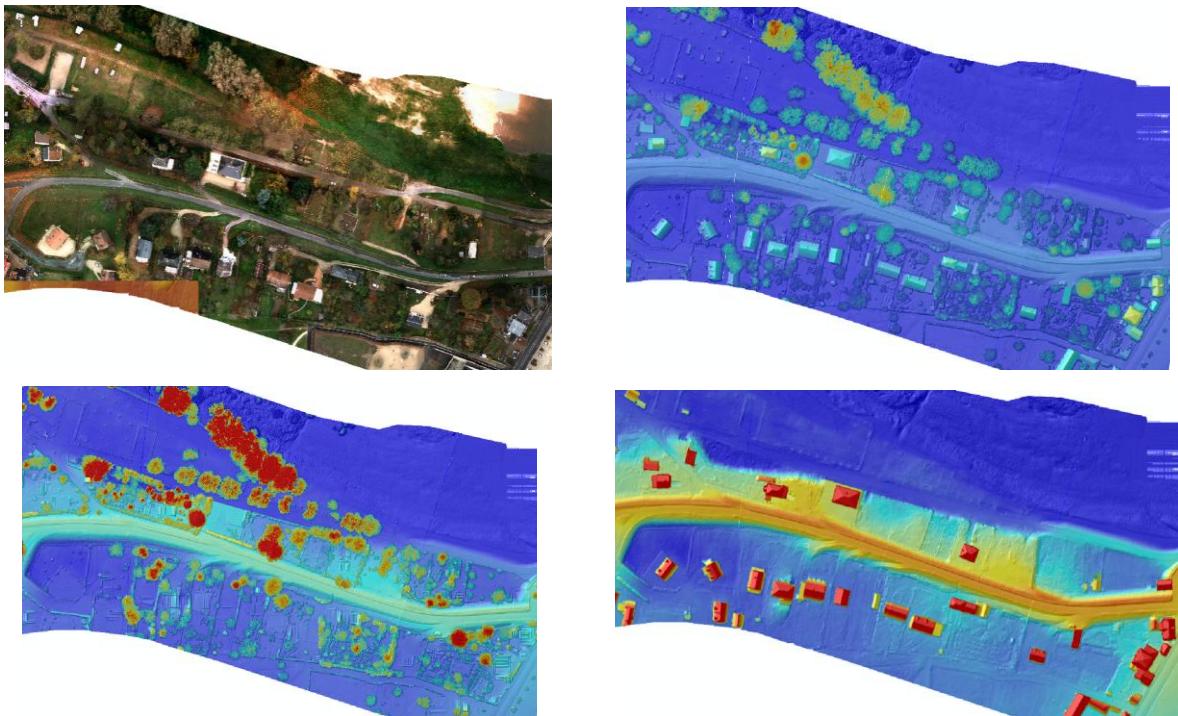

Figure 10: Left to Right, Bottom to Top: Ortho-Mosaic, DSM, No-Construction DSM, No-Vegetation DSM from the Same Area

v. Digital Terrain Model

The digital terrain model (DTM) contains filtered laser data to show only the topography. It includes levees and railway embankment as well as all constituents or related hydraulic works (parapets, earth ridge, ballast).

Laser recorded data are filtered so as to remove all items unrelated to the ground topography or the hydraulic work, such as vegetation, buildings away of the levee, cars, etc (Figure 11). As in DSMs, the grid mesh size is 0.10 meter.

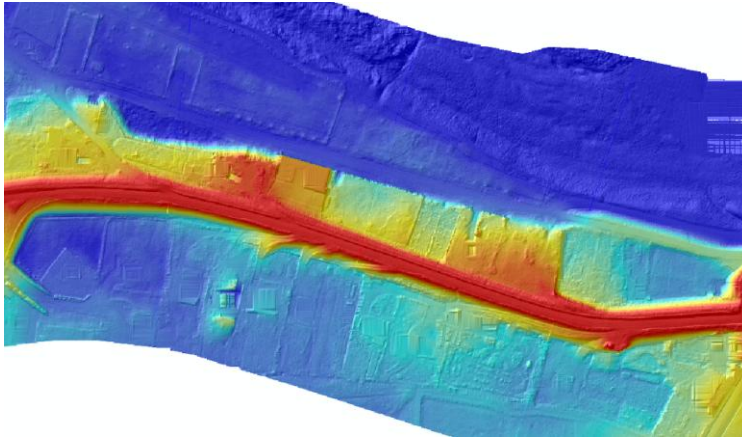

Figure 11: DTM of Same Area as Above

vi. Topographic Material

Top and toe longitudinal profiles up and down the embankment, cross-sections and topographic plans were drawn up on a number of selected specific levee sections along the overflown alignment. Below is an example (Figure 12) with Jargeau spillway topographic plan.

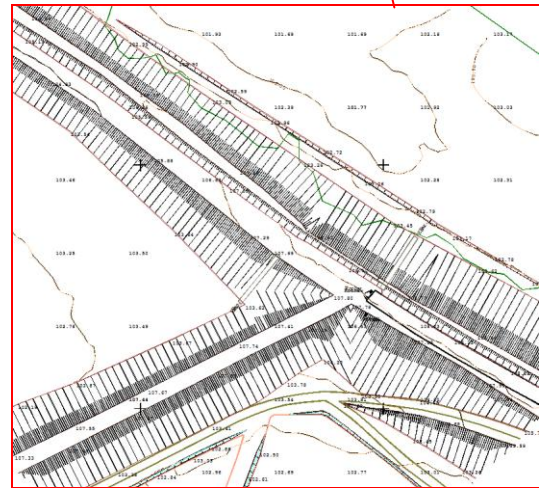
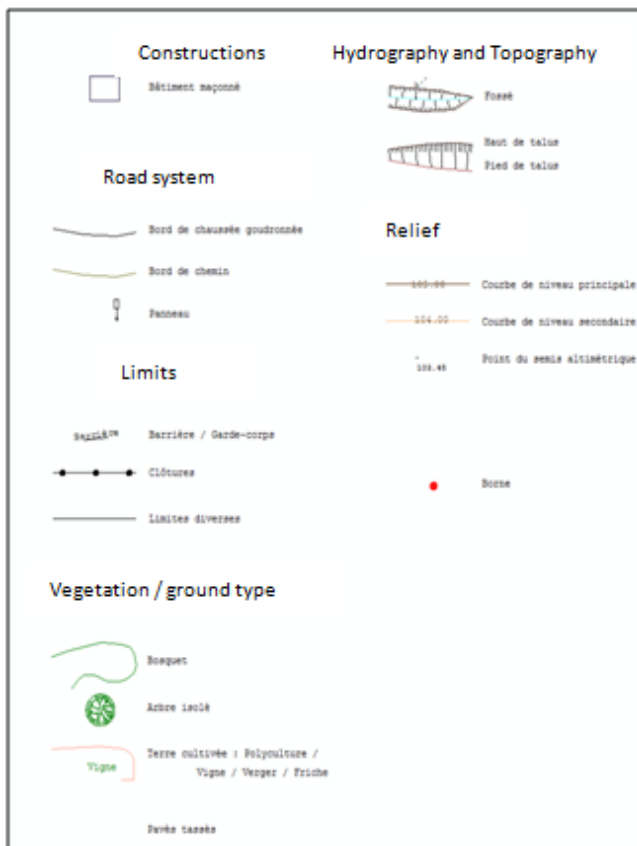
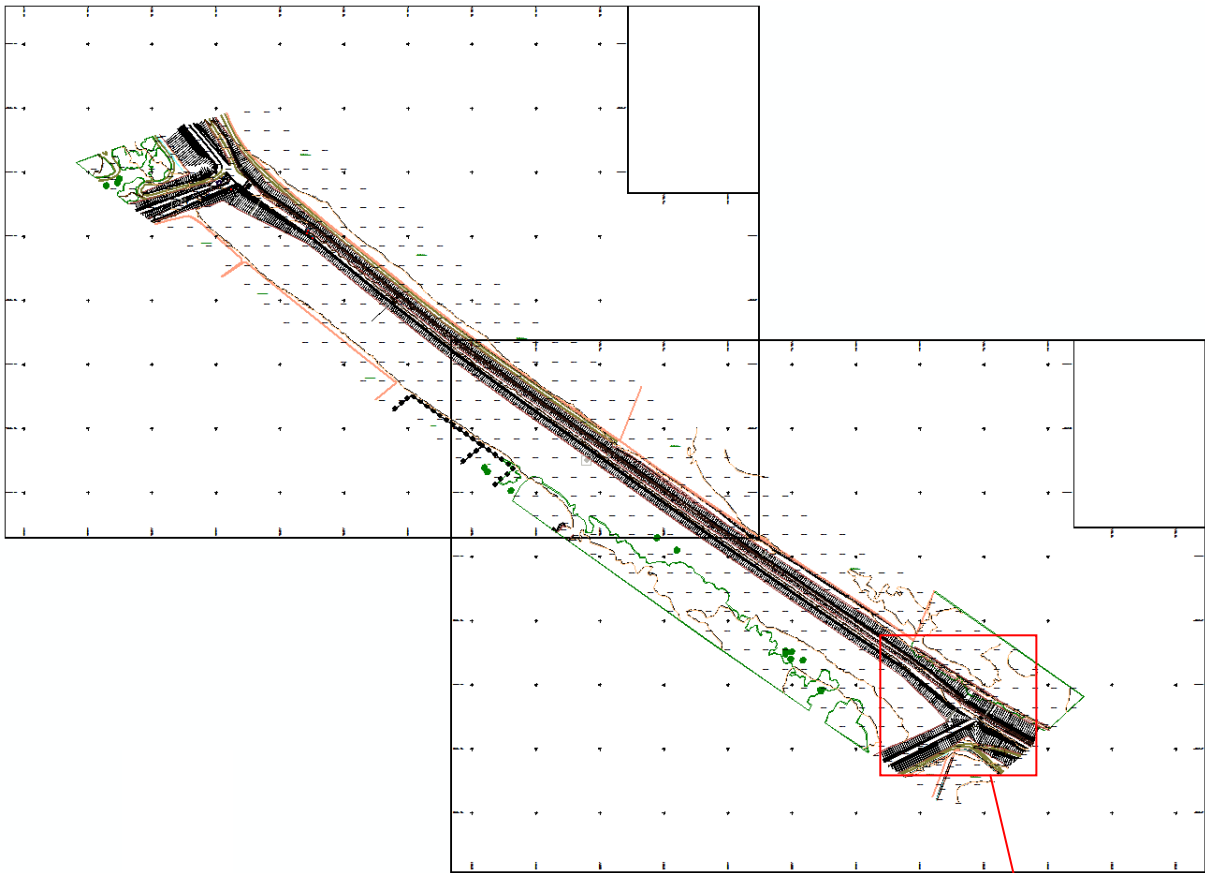

Figure 12: Abstract from Jargeau Spillway Topographic Plan

d) Work Preparation and Completion Time on Pilot Site

The table below includes all periods of time required by FloodProbe subtask 3.2.2 managers to prepare Lidar remote sensing experiment on Val d'Orléans levee pilot site.

Tasks or Events	Dates or Deadlines
WP3 steering committee approving Val d'Orléans as pilot site	WP3 Workshop, April 12-13 th , 2010 in Paris
Prospecting financial partners (€50 k net financial resources needed to complete the assignment)	May-July 2010
Agreements in principle from DREAL Centre and SNCF to provide €40 k and €10 k net financial support, respectively	July 2010
Drafting partnership agreement and technical specifications	August 2010
Technical meetings and interactions between partners and Fugro-Geoid to round up the agreement and technical specifications	September-October 2010
Agreement execution (4 signatories)	November 15 th , 2010

Table 2: *Dates or Deadlines for Each Tasks or Events of FloodProbe Subtask 3.2.2*

The second table below compares the amounts of time allocated to complete Lidar acquisition and imagery works and to provide data as prescribed under the initial specifications, and the dates when data was actually received.

Data or Products	Specifications	Actual Receipt
Acquisition flight performed	not specified	November 17-18 th , 2010
Raw laser data, raw photograph and raw video acquisition and provision	15/01/2011	1/02/2011
Ortho-corrected photographs	not specified	02/03/2011
DSM drawn up and provided	15/02/2011	02/03/2011 : 3 grids (0.5 m, 0.2 m and 0.1 m grids) on test areas handed in 27/04/2011 (0.1 m grid)
DTM drawn up and provided	31/03/2011	02/03/2011 : 2 grids (0.5 m and 0.1m grids) on test areas handed in 27/04/2011 (0.1 m grid)
No-vegetation DSMs and no-construction DSMs drawn up and provided	not prescribed	19/07/2011 (0.1 m grid)
Topographical material sets drafted and provided	upon order	Jargeau spillway: December 2011

Table 3: *Dates of Reception for Each Kind of Data*

Important Note:

Specifications did not prescribe the production of no-vegetation or no-construction DSMs (green highlighted item). Also, the 0.1 m and 0.5 m DSM comparative study performed on 5 test areas took longer than expected as the selected final deliverables were 0.1 m DSM and DTM grids.

New DSM products (initially not prescribed) and the late selection of final DSM and DTM grid extended the final deadline for data provision. Without such delays due to the pilot operation being an experiment, it is reasonable to assert that, in operational conditions, DSMs and DEMs of the entire overflown alignment (70 km) would have been provided in May or June 2010, that is 5 to 6 months after the flight.

III.2 Three Experimental Test Areas - Overview

Three specific areas have been particularly studied on Val d'Orléans, which permits to suggest a method for using data stemming from Lidar acquisition and aerial imagery so as to successfully contribute to a levee assessment. Each area appears specifically challenging and shall be detailed hereinafter.

a) Sites With Woodland

i. Background

The overflown alignment shows some ligneous vegetation. Val d'Orléans levees are mostly well-maintained. However, some trees or bushes, sometimes along the same line, have grown next to levee toes and, less frequently, directly on the faces. Roots tend to get fixed in the levee body and therefore create weak spots with regard to internal erosion hazards, particularly when the tree dies and the root system begins to rot [Mériaux & al., 2006]¹⁵. This section shall be focused on woodland. The area down Val d'Orléans left bank levee was studied: from Georges V bridge up to Saint-Hilaire-Saint-Mesmin.



Figure 13: Map of the Area of Interest: from Georges V bridge up to Saint-Hilaire-Saint-Mesmin

ii. Problem

Identifying vegetation zones on this area is rather easy. However, determining the vegetation (and, first of all, its height) is more challenging a task. Also, the first thing to do is identify all trees having their stump on one of the faces or close to the toe. For instance, aerial photographs will make it difficult to assess for certain that a tree stump appearing rather close to the levee toe is rooted in the slope, due to foliage growth hindering visual monitoring.

¹⁵ Mériaux P., Vennetier M., Aigouy S., Hoonaker M., Zylberblat M., 2006 – Diagnosis and Management of Plant Growth on Embankment Dams and Dykes, 22nd Congress on Large Dams, ICOLD, Barcelona, June 2006.

iii. Goals

First, the purpose is to identify all woodland items on the geographical area as defined above. Then, vegetation heights are meant to be classified. And the last step is to try to determine if some trees are rooted in the levee body or toe: those shall then be subjected to a detailed assessment (determining whether and how the tree must be removed or not).

iv. Main Results

Reviewing both aerial photographs and videos will help perform a first quality assessment of the vegetation cover and type.

The shadowing applied to DSM using the GIS tool¹⁶ helps view trees displaying a rather round crown from above (Figure 14). However, hedge or shrub areas are less easily identifiable, but that is not the main purpose of this study since these ligneous plants, although they may hinder visual inspection on site, have thin and short roots that are less dangerous to the levee.

Therefore, woodland polygons may be delineated based on round-shaped areas shown on the DSM (Figure 15).

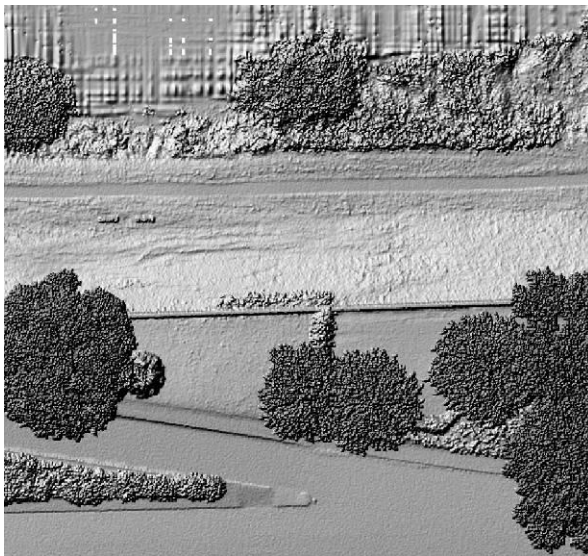

Figure 14: DSM with Shadowing

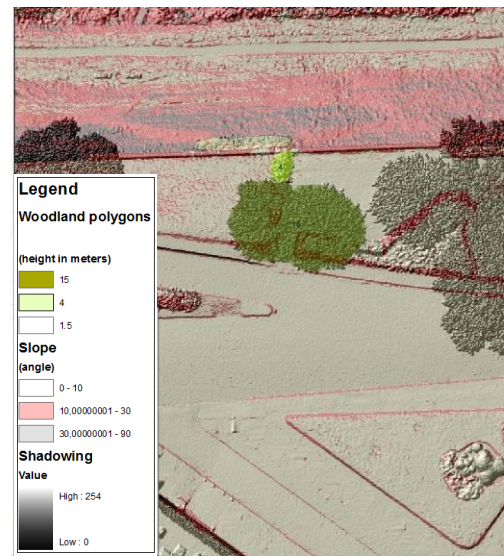

Figure 15: Delineated Vegetation Polygon

As the tree standing close to the levee is mapped, it has to be determined whether the stump is rooted or not in the levee body or, if it is not, how far from the face toe it is located. To do so, laser raw points are used with raw data operating software (Fugro-Viewer) to produce cross sections of the levee and its environment on the overflow corridor right-of-way.

Below are some typical vegetation items surveyed on the area of interest:

¹⁶ In this instance, ArcGis software

- On the levee slope, on the Loire river side and down the slope on the land side:

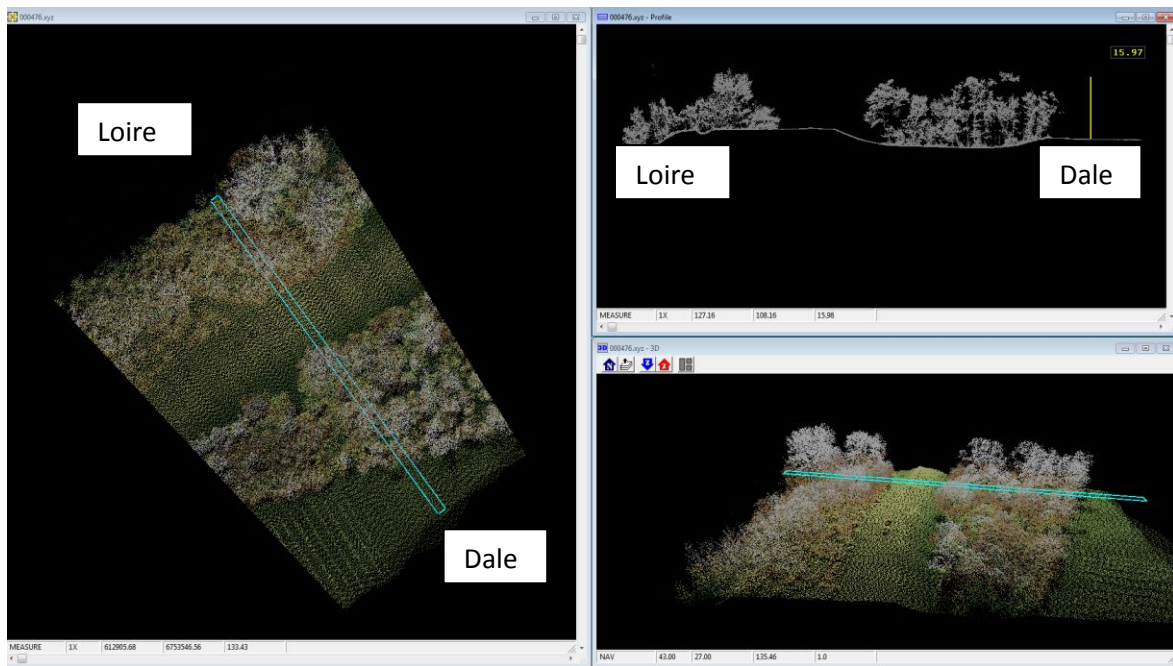

Figure 16: Example of Vegetation on Levee Slope, on Loire River Side and Down the Slope on the Land Side

The laser raw point operating software produces a plan view (left), a cross section (top right) and a 3D view (bottom right).

Vegetation appears on the land side close to the levee toe. On the Loire river side (left cross-section), it spreads up to the levee top.

- Down the levee toe, on the Loire river side, with a stone curb:

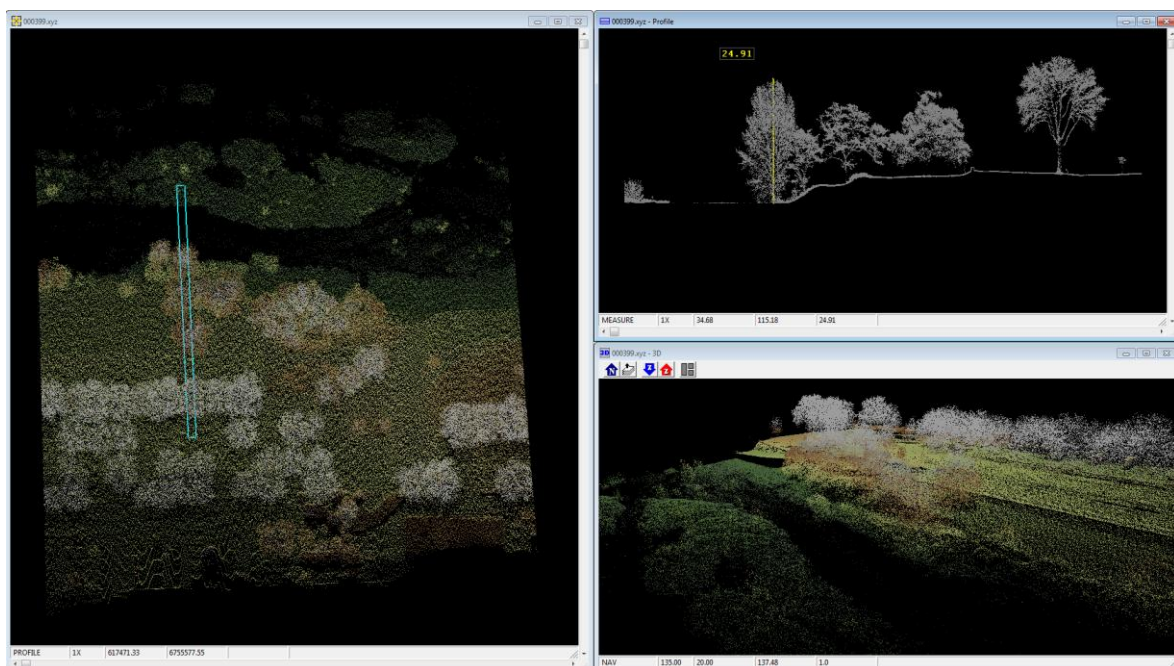

Figure 17: Example of Vegetation down the Levee Toe, With a Curb

This cross section (top left) helps measure each tree height and ensures the forester can determine some of the species from the crown shape.

- On the slope on the river side, with the levee being close to the Loire river low-water bed

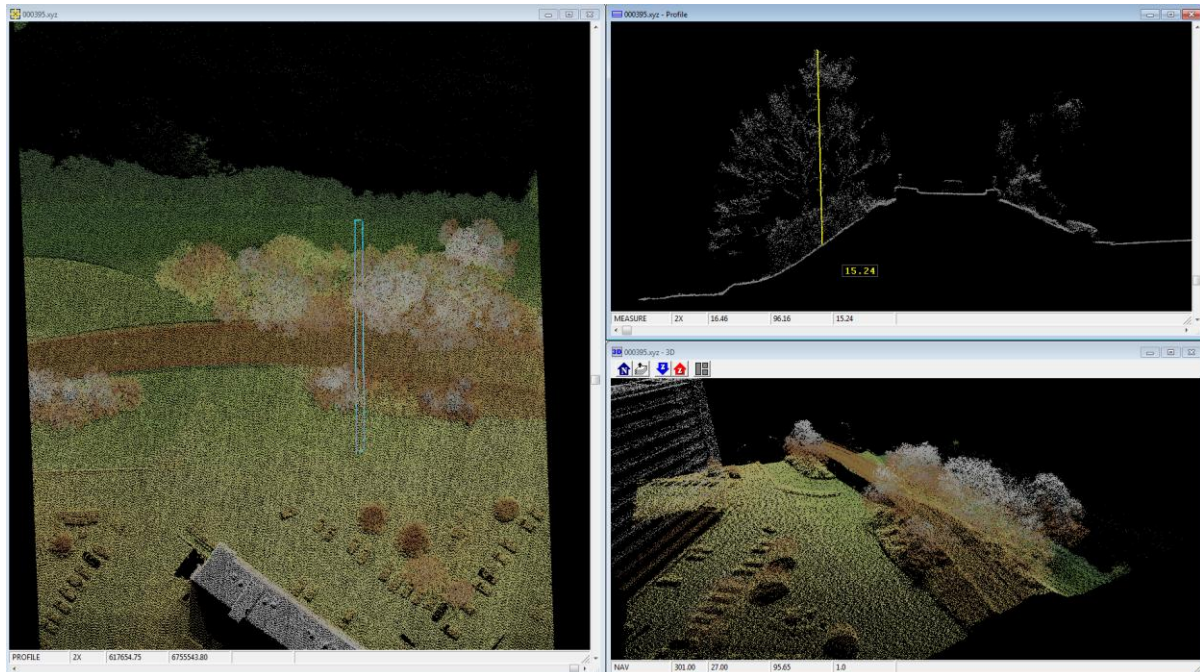

Figure 18: Example of Vegetation on the Levee River Side Slope, Close to Low-Water Bed

A group of trees has grown on that face. One of the trees identified in this group is rather massive (15 m high): its root system is most likely extensive and presumably enters deep in the levee body, which is challenging to the work manager. Moreover, the crown shows a significant wind resistance which may lead to the tree being pulled out in the event of a storm, inducing potential damage to the face and masonry works.

The map below reveals the vegetation mapping over the area of interest.

Trees or tree groups are mapped under one of the GIS layers in various shades of green polygons, depending on their height class. The number displayed inside the polygon indicates the tree's approximate height or the highest tree group's height based on the results stemming from cross-section raw data.

Cartography of vegetation on dikes from Saint-Pryve-Saint-Mesmin to Orleans urban area

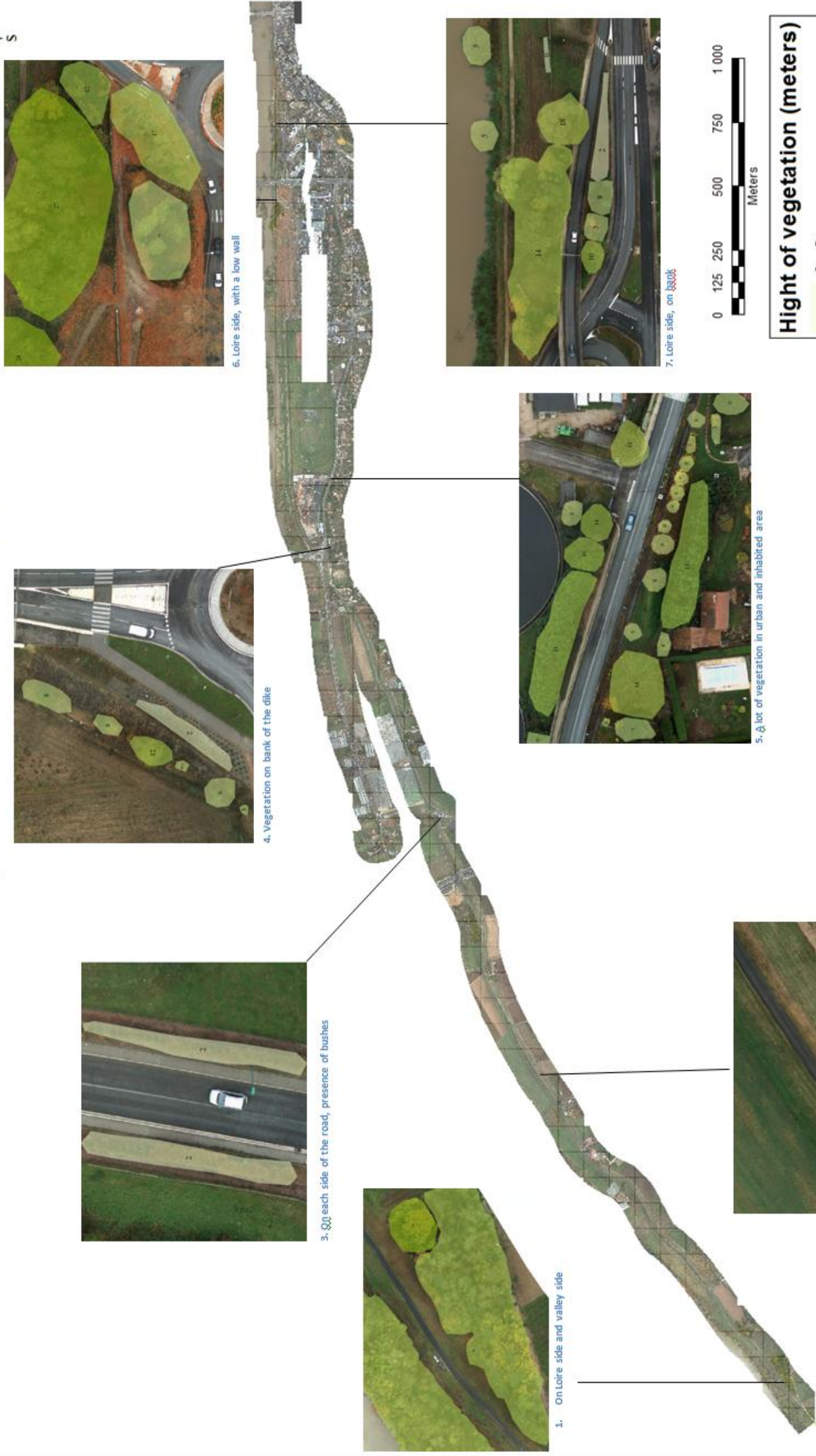

3. On each side of the road, presence of bushes



1. On Loire side and valley side



2. No vegetation



4. Vegetation on bank of the dike



5. A lot of vegetation in urban and inhabited area



6. Loire side, with a low wall



7. Loire side, on bridge

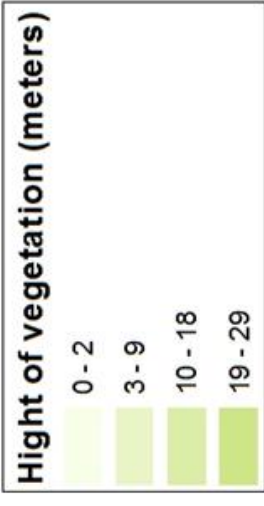
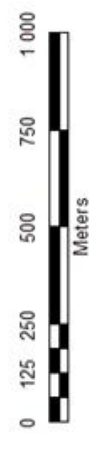

b) Capucins Levee

i. Background

Capucins levee is located in an urban area, between Orléans-Vierzon SNCF railway embankment (also overflowed by FliMap 400), upstream, and Georges V bridge on the left bank in Orléans, downstream (see maps below). This area shows different types of levees (and therefore transition areas from one levee type to another) and items indicating crossing infrastructures (gate operating stations, manhole covers, piping or sluice outlet structures), buildings or structures embedded in one of the faces (houses, building frontages, retaining walls, banisters, sight holes, etc.) or flashboard works on the earthridge or the parapet on the river side levee top. During the last high floods in late 19th century, the levee was submerged and some breaches occurred.

ii. Problem

Geophysical prospecting was recently carried out on this area (2011), yet unsuccessfully as the structure geometry proves to be too heterogeneous and the great number of irregularities and inconveniences associated with this urban area (all types of metal grids, road pavements, endless road traffic, etc.) generate too much "noise" in electromagnetic signals that may not be filtered out. The point would be to determine if the Lidar survey performed in November 2010, although it could not cross the levee, might help draw up a relevant assessment on this complex levee section.

iii. Goals

The goals are to identify and determine, using digital terrain and surface models available as deliverables from the Lidar survey, all external items that may contribute to the levee assessment, such as: vegetation cover on the faces or down the levee toe, construction embedded in one of the faces, walls and curbs, levee tops and toes, and all irregular works displayed on a levee section (sight holes, manhole covers, gate stations, flashboard works, banisters, wedges, etc.) and transition areas.

iv. Main Results

With ArcGis and its Spatial Analyst plug-in, DSM and DTM data were processed using various surface analysis tools such as: shadowing, slope effect or isogram. Brief examples of treatment results are provided hereafter (Fig 19 to 26). Summary mapping is produced by reporting all items identified on the Capucins levee into a GIS.

Aerial photography of SNCF bank - Capucins levee

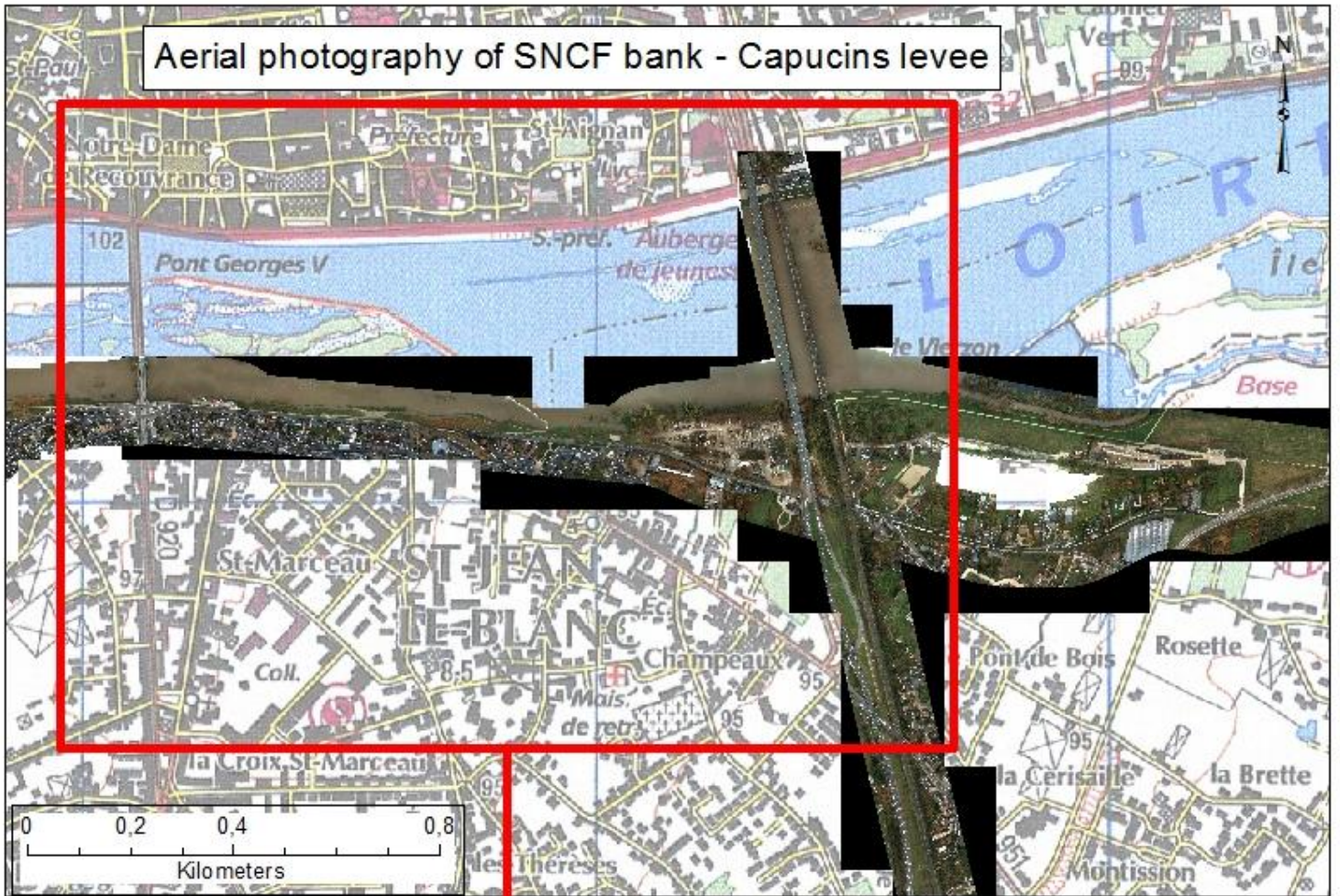

MNS of the same area

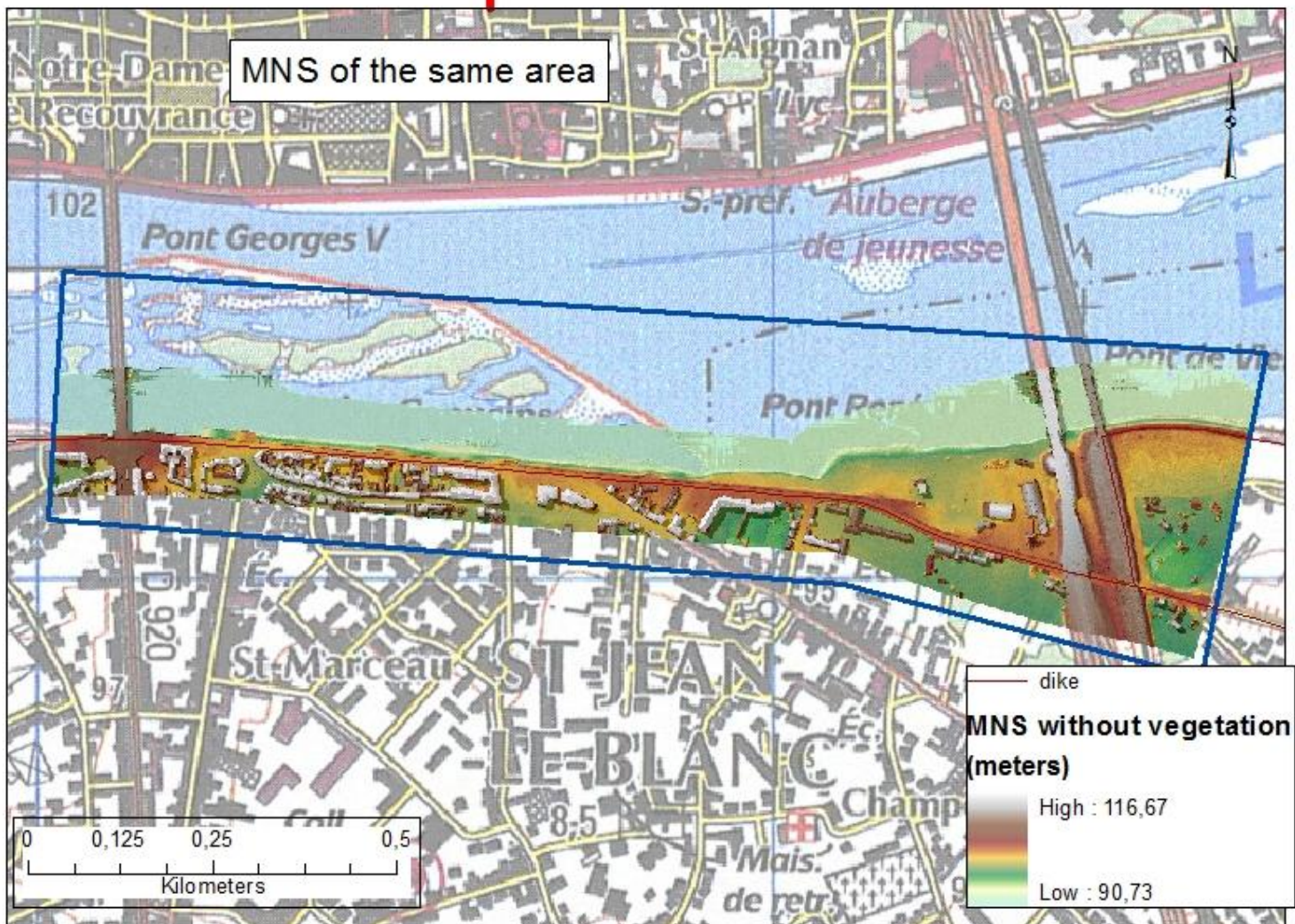

The no-vegetation DSM in the figure below promptly identifies the levee sections showing a clear difference in height between the top and the natural ground level on the land side (that is, most certainly levee tops strictly speaking), unlike other specific sections of structure displaying a topographically high area or an aggradation on the land side.

The following figures show the different treatment tools used on digital terrain or surface models to highlight and improve the determination of objects or irregular items found on the levees:

- **Shadowing**



Figure 19: Shadowing Treatment on DSM

Shadowing is implemented for a better viewing of the surface relief. This will help identify any small depressions (paths, manholes) and heightening (earthridge, parapets, manhole covers, sight holes, pipes or other constructions made of concrete).

- **Slope Effect**

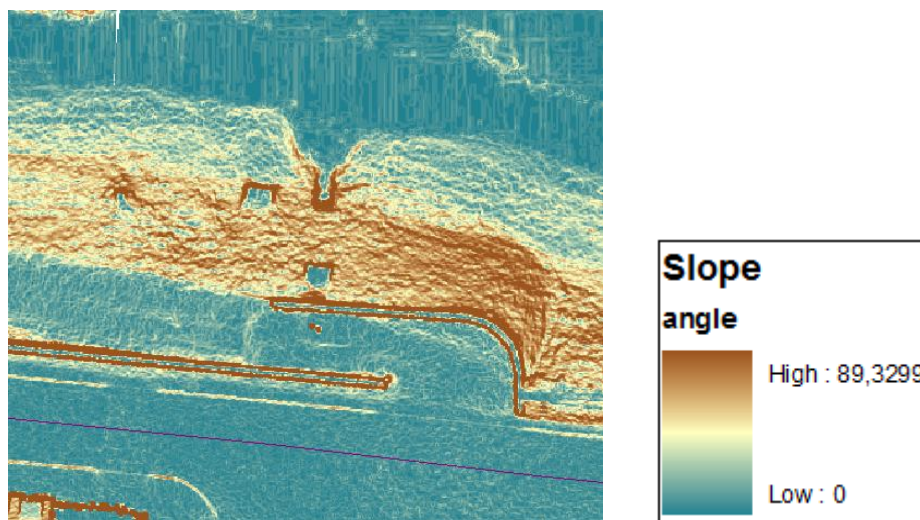

Figure 20: Slope Treatment on DSM

The slope effect brings out all thick curbs, slopes and slope change lines. Small terrace areas in the slopes, which are hardly ever natural, help detect man-made infrastructures: ramps, curbs, manhole covers, sight holes, etc.

The DSM (Figure 21) also highlights the curbs.

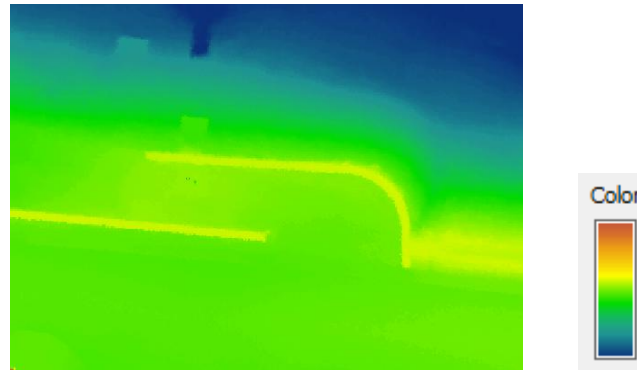

Figure 21: DSM Only

- **Isolines**

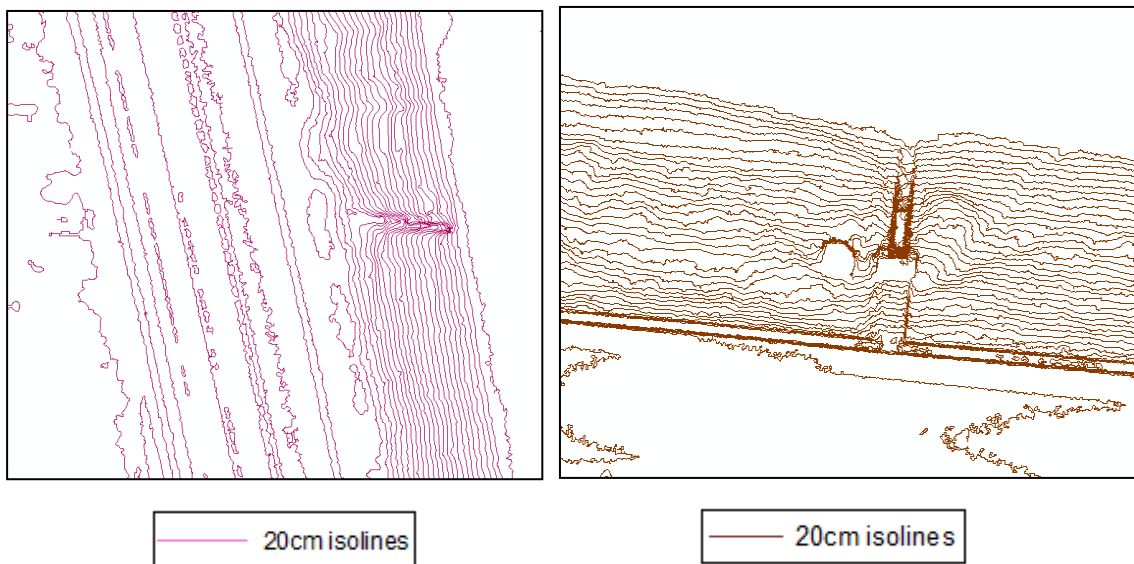

Figure 22: Isogram Treatment on DSM

The GIS outlining feature produces continuous isolines, with the same altitude as a value in this example. The difference in height between two isolines is 20 cm. The closer the isolines are, the steeper the slope is.

Isolines help determine upper points, lower points, depressions and items sticking out of the levee face as they alter the slope thereof on a local basis.

- Using GIS “Raster Computer” Feature

Considering that “vegetation + construction” DSM, no-vegetation DSM and no-construction DSM rasters are available, layers may be created displaying only the vegetation or the construction.

- To create a “vegetation only” layer: the only thing to do is subtract "no-vegetation DSM" from "vegetation + construction" DSM



Figure 23: Example of Vegetation Layer

- To create a “construction only” layer: the only thing to do is subtract "no-construction DSM" from "vegetation + construction" DSM

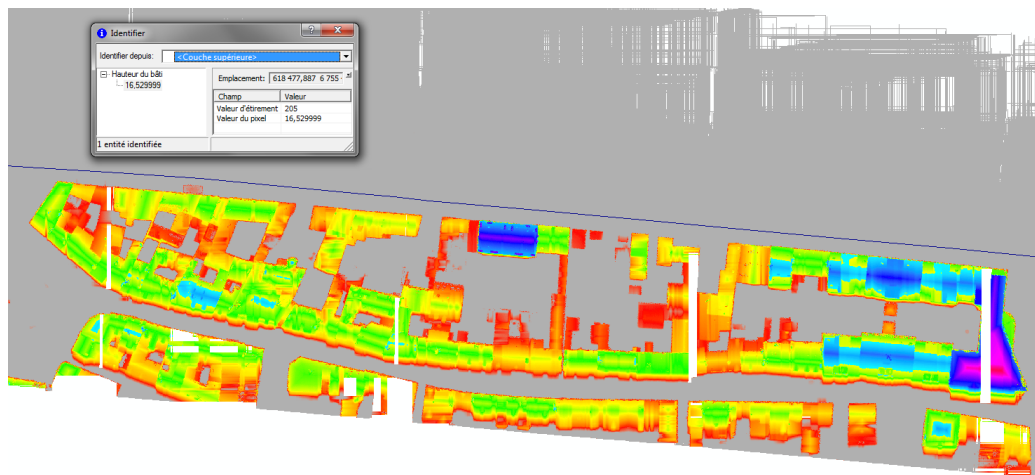

Figure 24: Example of Construction Layer

- **Coupled DTM and Shadowing**

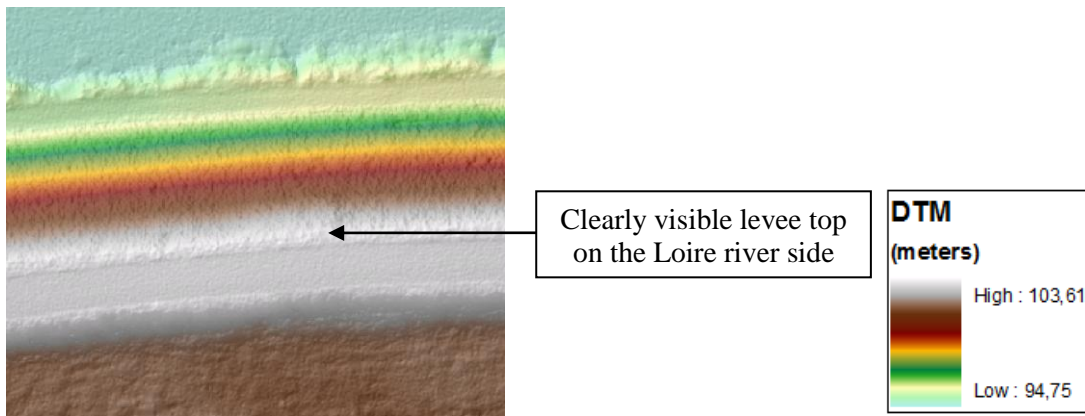

Figure 25: Superimposed DTM and Shadowing

This treatment helps identify the levee top right-of-way.

- **Coupled DTM and Isogram**

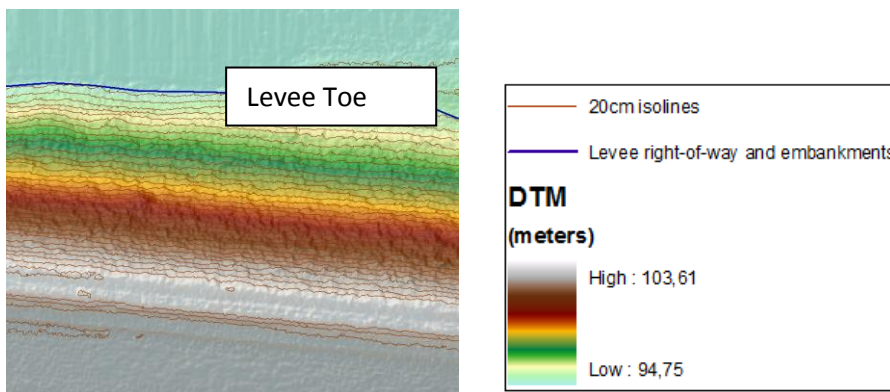
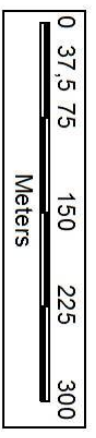
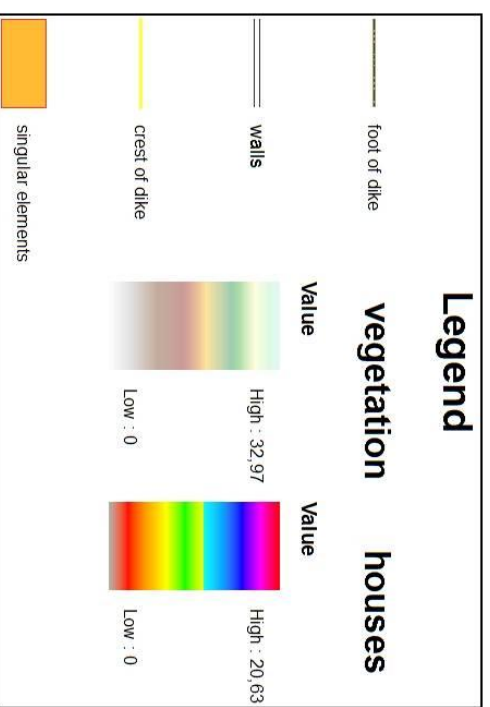

Figure 26: Superimposed DTM, Shadowing and Isolines

This will help identify the break line on levee toes.

Dike assessment on Capucins' levee area : Cartography of different elements with ArcGis



c) Town of Jargeau

i. Background

This area covers a district riparian to the river in the main borough of Jargeau, upstream Orléans on the left bank. Upstream (south-east), the alignment of interest begins at the earth levee section down Jargeau spillway, runs along the embedded stone quay wall in Jargeau small harbor, and stretches westward up to less urbanized districts down the former bridge abutment. The area of interest covers levees or quay walls over 2 km. This urban levee area includes multiple transition areas each time the levee set-up changes or is connected to a quay wall, as it is known that Jargeau borough is built on a “mound” (topographically high area).

During 19th century high floods, breaches occurred on the earth levee up the borough and a general overflow took place down the breaches up to the quay wall. Furthermore, a karstic sloughing recently occurred right behind the quay wall, underneath an old house (which has been removed since then) located up the Loire river access wedge, up the bridge. The quay wall had to be entirely rebuilt as reinforced concrete wall with a fake embedded stone face.

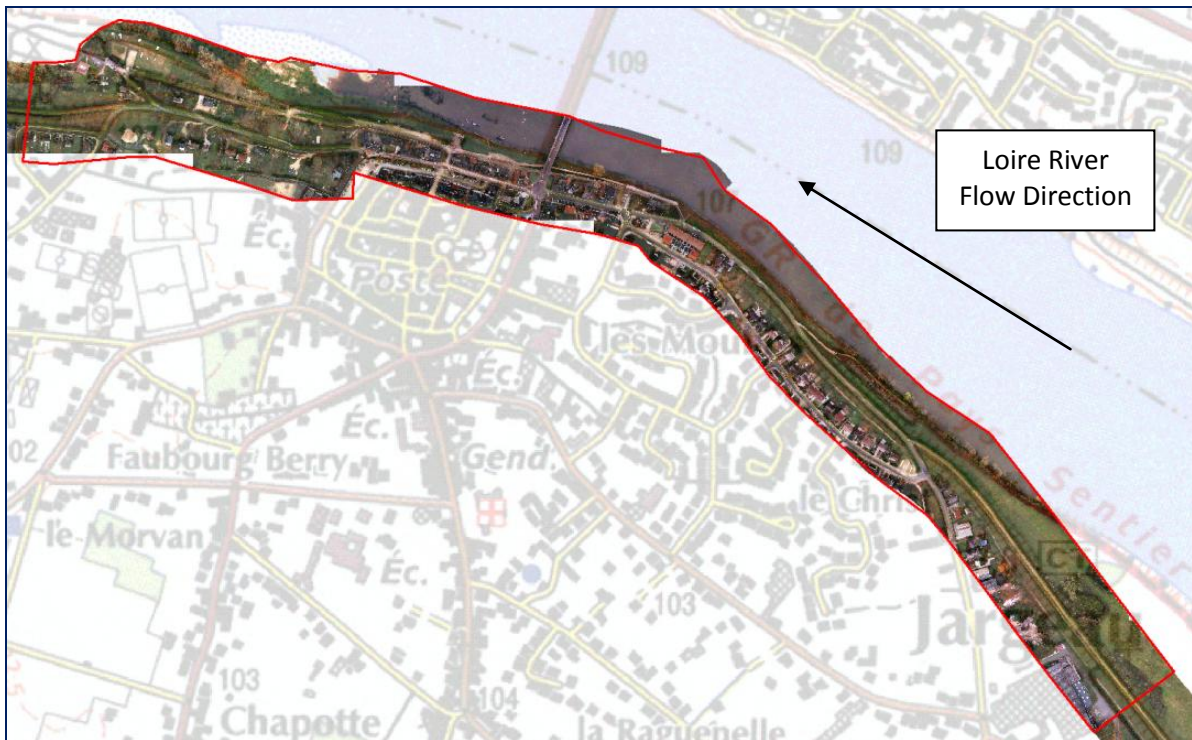

Figure 27: Map of the Area of Interest: Jargeau

ii. Problem

The point is to determine what kind of relevant information may be provided from using the Lidar in this area in terms of identification and determination of transition areas from one levee type to another. Indeed, such transition (or interface) areas, as inherently heterogeneous, are likely to create weak spots in the levee in the event of a flood. On Jargeau area, interface areas may connect an earth levee with a composite levee (embankment + quay wall), or connect a levee with a mound.

iii. Goals

The first goal is to use high resolution aerial photographs and digital terrain and elevation models, or shadowing, to identify the levee/quay wall transition areas. Second, the purpose is to use low resolution 2002 DTM (including plain floods) in conjunction with high resolution 2010 DTM (lined up with the levee) to identify areas where the levee connects with a “mound”, or different types of levees.

iv. Main Results

Using ArcGis (featuring FliMap Analyst plug-in) and MapInfo, four transition areas have been highlighted. Photographs and DSM with shadowing are displayed for each transition area.

- **Area 1**

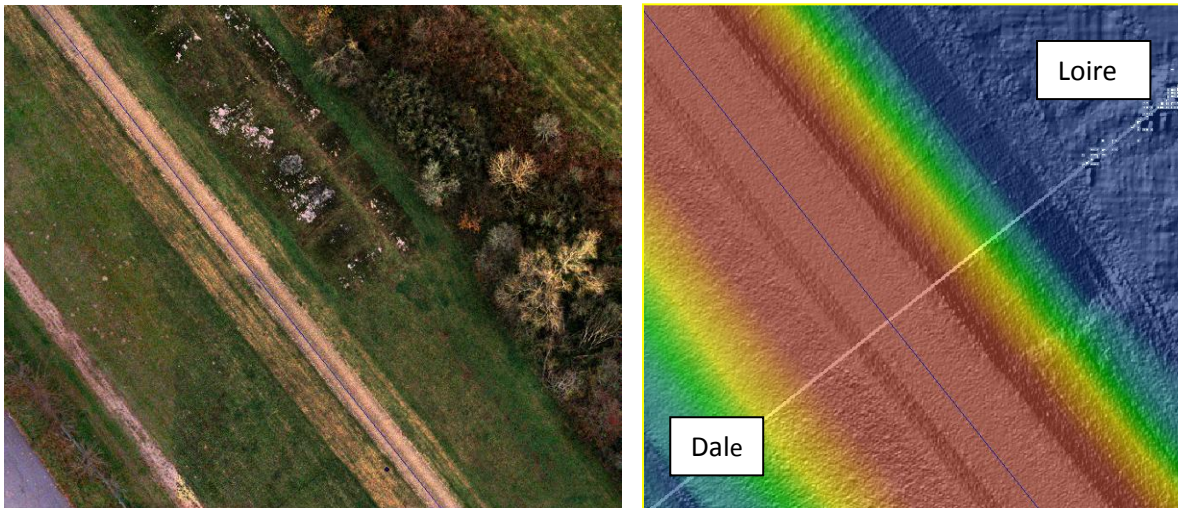

Figure 28: Example of a Transition between an Embankment and Riprap Blocks

The picture clearly shows (Figure 28) white riprap blocks on the Loire river side slope of the levee. Such transition area includes two points of contact (upstream and downstream, respectively) between a homogeneous earth levee and a dyke featuring a river side face protected by riprap rocks. As it happens, this area is located on former breaches dating back to 1856 and 1866. Presumably, the Loire river side face was reinforced with a riprap on the levee section that had been affected by one of the breaches and subsequently rebuilt. Also, the embankment type might very well be a different one on the levee section that has been rebuilt and protected on the river side, which cannot be directly highlighted by imagery and LiDAR techniques.

- Area 2

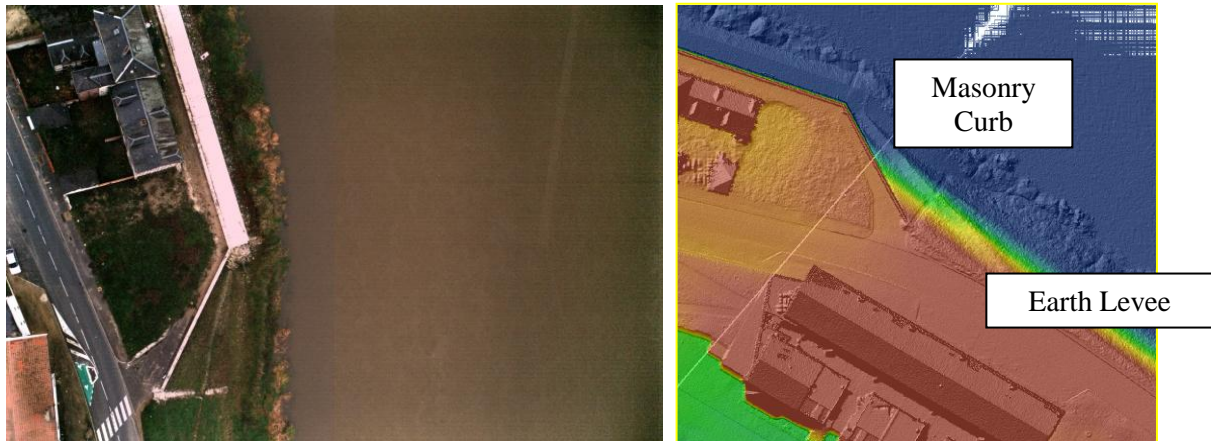

Figure 29: Example of a Transition between an Embankment and an Embedded Stone Wall

Irregular embedded stone wall is clearly visible on both the photograph and the DSM. This oblique embedded stone wall section might have been built following the 1856 overflow. It is about 30 m long.

- Area 3

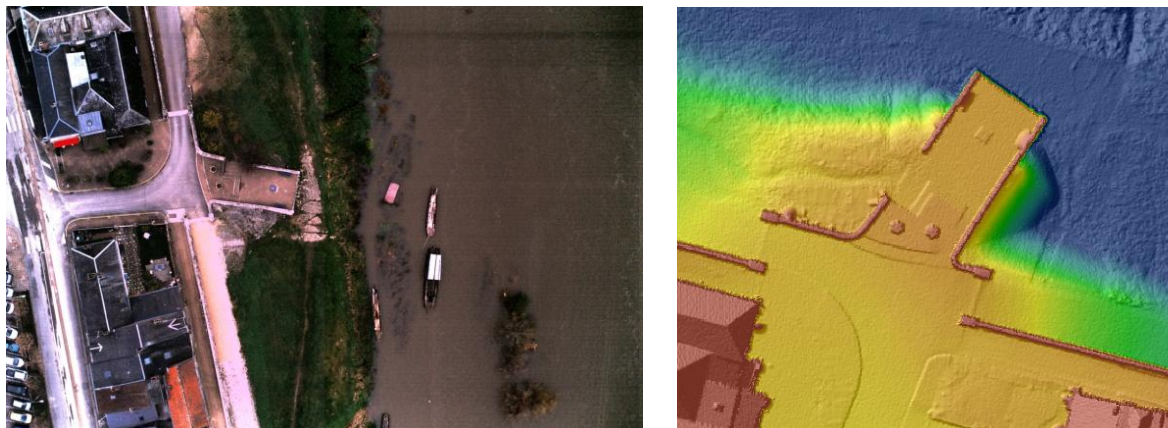

Figure 30: Example of a Transition between an Embankment and a Crossing Work

This potential transition or interface area is clearly displayed on the quay wall river side face and might, prima facie, recall a crossing work inlet structure. It is nothing of the sort but the former Jargeau bridge abutment platform. It is an irregular area in the quay wall local shape, with mainly hydraulic and geomorphological impacts in the event of a flood.

- Area 4



Figure 31: Example of a Transition between a Quay Wall, a House and an Earth Levee

This is a particularly complex transition area: the quay wall is connected with the earth levee located up the town of Jargeau through a sharp bend. Right down this bend, a house ("La Maison du Cordon" rest house) is embedded in the river side face. Such a set-up is likely to weaken the earth levee at the upstream point of contact with the quay wall.

DTM 2002, that includes flood plains, should be used for a better identification of the areas where the levee connects with a "mound" (topographically high area). Although this DTM resolution is lower than DTM 2010, it provides topographical information on the entire dale (see both DTM compared in Figure 32). Therefore, both DTMs have been superimposed with MapInfo (Figure 33). The first figure clearly shows a difference in resolution between the high resolution levee section and the dale DTM. Probable mound areas are indicated by purple-colored circles on the map (Figure 33). Each of them includes, upstream and downstream respectively, a transition area between a composite (embankment + wall) levee or dyke and its connection with the mound.

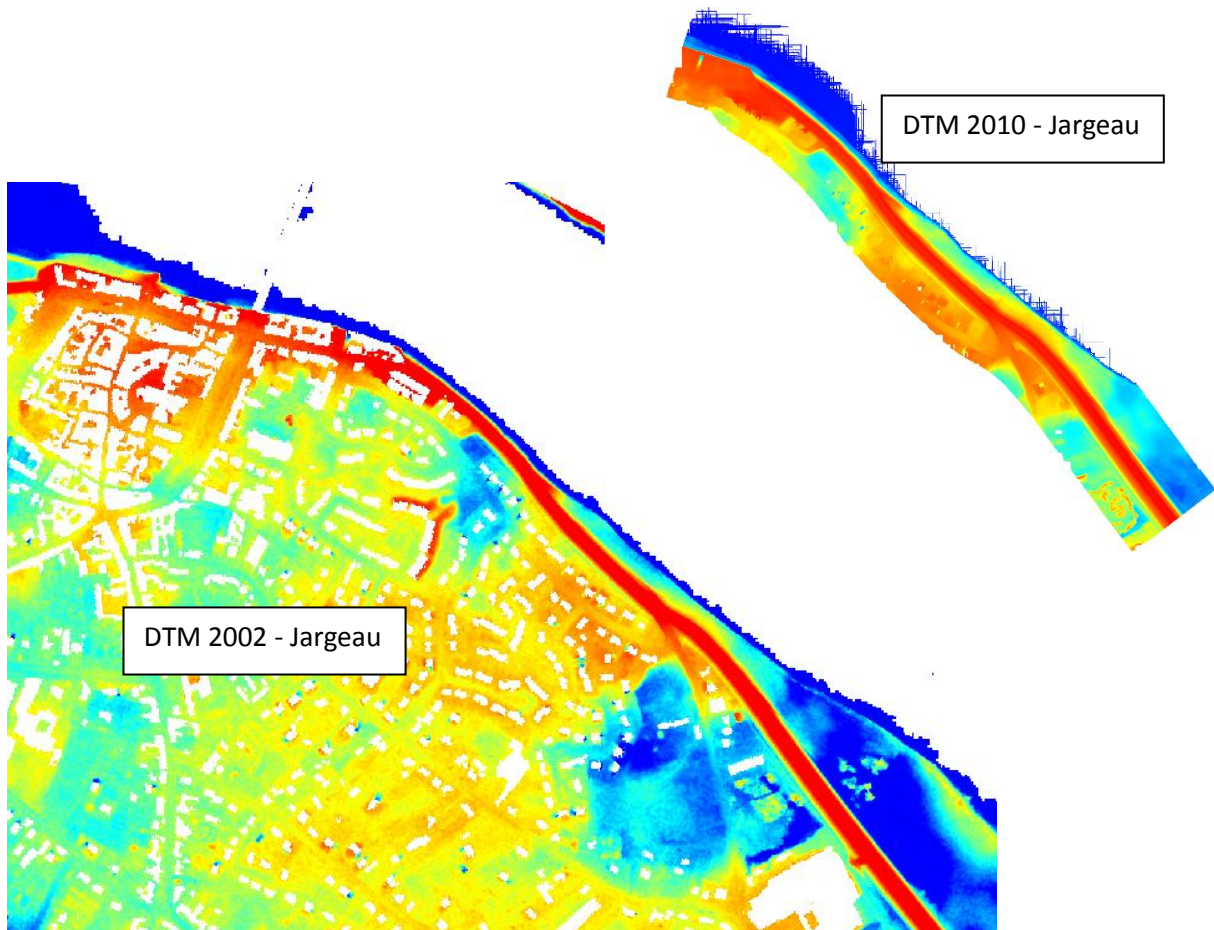

Figure 32: DTMs 2002 and 2010 Compared on Jargeau Area

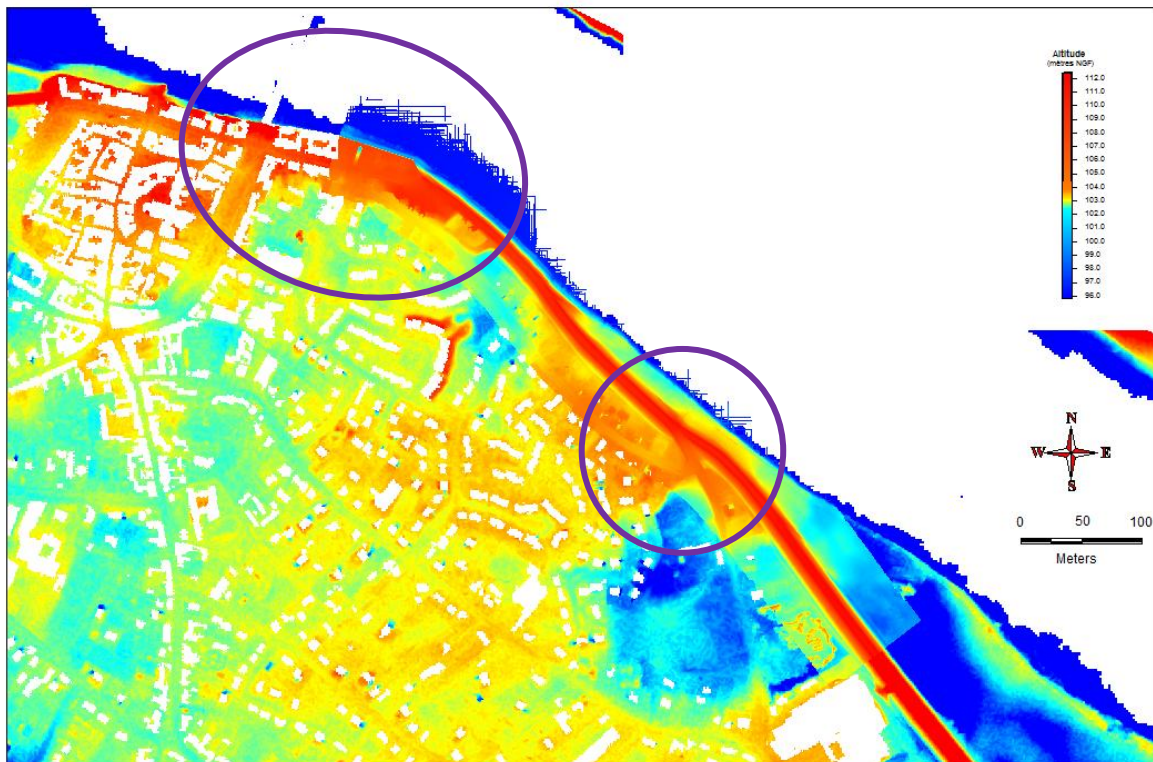

Figure 33: Superimposition of DTM 2002 and 2010

III.3 Proposed Method to Contribute to a Levee Assessment

This section shall suggest and describe a method for using data stemming from Lidar acquisition and aerial imagery so as to successfully contribute to a levee assessment. Each methodological item shall be backed up with an example derived from the November 2010 Lidar operation on Val d'Orléans levees.

a) Operating Aerial Photographs and Videos to Explore the Levee, Pre-Identify the Areas of Interest and Pre-Split them into Sections

As a first deliverable from this operation, high resolution aerial photographs and videos of the overflowed corridor are provided in oblique and nadir views.

i. Initial Levee Zoning

First, viewing videos helps identify a number of key items indicating the levee construction or condition: different types of works (embankment or masonry), woodland, embedded buildings or “levee toe/watercourse” junction or connection areas.

To do so, no geo-referenced raw videos may first be viewed (first delivered videos). However, identification will then prove difficult unless the levee alignment is split into sections matching the video files. Thereafter, the simplest way is to use FliMap Analyst¹⁷ plug-in with ArcGis (Figure 34) to play and run geo-referenced videos.

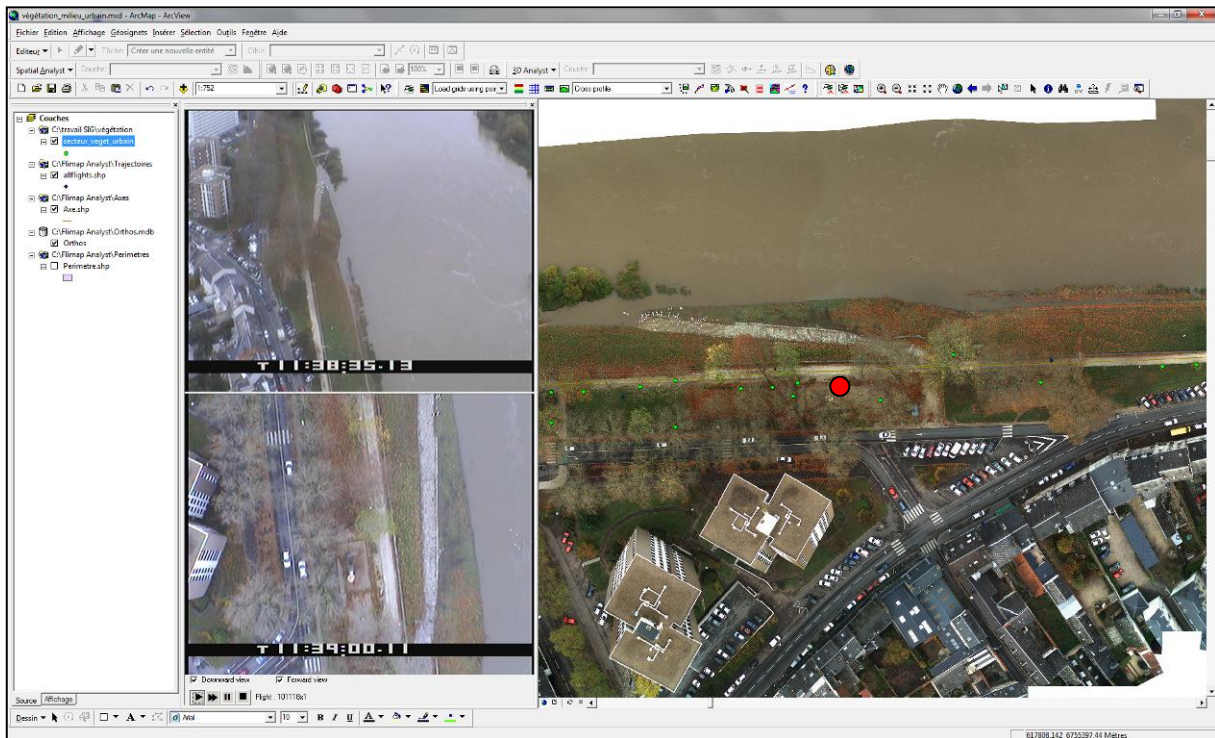

Figure 34: Playing Geo-Referenced Videos with FliMap Analyst Plug-In

¹⁷ DTM, DSM and imagery operating software tool offered with Fugro-Geoid's Flimap products.

Indeed, in Flimap Analyst, clicking a point in the flight path (see red dot on Figure 34 above) will start playing the video from that point. The oblique (forward) and nadir views are displayed within two superimposed windows. With this method, the items of interest may be directly mapped on the right-hand window (green dots on the map).

The benefit of using videos is that it provides a quick view of the entire area to be reviewed. Video playing may be stopped at any time to observe items or irregularities, or to rewind the video. The oblique view will provide both a preview of future alignment (before switching to vertical view) and a view in perspective for a better assessment of vegetation or frame heights.

Aerial photographs in Flimap Analyst are geo-referenced and ortho-corrected. Therefore, zooming in on the aerial photograph index chart (III.1, Figure 8) will display them. Below are examples of nadir view operations.

1. Various Types of Works: embankment, masonry



Figure 35: Oblique and Nadir Videos (Left) and Nadir Photograph (Right) of a Sample Earth Levee in Rural Area

This is a typical example of embankment dyke, or (earth) levee. The area is located between Guilly and Bouteille, up the Val d'Orléans, on the Loire river left bank. In this rural area, the impoundment system is based on an extensive embankment. Most levee set-ups in the Val de Loire area include a road running along the levee top (easy access for maintenance and in the event of a flood, provided the road traffic may be controlled). Down the slope on the land side, a light-colored stripe can be seen, indicating the draining material on the drainage blanket outlet of shell reinforcements built in the 1970's.



Figure 36: Oblique and Nadir Videos (Left) and Nadir Photograph (Right) of a Sample Levee with a Curb in Urban Area

These videos were taken over Orléans left bank urban area, on the Capucins levee. A wedge embedded stone wall can be seen in nadir view, and is far less visible in oblique view due the higher distance.

2. Woodland, Embedded Buildings



Figure 37: Oblique and Nadir Videos (Left) and Nadir Photograph (Right) of a Sample Vegetation Block on the Levee



The area is located in Guilly, on the Loire river left bank. In oblique view, a woodland block is quickly observed near the levee slope on the river side. Due to trees extensive crown growth, it is not possible to see if some of the stumps are growing down the slope, strictly speaking. Zooming in on the photograph in the upper right corner will help identify the type of trees.

Zoom in on vegetation: to determine vegetation type (hardwood, most likely oak trees).



Figure 38: Zoom in on Vegetation Block on Figure 37 Photograph



Figure 39: Oblique and Nadir Videos (Left) and Nadir Photograph (Right) of a Sample Frame Embedded in the Levee

This long building embedded in the levee slope on the land side is located in Châteauneuf-sur-Loire, on the river left bank.

3. “Levee Toe/Watercourse” Junction

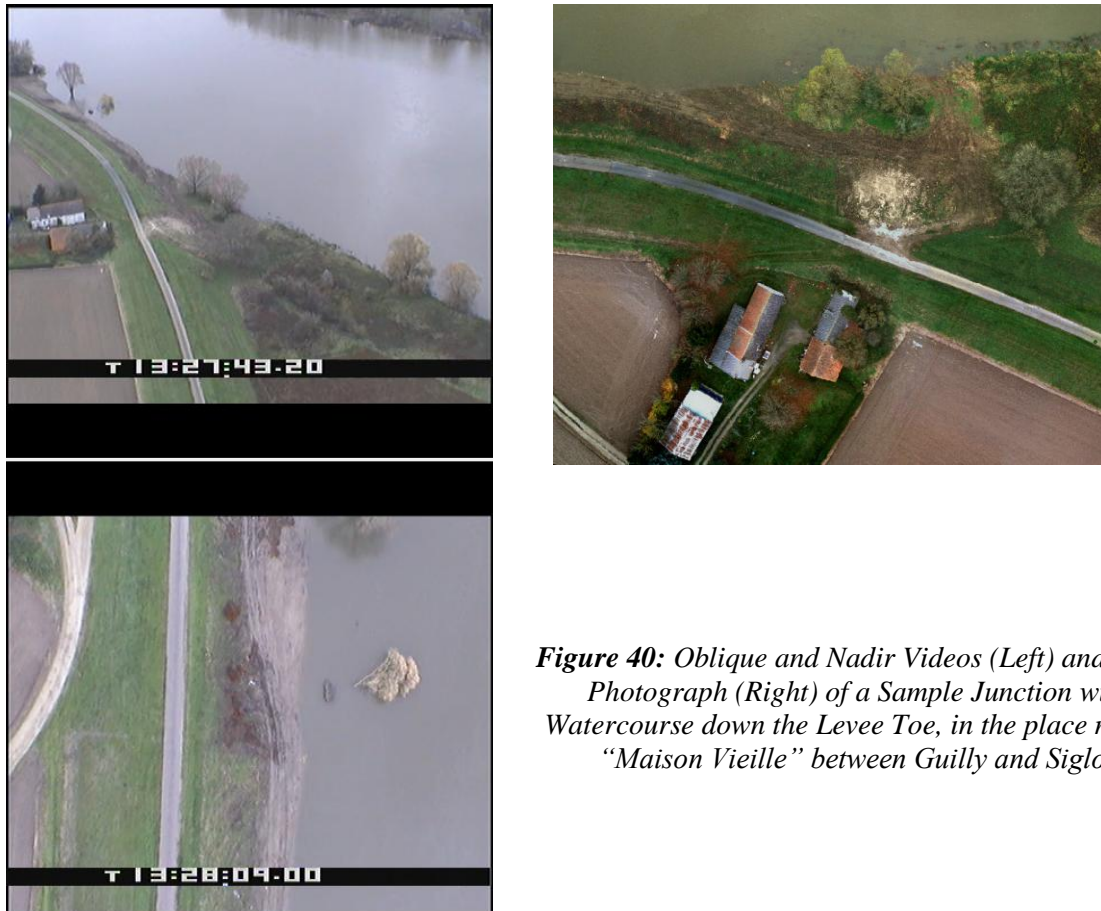

Figure 40: Oblique and Nadir Videos (Left) and Nadir Photograph (Right) of a Sample Junction with Watercourse down the Levee Toe, in the place named “Maison Vieille” between Guilly and Sigloy

Between Guilly and Sigloy on the left bank, in the place named “Maison Vieille”, the watercourse gets gradually closer to the levee toe, in downstream direction. Special attention must be paid to this river/levee “connecting” section due to external erosion or scouring hazard.

Here is another example of watercourse and levee toe getting close, a little higher upstream the river from the previous junction.



Figure 41: Other Example of Watercourse/Levee Toe Junction in the Place Named “le Vassy” in Sigloy

4. Potential Former Breaches Identification

On aerial photographs, it is rather easy to identify potential former breaches: indeed, if the scour hole has not been filled following the accident, there remains up the levee toe on the land side a water pond or a pseudo-round depression, if any, as shown on the DTM. In addition, the levee repair following the breach could have been done as an emergency repair with lower quality standards than the rest of the flood defence system. Specific investigation should be conducted on these areas.

The breach shown on the opposite picture is located in the well-named "la Brèche" locality. The former hole created by the breach was filled up with water.



Figure 42: Example of a Breach in the place named "la Brèche", upstream Sigloy Village

ii. Cross-Checking Against Historical Data

In addition to operating aerial images, historical data must be considered.

1. Breach Identification

Old maps dating back to 1850 include information on 1856 and 1866 floods (incorporated in the sequel): flood geographical limits, breaches indicated by an arrow across the levee, submerged levee sections and flood marker locations. Such maps are a valuable source of information for levee managers as they indicate all damages caused by the 19th century highest floods. Indeed, experience shows that a breach most often appears where a former breach has occurred and previously affected the levee.

Figure 43 below shows an old map of the Val d'Orléans left bank levee and, on the second map further down below, zooms in on the area between the railway embankment (already existing back in 1856) and Georges V bridge, in Orléans urban district.

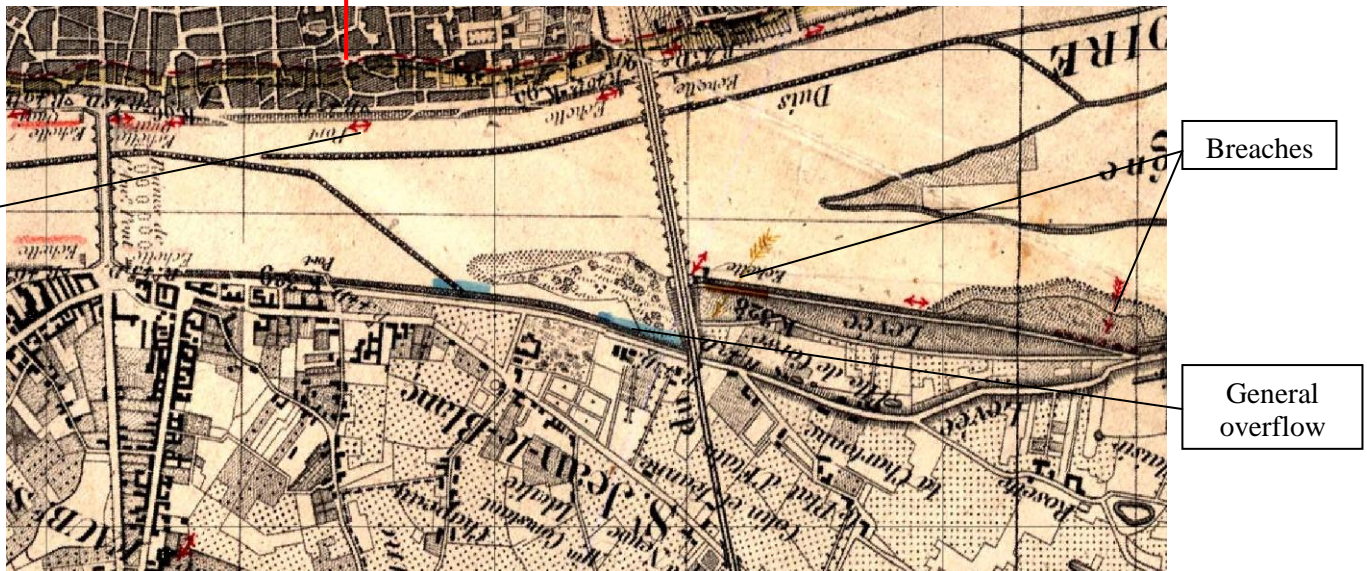
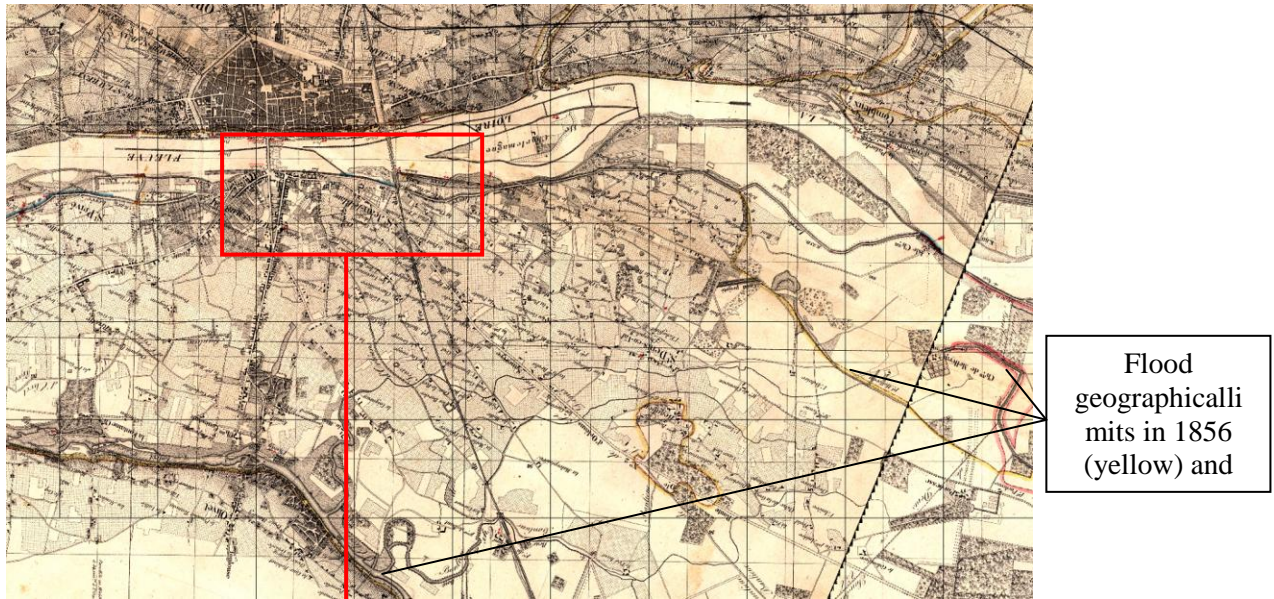

Figure 43: Old 1850 Map Showing Information on High Floods

From this map, one can see that all former breach areas have been repaired.

2. Reinforced Area Identification

Below is a reminder of the main reinforcement works that have been or are implemented on Loire river levees [Lino & al, 2000]:

- Shell land side thickening, on drainage blanket;
- Sealed shell river side thickening, with cut off-based protective lining (riprap, masonry);
- Sheet pile cut off driven from the levee top;
- Creation of a bentonite-cement diaphragm wall;
- Compaction by vibration (Johann Keller system) for sand and gravel sections.

Generally speaking, no documents or comprehensive database compiling all past reinforcement works on French levees are available. Yet, previous topographic plans indicating some of the work areas may be retrieved. The main issue is that such plans are seldom if ever updated.

With regard to Val d’Orléans, as levees are French State property, government departments (DDT or CETE) have plans that include information on the levee reinforced areas. Access to this type of information is also likely to become easier in the coming years with the development of SIRS Dignes – a GIS software tool designed for levees and provided to local services.

Below is an example of a reinforcement area topographic plan. The area is located over the “Rio de l’Ile Charlemagne” on the Loire river left bank, in Saint Denis en Val (upstream Orléans). This is a riprap reinforced levee toe, on the Loire river side.

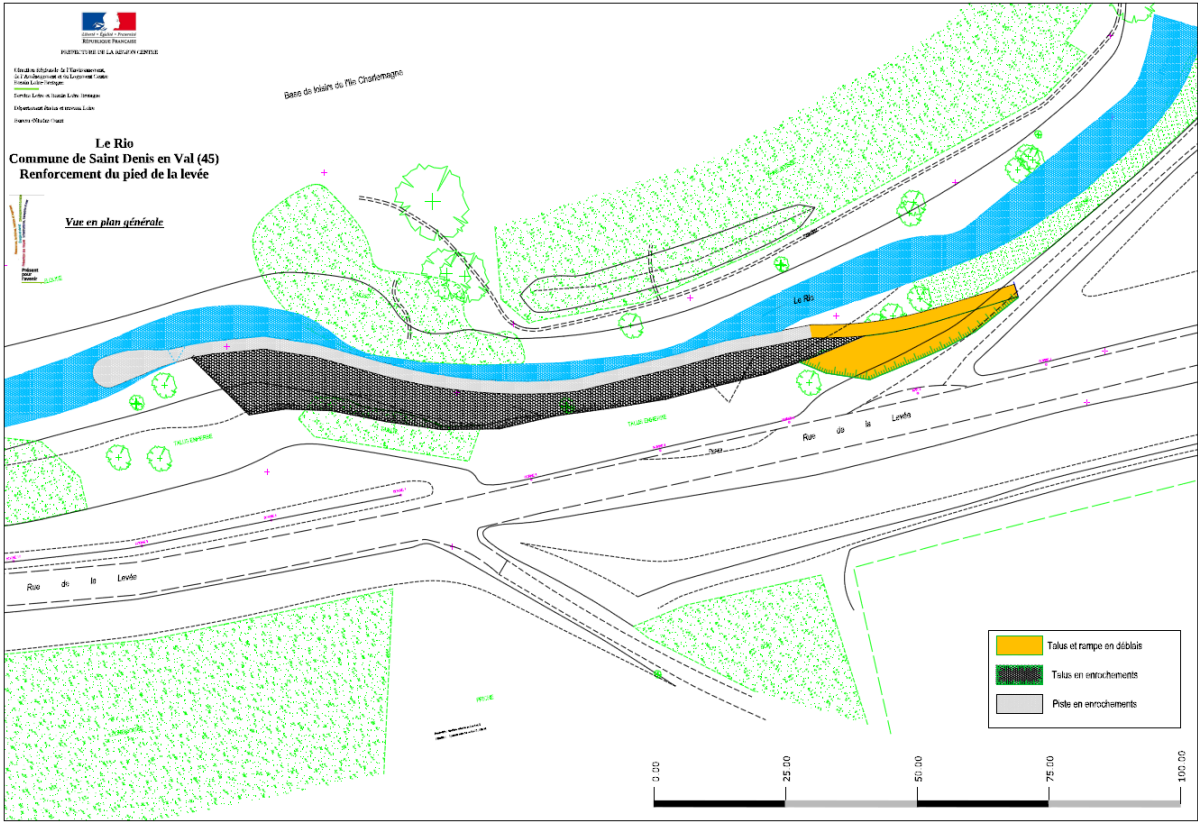

Figure 44: Rio Topographic Plan Including Levee Toe Reinforcement Area

In the absence of former topographic plans, high resolution aerial photographs may be used. However, internal reinforcement works such as sheet piles will not be visible in theory.

3. Comparison with Former Aerial Photographs

A great number of aerial photograph acquisition campaigns were carried out over the Val d'Orléans area. Below are compared photographs taken over the same area near Sandillon:

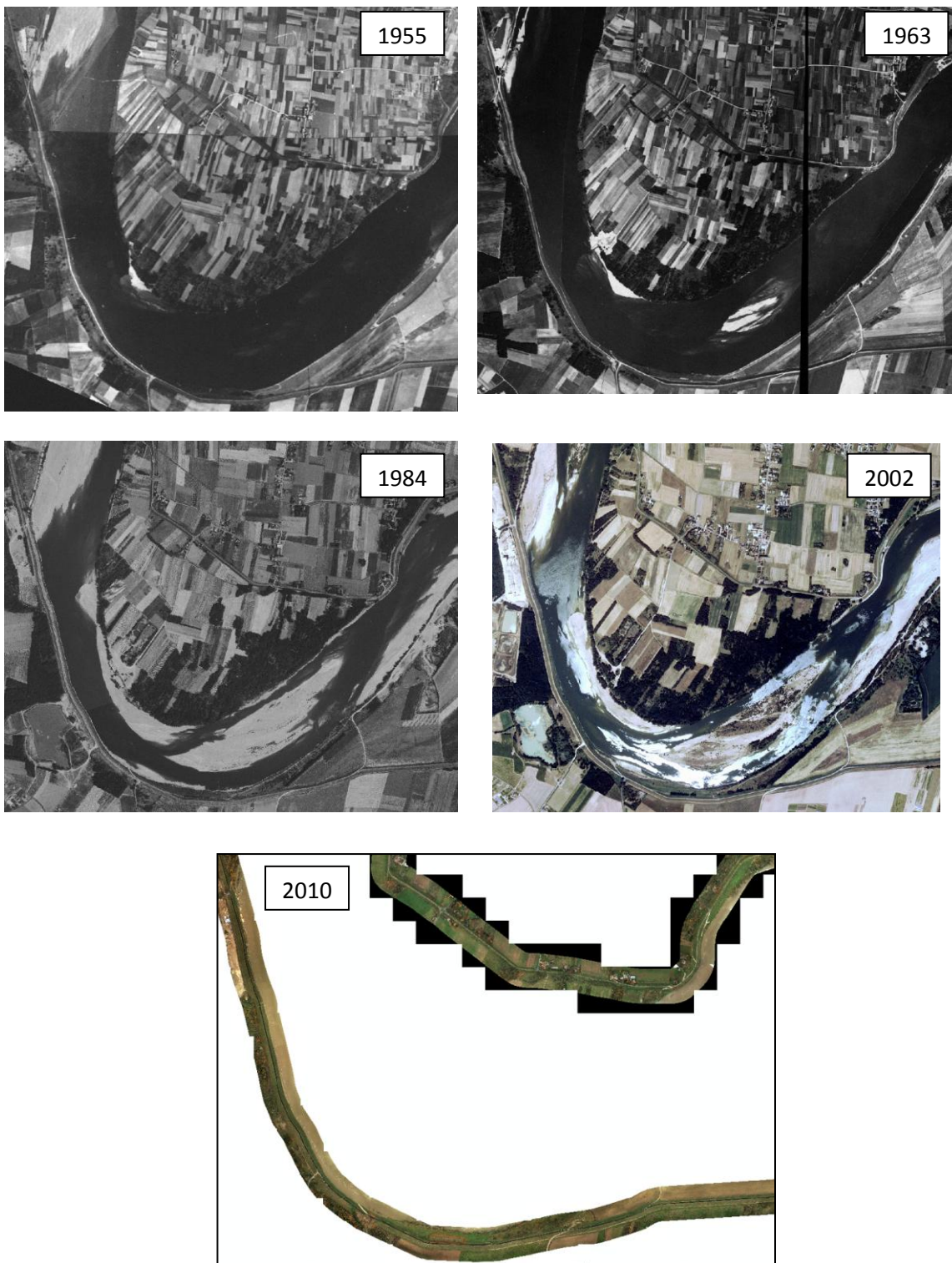

Figure 45: Aerial Photographs Taken during Various Acquisition Campaigns (1955, 1963, 1984, 2002, 2010) over Sandillon Area

In this instance, former photographs are not very useful since high resolution Lidar focuses on the levee and does not include flood plains (entire dale). The former photograph resolution is too low to be compared to the current Lidar. However, these may prove helpful for river geomorphological studies, including sand bank movements (see differences between 1955, 1963, 1984 and 2002). Over these years, no major change in the Loire flood plains horizontal alignment has been identified; bank erosions have most probably developed on a local basis but are too small to be observed and monitored on such conventional aerial photographs. Yet, this type of changes might be analyzed in the future by repeating high resolution photographic and Lidar campaigns similar to the November 2010 assignment.

Finally, former photographs help understand the changes in urbanization over time.

b) Topographic Plan

The 1/500-scale topographic plan is basic material used for identifying items on the ground. It serves as a support for visual observation. In exploration studies, as already mentioned (§I.3) the plan is used to implement geophysical and geotechnical soundings **before** and **after** they are performed, and reinforcement works later on. In addition, large-scale topographic plans are particularly useful for levee monitoring and maintenance.

It proves particularly useful with complex levees, as is the case on Capucins levee (Loire river left bank, upstream Georges V bridge) where there is a great number of manhole covers or crossing works, transition areas, retaining walls, free-standing trees and a railway embankment (affecting the levee plot). Figure 46 below is derived from this topographic plan, located 300 meters downstream the railway embankment. This is an interesting area owing to constructed entities embedded in the levee body (no slope toe can be seen on the land side).

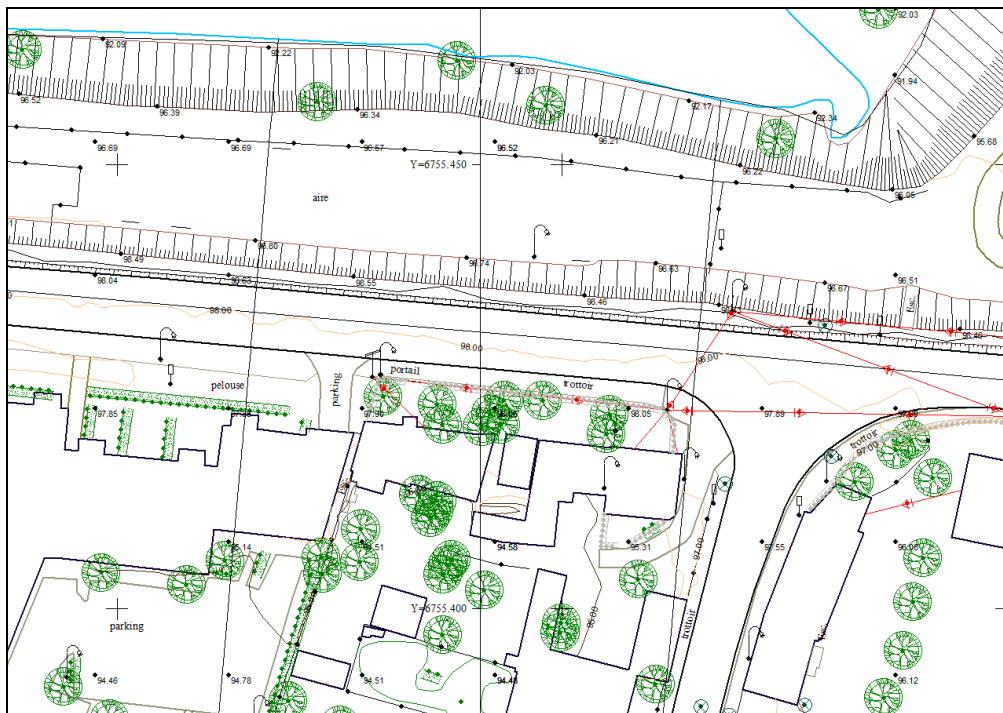

Figure 46: Example of 1/500 Topographic Plan on Capucins Levee

This plan was drawn up using both raw laser points, DTMs and aerial photographs, **but no ground visual inspection was performed**. The transition of DTM to a topographic plan requires an accurate interpretation work of data. A ground inspection may prove useful to clear up any uncertainties or correct any misinterpretation.

Raw laser points are used to identify top lines and show regular random points on a map.

Digital terrain and elevation models undergo specific treatments (slopes, level lines) so as to display slope tops and toes, level lines, free-standing trees, constructed entities, etc.

Aerial photographs are used to identify flat items such as limits, road system or small items with undetermined function (boundary marker, signs, etc.).

c) Using Lidar Data to Assess Levee Sensitivity to Various Break or Damage Risks

i. Internal Erosion Risk

As recalled in Chapter I, the main internal erosion risk factors are as follows: buildings embedded in levees, galleries or pipes crossing the levee, woodland and interface or transition areas. The purpose is to identify such factors based on their external features and determine them from Lidar data.

1. Embedded Constructed Entities

DSM data are provided as 100x150 meter raster plates. To produce a layer showing only constructed entities, each no-construction DSM raster (including vegetation) must be subtracted from DSM (including vegetation and constructed entities).

Below is an example of a house embedded in the levee slope on the land side (yellow circle on Figure 47). It is located in Guilly, just before the levee separates from the river downstream.

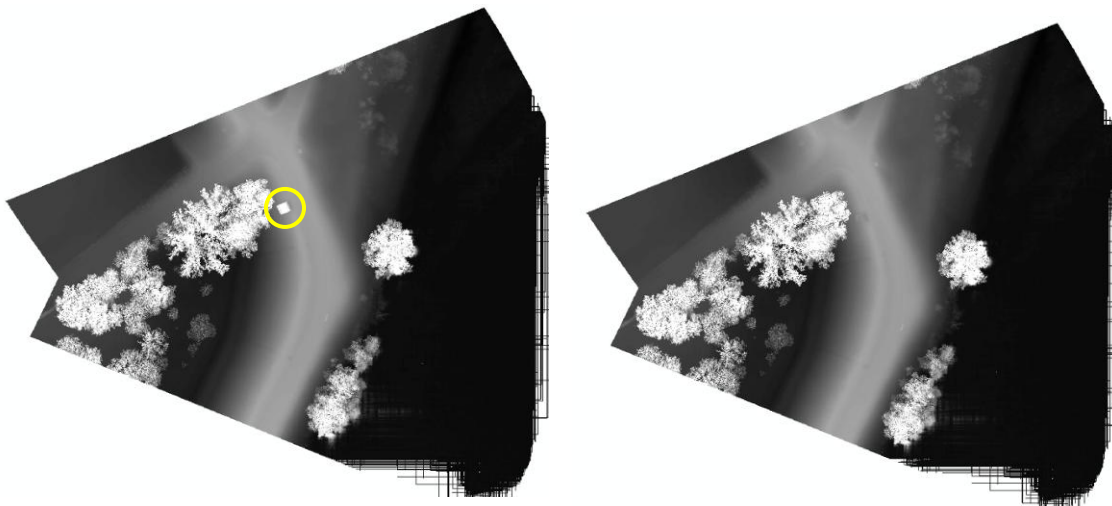

Figure 47: DSM (Left) and No-Construction DSM (Right)

The Raster computer feature in Spatial Analyst plug-in with ArcGis GIS software should be used to subtract both rasters: Spatial Analyst > raster computer. Select all relevant data and subtract them.



Figure 48: “Raster Computer” Window in Spatial Analyst Plug-In

A construction-only raster is produced. Colors have to be changed for a better viewing.

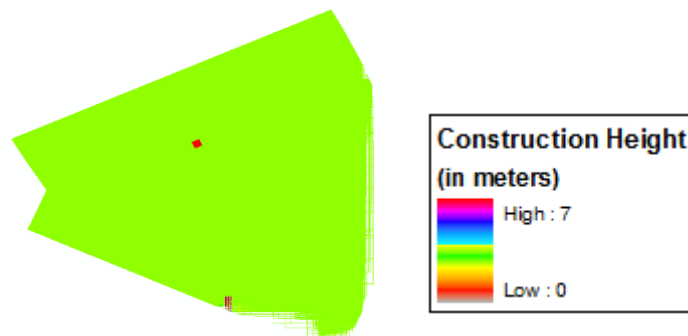

Figure 49: Result from DSM/No-Construction DSM Raster Subtraction

This method calculates the construction height (in meters), not the absolute altitude which is the default unit. In this instance, only one house is identified. However, treatment may be performed through more than one raster (possibly collated beforehand): see example on Capucins levee in III.2 b).

Another treatment may be carried out on DSM raster to make the relief more visible: this is referred to as shadowing: Spatial Analyst > Surface Analysis > Shadowing. The figure below results from superimposing DSM over shadowing raster.

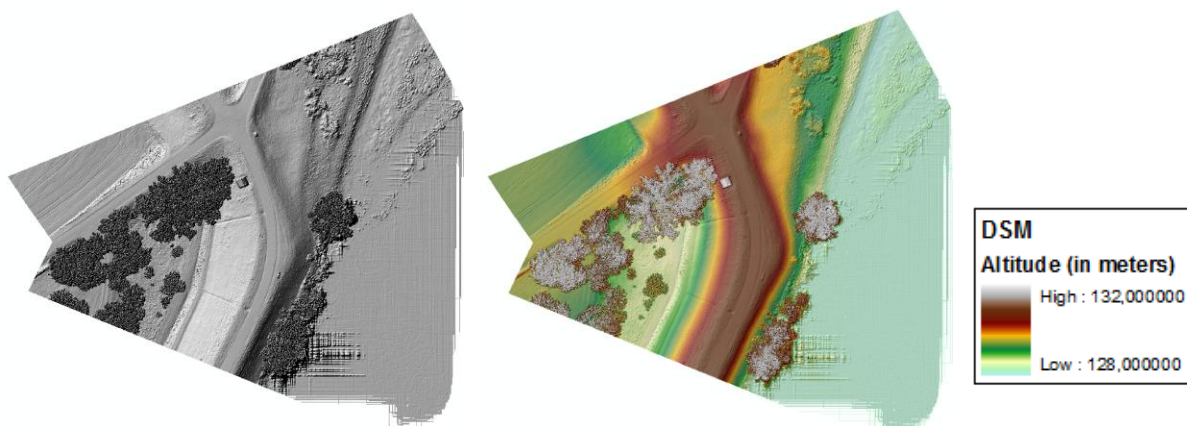
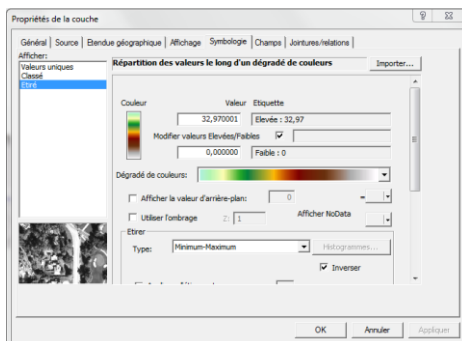

Figure 50: DSM with Black-and-White (Left) and Color (Right) Shadowing

DSM layer properties must be edited to display the shadowing layer beneath the DSM:



- Display > 40% transparency;
- Select a color palette for DSM;
- Do not forget to display DSM raster over the shadowing raster.

Figure 51: "Layer Properties" Window in ArcGis

2. Crossing Works

Based on the DSM, crossing galleries or pipes may be identified by their related external works such as sight holes (concrete well, covered with a removable lid, to access the piping) or entrance works (river or land side inlet or outlet).

A couple of different treatments can be produced with ArcGis: isolines or shadowing.
To identify such works, the following may be used:

- No-vegetation DSM with shadowing. Indeed, DSM will retain the works, and the absence of vegetation makes for a better viewing;
- Isolines superimposed over slope map: isolines clearly delineate the works items;
- And in addition ortho-photographs.

Let us see for example a crossing work on Capucins levee. Two sight holes appear on the left side of this work.

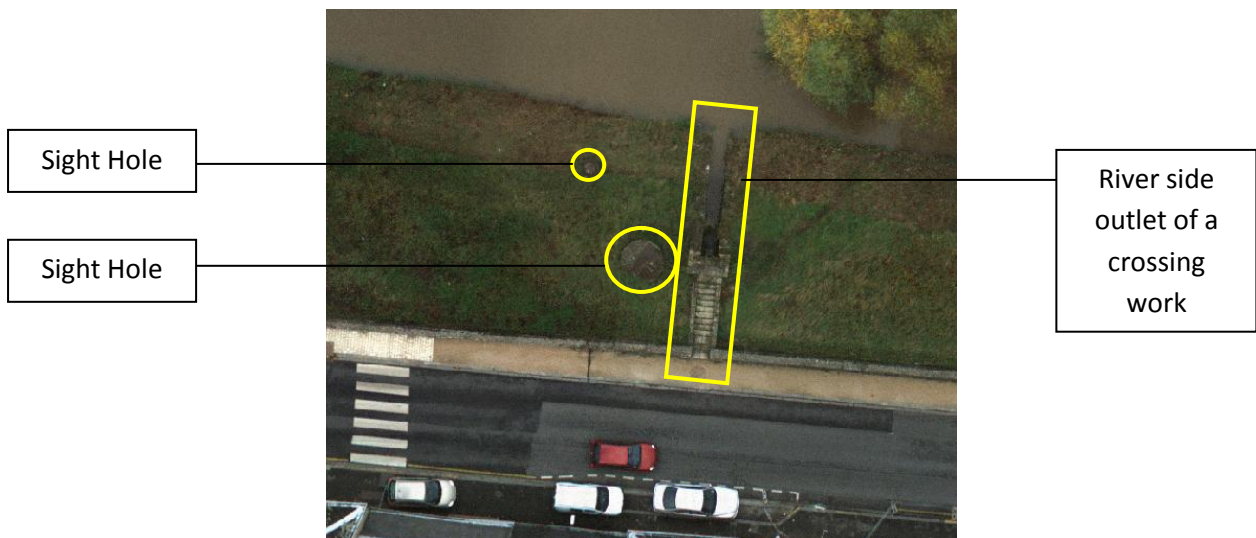
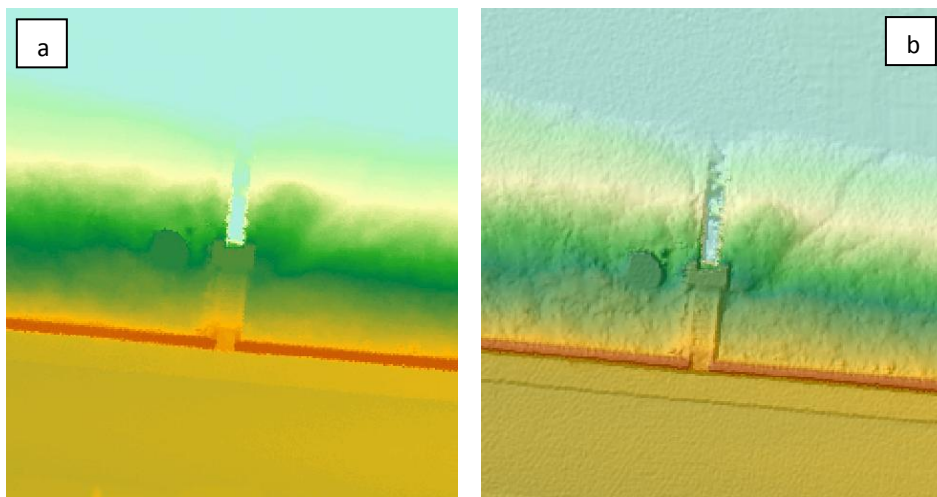

Figure 52: Photograph of Sight Holes and Outlet on Capucins Levee Crossing Work.

A couple of different treatments were produced with Arcgis: Spatial Analyst > Surface Analysis > isolines / slope / shadowing. The following was achieved:



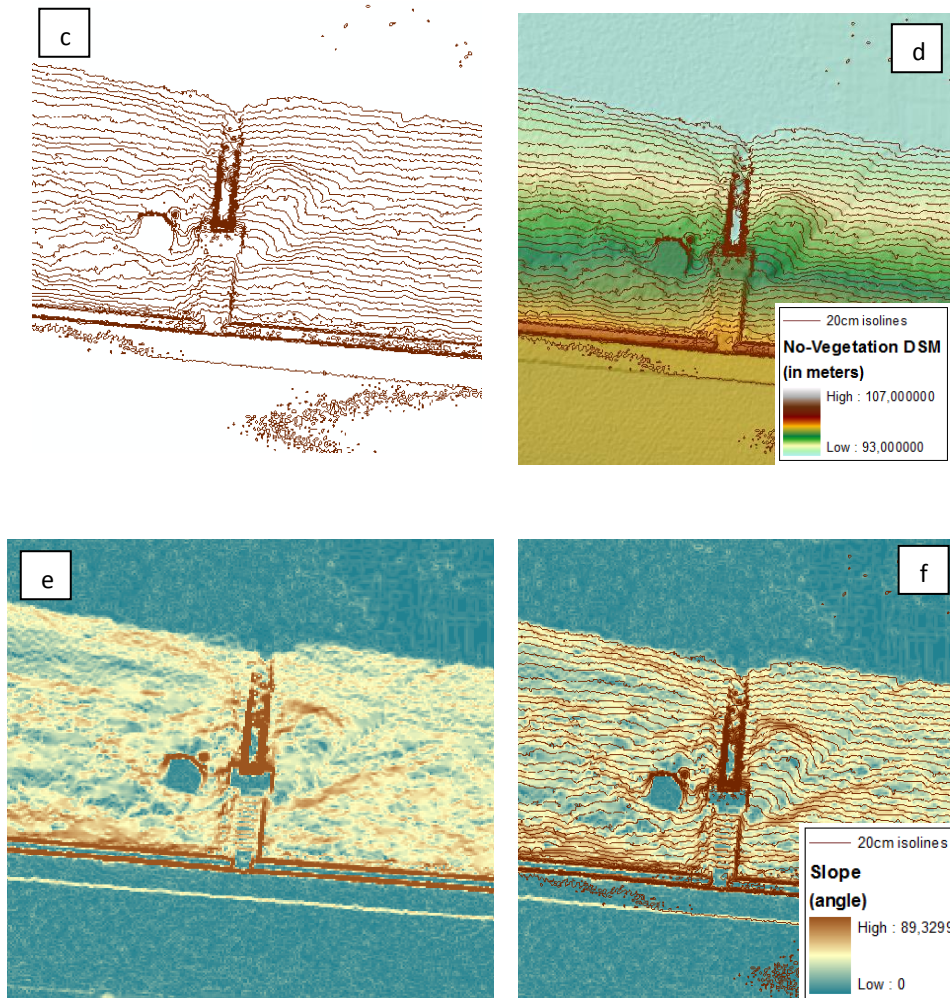

Figure 53: *Treatments Performed with ArcGis on Figure 52 Area.*

The two first figures are DSM-only (a) and DSM with shadowing (b). Then, 20 cm separated isolines were applied to figures (c) and (d) over the DSM with shadowing. The two last figures are the slope map (e) and isolines superimposed over slope map (f).

DSM-only does not highlight the work type. Some shadowing is required. Isolines clearly delineate the work items.

The slope color stresses flat surfaces (blue), indicating sight holes and road. Yet, when compared with aerial photograph, one item is not shown on any of these treatment figures: the sight hole in the upper left corner of the photograph.

In conclusion, priority should be given to isolines with no-vegetation DSM or isolines with slope to identify levee crossing work items, although it is essential to view orthophotographs that may provide additional information. For example, galleries inside the levee or flashboard galleries under water are not visible with LiDAR data.

The relevant methodology consists in, first, creating a polygon shape file to delineate items on the map. Then, in any event, display isolines. Finally, one should first display a no-vegetation DSM, followed by slopes and orthophotographs in the end.

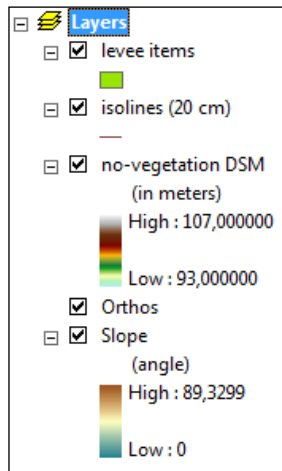
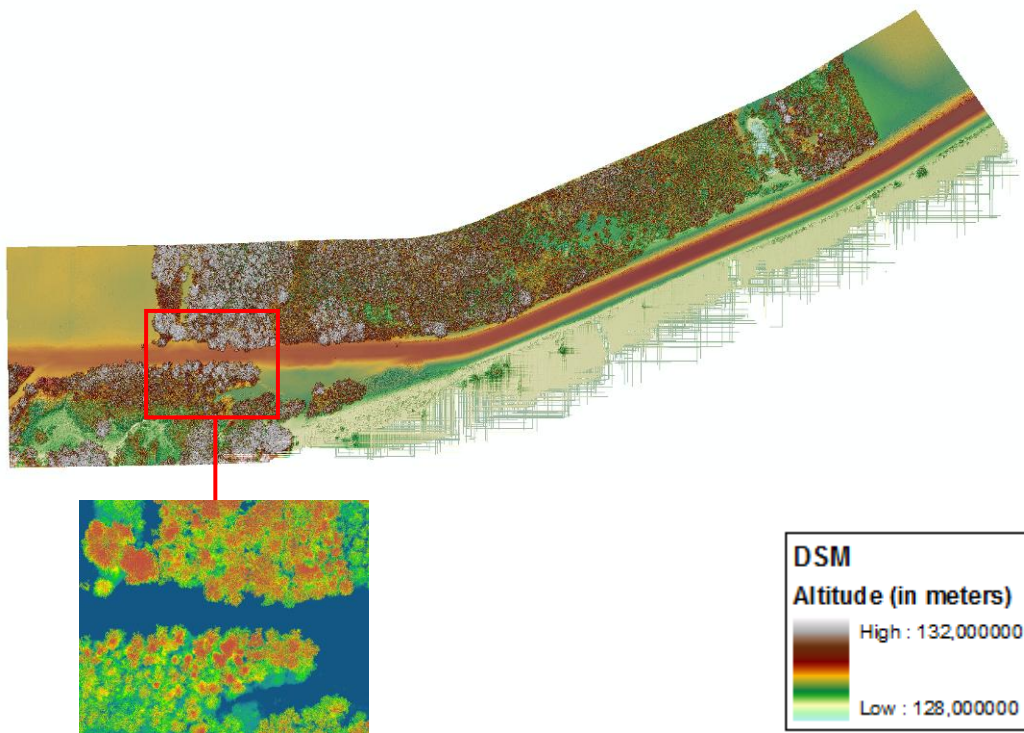

Figure 54: Layer Window in ArcGis

3. Ligneous Vegetation

Using the same process for creating the construction layer, the vegetation layer may be obtained from the raster computer: DSM (vegetation and construction) – no-vegetation DSM (that is, with construction only). The example below is located on the Loire river right bank, in Châteauneuf-sur-Loire. Most faces on this levee area are overrun by woodland. Figure 55 below show, from top to bottom: superimposed DSM and shadowing rasters, DSM raster, no-vegetation DSM raster and the result obtained from no-vegetation DSM being subtracted from the DSM.

Vegetation heights may be classified for a better determination of forest canopy strata or structures (trees, bushes, hedges, etc.).



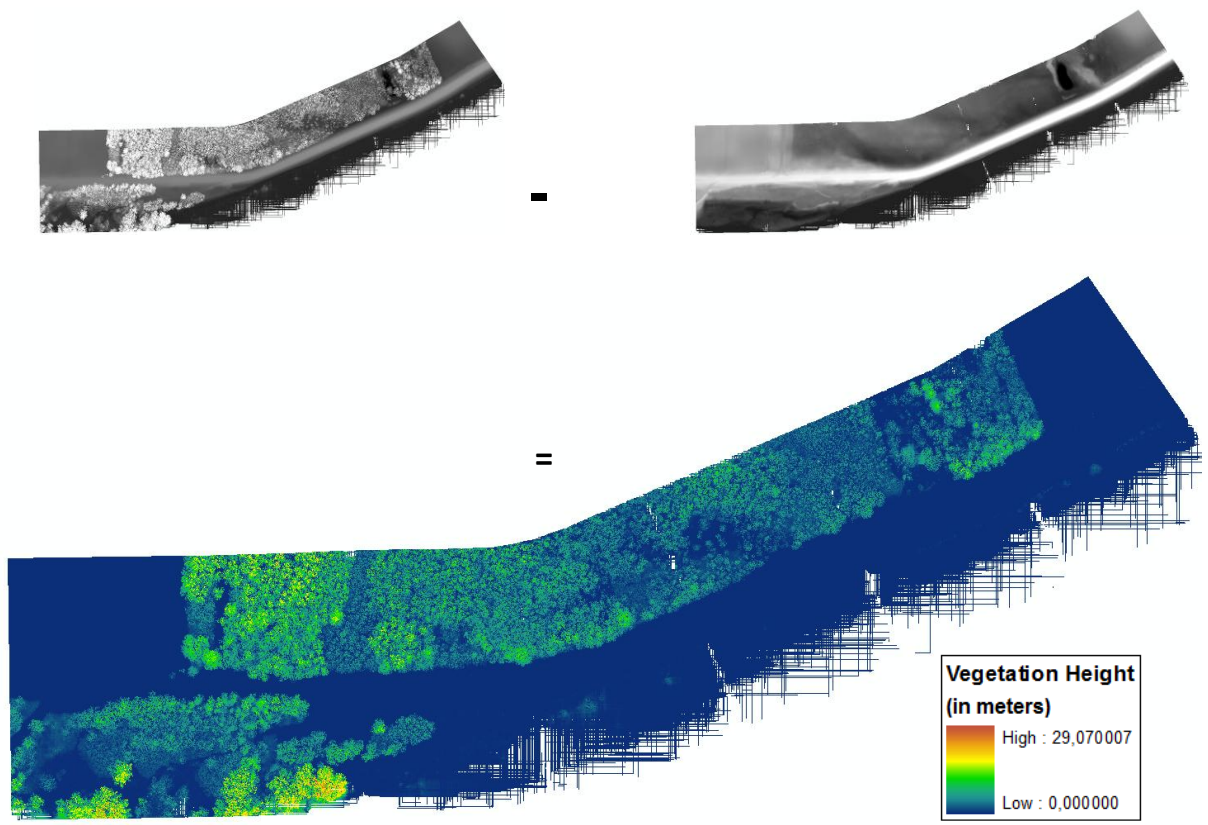

Figure 55: Example of DSM/No-Vegetation DSM Subtraction to Display Vegetation

To see if a tree is really on the levee toe or on the slope, it's relevant to create a cross section with raw points using Fugro Viewer software (Figure 56).

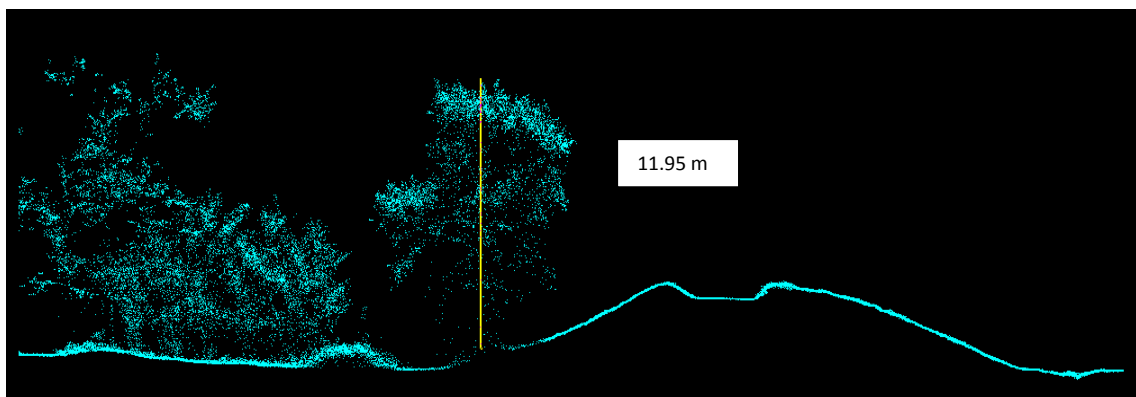

Figure 56: Cross-section on raw laser points

4. Transition Structures

Transition is typically a connection area between two civil engineering structures or works with different construction or geometrical profiles. These may be linear, surface or gradual transitions [Tourment & al., 2012]¹⁸. Also, they may be hidden, included but partially visible, or entirely external transitions. With Lidar technology, only **external or partially visible transition structures** shall be displayed.

To identify such structures, the following may be used:

- Orthophotographs;
- No-vegetation DSM with shadowing;
- Regularly separated cross-sections plotted on the levee: a change in slope may also indicate a transition area.

Below are examples of transition structures on Val d'Orléans left bank levee: Cables and piping in continuous section are not displayed since the Lidar cannot cross the ground. Only surface items are highlighted.

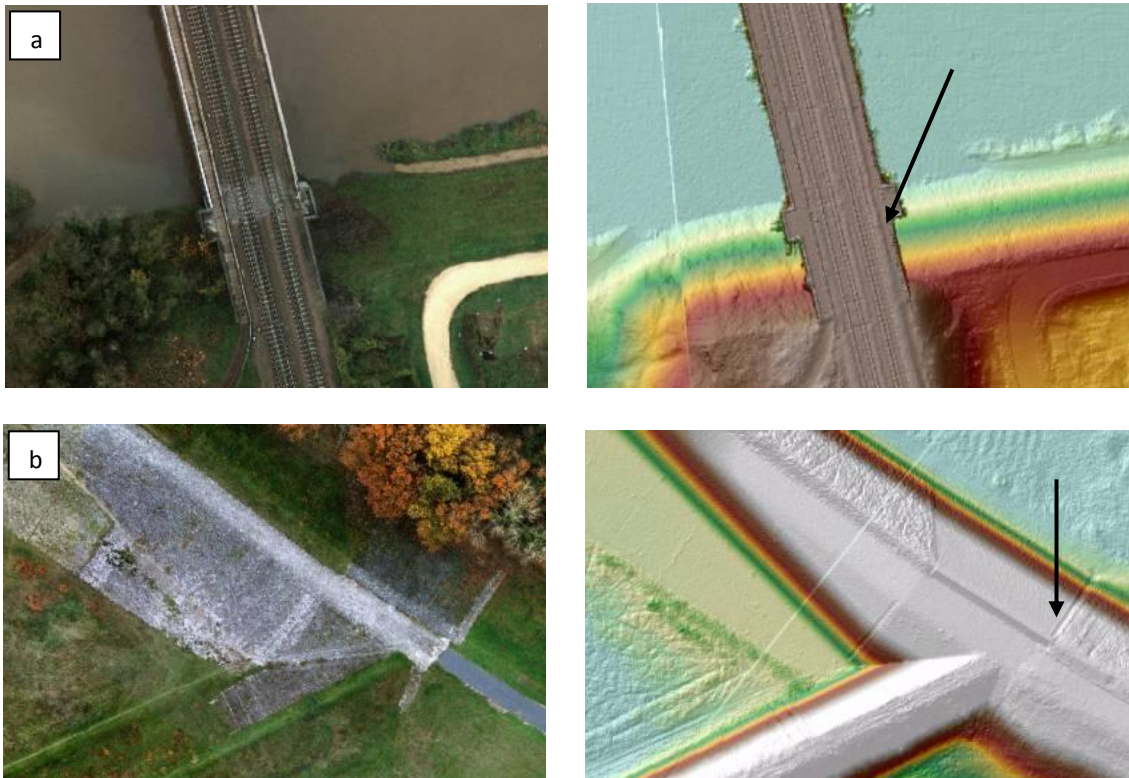

¹⁸ Tourment R, Royet P., Morris M.W. (2012). Levee failures related to structure transitions: typology, levee performance and improvements. *2nd European Conference on FLOODrisk Management (FLOODRisk 2012)*, Rotterdam (The Netherlands), November 20-22 2012.

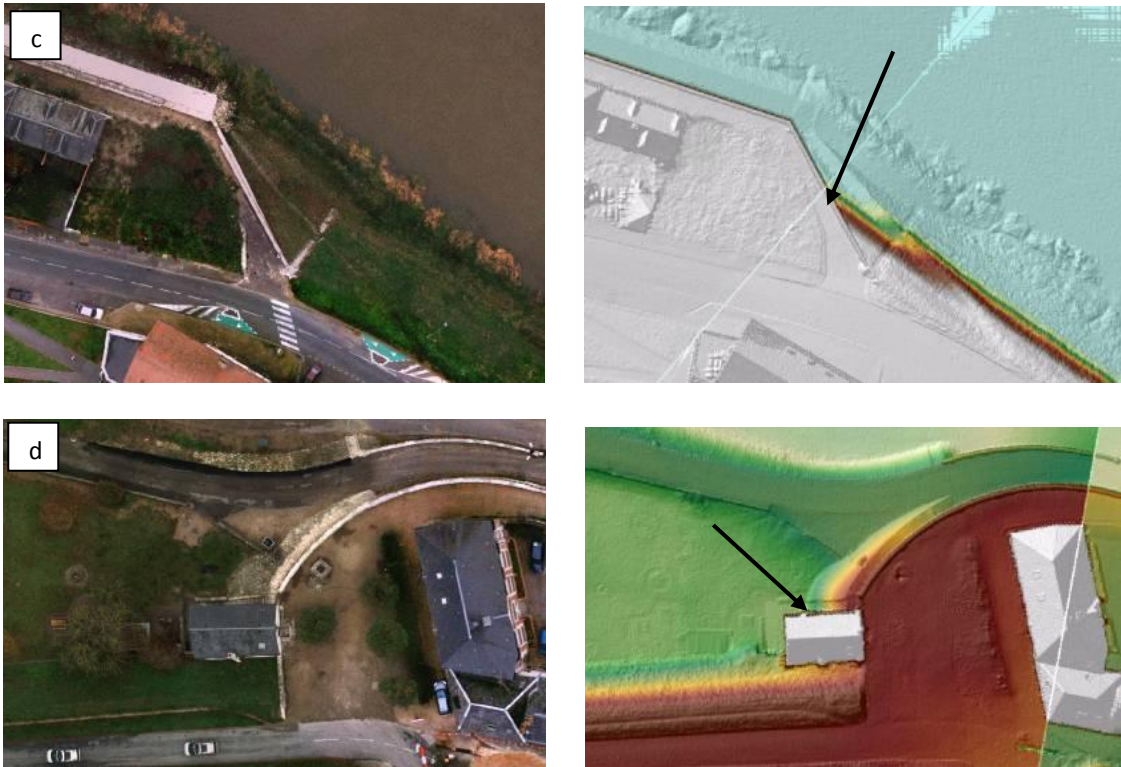

Figure 57: Photographs and DSMs of Sample Transition Structures

Figures above show, from top to bottom:

- Transition between an earth levee and SNCF railway embankment (a)
- Between an embankment levee and a masonry levee near the spillway (b)
- Next to Jargeau embedded stone dock (c), and junction between a wall and a house adjacent to a levee (d).

High resolution aerial photographs help quickly identify all works on levees, junctions, changes in lining, etc. Lidar data make it possible to measure terrain elevation, which would otherwise not be possible with aerial photographs, and shadowing is required for a proper viewing of the structure geometry.

No-vegetation DSM data must be used to display curbs and works included in the levee as removed in the DTM.

Vegetation should not be too dense so as not to hide any objects underneath, despite laser scanning high point density.

5. Topographic Plan Contribution

One of the topographic plan qualities is that it brings together all visible items from a given area (see I.3), and particularly structures or irregularities that are potential sources of internal erosion risk: crossing works (inlets, gates, sight holes, and pipes) trees, and transition structures.

ii. Overflow Risk

In the matter of internal erosion, overflowing is a major cause of breaches, at least for embankment levees. The methodology describes two processes to study overflow risk.

1. Levee Top Longitudinal Profile

For lack of any hydraulic study, an analysis of the levee longitudinal profile would be sufficient to identify, in a first step, all points and lower area where the overflow should start in the event of a major flood. Such lower points may be associated with a construction fault, the foundation settlement or anthropogenic activities.

The example below is located in Château de l'Isle, upstream Orléans on the left bank. A breach occurred on this levee area in 1866.

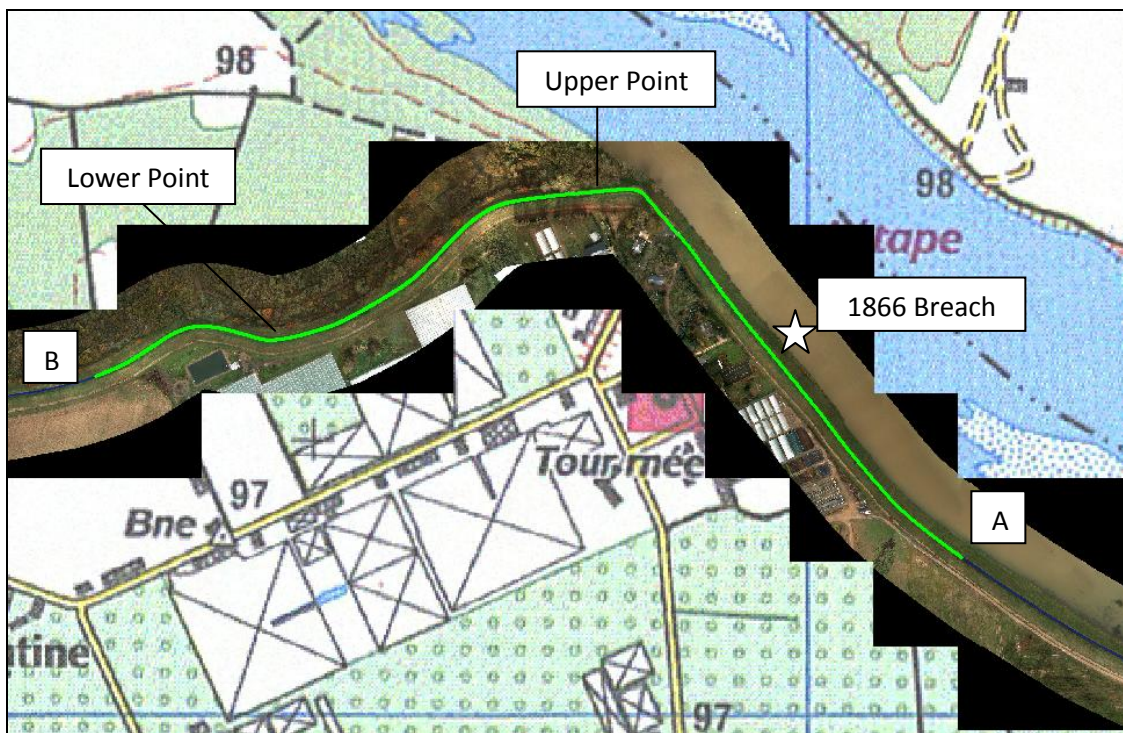

Figure 58: Château de l'Isle Location Map

Drawing up the levee top longitudinal profile lined up with the carriageway axis using FliMap Analyst will generate the following diagram:

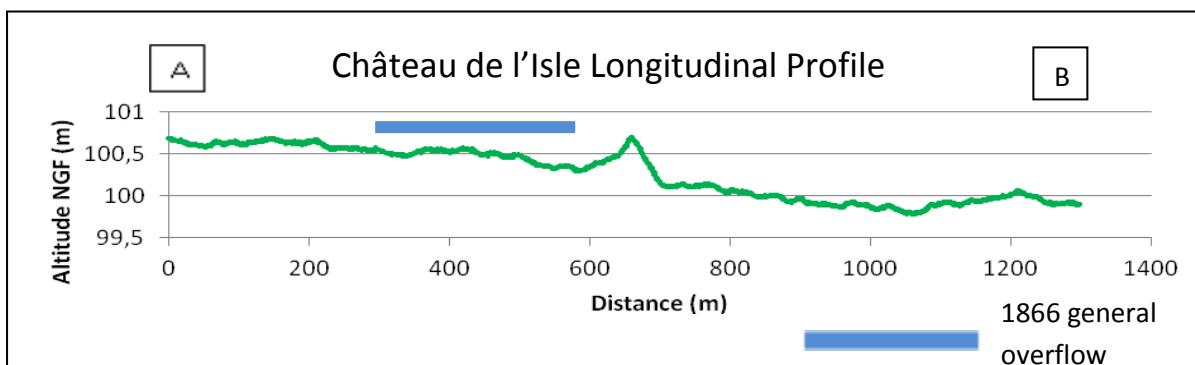

Figure 59: Levee Longitudinal Profile from Point A to Point B in Figure 57

Therefore, the longitudinal profile shows that a lower area is now included in this area downstream the 1866 breach area. By contrast, the levee top displays an upper point near the alignment bend where the levee separates from the river in downstream direction.

Finally, considering the overflow that previously occurred on this area due to a flood, such a risk should be taken into account as this might occur again, particularly in the section 700-1200 m down the upper point (as the 300-600 m section may have been raised during 1866 breach repair works).

2. Comparison between Flow Lines during Floods and Levee Longitudinal Profile

Overflow risk may be assessed by comparing flow lines during floods and the levee top longitudinal profile. The levee longitudinal profile can be drawn up on top of the earth ridge (levee upper point) or merely at the point of contact between the earth ridge toe and the carriageway. Indeed, earth ridges, considering the type and geometry thereof, are not to be considered as reliable with regard to a flood level that is close underneath the surface; these are wave walls. The levee safety level is therefore taken down to the earth ridge toe level or halfway across the carriageway (without regard to the earth ridge). It is relevant to compare the reference flood water level with this levee safety upper level to determine the freeboard available against the flood from which a protection is sought, and highlight all sections where the freeboard would be inappropriate.

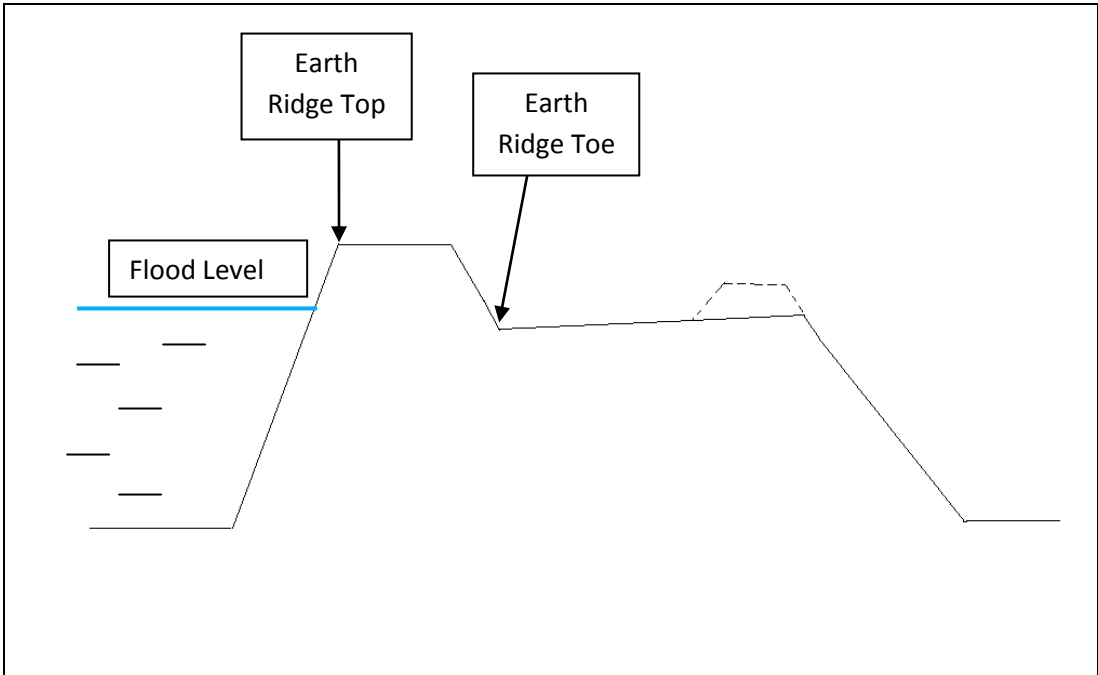

Figure 60: Loire River Levee Typical Profile

Flow line and longitudinal profiles should be easily and accurately associated with the same level and MP repository (NGF) to analyze the reference flood water levels with regard to levee geometry.

❖ Châteauneuf-sur-Loire Left Bank

Let us see for example the levee located on the Loire river left bank, near Châteauneuf-sur-Loire (see map below). Red dots indicate reference water levels known from 1856 flood. Unfortunately, there is no longitudinal profile of the flow line during floods available with closer points. Therefore, there are only three water level values available for this flood on a 3 km longitudinal profile.

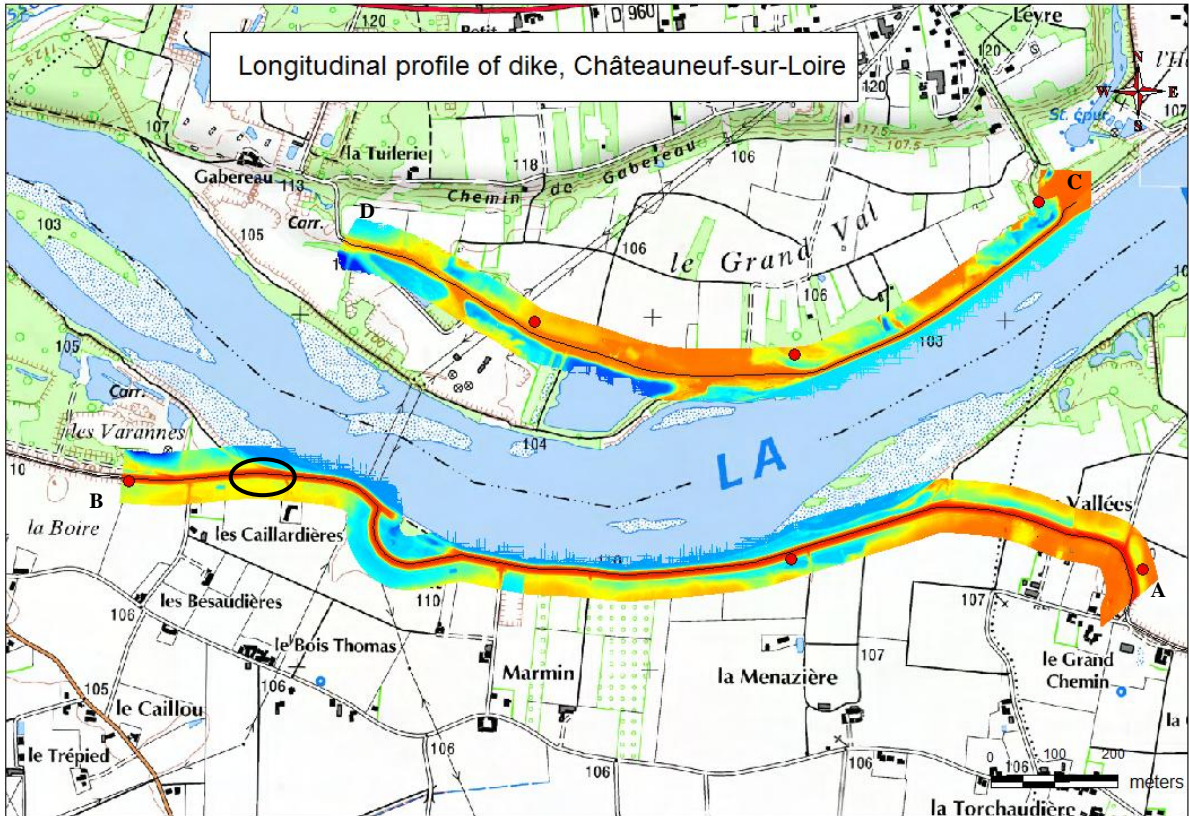

Figure 61: Châteauneuf-sur-Loire Location Map

The following diagram includes the superimposed items:

- Levee top longitudinal profile (halfway across the carriageway) of the left-hand side;
- 1856 flood water level (extrapolated polyline from three points).

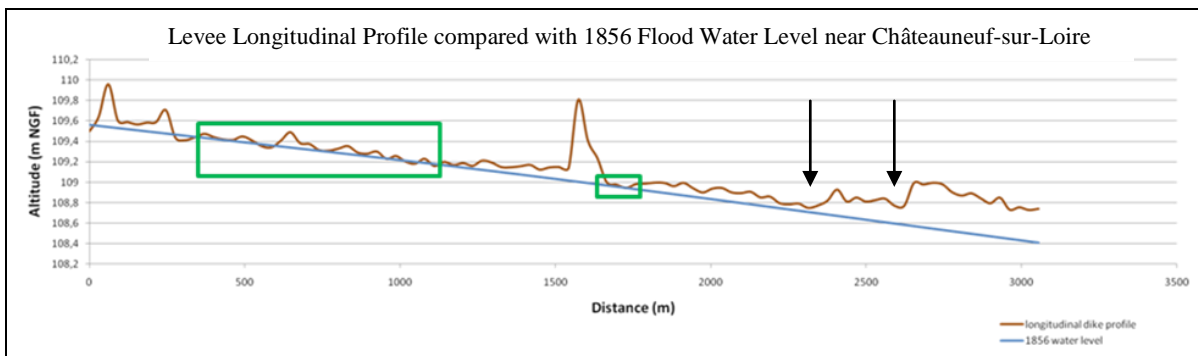

Figure 62: Diagram Showing 1856 Flood Water Level and Levee Profile from Point A to Point B on Loire River Left Bank

It appears on the graph that the 1856 water level crosses the levee top DTM for two sections of levee: see green rectangles between 350 - 1100 m and just after the high spot (1700 m).

For these sections of levee, the freeboard is insufficient.

Furthermore, the levee top is far above the water level just downstream the point where the levee separates from the Loire River (black ring on the map). There is a lower overflow risk at this location. However, from the name "la Boire" given to the place located down this area, one may infer that, in the past and most certainly during the 1856 flood, this area was most probably flooded by a levee overflow.

This result must be considered cautiously as the "1856 water level" polyline was drawn from 3 points only and uncertainties bearing upon this polyline are unknown. On the other hand, a unidimensional model was created by Hydratec on Loire to generate water levels for floods and rates of flow for a specific event.

If we focus only on the levee top longitudinal profile, we can identify lower points generating an overflow risk. Such lower points may be associated with a construction fault, the foundation settlement or anthropogenic activities. The two lower points on the graph are pointed to dark arrows. The first one (2300 m) corresponds to a former breach.

❖ Châteauneuf-sur-Loire Right Bank

Let us now consider another example from the Loire opposite bank, on Châteauneuf-sur-Loire borough.

On this section, most of the right bank levee touches the Loire River. Three historical reference water levels are available for this section (red dots, 1856 flood). If, on one diagram, the levee longitudinal profile is superimposed over carriageway axis and 1856 flood water level, the following is generated (upstream on the left-hand side of the diagram):

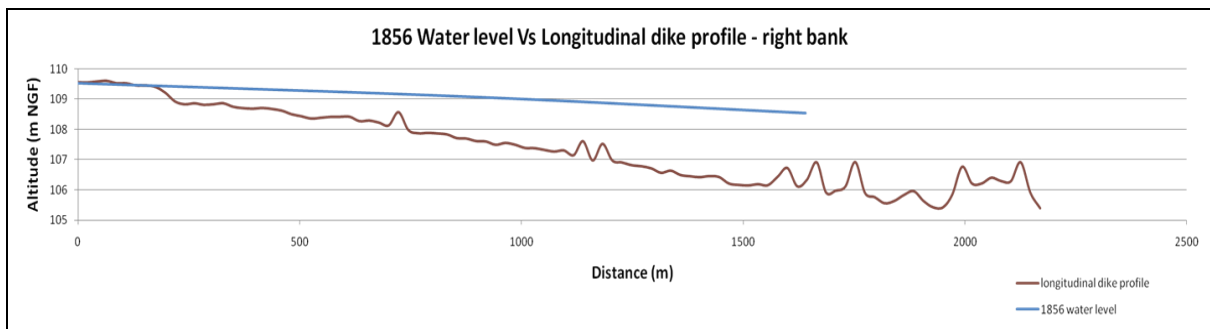

Figure 63: Diagram Showing 1856 Flood Water Level and Levee Profile from Point C to Point D on Figure 60 – Loire River Right Bank

In contrast with the previous example, the flow line during floods (1856) reaches far above the levee top and gradually increases in downstream direction.

In summary, a general overflow and a great number of breaches have occurred in the past on both levee areas of interest (see map Figure 64). This is clearly indicated by diagram curves above.

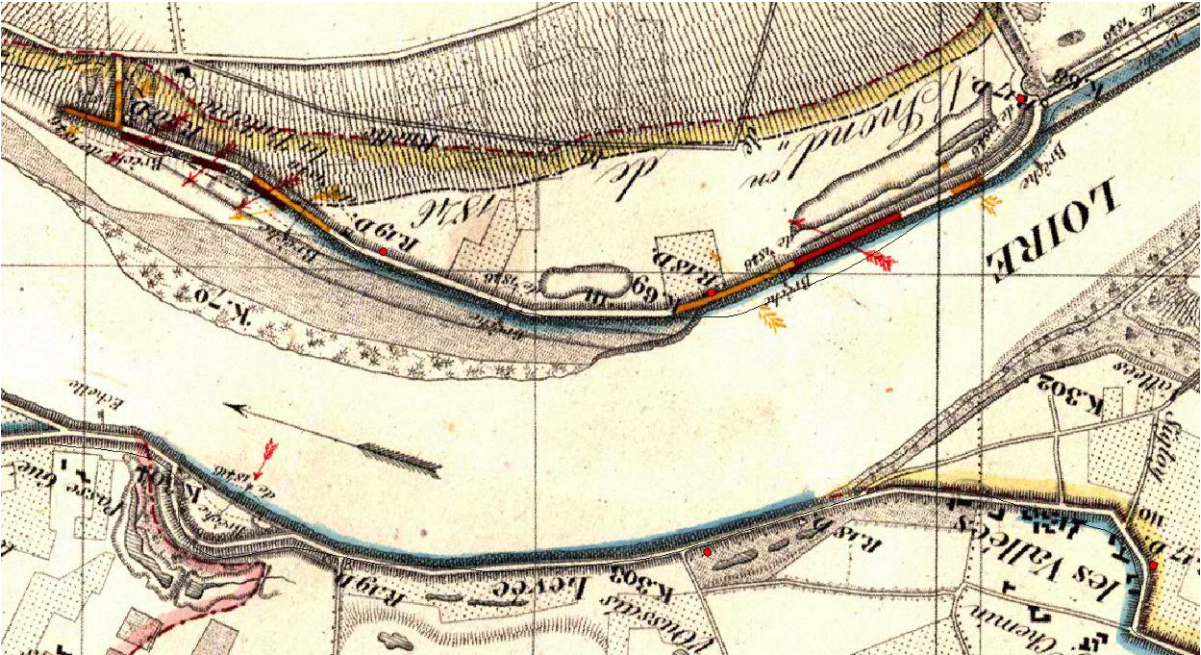

Figure 64: Former Map of the Same Area

3. Settlement Monitoring through Regular Lidar Acquisitions

Potential levee settlement issues (e.g.: compressible layer settlement in the foundation) or slumps (e.g.: movements due to karstic sloughing in the foundation) may be identified only by comparing topographical data recorded over time. These types of movements usually change, at a more or less slow pace, over several years. In order to identify and follow them up, high resolution Lidar acquisitions should be repeated at regular intervals, every 2 to 5 years for instance. Follow-up processes of this type are applied to levees in the Netherlands.

iii. Instability Risk

1. Low Levee Width and Steep Slope

It should be reminded that there is an overall instability risk on any one of the levee faces when several factors are brought together, particularly with a narrow levee cross-section and steep slopes (over 65% angle or batters lower than 3H/2V). Such adverse factors are quite frequently observed on former breach areas due to rush repair works.

The example below is located on Val de Bou levee, on the right bank, where the levee comes close to the Loire River. A breach occurred in 1866 a little bit further upstream. The bottom-hand figure shows the slope treatment produced on the raster, highlighting the relevant critical cross-section (slope on the land side > 65%).

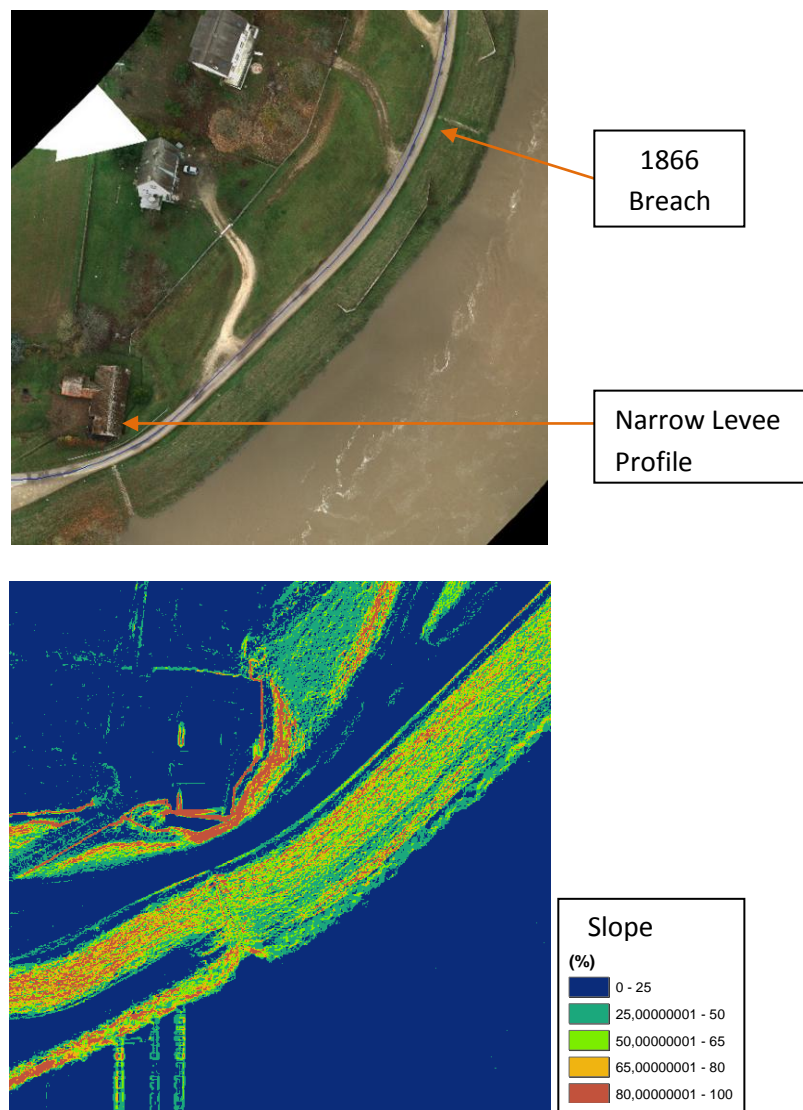

Figure 65: Example of a Narrow Levee Profile on the Loire River Right Bank, in Val de Bou

The house embedded in the levee slope on the land side makes the levee cross-section narrower. Below are DSM and DTM images of the area. The black line indicates the cross-section drawn up with FliMap Analyst.

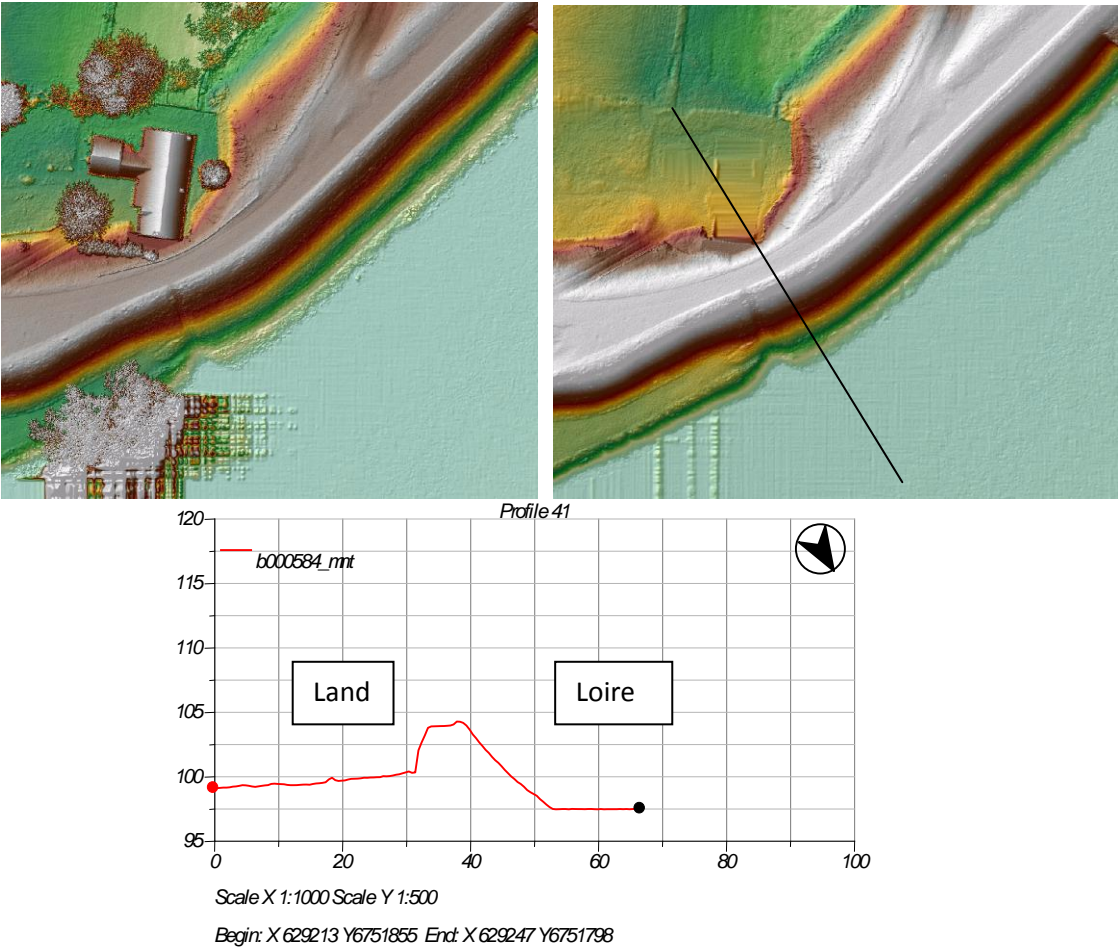

Figure 66: DSM Image of the Area on Figure 64 (Left), DTM (Right) and Cross-Section along Black Line (Bottom)

The land side slope is steep and the top is rather narrow. Such irregular profile is due to the house and conveys a high instability risk, all the more so as many breaches have occurred in this area.

With a view to determining such an instability risk and collecting input data for the purpose of performing a potential geomechanical modeling work (stability calculation), cross-sections should be produced at regular intervals so as to identify more accurately the profile geometrical changes. Yet, most levees in Val d'Orléans have a wide profile: it is therefore relevant to search for localized instability risks through a preliminary study of the slopes.

This study must be carried out in conjunction with a work type analysis: for instance, any embedded stone pitching¹⁹ may, indeed, efficiently contribute to improve the stability of a weak-looking levee slope.

¹⁹ Caution: such pitchings might be covered with a top soil layer, making them invisible through Lidar technique or aerial photograph.

2. Irregularities and Ancillary Works

All irregularities and ancillary works on slopes or near the levee toe are just so many potential weakness points in relation to levee or section of levee mechanical stability: for example, earth ridges, spillways, wedges, flashboard paths, pipes or gallery lock walls, etc. Below are a couple of sample irregularities surveyed over Val d'Orléans levees, from top to bottom: a flashboard gallery (Val de Bou), Jargeau spillway, a storm drainage pipe placed on the land side slope (frequently found on levee alignment) and a levee with earth ridge on the Loire river side.

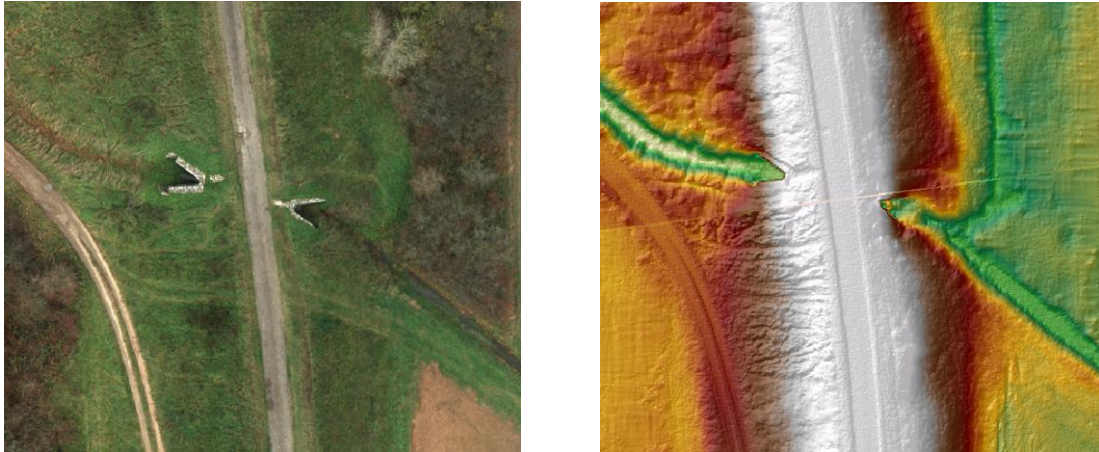

Figure 67: Flashboard Gallery on Val de Bou



Figure 68: Photograph of Inlet Work on Gallery Land Side (with Flashboard Gate that May Be Operated from the Levee)



Figure 69: Jargeau Spillway

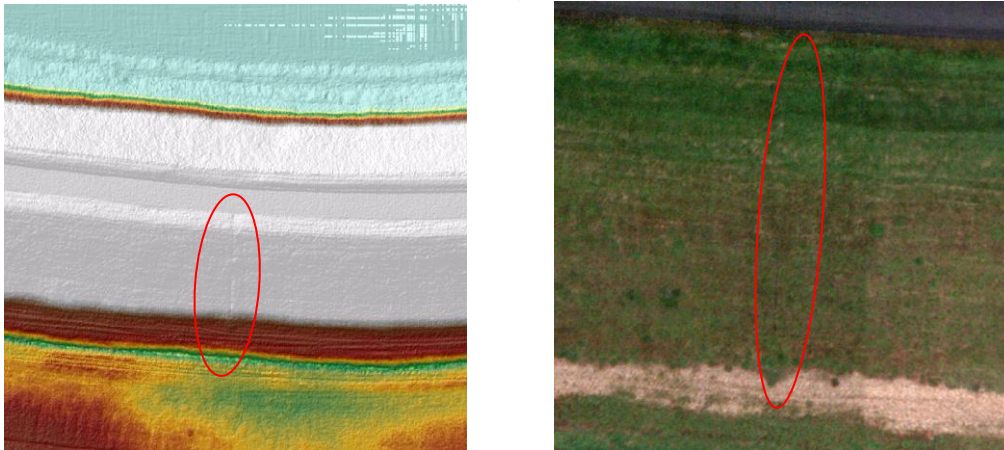

Figure 70: Storm Drainage Pipe on Loire Land Side

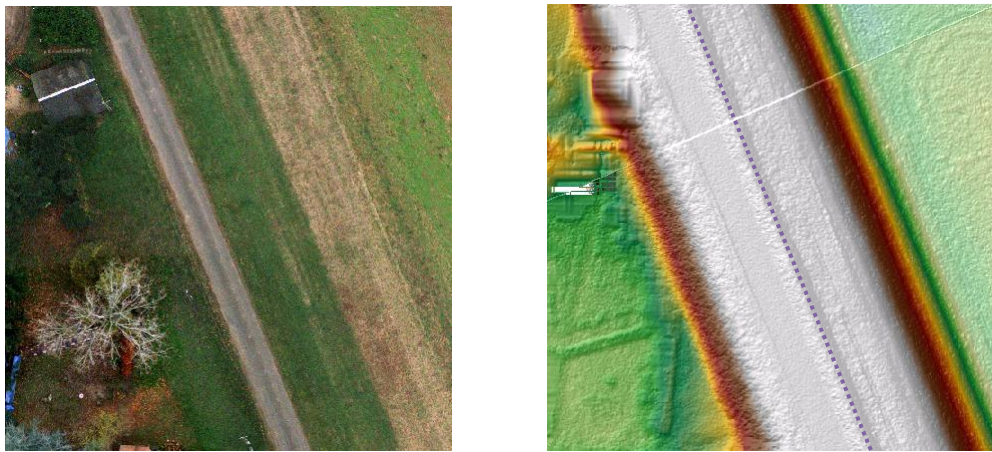

Figure 71: Levee with Earth Ridge, on Loire River Side

DSM or DTM with shadowing may be used to identify such irregularities. Works are clearly identifiable through DTM as they induce a change in the ground shape.

3. Topographic Plan Contribution

One of the topographic plan qualities is that it brings together all visible items from a given area (see I.3), and particularly structures or irregularities that are potential sources of instability risk.

iv. External Erosion and Scouring

It should be reminded that the levee being close to low-water bed bank is a risk factor with regard to external erosion caused by hydraulic stresses applied by the river, particularly during floods. Other levee sections, located where the levee-limited plain floods are narrowed, are also potentially affected by erosion risk on the river side slope. Lastly, trees, bridge piers or any construction item sticking out of the face on the river side of the dike induce a scouring risk.

1. Levee Close to Watercourse

Levees located immediately next to the low-water bed are particularly exposed to external erosion or scouring risks. Such risks may be analyzed by comparing current geo-referenced aerial photographs resulting from Lidar flight (2010) with aerial photographs stemming from previous campaigns. However, the resolution of former photographs is far lower than those provided from 2010 Lidar acquisition. Although external erosion risk was already known at the time of these campaigns, erosion attack geometry may not be determined from these photographs. Ideally, a comparison of **high resolution-only** aerial photographs taken at various points in time should be carried out to determine localized changes in erosion areas on the river side or any change in morphology. In addition, one should consider that photographic acquisitions have been performed at different times in the year, with different Loire river levels, and therefore may distort or complicate external erosion analysis on some specific areas.

Below are sample aerial photographs of levees located immediately next to low-water bed on Val d'Orléans. The compared photographs are acquisitions dating back to 2010 and 2006. Woodland growth is different on both pictures: trees have leaves on 2006 photographs, and the 2010 photograph resolution is substantially better.

From top to bottom, areas are located in Guilly, in Bouteille next to Maison Vieille, in Ouvrouer-les-Champs and in Sandillon.



Figure 72: 2006 (Left) and 2010 (Right) Aerial Photographs in Guilly



Figure 73: 2006 (Top) and 2010 (Bottom) Aerial Photographs in Location “Maison Vieille”

The tree line along the river is gone, most probably removed by man.



Figure 74: 2006 (Left) and 2010 (Right) Aerial Photographs in Ouvrouer-les-Champs

Winter photographs (2010), displaying trees without leaves hiding the works, are relevant (see below, riprap protective structure on the bank).

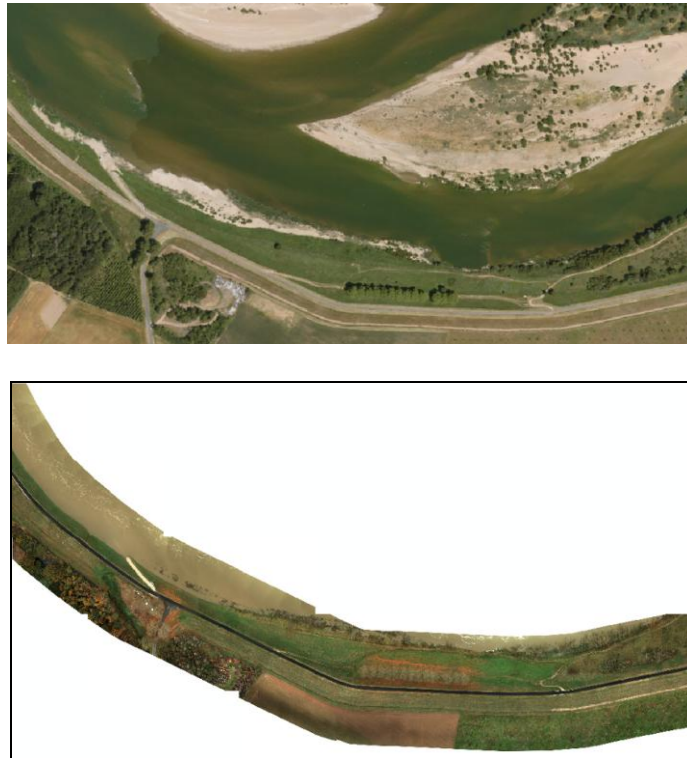

Figure 75: 2006 (Top) and 2010 (Bottom) Aerial Photographs in Sandillon

The 2010 narrow corridor does not provide any information on the river low-water bed geomorphology in front of the levee.

2. Levee Far from Watercourse

For levees that are further away from the watercourse, one should work on a smaller scale (dale) to identify, for instance, areas where the levee-limited flood plains are narrowed.

On Val d'Orléans, two areas where flood plains are narrowed may be identified between

- Ouvrouer-les-Champs and upstream Jargeau spillway;
- Sandillon and Saint-Denis-en-Val.

Either former aerial photographs or 2002 Lidar DTM of flood plains may be equally used to determine such apparently steady areas (at least as long as the levee horizontal alignment is not altered by works).

III.4 Conclusion

a) Relevance to Practice

In support of a real case of application (“Val d’Orléans” Pilot Site), our research work provide a methodology for using remote sensing LiDAR data and high-resolution aerial imagery – acquired in “dry conditions” (e.g. not in a flood context) - to contribute efficiently to a rural or urban flood defence structure diagnostic or assessment.

The main objective of our task 3.2.2 is resolutely operational: to put in practice the developed methodology, it is necessary to dispose high-resolution LiDAR data that our task deliverable “Technical specifications template for LiDAR aerial acquisition on dikes” allows to operate.

Topographic data furnished as deliverables of a LiDAR acquisition campaign are precious information tools regarding levee maintenance and operations.

b) Remaining gaps in Knowledge

Complementary means or investigation remain essential to lead to a complete assessment (or diagnostic): historical study and documentary analysis, visual inspection on field and geotechnical soundings and testings.

It should be interesting to compare topographical data recorded over time. Potential levee settlement issues or slumps would be identify through high resolution LiDAR acquisitions repeated at regular intervals, every 2 to 5 years, for instance. Considering the Z accuracy of 0.03 m in good surface conditions, the height displacement should be more than 0.05 m.

The presented methodology -both for LiDAR data acquisition terms and further utilizing data- could be adapted to emergency levee monitoring. Indeed, remote sensing LiDAR and helicopter-borne imagery, in association with extended spatial coverage and high-resolution, turns out to be potentially effective to contribute to a diagnostic during - or following - a flood event [Mériaux & Royet, 2007]. Indeed, waiting few days after a major flood allows clearing up the river side slope. So bank erosions would be characterized by LiDAR.

To complete the assessment of near watercourse located levees, a bathymetric LiDAR could be combined with the airborne traditional LiDAR to obtain data under water. The problem (for now) is that there is no available high-precision method of aerial bathymetric LiDAR essentially because the laser couldn’t cross trouble waters. So it’s still necessary to use sonar techniques to collect under water topography.