



**HAL**  
open science

## Construction of two genetic linkage maps in cultivated tetraploid alfalfa (*Medicago sativa*) using microsatellite and AFLP markers

Bernadette Julier, Sandrine Flajoulot, P. Barre, G. Cardinet, Sylvain Santoni, T. Huguet, Christian C. Huyghe

### ► To cite this version:

Bernadette Julier, Sandrine Flajoulot, P. Barre, G. Cardinet, Sylvain Santoni, et al.. Construction of two genetic linkage maps in cultivated tetraploid alfalfa (*Medicago sativa*) using microsatellite and AFLP markers. *BMC Plant Biology*, 2003, 3 (9), 19 p. 10.1186/1471-2229-3-9 . hal-02670483

**HAL Id: hal-02670483**

**<https://hal.inrae.fr/hal-02670483>**

Submitted on 31 May 2020

**HAL** is a multi-disciplinary open access archive for the deposit and dissemination of scientific research documents, whether they are published or not. The documents may come from teaching and research institutions in France or abroad, or from public or private research centers.

L'archive ouverte pluridisciplinaire **HAL**, est destinée au dépôt et à la diffusion de documents scientifiques de niveau recherche, publiés ou non, émanant des établissements d'enseignement et de recherche français ou étrangers, des laboratoires publics ou privés.

Research article

Open Access

## Construction of two genetic linkage maps in cultivated tetraploid alfalfa (*Medicago sativa*) using microsatellite and AFLP markers

Bernadette Julier\*<sup>1</sup>, Sandrine Flajoulot<sup>2</sup>, Philippe Barre<sup>1</sup>, Gaëlle Cardinet<sup>3</sup>, Sylvain Santoni<sup>4</sup>, Thierry Huguet<sup>3</sup> and Christian Huyghe<sup>1</sup>

Address: <sup>1</sup>INRA, Unité de Génétique et d'Amélioration des Plantes Fourragères, 86600 Lusignan, France, <sup>2</sup>Jouffray-Drillaud, INRA, 86600 Lusignan, France, <sup>3</sup>Laboratoire des Interactions Plantes-Microorganismes, UMR CNRS-INRA 2594/441, BP27, 31326 Castanet Tolosan cedex, France and <sup>4</sup>INRA, Station de Génétique et d'Amélioration des Plantes, Domaine de Melgueil, 34130 Maugeio, France

Email: Bernadette Julier\* - julier@lusignan.inra.fr; Sandrine Flajoulot - flajou@lusignan.inra.fr; Philippe Barre - barre@lusignan.inra.fr; Gaëlle Cardinet - cardinet@toulouse.inra.fr; Sylvain Santoni - santoni@ensam.inra.fr; Thierry Huguet - thuguet@toulouse.inra.fr; Christian Huyghe - huyghe@lusignan.inra.fr

\* Corresponding author

Published: 19 December 2003

Received: 10 October 2003

BMC Plant Biology 2003, 3:9

Accepted: 19 December 2003

This article is available from: <http://www.biomedcentral.com/1471-2229/3/9>

© 2003 Julier et al; licensee BioMed Central Ltd. This is an Open Access article: verbatim copying and redistribution of this article are permitted in all media for any purpose, provided this notice is preserved along with the article's original URL.

### Abstract

**Background:** Alfalfa (*Medicago sativa*) is a major forage crop. The genetic progress is slow in this legume species because of its autotetraploidy and allogamy. The genetic structure of this species makes the construction of genetic maps difficult. To reach this objective, and to be able to detect QTLs in segregating populations, we used the available codominant microsatellite markers (SSRs), most of them identified in the model legume *Medicago truncatula* from EST database. A genetic map was constructed with AFLP and SSR markers using specific mapping procedures for autotetraploids. The tetrasomic inheritance was analysed in an alfalfa mapping population.

**Results:** We have demonstrated that 80% of primer pairs defined on each side of SSR motifs in *M. truncatula* EST database amplify with the alfalfa DNA. Using a F1 mapping population of 168 individuals produced from the cross of 2 heterozygous parental plants from Magali and Mercedes cultivars, we obtained 599 AFLP markers and 107 SSR loci. All but 3 SSR loci showed a clear tetrasomic inheritance. For most of the SSR loci, the double-reduction was not significant. For the other loci no specific genotypes were produced, so the significant double-reduction could arise from segregation distortion. For each parent, the genetic map contained 8 groups of four homologous chromosomes. The lengths of the maps were 2649 and 3045 cM, with an average distance of 7.6 and 9.0 cM between markers, for Magali and Mercedes parents, respectively. Using only the SSR markers, we built a composite map covering 709 cM.

**Conclusions:** Compared to diploid alfalfa genetic maps, our maps cover about 88–100% of the genome and are close to saturation. The inheritance of the codominant markers (SSR) and the pattern of linkage repulsions between markers within each homology group are consistent with the hypothesis of a tetrasomic meiosis in alfalfa. Except for 2 out of 107 SSR markers, we found a similar order of markers on the chromosomes between the tetraploid alfalfa and *M. truncatula* genomes indicating a high level of colinearity between these two species. These maps will be a valuable tool for alfalfa breeding and are being used to locate QTLs.

**Background**

Alfalfa (*Medicago sativa* L.) is the most cultivated forage legume, with about 32 millions hectares over the world [1]. Its agronomical interest is based on its high protein content, suitable feeding value and favourable environmental balance (perenniality and no nitrogen fertilizer required). However the genetic progress in this species is slow because of its autotetraploidy [2], with  $2n = 4x = 32$  [3,4], its allogamy and the synthetic structure of the varieties. The development of a genetic linkage map would be a significant breakthrough, either to map candidate genes, to search for QTL of agronomical traits, or to make marker-assisted selection. Such analysis requires working on cultivated material, either in terms of genetic background or ploidy level.

In the past years, low density linkage maps were obtained on diploid forms of the *Medicago sativa* species complex [5-7]. The parental plants originated from CADL plants (Cultivated Alfalfa at the Diploid Level, diploid plants produced from cultivated tetraploid alfalfa) [6] or from natural populations, the crosses being made at the sub-specific level [5,7]. All these maps comprised from 89 to 153 RFLP, RAPD or isozymes markers, and spanned from 467.5 cM [7] to 659 cM [6]. A denser map based on a cross between *M. coerulea* and *M. quasifalcata*, was published in 2000 [8] and covered 754 cM for a haploid genome, with 868 markers (mainly RAPDs and RFLPs). A linkage map of tetraploid alfalfa was constructed with 82 RFLP markers, using two backcross populations of 101 individuals, and covered about 470 cM, with 7 homology groups only [9]. The number of polymorphic RFLP markers is clearly a limiting factor to the development of a saturated map at the tetraploid level in alfalfa.

Until recently, mapping procedures in autopolyploids plants were based on SDRF (single-dose restriction fragments) segregation in mapping populations analysed as pseudo-test crosses [10,11]. Genetic maps were obtained in autotetraploid species such as potato [12,13], alfalfa [9], tea [14], rose [15], birdsfoot trefoil [16] and in autooctoploid species such as sugar cane [17-19] and strawberry [20]. Recently, theoretical studies were published to analyse gene segregation and to perform the mapping in autotetraploid species [21-24] or even autooctoploid species [25]. All types of markers can be used: a dominant marker present in one parent in single dose (simplex or SDRF) or double dose (duplex), a dominant marker present in both parents (double simplex), and codominant markers (Figure 1). It is now possible to develop a map in autotetraploid species, based on all codominant or dominant markers, and to calculate linkage between pairs of markers, either in coupling phase or in repulsion phase. The software TetraploidMap, released in 2002 [26] is suited for this type of calculation. A

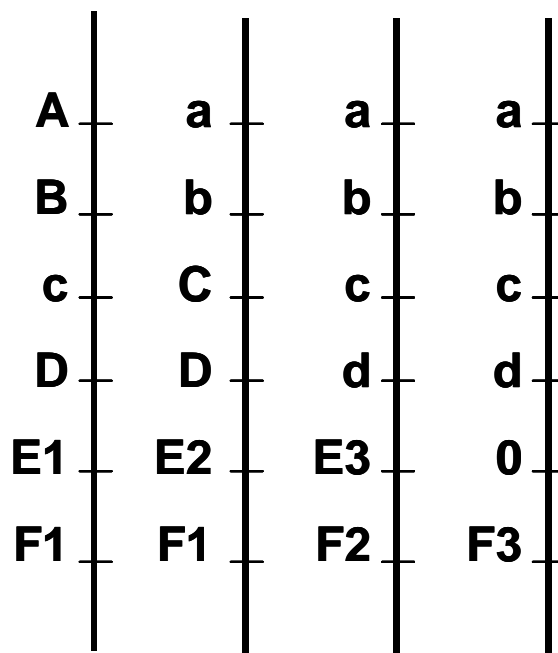

**Figure 1**  
**Marker types in an autotetraploid genotype.** Markers A, B, C and D are dominant markers. A, B and C are simple dose (simplex) and D is in double dose (duplex). A and B are linked in coupling phase, A and C or B and C are linked in repulsion phase. Loci E and F show codominant alleles in simple or double dose. A null allele is represented for locus E.

method aiming at ordering the markers into a linkage map of autotetraploid species using simulating annealing was also proposed [27], but no specific software is presently available.

In autopolyploid species, two facts are usually unknown: (1) does the whole genome show a tetrasomic inheritance, or do some parts of the genome have a disomic inheritance ? (2) what is the frequency of double-reduction ? Indeed, two sister chromatids could segregate in the same gamete after formation of a tetravalent during meiosis. Consequently, double-reduction creates new types of gametes and modifies the probabilities of each type of gametes in a segregating population [28-30]. Its frequency can be calculated by TetraploidMap software on codominant markers.

In this article, we report the construction of a genetic map for each of the parents of an F1 population obtained by crossing one individual from each of the Magali and Mercedes alfalfa cultivars and using the mass-revealed dominant AFLP markers together with codominant microsatellite (SSR) markers. We have used a set of SSRs

identified in the EST database of *Medicago truncatula* and mapped on *M. truncatula* Recombinant Inbred Lines (Huguet *et al.*, unpublished results) to construct alfalfa genetic maps. In the recent years, *M. truncatula*, an annual, diploid species of the *Medicago* genus, was chosen as a model species for the legume family [31,32]. A genetic map was recently developed using an F2 population [33] and preliminary evidence was given that diploid *M. sativa* and *M. truncatula* genetic maps were aligned. Considering the phylogenetic proximity of *M. truncatula* and alfalfa, we used these EST-based SSR, and some other SSR markers published in *M. truncatula* ([34], Santoni *et al.* unpubl.) or *M. sativa* [35], to build alfalfa linkage maps and to align all genetic maps.

Based on 599 AFLP and 107 SSR markers, we identified, for both parents, 8 groups of 4 homologous chromosomes each. The total length of the maps covered between 88 to 100% of the genome. We have numbered the homology groups of alfalfa as for *M. truncatula* [8,33].

## Results

### Mapping population

Alfalfa is an allogamous species with a strong inbreeding depression. Consequently, plants are highly heterozygous and selfing gives rise to either self-sterility or lethal allelic combinations or very "weak" plants. Homozygous lines cannot be obtained and F2 populations may suffer from a genetic bias induced by the death of some genotypes. So our mapping population is a set of 168 F1 individuals from the cross between Mercedes4.11 used as female parent and Magali2 used as male parent.

### AFLP markers

Using 27 AFLP primer pairs, a total of 599 polymorphic markers were scored on the mapping population (Table 1). Most of them segregated as simplex (Figure 1), but a large number of markers had other segregations, mainly duplex or double-simplex. Among all AFLP markers, the percentage of distorted markers reached 34.8%.

**Table 1: Segregation of polymorphic AFLP markers in alfalfa F1 mapping population from Mercedes4.11 × Magali2. Simplex and duplex markers were present in one parent, in 1 and 2 doses, respectively. Double-simplex markers were present in both parents in 1 dose. Among each type of marker, the number of distorted markers (P < 0.05) is indicated.**

	Markers present in		Total	Distorted
	Mercedes4.11	Magali2		
Simplex	196	193	389	107
Duplex	36	56	92	52
Double simplex		102	102	44
Others		16	16	
Total	350	367	599	

### SSR markers

#### Transfer of SSR to alfalfa

The SSR primer pairs mainly originated from *M. truncatula*: 35 among those developed by Santoni *et al.* ([34] and unpubl.), 1 published by Diwan *et al.* [35] and 187 obtained by Huguet *et al.* (unpubl. data). Nine SSR primer pairs were developed from an alfalfa genomic library [35] and tested on diploid and tetraploid alfalfa.

The amplification and polymorphism among the 2 parents were tested for these 232 primer pairs (Table 2). Only 19% of the primer pairs (44) gave no amplification. Over the 81% of primer pairs (187) that gave amplification, 34% (78) were monomorphic and 47% (110) were polymorphic between Magali2 and Mercedes4.1. So far, only 87 pairs have been used for genotyping in the mapping population.

#### Inheritance of SSR markers

With the 87 primer pairs (Table 3), 318 alleles (= bands) were scored, 284 of them being polymorphic in the mapping population. The parental genotypes were determined from the segregation of alleles at each locus using the "Findgeno" procedure from TetraploidMap software. The monomorphic bands were excluded from segregation analyses as a monomorphic allele is present at least in triplex dose in a parent. For 43 loci, the parental genotypes were determined, and the coefficient of double reduction ( $\alpha$ ) was not significantly different from 0 (Table 4). For 20 loci,  $\alpha$  was significantly different from 0 but the genotypes of the parents were also found under the absence of double reduction (Table 4). For 24 loci (Tables 5, 6), the parental genotypes could not be determined. The amplification of more than one locus was suspected from the visual reading of the gels (a large gap between groups of alleles was interpreted as the presence of 2 different loci, Figure 2) and from the segregation of alleles in the mapping population (i.e. the presence of individuals with more than 4 bands, or individuals with 3 alleles from the same parent). From 21 primer pairs, 41 polymorphic loci were identified, and their segregation was analysed (Table 5). The genotypes of the parents were determined, with double reduction for only 6 loci. Finally for 3 primer pairs (Table 6), a multilocus segregation was evidenced, but it was not possible to group the alleles in loci with an expected segregation. For these 3 primer pairs, the bands were treated as dominant markers to determine the parental genotypes (Table 6). For the loci that showed significant double-reduction (in Tables 4 and 5), all the F1 genotypes could have been formed without double-reduction. So the segregation of these markers in F1 is not different from segregation distortion.

Over the 104 polymorphic SSR loci with codominant segregation, the average number of alleles per locus in both

**Table 2: Amplification profiles for the 232 SSR primers pairs originating from three sources**

Source	Tested	No amplification	Monomorphic	Polymorphic	Mapped
[34], S. Santoni (unpubl.)	35	6	13	16	7
[35]	10	4	1	5	3
T. Huguet (unpubl.)	187	34	64	89	77
Total	232	44	78	110	87

parents was 2.9, and the average number of polymorphic alleles per locus was 2.6. These figures must be compared to 8 allelic positions in 2 autotetraploid parental genotypes. The number of polymorphic alleles was 183 in Mercedes4.11 (1.8 alleles per locus), and 188 in Magali2 (1.8 alleles per locus). A large number of 'null' alleles were identified as shown in Tables 4, 5, 6.

#### Map construction

All markers (simplex, duplex, double-simplex AFLPs and multi-allele SSR loci) except the distorted double-simplex AFLP markers were used to build maps. The map construction was performed in 3 steps. First, Tetraploid-Map calculated a  $\chi^2$  test of independence between markers, which led to 8 homology groups for each parent. Then within each homology group, TetraploidMap determined the linkage phase, recombination rate and LOD score between markers, whatever their dose. Linkage groups (i.e. chromosomes) within homology groups were manually identified using the linkage phase information. In both Mercedes4.11 and Magali2, for each homology group, 4 linkage groups were found, except for homology group 5 in Magali2 which had only 3 linkage groups. Finally, for each linkage group, the recombination rates and LOD scores were entered in the JoinMap software [36]. The order of the markers was calculated and the maps were drawn. For Mercedes4.11 (Figure 3), the map length was of 3045 cM, with 339 marker positions and an average distance between markers of 9.0 cM. The map of Magali2 (Figure 4) covered 2649 cM, with 350 marker positions and an average distance between markers of 7.6 cM. In both maps, the distorted markers were spread over the genome.

The repulsion linkages were distributed among each pair of chromosomes within one homology group, and this was observed for each homology group (figure 5, example for homology group 8 in Magali2).

Twenty four SSR primer pairs out of 87 gave multi-locus profiles. All the loci obtained with one primer pair were mapped close together (i.e. MTIC12-1 and MTIC12-2 in group 2, MTIC135-1 and MTIC135-2 in group 8 of

Magali2, etc.), except MTIC77-1 and MTIC77-2 which were mapped on group 8 and 3, respectively.

#### Composite map

The large number of polymorphic SSR loci made it possible to build a composite map, based on the recombination rate and LOD score for each pair of SSR markers in each homology group. Instead of 8 chromosomes per homology group for both parents, a single linkage group was obtained. The total length of the map (figure 6) reached 709 cM, with 107 loci. Conflicting linkages occurred in group 4, so this chromosome was split in 3 parts. The average distance between markers was 6.6 cM.

#### Discussion

The development of a dense genetic linkage map in cultivated tetraploid alfalfa is the first step in understanding the genetic control (QTLs) of traits of agronomic interest. Agronomic traits are not well evaluated in wild *M. sativa* because of its prostrate growth habit, so the dense map obtained in wild diploid *M. sativa* [8] can hardly be used for QTL detection of agronomic traits. As in other heterozygous species, and especially in autotetraploid ones [21], we used a F1 population for mapping. Indeed, even if a F2 generation could be a valuable tool in terms of number of recombination events, a selfing generation could lead to genetic skewing through the death of some inbred plants. We chose easy to use handy PCR markers: AFLPs and SSRs. AFLPs, because they are mass-revealed, help in covering the whole genome. SSRs mainly originated from EST databases of *M. truncatula*, are codominant, locus-specific and portable. They were previously mapped in this model species, and thus allow the analysis of synteny between the two species, alfalfa and *M. truncatula*.

#### Marker diversity and segregation in the mapping population

A large number of polymorphic markers were obtained for each AFLP primer pair. Among the two parents of the mapping population, almost 50% of the SSR primer pairs revealed polymorphism. It is noteworthy that the SSR loci, which gave amplified but monomorphic bands over the 2 parents of the mapping population, may reveal polymorphism in other genetic backgrounds, so the observed

**Table 3: Sequences of microsatellite primer pairs for each locus, linkage group (LG) in *M. truncatula* and reference. Sequences are given in the 5' to 3' direction (H for T. Huguët, unpubl.; S for S. Santoni, unpubl.)**

Locus	Left	Right	LG	Reference
AFct32	TTTTTGTCACCTCATTAG	TTGGTTAGATTCAAAGGGTTAC		[35]
AFct45	TAAAAACGGAAAGAGTTGGTTAG	GCCATCTTTCTTTTGCTTC		[35]
MTLEC2A	CGGAAAGATTCTGAATAGATG	TGGTTCGCTGTTCTCATG	3	[35]
MAW208206	CTTATGTGCGTGGTATTTCC	AGCTAAACCAACTACCTTTG	4	S
MAA660456	GGGTTTTTGATCCAGATCTT	AAGGTGGTCATACGAGCTCC	4	[34]
MAA660870	GTACATCAACAACCTTTCCT	ATCAACAAAATTCATCGAAC		S
MAL368684	GACCCTAATAACCAACTCCA	CCGTTACCGTCACTGTCGT	1	S
FMT13	GATGAGAAAAAGAAAAGAAC	CAAAAACACTCACTAACACAC	1	S
MTR58	GAAGTGGAAATGGGAAACC	GAGTGAGTGAGTGAAGAGTGC	1	[34]
MAL369471	ATTCACACAAACCCATCTTC	AAACCCTTAGCACCGACA	1	S
AI974357	ATCTCAATCCCCAACTTGC	TCTCCTTACCCATCTTTGC	3	H
B14B03	GCTTGTTCTTCTTCAAGCTC	ACCTGACTTGTGTTTTATGC	5	H
B21E13	GCCGATGCTACTAATGTAGG	AAACTTGTCTTCTCTCAG	2	H
E318681	ACCATCAACACCAACAGCAG	TGCTACTTCCGCTTTGTTC	5	H
ENOD20	CGAACTTCGAATTACCAAAGTCT	TTGAGTAGCTTTGGGTTGTC	8	H
MTIC7	ACCACTTCTCCATCCATCCA	AGCTTGCTGCATGAGTGCT		H
MTIC12	TTCTCTTTTGACTCATACCA	CAACAACATGTTTATGCTTAGAAAC	2	H
MTIC14	CAAACAACAACACAACATGG	CCCATTGATTGGTCAAGGTT	6	H
MTIC19	TCTAGAAAAAGCAATGATGTGAGA	TGCAACAGAAGAAGCAAACA	2	H
MTIC21	GGTGATTGACTGTGGTGTCC	ATCCGGTCTCCAGGTTCTA	2	H
MTIC27	CGATCGGAACGAGGACTTTA	CCCCGTTTTCTTCTCTCT	2	H
MTIC35	GAAGAAGAAAAAGATAGATCTGTGG	GGCAGGAACAGATCCTTGAA	7	H
MTIC48	TTTTTGTTAGTTTGAATTTAGGTG	GCTACAAAGTCTTCTTCCACA	5	H
MTIC51	AGTATAGTGATGAAGTGGTAGTGAACA	ACAAAACTCTCCCGGCTTT	3	H
MTIC58	CATCATTAAACAACACGGCAAT	TGCAAAACAGAAACCGAAGA	5	H
MTIC64	CCCCTTCTTTTATGTTGTGG	AACAACACAATGGCATGGA	1	H
MTIC77	TCTTCATCGTTTCTTCTATTTC	GCCGTATGGTGTGTTGATG	3	H
MTIC79	AAAATCCAAAGCCCTATCACA	AGCGTGAGATTTTCCATCG	5	H
MTIC82	CACTTCCACACTCAAACCA	GAGAGGATTTGCGGTGATGT	7	H
MTIC84	TCTGAGAGAGAGACAAACAAACAA	GGGAAAAGGTGTAGCCATTG	1	H
MTIC90	TTTTCTTCTTCAAACCCCTAACCC	GATTATCGTTGAGCGGTGGT	4	H
MTIC93	AGCAGGATTTGGGACAGTTG	TACCGTAGCTCCCTTTTCCA	6	H
MTIC94	GCTACAACAGCGCTACATCG	CAGGGTCAGAGCAACAATCA		H
MTIC95	AAAGGTGTTGGGTTTTGTGG	AGGAAGGAGAGGGACGAAAG		H
MTIC103	TGGGTTGTCCTTCTTTTTGG	GGGTGCAGAAGTTTGACCA	8	H
MTIC107	CAAACCATTTCTCCATTGTG	TACGTAGCCCCTTGCTCATT	1	H
MTIC124	TTGTCACGAGTGTTGGAATTTT	TTGGGTTGTCAATAATGCTCA	3	H
MTIC131	AAGCTGTATTTCTGATACCAAAC	CGGGTATTCCTTCTCTCCA	3	H
MTIC134	GCAGTTCGCTGAGGACTTG	CAATTAGAGTCTACAGCCAAAAACT	6	H
MTIC135	GCTGACTGGACGGATCTGAG	CCAAAGCATAAGCATTATTCA	8	H
MTIC145	CCAAAAGGGCAATTTTCTT	GCATAATTCAATACTTATCCATTC	2	H
MTIC153	TCACAACATGCAACAAAAGTGG	TGGGTGCGGTGAATTTCTGT	6	H
MTIC169	TCAAACCCTAAAACCCTTTCTC	GCGTGCTAGGTTTGAGAGGA	3	H
MTIC183	AAATGGAAGAAAGTGTCACG	TTCTTCAAGTGGGAGGTA	7	H
MTIC185	AGATTTCAATTCTCAACAACC	TCTATGATGGATACGATACGG	8	H
MTIC188	GGCGGTGAAGAAGTAAACGA	AATCGGAGAAACACGAGCAC	8	H
MTIC189	CAAACCTTTTCAATTTCAACC	ATGTTGGTGGATCCTTCTGC	3	H
MTIC210	CCAAACTGGCTGTGTTCAAA	CCGGTAAGCCTTGCTGTATG	2	H
MTIC230	GTAAGCGCCTGCTTGGACT	GAGATTCTGCCAAAATGCAA	2	H
MTIC232	TAAGAAAGCAGGTCAGGATG	TCCACAAATGTCTAAAACCA	7	H
MTIC233	GCGTAACGTAACAACATTCA	AAGGAACAATCCAGTTTTT	1	H
MTIC237	CCCATATGCAACAGACCTTA	TGGTGAAGATTCTGTTGTTG	3	H
MTIC238	TTCTTCTTAGGAATTTGGAG	CCTTAGCCAAGCAAGTAAAA	5	H
MTIC247	TTGCGCAACCTAAATTCAT	TGAGAGCATTGATTTTTGTG	1	H
MTIC248	TATCTCCCTTCTCTCTCC	GGATTGTGATGAAGAAATGG	8	H
MTIC249	TAGGTCATGGCTATTGCTTC	GTGGGTGAGGATGTGTGTAT		H
MTIC250	GCCTGAACTATTGTGAATGG	CGTTGATGATGTTCTTGATG	6	H
MTIC251	GCGATGCTATTGAGAAAAC	AAATAAACCCAAAGGACTCG	8	H

**Table 3: Sequences of microsatellite primer pairs for each locus, linkage group (LG) in *M. truncatula* and reference. Sequences are given in the 5' to 3' direction (H for T. Huguet, unpubl.; S for S. Santoni, unpubl.) (Continued)**

MTIC258	CACCACCTTCACCTAAGAAA	TGAAATTCACATCAACTGGA	1	H
MTIC272	AGGTGGATGGAGAGAGTCA	TCATGAATAGTGGCACTCAA	3	H
MTIC273	TGTTAGCAACTTTGTGATGG	TCCATTACAATACCCAGAGG	7	H
MTIC278	CTTACCCTCCACTGCTACTG	CGCATATAACAGAGGGTTTC	2	H
MTIC289	GCTGGTGTCAAAGAGGTCTA	AGATTTGAAACTGCCCTACA		H
MTIC299	AGGCTGTTGTACACCTTTG	TCAAATGCTTAAATGACAAAT	8	H
MTIC304	TTGGGCTTAATTTGACTGAT	AGCGTAAAGTAAAACCTTTC	2	H
MTIC314	TCTAATCCCAACAACACTCTT	GAAGAAGAAGCCATAGTGTA	1	H
MTIC318	TCAACCAACTCAATGCCACT	TTGTTGTGAAATGGAAAATGG	7	H
MTIC326	GATCACCTTTATGGAGTTTGAA	CGACTTCAATTGACCCCTA	4	H
MTIC331	CCCTCTTACCTCCTTTCCA	GGAAGAGAAGATGGGGTGT	4	H
MTIC332	CCCTGGGTTTTGATCCAG	GGTCATACGAGCTCCTCCAT	4	H
MTIC338	TCCCCTTAAGCTTCACTTTTTC	CATTGGTGGACGAGGTCTCT	3	H
MTIC339	CCACACAAAACACGCACTCT	GGTAGGATTGCCACGACTGT	4	H
MTIC343	TCCGATCTTGCCTCCTAAT	CCATTGCGGTGGCTACTCT	6	H
MTIC345	TCCGATCTTGCCTCCTAAT	CCATTGCGGTGGCTACTCT		H
MTIC347	TCCGATCTTGCCTCCTAAT	GGTTGAAATTGAAAGAAGAATCG	4	H
MTIC354	AAGTGCCAAAGAACAGGGTTT	AACCTACGCTAGGGTTGCAG	2	H
MTIC356	CGGCGATGGAAAATTGATAG	CCAATACAACTTTGCGTGAGA	8	H
MTIC365	ATCGGCGTCTCAGATTGATT	CGCCATATCCAAATCCAAAT	2	H
MTIC432	TGGAATTTGGGATATAGGAA	GGCCATAAGAACTTCCACTT	7	H
MTIC441	CTTCTTATCATCGCTTCC	CAGAGATTGAGAATCGAGAAG		H
MTIC446	ATAACTGGCTGAACAAATGC	TCTCCTCCACCCTCTATG	7	H
MTIC447	TCTTGTGTATCCTCCGAAC	TCCTGAGTTGTAGAGTGAGTGA	1	H
MTIC451	GGACAAAATTGGAAGAAAAA	AATTACGTTTGTGGATGC	2	H
MTIC452	CTAGTGCCAACACAAAAACA	TCACAAAACCTGCATAAAGC	2	H
MTIC470	GGTTCGTGATTTGTTTCGAT	CCCTTCACAGAATGATTGAT	7	H
MTIC471	ATCAGGTGATGATTGGTTTT	CCAACCATCTTTGTTTCCTA		H
MTIC475	GGATTGAAATGCACTCTCTC	TTAATAAACGCCGCTCCT	3	H

variability in our experiment is only an underestimated value of the extent of the variability existing within alfalfa cultivars.

Interestingly, the two parents of the mapping population shared the same characteristics: the number and proportion of simplex, duplex, double-simplex and distorted AFLP markers and the number of SSR alleles (1.8 alleles per locus and per parent).

A large number of null alleles were found with SSRs, possibly arising from mutations in alfalfa compared to *M. truncatula* in the sequences that match the SSR primers. The number of null alleles using SSR primers directly developed in alfalfa should be lower. Indeed, there was only one null allele in this mapping population for each of both SSR markers developed in alfalfa (AFct32 and AFct45). In *Prunus* [38] and sugar beet [39] a large number of null alleles were also identified when using SSR markers from different species.

Some SSR primer pairs (21 over 87) gave multi-locus amplification in alfalfa; this was also observed in soybean [37], *Prunus* sp [38], *Brassica* sp [39], sorghum [41], mungbean and lablab [42]. Multi-locus amplification was

evidenced from allele segregation in the mapping population. This can result from the duplication of zones of genome during the evolution between *M. truncatula* and *M. sativa*.

#### Mapping in alfalfa

Using the AFLP and SSR markers, distorted or not, we identified 8 groups of homologous chromosomes in each parent, each but one group with 4 chromosomes. The homologous status of the chromosomes was established by the codominant SSR loci and the repulsion linkages.

We obtained longer and more saturated maps with AFLPs and SSRs (662 and 761 cM for the haploid genome in Magali2 and Mercedes4.11, respectively) in the tetraploid cultivated alfalfa than in the previously published research with only RFLPs (470 cM for the haploid genome) [9]. Furthermore our map lengths were close to what was obtained in diploid alfalfa [8], with 754 cM.

We propose a portable reference map built with only SSR loci. It spans 709 cM for the haploid genome, covering 94% of the genome of diploid alfalfa [8]. The average distance between markers is 6.6 cM. A limited number of SSR

**Table 4: Characteristics of 63 SSR loci with tetrasomic inheritance. Are indicated: total number of alleles, number of polymorphic alleles, expected genotypes of the parents as determined by TetraploidMap software in alfalfa F1 mapping population from Mercedes4.11 × Magali2 (the non segregating bands in F1 were not considered), double reduction coefficient ( $\alpha$ ) and its statistical significant (LR). '0' indicated null allele. The letter indicating the allele (A-G) was attributed from the lowest to the highest molecular weight.**

Locus	Total number of alleles	Number of polymorphic alleles	Genotype of		Double reduction $\alpha$	LR test <sup>1</sup>	Remark
			Mercedes4.11	Magali2			
<b>Loci with non significant double reduction</b>							
FMT13	3	3	ABBC	AABB	0.00	0.00	
MAW208206	1	1	0000	AA00	0.02	0.04	
MAA660456	4	4	ABBC	ABCD	0.00	0.00	
MAL368684	3	3	ABC0	C000	0.00	0.00	
E318681	2	1	0000	B000	0.13	0.59	Allele A monomorphic, present in both parents
MTIC27	2	2	AAB0	AA00	0.14	1.27	
MTIC35	2	1	B000 or BB00	BB00 or B000	0.04	0.17	Allele A monomorphic, present in both parents
MTIC58	2	1	0000	A000	0.07	0.22	Allele B monomorphic, present in both parents
MTIC64	3	2	A000	AC00	0.03	0.10	Allele B monomorphic, present in both parents
MTIC79	3	2	AB00	0000	0.00	0.00	Allele C monomorphic, present in both parents
MTIC90	1	1	A000	0000	0.02	0.02	
MTIC95	3	3	AACC	AABC	0.00	0.00	
MTIC103	4	4	ACDD	BDD0	0.00	0.00	
MTIC124	3	3	AACC	AB00	0.05	0.63	
MTIC131	4	4	BCD0	ABD0	0.00	0.00	
MTIC145	3	3	0000	ABC0	0.00	0.00	
MTIC169	3	3	BC00	AA00	0.00	0.00	
MTIC189	5	5	ACD0	ABDE	0.00	0.00	
MTIC210	3	3	AABC	AABC	0.05	0.53	
MTIC232	2	1	B000	0000	0.00	0.00	Allele A monomorphic, present in both parents
MTIC237	2	1	B000	0000	0.12	0.61	Allele A monomorphic, present in both parents
MTIC247	2	2	AAB0	AA00	0.03	0.07	
MTIC248	3	3	BC00	A000	0.16	0.76	
MTIC272	3	2	CC00	BC00	0.01	0.02	Allele A monomorphic, present in both parents
MTIC289	4	3	0000	ACD0	0.00	0.00	Allele B monomorphic present in both parents
MTIC299	3	3	CC00	ABC0	0.00	0.00	
MTIC314	2	1	0000	B000	0.00	0.00	Allele A monomorphic, present in both parents
MTIC318	2	1	B000	0000	0.15	0.91	Allele A monomorphic, present in both parents
MTIC332	3	3	AAB0	ABC0	0.00	0.00	
MTIC338	3	2	C000	BBCC	0.03	0.26	Allele A monomorphic, present in Mercedes4.11
MTIC339	3	2	BC00	B000	0.00	0.00	Allele A monomorphic, present in both parents
MTIC343	4	4	BBCD	ABDD	0.00	0.00	
MTIC345	5	5	BCDE	AADD	0.00	0.00	
MTIC347	3	2	AA00	C000	0.05	0.40	Allele B monomorphic, present in both parents
MTIC354	4	4	ABCD	AABC	0.00	0.00	
MTIC356	2	1	0000	A000	0.16	2.13	Allele B monomorphic, present in both parents
MTIC365	4	4	ABCD	ABCC	0.00	0.00	
MTIC441	1	1	A000	0000	0.00	0.00	



**Table 4: Characteristics of 63 SSR loci with tetrasomic inheritance. Are indicated: total number of alleles, number of polymorphic alleles, expected genotypes of the parents as determined by TetraploidMap software in alfalfa F1 mapping population from Mercedes4.11 × Magali2 (the non segregating bands in F1 were not considered), double reduction coefficient ( $\alpha$ ) and its statistical significant (LR). '0' indicated null allele. The letter indicating the allele (A-G) was attributed from the lowest to the highest molecular weight. (Continued)**

MTIC446	3	2	B000	C000	0.06	0.32	Allele A monomorphic, present in both parents
MTIC451	5	5	ABCD	ABCE	0.00	0.00	
MTIC470	2	1	A000	0000	0.00	0.00	Allele B monomorphic, present in both parents
MTIC471	2	2	AAB0	A000	0.00	0.00	
MTIC475	2	1	0000	B000	0.00	0.00	Allele A monomorphic, present in both parents
<b>Loci with significant double reduction</b>							
Afct32	6	6	BCDF	ABE0	0.01	77.5	
Afct45	4	4	ABBD	AAC0	0.01	24.75	
B14B03	3	3	CC00	AB00	0.02	49.09	
MAA660870	5	5	ACDE	ABE0	0.04	46.20	
MAL369471	3	3	AABC	AA00	0.07	5.97	
MTR58	4	4	AAC0	BD00	0.01	98.04	
ENOD20	6	6	ADEF	BCE0	0.01	3.85	
MTIC7	2	2	AB00	BB00	0.04	20.69	
MTIC14	3	2	BC00	BB00	0.16	4.82	A monomorphic, present in both parents
MTIC94	2	1	0000	AA00	0.16	5.09	B monomorphic, present in both parents
MTIC153	4	4	ABC0	BCD0	0.15	39.4	
MTIC230	4	4	BCD0	AD00	0.16	7.69	
MTIC233	3	3	BC00	A000	0.04	142.2	
MTIC249	2	2	BB00	AB00	0.08	61.48	
MTIC251	4	4	BC00	AAD0	0.07	78.00	
MTIC273	3	3	AAB0	ABC0	0.00	6.71	
MTIC326	4	3	D000	AC00	0.14	66.21	B monomorphic, present in both parents
MTIC331	2	1	0000	BB00	0.03	49.70	A monomorphic, present in both parents
MTIC432	5	5	ABC0	ACDE	0.01	46.20	
MTIC447	3	2	AC00	0000	0.16	50.99	B monomorphic, present in both parents

<sup>1</sup> A LR test lower than a  $\chi^2$  with 1 df (3.84) is not significant at P = 0.05

markers spread on the whole genome can be chosen to build maps in other populations.

The dense maps including AFLPs will be valuable for an accurate QTL analysis in our population. The composite SSR map will be useful to compare QTL position in different populations.

As in published diploid and tetraploid alfalfa maps [43], we have found that AFct32 and MTLEC2A markers were mapped on the same chromosome (group 3) and AFct45 on another chromosome (group 8).

**Autotetraploidy in alfalfa**

Codominant markers are adequate tools to test the autotetraploid structure of the genome [22]. This study is the first demonstration of the tetrasomic inheritance of

chromosomes in alfalfa, using SSR markers. This autotetraploidy pattern is confirmed by the repulsion linkages between markers belonging to all homologous chromosomes. Recently in alfalfa, a preferential chromosome pairing at meiosis was found with RFLP markers in a F1 population [44]. We can hypothesize that this result originates from a choice of mapping population parents that are genetically distant (a non-dormant genotype of *M. sativa* and a very dormant genotype related to *M. falcata*).

In our study, some loci showed a significant double reduction frequency. Nevertheless, genotypes only originating from double-reduction were not found. The double-reduction obtained here is not different from a segregation distortion. The rate of double-reduction in alfalfa is presumably low, so its detection would require the

**Table 5: Characteristics of 41 SSR loci produced by 21 primer pairs showing multilocus segregation. Are indicated: total number of alleles, number of polymorphic alleles, expected genotypes of the parents as determined by TetraploidMap software in alfalfa F1 mapping population from Mercedes4.11 × Magali2 (the non segregating bands in F1 were not considered), double reduction coefficient ( $\alpha$ ) and its statistical significant (LR). '0' indicated null allele**

Locus	Total number of alleles	Number of polymorphic alleles	Genotype of		Double reduction $\alpha$	reduction LR test <sup>1</sup>	Remark
			Mercedes4.11	Magali2			
AI974357-1	4	4	CCD0	AB00	0.00	0.00	
AI974357-2	2	2	FF00	EE00	0.04	0.19	
B21E13-1	1	1	A000	A000	0.13	0.90	
B21E13-2	4	4	CDE0	BCCD	0.00	0.00	
B21E13-3	1	1	F000	0000	0.00	0.00	
MTIC12-1	4	4	ABCC	ABCD	0.00	0.00	
MTIC12-2	2	2	E000	EF00	0.02	0.02	
MTIC19-1	3	3	AA00	AABC	0.00	0.00	
MTIC19-2	2	2	DE00	0000	0.07	0.55	
MTIC19-3	1	1	F000	0000	0.04	0.06	
MTIC48-1	4	4	A000	BCD0	0.00	0.00	
MTIC48-2	1	1	EE00	0000	0.14	2.17	
MTIC51-1	3	3	ABC0	ABC0	0.09	39.05	
MTIC51-2	2	2	DE00	0000	0.04	0.19	
MTIC77-1	2	2	0000	AB00	0.02	0.05	
MTIC77-2	4	4	CDEF	CDDE	0.00	0.00	
MTIC77-3	1	1	G000	0000	0.07	0.22	
MTIC82	3	1	C000	0000	0.16	2.59	Alleles A and B monomorphic, present in both parents
MTIC84-1	1	1	0000	A000	0.00	0.00	
MTIC84-2	4	4	BCE0	DD00	0.00	0.00	
MTIC84-3	1	1	0000	F000	0.09	0.30	
MTIC93	3	1	C000	0000	0.15	0.89	Alleles A and B monomorphic, present in both parents
MTIC107	3	2	AA00	AAC0	0.05	3.78	Allele B monomorphic, present in both parents
MTIC134-1	5	5	BCE0	AD00	0.04	63.0	
MTIC134-2	2	2	F000	G000	0.00	0.00	
MTIC135-1	2	2	B000	AB00	0.00	0.00	
MTIC135-2	2	2	CD00 or CDD0	CDD0 or CD00	0.12	0.77	
MTIC135-3	1	1	E000	0000	0.00	0.00	
MTIC183-1	5	5	ACDE	BC00	0.02	43.74	
MTIC183-2	1	1	0000	F000	0.00	0.00	
MTIC185	3	2	B000	BC00	0.16	0.12	Allele A monomorphic, present in both parents
MTIC188-1	3	3	B000	AC00	0.06	0.63	
MTIC188-2	4	4	DEG0	DF00	0.00	0.00	
MTIC238-1	3	3	AACC	ABC0	0.16	57.67	
MTIC238-2	3	3	DEF0	FF00	0.03	5.18	
MTIC250-1	2	2	B000	AABB	0.00	0.00	
MTIC250-2	2	2	0000	CD00	0.10	1.28	
MTIC258	4	2	0000	AD00	0.16	22.9	Alleles B and C monomorphic, present in both parents
MTIC304	4	3	BBDD	ABDO	0.00	0.00	Allele C monomorphic, present in both parents
MTLEC2A-1	2	2	0000	AB00	0.00	0.00	
MTLEC2A-2	2	1	0000	D000	0.00	0.00	Allele C monomorphic, present in both parents

<sup>1</sup> A LR test higher than a  $\chi^2$  with 1 df (3.84) is significant

**Table 6: Segregation of the alleles obtained from three SSR primer pairs showing suspected multilocus segregation. Are indicated: total number of alleles, number of polymorphic alleles, expected genotypes of the parents as determined by the segregation of each allele**

Primer pair	Total number of alleles	Number of polymorphic alleles	Mercedes	Magali	Remark
MTIC452	7	7	ADEF	BCDFG	
MTIC21	6	6	BCE	ADF	
MTIC278	4	3		BCCD	Allele A monomorphic, present in Mercedes4.11

analysis of a large population. This result is in accordance with the observation of meiosis in alfalfa, which shows a low proportion of tetravalent formation [45]. Nevertheless, in mapping procedures, double reduction cannot be taken into account [23].

**Segregation distortion**

The segregation distortion reached 35% over the AFLP markers. The double-simplex and the duplex were more frequently distorted than the simplex markers. For the SSRs, considering the loci showing significant double reduction as distorted loci, the proportion of distortion was 25% (26 loci over 104). These rates of distortion are similar to that obtained in *M. truncatula* [33] or in diploid alfalfa [5-7]. But in tetraploid alfalfa, Brouwer and Osborn [9] obtained a segregation distortion of only 5.5% for the simplex RFLP alleles, and stated that the autotetraploidy could reduce the effect of deleterious alleles that cause distorted segregation. However, the restriction of the segregation distortion analysis to the simplex alleles could result in an optimistic view of the distortion. The random repartition of the distorted markers over our maps showed that no alfalfa genome region was particularly distorted contrarily to the situation in the *M. truncatula* genome [33].

**Transfer of SSR markers**

More than 80% of the SSR markers initially developed in the legume model species *M. truncatula* gave amplification products in alfalfa. This capacity to give rise to amplification in these species is not surprising since they belong to the same genus. Indeed, such transfers have already been reported across annual and perennial species of *Medicago* genus for 4 markers [43] and very recently for 89% of a set of 455 primer pairs developed from EST of *M. truncatula* [46]. The transfer of SSR markers among species within some genera has already been obtained in *Glycine* sp [37], *Prunus* sp [38] and *Brassica* sp [39], in the three cases with SSRs isolated from genomic DNA. The high level of SSR transferability allows the use of a large number of SSRs from public *M. truncatula* EST on alfalfa.

**Comparison with *M. truncatula* map**

Over the 94 SSR loci mapped on both *M. sativa* and *M. truncatula*, all but 2 were gathered in the same groups (T. Huguet, unpublished data) suggesting that no major chromosome rearrangement had occurred since the species differentiation. Unexpected mapping was obtained for (1) MTIC272 was mapped in group 3 of *M. truncatula* but group 6 in Magali2 and (2) MTIC77-1, a marker only present in Magali2 was mapped in group 8, although MTIC77-2 was mapped in group 3 in both parents as in *M. truncatula*. Eight SSRs could not be mapped, due to insufficient linkage with other markers (MTIC35, B21E13-1, B21E13-3, MTIC77-3, MTIC84-1, MTIC230 and MTIC356). Some SSR markers that were not mapped in *M. truncatula* because of the absence of polymorphism in mapping populations, were mapped in alfalfa: MTIC95 (group 1), MTIC7 (group 3), MTIC94 (group 4), MTIC289 and MTIC471 (group 7).

The order of SSR markers along chromosomes is very well conserved between tetraploid alfalfa and *M. truncatula* (T. Huguet, unpubl. data). The cases of misalignment can be explained by a lack of accuracy in the recombination rate estimation. Indeed a recombination rate has a standard error which varies with the size of the mapping population, the recombination rate and the type and phase of the pairs of markers [21]. In autotetraploid species, for a F1 mapping population of 168 individuals, the standard

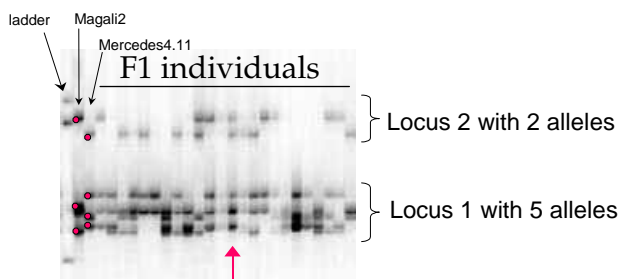

**Figure 2**  
**Amplification pattern obtained with one primer pair (MTIC134), showing 2 loci.** The arrow indicates one F1 individual with 5 alleles. The red dots are for each allele in both parents.

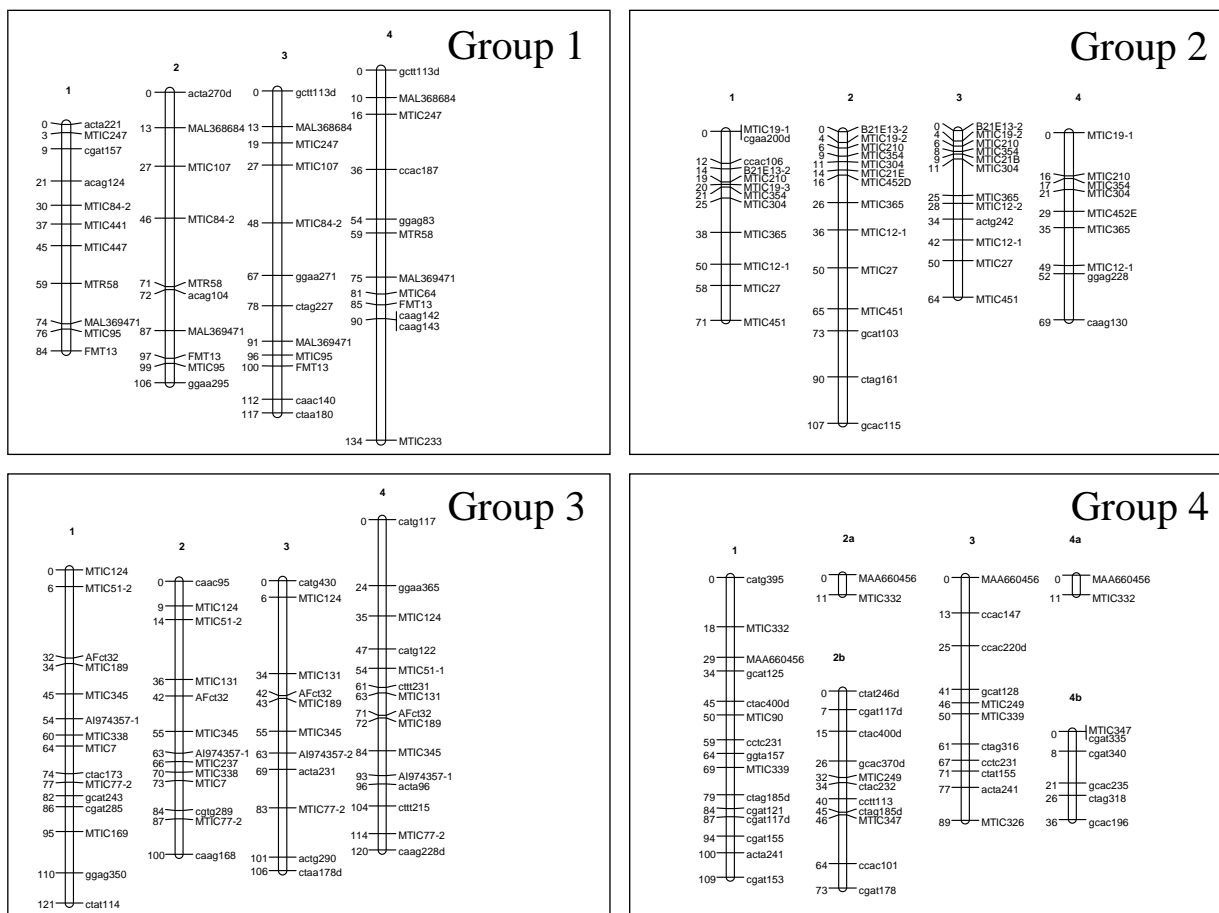

**Figure 3**  
**Genetic linkage map of Mercedes4.II, homology groups 1 to 4.** Mercedes4.II is the female parent of a F1 mapping population in tetraploid alfalfa. Each box contains the homologous chromosomes of one group. The groups were numbered similarly to *M. truncatula* (T. Huguet, unpublished data) and diploid *M. sativa* (G. Kiss, pers. comm.). The chromosomes within each group were arbitrarily numbered from 1 to 4 and are orientated as in *M. truncatula*. When JoinMap software split the map of one chromosome in 2 or 3, each linkage group was named by the number followed by a letter. The number to the left of the chromosomes refers to the genetic distances (Kosambi cM) from the top. The number to the right of the chromosomes refers to the marker names. The SSR markers are in upper-case and the AFLPs in lower-case letters. AFLP markers followed by "d" had a distorted segregation. When several SSR loci came from a single primer pair, their names were composed of the name of the primer pair followed by a number.

error of a recombination rate of 0.2 is 0.03 for two simplex markers and 0.07 for a simplex and a duplex, both in coupling phase. This synteny is a very positive point for the future use of *M. truncatula* genomics for genetic studies in cultivated tetraploid alfalfa.

The comparison of the alfalfa maps with that of *M. truncatula* using the SSR markers indicates that chromosomes 1, 2, 6 and 8 are well covered with markers regularly spaced all along *M. truncatula* homologous

chromosomes, but clearly more markers are needed on group 4, and on the upper parts of groups 3, 5 and 7.

We were surprised to note that the haploid genome map length in a F2 population of *M. truncatula* was about 2 times larger than our map on tetraploid alfalfa (1225 vs 709 cM), although DNA content of haploid genome was 1.5 times less in *M. truncatula* than in tetraploid alfalfa [47].

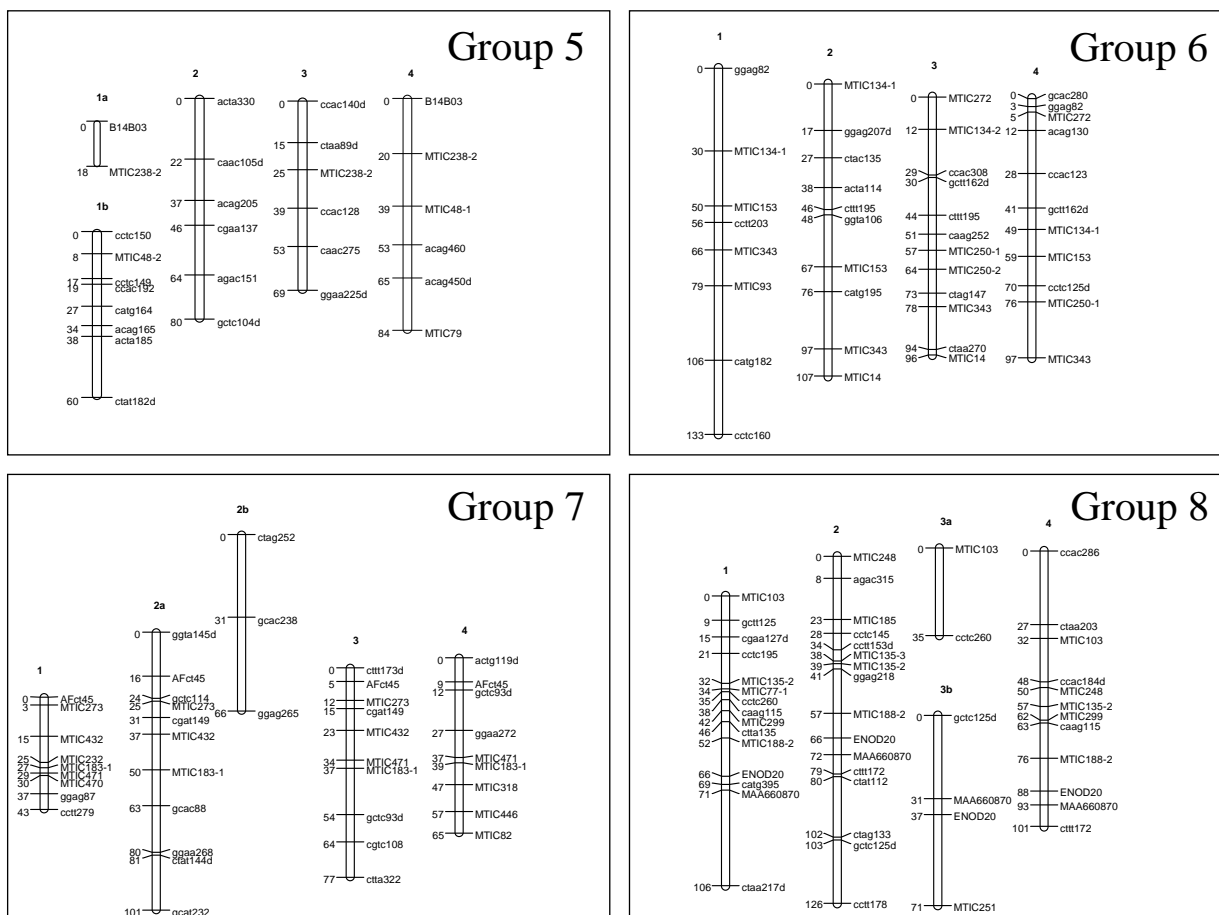

**Figure 4**  
Genetic linkage map of Mercedes4.11, homology groups 5 to 8. See legend in Figure 3.

**Conclusions**

We have obtained genetic linkage maps of cultivated tetraploid alfalfa using a combination of AFLP and SSR markers, with length and marker density close to saturation. Their comparison to *M. truncatula* maps through the common SSR markers reflects the synteny between these two species. The inheritance of the codominant SSR markers indicates a true autotetraploidy of alfalfa, with complete random pairing of chromosomes at meiosis. The orders of the markers on the chromosomes are very similar. The use of such maps to identify QTLs for agronomical traits is in progress in our laboratory.

**Methods**

**Mapping population**

The two parental plants were selected within the numerous alfalfa varieties bred in France. One originated from the Provence type cultivar Magali, and was named

Magali2. This genotype was previously used in a diallel crossing design [48] and has high general combining ability for forage digestibility and plant height. The other plant, Mercedes4.11, originates from the high yielding Mercedes cultivar, and was kindly provided by B. Bayle, from Limagrain Genetics company. It was selected after 2 cycles of selection for increased disease (*Verticillium albo-atrum*), pest (*Ditylenchus dipsaci*) and lodging resistance. In year 1999, the two plants were manually crossed, with Mercedes4.11 as the female parent. The flowers were castrated before stamina dehiscence, and the style was cleaned with alcohol at 70% to remove any pollen grains. The pollen of Magali2 flowers was harvested on a brush and applied on the style of female plant. A total of 236 seeds was harvested. In year 2000, a subset of 168 plants out of 230 germinated seeds, was randomly taken to represent the F1 mapping population.

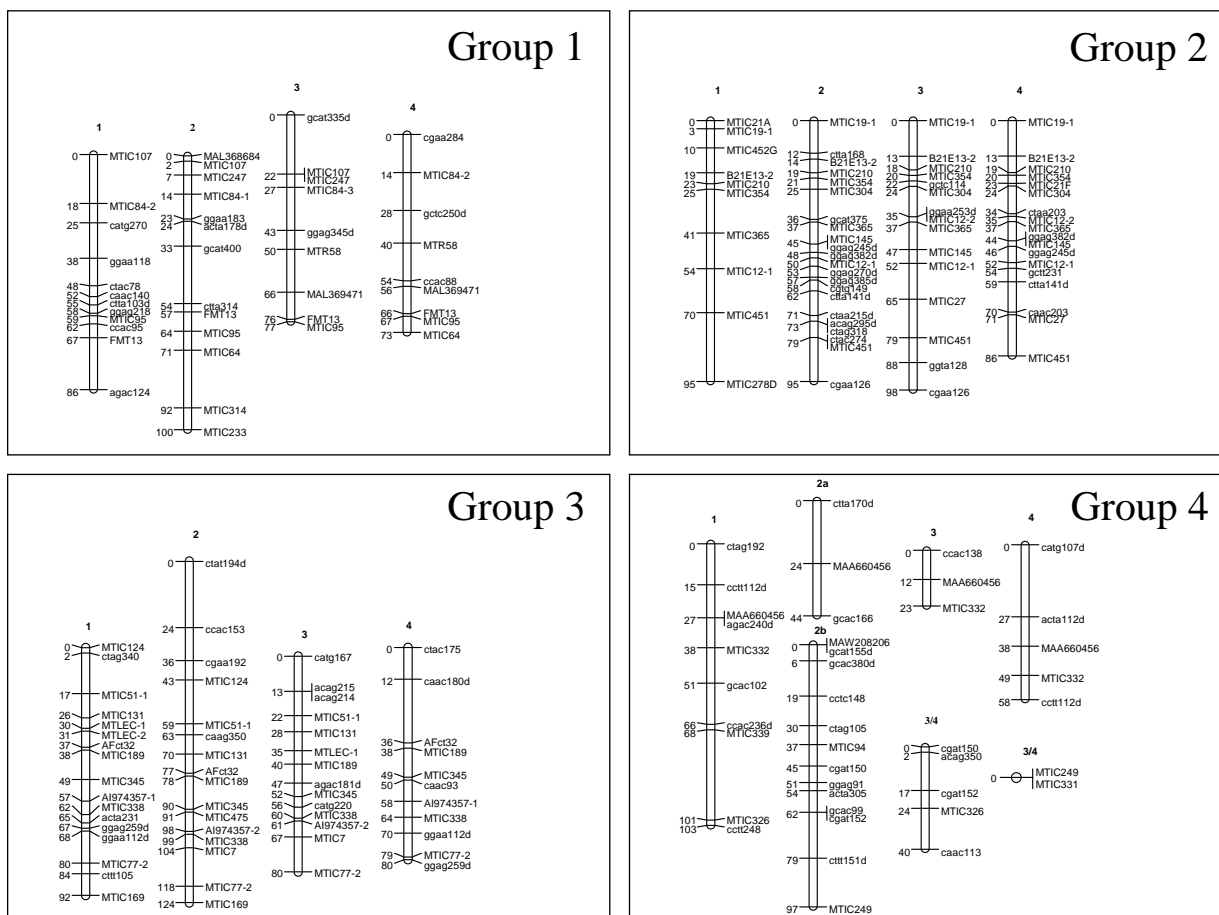

**Figure 5**  
**Genetic linkage map of Magali2, homology groups 1 to 4.** Magali2 is the male parent of a F1 mapping population in tetraploid alfalfa. See legend in Figure 3. In group 4, the linkage group numbered "3/4" indicated that it was linked to both chromosomes 3 and 4.

**DNA extraction**

Young leaflets were harvested on each plant, and DNA was extracted using a standard CTAB (hexadecyltrimethylammoniumbromide) procedure [49].

**AFLP markers**

AFLP analysis [50] was performed with the Gibco Brl kit AFLP™ Analysis System I, as recommended by the manufacturer, with some modifications designed to optimize the readability of the gels. Pre-amplification products were diluted 1:10 in water instead of 1:50. For some primer pairs, selective amplifications were performed with <sup>33</sup>P-labeled EcoRI selective primers as recommended by Gibco Brl. Reaction products were separated on 6% denaturing polyacrylamide sequencing gel with a 1X TBE buffer with 7 M urea. Electrophoresis was

performed at 85 W, for approximately 3 h 30 min, on a 38 × 53 cm gel apparatus. The gel was subsequently placed for 3 h at 75°C in a gel dryer and exposed to a Kodak Biomax MR X-ray film for 2–5 days.

For primer pairs analyzed without 5'-end-labeled EcoRI primer, products from selective amplifications were separated on denaturing polyacrylamide sequencing gels as above and visualized using a silver staining method [51].

Each AFLP marker was identified by the last 2 nucleotides of the two primers, followed by a number according to the size of the band. Only polymorphic bands were scored. Three cases of polymorphism were considered: bands present in Magali2 and absent in Mercedes4.11, bands absent in Magali2 and present in Mercedes4.11, and

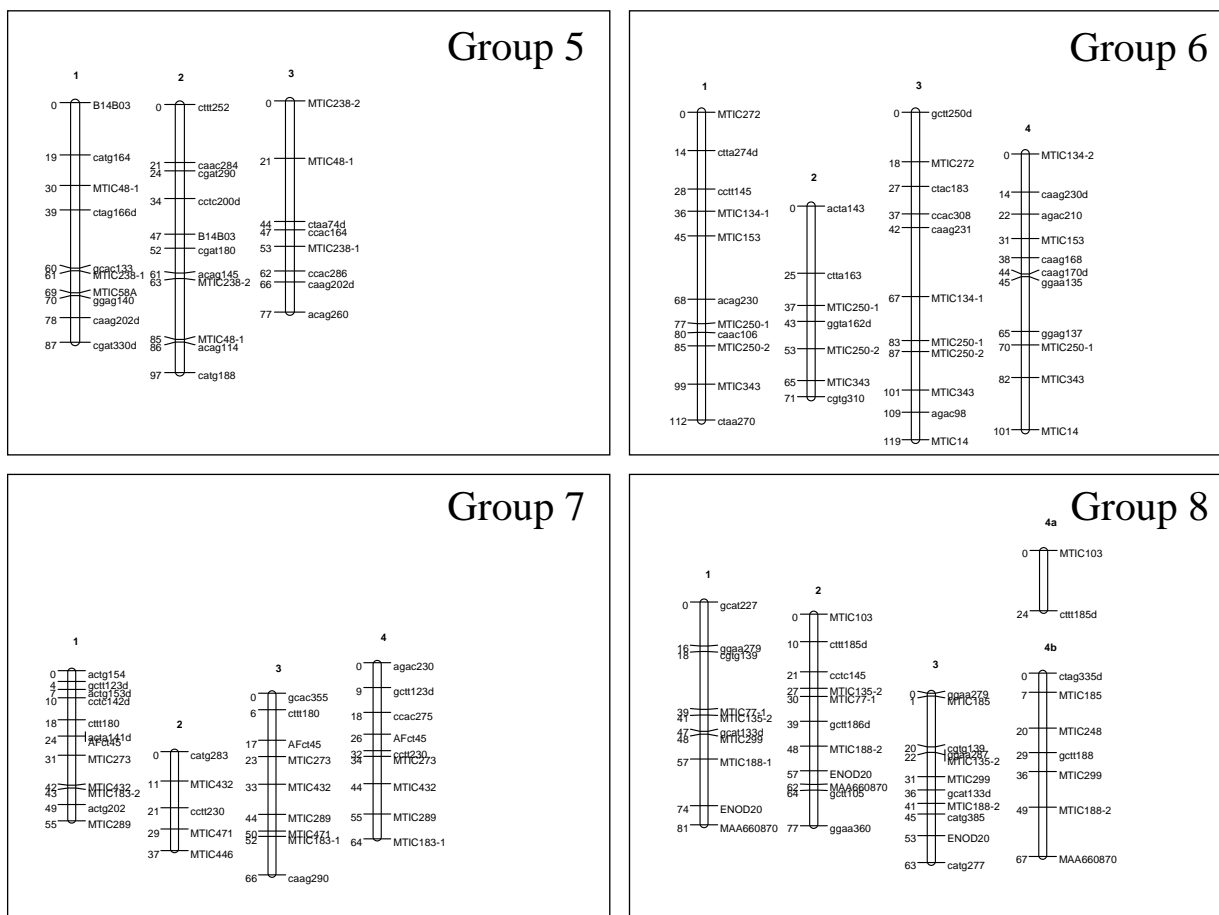

**Figure 6**  
Genetic linkage map of Magali2, homology groups 5 to 8. See legend in Figure 3.

bands present in both parents and segregating in the population. Twenty-seven AFLP primer pairs were used to genotype the whole population.

**Microsatellite markers (SSRs)**

The 232 SSR loci tested originated from 3 sources: 10 SSR markers published by Diwan et al [35], 35 from a SSR-enriched bank made on the model species *M. truncatula* [34], S. Santoni, unpublished data), and 187 SSR markers developed in *M. truncatula* from the public EST database (T. Huguet, unpublished data).

For SSR markers published by Diwan et al [35], PCR reactions were performed as described by the authors and amplification products were visualized using a silver staining method. For the other SSR loci, PCR products were revealed using silver staining method or a LI-COR IR<sup>2</sup> automated sequencer. For silver staining, PCR reac-

tions were performed in a final volume of 20 µl in a MJ Research model PTC-100 thermocycler. The reaction buffer contained 37.5 ng of template DNA, 0.2 mM of each deoxynucleotide, 1.5 mM MgCl<sub>2</sub>, 0.4 µM of each primer, and 0.5 unit of Platinum Taq DNA polymerase (Gibco Brl). An initial Taq polymerase activation step of 4 min at 94 °C, followed by a step of 35 cycles with 30 sec at 94 °C, 1 min at 55 °C and 1 min at 72 °C, plus a final elongation step of 7 min at 72 °C were performed. The PCR products were then separated on denaturing polyacrylamide sequencing gel as for AFLP markers. For the sequencer, 3 primers were used: the primer pairs (0.4 µM each) with one primers synthesized with a M13 forward or reverse primer sequence on the 5'-end, and one IRD-labelled M13 primer (0.4 µM). The M13 primer was added to the PCR product during the first few cycles of amplification. The labelled M13 primer was incorporated in subsequent cycles, thus labelling the PCR products. The

other PCR conditions were the same as for silver staining. The amplification products were separated on 6.5% denaturing polyacrylamide gel (LI-COR) as recommended by LI-COR.

From test experiments on the 2 parental plants plus 2 F1 plants, we classified the markers as showing no amplification (or a non specific amplification showing a multi-banding profile), showing amplification but with a monomorphic profile, and showing amplification with polymorphic profiles. The whole mapping population was then genotyped for 87 of these SSR loci.

#### **Marker detection and inheritance**

We used the "Findgeno" subroutine from the TetraploidMap software [26]. It gives the segregation type for each marker. The distorted AFLP markers were thus identified. For the SSR markers, the autotetraploid inheritance was tested. The software identifies the parental genotypes, from the phenotypes of the parents and of the F1 plants at each locus, without or with double reduction. For 24 loci, the number of alleles exceeded 4 for some F1 individuals, and the gels patterns clearly indicated that 2 or 3 loci were amplified (Figure 2). In these cases, several loci were scored for each primer pair and the segregation was analysed as described above. The locus names were thus composed of the name of the primer pair followed by a number (i.e. MTIC84-1 and MTIC84-2). When the parental genotype identification failed, the alleles amplified by the primer pairs were scored as dominant markers.

#### **Map construction**

The "Cluster" subroutine of the TetraploidMap software was used to create groups of markers that do not segregate independently. We wanted to obtain 8 groups with many markers, according to the number of base of chromosomes in alfalfa. We had to ask for 9 to 11 groups, as 1 to 3 of the groups had very few markers, and so had to be discarded. All the markers were included, distorted or not, except the AFLP markers present in both parents that did not segregate in 3:1 ratio.

Then for each homology group, the linkage for each pair of markers was analyzed ("Twopoint" subroutine). The markers can be unlinked, linked in a coupling phase or linked in a repulsion phase. A linkage was considered only if the LOD score was above 2. From the linkage analysis, the markers that composed each linkage group (chromosome) in each homology group were identified. The Twopoint procedure produced an output file containing the recombination rate and the LOD of each pair of markers. The order of the markers on each chromosome was determined using JoinMap 3.0 software [36], using the output file of the Twopoint procedure. We used the Kosambi distance, and the default parameters of JoinMap.

The alfalfa map was accepted if the  $\chi^2$  test in JoinMap was low, and so, some AFLP markers were excluded.

A composite map was built with only the SSR loci. The SSR previously assigned to the groups of homologous chromosomes, and the recombination rates between pairs of loci were used to build the map of each group using JoinMap. Three parameters of JoinMap were changed: "the number of maximum linkages to show per locus" was decreased from 2 to 1, "use linkage with REC smaller than" was changed from 0.40 to 0.49 and "LOD larger than" was changed from 1 to 0.5.

The cover of the maps was calculated by the ratio between the length of our maps and the length of the dense map of diploid alfalfa [8] (754 cM).

#### **Author's contributions**

BJ carried out the statistical and mapping analyses and drafted the manuscript, SF carried out most molecular analyses, TH, GC and SS provided information on *M. truncatula* SSR markers and contributed to the comparisons of alfalfa and *M. truncatula* maps, PB gave technical advice and contributed to the design of the study, CH coordinated the study and contributed to the discussion. All authors read and approved the manuscript.



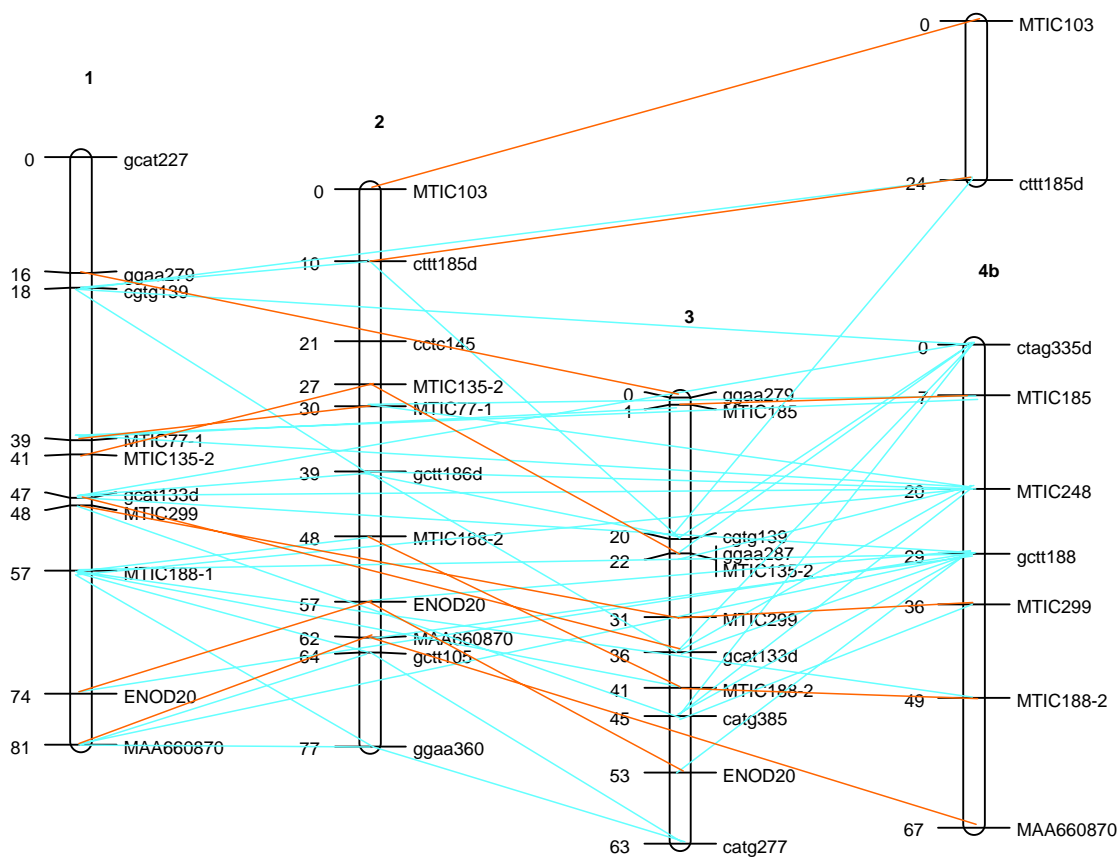

**Figure 7**  
**Repulsion linkages in the homology group 8 of Magali2 parent.** The red lines indicate alleles of a common SSR locus or duplex AFLP markers, and the blue lines show the repulsion linkages between markers.

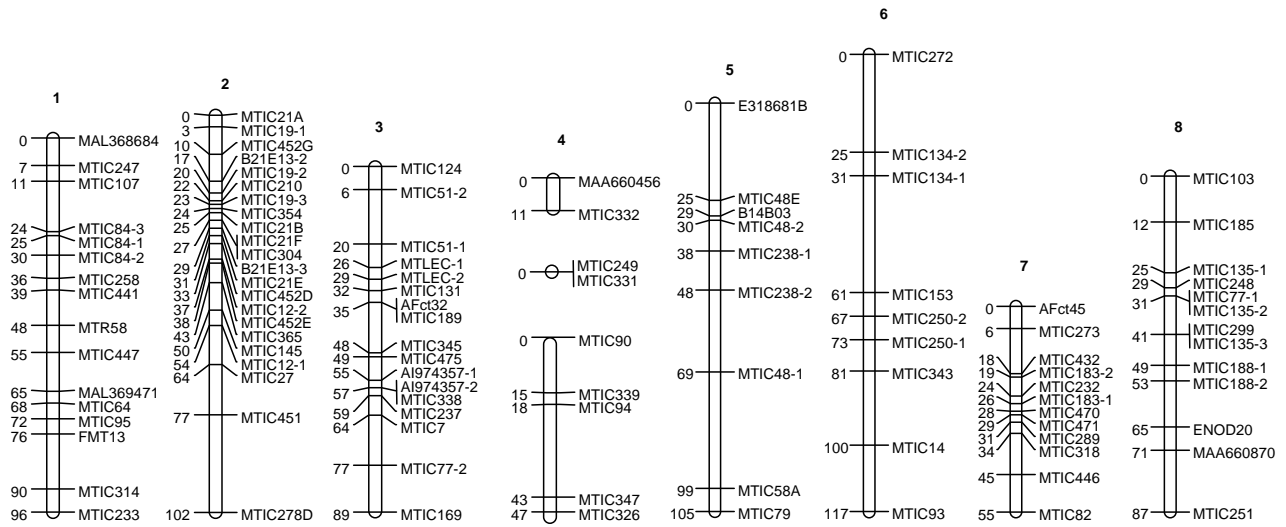

**Figure 8**  
Composite map with the SSR markers, for a FI mapping population in tetraploid alfalfa.

## Acknowledgements

We are very grateful to C.A. Hackett (Biomathematics & Statistics Scotland, Scottish Crop Research Institute, Dundee, UK) for her assistance in using TetraploidMap software. We thank F. Durand, P. Cormenier, C. Ecalte, A. Gilly, J. Jousse, D. Henri, D. Bousseau, J.B. Pierre, C. Gibelin and S. Berland for marker typing or plant maintenance. This program was supported by the Action Transversale Structurante "Medicago truncatula" of INRA (2000–2002).

## References

- Michaud R, Lehman WF, Rumbaugh MD: **World distribution and historical development. Alfalfa and alfalfa improvement – Agronomy Monograph no. 29, ASA-CSSA-SSSA, Madison, USA 1988:25-91.**
- Stanford EH: **Tetrasomic inheritance in alfalfa.** *Agron J* 1951, **43:222-225.**
- Armstrong JM: **Cytological studies in alfalfa polyploids.** *Can J Bot* 1954, **32:531-542.**
- Demarly Y: **Etude de l'hérédité de la bigarrure de la fleur chez la luzerne.** *Ann Amélior Plantes* 1954, **4:5-20.**
- Kiss GB, Csanádi G, Kalman K, Kaló P, Ökrész L: **Construction of a basic genetic map of Medicago using RFLP, RAPD, isozyme and morphological markers.** *Mol Gen Genet* 1993, **238:129-137.**
- Echt CS, Kidwell KK, Knapp SJ, Osborn TC, McCoy TJ: **Linkage mapping in diploid alfalfa (Medicago sativa).** *Genome* 1993, **37:61-71.**
- Brummer EC, Bouton JH, Kochert G: **Development of an RFLP map in diploid alfalfa.** *Theor Appl Genet* 1993, **86:329-332.**
- Kaló P, Endre G, Zimanyi L, Csanádi G, Kiss GB: **Construction of an improved linkage map of diploid alfalfa (Medicago sativa).** *Theor Appl Genet* 2000, **100:641-657.**
- Brouwer DJ, Osborn TC: **A molecular marker linkage map of tetraploid alfalfa (Medicago sativa L.).** *Theor Appl Genet* 1999, **99:1194-1200.**
- Wu KK, Burnquist W, Sorrells ME, Tew TL, Moore PH, Tanksley SD: **The detection and estimation of linkage in polyploids using single-dose restriction fragments.** *Theor Appl Genet* 1992, **83:294-300.**
- Yu KF, Pauls KP: **Segregation of random amplified polymorphic DNA markers and strategies for molecular mapping in tetraploid alfalfa.** *Genome* 1993, **1:844-851.**
- Meyer RC, Milbourne D, Hackett CA, Bradshaw JE, McNicol JW, Waugh R: **Linkage analysis in tetraploid potato and association of markers with quantitative resistance to late blight (Phytophthora infestans).** *Mol Gen Genet* 1998, **259:150-160.**
- Bradshaw JE, Hackett CA, Meyer RC, Milbourne D, McNicol JW, Phillips MS, Waugh R: **Identification of AFLP and SSR markers associated with quantitative resistance to Globodera pallida (stone) in tetraploid potato (Solanum tuberosum subsp tuberosum) with a view to marker-assisted selection.** *Theor Appl Genet* 1998, **97:202-210.**
- Hackett CA, Wachira FN, Paul S, Powell W, Waugh R: **Construction of a genetic linkage map for Camellia sinensis (tea).** *Heredity* 2000, **85:346-355.**
- Rajapakse S, Byrne DH, Zhang L, Anderson N, Arumuganathan K, Ballard RE: **Two genetic linkage maps of tetraploid roses.** *Theor Appl Genet* 2001, **103:575-583.**
- Fjellstrom RG, Steiner JJ, Beuselinck PR: **Tetrasomic linkage mapping of RFLP, PCR, and isozyme loci in Lotus corniculatus L.** *Crop Sci* 2003, **43:1006-1020.**
- Al-Janabi SM, Honeycutt RJ, McClelland M, Sobral BWS: **A genetic link to Saccharum spontaneum.** *Genetics* 1993, **134:1249-1260.**
- Da Silva JAG, Sorrells ME, Burnquist W, Tanksley SD: **RFLP linkage map and genome analysis of Saccharum spontaneum.** *Genome* 1993, **36:782-791.**
- Grivet L, D'Hont A, Roques D, Feldmann P, Lanaud C, Glaszmann JC: **RFLP mapping in cultivated sugarcane (Saccharum spp.): genome organization in a highly polyploid and aneuploid interspecific hybrid.** *Genetics* 1996, **142:987-1000.**
- Lerceteau-Köhler E, Guérin G, Laigret F, Denoyes-Rothan B: **Characterization of mixed disomic and polysomic inheritance in the octoploid strawberry (Fragaria × ananassa) using AFLP mapping.** *Theor Appl Genet* 2003, **107:619-628.**
- Hackett CA, Bradshaw JE, Meyer RC, McNicol JW, Milbourne D, Waugh R: **Linkage analysis in tetraploid species: a simulation study.** *Genet Res Camb* 1998, **71:143-154.**
- Luo ZW, Hackett CA, Bradshaw JE, McNicol JW, Milbourne D: **Predicting parental genotypes and gene segregation for tetrasomic inheritance.** *Theor Appl Genet* 2000, **100:1067-1073.**
- Luo ZW, Hackett CA, Bradshaw JE, McNicol JW, Milbourne D: **Construction of a genetic linkage map in tetraploid species using molecular markers.** *Genetics* 2001, **157:1369-1385.**
- Wu R, Gallo-Meagher M, Littell RC, Zeng ZB: **A general polyploid model for analyzing gene segregation in outcrossing tetraploid species.** *Genetics* 2001, **159:869-882.**
- Ripol MI, Churchill GA, da Silva JAG, Sorrells M: **Statistical aspects of genetic mapping in autopolyploids.** *Gene* 1999, **235:31-41.**
- Hackett CA, Luo ZW: **TetraploidMap, software suite for calculating linkage maps for autotetraploid populations.** 2002 [[ftp://ftp.bioss.sari.ac.uk/pub/cah/](http://ftp.bioss.sari.ac.uk/pub/cah/)].
- Hackett CA, Pande B, Bryan GJ: **Constructing linkage maps in autotetraploid species using simulated annealing.** *Theor Appl Genet* 2003, **106:1107-1115.**
- Bever JD, Felber F: **The theoretical population genetics of autopolyploidy.** *Oxford Surv Evol Biol* 1992, **8:185-217.**
- Thompson JD, Lumaret R: **The evolution dynamics of polyploid plants: origins, establishment and persistence.** *Trends Ecol Evol* 1992, **7:302-307.**
- Demarly Y: **Génétique des tétraploïdes et amélioration des plantes.** *Ann Amélior Plantes* 1963, **13:307-400.**
- Barker DG, Bianchi S, Blondon F, Dattée Y, Duc G, Flament P, Gallusci P, Génier G, Guy P, Muel X, Tournier J, Dénarié J, Huguet T: **Medicago truncatula, a model plant for studying the molecular genetics of the Rhizobium-legume symbiosis.** *Plant Mol Biol Rep* 1990, **8:40-49.**
- Cook D: **Medicago truncatula : A model in the making !** *Current Opinion in Plant Biology* 1999, **2:301-304.**
- Thoquet P, Ghérardi M, Journet EP, Kereszt A, Ané JM, Prosperi JM, Huguet T: **The molecular genetic linkage map of the model legume Medicago truncatula : an essential tool for comparative legume genomics and the isolation of agronomically important genes.** *BMC Plant Biology* 2002, **2:1** [<http://www.biomedcentral.com/1471-2229/2/1>].
- Baquerizo-Audiot E, Desplanque B, Prosperi JM, Santoni S: **Characterization of microsatellite loci in the diploid legume Medicago truncatula (barrel medic).** *Molecular Ecology Notes* 2001, **1:1-3.**
- Diwan N, Bhagwat AA, Bauchan GR, Cregan PB: **Simple sequence repeat (SSR) DNA markers in alfalfa and perennial and annual Medicago species.** *Genome* 1997, **40:887-895.**
- Van Ooijen JW, Voorrips RE: **JoinMap® Version 3.0, Software for the calculation of genetic linkage map.** *Plant Research International. Wageningen, The Netherlands* 2001.
- Peakall R, Gilmore S, Keys W, Morgante M, Rafalski A: **Cross-species amplification of soybean (Glycine max) simple sequence repeats (SSRs) within the genus and other legume genera: implications for the transferability of SSRs in plants.** *Molecular Biology and Evolution* 1998, **15:1275-1287.**
- Aranzana MJ, Pineda A, Cosson P, Dirlwanger E, Ascasibar J, Cipriani G, Ryder CD, Testolin R, Abbott A, King GJ, Iezzoni AF, Arús P: **A set of simple-sequence repeat (SSR) markers covering the Prunus genome.** *Theor Appl Genet* 2003, **106:819-825.**
- Rae SJ, Aldam C, Dominuez I, Hoebrechts M, Barnes SR, Edwards KJ: **Development and incorporation of microsatellite markers into the linkage map of sugarbeet (Beta vulgaris spp.).** *Theor Appl Genet* 2000, **100:1240-1248.**
- Saal B, Plieske J, Hu J, Quiros CF, Struss D: **Microsatellite markers for genome analysis in Brassica. II. Assignment of rapeseed microsatellites to the A and C genomes and genetic mapping in Brassica oleracea L.** *Theor Appl Genet* 2001, **102:695-699.**
- Tao YZ, Jordan DR, Henzell RG, McIntyre CL: **Construction of a genetic map in a sorghum RIL population using probes from different sources and its comparison with other sorghum maps.** *Aust J Agric Res* 1998, **49:729-736.**
- Humphrey ME, Konduri V, Lambides CJ, Magner T, McIntyre CL, Aitken EAB, Liu CJ: **Development of a mungbean (Vigna radiata) RFLP linkage map and its comparison with lablab (Lablab purpureus) reveals a high level of colinearity between the two genomes.** *Theor Appl Genet* 2002, **105:160-166.**

43. Diwan N, Bouton JH, Kochert G, Cregan PB: **Mapping of simple sequence repeat (SSR) DNA markers in diploid and tetraploid alfalfa.** *Theor Appl Genet* 2000, **101**:165-172.
44. Ma CX, Casella G, Shen ZJ, Osborn TC, Wu R: **A unified framework for mapping quantitative trait loci in bivalent tetraploids using single-dose restriction fragments: a case study from alfalfa.** *Genome Res* 2002, **12**:1974-1981.
45. McCoy TJ, Bingham ET: **Cytology and cytogenetics of alfalfa.** In: *Alfalfa and alfalfa improvement, ASA-CSSA-SSSA Agronomy monograph 29, Madison, USA 1988*:737-776.
46. Eujayl I, Sledge MK, Wang L, May GD, Chekhovskiy , Zwonitzer JC, Mian MAR: **Medicago truncatula EST-SSRs reveal cross-species genetic markers for Medicago spp.** *Theor Appl Genet* 2003 in press.
47. Blondon F, Marie D, Brown S, Kondorosi A: **Genome size and base composition in Medicago sativa and M. truncatula species.** *Genome* 1994, **37**:264-270.
48. Guines F, Julier B, Ecalle C, Huyghe C: **Genetic control of quality traits of lucerne (Medicago sativa L.).** *Austr J Agric Res* 2000, **53**:401-407.
49. Dellaporta SL, Wood J, Hicks JB: **A plant DNA miniprep: Version II.** *Plant Mol Biol Rep* 1983, **1**:19-21.
50. Vos P, Hogers R, Bleeker M, van de Lee T, Hornes M, Frijters A, Pot J, Peleman J, Kuiper M, Zabeau M: **AFLP: A new technique for DNA fingerprinting.** *Nucleic Acids Res* 1995, **23**:4407-4414.
51. Bassam BJ, Caetano-Anolles G, Gresshoff PM: **Fast and sensitive silver staining of DNA in polyacrylamide gels.** *Anal Biochem* 1991, **19**:680-683.

Publish with **BioMed Central** and every scientist can read your work free of charge

"BioMed Central will be the most significant development for disseminating the results of biomedical research in our lifetime."

Sir Paul Nurse, Cancer Research UK

Your research papers will be:

- available free of charge to the entire biomedical community
- peer reviewed and published immediately upon acceptance
- cited in PubMed and archived on PubMed Central
- yours — you keep the copyright

Submit your manuscript here:  
[http://www.biomedcentral.com/info/publishing\\_adv.asp](http://www.biomedcentral.com/info/publishing_adv.asp)

