



HAL
open science

A novel mechanism of action for v-ErbA: abrogation of the inactivation of transcription factor AP-1 by retinoic acid and thyroid hormone receptors

Christelle Desbois, Denise Aubert, Claude Legrand, Bertrand Pain, Jacques Samarut

► To cite this version:

Christelle Desbois, Denise Aubert, Claude Legrand, Bertrand Pain, Jacques Samarut. A novel mechanism of action for v-ErbA: abrogation of the inactivation of transcription factor AP-1 by retinoic acid and thyroid hormone receptors. *Cell*, 1991, 67 (4), pp.731-740. 10.1016/0092-8674(91)90068-a . hal-02700696

HAL Id: hal-02700696

<https://hal.inrae.fr/hal-02700696v1>

Submitted on 27 Sep 2023

HAL is a multi-disciplinary open access archive for the deposit and dissemination of scientific research documents, whether they are published or not. The documents may come from teaching and research institutions in France or abroad, or from public or private research centers.

L'archive ouverte pluridisciplinaire **HAL**, est destinée au dépôt et à la diffusion de documents scientifiques de niveau recherche, publiés ou non, émanant des établissements d'enseignement et de recherche français ou étrangers, des laboratoires publics ou privés.



Distributed under a Creative Commons Attribution 4.0 International License

A Novel Mechanism of Action for v-ErbA: Abrogation of the Inactivation of Transcription Factor AP-1 by Retinoic Acid and Thyroid Hormone Receptors

Christelle Desbois,^{*} Denise Aubert,[†]
Claude Legrand,[†] Bertrand Pain,[†]
and Jacques Samarut[†]

^{*}Immunovirologie Moléculaire et Cellulaire
Université Claude Bernard Lyon-1/CNRS UMR30
Faculté de Médecine Alexis Carrel
69372 Lyon Cedex 08
France

[†]Laboratoire de Biologie Moléculaire
et Cellulaire CNRS UMR49, INRA
Ecole Normale Supérieure de Lyon
69364 Lyon Cedex 07
France

Ligand-activated retinoic acid receptor α (RAR α) and c-ErbA α repress the AP-1-mediated transcriptional activation of the interstitial collagenase gene promoter by specifically decreasing the activity of the AP-1 transcription factor. On the other hand, the v-ErbA oncoprotein fails to repress the AP-1 activity and acts as a dominant negative oncoprotein by overcoming the repression of the AP-1 activity induced by RAR α and c-ErbA α . This maintenance by v-ErbA of a fully active AP-1 complex is correlated with the abrogation by this same oncogene product of the growth-inhibitory response of chicken embryo fibroblasts to retinoic acid treatment. This new mechanism of action of v-ErbA together with its previously discovered dominant repressor effect on transcription of thyroid hormone-activated target genes may explain the contribution of the v-erbA oncogene to sarcomatogenic and leukemogenic transformation.

Introduction

Although it has long been suspected that hormones play a role in cancer development, the direct involvement of hormone receptors in oncogenic transformation has been only recently demonstrated with the identification of the v-erbA oncogene. v-erbA is one of the two oncogenes carried by the avian erythroblastosis virus (AEV), a retrovirus that induces erythroleukemias and fibrosarcomas in chickens. The v-erbA oncogene represents a highly mutated version of its cellular homolog c-erbA, which encodes the α form of the nuclear receptor for the thyroid hormone triiodothyronine (T3) (Sap et al., 1986; Weinberger et al., 1986). The v-ErbA oncoprotein differs from the normal receptor by truncations at both ends and several scattered point mutations. These alterations result in a major functional difference: v-ErbA is no longer able to bind T3 although it can still bind to DNA (Munoz et al., 1988; Privalsky et al., 1988).

v-erbA acts as a dominant negative oncogene by over-

coming the transcriptional activation induced by its normal cellular counterpart on promoters linked to natural or synthetic T3 response elements (T3REs) (Damm et al., 1989; Sap et al., 1989). In erythroid cells, v-erbA blocks the differentiation program of early erythrocytic progenitors and inhibits the expression of T3-regulated erythrocytic genes (Gandrillon et al., 1989; Pain et al., 1990; Zenke et al., 1990). Chicken embryo fibroblasts (CEFs) that express v-erbA as the sole oncogene display anchorage-independent growth and exhibit increased growth potential in vitro. As a result of these growth control alterations, v-erbA strongly enhances the tumor formation of CEFs already transformed by v-erbB, the second oncogene of AEV (Gandrillon et al., 1987; Jansson et al., 1987). These effects of v-erbA appear, however, to involve signaling pathways different from those induced by mitogenic kinase oncoproteins (Diaz et al., 1989). Recently, we have shown that v-erbA abrogates the growth inhibition of CEFs induced by retinoic acid (RA) (Desbois et al., 1991). Assuming that the inhibitory effect of RA on the growth of CEFs is mediated by nuclear RA receptors (RARs), this result suggests a functional interference between the v-ErbA protein and RARs.

Receptors for steroid hormones, thyroid hormones, RA, and vitamin D₃ belong to a class of transcription factors that, upon binding to their ligand, recognize specific DNA sequences and regulate transcription of target genes (for reviews see Green and Chambon, 1986; Evans, 1988; Beato, 1989). These hormone receptors can either enhance or inhibit gene expression, depending on the cell type and on the response element involved, as it was demonstrated for the glucocorticoid receptor (Akerblom et al., 1988; Sakai et al., 1988; Diamond et al., 1990; Yang-Yen et al., 1990; Schüle et al., 1990b; Jonat et al., 1990). Thyroid hormone receptors (T3Rs) bind to a set of T3REs and enhance transcription when activated by T3 (Koenig et al., 1987; Glass et al., 1987; Izumo and Mahdavi, 1988; Damm et al., 1989; Sap et al., 1989). In the presence of RA, RARs can stimulate transcription from promoters containing either specific RA response elements (Vasios et al., 1989; de Thé et al., 1990), some T3REs (Umesono et al., 1988; Graupner et al., 1989), or a vitamin D₃ response element (Schüle et al., 1990a). Moreover, RARs and T3Rs can form heterodimers (Glass et al., 1989).

These data, demonstrating interactions between different hormone receptors, strengthen our results suggesting a functional interference between RARs and the v-ErbA protein in CEFs. In these same cells, the growth-inhibitory effect induced by RA treatment was also abrogated by expression of either the v-jun, v-fos, or v-src oncogenes (Desbois et al., 1991). The v-Jun and v-Fos oncoproteins are the viral counterparts of the c-Jun and c-Fos proteins, which are components of the AP-1 complex (Curran and Franza, 1988). The v-Src protein acts by inducing the AP-1 activity (Wasylyk et al., 1988). From these findings, we have suggested that RARs might functionally interact with

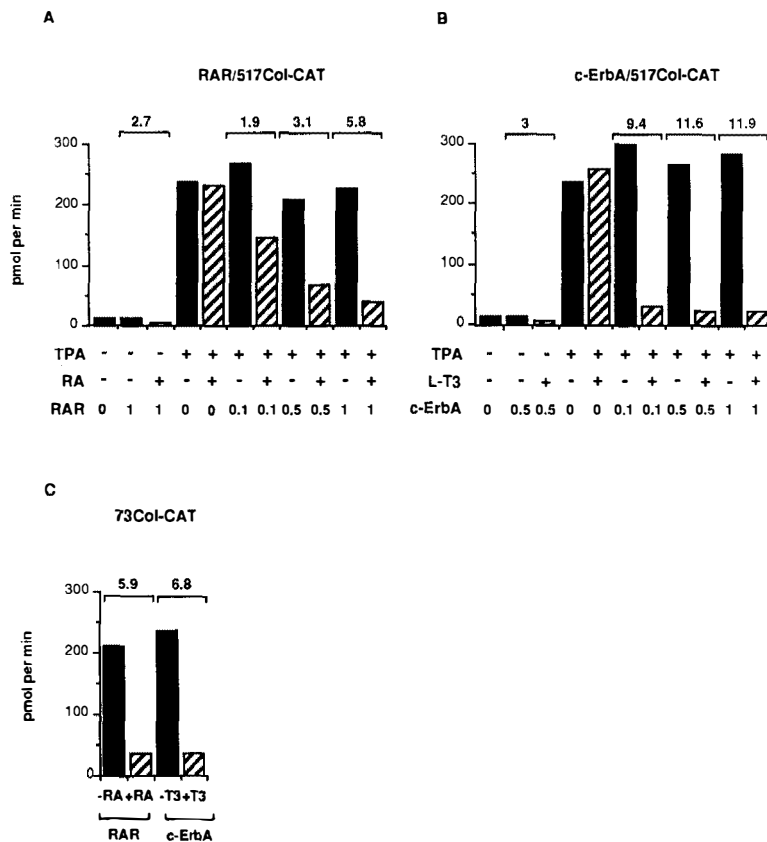

Figure 1. Repression of the Collagenase Promoter Activity by Ligand-Activated RAR α and c-ErbA α

HeLa cells were transfected with 1 μ g per 60 mm dish of the 517Col-CAT reporter gene together with increasing amounts of RAR α (A) and c-ErbA α (B) expression vector, (0.1–1 μ g as indicated under each bar). For each experiment reported, 2 μ g of RSV- β -galactosidase plasmid was added to monitor transfection efficiency. After 16–20 hr, the medium was changed, and HeLa cells were cultured in low serum concentration (0.5%) and, when mentioned, treated with 50 ng/ml TPA in the absence (black bars) or presence (striped bars) of either 10⁻⁶ M RA or 10⁻⁸ M T3 as indicated under each bar. After an additional 24 hr, HeLa cells were harvested and CAT activities were measured and normalized to β -galactosidase activities. The values are expressed in pmol/min and are representative of a typical experiment. Transfection experiments were made at least in triplicate. The extents of repression indicated at the top of the figure were the same in the triplicate experiments in spite of some variations in the transfection efficiency.

In (C) HeLa cells were cotransfected with 1 μ g of the 73Col-CAT reporter gene and with either 1 μ g of RAR α or 0.5 μ g of c-ErbA α expression vectors. HeLa cells were treated with TPA in the presence (striped bars) or absence (black bars) of either RA or T3 as indicated under each bar. The hormone-induced repression rates of the CAT activity are indicated at the top of the figure.

the AP-1 complex. Therefore, to verify this hypothesis, a transient expression system based on cotransfection assays has been designed.

We describe here how α forms of RARs and c-ErbA repress, in a ligand-dependent fashion, the activity of AP-1-regulated promoters, i.e., the interstitial collagenase promoter and a synthetic AP-1-dependent promoter, by specifically decreasing the activity of the AP-1 transcription factor. A similar repression by RARs has been recently found for the stromelysin gene promoter (Nicholson et al., 1990). Moreover, we show that *v-erbA* has lost this repression function and behaves as a dominant oncogene by abrogating the AP-1 repression induced by RAR α and c-ErbA α . This property of *v-erbA* is directly correlated with its ability to induce resistance of cells to the growth-inhibitory effect of RA. This is a newly described mechanism of action of the *v-erbA* oncogene, which together with the previously discovered dominant repressor effect on transcription of T3-activated genes, can contribute to the oncogenic transformation.

Results

Ligand-Activated RAR α and c-ErbA α Repress the Collagenase Gene Promoter

To determine whether the RA and T3 receptors can interfere with the AP-1 complex, transfection experiments were performed with the interstitial collagenase promoter. This gene was chosen because RA regulates its expression

negatively (Saus et al., 1988; Clark et al., 1987), whereas the AP-1 complex stimulates its activity through binding to specific DNA sequences referred to as the TPA responsive element or AP-1-binding site (Angel et al., 1987a). The reporter plasmid, 517Col-CAT, carries DNA sequences from positions -517 to +63 of the collagenase promoter linked upstream of a promoterless chloramphenicol acetyltransferase (CAT) gene (Angel et al., 1987a). This plasmid was cotransfected into HeLa cells with increasing amounts of human RAR α or chicken c-ErbA α expression vectors, in the presence or absence of their respective hormone. In these expression plasmids, RAR α and c-erbA α cDNA are under the transcriptional control of the Rous sarcoma virus long terminal repeat (RSV-LTR). To keep the amount of RSV-LTR constant, an "empty" expression vector was added. The basal AP-1 activity in HeLa cells was low and was strongly enhanced by TPA treatment (Figure 1). This basal activity was repressed about 3-fold in cells cotransfected with either RAR α or c-ErbA α in the presence of the respective hormone. However, estimations of the repression rates in these conditions are not accurate because of the extremely low CAT activity. Further investigations of the effect of hormone receptors on the collagenase promoter were conducted on cells treated with TPA. As shown in Figures 1A and 1B, ligand-activated RAR α and c-ErbA α strongly repressed the TPA-induced collagenase promoter activity. The extent of repression increased with the amount of receptor added. Transfection of only 0.1 μ g of c-ErbA α expression vector

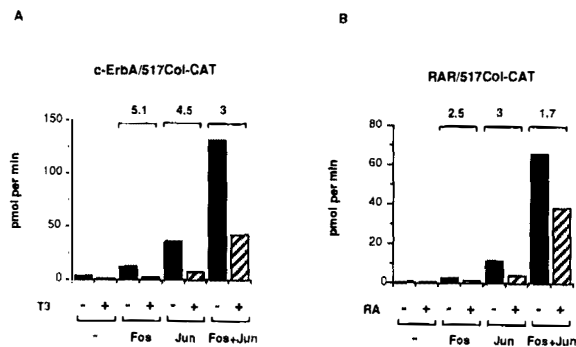

Figure 2. Repression of the Fos/Jun-Induced Collagenase Promoter Activity by Ligand-Activated RAR α and c-ErbA α

(A) HeLa cells were transfected as described in Figure 1 with 1 μ g of the 517Col-CAT reporter gene, 2 μ g of either Fos or Jun expression vectors together with 0.5 μ g of c-ErbA α expression plasmid. One microgram of Fos and 1 μ g of Jun expression plasmids were added in the cotransfection assays. After transfection, HeLa cells were cultured in 0.5% serum in the presence (striped bars) or absence (black bars) of T3. The extents of T3-mediated repression are indicated at the top of the figure.

(B) HeLa cells were transfected as in (A) except that 1 μ g of RAR α expression vector was added in place of the c-ErbA. HeLa cells were then incubated with or without RA as indicated.

led to a significant decrease of the CAT activity in the presence of T3. The TPA-induced activity of a reporter plasmid carrying only DNA sequences from positions -73 to +63 of the collagenase promoter (73Col-CAT) was also repressible by RAR α or c-ErbA α after activation by

their respective ligand (Figure 1C). This reporter construct retains the AP-1-binding site that is localized between positions -72 and -65 in the collagenase promoter (Angel et al., 1987a). The basal activity of this construct was also repressed by about 4-fold by the ligand-activated hormone receptors (data not shown).

To verify that RAR α and c-ErbA α repress the TPA-induced collagenase promoter activity by inactivation of the AP-1 function, we replaced TPA treatment with transfection of c-Jun and/or c-Fos expression plasmids. Cells were cotransfected with either RAR α or c-ErbA α expression vectors and the 517Col-CAT reporter gene. Figure 2 shows the results obtained in these experiments. In the absence of hormone, cotransfection of both c-Fos and c-Jun expression vectors strongly increased the reporter gene activity. Addition of either T3 (Figure 2A) or RA (Figure 2B) led to a repression of the collagenase gene promoter activity induced either by Fos or Jun or by Fos and Jun together. As observed previously (Figure 1), the repression by RAR α was lower than that induced by c-ErbA α . In both cases, the extent of repression was smaller when Fos and Jun expression plasmids were added simultaneously. This effect might result from overloading the cells with exogenous AP-1 products, whereas in cells transfected with either the Jun or Fos expression vectors, the level of AP-1 might be limited by the amount of the endogenous Fos or Jun products, respectively. Taken together, these data strongly suggest that the RA and the T3 receptors repress the collagenase promoter activity by inactivating the AP-1 transcription factor.

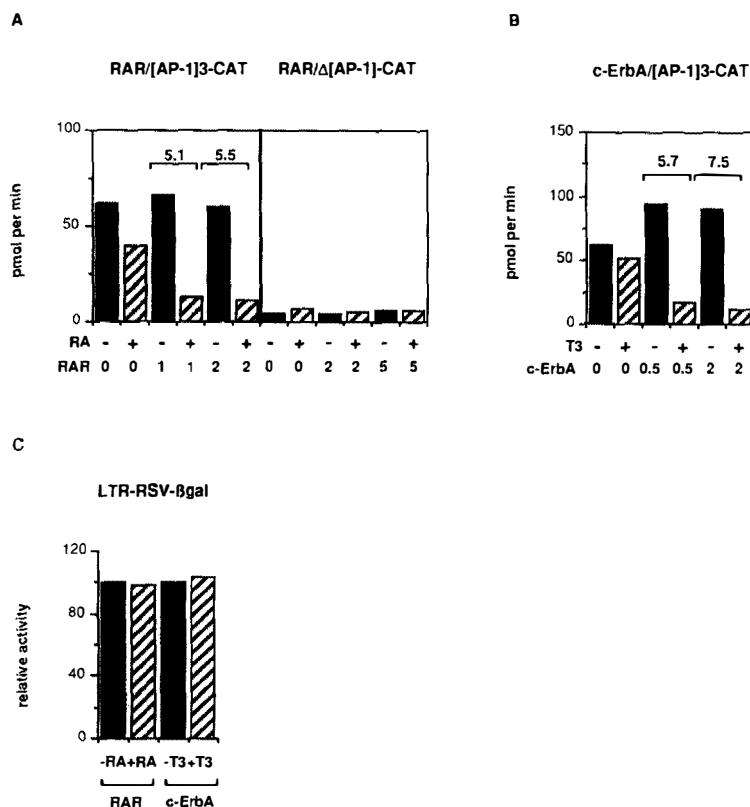

Figure 3. Identification of the AP-1-Binding Site as the Specific Target for Regulation by Ligand-Activated RAR α and c-ErbA α

(A) HeLa cells were transfected as in Figure 1 with increasing amounts of the RAR α expression vector, as indicated under each bar, together with either 1 μ g of the [AP-1]3-CAT reporter gene or 5 μ g of the similar construct that does not contain an AP-1-binding site (Δ [AP-1]-CAT). HeLa cells were treated with TPA and with RA (striped bars) or without RA (black bars) as indicated. The extents of RA-mediated repression are indicated at the top of the figure.

(B) HeLa cells were cotransfected with 1 μ g of the [AP-1]3-CAT reporter gene and with increasing amounts of the c-ErbA α expression vector. Twenty-four hours prior to harvesting, TPA was added in the presence (striped bars) or absence (black bars) of T3. As in (A), numbers at the top indicate the extent of T3-mediated repression.

(C) As a control, HeLa cells were transfected with either 1 μ g of RAR α or 0.5 μ g of c-ErbA α expression plasmids together with 2 μ g of RSV-LTR promoter not containing an AP-1-binding site. The RSV-LTR was linked upstream of the β -galactosidase reporter gene. HeLa cells were incubated with TPA in the presence or absence of RA, as indicated under each bar.

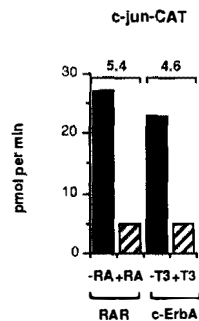

Figure 4. Repression of the TPA-Induced *c-jun* Promoter Activity by RAR α and c-ErbA α in a Ligand-Dependent Fashion

HeLa cells were transfected as in Figure 1 with 1 μ g of the reporter gene containing the -920 to +57 sequence of the *c-jun* promoter linked upstream of the CAT gene together with either 1 μ g of RAR α - or 0.5 μ g of c-ErbA α -expressing plasmids. Cells were then treated for 24 hr with TPA together with (striped bars) or without (black bars) hormones. Numbers at the top indicate the extent of repression induced by ligands.

Ligand-Activated RAR α and c-ErbA α Inactivate the AP-1 Activity

To check whether repression of the collagenase promoter by ligand-activated RAR α and c-ErbA α might account for a more general effect on AP-1-mediated transcription, the effect of these receptors on the function of other promoter-CAT constructs was investigated. We used a synthetic reporter construct, [AP-1]3-CAT, that carries three AP-1-binding sites upstream of sequences from positions -109 to +10 of the rabbit β -globin promoter linked to the CAT gene. The function of this chimeric promoter is strongly dependent upon AP-1 activation elicited by TPA treatment (Uriet et al., 1989). As shown in Figure 3A, RAR α repressed this promoter in a hormone-dependent manner. Under similar conditions, the activity of the control Δ [AP-1]-CAT chimeric construct that carries only the globin promoter linked to the CAT gene was not induced by TPA, nor changed by RAR α in the presence or absence of RA (Figure 3A). In parallel experiments in which c-ErbA α was transfected in place of RAR α , we observed a similar T3-dependent repression of the [AP-1]3-CAT reporter plasmid activity (Figure 3B). To check whether the effect of the hormone receptors was specific to AP-1 dependent promoters, we tested an RSV-LTR promoter that does not contain an AP-1-binding site. For this purpose, we used an RSV-LTR-driven β -galactosidase reporter gene. The activity of this promoter was not affected by expression of ligand-activated receptors in these cells (Figure 3C). Taken together, these data demonstrate that repression of transcription induced by ligand-activated RAR α or c-ErbA α is mediated by functional interference with the AP-1 transcription complex.

To extend the analysis of this repression induced by hormone receptors, we tested the effect of RAR α and c-ErbA α on the function of the quail *c-jun* promoter. The *c-jun* promoter is inducible by TPA (Angel et al., 1988). Although this promoter is activated by AP-1 in F9 cells (Angel et al., 1988), it has been suggested that it might be activated by an AP-1-related factor in HeLa cells (van Dam

et al., 1990; Offringa et al., 1990). The quail promoter sequence -920 to +57, which contains an AP-1-binding site at position -53 (M. Castellazi, personal communication), was linked to the CAT gene. As shown in Figure 4, this promoter was repressed by RAR α and c-ErbA α after activation by their respective ligands.

v-ErbA Does Not Repress the AP-1 Activity

We investigated whether the v-ErbA oncoprotein would exert repressing effects similar to those of RAR α and c-ErbA α on the AP-1 activity. HeLa cells were cotransfected with the RSV-LTR-driven expression vector of v-ErbA and with the 517Col-CAT, 73Col-CAT, or [AP-1]3-CAT reporter genes. Cells were treated with TPA, and the amount of RSV-LTR was kept constant by complementing with a plasmid carrying only this LTR. As seen in Figure 5, the v-ErbA protein did not repress the CAT activity of the three reporter genes tested, irrespective of the amount of transfected v-ErbA (0.1-5 μ g). Thus, unlike the normal T3 and RA receptors, the v-ErbA oncogenic protein has lost the ability to inhibit the AP-1 activity.

v-ErbA Abrogates the Inactivation of AP-1 Induced by RAR α or c-ErbA α

Since v-ErbA is unable to repress the AP-1 activity, we checked whether it might compete with c-ErbA α and RAR α and thereby could abrogate the inhibitory effect of these ligand-activated receptors. To this end, the 517Col-CAT reporter gene was cotransfected with either the RAR α or the c-ErbA α expression vectors and with increasing amounts of the v-ErbA-expressing plasmid. As shown in Figures 6A and 6B, addition of the v-ErbA expression vector abrogated, in a dose-dependent manner, the repression of the 517Col-CAT reporter gene activity induced by c-ErbA α or RAR α . Similarly, v-ErbA strongly reduced the inhibitory effect of RAR α on the [AP-1]3-CAT reporter gene (Figure 6B).

We further investigated the specificity of this functional interference by analyzing the effect of v-ErbA on the glucocorticoid receptor function, since this steroid receptor inactivates the AP-1 activity in a ligand-dependent fashion (Jonat et al., 1990; Schüle et al., 1990b; Yang-Yen et al., 1990). The 517Col-CAT reporter gene was cotransfected with the glucocorticoid receptor expression vector and with the v-ErbA-expressing plasmid in increasing amounts (Figure 6C). Addition of dexamethasone in the culture medium led to a strong repression of the 517Col-CAT activity. This repression was maintained in the presence of v-ErbA. Therefore, the v-ErbA protein abrogates the inactivation of the AP-1 complex by RAR α and c-ErbA α , and this effect appears to be highly specific to these two receptors.

Effect of Chimeric v/c-ErbA Proteins on AP-1 Activity

The v-ErbA oncoprotein differs from c-ErbA in several respects. A part of the retroviral *gag* gene is fused to the v-*erbA* sequence. This results in a fusion Gag-v-ErbA protein, with the Gag sequence replacing the first 12 amino acids of the c-ErbA protein. The other differences between

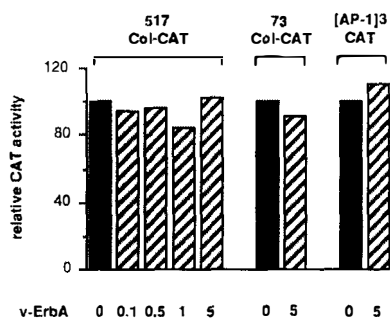

Figure 5. The AP-1 Activity Is Not Repressed by the v-erbA Oncogene
 HeLa cells were transfected with 1 μ g of either 517Col-CAT, 73Col-CAT, or [AP-1]³-CAT reporter genes together with various amounts (in μ g) of the v-ErbA expression plasmid as indicated under each bar, then treated with TPA for 24 hr prior to harvesting. Because of the large difference in the absolute enzymatic activities obtained for the three reporter genes (36–170 pmol per min of acetylated chloramphenicol), the results are expressed in relative CAT activities. The 100% value represents the CAT activity of each reporter gene in the absence of transfected v-ErbA (black bars).

the v-ErbA and c-ErbA proteins include 2 point mutations located close to the amino terminus, 2 point mutations in the DNA-binding domain, and 9 point mutations and a 9 amino acid deletion in the hormone-binding domain (Sap et al., 1986). To investigate the contribution of the different mutations in v-erbA to the altered properties of its protein product, concerning especially the AP-1 inactivation, chimeric receptors made of v-ErbA and c-ErbA α were constructed (Figure 7A). These v/c-ErbA chimeric receptors, introduced into expression vectors driven by the RSV-LTR, were analyzed in cotransfection studies for their ability to repress directly the 73Col-CAT reporter gene activity in HeLa cells (Figure 7B). To analyze the role of the residual Gag peptide in the Gag-v-ErbA protein, the gag sequence was replaced by the c-erbA sequence encoding the first 12 amino acids of the normal receptor. This construct (CAV54) did not repress the AP-1-mediated stimulation of the 73Col-CAT reporter gene activity. The

exchange of the v-ErbA amino half containing the DNA-binding domain for that of the c-ErbA protein gave rise to a chimeric construct (CAV98) that failed to repress the AP-1 activity. To check for the role of hormone binding on the repressive effect of the T3 receptors, we tested a chimeric construct (CAV5) in which part of the v-ErbA carboxyl terminus had been replaced by the homologous c-ErbA hormone-binding domain. In the presence of T3, the protein inactivates the AP-1-mediated expression of the 73Col-CAT reporter gene, although to a slightly lesser extent than c-ErbA. This inactivating effect was lost in the absence of T3. Therefore, the CAV5 product behaves similarly to the normal T3 receptor in this assay. Taken together, these data indicate that the inability of v-ErbA to inactivate AP-1 results mostly from mutations in the carboxy-terminal, hormone-binding part of the protein.

Effect of Chimeric v/c-ErbA Proteins on Induction of CEF Resistance to the Growth-Inhibitory Effect of RA

When expressed in CEFs, the v-erbA oncogene abrogates the growth inhibition induced by RA (Desbois et al., 1991). To check whether this response could be correlated with the antagonistic effect of v-ErbA against RARs in AP-1 inactivation, we analyzed the effect of the various v/c-erbA chimeric constructs on the inhibition of CEF growth induced by RA. The chimeric v/c-erbA genes were inserted into retroviral vectors. The c-ErbA and CAV constructs were inserted into the self-replicating RCAS retroviral vector (Hughes et al., 1987) that allows initiation of translation at the native initiation codon in the construct. The respective viruses were produced by CEF transfection with the plasmid DNA. For the XJ12 vector that expresses the original Gag-v-ErbA oncoprotein, the plasmid was cotransfected with the RAV-1 helper virus expression plasmid (Benchaibi et al., 1989).

It was determined that all the recombinant viruses expressed the expected v/c-ErbA products by assessment of the protein sizes after immunoprecipitation and SDS-polyacrylamide gel electrophoresis (data not shown). To

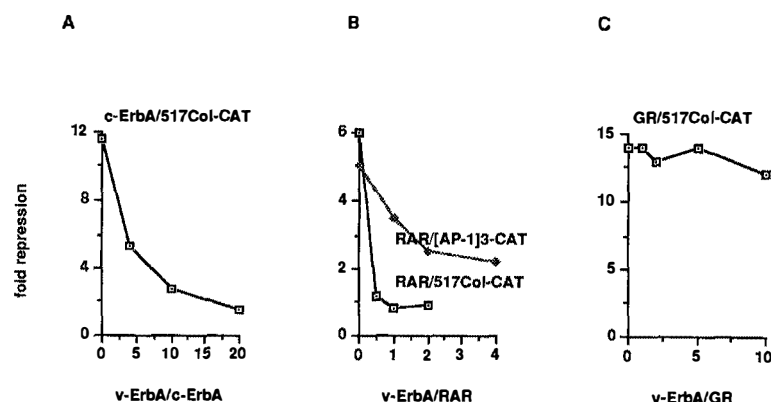

Figure 6. Competition Experiments between the v-ErbA Oncoprotein and Either the c-ErbA α , the RAR α , or the Glucocorticoid Receptor

(A) HeLa cells were cotransfected with 1 μ g of 517Col-CAT, 0.5 μ g of c-ErbA α expression vector, and increasing amounts of v-ErbA-expressing plasmid. HeLa cells were treated with TPA and with or without T3 for the last 24 hr. Numbers in abscissa represent the ratio between the molar amounts of v-ErbA and c-ErbA plasmids. The results are expressed as fold repression of the CAT activity obtained in hormone-treated versus untreated HeLa cell cultures.

(B) Similar competition experiments were performed between v-ErbA and RAR α . One microgram of 517Col-CAT or [AP-1]³-CAT reporter

genes was cotransfected with 1 μ g or 2 μ g of the RAR α expression vector, respectively. The results are expressed as in (A).
 (C) HeLa cells were transfected with 1 μ g of the 517Col-CAT reporter gene together with 1 μ g of the glucocorticoid expression vector and with increasing amounts of v-ErbA-expressing plasmid. HeLa cells were grown in medium supplemented with TPA without or with 10^{-6} M dexamethasone. The results are expressed as in (A).

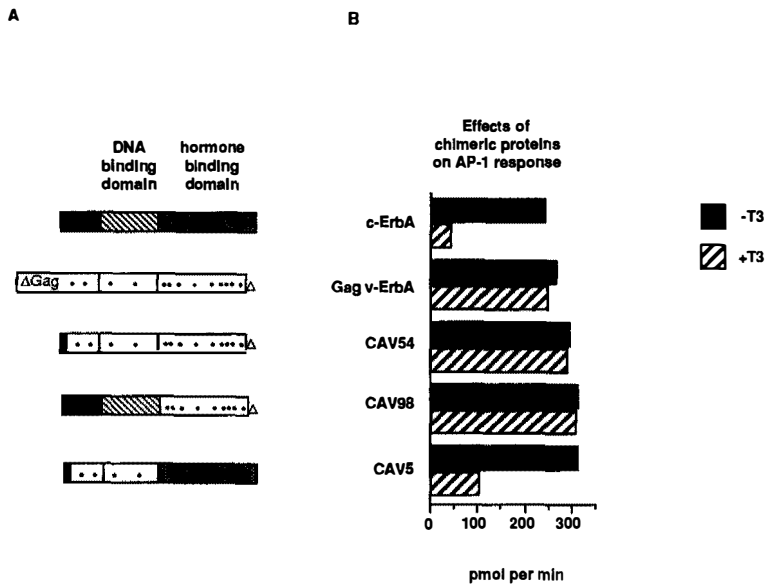

Figure 7. Effects of Chimeric v/c-ErbA Proteins on AP-1 Activity

(A) Schematic representation of the structure of c-ErbA α , v-ErbA, and the different chimeric constructs. These chimeric receptors were constructed as described in Experimental Procedures by using restriction enzyme sites common to v-ErbA and c-ErbA. The several scattered point mutations and the carboxy-terminal deletion in v-ErbA and the resulting chimeric constructs are respectively indicated by dots and triangles.

(B) HeLa cells were transfected as in Figure 1 with 1 μ g of the 73Col-CAT reporter gene together with 1 μ g of expression vectors for the different v/c-ErbA proteins represented in (A). HeLa cells were treated with TPA and with (striped bars) or without (black bars) T3 for 24 hr prior to harvesting.

test the ability of these viruses to induce resistance of CEFs to the growth-inhibitory effect of RA, CEFs were mass-infected with the respective recombinant virus stocks, passed once, then seeded in soft agar containing 10^{-6} M RA. The data are presented in Figure 8. Cultures infected with the RCAS control vector virus without insert gave rise to few very small colonies. The viruses CASBA54 and CASBA98, which both produce a recombinant ErbA product containing a v-ErbA carboxyl terminus, induced the growth of RA-resistant colonies similarly to XJ12. The CASBA5 virus, which contains the c-ErbA hormone-binding domain, also induced the growth of RA-resistant colonies but only in the absence of T3. Very few colonies were observed in cultures overexpressing the normal c-ErbA product (CASBA9), either in the presence or absence of T3. Indeed, overexpression of the c-ErbA protein in CEFs is probably deleterious, since after 5 days in cul-

ture with or without T3, we regularly observed a strong decrease of the expression of the c-ErbA protein. It is therefore likely that the absence of colonies in cultures infected with CASBA9 resulted from progressive death of the infected cells expressing the c-ErbA protein. Except for the normal c-ErbA product, we therefore observed a strong correlation between the ability of the recombinant v/c-ErbA products to overcome growth inhibition by RA and their inability to inactivate the AP-1 transcription complex.

Discussion

The results reported here show that RAR α and c-ErbA α repress the activity of AP-1-regulated promoters, i.e., the collagenase promoter and a synthetic AP-1-dependent promoter, by specifically inactivating the AP-1 transcrip-

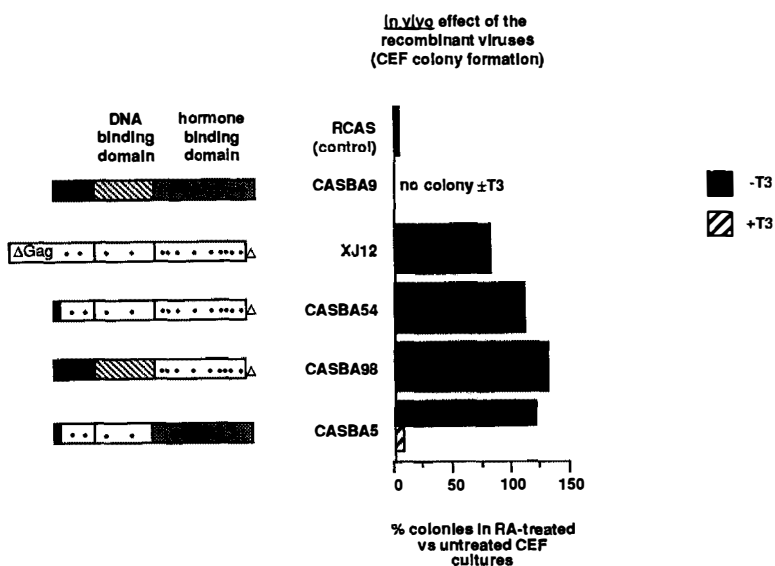

Figure 8. Effects of Chimeric v/c-ErbA Proteins on the Growth Inhibition of RA on CEFs. CEFs were infected with retroviruses expressing different v/c-ErbA chimeric proteins represented in the left part of the figure. They were then seeded in soft agar in the presence or absence of 10^{-6} M RA and, when indicated, in the presence of 10^{-8} M T3. An additional overlay identical to the original one was added 1 week later. Colonies were scored 2 weeks after seeding. The data are expressed as the percentage of colonies in RA-treated versus untreated CEF cultures. The values shown are averages calculated from triplicate cultures.

tion factor. On the other hand, the v-ErbA oncogene product has lost this repressive function and, moreover, is able to abrogate the AP-1 repression induced by the RA and T3 receptors. Therefore, this work brings to light a new mechanism of action of the v-*erbA* oncogene.

The effect of RAR α and c-ErbA α on the AP-1 transcription complex was investigated by analyzing the activity of different promoters whose expression is mediated by the AP-1 complex. First, we showed that the activity of these promoters was induced by treating cells with TPA or by cotransfecting c-Jun and/or c-Fos expression plasmids. In each case, this activity was repressed by RAR α and c-ErbA α . The repressive effect of these receptors depends upon the binding of their respective ligand. Second, we showed that RAR α and c-ErbA α have no effect on promoters whose AP-1-binding site is naturally absent or has been artificially deleted.

RAR α and c-ErbA α repress the *c-jun* promoter that also contains an AP-1-binding site. It has been suggested that in HeLa cells this promoter would be activated by an AP-1-related factor acting through the AP-1 motif (van Dam et al., 1990; Offringa et al., 1990). This might suggest that the interference spectrum of RAR α and c-ErbA α could be expanded to other members of the AP-1 transcription factor family.

The ligand-activated RAR α and c-ErbA α repress promoters that contain an AP-1-binding site, either in the context of a synthetic promoter or in the context of the authentic collagenase and *c-jun* promoters. The data showing that the AP-1 motif-dependent transcriptional activation of at least two genes is inactivated by the RA and T3 receptors strongly suggest that this type of interaction is a general process. Repression of the collagenase gene promoter by the ligand-activated glucocorticoid receptor (Jonat et al., 1990; Schüle et al., 1990b; Yang-Yen et al., 1990) and repression of the stromelysin gene promoter by the RA-activated RARs (Nicholson et al., 1990) have been recently reported. These two hormone receptors repress the activity of these gene promoters by inhibiting AP-1-mediated transcriptional activation. Taken together, these results and our own results illustrate a novel type of functional interference between members of different transcription factor families.

Several models have been proposed to explain the gene repression resulting from functional interferences between transcription factors (for review see Levine and Manley, 1989). The AP-1 complex represses transcription by at least two different mechanisms. First, this repression can occur through direct competition for binding sites. For instance, the AP-1 complex abrogates the vitamin D $_3$ -mediated and RA-mediated induction of the human osteocalcin gene promoter, through binding to the AP-1 site present in the core of the hormone response element (Schüle et al., 1990a). A negative regulation of gene expression can also be explained by direct interactions between transcription factors, leading to an inactive complex that is capable or incapable of binding to DNA. For example, the mutual repression between the AP-1 complex and the ligand-activated glucocorticoid receptor seems to involve protein-protein interactions that might lead to formation of

a complex incapable of binding either to the AP-1 or to the glucocorticoid response element recognition sites (Jonat et al., 1990; Yang-Yen et al., 1990). The exact biochemical nature of this complex remains to be elucidated. The mechanisms by which the RARs (Nicholson et al., 1990) or the adenovirus E1a (Offringa et al., 1990) repress the AP-1 activity are not yet determined. We have observed that a baculovirus-produced c-ErbA α protein (kindly provided by J. Ghysdael, Institut Curie, France) is unable to bind to the AP-1 recognition site, which excludes a direct interference of T3Rs and the AP-1 complex at a common binding site (data not shown). However, we have been unable so far to demonstrate any physical interaction between c-ErbA α or RAR α and the c-Jun or c-Fos proteins produced by in vitro translation in rabbit reticulocyte lysate. Eventual complexes between these proteins may be very unstable and may require other proteins to be stabilized.

We show that the v-ErbA oncoprotein differs from its c-ErbA normal counterpart by its failure to inactivate the AP-1 activity. This difference is largely because of structural differences between the carboxy-terminal half of the two proteins. Substituting the c-ErbA C-terminus for the homologous v-ErbA domain restored the T3-dependent repressive effect of the chimeric protein on the AP-1 complex. It is likely that the inability of v-ErbA to bind T3, due to mutations in the hormone-binding domain, is most likely responsible for the absence of an effect of v-ErbA on the AP-1 activity.

It is shown here that the v-ErbA oncoprotein behaves as a strong c-ErbA α and RAR α antagonist in the inactivation of the AP-1 complex. This effect appears specific for these receptors and is not observed with the glucocorticoid receptor. As a consequence, v-ErbA exerts a dominant effect by abrogating the specific inactivation of AP-1 by ligand-activated T3R α and RAR α . Several mechanisms can be proposed to explain the effect of the oncoprotein. Either v-ErbA could compete with c-ErbA α or RAR α for interaction with AP-1, or v-ErbA could form heterodimers with T3R α or RAR α , in a similar way to c-ErbA, which is able to form heterodimers with RARs (Glass et al., 1989), and thereby might inactivate these receptors. Following the last hypothesis, we may further imagine that v-ErbA would inhibit the action of a hormone-induced inactivator of AP-1.

The present findings provide an explanation for our previous observations that the growth-inhibitory response of CEFs to RA treatment is abrogated by expression of the v-*erbA* oncogene as well as by expression of the v-*src*, v-*jun*, or v-*fos* oncogenes (Desbois et al., 1991). On the basis of these results and because of the function of these oncogenes, we speculated the existence of a functional interference, on the one hand, between RARs and v-ErbA and, on the other hand, between RARs and the AP-1 complex. The data reported here thus confirm our previous suggestions.

The physiological relevance of the functional interference between v-ErbA and AP-1 was confirmed by comparing the effects of v-ErbA/c-ErbA chimeric proteins on, respectively, the inactivation of AP-1 and the induction of

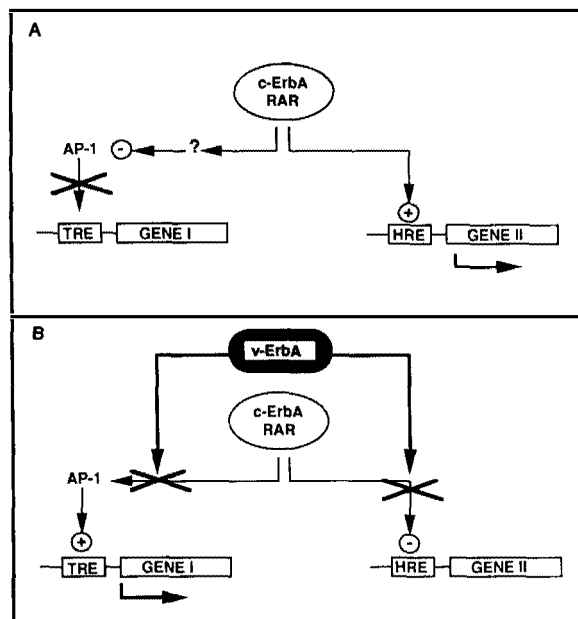

Figure 9. Model of Dual Actions of RAR α , c-ErbA α , and v-ErbA
 (A) depicts the dual action of normal RAR α and c-ErbA α upon activation by their respective ligand. (B) shows how v-ErbA interferes with the function of RAR α and c-ErbA α . TRE and HRE are the respective abbreviations for TPA response element and for hormone response element. Gene I and gene II refer to two types of genes controlled by AP-1 complex and hormone receptors, respectively.

resistance of CEFs to the growth-inhibitory effect of RA. We demonstrated that the induction of resistance to RA was correlated with the inability of these mutants to inactivate AP-1. We therefore assume that cells expressing the v-erbA oncogene display a fully active AP-1 complex and thereby exhibit an uncontrolled growth, even in the presence of RA.

The results presented herein illustrate that membrane and nuclear receptor signaling pathways converge on common regulatory elements and exert opposite effects on gene transcription. It is conceivable that these interactions between nuclear receptors and the AP-1 complex play a major role in the hormonal control of cellular proliferation and differentiation (Figure 9A). On the right side, RAR α and c-ErbA α can positively control the transcription of genes through direct interactions with hormone response elements. On the left side, these two receptors indirectly repress AP-1-regulated genes. RA and T3 are known to activate expression of genes involved in cell differentiation (Sporn and Roberts, 1991; Oppenheimer and Samuels, 1983). One example is the transcriptional activation of the carbonic anhydrase II gene in chicken erythrocytic cells (Pain et al., 1990). Among genes regulated by AP-1 are genes involved in the control of cell division, e.g., the *c-jun* proto-oncogene (Angel et al., 1988), and genes encoding extracellular matrix proteases, such as interstitial collagenase and stromelysin (Angel et al., 1987a, 1987b; Frisch et al., 1987). The dual action of RAR α and T3R α therefore accounts for the restriction of cell proliferation commonly associated with the differentiation induced by RA and T3. From such a model, we can understand

the role of v-erbA in oncogenesis (Figure 9B). The v-ErbA product inhibits the transcriptional activation of T3-regulated promoters (Damm et al., 1989; Sap et al., 1989; Pain et al., 1990; Zenke et al., 1990). In parallel, the oncoprotein activates the growth of fibroblasts and thereby enhances their tumorigenicity (Gandrillon et al., 1987; Jansson et al., 1987). It is likely that this second effect results from maintaining a fully active AP-1 activity in the cells. This dual effect of v-erbA can explain how this oncogene contributes to sarcomatogenic and leukemogenic transformation by directly inhibiting cell differentiation while simultaneously and indirectly activating cell proliferation.

Experimental Procedures

Construction of Expression Vectors and Reporter Genes

The RAR α expression vector was constructed by insertion of the human RAR α cDNA (Petkovich et al., 1987) (kindly provided by P. Chambon, Strasbourg, France) into a pRSV vector, downstream of the RSV-LTR. The RAR α cDNA was excised after digestion by EcoRI, blunt-ended, and cloned into a pRSV plasmid obtained by deleting the HindIII-ScaI fragment of the CAT sequence from pRSV-CAT (Gorman et al., 1982). The chicken c-ErbA α and v-ErbA expression vectors placed under control of the RSV-LTR have been described previously (Forman et al., 1988; Damm et al., 1989). The RSV-LTR-driven expression vectors for the v-ErbA/c-ErbA chimeric proteins were constructed from recombinant retroviral vector genomes in which the chimeric sequences were cloned. The chimeric sequences were excised from these virus genomes after digestion by ClaI and inserted into a pRSV plasmid. Details of the constructions of these chimeric receptors are described in the following section.

The expression vector for the human glucocorticoid receptor has been described previously (Kumar et al., 1987) and was kindly provided by P. Chambon (Strasbourg, France). The c-Jun expression plasmid, kindly provided by M. Castellazi (Lyon, France), was constructed by insertion of the FspI-ScaI fragment of the mouse *c-jun* cDNA into a pRSV vector (Ryseck et al., 1988). The expression vector for murine c-Fos was kindly provided by B. Wasylyk (Strasbourg, France) (Wasylyk et al., 1988). The collagenase promoter-CAT constructs (517Col-CAT and 73Col-CAT) have been described elsewhere (Angel et al., 1987a) and were provided by P. Herrlich (Karlsruhe, Germany). The [AP-1]₃-CAT plasmid carrying three AP-1 sites upstream of the -109 to +10 sequences of the rabbit β -globin promoter linked to the CAT gene has already been described (Urier et al., 1989) and was provided by A. Sergeant (Lyon, France). The *c-jun*-CAT reporter gene was kindly provided by N. La Vista and M. Castellazi (Lyon, France). It was constructed by ligation of the BamHI-BglII fragment of the quail *c-jun* promoter, which corresponds to the sequence from positions -920 to +57 upstream of the CAT gene.

Transfections and Reporter Assays

HeLa cells were routinely grown in Eagle's minimal essential medium with Earle's salts supplemented with 10% newborn calf serum. Twenty-four hours before transfection, 0.4×10^6 cells per 60 mm dish were plated in 5% serum-containing medium. Transfections of plasmid DNA into HeLa cells were performed using a calcium phosphate procedure derived from previously described protocols (Graham and van der Eb, 1973; Wigler et al., 1978). The amount of transfected DNA is indicated in the figure legends. The amount of RSV-LTR was kept constant by complementing with an "empty" expression vector. Cells were exposed to the precipitate for 16–20 hr, then refed with Eagle's minimal essential medium with Earle's salts supplemented with 0.5% serum, and incubated simultaneously with the various combinations of ligands for an additional 24 hr.

RSV- β -galactosidase (2 μ g per dish) was included as an internal control to normalize for transfection efficiencies. The β -galactosidase activity was measured as previously described (Nielsen et al., 1983).

CAT enzymatic activity was measured at room temperature by following the kinetics of chloramphenicol acetylation with [³H]acetyl CoA as substrate (Neumann et al., 1987). The method relies on the diffusion of labeled acetylchloramphenicol into a water-nonsoluble liquid scin-

tillation counting cocktail. For each assay, the initial rate of the enzymatic reaction ($v = d[P]/dt$) was determined and expressed in pmol/min. The details of the procedure will be described elsewhere.

Construction of Chimeric *erbA* Genes and Recombinant Retroviruses

Chimeric *v/c-erbA* genes were constructed by exchanging homologous fragments between the chicken *c-erbA α* and *v-erbA* sequences coming respectively from the pRSVc-*erbA α* plasmid (Forman et al., 1988) and from the pXJ12 plasmid (Benchaibi et al., 1989). The CASBA9 retroviral vector was constructed by inserting the entire coding sequence of *c-erbA*, obtained by digestion with EcoRI, into the ClaI site of the RCAS helper-independent retroviral vector by using the pCla12 adaptor plasmid (Hughes et al., 1987). CASBA5 was derived from CASBA9 by replacing the Drall1 fragment, which contains the DNA-binding domain, with the corresponding fragment of *v-erbA*. CASBA98 and CASBA54 were derived respectively from CASBA9 and CASBA5, by exchanging the C-terminal BstEII–ApaI fragment, which contains the hormone-binding domain, with that of *v-erbA*.

Virus Production and Colony Forming Assays

To produce the different CASBA viruses, CEFs were grown and transfected as previously described (Gandrillon et al., 1987). Virus suspensions were rescued 8 days after transfection. Viral titers were of about 10^8 particles per ml, as estimated by in situ detection of the number of cells expressing the p27Gag protein. The XJ12 virus was produced and titered as previously described (Gandrillon et al., 1987).

The colony-forming assay was performed as previously described (Gandrillon et al., 1987). The effect of chimeric *v/c-ErbA* proteins on induction of CEF resistance to the growth-inhibitory action of RA was analyzed. To check whether this effect was T3-dependent, especially for CEFs infected with the CASBA9 and CASBA5 viruses both containing the *c-ErbA* hormone-binding domain, the T3 intracellular concentration was controlled. This T3 cellular concentration was reduced by adding reverse T3 (r-T3) into the culture medium supplemented with normal serum. r-T3 is an antagonist of T3 that binds very poorly to the T3 receptors (Sap et al., 1986; Weinberger et al., 1986). r-T3 is supposed to compete with T3 for entering the cell and thereby maintain the T3 intracellular concentration at a low level (Pain et al., 1990). Similar results were obtained either with this procedure or with the use of T3-depleted serum after treatment with an anion exchange resin (Samuels et al., 1979). However, smaller and fewer colonies were recovered in experiments with T3-depleted serum, probably because treatment of serum with the resin also removed some growth factors (Pain et al., 1990). For this reason, we preferred to use normal serum supplemented with r-T3. Cultures were duplicated and incubated either in the presence of exogenous T3 or in the absence of exogenous T3 (in this case, the antagonist r-T3 was included). RA, T3, or rT3 was added respectively at 10^{-6} M, 10^{-8} M, and 10^{-7} M in the soft agar medium. An additional soft agar overlay identical to the original one was added 1 week after seeding. Colonies were scored 2 weeks after seeding.

Acknowledgments

We thank B. B. Rudkin for critical reading of the manuscript and M. Buisson and A. Sergeant for production of proteins by in vitro translation. We are grateful to M. Castellazi for plasmids and for communication of unpublished results. We also thank P. Chambon, B. Wasylk, and P. Herrlich for the gift of plasmids. This work was supported by the Centre National de la Recherche Scientifique, Université Claude Bernard Lyon-1 (Département de Biologie Humaine), Ecole Normale Supérieure de Lyon, Institut National de la Recherche Agronomique, Association pour la Recherche contre le Cancer (ARC), and Fédération Nationale des Centres de Lutte contre le Cancer. C. D. and D. A. were recipients of fellowships from Ministère de la Recherche et de la Technologie and are presently supported by ARC.

The costs of publication of this article were defrayed in part by the payment of page charges. This article must therefore be hereby marked "advertisement" in accordance with 18 USC Section 1734 solely to indicate this fact.

Received May 20, 1991; revised July 17, 1991.

References

- Akerblom, I. E., Slater, E. P., Beato, M., Baxter, J. D., and Mellon, P. L. (1988). Negative regulation by glucocorticoids through interference with a cAMP responsive enhancer. *Science* **241**, 350–353.
- Angel, P., Baumann, I., Stein, B., Delius, H., Rahmsdorf, H. J., and Herrlich, P. (1987a). 12-O-tetradecanoyl-phorbol-13-acetate induction of the human collagenase gene is mediated by an inducible enhancer element located in the 5'-flanking region. *Mol. Cell. Biol.* **7**, 2256–2266.
- Angel, P., Imagawa, M., Chiu, R., Stein, B., Imbra, R. J., Rahmsdorf, H. J., Jonat, C., Herrlich, P., and Karin, M. (1987b). Phorbol ester-inducible genes contain a common *cis* element recognized by a TPA-modulated *trans*-acting factor. *Cell* **49**, 729–739.
- Angel, P., Hattori, K., Smeal, T., and Karin, M. (1988). The *jun* proto-oncogene is positively autoregulated by its product, Jun/AP-1. *Cell* **55**, 875–885.
- Beato, M. (1989). Gene regulation by steroid hormones. *Cell* **56**, 335–344.
- Benchaibi, M., Mallet, F., Thoraval, P., Savatier, P., Xiao, J. H., Verdier, G., Samarut, J., and Nigon, V. (1989). Avian retroviral vectors derived from avian defective leukemia virus: role of the translational context of the inserted gene on efficiency of the vectors. *Virology* **169**, 15–26.
- Clark, S. D., Kobayashi, D. K., and Welgus, H. G. (1987). Regulation of the expression of tissue inhibitor of metalloproteinases and collagenase by retinoids and glucocorticoids in human fibroblasts. *J. Clin. Invest.* **80**, 1280–1288.
- Curran, T., and Franza, B. R., Jr. (1988). Fos and Jun: the AP-1 connection. *Cell* **55**, 395–397.
- Damm, K., Thompson, C. C., and Evans, R. M. (1989). Protein encoded by *v-erbA* functions as a thyroid-hormone receptor antagonist. *Nature* **339**, 593–597.
- Desbois, C., Pain, B., Guilhot, C., Benchaibi, M., French, M., Ghysdael, J., Madjar, J. J., and Samarut, J. (1991). *v-erbA* oncogene abrogates growth inhibition of chicken embryo fibroblasts induced by retinoic acid. *Oncogene*, in press.
- de Thé, H., del Mar Vivanco-Ruiz, M., Tiollais, P., Stunnenberg, H., and Dejean, A. (1990). Identification of a retinoic acid responsive element in the retinoic acid receptor β gene. *Nature* **343**, 177–180.
- Diamond, M. I., Miner, J. N., Yoshinaga, S. K., and Yamamoto, K. R. (1990). Transcription factor interactions: selectors of positive or negative regulation from a single DNA element. *Science* **249**, 1266–1272.
- Diaz, J. J., Gandrillon, O., Hentzen, D., Leguellec, D., Samarut, J., and Madjar, J. J. (1989). Increase in ribosomal protein S6 phosphorylation is due to *v-erbB*-transforming activity and not to *v-erbA* mitogenic activity in avian erythroblastosis virus-infected chicken embryo fibroblasts. *Oncogene Res.* **1**, 163–175.
- Evans, R. M. (1988). The steroid and thyroid hormone receptor superfamily. *Science* **240**, 889–895.
- Forman, B. M., Yang, C., Stanley, F., Casanova, J., and Samuels, H. H. (1988). *c-erbA* protooncogenes mediate thyroid hormone-dependent and -independent regulation of the rat growth hormone and prolactin genes. *Mol. Endocrinol.* **2**, 902–911.
- Frisch, S. M., Clark, E. J., and Werb, Z. (1987). Coordinate regulation of stromelysin and collagenase genes determined with cDNA probes. *Proc. Natl. Acad. Sci. USA* **84**, 2600–2604.
- Gandrillon, O., Jurdic, P., Benchaibi, M., Xiao, J.-H., Ghysdael, J., and Samarut, J. (1987). Expression of the *v-erbA* oncogene in chicken embryo fibroblasts stimulates their proliferation in vitro and enhances tumor growth in vivo. *Cell* **49**, 687–697.
- Gandrillon, O., Jurdic, P., Pain, B., Desbois, C., Madjar, J. J., Moscovici, M. G., Moscovici, C., and Samarut, J. (1989). Expression of the *v-erbA* product, an altered nuclear hormone receptor, is sufficient to transform erythrocytic cells in vitro. *Cell* **58**, 115–121.
- Glass, C. K., Franco, R., Weinberger, C., Albert, V. R., Evans, R. M., and Rosenfeld, M. G. (1987). A *c-erbA* binding site in rat growth hormone gene mediates *trans*-activation by thyroid hormone. *Nature* **329**, 738–741.
- Glass, C. K., Lipkin, S. M., Devary, O. V., and Rosenfeld, M. G. (1989).

- Positive and negative regulation of gene transcription by a retinoic acid–thyroid hormone receptor heterodimer. *Cell* 59, 697–708.
- Gorman, C. M., Merlino, G. T., Willingham, M. C., Pastan, I., and Howard, B. H. (1982). The Rous sarcoma virus long terminal repeat is a strong promoter when introduced into a variety of eukaryotic cells by DNA-mediated transfection. *Proc. Natl. Acad. Sci. USA* 79, 6777–6781.
- Graham, F. L., and van der Eb, A. J. (1973). A new technique for the assay of infectivity of human adenovirus 5 DNA. *Virology* 52, 456–467.
- Graupner, G., Wills, K. N., Tzukerman, M., Zhang, X. K., and Pfahl, M. (1989). Dual regulatory role for thyroid-hormone receptors allows control of retinoic-acid receptor activity. *Nature* 340, 653–656.
- Green, S., and Chambon, P. (1986). A superfamily of potentially oncogenic hormone receptors. *Nature* 324, 615–617.
- Hughes, S. H., Greenhouse, J. J., Petropoulos, C. J., and Suttrave, P. (1987). Adaptor plasmids simplify the insertion of foreign DNA into helper-independent retroviral vectors. *J. Virol.* 61, 3004–3012.
- Izumo, S., and Mahdavi, V. (1988). Thyroid hormone receptor alpha isoforms generated by alternative splicing differentially activate myosin HC gene transcription. *Nature* 334, 539–542.
- Jansson, M., Beug, H., Gray, C., Graf, T., and Vennström, B. (1987). Defective *v-erbB* genes can be complemented by *v-erbA* in erythroblast and fibroblast transformation. *Oncogene* 1, 167–173.
- Jonat, C., Rahmsdorf, H. J., Park, K.-K., Cato, A. C. B., Gebel, S., Ponta, H., and Herrlich, P. (1990). Antitumor promotion and antiinflammation: down-modulation of AP-1 (Fos-Jun) activity by glucocorticoid hormone. *Cell* 62, 1189–1204.
- Koenig, R. J., Brent, G. A., Warne, R. L., Larsen, P. R., and Moore, D. D. (1987). Thyroid hormone receptor binds to a site in the rat growth hormone promoter required for induction by thyroid hormone. *Proc. Natl. Acad. Sci. USA* 84, 5670–5674.
- Kumar, V., Green, S., Stack, G., Berry, M., Jin, J.-R., and Chambon, P. (1987). Functional domains of the human estrogen receptor. *Cell* 51, 941–951.
- Levine, M., and Manley, J. L. (1989). Transcriptional repression of eukaryotic promoters. *Cell* 59, 405–408.
- Munoz, A., Zenke, M., Gehring, U., Sap, J., Beug, H., and Vennström, B. (1988). Characterization of the hormone-binding domain of the chicken *c-erbA*/thyroid hormone receptor protein. *EMBO J.* 7, 155–159.
- Neumann, J. R., Morency, C. A., and Russian, K. O. (1987). A novel rapid assay for chloramphenicol acetyltransferase gene expression. *BioTechniques* 5, 444–447.
- Nicholson, R. C., Mader, S., Nagpal, S., Leid, M., Rochette-Egly, C., and Chambon, P. (1990). Negative regulation of the rat stromelysin gene promoter by retinoic acid is mediated by an AP1 binding site. *EMBO J.* 9, 4443–4454.
- Nielsen, D. A., Chou, J., Mackrell, A. J., Casabadian, M. J., and Steiner, D. F. (1983). Expression of a preproinsulin β -galactosidase gene fusion in mammalian cells. *Proc. Natl. Acad. Sci. USA* 80, 5198–5202.
- Offringa, R., Gebel, S., van Dam, H., Timmers, M., Smits, A., Zwart, R., Stein, B., Bos, J. L., van der Eb, A., and Herrlich, P. (1990). A novel function of the transforming domain of E1a: repression of AP-1 activity. *Cell* 62, 527–238.
- Oppenheimer, J. H., and Samuels, H. H., eds. (1983). *Molecular Basis of Thyroid Hormone Action* (New York: Academic Press).
- Pain, B., Melet, F., Jurdic, P., and Samarut, J. (1990). The carbonic anhydrase II gene, a gene regulated by thyroid hormone and erythropoietin, is repressed by the *v-erbA* oncogene in erythrocytic cells. *New Biologist* 2, 284–294.
- Petkovich, M., Brand, N. J., Krust, A., and Chambon, P. (1987). A human retinoic acid receptor which belongs to the family of nuclear receptors. *Nature* 330, 444–450.
- Privalsky, M. L., Boucher, P., Koning, A., and Judelson, C. (1988). Genetic dissection of functional domains within the avian erythroblastosis virus *v-erbA* oncogene. *Mol. Cell. Biol.* 8, 4510–4517.
- Ryseck, R. P., Hirai, S. I., Yaniv, M., and Bravo, R. (1988). Transcriptional activation of *c-jun* during the Go/G1 transition in mouse fibroblasts. *Nature* 334, 535–537.
- Sakai, D. D., Helms, S., Carlstedt-Duke, J., Gustafsson, J. A., Rothman, F. M., and Yamamoto, K. R. (1988). Hormone-mediated repression: a negative glucocorticoid response element from the bovine prolactin gene. *Genes Dev.* 2, 1144–1154.
- Samuels, H. H., Stanley, F., and Casanova, J. (1979). Depletion of L-3,5,3'-triiodothyronine and L-thyroxine in euthyroid calf serum for use in cell culture studies of the action of thyroid hormone. *Endocrinology* 105, 80–85.
- Sap, J., Munoz, A., Damm, K., Goldberg, Y., Ghysdael, J., Leutz, A., Beug, H., and Vennström, B. (1986). The *c-erbA* protein is a high-affinity receptor for thyroid hormone. *Nature* 324, 635–640.
- Sap, J., Munoz, A., Schmitt, J., Stunnenberg, H., and Vennström, B. (1989). Repression of transcription mediated at a thyroid hormone response element by the *v-erbA* oncogene product. *Nature* 340, 242–244.
- Saus, J., Quinones, S., Otani, Y., Nagase, H., Harris, E. D., and Kurkinen, M. (1988). The complete primary structure of human matrix metalloproteinase-3. *J. Biol. Chem.* 263, 6742–6745.
- Schüle, R., Umehono, K., Mangelsdorf, D. J., Bolado, J., Pike, J. W., and Evans, R. M. (1990a). Jun-Fos and receptors for vitamins A and D recognize a common response element in the human osteocalcin gene. *Cell* 61, 497–504.
- Schüle, R., Rangarajan, P., Kliewer, S., Ransone, L. J., Bolado, J., Yang, N., Verma, I. M., and Evans, R. M. (1990b). Functional antagonism between oncoprotein c-Jun and the glucocorticoid receptor. *Cell* 62, 1217–1226.
- Sporn, M. B., and Roberts A. B. (1991). Interactions of retinoids and transforming growth factor- β in regulation of cell differentiation and proliferation. *Mol. Endocrinol.* 5, 3–7.
- Umehono, K., Giguere, V., Glass, C. K., Rosenfeld, M. G., and Evans, R. M. (1988). Retinoic acid and thyroid hormone induce gene expression through a common responsive element. *Nature* 336, 262–265.
- Urier, G., Buisson, M., Chambard, P., and Sergeant, A. (1989). The Epstein-Barr virus early protein EB1 activates transcription from different responsive elements including AP-1 binding sites. *EMBO J.* 8, 1447–1453.
- van Dam, H., Offringa, R., Meijer, I., Stein, B., Smits, A. M., Herrlich, P., Bos, J. L., and van der Eb, A. J. (1990). Differential effects of the adenovirus E1A oncogene on members of the AP-1 transcription factor family. *Mol. Cell. Biol.* 10, 5857–5864.
- Vasios, G. W., Gold, J. D., Petkovich, M., Chambon, P., and Gudas, L. J. (1989). A retinoic acid-responsive element is present in the 5' flanking region of the laminin B1 gene. *Proc. Natl. Acad. Sci. USA* 86, 9099–9103.
- Wasylyk, C., Imler, J. L., and Wasylyk, B. (1988). Transforming but not immortalizing oncogenes activate the transcription factor PEA1. *EMBO J.* 7, 2475–2483.
- Weinberger, C., Thompson, C. C., Ong, E. S., Lebo, R., Gruol, D. J., and Evans, R. M. (1986). The *c-erbA* gene encodes a thyroid hormone receptor. *Nature* 324, 641–646.
- Wigler, M., Pellicer, A., Silverstein, S., and Axel, R. (1978). Biochemical transfer of single-copy eucaryotic genes using total cellular DNA as donor. *Cell* 14, 725–731.
- Yang-Yen, H.-F., Chambard, J.-C., Sun, Y.-L., Smeal, T., Schmidt, T. J., Drouin, J., and Karin, M. (1990). Transcriptional interference between c-Jun and the glucocorticoid receptor: mutual inhibition of DNA binding due to direct protein–protein interaction. *Cell* 62, 1205–1215.
- Zenke, M., Munoz, A., Sap, J., Vennström, B., and Beug, H. (1990). *v-erbA* oncogene activation entails the loss of hormone-dependent regulator activity of *c-erbA*. *Cell* 61, 1035–1049.

Note Added in Proof

In *Cell* 66, 885–893, Sharif and Privalsky showed that *v-erbA* can inhibit transcriptional activation by RAR on retinoic acid–responsive elements. These data together with our present data demonstrate that *v-erbA* has evolved to become a potent antagonist of RAR in several control pathways.