

## TABLE DES MATIERES

### Advances in soil structure characterization (oral)

Rare earth oxides as tracers for studying aggregate turnover X. Peng, S. Liu and Q. Zhu .....	12
Soil Structural State in Different Crop-Pasture Rotation Systems G. De León, M. Pérez-Bidegain, J. Terra and O. Ernst .....	13
Assessing the accuracy of total station scanning and close-range photogrammetry for measuring water-induced channels F. Zheng and S. Li .....	15
Application of X-ray Computed Tomography to investigate the effect of alternative traffic and tillage systems on soil physical properties W. Millington, P. Misiewicz, E. Dickin, D. White, S. Mooney and R. Godwin .....	17
Monitoring soil structure dynamics with passive acoustic emissions - soil biological activity M. Lacoste, S. Ruiz and D. Or .....	19
The Double Spade Method: a 'mini-profile' visual soil evaluation technique J. Emmet-Booth, D. Forristal, O. Fenton, G. Bondi and N. Holden .....	21
Changes in Subsoil Pore System and Anisotropy Caused by Agricultural Machinery Traffic I. Martínez, M. Stettler, M. Lorenz, J. Brunotte, P. Weisskopf and T. Keller .....	23
Classification of topsoil structural quality with physical thresholds A. Johannes, P. Weisskopf, R. Schulin and P. Boivin .....	25
Evaluating pedotransfer functions for the estimation of soil bulk density on cultivated fields I. Cousin, A. Ly, P. Bessard Duparc, O. Champolivier, M.-H. Bernicot and A. Bouthier .....	27
Studying the effect of desiccation cracking on the hydraulic behavior of a Luvisol-From an experimental and numerical approach D.K. Tran, N. Ralaizafisoarivony, R. Charlier, B. Mercatoris, A. Léonard, D. Toye and A. Degré .....	29
The Visual Evaluation of Soil Structure (VESS) in Tropical Soils: How and When to Sample R. Guimarães, C. Rogers, D. Rader, V. Pacheco, A. Cavalli and R. Barboza .....	31

### Advances in soil structure characterization (poster)

New applications of X-ray CT in soil science in the last 10 years X. Peng, H. Zhou, Z. Zhang and N. Bottinelli .....	33
Linking stress-strain test with X-ray CT analysis to examine the effects of soil moisture and soil tillage on soil structure J. Pöhlitz, J. Rücknagel, S. Schlüter, H.-J. Vogel and O. Christen .....	34
Size Distribution of Soil Pores: a Model allowing for Bi- modality needed to account for Management Effects J. Jensen, P. Schjønning, C. Watts, B.T. Christensen and M. Munkholm .....	37
Development of a Non-Destructive Quick and "Open Source" Method to Render an Image of Soil Compaction. O. Suc, O. Ancelin, Q. Storme, A. Bertin and H. Boizard .....	39
Assessment of pore-size distribution using a flatbed scanner based image analysis method. K. Binnie, B. McKenzie and T. Valentine .....	41
Exploring Visual Soil Evaluation and Examination methods on Ferralsols in Uganda W. Cornelis, D. Akodi, E. Komutunga, C. Agaba, E. Ahumuza and K. Oratungye .....	43
From the macro to the microaggregate: an alternative multiscale approach to quantify mechanical stability of aggregates D. Uteau, V. Felde and S. Peth .....	45
The role of the particle shape in the discrete element model of soil-sweep interaction K. Tamás, Z. Oláh and L. Rácz-Szabó .....	46
Developing the Discrete Element Model of Soil-Sweep Interaction Based on Field Test K. Tamás, A.E. Ince and E. Cakir .....	48

Interest of using 'profil cultural' method to describe vineyard soils, in order to assess and manage soil fertility R. Koller, A. Schaub and O. Rapp .....	50
Simplified method of soil structure assessment taking into account earthworm activity C. Turillon, A. Duparque, V. Tomis, V. Cretin, D. Piron and H. Boizard .....	52
Spatial Distribution of VESS Soil Quality Scores in Relation to Quantitative Soil Properties R. Guimarães, C. Rogers, R. Barboza, J. Machado, P. Zanini and V. Pacheco .....	54
Characterization of agricultural soils by the use of geographical information systems (GIS) and statistical analysis: case of the Cherrat-Morocco region H. Sehlaoui, R. Hassikou, A. Zouahri, B. Soudi, A. Douaik, H. Iaaich, H. Yachou, A. Ghanimi and H. Dakak .....	56
An Integrated Triple-Sensor Cone Penetrometer for Soil Physical Properties M. Naderi-Boldaji and M. Tekeste .....	58

### **Biogeochemical processus in soil (oral)**

Integrated Assessment of the Bio-preparations and Organic Fertiliser Effect on Soil Properties Z. Kriauciuniene, A. Adamaviciene, J. Sasnauskiene, R. Cepulienė, R. Velicka, V. Naujokiene, E. Šarauskis, A. Marcinkeviciene, K. Romaneckas and L. Masionyte .....	60
Tillage and irrigation management: effects on corn production and soil greenhouse gas emissions under Mediterranean conditions S. Franco-Luesma, E. Paracuellos, D. Plaza-Bonilla, J.L. Arrúe, C. Cantero-Martínez, J. Cávero and J. Álvaro-Fuentes ...	62
Challenges of <sup>15</sup> N field studies to measure N fertilizer recovery under irrigated conservation agriculture K. Grahmann, N. Verhulst, B. Govaerts, K. Dittert and A. Buerkert .....	64
Tillage can continuously reduce the radiocesium contamination and soil-to-crop transfer coefficient for 7 years after FDNPP accident. P. Li, Y. Gong and M. Komatsuzaki .....	66

### **Biogeochemical processus in soil (poster)**

First Analysis Of The Nitrate Leaching Risk For Different Fertilisers In The Persephone Project B. Daigneux, N. Molitor, J. Gennen and V. Debbaut .....	68
Availability efficiency of Phosphorus applied to volcanic soils using different phosphate sources D. Pinochet and J. Carrasco .....	70
Adopting no-tillage alters the molecular-level composition of soil organic matter in the North China Z. Du, G. Li and A. Zhang .....	72
Effect of chemical and no chemical amendments on soil salinity reduction in the region of Sed El mesjoune- Marrakech S. El Hasini, O. Iben Halima, H. Dakkak, A. Douaik, M. El Azzouzi and A. Zouahri .....	75

### **Design and assessment of soil tillage strategies (oral)**

Strip-till for maize in sandy loam soils: Importance of tillage depth, preceding cover crops and fertilization technique T. Thijs Vanden Nest and G. Ruyschaert .....	77
Temporal Changes of Soil Physical Properties in Maize Growing Season as Affected by Long-term Tillage Treatments in Northeast China H. Wang, L. Wang, W. Gao and T. Ren .....	79
No-tillage and Adequate N Fertilization Strategies: Key Practices to Enhance Grain Yield and Mitigate Global Warming in Mediterranean Agroecosystems D. Plaza-Bonilla, J. Álvaro-Fuentes, J. Lampurlanés, J.L. Arrúe, E. Pareja-Sánchez, S. Franco-Luesma and C. Cantero-Martínez	81
Influence of Tillage Practices on Some Engineering Properties of Cassava Tubers and the Performance of an Automated Cassava Peeler. O. Adetola, O. Olukunle and A. Olalusi .....	83

Chemical Composition of Maize Grain Depending on Tillage Systems and Nitrogen Fertilization I. Jug, D. Jug, B. urdević, V. Vukadinović, B. Brozović and B. Stipešević .....	85
Impact of cover crops on a wheat-corn rotation established with conventional, minimum or no tillage J. Labreuche, A. Geille and S. Bureau .....	87
A participatory design of cover crop no tillage techniques without herbicide L. Vincent-Caboud, J. Peigné and C. David .....	89
The influence of potato production on soil physical conditions with the depth of tillage as part of crop rotations. B. McKenzie, M. Stalham, K. Preedy and P. Hallett .....	91
Multicriteria Assessment of the Effects of Tillage Practices on Cropping Systems: Development of the Decision Support Tool DEXiSol C. Thibault, N. Cavan, J. Labreuche, P. Métais and F. Angevin .....	93
The Effect of Five Years of Tillage and Poultry Manure Application on Soil Physical and Chemical Properties, Growth and Yield of ginger T.M. Agbede .....	95
Effects of Cover Crops and Tillage Methods on Maize Growth and Soil Physical Properties on a Sandy Loam Soil L. Ren, T. Vanden Nest, G. Ruyschaert, T. D'Hose and W. Cornelis .....	97
Soil quality monitoring by farmers in the frame of a result-oriented scheme: the case of Swiss arable land O. Sauzet, K. Gondret, A. Johannes and P. Boivin .....	99
A root elongation assay for assessing the impact of tillage in medium-term management trials T. Valentine, K. Binnie, R. Stobart, P. Hallett, N. Morris, T. George, A. Newton and B. McKenzie .....	101
Intensity-capacity parameters and management of waterlogged volcanic soils F. Zúñiga, R. Horn and J. Dörner .....	103
Short-term effects of loosening and incorporation of straw into the upper subsoil on soil physical properties and crop yield G. Getahun, T. Kätterer, M. Munkholm, M. Parvag, T. Keller, K. Rychel and H. Kirchmann .....	105
Assessing annual and vertical variability of near- saturated hydraulic conductivity for Integrated Weed Management-based cropping systems C. Ugarte Nano, B. Nicolardot and M. Ubertosi .....	107
A novel deep tillage technique - Fenlong tillage B. Wei and X. Peng .....	110
 <b>Design and assessment of soil tillage strategies (poster)</b>	
Rates of Mechanized Tillage Operations as Affected by Manual and Mechanized Agricultural Bush Clearing Methods J. Adama .....	112
Appropriate Tillage Practices and N use to Improve Corn Yield in Irrigated Mediterranean Agroecosystems. E. Pareja-Sánchez, D. Plaza-Bonilla, J. Álvaro-Fuentes and C. Cantero-Martínez .....	113
Assessing the effects of agricultural management, grazing regimes and grass-clover leys on soil quality using the Soil Management Assessment Framework (SMAF) C.F. Zani, M.R. Cherubin, J. Gowing, G.D. Abbott, J.A. Taylor, E. Lopez-Capel and J. Cooper .....	115
Constructing fertile cultivated soil layer by tillage and straw incorporation in a Mollisoi in Northeast China X. Han, W. Zou and X. Lu .....	117
CA-SYS: A long term experimental platform on agroecology at various scales S. Cordeau, J. Bursin, P. Lemanceau, P. Marget, N. Munier-Jolain, S. Petit, C. Steinberg and V. Deytieux .....	120
Effect of tillage on corn yield, water use and water use efficiency under irrigated conditions J. Jabro, B. Stevens and B. Iversen .....	121
Tillage strategies to optimize rapeseed establishment: a method to support decision making S. Cadoux, A.-S. Perrin and G. Sauzet .....	123
Impact of soil tillage techniques on yield and net margin in different crop rotations J. Labreuche, G. Levesque and B. Dubois .....	125

How to design a cropping system to reach a good soil structure R. Koller, A. Schaub, O. Rapp, R. Reau and G. Fortino .....	127
Tillage effects on soil properties and consequences wheat development in north Algeria. S. Taibi, M.A. Feddal and M. Amara .....	129
Effect of Different Methods of Planting and Weeding on Machine Field Capacity and Yield of a Mixed Cropping Small Holder Farm F. Fayose, A. Olaniyan, B. Alabadan, K. Ogunleye, O. Omoju, C. Aladejebi, A. Fajimi and O. Ilesanmi .....	131
Effects of Tillage Operations on the Yield Components of Okra J. Olaoye, I. Oyeleke and M. Olaoye .....	133
Effect of different tillage methods on some soil physical properties and yield of two cottons cultivars. S. Nowrouzieh and H. Shamsabadi .....	135
 <b>SOC sequestration and management (oral)</b>	
Implementation of the 4 per 1000 initiative at the regional scale: A case study for Bavaria M. Wiesmeier, J. Burmeister, H. Hübner and I. Kögel-Knabner .....	137
Effects of Tillage on Storage and Pool Size of Organic Carbon when Crop Residue is Returned to the Soil Surface A. Liang, Y. Zhang, X. Li, E. Gregorich, N. McLaughlin, X. Zhang and Y. Guo .....	139
Long-term no tillage favors conserving carbon in the soil food web indicated by nematode metabolism analysis S. Zhang, X. Yang, S. Cui, P. Liu, D. Wu, W. Liang and A. Liang .....	141
There Are no Differences in Soil Carbon Storage Between Inversion Tillage and Reduced Tillage Systems in Medium-term Experiments in the UK J. Brown, R. Stobart, P. Hallett, N. Morris, T. George, A. Newton, T. Valentine and B. McKenzie .....	142
Long-Term Response of a Bahaiagrass Pasture to Elevated Atmospheric CO <sub>2</sub> and Nitrogen Management S. Prior, G. Runion and H. Torbert .....	144
Does conversion to conservation tillage really increase soil organic carbon stocks in organic arable farming? M. Krauss, F. Cuperus, A. Don, A. Gattinger, S. Gruber, W. Haagsma, F. Hegewald, J. Peigné, M. Chiodelli Palazzoli, F. Schulz, M. Van Der Heijden, L. Vincent-Caboud, M. Wiesmeier, R. Wittwer, S. Zikeli and M. Steffens .....	146
Biomass yield, nutrient removal, and soil chemical properties changes of perennial energy grasses G. Siri, M. Bustamante and O. Ernst .....	148
Early detection of temporal SOC stocks changes by accounting for spatial variability G. Vitte, F. Ferchaud, F. Chlebowski and B. Mary .....	150
Rye Cover Crop Improve the reduction of Net GWP and Increase Soil Organic Carbon Content in Both of Tillage and No-tillage Agroecosystem Y. Gong, P. Li and M. Komatsuzaki .....	152
Influence of exogenous organic matter composition after anaerobic digestion on heterotrophic microorganism's behaviour in agricultural soils. R. Beghin-Tanneau, F. Guerin, J. Scheiner, D. Serca, M. Guiresse and D. Kleiber .....	154
Tillage System and Spatial Variation of Soil Organic Carbon Budget In North Kazakhstan K. Akshalov, M. Tobias, M. Kuzhinov, A. Kiyas and Z. Taishukher .....	156
Impacts of Coal-derived Humic Acid on Yield, Nutrients Accumulation and Quality Characteristics of Sunflower under two Irrigation Regimes S.A. Sadiq, D.M. Baloch, A. Jan and M. Sharif .....	158
The Management of Organic Matter in the Soil of Continental Oases: Study of the Addition of Manure and Compost in the Gataaya Oasis N. Brahim, H. Ibrahim, N. Karbout, T. Gallali, W. Amelung and R. Bol .....	160
Carbon Sequestration as Effect of Long-term Complex Measures V. Boguzas, J. Aleinikoviene and V. Steponaviciene .....	162
Tillage intensity affects total SOC stocks in boreo-temperate regions only in the topsoil K. Meurer, N. Haddaway, M. Bolinder and T. Kätterer .....	164



Monitoring SOC changes in the long-term experiment of Boigneville show no effect of tillage after 47 years B. Mary, F. Ferchaud, F. Chlebowski, N. Blaszczyk and J. Labreuche .....	166
--	-----

### **SOC sequestration and management (poster)**

Removing crop residue in continuous no-tillage systems: Soil and productivity effects are site-specific D. Presley, J. Tatarko and Y. He .....	168
No-tillage with Continuous Corn Cropping Enhances Soil Aggregation and Organic Carbon Storage in Northeast China Y. Zhang, A. Liang, X. Li, E. Gregorich, N. McLaughlin, X. Zhang and Y. Guo .....	170
Detecting the drivers of erosion-induced SOC dynamics under conservation tillage F. Wilken, M. Sommer, K. Van Oost and P. Fiener .....	172
Short-term Effect of Soil Tillage and NPK Fertilization Rates on Soil Carbon Sequestration and Yield of <i>Colocasia esculenta</i> in Two Micro-environments in SE, Nigeria M. Anikwe and E. Ikenganya .....	174
Least limiting water range and soil pore-size distribution related to soil organic carbon dynamics following zero and conventional tillage of a black soil in Northeast China X. Chen, X. Shi and A. Liang .....	176
Corn residue removal for lignocellulose ethanol production and its potential impact on soil health. M. Al-Kaisi and J. Guzman .....	177
Controls of soil carbon turnover in the South-American grasslands G. Berhongaray, R. Alvarez and S. Imhoff .....	178
Assessment of Carbon and Nitrogen Stocks in Tillage Systems by a Perceptron Multi-Layer Model K. Abrougui, B. Mercatoris, H. Boukhalfa, C. Khemis, M. Hamza and S. Chehaibi .....	180

### **Soil compaction and structure remediation (oral)**

Restoration of a compacted clayey sol with cover crop: recovery rate and processes involved P. Boivin, A. Johannes, A. Matter and V. Fell .....	182
The need of lime on clayey soils in arable crops in Germany - status quo T. Frank .....	185
Recovering Crop Yields on Compacted Soils: Combining Soil Science with Plant Physiology T. Tino Colombi and T. Keller .....	187
Improvement of soil-water-use-efficiency in plant production by optimized liming A. Hanssen, I. Zimmermann and R. Horn .....	189
Damage of Paddy Soil during the Turning Maneuver of Tracked Harvester Z. Ding, Y. Li and Z. Tang .....	191
Soil structure recovery after compaction - roles and dynamics of different structure forming processes P. Weisskopf, T. Colombi, D. Or, A. Walter, R. Reiser and T. Keller .....	193
Effect of Tyre Inflation Pressure, Soil Moisture Content and Wheel Tracks on Soil Compaction and Maize Growth G. Ruyschaert, T. D'Hose, L. Ren and W. Cornelis .....	195
Yield Level is Fundamental Factor Influencing Soybean Yield Response to Subsurface Soil Tillage. O. Ernst, P. Etchegoimberly and R. Izaguirre .....	197
Impact of harvest in autumn on soil compaction and plant development for the next crops S. Hervieu, A. Duparque, C. Turillon, V. Tomis, B. Decoopman, V. Hallaire and H. Boizard .....	199
Survey of Soil Structure and Soil Management in UK Horticulture P. Newell Price, D. Munro, E. Sagoo and J. Cloy .....	201
Regeneration effect in the subsoil of a clay soil in South- East Norway five years after the compaction T. Seehusen, R. Riggert, H. Fleige, T. Børresen and H. Riley .....	203

Classified Paper Waste Use for Training Land Rehabilitation H. Torbert, R. Busby and S. Prior .....	205
Effects of modern heavy traffic on subsoil structural characteristics M. Pulido-Moncada, L. Munkholm and P. Schjønning .....	207
A field evaluation of soil compaction by the medium-sized combine harvesters in fully mechanized smallholding farms Q. Ding, H. Wang, X. Chen, Y. Li, K. Sun and R. He .....	209
Understanding precompression stress: Measurement and DEM simulation of confined uniaxial compression of unsaturated soil samples. J. De Pue, G. Di Emidio and W. Cornelis .....	211
Soil deformation and possibilities for soil amelioration - what are the main processes and driving forces to guarantee longterm sustainable land management? R. Horn, J. Dörner, H. Fleige, R. Horn and X. Peng .....	212
Dynamic Changes of Wheel Load and Mean Contact Area Pressure during Sugar Beet Harvest and Soil Tillage M. Lorenz, K. Nolting and J. Brunotte .....	213
Risk assessment of soil compaction in Europe - a case study comparing rubber tracks or wheels on machinery M. Lamandé, M. Greve and P. Schjønning .....	215
Plant Residues Decomposition Effect on Soil Aggregate Stability G. Stegarescu, E. Reintam, T. Tonutare and K. Kauer .....	216
Controlled Traffic Farming "light"- A way to improve soil structure? A. Latsch, U. Zihlmann and T. Anken .....	218
A prototype multi-sensor kit for soil bulk density measurement using combined frequency domain reflectometry and visible and near infrared spectroscopy R. Al-Asadi and A. Mouazen .....	220
Long-term effects of intense tillage of olive groves in south of Tunisia. Is there a solution? M. Hazoug, P. Podwojewski, M. Abichou and M. Moussa .....	222
Evolution of Agricultural Tire technologies and their impact on soil compaction P. Vervaet, M. Stettler and F. Pinet .....	224
Assessing the effect of different pasture improvement managements on soil pore functions, soil mechanical strength, and pasture production dynamics J. Dörner, R. Horn, D. Dec, I. Ordóñez and F. Zúñiga .....	227
 <b>Soil compaction and structure remediation (poster)</b>	
Soil Compaction Caused by Four-Wheel Tractor with Disc Plow Attachment in an Upland Soil Condition M. Torino, R. Amongo, A. Fajardo, D. Suministrado and R. Eusebio .....	229
Use of different procedures to determine pre-compression stress from soil compressing test data in four different soil textural classes S.B. Mousavi, S. Peth and D. Uteau .....	231
Subsoil Compaction as a Tool to Impact on Seepage in Recultivation Areas. E.J. Murer .....	233
Effect of Tillage on Soil Compaction in Black Soil of Northeast China H. Zheng, J. Zheng, Y. Luo, R. Li, H. Wang and W. Liu .....	234
Ameliorating the Structure of a Degraded Vertisol Using Mechanical and Biological Tillage under a South African Sub-tropical Climate S. Materechera .....	236
Finite Element Simulation of Soil Stress Measurement by Load Cell Transducers M. Naderi-Boldaji and T. Keller .....	238
Changes in Soil Compaction Characteristics with Soil Water Suction and Texture M. Naderi-Boldaji and T. Keller .....	240

Crop damage and yield responses from wheeling with multiple paths vs. multiple drives A. Evgrafova, S.K. Nielsen, M. Walter, S. Boldsen, M. Lamandé, C. Jæger, L. Munkholm and O. Green .....	242
Agricultural traffic effect on maize ( <i>Zea mays</i> L.) yields in the Argentinean Pampas M. Masola, C. Alesso, M. Carrizo and S. Imhoff .....	244
Estimation of Soil Compaction by Using Penetrometer in a Long-term Tillage Experiment. T. Rátonyi, P. Ragán, J. Nagy, A. Széles, P. Fejér and E. Harsányi .....	249
Assessing the physical quality degradation of Aquands in a gradient land uses in southern Chile D. Dec, J. Dörner, F. Zúñiga, O. Thiers, L. Paulino and S. Valle .....	251
Influence of three types of organic mulch on the bulk density and total porosity of a durostoll of a dry sub- humid area of northern Ecuador Y. Gladys .....	253
Effect of Dairy Treated-Waste Application on the Penetration Resistance and Effective Stress of an Argiudoll S. Imhoff .....	255
Effects of tractor speed on soil compaction under different moistures content C. Khemis, K. Abrougui, R. Amami, L. Ren, S. Chehaibi and W. Cornelis .....	257
Impact of tillage intensity on clay loam soil structure O. Daraghme, C. Petersen, M. Munkholm, L. Znova, P.B. Obour, S.K. Nielsen and O. Green .....	259
Root traits effect on soil traffic-induced shear in agroecosystems, the case of cover crops M. Forster, C. Ugarte Nano, M. Lamandé and M.-P. Faucon .....	261
 <b>Soil conservation (poster)</b>	
Soil temperature and moisture as affected by mulching and cover crop management in saffron ( <i>Corocus sativus</i> L.) M. Jafarimoghadam, E. Ghasemi and N. Khalesi .....	263
Modeling effects of straw mulching on soil water and temperature regimes in rain-fed soybean field of central Japan M.A. Kader, K. Nakamura, M. Senge and S. Kawashima .....	265
Effect of Conservation Soil Tillage and Nitrogen Fertilization on Selected Soil Properties and Crop Productivity D. Jug, I. Jug, M. Birkás, V. Vukadinović, J. Lipiec, B. Brozović and B. urdević .....	267
Using the Hydroseeding Method to Establish Plant Vegetation Cover the Eroded Areas of Burdur in Turkey E. Alim, A. Okudan, S. Basaran, H.I. Yolcu and M. Terzi .....	269
The influence of main and cover crops in organic farming on soil water-stable aggregate stability in Estonia M. Are, T. Kaart, A. Astover, K. Kauer, A. Selge and E. Reintam .....	271
Timing, tilth and temperature determine the effect of soil structure liming on aggregate stability J. Blomquist and K. Berglund .....	273
The legacy effect of greenwaste compost application on crop performance in a long running UK field experiment. D. Clarke, N. Morris and E. Stockdale .....	275
Least Limiting Water Range Under Integrated Production Systems -ICL and ICLF. K. Cavalieri-Polizeli, D. Nascimento, A. Silva, N. Favaretto and L.M. Parron .....	277
Effects of Long-term Conversion Tillage on Least Limiting Water Range and Soil Macrostructure of Subsoil in North China Plain M. Tian, T. Ren, H. Zhou and W. Gao .....	279
Subsurface Banding vs. Surface Broadcasting of Poultry Litter Effects on Nutrient Losses to Runoff from a No-tillage Maize Cropping System. D. Watts and T. Way .....	281
Soil Acidity Correction with a Liquid Conditioner in the Center-West of Santa Fe-Argentina R. Martel, A. Valinotti and S. Imhoff .....	283
Participative Quality Index (IQP) of Direct-Planting System and its applications in different Brazilian regions. J. Galende and R. Ralisch .....	285

The Influence of Conservation versus Conventional Tillage on the Physics Properties of a Cultivated Chernozems in Southern Romanian Plane L. Burtan, A.-R. Lacatusu, M. Coronado, A. Vrinceanu and M. Dumitru .....	287
Stability of Soil Aggregates Affected by soil tillage and organic and inorganic fertilization in long-term field experiments A. Dunai and Z. Toth .....	289
Subsurface Drainage in an aquic Argiudoll at the Central Region of Santa Fe G. Camussi, R. Marano and S. Imhoff .....	292
Effect of Qum landfill leachate on soils chemical composition S. Khoramnejadian and M. Khorasanizadeh .....	294
Indigenous Tillage Practices in Anambra State, Southeast Nigeria: Implications for Soil and Water Conservation. P. Nnabude and A. Onunwa .....	297
Seasonal dynamics of the physical quality of volcanic ash soils under different land uses in southern Chile S. Valle, J. Dörner, F. Zúñiga and D. Dec .....	298
The impact of the slope on the organic and minerals amendments in the salinity of soil in the south Tunisian S. Maatoug and A. Hatira .....	300
Some Soil Quality Indicators and Their Relations under Different Tillage in a Clay Soil of Semi-Arid Mediterranean Z.B. Barut, I. Celik and M. Turgut .....	302

## Soil conservation (oral)

49-years of no-tillage and crop residue retention on a Vertisol in north-eastern Australia: lessons learnt Y. Dang, R. Dalal, S. Reeves, G. Thomas, J. Thompson, K. Page, W. Wang, J. Somasundaram, N. Seymour and G. O'leary 304	
Effects of Conservation Tillage based Agro-geo-textiles on Resource Conservation in Sloping Croplands of Indian Himalayan Region R. Singh, N. Sharma, J. Deshwal, B. Ghosh, N. Alam, U. Mandal, G. Kumar, T. Roy, R. Bhattacharyya and P. Mishra .....	306
Topsoil Macroporosity as Affected by Long-term Crop Sequence and Manure Use A. Palojärvi, E. Ketoja and L. Alakukku .....	308
Quantifying soil displacement and tillage erosion rate by different tillage systems in dryland northwestern Iran M. Kouselou, S. Hashemi, I. Eskandari, B. McKenzie, E. Karimi, A. Rezaei and M. Rahmati .....	310
A plot study to characterize the effects of water-induced channel, tillage operation and their interaction on water erosion in subsequent runoff events F. Zheng, S. Li and D. Lobb .....	312
Soil Conservation and Sustainable Landuse Designs, Based on Inventory of Land Degradation, in Some Small Watersheds in Eastern Romania C. Hurjui, N. Popa and G. Petrovici .....	314
Soil Health Assessment: Past Accomplishments, Current Activities, and Future Opportunities D. Karlen, K. Veum and J. Obrycki .....	316
Recovery of soil quality after application of long-term tillage treatments J. Cloy, B. Ball and G. Miller .....	318
Soil Nutrient Management and Crop Production under Conventional and Conservation Tillage System in Dryland Farming System of Pakistan M. Sharif, S.S. Ijaz, M. Ansar and S.A. Sadiq .....	320
Innovative Cover Cropping Systems for Sandy Loam Soils in the Mid-Atlantic Region, USA. M. Reiter, B. Wolters and C. Lawrence .....	322
Sustainable intensification alternatives to Rice-Pasture system in Uruguay: Impacts on rice yield and soil organic C during the transition. I. Macedo, V. Pravia, J. Castillo and J. Terra .....	324
Evaluation of Surface Runoff and Soil Loss in Conservation and Conventional Tillage in a Degraded Inceptisol of Ecuador I. Martínez, C. Velastegui, D. Brown, M. Romero, C. Arcos, J. Prado and M. Gómez .....	326

Effects of soil tillage intensity and compost application in ecological management systems on soil aeration and mechanical stability D. Uteau, U. Roskopf, M. Finckh and S. Peth .....	329
Structure Stability of Long-term Cultivated Soils in the Ethiopian Highland: Effect of Lime and Polyacrylamide A. Mamedov, H. Fujimaki and A. Tsunekawa .....	330
The link between cropping system and overland flow dynamics: the IDR-tool for farmer advice and its validation P. Van Dijk, M. Sivacheva and R. Koller .....	332
Water Erosion Reduction using Various Soil Tillage Approaches. V. Smutný .....	334
Short-term impacts of conservation and traditional agriculture on natural resources in the Peruvian highlands J. Ocaña Reyes, O. Zelarayán Muñoz, R.C. Girón Aguilar, P. Vergara Jimenez and L. Suarez-Salas .....	336
Soil Erosion Assessment And Monitoring In The South High Atlas Of Marrakech Using Remote Sensing And Gis. Z. Zouhair Ourhizif .....	338

### **Soil ecology and ecosystem services (oral)**

Weed response to tillage and cover crop tactics in contrasted crop sequences within long-term experiments P. Métais, J. Labreuche, G. Adeux and S. Cordeau .....	341
Evaluation of archaeal, bacterial and fungal diversity in a long-term wheat- pea rotation under different tillage practices in the Loess Plateau, China E. Essel, L. Li, R. Zhang, Z. Luo, L. Cai and J. Xie .....	343
Relationships between physical and biological indicators in natural and agricultural soils of the semiarid Argentinean Pampa. R. Fernández, I. Frasier, A. Quiroga and E. Noellemeyer .....	345
Nature Farming: New Trends of Organic No-till System in Japan R. Hashimi and M. Komatsuzaki .....	348
Assessing soil diversity and function in organic and conventional minimum tillage plots J. Cooper, T. Feng, N. Gray, S. Kumar, P. Leary, S. Suchitwarasan and L. Xu .....	350
Short-term dynamic of soil properties and soil organisms under contrasting tillage systems S. Coulibaly, A. Aschi, M. Aubert, N. Brunet, M. Legras, F. Bureau and M. Chauvat .....	352
Does the soil structure affect the distribution of soil biological activities in a soil profile? D. Piron, P.-A. Maron, E. Franc, N. Cheviron, H. Boizard, D. Cluzeau and L. Ranjard .....	354

### **Soil ecology and ecosystem services (poster)**

Soil microbial community control the response of soil CO2 emission and crop yield to drought under conservation tillage S. Jia .....	356
Cover crops replace fallow in semi-arid durum cropping systems B. Allen and J. Jabro .....	358
The response of maize yield to tillage depth and straw incorporation in a Mollisols in Northeast China W. Zou, X. Han and X. Lu .....	360
Nitrous Oxide Emission from a Silty-Loamy Soil due to on surface and subsurface application of Pig Slurry M. Carrizo, J. Nicolier, M. Masola, V. Gregorutti and S. Imhoff .....	363
Tillage system effects on weed seedbanks in a clay soil in Algeria M.A. Feddal, M. Amara, L. Boudhar and Z. Mohammedi .....	365
The effect of reduced technologies of soil treatment on weed infestation in the stand of spring barley in the conditions of climatically drier area in South Moravia Region in the Czech J. Winkler, V. Smutný and L. Neudert .....	367
Ecological functions of Soil Actinomycetes of Mongolia J. Norovsuren, I. Boykova, V. Savich and G. Zenova .....	369

Effects and mechanism study of electrokinetic remediation of soil polluted by oxytetracycline H. Li, C. Zhu, J. Ye, B. Li and Z. Zhang .....	371
---	-----

### **Tillage and Smart farming (oral)**

Water Retention and Consistency Approaches for Determining the Water Contents for Tillage P.B. Obour, J. Jensen, M. Lamandé, C. Watts and M. Munkholm .....	373
Precision Nutrient Management: A Viable Alternative for Small- fragmented Land holdings in Changing Climate Scenario in South Asia S. Sharma, P. Chivenge and S. Beebout .....	375
The impact of soil tillage on soil strength and winter wheat performance in a long running UK field experiment N. Morris, D. Clarke and E. Stockdale .....	377
Effects of Soil Tillage and Foliar Fertilization on Biomass Yield of Post-Harvest Seeded Sorghum Cultivars B. Stipešević, B. Brozović, D. Jug, I. Jug, V. Vukadinović and B. urdević .....	379
Estimation of available days for cultivation work: evaluation of J-Dispo tool using CHN dynamic crop model P. Métais, P. Bessard Duparc, R. Trochard and B. Soenen .....	381
Hydrological Evaluation of Tillage Practices in Dry-land Vineyards of Catalonia (NE Spain) I. Pla-Sentís .....	383
Evaluation of a Harvest Logistics Fleet Optimisation Tool as a Soil Compaction Mitigation Strategy A. Villa-Henriksen, N. Skou-Nielsen, A. Evgrafova, C. Sørensen, O. Green and G. Edwards .....	385
Intensified Mechanization for Improved Soil Productivity and Fertility in Paddy-dryland Crop Rotations R. He, X. Chen, L. He, K. Sun and Q. Ding .....	387
Controlled Traffic Farming (CTF) Reduces Soil Emissions, Saves Nitrogen, and Reduces other Environmental Impacts of Mechanised Cropping. C. Bluett, J. Tullberg, D. Antille and C. Scheer .....	389

### **Tillage and Smart farming (poster)**

A new soil spectral index to assess effect of soil tillage on soil water content I. Soltani, Y. Fouad, D. Michot, P. Breger, R. Dubois, P. Pichelin and C. Cudennec .....	391
Study on Cloud-based Research platform for the Smart Greenhouse farming J.H. Baek, P.W. Yang, Y. Hong, H.D. Lee, S.C. Kim and J.S. Lee .....	392
Evaluation of Data Reliability for the Application of IoT(Internet of Things) Technology in Smart Greenhouse J.S. Lee, P.W. Yang, Y. Hong, H.D. Lee, S.C. Kim and J.H. Baek .....	394
Evaluation of Two Methods Measuring Soil CO <sub>2</sub> Emission in a Tillage Experiment M. Dencső, E. Tóth, Á. Horel, I. Potyó, M. Birkás and G. Gelybó .....	396

### **Tires, tillage and seeding equipment design (oral)**

An Empirical and Experimental Analysis of Interaction between Row Cleaner Parameters and Plant Residues in Strip Tillage E. Šarauskis, K. Lekavičienė, V. Naujokienė and S. Buragienė .....	399
Field Performance of Tiller Using Tilling Wheel of Different Blade Shapes A. Fajardo .....	401
Effect of tire inflation pressure on soil properties and yield in a corn-soybean rotation for three tillage systems in the Midwestern United States M. Shaheb, T. Grift, R. Godwin, E. Dickin, D. White and P. Misiewicz .....	403
Survey of poor crop establishment in Danish winter wheat fields and an automatic seed drill depth control system S.K. Nielsen, K.H. Madsen, M. Munkholm, M. Nørremark, M. Lamandé, F. Foldager, A. Evgrafova, E.H. Bennetzen, J.E. Jensen and O. Green .....	405

## Rare earth oxides as tracers for studying aggregate turnover: bridging soil physical and biological processes

Xinhua Peng<sup>1,\*</sup>, Qiaohong Zhu<sup>1</sup>, Zhongbin, Zhang<sup>1</sup>, Paul D. Hallett<sup>2</sup>,

<sup>1</sup>State Key Laboratory of Soil and Sustainable Agriculture, Institute of Soil Science, Chinese Academy of Sciences, Nanjing 210008 (China)

<sup>2</sup>Institute of Biological and Environmental Sciences University of Aberdeen Aberdeen AB24 3UU, UK.

### Abstract

The decomposition of soil organic matter (SOM) generally improve soil aggregation. However, the biophysical process is not well understood due to the difficulty in tracking the aggregate turnover pathway. This study used a combined tracer approach of isotopically labelled carbon (C) and rare earth oxides (REO) to determine soil aggregate transfer paths following input of organic matter. A model quantifying aggregate turnover rates over time was verified by a controlled incubation study. Four natural soil aggregate size ranges (<0.053 mm, 0.053-0.25 mm, 0.25-2 mm and 2-5 mm) were labelled with different REO tracers and packed to form a composite soil sample. The organic input was 1 mg <sup>13</sup>C g<sup>-1</sup> soil of <sup>13</sup>C-labelled glucose. There were four treatments: i) soil without REO and <sup>13</sup>C as a control, ii) soil labelled with REO, iii) soil without REO but amended with <sup>13</sup>C-glucose, and iv) soil labelled with REO and amended with <sup>13</sup>C-glucose. Aggregate stability, REO concentrations, soil respiration and <sup>13</sup>C were measured after 0, 7, 14 and 28 days incubation. REOs were found to not impact microbial activity ( $P > 0.05$ ). Based on the 84%-106% recovery of REOs after wet sieving of aggregates, and a close 1:1 relationship between measured aggregates and model predictions, REOs were found to be an effective tracer for studies of aggregate dynamics. A greater portion of aggregates transferred between neighbouring size fractions. The turnover rate was faster for macroaggregates than for microaggregates, and slowed down over the incubation time. The new C was accumulated more but decomposed faster in macroaggregates than in microaggregates. A positive relationship was observed between the <sup>13</sup>C concentration in aggregates and the aggregate turnover rate ( $P < 0.05$ ). The relative change in each aggregate fraction generally followed an exponential growth over time in the formation direction and an exponential decay in the breakdown direction. We proposed a first order kinetic model for aggregate dynamics which can separate aggregate formation, stabilization and breakdown processes. This study demonstrates that REOs can track aggregate life cycles and provide unique and important information about the relationship between C cycling and aggregate turnover.

**Keywords:** Aggregate turnover; Modelling, Organic amendment; Rare earth oxide; Soil aggregation

## Soil structural state in different crop-pasture rotation systems

De León Gastón <sup>1</sup>; Pérez Bidegain Mario <sup>2\*</sup>; Terra José <sup>3</sup>; Ernst Oswaldo <sup>2</sup>.

<sup>1</sup> *Universidad de la República. Centro Universitario Regional del Este. Rutas 9 y 15, Rocha, 27000, Uruguay.*

<sup>2</sup> *Universidad de la República. Facultad de Agronomía. Avda. E. Garzón 780, Montevideo, 12900, Uruguay.*

<sup>3</sup> *Instituto Nacional de Investigación Agropecuaria. Ruta 8, Km 282, Treinta y Tres, 33000, Uruguay.*

\* Corresponding author: mperezb@fagro.edu.uy

### Introduction

Soil compaction in no tillage systems is a degrading process that reduces crop productivity and soil quality. On the other hand, pastures have an important role in the creation of pores and in the structural stability of the soil. Understanding the processes that lead to the improvement of the physical condition of the soil is of utmost importance for its management. The methodology "Cultural Profile" (CP) is based on the visual identification of structures with different states of porosity, allowing to make inferences about the quality of the soil (Gautronneau and Manichon, 1987). In this study, we used the CP to evaluate soil structure of a Uruguayan Abruptic Argiudoll after 20 years of contrasting management: continuous cropping and crop-pasture rotation.

### Material and methods

Three contrasting cropping systems were analyzed: continuous cropping, crop-pasture rotation (two years of crop and four of perennial pastures), and a no crop system (grazed grassland). Crop-pasture system was analyzed at the end of pasture and crop phase. Therefore, treatments were (n=4): continuous cropping (CC), crop-pasture rotation after two years of crops (R2C), crop-pasture rotation after four years of pastures (R4P), and grassland (G). We followed the CP methodology improved by Boizard et al. (2017) and Sasal (2003). Measurement were performed on pits of 2 m long and 0.6 m deep. On each pit (n=2) we quantified the proportion of the surface occupied by CP structures:  $\Delta$ ,  $\Phi$ ,  $\Gamma$ , and  $O$ . On those structures, we considered the main origin of the porosity: root activity (b1) or soil fauna activity (b2). On the same pits we measured, soil strength (SS), soil bulk density (BD), soil structural porosity (SP), and soil textural porosity (TextP). Sampling units were all of the structures described visually. A pocket van tester was used to measure SS, it was applied 5 and 10 times in structures smaller and greater than 0.1 m<sup>2</sup>, respectively. The cylinder method was used to measure BD. To calculate TP we used the following equation  $TP=1-(BD/RD)$ , with RD 2.65 gr.cm<sup>-3</sup>. By kerosene immersion, SP was determined (Sasal, 2003). To calculate TextP we used the following equation  $TP=SP+TextP$ . Additionally, root frequency (RF) was evaluated on a grid. Treatment effect on the proportion of CP structures was analyzed using the  $X^2$  test ( $\alpha=0.05$ ). Within treatments, we compared mean values of SS, BD and SP of CP structures using one-way ANOVA ( $\alpha=0.05$ ). Among treatments, we compared overall weighted mean of SS, BD and TextP.

### Results and discussion

Cropping systems influenced the proportion of structures described by CP (Table N°1). In all treatments  $\Delta$  structure was found. However, quality of  $\Delta$  structure was improved in R4P and G, given a greater radicular exploration and biological activity (C $\Delta$ b2). Moreover, in CC and



R2C the porosity of  $\Delta$  was low, and associated with root growth (C $\Delta$ b1). The same behavior was found in  $\Phi$  structure, the main source of pores was root activity in CC and R2C (C $\Phi$ b1) and roots activity and fauna in G and R4P (C $\Phi$ b2). The structure O $\Gamma$  was only visualized in CC and R2C associated with a sowing bed (Table N°1). Among cropping systems, CC had a higher SS value (88.5 KPa), SS in R4P and G was not significant different (81.6 and 81.7 KPa, respectively). Within cropping systems, structures had differences in SS, regardless of treatment  $\Delta$  had the highest mean (Table N°1). Root frequency was 30.3% in G; 31.7% in R4P, 11.8% in R2C and 23.8% in CC. Bulk density ( $\text{g.cm}^{-3}$ ) in CC was higher than G and R2C ( $1.46 > 1.41$  and  $1.38$ ). In R4P, BD was  $1.43$  ( $\text{g.cm}^{-3}$ ). As expected in a soil type, TextP was not different between cropping systems 32.7%. In crop systems the porosity had its origin in the expansion-contraction of soil by weather effects. However, in the systems that presented pastures, the main origin of the macroporosity was associated to the fauna biological activity. Moreover, pastures systems had higher RF and lower BD.

Table N° 1: Percentage of cultural profiles structures in different cropping system, p-value of  $\chi^2$  test. Mean soil strength (KPa) according to structures and cropping system, p-value of one way ANOVA. Means followed by the same letter on the same treatment are not significant different according to LSD Fisher test.

	Cultural profile structures (%)						P-value	Soil strength (KPa)						P-value
	O $\Gamma$	C $\Gamma$ b2	C $\Phi$ b1	C $\Phi$ b2	C $\Delta$ b1	C $\Delta$ b2		O $\Gamma$	C $\Gamma$ b2	C $\Phi$ b1	C $\Phi$ b2	C $\Delta$ b1	C $\Delta$ b2	
<b>CC</b>	15	0	60	0	25	0	0,0001	54a	-	76b	-	105c	-	0,0001
<b>R2C</b>	16	0	59	0	25	0		46a	-	73b	-	109c	-	0,0001
<b>R4P</b>	0	0	0	73	0	27		-	-	-	73a	-	87b	0,0001
<b>G</b>	0	5	0	75	15	5		-	64a	-	55a	87b	67a	0,0001

CC: continuous cropping; R2C: crop-pasture rotation after two years of crops; R4P: crop-pasture rotation after four years of pastures and G: grassland.

## Conclusion

Soil quality evaluated through CP evidenced a better state in pasture than in crop phase, in a crop-pasture system. The main effect of pastures was macroporosity development that modified compact structures, such as  $\Delta$ . Furthermore, we found evidence that continuous cropping systems may compromise soil long term sustainability. Practical implications of this study reveal the importance of including perennial pastures in cropping systems.

## References

- Boizard, H. Peigné, J. Sasal, M. Guimaraes, M. Piron, D. Tomis, V. Vian, J. Cadoux, S. Ralisch, R. Tavares, J. Heddadj, D. De Battista, J. Duparque, A. Franchini, J. Roger-Estrade, J. 2017. Developments in the “profil cultural” method for an improved assessment of soil structure under no-till, In Soil Tillage Res, Volume 173, 92-103.
- Gautronneau, Y. Manichon, H. 1987. Guide méthodique du profil cultural. CEREF/ISARA, Lyon, France.
- Sasal, M. 2003. Factores condicionantes de la evolución estructural de suelos limosos bajo siembra directa. Efecto sobre el balance de agua. Facultad de Agronomía – Universidad de Buenos Aires.

## Assessing the accuracy of total station scanning and close-range photogrammetry for measuring water-induced channels

F. Zheng<sup>1,2</sup>, S. Li<sup>1,2\*</sup>

<sup>1</sup>Fredericton Research and Development Center, Agriculture and Agri-food Canada, Fredericton, NB, E3B 4Z7, Canada

<sup>2</sup>Department of Soil Science, University of Manitoba, MB, R3T 2N2 Canada

\* corresponding author: [Sheng.Li@agr.gc.ca](mailto:Sheng.Li@agr.gc.ca)

### Introduction

Water-induced channel is one of the main forms of soil erosion in cultivated fields, causing soil loss and crop yield reduction (Lal, 2001). Traditionally, geometry and volume of water-induced channels are measured with rulers or measuring tapes to estimate erosion rate (Hill and Kaiser, 1965). However, these methods are generally time and labour consuming, and can cause soil surface disturbance. In order to overcome these limitations, remote sensing techniques have been introduced. In comparison to the traditional methods, remote sensing is less labor intensive and much quicker, as well as has much higher spatial resolution and does not cause soil surface disturbance. However, there is a lack of quantitative information on the accuracy of these remote sensing techniques. In this paper, one passive remote sensing method: Total Station Scanning (TSS) and one active remote sensing method: Close-Range Photogrammetry (CRP) were tested to: a) estimate the accuracies of the TSS and CRP under different settings on detecting the geometry of channels and, b) assess the applicability of the TSS and CRP method under scenarios with various spatial, temporal and resource constraints.

### Materials and Methods

An artificial board surface approximately 2.4 m x 2.4 m in size was built as the target surface used in this study, on which two-by-four lumbers and plywood board cuts were used to make eight Artificial Channels (AC), three V-channels and five U-channels of different orientations and sizes, mimicking the channel types observed in the field. The board surface was surveyed with TSS and CRP and three parameters: the maximum channel width, maximum channel depth, and cross-sectional area were extracted at 10 locations along each AC. The extracted values were compared against manual measurements to assess their errors. For the TSS, a Trimble VX total station was used. The machine was mounted on a tripod located on the centerline of the board, 1 m away from its edge. Three station heights, 1.0 m, 1.5 m and 2.0 m above the ground, were tested. For the CRP, a Nikon D7000 camera was used. Six shooting angle treatments (at 90°, 80°, 70°, 60°, 45° and 30° with 60% images overlap) and five image overlap treatments (90%, 80%, 70%, 60% and 50% at 70° shooting angle) were applied. The applicability of the two remote sensing methods was evaluated by comparing their equipment needs, time consumptions and detection areas.

### Results and discussion

For the V-channel, with the TSS method, errors for depth measurement were consistently underestimated whereas for the width and area measurements, there was no consistent over- or under-estimation. There was no consistent trend with channel size for absolute errors of width and depth measurements. As a result, the relative error increased when channel size decreased and reached ~100% for channels with width and depth less than 0.6 cm and 0.5 cm, respectively. However, for area measurement, absolute errors increased with channel size. For the three

different channel orientations, the TSS method had smallest errors with the vertical channels and largest errors with the horizontal channels in depth and area measurements whereas for width, the value of angled channel had the largest error. For TSS station height settings, the errors of 1.0 m station height for all three measures were slightly but consistently higher than those of 1.5 m and 2.0 m station heights. With the CRP method, there was no consistent over- or under-estimation with any of the three measurements. Similar to the TSS method, no consistent trend with channel size was observed for width and depth and absolute error for area measurement increased as channel size increased. For the three channel orientations, for all three measures, errors follow the order of vertical channels > angled channels > horizontal channels. For CRP shooting angle setting, all three measurement errors were at similar level until the shooting angle decreased to 45°. For CRP image overlap setting, errors of three measurements were similar until the image overlap rates were below 60%.

For the U-channel, with the TSS method, there was a consistent overestimation of errors for width measurement whereas for the depth and area measurements, there was no consistent over- or under-estimation. For the three channel sizes, the errors for width and area measurements followed the order of deep channel > wide channel > regular channel, whereas the errors for depth measurement follow the order of regular channel > deep channel > wide channel. Unlike the trends of errors, the SD values for all three measures follow the same order of wide channel > deep channel > regular channel. For the three channel orientations, the errors and SD values for area and width were smallest for vertical channels whereas for depth, both errors and SD values were similar with all three orientations. For TSS station height setting, trend was similar to that with V-channel. With the CRP method, unlike the TSS method, there was a consistent underestimation for area measurement. Besides, there was no consistent over- or under-estimation for width and depth measurements. For the three different channel sizes, both errors and SD values of the deep channel were the largest for all three measurements. For the three orientations and different settings of CRP, the results were similar to those for the V-channels.

With respect to the applicability, the TSS method requires about 30 times longer time than the CRP methods for data collection and data processing. However, for one run, the TSS method was capable of detecting an area of 360 m<sup>2</sup> whereas the CRP method was only capable of detecting an area of about 20 m<sup>2</sup>.

## Conclusion

The accuracy level of the TSS and CRP methods varies with their settings. With appropriate settings, both the TSS and CRP method are able to provide the estimations at the centimeter accuracy level. The CRP method appears to have the potential to achieve higher accuracy. However, neither method showed promising results for sub-centimeter level measurements. Therefore, both methods are accurate enough for rill and gully erosion but not for sheet erosion. Also, although the TSS method collects data much slower than the CRP method, it can detect a much larger area in one run.

## References

- Hill, W. W., and Kaiser V. G., 1965. Method of measuring soil erosion losses: rill and sheet erosion. Soil Conserv. Serv., US Dep. Agr. Soil Survey Technical Notes, pp. 13-14.
- Lal, R. A., 2001. Soil degradation by erosion. *Land degradation & development*, 12(6), pp. 519-539.

## Application of X-ray Computed Tomography to investigate the effect of alternative traffic and tillage systems on soil physical properties

\*Anthony Millington<sup>1</sup>, Paula Misiewicz<sup>1</sup>, Edward Dickin<sup>1</sup>, David White<sup>1</sup>, Sacha Mooney<sup>2</sup>, and Richard Godwin<sup>1</sup>

<sup>1</sup>Harper Adams University, Newport, Shropshire, TF10 8NB, UK.

<sup>2</sup>The University of Nottingham, Sutton Bonington, Leicestershire, LE12 5RD, UK.

\*Corresponding author: amillington@harper-adams.ac.uk

### Introduction

Dry bulk density is a widely accepted means of identifying changes in soil compaction and total soil porosity in response to vehicular traffic and the mechanical effect of tillage operations but it does not allow the quantification of pore size, their distribution and connectivity within the soil. X-ray Computed Tomography (CT) is a non-destructive 3D imaging technique that can be used to measure soil pore size distribution (Rab *et al.*, 2014). X-ray CT uses mathematical reconstructions from attenuation of radiation to produce 3D models of the soil sample to visualise the changes in pore system through the soil profile.

### Material and methods

An investigation was conducted in 2016 using X-ray CT on a long term randomised 3x3 factorial traffic (Random Traffic Farming with standard tyre inflation pressures (RTF), Random Traffic Farming with low tyre inflation pressures (LGP) and Controlled Traffic Farming (CTF) systems) and tillage (Deep, 250mm; Shallow, 100mm and No-till) plot experiment initiated in 2011 at Harper Adams University, UK (Godwin *et al.*, 2017). The nine plots 4 m wide x 80 m long were replicated in four blocks. Each plot had a pair of wheelways about the centre line that were used for cultivation and drilling operations using a Massey Ferguson 8480 with Michelin Axiobib tyres (IF 650/85 R38 TL 179D, rear and IF 600/70 R30TL 159D, front). Tyre pressures were set to 1.2 bar front, 1.5 bar rear for RTF plots and 0.7 bar front and rear for LGP and CTF plots. Cultivation treatments were applied prior to drilling using a 4 metre Vaderstad Topdown. Spring oats (Aspen) was drilled using a Vaderstad 4 metre Spirit drill in April 2016. The soil was a slightly stony sandy loam (Claverley Association). Soil cores (50 mm diameter x 300 mm length) were collected prior to harvest from wheelways in RTF and LGP plots and the untrafficked areas in the CTF plots.

The soil cores were scanned using a Phoenix v|tome|x m X-ray microfocus CT system at the Hounsfield Facility, the University of Nottingham, UK. CT system parameters were 160 kV, 180  $\mu$ A, 200 ms detector time and 72  $\mu$ m resolution. The 3D X-ray attenuation maps were exported as top view (cross sectional area) TIFF files. Stacked images were analysed using ImageJ version 1.50i. An area of interest 400 pixel (28.8 mm) x 400 pixel in the centre of the images was selected. Soil pore space was selected by segmenting using the Li thresholding algorithm on binary images. Image J was used to acquire the size and distribution of all pores in the images. VGStudioMax was used to determine the percentage of the pores in each core connected from the surface downwards. Soil cores were subsequently sectioned (50 mm lengths) and dried at 105°C to determine bulk densities and calculate physical soil porosities.

### Results and discussion

Figure 1 shows the mean effects of the treatments on soil porosity for depth 0-250 mm. These total porosities were obtained by combining the CT derived porosities with a constant of 31% calculated using bulk density derived porosities (Millington *et al.*, 2018). This constant equated to water filled pore space identified by previous researchers for a sandy loam soil. Shallow tillage treatments increased the total soil percentage porosity by 11% ( $p=0.029$ ,  $LSD=3.669$ ). There was no significant difference in soil porosity between standard and low

tyre inflation pressure treatments. Vehicular traffic reduced total soil porosity by 11% ( $p=0.006$ ,  $LSD=3.669$ ), where inflation pressure had no significant effect. However, standard tyre inflation pressure tyres (RTF) significantly decreased pore connectivity (Table 1) ( $p=0.09$ ,  $LSD=12.3$ ) with low tyre inflation pressure treatments resulting in 12% greater pore connectivity than standard tyre inflation pressure treatments.

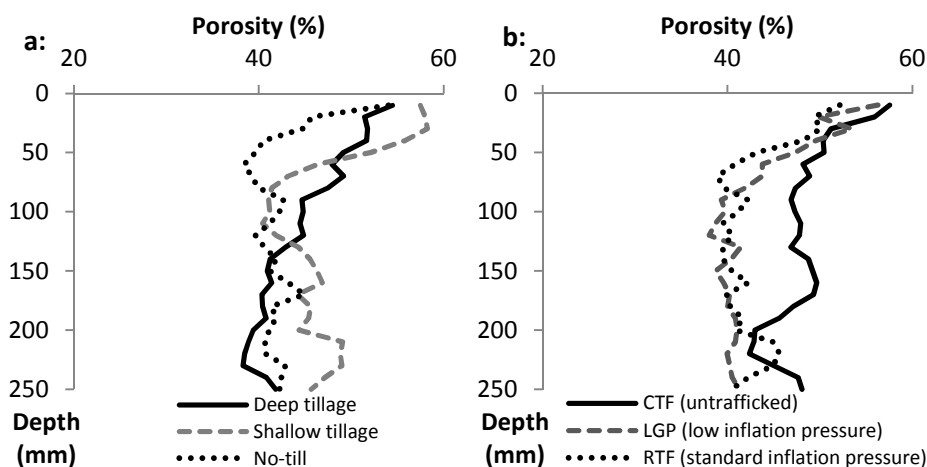

Figure 1 - Mean soil percentage porosity 0-250 mm depth for a: tillage b: traffic

Table 1 - Pore connectivity (%) (0-250 mm depth)

Traffic/Tillage	Pore Connectivity (%)			
	Deep	Shallow	Zero	Mean
CTF	95.0	94.4	89.4	92.9 <sup>b</sup>
LGP	94.4	91.2	85.9	90.5 <sup>ab</sup>
RTF	83.3	78.0	78.6	80.0 <sup>a</sup>
Mean	90.9 <sup>a</sup>	87.9 <sup>a</sup>	84.7 <sup>a</sup>	

(Means not followed by the same letters are significantly different from each other at the 0.1 probability level).

### Conclusion

1. The overall mean porosity (0-250 mm) was highest for the shallow tillage system.
2. Standard and low tyre inflation pressure traffic systems reduced total soil porosity by similar amounts.
3. The low tyre inflation pressure system had 12% greater pore connectivity compared to the standard tyre inflation pressure system.

### Acknowledgements

The authors would like to express their thanks to The Douglas Bomford Trust, Manufacture Française des Pneumatiques Michelin and Vaderstad UK Ltd. and to the staff of Harper Adams University and the Hounsfield Facility, the University of Nottingham.

### References

- Rab, M A, Haling, R E, Aarons, S R, Hannah, M, Young, I M and Gibson, D. 2014. Evaluation of X-ray computed tomography for quantifying macroporosity of loamy pasture soils. *Geoderma*, 213, pp.460-470.
- Godwin R J, Misiewicz P A, Smith E K, Millington W A J, White D R, Dickin E T and Chaney K. 2017. Summary of the effects of three tillage and three traffic systems on cereal yields over a four-year rotation. *Aspects of Applied Biology*, 134, pp. 233-242.
- Millington, W A, Misiewicz, P A, White, D R, Dickin, E T, Mooney, S J and Godwin, R J. 2018. How to relate X-ray Computed Tomography derived porosities to physical soil porosity in a randomised 3x3 factorial traffic and tillage field experiment. *ASABE Annual International Meeting, Detroit, Michigan, USA, 29 July - 01 August, 2018*, p.1801651 (In Press).

## Monitoring soil structure dynamics with passive acoustic emissions – soil biological activity

M. Lacoste<sup>1\*</sup>, S. Ruiz<sup>2</sup>, D. Or<sup>2</sup>

<sup>1</sup> *URSOLS, INRA, 45075 Orléans, France*

<sup>2</sup> *Soil and Terrestrial Environmental Physics, Institute of Biogeochemistry and Pollutant Dynamics, ETH Zurich, Zurich, Switzerland*

\* corresponding author: [marine.lacoste@inra.fr](mailto:marine.lacoste@inra.fr)

### Introduction

Biological activity plays an important role in natural and managed soil by generating and sustaining favorable soil structure. Plant roots and earthworms are particularly important in creating biopore networks that promote aeration and infiltration and in stimulating microbial activity forming biological hotspots. Available observation methods for soil structure quantification are often limited to episodic snapshot that may miss these highly dynamic biophysical processes. Some methods such as rhizotron imaging may provide qualitative insights within certain windows of observation, but the picture remains limited when inferring root system dynamics. Modern application of X-ray computed tomography have provided new insights into soil structure characteristics and the resulting soil bioturbation by earthworms and plant roots. However, such methods remain lab based and not yet available for *in situ* monitoring. We report application of passive acoustic emissions (AE) measurements that identify mechanical activity in soil. AE are generated by release of elastic energy due to modification of grain contacts, crack formation, friction between aggregates and grains, and changes in air-water interfaces (Michlmayr et al., 2012); all of which may occur during soil structure formation. The working hypothesis is that AE generated during soil displacement by growing plant roots and burrowing earthworms could be quantified continuously and *in situ*, and allow monitoring of windows of activity and soil structure dynamics.

### Materials and methods

We monitored AE produced by earthworm activity and maize roots growing into soil using three separate experimental protocols. AE resulting from earthworm activities were monitored using glass cells: one kept empty to monitor background noise; two filled by a silt loam soil and closed to minimize soil water evaporation (one used to monitor earthworm activity, the other as a control). An endogeic earthworm, *Octolasion cyaneum*, was placed into a glass cell at the beginning of the experiment. The second experimental protocol monitored AE resulting from roots growing in a glass cell filled with a sandy soil and supplied by a hanging water bottle to maintain constant water content. Three maize seeds were planted at the soil surface. Background noise occurring during the experiment was also monitored. For the first two protocols, AE were linked with time-lapse imaging to compare visually observable activity with measured AE. The third experiment monitored AE resulting from root growth in a square soil columns in order to explore the method feasibility for field like applications (using acoustic waveguides inserted in the soil). Two columns were filled with the sandy soil, one used for root growth monitoring and the other as a control (bare soil), and a constant water content was maintained. The AE monitoring system comprised of a digital multi-channels AE-measurement system (Vallen, DE) and passive piezoelectric AE-sensors with a wide frequency response. In the glass cell experiments, the AE sensors were in contact with the background glass face. For the “*in situ*” monitoring in the soil column experiment, glass acoustic waveguides were used to ensure good contact between the soil and the AE sensors and reduce attenuation of acoustic waves in soil.

## Results and discussion

The AE recorded during the three experiments were in good agreement with independent (imaging) observations of earthworm burrowing and plant roots growing. For the earthworm experiment, the daily AE rate was strongly linked with creation of new tunnels (Fig. 1), and was less correlated with earthworm movement in soil, due to re-use of pre-existing tunnels. For the plant roots, observed root growth and elongation trends were strongly correlated with AE event rate. In contrast, temporal trends in evaporation did not correspond to AE events recorded in the same cell (i.e., the AE recording primarily mechanical deformation and not air-water interfaces). The number of AE recorded from the soil columns with growing maize roots were several orders of magnitude larger than AE emanating from bare soil under similar conditions. The results support the hypothesis that the soil bioturbation by both earthworms and plant roots generate measurable AE events that were highly correlated with the observed activities. The resulting AE patterns from the controls were clearly different (temporal patterns and magnitudes) from cells and column containing biological agents.

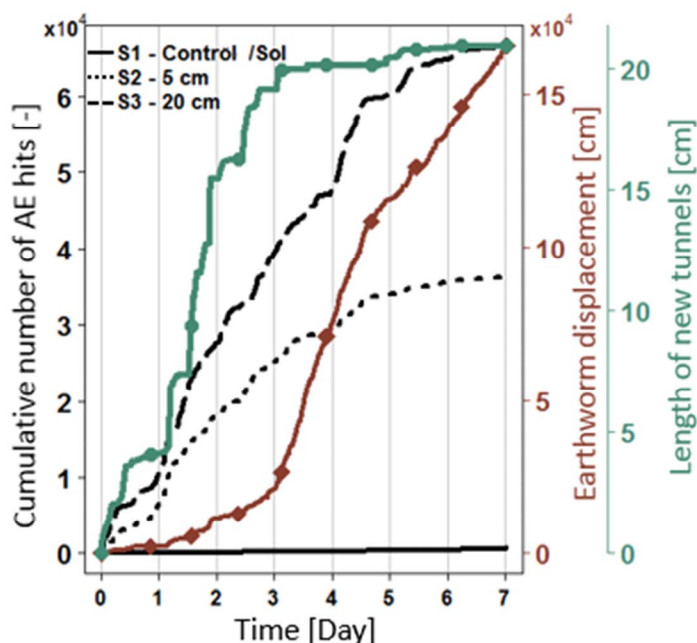

Figure 1. AE monitoring and earthworm activity in a soil filled glass cell.

## Conclusions

The results of this study are exploratory and monitoring using the AE method require further development and refinement for broader applications. Nevertheless, results suggest that AE monitoring could offer a window into largely unobservable dynamics of soil biomechanical questions such as when do roots grow? or how earthworm activity varies with time and with soil wetness conditions? Resolving such processes at the level of detail offered by AE could enhance our understanding of soil structure-forming processes and the mechanics of life below ground.

## References

Michlmayr, G., Cohen, D. and Or, D., 2012. Sources and characteristics of acoustic emissions from mechanically stressed geologic granular media - A review. *Earth-Science Reviews* 112, 97-114.

## The Double Spade Method: a ‘mini-profile’ visual soil evaluation technique

J.P. Emmet-Booth<sup>1\*</sup>, P.D. Forristal<sup>2</sup>, O. Fenton<sup>3</sup>, G. Bondi<sup>3</sup>, N.M. Holden<sup>1</sup>

<sup>1</sup>*School of Biosystems and Food Engineering, University College Dublin, Belfield, Dublin 4, Ireland*

<sup>2</sup>*Crop Science Department, Teagasc Oak Park, Carlow, Co. Carlow, Ireland*

<sup>3</sup>*Teagasc Environment Research Centre, Johnstown Castle, Co. Wexford, Ireland*

\* corresponding author: jeremy.emmet-booth@ucdconnect.ie

### Introduction

Visual Soil Evaluation (VSE) methods are established for soil quality assessment and focus on the examination of soil structure and associated anthropogenic impacts. VSE techniques, of which numerous types exist, are successfully used internationally both in soil research and as sustainable soil management tools. Techniques are generally categorised into profile and spade methods. Profile methods examine entire soil profiles in soil-pits to depths of ~ 1.5 m, exploring interactions between inherent soil features and anthropic management at specific sample points. Spade methods examine the upper soil profile, often by extracting sample blocks of topsoil by spade and focus on anthropic impacts. The VESS method (Guimarães et al., 2011) is a widely used spade method and involves assessment of soil sample blocks to 25 cm depth. However, in arable soils, important structural features may occur just below this depth such as plough pans, which VESS may not capture. The SubVESS method (Ball et al., 2015) follows principles of VESS but allows assessment to ~ 1 m depth. However, the later involves soil-pit excavation by mechanical means, which may be destructive, costly, time consuming and limit replication. When used in on-farm situations by farmers or advisors, full soil-pit excavation may not be desirable. Here we describe a method previously outlined (Emmet-Booth *et al.* 2018) called the Double Spade Method (DS) designed to examine mini-profiles in soil pits to 40 cm depth, therefore capturing potential structural features below the VESS assessment depth, without requiring full soil-pit excavation.

### Materials and Method

DS is derived from VESS and SubVESS, using principles from both. At a desired sampling location, a soil-pit is excavated to 40 cm depth by spade, ensuring that one side, or profile face, of the pit is undamaged. This soil-pit can be an extension of a pit resulting from deploying VESS, as the methods can be used together. As with SubVESS, layers of varying structure are initially identified by inserting a trowel tip or knife at intervals down the profile face and noting changes in perceived penetration resistance. Layers are marked with plastic tags and their depths are recorded on a score sheet (Figure 1). Each layer is then assessed separately by individually examining and scoring seven soil properties. The scoring system and classification is based on VESS, with three condition scores applied in each case, representing good (1), moderate (3) or poor (5) quality, but intermediate values are also possible (2 or 4). Perceived penetration resistance is first considered in terms of ease of trowel insertion within the layer. Redox morphology is next examined, indicated by layer colour, followed by aggregation. This is conducted by levering intact aggregates or fragments out of the profile face and their size and shape are considered. Internal visible porosity is examined within the aggregates or fragments and in doing so, rupture resistance is assessed while breaking. Finally rooting is considered within the layer either by examining broken aggregates or soil fragments or exposing roots within the profile by trowel. The individual property scores for each layer are added and divided by 7, giving mean layer scores. As with VESS, the addition of layer scores multiplied by corresponding layer depths, divided by the



overall profile depth, gives a single overall score. This can be calculated for different zones of interest, for example 0 to 20 or 20 to 40 cm depth. The latter may just be desirable if DS is used in conjunction with VESS.

## Double Spade Method

Sample Point

Record the position of identified layers below

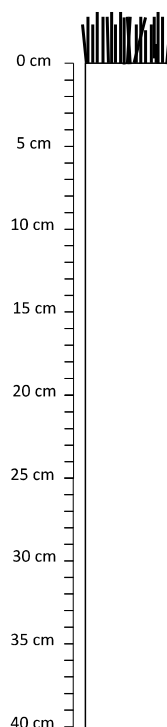

A Penetration Resistance		✓	
	Layer 1	Layer 2	Layer 3
1 Easy to insert trowel / knife	<input type="radio"/>	<input type="radio"/>	<input type="radio"/>
2 Intermediate value	<input type="radio"/>	<input type="radio"/>	<input type="radio"/>
3 Requires some force to insert trowel / knife	<input type="radio"/>	<input type="radio"/>	<input type="radio"/>
4 Intermediate value	<input type="radio"/>	<input type="radio"/>	<input type="radio"/>
5 Requires considerable force to insert trowel / knife	<input type="radio"/>	<input type="radio"/>	<input type="radio"/>

B Redox Morphology		✓	
	Layer 1	Layer 2	Layer 3
1 No mottling evident	<input type="radio"/>	<input type="radio"/>	<input type="radio"/>
2 Intermediate value	<input type="radio"/>	<input type="radio"/>	<input type="radio"/>
3 Distinct orange mottles present	<input type="radio"/>	<input type="radio"/>	<input type="radio"/>
4 Intermediate value	<input type="radio"/>	<input type="radio"/>	<input type="radio"/>
5 Grey / blue zones present	<input type="radio"/>	<input type="radio"/>	<input type="radio"/>

C Aggregate / Fragment Size		✓	
	Layer 1	Layer 2	Layer 3
1 Aggregates predominantly small (< 3 cm)	<input type="radio"/>	<input type="radio"/>	<input type="radio"/>
2 Intermediate value	<input type="radio"/>	<input type="radio"/>	<input type="radio"/>
3 Aggregates predominantly large (> 5 cm)	<input type="radio"/>	<input type="radio"/>	<input type="radio"/>
4 Intermediate value	<input type="radio"/>	<input type="radio"/>	<input type="radio"/>
5 No aggregation, only fragments from a solid block obtainable (or single grain)	<input type="radio"/>	<input type="radio"/>	<input type="radio"/>

D Aggregate / Fragment Shape		✓	
	Layer 1	Layer 2	Layer 3
1 Predominantly rounded (can include granular)	<input type="radio"/>	<input type="radio"/>	<input type="radio"/>
2 Intermediate value	<input type="radio"/>	<input type="radio"/>	<input type="radio"/>
3 Mixture of sub-angular and angular	<input type="radio"/>	<input type="radio"/>	<input type="radio"/>
4 Intermediate value	<input type="radio"/>	<input type="radio"/>	<input type="radio"/>
5 Predominantly angular with smooth faces (or single grain)	<input type="radio"/>	<input type="radio"/>	<input type="radio"/>

E Intra-aggregate porosity		✓	
	Layer 1	Layer 2	Layer 3
1 Many fine pores visible	<input type="radio"/>	<input type="radio"/>	<input type="radio"/>
2 Intermediate value	<input type="radio"/>	<input type="radio"/>	<input type="radio"/>
3 Some cracks and fissures visible	<input type="radio"/>	<input type="radio"/>	<input type="radio"/>
4 Intermediate value	<input type="radio"/>	<input type="radio"/>	<input type="radio"/>
5 No pores, cracks or fissures visible	<input type="radio"/>	<input type="radio"/>	<input type="radio"/>

F Rupture Resistance		✓	
	Layer 1	Layer 2	Layer 3
1 Crumbles easily between forefinger and thumb	<input type="radio"/>	<input type="radio"/>	<input type="radio"/>
2 Intermediate value	<input type="radio"/>	<input type="radio"/>	<input type="radio"/>
3 Requires one hand to break	<input type="radio"/>	<input type="radio"/>	<input type="radio"/>
4 Intermediate value	<input type="radio"/>	<input type="radio"/>	<input type="radio"/>
5 Requires considerable effort or two hands to break	<input type="radio"/>	<input type="radio"/>	<input type="radio"/>

G Rooting		✓	
	Layer 1	Layer 2	Layer 3
1 Roots unrestricted and growing throughout	<input type="radio"/>	<input type="radio"/>	<input type="radio"/>
2 Intermediate value	<input type="radio"/>	<input type="radio"/>	<input type="radio"/>
3 Roots few, restricted or distorted	<input type="radio"/>	<input type="radio"/>	<input type="radio"/>
4 Intermediate value	<input type="radio"/>	<input type="radio"/>	<input type="radio"/>
5 No roots evident	<input type="radio"/>	<input type="radio"/>	<input type="radio"/>

Layer Scores	
Score Total	Layer Score
Layer 1 <input type="text"/> ÷ 7 = <input type="text"/>	<input type="text"/>
Layer 2 <input type="text"/> ÷ 7 = <input type="text"/>	<input type="text"/>
Layer 3 <input type="text"/> ÷ 7 = <input type="text"/>	<input type="text"/>

Figure 1: The Double Spade Method score sheet

## Conclusion

DS allows the assessment of soil structure to 40 cm, a critical depth in arable soils. This is deeper than VESS assesses but without the need for mechanical soil pit excavation needed for SubVESS. Refinement of the procedure is required. The inclusion of reference images to the score sheet would be beneficial as well as further testing.

## References

- Ball B.C., Batey T., Munkholm L.J., Guimarães R.M.L., Boizard H., McKenzie D.C., Peigné J., Tormena C.A., Hargreaves P., 2015. The numeric visual evaluation of subsoil structure (SubVESS) under agricultural production. *Soil & Till. Res.*, 148, 85-96.
- Emmet-Booth J.P., Forristal P.D. Fenton O. Bondi G., Holden N.M., 2018. The influence of depth of observation on the information conveyed by visual soil evaluation. *Soil Till. Res. Under Review*.
- Guimarães R.M.L., Ball B.C. Tormena C.A. 2011. Improvements in the visual evaluation of soil structure. *Soil Use & Man.*, 27, 395-403.

## Changes in subsoil pore system and anisotropy caused by agricultural machinery traffic

Ingrid Martínez<sup>1\*</sup>, Matthias Stettler<sup>2</sup>, Marco Lorenz<sup>3</sup>, Joachim Brunotte<sup>3</sup>, Peter Weisskopf<sup>4</sup>, Thomas Keller<sup>4,5</sup>

<sup>1</sup>Universidad Técnica del Norte, Facultad en Ciencias Agropecuarias y Ambientales FICAYA, Av. 17 de Julio N5-21, Ibarra, Ecuador

<sup>2</sup>Bern University of Applied Sciences, School of Agricultural, Forest and food Sciences HAFL, Länggasse 85, CH-3052 Zollikofen, Switzerland

<sup>3</sup>Thünen Institute of Agricultural Technology, Bundesallee 50, D-38116 Braunschweig, Germany

<sup>4</sup>Agroscope, Department of Agroecology & Environment, Reckenholzstrasse 191, CH-8046 Zürich, Switzerland

<sup>5</sup>Swedish University of Agricultural Sciences, Department of Soil & Environment, Box 7014, SE-75007 Uppsala, Sweden

\*corresponding author: [immartinez@utn.edu.ec](mailto:immartinez@utn.edu.ec)

### Introduction

Soil compaction caused by agricultural field traffic is one of the main causes of environmental and agronomic problems worldwide. It increases soil mechanical resistance and negatively impacts soil gas transport processes, which restrict root development and thus crop productivity, and adversely influences the environment by enhancing surface runoff and greenhouse gas emissions (Alaoui et al., 2018). Compaction effects have been shown to persist for long periods (years to decades). Soil compaction may also modify the anisotropy of the soil pore system (Berisso et al., 2013), but only few studies have addressed this aspect. The objective of this study was to determine the changes in soil porosity and gas transport properties caused by agricultural vehicular traffic and to quantify the effect of compaction on the anisotropy of these properties.

### Material and methods

A wheeling experiment was conducted with five repeated passes of a two-axle self-propelled agricultural vehicle (wheel load 8 Mg, tyre size: 1050/50 R32, tyre inflation pressure: 100 kPa) on an arable clay soil in North-Western Switzerland. Undisturbed soil cores were collected at 0.1, 0.2 and 0.4 m depth at 0, 0.5 and 3 m lateral distance from the centreline of the wheel rut. At each lateral position and depth, cores were samples in two directions (vertical and horizontal). Air permeability ( $k_a$ ) and gas diffusivity ( $D_p/D_0$ ) were measured at three different soil matric potentials (corresponding to  $pF$  values of 1.5, 2.0, 2.5;  $pF = \log(-h)$ , where  $h$  is the matric potential).

### Results and discussion

Air permeability ( $k_a$ ) and the relative gas diffusion coefficient ( $D_p/D_0$ ) as a function of matric potential are shown in Fig. 1. We found a high anisotropy for the unwheeled soil (3 m lateral distance from the centreline of the wheel rut) with higher  $k_a$  and  $D_p/D_0$  in vertical than horizontal direction. This was probably due to vertical biopores. Compaction due to the vehicle passage reduced the gas transport properties in vertical direction, while  $D_p/D_0$  were little affected in horizontal direction. There was a stronger decrease in  $k_a$  under the edge of the rut (0.5 m lateral distance from the centreline of the rut) than beneath the centreline of the rut, especially at wet conditions ( $pF = 1.5$ ) reflecting a decrease in macroporosity and macropore continuity (Berisso et

al., 2013).  $D_p/D_0$  in vertical direction decreased significantly due to compaction, and the decrease was similar beneath the centreline and the edge of the rut. Due to compaction,  $D_p/D_0$  was reduced to values close to the critical limit for adequate soil aeration ( $< 0.005$ ) at all measured matric potentials. Similar as for  $k_a$ ,  $D_p/D_0$  in horizontal direction was little affected by compaction.

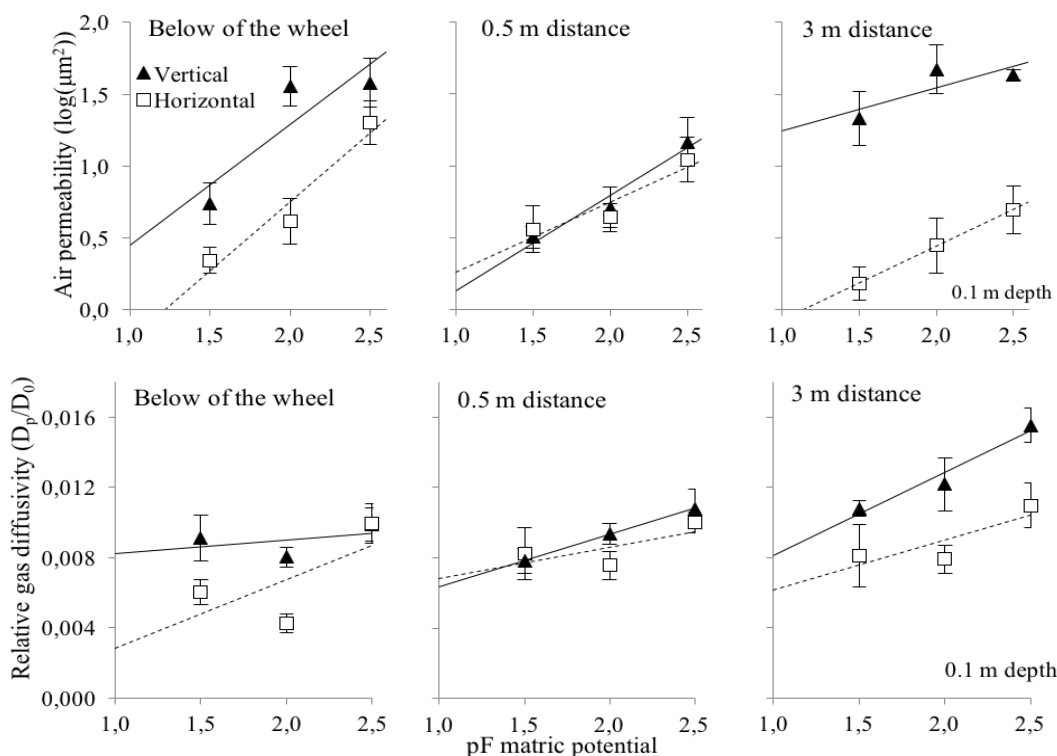

Figure 1. Air permeability ( $k_a$ ) and relative gas diffusion coefficient ( $D_p/D_0$ ) as a function of  $pF$  ( $= \log(-h)$ , where  $h$  is the matric potential) for vertical and horizontal orientation at 0.1 m depth.

## Conclusion

Soil compaction by wheeling traffic significantly modified the gas transport parameters and the anisotropy of  $k_a$  and  $D_p/D_0$ .  $k_a$  and  $D_p/D_0$  mainly decreased in the vertical orientation. Because the pore system of the unwheeled soil had a dominant vertical orientation,  $k_a$  and  $D_p/D_0$  became isotropic due to compaction. The decrease in  $k_a$  and  $D_p/D_0$  was higher under the edge of the wheel rut than under the centreline of the wheel rut, indicating that shear effects at the edge of a tyre decreased the pore continuity.

## References

- Alaoui, A., Rogger, M., Peth, S., Blöschl, G. 2018. Does soil compaction increase floods? A review. *J. Hydrol.* 557, 631-642.
- Berisso, F.E., Schjønning, P., Keller, T., Lamandé, M., Simojoki, A., Iversen, B.V., Alakukku, L., Forkman, J., 2013. Gas transport and subsoil pore characteristics: Anisotropy and long-term effects of compaction. *Geoderma* 195-196, 184-191.

## Classification of topsoil structural quality with physical thresholds

Alice Johannes<sup>a\*</sup>, Peter Weisskopf<sup>a</sup>, Rainer Schulin<sup>b</sup>, Pascal Boivin<sup>c</sup>

<sup>a</sup> Swiss Federal Research Station Agroscope, Soil Fertility and Soil Protection group, Department of Natural Resources & Agriculture, Reckenholzstrasse 191, CH-8046 Zurich,

<sup>b</sup> Swiss Federal Institute of Technology ETH Zürich, Institute of Terrestrial Ecosystems, Universitätstrasse 16, 8092 Zürich, Switzerland

<sup>c</sup> University of Applied Science of Western Switzerland hepia, Soils and Substrates group, Institute Land-Nature-Environment, route de Presinge 150, 1254 Jussy Geneva, Switzerland

\*corresponding author: alice.johannes@agroscope.admin.ch

Soil structure quality is increasingly threatened and must be protected by environmental regulations. However, this is not done, so far, because no indicators and corresponding classification scheme for harmful versus acceptable conditions fulfilled the many necessary conditions. The aim of this study was to solve this issue. We used shrinkage curve analysis for precise physical measurements allowing to cope with field constituents and water content variability, and visual evaluation yielding scores from 1 (good) to 5 (poor) to define a structure quality classification scheme. We characterized 185 undisturbed samples, collected from 162 sites at 5-10 cm depth on a unique soil type, Cambi-Luvisol, across western Switzerland. We found that structural porosity and soil organic carbon content (SOC) were the most discriminant indicators to classify the visual scores (Figure 1). The good score values (1-2.5) corresponded to significant correlations of structural porosity and SOC, thus the structure quality could be classified with structural porosity volume provided that SOC was taken into account: the larger the SOC, the larger must be the structural porosity for equivalent structure quality.

Additionally, because SOC and clay content are correlated, more SOC is needed to reach a good structure quality when clay content increases. This is in close agreement with the findings of Feller & Beare (1997) and Johannes *et al.* (2017). Therefore, an improved soil structure quality can be achieved in two steps. First by targeting an optimal value of SOC which depends on clay content. Secondly by targeting an optimal physical value which depends on SOC, as presented in Figure 1.

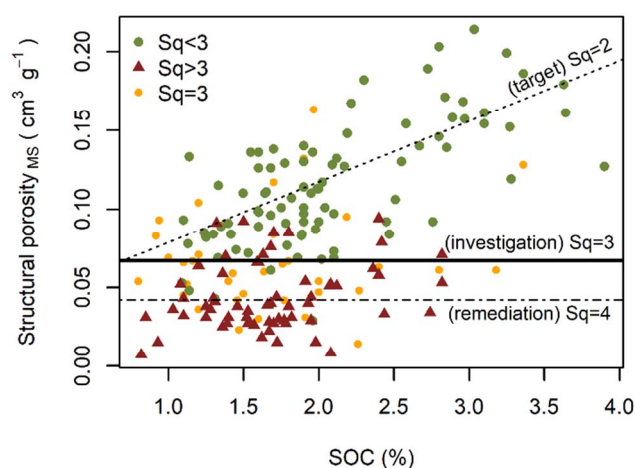

**Figure 1: Structural porosity at maximum swelling point (MS) as a function of soil organic carbon (SOC) with target values (dotted line), investigation threshold (full line) and remediation threshold (dashed line) and with observations of good structural quality ( $Sq < 3$ , represented by full green dots), medium structural quality ( $Sq = 3$ , represented by full yellow dots) and poor structural quality ( $Sq > 3$ , represented by red triangles).**

The gravimetric air content at -100 hPa ( $A_{-100}$ ) was highly correlated to structural porosity ( $R^2$  0.95) and the gravimetric water content at -100 hPa ( $W_{-100}$ ) was highly correlated to SOC ( $R^2$  0.72). These two indicators are easy and inexpensive to measure which is an important aspect in the application for environmental regulations. Therefore, for application purposes we suggested to use  $A_{-100}$  instead of structural porosity and  $W_{-100}$  instead of SOC to classify soil structure quality. With respect to the threshold limit of structure quality score 3 departing damaged and acceptable structure,  $A_{-100}$  and  $W_{-100}$  classified soil structure quality well and there was a significant correlation of  $A_{-100}$  to  $W_{-100}$  for soils with good structure quality. Therefore, the proposed classification scheme uses the relationships between  $A_{-100}$  and  $W_{-100}$  for scores 2, 3, and 4 as target, investigation and remediation values, respectively (Table 1).

**Table 1: Limit values of gravimetric air content at -100 hPa and their interpretation. (Adapted from a table submitted to Ecological Indicators Journal)**

Limit value	$A_{-100}$	Corresponding CoreVESS score	Interpretation
Target	$0.023 + 0.288 \times W_{-100}$	Sq=2	A guide value for soil management. Healthy soils should be above this value.
Investigation	$0.068 \text{ cm}^3 \text{ g}^{-1}$	Sq=3	Value below which the reasons for the poor soil structure quality should be investigated and soil management must be adapted to improve structure quality.
Remediation	$0.045 \text{ cm}^3 \text{ g}^{-1}$	Sq=4	Short term improvements of soil structure quality are needed.

$A_{-100}$ : Gravimetric air content at -100 hPa ( $\text{cm}^3 \text{ g}^{-1}$ );  $W_{-100}$ : Gravimetric water content at -100 hPa ( $\text{g g}^{-1}$ )

This method classified 91% of the “poor” structures under the investigation limit and 92% of the “good” structures above the investigation limit. This improves sharply the correctness of classification compared to previous indicators and can be proposed for soil structure protection regulation. Further research is needed to develop structural quality threshold values for subsoil and other soil types.

## References

- Feller, C. & Beare, M.H. 1997. Physical control of soil organic matter dynamics in the tropics. *Geoderma*, **79**, 69–116.
- Johannes, A., Matter, A., Schulin, R., Weiskopf, P., Baveye, P.C. & Boivin, P. 2017. Optimal organic carbon values for soil structure quality of arable soils. Does clay content matter? *Geoderma*, **302**, 14–21.

## Evaluating pedotransfer functions for the estimation of soil bulk density on cultivated fields

\*[I. Cousin](mailto:Isabelle.Cousin@inra.fr)<sup>1</sup>, Ly A.<sup>2</sup>, Bessard Duparc P.<sup>3</sup>, Champolivier L.<sup>4</sup>, Bernicot M.H.<sup>5</sup>, Bouthier A.<sup>2</sup>

<sup>1</sup> INRA, UR Science du Sol, 45075 Orléans cedex 2, France

<sup>2</sup> ARVALIS – Institut du végétal, 17700 Saint Pierre d'Amilly, France

<sup>3</sup> ARVALIS – Institut du végétal, 44370 Loireauxence, France

<sup>4</sup> TerresInovia, 31320 Auzeville Tolosane, France

<sup>5</sup> GEVES, 49071 Beaucozézé, France

\* corresponding author : [Isabelle.Cousin@inra.fr](mailto:Isabelle.Cousin@inra.fr)

### Introduction

Soil bulk density is a key physical parameter for the estimation of soil properties; it is necessary for the calculation of element stocks (carbon storage, for example) or the evaluation of fluid transfers (hydraulic properties for the evaluation of water storage, for example). The measurement of soil bulk density is time-consuming and usually requires destructive measurements. Moreover, it is highly variable both in space and time, especially for soil surface horizons submitted to agricultural practices. Numerous pedotransfer functions (PTF), that usually consist in linear equations using quite easily available soil parameters (like soil texture, or soil carbon content) for the calculation of the bulk density, can be found in the literature. The objective of this work is to evaluate PTFs dedicated to the calculation of soil bulk density in the context of cropped fields in France.

### Material and Method

A large database has been created, gathering 830 measurements of bulk density from surface and deep horizons of cultivated soils, realised by French technical and research institutes. Among them, 569 data were collected from undisturbed soil cylinders. Bulk density as well as soil type, texture, granulometric values, organic matter content, pH, CEC, were stored in the database. Fifteen pedotransfer functions allowing the estimation of the soil bulk density were selected in the literature by using the following criteria: i) PTF developed in the same agro-pedo-climatic contexts, ii) PTF to be used in cultivated soils, iii) PTF using the same parameters as those available in the database. The evaluation of PTFs was realised by comparing measured bulk density values with estimated values calculated by the PTFs, using bias, root mean square error (RMSE) and efficiency values. An efficiency larger than 0.5 was considered as high, and an efficiency between 0.2 and 0.5 was considered as acceptable. The best PTF performance corresponded to the minimal value of RMSE and the highest efficiency.

### Results and Discussion

The pedotransfer functions were evaluated either for all the horizons, or for the surface horizons only, or for the deep horizons only. Among the evaluated PTF, none exhibited satisfying RMSE, bias and efficiency values. Nevertheless, the following ones were considered as not too bad: i) Dexter et al. (2008) and Keller et al. (2010) for all the horizons (Figure 1), ii) Hollis et al. (1998) for the surface horizons and iii) Leonaviciute (2000) for the deep horizons. The next step consisted then in adjusting the PTF formalisms of these PTF over the French database. The best PTF is then the adjusted Keller et al. (2010) for both the surface and deep horizons (equation 1):

$$\text{Bulk density} = 1.437 + (0.007690) \cdot \text{clay} + (0.003881) \cdot \text{sand} - (0.0001494) \cdot \text{clay}^2 - (0.00001991) \cdot \text{sand}^2 - (0.0008799) \cdot \text{silt} \cdot \text{OM} - (0.001211) \cdot \text{sand} \cdot \text{OM} \quad [\text{equation 1}]$$

where *clay*, *sand*, *silt* and *OM* represent the concentration of clay, sand, silt and organic matter.

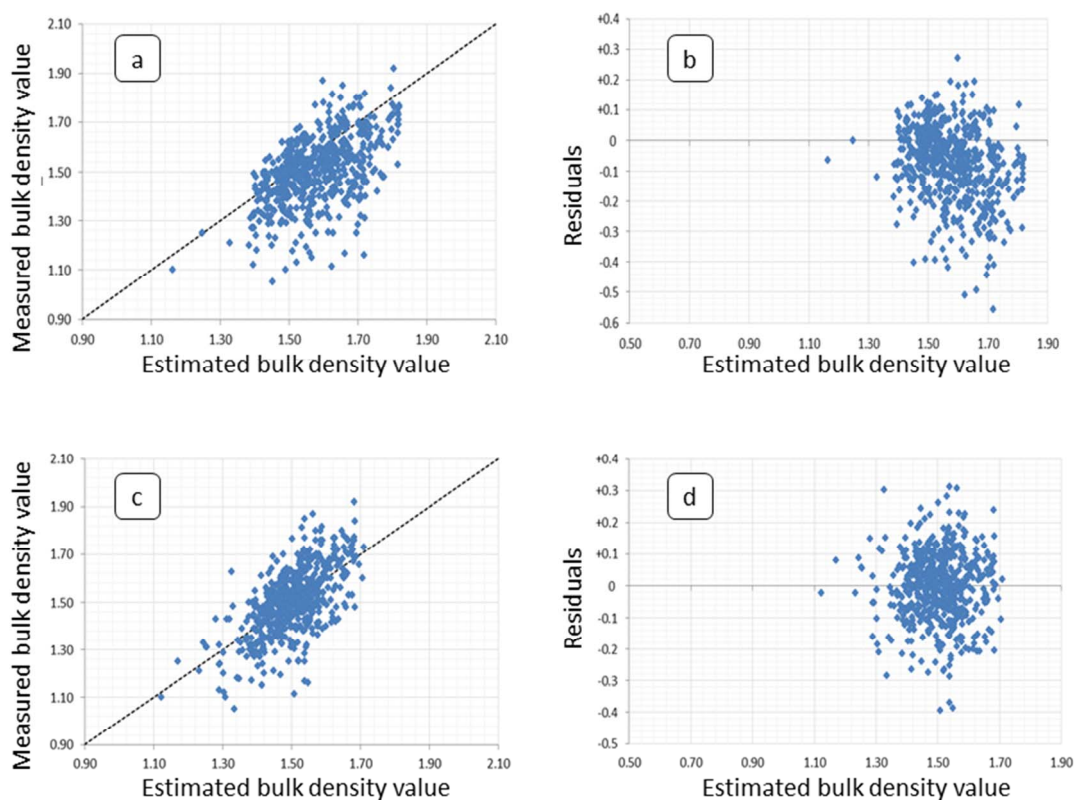

Figure 1: Evaluation of the Keller et al. (2010) PTF. Comparison of estimated and measured values (-a- for the initial PTF and -c- for the modified PTF). Residuals of the evaluation (-a- for the initial PTF and -c- for the modified PTF).

## Conclusion

A large database has been created for the evaluation of bulk density in soils from cultivated areas. The adjusted Keller et al. (2010) pedotransfer function provides the best estimation of bulk density for French soils and can be applied over the whole territory. Improvements could integrate agricultural practices as qualitative characteristics in new PTF.

## References

- Dexter A.R., G. Richard, D. Arrouays, E.A. Czyż, C. Jolivet d, O. Duval, 2008. Complexed organic matter controls soil physical properties. *Geoderma*, 144, 620 – 627.
- Keller, T., Håkansson, I, 2010. Estimation of reference bulk density from soil particle size distribution and soil organic matter content. *Geoderma*, 154, 398–406.
- Hollis, J.M., Hannam, J., Bellamy, P.H., 2012. Empirically-derived Pedotransfer functions for predicting bulk density in European soils. *Eur J Soil Sci*, 63, 96–109.
- Leonaviciute, N., 2000. Predicting soil bulk and particle densities by pedotransfer functions from existing soil data in Lithuania. *Geografijos Metrastis* 33, 317–330.



## Studying the effect of desiccation cracking on the hydraulic behavior of a Luvisol-From an experimental and numerical approach

D. K. Tran<sup>1,2\*</sup>, N. Ralaizafisoloarivony<sup>1</sup>, R. Charlier<sup>2</sup>, B. Mercatoris<sup>1</sup>, A. Léonard<sup>3</sup>, D. Toye<sup>3</sup>,  
A. Degré<sup>1</sup>

<sup>1</sup>University of Liège-Gembloux Agro-Bio Tech, Passage des Déportés 2, 5030 Gembloux, Belgium

<sup>2</sup>University of Liège, Department ArGEnCo, Quartier POLYTECH 1, Allée de la Découverte 9, 4000 Liège, Belgium

<sup>3</sup>University of Liège, Department Chemical, Quartier AGORA, Allée du 6 Août 19, 4000 Liège, Belgium

\*Corresponding author: [duckien.tran@uliege.be](mailto:duckien.tran@uliege.be)

### Introduction

Cracking due to desiccation on soil surface is a common phenomenon and related to the interaction between soil and atmosphere. Indeed, during dry seasons, high evaporation of pore water near the soil surface leads to a more significant soil suction in that region. The suction results in compressive stresses on the soil structure and produces shrinkage including cracking. As the crack network forms, the natural soil structure is strongly modified, which influences the soil's hydraulic behavior directly and provides preferential flow pathways for soil-water transport.

The work aims to study the formation of cracks during evaporation process of a *Luvisol* and evaluate how cracking affects the soil hydraulic conductivity. Laboratory experiments were firstly performed to investigate the initiation and propagation of cracks on soil surface. Through the tests, the hydraulic properties and the drying kinetics of soil samples were also determined. Finally, numerical simulations were carried out to emphasize the effect of desiccation cracking on the moisture transport mechanisms in soil samples.

### Material and method

The soil used in the experiment is classified as a *Cutanic Luvisol*. Undisturbed soil samples were taken from the field named "Bordia", located in Gembloux, Belgium. Drying tests were performed by means of HYPROP which is an accurate instrument for an evaporation method (Peters and Durner, 2008). In this technique, saturated soil sample is placed on the device and both are weighed on a precision balance. The soil surface then is exposed to a free evaporation under atmospheric conditions. To increase the rate of evaporation, a heat-lamp-bulb is placed one meter above the soil surface. The variation in hydraulic head inside the soil sample is assessed by two tensiometers placed at different height while the change in water content is determined by the weight changes of the sample. Both data are recorded during the tests and they are used to determine hydraulic properties of the soil sample. The drying kinetics of soil sample can also be characterized by representing the drying curves in different ways: drying rate versus time or, drying rate versus averaged moisture content, in which the drying rate,  $q = -\frac{dm}{dt}$ , is calculated on the basis of the weight changes. Along with these measurements, a camera is positioned above the soil sample to capture images every 30 minutes as to assess how cracks initiate and evolve on the soil surface.



A numerical modelling of soil evaporation process based on a thermo-hydro-mechanical framework was conducted in order to understand the impact of cracks on the soil hydraulic behavior. All the constitutive models have been implemented in the finite element code LAGAMINE developed by the University of Liège. Briefly, the drying kinetics is modelled using the boundary layer model (Gerard et al., 2010), assuming that the vapor and heat transfer take place in a boundary layer at the surface of the porous medium. The embedded fracture model is chosen to represent the development of the fractures in porous medium in which fracture opening is activated by a threshold strain parameter (Olivella and Alonso, 2008).

## Results and discussion

We investigated the formation of desiccation cracks in parallel with the evolution of the soil moisture content. The results of the experiment show that there were three periods of drying soil occurring in varying atmospheric conditions (relative humidity and temperature). The first period was characterized by a high and constant drying rate (CRP),  $q \approx 3.5 \times 10^{-7} \text{ kg. s}^{-1}$ . Cracks were formed at the end of this period as the most shrinkage occurred and the drying stresses rose to a maximum value. Several cracks in the range of 0.5 – 2 mm wide were observed. It should be noted that undisturbed soil samples had some pre-existing cracks in soil matrix. The second period (FRP) was considered to begin when the drying rate declined. During this period, the soil surface experienced a rapid drying. Transitions between periods CRP and FRP was characterized by a “critical-moisture content”,  $\bar{w}_{cr} = 0.2 - 0.25$ . The third period was distinguished by a low, relatively constant drying rate. No more cracks developed in this period.

2D-axisymmetric modelling of cylindrical samples were performed. The numerical results for mass loss, drying rate and drying curve showed a good fit with the experimental ones. An increase in intrinsic permeability up to one order was observed in the fracture zones. This caused a quicker drying of soil samples during the period FRP. On the moisture transport mechanisms, Darcy’s flow increased in the fracture zones as preferential flows developed while vapor diffusion showed only a slight modification.

## Conclusion

In this work, we have suggested using HYPROP device to investigate soil behavior associated with cracks formation during drying process caused by evaporation. We have validated the capacity of the numerical model to reproduce the drying tests conducted. Our results also have suggested that using a simple concept of cracking development, a continuum model is capable of modelling preferential flows developed in a fractured porous medium such as agricultural soil.

## References

- Peters, A., Durner, W., 2008. Simplified evaporation method for determining soil hydraulic properties. *J. Hydrol.*, 356 (1–2), 147–162.
- Gerard, P., Léonard, A., Masekanya, J. P., Charlier, R., Collin, F., 2010. Study of the soil–atmosphere moisture exchanges through convective drying tests in non-isothermal conditions. *Int. J. Numer. Anal. Meth. Geomech.*, 34(12), 1297-1320.
- Olivella, S., Alonso, E. E., 2008. Gas flow through clay barriers. *Géotechnique*, 58(3), 157-176.

## **The Visual Evaluation of Soil Structure (VESS) in Tropical Soils: How and When to Sample**

Rachel Muylaert Locks Guimarães<sup>1</sup>, Craig David Rogers<sup>2</sup>, Denise Roberta Rader<sup>1</sup>, Vacilania Pacheco<sup>1</sup>, Aline Cavalli<sup>1</sup>, Renan Augusto Lack Barboza<sup>1</sup>

<sup>1</sup>*Federal University of Thechnology-Paraná, Câmpus Pato Branco, Brazil*

<sup>2</sup>*Independent scholar, Pato Branco, Brazil*

\*corresponding author: rachelguimaraes@utfpr.edu.br

### **Introduction**

Ten-years on from the publication of the original version of the Visual Evaluation of Soil Structure (VESS) method by Ball et al. (2007), the VESS method is now the most frequently used visual method for the assessment of soil structural quality in Brazil. The original method was adapted and updated from the Peerlkamp test, with improvements and the most up to date version of the associated decision chart published by Guimarães et al. (2011).

Since it was introduced to Brazil VESS has been shown to work well on tropical soils, with VESS scores shown to correlate well with a number of soil quality indicators, such as soil bulk density, macro and microporosity, least limiting water range, tensile strength and weighted mean diameter, as well as with macrofauna indicators. As the method has been disseminated through Brazil it has been tested under a greater variety of soil types, cropping systems and environments, which have lead to VESS being exposed to a greater number of challenges. Despite VESS correlating well with quantitative soil quality indicators in tropical soils, the new exposure has resulted in a number of questions being put forward in relation to how and when to sample. There are many large-scale farms in Brazil and it is of interest to know the adequate number of VESS samples required to accurately and efficiently characterise a field. Further to this, the moisture content of the soil during the VESS evaluation is important, as it affects how the aggregate responds to the aggregate hand test, meaning that aggregates can appear to be more, or less, compacted than they actually are. Field observation have indicated that the standard two days after a rainfall event commonly used for optimal sampling at field capacity may not be accurate under certain conditions in Brazil.

The objective of this work was to improve VESS sampling by indicating the preferred sampling number, pattern and time.

### **Material and methods**

#### *VESS sampling number and pattern*

To assess the preferred sample number and collection pattern for VESS a field located on a farm in Chopinzinho in Parana, Brazil, containing soybean in the summer and ryegrass for fodder in the winter was sampled. The sampling area was 100 m x 100 m, with samples taken at 20 m intervals, giving a total of 36 sampling points in a grid. At each sampling point a VESS sample was performed. VESS is an integrated semi-quantitative method for the assessment of soil structural quality involving the manual breakdown of soil aggregates along their fracture lines, identification of layers of contrasting structure, measurement of layer thickness and the assignment of a score by comparing the structure of the sample with the VESS chart. The chart contains descriptions and pictures of each proposed soil structure quality to guide the user in their assessment of the soil using a variety of soil characteristics including aggregate strength, shape and porosity, alongside colour and smell, to assign the soil a score that indicates the structural quality of the soil. Analysis of the variability of the VESS score and mapping of the spatial distribution allowed the calculation of the number of

samples needed to characterise a field and also allowed the comparison between the full sampling grid and “Z”, “W” and transect sampling patterns.

#### *Effect of soil moisture on VESS*

Seventy aggregates from Sq 4 soil layers of an Oxisol (80% clay) were collected after a rainfall event from an oat field in Pato Branco, Brazil. Every 24 hrs, ten of the aggregates were assessed in the laboratory using the VESS aggregate hand test during the aggregate drying cycle to identify the response of the aggregate when submitted to the hand test. In conjunction with the hand test, samples for gravimetric water content were taken each day.

### **Results and Discussion**

The results showed that there was no difference between the mean Sq score acquired for the full sampling grid and those found for the “Z”, “W” and transect sampling patterns. This indicates that the pattern with the least amount of sampling effort would be the most efficient for characterising the studied area. It was also found that the minimum number of samples needed to accurately characterise the field using VESS would be one per hectare. Although, for statistical reasons, we recommend that at least three samples be taken per hectare (Guimarães et al., 2017).

It was found that the best time to sample VESS was 3-6 days after a rainfall event. If taken earlier than 3 days after, then the aggregates do not break, instead they deform under pressure during the hand test. While six days after the rainfall event the aggregates become too hard to perform aspects of the method, such as the progressive aggregate breakdown (last column of the VESS chart – Guimarães et al., 2011).

### **Conclusion**

These results indicate that three VESS samples were needed to accurately characterise the 1 ha area sampled in the study and that the sampling pattern did not affect mean Sq score. Further to this, it was found that sampling at field capacity could mean that the soil is too wet for performing VESS under some conditions in Brazil, which could result in evaluation errors, especially with inexperienced users. It is proposed that the period 3-6 days after a rainfall event may be best for sampling VESS in Brazil.

### **References**

- Ball, B.C., Batey, T., Munkholm, L.J., 2007. Field assessment of soil structural quality— a development of the Peerlkamp test. *Soil Use Manag.* 23, 329–337.
- Guimarães, R.M.L., Ball, B.C., Tormena, C.A., 2011. Improvements in the visual evaluation of soil structure. *Soil Use Manag.*, 27, 395-403.
- Guimarães, R.M.L., Lamandé, M., Munkholm, L.J., Ball, B.C., Keller, T. 2017. Opportunities and future directions for visual soil evaluation methods in soil structure research. *Soil Till. Res.*, 173, 104-113.

# New applications of X-ray CT in soil science in the last 10 years: a review

H. Zhou<sup>1</sup>, Z. B. Zhang<sup>1</sup>, N. Bottinelli<sup>1,2</sup>, X. Peng<sup>1</sup>

<sup>1</sup>State Key Laboratory of Soil and Sustainable Agriculture, Institute of Soil Science, CAS, Nanjing 210008, China

<sup>2</sup>IRD, UMR 242 iEES, Centre IRD Bondy, 32 avenue H. Varagnat, 93143 Bondy, France

In the past 10 years, there is a growing application of X-ray CT in soil science, particularly in characterizing macropore structure, crack generation, crop root architecture, and location of particular organic matter (POM) in aggregates and so on. This work will review new applications of X-ray CT in soil science, and try to find the new frontiers in this aspect.

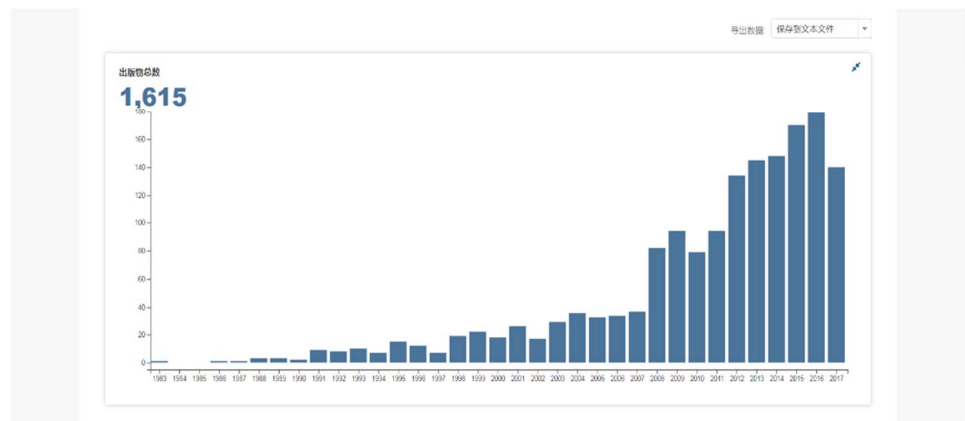

## Linking stress-strain test with X-ray CT analysis to examine the effects of soil moisture and soil tillage on soil structure

Julia Pöhlitz<sup>1\*</sup>, Jan Rücknagel<sup>1</sup>, Steffen Schlüter<sup>2</sup>, Hans-Jörg Vogel<sup>2</sup>, Olaf Christen<sup>1</sup>

<sup>1</sup> Martin-Luther-University Halle-Wittenberg, Department of Agronomy and Organic Farming Betty-Heimann-Str. 5, 06120 Halle/Saale, Germany

<sup>2</sup> Helmholtz Centre for Environmental Research GmbH – UFZ, Department of Soil Physics, Theodor-Lieser-Str. 4, 06120 Halle/Saale, Germany

\*Corresponding author: Email address: [julia.poehlitz@landw.uni-halle.de](mailto:julia.poehlitz@landw.uni-halle.de), phone: 0049/345522631, address: Department of Agronomy and Organic Farming, Martin-Luther-University Halle-Wittenberg, Betty-Heimann-Str. 5, 06120 Halle/Saale

### Introduction

In recent years there has been an increasing application of a variety of conservation tillage techniques where the soil is protected by not carrying out a deeper, non-turning primary tillage and leaving crop residues on the soil surface, which provides environmental and economic benefits such as the conservation of water, preventing soil erosion and saving time during seedbed preparation. However, each tillage application affects physical soil properties and processes.

In addition to other soil properties, the water content plays an important role for the mechanical stability of a soil. There are seasonal fluctuations in water content. This means that the mechanical stability of a soil varies in the course of the year depending on the water content. This fact must be taken into account in agricultural operations in order to protect the soil from the risk of soil compaction.

The compaction behavior of a soil is conventionally determined using the uni-axial stress strain test and expressed either as a stress-strain or stress-dry bulk density curve in a semilogarithmic graph, allowing the mechanical precompression stress to be determined according to the graphical method of Casagrande, which describes the mechanical stability of a soil. In structured soils, dry bulk density is not a sufficient measure of stability, since it only describes mass per volume and not the arrangement of individual particles, which is important information when evaluating mechanical behavior. Parameters which describe soil structure (dry aggregate density, aggregate and pore size distribution, porosity etc.) lead to a disturbance of the soil sample, and repeated measurement on the same soil sample is no longer possible. In recent decades, non-destructive imaging methods such as computed tomography have been successfully used for soil physical problems.

### Material and methods

Tillage and soil moisture differences are investigated using combined classical soil mechanical and computed tomographic (CT) methods on a Chernozem (texture topsoil: silty clay loam) for two tillage variants ‘cultivator’ (C) and ‘plough’ (P) and for two matric potentials ‘-6 kPa’ and ‘-1000 kPa’ (referring to  $pF_{1.8}$  and  $pF_{4.0}$ , i.e. decadic logarithm of matric potential in -hPa) in March 2016. The parameters dry bulk density (BD) and saturated conductivity ( $K_s$ ) at 16–22 cm soil depth were determined to classify the initial soil physical condition. Stress-strain tests for the load steps 10, 25, 50, 100, 200, 350, 500, 1250 and 2500 kPa were performed also at 16–22 cm depth. The mechanical precompression stress was

determined on the stress-dry bulk density curves. Furthermore, CT images (resolution 60  $\mu\text{m}$ ) and morphometric parameters (macropore size, macroporosity, macropore connectivity, anisotropy) of the same soil samples were determined after each load step.

## Results and discussion

In general tillage with plough lead to a significantly lower dry bulk density and a significantly higher saturated conductivity compared to tillage with cultivator. Overall, both tillage treatments displayed intact soil structures, where BD values were lower than a site-specific, root-limiting density of  $1.50 \text{ g cm}^{-3}$  and  $K_s$  values were higher than  $10 \text{ cm d}^{-1}$  as generally recommended in literature.

Generally, the stress-dry bulk density curve of cultivator showed a significantly higher initial dry bulk density compared to plough for both matric potentials. The stress-dry bulk density curves at different matric potentials showed no difference for the cultivator treatment. At pF4.0, the stress-dry bulk density curve for the plough had a significantly lower initial dry bulk density compared to  $P_{pF1.8}$ .

In general the cultivator treatments had significantly higher mechanical precompression stresses compared to the plough treatments. For both tillage variants, mechanical precompression stress increased at pF4.0 but did not result in any significant change for cultivator while the matric potential was the decisive factor for the mechanical stability of the plough soil being disproportionately increased.

The CT image cross sections and the computed tomographic parameters in general confirmed the conventionally observed soil mechanical behavior. In general the cultivator treatments had lower average pore size, porosity and connectivity values compared to the plough treatments at the beginning of the stress-strain tests for both matric potentials. For the entire load application, there were no differences in the average pore size, porosity and connectivity values within the cultivator treatments. For the plough treatments, these values were significantly higher at pF4.0 during the stress-strain tests corresponding to the disproportionately higher mechanical precompression stress. In both tillage variants, increasing load application anisotropy increase more slowly at pF4.0. At the same time, as stress application increased for both tillage variants and matric potentials, the increase in dry bulk density led to a decrease in average pore size, porosity, and connectivity, while anisotropy increased.

Finally, the change in matric potential in the cultivator treatment did not result in any significant change in mechanical precompression stress or the soil structure. By contrast, in the plough treatment, mechanical stability and changes in soil structure were highly sensitive to soil moisture. This was confirmed by the CT images of the pore structure. They revealed that with increasing mechanical stress, the diameters of the macropores decreased due to compression while soil aggregates were pushed together towards a coherent soil mass.

## Conclusion

The present study has shown that the water content can have a decisive influence on the mechanical stability of a soil, particularly in conventional soil cultivation with plough. Therefore, driving at drier times is particularly advantageous in tillage systems with plough. Furthermore, it was possible to confirm that the computed tomographic parameters used are closely related to the mechanical parameters determined conventionally. The computed

tomographic parameters therefore provide valuable information about the impact of tillage on microscopic pore space attributes that improves our understanding of soil functional behavior on much larger scales.

## Size Distribution of Soil Pores: a Model allowing for Bi-modality needed to account for Management Effects

Johannes L. Jensen<sup>1\*</sup>, Per Schjønning<sup>1</sup>, Christopher W. Watts<sup>2</sup>, Bent T. Christensen<sup>1</sup>, Lars J. Munkholm<sup>1</sup>

<sup>1</sup>Department of Agroecology, Research Centre Foulum, Aarhus University, 8830 Tjele, Denmark

<sup>2</sup>Department of Sustainable Agriculture Sciences, Rothamsted Research, Harpenden, United Kingdom

\*Corresponding author: [jlj@agro.au.dk](mailto:jlj@agro.au.dk)

### Introduction

The soil water retention curve reflects the pore size distribution and is a basic characteristic affecting soil functions. This is especially the case in the range 10-15000 hPa matric potential where processes such as air exchange and water uptake by plants take place. Further, soil water retention is a primary hydraulic property used as an input for modelling water flow in unsaturated soil. van Genuchten (1980) suggested a widely used model for describing soil water retention (>10000 citations; Web of Science, February 2018). However, the van Genuchten equation (vG) only describes soils with a uni-modal pore size distribution. Dexter et al. (2008) proposed a double exponential equation (DE), which describes bi-modal pore size distributions, and has the additional advantage in providing parameters with physical meaning. The objective of this study was to evaluate how the vG and DE equations fit to water retention data for soils with contrasting long-term management. We excluded confounding effects of soil type and climate.

### Materials and methods

Soil samples from the Highfield long-term ley-arable experiment at Rothamsted Research (UK) were retrieved in spring 2015 from treatments established in the 1940s and 50s. The soil type was silt loam with a similar texture for all treatments. Four treatments with four field replicates were studied: Bare fallow maintained free of plants by regular tillage, Continuous arable rotation (winter cereals), Ley-arable rotation; a three-year grass/clover ley followed by three years arable, and Grass. We measured water content from 24 replicate undisturbed 100 cm<sup>3</sup> soil cores (61 mm diameter, 34 mm height) extracted from the 10-cm soil layer from each treatment at -10, -30, -100, -300 and -1000 hPa matric potential using tension tables and pressure plates. Water retention at -1.5 MPa was measured on <2-mm soil using the dewpoint method. Data was fitted to the vG equation with the widely used Mualem restriction ( $m=1-1/n$ ), which prevents over-parameterization and leads to more stable results. The A2 parameter in the DE model is interpreted as structural pore space. We related the structural pore space to soil organic carbon (SOC) content through the structural void ratio (V2):  $V2 = A2 / (1-P)$ , where P is porosity.

### Results and discussion

Mean Akaike Information Criterion (AIC) values, when using the DE and the vG equations were -69.1 and -43.8, respectively. Similarly, mean root mean squared error (RMSE) values were lower when using the DE compared to the vG equation with values of 0.0019 and



0.0164 m<sup>3</sup> m<sup>-3</sup>, respectively. Both indicate that the pore size distribution for this silt loam is better described with a bi- than a uni-modal model. The RMSE value increased from 0.010 to 0.028 m<sup>3</sup> m<sup>-3</sup> with an increase in SOC from 0.84 to 4.04 g C 100 g<sup>-1</sup> minerals when using the vG equation ( $R^2=0.72$ ,  $P<0.001$ ), whereas no systematic error was observed when using the DE equation. The increase in RMSE with increasing SOC content could be ascribed to a more distinct bi-modal pore size distribution for soils with higher SOC content and less tillage. This was supported by the increase in structural void ratio (V2) with increasing SOC content and decreasing tillage intensity ( $R^2=0.74$ ,  $P<0.001$ ). The vG equation assumes that the pore size distribution is uni-modal and hence fails to describe the more pronounced bi-modality of soil from the grass treatment (Figure 1).

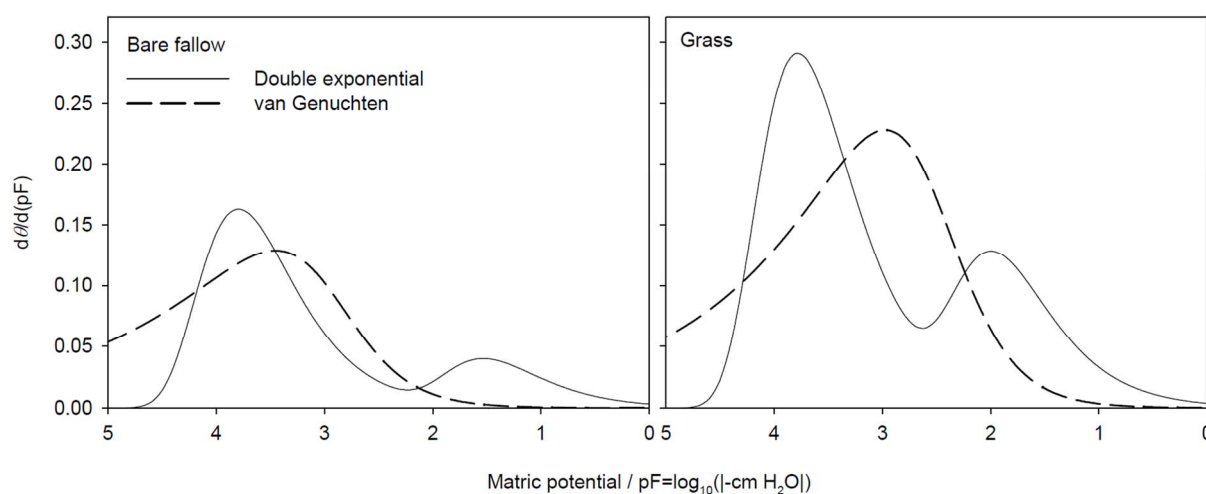

**Figure 1:** Pore size distribution ( $d\theta/d(pF)$ ) as a function of matric potential for the bare fallow (left) and grass treatment (right) either obtained by differentiating the double exponential (solid line) or the van Genuchten equation (dashed line).

Further, the dominating pore size of the structural peak was estimated to 89  $\mu\text{m}$  for the bare fallow treatment, while it was in the range 30-50  $\mu\text{m}$  for the arable, ley-arable and grass treatments. This may relate to the high tillage intensity in the bare fallow soil. The vG equation overestimated the pore volume in the size range 10-30  $\mu\text{m}$  (pF 2.5-2) and underestimated the pore volume at pF 3 and 1 - again the error was more pronounced for the more structured soils. Introducing systematic errors depending on management (e.g. SOC and tillage) may have severe impacts in modelling key soil processes.

## Conclusions

This study showed that the DE equation provided a better fit to soil water retention data for a silt loam soil than the vG equation. The RMSE of the vG fit increased with an increase in SOC / decrease in tillage intensity. This was reflected in a more distinct bi-modal pore size distribution for less disturbed and better structured soils.

## References

- Dexter, A. R., Czyz, E. A., Richard, G., Reszkowska, A. 2008. A user-friendly water retention function that takes account of the textural and structural pore spaces in soil. *Geoderma* 143, 243-253.
- van Genuchten, M. T. 1980. A closed-form equation for predicting the hydraulic conductivity of unsaturated soils. *Soil Sci. Soc. Am. J.* 44, 892-898.

## Development of a Rapid and “Open Source” Method to Render a Non-Destructive Image of the Soil Compaction.

Suc O.<sup>1\*</sup>, Ancelin O.<sup>1</sup>, Storme Q.<sup>2</sup>, Bertin A.<sup>3</sup>, Boizard H.<sup>4</sup>

<sup>1</sup> *Chambre d’agriculture de la Somme, 80000 Amiens, France*

<sup>2</sup> *Student Université de Picardie Jules-Verne, 80000 Amiens, France*

<sup>3</sup> *Student UniLasalle, 76130 Mont-Saint-Aignan, France*

<sup>4</sup> *INRA, UPR1158 AgroImpact, 80200 Estrées-Mons, France*

\* Corresponding author: o.suc@somme.chambagri.fr

### Introduction

On intensive agricultural production areas, building linear infrastructures as natural gas pipeline may have a real impact on soil properties and crops yields. So, for many years, the “*Chambre d’agriculture de la Somme*” has followed each big worksite building underground gas pipeline or electric power lines. After the worksite, in partnership with the owner of the infrastructure, field measurements are made during three years on some fields to assess the impact of the worksite and how the soil recovers its potential. One of those measurements consists in analysing soil compaction. But as we need to observe the soil compaction each year at the same place, a non-destructive method has to be used. So, an electronic penetrometer is used in substitution or in addition to the “*profil cultural*” method (Boizard, 2017). But the penetrometer doesn’t provide any “picture” of the soil. It only gives the penetration resistance (Shothorst, 1968) data on each dot. The main idea is that a 2D image of the soil would be better to analyse the compaction on each part of the worksite (trench, trail ...) and on control zone. The aim of this article is to explain a quite easy way to render the data of the penetrometer to a very simple 2D image of the soil compaction called “Interpolated Penetrometric Soil Profile”.

### Material and method

To collect data on the field, an electronic penetrometer is used. The equipment is an “Eijkelpkamp Penetrologger” which records data from 0 to 80cm depth with an accuracy of 1cm and an accuracy of 1N for the strength (i.e. 0.01MPa for a cone surface of 1cm<sup>2</sup>) This device is delivered with a software to draw a graph showing resistance as a function of depth for each point and export these data as a text file (.TXT). In our context, a precise localization of the measures is needed. So a corrected GPS is used to set up the measurements every year at the same place. Field measurements are made between October and March, while the soil is maintained at field capacity. Measuring points are marked perpendicular to the linear infrastructure. So each zone of the worksite (trench, trail, soil storage ...) and a control zone outside of the worksite are observed. 12 measurements are made every meter along 11 m (from 0 to 11) for a classical worksite or 16 measures every 2 meters along 30 m (from 0 to 30) for large worksites. Each measurement is repeated 4 times spaced 2 meters. The data are analysed with a spreadsheet and R software. For each measure there are 81 values (every centimetre from 0 to 80). An average of the 4 repeated values is calculated for every measure. Empty values are filled with the last value upper and the spreadsheet is presented as a matrix of 3 columns: X (from 1 to 12), Y (from 0 to 80) and the average value. The 972 (12\*81) values are not sufficient to have a smooth and “natural” image of the soil profile. So the values are interpolated, with R, between 1 and 12 (i.e. the width) with a step of 0.125 (every 12.5cm) and between 0 and 80 (i.e. the depth) with a step of 0.5 (every 0.5cm). So the final dataset is populated with 14329 values (89\*161). The interpolation is calculated with the “*akima*” library of R and the “*interp*” command:

```
>interp(x, y, z, xo=seq(1,12,by=0.125), yo=seq(-80,0, by=0.5), linear =FALSE,
extrap=TRUE, duplicate = "median", dupfun = NULL)
```

With x = ID of the measure; y = depth of the value\*-1 and z = average value.

The final dataset is used to render an image with R and the “image” command which produces a “heatmap” where the different kinds of resistance are represented by different shades of blue (for the most friable zone) to green, yellow or red (for the most compacted zone).

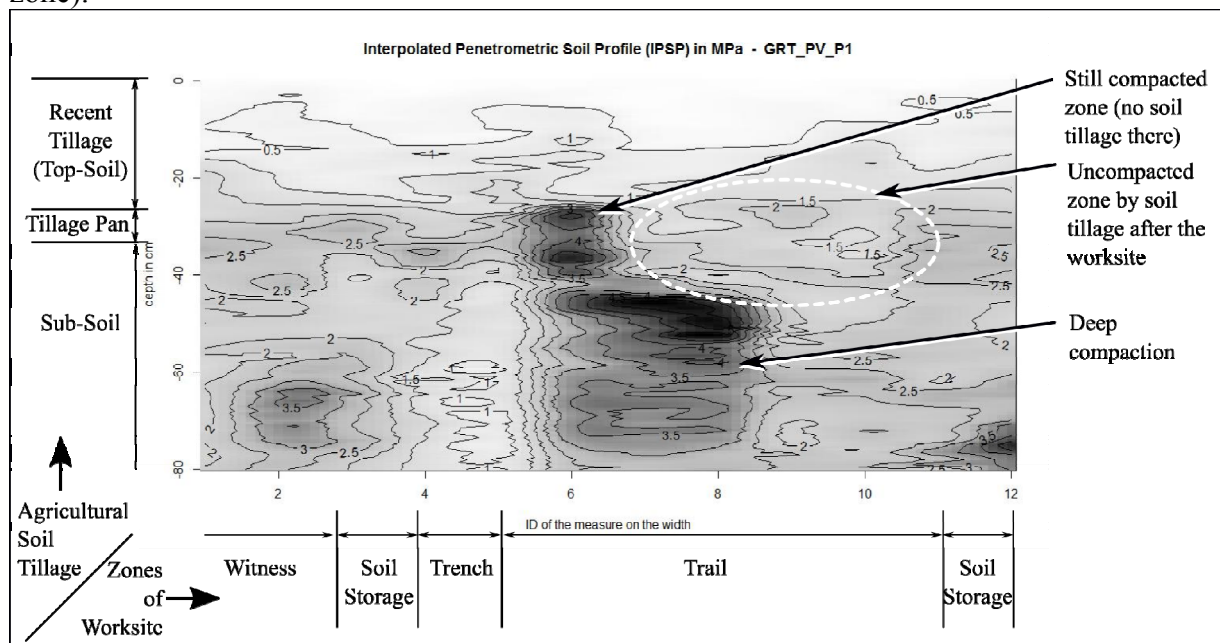

Figure 1: Interpreted IPSP

## Results and discussion

With such an image of the soil resistance, it's quite easy to see where the problems are. The correlation between the location of the resistant zones and the compacted zones has been demonstrated the “*profil cultural*” method during and after the worksite. Just like traffic lights, the colours indicate the depth and the width of the resistant and friable zones. So one can take a decision: - Is it necessary to have a deep soil tillage to break up the compacted zones? – With which equipment? Obviously, the accuracy of this method is not sufficient to describe the compaction as precisely as the “*profil cultural*” and how the soil is recovering a natural state. But, within less than 2 hours, an assessment of the soil over more than 20 m width can be made without digging a single hole. Moreover, by measuring over time, it's possible to evaluate the evolution of the soil structure.

## Conclusion

A little picture is better than a long discussion. With the Interpolated Penetrometric Soil Profile, the “*Chambre d'agriculture de la Somme*” has a tool to explain easily the consequences of a worksite for the soil, even to people who have no agronomic training. The possibility to compare exactly the same place before and after a soil tillage or year after year without spending too much time is a competitive advantage of this method. With enough images of the same place, why not considering a film afterwards?!

## References

- Boizard, H., Peigné, J., Sasal, M. C., de Fátima Guimarães, M., Piron, D., Tomis, V., Vian, J.-F., Cadoux, S., Ralisch, R., Tavares Filho, J., Heddadj, D., De Battista, J., Duparque, A., Franchini, J. C., and Roger-Estrade, J. (2017). Developments in the “*profil cultural*” method for an improved assessment of soil structure under no-till. *Soil and Tillage Research* 173, 92-103.
- Schothorst, C.J., (1968) De relatieve dichtheid van humeuze gronden. *De Ingenieur* 80-2; p.B1-88.

## Assessment of pore-size distribution using a flatbed scanner based image analysis method.

\*K. Binnie<sup>1</sup>, B.M. McKenzie<sup>1</sup>, T.A. Valentine<sup>1</sup>

<sup>1</sup> *The James Hutton Institute, Invergowrie, Dundee, DD2 5DA, Scotland, UK*

\* Corresponding author: [kirsty.binnie@hutton.ac.uk](mailto:kirsty.binnie@hutton.ac.uk)

### Introduction

Soil physical conditions have the potential to affect the crop yield. The availability of the correct size pore space can have an affect on the way roots elongate and thus access water and nutrients (Valentine et al., 2012). Tillage is used to prepare the soil for sowing and changes soil structure. Traditional ways to assess the physical conditions of the soil involve the use of tension tables, CT scanning and visual soil assessment (Rabot et al., 2018). Some of these assessments can be time consuming, involve processing of large individual datasets and/or be reliant on expert opinion. Within the scope of this study an alternative and complementary process for quantifying soil structure will be investigated, utilising affordable high resolution scanners.

### Material and Methods

Soil samples were collected after a barley crop had been harvested during September 2016 at the Mid-Pilmore site, the James Hutton Institute, Dundee. The tillage (Tillage - TILL) treatments sampled were conventional, mouldboard ploughing to 20 cm and disking (P) and minimum tillage, shallow non-inversion tillage to a depth of 7 cm (M). Twenty four intact soil cores, 50mm diameter by 100mm height, were taken from 2-12cm below the soil surface. The soil water content was adjusted to a matric potential of -1kPa, -5kPa, -20kPa and -50kPa (matric potential – MP) six cores each. Once soil cores had equilibrated they were broken in half either (Break Method - BM) by hand or with the use of a bread knife. The exposed surfaces of both sections were scanned using a cheap, but high resolution flatbed scanner at 1200dpi. Images obtained from the scanner were analysed using an Rscript developed to analyse the surface features of the samples and produce a pore size distribution plot. Comparisons of the pore size distribution obtained using the image analysis method was made with pore size distributions obtained from water retention curve assessments of cores taken from the same plots but at different sampling time (McKenzie et al., 2017). Cores used for image analysis are currently being processed through water release curves. The effects of TILL, MP and BM on the pore size distribution was analysed using mixed models in R.

### Results and Discussion

Pores size diameter, recorded by the image analysis method, is limited by the resolution of the scanner and the image quality. The data are not suitable to measure the very fine pores obtained at the dry end of a water retention curve. However soil pores were measured in the range which covered the range of pores sizes found to be important for root elongation of barley roots in (Valentine et al., 2012) and the range of pores usually considered important for plant available water. An example of structural information captured is illustrated in Figure 1. Breaking Method (P=0.045) and the Matrix Potential (P= 0003) significantly affected the number of pores captured by the image analysis methods. The Break Method also interacted with the pore distribution profile (P<0.001). The knife splitting method produced a smoother surface for imaging the split soil cores, but also resulted in soil drag across the surface. While this may enable more accurate water release curves, the hand break

method produced a more complicated and structurally relevant surface for imaging as the cores broke along natural weak surface cracks. Analysis of the hand split cores, found no significant contribution of MP to the final model but significant differences between the different Tillage treatments ( $P=0.04$ ), with Shallow non inversion cores having a higher number of pores that those from Plough plots. There was no significant interaction with pore sizes. These specific cores are currently being processed through a series of matric potentials to produce water retention curves, however, the image analysed cores results were compared with pore space information gained from analysis of water retention curves from the same site but using a different set of cores taken at 2-5cm and 7-12 cm (McKenzie et al., 2017). For these cores no differences were found between the two tillage treatments as main effects ( $P=0.582$ ) but difference were found for the interaction between tillage and pore size groups ( $P=0.003$ ). Consistent with the image analysis methods apart from the largest category of pores, a higher number of large pores were found in the Shallow non-inversion cores than in the cores from the plough system.

**Figure 1** Structural information extracted marked in black. Areas with large structural cracks can be separated from areas with small structural features. Method does not capture cracks that continue to edge of assessment area. The smallest category of pores is estimated at 0.02 mm diameter

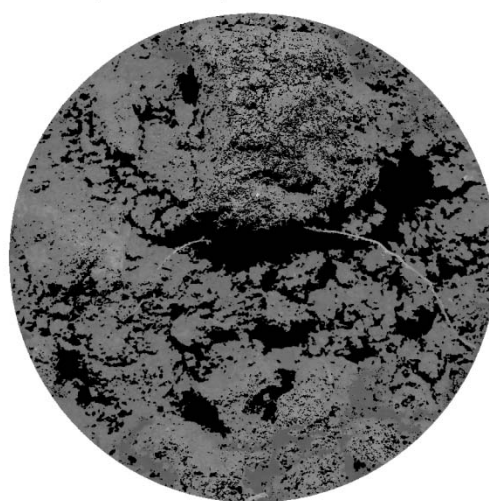

## Conclusion

This method enabled a fast assessment of the larger pore size ranges present in two sets of cores obtained from two different tillage treatments, showing differences in the counts of different cores categories between two tillage systems. Utilising high resolution flatbed scanners makes it a cost effective and high through put method.

## References

McKenzie B.M., Stobart R., Brown J.L., George T.S., Morris N., Newton A.C., Valentine T.A., Hallett P.D., 2017. Platforms to test and demonstrate sustainable soil management: integration of major UK field experiments. *AHDB Final Report RD-2012-3786*, 178pp.

Rabot E., Weismeyer M., Schluter S., Vogel H.-J., 2018. Soil structure as an indicator of soil functions: A review. *Geoderma*, 314, 122-137.

Valentine T.A., Hallett P.D., Binnie K., Young M.W., Squire G.R., Hawes C., Bengough A.G., 2012. Soil strength and macropore volume limit root elongation rates in many UK agricultural soils. *Ann.Bot.*, 110(2), 259-270.

## Exploring Visual Soil Evaluation and Examination methods on Ferralsols in Uganda

W.M. Cornelis<sup>1\*</sup>, D. Akodi<sup>1,2</sup>, E. Komutunga<sup>2</sup>, C. Agaba<sup>2</sup>, E. Ahumuza<sup>2</sup>, K. Oratungye<sup>2</sup>  
<sup>1</sup> Ghent University, Department of Environment, Soil Physics Unit, 9000 Ghent, Belgium  
<sup>2</sup> Nat. Agricultural Research Lab. (NARL), Soil & Agrometeorology Unit, Kampala, Uganda  
 \* corresponding author: Wim.Cornelis@UGent.be

### Introduction

Soils in Uganda are often moderately to highly degraded hence showing low productivity. Several national and international initiatives have been undertaken to improve soil quality and thus increase crop production. However, countries such as Uganda are lacking means to evaluate and examine soil quality, particularly soil physical quality. Visual soil evaluation and Examination (VSEE) methods which comprise rapid and simple tests that offer a numeric assessment of soil structure (Pulido Moncada et al., 2017) might therefore have a great potential. With several VSEE approaches or variants being published and used, the question remains which one suits best the conditions and purposes in a given region of interest. Our study area is dominated by Ferralsols which are known for their good physical properties (such as excellent porosity and good permeability), though they typically have limited plant available water capacity.

The objective of this study was therefore to test (i) the feasibility of VSEE methods in detecting changes in structural quality of highly weathered soil resulting from soil-improving cropping systems, (ii) if VSEE-based soil quality scores (Sq) are correlated with (iia) quantitative soil physical properties used as soil quality indicators (SQI) and (iib) soil hydraulic properties like water retention curve and permeability, and thus would be helpful in predicting the effect of soil management on field and regional water balances with soil-hydrological models.

### Material and methods

The tests were conducted and samples taken on Ferralsols with sandy clay loam texture, from the 0-15 cm topsoil and the 15-30 cm moderately compacted subsoil. Samples were taken from 18 farmers' maize fields that were under conventional tillage, permanent planting basins and rip lines for three years, and from four locations in a natural forest. The VSEE approaches tested were Visual Evaluation of Soil Structure (VESS, Guimarães et al., 2011), coreVESS (Johannes et al., 2017) and Visual Soil Evaluation (VSA, Shepherd, 2009). VESS and VSA are spade tests, whereas coreVESS evaluates soil structure in the laboratory from undisturbed soil samples. For both spade tests, we used a double spade variant (i.e. two spades of 15 cm each till 30 cm depth) and did the field tests when soils were near field capacity. Soil cores for coreVESS were brought to a matric suction of 100 hPa (which corresponds to field capacity of Ferralsols). For all tests, we scored categories (e.g. visual porosity, strength, aggregate size and shape) individually resulting in an aggregated Sq score. This allowed to find out which categories best explained variation in SQI. For VESS, we also gave soil blocks an integral Sq score to comply with the original procedure.

A wide variety of quantitative SQIs was measured in the lab, including bulk density, air permeability, water permeability, aggregates stability, the water retention curve and its derived properties like air capacity and plant available water capacity.

### Results and discussion

All three VSEE approaches showed a significant better soil quality in the natural forest (good quality) as compared to maize fields (fair/moderate quality), with the subsoils always showing

lower quality than the topsoil. No differences were however found between the three cropping practices.

The VESS approaches based on aggregated Sq scores from individually scored categories seemed to best respond to differences in soil quality with a coefficient of variation (CV) of 30-33%. VESS with integral Sq score had a CV of 25%, whereas VSA (based on the original nine categories – potential rooting depth was excluded since we did not dig deeper than 30 cm) had an 8% CV. VSA evaluates several categories that were constant in our study and not affected by land use and cropping system. When excluding those CV became 22%. CoreVESS overestimated Sq (lower scores, better soil quality) as compared to VESS, primarily because it does not consider ‘number and distribution of roots’. It was shown however that this criterion can be accurately evaluated visually in cores. When including the roots category, VESS and coreVESS scores matched better. VSA tended to overestimate soil quality, particularly at when soil quality was rather low. A very high correlation was found between ‘difficulty to break aggregates’ and ‘aggregate size and shape’ ( $r=0.996$ ), suggesting that it might not be necessary to evaluate both.

Statistical analysis showed that there was a good to moderate agreement between the VSEE-based Sq and SQIs, with Pearson  $r$  values of 0.61-0.69 for bulk density, 0.77-0.78 for air capacity, 0.60-0.66 for log of air permeability, 0.53-0.58 for log of water permeability, and 0.38 for mean weighted diameter under fast wetting (Fig. 1). No correlations were found with plant available water capacity ( $r<0.25$ ). We also found a significant correlation with the shape of the water retention curve, particularly in the wet range ( $r>0.50$ ).

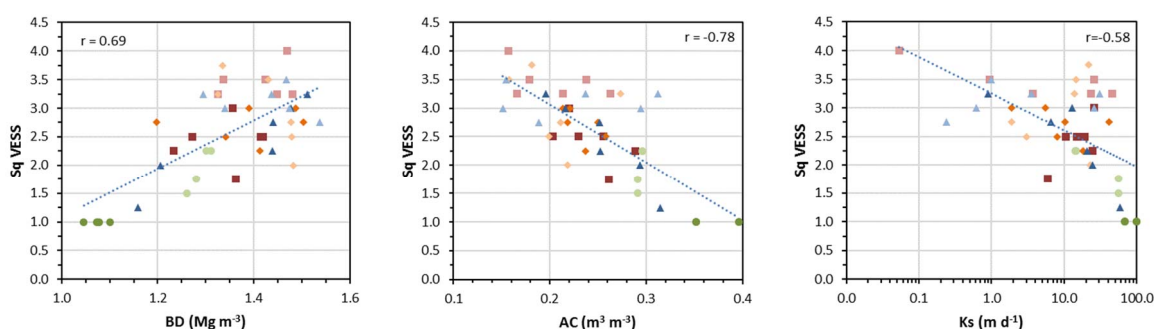

Figure 1: Aggregated soil quality score Sq from VESS versus bulk density BD, air capacity AC and saturated hydraulic conductivity Ks (N=44)

## Conclusions

Our results show that in general, VSEE methods are promising alternatives to evaluate differences in physical soil quality of highly-weathered soils in a rapid, intuitive, practical and cheap way.

## References

- Guimarães, R.M.L., Ball, B.C. and Tormena, C.A. (2011). Improvements in the visual evaluation of soil structure. *Soil Use Man.*, 27, 395-403.
- Johannes, A., Weisskopf, P., Schulin, R. and Boivin, P. (2017). To what extent do physical measurements match with visual evaluation of soil structure? *Soil Till. Res.*, 173, 24-32.
- Pulido Moncada, M., Helwig Penning, L., Timm, L.C., Gabriels, D. and Cornelis, W.M. (2017). Visual examination of changes in soil structural quality due to land use. *Soil Till. Res.*, 173, 83-91.
- Shepherd, T.G. (2009). *Visual Soil Assessment. Vol. 1. Field Guide for pastoral grazing and cropping on flate to rolling country.* Second Ed. Horizons Regional Council, Palmerston North, 119p.



## From the macro to the microaggregate: an alternative multiscale approach to quantify mechanical stability of aggregates

D. Uteau\*<sup>1</sup>, V. Felde<sup>1</sup>, S. Peth<sup>1</sup>

<sup>1</sup> Department of Soil Science, Faculty of Organic Agricultural Sciences, University of Kassel, Witzenhausen, Germany.

\* corresponding author: uteau@uni-kassel.de

### Introduction

Soil structure is organized in a hierarchical way with different sizes of aggregates, which are generated by repeated cycles of formation, destruction and reformation (Tisdall and Oades 1982). Soil micro-aggregates (here defined as smaller than 250  $\mu\text{m}$ ) and are considered to be the primary building units of soil structure. They control the interaction, transport and turnover of soil constituents due to their longer turnover times compared to macro-aggregates (Six et al. 2004). Despite the importance of micro and macro-aggregate formation for a multitude of soil functions little quantitative knowledge on the mechanical stability is available and underlying interacting processes are poorly understood.

### Material and Method

We analyzed soil aggregates taken from the experimental station Scheyern (Technical University of Munich). Aggregates from the same parental material (loess) were dry sieved to 2 mm equivalent diameter and separated according to their clay content (8% and 30%). Individual aggregates (n=3) were scanned in a X-Ray CT (Zeiss Xradia-Versa 520) with a voxel resolution of 1  $\mu\text{m}$  to analyze its 3D structure. Afterwards they were crushed down by a material testing machine until failure. From a displacement/force curve, a work can be calculated which is equivalent to the mechanical energy stored in the aggregate. The resulting aggregate pieces were crushed again to obtain further works. The process was repeated successively until reaching the microaggregate size, thus measuring the energy from 2 to 0.250 mm.

### Results

Results show a high influence of the clay content on soil mechanical stability. Higher clay content showed increased energy along the full scale. Only at the microaggregate scale coarser particles started to play a major role (even if particle crushing was avoided). Particle connection points played a dominant role along the analyzed scale.

### Conclusions

Mechanical stability of air-dry aggregates is greatly influenced by its clay content. The use of 3D image analysis complemented well the method and topological variables could be related to mechanic properties. The proposed method, derived from the standard crushing test, avoids the laborious and inaccurate estimation of the sheared surface. It is hence recommended for further research, especially in coarser aggregates to enhance the scale dependent information.

### Literature

Six, J., Bossuyt, H., Degryze, S., Denef, K., 2004. A history of research on the link between (micro)aggregates, soil biota, and soil organic matter dynamics. *Soil and Tillage Research, Advances in Soil Structure Research* 79, 7–31.

<https://doi.org/10.1016/j.still.2004.03.008>

Tisdall, J.M., Oades, J.M., 1982. Organic matter and water-stable aggregates in soils. *Journal of Soil Science* 33, 141–163. <https://doi.org/10.1111/j.1365-2389.1982.tb01755.x>

Key words: structure, microaggregate, crushing test



# The role of the particle shape in the discrete element model of soil-sweep interaction

K. Tamás<sup>1\*</sup>, Zs. Oláh<sup>1</sup>, L. Rácz-Szabó<sup>1</sup>

<sup>1</sup> *Budapest University of Technology and Economics, Department of Machine and Product Design, 1111 Budapest, Hungary*

\*corresponding author: [tamas.kornel@gt3.bme.hu](mailto:tamas.kornel@gt3.bme.hu)





## Introduction

The optimization of agricultural production is an issue of great importance, therefore analysing the energetic background of tillage could be useful to optimize the processes. Nowadays the discrete element method (DEM) is commonly used by researchers for this kind of study. Initially the soil DEM models were developed by using spherical assemblies, but it is important nowadays to examine how different particle shapes can affect on the behavior of the soil model. An accurate and reliable predictions can only be given if the input parameters are carefully selected in the simulation program code and the calibrated results should be compared to actual physical measurements (Coetzee, 2016). In this study a DEM model was developed for the calibration of the particle shape. This study is part of a research based on developing models with which accurate simulation of the soil-sweep interaction would be available based on the laboratory soil bin study. The objective of this study was to investigate the soil-tool interaction with particular attention to the shape of the soil particles and how they can affect the draught force of sweep tool the damping behavior and the displacement of particles' in the particle assembly.

## Material and Methods

The calibration process was performed to find the appropriate particle shape, most suitable for the simulation of energy dissipation and particle displacement. By comparing the experimental and simulation results we could improve the model of soil in the soil-sweep tool interaction model and finally the parameters of the DEM model were validated by comparing the simulated draught force results to the measured ones from the soil bin experiment (Gürsoy et al., 2017). In this simulations two simplified sweep tools with attack angle of 0° and 30° were utilized (Figure1) to analyze the energetic background of the particle assembly was made of various shapes of particles (Table 1). The perpendicular tool geometry (0°) performs cutting and does not raise the soil vertically, while the other tool geometry is responsible for the vertical mass transport because of the attack angle of 30 °. The soil model was created with the utilization of clumps (Table 1), which are complex particles assembled from spheres. The effect of the shape of these particles (clumps) on the behavior of the set was computed, and these results were compared to the simulation results of purely spherical sets. The radius of the particles was 20 mm, respectively.

Table 1: Setting of the sets of particles used in the calibration process.

Shape and the Proportion of Particles:				
1. Setting	100%	0%	0%	0%
2. Setting	0%	90%	5%	5%
3. Setting	0%	5%	90%	5%
4. Setting	0%	5%	5%	90%

## Results and Discussion

Studying the behavior of the sphere set (Setting 1 in Table 1), it can be concluded that there was a relatively small difference between the average values of draught force calculated in simulations with both tool geometries (attack angle of  $0^\circ$  and  $30^\circ$ ) at working speeds of 0.5 and 2 m/s as well, nevertheless at the other working speeds the difference between the draught forces in case of the perpendicular and the other tool geometry has significantly increased.

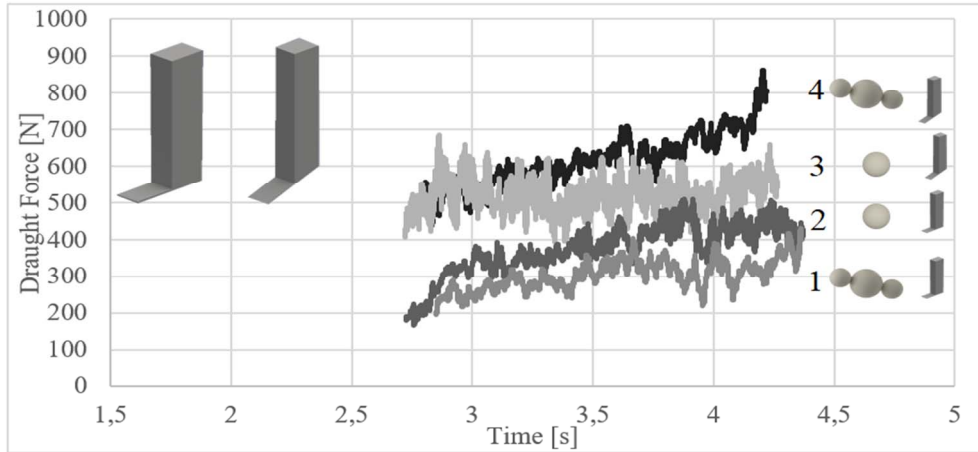

Figure 1: Simulation results comparing the cases Setting 1 and Setting 3 as given in Table 1. at the working speed of 0.5 m/s regarding the different simplified tool geometries used in the simulations.  
(Graph 1: Setting 3, perpendicular tool geometry; Graph 2: Setting 1, perpendicular tool geometry; Graph 3: Setting 1,  $30^\circ$  tool geometry; Graph 4: Setting 3,  $30^\circ$  tool geometry.)

These results show well the characteristics of the behavior of spheres: the excessive rotation of elements appears in the simulations, therefore to develop a model that can more effectively approximate the real soil behavior, the usage of complex soil particles or the introduction of a rolling resistance moment for the spheres is needed (Ono et al., 2013). In Setting 2, the clumps of two spheres were dominant. On Figure 1, it can be clearly seen that the largest difference between draught forces was created by Setting 3, where the dominance of the elongated particle was significant and the interlocking mechanism works. At Setting 4, the smallest difference in the draught force is at the lowest working speed.

## Conclusion

Comparing clumps to spheres used in DEM soil-tool simulations, it can be concluded that with the utilization of clumps a more real-like deformation zone could be created, which is responsible for the mass that increases the draught force. In order to describe the thixotropic behavior of the soil, clumps are more suitable than spheres, as the phenomenon of soil transport is better simulated with them. For the reasons explained, Setting 3 from Table 1 was selected to run additional simulations of the discrete element model of the soil sweep interaction.

## References

1. Coetzee C.J., 2016. Calibration of the discrete element method and the effect of particle shape, Powder Technol. 297, 50-70. doi: 10.1016/j.powtec.2016.04.003
2. Ono I., Nakashima H., Shimizu H., Miyasaka J., Ohdoi K., 2013. Investigation of elemental shape for 3D DEM modeling of interaction between soil and a narrow cutting tool, J. of Terramech. 50, 265-276. doi: 10.1016/j.jterra.2013.09.001
3. Gürsoy, S., Chen, Y., & Li, B. 2017. Measurement and modelling of soil displacement from sweeps with different cutting widths. Biosyst. Eng., 161, 1-13. doi: 10.1016/j.biosystemseng.2017.06.005

## Developing the Discrete Element Model of Soil-Sweep Interaction Based on Field Conditions

K. Tamás<sup>1\*</sup>, A. E. Ince<sup>1</sup>, E. Cakir<sup>1</sup>

<sup>1</sup> *Budapest University of Technology and Economics, Department of Machine and Product Design, 1111 Budapest, Hungary*

\* corresponding author: [tamas.kornel@gt3.bme.hu](mailto:tamas.kornel@gt3.bme.hu)

### Introduction

Soil-tool interaction plays important role in tillage process. It shapes the character of the application in different aspects such as required power depending on force applied to sweep tool and soil disruption caused by sweep. In order to predict the result of the tillage operation in field as well as maximize the efficiency of the tillage process, developing a soil model to make simulations that gives real-like results would be very useful for applications those involve soil-tool interaction (Milkevych et al., 2018). In this regard, this study consists of draught experiments in fields, cone penetration tests (Kotrocz et al., 2016), laboratory analysis of soil physical and mechanical conditions and development of discrete element method (DEM) model which consists calibration and validation. Experiments and laboratory analyses carried out for two fields; sandy and clayey. This paper aims to develop an accurate DEM models of soil-sweep interactions for different soil types (sandy and clayey) and cone penetration that would be feasible for tillage applications and contains useful results for researchers.

### Material and method

Field experiments for this study carried out in National Agricultural Research and Innovation Centre in Gödöllő, Hungary. Draught measurements were taken with two different sweep tools attached to a tractor with the working depth of 20 cm in sandy field and clayey field. Soil properties are different for these fields (e.g. moisture content, particle size, void ratio) which effects draught. Soil samples were taken from fields at various depths for soil physical properties and tests were carried out along with direct shear box test in order to obtain soil mechanical properties. Additionally, cone penetration tests were carried out. Simulations were conducted in YADE software. In simulations, 3-dimensional box (1 m × 2 m × 2 m) was created to serve as a base for the assembly of clumps which formed with combination of numerous basic spherical particles to realistic representation of soil and its effect on energy dissipation (Hang et al., 2017). Sweep tools, those used in field tests, scanned with 3-D scanner and modified (meshed) for simulation usage in Autodesk Meshmixer, Solidworks and Gmsh. Soil samples which taken from fields were analysed and properties of soils were used to set the soil parameters for DEM simulations. Same speeds that were utilized in field experiments also utilized in simulations ranging from 0.96 m/s to 2.56 m/s. By changing parameters in particles' contacts such as Young's modulus, shear and normal cohesion and friction angle; results of simulation and field tests were compared which respect to draught. Eventually, optimal parameter sets were obtained and validated for both fields. Furthermore, parameter sensitivity studies were carried out. Figure 1a explains the aim of the developed model. With suitable parameters set, simulations approximate field results with acceptable error and simulation plot converge to field test plot.

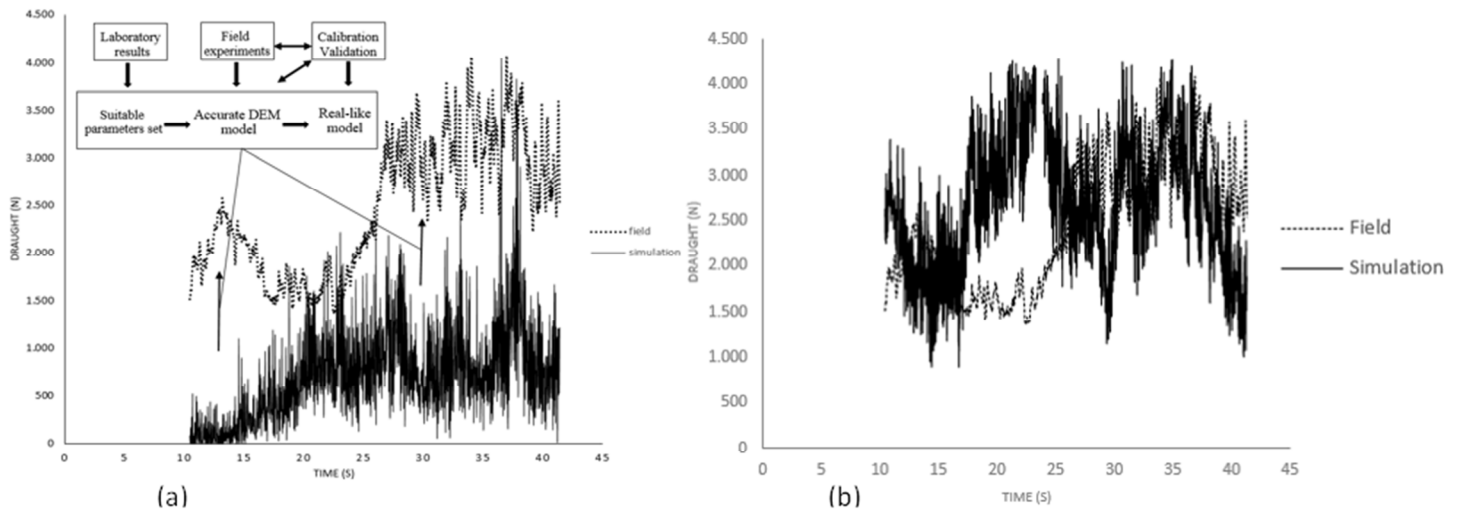

Figure 1: The validation process of DEM simulation based on field test results. (a) The simulated draught with the utilization of an initial parameter set (before the validation). (b) Plots with the validated parameters set.

## Results and discussion

Field tests show that draught is dependent on speed and there are fluctuations in draught due to field conditions (Figure 1b). This is mainly caused by its inhomogeneity, voids in soil, thixotropic nature of soil, as well as substances in soil such as roots, plants' residues etc. Draught is also connected with properties of soil (e.g. how much clay or sand it contains, particle dimensions and moisture content). Combination of results that derived from different fields, different sweep tools and different speeds supported calibration of model parameters and validation process. Developed DEM model give similar results to field experiments mainly owing to usage of realistic particles (clumps) rather than only spheres because its effect on energy dissipation during the tillage process, considering field conditions (e.g. cohesion) and multiple validation steps. It is noted that Young's modulus, friction angle, rolling friction coefficient and cohesion forces in the inter particle connections impact nature of soil and therefore draught.

## Conclusion

Developed model successfully represents real soil in simulations with reasonable relative error. Results for draught in simulations comply with field test and also fluctuations of draught in simulations are similar to the one in field experiments. As a results, proposed model can be used for similar applications. Furthermore, developed model for draught can be useful for analysis of tillage for similar fields by approximation of draught so behaviour of the soil could be estimated depend of speed and soil type.

## References

- Hang, C., Huang, Y., & Zhu, R. (2017). Analysis of the movement behaviour of soil between subsoilers based on the discrete element method. *Journal of Terramechanics*, 74, 35-43.
- Kotroc, K., Mouazen, A. M., & Kerényi, G. (2016). Numerical simulation of soil-cone penetrometer interaction using discrete element method. *Computers and Electronics in Agriculture*, 125, 63-73.
- Milkevych, V., Munkholm, L. J., Chen, Y., & Nyord, T. (2018). Modelling approach for soil displacement in tillage using discrete element method. *Soil and Tillage Research*, 183, 60-71.

## **Interest of using ‘profil cultural’ method to describe vineyard soils, seeking to assess and manage soil fertility**

R. Koller<sup>1\*</sup>, A. Schaub<sup>2</sup>, O. Rapp<sup>3</sup>

<sup>1</sup>*Association pour la Relance Agronomique en Alsace, 67300 Schiltigheim, France*

<sup>2</sup>*Chambre Régionale d’Agriculture Grand Est, 67300 Schiltigheim, France*

<sup>3</sup>*Chambre d’Agriculture Alsace, 67300 Schiltigheim, France*

Corresponding author : [r.koller@alsace.chambagri.fr](mailto:r.koller@alsace.chambagri.fr)

### **Introduction**

Winegrowers often worry about soil fertility of their vineyards and soil degradation. Fertility is frequently described according to chemical, physical and biological variables. Chemical and biological soil characteristics are evaluated with validated analytical methods, whereas physical characteristics of soil are more rarely studied.

Physical characteristics of soil fertility in vineyards are a significant part of two research projects dealing with assessments of vineyard systems: Casdar SYSVIT-SOLVIN (2014-2016) assessed impact of low-input vineyard systems on soil, grapes and wines quality and Dephy-Expe PEPSVI (2013-2018) is a platform dedicated to test and assess innovative vineyard systems according to agronomic, environmental, social and economic characteristics : organic, conventional and innovative, using several levers to reduce pesticides use. These two combined research programs, SYSVIT-SOLVIN and PEPSVI supported a soil fertility analysis including soil structure descriptions using a soil profile method, the ‘profil cultural’.

That soil profile method qualifies the soil horizons with a lateral partition related to the location of wheel tracks and tillage machines, according to the potential rooting and the impacts of tillage and practices on soil structure. This method helps analyzing the causes of degraded soils and leads to wonder about results relative to the capacity of vineyard to mobilize soil resources, and also how to sample the soil in order to assess biological and chemical fertility.

### **Method**

23 soil structural profiles have been described in these studies, distributed in Alsace, in Loire valley and in Bordeaux, on 6 locations. Soil profiles were opened perpendicularly to the rows, under vine row and under inter-rows to get the differences between the two parts of a soil vineyard. Morphological units in the soil have been identified and classified using the ‘profil cultural’ method, looking at spatial arrangement of clods and type of clods. Observations have been completed with bulk density measurements related to some typical morphological units.

### **Results**

First result, despite an important pedological diversity between locations, all soil structural profiles showed common figures resulting from current rolling, with compactions under wheel tracks located under inter-rows from surface to 30 cm deep, and non-settling soil under rows. Bulk density validated the soil profiles observations with results between 1,3 and 1,6 g/cm<sup>3</sup> according with the identified morphological units (see table below).

Site Bordeaux / INRA Grande Ferrade			
Structural unit classification	Estimated ability to rooting	n	Bulk density $\text{g/cm}^3$
F-SF / ... / ...	Favourable	7	1,33
SF-F / pm / ...	Favourable	5	1,35
SD / mm / $\Phi$	Little favourable	13	1,46
M / ... / $\Delta$	Extremely unfavorable	4	1,59

Site Alsace / Lycée Rouffach			
Structural unit classification	Estimated ability to rooting	n	Bulk density $\text{g/cm}^3$
SF / pm / $\Phi^+$ à $\Delta$	Favourable	4	1,31
SD / pm / $\Phi$	Little favourable	2	1,42
M / ... / $\Delta$	Extremely unfavorable	2	1,60

Bulk density measurements on samples from different morphological units

The second results of soil profiles analysis is that some very deep degradations of the soil (more than 30 cm deep) can be noticed under vine row and also under inter-rows. Because of their location, those very deep degradations are not linked to annual tillage practices but seem to be linked to the past of the vineyard and especially to the vineyard plantation operations.

The third result shown that the current diversity of vineyard systems, including annual tillage practices, do not seem to be a determining factor of the soil structural states and vine roots development.

These results asked new questions about soil fertility: (i) sample strategy for soil analysis in the vineyard should include differences between rows and inter-rows; (ii) advices about combining tillage on one inter-row and cover crops in the second inter-row have to be clarified ; (iii) which soil structure and fertility is the best for vine production and (iv) be careful about planting vineyard in order not to damage the soil structure of the field for many years.

Authors thank RITTMO and INRA for supporting the research projects SYSVIT-SOLVIN and PEPSVI.

#### References

Boizard, H et al., 2016. Developments in the « profil cultural » method for an improved assessment of soil structure under no-till. Soil and Tillage Research, volume 173, p. 92-103

Manichon, H., et Gautronneau, Y., 1987. Guide méthodique du profil cultural. ISARA & INA-PG : 62 p.  
<http://profilcultural.isara.fr/index.php/profilcultural>

Roger-Estrade, J. et al., 2011. Dégradation physique des sols agricoles et forestiers liée au tassement : principaux résultats du projet GESSOL-ADD DST. EGS, volume 18, n° 3. p. 187-199

## Simplified method of soil structure assessment taking into account earthworm activity

Turillon C.<sup>1\*</sup>, Duparque A.<sup>1</sup>, Tomis V.<sup>1</sup>, Cretin V.<sup>1</sup>, Piron D.<sup>2</sup>, Boizard H.<sup>3</sup>

<sup>1</sup>Agro-Transfert Ressources et Territoires, 80200 Estrées-Mons, France.

<sup>2</sup>University of Rennes1, UMR EcoBio, F-35380 Paimpont, France

<sup>3</sup>INRA, UPR1158 AgroImpact, 80200 Estrées-Mons, France

\*Corresponding author [c.turillon@agro-transfert-rt.org](mailto:c.turillon@agro-transfert-rt.org)

### Introduction:

For many years, reduced and no-tillage systems have increased in different French regions. In those systems, farmers expect a regeneration of compacted soils by natural agents, like climatic conditions, roots growth and macrofauna (especially earthworms in France). They need a simplified method to evaluate jointly soil structure and effect of natural agents, in particular earthworm activity.

Currently, there are several methods of soil structure assessment using spade. But few of them allows to evaluate earthworm activity for regeneration of soil structure. Methods that make it are coupled with counting of earthworms, which can take a long time. Furthermore, earthworms are sensible to soil moisture, so counting periods are restricted.

Conversely, features of earthworm activity allows to evaluate intensity of activity at all seasons of the year because these traces are more perennial.

That is why we currently work on development of a simplified method of soil structure assessment taking into account biostructures resulting from earthworm activity.

### Description of the method:

Equipment: spade, a piece of tarpaulin, measuring tape.

Protocol:

6 spade samples are taken on a diagonal about 3 meters wide in the direction of tillage (method proposed by OPVT: earthworm participatory observatory in France: <https://ecobiosoil.univ-rennes1.fr/page.php?93>).

Each sample is gently set on the tarpaulin and, in a first step, it is evaluated as for soil structure with VESS method (Ball et al, 2007; Boizard et al, in Baize, 2013).

A score from 1 (very good structure) to 5 (very bad structure) is assigned to every horizon that can be distinguished on the sample (1 to 3).

Then, when the structure of the horizon is scored 1 or 2, only fine and small aggregates are observed; then, the form of aggregates indicates whether they were created by physical processes (climate and soil tillage giving angular aggregates) or biological processes (giving rounded aggregates).

When the structure scores are 3, 4 or 5, earthworm biostructures can be observed on each clod that are present in the horizon, by open them to examine their inner structure.

Structure with clods (Sq 3 to 5) : biology notation on clods		
Name	Distinctive fetures of recognition	Illustrations
<b>A. not any biostructure</b>	Total absence of biostructure	
<b>B. few biostructures</b>	Somes traces of biostructures, especially macropores	
<b>C. regeneration in progress</b>	Many traces, especially located on the periphery of the clod Presence of compacted portion(s) without biostructure of significant size (3 - 5 cm)	
<b>D. highly developed regeneration</b>	Many traces, on all surface of the clod Possibly some small isolated compacted portion(s), with not or little biostructure	

Figure 1 : assessment grid of intensity of earthworm activity (extract)



2 types of biostructures are noted: macropores or rejecting casts (Piron et al., 2017). 4 categories of intensity of biostructure are defined from A (not any trace of biological activity) to D (highly developed bio-regeneration, i.e. many biostructures on all the inner surface of the clod). An assessment grid with photos has been developed to help users to choose the right category for each clod (figure 1). In the version of the method for use by farmers and advisers, the chosen category for the whole horizon corresponds to the majority category for the observed clods. If the method is used to conduct experiments, the account of percentage of clods in each biostructure category will allow more accurate comparisons between the studied situations.

### **Results and discussion:**

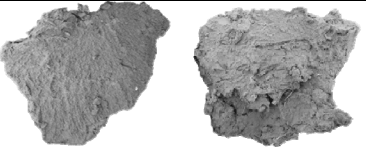
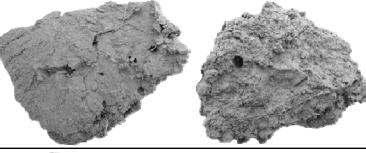
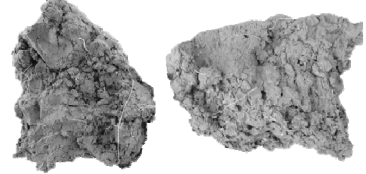
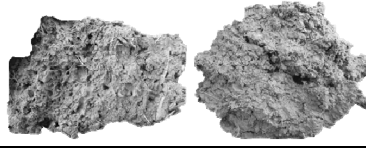
The implementation of the method in agricultural fields with advisers highlighted its performances in terms of:

- Pertinence: for studying regeneration, observation of biostructures is more appropriate than counting earthworms. Biostructures are rather persistent in the soil, so it is possible to evaluate earthworm activity even in the absence of the individuals.
- Applicability: as the traces remain in the soil, the observation periods are widened compared to the periods adapted to the counting of earthworms. It must still avoid too dry periods (difficulty to push the spade) or too wet (analysis falsified of the soil structure).
- Appropriation: a learning time is necessary, but after at least 3 or 4 samples, or better, a series of 6 samples, a user can be independent with the assessment grid;
- Rapidity: after appropriation of the method, it takes 5 to 10 min per sample according to the use of the method. It takes a total of 30 to 60 min to diagnose properly an agricultural field.

This method can be applied for different uses:

Farmers or advisers can apply the method for short-term decision-making for tillage to implant next crops, or to assess the effect of tillage or cover crop on soil structure. They can also use it to monitor the soil biological quality after a change in farming operations or compare and discuss the soil behaviour in different fields with various farming practices. The method can be applied in led works to develop, in a very concrete way, the awareness of students to management of soil structure integrating the role of biology. One of the expected uses (in test) is also to allow experimenters to implement the method in a plots network to study the effects of agricultural practices on biological activity of soil, follow its evolution throughout time and produce scientific and technical references.

### **Conclusion:**

The visual assessment method presented can be considered as an evaluation of the VESS method of Ball et al (2007) and of the morphological description of earthworm bioturbation patterns proposed at the profile scale by Piron et al. (2017), the second being used to enrich the first. The use of the method with agricultural advisers in working groups highlighted the practicality and ease of appropriation of the method. The repeatability of the method in experimental contexts will be examined in further works.

### **Références:**

- Ball B. C., Batey T., & Munkholm L. J., 2007. Field assessment of soil structural quality—a development of the Peerkamp test. *Soil use and Management*, 23(4), 329-337.
- Boizard, H., Ball, B.C., Shepherd, G., Roger-Estrade, J., 2013. Caractérisation au champ de la structure des horizons de surface des sols cultivés. In : *Les sols et leurs structures : Observations à différentes échelles*. (Baize, D., Duval, O., Richard, G., coord), chap. 8, Quae Ed., Versailles, 119-129.
- Piron D., Boizard H., Heddadj D., Pérès G., Hallaire V., Cluzeau D. 2017 Indicators of earthworm bioturbation to improve visual assessment of soil structure. *Soil Till. Res.*, 173, 53-63.



## Spatial Distribution of VESS Soil Quality Scores in Relation to Quantitative Soil Properties

Rachel Muylaert Locks Guimarães<sup>1\*</sup>, Craig David Rogers<sup>2</sup>, Renan Augusto Lack Barboza<sup>1</sup>, José Matheus de Camargo Machado<sup>1</sup>, Pedro Paulo Golçalves Zanini<sup>1</sup>, Vacilania Pacheco<sup>1</sup>

<sup>1</sup>*Federal University of Thechnology-Paraná, Câmpus Pato Branco, Brazil*

<sup>2</sup>*Independent scholar, Pato Branco, Brazil*

\*corresponding author: rachelguimaraes@utfpr.edu.br

### Introduction

The sustainable utilisation of agricultural systems relies heavily on the monitoring of soil structural quality to identify degradation, inappropriate use and management, and to allow practices to be implemented that ameliorate the problem. Properties of the structural quality of soil are commonly monitored using quantitative techniques. Quantitative indicators such as bulk density, soil resistance to penetration, macro- and micro-porosity, and infiltration rate, are useful guides to soil structural quality as they provide information on how the structure of soil is working to supply water, air and support to plants. However, individually these properties only give a partial view of the structural quality of the soil. Semi-quantitative techniques, such as visual soil evaluation methods, are rapid and simple tests that offer a more integral and holistic numeric assessment of the soil structure and of soil physical quality, as they include within the assessment a wide range of soil and biological aspects, such as aggregate strength, shape and size, porosity, colour and smell, roots and fauna. As fields are rarely homogeneous, instead exhibiting a variety of different localised soil, crop, and environmental characteristics (Rogers et al., 2014), semi-quantitative techniques are ideal for capturing a more complete view of the overall quality of the field.

The Visual Evaluation of Soil Structure (VESS) originally proposed by Ball et al. (2007) is a spade method which assesses soil structural quality by comparing features of aggregates and roots with a description chart to attribute a soil quality score (Sq). The most up-to-date and most widely available scoring chart, including the progressive fragmentation of aggregates to confirm the score, was published by Guimarães et al. (2011). The scores produced by this simple and rapid visual test have been correlated with many measured physical qualities including tensile strength, bulk density, resistance to penetration, least limiting water range, hydraulic properties and air permeability, demonstrating its reliability for assessing soil structural quality. As VESS integrates various aspects of soil quality it is believed that it can be used to take an overall view of field health, while the quantitative techniques provide only one facet that is potentially more subject to localised variability.

The objective of this work was to map the spatial distribution of quantitative and semi-quantitative soil quality indicators to compare and contrast their ability to give an overall picture of soil quality.

### Material and Methods

The sampling was located on a farm in Chopinzinho in Parana, Brazil, in a field that contained soybean in the summer and ryegrass for fodder in the winter. The sampling area was 100 m x 100 m, with samples taken at 20 m intervals, giving a total of 36 sampling points in a grid. In addition, eight intermediate samples (10 m intervals) were taken in the form of two randomly placed crosses. At each sampling point undisturbed samples were taken from the 0-5 cm and 10-15 cm depths, corresponding to the first and second layers of contrasting structure according to VESS, to measure bulk density and macroporosity. From each

sampling point a soil slice was also extracted and VESS was performed following Guimarães et al. (2011).

The spatial distribution of quantitative and semi-quantitative soil properties in the field was then assessed using geostatistical methods; isotropic experimental semivariograms were constructed to describe the spatial dependence structure of the properties. After the experimental semivariance was plotted, the model providing the best fit to the semivariogram, as indicated by the  $R^2$  values calculated by the GS+ software (GS+ version 9, Gamma Design Software) was selected.

For those properties that indicated spatial dependence in their experimental semivariograms, kriging was used to interpolate estimates for locations between the assessed sampling points to create contour plots. While, for data sets that returned semivariograms showing no spatial dependence Inverse Distance Weighting was used to construct the contour plots. Contour plots were constructed using Surfer version 7 (Golden Surfer Inc.).

### Results and discussion

VESS in the second soil layer was shown to be quite homogeneous across the field, with Sq scores only ranging between 4.5 and 3.5, which indicates that the areas of the field are either compacted (Sq4) or that the structure of the soil has changed and is in need of long term management changes to restore the soil quality or prevent further damage (Sq3). This was contrasted by the distribution of the bulk density and macroporosity, which were comparatively patchy in this layer. Substantial areas of both high and low bulk density were found throughout the field in areas that corresponded with areas of low and high macroporosity, respectively. In the first soil layer VESS was slightly more heterogeneous with a large patch of poor soil quality (Sq 4-5) found in an area that corresponded with higher levels of bulk density and low macroporosity in the same layer.

### Conclusion

In conclusion, in the first soil layer VESS correlated well with bulk density and macroporosity. While in the second layer, VESS was more homogenous than the other two indicators. VESS was better at giving an overall picture of field health, while the quantitative properties were able to bring to light localised variation affecting specific aspects of soil quality.

### References

- Ball, B.C., Batey, T., Munkholm, L.J., 2007. Field assessment of soil structural quality— a development of the Peerlkamp test. *Soil Use Manag.* 23, 329–337.
- Guimarães, R.M.L., Ball, B.C., Tormena, C.A., 2011. Improvements in the visual evaluation of soil structure. *Soil Use Manag.*, 27, 395-403.
- Rogers, C.D., Guimarães, R.M.L., Evans, K.A., Rogers, S.A., 2014. Spatial and temporal analysis of wheat bulb fly (*Delia coarctata*, Fallén) oviposition: consequences for pest population monitoring. *J. Pest Sci.*, 88, 75-86.

# CHARACTERIZATION OF AGRICULTURAL SOILS BY THE USE OF GEOGRAPHICAL INFORMATION SYSTEMS (GIS) AND STATISTICAL ANALYSIS: CASE OF THE CHERRAT-MOROCCO REGION

H. Sehlaoui<sup>1,2\*</sup>, R. Hassikou<sup>2</sup>, A. Zouahri<sup>2</sup>, B. Soudi<sup>3</sup>, A. Douaik<sup>2</sup>, H. Iaaich<sup>2</sup>, H. Yachou<sup>2</sup>, A. Ghanimi<sup>4</sup>, H. Dakak<sup>2</sup>.

<sup>1</sup> *University Mohammed V, Faculty of Sciences, Department of Biology, Mycology and Environment, Rabat, Morocco.*

<sup>2</sup> *National Research Institute of Agricultural Research, CRRAR, Research Unit on the Environment and Conservation of Natural Resources B.P: 6356 - Institutes, 10101 - Rabat, Morocco.*

<sup>3</sup> *DRNE, Agronomic and Veterinary Institute Hassan II, Rabat.*

<sup>4</sup> *University Mohammed V, Faculty of Sciences, Department of chemistry, Rabat, Morocco.*

\* corresponding author: [sehlaoui.habiba@gmail.com](mailto:sehlaoui.habiba@gmail.com)

## Introduction

Agriculture is the first national development priority because of its central role in the country's economy (MAPM, 2011). It is one of the three pillars of the environment besides the quality of water and air (Andrews et al, 2002). Thus, soil quality is at the center of many debates and issues for sustainable agriculture and protection of the environment. In this regard, soil characterization and assessment can provide a means for determining the level of soil degradation, guiding proper land management, and establishing the needs in soil nutrients (Chen et al., 2013). In this context, the objective of this work is to study the current state of the perimeter of Cherrat, which has undergone significant agricultural expansion.

## Material and method

### Presentation of the study area

The perimeter of Cherrat is a subdivision of the Moroccan region Benslimane. It is spread over an area of 7619 Ha. Due to its geographical location, the climatic regime of the study area is semi-arid with a sub-humid trend towards the coast. Its annual rainfall is of the order of 440 mm. The average minimum temperature is 12.9 ° C, while the average maximum temperature is 23.7°C. The commune of Cherrat is characterized by its strong agricultural activity especially market gardening and viticulture.

### Sampling and analysis

The geo-referenced sampling was carried out on the basis of the orientations of the representatives of the "Provincial Directorate of Agriculture (DPA)" of Benslimane. The physico-chemical study of the soils in this area was preceded by geo-referenced sampling following a network of 29 soil samples well distributed over the entire area. Samples were taken using an auger in the 0-20 cm horizon. The parameters analyzed are: pH, electrical conductivity (EC), cation exchange capacity (CEC), organic matter, assimilable phosphorus, assimilable potassium, total nitrogen, and soil texture.

A statistical analysis of these parameters was developed using the SPSS software. It was based on the descriptive analysis, the principal component analysis, the correlation matrix and also the Ascending hierarchical classification. Geographic Information System (GIS) was established to study the spatial distribution of the different classes that characterize the study area.

## Results and discussion

### Descriptive analysis of soil quality parameters

The descriptive analysis showed a strong variability. The assimilable phosphorus has the most variable component. Its coefficient of variation is of the order of 87.65%. It ranges from 6.93 to 268.95 ppm with an average of 72.99 ppm. It is followed in terms of variability by: EC (82.65%), organic matter (63.01%), nitrogen (52.50%), exchangeable potassium (51.30%), CEC (12.26%). While pH has the least variable parameter with a coefficient of variation of 9.11%, the majority of soils are relatively neutral to alkaline. Regarding soil texture, the average content of sand, silt and clay soil is 52%, 23% and 25%, respectively. The highest coefficient of variation is recorded for the clay content, which is 41%.

### Principal Component Analysis

The results show that the factors F1, F2, and F3 have the eigenvalues of 3.2, 2.1, and 1.5 respectively. We also note that most of the information (70%) is explained by these first three factorial axes. The first

component (F1 axis), describing 32.7% of the total variance, is defined by the CEC variables and clay content towards its positive pole, and the percentage of sand towards its negative pole. Axis 2 (F2), with 21.6% inertia, is expressed as pH. While the 3rd axis (F3), which contributes with 15.8% of inertia is determined by the percentage of silt towards its negative pole.

### Ascending Hierarchical Classification Analysis

The dendrogram from this classification highlights four groups. The first group has 45% of the total samples. This group is characterized by a medium conductivity and phosphorus content, and a high sand percentage. The second class includes 21% of the analyzed samples. On the one hand, they have low conductivity and nitrogen values and, on the other hand, high percentages of potassium and sand. Group 3 has low MO, phosphorus, sand, and conductivity values due to its silty-clayey structure that decreases infiltration of Na<sup>+</sup> ions. While group 4 classifies soils with a porch potassium content of the total average, and high CEC, MO, and clay percentage values.

### Spatial distribution of the classes

The spatial distribution of the different classes is presented in Figure 1:

C1: in this class it can be noted that soils tend to be low in potassium and this is partly explained by the sandy soil texture but can also be attributed to the lack of potassium fertilization in the cultivation practices of this distributed region south of the study area.

C2: Unlike the first class and although it is also sandy texture, there are very high levels of potassium and also phosphorus with a significant rate of organic matter. This probably indicates extensive use of fertilization, both mineral and organic by farmers located in the central part of the study area.

C3: although one could not pronounce on this class since it contains only one point, the rather high electrical conductivity observed can be explained in relation to its location near the sea. Indeed, it could be a marine intrusion. Other nearby points must be taken to confirm or not the existence of this class.

C4: points of this class are distributed south and west of the study area. It is characterized by medium textured soils with low EC, high P and K and also Mo, which can also be explained by the use of mineral fertilizers and organic amendments.

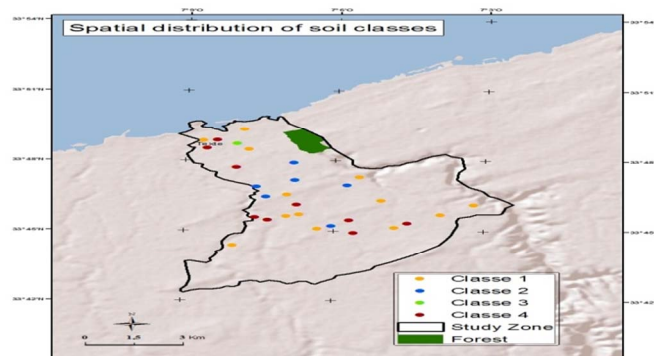

**Figure 1:** Spatial distribution of soil classes

### Conclusion

This study allowed us to make a summary characterization of soils in the Cherrat region, epitomized by the presence of different classes of soil parameters. This classification of the main soil parameters allowed us to approach and discern in addition the farming practices applied by the farmers in the different parts of the zone, particularly in relation to fertilization. Therefore, an adaptation of crops and cultivation techniques is necessary to ensure sustainable preservation of the natural resources of the Cherrat region. Nevertheless, we recommend a consolidation of this study by verifications and a possible survey of farmers in this region.

### References

- Andrews, S.S., Karlen, D.L., Mitchell, J.P., 2002. A comparison of soil quality indexing methods for vegetable production systems in Northern California. *Agriculture, Ecosystems & Environment* 90, 25–45.
- Chen, Y.D., Wang, H.Y., Zhou, J.M., Xing, L., Zhu, B.S., Zhao, Y.C., Chen, X.Q., 2013. Minimum data set for assessing soil quality in farmland of northeast China. *Pedosphere* 23, 564–576.
- Ministère de l'Agriculture et de la Pêche Maritime (MAPM) ,2011: le conseil agricole une nouvelle stratégie de service aux agriculteurs, Situation de l'agriculture au Maroc n°9.

## An Integrated Triple-Sensor Cone Penetrometer for Soil Physical Properties

M. Naderi-Boldaji<sup>1\*</sup>, M. Tekeste<sup>2</sup>

<sup>1</sup> *Department of Mechanical Engineering of Biosystems, Faculty of Agriculture, Shahrekord University, Shahrekord 88186-34141, Iran*

<sup>2</sup> *Department of Agricultural and Biosystems Engineering, Iowa State University, Elings Hall, Ames, IA 50011, USA*

\* Corresponding author: [naderi.mojtaba@agr.sku.ac.ir](mailto:naderi.mojtaba@agr.sku.ac.ir); [m.naderi@ut.ac.ir](mailto:m.naderi@ut.ac.ir)

### Introduction

Information about the spatial variability of soil attributes (i.e. physical, chemical and nutritional) within a field is essential for decision-making in precision agriculture (PA). For map-based approaches in PA, diverse sensor techniques are utilized to rapidly collect information at field-scale (Zeng et al., 2008). Mapping the soil physical attributes (i.e. the state of compactness, water content, soil texture etc.) across a field would provide useful information to (i) estimate the extent of land degradation by compaction, (ii) manage soil traffic and evaluate land use impacts on soil compaction and (iii) explain the spatial variability in crop yield and prescribe appropriate practices to ameliorate the crop efficiency (Servadio et al., 2017). However, PA technology is still limited to obtain some soil characteristics (e.g. soil texture) rapidly, easily and inexpensively (Adamchuk et al., 2004). There has been significant progress in the development of combined soil compaction sensors by fusing sensors to simultaneously measure soil strength, soil water content and soil texture. Sensor fusion systems for soil compaction generally include (i) mechanical-dielectric fusion, (ii) mechanical-optical (NIR sensor), (iii) mechanical-dielectric-Gamma ray fusion and (iii) optical-dielectric fusion. To the best of our knowledge, no sensor fusion has been reported so far with a combination of high-frequency acoustic, dielectric and load cell sensors on a single probe for soil physical characterization. The aim of this study was to develop and evaluate a multi-sensor probe (i.e. mechanical-dielectric-acoustic) as a novel sensor fusion for applications in soil physical sensing in precision agriculture.

### Material and method

The multi-sensor probe was developed by integrating a dielectric sensor, an acoustic sensor and a load cell on a stainless steel conical probe (Fig. 1). The dielectric sensor works based on the impedance measuring technique introduced by Gaskin and Miller (1996). The impedance of the sensor varies with soil dielectric constant which is in turn affected by the water content of the surrounding soil within the zone of influence of the fringe-field formed between the edges of the two electrodes. A high-frequency piezo sensor (KRNBB-PC Point contact sensor, KRN Services, Inc., Richland, WA, USA) with a frequency range of 10-1000 kHz was installed inside the cone. A long cone shoulder (45 mm, cf. Fig. 1) was considered to accommodate the 28 mm long AE sensor and the connection plug inside the probe. The cables of the dielectric and AE sensors were passed through a 5 mm diameter hole in the cone rod. Laboratory vertical penetration tests were carried out in clay, loam and sandy soil textures. Each soil texture was prepared at 0.4, 0.6 and 0.8 PL (lower Atterberg's plastic limit) water contents. The soils were remolded in three-layer columns (200 mm diameter, 600 mm height) at three bulk densities of 1.25 Mg m<sup>-3</sup> for the top layer (0-200 mm depth), 1.55 Mg m<sup>-3</sup> for the middle layer (200-400 mm depth) and 1.40 Mg m<sup>-3</sup> for the bottom layer (400-600 mm depth). Penetration resistance measurements were made

using the Instron machine with a sampling rate of 100 Hz. Penetration tests were performed at 5 mm/s speed up to 600 mm depth.

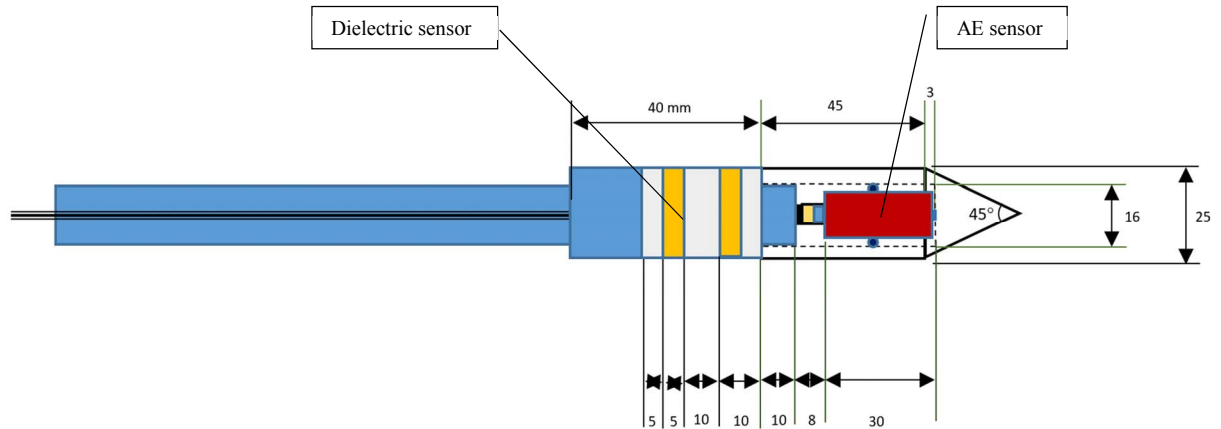

Figure 1: Schematics and dimensions of the multi-sensor probe.

### Results and discussion

It was found that the variations in soil volumetric water content are well explained by the dielectric sensor measurements. No significant effect of soil texture (i.e. clay content) was found on the dielectric sensor measurements. Some acoustic emission characteristics (e.g. amplitude, counts, energy, duration, etc.) were highly responsive to the variations in soil bulk density. Principal component analyses on the FFT-transformed frequency discriminated well the sandy soil from the loam and clay soils. The results by PCA analysis was supported with cluster analysis and k-nearest neighbor classification. With only the dielectric sensor, variations in soil water content were explained with  $R^2 = 0.87$ ,  $RMSE = 0.027 \text{ m}^3 \text{ m}^{-3}$ , whilst the fusion of mechanical and acoustic sensors improved the model to  $R^2 = 0.96$  with  $RMSE = 0.015 \text{ m}^3 \text{ m}^{-3}$ .

### Conclusion

The acoustic frequency distribution distinguished well the sandy soil from loam and clay soils but an overlap occurred between the clay and loam soil classes. This supported the hypothesis that passive high-frequency acoustic emission is informative on soil particle size distribution. The acoustic frequency distribution spectra and penetrometer resistance were found to be influenced by soil water content. Hence, with the fusion of load cell, dielectric and acoustic sensors data, soil volumetric water content could be predicted with an error noticeably smaller than that with only the dielectric sensor.

### References

- Adamchuk, V.I., Hummel, J.W., Morgan, M.T., Upadhyaya, S.K., 2004. On-the-go soil sensors for precision agriculture. *Comput. Electron. Agric.* 44, 71-91.
- Servadio, P., Bergonzoli, S., Verotti, M., 2017. Delineation of management zones based on soil mechanical-chemical properties to apply variable rates of inputs throughout a field (VRA). *Eng. Agric. Environ. Food* 10(1), 20-30.
- Zeng, Q., Sun, Y., Schulze lammers, P., Ma, D., Lin, J., Hueging, H., 2008. Improvement of a dual-sensor horizontal penetrometer by incorporating an EC sensor. *Comput. Electron. Agric.* 64, 333-337.



## Integrated Assessment of the Bio-preparations and Organic Fertiliser Effect on Soil Properties

Z. Kriauciuniene<sup>1\*</sup>, A. Adamaviciene<sup>1</sup>, J. Sasnauskiene<sup>1</sup>, R. Cepulienė<sup>1</sup>, R. Velicka<sup>1</sup>, V. Naujokiene<sup>1</sup>, E. Sarauskis<sup>1</sup>, A. Marcinkeviciene<sup>1</sup>, K. Romaneckas<sup>1</sup>, L. Masilionyte<sup>2</sup>

<sup>1</sup> Aleksandras Stulginskis University, Studentu str. 11, Akademija LT-53361, Kaunas dist., Lithuania

<sup>2</sup> Joniskelis Experimental Station of Lithuanian Research Centre for Agriculture and Forestry, Joniskelis, LT-39301 Pasvalys distr., Lithuania

\* corresponding author: [zita.kriauciuniene@asu.lt](mailto:zita.kriauciuniene@asu.lt)

### Introduction

The permanent and intensive use of soil for agricultural production changes natural soil processes and soil properties. In order to maintain soil fertility, it is necessary to implement timely human-managed soil improvement technologies. Soil improvement can be done using biological products and organic fertilisers. In crop production, biological preparations are used for different purposes, aiming at increasing the productivity of agricultural crops and improving soil properties. After spraying of biological preparations in the field, organic colloids in the soil forms. It changes soil temperature, which is affecting plant germination and yield (Jakiene et al., 2013). Another important factor is soil respiration, which depends on different soil properties, crop residues, depth of incorporation, decomposition, soil tillage, climatic conditions and other factors such as soil organic carbon, fertilisation systems and crop rotation (Carbonell -Bojollo et al., 2011; Buragiene et al., 2015). Air and soil temperatures influence the intensity of soil microorganism activity and, at the same time, determine the intensity of global warming causing CO<sub>2</sub> emissions in the atmosphere (Buragiene et al., 2015). However, there is a lack of knowledge about the effect of biological preparations and their mixtures with organic fertilizers on the soil temperature, electrical conductivity, CO<sub>2</sub> emissions, humidity, hardness, bulk density and porosity. Integrated assessment is a useful tool for the complex evaluation of different measures effect on multiple soil properties.

### Material and method

Experiments were performed in 2015–2016 at the Experimental Station of Aleksandras Stulginskis University (54°53' N, 23°50' E) in Lithuania. This study aimed to investigate the influence of biological preparations and organic fertiliser (slurry) on soil properties and CO<sub>2</sub> emissions from soil. The soil at the experimental site Calc(ar)i-Endohypogleyic Luvisol. Treatments of the experiment: 1) soil without measures application (Control); 2) soil with biological preparation application (Bio1); 3) soil with slurry application (S); 4) soil with slurry and biological preparation application (SBio2). Timing of soil properties measurements: 1) after measures application (beginning of experiment); 2) after 2 months (in autumn); 3) after 7 months (in spring); 4) after 14 months (in autumn). Experiment was carried out in three replications. Biological preparation Bio1 was used for the soil activation and composting, Bio2 – for aerobic conversion of slurry. In the composition of Bio1 included: dolomite, molasses and magnesium sulphate, in Bio2 – calcium carbonate and molasses. The soil temperature and electrical conductivity was measured using Delta-T HH2 Moisture Meter, CO<sub>2</sub> emission rate with ADC BioScientific LCpro+ System, soil hardness assessed using Eijkelkamp Penetrologer, moisture – by oven drying, soil bulk density – by field inspection vane tester, and porosity using Air Pycnometer. Integrated assessment of different soil properties performed based on G. Weinschenk et al. (1992), G. Lohmann (1994) and K. U. Heyland (1998) methodology, according to the formula:

$$EC_i = (X_i - X_{min}) \times (X_{max} - X_{min})^{-1} \times 8 + 1, \quad (1)$$

here  $EC_i$  – is the evaluation score of a certain value for a given indicator;  $X_i$  – certain value of a given indicator,  $X_{max}$  – max value of a given indicator;  $X_{min}$  – min value of a given indicator.

### Results and discussion

Usually the impact of different treatments on soil properties is considered separately, without being integrated into assessment system. Therefore, it is difficult to assess which factor has the highest effect on the soil. This problem can be solved using the integrated assessment method. In order to transfer the values which are expressed in different units to one scale, EC of a certain values for various indicators were calculated. 1 point corresponded to the minimal value, 9 – for the highest value. All other values for the same indicator calculated according to the formula (1). Indicators recalculated into EC depicted in diagram (Fig. 1). The scale also shows the average value of individual indicators – an assessment threshold of 5 points. The efficiency of the treatment reflects the limited area of all its values expressed in EC.

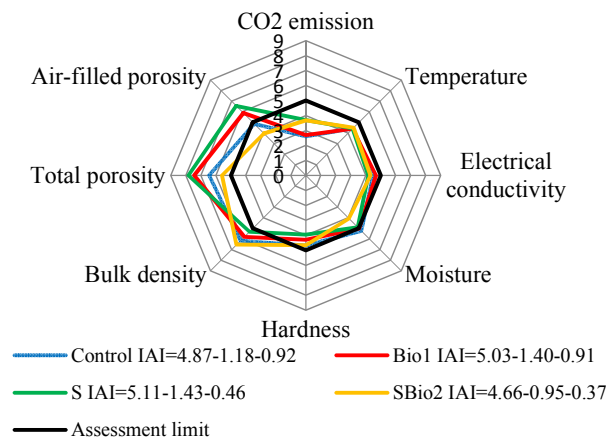

Figure 1: Integrated assessment of soil properties. Integrated Assessment Index (IAI) consists of the average score, the standard deviation of the scores and the standard deviation of the scores that are below the assessment threshold.

Integrated assessment showed, that soil CO<sub>2</sub> emission, soil temperature, electrical conductivity, moisture and hardness were less influenced by biological preparations and slurry used, but soil bulk density, and especially total and air-filled porosity were influenced more. The soil bulk density in the soil treated with slurry and Bio1 were lower than in control and total and air-filled porosity were higher.

### Conclusion

Integrated assessment is a useful tool for the complex evaluation of different treatments effect on multiple soil properties. Integrated assessment showed, that soil CO<sub>2</sub> emission, temperature, electrical conductivity, moisture and hardness were less influenced by biological preparations and slurry, but soil bulk density, and total and air-filled porosity were influenced more.

### References

- Buragiene S., Sarauskis E., Romanekas K., Sasnauskiene J., Masilionyte L., Kriauciuniene Z. (2015). Experimental analysis of CO<sub>2</sub> emissions from agricultural soils subjected to five different tillage systems in Lithuania. *Science of the Total Environment* 514: 1-9
- Carbonell-Bojollo R., Ganzalez-Sanchez E.J., Veroz-Conzalez O., Ordonez-Fernandez R. (2011). Soil management systems and short term CO<sub>2</sub> emissions in a Clayey soil in southern Spain. *Science of the Total Environment* 409(15): 2929-2935
- Jakiene E., Liakas V. (2013). Effect of the biological preparations Azofit and Amalgerol on sugar beet seeding, In: *Proceedings of 6th International Scientific Conference "Rural development"*, November, Akademija, Lithuania, 28-29



## Tillage and irrigation management: effects on corn production and soil greenhouse gas emissions under Mediterranean conditions

Samuel Franco-Luesma<sup>1\*</sup>, Elena Paracuellos<sup>1</sup>, Daniel Plaza-Bonilla<sup>1</sup>, José Luis Arrúe<sup>1</sup>, Carlos Cantero-Martínez<sup>2</sup>, José Cavero<sup>1</sup>, Jorge Álvaro-Fuentes<sup>1</sup>

<sup>1</sup>Soil and Water Department, Estación Experimental de Aula Dei (EEAD), Spanish National Research Council (CSIC), Avda. de Montañana 1005, 50059 Zaragoza, Spain.

<sup>2</sup>Crop and Forest Sciences Department, EEAD-CSIC Associated Unit, Agrotecnio, University of Lleida, Avda. Rovira Roure 191, 25198 Lleida, Spain

\*corresponding author: [sfranco@eead.csic.es](mailto:sfranco@eead.csic.es)

### Introduction

Under Mediterranean conditions, high corn productivities are dependent on irrigation supply, large amounts of N fertilizer and intensive tillage practices. Soil tillage and irrigation management may have a significant impact on grain yield and soil greenhouse gas (GHG) emissions in Mediterranean agroecosystems. The objective of this work was to assess the impact of tillage and irrigation management on corn (*Zea mays L.*) production and the emissions of carbon dioxide (CO<sub>2</sub>), methane (CH<sub>4</sub>) and nitrous oxide (N<sub>2</sub>O) from soil in a corn monoculture.

### Material and methods

The field experiment was carried out during three years at the EEAD-CSIC experimental farm (41° 43' N, 0° 48' W, 225 masl) located in Zaragoza (NE Spain). In 2015, a small scale (1 ha) field experiment was established to compare two irrigation systems (i.e. sprinkler, S, and flood, F) and three tillage systems (i.e. conventional tillage, CT; no-tillage maintaining the crop stover, NTr; and no-tillage removing the crop stover, NT). The experimental design was a split-block with three replicates per plot, with a plot size of 6 x 18 m. The soil at the experimental site is a silty loam soil (21% sand, 63% silt, 16% clay), with a basic pH of 8.0 in the upper 0–50 cm soil layer. Irrigation frequency varied according to the irrigation system, with two times per week for sprinkler irrigation and every 10 days for flood irrigation. This irrigation frequency was maintained from June to September. Irrigation water was applied according to crop water requirements. During the 3 years of experiment, the total amounts of water applied in sprinkler and flood irrigation systems were 7290 m<sup>3</sup> ha<sup>-1</sup> and 8430 m<sup>3</sup> ha<sup>-1</sup>, 7070 m<sup>3</sup> ha<sup>-1</sup> and 8840 m<sup>3</sup> ha<sup>-1</sup>, and 6859 m<sup>3</sup> ha<sup>-1</sup> and 7046 m<sup>3</sup> ha<sup>-1</sup> in 2015, 2016 and 2017, respectively. Corn sowing and harvesting were carried out on April and October, respectively. The same amount of fertilizer was applied in all treatments. At planting, 800 kg ha<sup>-1</sup> of a NPK (8-15-15) compound fertilizer was applied. On mid-June, 740 kg ha<sup>-1</sup> of calcium ammonium nitrate (27% N) was applied as top dressing (V10). Soil greenhouse gas emissions -carbon dioxide (CO<sub>2</sub>), nitrous oxide (N<sub>2</sub>O) and methane (CH<sub>4</sub>)- were measured weekly during the three growing seasons using static chambers, and daily during the five days following N application and following each flood irrigation. Gas samples were analyzed using a gas chromatograph equipped with a flame ionization detector (FID) coupled with a methanizer for CO<sub>2</sub> and CH<sub>4</sub> analysis, and an electron capture detector (ECD) for N<sub>2</sub>O analysis. Soil temperature, soil water filled pore space (WFPS) and inorganic N content were also determined on each gas sampling date (0-5 cm soil depth). The GWP (global warming potential) was calculated using the coefficients provided in the fifth assessment report of the IPCC. Yield components were also determined after harvest.

## Results and discussion

In the 2016 and 2017 growing seasons, the greatest emissions of soil CO<sub>2</sub> were observed in CT-S. Likewise, cumulative soil CO<sub>2</sub>-C emissions were around 30% higher for CT compared with NTr and NT during the three growing seasons. Soil N<sub>2</sub>O emissions were strongly affected by the irrigation system. During the three growing seasons, F irrigation showed the highest cumulative soil N<sub>2</sub>O emissions compared with S, being 33%, 51%, and 39% greater in 2015, 2016 and 2017, respectively. Differences in cumulative N<sub>2</sub>O emissions between S and F irrigation could be related with the observed differences in WFPS between irrigation systems and, thereby, with the impact of oxygen availability on nitrification and denitrification processes. The highest CO<sub>2</sub> emissions coincided with the lowest WFPS values, while, in contrast, N<sub>2</sub>O showed the highest emissions for the highest WFPS values. These differences between soil gases and WFPS relationship may be related to the impact of oxygen availability on mineralization and denitrification processes.

The grain yield was affected by the irrigation system and the tillage system through their direct effect or their interaction all years. Significant differences between treatments were observed in 2015 and 2016, with the highest yield in NTr-S and NT-S in 2015 and CT-S in 2016. The NTr-F, however, was the treatment with the lowest yield values for these same two years. In 2017, there were not significant differences between treatments, but there were significant differences between irrigation system and tillage, being higher in S compared with F and in CT compared with NT.

The GWP index only showed significant differences between treatments in 2017, with the highest value in CT-S and the lowest value in NT-F. In 2015 and 2016, CT presented higher GWP values than NTr and NT. Finally, the yield-scaled GWP only showed significant differences between treatments in 2016 and 2017. In 2016, NTr-F had the highest value compared with NT-F that presented the lowest yield-scaled value. In 2017, however, CT-S was the treatment with the greatest values, with NTr-S and NT-S showing the lowest values.

## Conclusion

This work highlights the importance of an appropriate selection of tillage and irrigation management to maximize corn yield and to minimize soil GHG emissions. Our results showed that irrigation system affected differently to the CO<sub>2</sub> and N<sub>2</sub>O emissions. While tillage did not affect N<sub>2</sub>O emissions, conventional tillage resulted in higher CO<sub>2</sub> emissions compared with no-tillage maintaining the crop stover and no-tillage removing the crop stover. The lower soil bulk density values under conventional tillage could favour greater soil aeration stimulating soil respiration. Besides, irrigation system and tillage also affected the corn grain yield and the yield-scaled GWP. For all of these reasons, in order to get higher grain yield with the lower GHG emissions flood irrigation and conventional tillage should be avoided as agricultural practices under Mediterranean conditions.

## Challenges of $^{15}\text{N}$ field studies to measure N fertilizer recovery under irrigated conservation agriculture

Kathrin Grahmann<sup>1,2\*</sup>, Nele Verhulst<sup>3</sup>, Bram Govaerts<sup>3</sup>, Klaus Dittert<sup>4</sup>, Andreas Buerkert<sup>1</sup>

<sup>1</sup> Organic Plant Production and Agroecosystems Research in the Tropics and Subtropics, Universität Kassel, Witzenhausen, Germany

<sup>2</sup> Instituto Nacional de Investigacion Agropecuaria-Uruguay, La Estanzuela, Uruguay

<sup>3</sup> International Maize and Wheat Improvement Center (CIMMYT), Apdo. Postal 6-641, 06600 Mexico, D.F., Mexico

<sup>4</sup> Plant Nutrition and Crop Physiology, Department of Crop Sciences, Georg-August-Universität Göttingen, Germany

\* Corresponding author: Kathrin.Grahmann@gmail.com

### Introduction

In most agroecosystems, nitrogen (N) is the most important nutrient limiting plant growth. The application of  $^{15}\text{N}$  labeled fertilizer provides a tool to quantify uptake and conversion efficiency of fertilizer N in the soil-plant system, which is of particular interest in conservation agriculture (CA). This management system is based on minimum tillage, crop residue retention and crop diversification. Presently, CA is promoted in the Yaqui Valley in Northern Mexico, Mexico's major wheat-producing area, which represents one of the world's largest wheat growing systems under irrigation.

### Materials and methods

A labeled fertilizer experiment with urea  $^{15}\text{N}$  was implemented in micro-plots to measure N fertilizer recovery and N surface runoff by irrigation water in three different tillage-straw systems (CTB: conventionally tilled beds, PB-straw retained: permanent raised beds with residue retention, PB-straw burned: permanent raised beds with residue burning). The cropping system is an annual rotation of maize in summer and wheat in winter with gravity furrow irrigation. One pre-planting irrigation of approximately 120 mm was followed by four auxiliary irrigations of 80–100 mm for both crops. As no physical borders were used on the micro-plots, horizontal N fertilizer movement by surface water runoff was checked by taking soil subsamples at 0.5, 1, 2, 4, 8, 16, 32 and 100 m behind the end of each micro-plot at 2 depths (0–15, 15–30 cm) in April 2015 after the last wheat irrigation and a total of two crops and 10 irrigations.

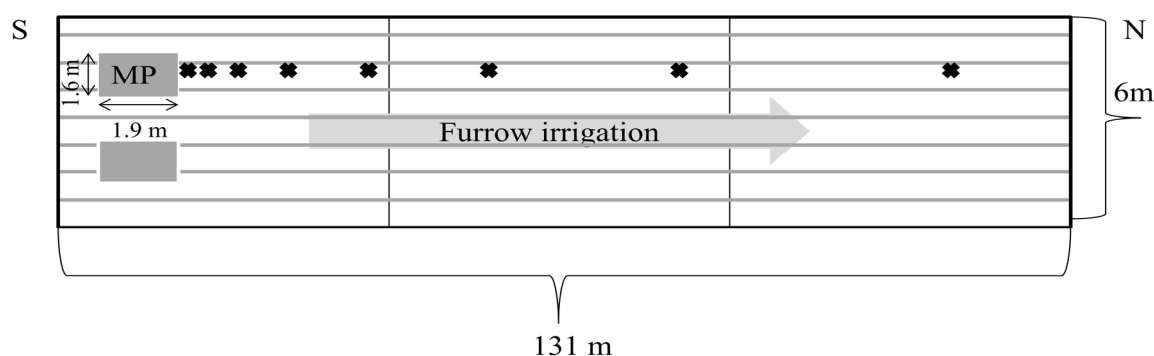

**Fig. 1** Experimental plot design and soil sampling map

## Results and discussion

We found considerable amounts of  $^{15}\text{N}$  in the first 2 to 4 m behind the micro-plot in the first 15 cm soil depth. At 0-15 cm depth, labelled soil N was found up to 8 m after the micro-plot, indicating transport of  $^{15}\text{N}$  fertilizer in the irrigation water (Fig. 2). At 15-30 cm depth, considerable amounts of  $^{15}\text{N}$  were only found up to 1 m after the micro-plot and averaged over treatments 1.9 and 1.4 kg N ha $^{-1}$  after 0.5 and after 1 m, respectively. In the upper soil layer, Ndff averaged 3.1 kg N ha $^{-1}$  2 m behind the micro-plot. Ndff was significantly affected by sampling depth and distance to the micro-plot and decreased significantly with increasing distance to the micro-plot. The approximate, interpolated loss of  $^{15}\text{N}$  fertilizer by lateral movement in the first 30 cm soil depth through irrigation water was 14% in CTB, 17% in PB-straw and 11% in PB-burn.

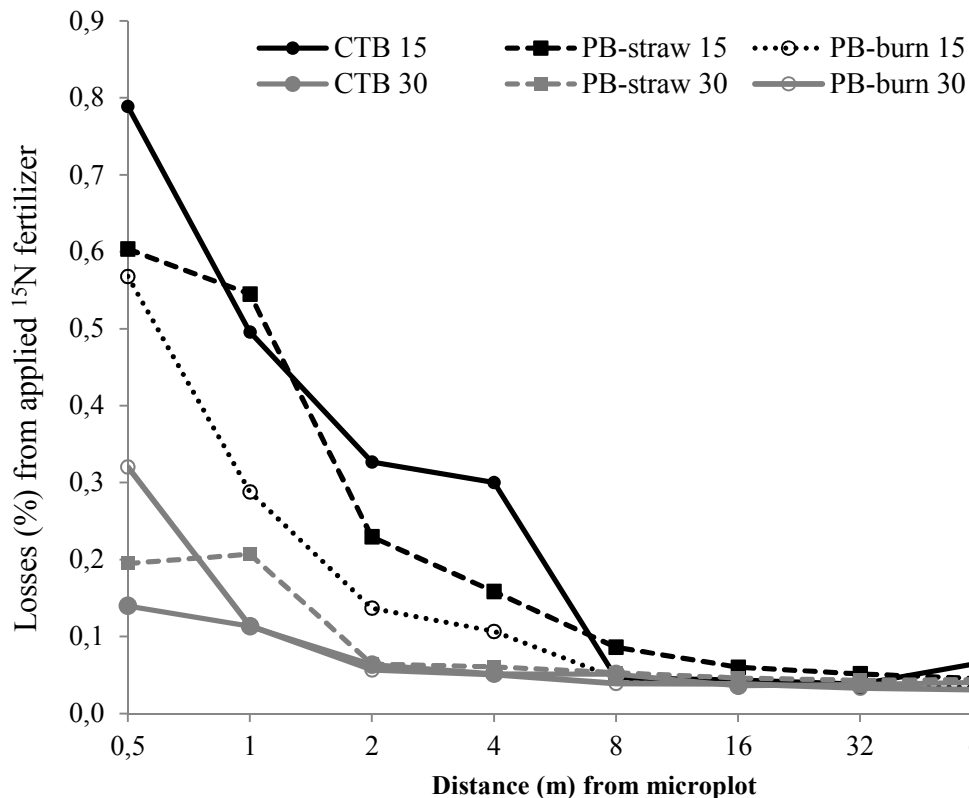

**Fig. 2** Losses of nitrogen derived from fertilizer (in % from applied labelled fertilizer) by horizontal movement of  $^{15}\text{N}$  fertilizer in 0-15 and 15-30 cm soil depth taken in eight distances (in m) behind the micro-plots (CTB: conventionally tilled beds, PB-burn: PB-straw burned, PB-straw: PB-straw retained) in NW Mexico.

## Conclusions

Application of  $^{15}\text{N}$  fertilizer revealed possible N losses by surface water runoff and lateral N movement. The installation of physical borders around micro-plots under irrigation was not required in the present study, which allowed normal field traffic as practiced on farmer's fields. However, N fertilizer losses by surface water runoff have to be taken into account when calculating fertilizer efficiency on the field level.

## **Tillage can continuously reduce the radiocesium contamination and soil-to-crop transfer coefficient for 7 years after FDNPP accident.**

Peiran Li<sup>1</sup>, Yingting Gong<sup>1</sup>, Masakazu Komatsuzaki<sup>2\*</sup>

<sup>1</sup>*Graduate School of Agriculture, Ibaraki University, Ami, Japan*

<sup>2</sup>*Center for International Field Agriculture Research and Education, Ami, Japan*

\*corresponding author: [masakazu.komatsuzaki.fsc@vc.ibaraki.ac.jp](mailto:masakazu.komatsuzaki.fsc@vc.ibaraki.ac.jp)

### **Introduction**

The nuclear accident at Fukushima Dai-ichi Nuclear Power Plant (FDNPP) occurred as a consequence of the massive earthquake and associated tsunami on March 11, 2011, which was the first nuclear power plant accident in Asia. A large amount of radiocesium (<sup>134</sup>Cs and <sup>137</sup>Cs) were released and spread across a wide area in Japan. This nuclear accident has different radionuclide movement in agroecosystem compare with Chernobyl Accident in 1986. We focuses the long term radiocesium movement in agroecosystem in Japan especially the relationship between tillage inversion and radiocesium contamination. This information will be important to many country and area where the nuclear power plants are located. Therefore, in this study, we monitored the radiocesium contamination in soil, cover crops and soybean under different agriculture managements from 2011 to 2017. The objectives of this study were to clarify the change of transfer coefficient from soil to plant and the radioecology in various agriculture systems for a long time after FDNPP accident.

### **Material and method**

A 7-years field experiment was conducted from 2011 to 2017 at Center for International Field Agriculture Research and Education (36°1'57.7"N, 140°12'43.6"E) in Ibaraki University, this site located 170km from FDNPP in the Kanto region of Japan. Split plot experimental design with 4 replications was used in this study. Tillage systems (Moldboard Plow: MP, Rotary Cultivation: RC, No Tillage: NT) were the main factors and cover crop species (rye: RY, hairy vetch: HV, fallow: FA) were side factors. Soil samples were collected by steel cylinder and then divided into four samples at 0–2.5, 2.5–7.5, 7.5–15, and 15–30 cm depths. Exchangeable Cs (ExCs) in soil was extracted from air-dried soil with ammonium acetate. The concentration of <sup>134</sup>Cs and <sup>137</sup>Cs in soil, cover crops, soybean grain and residue were determined by Ge-semiconductor detector. Transfer factors (TF) relating soil concentrations to plant concentrations of contaminants were calculated as follows:

$$TF = \frac{(^{134,137}\text{Cs}(\text{Bq kg}^{-1} \text{ dry weight}))_{\text{plant}}}{(^{134,137}\text{Cs}(\text{Bq kg}^{-1} \text{ dry weight}))_{\text{soil}}}$$

### **Results and discussion**

Most of radiocesium distributed on the surface soil after FDNPP accident in 2011, however, the radiocesium distribution became more uniform in different soil layers after tillage from

2012 comparing with NT. Because tillage can displace the high contaminated soil into deeper layers. Radiocesium content in soil decreased generally since 2011, due to the natural decay of radiocesium and the migration with rainfall. Similar with total Cs, ExCs content in the 0-2.5cm layer in NT was higher than those in MP and RC. Radiocesium content in soybean grain and residue decreased sharply from 2011 to 2013, nevertheless, it became more stable since 2014 to 2017 (Figure.1). Radiocesium content in soybean grain under NT was consistently higher than it under RC and MP. Not merely because tillage can transfer the contaminated soil into deeper depth, it can also enhance the formation of Cs-specific edge sites with clay minerals for chelation. Cs content in rye were consistently lower than hairy vetch and fallow weeds in each year, and radiocesium content in cover crop had a significant negative correlated with biomass accumulation. The transfer coefficient from soil to soybean grain peaked in 2011, then it decreased sharply and became stable from 2012 to 2017. The soybean grain in NT also had higher transfer coefficient than it in MP and RC (Figure.1).

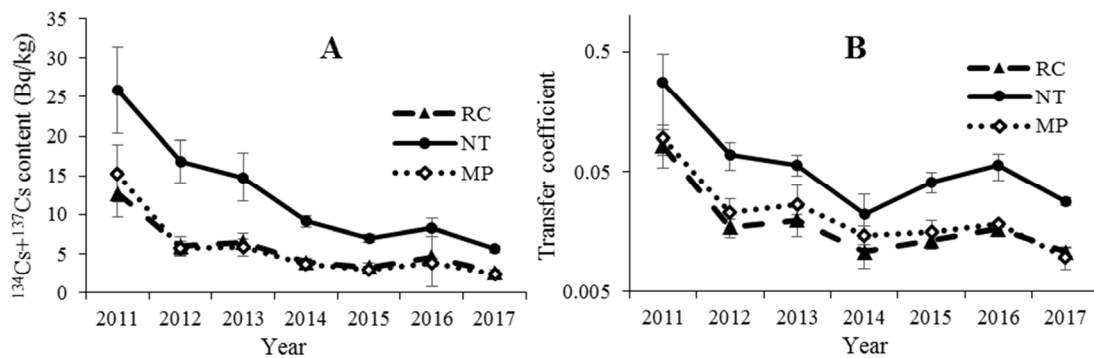

Figure 1: Radiocesium content in soybean grain (A) and the transfer coefficient from soil to soybean grain (B) were measured from 2011 to 2017. Error bars correspond to standard error.

## Conclusion

After the FDNPP accident, the radiocesium contamination in soil, soybean and cover crops continuously decreased from 2011 to 2013, but this trend gradually slowed down from 2014 to 2017. Transfer coefficient also declined sharply in 2011 and became stable from 2012 to 2017. The vertical distribution of radiocesium were different between tillage treatments, similar phenomenon was also observed on vertical distribution of ExCs. The vertical distribution of radiocesium can strongly affect soybean radiocesium uptake and accumulation. These results will contribute to understand the long term impact of the radionuclide accident on agroecosystems in Asia.

## References

Hoshino Y., Komatsuzaki M., 2018. Vertical distribution of radiocesium affects soil-to-crop transfer coefficient in various tillage systems after the Fukushima Daiichi Nuclear Power Plant accident. *Soil Till. Res.*, 178, 179-188.

## **Analysis of the nitrate leaching risk for different fertilizers on permanent grassland in the Persephone project**

Daigneux, B.<sup>1</sup>, Romain A-C.<sup>2</sup>, Gennen, J.<sup>1</sup>, Debbaut, V.<sup>2</sup>, Tsachidou, B.<sup>3</sup>

<sup>1</sup> *Agra-Ost, Belgium;*

<sup>2</sup> *ULiège – Sensing of Atmosphere and Monitoring, Belgium*

<sup>3</sup> *Luxembourg Institute of Science and Technology, Luxembourg*

### **Introduction**

In the context of the Project «Perséphone: Intégration de la filière biogaz dans la nouvelle Bio-économie», financed by the European Regional Development Fund 2014-2020 INTERREG VA «Greater Region», our non-profit association is in charge of five organic and chemical fertilization field trials (2017-2019). This paper is based on the first data collected through 2017 and will present the analysis of the nitrate leaching risk for that year under permanent cut grassland. Koszela et al. (2015) demonstrated the fertilisation capacity of biogas residues, while Odlare et al. (2007) observed that biogas residues enhanced the proportion of metabolically active microorganisms, nitrogen mineralization capacity and had no negative effects on either chemical or microbiological properties of the soil. On the other hand, in a study performed by Wang et al. (2016), the application of biogas residues resulted into increased nitrogen volatilization. Therefore, to study the environmental impact, it is important to estimate soil nitrate leaching risk, especially during autumn, the focus point of this presentation. This study will also help to assess the value of biogas residues as an organic fertilizer and to evaluate its environmental benefits, to compare the impact of each tested fertilizer on the yield, microbial activity and evolution of soil physicochemical properties, and to assess the environmental risk induced by an organic based fertilisation scheme on a permanent mown meadow.

### **Materials and methods**

In this ongoing field trial, four different fertilisers were tested in three areas (Emmels (Be), Grendel (Be) and Laneuvelotte (Fr)). The fertilizers applied were i) local biogas residues at 350 units of total N/ha, ii) biogas residues of Faascht farm (Grendel, Be) at 230 U of N/ha, iii) local manure at 230 U of N/ha and iv) ammonium nitrate at 230 U of N/ha, which are compared to the unfertilized control (Te) and among each other. Nitrate leaching risk is indicated by mineral N measurement in soils which takes place in February, before fertilizer application, and in October, after the last forage harvest. This is the recommended strategy in Belgium. A high nitrate content in soil will increase the potential nitrate leaching risk. As Vandenberghe cited (2013), during the year, nitrogen measurements are taking place by GxABT of Uliège and UCL to provide reference for the farmers. Soil cores of 90 cm are collected and divided in layers of 0-30, 30-60 and 60-90 cm which subsequently analysed for nitrate content using official Wallonia measurement (based on ISO/TS 14256-1:2003). For our statistical analysis we used R studio software (R version 3.4.3 (2017-11-30)).

### **Results and discussion**

An ANOVA test performed shows that the risk for nitrogen leaching differs in regard of the variants ( $P < 0.001$ ). The post-hoc Tukey's analysis demonstrates significant differences between variants. This first assessment of nitrogen leaching risk reveals no significant differences between biogas residue treatments and the control ( $p < 0.05$ ). A similar observation has been made for the manure variant ( $p < 0.05$ ). On the contrary, the ammonium nitrate

variant (230 u N/ha) shows a significant difference compared to the control ( $p < 0.001$ ). In addition, the average value of the soil nitrate concentration under the application of ammonium nitrogen is considerably higher compared to the rest of the variants. This is demonstrated in the figure 1 below.

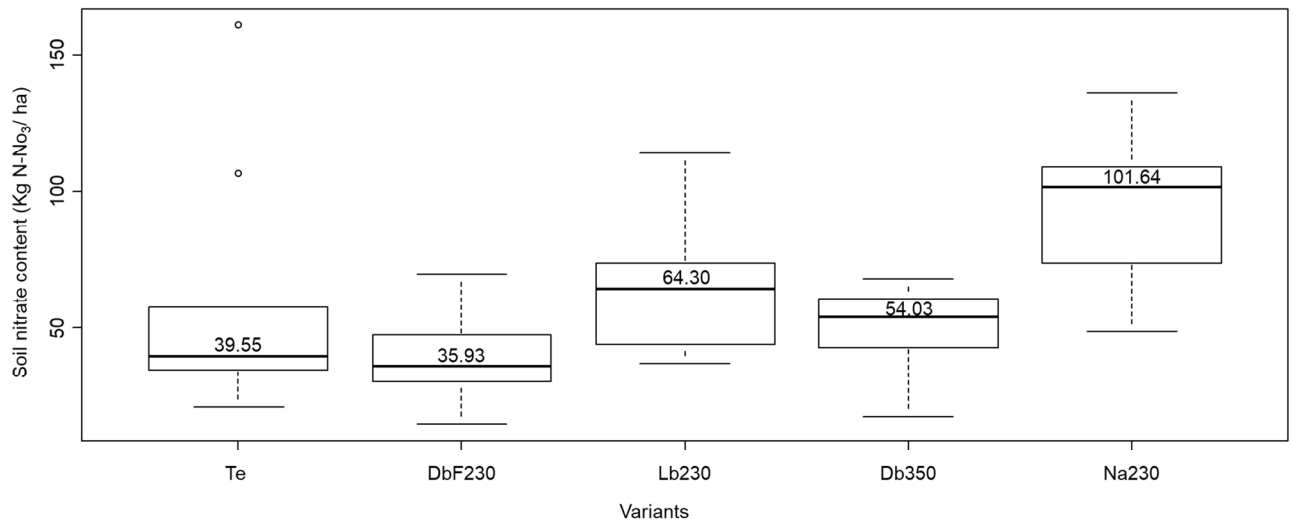

Figure 1: Box plot of soil nitrate content (Kg N-NO<sub>3</sub> / ha) after the application of four different fertilizers. Caption: Te = Control, DbF230 = Biogas residues of Fascht farm at 230 U N/ ha, Lb230 = local manure at 230 U N/ ha, Db350= local biogas residues at 350 U N/ ha, Na230 = ammonium nitrate at 230 U N/ ha

## Conclusion

Our data show that the use of biogas residues and manure do not increase the values of nitrogen leaching even at the maximum dose of 350 u N/ha. In addition, it is important to note that part of the nitrogen present in biogas residues and manure is found in the organic matter. The release of this organic nitrogen depends on ammonification and nitrification. These processes are retroactive in regard of the fertilisation and highly depend on weather conditions. Organic and mineral fertilisation will continue throughout the following years and the measurements obtained will indicate if the organic matter, present in biogas residues and manure, has the potential to increase or mitigate nitrogen leaching risk.

**Acknowledgements:** The presented research was carried out as a part of the research project Interreg VA Grandrégion « Perséphone : Intégration de la filière biogaz dans la nouvelle Bio-économie ». This project is funded with the help of FEDER, German-speaking community of Belgium and Wallonia. Authors also thank all the partners of the project, especially Philippe Delfosse and Bella Tsachidou for their suggestions on the sampling scheme and the constructive discussions.

## References

- Koszel, M., & Lorencowicz, E., 2015. Agricultural Use of Biogas Digestate as a Replacement Fertilizers. *Agriculture and Agricultural Science Procedia*, 7, 119–124.
- Odlare, M., Pell, M., Svensson, K., 2008. Changes in soil chemical and microbiological properties during 4 years of application of various organic residues. *Waste Management*, 28(7), 1246-1253.
- Wang, L. L., Li, W. Z., Wang, Z. J., Wang, Z. W., Sui, C., & Li, Y., 2016. Effects of digestate application depth on soil nitrogen volatilization and vertical distribution. *International Journal of Agricultural and Biological Engineering*, 9(5), 101–107.



## Availability efficiency of Phosphorus applied to volcanic soils using different phosphate sources

Dante Pinochet\*, J. Carrasco

Instituto de Ingeniería Agraria y Suelos. Facultad de Ciencias Agrarias. Universidad Austral de Chile. dpinoche@uach.cl. Edificio Federico Saelzer. Segundo Piso. Campus Isla Teja, Valdivia.

### Introduction

Nutrient use efficiency (NUE) is used as an agronomic tool to evaluate soil-crop-fertilizer relationship. Since Moll et al (1982) two component of this efficiency were differentiated: nutrient uptake efficiency (NAE, kg uptaked per kg of available nutrient in the soil, from fertilizer and native sources) and nutrient utilization efficiency (NUtE, kg MS produced per kg nutrient uptaked). However, we think that another component of the NUE is needed to clarify aspects of fertilizer management (types and presentation) on the availability component including those parameters related to soil availability indexes, diagnostic depth evaluated and soil tillage management. All this aspects should be expressed as nutrient availability efficiency (NAvE) and are independent of NAE and NUtE (Sandaña and Pinochet, 2014). The value of NAvE would be expressed as kg fertilizer per ha to increase 1 unity (usually ppm) of the available nutrient. The relative expression of the unity of available nutrient depends on the soil, the sampling depth, the characteristics of the fertilizer used, the fertilization management, and the soil. In this work we show the case of phosphorus fertilization using two fertilizers of different water solubility and the soil depth sampling was 20 cm of soil.

### Materials and Methods

**Incubations experiments.** To soil samples from different volcanic soils (two Andisols, Malihue and Valdivia soil series and one Ultisol, Cudico series) were mixed with two different fertilizers and incubated at 70% maximum water holding capacity and 25°C for 365 days. Two fertilizers of different solubility were compared: phosphate di potassium (DKP, 100% water soluble) and monocalcium phosphate (MCP, 75% water soluble). The Olsen and Resin P extraction were measured at 1, 7, 15, 30, 60, 120 days of incubation. At 365 days a complete fractionation of P was evaluated in the soil samples using the Tiessen and Moir methodology. **Evaluation of Availability efficiency at field conditions.** Five experiments were designed in randomized blocks using Andisols, Utisols and andic Inceptisols. The treatments were four P rates and a control with no application. Two fertilizers were evaluated: mono-ammonium phosphate (MAP) of 95% water solubility and mono-calcium phosphate (MCP) of 72 % of water solubility. The P applied was incorporated homogeneously in the 15 cm of soil. The crops used were wheat, turnips, potato and annual ryegrass and crop yield and crop uptake was measured. From each P rate applied, it was subtracted the P uptaked in the aboveground dry matter by the crop

(including harvested organ) and that amount was related to a P availability index (P-Olsen) measured in each plot after the crop was harvested. The sampling depth was 20 cm. The measurement of P soil index was two days after crop harvest.

## Results and Discussion

Figure 1A shows that P-Olsen index increase similarly for both fertilizers evaluated independently of the rate used and the time of evaluation. The relation between both values was linear and the slope revealed that are related with their P water solubility, and the most soluble source increased more Olsen-P to a same rate. Similar results were found using Resin-P method (data not shown).

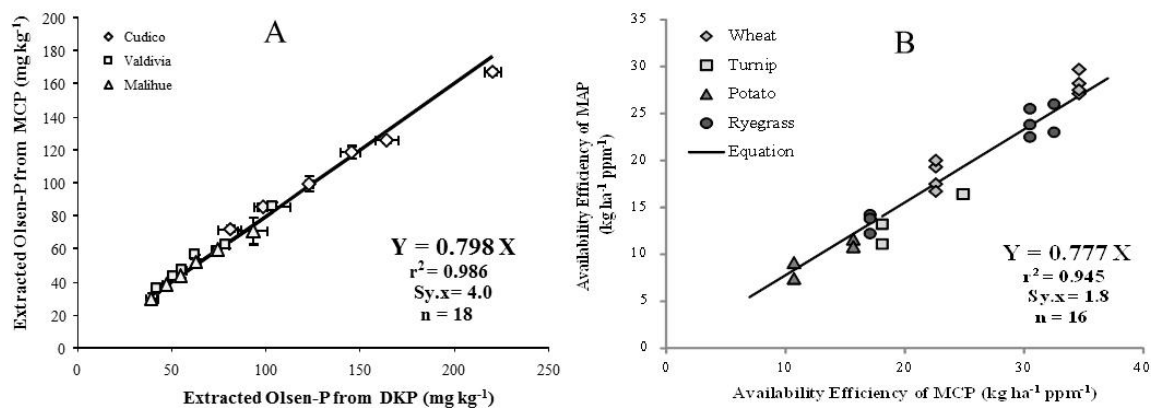

Figure 1. A. Relation between extracted P by Olsen method from P added as dipotassium phosphate and monocalcium phosphate in a soil-phosphate incubation study with different volcanic soils. B. Field evaluation of Availability efficiency using monocalcium phosphate (MCP) and mono ammonium phosphate (MAP) in different volcanic soils with different crop types.

Similar results were found at field conditions (Figure 1B), showing that the relation between soluble P water was expressed independently of soil and the crop evaluated, suggesting it as a useful parameter to evaluate fertilizers effect on the NUE.

## Conclusions

A parameter to describe phosphorus availability efficiency was established for volcanic soils, which shows the effect of fertilization management and separating it from other aspects of nutrient use efficiency.

## References

- Moll, R.H., Kamprath, E.J., Jackson, W.A. 1982. Analysis and interpretation of factors which contribute to efficiency to nitrogen utilization. *Agron. J.* 74, 562–564
- Sandaña, P., Pinochet, D. 2014. Grain yield and phosphorus use efficiency of wheat and pea in a high yielding environment. *J. Soil Sci. Plant Nutr.* 14, 973-986

## Adopting no-tillage alters the molecular-level composition of soil organic matter in the North China

Zhangliu Du<sup>1\*</sup>, Myrna J. Simpson<sup>2</sup>, Guichun Li<sup>1</sup>, Aiping Zhang<sup>1</sup>

<sup>1</sup>Key Laboratory for Agro-environment of Ministry of Agriculture, Institute of Environment and Sustainable Development in Agriculture, Chinese Academy of Agricultural Sciences, Beijing 100081, China

<sup>2</sup>Environmental NMR Centre, Department of Physical and Environmental Sciences, University of Toronto Scarborough, 1265 Military Trail, Toronto, ON M1C 1A4, Canada<sup>2</sup>

Corresponding author: [duzhangliu@caas.cn](mailto:duzhangliu@caas.cn)

### Introduction

Adopting no-tillage has been widely considered as a potential way to sequester soil organic matter (SOM), thus mitigating the global change (Lal, 2004). It is well known that the conversion of conventional tillage to no-tillage may result in an accumulation in SOM, particularly in the surface of soils (Du et al., 2017). Also some studies have indicated that long-term management of no-tillage may alter the bulk composition of SOM (Zhao et al., 2012). However, a detailed molecular-level analysis of the SOM is needed to better understand how cultivation may alter SOM biogeochemistry.

### Material and method

A field experiment was conducted at the Huantai Experimental Station (36° 57' N, 117° 58' E) for Ecological and Sustainability and locates in Shandong Province, north China. The local cropping system is a winter wheat–maize crop rotation. The tillage experiment established in 2007 was included two treatments (MP, moldboard plow with residue; NT, no-till with residue). Soil samples from 0–10 and 10–20 cm layer were collected in 2015. Biomarker methods included solvent extraction and CuO oxidation for the analysis of free lipids of plant and microbial origin and lignin-derived phenols, respectively.

### Results and discussion

The solvent-extractable biomarkers of contrasting tillage soils contained a series of free acyclic and cyclic lipids (acyclic: n-alkanes, n-alkanols, and n-alkanoic acids; cyclics: steroids) and sugars (glucose, mannose, and sucrose; **Table 1**). In the studied soils, the n-alkanes ranged from C<sub>18</sub> to C<sub>33</sub> with a C<sub>max</sub> at C<sub>31</sub> for both treatments; the n-alkanols ranged from C<sub>16</sub> to C<sub>30</sub> with a C<sub>max</sub> at C<sub>26</sub>. The n-alkanoic acids ranged from C<sub>12</sub> to C<sub>28</sub> and also included some short-chain mono-unsaturated compounds. The carbohydrates including glucose, sucrose and trehalose are identified in our study. Besides, the steroids are consisted of campesterol, stigmasterol and sitosterol. Compared with MP treatment, the concentrations of total n-alkanes, n-alkanoic acids and acyclic lipids (including n-alkanes, n-alkanols, and n-alkanoic acids) under NT were higher by 72.6%, 33.3% and 51.8%, respectively. As for the steroids compounds, the change from MP to NT increased by 114.0%. Ratios of solvent-extractable biomarker concentrations were calculated to further assess changes in SOM composition and degradation status (Otto and Simpson, 2005). The ratio of acyclic/cyclic compounds under NT was reduced by 66.6% relative to MP treatment, suggesting more cyclic lipids were accumulated in the NT soils. The lower

acyclic/cyclic aliphatic lipid ratio is considered to be with progressive SOM degradation (Otto and Simpson, 2005).

**Table 1** The quantities of compounds identified in the solvent extracts of the different tillage soils

Soil layer: 0-10 cm	MP	NT	T-test
<i>Solvent-extractable compounds</i>			
	$\mu\text{g/g soil}$		
$\Sigma$ n-alkanes	14.3 $\pm$ 1.4	24.7 $\pm$ 1.7	**
$\Sigma$ n-alkanols	6.7 $\pm$ 1.2	9.2 $\pm$ 0.8	ns
$\Sigma$ n-alkanoic acids	611.8 $\pm$ 30.4	809.3 $\pm$ 64.1	*
$\Sigma$ acyclic lipids	632.8 $\pm$ 31.1	843.2 $\pm$ 64.9	*
$\Sigma$ carbohydrates	18.7 $\pm$ 4.9	28.4 $\pm$ 4.7	ns
$\Sigma$ steroids	47.4 $\pm$ 5.6	101.5 $\pm$ 9.6	**
$\Sigma$ cyclic lipids	47.4 $\pm$ 5.6	101.5 $\pm$ 9.6	**
Acyclic/Cyclic	14.0 $\pm$ 1.8	8.4 $\pm$ 0.6	*

Alkaline CuO oxidation showed significantly increased concentrations of lignin-derived phenol monomers but not a shift in the relative proportion of these components in the NT soils (Table 2). This treatment yielded several types of lignin-derived compounds, including phenol monomers (vanillyl, syringyl and cinnamyl classes) and dimers (5,50',  $\alpha$ ,1-monoketone,  $\alpha$ , 2-methyl). Several benzyl compounds were also identified which may be derived from lignin and other sources such as protein. Compared with MP, the concentrations of Vanillyls, Syringyls, Cinnamyls and total phenol monomers (denoted as  $\Sigma$ VSC) under NT soils was higher by 59.0%, 69.8%, 60.3% and 63.7%, respectively. Ratios of lignin-derived phenol compounds were calculated to assess the lignin degradation status and the relative proportion of monomeric and dimeric lignin components in the soils (Gonçães and Hedges 1992; Otto and Simpson 2006). In this study, the ratios of S/V, C/V, (Ad/Al)<sub>s</sub>, and (Ad/Al)<sub>v</sub> did not change significantly with any treatments.

**Table 2** The quantities of compounds identified in the CuO oxidation extracts of different tillage soils.

Soil layer: 0-10 cm	MP	NT	T-test
	Mean	Mean	
$\mu\text{g/g soil}$			
<i>Lignin-derived phenols</i>			
Vanillyls (V)	49.93 $\pm$ 1.45	79.39 $\pm$ 5.78	**
Syringyls (S)	72.04 $\pm$ 2.59	122.35 $\pm$ 9.95	**
Cinnamyls (C)	33.89 $\pm$ 3.33	54.32 $\pm$ 7.49	*
$\Sigma$ VSC	154.45 $\pm$ 4.46	252.81 $\pm$ 23.23	*
S/V	1.45 $\pm$ 0.10	1.54 $\pm$ 0.06	ns
C/V	0.70 $\pm$ 0.08	0.67 $\pm$ 0.06	ns
(Ad/Al) <sub>s</sub>	0.67 $\pm$ 0.10	0.66 $\pm$ 0.01	ns
(Ad/Al) <sub>v</sub>	0.58 $\pm$ 0.05	0.52 $\pm$ 0.03	ns

### Conclusion

Using the molecular-level methods could reveal differences in molecularly distinct SOM components under the contrasting tillage soils. The shift from conventional tillage to the no-till system increased the concentrations of total n-alkanes, n-alkanoic

acids and acyclic lipids and decreased the acyclic/cyclic aliphatic lipid ratio, with indication of progressive SOM degradation. Besides, the lignin-derived compounds (Vanillyls, Syringyls, Cinnamyls and total phenol monomers) significantly increased when adopting no-till practice. Our study could provide some molecular information of SOM compositions to well understand the its stabilization mechanism in the no-tilled soil.

#### **Acknowledgements**

This research was funded by the National Natural Science Foundation of China (No.41671305).

#### **References**

- Du, Z., Angers, D. A., Ren, T., Zhang, Q. and Li, G. 2017. The effect of no-till on organic C storage in Chinese soils should not be overemphasized: A meta-analysis. *Agriculture, Ecosystems and Environment* 236:1-11.
- Goñi, M.A., Hedges, J.I., 1992. Lignin dimers: Structures, distribution, and potential geochemical applications. *Geochimica et Cosmochimica Acta* 56, 4025-4043.
- Lal, R. 2004. Soil carbon sequestration impacts on global climate change and food security. *Science* 304(5677):1623-1627.
- Otto, A., Shunthirasingham, C., Simpson, M.J., 2005. A comparison of plant and microbial biomarkers in grassland soils from the Prairie Ecozone of Canada. *Organic Geochemistry* 36, 425-448.
- Otto, A., Simpson, M.J., 2006. Evaluation of CuO oxidation parameters for determining the source and stage of lignin degradation in soil. *Biogeochemistry* 80, 121-142.
- Zhao, H., Lv, Y., Wang, X., Zhang, H. and Yang, X. 2012. Tillage impacts on the fractions and compositions of soil organic carbon. *Geoderma* 189–190:397-403.

## **Effect of chemical and no chemical amendments on soil salinity reduction in the region of Sed El mesjoune- Marrakech**

S. El hasini<sup>1\*</sup>, O.Ibenhalima<sup>2</sup>, H. Dakkak<sup>2</sup>, A. Douaik<sup>2</sup>, M. El azzouzi<sup>1</sup>, A. Zouahri<sup>2</sup>

<sup>1</sup> *Laboratory of Materials, Nanotechnologies and Environment, Faculty of Sciences, University Mohammed V, Av Ibn Battouta, BP1014, Rabat, Morocco.*

<sup>2</sup> *Research Unit on Environment and Conservation of Natural Resources, National Institute of Agricultural Research (INRA) PO Box 6356 Rabat-Institut10101, Rabat Morocco.*

\*Corresponding author: [elhasinisoukaina3@gmail.com](mailto:elhasinisoukaina3@gmail.com)

### **Introduction:**

Soil salinization is a major problem affecting arable land throughout the world, reducing the yield of wide variety of crops. The accumulation of salt in soils is caused largely by irrigation water which contains the sodium chloride and the seawater (Ulrich, 2014).

This trouble constitute the most important land degradation processes in the The lands surrounding the seasonal lak of Sed El masjoune, north of Marrakech (MOROCCO). This land is close to the desert; it represents a rugged terrain with Dry, flat, and virtually barren when the rainfall averages a few centimeters a year.

In this regard the application of chemical and no chemical amendments is expected to alleviate the effect of salinity influencing positively the plant growth. Chemical fertilizers are known by their important role in increasing soil fertility and crop productivity and organic fertilizers have been investigated for their effectiveness in soil remediation , they are very riche of nutrient elements and have a high quantity of organic matter which can reinforce soil physical properties by improving the total stability and lessening soil bulk density. They can moreover improve soil biochemical and biological properties and optimize the structure of soil microbial community, (Ning, 2017). the aim of the work describing here is to investigate and evaluate how the electrical conductivity of soil can be changed by adding two doses of gypsum (3,85g/kg ; 7,69g/kg) and 5g/kg of two types of compost to three types of soil; no salty, salty, and very salty soil and incubating the mixtures for proximately seven months.

### **Material and method**

Soils are collected from three sites around Sed El mesjoune seasonal lak in july 2016, served and transported to the laboratory where the primitive analysis to determine the general properties were performed. The primal conductivity of the no salty soil S1, Salty soil S2 and very salty soil S3 was respectively 0,74; 7 and 20,5 mS/cm. the quantity of 11kg was put into pots with 30; 18 and 25 cm top, bottom and height diameters respectively, with holes in the bottom. Pots were treated with 0 (T), 3,85 (G1) and 7,69 g/kg(G2) of gypsum and 5g/kg of C1: compost1 fabricated by vegetable fermentation and C2: compost 2 issued from wood and paper. All pots were randomized in a greenhouse. The experiments were conducted for seven months, soil sampling was carried out every 20 days, the soil extracted from the pots is carried to the laboratory, dried and ground to pass 2mm sieve for measuring the electrical conductivity. This last is determined by using the saturation extracts.

### **Results and discussion:**

After measuring the electrical conductivity in each sampling period, the results expressed at mS/cm are recapitulated and presented in diagrams (figure1)

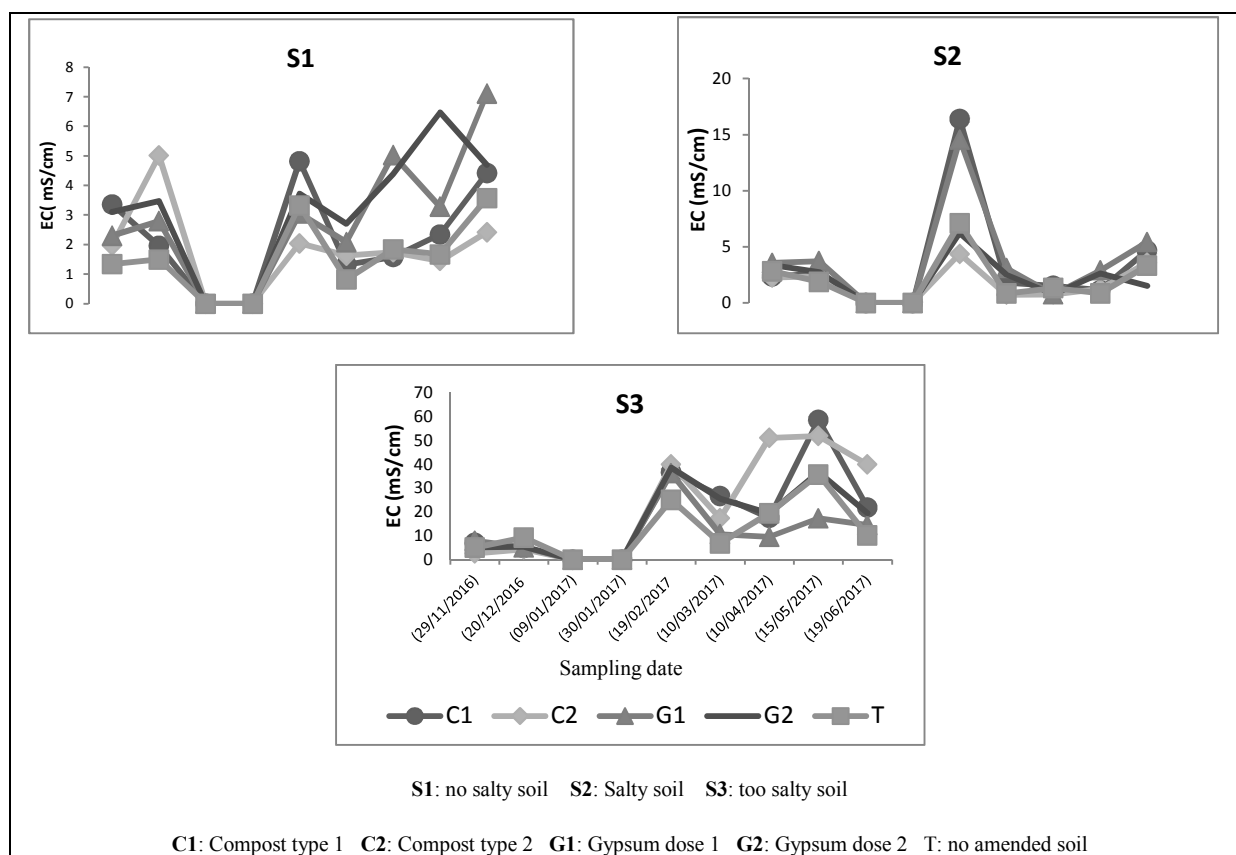

Figure 1: Variation of Electrical conductivity over the incubation period

For the three types of soil the electrical conductivity is decreased significantly in the third and the fourth takes, all points was overlapped which improve the effectiveness of all types of amendment used in this period. after the fourth sampling the conductivity increased rapidly to rich its highest value in the fifth, by comparing electrical conductivity's values in this step we detect that the compost C2 resist more efficiently and allow to maintain the same level of conductivity throughout all incubation period for the salty and no salty soils. That may be due to the effectiveness of humic acid of the compost 2, which constitute the important component of compost's organic matter of compost reflecting the finding of (Çimirin, 2010). For the very salty soil the amendment more appropriate is the gypsum G1.

## Conclusion

To alleviate the effect of soil salinity the appropriate period of incubation is two months, and the more effective amendment is the compost2 for salty soil, but for the very salty soil the suitable amendment is gypsum with 3,85g/kg.

## References:

- Çimirin K., Önder T., Metin T., Burcu T., 2010. Phosphorus and humic acid application alleviate salinity stress of pepper seedling. *African Journal of Biotechnology.*, 9(36), 5845-5851
- Ning C., Gao P., Wang B., Lin W., Jiang N., Cal K., 2017. Impacts of chemical fertilizer reduction and organic amendments supplementation on soil nutrient, enzyme activity and heavy metal content. *Journal of Integrative Agriculture.*, 16(8), 1819-1831
- Ulrich D., Aaron B.S., Tomoaki H., Wei L., Guohua X., Julian I., 2014. Plant salt-tolerance mechanisms. *Plant Science Conferences.*

## Strip-till for maize in sandy loam soils: Importance of tillage depth, preceding cover crops and fertilization technique

T. Vanden Nest<sup>1,\*</sup>, G. Ruyschaert<sup>1</sup>

<sup>1</sup>ILVO, Flanders Research Institute for Agriculture, Fisheries and Food, Plant Sciences Unit, Burg. Van Gansberghelaan 109, 9820, Merelbeke, Belgium

\*corresponding author: thijs.vandennest@ilvo.vlaanderen.be

### Introduction

Strip-tillage is currently gaining interest as a conservation tillage technique in maize (*Zea mays* L.) and sugarbeet (*Beta vulgaris* L. ssp. *Altissima*) by research institutes in Belgium. Strip-till is expected to reduce the time and energy consumption of tillage, erosion and stimulate soil life in comparison with conventional moldboard ploughing. The practical feasibility on Belgian farms, is however still under discussion. There is little experience with this technique. The objective of this study was to measure the effect of (i) tillage technique (CT: conventional moldboard ploughing, NIT: non-inversion tillage, S: strip-till), (ii) preceding cover crop (R: rye *Secale cereale* L., WM: white mustard *Sinapis alba* L.) and (iii) strip-till tillage depth (16-25cm) on maize yield. Two experiments were conducted on sandy loam soil, experiment A in 2016 and experiment B in 2017.

### Material and methods

Experiment A and B (50°58'53"N 3°46'33"E, average annual temperature and rainfall: 9°C, 836 mm) had a split-plot and a strip-split-plot design, respectively, both with 4 blocks. In experiment A (C% 1.4, pH-KCl 5.5), rye was sown as cover crop in October 2015 after harvest of potatoes and decompaction of the tillage layer (25 cm). On April 19<sup>th</sup> 2016, 35 m<sup>3</sup> ha<sup>-1</sup> cattle slurry was applied with a line spreading boom in treatments CT, NIT and in S1-S3. The soil was tilled with a cultivator (10cm) in CT and NIT. On May 2<sup>nd</sup>, the rye in treatments S1-S6 was chopped with a flail mower. On May 9<sup>th</sup>, treatments CT and NIT were tilled (30cm) by a moldboard plough and an Actisol cultivator for non-inversion tillage, respectively. A rotary harrow (8cm) was used for seedbed preparation. In S1-S6, the strip-till was carried out with a Carré INRO at different depths (see table) on May 9th. In S4-S6 this was combined with cattle slurry injection (35 m<sup>3</sup> ha<sup>-1</sup>). On May 9<sup>th</sup> the maize was sown (105 000 seeds ha<sup>-1</sup>, 6cm depth, 75cm between rows) with additional 200 kg ha<sup>-1</sup> fertilizer (16-6-23(-2)(-5)) in the maize row. On May 11<sup>th</sup> 200 kg ha<sup>-1</sup> ammonium nitrate (27%N) was added as a top dressing on all treatments. In experiment B (C% 1.5, pH-KCl 6.0), white mustard (August 30<sup>th</sup>, 20 kg ha<sup>-1</sup>) and rye (October 7<sup>th</sup>, 150 kg ha<sup>-1</sup>) were sown as cover crops in treatments WM and R, respectively, after decompaction of the tillage layer (25cm). In R, glyphosate was applied (4 L ha<sup>-1</sup>, March 29<sup>th</sup> 2017) and both cover crops were chopped with a flail mower (April 5<sup>th</sup> 2017). On April 10<sup>th</sup>, 45 m<sup>3</sup> ha<sup>-1</sup> cattle slurry was applied with a line spreading boom in treatments CT and NIT and the soil was tilled with a cultivator (10cm). On April 20<sup>th</sup>, treatments CT and NIT were tilled (30cm) by a moldboard plough and a Carré Neoloab cultivator for non-inversion tillage, respectively. A rotary harrow (8cm) was used for seed bed preparation. In S1 and S2, the strip-till was carried out with a Carré INRO at 15 and 25 cm depth, combined with cattle slurry injection (45 m<sup>3</sup> ha<sup>-1</sup>) on April 20<sup>th</sup>. On April 20<sup>th</sup> the maize was sown (105 000 seeds ha<sup>-1</sup>, 6cm depth, 75cm between rows) with additional 200 kg ha<sup>-1</sup> fertilizer (16-6-23(-2)(-5)) in the maize row. The maize in both experiments was harvested as silage maize (A: September 19<sup>th</sup> 2016; B: September 7<sup>th</sup> 2017), with field trial



equipment. Subsamples were dried (72h, 70°C), to determine the total dry matter (DM) crop yield.

### Results and discussion

**Experiment A:** Due to the cattle slurry injection in the tilled strip (S1-S3), the crop yield was significantly increased compared to slurry application to the surface (S4-S6). The crop yield in the strip-till treatments was however dramatically low, compared to CT and NIT. Increasing the tillage depth in strip-till, increased the crop yield. Shallow profile pits (40-50cm) revealed that maize roots explored the whole tillage layer in treatments CT and NIT. However, the maize roots were not capable of growing outside the tilled strip in S1-S6. Due to the very wet conditions in spring 2016 (>150% of the monthly average rainfall in March, April and May), the soil was not dry enough for good tillage practices at any moment during the sowing period. The combination of a too moist soil and the density of the rye roots, resulted in a very bad tillage with the strip-till machinery. With conventional moldboard plowing, this was not an issue. During June (>250% of the average monthly rainfall), the strip-till plots were regularly flooded for a few hours due to heavy rainfall.

**Experiment B:** There was no significant effect of the preceding cover crop, tillage method or tillage depth on the maize crop yield. In springtime 2017, the weather conditions were dry (April-June, 50% of the average monthly rainfall) and the soil was in good condition to be tilled. Although the soil in the strip-till treatments was better crumbled after white mustard, compared to rye (more and bigger soil clods), the visual differences were small. Shallow profile pits revealed that maize roots in strip-till could easily spread outside the tilled strip.

**Table 1: Average Dry matter crop yield for the field trials in 2016 and 2017. Statistical significant groups are indicated with different letters (Tukey test) (NS: not significant).**

Experiment A (2016)				Experiment B (2017)			
Slurry Application (p<0.001)	Tillage method	Tillage depth (cm)	Crop yield (kg DM ha <sup>-1</sup> ) (p<0.001)	Cover Crop (NS)	Tillage method	Tillage depth (cm)	Crop yield (kg DM ha <sup>-1</sup> ) (NS)
*	CT	30	18 463 <sup>a</sup>	R	S1	15	22 667
	NIT	30	16 404 <sup>ab</sup>		S2	25	22 999
Line Spreading Boom <sup>B</sup>	S1	15	8 029 <sup>c</sup>		NIT	30	21 862
	S2	19	9 214 <sup>de</sup>		CT	30	22 215
	S3	23	9 913 <sup>de</sup>		S1	15	21 718
**Row Injection <sup>A</sup>	S4	15	11 868 <sup>cd</sup>		WM	S2	25
	S5	19	13 711 <sup>bc</sup>	NIT		30	22 816
	S6	23	13 991 <sup>bc</sup>	CT		30	22 080

\*In the treatments CT and NIT, the slurry was incorporated in the soil with a cultivator (10 cm) immediately after spreading.

\*\*The slurry was injected simultaneously with the strip-tillage to a depth 10 cm shallower than tillage depth.

### Conclusion

We conclude that strip-till can achieve the same crop yields in silage maize as conventional moldboard ploughing and non-inversion tillage, however extreme wet conditions have a more adverse effect on strip-till than conventional or non-inversion tillage. In dry soil conditions, tillage depth and preceding cover crop have little effect on crop yield in strip-till. Based on experiment A, slurry injection in the row instead of surface application should be preferred in strip-till.

# Temporal Changes of Soil Physical Properties in Maize Growing Season as Affected by Long-term Tillage Treatments in Northeast China

Hengfei Wang, Li Wang, Weida Gao, and Tusheng Ren\*

College of Resources and Environmental Sciences, China Agricultural University, Beijing China 100193

\* Corresponding author: tsren@cau.edu.cn

## Introduction

Intensive tillage systems have led to soil degradation in Northeast China due to the loss of soil organic matter (SOM), soil structure deformation, and soil erosion by wind and water (Liu *et al.*, 2010). Recently conservation tillage practices are introduced to reverse the trend of soil degradation. It is generally believed that conservation tillage is effective in reducing soil erosion (Lal *et al.*, 2007) and increasing the soil organic carbon content, water holding capacity, and aggregate stability (Soane *et al.*, 2012; Zhang *et al.*, 2015; Alvarez and Steinbach., 2009). However, there are skepticisms that the new practices will bring about negative changes in soil physical strength (Soane *et al.*, 2012), aeration, and thermal environment (Zhang *et al.*, 2015), and therefore, affect root growth adversely. In this study, we investigated the temporal changes of soil physical properties in maize growing season under conventional and conservation tillage systems.

## Material and method

The field experiment was established in 2011 at the Lishu Experimental Station of China Agricultural University, located in Lishu County of China. The average annual temperature is 5.9 °C and annual precipitation is 556 mm. The soil is a Vertisol with a silty clay loam (23.9% sand, 45.2% silt, and 30.9% clay) texture. The prevalent cropping system is mono-cropping maize (*Zea mays* L.). The experiment includes three tillage practices: conventional tillage (CT, moldboard plow, ridging with crop residue removed), zero tillage (ZT, direct seeding into standing stubble), and rotational tillage (RT, 3-year ZT plus 1-year CT). The plot size is 21.6 m by 63 m. In 2017 and 2018, root-zone soil temperature, water content, and penetrometer resistance were monitored continuously, and intact samples were collected at 0-20 cm depth for several times to determine the changes of soil bulk density and water retention characteristics in maize growing season. Maize root growth, above-ground shoot growth, and crop yield were also measured.

## Results and discussion

Compared with the CT, the ZT and RT treatments significantly increased soil bulk density and water content at the 0- to 20-cm layer (Table 1). Soil temperatures under ZT and RT were lower than that under CT before the 6-leaf growth stage, which were attributed to the higher water contents and residue cover at soil surface. No significant soil temperature differences among the tillage treatments were observed at the 12-leaf growth stage. Under normal water conditions, ZT and RT tended to have similar penetrometer resistance to that of CT. During dry periods, however, CT had greater penetrometer resistance than ZT at lower depths (Fig. 1), which increased soil mechanical impedance and produced adverse influence on maize root elongation.

Tillage treatments also affected maize growth in 2017 (Table 1). Compared to the CT, the ZT and RT treatments reduced plant height, leaf area index, and root biomass in the earlier growth stages (e.g., before the 6-leaf growth stage). The differences among the treatments became smaller at later growth stages (e.g., the dough stage), and the ZT and RT treatments even showed significantly higher leaf areas than that of the CT treatment. Finally, compared to the CT practice, the ZT treatment produced significantly higher crop yield, while the RT treatment gave equivalent maize yield. Thus, although conservation tillage practices (i.e., ZT and RT) delayed maize growth in the earlier stages due to a lower soil temperature, they provided more favorable soil conditions for maize at later stages, which resulted in similar or even higher maize yields.

## Conclusion

Conservation tillage practices altered soil bulk density, temperature, and water content significantly. Due to the higher water contents and lower temperatures, the ZT and RT treatments delayed maize growth in the earlier season. The adverse effect was reversed at later stages because conservation tillage systems produced more favorable soil thermal and hydraulic environments for plant roots. We concluded that the conservation tillage systems provided viable alternatives to the CT practice in Northeast China.

**Table 1**

Soil physical properties and maize traits as affected by tillage treatments in 2017. Different lower case letters in a row means significant difference between treatments at  $P < 0.05$ .

Soil/crop parameter	Growth stage	CT	ZT	RT
Bulk density ( $\text{g cm}^{-3}$ )	Sowing	1.26 c	1.43 b	1.51 a
	Harvest	1.32 b	1.48 a	1.52 a
Soil water content ( $\text{cm}^3 \text{cm}^{-3}$ )	Sowing	0.21 b	0.33 a	0.34 a
	6-leaf	0.21 b	0.30 a	0.33 a
	12-leaf	0.32 a	0.36 a	0.37 a
Soil temperature ( $^{\circ}\text{C}$ )	Sowing	17.66 a	15.27 b	14.20 b
	6-leaf	23.37 a	21.87 b	21.63 b
	12-leaf	21.61 a	21.46 a	21.47 a
Root biomass ( $\text{g plant}^{-1}$ )	6-leaf	9.15 a	5.02 b	4.95 b
	Milk	24.09 a	21.35 b	22.54 b
	Harvest	22.98 a	20.13 b	19.69 b
Plant height (cm)	6-leaf	108.7 a	80.7 b	82.2 b
	12-leaf	195.3 a	172.8 c	186.6 b
	Milk	256.2 a	259.8 a	263.7 a
Leaf area ( $\text{cm}^2 \text{plant}^{-1}$ )	6-leaf	4683.4 a	3061.6 c	3652.5 b
	12-leaf	9095.2 a	8812.5 a	9112.9 a
	Milk	9059.3 a	9456.4 a	9544.9 a
	Dough	6972.7 b	8852.0 a	8865.3 a
Maize yield ( $\text{kg ha}^{-1}$ )	Harvest	11480 b	12248 a	10441 b

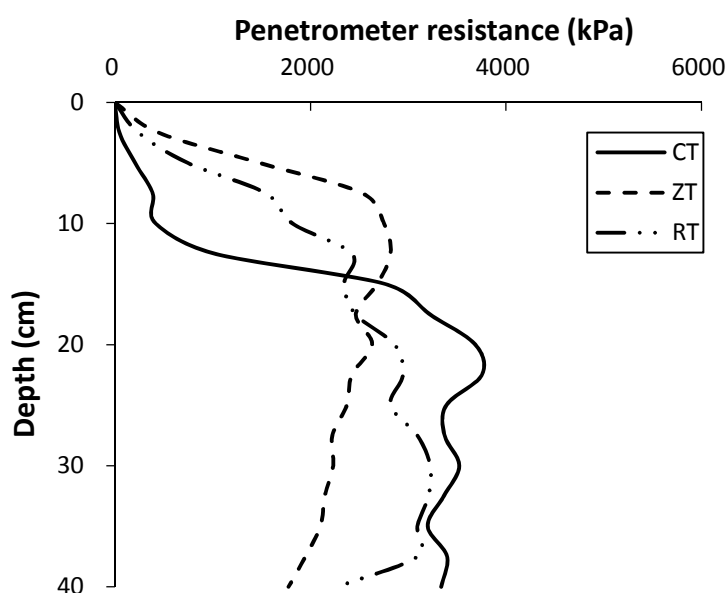

**Fig. 1. Penetrometer resistance under three tillage practices during a dry period in 2017.**

### References

- Alvarez, R., Steinbach, H.S., 2009. A review of the effects of tillage systems on some soil physical properties, water content, nitrate availability and crops yield in the Argentine Pampas. *Soil Till. Res.* 104 (1), 1-15.
- Liu, X.B., Zhang, X.Y., Wang, Y.X., Sui, Y.Y., Zhang, S.L., Herbert, S.J., Ding, G., 2010. Soil degradation: a problem threatening the sustainable development of agriculture in Northeast China. *Plant Soil Environ.* 56, 87-97.
- Soane, B.D., Ball, B.C., Arvidsson, J., Basch, G., Moreno, F., Roger-Estrade J., 2012. No-till in Northern, Western and South-Western Europe: a review of problems and opportunities for crop production and the environment. *Soil Till. Res.* 118, 66-87.

## **Tillage and N Fertilization Strategies: Determining Best Combination to Enhance Grain Yield and Mitigate Global Warming in Mediterranean Agroecosystems**

D. Plaza-Bonilla<sup>1,2\*</sup>, J. Álvaro-Fuentes<sup>2</sup>, J. Lampurlanés<sup>3</sup>, J. L. Arrúe<sup>2</sup>, E. Pareja-Sánchez<sup>1</sup>, S. Franco-Luesma<sup>2</sup>, C. Cantero-Martínez<sup>1</sup>

<sup>1</sup> *Department of Crop and Forest Sciences, Associated Unit to EEAD-CSIC, Agrotecnio, University of Lleida, Av. Rovira Roure 191, 25198 Lleida, Spain*

<sup>2</sup> *Soil and Water Department, Estación Experimental de Aula Dei (EEAD), CSIC, Avda. de Montañana 1005, 50059 Zaragoza, Spain*

<sup>3</sup> *Department of Agricultural and Forest Engineering, Associated Unit to EEAD-CSIC, Agrotecnio, University of Lleida, Av. Rovira Roure 191, 25198 Lleida, Spain*

\* corresponding author: [daniel.plaza@pvcf.udl.cat](mailto:daniel.plaza@pvcf.udl.cat)

### **Introduction**

Mediterranean agriculture under rainfed conditions is characterized by low yields and soil vulnerability to degradation, which can be exacerbated by global warming. Therefore, management practices must be oriented towards a more sustainable approach, dealing with Mediterranean agriculture pedoclimatic limitations and aiming at mitigating greenhouse gas emissions. In this context, agricultural management practices play a major role. The objective of this work was to study the impact of tillage systems and N fertilization strategies on crop production, greenhouse gas emission and soil carbon under rainfed winter cereal-based cropping systems.

### **Materials and Methods**

Two field experiments were set up (Agramunt, 41°48'N, 1°07'E, established in 1996; Senés, 41°54'N, 0°30'W, established in 2010) in the Ebro valley (NE Spain), comparing two tillage systems (conventional intensive tillage, CT; no-tillage, NT) and N fertilization strategies (0, 60 and 120 kg N ha<sup>-1</sup> of mineral fertilizer in Agramunt, and 0, 75 and 150 kg N ha<sup>-1</sup> with mineral fertilizer or pig slurry in Senés). The proposed fertilization strategies were aimed at comparing the N rate traditionally used by farmers with a 50% reduction and a control treatment. The experiment consisted of a randomized complete blocks design with three replications. Plot size was adapted to the use of commercial machinery, with a minimum plot size of 240 m<sup>2</sup>. In both sites a winter cereal-based cropping system was studied, with crop residues maintained, incorporated under CT and spread over the soil surface in NT. Soil water and mineral N dynamics were quantified at key specific dates during the cropping season. Crop productivity as above-ground biomass and grain yield were determined. Soil organic carbon (SOC) was quantified at specific dates over the entire plough layer (i.e. 0-40 cm) with the use of wet oxidation and soil bulk density determination. Soil greenhouse gas emission (nitrous oxide, N<sub>2</sub>O, and methane, CH<sub>4</sub>) was quantified during two cropping seasons using non-steady state static chambers (Hutchinson and Mosier, 1981) with intensive samplings during N fertilization applications (i.e. 24 h prior and 3h and 48 h after the application). Gas samples were analyzed with a gas chromatography system equipped with a flame ionization detector to analyze CH<sub>4</sub> and an electron capture detector to analyze N<sub>2</sub>O, and configured to analyze both gases with a unique injection. Ancillary variables such as soil temperature (at 5 cm depth), soil water filled pore space and mineral N (as ammonium and nitrate) were also determined on each gas sampling date.

### **Results and discussion**

The use of NT led to greater soil water recharge than CT in both sites, increasing the amount of water available to the crop at the beginning of the tillering stage (at the end of January in our conditions) when crop grows and develops due to greater air temperatures. In Agramunt, as an average of 18 years of experiment, NT increased barley grain yield by a 10, 47 and 53% compared with CT when applying 0, 60 and 120 kg N ha<sup>-1</sup>, respectively. In Senés, NT showed 1.0, 1.7 and 6.3 times greater grain yield than CT in three of the four cropping seasons analyzed. In Senés, pig slurry application led to the same (in 3 out of 4 years) or higher (in 1 out of 4 years) grain yield than an equivalent rate of mineral N fertilizer. In both sites, crop response to the highest N rate was nil under CT and marginal under NT. Crop response to N fertilizer is highly dependent on soil water availability under rainfed Mediterranean conditions, which explains the greater crop yields under NT when applying increasing N rates, being the response greater on drier years (Cantero-Martínez *et al.* 2003). The positive impact of NT on crop biomass in most of the years analyzed increased the amount of C inputs returned to the soil as crop residues and led to a significant increase in SOC. Tillage and N fertilization single effects affected significantly N<sub>2</sub>O emissions in Senés. The impact of tillage on soil N<sub>2</sub>O emissions differed depending on the site: whereas similar N<sub>2</sub>O emissions were observed in Agramunt between CT and NT, greater emissions were observed in NT compared with CT in Senés. The increase in N rate independently of the source of N (mineral N or pig slurry) increased N<sub>2</sub>O emissions, while no differences between N sources were observed for a given N rate. The soil acted as a net sink of CH<sub>4</sub> in both sites, showing most sampling dates negative fluxes of this greenhouse gas with the exception of N fertilization applications. Tillage affected differently CH<sub>4</sub> fluxes depending on the site: while greater CH<sub>4</sub> absorption occurred in Agramunt when using NT the contrary results were observed in Senés. It could be hypothesized that the differential response to tillage of N<sub>2</sub>O and CH<sub>4</sub> in Agramunt and Senés could be the result of soil structure improvement when maintaining NT practices in the long term (Plaza-Bonilla *et al.*, 2013). Regarding to this last point, the maintenance of NT could have enhanced soil porosity (in magnitude and/or continuity) under NT in Agramunt reducing denitrification and enhancing soil methanotrophic (i.e. oxidation of CH<sub>4</sub>) activity.

## Conclusion

In synthesis, the results we report here point out that the use of NT, maintained over time, and the application of medium rates of N using either synthetic fertilizers or pig slurry are key practices to mitigate greenhouse gas emissions, sequester soil C and enhance winter cereal yields in semiarid rainfed Mediterranean agroecosystems.

## References

- Cantero-Martínez, C., Angas, P., Lampurlanés, J., 2003. Growth, yield and water productivity of barley (*Hordeum vulgare* L.) affected by tillage and N fertilization in Mediterranean semiarid, rainfed conditions of Spain. *Field Crops Res.* 84, 341-357.
- Hutchinson G.L., Mosier A.R., 1981. Improved soil cover method for field measurement of nitrous oxide fluxes. *Soil Sci. Soc. Am. J.* 45, 311-316.
- Plaza-Bonilla, D., Cantero-Martínez, C., Viñas, P., Álvaro-Fuentes, J., 2013. Soil aggregation and organic carbon protection in a no-tillage chronosequence under Mediterranean conditions. *Geoderma* 193-194, 76-82.

## **Influence of Tillage Practices on Some Engineering Properties of Cassava Tubers and the Performance of an Automated Cassava Peeler.**

*O. A. Adetola\*<sup>1</sup>, O. J. Olukunle<sup>1</sup>, A. P. Olalusi<sup>1</sup>*

*<sup>1</sup>Department of Agricultural and Environmental Engineering, Federal University of Technology, PMB 704 Akure, Ondo State, Nigeria*

\*Corresponding author: [oaadetola@futa.edu.ng](mailto:oaadetola@futa.edu.ng)

### **Introduction**

All the unit operations in cassava processing had been fully mechanized except peeling which has invariably slow down medium-large scale utilization of the crop. This research tends to solve the problem of irregularity in size and shape of cassava tubers in order to enhance the better performance of cassava peeling machine, design machines for handling and processing of cassava tubers. Odigboh (1976) made appreciable efforts to effectively peel cassava through innovative models of cassava peeling machines. These seem to be the pioneers. The machines had peeling efficiency of 63%, capacity of 165 kg/hr, tuber loss of 21%, and manually operated. The cassava peeler is tedious to operate, tuber losses are high, and it consumes a lot of human energy. Olukunle and Akinnuli (2013) developed an automated cassava peeler which includes: metering device, conveyor, tuber guide etc. The machine impacts a rotary motion on the tuber through shear or abrasion effect. Modeling aspect was introduced to enhance the efficiency of the machine. The machines had peeling efficiency range of 48.40 - 88.73 %, capacity of 500-583 kg/hr, tuber loss of 14 %, and operating speed of 150 – 275 rpm. The peeler required technical-know-how and can't fully peel small size of tubers. This study investigated the influence of tillage practices on some engineering properties of cassava tubers and the performance of an automated cassava peeler.

### **Material and Method**

Two field experiments were conducted between May 2014 to April 2015 and May 2015 to April 2016. Eight tillage methods used for the experiment were; Ploughing + Harrowing, Ploughing + Harrowing + Ridging, Manual Ridging, Zero or No-till, Ploughing + Harrowing + Manual Digging + Saw-dust placed at the base, Ploughing + Harrowing + Ridging + Saw-dust placed at the base, Manual Ridging + Saw-dust and Manual Digging + Saw-dust placed. TME 419 improved cassava variety, one fertilizer rate of 933.75 of NPK 15:15:15 was used. The tillage treatments and fertilizer rate were imposed on rain-fed and irrigated cassava fields. The experiment was 8x1x2 factorial combinations of tillage methods, fertilizer rate and rain-fed or irrigated scheme arranged in split-split plot design with three replications. The tillage methods constituted the main plot while fertilizer rate and soil moisture levels were the sub and sub-sub plots. The treatment plots were 3x3 m while the total field plot was 18 m<sup>2</sup>. A line spacing of 1 meter between the cassava plants was observed. Cassava stems of 20 cm long were planted at depth of 5-10 cm. The cassava plants were harvested 10<sup>th</sup> -11<sup>th</sup> months after planting. The effect of treatments on some physical and mechanical properties of cassava tubers and on the performance of an automated cassava peeler was evaluated using automated cassava peeler developed at the department of Agricultural and Environmental Engineering, Federal University of Technology Akure. Statistical Package for Social Science (SPSS 21 version) was used to analyze the data generated from this study.

## Results and discussion

The tillage practice that gave the uniform and regular length, width, thickness, size, aspect ratio, surface area, sphericity, roundness, unit mass, unit volume, true density, bulk mass, bulk volume, bulk density, porosity, angle of repose and coefficient of static friction is Manual Ridging + 10 cm Saw-dust placed at the base (treatment 7). Manual Ridging + 10 cm Saw-dust placed at the base tillage practice enhanced the better performance of the automated cassava peeling machine with tuber length of  $33.04 \pm 2.30^{ab}$  cm, width of  $5.04 \pm 0.47^{ab}$  cm, thickness of  $4.36 \pm 0.40^a$  cm, size of  $8.86 \pm 0.69^a$  cm, aspect ratio of  $16.80 \pm 1.81^{ab}$  %, surface area of  $266.50 \pm 37.4^a$  cm<sup>2</sup>, sphericity of  $28.37 \pm 1.95^{ab}$  cm, roundness of  $73.68 \pm 14.14^{ab}$ , unit mass of  $0.57 \pm 0.12^{ab}$  kg, unit volume of  $0.55 \pm 0.11^{ab}$  m<sup>3</sup>, true density of  $0.99 \pm 0.09^a$  kg/m<sup>3</sup>, bulk mass of  $9.39 \pm 0.00^h$  kg, bulk volume of  $8.8 \pm 0.00^h$  m<sup>3</sup>, bulk density of  $0.99 \pm 0.00^c$  kg/m<sup>3</sup>, porosity of  $56.51 \pm 7.25^{ab}$  %, angle of repose of  $71.17 \pm 0.44^b$  coefficient of static friction of  $2.86 \pm 0.07^{ab}$ , compressive extension at break of  $45.27 \pm 0.69^b$  mm, compressive strain at break of  $3.02 \pm 0.04^a$  mm/mm, compressive load at break of  $31596.59 \pm 482.65^f$  N, compressive stress at break of  $11.18 \pm 0.17^d$  MPa, energy at break of  $239.09 \pm 3.65^f$  J, extension at break of  $-45.27 \pm 0.69^a$  mm, compressive load at maximum compressive extension of  $31596.59 \pm 482.65^f$  N, compressive strain at maximum compressive extension of  $3.02 \pm 0.0^a$  mm/mm, maximum compressive extension of  $45.27 \pm 0.69^b$  mm, compressive stress at maximum compressive extension of  $11.18 \pm 0.17^d$  MPa, modulus automatic of  $1.95 \pm 0.03^b$  MPa, compressive load at yield of  $3594.28 \pm 54.91^e$  N, compressive extension at yield of  $15.95 \pm 0.24^c$  mm, compressive strain at yield of  $1.06 \pm 0.02^d$  mm/mm, compressive stress at yield of  $1.27 \pm 0.02^c$  Mpa, peeling efficiency of 92.88 %, percentage of broken tubers of 16.78 %, percentage of flesh loss from tuber of 8.90 %, machine throughput capacity of 1.10 tonnes/hr, mass of unpeeled patches of 0.34 % and material recovery of 93.45 % respectively. Thus, the challenge of peeling off of unacceptable percentage of useful flesh during mechanical peeling could be solved using Manual Ridging + 10 cm Saw-dust placed at the base as reported by researchers that attempts at mechanizing the cassava peeling operation have been acknowledged but machines have not been fully developed yet due to the irregularity in the shape of the tubers as well as the wide variations in the thickness of the peel, tuber size and weight across different varieties of the crop as no efficient cassava peeler is presently in the market in Nigeria (Oriola and Raji, 2013).

## Conclusion

The study had provided relevant data required by farmers, food processors and engineers for the modification and development of systems for planting, handling and processing of cassava tubers into useful products. With mechanization of cassava peeling, high quality products, high processing efficiency, minimum loss of tubers and high peeling efficiency of 92.88 % should be aimed at; which will make the cassava farming and processing much more profitable. This will enhance safe and abundant food for the 40% projected increase in world population by 2030.

## References

- Odigboh, E. U., 1976. A cassava peeling machine: development, design and construction. *Journal of Agricultural Engineering Research*, 21, 361-369.
- Olukunle, O. J. and Akinnuli, B.O., 2013. Theory of an automated cassava peeling system. *International Journal of Engineering and Technology (IJET)*, 2, 2277-2287.
- Oriola, K. O. and Raji, A. O., 2013. Trends at mechanizing cassava postharvest processing operations. *International Journal of Engineering and Technology (IJET)*, 3(9), 879-887.

## Chemical Composition of Maize Grain Depending on Tillage Systems and Nitrogen Fertilization

Irena Jug<sup>1\*</sup>, Danijel Jug<sup>1</sup>, Boris Đurđević<sup>1</sup>, Vesna Vukadinović<sup>1</sup>, Bojana Brozović<sup>1</sup>, Bojan Stipešević<sup>1</sup>

<sup>1</sup> *University of J.J. Strossmayer, Faculty of Agriculture in Osijek, Vladimira Preloga 1, Osijek, Croatia*

\* corresponding author: [ijug@pfos.hr](mailto:ijug@pfos.hr)

### Introduction

Many sustainable agronomic practices can be adopted to contain environmental risks of crop production and, at the same time, sustain yield and quality. Soil tillage is one of the basic agrotechnical interventions in crop production due to the influence on soil, environment and plant growth. By applying appropriate soil tillage systems, in particular conservation tillage, better soil water storage and decreased soil erosion and compactness are achieved. (Chaghazardi et al., 2016). The soil moisture, fertility and spatial distribution of the roots are affected by tillage practices. The combination of high soil density and the presence of a soil ploughing pan typically inhibits the growth of maize which is reflected in the height and quality of the yield. Maize grain yields have increased dramatically over the last decade, and concurrently end-uses have proliferated requiring special quality characteristics. Increased grain yield have resulted in lower protein concentration except when the yield increase resulted from nitrogen fertilizer application. Higher nitrogen application rates alter the amino acid balance thereby reducing the nutritional value. Starch content and oil concentration are largely influenced by hybrid choice, but also, effects of production practice have been documented. Essential mineral nutrient levels are often influenced by fertilizer application. Grain composition is a result of the genetic make-up of the parent plant and the environment (largely determined by weather conditions during maturation of the cereals) but it is not clear how much the amount of assimilates influences grain composition. Nitrogen assimilate level directly influences the activity of enzymes and indirectly affects the assimilate supply by altering plant biomass, photosynthesis, and nitrogen metabolites.

In this framework, the aim of this research was to study the effects of different conservation soil tillage systems and nitrogen fertilization on yield and chemical composition of maize grain.

### Material and Methods

Stationary field experiment was set up in 2009 at two experimental stations and two different soil types in eastern Croatia, Stagnosol and Gleysol soil type. Maize (FAO 450) was sown in spring of 2013. Fertilization with phosphorus and potassium (according to fertilizer recommendation based on soil analysis) was uniform for all tillage treatments: 140 kg P<sub>2</sub>O<sub>5</sub> ha<sup>-1</sup> and 151 kg K<sub>2</sub>O ha<sup>-1</sup>, while nitrogen fertilization, depending on the fertilizer treatment, was: reduced fertilization – 147 kg N ha<sup>-1</sup>, optimal fertilization (according to recommendation) – 210 kg N ha<sup>-1</sup> and excessive fertilization – 273 kg N ha<sup>-1</sup>. The experiment was set up as randomized complete block design in four repetition. Soil tillage treatment included 5 different tillage treatments: SS-subsoiling, CH-chiselling, DH-disk-harrowing, NT-no-till and CT-conventional tillage. The size of basic experimental plot for each individual tillage treatment was 600 m<sup>2</sup> and 195 m<sup>2</sup> for each individual fertilization treatment. In the experiment the following were evaluated for each plot: content in the grain of total protein, starch, fibre, fat, nitrogen, phosphorus and potassium. Nitrogen content in the grain was determined by the Kjeldahl method and converted to total protein (N × 6.25). Starch content was determined by



shaking seed samples with TRIS buffer (pH = 9.2) until the protein was completely dissolved. The remaining sediment was dissolved in hot water. Starch was determined by spectrophotometry ( $\lambda=660$  nm) in the form of a complex with iodine. Crude fibre is determined gravimetrically after chemical digestion and solubilisation of other materials present. Content of P and K in maize grain was determined by wet digestion (mixture HClO<sub>4</sub>, H<sub>2</sub>SO<sub>4</sub> and H<sub>2</sub>O<sub>2</sub>). Measurements were made by Atomic Absorption Spectrometry. All collected data were analysed statistically using analysis of variance (ANOVA) and the means were compared by F-test protected LSD values calculated for P<0.05.

### Results and discussion

Soil tillage practices significantly influence on chemical composition of maize grain (content of protein, starch, fibre, fat, nitrogen, phosphorus and potassium). The content of proteins, crude fibres and starch was significantly influenced by nitrogen fertilization, while the soil type affected only the crude fibres. The highest content of fat (3.91%) and starch (69.20%) was observed on SS treatment, while the lowest fat was recorded on NT (3.67%) and starch on CT treatment (67.04%). The highest value of crude fibres (2.35%), protein (9.14%) and nitrogen content (1.46 %) were measured in maize grain at CT. The highest values of all parameters were recorded on optimal nitrogen fertilization treatment (Seebauer et al., 2010) with the exception of fat while the lowest values were measured on reduced nitrogen fertilization. Similar results were obtained by Thomison et al. (2004) where grain oil concentration was not influenced by the N fertilization. The soil type significantly influenced only crude fibre content which had a higher proportion on Stagnosol. Very significant interactions of treatments were observed in all studied parameters. Multiple correlation analysis showed significant positive correlations between phosphorus and potassium concentration in maize grain ( $r = 0.957^{**}$ ) as well as positive correlations of these elements with fat ( $r = 0.408^*$ ;  $r = 0.430^*$ ) and crude fibre ( $r = 0.444^*$ ;  $r = 0.437^*$ ). The strongest correlation was observed between nitrogen concentrations and content of protein ( $r = 1.00^{**}$ ).

### Conclusion

Soil tillage and nitrogen fertilization significantly affected the chemical composition of maize grain. The highest content of starch and fat was recorded in maize on SS treatment, while the highest content of protein and crude fibre were recorded on CT treatment. Optimal fertilization with nitrogen has recorded the highest values of all parameters except fat. According to finding of this study, conservation tillage, especially subsoiling was more efficient in synthesis of starch and fat, while conventional tillage was more efficient in synthesis of protein, crude fibre and nitrogen accumulation.

### References

- Chaghazardia, H.R., Jahansouza, M.R. Ahmadi, A., Gorji, M., 2016. Effects of tillage management on productivity of wheat and chickpea under cold, rainfed conditions in western Iran. *Soil Till. Res.*, 162 (2016) 26–33. DOI: 10.1016/j.still.2016.04.010.
- Seebauer, J.R., Singletary, G.W., Krumpelman, P.M., Ruffo, M.L., 2010. Relationship of source and sink in determining kernel composition of maize. *J Exper Bot* 61: 511-519.
- Thomison, P.R., Geyer, A.B., Bishop, B.L., Young, J.R., Lentz, E., 2004. Nitrogen fertility effects on grain yield, protein, and oil of corn hybrids with enhanced grain quality traits, *Crop Management* 3: 1.

21st Triennial ISTRO Conference - September 24th-27th 2018 – France, Paris

## **Impact of cover crops on a wheat–corn rotation established with conventional, minimum or no tillage**

Jérôme Labreuche<sup>1\*</sup>, Aurélie Geille<sup>1</sup>, Sylvain Bureau<sup>1</sup>

<sup>1</sup> ARVALIS-Institut du végétal, Station Expérimentale, 91720 Boigneville, FRANCE

\* corresponding author: [j.labreuche@arvalis.fr](mailto:j.labreuche@arvalis.fr)

Keywords: cover crops, tillage, emergence, yield

In order to investigate the impact of minimum tillage on crop productivity and soil quality, a long term experiment was carried out in 1970 in Boigneville (France, 70 km south of Paris). The climate is temperate oceanic, with an average temperature of 10.9°C and rainfall of 635 mm per year. The orthic luvisol is developed on loess. The A horizon contains 24% of clay, 1.02% of carbon and had a 7.1 pH H<sub>2</sub>O. The B horizon contains 32% of clay. The soil contains no CaCO<sub>3</sub> on the upper 70 cm but 31% at 1 m depth. It has a good drainage, an average structural stability and a good ability to crack when it dries in summer.

In the winter wheat-corn rotation, three soil tillage techniques are compared: conventional tillage (CT, 20 cm depth annual plough based system), minimum tillage (ST, 5 to 10 cm depth) and no till (NT) (Labreuche and Closset, 2012).

Cover crops were introduced in the field trial between wheat and corn summer 2001. Each plot was divided in two parts: with and without cover crops, the soil tillage remaining quite the same. Volunteers and weeds on bare soils were usually destroyed in September chemically or with one additional stubble cultivation. Since summer 2015, cover crops were established on the entire plots.

Cover crops were established at early september from 2001-2002 to 2007-2008. They were then sown in august. The species were oat (*Avena sativa*) at the beginning, then oat with leguminous crops and since 2013/2014 a mixture of mustard (*Sinapis alba*), phacelia (*Phacelia tenuifolia*) and leguminous crops. They were destroyed at two periods: autumn for CT, ST and NT (mid November to mid December); winter for ST and NT (late February to early April). The cover crops biomass at their destruction period was on average of 1.2 t<sub>DM</sub>/ha in autumn and 1.9 t<sub>DM</sub>/ha in winter. This biomass was most years not very important: establishment in difficult conditions (straw in the seedbed, lack of water), slugs attack, lack of nitrogen...

Corn emergence is lower after cover crops if they are destroyed late (table 1). The seedbed moisture was sometimes more important and it had an impact on seedbed quality (clods for ST, seed furrow closure for NT). Pests were also more important (crows, slugs, rodents). These problems were usually not observed after cover crops destroyed late autumn. In this case, seedbed parameters were quite the same between with and without cover crops (residues, soil moisture). There is no impact of cover crops on corn yield, except for NT after early destruction. (table 1).

Table 1: Difference of corn yield components between cover crop and bare soil for the same soil tillage technique according to soil tillage and cover crop destruction period (harvest 2003 to 2015). ANOVA results are in brackets (NS: p value > 0.10; .: p value <0.10; \*: p value <0.05; \*\*: p value <0.01; \*\*\*: p value <0.001).

	Autumn destruction			Winter destruction	
	CT	ST	NT	ST	NT
<b>Sowing density (grain/ha)</b>	0	0	0	0	0
<b>Corn emergence (plants/ha)</b>	-974	-2 039	-877	-6 679	-3 802
<b>% of emergence</b>	-1.0	-2.0	-0.8	-6.7	-3.8
<b>Number of ears per ha</b>	-1 177	277	-1 629	427	-3 135
<b>Number of grains per ear</b>	4.5	-4.6	18.9	-7.9	3.2
<b>Number of grains per m<sup>2</sup></b>	-16	-26	85	-65	-74
<b>Weight of 1000 grains (g)</b>	1.3	3.2	1.9	-4.0	-0.1
<b>Yield (t/ha with 15% of water content)</b>	-0.04 (NS)	0.01 (NS)	0.22 (.)	-0.27 (NS)	-0.26 (NS)
<b>Grain water content (%)</b>	0.0	0.6	-0.4	2.3	1.3

Cover crops did not have a significant impact on wheat yield.

They tended to decrease net margin of corn, particularly in case of late destruction. They had a positive impact on wheat net margin, especially for winter destruction. For the wheat-corn rotation, cover crops have a negative impact on net income, whatever is the soil tillage and the destruction period.

Table 2: Difference of corn and wheat yields and net margin between cover crop and bare soil for the same soil tillage technique according to soil tillage and cover crop destruction period. ANOVA results are in brackets (NS: p value > 0.10; .: p value <0.10; \*: p value<0.05; \*\*: p value<0.01; \*\*\*: p value<0.001).

	Autumn destruction			Winter destruction	
	CT	ST	NT	ST	NT
<b>Corn yield from 2002 to 2015 (t/ha at 15%)</b>	-0.04 (NS)	0.01 (NS)	0.22 (.)	-0.27 (NS)	-0.26 (NS)
<b>Wheat yield from 2003 to 2016 (t/ha at 15%)</b>	-0.03 (NS)	0.15 (NS)	0.03 (NS)	0.17 (NS)	0.15 (NS)
<b>Wheat proteins from 2003 to 2016 (%)</b>	0.04	0.08	0.23	0.28	0.33
<b>Net margin for corn from 2002 to 2015 (€/ha)</b>	-42.0	-62.0	-71.0	-91.0	-94.0
<b>Net margin for wheat from 2003 to 2016 (€/ha)</b>	3.0	27.0	28.0	32.0	44.0
<b>Net margin for the corn-wheat rotation (€/ha/year)</b>	-19.5	-17.5	-21.5	-29.5	-25.0

## References

Labreuche J. and Closset M., 2012. Crop yields after 41 years of no tillage and minimum tillage farming in a wheat–corn cropping system in France. 19th Triennial ISTRO Conference, September 2012, Montevideo, Uruguay.

## A participatory design of cover crop no tillage techniques without herbicide

Laura Vincent-Caboud<sup>1\*</sup>, Joséphine Peigné<sup>1</sup>, Christophe David<sup>1</sup>

<sup>1</sup> Department of Agroecology and Environment, ISARA-Lyon (member of the University of Lyon), 23 rue Jean Baldassini, F-69364 Lyon Cedex 07, France; jpeigne@isara.fr

\* Correspondence: lavincent-caboud@isara.fr

### Introduction

Cover crop no tillage (CCNT) without herbicide appears as a promising practice on arable crops production with potential benefits as: (1) improving soil fertility, (2) managing weeds and (3) saving labor and energy consumption. The CCNT involves the direct seeding of cash crop into living or mulch cover crop to prevent the germination of weed seeds (Mirsky et al., 2013). Despite the growing interest of farmers, the CCNT is poorly practiced without herbicide, related to the major challenges remaining on weed control, cover crop management and cash crop performances (Vincent-Caboud et al., 2017). Most studies carried out on this issue showed that technical changes on field could improve the CCNT success without herbicide (*e.g.*, increasing cover crop seeding rate, selecting appropriate cover crop species, planting earlier cover crop). However, there is a need to rethink the insertion of the CCNT in cropping systems and taking account the farmers' objectives and constraints (*e.g.*, soil type, equipment) to foster the widespread of the CCNT. According to Vincent-Caboud et al. (2018) there are few references and still major issues for implementing the CCNT techniques into cropping systems without herbicide (*e.g.*, perennial weeds management in crop rotations, nitrogen availability for cash crops). The objective of this study is to involve farmers in a participatory process to improve the identification of relevant solutions to practice CCNT without herbicide.

### Material and Method

A research process on participatory methods has been implemented in southern France to observe ways and effects of farmers involvement for addressing the challenges of the CCNT techniques without herbicide use. The design process involving the local farmers has combined on-farms trials carried out with farmers and collective workshops with candidates to design innovative organic cropping system integrating CCNT techniques (Figure 1). The on-farm trials had been established after several formal and informal interactions (*e.g.*, interviews, visits) with farmers to identify tradeoffs addressing the responsive interests of farmers and researchers (*e.g.*, exchange of knowledge, equipment use, seed investment). Based on scientific knowledge (*e.g.*, literature, expertise) as well as farmers' objectives and constraints, on-farm trials were designed and then implemented. From these on-farm trials, field visits were organized with stakeholders (advisors, farmers, researchers) to collectively evaluate the agronomic performances of the trials and discuss on changes to improve the on-farm trials. Adjustments suggested were then experimented on-farm with voluntaries local farmers. Field visits also aimed to get farmers involved in collective workshops. At collective workshops, farmers and researchers discussed the scientific results of the trials carried out on field prior to design organic cropping systems integrating CCNT techniques. The participants included (1) local farmers in organic and conventional farming without experience in CCNT, (2) local farmers conducting the on-farm trials (3) innovative farmers on organic CCNT, and (4) researchers. Then, a second workshop was organized to discuss with farmers on agronomic, economic and social performances of the designed cropping systems.

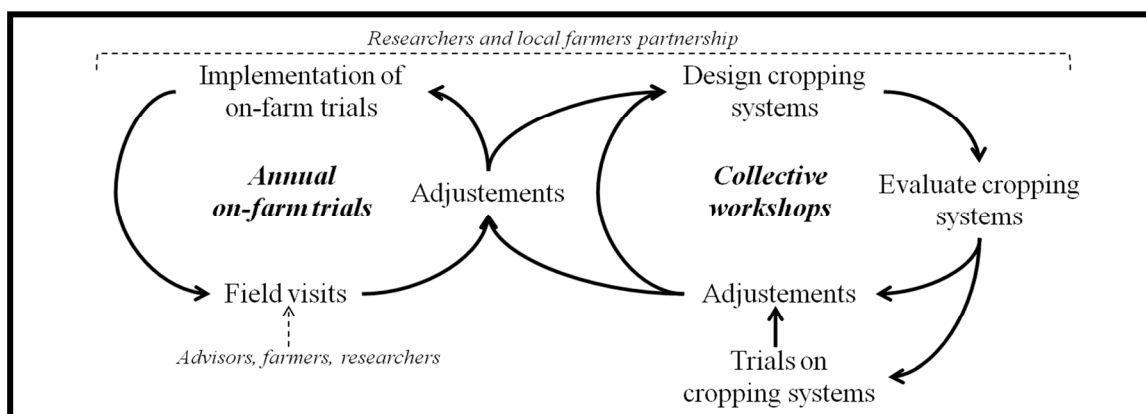

Figure 1: Research process implemented with farmers for addressing the challenges of the CCNT without herbicide

## Results and discussion

First results show the high interest of farmers regarding the participatory approach to implement CCNT techniques without herbicide. More than forty stakeholders (*e.g.*, farmers, researchers, advisors) visited tow trials carried out on the first year of the research process and seven on-farm trials were implemented the second year. Designing the trials with farmers and discussing with local farmers during the field visit raised poorly documented issues in the literature. For instance, according to farmers, row spacing should be reduced in CCNT to improve the soil covering of crops. To address the identified concerns from farmers' (*e.g.*, row spacing, direction of cover rolling, cover species and cultivars), new trials were implemented the second year. Design workshops involved thirty participants. Farmers and researchers involved in the collective workshops designed six cropping systems integrating organic CCNT. Results show a mean of 70 % of crops sown in CCNT and the CCNT techniques are mainly applied on spring crops. The participants have discussed on a diversity of aspects as a rule of decision to perform the CCNT: weed infestation, soil temperature, soil quality and remaining residues left on soil surface. The farmers involvement conducted to the identification of new challenges to design relevant cropping systems integrating CCNT. For example, farmers suggested changing on fertilization strategies with the application of organic input mostly on the cover crop rather than the cash crop to improve the cover crop performance, thereby managing the weed development.

## Conclusion

The involvement of farmers allowed identifying new research questions which have to be addressed to foster the integration of the CCNT without herbicide in farms. Carrying out a research process combining annual on-farm trials with farmers and a participatory design of cropping systems provides complementary aspects for enriching discussions and suggesting relevant solutions considering the farmers objectives and constraints. The several activities organized on field (*e.g.*, field visits, results presentation) and supports provided on the agronomic annual results of trials (*e.g.*, technical documents, pictures, videos) have also proven to be useful to involve farmers in the process.

## References

- Mirsky, S.B., Ryan, M.R., Teasdale, J.R., Curran, W.S., Reberg-Horton, C.S., Spargo, J.T., Wells, M.S., Keene, C.L., and Moyer, J.W. (2013). Overcoming Weed Management Challenges in Cover Crop–Based Organic Rotational No-Till Soybean Production in the Eastern United States. *Weed Technol.* 27, 193–203.
- Vincent-Caboud, L., Peigné, J., Casagrande, M., and Silva, E.M. (2017). Overview of Organic Cover Crop-Based No-Tillage Technique in Europe: Farmers' Practices and Research Challenges. *Agriculture* 7, 42.
- Vincent-Caboud, L., Casagrande, M., David, C., Matthew R ; Ryan, Silva, E.M., and Peigné, J., (2018). Can Mulch No Tillage be integrated into Organic Farming for Arable Soybean and Maize Production? – a review. *Soil Tillage Res.* (in revision process).

## **The influence of potato production on soil physical conditions within the depth of tillage as part of crop rotations.**

B.M. McKenzie<sup>1\*</sup>, M.A. Stalham<sup>2</sup>, K.F. Preedy<sup>3</sup>, and P.D. Hallett<sup>4</sup>.

<sup>1</sup> *The James Hutton Institute, Invergowrie, Dundee, DD2 5DA, UK*

<sup>2</sup> *NIAB CUF, Agronomy Centre, 219B Huntingdon Rd, Cambridge CB3 0DL, UK*

<sup>3</sup> *BioMathematics & Statistics Scotland, Invergowrie, Dundee, DD2 5DA, UK*

<sup>4</sup> *Institute of Biological and Environmental Sciences, University of Aberdeen, Aberdeen, AB24 3UU, UK*

\*Corresponding author: [blair.mckenzie@hutton.ac.uk](mailto:blair.mckenzie@hutton.ac.uk)

### **Introduction**

Potatoes are a major food crop and are usually grown in rotation with cereals. Potato production involves extensive soil manipulation to create an environment in which tubers can easily expand and not be deformed or damaged by stones or clods within the soil. The root system of the potato crop should also be able to proliferate through the soil to access water and nutrients but the soil must have sufficient drainage so as not to become waterlogged as this increases the risk and severity of diseases. While soil preparation to prepare beds for potato planting varies between sites, a typical sequence of operations in the U.K. involves deep-ripping to 40 cm, ploughing to 35 cm, bed-forming, de-stoning and planting. Similarly, at harvest the soil in the beds is lifted and separated from the tubers by sieving. Both planting and harvesting operations disrupt pore networks within the soil and may break apart stable aggregates. This study focussed on the structural dynamics of the cultivated soil (i.e. 0-35 cm) and used a range of indexes of soil physical quality.

### **Materials and Methods**

Soil samples were collected from experiments comparing different tillage equipment, de-stoning depths or the efficacy of amendment with organic matter. Core samples (55 mm diameter, 40 mm height) were taken from cereal stubble prior to the potato crop, during the potato crop, immediately post-harvest and in subsequent crops. Cores were collected from the surface, from within the Ap horizon and at the maximum tillage depth. Water retention curves were determined on the soil in the cores using ceramic suction plates and pressure plates covering saturation and -1, -5, -20, -50, -300, and -1500 kPa matric potentials. At -20, -50 and -300 kPa mechanical impedance was measured with a needle penetrometer (1mm diameter, 30 degree semi-angle with a relieved shaft fitted to a mechanical test frame). The data obtained were used to determine multiple soil quality measures including bulk density, macroporosity, plant available water (PAW), easily available water (EAW), least limiting water range (LLWR) and the "S" index (Dexter 2004). Bulk soil samples were taken pre-potato harvest to determine aggregate stability.

### **Results and discussion**

By plotting the data for each of the indexes against time of sampling, the impact of potatoes in the rotation and particular practices for potato production can be assessed. For example, Figure 1 is a box and whisker plot of soil bulk density for the site GVAP Hales Hospital. The dates correspond to part of a crop rotation: 11/04/13 cereal stubble, 08/07/13 pre-harvest potatoes, 08/10/13 post-harvest potatoes, 19/05/14 winter wheat crop, 19/08/14 winter wheat stubble and 26/03/15 sugar beet crop. The number 0, 15 and 30 are the depths of sampling and Deep or Shallow refers to the depth of de-stoning either 36 or 24 cm.

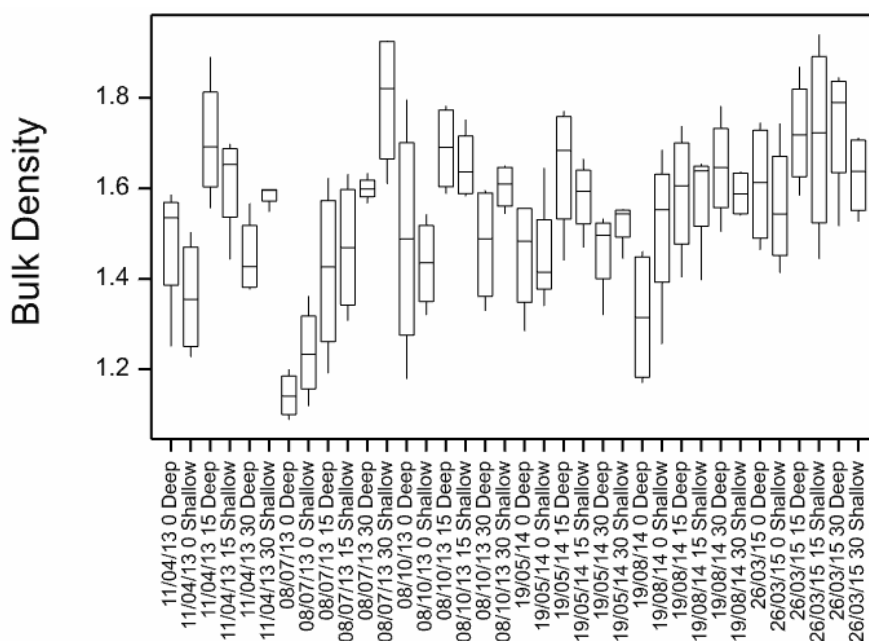

Figure 1: Soil bulk density ( $\text{g cm}^{-3}$ ) for depth of sampling (0, 15 and 30 cm) by de-stoning treatment (Deep or Shallow) over time for the GVAP Hales Hospital site .

In addition to quantifying the effects on soil physical quality under different interventions, as part of potato production, comparisons of different indexes will be made.

### Conclusions

Minimising the depth of tillage operations improved production efficiency without adversely affecting yield. Alternative tillage machinery did not improve soil conditions during potato production. Applications of organic matter helped maintain soil stability. Carefully managed potato crops, grown as part of rotations including cereals produce using conventional tillage, did not leave a detrimental legacy for soil in the Ap horizon. The effects on soil physical conditions of growing potatoes, in rotation with cereals grown under no-till or min-till systems, is yet to be determined.

### References

Dexter A.R. 2004. Soil physical quality – Part 1. Theory, effects of soil texture, density and organic matter and effects on root growth. *Geoderma*, 120, 201-14.

## Multicriteria Assessment of the Effects of Tillage Practices on Cropping Systems: Development of the Decision Support Tool DEXiSol

C. Thibault<sup>1</sup>, N. Cavan<sup>2,1\*</sup>, J. Labreuche<sup>3</sup>, P. Métails<sup>4</sup>, F. Angevin<sup>1</sup>

<sup>1</sup>INRA, UAR Eco-Innov, 78850 Thiverval-Grignon, France

<sup>2</sup>INRA, UR Science du Sol, 45075 Orléans cedex 2, France

<sup>3</sup>ARVALIS – Institut du végétal, 91720 Boigneville, France

<sup>4</sup>ARVALIS – Institut du végétal, 63360 Saint-Beauzire, France

\* corresponding author : [nicolas.cavan@inra.fr](mailto:nicolas.cavan@inra.fr)

### Introduction

Tillage operations have numerous effects on cropping systems (direct or indirect ones – via modifications of soil structure). Labreuche et al. (2014) defined tillage strategies (succession of tillage operations) and summarized their potential effects on the cropping systems, depending on some elements of context, like crop succession and pedo-climatic conditions. Assessing holistically performances of tillage strategies implies the characterisation of cropping systems with many indicators of various natures (economic, environmental, social...) and taking into account the agro-pedo-climatic context. The DEXi method, which manage this type of aggregation for decision-making was therefore used (Bohanec et al., 2015) to develop the DEXiSol tool for the multicriteria assessment of tillage practices on cropping systems.

### Material and Method

The development of such a tool requires i) decomposition of the complex problem into sub-problems easier to solve; ii) definition of characterization criteria that can be filled in different ways and iii) definition of ponderations to aggregate these criteria in a decision tree. Some of the criteria were selected from MASC 2.0, a model of sustainability assessment also based on DEXi (Craheix et al., 2012). Indicators informing the characterization criteria were chosen to describe the tillage effects and are mainly based on cultural practices or quantitative (hence need to be discretised). They were defined by a literature analysis or from interviews of 25 experts. The first version of DEXiSol was tested on the long-term tillage trial of Boigneville (**3 tillage strategies**: ploughing; shallow tillage; direct drilling and **3 crop successions**: winter wheat; w. wheat - maize; sugar beet - w. wheat - spring pea - s. barley).

### Results and Discussion

The DEXiSol structure is presented in figure 1. A guide is provided for each criteria that users should fill (*italic*). Underlined criteria (fig 1) integrate pedo-climatic context in their definition or in the ponderations used for their aggregation (for example, *soil erosion limitation* is more important for soil physical fertility in some French regions). Synoptic tables are used to compare easily tillage strategies for all the identified indicators (examples are provided in Craheix et al., 2012). The overall performance in the Boigneville trial mainly depends on crop succession (a higher performance for a longer crop succession). For each succession, tillage systems have the same overall performance, but differences appear between them deeper in the tree, on basic indicators or less aggregated indicators (such as *preservation of soil quality*).

### Conclusion

DEXiSol assembles in an holistic way recent knowledge on tillage practices effects on cropping systems and presents assessment results in a synthetic way (all characterization criteria in one synoptic table). Therefore, it could become a decision support tool to improve or select a tillage strategy. Complementary work is needed to continue model evaluation and perform sensitivity analysis. The model should also be evaluated in other contexts (e.g crop successions with rapeseed and winter cereals, sown mainly with reduced tillage in France).



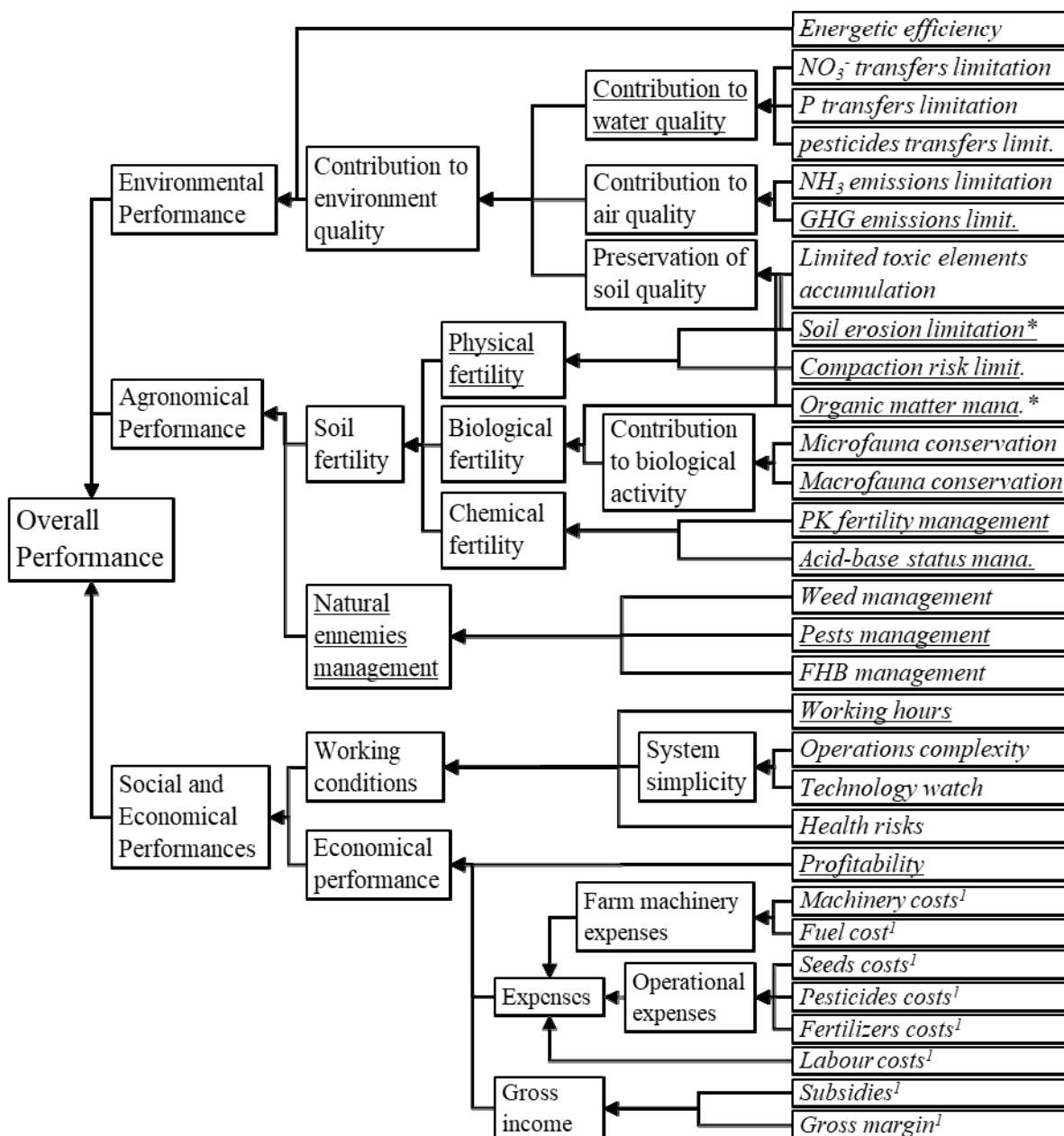

Figure 1: **DEXiSol structure**. User should fill every criterion in italic. A user's manual is provided for each of these criteria. User can adapt the evaluation to pedoclimatic context with underlined criteria (basic criteria are function of soil parameters, and ponderation of aggregated criteria can be modified to describe the context). <sup>1</sup>These criteria are used to describe farm economics but with a nil contribution to economical performances (if Profitability is known). \*Criteria used to describe soil fertility and soil preservation. GHG: greenhouse gases. FHB: fusarium head blight.

### References

- Bohanec, M.: [DEXi: Program for Multi-Attribute Decision Making, User's Manual](#). IJS Report DP-11897, Jožef Stefan Institute, Ljubljana, 2015.
- Craheix D., Angevin F., Bergez J.-E., Bockstaller C., Colomb B., Guichard L., Reau R., Doré T. 2011. MASC 2.0, un outil d'évaluation multicritère pour estimer la contribution des systèmes de culture au développement durable. *Innovations Agronomiques* 20 (2012), 35-48.
- Labreuche J., Laurent F., Roger-Estrade J., 2014. Faut-il travailler le sol ? Acquis et innovations pour une agriculture durable. Versailles : Editions Quae.

## The Effect of Five Years of Tillage and Poultry Manure Application on Soil Physical and Chemical Properties, Growth and Yield of ginger

Taiwo Michael Agbede\*

*Department of Crop, Soil and Pest Management Technology, Rufus Giwa Polytechnic, P.M.B. 1019, Owo, Ondo State, Nigeria*

\*Corresponding author: E-mail: [agbedetaiwomichael@yahoo.com](mailto:agbedetaiwomichael@yahoo.com)

### Introduction

Ginger (*Zingiber officinale* Roscoe) is an important commercial crop grown for its aromatic rhizomes which are consumed as delicacy, medicine, spices and as special vegetable in daily diets worldwide. Tillage and use of organic manure are essential agronomic practices that affect soil properties and have a direct impact on soil sustainability and crop productivity. Studies on tillage requirement for ginger are few and gave inconclusive and conflicting results. Hence, there is a dire need to study the tillage requirement and soil conditions affecting ginger in order to raise the production level from the average yield of 12-15 Mg ha<sup>-1</sup> to the potential yield of 25-35 Mg ha<sup>-1</sup> in order to meet demand for the rhizomes. Also, previous studies were short-termed; aside from inconclusive. In Kaduna State, Nigeria, Sati and Bala (2017) found that the flatbed tillage method produced the highest yield of ginger, followed by ridges and mounds, respectively. A study conducted at the Hill Agricultural Research Station, Khagrachari, Bangladesh indicated that ginger yields in zero tillage plots were greater than in furrow and conventional plots (Zaman et al., 2002). Plant nutrients usually supply by the soil in most Sub-Saharan environment are often inadequate and sometimes in plant unavailable form hence, they need to be augmented with organic resources such as poultry manure (PM) that are readily available, cheap and environmentally friendly. Since tillage is known to degrade soil properties, and now that emphasizes are gradually shifting to organic agriculture to maintain soil productivity and limit the use of chemical fertilizers some of which have contributed to the changing climate, the objective of this study was to assess the effect of a five-year of tillage and PM application on soil physical and chemical properties, growth and yield of ginger on Alfisols in southwest Nigeria.

### Materials and methods

Five years (2012-2016) field experiments were carried out at Owo (site 1 - latitude 7<sup>o</sup> 13'N, longitude 5<sup>o</sup> 32'E) and Uso (site 2 - latitude 7<sup>o</sup> 12'N, longitude 5<sup>o</sup> 32'E) in the forest-savanna transition zone of southwest Nigeria. Uso is located 10 km from Owo. The experiments were conducted to assess the long term effect (at year five) of cropping and soil management method on soil physical and chemical properties, growth and yield of ginger. The study was a 2 x 5 x 5 factorial experiment with three replicates. The treatments were five tillage methods; zero tillage (ZT), manual ridging (MR), manual mounding (MM), ploughing plus harrowing (P+H) and ploughing plus harrowing twice (P+2H) and five levels of PM (0, 5.0, 10.0, 15.0, 20.0 Mg ha<sup>-1</sup>). Each block comprised 25 plots, each of which measured 12 m x 10 m. Tillage was followed by initial manual clearing with cutlass. Two weeks after tillage treatments were performed in the study sites; mature ginger rhizomes (Taffin Giwa cv) were cut into seed-pieces weighing about 45 g. The seed-pieces were planted at a spacing of 20 cm x 20 cm at depth of 5 cm in April each year. The PM was applied two weeks after planting using incorporation method. Weeding was manual with a hoe at 4 and 8 weeks after planting. Data on plant height, number of leaves and

number of tillers were taken at 150 days after planting (DAP) while the number of rhizomes and rhizome yield of ginger was determined at harvesting. Prior to the start of the experiment in 2012, composite soil samples were collected from 0–15, 15–30 and 30–45 cm depths of profile pits dug at the two study sites for physical and chemical analysis (Table 1). In 2016 at harvest of ginger, composite soil samples were also collected on plot basis from 0-15 cm depth for physical and chemical analysis.

Table 1. Soil physical and chemical properties (0-45 cm depth) of the study sites prior to experimentation in 2012

Property	Site 1			Site 2		
	0-15 cm depth	15-30 cm depth	30-45 cm Depth	0-15 cm depth	15-30 cm depth	30-45 cm depth
Sand (g kg <sup>-1</sup> )	672	665	658	680	676	668
Silt (g kg <sup>-1</sup> )	178	169	157	155	146	141
Clay (g kg <sup>-1</sup> )	150	176	185	165	178	191
Textural class	Sandy loam	Sandy loam	Sandy loam	Sandy loam	Sandy loam	Sandy loam
pH (water)	6.1	6.0	5.9	5.8	5.7	5.6
Bulk density (Mg m <sup>-3</sup> )	1.55	1.62	1.71	1.58	1.69	1.81
Organic matter (%)	2.63	2.46	2.31	2.55	2.37	2.22
Total N (%)	0.18	0.15	0.13	0.16	0.13	0.11
Available P (mg kg <sup>-1</sup> )	9.3	8.9	8.4	9.8	9.1	8.7
Exchangeable K (cmol kg <sup>-1</sup> )	0.16	0.14	0.12	0.15	0.14	0.12
Exchangeable Ca (cmol kg <sup>-1</sup> )	1.89	1.69	1.56	1.67	1.48	1.35
Exchangeable Mg (cmol kg <sup>-1</sup> )	0.45	0.39	0.35	0.58	0.44	0.39

## Results and discussion

Soil bulk density (BD) increased, while soil water content (WC) decreased with increase in tillage intensity, whereas soil OM, N, P, K, Ca and Mg reduced with increase in tillage intensity, thus ZT conserved soil nutrients the most, and increased nutrient uptake. Soil OM and nutrient concentrations was lowest under the P+2H treatment due to leaching, oxidation and increased biological activity (Adekiya et al., 2016). The ZT, MR and MM treatments prompted quicker growth and higher rhizome yield. As rate of PM increased from 0 to 20.0 Mg ha<sup>-1</sup> soil BD and WC improved and soil pH, OM, N, P, K, Ca and Mg increased. The 15.0 Mg ha<sup>-1</sup> PM gave the highest soil K, Ca and Mg, growth and yield parameters of ginger. Owo site had significantly higher growth and yield parameters of ginger compared with Uso site attributed to better soil nutrients especially K at Owo site. Growth and yield parameters of ginger increased with increase in PM level up to 15.0 Mg ha<sup>-1</sup>. Among all tillage cum manure treatments, ZT+15.0 Mg ha<sup>-1</sup> PM gave the highest values of growth and yield parameters of ginger.

## Conclusion

ZT most conserved soil properties and sustained higher growth and yield of ginger while PM at 15.0 Mg ha<sup>-1</sup> most increased chemical properties, growth and yield of ginger. For soil and ginger sustainability and productivity, combination of ZT and PM at 15.0 Mg ha<sup>-1</sup> is recommended in the study areas.

## References

- Adekiya, A.O., Agbede, T.M., Ojeniyi, S.O., 2016. The effect of three years of tillage and poultry manure application on soil and plant nutrient composition, growth and yield of cocoyam. *Expl. Agric.*, 52(3), 466-476.
- Sati, S.A., Bala, G., 2017. A comparative analysis of ginger cultivation methods in Kurmin-Jatau, District of Jaba Local Government Area, Kaduna State, Nigeria. *Asian J. Soil Sci. Plant Nutr.*, 1(1), 1-18.
- Zaman, M.M., Masum, A.S.M.H., Ahmed, N.U., Salam, M.A., Rahman, M.H., 2002. Effect of tillage and mulch on the growth and yield of ginger in the hilly area. *J. Biol. Sci.*, 2(2), 121-123.

## Effects of Cover Crops and Tillage Methods on Maize Growth and Soil Physical Properties on a Sandy Loam Soil

L. Ren<sup>1\*</sup>, T. Vanden Nest<sup>2</sup>, G. Ruyschaert<sup>2</sup>, T. D'Hose<sup>2</sup>, W. Cornelis<sup>1</sup>

<sup>1</sup>*Ghent University, Department of Environment, Ghent, Belgium*

<sup>2</sup>*ILVO, Flanders Research Institute for Agriculture, Fisheries and Food, Plant Sciences Unit, Burg. Van Gansberghelaan 109, 9820, Merelbeke, Belgium*

\*corresponding author: [Lidong.ren@ugent.be](mailto:Lidong.ren@ugent.be)

### Introduction

Soil compaction is a worldwide threat to sustainable agriculture, as it has various adverse impacts on soil quality, crop growth and the environment. As part of this response, tillage is recognized as a fast and efficient method and plant roots are believed as an environmental friendly and promising way to alleviate soil compaction. However, the effects of cover crops and strip tillage on arable soil and crop growth to alleviate soil compaction are not well documented. The objectives of this study were to 1) assess the effect of two winter cover crops (white mustard and winter rye) on the next season's soil properties and maize growth; 2) compare the effects of strip tillage (ST) and intensive tillage (IT) on soil physical properties, soil water content and maize growth.

### Material and methods

A field trial was conducted on a sandy loam soil in Belgium. Between Autumn 2016 and Spring 2017 (winter season), two types of cover crops were grown (white mustard with tap roots and winter rye with fibrous roots) in a randomized block design with eight replications. In Spring 2017, an additional factor, Spring tillage, was introduced, i.e., ST and IT in a split plot design and afterwards maize was grown as the main crop in 2017(Summer season). We thus had four treatments by combining the two tillage practices with the two previous cover crops. Three replications were chosen in the Summer season. In the Winter season, cover crop biomass and root distribution (core-break method) were measured. In the Summer season, soil moisture content, penetration resistance, root distribution (trench profile method; Fig. 1) and maize biomass were observed.



Fig. 1. Trench profile method to detect root distribution between two maize row

## Results and conclusion

The two different cover crops types showed no significant differences on soil physical properties in a one year's system, but slight differences were found in maize root growth (Fig. 2) and above-ground biomass.

Strip tillage was sufficient to temporarily loosen the soil in crop rows. The out-row soil properties, i.e., penetration resistance, bulk density and porosity structure differed between ST and IT in the top 30 cm, which greatly restricted maize root distribution (Fig. 2), but did not affect maize growth. Worth mentioning is that the first half of 2017 was exceptionally dry according to Royal Meteorological Institute of Belgium (RMI). In contrast, ST seemed to be better in terms of overall mean maize biomass. Overall, ST seemed suitable to apply in the study area for maize growth after IT in the previous year; however, a long-time study will be useful to confirm and extend this conclusion.

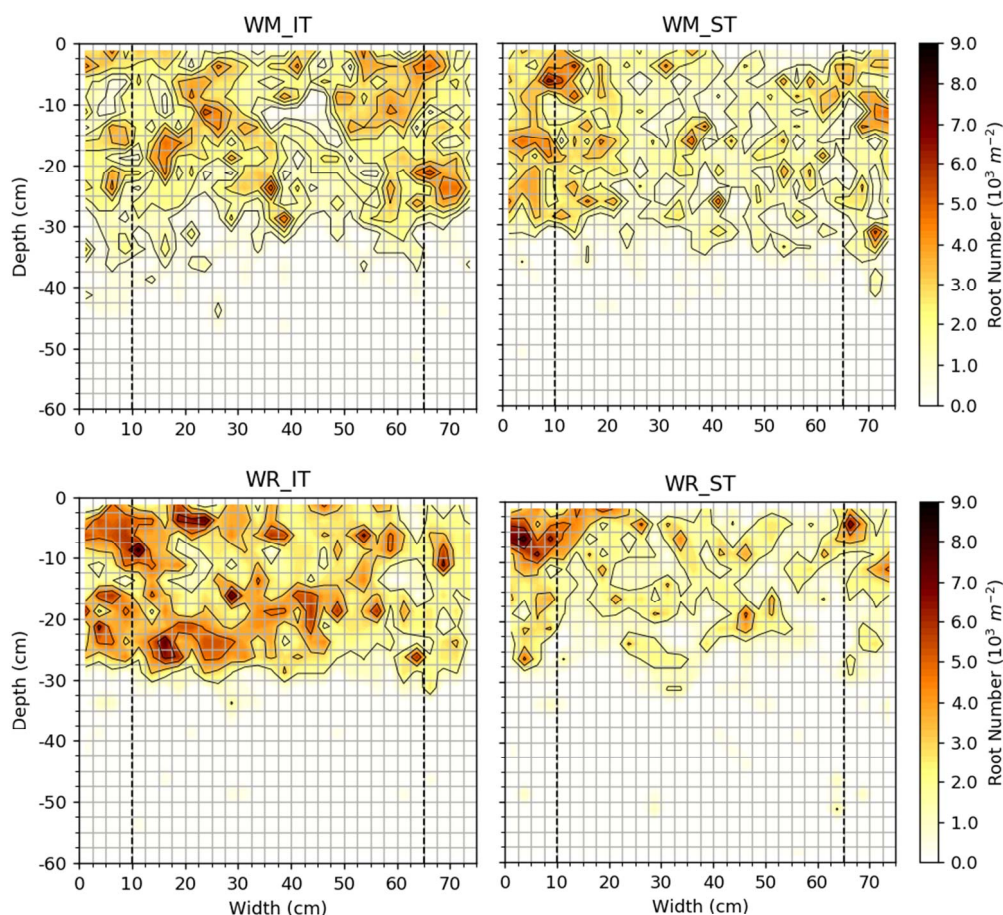

Fig. 2. Average (n=3) maize root number density profile distribution in each treatment (WR\_IT = winter rye \_ intensive tillage, WR\_ST = winter rye \_ strip tillage, WM\_IT =white mustard \_ intensive tillage, WM\_ST = white mustard \_ strip tillage). The maize rows were located at 0 and 75 cm. The dashed lines indicate the border of the tilled area of ST where residues were removed.



## **Soil quality monitoring by farmers in the frame of a result-oriented scheme: the case of Swiss arable land**

Ophélie Sauzet<sup>1\*</sup>, Karine Gondret<sup>1</sup>, Alice Johannes<sup>2</sup> and Pascal Boivin<sup>1</sup>

\* [ophelie.sauzet@hesge.ch](mailto:ophelie.sauzet@hesge.ch)

1: HEPIA, inTNE-Agronomy, University of applied sciences of western Switzerland, 150 route de Presinge, CH 1254 Jussy-Geneva

2: Swiss Federal Research Station Agroscope, Soil Fertility and Soil Protection group, Department of Natural Resources & Agriculture, Reckenholzstrasse 191, CH-8046 Zurich, Switzerland

### *Preserving soil quality*

IPBES (2018) acknowledges that globally soil quality is severely depleted, particularly under intensive agriculture. The public awareness on the importance of soil functions has dramatically raised, and a large part of the Sustainable Development Goals rely on soil quality. Therefore, a growing pressure is applied on agriculture to preserve and restore soil quality.

### *The need for result oriented agricultural management schemes*

Soil quality in arable land is addressed by different action-oriented policy tools. In high income countries, farmers can be subsidised for the application of recommended techniques. A general finding is that the action-oriented schemes largely fail to reach their objectives (Burton & Schwarz, 2013). This is also observed in Switzerland, where the agro-environmental monitoring reports steady indicators of environmental impact along the past decade. In detailed studies comparing different soil management systems such as conservation agriculture and conventional tillage, a small or even non-significant difference of soil quality between these systems was found, together with a very large heterogeneity within each. This is why action-oriented schemes are questioned and result-oriented management schemes are called. The conditions and advantages of the latter are reviewed by (Burton & Schwarz, 2013). Result-oriented management schemes were not applied to the management of soil quality in arable land, so far, in particular because indicators fulfilling the conditions were not available.

### *Soil quality and visual assessment*

Soil quality is the capacity of soils to function in an ecosystem with a given land management while guaranteeing agricultural production (Bünemann *et al.*, 2018). Since many soil functions depend on the soil's structural state, the structure becomes a guarantee of soil quality. The VESS spade test has been developed and tested in recent years (Ball *et al.*, 2017) i) delivers immediate and reliable results, ii) facilitates communication between farmers and scientists, and iii) provides an interpretable soil quality index. VESS is already used for soil quality monitoring (Mueller *et al.*, 2013). Soil structure may change rapidly with seasons and plant growth, upon trafficking or tillage. Therefore, VESS is a short term (season) indicator.

### *Soil quality and OM content*

OM is the main indicator for overall soil quality because it determines most of the soil functions. However, the OM:clay ratio was shown to determine structure quality for different soils (Feller & Beare, 1997; Dexter *et al.*, 2008; Johannes *et al.*, 2017). In other words: more organic matter with increasing clay content is needed to reach a given structure quality level and OM:clay ratio is a driver of soil structure quality. Changes in OM content as a function of soil management are usually detectable after 5 to 10 years at field scale, therefore OM:clay ratio is a middle term (5-10 years) indicator. (Johannes *et al.*, 2017) showed that optimal structure quality (VESS score < 2) corresponds to an average OM:clay ratio of 24%, the limit

between acceptable and damaged structure corresponds to 17% OM:clay ratio, and degraded structures (VESS > 4) correspond to OM:clay ratio < 12%.

#### *A farmer-based monitoring*

Success of result-based schemes depends on i) the involvement of farmers by self-monitoring through visual assessment, ii) the combination with regular analytical control, and iii) the integration of a sampling protocol whose reliability has already been demonstrated. Self-monitoring by farmers increases their involvement and the social value of the result-based schemes (Burton & Schwarz, 2013).

VESS and OM:clay ratio, which is a relevant and more holistic assessment of soil quality, fulfill the conditions for a result-oriented management scheme of soil quality. This approach was discussed with the different actors involved in arable land management in Vaud canton, Switzerland. Farmers, advisers, cantonal authorities and scientists agreed on a monitoring based on these indicators and performed by farmers. A mobile phone app was designed to allow teaching VESS, help farmers in the monitoring, and store the results. The sampling requirements of the VESS spade test were established after a spatial variability analysis (Leopizzi *et al.*, 2018). In Switzerland, to receive subsidies, farmers must analyze their topsoil for OM content (2-20 cm) at least each 10 year at plot scale (Required Ecological Benefits: REB). The minimum detectable change (MDC) and the standard deviation of deviation to the true mean (representativeness) with REB sampling protocol were quantified and compare to most soil quality monitoring networks. Finally all agricultural plots are digitalized in a federal GIS.

#### *Result oriented soil quality management scheme*

The following scheme was adopted with the farmers: When OM:clay ratio is smaller than 12%, farmers can only receive subsidies for personal training and advisers services. From 12 to 24%, the annual subsidy per ha is increasing, provided that the VESS score of the plot is not larger than 3 two consecutive years. At 24%, the maximum subsidy level is reached.

#### *References*

- Ball, B.C., Guimarães, R.M.L., Cloy, J.M., Hargreaves, P.R., Shepherd, T.G. & McKenzie, B.M. 2017. *Visual soil evaluation: A summary of some applications and potential developments for agriculture. Soil Tillage Res*, 173, 114–124.
- Bünemann, E.K., Bongiorno, G., Bai, Z., Creamer, R.E., De Deyn, G., de Goede, R., Fleskens, L., Geissen, V., Kuyper, T.W., Mäder, P., Pulleman, M., Sukkel, W., van Groenigen, J.W. & Brussaard, L. 2018. *Soil quality – A critical review. Soil Biol Biochem*, 120, 105–125.
- Burton, R.J.F. & Schwarz, G. 2013. *Result-oriented agri-environmental schemes in Europe and their potential for promoting behavioural change. Land Use Policy*, 30, 628–641.
- Dexter, A.R., Richard, G., Arrouays, D., Czyz, E.A., Jolivet, C. & Duval, O. 2008. *Complexed organic matter controls soil physical properties. Geoderma*, 144, 620–627.
- Feller, C. & Beare, M.H. 1997. *Physical control of soil organic matter dynamics in the tropics. Geoderma*, 79, 69–116.
- Johannes, A., Matter, A., Schulin, R., Weisskopf, P., Baveye, P.C. & Boivin, P. 2017. *Optimal organic carbon values for soil structure quality of arable soils. Does clay content matter? Geoderma*, 302, 14–21.
- Leopizzi, S., Gondret, K. & Boivin, P. 2018. *Spatial variability and sampling requirements of the visual evaluation of soil structure in cropped fields. Geoderma*, 314, 58–62.
- Mueller, L., Shepherd, G., Schindler, U., Ball, B.C., Munkholm, L.J., Hennings, V., Smolentseva, E., Rukhovic, O., Lukin, S. & Hu, C. 2013. *Evaluation of soil structure in the framework of an overall soil quality rating. Soil and Tillage Res*, 127, 74–84.

## **A root elongation assay for assessing the impact of tillage in medium-term management trials**

\*T.A.Valentine<sup>1</sup>, K.Binnie<sup>1</sup>, R. Stobart<sup>2</sup>, P.D. Hallett<sup>3</sup>, N.L. Morris<sup>4</sup>, T.S. George<sup>1</sup>, A.C. Newton<sup>1</sup> and B. McKenzie<sup>1</sup>.

\*Corresponding author: Tracy.Valentine@hutton.ac.uk

<sup>1</sup>The James Hutton Institute, Invergowrie, Dundee, DD2 5DA, Scotland, UK

<sup>2</sup>Sainsbury's supermarkets Ltd., 33 Holborn, London EC1N 2HT, UK

<sup>3</sup>Institute of Biological and Environmental Sciences, University of Aberdeen, Aberdeen, AB24 3UU, Scotland, UK

<sup>4</sup>NIAB, Morley, Wymondham, Norfolk NR18 9DF, UK

### **Introduction**

Tillage in various forms is a standard preparation prior to crop sowing. This process changes soil physical structure and can also alter the stratification of soil nutrients. Recent increases in the use of reduced tillage in UK exposed a knowledge gap in the effects of alternative forms of tillage on UK soils and the potential knock on effects on plant productivity and farm sustainability. The "Platforms to test and demonstrate sustainable soil management: integration of major UK field experiments" project aimed to address this knowledge gap (McKenzie et al., 2017). The project utilised four medium term (6-11 year) soil management trials within the UK including various tillage methods. The authors assessed physical, chemical (including carbon) changes, variation in cultivar yield and economic performance under the different tillage systems. The object of this part of the project was to assess changes in soil physical structure as a result of the different tillage systems and assess the potential knock on effects on root elongation and plant performance.

### **Materials and Methods**

Soil samples were obtained from four medium term farm management trials based in the UK (STAR, NFS and Mid-Pilmore, CSC). The sites have contrasting soil textures. Each trial included plots managed by mouldboard ploughing to 20 cm and disking (P) and at least one of the following treatments: no till (NT); shallow non-inversion tillage to a depth of 7 cm (SNI); deep non-inversion tillage to a depth of greater than 25 cm (DNI); compaction by ploughing to 20 cm followed by wheeling with an 8.8 Mg total load (C). Soil was sampled from multiple replicate plots as intact soil cores (approximately 5cm diameter x 5cm height) and as homogenised loose soil across four growing seasons. Samples were taken at the beginning and middle of the growing season, and after harvest, at a range of depths (2-7cm, 7-12cm, 25-30cm and 30-35cm). Not all combinations of depth and sampling stage were obtained, for example mid-season samples were usually only taken at 2-7cm. Intact cores were processed through a matrix potential sequence to obtain water retention curves. Soil strength measurements were taken at three matric potentials using an Instron linked needle penetrometer. Air filled porosity, volumetric water content at different matric potentials was calculated as in Valentine et al. (2012). Loose soil was sieved and packed into cores at a reduce bulk density compared with intact cores. Root elongation assays were performed at a matric potential of -20kPa as in Valentine et al. (2012) using barley (*Hordeum vulgare*) seedlings (cv. Optic) with growth recorded over 48 hours. Elongation rate was calculated by subtracting the length of the longest root at sowing from the final length. Linear mixed models were developed to assess the effects of Trial, Tillage, Sampling time and Depth on the soil physical and chemical properties and the effects of these management and soil properties on root elongation rates. All analysis was performed in R.



## Results and discussion

Significant differences in soil structure were found between the trial sites and between tillage treatments. The vast majority of the variation in soil physical and chemical properties was associated with differences between sites however there were changes in soil structure associated with the tillage methods. Significant changes due to tillage were found for dry bulk density (DBD), air filled porosity (AFV), volumetric water content (VWC) and pore space distribution in some, but not all trials. Root elongation rates in the soil cores were affected by trial site, tillage, sampling time and the depth at which the samples were taken (Figure 1). There were multiple significant interactions. Root elongation was frequently below optimum with average elongation rates ranging from 0.06 – 0.48 mm/hr. Averaged across all trials, depths and sampling times root elongation rates ranged from 0.20 mm/hr in soil from the DNI plots to 0.27 mm/hr in soil from the C plots. Thirty-seven percent of the variation in root elongation rates could be accounted for by differences in the physical status of the soil cores, accounting for a greater proportion than chemical properties (approx. 20%). In addition after reducing the differences in physical properties by repacking the soil cores at a reduced DBD no differences were found between the root elongation rates linked to Trial, Tillage, sampling time or depth. Soil pore structure and AFV were important parameters that were linked to changes in tillage, sampling time and sampling depth across the different trials, with these properties having strong correlation with the root elongation rates.

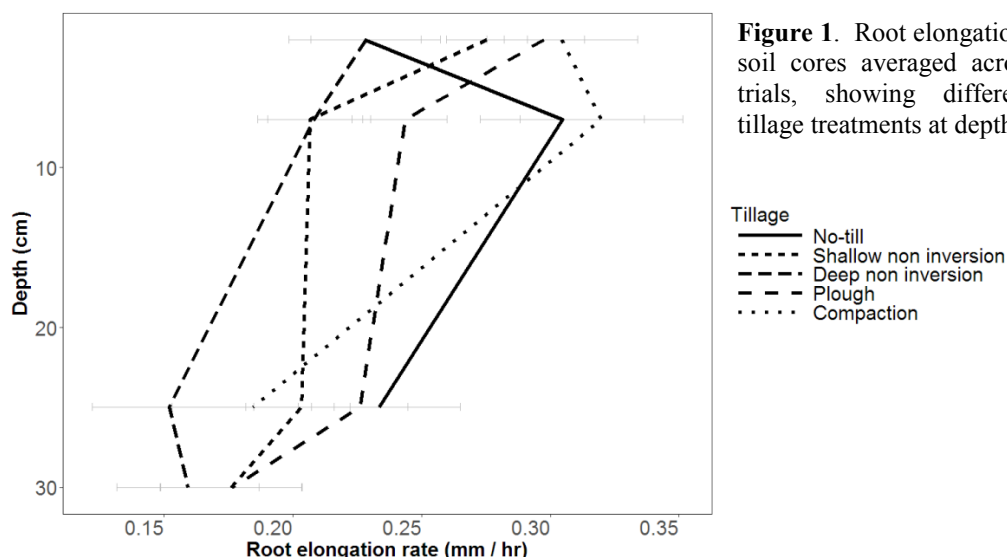

**Figure 1.** Root elongation rates in intact soil cores averaged across four tillage trials, showing differences between tillage treatments at depth.

## Conclusions

Evidence of effects of trial, tillage both within and across sites, sampling time and sampling depth were found in terms of the rates of root elongation achieved and in terms of changes in soil physical properties. Chemical properties of the soil accounted for a larger proportion of the variation in root elongation in this dataset than reported in Valentine et al (2012), however the physical properties still accounted for a greater proportion of the variation in root elongation rates than the chemical properties and the differences in the physical properties are likely to be the main drivers in differences at this early rooting stage.

## References

- McKenzie, B.M., Stobart, R., Brown, J.L., George, T.S., Morris, N., Newton, A.C., Valentine, T.A., Hallett, P.D. 2017. Platforms to test and demonstrate sustainable soil management: integration of major UK field experiments. *AHDB Final Report RD-2012-3786*, 178pp.
- Valentine, T.A., Hallett, P.D., Binnie, K., Young, M.W., Squire, G.R., Hawes, C., Bengough, A.G. 2012. Soil strength and macropore volume limit root elongation rates in many UK agricultural soils. *Annals of Botany*, 110(2), 259-270.

## Intensity-capacity parameters and management of waterlogged volcanic soils

F. Zúñiga<sup>1,2\*</sup>, R. Horn<sup>3</sup>, J. Dörner<sup>2,4</sup>

<sup>1</sup> Graduate School, Faculty of Agricultural Sciences, Universidad Austral de Chile, Campus Isla Teja, Valdivia, Chile.

<sup>2</sup> Instituto de Ingeniería Agraria y Suelos, Universidad Austral de Chile, Campus Isla Teja, Valdivia, Chile.

<sup>3</sup> Institute for Plant Nutrition and Soil Sciences, Christian Albrechts University, Olshausenstrasse 40, 24118 Kiel, Germany

<sup>4</sup> Centro de Investigación en Suelos Volcánicos (CISVo), Universidad Austral de Chile, Campus Isla Teja, Valdivia, Chile.

\* corresponding author: [felipezunigaugalde@gmail.com](mailto:felipezunigaugalde@gmail.com)

### Introduction

In southern Chile, humid temperate climate enables the grasslands management based in grazing systems (mainly dairy, beef, and sheep's). The main soils in these agroecosystems are derived from volcanic materials (Andosols) covering around 60% of the agricultural and livestock landscape in Chile. These soils exhibit specific properties as: i) bulk density  $\leq 0.9 \text{ Mg m}^{-3}$ ; ii) high reactivity  $\text{Al}_o + 0.5\text{Fe}_o \geq 2\%$  and iii) SOC  $< 25\%$  (Shoji et al., 1993). One specific group of these soils (Aquands) are called “Ñadis” (ÑS) that occupy the glacial plains between moraines. They are characterised by the presence of iron cemented layer (Bsm) favouring intense waterlogging during winter (May to September), also by the high spatial dependency of soil depth that regulates the water table (Dörner et al., 2017). Ameliorative strategies, such as mole drainage, can drain ponding water from the soil. Combined with fertilisation that improves the performance of naturalised grasslands even if the success of these managements depends on soil physical properties (e.g. intensity-capacity parameters, Horn and Kutilek, 2009). This paper explores the anisotropy of intensity-capacity parameters of a ÑS profile before mole drainage implementation and the interaction between drainage-fertilisation strategies as productive attributes in those pastures.

### Material and method

We selected a ÑS soil profile (Alerce soil series) classified as Duric histic Placaquand. Soil morphological descriptions, specific dissolution techniques ( $\text{Al}_o$ ,  $\text{Fe}_o$ , NaF pH) defined andic properties. Undisturbed soil samples in vertical ( $v$ ) and horizontal ( $h$ ) direction were used to quantify the air permeability ( $k_a$ ) at -3, -6, -15 and -33 kPa of matric potential as well as the soil profile distribution of pores sizes. In the naturalised grassland we established an experiment with drainage and fertilization with 4 treatments: T0 (without drainage and fertilization); T1 (without drainage + fertilization); T2 (continuous drainage + fertilization) T3: (controlled drainage + fertilization)<sup>1</sup>. 3 exclusion cages by treatments were installed for evaluate the biomass accumulation and the relation with the climate conditions of the agroecosystem.

### Results and discussion

From the top (0-17 cm) to the bottom (48-57 cm),  $\text{Al}_o+0.5\text{Fe}_o$  varied between 2.58 to 5.26%, SOC between 25 to 7% and mean of NaF pH was 11.5. These data affirm that the andic properties dominate in all horizons. Independent of the sampling orientation, the bulk density as a scalar was  $0.48 \text{ Mg m}^{-3}$ . The main differences were found at 50 cm in the middle pores (MP,

<sup>1</sup> Controlled drainage means that among October to March we put a sluice to avoiding the water from drainage from naturalised fertilised grassland. Continuous drainage indicates that the water flows free during all year.

Figure 1B), that could be related to differences in the soil volume sampled consequence of sampling orientation. Likewise, the matric potential increase, the air fluxes are higher. The highest value of air permeability was  $2.20 \log \mu\text{m}^2$  (Figure 1E). At 57 cm, where the soil structure is weak, the horizontal sampling could favour the crack formation during sampling.

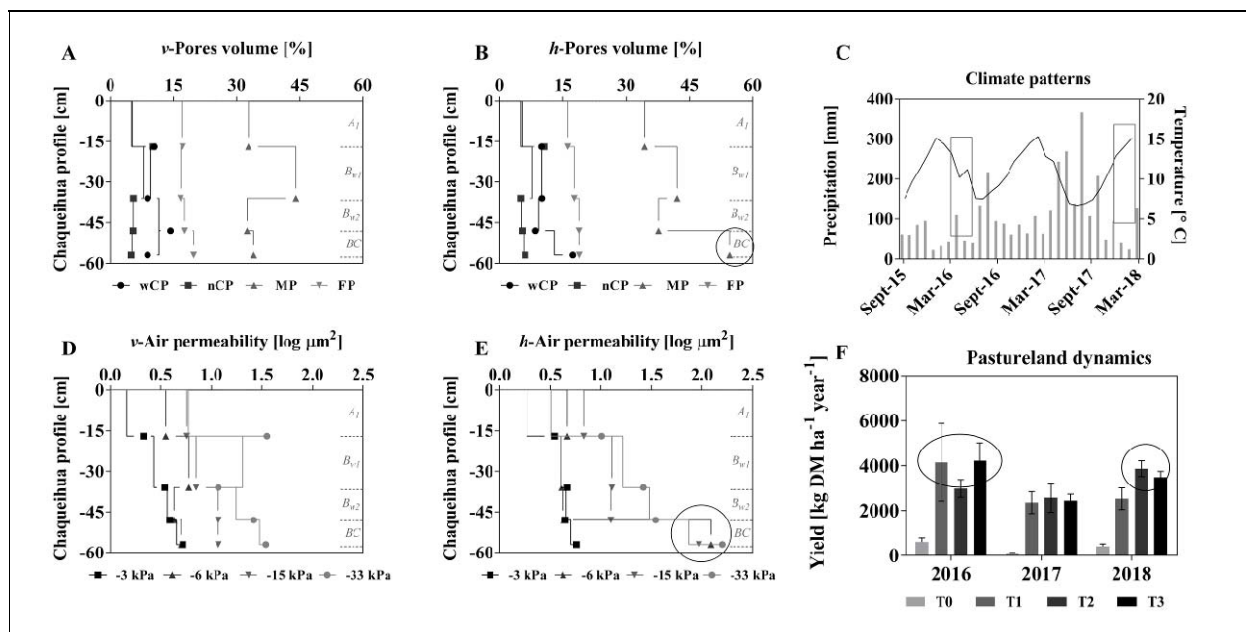

Figure 1. Distribution of soil physical properties according to sampling orientation (*v-h*). A-B: Pore size distribution; D-E: Air permeability. C: Climogram of precipitation and temperature and F: Yield of pasture through the experimental period (2016-2018).

The drainage-fertilization strategies provoked a positive response in the yield of naturalised grasslands. In late summer (Mar-16) the rainfall and adequate temperature ( $12\text{ }^{\circ}\text{C}$ ) favour the biomass accumulation (Figure 1C). Thus, pastures that conserve the water in dry season due to controlled drainage (T1 and T3) reached the highest yield (Figure 1F,  $4,000 \text{ kg MS ha}^{-1}$ ). Between December 2017 to March 2018, the mean temperature was  $13.7^{\circ}\text{C}$  and high rainfall accumulation reached (284 mm), allowing the increase of biomass in T2 (free drainage) and T3 (controlled drainage). This soil has a high storage capacity of water (35-45%) of middle pores ( $\phi = 10\text{-}0.2 \mu\text{m}$ ) that extend the available water period for the plants and results in yield increase of NG, especially in wet summer seasons.

## Conclusion

The Duric histic Placaquand has a small bulk density, a wide pore size distribution with dominating by middle pore sizes in the B horizon, where the anisotropy of air permeability as well defined. A large amount of plant available water supports a beneficial biomass production, particularly in wet summer season.

## References

- Dörner, J., Horn, R., Dec, D., Wendroth, O., Fleige, H., Zúñiga, F., 2017. Land-Use-Dependent Change in the Soil Mechanical Strength and Resilience of a Shallow Volcanic Ash Soil in Southern Chile. *Soil Sci. Soc. Am. J.* 81, 1064–1073. doi:10.2136/sssaj2016.11.0378
- Horn, R., Kutilek, M., 2009. The intensity–capacity concept—How far is it possible to predict intensity values with capacity parameters. *Soil Till. Res.* 103, 1-3. doi:10.1016/j.still.2008.10.007
- Shoji, S., Dahlgren, R., Nanzyo, M., 1993. Volcanic Ash Soils. Genesis, Properties and Utilization. Elsevier, Amsterdam.

## Short-term effects of loosening and incorporation of straw into the upper subsoil on soil physical properties and crop yield

Gizachew Tarekegn Getahun<sup>a\*</sup>, Thomas Kätterer<sup>a</sup>, Lars Juhl Munkholm<sup>c</sup>, Mohammed Masud Parvage<sup>a</sup>, Thomas Keller<sup>ab</sup>, Katrin Rychel<sup>a</sup>, Holger Kirchmann<sup>a</sup>

<sup>a</sup>Department of Soil and Environment, Swedish University of Agricultural Sciences, Box 7014, SE-750 07 Uppsala, Sweden

<sup>b</sup>Agroscope Reckenholz-Tänikon Research Station ART, Department of Natural Resources and Agriculture, Reckenholzstrasse 191, CH-8046 Zurich, Switzerland

<sup>c</sup>Aarhus University, Faculty of Agricultural Sciences, Department of Agroecology and Environment, Research Centre Foulum, P.O. Box 50, DK-8830 Tjele, Denmark

\*Corresponding author: Gizachew Tarekegn Getahun, [gizachew.tarekegn.getahun@slu.se](mailto:gizachew.tarekegn.getahun@slu.se)

### Introduction

Subsoil that is compacted, nutrient-deficient or low in soil organic matter (SOM) can limit crop growth, yield and quality (Kautz et al., 2013). Improving subsoil by loosening may not last, as soils re-compact with time. Therefore, combining loosening with other soil amelioration practices may be relevant (Hamza and Anderson, 2005). The aims of the paper were to investigate the short-term effect of deep loosening and injection of straw slurry (30 Mg dry mass ha<sup>-1</sup>) into the upper subsoil on soil physical properties, crop growth and yield.

### Material and methods

The field study was on a Eutric Cambisol at Säby (Uppsala, Sweden; 59°49'N, 17°42'E) used for arable crops for more than 100 years. It started in autumn 2015 and monitored soil and crop properties during 2016. Treatments include subsoil loosening only, subsoil loosening + straw incorporation and control. Cereal straw was submerged in water to produce a slurry for injection. The net subsoil area affected by loosening was 43% per plot (32 cm width x 9 cm depth). During loosening of the soil, the straw slurry was injected under pressure into the upper subsoil through rectangular openings in metal pipes welded behind each vertical tine and mounted on the back of a slurry tank.

Subsoiling and straw incorporation were performed to 25-34 cm depth. The organic amendment was applied at about 30 Mg dry mass ha<sup>-1</sup>. The soil area affected by loosening + straw treatment was 43%, of which 11% was enriched with straw slurry. Loosening and loosening plus straw injection lines were marked and soil and crops were sampled randomly along the lines. Soil samples were taken in each plot at 29-34 cm depth. Final yield was measured from combine-harvester data for the whole plot. Total porosity was calculated assuming a particle density of 2.65 g cm<sup>-3</sup>. Particle density was corrected for straw addition in the loosening + straw slurry treatment, which was denoted as 1.41 g cm<sup>-3</sup> (average of decomposed and undecomposed straw) (Guerif cited in Soane, 1990). Saturated water content ( $\theta_{\text{sat}}$ ), water content at field capacity ( $\theta_{\text{fc}}$ ) and wilting point ( $\theta_{\text{wp}}$ ) were estimated from a pedotransfer function (PTF) used to predict hydraulic properties of Swedish soils (Model 8 in Kätterer et al., 2006). The results were associated with different soil pores to calculate pore size distribution. The difference between  $\theta_{\text{fc}}$  and  $\theta_{\text{wp}}$  multiplied by the thickness of the soil layer was considered to represent plant-available water in that specific soil layer. Analysis of variance was performed with the R-software, version 3.4.0. Pearson correlation coefficient was calculated to assess the relationships between soil parameters.

### Results and discussion

The concentration of SOC at 29-34 cm was higher in the loosening + straw treatment than in the control in spring ( $P=0.01$ ) and autumn ( $P=0.01$ ). The large amount of straw added was the driving factor for the increase in SOC. Bulk density in the 29-34 cm layer was lower for

loosening + straw than for the loosening treatment only ( $P=0.006$ ) and for the control in autumn. Lower BD values were due to the combined effects of the large amount of organic material added being less dense than soil mineral particles and enhancing soil porosity, and of deep loosening. Bulk density in the loosening + straw treatment remained almost unchanged even after a number of field operations during 2016, showing that organic material incorporation plus loosening had a more positive effect than loosening only. There was a statistically significant negative correlation between SOC and BD ( $R^2=0.45$  in spring,  $R^2=0.96$  in autumn). In spring, water content in the 29-34 cm soil layer was 41.3, 25.3 and 22.5% in the loosening + straw, loosening only and control treatments, respectively, with loosening + straw being significantly different from the other two treatments. In autumn, differences in water content were not significant, although somewhat higher than in the control ( $P=0.08$ ). However, penetration resistance (PR) was significantly lower in the loosening + straw treatment than in the control and loosening only.

Penetration resistance in autumn 2016 was positively related to soil BD  $R^2=0.48$  ( $P=0.01$ ) and negatively to water content  $R^2=0.56$  ( $P=0.005$ ). Lower BD and a tendency for higher water content in the loosening + straw treatment most likely caused the lower PR values.

The cereal straw, with a water-holding capacity of  $5.5 \text{ mL g}^{-1}$  dry weight, was expected to increase the water-holding capacity in the 25-34 cm soil layer by 15 mm. Estimation of potential available water in the 29-34 cm layer using a PTF showed that the loosening + straw treatment increased plant-available water significantly, by e.g. 6.4 mm in spring ( $P=0.01$ ), compared with the control. A yield increase of 5.6% in the loosening + straw treatment could be partly explained by having 6.4 mm more plant-available water, which reflected the ability of SOC to store more water than soil only. Thus, longer periods of moist conditions in the straw slurry lines than in untreated soil could have favoured root and plant growth in general. Pore volume in which roots could grow (macro and meso) was 37% higher in the loosening + straw treatment than in the control, while plant-available water was 56% higher. These results indicate that the plant-available water in the loosening + straw soil contributed more to the yield increase than porosity, which provides channels for roots to grow. In the loosening treatment, both pore volume (macro and meso) and plant-available water contributed to a similar extent to the yield increase. Grain yield records showed that loosening + straw resulted in significantly higher yield (5.6%,  $P=0.03$ ) than the control. However, the increase in yield may have been underestimated, since there was weed infestation in the loosening + straw treatment. The yield response due to loosening also tended to be significantly higher than in the control (4%,  $P=0.06$ ).

### Conclusion

Our results suggest that loosening and incorporation of straw slurry into the upper subsoil has the potential to improve soil physical conditions in the short term. Lower soil BD, improved porosity and higher water content resulting in 5.6% higher yield. Compared to pore volume where roots can grow (macro and meso), plant available water contributed more to yield increase.

### References

- Hamza, M., and Anderson, W. (2005). Soil compaction in cropping systems: a review of the nature, causes and possible solutions. *Soil and tillage research* **82**, 121-145.
- Kautz, T., Amelung, W., Ewert, F., Gaiser, T., Horn, R., Jahn, R., Javaux, M., Kemna, A., Kuzyakov, Y., and Munch, J.-C. (2013). Nutrient acquisition from arable subsoils in temperate climates: A review. *Soil Biology and Biochemistry* **57**, 1003-1022.
- Kätterer, T., Andrén, O., and Jansson, P.-E. (2006). Pedotransfer functions for estimating plant available water and bulk density in Swedish agricultural soils. *Acta Agriculturae Scandinavica Section B-Soil and Plant Science* **56**, 263-276.
- Soane, B. (1990). The role of organic matter in soil compactibility: A review of some practical aspects. *Soil and Tillage Research* **16**, 179-201.

## Assessing annual and vertical variability of soil near-saturated hydraulic conductivity for Integrated Weed Management-based cropping systems

C. Ugarte Nano<sup>1\*</sup>, B. Nicolardot<sup>2</sup>, M. Ubertosi<sup>2</sup>

<sup>1</sup> UniLaSalle, Chaire Agro-Machinisme et Nouvelles Technologies, UP AGHYLE, 60000 Beauvais, France

<sup>2</sup> UMR Agroécologie, AgroSup Dijon, CNRS, INRA, Université Bourgogne Franche-Comté, 21000 Dijon, France

\* corresponding author: carolina.ugarte@unilasalle.fr

### Introduction

Tillage affects soil structure with consequences on other key soil properties such as the near-saturated hydraulic conductivity,  $K(h)$ , which is responsible for water flow and solute transport in the vadose zone.  $K(h)$  plays a major role in agroecosystem services by regulating water cycle and thus affecting nutrients cycles and crop production. Integrated Weed Management (IWM)-based cropping systems uses a combination of agricultural practices to reduce the use of herbicides for weed control, i.e. diversified crop rotations with diversified sowing dates, delayed autumn sowing, and intensive superficial tillage techniques such as the false seed technique and mechanical weeding (Chikowo et al., 2009). Among those agricultural practices, intensive superficial tillage techniques directly affects hydraulic properties and their temporal and spatial variability (Strudley et al., 2008). Less attention has been paid to  $K(h)$  vertical variability, while for  $K(h)$  annual variability results differ among studies because of the numerous factors involved. Factors influencing  $K(h)$  vertical variability include soil type, initial soil water content, porosity network, crop and cropping periods and tillage treatments (Schwen et al., 2011). The aim of our study was to assess the vertical and annual variability of the near-saturated hydraulic conductivity  $K(h)$  of a clayey soil for three IWM-based cropping systems with contrasting levels of tillage interventions.

### Materials and methods

The three IWM-based cropping systems considered (S2, S4 and S5) belong to a long term experiment started in 2001 at the INRA Dijon experimental unit in France (Chikowo et al., 2009). They presented increasing levels of tillage interventions (i.e. average superficial tillage operations per year) from cropping system S2 to S5 and decreasing reliance on herbicides from cropping system S2 to S5. The soil was a silty clay (USDA) with shrink-swell behavior classified as Cambisol hypereutric (WRB) and presented 3 soil layers: superficial tillage layer Ap1, plough layer Ap2 and structural layer Bm. Each cropping system was characterized in terms of its near-saturated hydraulic conductivity  $K(h)$  and initial water content  $\theta_i$ , at 3 soil depths: 10 cm (Ap1), 20 cm (Ap2) and 50 cm (Bm), with 3 replicates per soil depth. Soil characterization was repeated for 2 or 3 consecutive years for all cropping systems and soil layers. The tension disc infiltrometer device was used to measure *in situ* steady state infiltration rates at -5, -3, -2 and -1 cm pressure heads ( $h$ ). The hydraulic conductivity at each supply pressure head was then derived from steady state infiltration rates to obtain  $K(h)$  for all cropping systems, soil layers and year of measurements. To assess the vertical and annual variability of  $K(h)$  and  $\theta_i$  for each cropping system, effects of soil layers and year of measurement were analyzed using analysis of variance (ANOVA) tests.

### Results and discussion

Comparable  $K(h)$  values within horizons are explain by the well-developed porosity networks throughout the entire soil profiles resulting in comparable water conducting characteristics



(i.e. tortuosity, pore orientation and continuity) within soil layers (Figure 1). Annual variability of  $K(h)$  was analyzed independently for each cropping system. Hypothesis suggesting annual variability of  $K(h)$  related to the variability of initial water content, level of tillage interventions, crop and cropping periods and weather conditions was confirmed only for the superficially tilled cropping systems S4 and S5. Our results suggest a negative relationship between  $K(h)$  and soil initial water content  $\theta_i$  for all pressure head values, which may be related to the increase of soil macroporosity due to shrinkage under drier soil conditions. Absence of annual variability of  $K(h)$  was found for the no-till cropping system S2 despite the variability of soil initial water content, in agreement with the time-invariable effective macroporosity (results not shown). Our results allowed to confirmed the annual  $K(h)$  stability of no-till cropping system S2 in comparison to superficially tilled IWM-based cropping systems S4 and S5.

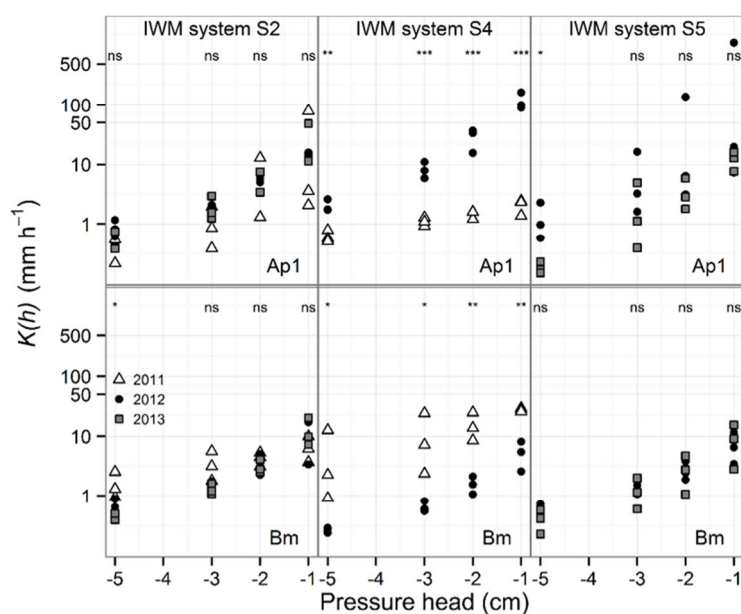

Figure 1 Near-saturated hydraulic conductivity  $K(h)$  for each IWM-based cropping system (S2, S4, S5) for all years of measurement (2011, 2012, 2013) and soil layers Ap1 and Bm. Symbols correspond to all experimental values (for each cropping system, 3 replicates for each soil layer and year of measurement). Significance levels calculated with 1-way ANOVA for factor “YEAR” are indicated on each graph: \*\*\* =  $P < 0.001$ , \*\* $P < 0.01$ , \* =  $P < 0.05$ ,  $P < 0.1$ , ns = not significant.

## Conclusions

No vertical variability of  $K(h)$  for any of 3 IWM-based cropping systems and years of measurement was observed in the context of a well-structured silty clay loam. Vertical homogeneity of  $K(h)$  was related to the well-structured porosity network of the clayey soil with shrink-swell behavior. Hypothesis suggesting the annual variability of  $K(h)$  was confirmed only for the superficially tilled cropping systems S4 and S5. The no-till cropping system S2 presented time-invariable  $K(h)$  for all horizons and despite different initial soil water content conditions. Our results allowed confirming the temporal stability of no-till cropping system S2 compared to superficially tilled cropping systems S4 and S5.

## References

Chikowo, R., Faloya, V., Petit, S., Munier-Jolain, N.M., 2009. Agric. Ecosyst. Environ. 132, 237–242.

Schwen, A., Lawrence-Smith, G.H.-R.-E., Sinton, S.M., Carrick, S., Clothier, B.E., Buchan, G.D., Loiskandl, W., 2011. Soil Sci. Soc. Am. J. 75, 822–831.

Strudley, M.W., Green, T.R., Ascough II, J.C., 2008. Soil Tillage Res. 99, 4–48.



1           **A novel deep tillage technique — Fenlong tillage**

2   Benhui Wei<sup>1</sup>, Xinhua Peng<sup>2,\*</sup>

3           <sup>1</sup>*Institute of Cash Crops, Guanxi Academy of Agricultural Sciences, Nanning,*  
4           *530007;*

5           <sup>2</sup>*Soil and Sustainable Agricultural State Key Laboratory, Institute of Soil Science,*  
6           *Chinese Academy of Sciences, Nanjing, 210008)*

7

8           Corresponding author:

9           Xinhua Peng

10          xhpeng@issas.ac.cn

11          Tel: +86-(0)25-8688 1198

12

13

14 **Abstract**

15 Fenlong tillage technique, inspired by the principle that carpenters use  
16 a spiral drill to make holes and loosen debris, is composed of several  
17 groups of “spiral drills”, which enter soils vertically, run in a horizontal  
18 rotation way, and break soil blocks into pieces. With the spiral drill, the  
19 Fenlong tillage can easily reach down to 30-40 cm soil depth or even  
20 deeper, while the upper and lower soil layers are kept in order. Thus, the  
21 Fenlong tillage may be re-named as “deep horizontal rotary tillage”. The  
22 Fenlong tillage increases the depth of soil plough layer remarkably so that  
23 better physical conditions are prepared for crop root growth.  
24 Consequently, the utilization efficiency of water and nutrient resources is  
25 greatly enhanced. Over the past decade, 36 experimental sites across 12  
26 provinces nationwide showed that the Fenlong tillage increased the yield  
27 of different crops by 6.7%-53.7% as compared with the traditional rotary  
28 tillage. Thus, the Fenlong tillage may provide a new tool for increasing  
29 food production.

30

31 **Keywords:** Deep horizontal rotary tillage; Fenlong tillage; Crop yield

32

## **Rates of Mechanized Tillage Operations as Affected by Manual and Mechanized Agricultural Bush Clearing Methods**

**J.C. Adama**

**Department of Agricultural and Bioresources Engineering**

**Michael Okpara University of Agriculture, Umudike,**

**P.M.B. 7267, Umuahia-Nigeria**

**08039146246**

**[adamajoseph@yahoo.com](mailto:adamajoseph@yahoo.com)**

### **Abstract**

Timeliness is a factor in field operation for optimum crop yield. Power selection for mechanized field operation is governed by the ability of the machinery to accomplish the operation within the required time limit. A research was carried in the derived Savannah zone of Nigeria to determine the rates of mechanized tillage operations as affected by manual and mechanized agricultural bush clearing methods. The tillage operations considered are ploughing, harrowing and ridging. Four blocks were mapped out in each of the two locations (8 blocks) in the zone. Each block was divided into four plots (16 plots). Three plots in each block were cleared mechanically using three categories of tractor bulldozer models D6, D7 and D8. The fourth plot was cleared manually. For the tillage operation, a 41kW-two-wheel drive tractor was used. A one meter width disc plough was used for the ploughing operation. For harrowing, an offset disc harrow of width 3 m was used. The ridging operation was carried out using a 3 m width disc ridger. The experiments were performed in the first and second planting seasons of 2012, 2013 and 2014. The time used to complete the operations in each plot was recorded using a stopwatch. The rate of operation was obtained by dividing the size (0.01 ha) of each plot by the time taking to complete the operation.

Results show that for the three operations and in the two locations the rates of operation were higher in areas cleared manually than in areas cleared mechanically. For ploughing operation, the difference ranged from 0.01 to 0.02ha/hr at Agu Ukehe and between 0.02 to 0.03ha/hr in Ako Nke

**Tillage, Agriculture, Bush Clearing, Mechanization.**

## Appropriate Tillage Practices and N use to Improve Corn Yield in Irrigated Mediterranean Agroecosystems.

E. Pareja-Sánchez<sup>1\*</sup>, D. Plaza-Bonilla<sup>1,2</sup>, J. Álvaro-Fuentes<sup>2</sup>, C. Cantero-Martínez<sup>1</sup>

<sup>1</sup> Department of Crop and Forest Sciences, Unidad Asociada EEAD-CSIC, Agrotecnio, University of Lleida, Av. Rovira Roure 191, 25198 Lleida, Spain.

<sup>2</sup> Departamento de Suelo y Agua, Estación Experimental de Aula Dei (EEAD), CSIC, Avda. de Montañana 1005, 50059 Zaragoza, Spain.

\* corresponding author: [e.parejasanchez@gmail.com](mailto:e.parejasanchez@gmail.com)

### Introduction

In the Mediterranean rainfed area of the Ebro valley (NE Spain), an increasing adoption of reduced tillage (RT) and no-tillage (NT) techniques has taken place over the last 30 years (Lampurlanés *et al.*, 2016). However, as in many arid and semiarid regions, rainfed areas are transformed into irrigation to stabilize or increase crop yields. In these irrigated areas, the limited knowledge of a proper use of RT or NT systems makes difficult their adoption by farmers and jeopardizes the soil quality benefits attained with long-term NT. Moreover, the gradual occupation of irrigation, leads to an increase in nitrogen use. In irrigated Mediterranean conditions, there is a lack of knowledge on the interactive effects of tillage and N fertilization on corn production, and on water use efficiency (WUE) and nitrogen use efficiency (NUE). Therefore, the aim of this work was to evaluate the combined impact of tillage systems and mineral N fertilization rates on corn grain yield, WUE and NUE under Mediterranean irrigated conditions.

### Materials and Methods

A long-term field experiment (LTE) under rainfed barley monoculture was established in 1996 in Agramunt, NE Spain, maintained until 2014. Mean annual precipitation and potential evapotranspiration were 430 and 855 mm, respectively. The experiment was transformed into irrigation by installing a fixed sprinkler system in 2015 with corn (*Zea mays* L.) monoculture as cropping system. Three types of tillage (CT, RT, NT) and three mineral N fertilization rates (0, 200, 400 kg N ha<sup>-1</sup>) were compared in a randomized block design with three replications. The CT treatment consisted of one pass of rototiller to 15 cm depth followed by subsoiler to 35 cm depth and finished by one pass of disk plough to 20 cm depth, according to the traditional practices for corn cultivation in the area. The RT treatment consisted of one pass of a strip-till implement on the planting line to 30 cm depth. In the NT treatment non-selective herbicides were applied for weed control. In 2015, an adjacent experiment with the same layout was set up (short-term experiment, STE) in an area previously managed under long-term NT. The experiment covered three corn growing seasons (from April to November 2015, 2016 and 2017). Nitrogen fertilization rates were split in one pre-sowing (urea) and two top-dressing applications at V5 and V10 (ammonium nitrate). Soil samples from each plot were collected prior to planting (mid-March) and after harvest (mid-November). Soil water content (SWC) and soil nitrate content were quantified at three depth intervals (0–30, 30–60 and 60–90 cm depth). Corn yield, yield components and above-ground biomass were quantified at harvest. The WUE for above ground biomass and yield (WUE<sub>B</sub> and WUE<sub>Y</sub>, respectively), and NUE were calculated for each season. Water use (WU) was calculated as the difference in SWC between planting and harvest plus the rainfall received and the irrigation water applied between both dates. WUE<sub>B</sub> and WUE<sub>Y</sub> were calculated as above ground biomass between WU and grain yield between WU. Whereas NUE was calculated as grain yield between N supply, where N supply is the sum of soil nitrate–N at planting and N fertilizer applied

## Results and discussion

In the LTE there was a negative response of crop growth and yield under CT. As an average of the three seasons, NT and RT led to greater grain yield when applying 200 and 400 kg N ha<sup>-1</sup> (12962 and 13797 kg ha<sup>-1</sup> for NT and 11490 and 11291 kg ha<sup>-1</sup> for RT, respectively) compared to the use of the same rates under CT (9129 and 7306 kg ha<sup>-1</sup>, respectively). Differently, in the STE, tillage systems did not influence grain yields, while N application led to greater yields than the control (8679, 12905 and 12185 kg ha<sup>-1</sup> for the 0, 200 and 400 kg N ha<sup>-1</sup> treatments, respectively, as an average of the three seasons). The negative response of corn growth and yield to long-term CT would be explained by poor soil structural conditions, due to the intense tillage and their effect on water infiltration. Although irrigation water supply was the same for all tillage systems, water infiltration was reduced under CT due to the presence of a surface crust, which led to plant water stress (Pareja-Sánchez *et al.*, 2017). Lack of water under CT caused lower corn above-ground biomass, yield, and yield components and, therefore, lowers WUE<sub>B</sub> and WUE<sub>Y</sub>. In the STE, differences were only found in 2017, with greater above-ground biomass in NT and RT than CT, and greater number of plants per square meter and ears per plant in RT than CT and NT. Unlike LTE, in STE lower differences among tillage systems were observed due to the previous NT management. Long-term adoption of NT improved soil structural stability assuring adequate irrigation water infiltration. In both experiments, NT and RT enhanced SWC before pre-planting and after harvest leading to greater crop growth compared to CT. Soil nitrate content showed great differences between tillage systems during the 3 years in LTE. The use of long-term CT led to a significant accumulation of nitrate compared to NT. These high levels could be the result of long-term buildup rather than simple residual N from the previous year application. The long-term use of CT during the previous rainfed experimental period (1996 to 2014) led to an accumulation of nitrate due to the lack of enough water for N uptake (Morell *et al.*, 2011). Despite the supply of water by irrigation, it could be assumed that leaching was negligible during the growing season since it was only applied the necessary amount of water for crop growth and, likewise rain was scarce. Differently, in the STE soil nitrate content did not show differences between tillage systems. In the LTE, the highest NUE values observed occurred at control N rate in NT and RT. In these last two tillage treatments, water was used more efficiently to produce above-ground biomass and grain yield resulting in a more efficient use of N (NUE).

## Conclusion

Our data shows that in Mediterranean agroecosystems transformed into irrigation the use of NT and RT with medium rates of N leads to greater corn yield, WUE and NUE than the traditional management based on CT with high rates of mineral N.

## References

- Morell, F.J., Lampurlanés, J., Álvaro-Fuentes, J., Cantero-Martínez, C., 2011. Yield and water use efficiency of barley in a semiarid Mediterranean agroecosystem: long-term effects of tillage and N fertilization. *Soil & Tillage Research*. 117, 76–84.
- Lampurlanés, J., Plaza-Bonilla, D., Álvaro-Fuentes, J., Cantero-Martínez, C., 2016. Long-term analysis of soil water conservation and crop yield under different tillage systems in Mediterranean rainfed conditions. *Field Crops Research*. 189, 59–67.
- Pareja-Sánchez, E., Plaza-Bonilla, D., Ramos, M.C., Lampurlanés, J., Álvaro-Fuentes, J., Cantero-Martínez, C., 2017. Long-term no-till as a means to maintain soil surface structure in an agroecosystem transformed into irrigation. *Soil & Tillage Research*. 174, 221-230.

## Assessing the effects of agricultural management, grazing regimes and grass-clover leys on soil quality using the Soil Management Assessment Framework (SMAF)

Caio F. Zani<sup>1\*</sup>, Mauricio R. Cherubin<sup>2</sup>, John Gowing<sup>1</sup>, Geoffrey D. Abbott<sup>3</sup>, James A. Taylor<sup>1</sup>, Elisa Lopez-Capel<sup>1</sup>, Julia Cooper<sup>1</sup>

<sup>1</sup> School of Natural and Environmental Sciences, Agriculture Building, Newcastle University, Newcastle upon Tyne, NE1 7RU, United Kingdom

<sup>2</sup> Department of Soil Science, Luiz de Queiroz College of Agriculture, University of Sao Paulo, Piracicaba/SP, Brazil.

<sup>3</sup> School of Natural and Environmental Sciences, Drummond Building, Newcastle University, Newcastle upon Tyne NE1 7RU, United Kingdom

\* Corresponding author: [C.Fernandes-Zani2@newcastle.ac.uk](mailto:C.Fernandes-Zani2@newcastle.ac.uk)

### Introduction

While agricultural activity has provided essential products for humanity, it has also contributed to significant environmental impacts. Management changes to improved agricultural systems can play a key role towards attenuation of these issues while it ensures the delivery of essential functions and services provided by the soils. Among the potential improved agricultural systems, organic agriculture stands for being an ecological management which uses its site-specific ecosystem, biodiversity and natural fertility to support and ameliorate biodiversity and biological cycles (IFOAM, 2012). This management system might thus improve ecosystem services delivering a better soil quality (SQ) potential. SQ defines critical functions of which soils rely upon to operate properly and in a sustainable manner being therefore important for the assessment of both the current soil as well as future management decisions (Karlen et al., 1997). How well organic agriculture will perform towards conventional management, particularly regarding its SQ status remains unclear mainly due to improvements in the current conventional management and other practices used as grazing regimes and grass-clover ley. The evaluation of these factors are critical for a holistically assessment of organic agriculture as a future management strategy. Although some attempts have been made to assess the impacts of the management change from conventional to organic agriculture on some specific soil indicators, there are no studies that integrate the three key soil quality sectors i.e. biological, chemical and physical particularly in the UK. The soil management assessment framework (SMAF) tool has emerged as a potential option for SQ appraisal which encompasses biological, chemical, and physical soil functions (Andrews et al., 2004). Our over-arching aims were 1) to quantify SQ differences between mixed organic and conventional systems (that include pastoral ley and grazing effects) and 2) to evaluate the SMAF approach for monitoring SQ in cool temperate agricultural landscapes. A better understanding of the impacts of management choices on SQ can assist farmers, as well as government, to better plan strategies towards agricultural sustainability assuring longer-term productivity.

### Material and methods

The study was conducted in North-East England, UK at Nafferton Farm. Historically the farm was a conventional, mixed commercial system, with the main activities being a dairy herd, with associated pastoral production, and an arable cropping system. In 2001, there was a management change from conventional to organic across approximately 50% of the farm area (approximately 160 ha) while maintaining mixed (dairy and arable) production in the organic and non-organic systems. For the past 14 years the farm has been run with a mixed organic and a mixed conventional (non-organic) system side-by-side. Twelve commercial-

size representative agricultural fields (~ 120 ha of the total 320 ha of the farm), with six under conventional and six under full organic agriculture, were selected for this study. Each study field was selected after taking into account recent management (2007-2017), including the history of pastoral and cropping rotations. Fields were deliberately chosen to have differing lengths of pastoral leys. The location of the sampled points in each study field was selected out based on an a priori soil apparent electrical conductivity (ECa) analysis (0-70 cm depth, conducted in 2014 using a DualEM-1s sensor). In total across the 12 fields there were 36 points (2 managements X 6 fields/management X 3 points/study field). At each site, there were two undisturbed 0-0.9 m soil cores collected using a hydraulic soil sampler designed by Atlas Copco Company ([www.atlascopco.com](http://www.atlascopco.com)) and a metallic tube (100 cm length, 3 cm inner diameter), totaling 72 sampled cores across the farm. The soil cores were manually cut during sampling into 0-15; 15-30 and 30-60 cm depths resulting in a total of 216 undisturbed soil core sections. In addition, three disturbed samples (0-15 cm) were also taken near each of the 36 selected points using an auger, providing 108 disturbed soil samples. The following eight soil indicators were analysed: chemical - active acidity (pH), phosphorus (P) and potassium (K); physical - aggregate stability (AS), bulk density (BD) and particle-size distribution (PSD) and biological - soil C concentration (C) and microbial respiration (MR). The SMAF approach was used to convert each soil indicator measurement into a soil quality index (SQI) score. The SQI for each soil indicator were obtained through scoring algorithms that converted the measured soil indicator values into 0 to 1, being a score of 0 considered the poorest and 1 the finest score (Andrews et al., 2004). The SQI were obtained taking into account defined threshold values as well as other site-specific factors, such as organic matter content, soil texture, climate, Fe<sub>2</sub>O<sub>3</sub> class, soil sampling season, clay mineralogy, region, crop (at the moment of sampling), the rotation, slope, method for P and EC and weathering class. The SQI scores obtained for each indicator were then compared to the soil indicator measurements itself. Secondly, once the individual SQI scores were verified as being in line with the real soil indicator measurements, an integrative approach into sectors (chemical, physical and biological), as well as an overall SQI, was performed. The effects of agricultural management and grazing regimes and its interaction were assessed for each sector as well as for the overall SQI for 0-15; 15-30 and 30-60 cm depth intervals.

## Results and discussion

At the moment, all field and laboratory analyses were already conducted. However, we are still evaluating the results and applying it into the SMAF. The null hypotheses are ultimately that 1) organic management does not lead to improvements in soil physical and biological conditions and overall SQ chiefly, and 2) that SMAF is not suitable to assess SQ in northern UK systems.

## Conclusion

The statistical analysis as well as SMAF approach are still undergoing and the conclusions will be presented at the ISTRO conference.

## References

- Andrews S.S., Karlen D.L., Cambardella C.A.. 2004. The soil management assessment framework: A quantitative evaluation using case studies. *Soil Sci Soc Am J.* 68:1945-1962.
- IFOAM 2012. *The IFOAM Norms for Organic Production and Processing*. In: (INTERNATIONAL FEDERATION OF ORGANIC AGRICULTURE MOVEMENTS (IFOAM), B. & GERMANY (eds.)).
- Karlen D.L., Mausbach M.J., Doran J.W., Cline R.G., Harris R.F., Schuman G.E.. 1997. Soil quality: A concept, definition, and framework for evaluation. *Soil Sci Soc Am J.* 61:4-10.

## Constructing fertile cultivated soil layer by tillage and straw incorporation in a Mollisol in Northeast China

X. Z. Han, W. X. Zou, X. C. Lun

*Northeast Institute of Geography and Agroecology, Chinese Academy of Science, 150081, Harbin, China*

Corresponding author: [xzhan@iga.ac.cn](mailto:xzhan@iga.ac.cn)

### Introduction

In Northeast China, Mollisol was derived from the gravel and clay in the tertiary and quaternary periods. The parent material was composite of clay and loam, which contributed to a uniform soil texture with about 30% of clay (<0.002 mm) (He et al., 1999). Soil chemical-physical properties of Mollisol with heavy soil texture depended on the contents of organic matter and aggregate. High contents of soil organic matter and aggregate would support better soil properties. Mollisol is one important cultivated soil in Northeast China. Thick plough pan has been observed in Mollisol due to long term tillage with low power tractors and animal power, which has limited the conduction of water, heat and air in soil layer. Some of Mollisol has exposed to subsoil and parent material. Degraded Mollisol has been found and accounted for 30% of cultivated soil area, which has threatened the guarantee of crop production in Northeast. Therefore, it is necessary to construct fertile cultivated soil layer in order to recover soil production of Mollisol. A lot of researches have been done to cultivate fertile soil layer by incorporating straw into surface soil (0-15 cm) (Lao et al., 2002), but we wanted to incorporate straw and organic manure into subsoil to destroy plough pan and increase soil fertility in subsoil. The objective of this study was to construct a fertile and thick cultivated soil layer by tillage practices.

### Material and method

This study was conducted at the National Field Research Station of Agro-ecosystems (126°38'W, 47°26'N; 240 m above sea level) at Hailun County, Heilongjiang province in Northeastern China from 2009 to 2011. The climate in Hailun County is described as a temperate continental monsoon type with an average annual precipitation from 1953 to 2008 of 550 mm; approximately 60% of rainfall occurred between July and September. The annual mean air temperature is 1.5°C with an annual frost-free period of about 120 days. The soil is described as Black soil (Mollisol in American Soil classification system), derived from loam loess, with approximately 40% clay content. One crop was grown per year with main crops of soybean and maize. Each treatment replicated four times with a randomized block design. Each plot had an area of 20.4 m<sup>2</sup>. Maize straw at the rate of 7500 kg/hm<sup>2</sup> (ST+S) and pig manure at the rate of 15000 kg/hm<sup>2</sup> (ST+OM) were incorporated into subsoil within 20-35 cm in fall 2006. A simple simulated graph has been showed in figure 1. No organic matter incorporation was a contrast (TT). 150 kg/hm<sup>2</sup> N , 60 kg/hm<sup>2</sup> P<sub>2</sub>O<sub>5</sub>, 40 kg/hm<sup>2</sup> K<sub>2</sub>O as urea, (NH<sub>4</sub>)<sub>2</sub>HPO<sub>4</sub> and K<sub>2</sub>SO<sub>4</sub> were applied for maize, and 60 kg/hm<sup>2</sup> N , 60 kg/hm<sup>2</sup> P<sub>2</sub>O<sub>5</sub>, 30 kg/hm<sup>2</sup> K<sub>2</sub>O as urea, (NH<sub>4</sub>)<sub>2</sub>HPO<sub>4</sub> and K<sub>2</sub>SO<sub>4</sub> were applied for soybean in 2007 for plots. Maize straw was cut into less than 2 cm. Seed emergence has been recorded on 22th May. Soil samples were collected from 0-85 cm soil layer using auger on 22<sup>th</sup> May and 20<sup>th</sup> September to measure soil water content using oven. Soil bulk density, hydraulic conductivity and soil microbiology were measured in this study. Soil porosity and water use efficiency of maize and soybean were calculated using some equations.



## Results and discussion

Straw and pig manure incorporation impacted significantly soil physical properties within 20-35 cm soil depth, did not impact those in surface soil. Compared with TT, bulk density in ST+S and ST+OM treatments were decreased by 9.88% and 6.20%, soil porosity in ST+S and ST+OM were increased by 9.58% and 6.02%, soil hydraulic conductivity in ST+S and ST+OM were increased by 1.67 times and 0.73 times. Incorporating straw and pig manure into soil has destroyed plough plan, and loosed subsoil, then decreased bulk density and increased porosity and hydraulic conductivity. Meanwhile, organic amendment could play a function as wedge that would consistently improve the ratio of solid, liquid and air in soil. Soil fertility could be increased when organic amendment decomposed. The quantity of fungi, bacteria and actinomycetes also were increased in treatments with organic amendment due to more available substance supplied to microbe and improved aeration (Cai et al., 2004). Better soil condition has supported higher crop yield. Compared with TT treatment, maize yield was increased by 40.24% and 63.83% for ST+S and ST+OM treatments, and soybean yield was increased by 31.00% and 45.86% for ST+S and ST+OM treatments. Soil properties could be limiting factors impacting crop yield when enough chemical fertilizer has been applied. So, improved soil physical properties have been favorite to crop growth, then obtain higher yield.

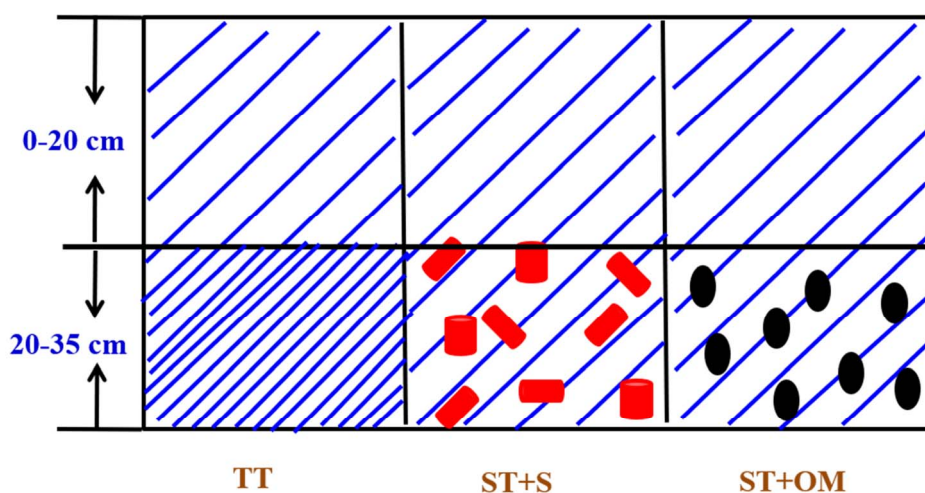

Figure 1: Schematic diagram of constructing fertile cultivated soil layer. TT, ST+S and ST+OM represented tradition tillage, incorporating straw into subsoil, and incorporating pig manure into subsoil. Red symbol represented straw, black symbol represented pig manure.

## Conclusion

Constructing fertile cultivated soil layer by combination of tillage and straw incorporation was an effective practice for Mollisol in Northeast China, which could improve soil physical environment and increase the quantity of microbe. Crop yield also has a positive response to constructed fertile soil layer.

### References:

- He W., 1992. Heilongjiang Soil. Beijing: China Agriculture Press. (In Chinese)  
 Lao X., Wu Z., Gao Y., 2002. Effect of long-term returning straw to soil on soil fertility. Transactions of the Chinese Society of Agricultural Engineering, 18(2): 49-52. (In Chinese with English abstract)  
 Cai X., Qian C., Zhang Y., 2004. Microbial characteristics of straw-amended degraded

soils in central Tibet and its effect on soil fertility. *Chinese Journal of Applied Ecology*, 15(3): 463-468. (in Chinese with English abstract)

## CA-SYS: A long term experimental platform on agroecology at various scales

, Stéphane Cordeau <sup>1</sup> \*, Judith Burstin <sup>1</sup>, Philippe Lemanceau <sup>1</sup>, Pascal Marget <sup>2</sup>, Nicolas Munier-Jolain <sup>1</sup>, Sandrine Petit <sup>1</sup>, Christian Steinberg <sup>1</sup>, Violaine Deytieux <sup>2</sup>

<sup>1</sup> *Agroécologie, AgroSup Dijon, INRA, Univ. Bourgogne Franche-Comté, F-21000 Dijon, France*

<sup>2</sup> *INRA, UE115 Domaine Expérimental d'Epoisses, F-21000 Dijon, France*

\* Corresponding Author: [stephane.cordeau@inra.fr](mailto:stephane.cordeau@inra.fr)

The French National Institute for Agricultural Research (INRA) has established an ambitious, multi-scale, agricultural experimental infrastructure (the CA-SYS platform) as a collaboration between the Research Unit, *Agroécologie* (Dijon, eastern France), and the Experimental Research Unit, *Domaine d'Epoisses* (20 km next to Dijon). CA-SYS covers an area of 120 ha, and is divided into 47 fields, each of which has drainage and can be irrigated, and will be initiated in autumn 2018. The aims of CA-SYS are to: i) design and evaluate new agroecological systems; ii) study the transition from current farming systems towards these new agroecological systems, with goals that include agronomical performance, the evolution of farming practices and multi-performance criteria; iii) breed new varieties adapted to agroecological conditions, for example tolerance to stressors and the enhancement of beneficial plant-microbe interactions; iv) understand the ecological processes underlying the functioning of agroecological systems; and, v) develop and adapt experimental methods for studying agroecological systems.

The originality of CA-SYS is that it is explicitly conceived for the development and evaluation of new agroecological systems across agriculturally realistic scales (Cordeau *et al.*, 2015). An agroecological system will comprise a matrix of fields of one (or a few) cropping systems over a number of years. These fields will interact with adjacent semi-natural habitats in the landscape (woods, hedges, grass margin strips, flower strips). This spatio-temporal arrangement of fields and semi-natural habitats will be considered as a coherent strategy, implemented to meet specific goals. The agroecological systems tested across CA-SYS will consist of three zone of manipulation of the amount of adjacent semi-natural habitats available to enhance the natural enemies of pests and four cropping systems combining a large diversity of farming practices (no-till & cover crop based-systems, tillage-based systems).

CA-SYS has ambitious objectives, including an increase in the multi-performance of systems (profitability and productivity identical to neighbouring farmers over a 10 year-horizon, low environmental impact), by maximising the use of biological processes (biological control of pests, improving nitrogen cycling) and reducing the use of inputs (nitrogen, water, pesticides).

CA-SYS is designed to allow research across four major themes: i) Breeding and evaluation of plant ideotypes for agroecological systems; ii) Understanding of plants/microbes (beneficial and pathogen) interactions in support of farm production goals using low levels of inputs; iii) The role of spatial-temporal structure and processes in functional biodiversity and biological control; and, iv) The design and evaluation of new agroecological systems.

### References

Cordeau, S., Deytieux, V., Lemanceau, P., Marget, P., 2015. Towards the establishment of an experimental research unit on Agroecology in France. *Aspects of applied biology* 128: Valuing Long-Term sites and Experiments for Agriculture and Ecology, 271-273.

## Effect of tillage on corn yield, water use and water use efficiency under irrigated conditions

J.D. Jabro<sup>1\*</sup>, W.B. Stevens<sup>1</sup>, and W.M. Iversen<sup>1</sup>

Northern Plains Agricultural Research Laboratory, USDA-ARS, 1500 N. Central Avenue  
Sidney, MT 59270, USA.

\* Corresponding author: [jay.jabro@ars.usda.gov](mailto:jay.jabro@ars.usda.gov).

### Introduction

One of today's greatest challenges of irrigated agriculture is to produce more food with less water, which can be accomplished by maximizing crop water use efficiency (WUE). Few studies have reported the effects of various tillage practices and crop rotations on corn water use and water use efficiency. Limited research has been conducted on comparing different tillage practices and evaluating their impact on crop WU and water WUE of corn in Northern Great Plains region. Thus our objective was to evaluate and compare the effect of NT and CT practices on water use (WU) and WUE of corn in a corn (*Zea mays* L.)-soybean (*Glycine max* L.) rotation on a sandy loam soil under overhead sprinkler irrigation system in the northern Great Plains

### Materials and Methods

A 6-yr field study was conducted in spring 2013 at the USDA-ARS irrigated research farm- 37 km E. Williston, ND, USA. The predominant soil at the research site is Lihen sandy loam consisting of very deep, well or somewhat excessively drained soil. The experiment was designed as a randomized complete block with five replications. Plots were not on the same location every year and plot size was 6 to 8 m wide×30 m long. All plots were irrigated with a self-propelled overhead linear move sprinkler irrigation system. The two tillage systems used in this study consisted of no-tillage or direct seeding (NT) and conventional tillage (CT). The CT consisted of one pass with a tandem disk at 7 cm deep. Two passes were then made with a ripper with 7 shanks spaced 60 cm apart. A tine leveler and rolling mulcher were mounted behind the ripper shanks. The ripper was set to till 30 cm deep. The tilled plots received a finishing pass with a cultipacker. Two corn cob samples were hand-harvested from each plot. Each sample consisted of cobs from a total of 6 m of row, with 3-m from one row and another 3-m from an adjacent row. The 3-m row segments were sequential, so one began where the other ended. The rows were 0.61 m apart. The average of the two samples was used to represent yield for that plot. The crop water use (WU) and water use efficiency (WUE) for corn were determined according to the water balance and WUE equations (Jabro et al., 2012; 2014). Soil water contents were in-situ monitored weekly at 23, 46, 61, 76 and 91 cm depths in every plot by a neutron probe. Drainage water amounts were measured weekly using 18 automated passive capillary (PCAP) fluxmeters placed 91 cm below the soil surface. The PCAPs were constructed of 75 cm long polyvinyl chloride pipe with a collecting surface area of 0.1 m<sup>2</sup>. Drainage water amounts were collected from the PCAPs weekly throughout the growing season. Daily average, maximum, minimum, air temperature, and monthly total precipitation for all growing seasons were collected from a weather station at the study site.

## Results and discussion

Seasonal WU and WUE values for corn in 2014, 2015, 2016 and 2017 growing seasons were determined. Corn yield, WU and WUE for corn in 2014, 2015, 2016 and 2017 growing seasons and averaged across four years are illustrated in Figure 1.

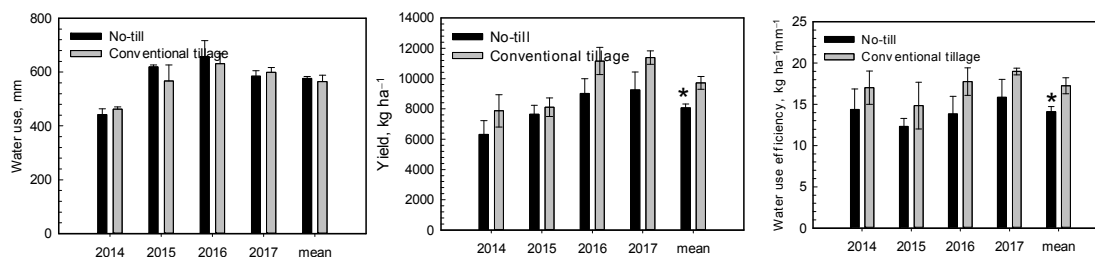

Figure 1. Corn water use, yield and WUE in 2014, 2015, 2016, and 2017 growing seasons and their means across years. Error bars represent 2 standard errors of the mean

Statistical analysis indicated that no significant differences were found between NT and CT for WU in all four years (Figure 1). Results showed that average corn grain yield across four years was significantly lower in NT than in CT. Corn yield differences due to tillage may have been associated with variations in soil water content, soil temperature, and plant population between NT and CT practices. Results also showed no significant differences between NT and CT for corn WU.

## Conclusions

Averaged across four years, corn yield and WUE were significantly different between NT and CT practices. However, crop WU was not affected by the tillage practice. While NT practice is promising alternative to CT for agricultural production that conserve soil water storage, further research is needed to evaluate the effect of tillage practices on WU and WUE in clayey soils.

## References

Jabro, J.D., W.B. Stevens, W.M. Iversen, R.G. Evans, and B.L. Allen. 2014. Crop water productivity of sugarbeet as affected by tillage. *Agronomy J.* 106:2280–2286.

Jabro, J.D., W.M. Iversen, R.G. Evans, and W.B. Stevens. 2012. Water use and water productivity of sugarbeet, malt barley and potato as affected by irrigation frequency. *Agronomy J.* 104(6):1510-1516.

## Tillage strategies to optimize rapeseed establishment: a method to support decision making

S. Cadoux<sup>1\*</sup>, Anne-Sophie Perrin<sup>2</sup>, and G. Sauzet<sup>3</sup>

<sup>1</sup>*Terres Inovia, 78850 Thiverval-Grignon, France*

<sup>2</sup>*Terres Inovia, 34000 Montpellier, France*

<sup>3</sup>*Terres Inovia, 18570 Le Subdray, France*

\* corresponding author: [s.cadoux@terresinovia.fr](mailto:s.cadoux@terresinovia.fr)

### Introduction

Agriculture must succeed in reconciling productivity, profitability and conservation of the environment. In France, winter oilseed rape (rapeseed) is the second arable crop in terms of cultivated areas, and also in terms of treatment frequency index and nitrogen applied per hectare (AGRESTE 2014 in Cadoux *et al.* 2015). However, Cadoux *et al.* (2015) have highlighted the ability of rapeseed to withstand the presence of pests provided a sufficient growth in autumn. Obtaining such a ‘robust’ rapeseed, weakly dependent on pesticides, implies a satisfactory emergence and no factors limiting the growth in autumn. Soil tillage plays a key role in getting these states but its effects can be antagonistic:

- Positive effects of tillage: improves soil structure and thus rapeseed rooting and water drainage, helps manage straws, disturbs pests such as slugs or small rodents, etc.
- Negative effects of tillage: stimulates weed germination (especially geraniums), dries the soil, increases the sensitivity to slaking, etc.

Soil tillage strategies thus have to be adapted to each field condition in order to optimize rapeseed establishment and growth in autumn. The aim of this study was to develop a method to support farmers in choosing adapted tillage practices.

### Materials and methods

The method developed in this paper was based on expertise and tests and improvement loops with farmers, who were part of an innovation network. The farms were located in central France, in a semi-oceanic climate. Soils were mainly of two types: shallow and stony clay-limestone or deep sandy loam sensitive to slaking and waterlogging.

Method development followed four steps:

- Defining the criteria to take into account
- Defining how to inform them operationally
- Prioritizing their importance
- Defining tillage practices adapted to reach the expected states, including no-till (direct seeding), strip-till, superficial tillage, deep tillage, full inversion tillage

### Results and discussion

Four criteria were selected and prioritized to help choosing adapted tillage strategy:

- **(i) Soil structure:** the diagnosis was made using a spade method, inspired by that developed by ISARA Lyon (2016), taking into account the recent development in the ‘profil cultural’ method (Boizard *et al.* 2017), and adapted for a quick use by farmers. The diagnosis took into account (i) the soil behavior on the spade and (ii) the dominant type of porosity of clods defined after breaking morphological units (table 1). It led to three tillage options: (i) no-till advised, when soil structure is favorable, (ii) deep tillage advised, when soil compaction is too severe to allow a satisfying rooting of the rapeseed and, (iii) both tillage or no-till possible, when other criteria are likely to have more impact than soil structure;
- **(ii) Straw management:** when the residues of the preceding crop are abundant and are returned and buried in the soil, they are likely to disturb the germination and the

emergence of the rapeseed. We thus distinguished two options: (i) no need to bury the residues, when they are removed or when seeding equipment is adapted to the presence of residues on the ground (no-till possible) (ii) need to bury the residues, when they are abundant and no adapted equipment is available (tillage needed);

- **(iii) Weed and pest pressure:** 2 options regarding weeds and pests were proposed to optimize their control, depending on the main risk: (i) broadleaf weeds whose germination can efficiently be avoided by limiting soil disturbance, (ii) grass weeds or slugs or small rodents that can be disturbed by tillage;
- **(iv) Soil behavior:** 2 soil characteristics were taken into account and led to 2 options depending on the main risk: (i) risk of slaking that can be mitigated with no-till, (ii) risk of waterlogging that can be mitigated with deep tillage.

		2- Dominant type of porosity of clods		
		$\Gamma$ (high structural porosity)	$\Phi$ or $P$ ( $\Delta$ clods with cracks)	$\Delta$ (no visible macropores and no cracks)
1- Observations on the spade => type of morphological units	Fine aggregates that do not hold on the spade => 'O' (highly fragmented)	No-till advised	No-till advised	Tillage or no-till possible
	Separation into big blocks => 'B' (decimetric clods)	No-till advised	Tillage or no-till possible	Tillage or no-till possible
	Massive soil block => 'C' (massive structure)	Tillage or no-till possible	Deep tillage advised	Deep tillage advised

Table 1: Criteria for description and interpretation of soil structure

Three decision trees, corresponding to three main soil types (clay soils, sandy loam soils, and balanced soils), were built to take into account these four criteria and to come up with an operational advice.

The implementation of the method included four steps: (i) collection of information on the field, (ii) observations and soil structure diagnosis in the field, (iii) decision-making using decision trees, and (iv) evaluation of the results obtained with the practices actually implemented in the field (optional).

This method was implemented for three years in the farmer's group described above. The three first steps were usually done in April/May, before the harvest of the crop preceding the rapeseed. The evaluation step mainly occurred in autumn.

## Conclusion

Rapeseed establishment is a key stage that determines the ability of rapeseed to withstand pest pressure without the need for inputs. The role of soil tillage is crucial but antagonistic effects make difficult decision-making. The method developed helps to prioritize problems and to decide which practices are best suited to each field conditions. Beyond the individual optimization of tillage practices, farmers claim that this method is an opportunity to exchange with peers and advisors on the agronomic levers of field management.

In the future, we would like to adapt this method to other crops in order to enlarge the decision-making at the scale of the cropping system.

## References

- Cadoux S., Sauzet G., Valantin-Morison M., Pontet C., Champolivier L., Robert C., Lieven J., Flénet F., Manganot O., Fauvin P., Landé N., 2015. Intercropping frost-sensitive legume crops with winter oilseed rape reduces weed competition, insect damage and improves nitrogen use efficiency. *OCL*, 22(3) D302.
- ISARA Lyon, 2016. Test Bêche, guide d'utilisation.
- H. Boizard, *et al.*, 2017. Developments in the "profil cultural" method for an improved assessment of soil structure under no-till. *Soil Tillage Res.* 173, 92-103.

21st Triennial ISTRO Conference - September 24th-27th 2018 – France, Paris

## **Impact of soil tillage techniques on yield and net margin in different crop rotations**

Jerome Labreuche<sup>1\*</sup>, Geoffroy Levesque<sup>1</sup>, Baptiste Dubois<sup>1</sup>

<sup>1</sup> ARVALIS-Institut du vegetal, Station Experimentale, 91720 Boigneville, FRANCE

\* corresponding author: [j.labreuche@arvalis.fr](mailto:j.labreuche@arvalis.fr)

In order to investigate the impact of minimum tillage on crop productivity and soil quality, a long term experiment was carried out in 1970 in Boigneville (France, 70 km south of Paris). The climate is temperate oceanic, with an average temperature of 10.9°C and rainfall of 635 mm per year. The orthic luvisol is developed on loess. The A horizon contains 24% of clay, 1.02% of carbon and has a 7.1 pH H<sub>2</sub>O. The B horizon contains 32% of clay. The soil contains no CaCO<sub>3</sub> on the upper 70 cm but 31% at 1 m depth. It has a good drainage, an average structural stability and a good ability to crack when it dries in summer.

This field trial included at its beginning three crops rotations:

- Trial D: Continuous corn without irrigation, from harvest 1971 to 1994. Only one replicate was carried out.
- Trial C: Continuous winter wheat without irrigation from 1971 to 2009. In order to face a strong rye grass population, wheat was destroyed in 2010 and a crop rotation was introduced from 2011 until 2016. Only one replicate was carried out.
- Trial A: A corn-winter wheat rotation without irrigation from 1971 to 1997. Each crop was present each year on four replicates. From 1998 to 2017, an irrigated corn-winter wheat rotation was still in place with each crop on two replicates (trial A1). Another irrigated rotation with four crops established each year with one replicate was introduced in 1998 (trial A2): sugar beet-winter wheat-spring pea or winter field bean or oil seedrape-spring barley.

For each crop rotation, four soil tillage techniques were compared: conventional tillage (CT, 20 cm depth annual plough based system), minimum tillage (ST, 5 to 10 cm depth) and no till (NT). For the last technique, crops were usually established without any soil tillage (no till), but sometimes included a superficial tillage or a strip tillage (table 1). For no till or strip till, the drills that established crops were equipped with discs.

In this paper, three parameters are analyzed: crop emergence and yield, net margin. It was not possible to make any analysis of variance of yield for trials with only one replicate (trials C, D and A2). The net margin has been calculated:  $\text{yield} \times \text{price} + \text{subsidies} - \text{inputs} - \text{cost of mechanization} - \text{cost of hired or family labor} - \text{cost of irrigation} - \text{farm rent} - \text{national insurance contribution} - \text{miscellaneous expenditures} - \text{return on equity}$ . Margin was calculated on the basis of practices and yields measured each year on each plot. Prices of grain and inputs were an average over the 2010-2016 period. Usually, inputs have not been different between soil tillage strategies, except for glyphosate. We considered that the number of labor units was the same whatever the soil tillage strategy. It means that the labor cost was the same in spite of differences on the time spent on the tractor. Subsidies were calculated on the basis of 2017. A positive net margin with our calculation method means that all factors of production are paid (land, asset, family labor). However, our calculation sometimes gives far negative margin because of old technical data (yield, practices) with current prices and subsidies.

Over all the trials and years of harvest, superficial and no tillage decreased the income of sales of 61 €/ha. However, savings on mechanization were of 49 €/ha, including 27 l/ha of fuel. The net margin decreased on average of 5 €/ha, while the time spent in the field decreases of 49 mn/ha. Minimum



tillage improved some soil characteristics (surface sealing, trafficability...) but was however more dependent on herbicides.

There were some differences on net margin between conventional and minimum tillage depending on the crop, the preceding crop and the soil tillage technique. Sugar beet and spring pea appeared as not very well adapted to min till (table 1). Strip tillage seemed to be more suitable to sugar beet than superficial tillage and no till. Corn, winter wheat and spring barley were more adapted to min till with in some cases an improvement of net income, except for continuous wheat (ST and NT) and wheat after an irrigated corn (NT, without any corn straw chopping).

Table 1: Crop emergence (%), yield (t/ha) and net margin (€/ha) according to soil tillage technique, crop and preceding crop. For A1 trial, anova results are in brackets (NS: p value > 0.10; .: p value < 0.10; \*: p value < 0.05; \*\*: p value < 0.01; \*\*\*: p value < 0.001). Results are compared to CT. Colors help to analyze net margin (in red: < -100 €/ha compared to CT; orange: -100 à -51 €/ha; yellow: -50 à -26 €/ha; white: -25 to +25 €/ha; apple green: +26 à +50 €/ha; dark green: > +50 €/ha).

Trial	Crop / Preceding crop	Harvest year	Conventional Tillage (CT)	Superficial Tillage (ST)	No Tillage (NT)	NT or ST or Strip tillage (NTbis)
C	Winter wheat / Winter wheat (straw burnt)	1977-2001	PL, HA, SD 79 %, 7.54 t/ha, 217 €/ha	Rotavator, DD 85 %, 7.54 t/ha, 219 €/ha	No till, DDSD 85 %, 7.69 t/ha, 240 €/ha	
C	Winter wheat / Winter wheat (straw chopped)	2002-2009	SC, PL, RH, SD 68 %, 6.89 t/ha, 130 €/ha	SC, RH or Rotavator, DD 70 %, 6.21 t/ha, 60 €/ha	Spring tine harrow*2, DDSD 67 %, 6.22 t/ha, 73 €/ha	
C	Rotation	2010-2016	SC, PL, RH, SD ././, 21 €/ha	SC, DD ././, 21 €/ha	No till, DDSD ././, 9 €/ha	
D	Corn (non irrigated) / Corn (straw chopped)	1987-1994	PL, HA, Vb, SD 89 %, 5.85 t/ha, -401 €/ha	Stubble plough, HA, Vb, SD 92 %, 5.96 t/ha, -405 €/ha	PTO driven strip till, SD 91 %, 5.66 t/ha, -404 €/ha	
A1	Winter wheat / Corn (non irrigated)	1980-2002	Chopping, PL, HA or RH, SD 74 %, 8.43 t/ha (reference), 354 €/ha	Chopping, Rotavator, DD 76 %, 8.49 t/ha (NS), 418 €/ha	Chopping, No till, DDSD 73 %, 8.48 t/ha (NS), 349 €/ha	
A1	Winter wheat / Corn (irrigated)	2007-2012	Chopping, PL, RH, SD 73 %, 8.58 t/ha (reference), 440 €/ha	Chopping, Rotavator, DD 63 %, 8.60 t/ha (NS), 484 €/ha STbis : Semavator 78 %, 8.24 t/ha (NS), 438 €/ha	No till, DDSD 59 %, 7.71 t/ha (**), 360 €/ha	No till, DDSD, Chopping after seeding 58 %, 8.34 t/ha (NS), 432 €/ha
A1	Corn (non irrigated) / Winter wheat	1979-1998	PL, RH, SD 88 %, 6.63 t/ha (reference), -414 €/ha	Stubble plough, RH, SD 88 %, 6.61 t/ha (NS), -407 €/ha	PTO driven strip till, SD 88 %, 6.62 t/ha (NS), -320 €/ha	
A1	Corn (irrigated) / Winter wheat (+ CC)	2002-2017	CC, PL, RH, DDSD 92 %, 10.14 t/ha (reference), -327 €/ha	CC, RH or Vb, DDSD 93 %, 10.50 t/ha (**), -267 €/ha	CC, No till, DDSD 83 %, 9.82 t/ha (NS), -332 €/ha	
A2	Sugar beet (irrigated) / Spring barley (+ CC)	2003-2015	SC, CC, PL, RH, Vb, DDSD 81 %, 101.9 t/ha, 704 €/ha	SC, CC, RH, DDSD 78 %, 98.3 t/ha, 602 €/ha	CC, No till, DDSD 58 %, 95.8 t/ha, 578 €/ha	
A2	Sugar beet (irrigated) / Spring barley (+ CC)	2012-2017	SC, CC, PL, RH, Vb, DDSD 81 %, 114.0 t/ha, 1015 €/ha	SC, CC, RH, DDSD 76 %, 111.2 t/ha, 911 €/ha		CC, Strip till*2, DDSD 81 %, 113.5 t/ha, 963 €/ha
A2	Winter wheat / Sugar beet	1999-2017	Vb, PL, RH, SD 67 %, 8.38 t/ha, 394 €/ha	Vb, RH, SD 65 %, 8.19 t/ha, 404 €/ha	Vb, DDSD 67 %, 8.45 t/ha, 422 €/ha	
A2	Spring peas / Winter wheat/ha/heat	1998-2003	SC, PL, RH, SD or DD 84 %, 5.41 t/ha, 373 €/ha	SC, RH, SD or DD 79 %, 5.15 t/ha, 338 €/ha STbis : SC, DDSD 80 %, 4.88 t/ha, 281 €/ha	No till, DDSD 75 %, 4.97 t/ha, 283 €/ha	Rotavator (Horsch SE) 86 %, 4.75 t/ha, 284 €/ha
A2	Winter field beans / Winter wheat	2008-2012	SC, PL, RH, DDSD 101 %, 3.31 t/ha, 142 €/ha	SC, DDSD 95 %, 3.12 t/ha, 169 €/ha	No till, DDSD 84 %, 3.39 t/ha, 222 €/ha	
A2	Oil seedrape / Winter wheat	2014-2017	SC, PL, RH, DDSD 74 %, 3.83 t/ha, -83 €/ha	SC, SC, DDSD 72 %, 3.67 t/ha, -91 €/ha	No till, DDSD 54 %, 3.56 t/ha, -82 €/ha	Strip till, DDSD 82 %, 3.69 t/ha, -83 €/ha
A2	Spring barley / Pea or field bean (+ CC)	1999-2014	SC, CC, PL, RH, SD or DD 75 %, 7.64 t/ha, 274 €/ha	SC, CC, RH, SD or DD 78 %, 7.61 t/ha, 289 €/ha STbis : SC, CC, DDSD 70 %, 7.56 t/ha, 275 €/ha	CC, No till, DDSD 69 %, 7.72 t/ha, 302 €/ha	
A2	Spring barley / Oil seedrape (+ CC)	2015-2017	CC, PL, RH or Vb, DDSD 79 %, 7.44 t/ha, 231 €/ha	CC, SC, RH or Vb, DDSD 78 %, 7.65 t/ha, 280 €/ha	CC, No till, DDSD 47 %, 7.34 t/ha, 253 €/ha	

Rotation in C trial from 2010 to 2016: Fallow (wheat destroyed in May)-Spring pea-Oil seedrape-Winter wheat-Spring barley-Corn-Winter wheat (% of emergence and yields have not been averaged)  
CC: cover crop ; SC : Stubble cultivation with discs or tines ; PL : Plough ; RH : Rotary harrow ; HA: Harrow with reciprocating bars ; Vb: Danish tine cultivator ; HE: Spring tine harrow; SD: Shoe drill ; DD: Disc drill ; DDSD: Disc direct seeding drill.

## Designing cropping systems to improve soil structure

R. Koller<sup>1\*</sup>, A. Schaub<sup>2</sup>, O. Rapp<sup>3</sup>, R. Reau<sup>4</sup>, G. Fortino<sup>5</sup>

<sup>1</sup>*Association pour la Relance Agronomique en Alsace, 67300 Schiltigheim, France*

<sup>2</sup>*Chambre Régionale d'Agriculture Grand Est, 67300 Schiltigheim, France*

<sup>3</sup>*Chambre d'Agriculture Alsace, 67300 Schiltigheim, France*

<sup>4</sup>*UMR Agronomie INRA/AgroParisTech/Université Paris-Saclay, 78850 Thiverval-Grignon, France*

<sup>5</sup>*Chambre d'agriculture de la Manche, 50000 Saint Lô, France*

Corresponding author: [r.koller@alsace.chambagri.fr](mailto:r.koller@alsace.chambagri.fr)

### Introduction

Farmers and farmer's advisers seek to obtain a soil structure which allows for production, prevents from soil degradation or even improves soils fertility in case of disturbed soil functioning. To achieve these objectives, several levers for action can be used which influence, directly or indirectly, soil structure and related soil porosity and stability levels. Actions are not only related to soil tillage itself, but as well to the management of machinery traffic in the field and of soil structural stability. For fields with annual crops, each decision for action needs to be taken in line with the entire set of technical operations carried out in the context of the cropping system. To facilitate the construction of a decision-making system defining the cropping system, we use a causal diagram which describes the links between agricultural practices and their results by considering involved processes.

### Cropping system, decision-making scheme, causal diagram

A cropping system is defined as the entire set of technical actions carried out on a field over the years. It is characterised by crop types, their sequence, and related technical operations conceived in a logical and organised manner. It is set-up to achieve relevant objectives of the farmer related to economical profits, autonomy, resilience, working load and conditions, etc., while respecting external requirements such as legislations, contractual and environmental requirements, as well as internal requirements such as limitation of fertilisers and pesticides uses.

For each theme to be addressed (such as weed and pest control, or porosity management), a decision-making scheme (Reau, 2017) describes all the technical action levers during the crop rotation to be used by the farmer to achieve the expected results. This scheme can be used either to formalise farmer's reasoning, for instance to inform and/or inspire other farmers, to identify causes of dissatisfaction, or to develop a multiannual forward planning of technical operations. It is build on the basis of current knowledge on (1) processes which determine soil porosity, (2) the operations that influence these processes, and (3) their time scales. This knowledge is summarized in the causal diagram of soil porosity and serves to motivate the choices written down in the decision-making scheme. Here we present the causal diagram related to soil porosity management (**Figure 1**).

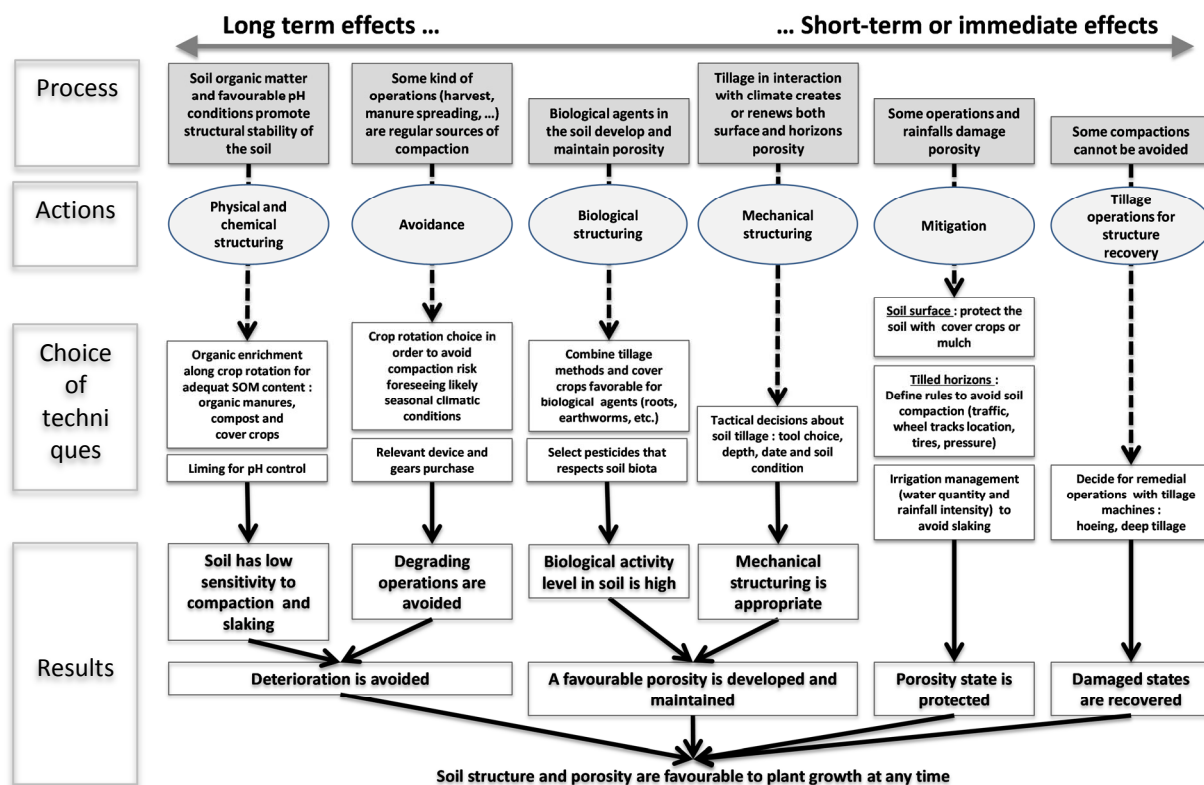

Figure 1: causal diagram for soil porosity management

### An example of a decision-making scheme for porosity management

The example concerns a mixed-crop dairy farm in the Alsace (France). The farmer has chosen to break with the conventional crop rotation in the area, which consists of  $n^*$ maize – wheat and annual ploughing. The farmer's objectives concerning his cropping system are sufficient crop production at low fertiliser, pesticides and fuel input levels. Moreover, he is particularly interested in improving the fertility of his soils. The soil-related technical operations carried out on the retained 9-years crop rotation are: (1) reduced tillage without ploughing (2) permanent soil cover by vegetation or crop residues, (3) reduced ground pressures caused by various machines, (4) use of pesticides with low ecotoxicity, (5) frequent input of organic matter into the soil. These operations target to limit soil compaction and to improve soil structure by stimulating biological activity. The cropping system is being tested since autumn 2011. The farmer uses easily accessible observation methods to judge whether his system leads to the expected results: a crumbly soil surface state, sparse presence of highly compacted zones (using a spade test), absence of deep wheel track ruts, and abundance of earth worm castings. The accompanying researcher examines the quality of the structure using a soil profile method ("profil cultural"). At the beginning of the experiment, 95% of the ploughed soil layer (0 to 25 cm) showed very or extremely unfavourable conditions for root development. After 6 years (barley, 3 years of alfalfa, fodder maize and rape), the soil structure has changed into moderately favourable to favourable over the entire profile and the ploughpan has disappeared.

Boizard, H et al., 2016. Developments in the « profil cultural » method for an improved assessment of soil structure under no-till. *Soil and Tillage Research*, volume 173, p. 92-103

Manichon, H., et Gautronneau, Y., 1987. Guide méthodique du profil cultural. ISARA & INA-PG : 62 p. <http://profilcultural.isara.fr/index.php/profilcultural>

Reau R., Cros C., Leprun B., Merot E., Omon B. Paravano L., 2017. La construction des schémas décisionnels et leurs mobilisations dans le changement des systèmes de culture. *Revue AE&S vol.6, n°2,14*.

## **Tillage effects on soil properties and consequences wheat development in north Algeria.**

S. Taibi<sup>1\*</sup>, M.A Feddal<sup>2</sup>, M. Amara<sup>2</sup>

<sup>1</sup> *Université SAAD DAHLAB, Blida, Algérie.*

<sup>2</sup> *Ecole nationale supérieure agronomique, EL HARRACH, Alger, Algérie.*

Corresponding author : [taibisabrina86@gmail.com](mailto:taibisabrina86@gmail.com)

### **Introduction**

Soil preparation is one of the largest operations in the technical itinerary; they aim to improve the conditions for plant growth (Strudley and al., 2008). Farmers have several options work the soil, all of which can be classified in one of the three tillage systems: no-till, minimum tillage, and conventional tillage, the latter has the advantage that the machines used are widely available and the techniques are well known to farmers. Direct seeding may require the purchase of machinery or new accessories and, in many cases; farmers must learn to operate them. The conventional tillage can make the more porous and soft ground, which promotes the exchange of air and root growth. It's also a good way to incorporate manure. In addition, the well worked soil warms faster in the spring. (Tebrügge and al., 1999).

In Algeria, the results of research conducted during ten years In the framework of cooperation with the technical institute of crop of Algiers have Shown that the direct seeding present many problems, the development of these techniques has been accompanied by an increasing use of herbicides needed to control the development of weeds which is no longer provided, in part, by plowing. These systems are efficient but high costs of chemical inputs thus increasing their potential for pollution of surface waters, on field investigations claim that the few farmers using direct seeding are questioning the effect of this technical development of weeds, adapting their equipment fleet. (Sadeghi and Bahrani., 2009).

Many scientific references on the impact of tillage systems on soil quality are available in Algeria, but almost exclusively, these references point to comparisons between conventional tillage, minimum tillage and direct seeding, for our part, we have introduced a tool chain including an agricultural tillage and including a work with no-till cover crop.

The objective of this study is to follow in the first year of application of different tillage techniques (conventional and minimum tillage) the bulk density measurements, moisture, porosity, water filled pore space, cone index, and rooting durum and durum yield.

### **Material and methods**

The experiment was conducted during the 2015/2016 crop year at the Central Farm of National High School of Agronomy. The objective of this study is essentially the analysis of the effect of three chains of agricultural tools (chain 1 (CH1): deep plowing, chain 2 (CH2): agronomic plowing, chain 3 (CH3): Minimum Tillage without plowing), for the establishment of a durum wheat, on soil physical properties and the impact on root development and yield wheat.

### **Results and discussion**

the results show that in dry conditions and in conditions of low rainfall, the minimum tillage allows the storage of surface water, while in conditions of heavy rain, deep plowing permits

good infiltration, we recorded the highest moistures. The depth 0-20 cm, the agronomic tillage provides good water retention in the soil. However, that there is little difference in the evolution of soil moisture for the three chains of tools, this development follows that of rainfall. On the other hand, was detected over the entire depth a sudden drop in soil moisture during the latter stages, this is due to the climatic conditions of the region from April or there were significant reductions rainfall.

We can therefore conclude that the porosity decreases from the conventional technique the minimum technical. At this technique we find homogeneity of soil porosity on almost any profile; which is not the case for other fields where the porosity is higher on the surface. We must also remember that these results are directly related to the bulk density that does not have a remarkable change during the experiment. However, it is be careful when interpreting the results because they can be noisy by other mechanism (wetting, drying and packing). Minimum tillage is characterized by a decrease of the macroporosity which is original, created by plowing. So the soil porosity is generally reduced in conservation systems but, like biological systems, they favor the formation of macro-pores of biological origin. These changes occur gradually and differences between the systems are measurable after several years of differentiation.

The agronomic tillage allows better cone index surface and up to 20 cm. While, the conventional tillage significantly reduced cone index in deep 30 cm. The minimum tillage causes an increase of cone index throughout the profile of soil.

The results of root development showed that the average of the root density varies from one technique to another and from one stage to another. The density varies between 1.2 g / dm<sup>3</sup> and 3.37 g / dm<sup>3</sup>, the latter is the most important value to the maturation stage for conventional tillage. Root density increases the heading stage to stage maturation to reach its maximum value of 3.37 g / dm<sup>3</sup> at CH1, while at the level of CH2 and CH3 root density decreases slightly after the flowering stage to reach respectively 3,02 g/dm<sup>3</sup> and 2.5g/dm<sup>3</sup>. However, this density is greater at CH2 in the first two stages. The agronomic tillage allows obtaining good yield while the minimum tillage records a much lower yield.

## Conclusion

In the experimental conditions of this study, the agronomic tillage can be an alternative to conventional tillage. This tillage method is easily achievable from a technical standpoint and can generate economic gains from the practice of plowing, but its effects on soil and crop yields need to be studied in the longer term.

For the future, recommending to focus work on other parameters such as weight distribution of aggregates, which is the best way to assess and characterize the action of the tool on the soil structure, giving more details on the size of the clumps formed after the passage of the tool as well as their ratio to the volume of soil moved.

## References

- Sadeghi H. M.J. Bahrani. 2009 - Effects of crop residue and nitrogen rates on yield and yield components of two dryland wheat (*Triticum aestivum* L.) cultivars. *Plant Prod. Sci.* 12: 497-502.
- Strudley M. W., Green T. R. et Ascough J. C. 2008 - Tillage effects on soil hydraulic properties in space and time : State of the science. *Soil and Tillage Research*, 99(1): 4-48.
- Tebrügge F et Düring R.A., 1999 - Reducing tillage intensity -- a review of results from a long-term study in Germany. *Soil and Tillage Research* 53:15-28.

## **Effect of Different Modes of Planting and Weeding on Machine Field Capacity and Yield of a Mixed Cropping Small Holder Farm.**

F.T. Fayose<sup>1\*</sup>, A. M. Olaniyan<sup>1</sup>, B. A. Alabandan<sup>1</sup>, K. Ogunleye<sup>2</sup>, O. Omoju<sup>2</sup>, O. Aladejebi<sup>3</sup>, A. Fajimi<sup>4</sup>, O. Ilesanmi<sup>1</sup>

<sup>1</sup>*Department of Agricultural and Bioresources Engineering, Federal University Oye Ekiti*

<sup>2</sup>*Department of Soil Science, Federal University Oye Ekiti*

<sup>3</sup>*Department of Agricultural Economics and Extension, Federal University Oye Ekiti*

<sup>4</sup>*Department of Crop and Horticultural Sciences, Federal University Oye Ekiti*

\* corresponding author: [folasayo.fayose@fuoye.edu.ng](mailto:folasayo.fayose@fuoye.edu.ng)

### **Introduction**

Nigeria has great potential for cultivation of a wide variety of crops as its soil and climatic conditions are very suitable for crop cultivation. However, growing crops with human labour (planting, weeding etc) has been the common practice in Nigeria and that is why subsistent farming is still predominant. Also, the common practise of small farm holders is mixed cropping. The level of mechanization for commodity crop production is very low in Nigeria and this has contributed to low agricultural productivity. The role of the use of agricultural machines can never be overemphasized in the bid to expand and promote agricultural productivity and ecological system stability. Also, reduction of drudgery and higher agricultural products prices which are dividends of mechanization may encourage youths in Sub Sahara Africa to farming. At a time when the country is considering renaissance of agriculture as the economic mainstay of the country in place of oil, there is the need to foster small scale farm machinery for improving sustainable agricultural production in South West Nigeria. Therefore, this research was focussed on the identification of improved tools for agricultural production processes, the effect of their utilization to reduce this drudgery which has led to dwindling labour supply and a consequent hike in cost of production of agricultural produce. There is the need to compare the performance of different types of planters and weeding methods so as to be able to recommend optimum conditions for their use.

### **Materials and Methods**

Experiment was conducted at the Experimental Farm of the Department of Agricultural and Bioresources Engineering, Federal University Oye Ekiti with the following GPRS readings: N07°48.573'E005°29.786', Elevation 1.00 and accuracy 1:15.0. The soil texture is sandy loam with a PH of 6.4 and bulk density 1.25kg/cm<sup>3</sup>. After an initial conventional tillage of the one hectare farm, labour saving mechanical jab and rotary planters, reciprocating weeder and manual methods were used to establish a mixed cropping one hectare farm of maize and cassava under rain-fed conditions. The effects of these treatments were studied using the following relevant parameters: field capacity of planting, weeding and yield of crops. The yield of crop methods used include ear and stover weight for maize (Nielsen 2014) and cassava weight/area (FAO 2006). The experiment was conducted using a Split plot design with two replicates as explained by Montgomery (2012). The main plot was that of cassava while the subplots include maize planted with different modes and weeding. The experimental layout is shown in Figure 1. The data were subjected to two way analysis of variance to test the effect of planting and weeding on parameters measured. Also, one way ANOVA, least significant follow up tests were carried out.

### **Results and Discussion**

The highest field capacity among the planting methods was that of rotary planting with 1.53 ha/hr while, 0.44 ha/hr and 0.24 ha/hr were obtained for jab and manual planting respectively. A field capacity of 0.012ha/hr was obtained for mechanical weeding as against 0.0036 ha/hr with manual weeding. The functional efficiency of the weeding machine was 98% while the quality performance efficiency was 88%. The yield of the maize stover are as follows: Manual planting 6.9 tonnes/ha, Rotary planting 11.5 tonnes/ha, Jab planting 3.9 tonnes/ha while that of the average ear weight are 15.42 tonnes/ha for rotary planting, 10.33 tonnes/ha for manual planting and 5.83 tonnes/ha for jab planting. From these the highest yield of maize was that by rotary planting, followed by manual planting and the least is that by jab planting. The effect of the use of chemical weeding reduced the yield of cassava roots to 60 ton/ha as against 81 ton/ha for manual/mechanical weeding because many of the roots on the chemically weeded plots got spoilt prior to harvesting. Further investigation is ongoing to substantiate the facts. However, these observations are in agreement with the fact that mechanical manipulation of the soil by way of planting and weeding loosen the soil between rows, thus increasing air and water intake capacity, thereby increasing yield.

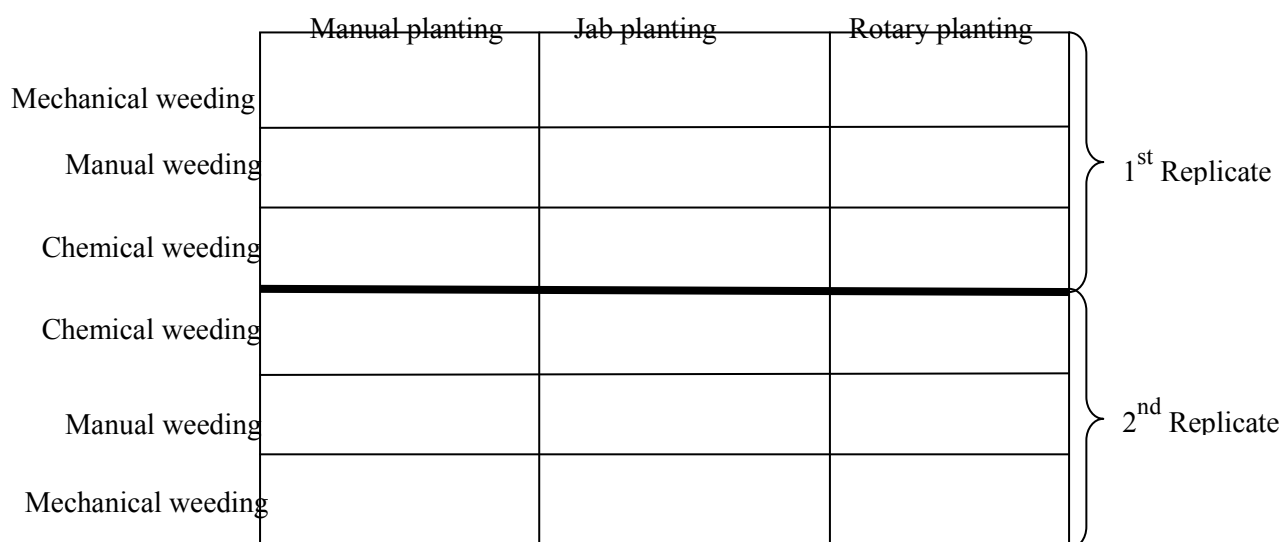

Figure 1: Experimental layout of the plot

### Conclusion

A study of the effect of different methods of planting and weeding on machine field capacity and yield of a mixed cropping small holder farm has been done. By the time this work is completed, there will be an understanding of the effect of the different methods studied which would assist in recommending best practices on mechanization of crop production processes to small holder farmers and other users in the study area.

### References

- FAO 2006. Cassava Assessing Handbook for Improved Integration of Cassava in the FAO/WFP Joint Crop and Food Supply Assessment Mission (CFSAM). Food and Agriculture Organization (FAO) of the United Nations, Rome, Italy. [http://fsg.afre.msu.edu/cassava/FAOCassava\\_Guidelines.pdf](http://fsg.afre.msu.edu/cassava/FAOCassava_Guidelines.pdf). retrieved on 12/01/2017
- Montgomery, D.C. 2012. Design and Analysis of Experiments 8<sup>th</sup> Edition, John Wiley and Sons Incorporated
- Nielsen, RL. 2014. Estimating Corn Grain Yield Prior to Harvest. Corny News Network, Purdue University. <http://www.agry.purdue.edu/ext/corn/news/timeless/YldEstMethod.html>. retired on 15/10/2016







		rate						
Soil Physical Characteristics (0-15 cm depth)	Moisture content (%)	0	10.8b	10.7b	9.3a	9.7a	9.4a	
		5	11.9b	10.8b	9.5a	10.0b	9.6a	
		10	10.4b	10.5b	9.0a	9.4a	9.1a	
	Bulk density (Mgm <sup>-3</sup> )	0	1.52b	1.48a	1.55b	1.42a	1.40a	
		5	1.46a	1.42a	1.65b	1.44a	1.46a	
		10	1.45a	1.50b	1.67b	1.42a	1.40a	
	Porosity (%)	0	45.60a	46.10a	47.60a	48.20a	49.40b	
		5	47.60a	44.10a	46.10a	46.80a	46.80b	
		10	44.80a	43.40a	45.20a	45.50a	46.60b	
	Soil strength (MPa)	0	0.840a	0.740a	0.920b	1.000b	0.730a	
		5	0.870a	0.860a	0.880b	1.100b	0.700a	
		10	0.920b	0.870a	0.910b	1.120b	0.700a	
Growth Parameters at Three Levels of NPK Fertilizer Rates (0, 80, 150 kg/ha)	Height (m x 10 <sup>-2</sup> )	0	132.6a	136.4a	159.6c	138.5a	142.8a	
		80	140.2b	144.3b	169.8c	142.7b	140.2b	
		150	144.2b	148.7b	174.8c	150.6b	152.4b	
	Fruiting Pattern	0	5.0a	6.0a	7.5b	6.0a	7.0a	
		80	6.0a	5.0a	9.0b	7.0a	7.0a	
		150	6.5a	7.0a	8.5b	7.0a	8.0a	
	Stem Diameter (m x 10 <sup>-2</sup> )	0	1.80a	2.10b	2.38b	2.30b	2.34b	
		80	2.00b	2.20b	2.40b	2.70b	2.32b	
		150	1.90a	2.20b	2.42b	2.32b	2.30b	
	Yield (t/ha)	0	0.52a	0.62a	0.73b	0.63a	0.73b	
		80	0.62a	0.52a	0.94b	0.73b	0.67a	
		150	0.60a	0.73b	0.83b	0.76b	0.83b	
	Number of Leaves	0	8.0b	5.0b	4.0a	6.0b	9.0b	
		80	7.0b	7.0b	5.5a	7.0b	8.0b	
		150	9.0b	6.0b	5.5a	6.0b	10.0b	
	Leaf Area (m x 10 <sup>-2</sup> )	0	158.80a	162.40a	238.00c	180.20a	230.80b	
		80	180.40a	180.80a	240.00c	200.80b	232.40b	
		150	190.20b	200.20b	242.00c	210.40b	230.40b	

\* Means carrying the same letters are not significantly different (P = 0.05) according to Duncan's Multiple Range Test

## References

- IITA (2000). International Institution for Tropical Agriculture Laboratory Manual IITA, Ibadan, Nigeria.
- Samuel, T. M. and E. A. Ajav. 2010. Optimum Tillage System for Pepper Production in an Alfisol of South-Western Nigeria. African Journal of Agricultural Research. Vol. 5(19):2647 – 2652.
- Omotoso, S. O. and O. S. Shittu. 2007. Effect of NPK Fertilizer Rates and Method of Application on Growth and Yield of Okro (*Abelmoschus esculentus* (L.) Moench) at Ado Ekiti Southern, Nigeria. International Journal of Agricultural Research. 2(7):614 – 619.

## **Effect of different tillage methods on some soil physical properties and yield of two cotton cultivars.**

Shahram NOWROUZIEH<sup>1\*</sup>, HoseynaliShamsabadi<sup>2</sup>

<sup>1</sup>Assistant Professor, Cotton Research Institute, Agricultural Research, Education and Extension Organization (AREEO), Tehran, Iran.

<sup>2</sup>Assistant Professor, Department of Mechanics of Bio-system Engineering, University of Agricultural Sciences and Natural Resources, Gorgan, Iran.

\* corresponding author: snowrozieh@gmail.com

### **Introduction**

Cotton is the most important crop in east and north of Iran. Conventional tillage is applied almost in all arable lands of Iran. Soil is ploughed in autumn and left during winter to crumble. In March, a cultivator is used to break large clods and after soil preparation the cotton seed was planted. The advantages of conservation tillage were peered after wheat harvesting in May. In this situation field preparation has to be done within a short-time, before the rain of May and June. So with no tillage, the tillage time was omitted and cotton was planted as soon as possible.

The objective of this study was to investigate the effects of different tillage systems on some soil physical properties and yield of two cottons cultivars (Golestan and Khordad).

### **Material and method**

The experiments were carried out in the Experimental Farm Station of the Cotton Research Institute, Iran in 2013. The soil was silt clay loam with an FAO standard. After wheat harvesting in end of May, the residue was baled by baler. For this study, a field experiment was performed in a randomized complete block design (RCBD) with three replications. Three levels of tillage methods include: surface tillage (disc harrow), minimum tillage (cyclotiller + disc harrow) and conventional tillage (mouldboard plow + disc harrow). These were taken as main plots and two cotton cultivars, Golestan and Khordad, were attributed to sub-plots. Soil physical properties include temperature, aggregation (MWD), porosity and moisture measured after seed planting in two depths, 0-15 cm (D1) and 15-30 cm (D2). Also for studying the response of cotton plant to different tillage methods, the cotton yield and wheat straw yield were calculated. Data were statistically analyzed using the SAS software and treatment means were separated out using the least significant difference (LSD) at 5% probability level.

### **Results and discussion**

#### **Wheat straw**

In surface tillage treatment, the disc harrow was used only for mixing the fertilizers and herbicide. So the wheat straw in this treatment was more than the others. On the other hand, in conventional tillage treatment (where mouldboard plow is used), all wheat straw covered by soil and the residue were very low (Table 1).

#### **Soil moisture**

Measurement of soil moisture in 0-15 cm and 15-30 cm depths showed that relative moisture changed across treatments. This difference is greater in 0-15 cm than 15-30 cm. Analysis of variance of soil moisture data indicated that there was no significant difference between treatments in 0-15 cm and 15-30 cm depths.

As shown in Table1, in the 0-15 cm soil layer, the highest moisture level was observed in the surface tillage treatment and the lowest moisture level was observed in the conventional tillage treatment. The reason for such a difference in moisture can be attributed to the residual cover that prevents direct exposure to sunlight. In the 15-30 cm soil layer, the minimum tillage treatment had the highest moisture compare to the other treatments. This higher moisture could affect the cotton yield as the main cotton roots generally develop in this soil depth.

**Table 1- Mean comparison of soil physical properties in different tillage systems.**

S.O.V	Wheat straw (g.m <sup>2</sup> )	Soil moisture (%)		Soil temperature (c)	MWD (mm)		Porosity (%)	
		D1	D2		D1	D2	D1	D2
		Surface Tillage	461 <sup>a</sup>		21.29 <sup>a</sup>	20.66 <sup>a</sup>	37.88 <sup>a</sup>	1.64 <sup>a</sup>
Minimum Tillage	242 <sup>b</sup>	21.24 <sup>a</sup>	20.75 <sup>a</sup>	38.02 <sup>a</sup>	1.61 <sup>a</sup>	1.79 <sup>a</sup>	52.57 <sup>a</sup>	42.89 <sup>b</sup>
Conventional Tillage	32 <sup>c</sup>	20.43 <sup>a</sup>	20.56 <sup>a</sup>	38.26 <sup>a</sup>	1.45 <sup>b</sup>	1.64 <sup>a</sup>	54.93 <sup>a</sup>	48.05 <sup>a</sup>

Mean in each column followed by similar letters are not significantly different in 5% probability level

### Soil Temperature

As shown in Table1, surface soil temperature increased with increasing soil tillage, but the differences were not significant. The maximum soil temperature belonged to conventional tillage. One of the reasons could be explained by direct sunlight to the soil surface.

### Soil mean weight diameters (MWD)

At wheat harvest of, the MWD values ranged from 1.45 to 1.64 mm (Table 1). In the 0-15 cm soil layer, the MWD significantly differed among the treatments, but the MWD of all treatments did not differ in the 15-30 cm. Alvarez and Steinbach (2009) reported that the change in mean MWD was greater under plowing + harrowing than under reduced tillage or no tillage. This study also confirmed this result.

### Soil Porosity

Soil porosity was positively related to tillage. The percentage of soil porosity was significantly higher in conventional tillage than in surface tillage (Table 1). The same relation between soil porosity and different tillage was observed in two depths (Table 1). But the upper layer of soil was more affected than the sub-surface soil layer.

The cotton yields for two cotton cultivars were higher in minimum tillage than in the other treatments (Figure 1). Minimum cotton yield was obtained in conventional tillage in spite of more soil tillage, cost and time involved for soil preparation. The relationship between yield and soil tillage treatments may be due to the effect of tillage treatments on moisture content and soil temperature.

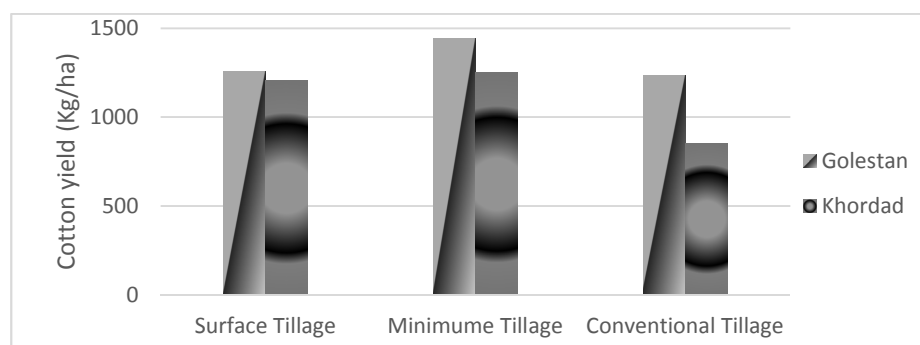

**Figure 1- Cotton yield in different tillage system**

### Conclusion

Despite, there was no significant difference in cotton yield among the tillage systems, the benefits of reducing fuel consumption, saving time, maintaining soil organic matter and reducing costs under conservation tillage systems for cotton production was observed. Hence, conservation tillage system is recommended. Increasing water holding capacity in soils is another advantage of a non-plowing crop system. Regarding the importance of water for agriculture, especially for cotton farming, increasing the potential of water storage in the soil due to the more vegetative residue could keep the plant alive under hot conditions and from drought stresses (due to reduced water evaporation from the soil surface).

### References

Alvarez, R. & Steinbach, H.S. 2009. A review of the effects of tillage systems on some physical properties, water content, nitrate availability and crops yield in the Argentina Pampas. *Soil Till. Res.*, 104:1-15.

## Implementation of the 4 per 1000 initiative at the regional scale: A case study for Bavaria

M. Wiesmeier<sup>1,2\*</sup>, J. Burmeister<sup>2</sup>, R. Hübner<sup>3</sup>, I. Kögel-Knabner<sup>1,4</sup>

<sup>1</sup>*Chair of Soil Science, TUM School of Life Sciences Weihenstephan, Technical University of Munich, Freising, Germany*

<sup>2</sup>*Bavarian State Research Centre for Agriculture, Freising, Germany*

<sup>3</sup>*Chair for Strategic Landscape Planning and Management, TUM School of Life Sciences Weihenstephan, Technical University of Munich, Freising, Germany*

<sup>4</sup>*Institute for Advanced Study, Technical University Munich, Garching, Germany*

\*corresponding author: martin.wiesmeier@lfl.bayern.de

### Introduction

The ambitious “4 per 1000” initiative launched in 2015 aims at increasing world’s soil organic carbon (SOC) stocks in the upper 40 cm by 4 per mille each year in order to offset anthropogenic CO<sub>2</sub> emissions ([www.4p1000.org](http://www.4p1000.org)). For practical implementation of the initiative, regional feasibility studies are needed including an analysis of SOC stocks, an estimation of the C storage potential, and a comprehensive, spatially explicit development of improved land management scenarios, based on an analysis of existing land management practices. In this study, we estimated the potential of SOC increases in agricultural soils of Bavaria (Germany) by widespread implementation of improved management practices, such as reduced tillage intensity, cover cropping, improved crop rotations, organic farming, agroforestry and conversion of cropland to grassland.

### Material & Methods

Due to the limited capacity of soils to store SOC, the C storage potential of soils of Bavaria was estimated on the basis of the C saturation of the fine mineral fraction <20 µm (Hassink, 1997). For 95 representative sites the C saturation deficit of the fine fraction was calculated representing the C storage potential (Wiesmeier et al., 2014). The C saturation deficit was estimated as the difference between the C storage capacity of the fine fraction according to Hassink (1997) and the actual C content of the fine fraction derived from soil fractionation. In order to determine the amount of SOC that has to be yearly sequestered in soils of Bavaria according to the 4 per 1000 aim, total SOC stocks of agricultural soils (cropland and grassland) were estimated for the depth 0 to 40 cm on the basis of data set of 786 soil profiles with measured SOC stocks (Wiesmeier et al., 2012). A SOC map with a spatial resolution of 100 m was generated using the Random Forest model with different climatic, topographic and pedogenic factors as predictors. For a precise estimation of the total C sequestration potential, agricultural management data (InVeKoS data) from the period 2012-2015 was used to derive actual management practices for each agricultural field in Bavaria. Based on the analysis of the status quo of agricultural soil management, different improved management scenarios were developed including cover cropping, improved crop rotations, organic farming, agroforestry and conversion of cropland to grassland. Mean C sequestration rates for these practices were derived from the literature.

### Results & Discussion

The determination of the SOC saturation level showed that agricultural soils of Bavaria generally have a high C sequestration potential, as a mean SOC saturation level of 50% and 73% was found for cropland and grassland soils, respectively. Agricultural soils could additionally store 35 t C ha<sup>-1</sup> on average, exceeding C sequestration rates of the included

management practices ( $0.16$  to  $0.73 \text{ t ha}^{-1} \text{ yr}^{-1}$ ) by a factor of 50 to 220. Although a new SOC equilibrium will probably be reached before achieving the maximum storage capacity, there seems to be no limitation for a build-up of SOC in most soils within several decades. An analysis of the SOC map showed that a total amount of 276 Mt SOC is stored in the upper 40 cm of agricultural soils of Bavaria. Therefore, an amount of 1.1 Mt C has to be sequestered each year in order to achieve the 4 per mill target.

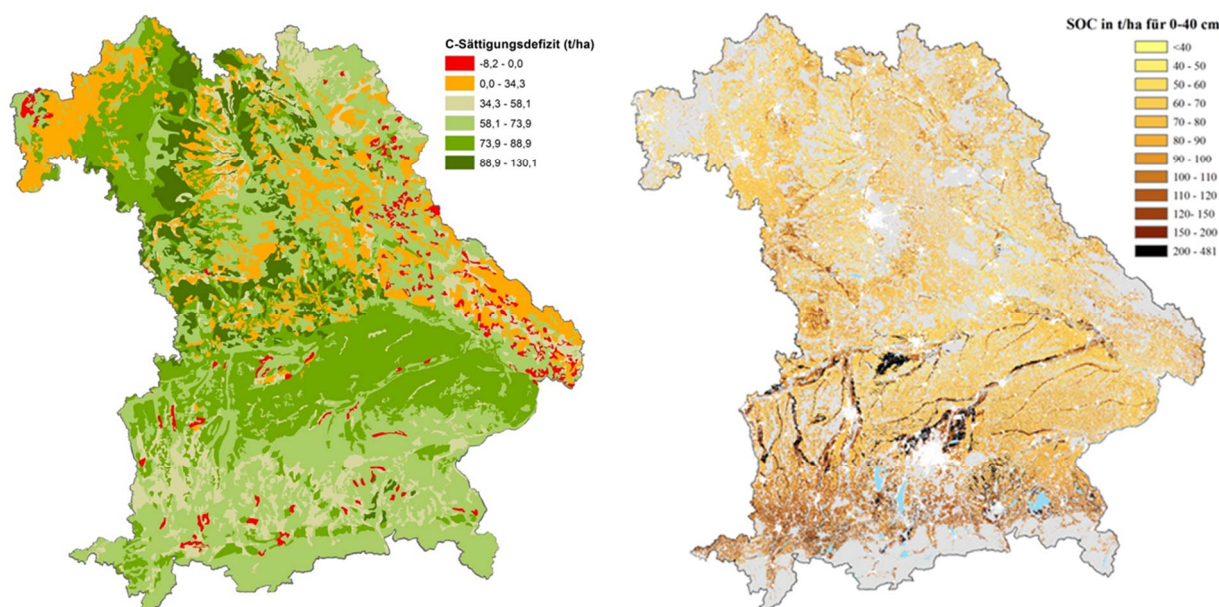

Figure 1: The C storage potential (C saturation deficit of the fine mineral fraction, left) and SOC stocks in the upper 40 cm in agricultural soils of Bavaria (right)

However, a comprehensive and spatially explicit analysis of different management options showed that a maximum amount of only  $0.37 \text{ Mt C yr}^{-1}$  could be sequestered. This analysis was based on following assumptions: (1) increase of the cropland area with cover cropping by 29%, (2) improvement of crop rotations at 18% of the cropland area of Bavaria, (3) introduction of agroforestry at 5% of the agricultural area, (4) extension of the cropland area with organic farming to 12% of the area and (5) conversion of cropland to grassland at 2% of the area.

### Conclusions

Although only 30% of the 4 per mill target can be reached in Bavaria by widespread implementation of improved agricultural management practices, the estimated C sequestration potential would significantly counterbalance regional greenhouse gas emissions from the agricultural sector in Bavaria. Moreover, there are further benefits associated with C sequestration such as improved soil fertility, soil structure and water holding capacity, a reduced risk of soil erosion, eutrophication and water contamination as well as reduced costs for fossil fuel and fertilizers.

### References

- Hassink J., 1997. The capacity of soils to preserve organic C and N by their association with clay and silt particles. *Plant and Soil* 191, 77-87.
- Wiesmeier M., Spörlein P., Geuss U., Hangen E., Haug S., Reischl A., Schilling B., von Lützow M., Kögel-Knabner I., 2012. Soil organic carbon stocks in southeast Germany (Bavaria) as affected by land use, soil type and sampling depth. *Global Change Biology* 18, 2233-2245.
- Wiesmeier M., Hübner R., Spörlein P., Geuß U., Hangen E., Reischl A., Schilling B., von Lützow M., Kögel-Knabner I., 2014. Carbon sequestration potential of soils in southeast Germany derived from stable soil organic carbon saturation. *Global Change Biology* 20, 653-665.

## Effects of Tillage on Storage and Pool Size of Organic Carbon when Crop Residue is Returned to the Soil Surface

Aizhen Liang<sup>a,c\*</sup>, Yan Zhang<sup>a,b,c</sup>, Xiujun Li<sup>a,c</sup>, Edward G. Gregorich<sup>b</sup>, Neil B. McLaughlin<sup>b</sup>, Xiaoping Zhang<sup>a</sup>, Yafei Guo<sup>a,c</sup>

*a. Northeast Institute of Geography and Agroecology, CAS, Changchun 130102, China*

*b. Ottawa Research and Development Centre, Central Experimental Farm, Agriculture and Agri-Food Canada, Ottawa, ON K1A 0C6, Canada*

*c. University of Chinese Academy of Science, Beijing 100049, China*

\*Corresponding author: [liangaizhen@iga.ac.cn](mailto:liangaizhen@iga.ac.cn)

### Introduction

Conventional tillage (CT) in northeast China usually involves complete removal of crop residue after harvest and deep ploughing in the fall. Removal of crop residue has caused soil organic carbon (SOC) losses of approximately 50% and negatively affected soil physical, chemical, and biological properties. Different tillage practices can influence the carbon inputs, distribution of C and physical SOC pools like aggregates. It may also be worthwhile to explore changes in the chemical composition of different SOC pools that are important for C sequestration. Analyze the labile pool could provide more insight into, and understanding and early indications of, effects of soil management on SOC. In contrast, changes in the recalcitrant C pool could provide clues about the potential for SOC storage over the long term. In this study, we established a field experiment with three tillage practices – no-tillage (NT), ridge-tillage (RT), and moldboard plough (MP) – to evaluate potential soil conservation practices. Crop residues were not removed in the NT treatment but in the RT and MP treatments residues were removed before ploughing and returned to the soil surface afterwards. The rationale for this approach is to protect the soil from wind and water erosion after plowing, ensure the efficient use of rainfall water, and maintain good seedbed preparation. Our objective was to evaluate the effects of different tillage practices with residue returned to the surface on crop yields, SOC storage, and SOC pools isolated by sulfuric acid hydrolysis.

### Material and method

The study site is located in the North Temperate Zone, with a continental monsoon climate. The soil is classified as black soil (Typic Hapludoll, USDA Soil Taxonomy) with a clay loam texture (36% clay, 24% silt and 40% sand). The site had been used for continuous maize production under conventional tillage management as described above for more than 15 years prior to 2001. The long-term tillage experiment was established in a split-plot randomized complete block design with three tillage practices and four replications. Tillage practices, (no-tillage (NT), ridge-tillage (RT), mouldboard plough (MP)) were applied at the whole-plot level, with a maize-soybean (*Zea mays* L. and *Glycine max* Merr.) rotation system applied at the sub-plot level (5.2 m × 20 m). Seven soil samples were collected from each plot in four replicate cores down to a depth of 30 cm when the study was initiated in 2001 and then again in the maize phase after harvest in 2013 under three treatments. Each soil core was separated into three segments corresponding to depths of 0-5, 5-10, 10-20 and 20-30 cm. We used a two-step acid hydrolysis procedure with H<sub>2</sub>SO<sub>4</sub> as the extractant to determine labile and recalcitrant C pools.

### Results and discussion

In this experiment, NT and RT treatments showed a greater accumulation in SOC storage compared to MP for the entire plough layer (0–20 cm), but there was no difference in SOC storage for the 0–30 cm depth. The results are consistent with other studies where NT enhanced SOC storage in the surface layer but reduced SOC storage in deeper layers. The apparent high SOC storage gains in surface layer disappear when deeper soil layers are included. The total labile C (i.e., LP1 + LP2), as isolated by acid hydrolysis, comprised 39%-45% of SOC, whereas resistant C (i.e., RP-C) accounted for 55-61%. These findings are consistent with those of Muñoz-Romero who also reported that the SOC comprised 62% resistant C and 38% labile C. Our results showed that the LP1-C and LP2-C concentration were approximately the same; however, other studies found that LP2-C was three-fold greater than LP1-C. The discrepancies among experiments may be caused by differences in soil types, textures, and management.

The observation that there was a greater proportion and absolute concentration of LP2-C in both the 0–5 and 5–10 cm layers under RT than that in the same layers under NT and MP can probably be explained by the tillage operations. When the soil is ridged early in the growing season, some partially decomposed residue on the surface from the previous crop year is mixed with soil in the 0–10 cm layer; this would likely affect mineralization of the residue, which is mainly cellulosic in origin. Although there are relative differences between LP1-C and LP2-C in all tillage practices over the experiment, total LPC showed no difference among them except in the surface layer. A transfer of C between the LP1-C and LP2-C pool has been shown, and this may lead to no significant difference in LPC among treatments at deeper depths. The RP-C fraction exhibited a similar trend to that of SOC in all treatments, indicating it could provide clues about the SOC dynamics over the long-term.

## Conclusion

Tillage had no effect on both soybean and maize yield, thus there was no difference in C inputs among treatments. Soils under NT and RT had higher SOC storage than under MP in the plough layer (0–20 cm). This difference disappeared when deeper soil layers were included in the calculation of SOC storage in the 0–30 cm layer. Although all tillage treatments had the same SOC storage, the high rate of SOC storage under RT implies that it may be better for long-term SOC storage and therefore needs further study. Tillage also affected different SOC pools. The higher LP2-C/LPC ratio in RT suggests that SOC is more stable under RT than under either MP or NT. There was no difference in total LPC among treatments in all layers except the surface 0–5 cm layer, suggesting that it is not a good indicator of SOC dynamics for long-term study. The RP-C had no change in the deeper layers under NT compared to the start of the experiment indicating that this C pool was resistant to decomposition. However RP-C increased in the 0–5 cm layer under NT and in the whole profile under RT and MP, indicating that returning crop residue to the soil is critical for the long-term SOC storage and a driving factor in SOC change.

## References

- Pandey, D., et al., 2014. Recalcitrant and labile carbon pools in a sub-humid tropical soil under different tillage combinations: A case study of rice-wheat system. *Soil Till Res* 143, 116-122.
- Muñoz-Romero, V., et al., 2017. Effects of tillage, crop rotation and N application rate on labile and recalcitrant soil carbon in a Mediterranean Vertisol. *Soil Till Res* 169, 118-123.
- Rovira, P., Vallejo, V.R., 2002. Labile and recalcitrant pools of carbon and nitrogen in organic matter decomposing at different depths in soil: an acid hydrolysis approach. *Geoderma* 107, 109-141.

**ISTRO2018/55**

**Long-term no tillage favors conserving carbon in the soil food web indicated by nematode metabolism analysis**

S. Zhang<sup>a</sup>, X. Yang<sup>b</sup>, S. Cui<sup>c</sup>, P. Liu<sup>a</sup>, D. Wu<sup>a</sup>, W. Liang<sup>c</sup> and A. Liang<sup>a</sup>

<sup>a</sup>Northeast Institute of Geography and Agroecology, Chinese Ac, Shengbei Street No.4888, Changchun, China, 130012 Changchun, China

<sup>b</sup>Harrow Research and Development Centre, Agriculture and Agri, Harrow, Ontario, Canada NOR IGO, Ontario, ON, Canada NOR IGO

<sup>c</sup>Institute of Applied Ecology, Chinese Academy of Science, Wenhua Street No.72, Shenyang, China, 110016 Shenyang, China  
zhangshixiu@iga.ac.cn

Number of words in abstract: 0

Keywords: soil C sequestration - soil nematodes - carbon partitioning - metabolism

Technical area: SOC sequestration and management

Special session: Not specified

Presentation: Oral

Special equipment: No specific equipment needed



## There Are no Differences in Soil Carbon Storage Between Inversion Tillage and Reduced Tillage Systems in Medium-term Experiments in the UK

J.L. Brown<sup>1\*</sup>, R. Stobart<sup>2,3</sup>, P.D. Hallett<sup>4</sup>, N.L. Morris<sup>3</sup>, T.S. George<sup>1</sup>, A.C. Newton<sup>1</sup>, T.A. Valentine<sup>1</sup> and B.M. McKenzie<sup>1</sup>.

<sup>1</sup> *The James Hutton Institute, Invergowrie, Dundee, DD2 5DA, Scotland, UK*

<sup>2</sup> *Sainsbury's Supermarkets Ltd., 33 Holborn, London EC1N 2HT, UK*

<sup>3</sup> *NIAB, Morley, Wymondham, Norfolk NR18 9DF, UK*

<sup>4</sup> *Institute of Biological and Environmental Sciences, University of Aberdeen, Aberdeen, AB24 3UU, Scotland, UK*

\*Corresponding author: [jennifer.brown@hutton.ac.uk](mailto:jennifer.brown@hutton.ac.uk)

### Introduction

By inverting the soil, mouldboard ploughing changes many soil properties including bulk density, aeration, drainage, thermal regimes, and the soil biology. These changes, together with the break up of plant residues, may expose previously protected organic matter to oxidation and potentially release CO<sub>2</sub> (Sun et al., 2011). Reduced tillage, through either no till or non-inversion tillage to shallower depths, may limit CO<sub>2</sub> release and help increase the store of carbon in the soil. However, the positive effects of reduced tillage may have been overestimated due to a sampling bias towards the soil surface, the reporting of soil carbon as a concentration without taking into account bulk density, the effect of stone content and the length of time the management practices have been in place.

The objective of this study was to assess the impacts of five tillage treatments on the content and depth distribution of carbon in soils from medium-term experimental plots in the UK.

### Materials and Methods

Experimental plots were located in three sites with contrasting soil textures in the UK (STAR, NFS and Mid-Pilmore). The treatments had been in place for between 6-10 years and were, mouldboard ploughing to 20 cm and disking (P), no till (N), min till by shallow non-inversion tillage to a depth of 7 cm (M), compaction by ploughing to 20 cm followed by wheeling with a 8.8 Mg total load (C) and deep plough to 25 cm (D). Soil samples were taken in August 2013 at 5 intervals to a depth of 60 cm. Total carbon was determined on ball-milled soil using a Thermo Flash EA 1112 Elemental Analyser. Statistical analyses were performed with GenStat 18<sup>th</sup> edition using ANOVA and REML with least significant differences (LSD) at P<0.05.

### Results and discussion

Bulk density was not significantly affected by tillage treatment in any of the sites. The interaction treatment x depth was significant at Mid-Pilmore. The surface soil of the P treatment had greater bulk density than the M treatment. There were no differences in carbon content between treatments at either the STAR or NFS sites. In Mid-Pilmore, there was greater carbon content in the P treatment compared to the M and N treatments. Carbon content was greater in the surface layers in STAR and NFS. In Mid-Pilmore, the greatest carbon content occurred below the plough layer (Figure 1). The interaction treatment x depth was not significant in STAR and Mid-Pilmore. In NFS, there was greater carbon content in the surface of the D and M treatments compared to the P. These differences in carbon distribution would not be apparent if sampling had been confined to the 20 cm depth of the plough layer alone. The disregard of bulk density in measuring soil carbon has been highlighted by many researchers, but another neglected component of soil that may bias results, is stone content (i.e. > 2 mm). Adjusting bulk density for stone content in Mid-

Pilmore did not change the main conclusion of greater carbon content in the P treatment, but it changed the significance of the treatment x depth interaction. This resulted in the P treatment showing greater carbon content at and immediately below the depth of ploughing compared to the M and N treatments. The C treatment also showed greater carbon content than the M and N treatments at the plough layer. In the sub-soil, the C treatment had lower carbon content than all other treatments. The accumulation of carbon at the plough layer with inversion tillage is a common observation (Gal et al., 2007) and it is attributed to the turning down of crop residue during ploughing. Although our results show no advantages of using reduced tillage for soil carbon storage, there may be other benefits not investigated in this study. For example, the accumulation of SOC in the soil surface with reduced tillage, may increase aggregate stability lowering the risk of erosion and run-off. Other potential benefits include increased water retention, biological activity and nutrient cycling in the soil surface. The preparation of the land is faster and less energetically demanding due to fewer passes, allowing sowing at an optimum time. This is important in the UK where farmers often have a narrow window of opportunity to establish the following crop (Morris et al., 2010). The amount of fuel used in comparison to conventional tillage should also be taken into consideration when assessing the overall advantages of reduced tillage.

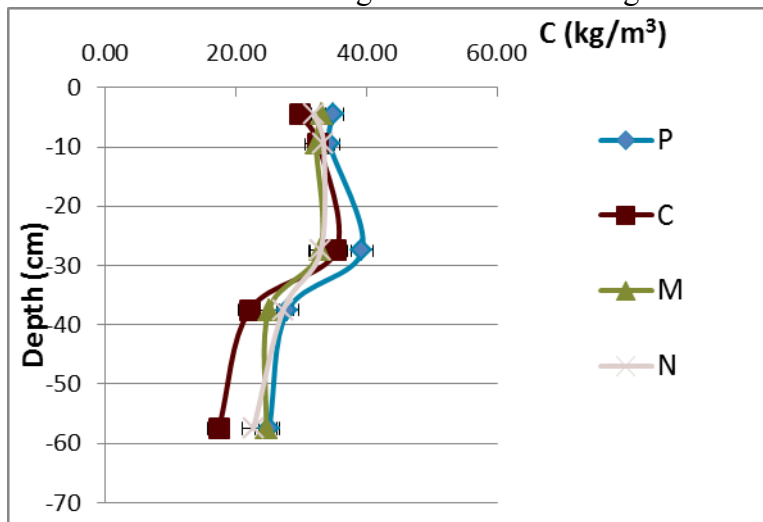

Figure 1: Carbon content by soil depth and tillage treatment in Mid-Pilmore, Scotland, UK.

## Conclusions

Carbon content was either not affected by tillage treatment (NFS and STAR) or was greater in conventional inversion tillage than in the reduced tillage systems (Mid-Pilmore). Bulk density at the time of sampling was also not affected by tillage treatment in NFS and STAR. In Mid-Pilmore, the reduced tillage systems showed higher bulk densities than the inversion treatments in the subsoil. We demonstrated that neglecting stone content when quantifying carbon storage in soils can result in considerable differences, so it is important to include. Our results suggest that in the medium term in the UK, reduced tillage practices cannot be recommended as a carbon storage practice, when a soil profile of 60 cm is taken into account.

## References

- Morris N. L., Miller, P.C.H., Orson, J.H., Froud-Williams, R.J. 2010. The adoption of non-inversion tillage systems in the United Kingdom and the agronomic impact on soil, crops and the environment- A review. *Soil Till. Res.*, 108, 1-15.
- Sun B., Hallett P., Caul S., Daniell T.J., Hopkins, D.W. 2011. Distribution of soil carbon and microbial biomass in arable soils under different tillage regimes. *Plant soil* 338, 17-25.
- Gál, A., Vyn, T. J., Michéli, E., Kladvko, E. J., McFee, W. W. (2007) Soil carbon and nitrogen accumulation with long-term no-till versus moldboard plowing overestimated with tilled-zone sampling depths. *Soil Till Res* 96: 42-51.

## Long-Term Response of a Bahiagrass Pasture to Elevated Atmospheric CO<sub>2</sub> and Nitrogen Management

\*Stephen A. Prior, G. Brett Runion, and H. Allen Torbert

USDA-ARS National Soil Dynamics Laboratory, Auburn, AL USA 36832

\*steve.prior@ars.usda.ars

### Introduction

The level of CO<sub>2</sub> in the atmosphere is increasing at an unprecedented rate due primarily to fossil fuel burning and land use change (Keeling and Whorf, 2001). Plant responses to elevated CO<sub>2</sub> are well documented, showing increased photosynthesis and resource use efficiencies that often increase plant growth (Amthor, 1995). In some cases, plants do not respond to increased CO<sub>2</sub> when soil resources such as N are limiting. Nitrogen is the element most limiting to biomass production and is key to both plant and soil C dynamics. Understanding CO<sub>2</sub>-induced changes in plant/soil N interactions is critical to N management for both profitable and environmentally sound agricultural systems. Pastures occupy 80 million acres in the southeastern U.S., which is ~75% of the total pasture acreage in the eastern U.S. While the effects of elevated CO<sub>2</sub> on natural grasslands have received some attention, managed pastures remain understudied. Therefore, a long-term experiment examining the response of a southeastern pasture system (bahiagrass, *Paspalum notatum*) to current and elevated levels of CO<sub>2</sub> with a soil N management treatment (no N = unmanaged and added N = managed) was implemented.

### Material and methods

The response of a southeastern bahiagrass pasture system to current and elevated (+200 ppm) CO<sub>2</sub> levels was examined in a study initiated in spring 2005 on an outdoor soil bin (7m x 76 m) at the USDA-ARS National Soil Dynamics Laboratory in Auburn, Alabama, USA. After an 1-yr establishment period, a N management factor (no N vs. added N) was added using a split-plot design replicated three times with N as main plots and CO<sub>2</sub> level as subplots within open top field chambers (Rogers et al., 1983) on a Blanton loamy sand (loamy, siliceous, thermic Grossarenic Paleudult). Nitrogen was applied to managed plots according to extension soil test recommendations; N [(NH<sub>4</sub>)<sub>2</sub>SO<sub>4</sub>] was applied three times per year at 90 kg ha<sup>-1</sup> per application. These two N treatments represent managed versus unmanaged pastures, both of which are common in the Southeast. The experiment ran for 10 years, and aboveground forage biomass was harvested three times per year (June, August, and October). At each harvest, plants were mowed to simulate a haying operation, and dry mass was recorded. Forage quality, in terms of C and N, was also determined by dry combustion method using a LECO TruSpec analyzer (LECO Corp., St. Joseph, MI); these data will not be presented here. Data analysis was conducted using the Mixed Models Procedure (Proc Mixed) of the Statistical Analysis System. Error terms appropriate to the split-plot design were used to test significance of main effects and their interactions. A significance level of ( $P \leq 0.10$ ) was established *a priori*.

### Results and discussion

Prior to N treatment initiation (establishment), forage biomass was unaffected by CO<sub>2</sub> treatment (data not shown). The main effect of CO<sub>2</sub> was significant in all 10 years; the average increase under elevated CO<sub>2</sub> was 14% (Fig. 1). The main effect of N was highly significant in all 10

years; the average increase from added N was 232%. The interaction of CO<sub>2</sub> x N was significant in all years except 2009; generally, forage biomass was increased by elevated CO<sub>2</sub> only with added N (15%). Tissue analysis indicated that high CO<sub>2</sub> lowered the C:N ratio in the no N treatment, but the opposite was observed with N fertilization (data not shown).

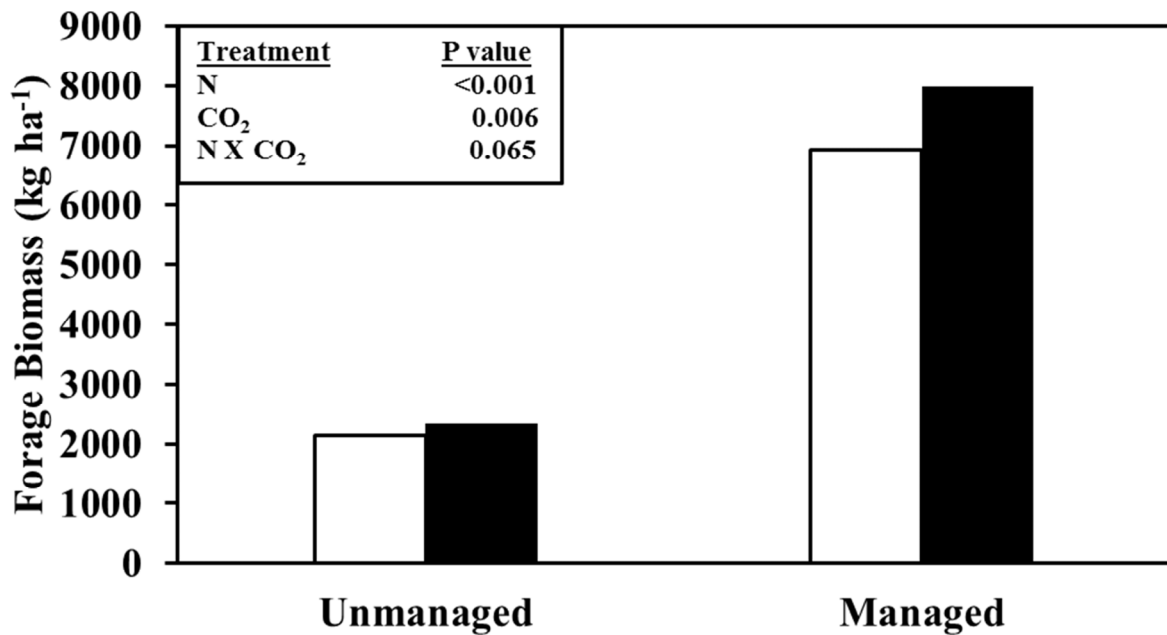

Figure 1: Cumulative annual bahiagrass forage biomass response to soil N (Unmanaged = no N; Managed = added N) under ambient (open white bars) or elevated (solid black bars) atmospheric CO<sub>2</sub>. Data shown represent the 10 year average.

**Conclusion**

Results show that N fertilization can significantly increase forage biomass production regardless of CO<sub>2</sub> level. Elevated CO<sub>2</sub> increased forage biomass only when soil N was added; however, forage quality (in terms of C:N ratio) may decline slightly under these conditions. Ongoing efforts are examining changes in soil organic C and N, including assessing the potential of this pasture system to sequester CO<sub>2</sub> as soil C and the influence on trace gas emissions (CO<sub>2</sub>, CH<sub>4</sub>, and N<sub>2</sub>O).

*References*

*Amthor, J.S., 1995. Global Change Biol., 1, 243-274.*

*Keeling, C.D. and Whorf, T.P., 2001. Atmospheric CO<sub>2</sub> records from sites in the SIO air sampling network. In: Trends, A Compendium of Data on Global Change. Carbon Dioxide Information Analysis Center, Oak Ridge National Laboratory, Oak Ridge, TN, pp. 14-21.*

*Rogers, H.H., Heck, W.W. and Heagle, A.S., 1983. Air Pollut. Control Assn. J., 33, 42-44.*

## Does conversion to conservation tillage really increase soil organic carbon stocks in organic arable farming?

M. Krauss<sup>1\*</sup>, F. Cuperus<sup>2</sup>, A. Don<sup>3</sup>, A. Gattinger<sup>4</sup>, S. Gruber<sup>5</sup>, W. Haagsma<sup>2</sup>, F. Hegewald<sup>3</sup>, J. Peigné<sup>6</sup>, M. Chiodelli Palazzoli<sup>1</sup>, F. Schulz<sup>7</sup>, M.G.A. van der Heijden<sup>8</sup>, L. Vincent-Caboud<sup>6</sup>, M. Wiesmeier<sup>9</sup>, R. Wittwer<sup>8</sup>, S. Zikeli<sup>10</sup>, M. Steffens<sup>1</sup>

<sup>1</sup>Research Institute of Organic Agriculture (FiBL), 5070 Frick, Switzerland

<sup>2</sup>Wageningen University & Research (WUR), 8219PH Lelystad, Netherlands

<sup>3</sup>Thünen Institute of Climate-Smart Agriculture, 38116 Braunschweig, Germany

<sup>4</sup>Chair in Organic Farming with focus on Sustainable Soil Use, Justus Liebig University Giessen, 35394 Giessen, Germany

<sup>5</sup>Institute of Crop Science, Agronomy (340a), University of Hohenheim, 70593 Stuttgart, Germany

<sup>6</sup>ISARA-Lyon, 69007 Lyon, France

<sup>7</sup>Research Station Gladbacherhof, Justus Liebig University Giessen, 65606 Villmar, Germany

<sup>8</sup>Plant-Soil Interactions, Research Division Agroecology and Environment, Agroscope, 8046 Zürich, Switzerland

<sup>9</sup>Institute for Organic Farming, Soil and Resource Management, Bavarian State Research Center for Agriculture, 85354 Freising, Germany

<sup>10</sup>Institute of Crop Science, Coordination for Organic Farming and Consumer Protection (340d), University of Hohenheim, 70593 Stuttgart, Germany

\*corresponding author: [maike.krauss@fibl.org](mailto:maike.krauss@fibl.org)

### Introduction

Aggravation of weather extremes increases awareness of climate change consequences. Mitigation options are in demand which aim to reduce the atmospheric concentration of greenhouse gases. For carbon dioxide (CO<sub>2</sub>), sequestration as soil organic carbon in the pedosphere is discussed globally. Amongst others, the conversion from ploughing to conservation tillage is argued to increase soil organic carbon (SOC) stocks as an accumulation of SOC in topsoil layers is commonly reported. Conservation tillage systems include tillage systems from no-tillage (or direct seeding) to different forms of reduced tillage, where tillage is still accomplished but less intensive compared with traditional ploughing. Yet, main findings of reviews and meta-analyses that compare SOC stocks between conservation tillage and ploughing changed over time: from a significant increase of SOC stocks to the question if there is any effect at all (Powlson *et al.*, 2014). The reason for this change is a sampling bias as a lot of campaigns only topsoil layers were assessed. However, changing the tillage regime redistributes SOC within the profile resulting in an increased stratification and often lower SOC stocks in deeper soil layers in conservation tillage systems. Apart from sampling depths, there are also other constraints in the assessment of SOC stocks including different methods of SOC concentration determination, bulk density determination (Walter *et al.*, 2016) and the discussion on the comparison of SOC stocks based on equivalent soil masses instead of equal sampling depths (Powlson *et al.*, 2014).

Organic farming differs compared with conventional agriculture in the diversification of crop rotations, increased organic matter input by organic fertilisation, perennial leys and cover crops as well as a non-chemical weed control. Thus, it is questionable if results on SOC sequestration in conventional systems (and thus the majority of studies) can be directly compared to organic farming with more complex SOC dynamics. There are some SOC measurements published of organic arable farming experiments comparing different tillage systems (Krauss *et al.*, 2017). Yet, methodologies and sampling depths vary between studies challenging the comparability. A systematic sampling campaign was consequently elaborated

to answer the question if the combination of conservation tillage and organic farming can really increase SOC stocks? Preliminary results will be presented at the conference.

### Material and methods

In nine organic long-term experiments (Table 1) on tillage systems in temperate Europe, a common soil sampling campaign takes place in autumn 2017 and spring 2018. All trials represent common mixed organic farming systems of the respective region with organic fertilisation and crop rotations including leys. While climatic conditions are similar, soil types vary from sandy to clayey soils.

All trials are sampled with the same technique and equipment. Undisturbed soil cores are taken with driving hammer probes (8 cm in diameter) to a maximum depth of 100 cm. The soil core is divided into the soil layers 0-30, 30-50, 50-70, 70-100 cm. The topsoil layer (0-30 cm) is further divided into the different tillage depths of the respective trial (Table 1). Bulk density is calculated and corrected for compaction according to Walter *et al.* (2016).

All samples are analysed in the same laboratory. Total carbon concentrations are determined by dry combustion on a VarioMax cube (Elementar Analysensysteme GmbH, Hanau, Germany). Inorganic carbon is determined by dry combustion on the same machine after removing the organic matter by heating the sample in a muffle furnace at 450°C for 4 hours.

Soil texture and pH are determined on pooled samples per soil layer for each trial as covariates and yields are compiled for each trial to assess carbon inputs.

Table 1. Overview on long-term experiments included in the sampling campaign

Country	Trial name (Institution according to author affiliations)	Starting date	Mouldboard plough	Reduced tillage
France	Thil trial <sup>5</sup>	2004	30 cm	Chisel, 5 cm
Germany	Organic Arable Farming Experiment Gladbacherhof <sup>6</sup>	1998	30 cm	Cultivator, rotary harrow 30 cm + 15 cm
	UHOH KH6 <sup>4</sup>	1999	25 cm	Chisel, 15 cm
	V501-505 Puch <sup>7</sup>	1997	25 cm	Chisel, 10 cm
	V501-505 Neuhof <sup>7</sup>	1997	25 cm	Chisel, 10 cm
Netherlands	BASIS <sup>2</sup>	2010	25 cm	Chisel, 15 cm
Switzerland	FAST <sup>8</sup>	2009	20 cm	Disc/rotary harrow, Geohobel 5 cm
	Frick trial <sup>1</sup>	2002	18 cm	Chisel, 10 cm
	Aesch trial <sup>1</sup>	2010	18 cm	Chisel, 10 cm

### Expected results

The common sampling relies on the same sampling and analytical methods performed by a core team that will realise a directly comparable dataset on a range of soil textures in temperate Europe. As experiments are not younger than eight years at sampling, a mid- to long-term effect of a tillage system change is statistically assessed under organic arable farming conditions.

### References

- Krauss, M., Ruser, R., Müller, T., Hansen, S., Mäder, P. and Gattinger, A., 2017. *Agr. Ecosyst. Environ.*, 239, 324-333.
- Powlson, D.S., Stirling, C.M., Jat, M.L., Gerard, B.G., Palm, C.A., Sanchez, P.A. and Cassman, K.G., 2014. *Nature Clim. Change*, 4, 678-683.
- Walter, K., Don, A., Tiemeyer, B. and Freibauer, A., 2016. *Soil Sci. Soc. Am. J.*, 80, 579-591.

## Biomass yield, nutrient removal, and soil chemical property changes in perennial energy grass systems

Guillermo Siri Prieto<sup>1\*</sup>, Mauricio Bustamante<sup>1</sup>, Oswaldo Ernst<sup>1</sup>

<sup>1</sup> Production Vegetal Department, EEMAC, Agronomy Faculty. Universidad de la Republica del Uruguay. 60.000, Ruta 3 km 363, Paysandú, Uruguay

\* Corresponding author: [siriprieto@fagro.edu.uy](mailto:siriprieto@fagro.edu.uy)

### Introduction

Perennial grasses are a promising source of bioenergy in the world, and sustainable agriculture requires soil quality maintenance over the long term. These grasses are more ecologically suitable than annual crops such as corn (Naik et al., 2010) due to higher biomass, lower establishment costs, reduced soil erosion, increased water quality, and enhanced wildlife habitat (McLaughlin et al., 2005). Perennial grasses such as elephantgrass (*Pennisetum purpureum* Schum.), giant reed (*Arundo donax* L.), and switchgrass (*Panicum virgatum* L.) have been proposed as key bioenergy crops in Europe and the US based on their low input requirements and high productivity. After a few years of perennial grass use, several studies showed increased SOC that was attributed to very high root mass. Large active pools of roots are important to soil carbon pools and to the soil functioning as a retentive nutrient cycling reservoir. However, high-yield biomass production could increase removal of accumulated mineral nutrients and potentially deplete soil nutrient levels over time. Therefore, an 8-yr field study was initiated in Uruguay to determine the impact of three perennial grasses on yield biomass productivity, nutrient removal, and soil chemical properties.

### Material and methods

Our experiment began in October 2007 and was conducted for 8 years at the EEMAC, Paysandú in western Uruguay. Soil at the site is a fertile Typic Argiudol. From 1970 to 2006, the site had been cultivated under a crop-pasture rotation (3-3 years of pastures and crops, respectively). The experiment was a completely randomized design with three replications. All species were planted in spring 2007. For giant reed and elephantgrass, rhizomes were planted at a population of 20,000 plants ha<sup>-1</sup>. The lowland switchgrass variety “Alamo” was planted at a seed rate of 5 kg ha<sup>-1</sup>. Since 2008, all species were harvested once per year in August. All grasses were fertilized annually in the spring at a rate of 100 kg N ha<sup>-1</sup> using urea (46-0-0). No grass diseases or pests were detected during the experiment. The species were harvested by cutting 10-cm above ground level for biomass yield. Sub-samples were ground and whole plant nutrient concentrations were determined in the laboratory using standard procedures. Soil K, P, and C content were measured at two depths (0-20 and 20-40 cm) 8 years after experiment initiation (2015). Replication and its interactions were considered random effects and treatments were considered fixed effects. For N, P, and K removal, statistical analysis eight year averages for each species. Least square means comparisons were made using Fisher’s protected least significant differences (LSD). A significance level of P=0.10 was established *a priori*.

### Result and discussion

Among species, elephantgrass biomass yield was the highest compared to giant reed or switchgrass averaged over years (21.34 vs. 17.64 or 16.50 Mg ha<sup>-1</sup>, Table 1). Similar results were reported by Siri-Prieto et al. (2017) in a similar experiment investigating harvest frequencies in Uruguay. Elephantgrass had the highest N, P, and K concentrations averaged over years (5.9, 1.5, and 18.5 g kg<sup>-1</sup>, respectively) (data not shown). Therefore, elephantgrass

had the highest total N, P, and K removal for these eight years (1024, 249, and 3124 kg ha<sup>-1</sup>, respectively). On the other hand, switchgrass had the lowest N, P, and K removal (399, 51, and 190 kg ha<sup>-1</sup>, respectively). Comparing the change in soil K content since the beginning of the experiment, we detected a strong reduction (50%) at the 0-20 cm depth (averaged over species after 8 years). Since the experiment started, no K fertilizer has been applied; consequently, a huge K negative balance occurred for all species. At 0-20 cm, giant reed had a

Table 1. Biomass yields (averaged over 2008-2015), accumulated N, P, and K removal, and soil P, K and C content at two depths after eight years (2015) as affected by species at the experimental site Paysandú, Uruguay.

	Species			LSD <sup>‡</sup> (0.10)	Benchmark
	Giant reed	Elephantgrass	Switchgrass		
Yield (Mg ha <sup>-1</sup> )	17.64	21.34	16.50	1.60	
Nutrient removal (kg ha <sup>-1</sup> )					
Nitrogen	633	1024	399	129	
Phosphorous	82	249	51	41	
Potassium	576	3124	195	190	
Soil conten (mg kg <sup>-1</sup> )					
Phosphorous					
0-20 cm	4.8	4.1	3.9	0.9	5.8
20-40 cm	2.4	2.7	3.3	ns	5.1
Potassium					
0-20 cm	5.7	4.2	4.0	1.0	9.5
20-40 cm	4.1	4.0	3.8	ns	8.7
Carbon					
0-20 cm	20.3	22.0	20.3	1.6	19.5
20-40 cm	13.9	12.9	12.9	ns	11.0

<sup>‡</sup>LSD least significant difference

54% higher K content (5.7 mg kg<sup>-1</sup>) than the other grasses. Similar results were found for soil P content in the upper zone. Comparing the 2007 to 2015 change in P content, we detected a reduction of 26% at the 0-20 cm depth averaged over species. Elephantgrass had 10% higher SOC (22.0 mg kg<sup>-1</sup>) compared to other grasses at the 0-20 cm depth. Comparing the 2007 to 2015 change in SOC content, all studied grasses increased SOC; however, this increase varied with soil depth. The highest increase was 20% in the 20-40 cm depth increment and 7% in the shallow depth (0-20 cm).

## Conclusion

All perennial grasses exhibited great potential for biomass production under climatic conditions of Uruguay. Elephantgrass biomass yield was highest compared to giant reed or switchgrass; however, Elephantgrass had the highest total nutrient removal. Switchgrass may be the best suited grass for Uruguayan conditions due to low nutrient removal. In only 8 years, all grass systems resulted in a 14% increase in SOC (0-40 cm depth), which could greatly increase soil quality properties under Uruguayan conditions.

## References

- McLaughlin S.B., Kszos L.A., 2005. *Biomass Bioenerg.*, 28, 515-535.
- Naik S.N., Goud V.V., Rout P.K., Dalai A.K., 2010. *Renew. Sust. Energ. Rev.*, 14, 578-597.
- Siri-Prieto G., Ernst O., Bustamante M., 2017. *Bioenerg. Res.*, 10, 853-863.



## Early detection of temporal SOC stock changes by accounting for spatial variability

Guillaume Vitte<sup>1</sup>\*, Fabien Ferchaud<sup>2</sup>, Florent Chlebowski<sup>2</sup>, Bruno Mary<sup>2</sup>

<sup>1</sup> INRA, UR 1158 AgroImpact, Site d'Estrées-Mons, F-80203, Péronne, France

<sup>2</sup> INRA, UR 1158 AgroImpact, Site de Laon, F-02000, Barenton-Bugny, France

\* corresponding author: [guillaume.vitte@inra.fr](mailto:guillaume.vitte@inra.fr)

### Introduction

Accurate assessment of soil organic carbon (SOC) stocks and their temporal variation is a crucial issue in order to determine the effect of cropping practices such as tillage. This objective is reinforced in the context of the 4 per mille initiative which aims at increasing SOC stocks through time in many agricultural areas in the world. Recent studies (*e.g.* Olson et al., 2014) have pointed out several requirements to avoid confusing effects: measuring stocks at time 0 ('pretreatments baseline'), determining bulk density, sampling at least down to the maximum depth affected by soil tillage, and measuring SOC over time, in order to make diachronic rather than synchronic analyses. The spatial variability of SOC is often a bottleneck toward achieving good estimates of temporal variations. In this study, we describe a means to account for spatial variability to improve the accuracy of SOC stock change assessments.

### Material and methods

In 2009, a long term experiment called SOERE ACBB was initiated at Estrées-Mons (northern France). It compares 6 treatments differing in tillage, fertilizer N rate and crop residue management (Coudrain *et al.*, 2015) using a randomized block design with 4 blocks and a total of 24 plots (11 ha). Four treatments have been analysed in this study: CONV, conventional management with annual ploughing; RT, reduced tillage (tillage < 8 cm); RT-RR, reduced tillage and residue removal; and RN, reduced N fertilisation (35% of CONV).

The soil was sampled to a depth of 60 cm in 2009 and 2015 using a tubular gauge (6-8 cm diameter). In 2009, 8 soil cores per plot and 6 other cores along 11 short distance transects were collected (open and close circles, Figure 1) in order to create a semivariogram. In 2015, 4 cores per plot were taken at 1 m distance from those sampled in 2009 (close circles). Cores were cut into three layers for organic C and N analysis: 0-10 cm (tilled layer in all treatments), 10-35 cm (tilled layer in CONV and RN), and 35-60 cm (untilled layer). The reference layer (~ 0-35 cm, *i.e.* 4900 t soil ha<sup>-1</sup>) represents the maximum tillage depth reached before and during this study. Bulk densities were measured using a gamma-densitometer (5-40 cm) and the cylinder method (other depths).

Calculations of SOC stocks were made on equivalent soil mass (ESM) basis (Ferchaud et al., 2015) using a dedicated R package (called *SEME*). The effect of treatments on SOC stocks (2009 and 2015) and on SOC stock changes was tested by analysis of variance (ANOVA) using a linear mixed effect model (*nlme* package). ANOVA was also used to test for differences between dates. Geostatistics were performed using the *gstat* package.

### Results and discussion

In 2009, the field exhibited moderate spatial variability: the mean SOC stock calculated from the 270 initial sampling points was 50.4 ± 3.8 t ha<sup>-1</sup> in the reference layer (coefficient of variation of 7.6%). However, the spatial variability was structured as is often reported in the literature. A spherical semivariogram model was fitted to the sample semivariogram of SOC stocks. This indicated that the range was 174 m with a small nugget effect, the nugget to sill ratio being equal to 0.30. No significant difference (p<0.05) was detected between treatments

in 2009 using the 4 points per plot resampled in 2015, but the initial mean stocks values could differ by up to 2.1 t ha<sup>-1</sup> (Table 1).

In 2015, SOC stocks significantly differed between treatments. RT had a greater stock than CONV in the upper layer (~0-10 cm) but a similar stock in the reference layer (~0-35 cm). SOC stocks did not differ between RT and RT-RR although crop residues were removed in the latter treatment.

Most interesting was the change in SOC stocks ( $\Delta$ SOC) between 2009 and 2015. The standard deviations of  $\Delta$ SOC were clearly much smaller than those of SOC stocks. SOC stocks in the upper layer only increased in the RT treatment, which received the highest amount of crop residues.  $\Delta$ SOC in the reference layer was similar in CONV and RT (both received the same amount of residue), despite the change in tillage.  $\Delta$ SOC was negative in the RT-RR treatment due to the lack of C substrate (significant at the 10% threshold).  $\Delta$ SOC was also negative in the RN treatment, which had a negative N surplus. This shows the possible control of SOC storage by N deficiency.

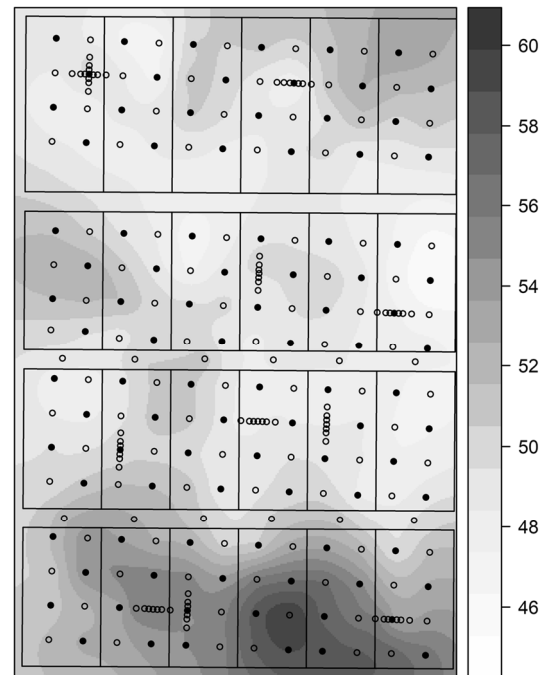

Figure 1. Map of sampling points and SOC stocks (t ha<sup>-1</sup>) in the reference layer (0-35 cm) in 2009 (obtained by ordinary kriging).

	CONV	RT	RT-RR	RN
<b>SOC stocks in 2009 (t ha<sup>-1</sup>)</b>				
~0-10 cm	15.1 (1.1) a	14.7 (0.8) a	15.5 (1.0) a	14.5 (0.4) a
~0-35 cm	50.6 (3.7) A	49.5 (2.8) A	51.6 (3.5) A	49.5 (2.3) A
<b>SOC stocks in 2015 (t ha<sup>-1</sup>)</b>				
~0-10 cm	15.2 (0.8) bc	17.3 (0.5) a	16.3 (0.5) ab	14.8 (0.3) c
~0-35 cm	51.2 (4.0) A	50.2 (2.9) AB	48.9 (2.3) B	46.9 (1.1) C
<b><math>\Delta</math>SOC between 2009 and 2015 (t ha<sup>-1</sup>)</b>				
~0-10 cm	0.2 (0.5) b	2.6 (0.5) a *	0.7 (1.0) b	0.2 (0.2) b
~0-35 cm	0.5 (1.7) A	0.7 (0.6) A	-2.6 (2.1) A	-2.6 (1.2) A *

Table 1. SOC stocks calculated in two layers at ESM in 2009 and 2015, and SOC change during the 6 years of study. Standard deviations are given within parentheses.

### Conclusion

The spatially structured SOC contents in the field at the onset of the experiment justified the analysis of temporal variations at the same sampling sites. Accounting for spatial variability allowed for reducing variability in assessing temporal SOC stock changes and detecting early changes. Superficial tillage resulted in more SOC storage in the upper soil layer but not in the reference layer. Systematic crop residue export or strong reduction in N fertilisation both resulted in net SOC stock declines. The *SEME* R package is available upon request.

### References

- Coudrain V., Hedde M., Chauvat M., Maron P.-A., et al., 2016. *Agric. Ecosyst. Environ.*, 225, 12-21.  
 Ferchaud F., Vitte G., Mary B., 2016. *GCB Bioenergy*, 8, 290-306.  
 Olson K.R., Al-Kaisi M. M., Lal R., Lowery B., 2014. *Soil Sci. Soc. Am. J.* 78, 348-360.

## **Rye Cover Crops Reduce Net GWP and Increase Soil Organic Carbon in Tillage and No-tillage Agroecosystems.**

Yingting Gong<sup>1</sup>, Peiran Li<sup>1</sup>, Masakazu Komatsuzaki<sup>2\*</sup>

<sup>1</sup> Graduate School of Agriculture, Ibaraki University, Ami, Japan

<sup>2</sup> Center for International Field Agriculture Research & Education, Ami, Japan

\* corresponding author: [masakazu.komatsuzaki.fsc@vc.ibaraki.ac.jp](mailto:masakazu.komatsuzaki.fsc@vc.ibaraki.ac.jp)

### **Introduction**

Agriculture remains a source of major biogenic greenhouse gases (GHGs) and plays a major role in regulating the exchange of GHGs between soils and the atmosphere. In particular, tillage management and use of cover crops can alter the production and consumption of primary biogenic GHGs: carbon dioxide (CO<sub>2</sub>) and nitrous oxide (N<sub>2</sub>O). Estimates of net production and consumption, or fixation of GHGs can be used to calculate Net Global Warming Potential (net GWP) (Robertson, 2000). Implementation of soil-based GHG mitigation activities are at an early stage. The impacts of cover crops and no-tillage on soil GHG emissions have not been adequately evaluated in soybean production systems. In this study, our aims were to investigate the effects of cover crops with different tillage methods on GHG emissions and net GWP, and to assess the potential use of different management systems in climate-smart agriculture. We hypothesized that rye cover crops can reduce net GWP and increase soil organic carbon (SOC).

### **Material and methods**

The experiment was conducted at the Center for International Field Agriculture Research and Education, Ibaraki University, Japan. This site was established in 2002 to research tillage and cover crop systems. The study was a split-split plot design, consisting of two tillage methods (no-tillage: NT, moldboard plow: MP) as main factors and three cover crops (fallow as control: FA, hairy vetch: HV and rye) as split factors with four replications. Gas samples were collected biweekly from 25 May 2017 to 11 January 2018 using the static chamber method and analyzed by gas chromatography. Cumulative emissions were calculated by linear interpolation of daily fluxes between gas sampling dates. Total GWP of N<sub>2</sub>O and CO<sub>2</sub> emission were calculated using the latest GWP values of 265 for N<sub>2</sub>O over a 100-year time horizon. Net GWP was the difference between GHG emissions and atmospheric CO<sub>2</sub>-C retention in cover crops. Soil samples (0-30cm) were collected monthly for nitrate nitrogen (NO<sub>3</sub>-N) concentration measurements (13 June 2017 to 28 November 2017). Core samples to a 30cm depth were divided (0-2.5, 2.5-7.5, 7.5-15 and 15-30 cm) for incremental measurements of soil organic carbon (SOC) using a CN analyzer. Cover crop biomass and respective carbon content were determined using standard methods.

### **Results and Discussion**

NT showed higher cumulative CO<sub>2</sub> emission than MP in each period. Fallow under MP had the lowest cumulative CO<sub>2</sub> emission (890 g/m<sup>2</sup>), while other treatments ranged from 1186 (HV under MP) to 1522 g/m<sup>2</sup> (FA under NT). HV combined with NT had the highest cumulative N<sub>2</sub>O emission (194 mg/m<sup>2</sup>). Rye under NT and fallow under MP (40 and 43 g/m<sup>2</sup>, respectively ; ) had relatively low emissions. GWP of CO<sub>2</sub> and N<sub>2</sub>O was mainly dependent on the CO<sub>2</sub> emission value. In general, NT values were observably higher compared to MP. Rye cover crops in NT and MP fixed significantly higher amounts of atmospheric CO<sub>2</sub> (~1500 g/m<sup>2</sup>), than HV and FA (Figure 1). This was likely due to rye having greater biomass than the other two cover crops, thereby contributing more C inputs into soil. With the exception of FA under NT, soil NO<sub>3</sub>-N concentrations, had peak values on 25 July 2017 during the most active stage of soybean vegetative growth. N<sub>2</sub>O emission had significant positive correlation with soil NO<sub>3</sub>-N (p<0.05) during the seedling and florescence stages of soybean. On the basis of the year 2008, rye cover crops in NT and MP significantly enhanced SOC in 2016. NT more effectively increased SOC than MP except at the 7.5-15 cm depth.

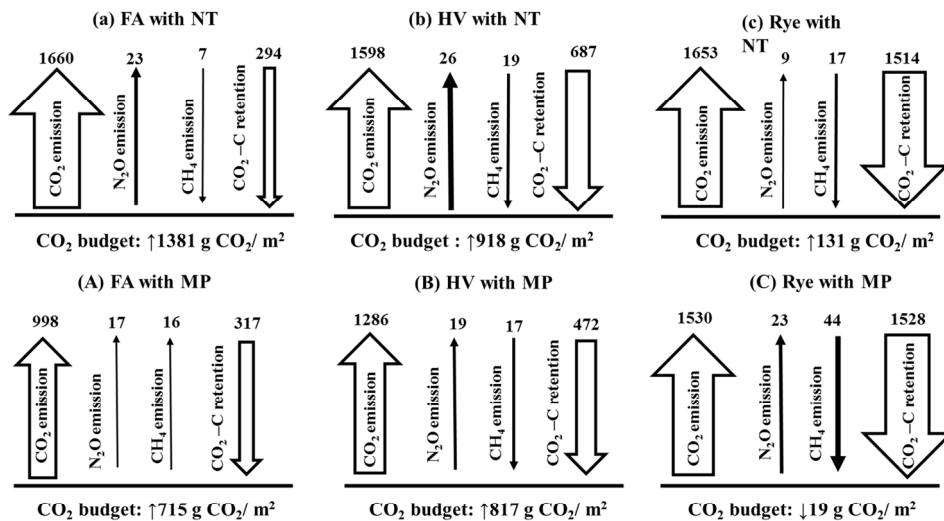

Figure 1: CO<sub>2</sub> flow consisting of GHG emissions from soil and atmospheric CO<sub>2</sub> retention in cover crops under different agriculture managements. Values are shown in CO<sub>2</sub> equivalents.

### Conclusion

Cumulative CO<sub>2</sub> emission and GWP was higher in NT than in MP. GWP of CO<sub>2</sub> and N<sub>2</sub>O was mainly dependent on CO<sub>2</sub> emission. The combination of HV and NT had the highest cumulative N<sub>2</sub>O emission. Rye cover crop fixed significantly higher amounts of atmospheric CO<sub>2</sub>-C in MP and NT. The relationship between soil NO<sub>3</sub>-N concentration and N<sub>2</sub>O emission varied by soybean growth stage. Rye cover crop and NT are effective in increasing SOC.

### References

Robertson, G.P., Paul, E.A., Harwood, R.R., 2000. Greenhouse gases in intensive agriculture: contributions of individual gases to the radiative forcing of the atmosphere *Science*, 289, 1922–1925.

## Influence of Exogenous Organic Matter Composition after Anaerobic Digestion on Heterotrophic Microorganism Behaviour in Agricultural Soils

R. Béghin-Tanneau<sup>1\*</sup>, F. Guérin<sup>2</sup>, J.D. Scheiner<sup>1,4</sup>, D. Serça<sup>3</sup>, M. Guiresse<sup>4</sup>, D. Kleiber<sup>1</sup>

<sup>1</sup>Ecole d'Ingénieurs de Purpan, Université de Toulouse, France

<sup>2</sup>Geosciences Environnement Toulouse, Université Paul-Sabatier, 31400 Toulouse, France

<sup>3</sup>Laboratoire d'Aérodologie-OMP, UMR-CNRS 5560, Université de Toulouse, France

<sup>4</sup>Ecolab, Université de Toulouse, CNRS, Toulouse, France

\*corresponding author: [robin.beghin@purpan.fr](mailto:robin.beghin@purpan.fr)

### Introduction

Agronomical valorisation is a common treatment for residual biomass. Fresh residual biomass can be directly spread or stabilised at first. There are two biological ways to stabilise organic matter: composting (aerobic digestion) or anaerobic digestion. Anaerobic digestion (AD) is the breakdown of organic materials by microorganisms in the absence of oxygen. AD produces biogas, a methane-rich gas that can be used as a fuel, which leads to residues broadly called “digestate”. Digestate can have an agronomical value when biogas is valued as a renewable energy source. Since policies support renewable energy source development, AD could become the primary way to valorise residual biomass. Extensive research has evaluated fertilizer value of digestates, especially concerning nitrogen (Möller, 2015). However, few studies have investigated potential change in soil organic matter (SOM) turnover in the long term after the replacement of fresh with digested residual biomass.

Long-term dynamics of SOM are simulated considering : annual SOM mineralisation rate and yield of carbon stored in soil after Exogenous Organic Matter (EOM) application. Exogenous Organic Matter (EOM) biodegradation is assessed during short term soil laboratory incubation measuring CO<sub>2</sub> efflux. In this way, there is some evidence to suggest that carbon retention in soil is equivalent with or without AD. Digestate is depleted in carbon compared to undigested biomass, and organic matter which remains after AD is less labile (Thomsen et al., 2013).

Such approaches, however, might not be appropriated in the case of the long-term replacement of fresh with digested residual biomass owing to potential change on heterotrophic micro-organisms behaviour. It has been observed that there is a clear shift in microbial community structure after digestate spreading comparing indigested biomass (Möller, 2015). The aim of this study is to determine if the change of EOM (Exogenous Organic Matter) composition during AD can influence SOM biodegradation rate.

### Material and methods

Laboratory incubations with intact soil cores (10 cm deep, 9.2 cm diameter, 850 g dry soil on average) were conducted. Agricultural soil was collected in the Garonne valley (sandy to clayey silt). Soil respiration stimulation was tested under four treatments with the same amount of carbon (1553 mg C pot<sup>-1</sup>): dry non-digested maize-silage (M), dry digested maize silage (D), sugar-cane sucrose (S), and soil-only controls (C). Substrates were shattered and sieved (0.25 mm and 2 mm). Soil CO<sub>2</sub> and CH<sub>4</sub> effluxes, and δ<sup>13</sup>C were determined using Cavity Ring-Down Spectroscopy technology (CRDS; Picarro G2201-I Analyzer) coupled with a soil respiration chamber. Discrete and repeated measurements have been done. Soil CO<sub>2</sub> efflux was partitioned into components derived from soil and substrates by using the

natural abundance difference in  $\delta^{13}\text{C}$  values of  $\text{C}_4$  substrates when applied to  $\text{C}_3$  soils (Kuzyakov, 2010).

Soil characteristics were the following: pH 6.4, 20.3 mg C  $\text{g}^{-1}$  soil and a  $\delta^{13}\text{C}$  value of -27.0‰. Before substrates incorporation,  $\text{CO}_2$ ,  $\text{CH}_4$  effluxes, and  $\delta^{13}\text{C}$  from soil were measured with the Picarro G2201-I Analyzer. Soil  $\text{CO}_2$  efflux was 1.2  $\mu\text{g CO}_2 \text{ g soil}^{-1} \text{ h}^{-1}$  and  $\delta^{13}\text{C-CO}_2$  was -26.9‰ for two weeks before treatment when  $\text{CH}_4$  efflux was below the detection limit.  $\delta^{13}\text{C}$  values were -12.0‰, 12.7‰, and -13.8‰ for sucrose (S), maize-silage (M), and digestate (D), respectively. Pore water sampling was also done (Rhizon MOM©, 0.15  $\mu\text{m}$  pore size, 5 cm porous) to determine the following parameters: dissolved carbon (DC), total nitrogen (TN), and inorganic nitrogen ( $\text{N-NH}_4^+$  and  $\text{N-NO}_3^-$ ).

## Results and discussion

Following all substrate additions, soil  $\text{CO}_2$  efflux was enhanced, and carbon efflux during the time course of the incubation was similar for all treatments. Sucrose (S) and non-digested maize (M) led to the largest increase in soil  $\text{CO}_2$  efflux, which peaked within 4 days after addition at 24.2 and 11.6  $\mu\text{g CO}_2 \text{ g soil}^{-1} \text{ h}^{-1}$ , respectively. Digested maize silage (D) led to a moderate increase in soil  $\text{CO}_2$  efflux peaking at 4.0  $\mu\text{g CO}_2 \text{ g soil}^{-1} \text{ h}^{-1}$ . After peaking, soil  $\text{CO}_2$  efflux followed a linear decrease. After 60 days of incubation, soil  $\text{CO}_2$  efflux had statistically reached basal respiration which was about 0.8  $\mu\text{g CO}_2 \text{ g soil}^{-1} \text{ h}^{-1}$  in the controls.

During the first 142 days, based on isotopic measurements, 58% of added sucrose C, 50% of non-digested maize C, 32% of digested maize silage C had been respired by soil heterotrophs. SOM biodegradation appeared to have not changed for soil with sucrose (S) and Non-digested maize (M). Digestate (D) additions resulted in significant decreased of SOM biodegradation of 47% compared to Controls (C). This trend is not diminishing after 142 days.

According to these data, change of EOM composition may influence SOM biodegradation rate at least temporarily after its incorporation. This observation may support the hypothesis that replacement of EOM with another might influence heterotrophic microorganism behaviour resulting in a modification of SOM biodegradation rate.

Further work is in progress to consolidate these findings. Soils samples were taken for phospholipid fatty acid (PLFA) analyses to characterize active microorganism populations. Another laboratory incubation is conducted with a soil having a higher organic matter content. Incubations had been performed with dry substrates without liquid ammonia ( $\text{NH}_4^+$ ). Further incubations will be conducted under two conditions: with and without  $\text{NH}_4^+$ . During the current experiment, nitrogen bioavailability could have been a limiting factor in microorganism development. Moreover, during anaerobic digestion, release of  $\text{NH}_4^+$  could explain the strong respiration increase that has been previously reported by others.

## References

- Kuzyakov, Y. 2010. *Soil Biol. Biochem.*, 42, 1363-1371.
- Möller, K. 2015. *Agron. Sustain. Dev.*, 35, 1021-1041.
- Thomsen, I.K., Olesen, J.E., Möller, H.B., Sørensen, P., Christensen, B.T. 2013. *Soil Biol. Biochem.*, 58, 82-87.

# Tillage System and Spatial Variation of Soil Organic Carbon Budget In North Kazakhstan

K. A. Akshalov<sup>1</sup>, M. Tobias<sup>2</sup>, M. Kuzhinov<sup>3</sup>, A. Kiyas<sup>1</sup> and Zh. Taishukher<sup>2</sup>

<sup>1</sup> Barayev Kazakh Research Institute of Grain Farming,  
Shortandy-1, Akmolinskaya oblast, Kazakhstan

<sup>2</sup> Amazone-Werke H.Dreyer GmbH&Co.KG, Germany

<sup>3</sup> Karabalykskaya experimental station, Kostanayskaya oblast, Kazakhstan

Corresponding author: [kanatakshalov@mail.ru](mailto:kanatakshalov@mail.ru)

## Introduction

Arable lands of Central Asia have the potential of carbon sink due to "global warming» (Lal, 2007). Soil carbon can be increased at the expense of practice and methods of proper land use management, disturbing the soil to a lesser extent and / or by increasing the biomass of cultivated crops (Derpsh, 2010). The conventional tillage practices in semiarid regions of North Kazakhstan farming practices involves conservation mechanical subsoil tillage practices with summer fallow to control weed infestation, to increase grain productivity (Suleimenov, 2007).

## Materials and method

The reseachers were carried out in different agro-climatic zones of Kazakhstan on the southern carbonate chernozem soils of the Akmolinskaya oblast on the long-term stationary experiment sites of the Barayev Kazakh Research Institute of Grain Farming Shortandy (Coordinates 51 ° 12N and 71 ° 02 ° E), on ordinary chernozem soils in Kostanayskaya oblast on long-term stationary experiment sites of the Karabalykskaya agricultural experimental station (53 ° 57 N 'and 69 ° 32'E) and on chestnut soils, on the crop-fields of "Akmola-Fenix" JSC of the Tselinogradskiyi rayont of the Akmolinskaya oblast (coordinates 51°12'N and 71°36'06 "E). Research was carried out on stationary field experiment plots set in 2006. The amount of precipitation in these zones ranges between 250 and 360 mm per year.

The study of the content of soil carbon was carried out in a five-year grain-fallow crop rotation: fallow field (conventional tillage), spring wheat, spring wheat, barley, spring wheat under the conventional soil tillage system. The study of the minimum tillage system was carried out in a similar cereal crop rotation only with the replacement of fallow field prepared mechanically to chemical fallow. The study of the No-Till system is carried out by the soil cover crop rotation: peas, spring wheat, spring wheat, flax, spring wheat. Crop-rotations are rotated in time and space (every field represents every year). In 2006, water-physical properties of soils were determined; soil samples were selected for comparative study of changes in soil carbon content and as initial data on soil fertility. Soil samples were dried in the laboratory in the open air (natural drying) and sieved through a sieve. The vegetable residues remaining on the sieve were separated. Soil samples were ground on a soil mill and soil carbon was determined using an automatic device by burning method. Statistical analysis of the analysis data was carried out. The sampling points of soil samples were recorded using the (GPS) geographic positioning system to analyze the spatial distribution of soil carbon.

## Results and discussion

After many years of application of the No-Till system and minimal soil treatment in the southern chernozem soils in the upper 0-5 cm soil layer, the content of macro aggregates 0.25 mm in size was 290 and 520 g / kg soil and 2.6-4.7 times as much compared with the conventional soil tillage system. Long-term use of the No-Till system and minimum tillage does not lead to soil compaction: in southern chernozem soils, the volume of soil in 2006 in the soil layer 0-7.5 cm was 1.15 g / cm<sup>3</sup>, in 2015 - 1.09 cm<sup>3</sup> and in 2017 - 1.12 g / cm<sup>3</sup>. With the No-Till system and the minimum tillage system, the amount of plant residues is 3.3 and 2.4 t / ha, respectively, and exceeds the conventional soil tillage system 2.8-3.9 times. The ordinary chernozems zone was characterized by high carbon input as plant residue and high carbon output as CO<sub>2</sub> emission, and mean annual soil SOC budget for cereal fields over long – term period was 0,05 Mg C ha<sup>-1</sup>. In contrast, the dark chestnut was characterized by low carbon input, and mean annual SOC budget for cereal fields and was 0,16 Mg C ha<sup>-1</sup>. The content of soil carbon significantly increased in the soil layer 0-7.5 cm by 6.9 mg or 12.4% under the No-Till system and by 2.8 mg or 11.0% with minimum soil tillage system. The level of sequestration and the content of soil carbon on chernozem soils is significantly higher than in chestnut soils: 29.8-32.7 Mg C ha<sup>-1</sup> in southern chernozems, and 37.7-42.1 Mg C ha<sup>-1</sup> on ordinary chernozems and 23.1-24.8 Mg C ha<sup>-1</sup> on chestnut soils under the No-Till system. In chestnut soils under the conventional soil treatment system, soil in the upper 0-7.5 cm layer of soil is significantly reduced in comparison with the soil layer of 7.5-15.0 cm, which is associated with intensive mineralization. The content of the potentially mineralized carbon was 4.34 and 3.51 Mg C ha<sup>-1</sup> under the No-Till system and minimum tillage, respectively, and 2.37 Mg C ha<sup>-1</sup> for conventional system of cultivation. In southern chernozems, the carbon balance of the soil is higher with the No-Till system and with minimum tillage and amounted to 3.6 with the No-Till system; on minimum tillage of soil - 2,8 and on conventional - 0,90 Mg C ha<sup>-1</sup>. A similar pattern also exists on other soil differences. The negative carbon balance in the fallow fields was minus 0.87 minus 1.21 Mg C ha<sup>-1</sup>. The absolute content and balance of carbon is significantly higher in chernozem soils.

## Conclusion

The level of sequestration and soil carbon content in chernozem soils is significantly higher than in chestnut soils: 30.0-32.7 Mg C ha<sup>-1</sup> in southern chernozems, and 36.6-43.1 Mg C ha<sup>-1</sup> on ordinary chernozems and 24.5-26.4 Mg C ha<sup>-1</sup> on chestnut soils under the No-Till system.

## References

### Journal articles:

Derpsh, R., Friedrich, T., Kassam, A., li, H.W., 2010. Current status of adoption of no-till farming in the world and some of its mail benefits. *Int.J. Agric. Biol.Eng.*3.1-25

### Books:

Lal, R., 2007. Researchable priorities in terrestrial carbon sequestration in Central Asia. In: *Climate Change and Terrestrial Carbon Sequestration in Central Asia*. Ed's: R.Lal, M. Suleimenov, Stewart, B.A., Hansen, D.O., Doraiswamy,P., - PP. 127-136.

Suleimenov, M., Akshalov, K., Eliminating summer fallow on black soils of Northern Kazakhstan// *Climate change and Terrestrial carbon sequestration in Central Asia*. 2007. In: *Balkema-Proceedings and Monographs in Engineering. Water and Earth Science*. London, Lieben, New-York, Philadelphia. Editors: R. Lal and etc. 2007, - PP. 267-277.



## Impacts of Coal-derived Humic Acid on Yield, Nutrient Accumulation and Quality Characteristics of Sunflower under Two Irrigation Regimes

S. Abdul- Sadiq<sup>\*1</sup>, D. M. Baloch<sup>2</sup>, A. Jan<sup>3</sup>, M. Sharif<sup>1</sup>, and N. Ahmed<sup>2</sup>

<sup>1</sup>Balochistan Agriculture College Quetta, Pakistan

<sup>2</sup>Faculty of Life Sciences, BUIEMS, Quetta, Pakistan

<sup>3</sup>Department of Agronomy, Agricultural University Peshawar, Pakistan

\*corresponding author: [sadiqagah@gmail.com](mailto:sadiqagah@gmail.com)

### Introduction

Organic sources are the most important means for sustainable crop production, which not only improve soil fertility but also reduce input costs and save the soil and environment from pollution. The sole application of chemical fertilizers may affect environmental quality due to excessive nitrate leaching, ammonia volatilization, and fixation of large amounts of applied phosphorus. The use of organic fertilizer sources for increasing crop production on a sustainable basis has become imperative due to the high cost of chemical fertilizers. Humic acid, known as the black gold of agriculture, is a polymeric naturally occurring organic compound that performs numerous functions. The humic acid that is present in sufficient quantity in low ranking lignitic coal of Pakistan was characterized by elemental analysis for the presence of phenolic, acidic, amino and quinone groups. Humic acid is a complex molecule having aromatic structure that is soluble in alkali and surrogated by carboxyl, phenolic, hydroxyl, and alkyl groups connected together through ester linkages. Lignitic coal derived humic acid is a low cost natural fertilizer with the potential to increase crop yield and act as a soil conditioner (Sharif et al., 2002). Humic acid contains 51-57% C, 4-6 % N, and 0.2-1% P that can help improve crop yields by supplying N and P to plants and improve physicochemical and biological environment of the soil. Humic acid has immense potential to restore microbial activities and plays a significant role in the transport and availability of micronutrients and the assimilation of N by plants. Supplementation of synthetic fertilizers with humic acid could minimize production cost, improve crop yields, and increase farmer income. The objectives of our research was to examine the effects of humic acid on yield components, nutrient accumulation, seed quality (oil, protein, fatty acids) of sunflower (*Helianthus annuus*) under recommended and 50% deficit irrigated conditions.

### Material and methods

The study was conducted for two consecutive growing years at Agriculture Research Institute in Quetta, Pakistan. The experiments were laid out in a randomized complete block design (RCBD) with two factors (Irrigation as Factor A and Humic Acid (HA) as Factor B) and three replications. Net plot size was 3 x 5 m with a buffer plot of 1 m (between the two main plots of irrigation levels) to control the seepage/border effect of irrigation. The sunflower hybrid Hysun-33 was used in the experiment. Standard agronomic practices were carried out accordingly. Humic acid in various concentrations was incorporated into soil one week before sowing. Four levels of humic acid (1, 2, 3 and 4 kg ha<sup>-1</sup>) alone and in combination with a basal dose of NPK fertilizer (90, 60, and 60 kg ha<sup>-1</sup> of N, P, and K, respectively) were used. Sunflower yield components, nutrient accumulation in leaf, and seed quality characteristics (protein content, oil content, and fatty acids) were recorded with set protocols. The recorded data was analyzed statistically by

using analysis of variance (ANOVA) techniques with a randomized complete block design and two factors (Irrigation levels and Humic acid levels). Mean values of all treatments were differentiated by using LSD at the 5% probability level.

### **Results and discussion**

Results revealed that application of 4 kg HA ha<sup>-1</sup> with a basal dose of NPK significantly increased achene yield (2677 kg ha<sup>-1</sup>), 100-seed weight (4.8 g), and head diameter (18.7 cm). In comparison, the addition of 3 kg HA+NPK ha<sup>-1</sup> significantly augmented number of seeds per head (1073) and total dry matter per plant (152.32 g). The maximum accumulation of N (2.47 %), K (3.67 %), and Fe (81.0 ppm) was recorded in the 1 kg HA+NPK ha<sup>-1</sup> treatment. Seed quality factors such as protein content (16.94 %), linoleic acid (51.12 %), palmitic acid (6.86 %), and stearic acid (1.79 %) were significantly affected by soil additions of humic acid in combination with a basal dose of NPK. However, the response of oil content and oleic acid to coal-derived humic acid was not significant. Agronomic traits, nutrient accumulation, and quality characteristics of sunflower plants were improved with application of full irrigation (four times), while 50 % irrigation (two times) severely reduced these traits. Improvement in sunflower traits could be attributed to improved soil structure that increased soil water holding capacity, drainage, and aeration thereby allowing for better root growth and crop nutrient uptake. Improvement in the overall growth of sunflower may also be attributed to the chelating nature of humic acid (Sharif et al., 2002), supply of N and P, and the stimulatory effects (Quaggiotti et al., 2004) or hormone-like activity of humic acids (Nardi et al., 2002) that allow for better uptake of essential nutrients required for optimum plant growth.

### **Conclusion**

There are sizeable quantities of coal reserves containing ample humic acid that can be exploited and utilized as an organic fertility source. This rich organic source has proved to be beneficial for boosting the yield of Sunflower in Quetta, Pakistan.

### *References*

- Nardi S., Pizzeghello D., Muscolo A., Vianello A., 2002. *Soil Bio. & Bioch.*, 34, 1527-1536.
- Quaggiotti S., Ruperti B., Pizzeghello D., Francioso O., Tugnoli V., Nardi S., 2004. *J. Exp. Bot.*, 55, 803-813.
- Sharif M., Khattak R.A., Sarir M.S., 2002. *Comm. Soil Sci. Plant Anal.*, 33, 19/20, 3567-3580.

## The Management of Organic Matter in the Soil of Continental Oases: Study of the Addition of Manure and Compost in the Gataaya Oasis

N. Brahim<sup>1\*</sup>, H. Ibrahim<sup>2</sup>, N. Karbout<sup>3</sup>, T. Gallali<sup>1</sup>, W. Amelung<sup>4</sup>, R. Bol<sup>5</sup>

<sup>1</sup> *University of Tunis EL Manar, Faculty of Sciences of Tunis, 2092 Tunis, Tunisia*

<sup>2</sup> *University of Carthage, Faculty of Sciences of Bizerte, 7021 Jarzouna, Tunisia*

<sup>3</sup> *Institute of Arid Regions, Km 22.5 Route du Djorf, 4119 Medenine, Tunisia*

<sup>4</sup> *Institute of Crop Science and Resource Conservation (INRES)/Soil Science and Soil Ecology, University of Bonn, Bonn 53115, Germany*

<sup>5</sup> *Institute of Bio-Geoscience, Agrosphere Institute (IBG-3), Juelich Research Center, Juelich 52428, Germany*

\* Corresponding author : [nadhembrahim@gmail.com](mailto:nadhembrahim@gmail.com)

### Introduction

In Tunisia, a Mediterranean country with a predominantly semi-arid climate, soil organic reserves have undergone several transformations along their history under the constraint of changing land use and intensifying the use of natural resources (Brahim and Ibrahim, 2018). Its current cropping systems, based largely on monoculture, have increased the erosion of the most fragile lands and contributed to their depletion in organic matter (OM), weakening their fertility and increasing their sensitivity to climate irregularities. Cultivated soils in Tunisia have very low OM contents rarely exceeding 1% with poor physicochemical properties (Gallali, 2004). This is due to very low crop residue release, low use of organic soil improvers and excessive tillage. Many studies have shown that amendments play an important role in the various biological and physicochemical properties of soils.

Traditionally, the organic management of oasis ecosystems has led farmers to add exogenous organic amendments such as manure, and recently compost made from date palm waste. This seems like a solution but still expensive. It is therefore necessary to focus on more sustainable management of OM. This amounts to making carbon stocks in oasis soils more important. The purpose of this work is to study arid soils, very poor in organic matter and under desert climatic conditions that require the continuous addition of manure and compost. We present the different results for three adjacent plots, where we will estimate the carbon stock of the soils under the three situations and see which type of organic input is the most suitable.

### Material and method

The Gataaya oasis is a continental oasis known for its high quality dates and good productivity, it is administratively attached to the governorate of Kebili. It is located about 8 km southwest of the city of Kebili, and was created in 1933 covering an area of 57 ha. The study area is characterized by a desert bioclimate (P= 150 mm/year, ETP= 1800 mm/year and T can exceed 50 ° C in summer). The soils are gypsum soils. At the oasis level, we have three adjacent parcels of  $\approx 0.5$  ha each: a plot where the soil is amended with compost, a plot where the soil is amended with manure and a third without any additions. The plan of the three parcels is focused on Figure 1 gives an idea about the location of their location in the oasis. Historically, the three plots were conducted for 10 years in the same way without any additions. Since 2013, an experiment has been carried out which consists in adding for one of the compost, the other of the manure and the last control remains, without any addition.

The sampling is performed every 10 cm, to a depth of 50 cm. The bulk density ( $D_b$ ) was determined by the cylindrical core method. Texture was assessed by Robinson's method. Organic carbon was measured by Walkey and Black method.

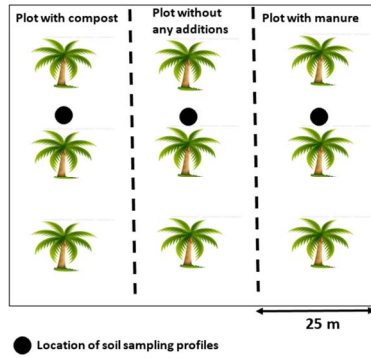

Figure 1: The experimental setup to characterize different soil treatments

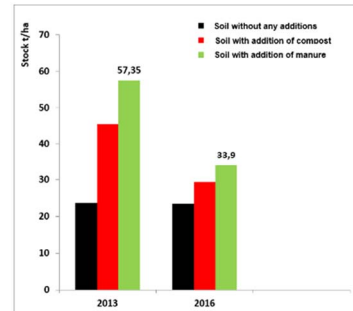

Figure 2: Evolution of carbon sequestration in the three plots after three years

To estimate SOC stocks, requires knowledge of the vertical distribution of OC in profiles. The way of calculating SOC stocks for a given depth consists of summing SOC Stocks by layer determined as a product of  $D_b$  ( $\text{g}/\text{cm}^3$ ), OC percentage, and layer thickness (cm). For an individual layer, we estimated the organic carbon stock (t/ha) by the following equation:  $\text{SOCstock} = \text{OC} \times D_b \times D$ .

## Results and discussion

### a) Variation of SOC stock for the 2016: soil without any additions.

We notice for the first parcel, the soil without addition. Carbon stock levels for the four soil layers decrease with depth. We recorded 9.3 t/ha in the first layer (0-10cm), we recorded in the two intermediate layers (10-20cm) 8.8 t/ha and 3.2 for the layer (0-30cm) finally, in the deep layer (30-50 cm) the stock is of the order of 2.2 t/ha.

### b) Variation of SOC stock for the 2016: soil with addition of compost.

The second plot, soil with added compost. The carbon stock contents for the four soil layers decrease with depth. We recorded 9.8 t/ha in the first layer 0-10cm, 11.5 t/ha us in the layer 10-20cm, 4.8 t/ha in the layer 0-30cm and 3.2 t/ha in the deep layer 30-50cm.

### c) Variation of SOC stock for 2016: soil with addition of manure.

The third plot, soil with addition of compost. The carbon stock contents for the four soil layers decrease as a function of depth, we recorded 11.7 t/ha in the layer 0-10 cm, 8.4 in the layer 10-20 cm, 9 t/ha in the layer 0-30cm and 4.8 t/ha in the deepest layer 30-50 cm.

## Conclusion

In 2013, the stock measured on 0-50 cm under the control plot is of the order of 23.7 t/ha. After the addition of the amendments, the stock values increased to 45.5 and 57.3 t/ha respectively under compost and manure. We note that the manure brings more MO to the soil and therefore a larger stock in comparison with the compost. In 2016, the stock at the control plot level is almost the same with a value of 23.5 t/ha. However, stocks under compost and manure amended plots fell to 29.3 and 33.9 t/h, respectively, resulting in a 35.6% drop in compost stock (16.2 t/ha) and under manure 41.89% (24 t/ha). In other words, the plot under compost has lost so 5.4t/ha/year, and the other manure it lost 8t/ha/year (Figure 2).

## References

Brahim N., Ibrahim H., 2018. Effect of Land Use on Organic Carbon Distribution in a North African Region: Tunisia Case Study. In book: Soil Management and Climate Change, Effects on Organic Carbon, Nitrogen Dynamics, and Greenhouse Gas Emissions. Elsevier edition, Chapter 2 pp.15-24.

Gallali T., 2004. Clés des sols. Edition CPU. 400 pages.

## Carbon Sequestration as Reflected by Long-Term Complex Measures

\*Vaclovas Boguzas, Jurate Aleinikoviene, Vaida Steponaviciene

*Institute of Agroecosystems and Soil Science*

*Aleksandras Stulginskis University*

*Studentu str. 11, Akademija, LT-53361 Kaunas distr.*

*Lithuania*

\*corresponding author: [vaclovas.boguzas@asu.lt](mailto:vaclovas.boguzas@asu.lt)

### Introduction

Our climate is changing and future weather patterns are increasingly uncertain. Therefore, improved management practices must integrate unique differences in climate and site-specific soil properties, including the use of cover crops and/or appropriate crop residue management to improve carbon sequestration (Lal, 2010). In addition, tillage intensity is widely recognised as playing a major role on soil organic matter (SOM). However, there is a lack of data on how long-term complex measures are impacted by farm management. Therefore, a study was initiated to evaluate the effects of long-term use of plant residues and green manure in combination with reduced tillage and direct drilling on organic carbon pools.

### Material and methods

Soil organic matter accumulation have been estimated in a long-term field experiment that was conducted on *Planosols* since 1999. Conventional tillage and reduced tillage systems with cover crop treatments were applied in this long-term field study. In one part of the experiment, the straw was removed, and in another portion of the study the straw was chopped and spread across plots. Factor A consisted of: R - straw removed (control) and S – straw chopped and spread. Factor B consisted of: CP - conventional deep ploughing (control), SP – shallow ploughing, SL - shallow loosening with sweep and disc harrows, SR - shallow loosening with rotary cultivator, GMR – catch cropping and green manure incorporation with rotary cultivator, and NT - no-tillage with direct drilling. The following crop rotation sequence was employed: spring rape (*Brassica napus*), winter wheat (*Triticum aestivum*), and spring barley (*Hordeum vulgare*).

### Results and discussion

After 16 years, soil tillage systems with permanent crop rotation and cover crop treatment influenced the accumulation of SOM via soil organic carbon (SOC) stabilization. However, the stocks of SOC in the conventional tillage system were not increased significantly. Meanwhile shallow rotovating, cover cropping, and no-tillage increased accumulation of SOC in the ploughed (0-20 cm) layer by 1.5 times. Reduced tillage also significantly increased accumulation of microbial biomass, whereby intensified accumulation of SOC and humification were both ascertained.

### Conclusion

Regular straw retention, shallow rotovating with or without green manure and direct drilling significantly increase organic carbon stocks in soil. These practices are efficient measures that aid in soil fertility resilience and recovery.

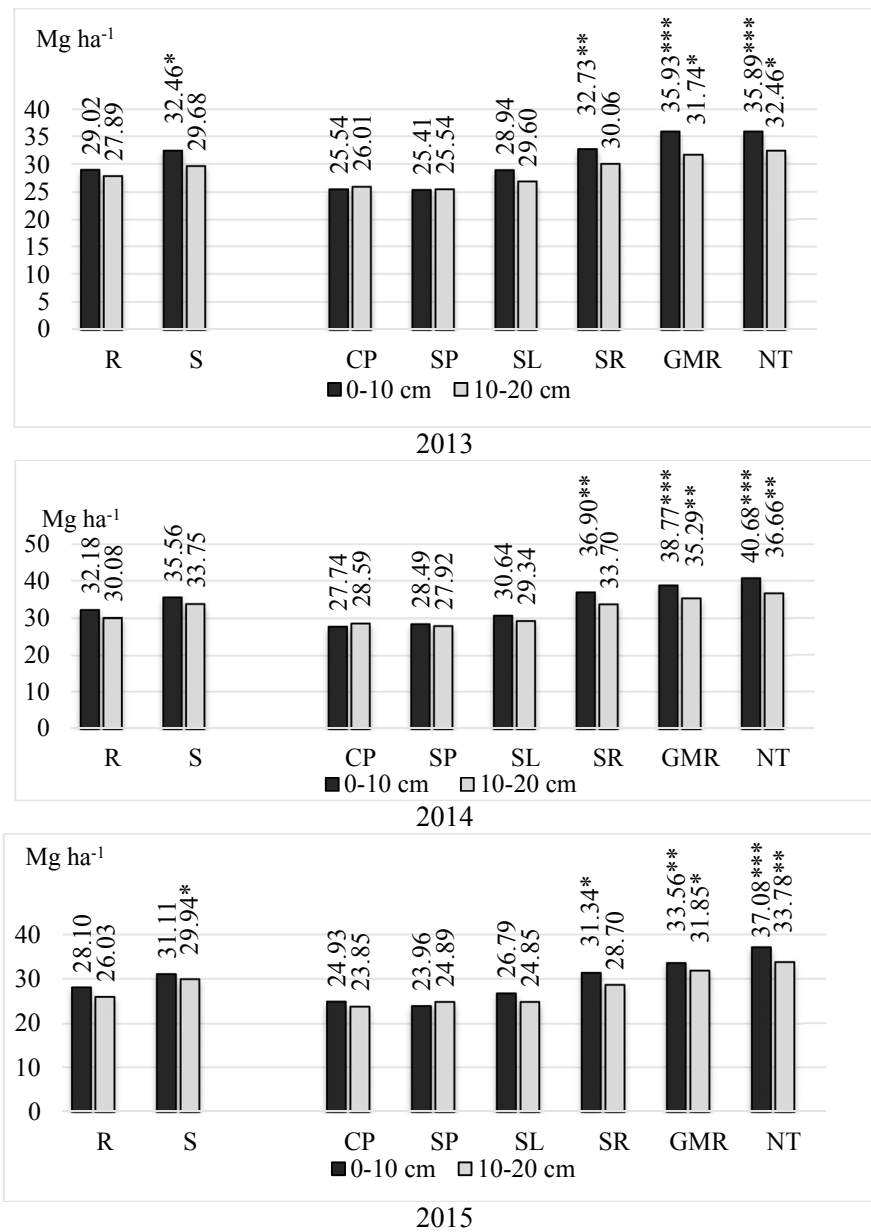

**Figure 1.** Soil organic carbon stocks in the upper and bottom plough layers,

Notes. Significant differences at \* $P \leq 0.05 > 0.01$ , \*\*  $P \leq 0.01 > 0.001$ , \*\*\*  $P \leq 0.001$ ; Fisher LSD test vs. control. Factor A: R - straw removed (control), S – straw chopped and spread. Factor B: CP - conventional deep ploughing (control), SP – shallow ploughing, SL - shallow loosening with sweep and disc harrows, SR - shallow loosening with rotary cultivator, GMR – catch cropping and green manure incorporation with rotary cultivator, NT - no-tillage, direct drilling.

**Acknowledgement.** This work was supported by the National Science Program “The effect of long-term, different-intensity management of resources on soils of different genesis and on other components of the agroecosystems” [grant number SIT-9/2015] funded by the Research Council of Lithuania.

*References*

Lal, R., 2010. *Food Sec.*, 2, 169-177.

## Tillage intensity affects SOC stocks on boreo-temperate regions only in the topsoil

K. H. E. Meurer<sup>1\*</sup>, N. R. Haddaway<sup>2</sup>, M. A. Bolinder<sup>1</sup>, T. Kätterer<sup>1</sup>

<sup>1</sup> Swedish University of Agricultural Sciences – SLU, Department of Ecology, 750 05 Uppsala, Sweden

<sup>2</sup> Mistra EviEM, Stockholm Environmental Institute, 115 23 Stockholm, Sweden

\* corresponding author: [katharina.meurer@slu.se](mailto:katharina.meurer@slu.se)

### Introduction

Shifting from high intensity (HT) to intermediate (IT) or no tillage (NT) practices on agricultural soils has been credited to be a promising option for increasing the carbon (C) sequestration potential. The consequences of conversion from CT to mainly NT on soil organic carbon (SOC) has been subject of some regional and global meta-analyses revealing an either beneficial or null effect. Certainly, some of the discrepancies between the outcomes of the meta-analyses might be explained by the methods used when compiling the datasets.

In this study, we evaluated SOC stock changes following conversion from conventional to conservation tillage using studies that have been compiled within a systematic map (Haddaway et al. 2015) and further selected during a systematic review (Haddaway et al. 2016). Studies concerning tillage were selected systematically and included in a global meta-analysis (Haddaway et al. 2017).

### Materials and Methods

Using the equivalent soil mass (ESM) approach, we extracted those studies from the global meta-analysis that reported either SOC concentrations or stocks in combination with bulk densities ( $\rho_b$ ). Cumulative SOC stocks were calculated over the entire soil profile considering the treatment-specific distribution of soil mineral mass and SOC concentration for fixed layer depths.

Stock changes ( $\Delta$ ) were calculated between all three treatments, i.e. HT vs. IT, IT vs. NT, and HT vs. NT.

The dataset was complemented with climate, soil, and management information from the original studies.

### Results

The dataset included data from a total of 101 paired long-term field trials covering 14 countries and 7 climatic zones. The most common reason for excluding a study was missing  $\rho_b$  or inconsistency between the depths for reported  $\rho_b$  and C concentrations or stocks.

Calculated SOC stocks were lower when the soil equivalent mass was considered and this difference is certainly visible in the stock changes between treatments. For the plough layer,  $\Delta$  was 15, 47, and 46 % lower for HT vs. IT, IT vs. NT, and HT vs. NT, respectively, than for treatment difference comparisons based on fixed depth layers.

Conversion of conventional to conservational tillage increased SOC stocks in the topsoil, but this effect decreased with depth and the (NT – HT)/NT ratio was almost zero at 0 – 50 and 0 – 60 cm. Estimated storage capacities in the upper 0 – 30 cm were  $3.22 \pm 1.48$  (HT vs. IT),  $2.18 \pm 1.40$  (IT vs. NT) and  $4.19 \pm 1.82$  Mg ha<sup>-1</sup>, respectively. Deeper layers could only be included for the HT vs. NT comparison and here the C storage capacity was reduced to < 0.10 Mg ha<sup>-1</sup> yr<sup>-1</sup> for the 0 – 60 cm layer.

None of the climate, soil, and management covariates was found to be a good predictor for relative C stock changes ( $\Delta_{rel}$ ).

## Conclusion

The positive effect of conservational tillage was found to be limited to the topsoil and it decreased with deeper depth. Based on these results, we highlight the need for deeper sampling, since otherwise, the sequestration potential might be overvalued.

The number of trials containing potentially valuable information was strongly reduced by the lack of reported bulk density ( $\rho_b$ ), which impeded the calculation of the equivalent soil mass. ESM correction is necessary, since otherwise, calculated stocks and resulting stock changes are likely to be biased towards the treatment with the higher bulk density.

The missing relation between relative SOC stock changes ( $\Delta_{rel}$ ) and potential drivers, such as climate, soil, and management, indicates that these covariates are more important at regional rather than global scale.

## References

Haddaway N.R., Hedlund K., Jackson L.E., Kätterer T., Lugato E., Thomsen I.K., Jorgensen H.B., Söderström B., 2015. What are the effects of agricultural management on soil organic carbon in boreo-temperate systems? Systematic Map. Environ. Evid., 4:23. Doi: 10.1186/s13750-015-0049-0.

Haddaway N.R., Hedlund K., Jackson L.E., Kätterer T., Lugato E., Thomsen I.K., Jorgensen H.B., Isberg P.-E., 2016. How does tillage intensity affect soil organic carbon? A systematic review protocol. Environ. Evid., 5:1. Doi: 10.1186/s13750-016-0052-0

Haddaway N.R., Hedlund K., Jackson L.E., Kätterer T., Lugato E., Thomsen I.K., Jorgensen H.B., Isberg P.-E., 2017. How does tillage intensity affect soil organic carbon? A systematic review. Environ. Evid., 6:30. Doi: 10.1186/s13750-017-0108-9.



## Monitoring SOC changes in the long-term experiment of Boigneville shows no effect of tillage after 47 years

*Bruno Mary*<sup>1\*</sup>, *Fabien Ferchaud*<sup>1</sup>, *Florent Chlebowski*<sup>1</sup>, *Nicolas Blaszczyk*<sup>2</sup>, *Jérôme Labreuche*<sup>2</sup>

<sup>1</sup> INRA, UR 1158 AgroImpact, Site de Laon, F-02000, Barenton-Bugny, France

<sup>2</sup> ARVALIS, Station Expérimentale, F-91720, Boigneville, France

\* corresponding author: [bruno.mary@inra.fr](mailto:bruno.mary@inra.fr)

### Introduction

Accurate assessment of soil organic carbon (SOC) stock and its temporal variation is crucial in order to determine the effect of cropping practices such as tillage. The benefit of no-tillage on SOC storage is still a controversial issue and recent meta-analyses have shown that this benefit was not as important as thought ten years ago. Methodological improvements have been proposed (*e.g.* Olson *et al.*, 2014) to make unbiased SOC estimates: measuring stocks at time 0, determining bulk density, sampling below the maximum depth affected by soil tillage, and measuring SOC over time, in order to make diachronic rather than synchronic studies. These recommendations were applied to one of the oldest tillage experiment (47 years) carried out in the world, at Boigneville in northern France.

### Material and methods

The soil tillage experiment was initiated at Boigneville (48°19'37"N, 2°22'56"E) in 1970. It is managed by ARVALIS. It compares 3 tillage treatments: annual full inversion tillage (FIT), shallow tillage (ST) and no-till (NT), crossed with 6 crop managements varying in straw management (export or return), crop rotation (2 or 4 year rotation) and catch crop (absence or presence), in a randomized block system with four blocks. Full details are given by Dimassi *et al.* (2014). In this paper, we will consider only the tillage effects, averaging the crop management treatments, since no interaction was found between these two factors.

The yield of the various crops (wheat, maize, sugarbeet, barley, fababean) was recorded on each plot at harvest. The soil was sampled at 12 dates between 1970 and 2017, on average every 4 years, from 0 to 33 cm, *i.e.* 5 cm deeper than the maximum ploughing depth. Results from the period 1970-2011 are detailed in Dimassi *et al.* (2014).

A new sampling campaign was achieved in 2017. Soil was sampled at 144 sites to a depth of 60 cm using a tubular gauge (6 cm diameter). Each soil core was divided into 7 layers (0-5, 5-10, 10-15, 15-28, 28-33, 33-40 and 40-60 cm) which were air dried, weighed and analysed for C and N content. Bulk densities were measured in 72 sites using a gamma-densitometer (5-40 cm) and the cylinder method (other depths).

Calculations of SOC stocks during the 47 years of the experiment were made on equivalent soil mass basis (Ferchaud *et al.*, 2015) using a dedicated R package (called *SEME*). The effect of treatments on SOC stocks was tested by analysis of variance (ANOVA) using a linear mixed effect model (*nlme* package).

### Results and discussion

In 1970, the field exhibited a very small spatial variability: the mean SOC stock calculated between the three tillage treatments was  $44.65 \pm 0.31 \text{ t ha}^{-1}$  in the reference layer (about 0-32 cm, corresponding to a soil mass of 4600 t/ha) and not significantly different. The initial SOC concentration was almost constant down to 28 cm (previous ploughing depth) and decreased rapidly below 28 cm (Fig. 1). In 2017, SOC concentration differed widely between tillage treatments: it markedly increased in the upper layer (0-10 cm) of NT and ST and also decreased significantly below 10 cm.

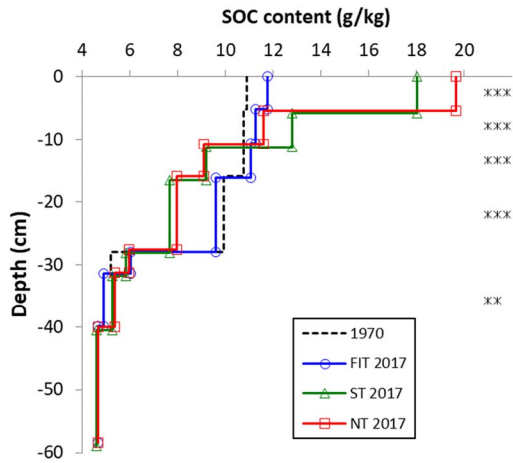

Figure 1. SOC concentration profile measured in 1970 and 2017.

The SOC stratification was consistent with the depth of crop residue incorporation. Cumulative SOC stocks between 28 and 60 cm did not differ between treatments.

SOC stocks of ST and NT increased markedly with time in the upper layer (0-10 cm) but also decreased significantly in the layer 10-32 cm, whereas small variations were observed in the FIT treatment (Fig. 2). SOC stocks in the whole reference layer followed a rather similar evolution between treatments, with a slight increase throughout time, and no significant difference between treatments at any time.

The absence of tillage effect on SOC storage cannot be attributed to differences in crop residues since the average crop yields did not differ between tillage treatments during the whole experiment. The decrease of SOC stock in the 10-32 cm layer shows that C mineralization is active in this layer in ST and

NT treatments in spite of the absence of soil tillage.

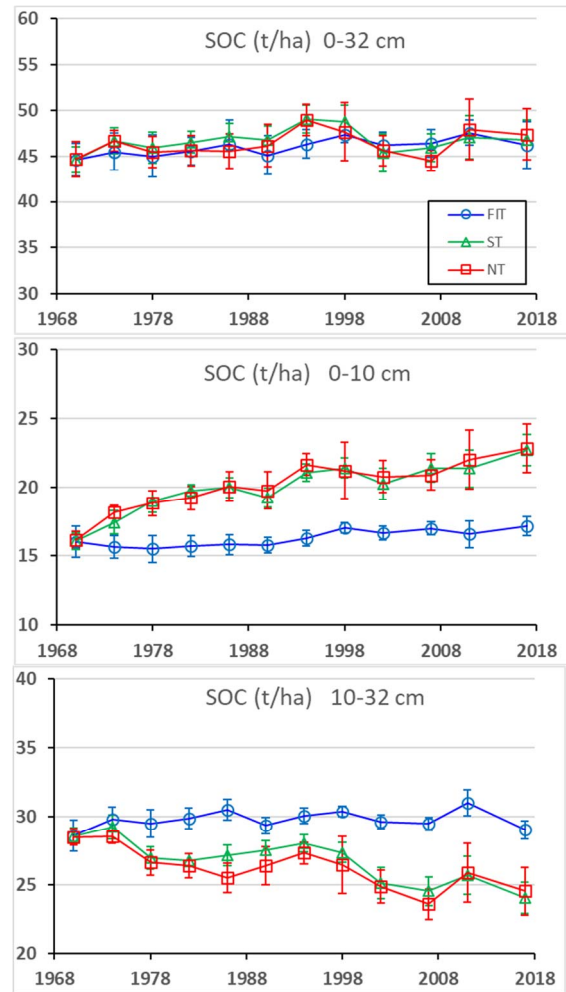

Figure 2. Evolution of SOC stocks during 47 years in three soil layers, according to soil tillage treatment.

**Conclusion**

This long-term experiment is a very valuable tool to analyse the effect of tillage as a single factor, contrary to conservation agriculture which may combine other factors such as longer crop rotation and permanent cover crops. The long duration, the quality of the methodological approach and the consistency of the results obtained in this diachronic study allow to make reliable conclusions on the effect of tillage on SOC storage on the long term, under these pedo-climatic conditions. Efforts to conduct similar diachronic studies in other sites should be encouraged. The *SEME* R package is available upon request.

*References*

Dimassi B., Mary B., Wylleman R., Labreuche J., Couture D., et al., 2014. *Agric. Ecosyst. Environ.*, 188, 134-146.  
 Ferchaud F., Vitte G., Mary B., 2016. *GCB Bioenergy*, 8, 290-306.  
 Olson K.R., Al-Kaisi M. M., Lal R., Lowery B., 2014. *Soil Sci. Soc. Am. J.* 78, 348-360.

## Removing crop residue in continuous no-tillage systems: Soil and productivity effects are site-specific

\*D., Presley<sup>1\*</sup>; J., Tatarko<sup>2</sup>; Y., He<sup>3</sup>.

<sup>1\*</sup> *Department of Agronomy, Kansas State University, Manhattan, KS, 66506, USA*

<sup>2</sup> *USDA-ARS Rangeland Resources and Systems Research Unit, Fort Collins, CO, 80526, USA*

<sup>3</sup> *Drainage and Engineering Department, Sichuan University, Chengdu, China*

\*corresponding author: [deann@ksu.edu](mailto:deann@ksu.edu)

Crop residue removal for other use such as bioenergy feedstock must be evaluated to assess the long-term effects on soil properties ecosystem services, including the susceptibility of soil loss on wind erosion-prone soils such as those of the central Great Plains, USA. Two no-tillage experiments will be summarized in this presentation. In the first, a long-term experiment began in 2009 and continues to the present. The experiment is conducted at one rainfed and one irrigated location, on small plots, under continuous corn. The dryland site is less productive and removing crop residue did not affect average crop yields, but soil organic carbon (SOC) declined over time and with increasing levels of crop residue. The opposite was true at the irrigated site: Crop residue removal did not affect SOC but increasing levels of removal increased crop yields. A comparison of the wind erodible fraction (WEF, <0.84 mm) versus the bulk soil sample showed an enrichment of soil P in the WEF of 7 and 28% for the dryland and irrigated sites, respectively. This highlights the importance of crop residue retention for controlling wind erosion and maintaining soil nutrient levels.

Figure 1. Comparison of SOC in the upper 10 cm of the soil profile. Left: At the dryland Ottawa site, relative to 2009, the 0% removal treatment has accumulated SOC; 25 to 100% removal is leading to SOC declines. Treatments followed by the same letter are not statistically different at  $p=0.05$ . Right: There are no significant differences among treatments at the irrigated Colby location at  $p=0.05$ .

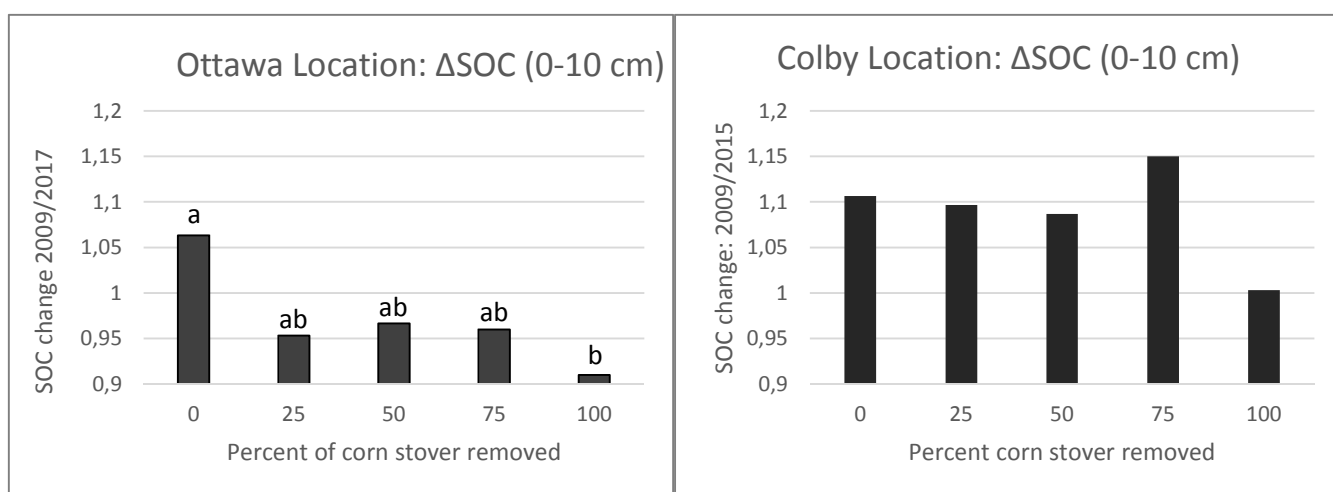
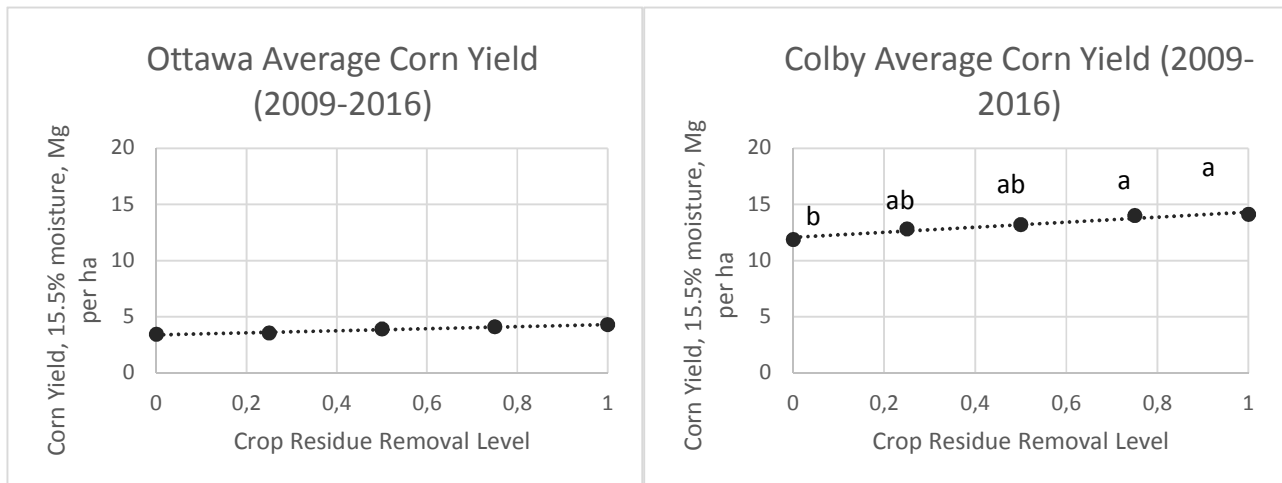

Figure 2. Average corn grain yields, 2009-2016 in continuous no-till corn system. Upper graph: At the dryland Ottawa site, removing crop residue has no effects on crop yield. There are no significant differences at  $p=0.05$ . Lower graph: At the irrigated Colby site, the site has silt loam soils and is irrigated, and crop yields are high. It appears that removing 75 or 100% of the crop residue improves yields relative to the 0% removal treatment. Treatments followed by the same letter are not statistically different at  $p=0.05$ .



In the second experiment, six on-farm trials were conducted by He et al. (2018) from 2011 to 2013 to determine the effects of crop residue removal at increments of 0, 25, 50, 75, and 100% removal on soil wind erosion parameters. The field measured soil properties were included as input parameters into the Single-event Wind Erosion Evaluation Program (SWEEP), a sub-model of the Wind Erosion Prediction System. SWEEP predicted the wind velocity that initiated wind erosion as well as soil loss under each crop residue removal level at a wind velocity of  $13 \text{ m s}^{-1}$  for three hours. The total amount of estimated soil lost in three hours ranged from  $\approx 2$  to  $25 \text{ Mg ha}^{-1}$ , and the tolerable soil loss for these soils was  $11.2 \text{ Mg ha}^{-1}$ . Fifty percent crop residue removal appears sustainable from a wind erosion perspective for all sites, while 75% residue removal caused simulated wind erosion at three out of six sites, reinforcing the need for site-by-site evaluation of the potential amount of crop residue that may be harvested while minimizing environmental impacts and effects on soil properties.

Reference:

He, Y., Presley, D.R., Tatarko, J, and Blanco-Canqui, H., 2018. Crop residue harvest impacts wind erodibility and simulated soil loss in the Central Great Plains. *Global Change Biol. Bioenergy*. 10:213-226. doi: 10.1111/gcbb.12483

## No-tillage with Continuous Corn Cropping Enhances Soil Aggregation and Organic Carbon Storage in Northeast China

Aizhen Liang<sup>a,c\*</sup>, Yan Zhang<sup>a,b,c</sup>, Xiujun Li<sup>a,c</sup>, Edward G. Gregorich<sup>b</sup>, Neil B. McLaughlin<sup>b</sup>, Xiaoping Zhang<sup>a</sup>, Yafei Guo<sup>a,c</sup>

*a. Northeast Institute of Geography and Agroecology, CAS, Changchun 130102, China*

*b. Ottawa Research and Development Centre, Central Experimental Farm, Agriculture and Agri-Food Canada, Ottawa, ON K1A 0C6, Canada*

*c. University of Chinese Academy of Science, Beijing 100049, China*

\*Corresponding author: [liangaizhen@iga.ac.cn](mailto:liangaizhen@iga.ac.cn)

### Introduction

In Northeast China conventional tillage (CT) practices involve removal of crop residue after harvest and moldboard plowing; this has been shown to cause a decline of soil organic carbon (SOC) storage at rate of 0.58 Mg C ha<sup>-1</sup> yr<sup>-1</sup> and a degradation of soil structure. No-tillage (NT) has been suggested as a management practice to increase SOC storage but its effectiveness in some soils and climates has been questioned. Some studies suggest that NT is more effective than CT for increasing SOC, whereas other research suggest that this is not always the case. Cropping systems can change SOC levels by affecting the amount and characteristics of crop residue and soil aggregation. Crop residue binds soil particles together into aggregates and protects SOC from mineralization. Different cropping systems contribute post-harvest residues varying in quantity and quality (chemical composition) which will control the carbon (C) inputs to soils, thereby affecting SOC storage. Soil aggregates play an important role for SOC storage, aggregate separation methods are useful to investigate the influences of tillage on SOC dynamics. The size, quantities and composition of aggregate fractions have been suggested to be sensitive to changes in SOC and thus serve as potential indicators of C sequestration under different tillage practices. More specifically, the quantity of C associated with occluded micro-aggregates was shown to account for the decrease in SOC under CT compared with NT. Hence, we established an experiment (2001): 1) to identify a tillage practice that enhanced SOC storage; 2) to evaluate the effects of tillage and cropping system on soil aggregates especially occluded micro-aggregates.

### Material and method

The experimental site is located in North Temperate Zone and has a continental monsoon climate. The soil is classified as black soil (Typic Hapludoll, USDA Soil Taxonomy) with a clay loam texture (average 36% clay, 24% silt and 40% sand). The site had been under conventional tillage management and continuous corn production for more than 15 years prior to 2001. The long-term tillage experiment was established in a split plot randomized complete block design with five treatments and four replications. Five treatments were studied: a) NTR: no tillage with corn-soybean (CS) rotation (corn: *Zea mays* L.; soybean: *Glycine max* Merr.); b) MPR: moldboard plowing with corn-soybean rotation; c) NTC: no tillage with continuous corn (CC); d) MPC: moldboard plowing with continuous corn; e) CTC: conventional tillage with continuous corn (this is the conventional farming practice in Northeast China). Seven soil samples were collected from each plot in the corn phase down to a depth of 30 cm in the beginning of the experiment (2001) and after harvest in 2013. Each soil core was separated into four segments corresponding to depths of 0–5 cm, 5–10 cm, 10–20 cm and 20–30 cm. Soil samples were gently broken and

air-dried. The seven samples were combined to form a composite sample for each depth and each plot.

### Results and discussion

Our results showed that returning residue to the soil significantly increased SOC storage in all tillage/cropping systems with NTC having the highest rate of SOC storage at  $0.71 \text{ Mg C ha}^{-1} \text{ yr}^{-1}$ . Soil under NTR exhibited a significant SOC decline deeper in the soil (5–30 cm) but overall SOC storage in 0–30 cm profile was equal to that under MPR. The SOC in occluded micro-aggregates was much higher than that associated with unprotected micro-aggregates. The effects of tillage on aggregate size and SOC concentration occurred mainly in the surface layer (0–5 cm) whereas the effect of cropping system on aggregate size and SOC concentration occurred at deeper depths. Cropping system affected the proportions of occluded and non-occluded silt & clay in all soil layers. NTC had the highest SOC storage, highest proportion and associated SOC in occluded micro-aggregates across all experimental treatments. Six and Paustian identified occluded micro-aggregates as a robust indicator for management-induced SOC changes over decadal time scales.

### Conclusion

Returning residue to the soil significantly increased SOC storage in all tillage/cropping systems with NTC having the highest rate of SOC storage at  $0.71 \text{ Mg C ha}^{-1} \text{ yr}^{-1}$ . The NTC treatment had the highest SOC storage among all treatments. It also fostered greater long-term SOC storage because it had the highest proportion and highest OC concentration in occluded micro-aggregates compared to other treatments. The effects of tillage on aggregate size and OC concentration mainly occurred in the surface layer (0–5 cm) while the effect of cropping system on aggregate size and OC concentration mainly occurred at deeper depths. Our findings suggest that no-till with continuous corn is the best tillage/cropping system for increasing SOC storage in the black soil zone in Northeast China.

### References

- Cates, A.M., Ruark, M.D., Hedtcke, J.L., Posner, J.L., 2016. Long-term tillage, rotation and perennialization effects on particulate and aggregate soil organic matter. *Soil Till. Res.* 155, 371–380.
- Six, J., Paustian, K., 2014. Aggregate-associated soil organic matter as an ecosystem property and a measurement tool. *Soil Biol. Biochem.* 68, A4–A9.
- West, T.O., Post, W.M., 2002. Soil organic carbon sequestration rates by tillage and crop rotation. *Soil Sci. Soc. Am. J.* 66(6), 1930–1946.

# Detecting the drivers of erosion-induced SOC dynamics under conservation tillage

Florian Wilken<sup>1\*</sup>, Michael Sommer<sup>2,3</sup>, Kristof Van Oost<sup>4</sup>, and Peter Fiener<sup>1</sup>

<sup>1</sup>Institute for Geography, Universität Augsburg, Augsburg, Germany

5 <sup>2</sup>Institute of Soil Landscape Research, Leibniz-Centre for Agricultural Landscape Research ZALF e.V., Müncheberg, Germany

<sup>3</sup>University of Potsdam, Institute of Earth and Environmental Sciences, Potsdam, Germany

<sup>4</sup>Earth & Life Institute, TECLIM, Université catholique de Louvain, Louvain-la-Neuve, Belgium

\*Correspondence to: Florian Wilken (florian.wilken@geo.uni-augsburg.de)

## 10 Introduction

Coupled modelling of soil erosion, carbon redistribution and turnover has received great attention over the last decades due to large uncertainties regarding erosion-induced carbon fluxes. For a process-oriented representation of event dynamics, coupled soil organic carbon (SOC) erosion models have been developed. However, there are currently few models that represent tillage erosion, preferential water erosion and transport of different carbon fractions (e.g. mineral bound carbon, carbon encapsulated by soil aggregates). The conventional approach to modelling coupled soil erosion and SOC turnover is to treat SOC as a stable part of the bulk parent soil and conceptually model (long-term) erosion. As this approach ignores event based processes, it leads to biased estimates of both water erosion-induced SOC redistribution and its effect on vertical C fluxes (Doetterl et al., 2016). Furthermore, the effects of tillage erosion on vertical C fluxes have not yet been evaluated in detail, although a representation has been accounted for in some modelling studies (Van Oost et al., 2005). The aim of this study is to couple a spatially distributed, process-oriented and event-based water erosion model with a tillage erosion model and a SOC turnover model in order to analyse the importance of individual erosion processes upon the erosion-induced C balance of agricultural catchments under strict soil conservation.

## Material and methods

We couple a process-oriented multi-class sediment transport model with a carbon turnover model (MCST-C; Wilken et al., 2017) to identify relevant redistribution processes for carbon dynamics. The model represents (i) grain size specific sediment and SOC transport and deposition, (ii) alterations of transport properties due to soil aggregation and aggregate-specific SOC allocation, (iii) lateral redistribution by tillage erosion and (iv) the model keeps track of the vertical soil profile development and SOC turnover. The study areas are two arable catchments (C1: 3.7 and C2: 7.8 ha) under strict conservation tillage near Munich, Germany. The catchments show different sedimentological connectivity, as the thalweg of catchment C2 is covered by a grassed waterway. The main cropping principle is to keep soil covered by vegetation or residues as long as possible. A main priority of the applied management practice is to link mulch tillage to profit optimization. Initially, the model was set-up to reproduce measured soil erosion between 1994 and 2001 to define the parametrization for the reference run. Subsequently, the parametrization of single erosion processes were altered ( $\pm 50\%$ ) or turned off in relation to the reference run (Tab.1) to understand the role of individual erosion processes on SOC dynamics.

35

**Table 2. Model parameterisation to analyse the effects of different erosion processes upon C fluxes. Model runs are abbreviated as follows: reference run (Ref), without tillage erosion (Til<sub>off</sub>), water erosion without grain size selectivity (GS<sub>off</sub>), high threshold for rill initiation (Ril<sub>lo</sub>), low threshold for rill initiation (Ril<sub>hi</sub>), without soil aggregation (Agg<sub>off</sub>), low soil aggregation (Agg<sub>lo</sub>), high soil aggregation (Agg<sub>hi</sub>), without water erosion (Wa<sub>off</sub>), low tillage erosion (Til<sub>lo</sub>), and high tillage erosion (Til<sub>hi</sub>).**

Processes	Parameter (unit)	Ref	Til <sub>off</sub>	GS <sub>off</sub>	Ril <sub>lo</sub>	Ril <sub>hi</sub>	Agg <sub>off</sub>	Agg <sub>lo</sub>	Agg <sub>hi</sub>	Wa <sub>off</sub>	Til <sub>lo</sub>	Til <sub>hi</sub>
Water erosion												
with vs. w/o tillage erosion	(-)	+ <sup>a</sup>	-	+	+	+	+	+	+	+	+	+
with vs. w/o grain size selectivity	(-)	+	+	-	+	+	+	+	+	+	+	+
varying rill/interrill erosion	$\tau_{crit}^b$ (Pa)	0.9	0.9	0.9	1.35	0.45	0.9	0.9	0.9	0.9	0.9	0.9
varying small micro & microaggregates	(%)	60	60	60	60	60	0	30	90	60	60	60
Tillage erosion												
with vs. w/o water erosion	(-)	+	+	+	+	+	+	+	+	-	+	+
varying tillage intensity	$k_{til}^c$ (kg m <sup>-1</sup> yr <sup>-1</sup> )	169	0	169	169	169	169	169	169	169	85	254

<sup>a</sup> + and - indicate whether a process is modelled or not; <sup>b</sup> critical shear stress for rill initiation; <sup>c</sup> tillage erosion coefficient.

5

## Results and discussions

The erosion component of the model was successfully validated against a continuous 8-year data set of surface runoff (NSE: 0.83; R<sup>2</sup>: 0.94) and sediment delivery (NSE: 0.92; R<sup>2</sup>: 0.95). Our results show that tillage erosion dominates the erosion-induced vertical C fluxes in both catchments. The total erosion-induced C sequestration potential over 50 years of simulation for tillage erosion was 7 and 9 g C m<sup>-2</sup> and for water erosion only 3 and 2 g C m<sup>-2</sup> in the catchments. The higher effect of tillage erosion on C sequestration results, in part, from the soil conservation system established at the research farm, as water erosion was reduced by roughly a factor of 20 in both catchments and the tillage transport coefficient was only about 3-times smaller as a result of the mulch tillage system. In contrast to vertical C fluxes, lateral erosion-induced C fluxes are substantially affected by a number of event-specific processes. Over the simulation period, three large water erosion events, cause nearly 60% of the total SOC delivery in both catchments. This underlines the importance of accounting for individual events. In our modelling example, neglecting enrichment would lead to a 36% and even more extreme 63% underestimation of the total SOC delivery in catchment C1 and C2, respectively. The grassed waterway of catchment C2 substantially reduced the sediment delivery, but also leads to a constantly high SOC enrichment as coarse particles are deposited in the grassed waterway. Soil aggregation transforms unconsolidated fine primary particles, a highly mobile SOC fraction, into soil aggregates, a fraction in which SOC is far less mobile. Upon increasing the aggregation level of the model from non-aggregated (Agg<sub>off</sub>) to heavily aggregated (Agg<sub>hi</sub>) soil conditions, we found an increase in SOC deposition for both catchments 47% and 83%. Hence, soil aggregation efficiently reduces SOC delivery, particularly in catchments of small sedimentological connectivity like catchment C2.

## Conclusions

The model experiment was able to estimate the relevance of different soil erosion processes in terms of their impact on vertical and lateral C fluxes for two catchments of different hydrological and sedimentological connectivity properties under soil conservation management. We found that tillage erosion under mulch tillage dominates on-field soil redistribution and vertical erosion-induced C fluxes on arable land, while water erosion processes have a much more limited effect. However, episodic lateral SOC delivery is critically important for the carbon balance. Ignoring SOC enrichment in delivered sediments leads to a pronounced underestimation of delivered SOC, particularly for catchments with connectivity reducing structures like grassed waterways or filter strips. Soil aggregates substantially reduce SOC delivery by turning highly mobile fine primary particles into less mobile soil aggregates. Our results stress the relevance and sensitivity of event based water erosion processes and the crucial role of tillage erosion on SOC dynamics especially under conservation tillage.

## References

- Doetterl, S., Berhe, A. A., Nadeu, E., Wang, Z., Sommer, M. and Fiener, P., 2016. Erosion, deposition and soil carbon: A review on process-level controls, experimental tools and models to address C cycling in dynamic landscapes, *Earth-Sci. Rev.*, 154, 102-122.
- Van Oost, K., Govers, G., Quine, T., Heckarth, G., Olesen, J. E., De Gryze, S., and Merckx, R. 2005. Landscape-scale modeling of carbon cycling under the impact of soil redistribution: The role of tillage erosion, *Global Biogeochem. Cycles*, 19, 1-13.
- Wilken, F., Fiener, P., and Van Oost, K. 2017. Modelling a century of soil redistribution processes and carbon delivery from small watersheds using a multi-class sediment transport model, *Earth Surf. Dynam.*, 5, 113-124.



## Short-term Effect of Soil Tillage and NPK Fertilization Rates on Soil Carbon Sequestration and Yield of *Colocasia esculenta* in Two Micro-environments in SE, Nigeria

Martin. A.N. Anikwe\* and E.E Ikenganyia

Department of Agronomy and Ecological Management, Enugu State University of Science and Technology, P.M.B 01660 Enugu, Nigeria.

\*Corresponding author: [anikwema@yahoo.co.uk](mailto:anikwema@yahoo.co.uk)

### Introduction

Tillage is the physical manipulation of soil, performed to create conditions suitable for germination of seeds, seedling emergence, root growth and to reduce competition from weeds. Various studies have indicated that conventional tillage (CT) and N fertilization may reduce soil organic matter level by enhancing C mineralization and limiting C inputs and that conservation tillage (NT) and N fertilization can increase C storage and active C fractions in the surface soil. Quantification of soil carbon (C) cycling as influenced by management practices is needed for C sequestration and soil quality improvement studies. Cocoyam can grow in ecological conditions (waterlogged soils, shaded environment, etc.) which another crop may find difficult or adverse. Most of the ecological constraints in the cocoyam production can be tackled efficiently and possibly solved with modifications of the farming systems (Anikwe et al., 2007). Limited information is available about the short-term combined effects of cropping system, tillage and N fertilization on SOC sequestration in degraded Ultisols with kaolinitic clay mineralogy and isohyperthermic temperature regime in the southeastern part of Nigeria. The objectives of this study is to determine the short-term effect of CT and NT practices on soil organic carbon sequestration and yield of cocoyam (*Colocasia esculenta*) in two agro-environments in southeast Nigeria.

### Materials and methods

The experiment was carried out on the same plots for two consecutive planting seasons (2013 and 2014) at two locations in southeastern Nigeria. At each site, a total area of 11 m x 20.5 m (225.5 m<sup>2</sup>) was mapped out for the experiment. The field was divided into five blocks with each block having four experimental units giving a total of 20 plots. The experimental units comprised two rates (150 kg ha<sup>-1</sup> and 300 Kg ha<sup>-1</sup>) of NPK 15:15:15 Fertilizer and two tillage systems, viz. CT (tilled plots on 0-30 m raised beds) and NT plots on flatbeds. The test crop was a variety of cocoyam (*Colocasia esculenta* Schott, [cultivar: ede ofe]). Cocoyam setts weighing 25–30 g were planted at one sett per hole at 5 cm depth using 50 cm intra - inter-row spacing. A total of 35 setts were planted in each plot making a plant population of 40,000 plants per hectare. Fertilizer (NPK 15:15:15) was applied in bands 28 DAP. Four undisturbed soil core samples and four auger were randomly collected from 0 - 20 cm and 20 – 40 cm depths in each plot at 95 days after planting (DAP). Soil samples collected within the experimental period were analyzed in the laboratory for SOC, and Bulk density using standard procedures.

### Results and discussion

The result indicated significant differences (P=0.05) in soil organic carbon sequestered in Iwollo and Agbani sites at both depths (0-20cm and 20-40cm) and planting seasons (2013 and 2014) respectively. The quantity of carbon sequestered in the soil at 0-20cm soil depth for both sites was 46.7- 90.9 and 65.0-117.9 Mg ha<sup>-1</sup> respectively for 2013 and 2014 planting season in NT plots treated with 300 Kg/ha of NPK. This was followed by NT plots treated with 150 Kg ha<sup>-1</sup> of NPK which sequestered 55.5-86.2 and 46.7-91.9 Mg ha<sup>-1</sup> organic carbon. CT plots that received 300 Kg/ha NPK with 11.3-47.6 Mg ha<sup>-1</sup> organic carbon had 44 % and 28 % lower stored organic

carbon content when compared to NT, NPK 150 Kg/ha plots for 2013 and 2014 planting season respectively. These results showed that NT plots had significantly higher post-harvest sequestered organic carbon content when compared to CT plots at 0-20cm soil depth. At 20-40 cm soil depth, NT plots that received 300 and 150 Kg/ha NPK with 165 - 184.8 Mg ha<sup>-1</sup> and 152.6-173.2 Mg ha<sup>-1</sup> stored organic carbon had 49-64 % higher stored organic carbon content when compared to CT plots that received 300 and 150 Kg/ha NPK for 2013 and 2014 planting season respectively at both sites. These results showed that statistically higher quantity of sequestered organic carbon was found at NT plots when compared with CT sites. This indicates that CT practices significantly limits soil organic carbon (SOC) sequestration. The results also showed that more of the C in both CT and NT plots is concentrated at the lower, 20-40 cm when compared to the 0-20cm soil depth. This could be due to continuous cultivation on the topsoil since traditional hoes which are commonly used tillage equipment rarely dig beyond 20-30 cm soil depth hence only the upper 0-20 cm layer is continuously pulverized and disturbed. Carbon storage as SOC is controlled by the soil environment and the quality of the organic matter in which the carbon resides. Significantly higher corm yields were found in CT plots with 300 and 150 Kg/ha N when compared to NT plots with 300 and 150 Kg/ha N at both sites (Data not shown).

### Conclusions

The results presented in this study indicated that at both site, CT and NT with different rates of NPK fertilization rates significantly increased soil organic carbon (SOC) stocks at the 20-40 cm depth when compared to 0-20 cm soil layer. Significantly higher quantity of sequestered organic carbon was found at NT plots when compared with CT sites. This indicates that CT practices significantly limits soil organic carbon (SOC) sequestration. NT soil management practices can sequester C, offset atmospheric CO<sub>2</sub> levels, and improve soil and environmental quality on a short-term basis when compared to CT. Tillage practices and N fertilization rates significantly (P=0.05) affected yield indices of cocoyam. CT with 300 Kg of NPK 15:15:15 had the highest corm yield, followed by No-till with 300 Kg/ha. This means that CT with 300 Kg/ha provided a better edaphic environment for the crop than other treatments used in the study. A better edaphic condition provided by CT was compensated for by higher doses of N fertilizer in NT Plots.

**TABLE 1: Effect of tillage and N fertilization rates on carbon sequestration at different soil depths in Iwollo and Agbani Sites during 2013 and 2014 planting seasons**

Treatment	IWOLLO SITE				AGBANI SITE			
	0 -20 cm		20 - 40 cm		0 -20 cm		20 - 40 cm	
	2013	2014	2013	2014	2013	2014	2013	2014
CT150	48.5	64.7	62.4	78.5	8.8	26.7	6.5	4.5
CT300	47.6	66.6	91.8	82.8	11.5	32.8	11.4	53.2
NT150	86.2	91.9	173.2	152.6	42.4	55.5	46.7	62.2
NT300	90.9	117.9	184.8	165.0	46.7	65.0	54.5	121.8
F-LSD(0.05)	0.4	2.2	3.2	1.3	1.6	1.4	3.2	6.4

CT150 and 300 = Conventional Tillage with 150 and 300kg of NPK 15:15:15

NT150 and 300 = No-Tillage with 150 and 300kg of NPK 15:15:15

### References

Anikwe, M. A. N., Mbah, C. N., Ezeaku, P. I., and Onyia, V. N. 2007. Tillage and plastic mulch effects on soil properties and growth and yield of cocoyam (*Colocasia esculenta*) on an Ultisol in southeastern Nigeria. *SOIL TILL RES*, 93(2), 264-272.

Least limiting water range and soil pore-size distribution related to soil organic carbon dynamics following zero and conventional tillage of a black soil in Northeast China

Xuewen Chen<sup>1</sup>, Xiuhuan Shi<sup>2</sup>, Aizhen Liang<sup>1\*</sup>

1. Northeast Institute of Geography and Agroecology, Chinese Academy of Sciences, Changchun 130102, People's Republic of China
2. Chinese Academy of Agricultural Engineering, Beijing 100125, People's Republic of China

**Abstract:** To improve the understanding of soil structure controls over soil organic carbon (SOC) dynamics, a study was conducted to explore the relationship between least limiting water range (LLWR), which was calculated based on soil bulk density and soil pore-size distribution, and the effects of LLWR, which was calculated based on soil bulk density and soil pore-size distribution on SOC mineralization following no tillage (NT) and mouldboard ploughing (MP). In contrast to MP, NT had a significantly greater volume of large macropores (>100  $\mu\text{m}$ ) at depths of 0-0.05 and 0.2-0.3 m, but a significantly lower volume of small macropores (30-100  $\mu\text{m}$ ) at depths of 0-0.05, 0.05-0.1, 0.1-0.2 and 0.2-0.3 m. The volume of meso- (0.2-30  $\mu\text{m}$ ) and micro-pores (< 0.2  $\mu\text{m}$ ) at different depths under the two tillage practices were similar. Tillage-induced changes in soil bulk density and pore-size volumes affected the ability of soil to fulfil essential soil functions in relation to organic matter turnover. Soil pore-size distribution, especially small macropores greatly affected LLWR and there was a significant correlation between LLWR, which was calculated based on soil bulk density, and the proportion of small macropores. The proportion of small macropores were used to calculate LLWR instead of soil bulk density and the values for NT and MP soils ranged from 0.073 to 0.148  $\text{m}^3$  water/ $\text{m}^3$  soil. Using the proportion of small macropores rather than bulk density in the calculation of LLWR resulted in more sensitive indications of SOC mineralization. Variation in the proportion of small macropores can help characterize the impacts of tillage practices on dynamics of LLWR and SOC sequestration.

## **Corn residue removal for lignocellulose ethanol production and its potential impact on soil health.**

Mahdi Al-Kaisi, Professor, Iowa State University

Jose Guzman, Assistant Professor, South Dakota State University

Agriculture management practices can significantly impact soil health biological, chemical, and physical properties through changes in C inputs and C losses. This study investigated the short-term effects of tillage (no-tillage [NT] and chisel plow [CP]), residue removal rate (0, 50, and 100%), and N rates of 0, 170, and 280 kg N ha<sup>-1</sup> on soil C storage, soil bulk density, water infiltration, aggregate stability, and soil compaction. Studies were established in 2008 and continued to 2011 on a Nicollet and Canisteo clay loam (poorly-drained) soil association at Ames, central Iowa site (AC) and a Marshall silty clay loam (well-drained) at Armstrong Research Farm, southwest Iowa site (ASW) in continuous corn (*Zea Mays* L.). Findings from the C budget show that under CT with an N rate of 170 kg N ha<sup>-1</sup> in continuous corn, there was no significant change in net soil C with no residue removal. Any residue removal had negative impacts on soil bulk density, water infiltration and aggregate stability at both sites regardless of N rate. Increasing N rate from 170 to 280 kg N ha<sup>-1</sup> resulted in greater potential C inputs from above and belowground biomass, although C losses were not significantly different across N rates. Averaged across both tillage systems and at 280 kg ha<sup>-1</sup> N rate for continuous corn, approximately 5.10 and 4.18 Mg ha<sup>-1</sup> and 5.23 and 5.18 Mg ha<sup>-1</sup> in 2010 and 2011 for AC and ASW sites, respectively of the residue should remain on the field to sustain soil C. These findings suggest that residue removal needs to be approached on yearly basis with particular consideration to site's yield potential and weather condition as the residue biomass production can be variable.

## Controls of soil carbon turnover in the South-American grasslands

G. Berhongaray<sup>1,2</sup>, R. Alvarez<sup>1,3</sup> and S. Imhoff<sup>1,2\*</sup>

<sup>1</sup>CONICET, Argentina.

<sup>2</sup> Facultad de Ciencias Agrarias, Universidad Nacional del Litoral, Kreder 8503, Esperanza, Argentina.

<sup>3</sup> Facultad de Agronomía, Universidad de Buenos Aires, Av San Martín 4453, Buenos Aires, Argentina.

\*corresponding author: [simhoff@fca.unl.edu.ar](mailto:simhoff@fca.unl.edu.ar)

### Introduction

The carbon sequestration capacity of soils depends on the carbon (C) inputs and the residence time of that C in the soil (turnover rate). The C inputs depend on plant productivity, which is related to climate and vegetation type. The allocation of the C inputs in the soil profile depends on the partition that plants give to above-ground biomass and the roots, finally determining the vertical distribution of soil organic carbon (SOC) (Jobbágy and Jackson 2000, Yang et al., 2007). On the other hand, factors that affect the turnover rate include climatic factors, such as temperature and humidity, chemical factors such as soil pH, and physical protection factors from soil mineral particles (Schimel et al., 1994). These relationships have been well studied in the surface horizons of the soil. However, the effect of these variables on the turnover rate at different depths in the profile has been little studied. Our objective is to understand the biophysical factors that affect the C turnover rate in the soil profile of the South-American grasslands.

### Materials and methods

A database of SOC stocks was compiled from 18 peer reviewed publications. The data set includes 196 SOC profiles, 112 from grasslands and 84 from paired afforestations (trees) distributed over Argentina, Brazil and Uruguay. For this compilation we only included data from upland soils, with SOC measured to a minimum 1 m depth (except for one site where SOC was measured to 60 cm depth). Lowlands (flooding areas) and shallow soils were discarded. Sand content was also compiled. The climatic characteristics: mean annual precipitation (MAP) and temperature (MAT), and the mean temperature of the coldest and hottest month (T<sub>min</sub> and T<sub>max</sub>) for each site was estimated using the LocClim model (FAO, 2006). The C inputs to each soil layer was estimated from the net primary productivity (NPP) using the global NCEAS model, using separate equations for tree and non-tree ecosystems, and specific equations for the vertical distribution of roots. The turnover time (t, in years) was calculated from the SOC stock and C input (kg C m<sup>-2</sup> y<sup>-1</sup>):

$$t = \frac{SOC \text{ (kg C m}^{-2}\text{)}}{C \text{ inputs (NPP; kg C m}^{-2}\text{y}^{-1}\text{)}}$$

The fraction of SOC that is recycled every year is known as the turnover rate (k):

$$k = \frac{1}{t}$$

The turnover rate was correlated against soil and climatic variables using Pearson's linear method. Statistical comparisons were made with ANOVA (p = 0.05) between vegetation types for each soil layer.

### Results and discussion

The NPP, SOC and turnover rate were higher in the afforestation as compared to the grasslands at all soil depths (Table 1). These results indicate that tree soils are more dynamic

than grasslands soils in terms of the carbon cycle. The turnover rate was strongly correlated with the soil depth, explaining 65% of its variation (Figure 1). The temperature was the only climatic variable that correlated with  $k$ , while sand content had a little degree of correlation, still significant.

Table 1: Net primary productivity (NPP), soil organic carbon (SOC) and turnover rate ( $k$ ) for different soil layers in grasslands and forest. Different letters indicate statistical differences (ANOVA,  $p < 0.05$ ) of  $k$  between vegetation types.  $\pm$ : confidence interval.

Depth	NPP (t C ha <sup>-1</sup> )		SOC (t C ha <sup>-1</sup> )		$k$ (y <sup>-1</sup> )	
	Grassland	Forest	Grassland	Forest	Grassland	Forest
0-25	3.26 $\pm$ 0.07a	4.59 $\pm$ 0.09b	49.6 $\pm$ 2.8a	53.3 $\pm$ 3.5b	0.077 $\pm$ 0.004a	0.101 $\pm$ 0.006b
25-50	0.11 $\pm$ 0.08a	0.44 $\pm$ 0.09b	22.2 $\pm$ 2.3a	32.2 $\pm$ 3.1b	0.009 $\pm$ 0.004a	0.018 $\pm$ 0.006b
50-75	0.07 $\pm$ 0.05a	0.13 $\pm$ 0.06b	17.3 $\pm$ 2.2a	22.2 $\pm$ 2.2b	0.005 $\pm$ 0.004a	0.010 $\pm$ 0.004b
75-100	0.07 $\pm$ 0.06a	0.11 $\pm$ 0.07b	15.2 $\pm$ 2.7a	17.6 $\pm$ 3.3b	0.003 $\pm$ 0.003a	0.009 $\pm$ 0.005b

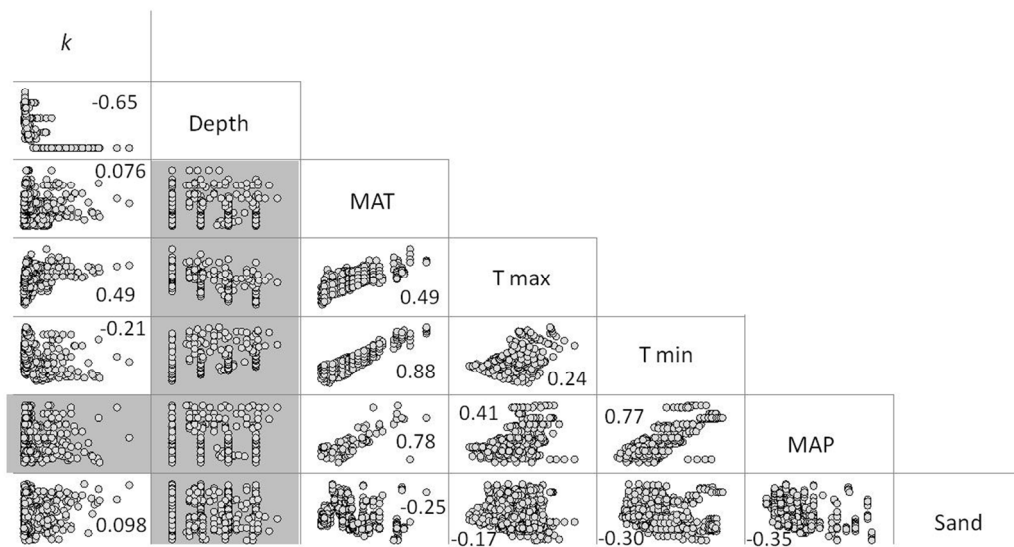

Figure 1: Pearson correlation coefficients between turnover rate ( $k$  year<sup>-1</sup>), with soil and climatic variables. Non-significant correlations are indicated gray ( $p > 0.05$ ).

Understanding the vertical distribution of SOC turnover is essential for the soils of the South-American grasslands where land-use conversion is still undergoing at high rates. For example, this results allow us to approximate how much time is necessary to affect the subsoil C after a land-use change.

### Conclusions

Trees increased soil organic carbon content and dynamic. This research also highlight the importance of soil depth as a control of the turnover rate

### References

Jobbágy E.G., Jackson R.B., 2000. *Ecol. App.*, 10: 423-436.  
 Schimel D.S., Braswell B., Holland E.A., McKeown R., Ojima D.S., Painter T.H., Parton W.J., Townsend A.R., 1994. *Global Biogeochem. Cy.*, 8: 279-293.  
 Yang Y.H., Mohammad A., Feng J.M., Zhou R., Fang J.Y., 2007. *Biogeochem.* 84: 131-141.

## Assessment of Carbon and Nitrogen Stocks in Tillage Systems by a Perceptron Multi-Layer Model

Khaoula. Abrougui<sup>1\*</sup>, Benoît. Mercatoris<sup>2</sup>, Hassina. Boukhalfa<sup>3</sup>, Chiheb. Khemis<sup>1</sup>, Elies Hamza<sup>4</sup>, Sayed. Chehaibi<sup>1</sup>

<sup>1</sup>Higher Institute of Agronomy, UR 13 AGR 03, University of Sousse, 4042 Chott Meriem, Tunisia

<sup>2</sup>TERRA Teaching and Research Centre, Biosystems Dynamics and Exchanges, Gembloux Agro-Bio Tech, Liège University, Passage des Déportés, 2, 5030, Gembloux, Belgium

<sup>3</sup>University Mohamed khidar Biskra, 07000, Algeria

<sup>4</sup>Institute of Agricultural Research and Higher Education, 1002, Tunisia

\*corresponding author: [khaoula\\_abr@yahoo.fr](mailto:khaoula_abr@yahoo.fr)

### Introduction

Tillage practices involving annual plowing without other soil management practices are increasingly being recognized to have deleterious effects on soil conditions. Conservation tillage systems leave more than 30% crop residues on the surface or concentrate them in the first few centimeters of soil. Whereas plowing buries and distributes these crop residues over the depth of the tilled layer. This change in distribution of crop residues within the soil profile will have consequences on the contents and stocks of soil organic matter and nutrients (Sasal et al., 2006). The use of Artificial Neural Networks (ANN) can be considered an alternative approach for predicting the evolution over time of certain measured parameters. The objective of this study was to evaluate the impact of different tillage systems in organic farming on soil carbon (C) and nitrogen (N) stocks, and use this data to develop ANN models for predicting these stocks as a function of tillage depth, water content, soil resistance to penetration, and microbial biomass.

### Material and method

Tests were carried out on poorly developed alluvial soil (10% clay, 57% silt, 33% sand) at the Higher Institute of Agronomy of Chott Meriem (Tunisia). Samples were collected at different depths corresponding to the limits of the utilized equipment (10, 20, and 30 cm of depth). The Walkley and Black method was used for the determination of soil organic matter, and Kjeldahl's for the analysis of total nitrogen content. The stocks of C and N ( $t\ ha^{-1}$ ) were calculated for each horizon as a function of the concentrations of C or N, bulk density, and depth of the corresponding horizon. Experimental data were then used to develop the ANN (Artificial Neural Network) model (configurations were evaluated involving data generation required for model learning/testing), the ANN configuration was evaluated to select the optimal configuration, and the optimal ANN model was validated using a data set other than that used for learning (Abrougui et al., 2014).

### Results and discussion

The C and N stocks of the 0-10 cm horizon of the reduced tillage modality were significantly higher than stocks of the conventional and agronomic tillage modalities. Nitrogen stocks within the 10-20 and 20-30 cm horizons were generally higher for conventional techniques than reduced tillage. When C and N stocks were reported to 0-20 cm, stocks of the conservation technique modality were generally higher than those of other modalities that generally had lower total stocks. The increase in C and N stocks therefore does not appear from a difference in buried dry matter, but more from a difference in the rate of crop residue degradation. These observations confirm the effect of utilized tillage system and crop residue burial depth on organic matter degradation rate. Findings indicate that total stocks of C and N

react slowly to changes in farming practices and that it is possible to identify tillage system effects after several years of treatments.

The best configuration for predicting C stocks used two hidden layers with eight neurons in the upper and lower levels. The best configuration for predicting N stocks used 2 hidden layers with 10 neurons in the upper and lower levels. These artificial neural network models showed very good agreement between predicted and desired values of C and N stocks. These results testify to the generalization abilities of the Perceptron Multi-Layer Model (MLP).

### **Conclusion**

When C and N stocks were reported for soil layers (0-30 cm), the small differences in treatments indicated that organic matter levels slowly respond to changes in cropping practices. Results showed that changes in soil structure, concentration of organic matter, and microbial soil activities at the surface of the simplified treatment (TS) during the first years of treatment differentiation do not reduce the provisional potential of soil N, which is one of the main factors limiting production levels in organic farming. The resulting database has led to the development of a Perceptron Multi-Layer Model (MLP) dedicated to the physicochemical recognition of a sandy loam soil based on three different tillage techniques.

### *References*

- Abrougui, K., Gabsi, K., Fki, H., Chenini, I. and Chehaibi, S., 2014. Int. J. Current Eng. Technol., 4(5), 3567-3573.*
- Sasal, M.C., Andriulo, A.E. and Taboada, M.A., 2006. Soil Till. Res., 87, 9-18.*



## Restoration of a Compacted Clayey sol with Cover Crop: Recovery Rate and Processes Involved.

Pascal Boivin<sup>1\*</sup>, Alice Johannes<sup>2</sup>, Adrien Matter<sup>1</sup> and Victor Fell<sup>1</sup>

\* [pascal.boivin@hesge.ch](mailto:pascal.boivin@hesge.ch)

1: HEPIA, inTNE-Agronomy, University of applied sciences of western Switzerland, 150 route de Presinge, CH 1254 Jussy-Geneva

2: Swiss Federal Research Station Agroscope, Soil Fertility and Soil Protection group, Department of Natural Resources & Agriculture, Reckenholzstrasse 191, CH-8046 Zurich, Switzerland

### Introduction

Soil compaction is one of the major threats to soil quality because all soil functions are impacted. Both mechanical (e.g. tillage) and biological (e.g. cover crops) tools are commonly used to restore soil structure. However, the role of soil constituents on soil structure forming and protection has also been emphasized. Clay minerals are at the origin of abiotic structuration through shrink-swell processes. The role of soil organic carbon (SOC) on the soil structure has been widely studied (Kay, 1998). SOC is correlated to structure quality, stability and structure resilience, hence it strongly determines structure vulnerability. Moreover, SOC content is modified, positively or negatively, by agricultural practices, and significant changes may occur within 5 years, i.e. this factor can be controlled by farmers contrarily to e.g. texture or mineralogy. Because of the growing concerns on soil quality and the increased focus on soil functions, the protection of soil structure in arable land becomes a priority. Though techniques allowing structure restoration are documented, the operational question for farmers is at which rate the structure can be improved and its vulnerability decreased. This question is less documented, to our best knowledge, in particular if production requirements must be taken into account. The objective of this study is to quantify and analyze the processes of structure recovery, in a clayey cambisol under intensively cropped orchard, after soil tillage and one season of cover-crop growth.

### Methods

The soil is a clayey cambisol developed on morain, and cultivated with apple trees since 1990. Its average clay content is 35%, and it is strongly depleted in organic carbon with a Corg:clay ratio of 5. The soil is compacted with an average bulk density of 1.45 at -10 hPa and 1.7 at dry state. The average visual evaluation of soil structure (VESS) on the spade test is 4. After sampling the soil at 5-10 cm and 20-25 cm depth for initial situation, the soil was ploughed with a digging machine and a cover crop of *Sorghum bicolor* was seeded in April. *Sorghum* growth was characterized, and in September the soil was described for structure and root growth, and sampled for analyses. The physical properties were obtained using shrinkage analysis (ShA) performed on undisturbed samples. VESS and CoreVESS were also performed, and the soil samples were analyzed for texture, SOC, pH and CEC.

### Main results and discussion

The SOC content of the soil increased significantly of 0.9 % at 5-10 cm depth, due to incorporation of the very first cm of topsoil by tillage, and remained constant at 20-25 cm depth. On the top layer, the Corg:clay ratio increased from 5 to 7 %. The VESS scores decreased significantly in both layers. The top layer VESS average score was 2 after treatment.

The ShA parameters were significantly modified in the top layer, with in particular a sharp increase of the soil and structural porosity volumes. Moreover, the relationships between these parameters and SOC were significantly changes: the increase in pore volumes was only

partly due to SOC increase and the additional pore volume corresponded to a shift in the intercept of the relationship (Figure 1). These changes are analogous, but inverse, to the changes reported in the case of soil compaction in previous studies, thus featuring a general pattern of structure quality changes. According to these results, the structure recovery is partly due to root development and biological activity. However the structure remains vulnerable since the SOC:clay ratio is far below the required values for good structure quality (Johannes et al., 2017).

### Main conclusions

In a season, the structure quality and the VESS scores were greatly improved from degraded to good structure in the top layer. The changes were concordant with the root development, and significant changes were also observed below the plough layer. Therefore, the *Sorghum bicolor* root system was largely responsible for the improvement of the structure, though it was not possible to make distinction with the effect of the soil tillage. A significant SOC increase was also observed but accounted for a small part of the structure recovery only. Further SOC increase is necessary to secure the structure recovery and decrease its vulnerability.

### References

- Fell, V., Matter, A., Keller, T., Boivin, P., 2018. Patterns and factors of soil structure recovery as revealed from a tillage and cover-crop experiment in a compacted orchard. *Front. Environ. Sci.* in press.
- Johannes, A., Matter, A., Schulin, R., Weiskopf, P., Baveye, P.C., Boivin, P., 2017. Optimal organic carbon values for soil structure quality of arable soils. Does clay content matter? *Geoderma* 302, 14–21. <https://doi.org/10.1016/j.geoderma.2017.04.021>
- Kay, B.D., 1998. Soil structure and organic carbon : a review., in: R. Lal, J.M.K. (Ed.), *Soil Processes and the Carbon Cycle, Advances in Soil Science*. Boca Raton, Fla. CRC Press, pp. 169–197.

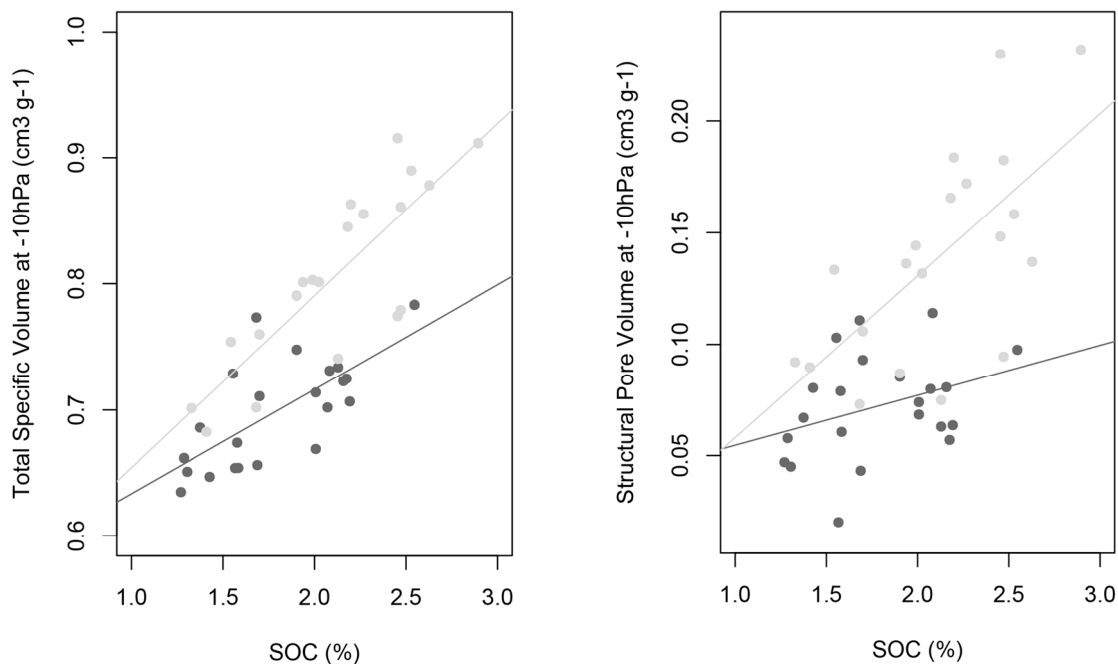

Figure 1. Soil specific volume (left) and specific structural pore volume (right) as a function of soil organic carbon content (SOC). Grey: after recovery, dark grey : before recovery. Dots: experimental values, lines: regression. Adapted from (Fell et al., 2018)



## The need of lime on clayey soils in arable crops in Germany

Tina Frank\*, Iris Zimmermann, Rainer Horn

*Institute of Plant Nutrition and Soil Sciences, Christian-Albrechts-University Kiel,*

*Hermann-Rodewald-Str. 2, 24118 Kiel, Germany*

\*corresponding author: t.frank@soils.uni-kiel.de

### Introduction

The degradation of arable soils due to natural acidification and the additional application of acidifying fertilizers is one of the factors endangering food security for a growing world population (HOLLAND ET AL. 2018). Accordingly, the development of management practices that increase structural stability in arable soils is required.

Low soil pH enhances clay leaching under humid climates. The clay dispersion and depletion in the topsoil weaken the soil structure and can cause a disturbed water infiltration if silting occurs at the soil surface. This can lead to intensified erosion, and denitrification, causing losses of 15 to 30 % N (RUHBERG 2017). Liming is a long established practice for the amelioration of acidic soils, but it also supports the formation of a stable aggregate structure, particularly in heavy soils, and is associated with an improved soil stability (HAYNES AND NAIDU 1998).

Most of the recent studies on the effects of lime application on physical and economic parameters have been conducted in Oxisols (Brazil) and Alfisols (Australia), only a few in other soils and climatic conditions (KUNHIKRISHNAN ET AL. 2016). Consequently, further research is needed to determine whether the observed processes can be transferred to soils from Central Europe, and to integrate these results for site-specific practical liming recommendations. In our research, results on the current state of lime in soils are necessary to compare the established plots with different treatments of lime and nitrogen. Development of recommendations for farming practices, in consideration of nutrient- and water availability as well as aspects of soil protection, and based on new scientific insights due to liming will be possible.

### Material and methods

Field trials were carried out on seven different sites in Germany during 2017 to develop new lime application recommendations for farmers. Each experimental area was subdivided into 12 units of 6x18 m (12 m<sup>2</sup>) with a Randomized Complete Block Design. The tested treatments were three different rates of lime, four different rates of nitrogen-application, and a control without lime and nitrogen application in a cross-classification, all replicated four times. The application rates were based on the guidelines of VDLUFA (2000).

In 2017, soil samples were taken from each of the control plots at a depth of 15 cm. The samples were air-dried, sieved and analyzed for standard chemical parameters in the laboratory. Moreover, undisturbed soil cores were sampled to determine bulk density ( $d_B$ ), saturated hydraulic conductivity ( $k_s$ ), plant available water (PAW), total porosity (TP), shear parameters: angle of internal friction ( $\phi$ ) and cohesion ( $c$ ) under different loading conditions, and the pre-compression stress ( $\sigma_{pc}$ ). The experimental sites were very heterogeneous in their soil properties and various soil types (Fluvisols, Gleysols, Planosols, Luvisols, Cambosols and sub types) were determined. The clay content varied between 10 and 37 %.

## Results and discussion

All control plots had pH values  $< 6$ . The three sites with the highest clay content (21 % - 37 %) showed a high  $k_s$ . The other four sites (clay content  $< 14.5$  %) showed average to extremely low  $k_s$  values. TP varied from low to high.  $d_B$  varied between low to middle. PAW varied between low and extreme low.  $\bar{O}_{pc}$  was extremely low to low. C and  $\varphi$  showed similar values according to the characteristic values of DVWK (1997) (DVWK 1995, 1997).

Because of the low pH of all control plots, independent of the soil type, a lime application is recommended. The low water transport and plant available water storage ability of the surveyed soils, combined with poor structural stability showed an urgent need for improvement. In addition, the results depend on soil texture and soil structure.

## Conclusion

Our results show that much less lime is being applied on cropland areas in Germany than required. Lime requirements due to VDLUFA (2000) varies with soil type, organic matter content, and form of usage. But, a target pH for cropped land is  $\text{pH} > 5.4 - 7$  to enhance nutrient use efficiency, biological activity, yield growth, soil structure and a sustainable soil fertility (RUHBERG 2017).

## References

DVWK (1995): Gefügestabilität ackerbaulich genutzter Mineralböden; Teil 1: Mechanische Belastbarkeit.

DVWK Merkblätter zur Wasserwirtschaft 234.

DVWK (1997): Gefügestabilität ackerbaulich genutzter Mineralböden; Teil 2: Auflastabhängige Veränderung von bodenphysikalischen Kennwerten. DVWK Merkblätter zur Wasserwirtschaft 235.

Haynes, R. J.; Naidu, R., 1998: Influence of lime, fertilizer and manure applications on soil organic matter content and soil physical conditions: a review. In: *Nutrient Cycling in Agroecosystems* 51, 123–137.

Holland, J. E.; Bennett, A. E.; Newton, A. C.; White, P. J.; McKenzie, B. M.; George, T. S. et al., 2018: Liming impacts on soils, crops and biodiversity in the UK. A review. In: *The Science of the total environment* 610-611, 316–332. DOI: 10.1016/j.scitotenv.2017.08.020.

Kunhikrishnan, A.; Thangarajan, R.; Bolan, N. S.; Xu, Y.; Mandal, S.; Gleeson, D. B. et al., 2016: Functional Relationships of Soil Acidification, Liming, and Greenhouse Gas Flux. In: Bd. 139: Elsevier (Advances in Agronomy), 1–71.

Ruhberg, K. I., 2017: Mehr Nährstoffeffizienz, sichere Erträge, Grundwasserschutz. In: *Bauernblatt*, 47–49.

Verband Deutscher Landwirtschaftlicher Untersuchungs- und Forschungsanstalten (VDLUFA) (2000):

Bestimmung des Kalkbedarfs von Acker- und Grünlandböden.

<http://www.vdlufa.de/joomla/Dokumente/Standpunkte/0-9-kalk.pdf>

## Recovering Crop Yields on Compacted Soils: Combining Soil Science with Plant Physiology

Tino Colombi<sup>1,2\*</sup>, Thomas Keller<sup>1,2</sup>

<sup>1</sup> Department of Soil and Environment, Swedish University of Agricultural Sciences (SLU), Uppsala, Sweden

<sup>2</sup> Department of Agroecology and Environment, Agroscope, Zurich, Switzerland

\* Corresponding author: [tino.colombi@slu.se](mailto:tino.colombi@slu.se)

### Introduction

Soil compaction of agricultural land, which mainly results from vehicular traffic, is a major threat to crop production and food security. Compaction is a global problem, but especially pronounced in industrialized countries. Compacted soils are characterized by decreased (macro-) porosity leading to adversely changed soil physical functions, like increased penetration resistance and increased risks of soil hypoxia due to decreased soil aeration and water infiltration rates (Batey, 2009). These alterations of the soil physical conditions significantly impede root growth and result in decreased accessibility of plants to water and nutrients. The effects of compaction on soil physical functions are long-lasting, leading to decreased crop productivity for several years after a compaction event. In order to develop strategies to alleviate these adverse effects on food security, an approach that combines plant and soil science is needed. Our overall aims are i) to understand the impacts of compacted soil on below- and aboveground plant growth, ii) to quantify interactions at the root-soil interface that are relevant for root and shoot growth on compacted land and iii) to identify strategies to recover crop productivity after a compaction event. Here, we present a synthesis of different studies that addressed these aims at spatial scales from the single root to the field plot (Colombi et al., 2018, 2017a, 2017b; Colombi and Walter, 2017).

### Material and methods

A number of studies, both in the laboratory and in the field, were carried out using wheat (*Triticum aestivum*, L.), soybean (*Glycine max*, L.) and maize (*Zea mays*, L.). The crops were grown under different levels of soil compaction. In all experiments, the severity of soil compaction was assessed by measurements of soil bulk density, penetration resistance and gas transport rates. In a first study, maize was grown in the field on loose and compacted soil. Water uptake and shoot growth rates were continuously monitored over the entire cropping season. At flowering, root architectural properties such as root number, root diameter and rooting depth were quantified from excavated root crowns and soil cores. Two different pot studies were carried out, in which 14 different wheat varieties were grown under controlled conditions in growth chambers. Initial root elongation and thus the genotypic ability to penetrate compacted soil, was measured after 48 hours of growth together with root diameter and root tip shape. Furthermore, root system development was quantified over a period of three weeks using X-ray computed tomography (CT) and was combined with regular plant height measurements. In a fourth study, which was conducted both in the field and under controlled conditions, compacted soil was perforated using steel strings to create artificial macropores. The interactions of soybean, wheat and maize roots with these artificial macropores were quantified from X-ray CT scans and were complemented again with measurements of aboveground plant growth rates.

### Results and discussion

Soil compaction induced different alterations of the root system architecture, namely shallower root systems, a decreased number of both axial and lateral roots, and root

thickening. These architectural changes limited the access of plants to soil water, which in turn decreased shoot growth rates and yield. These results show that improved root growth rates could be a key for improving crop productivity on compacted arable land. A promising strategy to recover yields is the development of novel crop cultivars that are adapted to the physical conditions of compacted soil, namely high penetration resistance. As a first step, root traits that increase both root growth and shoot development rates on compacted soil have to be identified. Root tip shape was related to the mechanical stress that roots exert during growth, and directly related to root elongation rates. We could show that roots of genotypes with rather sharp root tip opening angles grew significantly faster in compacted soil than roots with a blunt opening angle. Furthermore, root system development rate, expressed as the number of main and lateral roots, was significantly correlated to early shoot growth on compacted soil. Since root tip shape and root numbers are heritable, they are promising candidate traits to be selected for in breeding programs aiming to develop compaction tolerant varieties. Soil management operations may offer another option to improve root growth in compacted soil. We found that artificial macropores increased soil aeration and served as pathways of least resistance for growing roots. Root and shoot growth of maize, wheat and soybean increased significantly when compared to compacted soil that was not perforated. Interestingly, roots of all three investigated crops showed directed growth towards the artificial macropores. This finding indicates that crops extend their root system preferentially into soil compartments with conditions that are beneficial for root growth, which may result in increased resource uptake and crop productivity.

### Conclusion

An approach that combines soil science with plant physiology is crucial to understand how soil physical properties of compacted soil affect the plant root system and how this translates into accessibility to resources and crop yields. Understanding of soil-plant interactions forms the basis to identify strategies to increase root growth and agricultural productivity on compacted soil, namely the development of optimized cultivars and targeted soil management operations. As the presented approaches increase root growth, they are expected to not only help to recover crop yields but also to recover soil functions after a compaction event by creating new pore spaces.

### References

- Batey, T., 2009. Soil compaction and soil management - a review. *Soil Use Manag.* 25, 335–345. doi:10.1111/j.1475-2743.2009.00236.x
- Colombi, T., Braun, S., Keller, T., Walter, A., 2017a. Artificial macropores attract crop roots and enhance plant productivity on compacted soils. *Sci. Total Environ.* 574, 1283–1293. doi:10.1016/j.scitotenv.2016.07.194
- Colombi, T., Kirchgessner, N., Walter, A., Keller, T., 2017b. Root Tip Shape Governs Root Elongation Rate under Increased Soil Strength. *Plant Physiol.* 174, 2289–2301. doi:10.1104/pp.17.00357
- Colombi, T., Torres, L.C., Walter, A., Keller, T., 2018. Feedbacks between soil penetration resistance, root architecture and water uptake limit water accessibility and crop growth – A vicious circle. *Sci. Total Environ.* 626, 1026–1035. doi:10.1016/j.scitotenv.2018.01.129
- Colombi, T., Walter, A., 2017. Genetic Diversity under Soil Compaction in Wheat: Root Number as a Promising Trait for Early Plant Vigor. *Front. Plant Sci.* 8, 1–14. doi:10.3389/fpls.2017.00420

## **Improvement of soil-water-use-efficiency in plant production by optimized liming.**

A. Hanssen<sup>1\*</sup>, I. Zimmermann<sup>1</sup>, R. Horn<sup>1</sup>

<sup>1</sup> Institute of plant nutrition and soil science, CAU Kiel, Hermann Rodewaldstr. 2, 24118 Kiel, Germany

\*corresponding author: [a.hanssen@soils.uni-kiel.de](mailto:a.hanssen@soils.uni-kiel.de)

### **Introduction:**

About 50 % of the agricultural soils in Germany overall but also in the federal state of Schleswig-Holstein are undersupplied regarding lime. Liming as a measure of fertilisation can lead to various improvements in soils: apart from an increased pH value and a more effective buffer capacity are the availability of many nutrients and the activity of micro- and macro organisms amongst others increased. Often farmers apply  $\text{CaCO}_3$  but also  $\text{CaO}$  whereby the latter one may affect the soil strength through enhanced shrinkage and the following chemical formation of  $\text{CaCO}_3$  especially in soils with high contents of clay (and silt). The development and stabilisation of pore structures are enhanced by flocculation and aggregation of the clay particles via the supply of free calcium ions (Beetham et al., 2014). These structures can be stabilised further by organic matter and calcium-silicate-hydrates (C-S-H) and calcium-aluminate-hydrates (C-A-H). The change in pore structure influence hydraulic conductivity, soil water retention, soil gas diffusivity (Mordhorst et al., 2017), water repellency and others. While clay rich soils at low pH values tend to have corresponding disadvantages, which can be limiting factors in plant production. Regarding upcoming climate change in the future, estimations are forecasted for middle/northern Europe longer times of droughts and simultaneously longer and more severe rainfalls. Soils for plant production therefore need to be able to store additional water when it is scarce and incorporate/derive water when it is highly available to mitigate erosion or aeration problems. A sufficient supply of lime is regarded to be a key point in sustaining the productivity of soils.

### **Material and Methods:**

In order to quantify the effects of liming on soil structure formation and consequences for ecological processes, two field experiments in Schleswig-Holstein were set up at sites with high clay contents and low pH values. Quicklime ( $\text{CaO}$ ) and carbonated lime ( $\text{CaCO}_3$ ) in two different amounts (official recommendations with respect to texture, soil pH and organic matter contents x1 and x1.5) were applied and incorporated shortly afterwards in August of 2016. A randomised block design with 4 replicates was chosen with an average size per plot of  $108 \text{ m}^2$  big enough to exclude the effect of edges. Disturbed soil samples were taken for the analysis of chemical standard parameters and texture size distribution. Undisturbed soil samples were taken from two depths (10 and 30 cm) in stainless steel cylinders of  $100 \text{ cm}^3$  and  $471 \text{ cm}^3$  respectively for the analyses of saturated and unsaturated water conductivity ( $k_s$  and  $k_u$ ), soil water retention (PAW), soil gas diffusivity ( $D_s/D_o$ ), soil water repellency/contact angles (RI and CA). The samples were taken in the spring of 2017 which is equal to 7 months after lime incorporation and again in the summer of 2017 (11 months after liming).

### **Results and Discussion:**

First results show that especially in the topsoil (samples were taken in 10 cm depth) but also in the plow farrow (samples taken in 30 cm), there is an increase in  $k_s$  across the limed



treatments in comparison to the zero-lime reference. The highest values were reached in the quicklime x1.5 treatment related to the present fertilisation recommendations in Germany.  $K_u$  is higher in limed treatments than in the zero-lime treatment. Plant available water capacity in one of the sites in the topsoil is increased especially in the quicklime x1.5 and the carbonated lime x1.5 treatments.  $D_s/D_0$  results show for both sites and both depths an effect, especially for the samples from 10 cm depth the two x1.5 treatments reach the highest diffusion coefficients. Contact angles as an indicator for water repellency can be reduced throughout the lime treatments in comparison to the zero-lime treatment. The results show that the application of lime can rapidly improve the physical state of the soil due to pore structural aggregation, already 7 to 11 month after lime application and incorporation. The results indicate that fine pores are transformed to middle and narrow coarse pores, with the resulting improved physical conditions being mentioned. The results suggest that future recommendations of the lime amounts should consider the structural aspect as well and not just focus on the annual withdrawals as it is done today.

### *References*

- Beetham, P., Dijkstra, T., Dixon, N., Fleming, P., Hutchison, R., Bateman, J., 2014. Lime stabilisation for earthworks: a UK perspective. in: *Ground Improvement* Volume 168 Issue GI2, 81-95.
- Mordhorst, A., Zimmermann, I., Fleige, H., Horn, R., 2017. Changes in soil aeration and soil respiration of simulated grave soils after quicklime application. *J. Plant Nutr. Soil Sci.* 2017, 000, 1–12. DOI: 10.1002/jpln.201600351.

## **Damage of Paddy Soil during the Turning Maneuver of Tracked Harvester**

Zhao Ding\*, Yaoming Li, Zhong Tang

*Key Laboratory of Modern Agricultural Equipment and Technology, Ministry of Education, Jiangsu University, Zhenjiang, Jiangsu, 212013, China*

\*corresponding author: dingzhao0806@foxmail.com

### **Introduction**

The paddy soil has been severely damaged in recent decades in China due to the exponentially increasing use of tracked harvester in the harvest season. One of the first visible signs that the soil has been destroyed by tracked vehicle is excessive deformation of trafficked area (Raper, 2005). At present, the entire tracked harvester in China adopts unilateral brake turning pattern which can accomplish turning maneuver in a small area, and suitable for small pieces of paddy field. However, the braking force applied on the inner track usually causes the track shearing and bulldozing the soil beneath them result in serious soil damage (Wong, 2008), these damaged area may suffer serious soil erosion problems and also cause immobilization of vehicles (Li, Q et al., 2007). Therefore, it is necessary to study the turning behavior of tracked vehicles and its effects on soil damage. This research is mainly to investigate the influence of tracked harvester turning on paddy soil damage in order to seek some ways to mitigate the damage of soil.

### **Material and methods**

Both theoretical and experimental methods were used in this study. Base on the Wong's (2008) General Theory, a theoretical model for the prediction of the track shear force and track trafficked area during the vehicle turning, by taking into account the track slip effect, was developed. According to the simulation results, a new pivot turning pattern for tracked harvester was put forward to compare with the traditional unilateral brake turning pattern in respect of soil damage. The tracked harvester was used to conduct the test on the paddy soil, turning at both two patterns in three different soil conditions, as shown in Figure 1. The degree of soil damage was estimated in two indices: damaged area (DA) and damaged severity (DS). Damaged area is defined as the range of contract area caused by a tracked vehicle. Damage severity is defined as the average height of the soil pile due to the track shearing and bulldozing the soil beneath them. Both two indices can be measured by using soil profile measuring instrument. Sensors onboard the harvester monitors and records the track speed and the sprocket angular velocity in order to determine the track slip coefficient during the turning maneuver.

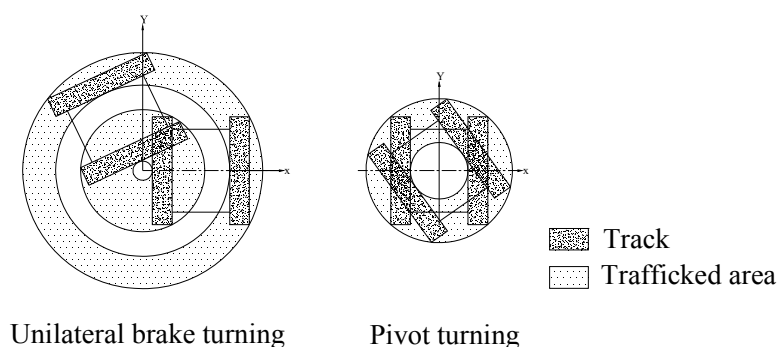

Fig.1 Two different turning patterns of tracked harvester

### Results and discussion

The simulation results show that the magnitudes of the shear force on the track decrease with the increase of slip coefficient, the pivot turning pattern produces smaller track shear force than the unilateral brake turning pattern when the track slip coefficient is greater than 0.48, but the always provides smaller damaged area than unilateral brake turning pattern, and the damaged area is increased with the increasing of track slip coefficient. In the paddy field test, when the track slip coefficient is measured as 0.54, the damage area caused by pivot turning pattern is 31% smaller than unilateral brake turning pattern and the average height of soil pile caused by the former pattern is 2.4% greater than the latter one. The simulation results are in reasonably close agreement with the available experimental data. We can conclude from both theoretical and experimental results that the pivot turning pattern is proved to be one of the effective ways to mitigate the damage of paddy soil and enhance the vehicle's turning ability.

### Conclusion

In this study, a theoretical model to predict the track shear force and traffic area caused by tracked vehicle turning is developed. A new pivot turning pattern for tracked harvester is put forward to compare with traditional unilateral brake turning pattern in the respect of soil damaged. It is shown that the theoretical model is effective in the prediction of soil damage caused by tracked vehicle turning, and the pivot turning pattern is proven to be a useful way to mitigate the damage of paddy soil.

### References

- Raper, R. L. (2005). Agricultural traffic impacts on soil. *Journal of Terramechanics*, 42(3-4), 259-280.
- Wong, J. Y. (2008). *Theory of ground vehicles*. John Wiley & Sons.
- Li, Q., Ayers, P. D., & Anderson, A. B. (2007). Modeling of terrain impact caused by tracked vehicles. *Journal of Terramechanics*, 44(6), 395-410.

## Soil structure recovery after compaction – roles and dynamics of different structure forming processes

P. Weiskopf<sup>1\*</sup>, T. Colombi<sup>1,2</sup>, R. Reiser<sup>1</sup>, D. Or<sup>3</sup>, A. Walter<sup>4</sup>, T. Keller<sup>1,2</sup>

<sup>1</sup> *Agroscope Research Station, Department of Agroecology and Environment, Reckenholzstrasse 191, CH-8046 Zürich, Switzerland*

<sup>2</sup> *Swedish University of Agricultural Sciences, Department of Soil & Environment, Box 7014, SE-75007 Uppsala, Sweden*

<sup>3</sup> *Swiss Federal Institute of Technology, Soil and Terrestrial Environmental Physics, Universitätstrasse 16, CH-8092 Zürich, Switzerland*

<sup>4</sup> *Swiss Federal Institute of Technology, Institute of Agricultural Sciences, Universitätstrasse 2, CH-8092 Zürich, Switzerland*

\* corresponding author: [peter.weisskopf@agroscope.admin.ch](mailto:peter.weisskopf@agroscope.admin.ch)

### Introduction

Structure is a fundamental feature of soils. It determines the size and quality of the living space for soil organisms and plant roots, and governs soil functioning as an ecosystem compartment and soil usability for agricultural production. Soil compaction by farming traffic modifies soil structure and adversely affects soil functioning. The regeneration of compacted structure is not solely possible by mechanical loosening with help of tillage measures – supporting physico-chemical and biological processes are necessary to improve soil structure at small scales and to improve structural stability. Although these processes are qualitatively known more or less, their contribution to structure improvement as well as possibilities to direct and enhance their activity by soil management is quantitatively not well understood. Thus there is a lack of information regarding soil structure recovery rates and regaining of various functions in the course of structure recovery.

To address this gap, we designed a long-term field experiment for systematically evaluating and monitoring post-compaction evolution of soil structure and associated functions – termed the soil structure observatory (SSO).

### Material and method

The SSO was established in 2014 on a loamy soil in Zürich (Switzerland) to provide information on functional recovery of compacted soil by different post-compaction soil management. The intention is to direct the activity of the recovery processes by applying combinations of different cropping and tillage practices (natural recovery of bare and vegetated soil, anthropogenically assisted recovery by arable crop rotation with and without

soil tillage). Observations were based on (i) continuous measuring of soil state variables and (ii) periodic sampling campaigns to quantify soil properties and soil organism populations (microorganisms, earthworms) as well as crop yields.

## **Results and discussion**

We present results of initial compaction and recovery within the first two years following compaction, focusing on soil physical functions.

Following compaction, infiltration rates were reduced by three orders of magnitude whereas porosity decreased by 15 and 3% at 0.1 and 0.6 m depths, respectively. Transport properties were influenced more significantly than bulk properties such as porosity. For example, the relative gas diffusion coefficient at -100 hPa decreased from 0.024 to 0.006 for a 15% decrease in porosity at 0.1 m depth. After compaction, mechanical penetration resistance nearly doubled within the 0-0.3 m layer (from 1.0 to 2.0 MPa).

Infiltration rates recovered within one year, with higher rates in vegetated relative to bare soil compacted plots. Recovery rates in deeper soil horizons were slower, with small increases in porosity and transport properties, dominated by the appearance of individual macropores (as seen in X-ray CT images). No clear differences in soil properties and their recovery were found among management and cropping systems, except for tillage treatments. The total porosity of the tilled topsoil (0.1 m depth) was fully recovered, but not fluid transport functions, indicating that tillage is not simply the inverse process of compaction. Nevertheless, soil fragmentation caused by tillage seems to accelerate soil structure recovery.

In contrast to the small extent of recovery of soil physical functions, crop yields recovered more rapidly, although they did not fully recover yet.

## **Conclusion**

We conclude that after a considerable compaction event soil functions recover at different rates, and that the overall recovery rates decrease with soil depth. Soil structure recovery by physico-chemical and biological processes is initiated in local pockets, e.g. through macropores created by roots and earthworms or cracks caused by soil shrinkage or tillage.

## Effect of tyre inflation pressure, soil moisture content and wheel tracks on soil compaction and maize growth

G. Ruyschaert<sup>1,\*</sup>, T. D'Hose<sup>1</sup>, L. Ren<sup>2</sup>, W. Cornelis<sup>2</sup>

<sup>1</sup>*ILVO, Flanders Research Institute for Agriculture, Fisheries and Food, Plant Sciences Unit, Burg. Van Gansberghelaan 109, 9820, Merelbeke, Belgium*

<sup>2</sup>*Ghent University, Department of Environment, Gent, Belgium*

\*corresponding author: [greet.ruyschaert@ilvo.vlaanderen.be](mailto:greet.ruyschaert@ilvo.vlaanderen.be)

### Introduction

Heavy machinery in combination with field trafficking under moist conditions leads to increasing problems with soil compaction in North-West Europe. Compaction problems mainly become visible during extreme weather conditions with drought stress and water logging as a result. One solution to prevent compaction is the use of a tyre inflation pressure system to increase the contact area of the tyre with the soil and as such soil stress. The objective of our study was to investigate the effect of wheel tracks, tyre inflation pressure and soil moisture conditions during slurry injection on rut depth, soil stress, soil compaction, soil water retention curves and maize growth. The trial was conducted under practice-oriented conditions. More details can be found in D'Hose *et al.* (2017).

### Material and methods

The field experiment was conducted near Ghent in Flanders, Belgium (50°57'N, 03°47'O), where the average annual temperature and rainfall is 9°C and 836 mm, respectively. Temperatures during the experiment (May-September 2016) were normal except for the warmer month of September (2.5°C above average, 1981-2010). Precipitation in May and June was 60-150% more than normal in those months, while September was dry (30-40% of average precipitation). The soil was a moderately wet to moderately dry Luvisol (WRB classification system), with a carbon content of 1.6% and pH-KCl of 5.9 (0-30 cm). Winter rye as a cover crop was preceding maize that was grown during the experiment. The experiment had a randomized block design with three replications and two factors, i.e., 1) slurry spreading under moist (M, 0.213 g/g, pF2.51 in 0-30 cm layer) or drier (D, 0.175 g/g, pF 2.86) soil conditions, and 2) slurry spreading with high (H, 3 bar) or low tyre inflation pressure (L, 1 bar). Tyre inflation pressure was changed with an automated tyre pressure system. Plots were 6x20 m<sup>2</sup>. The slurry spreader, with a content of 16 m<sup>3</sup>, had four tyres size 800/60R32 (Alliance 380 flotation radial) divided over two axes. After clipping winter rye, slurry was spread in the M plots on April 18, with the slurry spreader being completely filled (wheel load 5600 kg) both before driving with high (H plots) and low (L plots) inflation pressure. The tyre contact area and rut depth was measured after slurry spreading in each plot, and the wheel load was determined before and after slurry spreading of the three replicate plots. Slurry was superficially (5 cm) incorporated right after spreading with a rotary tiller. During this tillage operation the tractor tyres were in between the tyre tracks of the slurry spreader. The D plots were established similarly as the M plots on May 9. The soil was tilled with a moldboard plough (30 cm deep) and with a rotary harrow (seedbed preparation, low inflation pressure, 0.5 bar) on May 13. On May 14, maize was sown perpendicular to the tillage directions. After each slurry spreading event and maize sowing, penetration resistance and soil moisture was measured and 100-cc Kopecky rings (10 and 35 cm (plough pan) depth, in and outside track) were taken for bulk density, porosity and pF curves. Penetration

resistance was measured perpendicular to and in and outside the wheel track (15 measurements per transect with 15 cm distance, two transects per plot). Kopecky rings after sowing were only taken in the M-H plots. In each plot, 50 maize plants were harvested in the track and 50 outside the track of the slurry spreader on September 28. The entire plant was weighted for yield determination and a subsample was taken for dry matter content (48u, 70°C).

## Results and discussion

Under moist conditions, tyre contact area increased with 19%, rut depth decreased with 35% and soil stress (wheel load/contact area) decreased with 16% when tyre inflation pressure was lowered from 3 to 1 bar. Under dry conditions contact area increased with 67%, rut depth decreased with 15% and soil stress decreased with 40%.

Bulk density and porosity did not significantly differ between H and L plots in the top layer (10 cm) after slurry spreading ( $p > 0.18$ ), but were higher and lower, respectively, when spreading was under moist than under dry conditions ( $p < 0.10$ ). No differences were found in bulk density, porosity and pF curves at positions under and between wheel tracks of the spreader. There were also no significant differences in these soil physical parameters at 35 cm depth after slurry application.

Decreasing tyre inflation pressure was especially beneficial under moist conditions resulting in lower penetration resistance values in the top layer (5-20 cm). No clear differences were found below the plough pan. No differences in penetration resistance under and between tracks were found under dry conditions. Any differences in penetration resistance in the arable layer (0-30 cm) were erased by ploughing.

Average dry matter maize yield was 21 ton/ha. There were no significant differences between the treatments ( $p > 0.11$ ), but dry matter content of the maize was significantly higher between tracks of the slurry spreader (41%) than under the tracks (39%). In three of the four treatments (M-L, M-H, D-H), dry matter yield was higher between tracks than under the tracks, but this was only significant for D-H ( $p < 0.05$ ; 22.3 vs 19.1 ton/ha).

## Conclusion

Soil moisture content and tyre inflation pressure during slurry spreading has an impact on tyre contact area, rut depth and soil stress. Only limited difference in soil physical parameters of the top layer could, however, be found. There were no differences induced in soil physical parameters under the plough pan. Perhaps differences in soil compaction could only be found after several passes with heavy machinery and not after one pass as was the case in our study, especially when a plough pan (ca 4 MPa) is already present. Another factor could be that even under 'moist' conditions the soil was relatively dry (pF 2.51). There was no effect of moisture conditions or tyre inflation pressure on maize yield. Despite limited differences in soil physical properties, dry matter content was significantly higher between wheel tracks than under wheel tracks and dry matter yield was in three of four treatments higher.

## References

D'Hose, T., Lidong, R., Cornelis, W., Ruysschaert, G., 2017. Effect van bandenspanning en bodemvochtgehalte op bodemverdichting en gewasgroei. ILVO Mededeling 230, Merelbeke, Belgium, 50p.

# Yield Level is a Fundamental Factor Influencing Soybean Yield Response to Subsurface Soil Tillage

O. Ernst<sup>1\*</sup>, P. Etchegoimberry<sup>1</sup>, M. Cadenazzi, R. Izaguirre<sup>1</sup>.

<sup>1</sup> Facultad de Agronomía, Universidad de la República Oriental del Uruguay.

\* corresponding author: [oenrst@fagro.edu.uy](mailto:oenrst@fagro.edu.uy)

## Introduction

After fifteen year of continuous cropping under a no till system, excessive compaction of the topsoil is regarded as one of the primary reasons for yield reductions. Recently it has been suggested that the use of subsurface tillage can mitigate this problem. However, while mechanical disruption effects on soil penetration resistance have been well documented, its effect on crop yield is variable (Botta et al., 2010; Schneider et al., 2017). Our objectives were to: (i) quantify the effect subsurface tillage on rainfed soybean yield under continuous agriculture; (ii) propose a critical soil penetration resistance value to justified soil compaction alleviation. The strategy selected to achieve these objectives was to perform on-farm trials during three growing seasons. The study area is located in the western part of Uruguay. Soils are classified as Typic Argiudolls & Hapludolls, and are considered prime agricultural land. Mean annual precipitation is about 1200 mm, fairly evenly distributed throughout the year, but with large intra- and inter-annual variations. Water deficits occur frequently during summer growing season (between November and March )and water surpluses between May and October. Data were collected from 8 on-farm trials over three growing seasons: 2014, 2015 and 2016. At each field, we installed two pairs of 300x30-m plots with three replications; each pair compared the performance of soybean under continuous no till (NT) vs subsurface decompaction to 0.4 m depth (D), using paraplow applied during the previous autum (5 to 7 month before plantig date). Both, soil penetration resistance (*RP*) and grain yield were registered using a grid sample of 30 m x 30 m. Growing conditions were quantified by generating a Yield Index (*YI*), estimated as the mean of the top decile of soybean yield of each experimental site. This method was previously used by other authors to estimate the attainable yield in different regions and represents the yield that can be reached by producers at a specific site.

## Results

Soil penetration resistance and mean soybean yield were significantly ( $p \leq 0.05$ ) improved by D, but, we quantified a strong interaction of site\*treatment. We identify three different initial soil compaction levels (Figure 1). After 5 to 7 months of applied subsurface decompaction, *RP* was reduced significantly until 0.4 m depth ( $P \leq 0.05$ ) only for those sites with initial mean *RP* > 1500 HPa (Figure 1 A). However, yield response was more related to yield level of the site than initial *RP* (Figure 2).



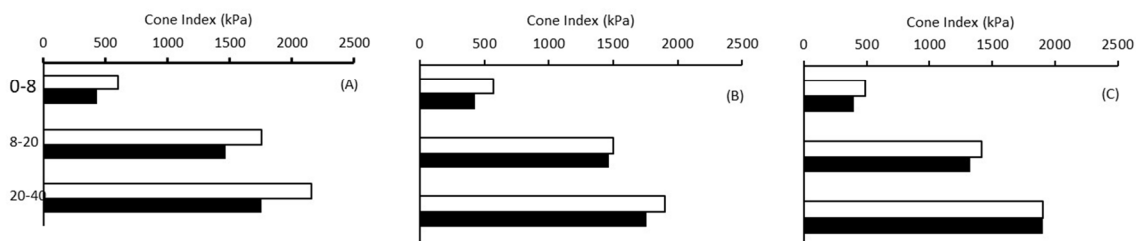

Figure 1. Cone index (kPa) measured at planting date of soybean under continuous No-till (white) and subsurface descompaction (black) in three different soil depth (0-8 cm, 8-20 cm and 20-40). A= High initial Cone Index; B= Medium initial Cone Index; C= low initial Cone Index.

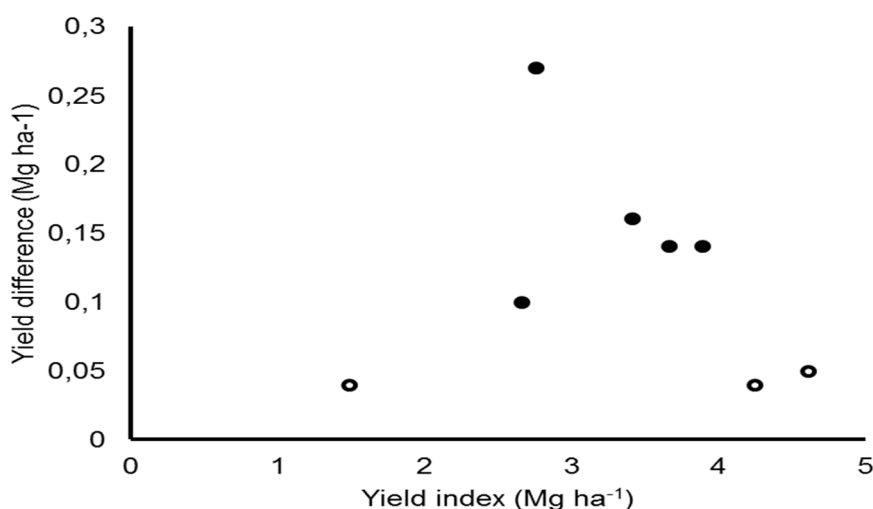

Figure 2. Soybean yield response to subsurface tillage as a function of the yield index (YI). Soybean Yield response corresponds to the difference between yield of soybean under descompacted (D) and yield of soybean under continuous no till (NT). Yield Index corresponds to upper decil of soybean yield obtained in each experiment.

Means yield increment was  $0.14 \text{ Mg ha}^{-1}$ , but the magnitude differed between sites. While both, under low and highest YI, (corresponding to low and high yield respectively) the soybean was not significantly affected (yield difference was less than  $0.05 \text{ Mg ha}^{-1}$ ), when YI varied between 2 and  $4 \text{ Mg ha}^{-1}$ , it was significantly increased by soil subsurface loosened.

## Conclusions

Soil RP was reduced by soil subsurface descompaction, but soybean yield response was related to soyben yield level defined by specific site\_growing conditions.

## References

- G. Botta, A. Tolon-Becerra, X. Lastra-Bravo, M. Tourn, M., 2010; Tillage and traffic effects (planters and tractors) on soil compaction and soybean (*Glycine max L.*) yields in Argentinean pampas. *Soil Till. Res.*, 110, 167–174.
- F. Schneider, A. Don, I. Hennings, O. Schmittmann, S. Seidel, 2017. The effect of deep tillage on crop yield: What do we really know?. *Soil Till. Res.*, 174, 193-204.

## **Impact of harvest in autumn on soil compaction and plant development for the next crops**

Hervieu S.<sup>1\*</sup>, Duparque A.<sup>1</sup>, Turillon C.<sup>1</sup>, Tomis V.<sup>1</sup>, Decoopman B.<sup>2</sup>, Hallaire V.<sup>3</sup>, Boizard H.<sup>4</sup>

<sup>1</sup>*Agro-Transfert Ressources et Territoires*, 80200 ESTREES-MONS, France.

<sup>2</sup>*Chambre Régionale d'Agriculture de Bretagne*, 35042 Rennes, France

<sup>3</sup>*INRA, UMR1069 SAS*, 35042 Rennes, France

<sup>4</sup>*INRA, UPR1158 AgroImpact*, 80200 Estrées-Mons, France

\*Corresponding author [s.hervieu@agro-transfert-rt.org](mailto:s.hervieu@agro-transfert-rt.org)

### **Introduction**

Industrial crops as sugar beet and potatoes take a large place in cropping systems in Northern France. In the context of animal production, silage maize is also important in Brittany. For many years, machinery, especially beet harvester, have become heavier and the improvements in tires has not been able to compensate the increase of machine load (Schjønning et al. 2016). In Northern France, autumn harvest operations are often carried out in wet conditions (Soil water content at field capacity or more). Moreover, the area sown to sugar beet and potatoes has increased (+23 % between 2015 and 2017 for sugar beet) and the beet harvesting campaign spreads over a longer period in winter now. Thus, the risk of compaction has increased significantly. Moreover, soil compaction seems to be the worst type of land degradation that limits agricultural productivity (Shah et al., 2017). In 2015 and 2016, experiments were conducted in order to study the impact of harvest traffic on soil physical properties and on subsequent plant growth and yield. The main results from these experiments are presented.

### **Material and method**

Experiments were conducted in farmers' fields in 6 sites in Northern France and 2 sites in Brittany. The harvest operations studied (sugar beet and potatoes harvesting, corn silage) occurred in autumn 2015. Experimental conditions in each site varied as for soil texture (silt to clay silt), soil water content (SWC), machinery characteristics, loading level of bunker or trailer. When possible, a control treatment was studied, in general between the wheel tracks. Two types of soil physical properties (penetration resistance: PR; bulk density: BD) were measured in all sites. In Northern France, these measurements were coupled with direct observations of the soil structure by the "profil cultural" method (Boizard et al, 2017) and with root development observations (*in situ* root vertical mapping) on the next crop. Crop growth and yields were also recorded. In Berny (deep loam in Northern France) a 6-rows sugar beet harvester with 2 bunker load treatments (full and empty) and 2 steer modes (in-line and crab steering) were used for the experimental traffic. Treatments were applied with three replicates. BD and PR were analysed for all the plots. In Kerguehenec (loam to sandy loam in Brittany), PR and near-saturated hydraulic conductivity at several water potentials (Bottinelli et al., 2013) were studied after a corn silage.

### **Results and discussion**

Despite low rainfalls in late September and in October, the SWC reached the field capacity in several sites. Every site showed compacted soils to a depth of 30 cm (through PR and/or BD or soil profile assessments) under wheel tracks, either for empty or full bunker (axle loads from 11 t to 28 t). The wet spring in 2016 affected the following crops on several sites and revealed the potential effect of compaction on plants root growth, aerial development and yield. Yield losses up to 18% in wheat and 29% in maize silage were observed. In particular, in the case of the Berny site, at SWC near to field capacity, BD and PR measurements under

the wheel tracks (table 1), as well as visual soil structure assessment (figure 1.A), showed important impacts on the soil up to 30 cm deep for the experimental treatment "full bunker" (max axle load = 28 t, pvalue <0.05 for PR). Moreover, observation of both steer modes of the harvester showed that double passages of wheels (front + rear wheels on the same track in-line steering) increase the intensity of compaction in the 0-30 cm layer compared to single passages (crab steering). In the zones where high soil compaction was observed, significant differences in deep root development (figure 1.B) and a loss of yield of the following wheat crop (up to 18% vs control; pvalue=0.08) could be noticed. In Kerguehenec, no significant difference was found through PR, but hydraulic conductivity measurements (K) revealed the impacts of maize silage operation on soil structure (table 2).

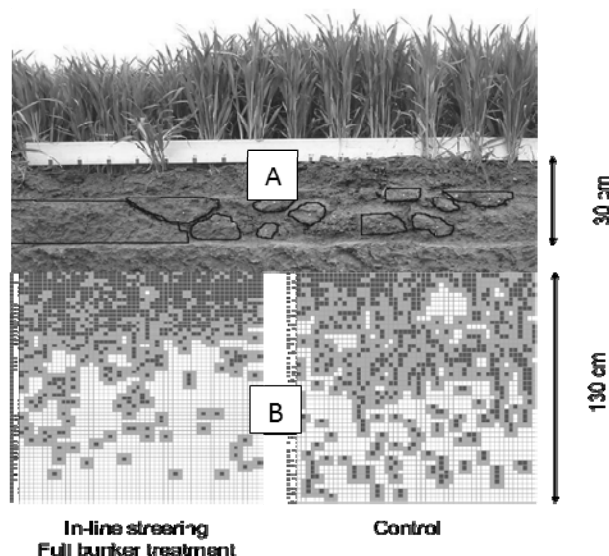

**Figure 1: Results in Bery site.**

A = image of the "profil cultural" (encircled in black: compacted zones); B - Root abundance (in deep grey: presence of a root, in light grey: roots exploration area)

**Table 1: Bulk Density (BD) and Penetration Resistance (PR) measured at 20cm depth in Bery (in-line steering mode). \* = significant differences,  $\alpha = 5\%$**

	Full bunker	Control
<b>BD*</b>	1,54	1,48
<b>PR* (Mpa)</b>	1.79	1.38

**Table 2: Hydraulic conductivity at -0.05kPa (Kerguehenec)**

	Hydraulic conductivity (mm/h)	
Depth (cm)	Control	Full bunker
<b>5-15</b>	218	17.4
<b>15-25</b>	84.7	47.2
<b>30-40</b>	76.4	87.5

## Conclusion

Our results show that the different autumn harvest operations studied in this paper can have significant negative effects on soil structure and on the performance of the next crop. On a methodological point of view, BD or PR measurements have not always been accurate enough to conclude on the significant effects of machinery passages on soil, while root development and following crop growth or yield revealed negative impacts. As well as the results of infiltration tests performed in Brittany, Schjønning et al. experience (2016) suggests that more subtle soil measurements, like porosity, air or water permeability, would certainly bring useful information. They will be performed in current field experiments on the subject.

## References

- Boizard, H., Peigné, J., Sasal, M. C., de Fátima Guimarães, M., Piron, D., Tomis, V., Vian, J.-F., Cadoux, S., Ralisch, R., Tavares Filho, J., Heddadj, D., De Battista, J., Duparque, A., Franchini, J. C., and Roger-Estrade, J. 2017.. *Soil and Tillage Research* 173, 92-103.
- Bottinelli, N., Menasseri, S., Cluzeau, D., Hallaire, V. (2013). *Soil Use and Management*, 29 (3), 401 - 409
- Schjønning, P., Lamandé M., Munkholm J.L., Lyngvig H.S, Nielsen J.A.. 2016. *Soil Tillage Res.* 163: 298–308
- Shah, A.N., M. Tanveer, B. Shahzad, G. Yang, S. Fahad, S. Ali, M.A. Bukhari, S.A. Tung, A. Hafeez, and B. Souliyanonh. 2017. *Environ. Sci. Pollut. Res.* 24(11): 10056–10067

## Survey of Soil Structure and Soil Management in UK Horticulture

J.P. Newell-Price<sup>1\*</sup>, D.G. Munro<sup>2</sup>, E. Sagoo<sup>2</sup>, J. Cloy<sup>3</sup>

<sup>1</sup> ADAS Gleadthorpe, Meden Vale, Mansfield, Nottinghamshire, NG20 9PD, UK

<sup>2</sup> ADAS Boxworth, Boxworth, Cambridgeshire, CB23 4NN, UK

<sup>3</sup> SRUC, Crop and Soil Systems, West Mains Road, Edinburgh, EH9 3JG, UK

\* corresponding author: [paul.newell-price@adas.co.uk](mailto:paul.newell-price@adas.co.uk)

### Introduction

Soils within horticultural systems are often subjected to intensive or frequent cultivations, with certain crops also being harvested multiple times, or in challenging conditions. The combination of these operations can cause soil compaction and other forms of soil structural degradation, which can be a significant factor limiting crop production in cultivated systems. In the UK, optimal soil management has been highlighted as key to improving productivity, profitability and sustainability within horticultural systems. There was however a lack of detailed information regarding current soil structural condition and soil management practices in horticulture. This paper aimed to establish baseline information across a range of horticultural crops (annual and perennial) within England and Scotland.

### Methods

A soil structure survey of horticultural crops was carried out between September 2015 and October 2016 and comprised of 75 fields located on 49 holdings. The survey included a wide range of annual crops and perennial crops. For annual crops, the survey was carried out twice (pre- and post- planting/drilling). To characterise the topsoil at each field site, baseline topsoil samples (0-15 cm depth) were taken and analysed for pH; extractable phosphorus, potassium and magnesium; organic matter; and particle size distribution. At each site a cone penetrometer (0-50 cm) was used to quantify the range and depth of (maximum) penetration resistance at twenty randomly selected points across the main body of the field (pre-planting), and across the drilled/planted area (post-planting).

At each sampling occasion, the following measurements/assessments were carried out at the three points where the maximum, median and minimum topsoil penetration resistance values were recorded:

- Dry bulk density (core cutter method)
- Mid topsoil (10-15 cm), Upper subsoil (30-35 cm), Deeper subsoil (40-45 cm).

Visual soil evaluations:

- Visual Soil Assessment (VSA; Shepherd, 2000) – topsoil
- Visual Evaluation of Soil Structure (VESS; Guimarães, 2011) – topsoil
- SubVESS (Ball, 2015) – subsoil

Cone penetrometer tests:

- 40-60 cm depth (maximum resistance and depth of maximum resistance x 3)

In addition to the compaction survey, a parallel grower survey of soil management practices was carried out. This included questions on attitudes towards soil management, visual soil evaluation and specific soil management practices carried out on each farm.

## Results

### *Annual crops*

VSA measurements indicated that the percentage of annual cropping sites in ‘Good’ condition increased from 44% pre-planting to 58% post-planting. Tillage pan assessments carried out as part of VSA showed that 61% of annual cropping sites had some form of tillage pan post-planting, with 40% well-developed. The percentage of soils scoring as ‘Friable’ or ‘Intact’ in the VESS assessments increased from 62% pre-planting to 70% post-planting, with 19% still scored as ‘Firm’ post-planting. On average bulk density increased with depth as would be expected with increasing load above sampling depth. Bulk density values were generally higher than trigger and concern values developed by the UK Soil Quality Indicator Consortium (UKSIC; Merrington, 2006), particularly post-planting.

### *Perennial crops*

According to visual soil assessments, all perennial crop sites were in either moderate or good soil structural condition. Compacted topsoil layers and signs of subsoil compaction were common in perennial crops, although there was no clear pattern relating the age of perennial crops and soil condition. At the majority of perennial crop sites soil structure was not a major limitation to drainage, nutrient use efficiency or productivity.

### *Soil management survey*

Growers were using a wide range of methods to establish crops and improve soil structure on their farms and nurseries, with cover cropping and the application of organic amendments most widely used. Many growers felt cultivations were an important tool for tackling soil structural issues; in particular subsoiling to depth was specifically mentioned by 43% of annual crop growers and 65% of perennial crop growers. Around a third of annual crop growers and three quarters of perennial crop growers were keen to learn more about visual assessment of soil structure to inform soil management decisions.

## Conclusions

The survey of soil structure identified that the majority of soils under annual and perennial cropping were in moderate condition pre-planting. This was largely related to the presence of a tillage pan, and low earthworm numbers. In general, cultivations successfully resulted in an overall improvement in soil structural conditions. However, cultivations were not always matched to soil conditions, highlighting the need for visual assessment of soils prior to cultivation and to check cultivation effects.

## Acknowledgements

Funding of this work by Agricultural and Horticultural Development Board (AHDB) horticulture is gratefully acknowledged.

## References

- Ball, B.C., Batey, T., Munkholm, L.J., Guimarães, R.M.L., Boizard, H., McKenzie, D.C., Peigné, J., Tormena, C.A. and Hargreaves, P. (2015). *Soil Till. Res.* 148, 85–96.
- Guimaraes, R.M.L., Ball, B.C., Tormena, C.A. (2011). *Soil Use Manage* 27, 395–403.
- Merrington, G. (2006). *The Development and Use of Soil Quality Indicators for Assessing the Role of Soil in Environmental Interactions.* Environment Agency Science Report SC030265, 241pp.
- Shepherd, T.G. (2000). *Visual Soil Assessment. Volume 1. Field guide for cropping and pastoral grazing on flat to rolling country.* horizons.mw & Landcare Research, Palmerston North. 84pp.

## Regeneration effect in the subsoil of a clay soil in South- East Norway five years after the compaction

\**Till Seehusen*<sup>1</sup>, *Roland Riggert*<sup>2</sup>, *Heiner Fleige*<sup>2</sup>, *Trond Børresen*<sup>3</sup>, *Hugh Riley*<sup>1</sup>

<sup>1</sup>Norwegian Institute of Bioeconomy Research (NIBIO), Postboks 115, NO-1431 Ås

<sup>2</sup>Institut für Pflanzenernährung und Bodenkunde, CAU zu Kiel, Hermann-Rodewald-Str. 3, 24118 Kiel

<sup>3</sup>Norwegian University of Life Sciences, NO-1430 Ås

### Introduction

Increasing economic pressure leads to a need for intensification and the use of larger machinery also on Norwegian farms. As a result, heavy machinery is also used on relatively small farms and small fields. In Norway, the growing season is quite short and the soils return to field capacity quite early in autumn so that this machinery is often used under not workable soil conditions, which gives a high risk for severe (sub-) soil compaction. Despite these risks, there are only a few recent studies of soil compaction in Norway (Seehusen, Børresen et al. 2014, Seehusen, Riley et al. 2014). A comparatively long winter period and frost, which may occasionally reach depths beneath the ploughed layer -also in the Southern parts of Norway- arises the question if there is a possibility for soil structure to recreate over time.

### Material and methods

In 2011, compaction trials were carried out with two different tractor- slurry tank combinations on a heavy clay soil (Stagnosol, 45 % clay) in South- East Norway near the town of Sarpsborg.

The two different machine combinations had a total weight of (a) 16 Mg with a wheel load of 4.1 Mg and a max. ground pressure of 130 kPa and (b) 36 Mg with a wheel load of 6.6 Mg and a max. ground pressure of 121 kPa.

In addition, two different wheeling intensities (1x and 10x) were investigated for both combinations. The trial was done on two different plots. One plot had been under minimum tillage for nine years prior to the compaction trial. During this time, this plot has always been direct drilled, only occasionally grubbed down to a few centimeters (minimum tillage - K). On the second plot, an annual ploughing has taken place (30 cm) for nine years prior to the trial (conventional tillage - P).

Cylinder samples were taken at three depths (20 cm, 40 cm and 60 cm) and analyzed for: dry bulk density (BD), precompression (Pc), pore size distribution and air capacity (AC), air permeability (KI) and unsaturated water conductivity ( $K_{sat}$ ).

In addition, the *Compaction Verification Tool (CVT)* was used to assess potential (sub-) soil compaction. This tool allows an evaluation of the soil compaction by using the parameters air capacity (AC) and saturated water conductivity ( $K_{sat}$ ) and their defined threshold values (AC 5 % and  $K_{sat}$  10 cm/d<sup>-1</sup>). In case that wheeling exceeds both threshold values (compared to the unloaded reference) this leads to class IV; if only one value falls underneath its threshold value, class II or class III are suggested. If wheeling does not exceed one of the threshold values, the class I is suggested. A detailed description of the *CVT* is given in Zink et al. (2011).

These plots have been under (cereal) production and have been ploughed (25-30 cm) since 2011. After a five-year regeneration period, new samples on the former compacted plots were taken (2016) and were analyzed for the same parameters as done in 2011. The results from 2016 were then compared with the results from 2011 to a determine a potential regeneration effect.

### Results and discussion (summary, some chosen parameters)

The results from 2011 showed that wheeling with the chosen wheel loads and intensities led to harmful (sub-) soil compaction, independent of the former soil treatment and machinery weight. Both higher wheel load and increased wheeling intensity increased the soil compaction. The area that had been minimum tilled before had a higher stability and was less affected by compaction. The CVT showed that multiple wheeling led to an increase in class IV (harmful compaction) for both variants, irrespective of soil tillage (Table 1.) (Seehusen, Børresen et al. 2014, Seehusen, Riley et al. 2014).

Table 1. Results from the CVT for multiple wheeling (10x) with 6.6 Mg wheel load in 40 cm and 60 cm depths for the years 2011 (after the compaction) and 2016. P= ploughing, K= minimum tillage. CVT based on threshold  $AC$  values of 5% and  $K_{sat}$  values of  $10\text{cm/d}^{-1}$ . Class I= no value below the threshold value, class II and III= either  $AC$  or  $K_{sat}$  beneath threshold value, class IV: Both  $AC$  and  $K_{sat}$  beneath threshold value, assumed harmfully compacted (Zink, et.al. 2011)

6.6 Mg 10x		CVT Class			6.6 Mg 10x		CVT Class		
40 cm		I	II+III	IV	60 cm		I	II+III	IV
2011	P	0 %	60 %	40 %	2011	P	0 %	0 %	100 %
2011	K	60 %	40 %	0 %	2011	K	0 %	0 %	100 %
2016	P	60 %	40 %	0 %	2016	P	50 %	50 %	0 %
2016	K	90 %	10 %	0 %	2016	K	0 %	100 %	0 %

The results of the resampling (2016) of the maximum load variant (6.6 Mg, multiple wheeling) documented a certain regeneration effect on soil parameters compared to 2011. The results of the CVT analysis, for example, show a certain regeneration effect in both 40 cm and 60 cm soil depth (Table 1) since no more harmful soil compaction (class IV) could be detected in these depths. However, this analysis also shows that the initial state has not been reached again since there still is a high share of classes II and III compared to the assumed reference plot (not shown).

## Conclusion

The results from the (re-) sampling after a five year regeneration period (2016) document a certain regeneration effect without the initial state (before the compaction) to be reached. Anyhow, further research on possible regeneration of soil compaction is needed. In particular, the effect of the high clay content of the examined soils in combination with the northern European climate conditions with comparatively dry conditions in summer and very humid, often cold conditions in winter on soil structure and soil compaction should be examined over a longer period of time.

## Literature

- Seehusen, T., T. Børresen, B. I. Rostad, H. Fleige, A. Zink and H. Riley (2014). "Verification of traffic-induced soil compaction after long-term ploughing and 10 years minimum tillage on clay loam soil in South-East Norway." *Acta Agric. Scand., Sect. B*, **64**(4): 312-328.
- Seehusen, T., H. Riley, R. Riggert, H. Fleige, T. Børresen, R. Horn and A. Zink (2014). "Traffic- induced soil compaction during manure spreading in spring in South-East Norway." *Acta Agric. Scand., Sect. B*: 220-234.
- Zink, A., H. Fleige and R. Horn (2011). "Verification of harmful subsoil compaction in loess soils." *Soil & Tillage Research* **114**(2): 127-134.

\*till.seehusen@nibio.no



## Classified Paper Waste Use for Training Land Rehabilitation

H. Allen Torbert<sup>1\*</sup>, Ryan R. Busby<sup>2</sup>, and Stephen A. Prior<sup>1</sup>

<sup>1</sup>U.S. Department of Agriculture, Agricultural Research Service, National Soil Dynamics laboratory, Auburn, AL USA 36832

<sup>2</sup>U.S. Army Construction Engineering Research Laboratory, Champaign, IL, USA 61826

\*corresponding author: [allen.torbert@ars.usda.gov](mailto:allen.torbert@ars.usda.gov)

### Introduction

The United States of America Military needs large land areas for training and testing activities. Currently, the US Department of Defense (DoD) manages 9.7 million hectares of land for military training operations. Many times, training activities result in significant land disturbance that requires rehabilitation. On average, land rehabilitation costs \$5,000 per hectare and generally has a 50% failure rate due to competition with weeds. As a result, improving land rehabilitation success could result in significant cost savings. For example, improving the success rate to 90% per 100 hectares would save \$198,000 per year. The addition of cellulose materials to impacted areas has been shown to improve the success of desirable perennial native vegetation. This is because soil disturbance increases available N in soils, which improves the competitiveness of weeds compared to desirable vegetation. The addition of high C:N ratio materials creates N demand in soil microbial biomass that causes N to become immobilized and unavailable to plants. Desirable perennial native vegetation species are adapted to N-limiting conditions, resulting in these species having a competitive advantage and a greatly improved success rate in establishment. Land managers commonly incorporate cellulosic materials such as sucrose, sawdust, and straw in rehabilitation efforts, but these materials can be expensive (e.g., sucrose costs  $\approx$  \$60,000 per hectare). On a different management issue, the DoD must destroy thousands of classified documents each year, and Federal regulations require that classified documents be pulverized. The pulverizing process results in paper fiber sizes that are too small to be used in normal paper recycling. Therefore, all pulverized documents must be landfilled, which becomes very costly due to the volume produced. For example, an average Tier 1 military installation produces  $\approx$ 90 Mg/year (230 m<sup>3</sup>/year). With landfill tipping fees at  $\approx$  \$100/Mg, the total disposal cost can equal \$9,000/year/installation. The objective of this study was to determine if waste paper from pulverized classified documents could be used in land rehabilitation efforts to establish native grass species.

### Material and method

The study was established on April 2016 at two sites on Ft. Polk, LA, USA: the Briley site was on an Ultisol (Briley Loamy Fine Sand) and the Eastwood site was on an Alfisol (Eastwood Silt Loam). A randomized complete block design with 4 replicates was used with pulverized paper application rates of 0, 18, 27, 54, and 72 Mg ha<sup>-1</sup> at the Briley site, while rates of 0, 9, 18, 27, and 36 Mg ha<sup>-1</sup> were used at the Eastwood Site. Both sites were seeded with Big Bluestem (*Andropogon gerardii*), Switchgrass (*Panicum virgatum*), Little Bluestem (*Schizachyrium scoparium*), and Indiangrass (*Sorghastrum nutans*) at 45 PLS Kg ha<sup>-1</sup>. Soil and plant samples were collected in October 2016 for treatment evaluation. Soil cores were collected down to 60 cm and analyzed for bulk density, plant nutrients, heavy metals, and pH. The vegetative cover was measured using 200-point samples/plot, and species composition and basal cover by species/group was determined. Biomass samples were collected from three ¼ m<sup>2</sup> samples/plot



and analyzed for nutrients and heavy metals. Before application, paper samples were measured for heavy metals, phthalates, antimony, and bisphenol A.

### Results and discussion

Results from paper analysis indicated that all heavy metals were well below EPA limits for land application and no phthalates were detected at the 50 ppm detection level. Results would establish paper loading limits at 415 Mg per year or 8,300 Mg cumulatively per hectare. Planted grass cover increased with increasing paper, with biomass peaking at 36 Mg ha<sup>-1</sup>. Paper application had virtually no effect on soil heavy metal concentrations, except for a 3 ppm increase in copper (a plant micro-nutrient) at the Briley site. Soil bulk density was decreased by 24% at the Briley site, but no change was observed at the Eastwood site. Paper decomposition was still occurring after the first growing season.

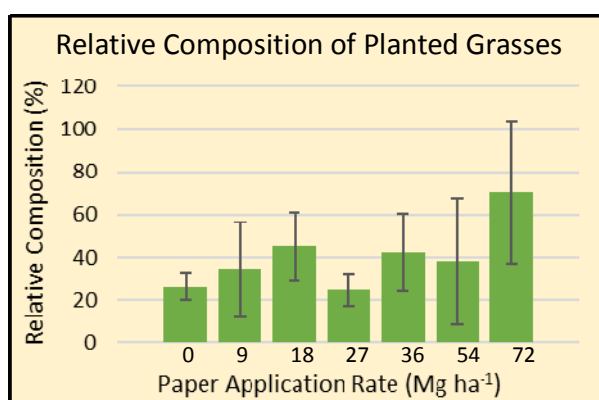

Figure 1: Planted grass cover increased with increasing paper.

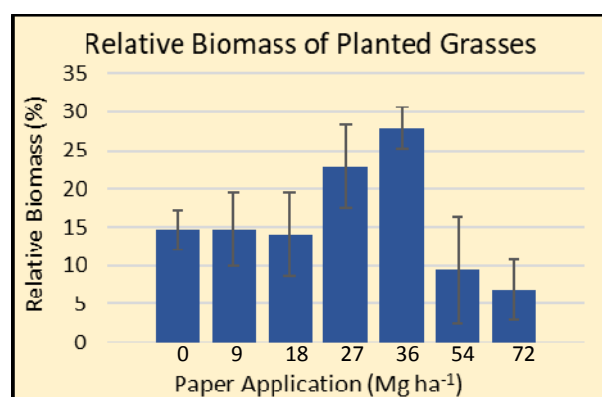

Figure 2: Planted grass biomass peaked at 36 Mg ha<sup>-1</sup>.

### Conclusion

Paper application improves establishment of native grasses and soil physical properties with no noticeable impact on soil contaminant levels. A 36 Mg ha<sup>-1</sup> rate appears to be the upper limit for adequate soil incorporation that promotes growth of native grasses on degraded training grounds.

## Effects of modern heavy traffic on subsoil structure

Mansonia Pulido-Moncada\*, Lars J. Munkholm, Per Schjønning

Aarhus University, Department of Agroecology, Research Centre Foulum, Blichers Allé 20, P.O. Box 5, DK-8830 Tjele, Denmark

\* corresponding author: mansonia.pulido@agro.au.dk

### Introduction

Soil compaction is one of the main degradation processes in agricultural soils worldwide. Its impact extends from crop production to environmental-related soil functions. In temperate regions like North Western Europe, top and subsoil compaction is an increasing problem related to heavy traffic and wet soil conditions. Several studies have reported that wheel load, and tyre inflation pressure are the main drivers of mechanical stress transmission into the soil. Modern heavy traffic with very high wheel loads impose risk of severe structural damage deep into the subsoil. However, there is a paucity of studies quantifying the effect of modern heavy traffic deep into the subsoil. This study address farm-realistic traffic at moist soil conditions for a temperate region sandy loam soil and quantifies heavy traffic induced changes in subsoil structure down to 0.9 m depth.

### Material and method

The study was conducted in an experimental field located at Research Centre Aarslev, Denmark (55° 81'80 18" N, 10° 26' 52"E). This site is located at an elevation of 51 m.a.s.l. The Aarslev soil is derived from glacial tills of the Weichsel glacial period and has been classified as Orthic Luvisols in the FAO classification system. The experimental treatments consisted of annual traffic applied wheel-by-wheel across the plots using different machinery. The treatments included no compaction (Control), compaction with a 3 Mg (M3) and 8 Mg (M8) of wheel loads with multiple passes (4-5) by a tractor-trailer combination for slurry application, and compaction with single pass wheel load of 12 Mg (S12) by a self-propelled tricycle-like machine for slurry application. The experimental treatments were replicated four times in a randomised block design with plots measuring 10 m wide x 30 long m. The compaction treatments were replicated four consecutive years. Subsoil structural quality was evaluated visually by the SubVESS method, and soil pore characteristics were quantified for minimally disturbed soil cores sampled at 30, 50, 70 and 90 cm depth. This study reports results for soil samples taken two years after completion of the four-year compaction treatments.

### Results and discussion

The SubVESS evaluations indicate the existence of a negative effect of the mechanical stresses caused by M8 up to c.75 cm depth. Surprisingly, the highest wheel load treatment, S12, did not show visual signs of increased compaction (compared to Control) at any depths. Our results, two years after the end of the compaction treatments, indicated that M8 significantly affects soil structural properties to >50 cm depth in terms of reduced subsoil structural quality, air permeability, pore volume and bulk density. Results also showed that the degree of compactness was  $\geq 95\%$  for M8 at 30 and 50 cm depth. Even though a pre-existing dense soil matrix was described in the studied soil, results confirmed that high wheel loads might cause significant subsoil compaction at >50 cm depth. Surprisingly, the S12 treatment did not show marked signs of decreasing structural quality at depths. Thus, our results indicate that primarily traffic implying multiple passes of highly loaded wheels is compromising soil structure at depth.

**Conclusion**

Four years of repeated, annual traffic with a single pass wheel load of c.12 Mg (S12) by a self-propelled tricycle-like machine for slurry application, had a negligible effect on soil structure in the soil profile. In contrast, wheel loads of c.8 Mg in combination with four consecutive wheel passes in a tractor-trailer system markedly affected subsoil structure in terms of morph-structural characteristics, soil strength and pore system from c.25 cm to c.70 cm depth. The S12 results further suggest the need of investigating the influence of factors other than wheel load and inflation pressure on the risk of subsoil compaction. The results also indicate that heavy traffic in dense soils creates a potentially restrictive subsoil structure for plant growth. Finally, our study highlights the need for future studies on the importance of repeated wheel passes and traction on soil deformation in the subsoil.

## **A field evaluation of soil compaction by the medium-sized combine harvesters in fully mechanized smallholding farms**

*\*Qishuo Ding<sup>1</sup>, Hao Wang<sup>1</sup>, Xinxin Chen<sup>1</sup>, Yinian Li<sup>1</sup>, Kerun Sun<sup>2</sup>, Ruiyin He<sup>1</sup>*

*\*Corresponding author: [qsding@njau.edu.cn](mailto:qsding@njau.edu.cn)*

*1 Nanjing Agricultural University, Nanjing 210031, P.R.China*

*2 Yinhuo Chunxiang Agricultural Machinery, Lianyungang, Jiangsu, P.R.China*

### **Introduction**

Full-developed mechanization facilitates timeliness and high work rate of field operations, safeguarding efficient crop rotation, improved exploitation on heat and radiation, and thus an increased soil productivity. However, continued pursuing on powerful agricultural machineries resulted into aggravated soil compaction by the field traffic (Tullberg et al., 2007).

In addition to scaled farms with powerful machineries, mechanization on smallholder farming systems, which are more widely distributed and increasingly important for regional food security (Thierfelder et al., 2015), provides an alternative scenario of soil-machinery interactions. Innovative technologies of precision AG provide incentives for increased field operations, e.g. multiple dressing and spraying. Although most of these operations were fulfilled with small- to medium-sized machineries, the over-exposure of structurally vulnerable soil to repeated wheeling still poses high risk to the soil health.

Reported investigation on traffic-induced soil compaction were mostly dedicated to prescribed testing procedure, conducted on scaled plots and using large machineries (Keller et al., 2012). Data was seldom seen from mechanized smallholding farms, particularly without researchers' intervention. The aim of this work was to implement a field investigation on mechanized harvesting to illustrate how extensive and intensive the medium-sized harvesters affect the soil in smallholding farmlands.

### **Materials and methods**

Field investigation was made from 2016 to 2017 in Luhe, Nanjing, Jiangsu Province. During the crop harvesting season, the regional fields were randomly scoured and a plot was chosen for sampling as once was found under harvesting. The size of each plot and the combine harvester's trafficking pattern within the plot were recorded.

Among the investigated fields, 54 plots were randomly chosen for detailed evaluations, including soil sinkage under the track site, penetration resistance and the change of soil physical properties (soil bulk density and water content in 0-5 and 5-10 cm soil layers).

In-situ plate sinkage test was made in a field as a reference for evaluation. Precompression stress and threshold soil sinkage were determined. In addition, statistical data from 4 scaled commercial farms, i.e. Huanghai, Dafeng, Chongming and Hongzehu State Farms, was collected for comparison.

### **Results and discussions**

The field of the smallholder rice-wheat farming systems was severely fragmented in Jiangsu

Province, East of China, with 89.5% of the measured plots being less than 0.2 ha. The length to width ratio of the plots was mainly found in a range of 2:1 to 4:1. While in scaled farms individual plot size was larger than 2.5 ha, and the maximum of which amounted to 10.5 ha. The length to width ratio in scaled farms ranged from 3:1 to 18:1.

All the harvesters observed in field operation were medium-sized and rubber tracked, including one brand from Japan (Kubota Pro688Q), one from Korea (Yanma YH880), and two Chinese brands (4LZ-4.0A and 4LZ-5G). Tracked harvesters revealed a well adaptation to the poor traffickability in trans-plots maneuvering. Yet the small operational width (2-2.2 m) and engine power largely limited the harvesters' field capacity, the maximum of which was 0.56 ha/hr. In comparison, heavy-duty harvesters (>120 hp) provided a working width > 4.5 m and a field capacity > 3.5 ha/hr.

The fieldwork pattern (the ordered traversal sequence of in-field tracking) of harvesters in smallholding farmlands revealed a totally chaotic manner, contrasting largely with scientifically recommended and optimized headland turning patterns, e.g. ( $\Omega$ -turn, U-turn and T-turn). Non-planned trafficking pattern led to aggravated soil damage to the headland soil.

Field compacting ratio (track-compacted area with respect to the total plot size) in the smallholding plots was large, accounting to 0.44 and 0.50, and 2.5 times higher than that of the scaled farms (< 0.2), indicating an alarming extensity of soil disturbance by the medium-sized harvesters.

Traffic-induced soil sinkage differed from plot to plot and varied among crop seasons. Among the 261 monitored sites, wheat harvesting led to a soil sinkage of 1-3 cm, while the rice harvesting were well above 4 cm, with the maximum depth of 14 cm. Considering the overwhelmingly large soil sinkage as compared with the threshold sinkage for precompression stress, as well as the overall increased penetration resistance, mechanized rice harvesting did result into considerable soil structure damage in the smallholder farming systems.

## Conclusions

Mechanized smallholder rice-wheat farming systems with intensified field operations is damaging the soil both extensively and intensively. Soil structural vulnerability to mechanized rice harvesting was significantly higher than wheat harvesting, which was evidenced by aggravated soil sinkage in reference to the threshold value of precompression stress. Chaotic fieldwork pattern implies the importance of soil protection training on harvester drivers. More field investigations on machinery-related soil processes are required for an improved design on agricultural machineries and the optimization on field operations for fully mechanized smallholding farms.

## References

- Tullberg, J. N., Yule, D. F., McGarry, D., 2007. *Controlled traffic farming: From research to adoption in Australia. Soil Till. Res.* 97(2): 272-281.
- Thierfelder, C., Mutenje, M., Mujeyi A., 2015. *Where is the limit? lessons learned from long-term conservation agriculture research in Zimuto Communal Area, Zimbabwe. Food Secur.* 7(1):15-31.
- Hemmat, A., Yaghoubi-Taskoh M., Masoumi, A., Mosaddeghi, M.R., 2014. *Relationships between rut depth and soil mechanical properties in a calcareous soil with unstable structure. Biosys. Eng.*, 118:147-155.

## Understanding precompression stress: Measurement and DEM simulation of confined uniaxial compression of unsaturated soil samples.

Jan De Pue<sup>1\*</sup>, Gemmina Di Emidio<sup>2</sup> and Wim Cornelis<sup>1</sup>

<sup>1</sup> Department of Environment, Ghent University, 9000 Ghent, Belgium

<sup>2</sup> Department of Civil engineering, Ghent University, 9000 Ghent, Belgium

\* corresponding author: [jan.depue@ugent.be](mailto:jan.depue@ugent.be)

Precompression stress (PCS) is the theoretical stress threshold at which the deformation of soil shifts from elastic to plastic processes. It indicates the soil strength and is a widely accepted proxy for quantifying the degree of soil compaction. It is commonly determined by performing a confined uniaxial compression experiment with an oedometer apparatus. Originally this method was developed for geomechanical applications working with saturated soils and long loading times to address foundation and slope stability problems, but it has shown to be applicable in soil physics as well, where unsaturated conditions and short loads are the main focus. The advantage of PCS is that it is straight-forward to interpret and convenient to use in applications such as Terranimo<sup>®</sup>.

However, research has shown that soil deformation is a more complex matter. The transition between the recompression curve and virgin compression line is more likely a gradual process than a sudden change (Berli, et al., 2004). Moreover, a standardized protocol to determine PCS is lacking; Depending on the applied stresses, loading times and even calculation methods, the PCS can differ significantly. Even though PCS is supposed to be a straight-forward soil property, the methodology to determine it lacks robustness and leads to PCS values which have a poor relation to other soil properties/variables such as bulk density, texture and matric potential (Arvidsson & Keller, 2004).

In this study, the soil deformation process under confined uniaxial compression is simulated using Discrete Element Modeling (DEM). Calibration of the model with lab data from undisturbed soil samples allows to determine physical parameters of the soil. A total of 126 samples have been collected to cover seven major soil textural classes (sand, loamy sand, light sandy loam, sandy loam, silt loam clay and heavy clay), three types of land use (cropland head, cropland center and grassland), two depths of sampling (40 cm and 70 cm) and three degrees of matric potentials (-6 kPa, -10 kPa and -33 kPa).

Simulation of the soil deformation can help to give more insight in the actual process to evaluate the validity of PCS, and allows to simulate soil deformation on different scales.

### References

- Arvidsson, J., & Keller, T. (2004). Soil precompression stress: I. A survey of Swedish arable soils. *Soil and Tillage Research*, 77(1), 85-95.
- Berli, M., Kulli, B., Attinger, W., Keller, M., Leuenberger, J., Flühler, H., . . . Schulin, R. (2004). Compaction of agricultural and forest subsoils by tracked heavy construction machinery. *Soil and Tillage Research*.

## **Soil deformation and possibilities for soil amelioration – what are the main processes and driving forces to guarantee longterm sustainable land management?**

*R.Horn<sup>1,\*</sup>, J.Dörner<sup>2</sup>, H.Fleige<sup>1</sup>, D.Holthusen<sup>3</sup> and Xh.Peng<sup>4</sup>*

*<sup>1</sup> Institute for Plant Nutrition and Soil Science, CAU Kiel, Germany*

*<sup>2</sup> Instituto de Ingeniería Agraria y Suelos, Universidad Austral de Chile, Valdivia, Chile*

*<sup>3</sup> Soils Department, Federal University of Santa Maria, Brazil*

*<sup>4</sup> Institute Soil Science, CAS Nanjing, China*

\*Corresponding author: rhorn@soils.uni-kiel.de

The quantification of soil degradation and hydraulic processes as a prerequisite for soil structure regeneration concerning better water gas and thermal fluxes or improved accessibility of surfaces for physicochemical exchange processes are required for various research, economic or environmental purposes. The interlink between soil strength defined as precompression stress, preshrinkage stress, pore rigidity, and soil functions are the major boundary conditions to also define the ways how to ameliorate soils sustainably. The rearrangement of particles in soils requires stresses, which exceed the actual maximum strength but which can be exerted by various constituents in soils like matric potential, mechanical stresses (i.e. shear forces) as well as biological processes. The improvement or amelioration of compressed soil horizons can be under agricultural approaches achieved by simple deep plowing and others, but the following sustainable land use needs to consider the decreased soil strength and mostly non-existing pore continuity, which also requires e.g. altered machine use or land management. On the other hand, both the impact of soil degradation and the relevance of soil amelioration on soil functions will be different depending on soil properties as e.g. effective soil depth, soil texture, clay minerals as well as soil structure and soil organic matter. If the link between the actual compaction status and possible natural amelioration processes in soils like extensive shrinkage due to appropriate plant use, biological or mechanical perforation or heterogenisation e.g. due to slotting are considered, we will gain long-term permeable and well structured soils with potentially even continuously self improving structure formation.

The principle processes as well as corresponding results from long-term alfalfa, perforation and chemical amelioration experiments will be discussed during an oral presentation.

# Dynamic Changes of Wheel Load and Mean Contact Area Pressure during Sugar Beet Harvest and Soil Tillage

M. Lorenz<sup>1\*</sup>, K. Nolting<sup>1</sup> & J. Brunotte<sup>1</sup>

<sup>1</sup> *Thünen Institute of Agricultural Technology, Bundesallee 47, D-38116 Braunschweig, Germany*

\* corresponding author: marco.lorenz@thuenen.de

## Introduction

Sizes and masses of agricultural machinery increased steadily over the past years and decades. This was primarily for economic and process efficiency reasons. High specialized machinery requires high operating grades. Especially under moist soil conditions, high wheel loads of agricultural machinery and repeated wheel passages due to intensive field traffic, e.g. at sugar beet harvest, significantly increase the probability of harmful soil structure damages, irreversible soil deformation and the risk of persistent subsoil compaction (Nawaz et al., 2013). Wheel load and contact area pressure is often assumed to be static. In practice, both are highly dynamic and change continuously e.g. during harvest (Duttmann et al., 2013). Furthermore, these dynamic soil loads remain only a few seconds or mostly less than a second on a specific soil particle, depending on the velocity of the machine. There is a need to consider the responses of soil due to dynamic load input, load transfer and deformation behavior under rolling wheels (e.g. Schjønning et al., 2015) to get a more realistic view of soil compaction processes in agriculture.

## Material and Methods

The field tests were carried out with a six row, two axle sugar beet harvester on a stagnic Luvisol in Lower Saxony, Germany during sugar beet harvest and a New Holland T7.270 tractor during ploughing. Both machines were equipped with ultrasonic sensors and pressure sensors in every tire rim. The ultrasonic sensors measure the distance between tire rim and the inside of the tire,

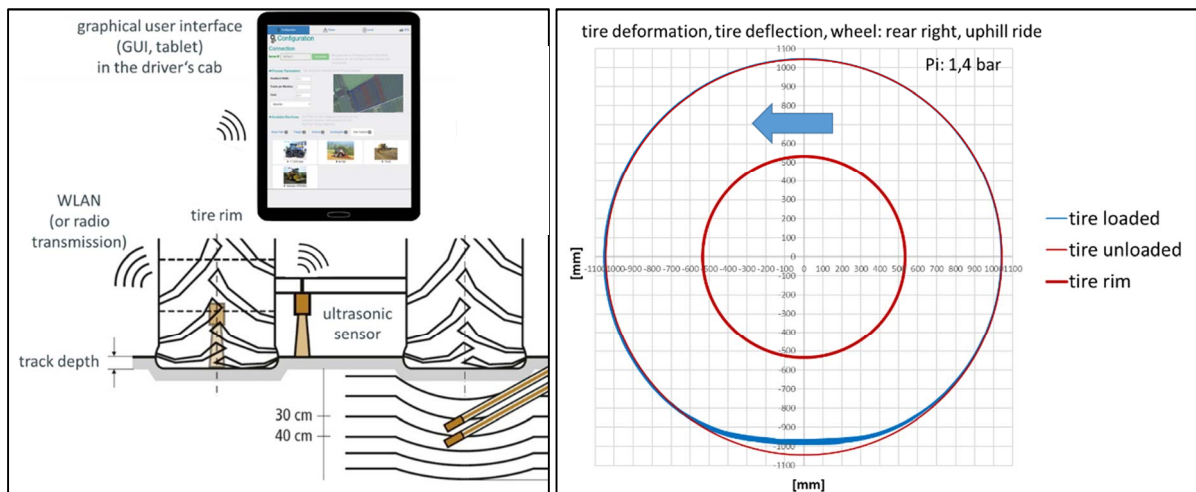

Figure 1: Ultrasonic sensor in the tire rim (left side) and tire deflection measurement during wheeling (right side)

that means the tire deflection (see Fig 1). The pressure sensors measure the tire inflation pressure. The static weights of the machines, axle and tire loads were measured with portable scales at the field edge for different load situations. The static mean contact area was meas-



ured under every tire for empty, half full and full bunker by powdering the tires and draw the contact area on a foil. The tire deflection was measured simultaneously.

To get information about the dynamic changes during wheeling, the tires of both machines were tested on a tire test device. Wheel load, tire inflation pressure, tire deflection and mean contact area were measured for different load situations in consideration of the tire charts of the manufacturer. Together with results from the field tests, strong correlations between tire deflection and wheel load were found, depending on tire dimensions and tire inflation pressure. Furthermore, strong correlations to mean contact area were also found, depending on tire dimensions and tire inflation pressure. By combining wheel load and mean contact area, the mean contact area pressure can be calculated.

The tire deflection and tire inflation pressure were measured in every tire of the sugar beet harvester during sugar beet harvest. Although the sensor rotates with the tire and measures the complete rotation, only one tire deflection value per tire rotation can be generated (see Fig 1). From the results of the field tests and the tire test device, dynamic changes of wheel load and contact area pressure were derived.

## Results and discussion

The static wheel loads of a sugar beet harvester with full bunker were between 10-12 Mg, depending on the particular load situation of the bunker. The comparison of static weighing by portable scales (or sensor system) and dynamic weighing by the sensor system during harvest showed, that the dynamic wheel load can be up to 33% (3-4 Mg) higher (or lower) for a short-term than the static wheel load. That was due to dynamic movements of the machine, hill slope or a non-uniform filling of the bunker during harvest. The corresponding dynamic mean contact area pressure can be up to 20% higher for a short-term than the static values. During ploughing, the wheel load of the rear wheels of the tractor can be up to 50% higher (ca. 1.5 Mg) when the plough is pulled out of the soil at the headlands compared to the wheel loads during ploughing. Furthermore, the machines can be dynamically weighed during field traffic by addition of the dynamic wheel loads of the four wheels. The resolution of the tire deflection measurement is 0.1 mm, that leads to a resolution in weighing of about 0.05-0.1 Mg during sugar beet harvest.

## Conclusion

With the presented sensor system, a dynamic weighing of machines, e.g. during harvest, was realized. Furthermore, the dynamic mean contact area pressure can be derived. For that, every tire must be analyzed on a tire test device and in the field. In combination with a high-resolution RTK-GPS the weight of the machine, the wheel loads and the mean contact area pressure under every tire can be determined and mapped for the entire field. With the results, a more realistic determination of soil loads and their spatial distribution within a field, e.g. during harvest, can be made. So, the dynamic load input, load transfer and deformation behavior under rolling wheels can be examined in a more realistic and detailed way. This is a prerequisite for a more precise understanding of soil compaction processes.

## References

- Duttmann, R., Brunotte, J. & Bach, M. 2013. Spatial analyses of field traffic intensity and modeling of changes in wheel load and ground contact pressure in individual fields during a silage maize harvest. *Soil Tillage Res.*, 126, 100–111.
- Nawaz, M., Bourrié, G. & Trolard, F. 2013. Soil compaction impact and modelling. A review. *Agron. Sustain. Dev.*, 33, 291–309.
- Schjønning, P., Stettler, M., Keller, T., Lassen, P. & Lamandé, M. 2015. Predicted tyre–soil interface area and vertical stress distribution based on loading characteristics. *Soil Tillage Res.*, 152, 52–66.

## **Risk assessment of soil compaction in Europe – a case study comparing rubber tracks or wheels on machinery**

M. Lamandé<sup>1,2</sup>, M.H. Greve<sup>1</sup>, P. Schjønning<sup>1</sup>

<sup>1</sup> *Faculty of Agricultural Sciences, Department of Agroecology and Environment, University of Aarhus, Research Centre Foulum, P.O. Box 50, DK-8830 Tjele, Denmark*

<sup>2</sup> *Norwegian University of Life Sciences, Faculty of Environmental Sciences and Natural Resource Management, Campus Ås, Universitetstunet 3, 1430 Ås, Norway*

\* corresponding author: [mathieu.lamande@agro.au.dk](mailto:mathieu.lamande@agro.au.dk)

Subsoil compaction is persistent and affects the wide diversity of ecological services provided by agricultural soils. Efficient risk assessment tools are required to identify sustainable agricultural practices. Vehicles should not transmit stresses that exceed soil strength. Wheel load is the primary source of high stress in the subsoil. However, very low contact stress without reduction of wheel load would also help reduce stress in the subsoil. In the present study, we tested experimentally the use of tracks instead of tires as a technical solution to increase contact area and reduce the magnitude of contact stresses. Then we compared the effects of traffic on soil physical properties using tires or tracks. Finally, we evaluated a state-of-the-art method for risk assessment of soil compaction beneath tracks or tires at the European level. Contact stress were measured below a fully-loaded sugar beet harvester equipped with either a large tire or with a rubber track in a realistic harvest situation. Seventeen stress transducers were installed across the driving direction at 0.1 m depth and covered with loose soil. Dry bulk density and air permeability were measured at 0.35 m depth after traffic. The contact area was larger and the maximum and vertical stress smaller beneath the rubber track than beneath the tire. Nevertheless, stress distribution beneath the rubber track was far from uniform, presenting high peak stresses beneath the wheels and rollers. Dry bulk density was similar after traffic for the two undercarriage systems, but air permeability was lower after traffic using the rubber track. Measured stress distributions beneath the tire and the track were used as input to calculate the soil profile vertical stress for comparison with soil strength at 0.35 m depth. Wheel Load Carrying Capacity was calculated for European soils for assessment of subsoil compaction risk when using the tire, the rubber track, and the rubber track assuming an even stress distribution. As expected from the contact area and stress measurements, the rubber track could carry higher loads than the tire. However, the air permeability results are interpreted as soil distortion due to high shear forces under the rubber track. This calls for a further development of the risk assessment method.

## Plant Residues Decomposition Effect on Soil Aggregate Stability

G. Stegarescu, T. Tonutare, K. Kauer, E. Reintam,

*Estonian University of Life Sciences, 51014 Tartu, Estonia*

\*corresponding author: [gheorghe.stegarescu@emu.ee](mailto:gheorghe.stegarescu@emu.ee)

### Introduction

The addition of plant residues leads to the formation of organic matter which is one of the main aggregates binding agent. Thus, soil organic matter plays a very important role for the soil aggregate stability improvement. Although, different organic materials can have different effect on aggregates stability, depending on its initial chemical composition (Abiven *et al.*, 2007). Despite numerous studies that have been done on organic matter decomposition influence on aggregate stability only few of them linked the biochemical composition of organic matter added to soil with aggregate stability (Abiven and Chenu, 2009). The main goal of this study was to evaluate the decomposition rate of different plant residues (wheat straw, rye and oilseed rape) and their effect on soil aggregate stability.

### Material and method

The soil used for the pot experiment was sampled from the top 0-20 cm layer from a 10 year field experiment with conventional and organic farming. The soil had a sandy-loam texture with the following characteristics 56,5% sand, 34% silt and 9,5% clay. Before starting the experiment the soil samples were dried at 21 °C. After drying, the soil was sieved through a 10mm sieve, making one average sample. From this sample were determined the chemical and physical parameters, total organic carbon and total organic nitrogen, aggregate stability, field capacity for water, maximum water holding capacity, water permeability. The plant material was collected from the same field experiment. Prior to experiment beginning the plant dry matter, total organic carbon, total organic nitrogen and biochemical composition of the plant material was determined. The pot experiment consisted of five treatments (V0 – control; V1 – soil mixed with wheat straw; V2 – soil mixed with rye; V3 – soil mixed with oilseed rape; V4 – sand) each of it divided in four replications. Soil was placed in 4000 ml pots and mixed with plant residues at a rate of 5 mg dry matter kg<sup>-1</sup>. The plant material was chopped in small pieces from 2 to 3 cm long. The treatments were kept at field capacity for water, covered with plastic foil and incubated at room temperature of 23 °C for 61 days. The water content was adjusted periodically. The determinations were done at 5, 10, 16, 23, 33, 44 and 61 days, before wetting and after wetting.

The water aggregate stability was determined on the Eijkelkamp's Wet Sieving Apparatus. The device has 0,25mm sieve openings. At first 4 g of dry soil were placed in a set of sieves and shaken in distilled water for 3 min<sup>-1</sup>. Then the same amount of soil sample was placed in other set of sieves and shaken for two hours in a 0,4% NaOH solution for organic matter decomposition. After that the cans were dried on water bath at 95 °C for 12 hours and 1 hour in the drying oven at 105 °C. The stable aggregates were obtained by dividing the weight of soil remained in NaOH solution cans by the sum of the soil weight from distilled water cans and weight of soil from NaOH solution cans.

The plant residues decomposition rate was determined by Thermo-Nicolet iS10 Fourier Transformed Infrared Spectrophotometer (FTIR). The data were collected at 4 cm<sup>-1</sup> resolution

over the range from 4000 to 400  $\text{cm}^{-1}$ . In all the measurements 32 scans were performed. Spectra replicates were averaged and corrected against the spectrum for ambient air as background and the automatic baseline correction was applied. Corrected peak height was obtained using OMNIC software (Nicolet Instruments Corp., Madison, WI).

## Results and discussions

The results of the study reveal that from five treatments only one showed a short, but higher significant increase in soil water aggregate stability. The initial aggregate stability of soil used for the experiment was 66,25%. On the 5<sup>th</sup> day the aggregate stability significantly decreased for all treatments, falling to 60,59% on average. Comparing the soil aggregate stability evolution between the treatments a minor increase has been observed on the 10<sup>th</sup> day, especially for the soil treated with wheat straw, which had 63,62% structural stable aggregates. Although, soil treated with rye and rape had 60,44% and 60,72% aggregate stability which was lower than control variant that had 62,21% on day 10. Nevertheless in the following days the aggregate stability slightly decreased in all the treatments. The wetting cycles had a negative effect for all treatments. For control and soil mixed with wheat straw structural stability was higher before each wetting procedure for example in control treatment on the day 5 the aggregate stability was 62,29% before wetting, than after wetting it decreased to 61,15%. Instead for soil mixed with rye, oilseed rape residues and sand pots wetting contributed to an increase in aggregate stability. The results of FTIR analysis showed no modification of the soil composition in the soil amended with wheat straw and rye. Generally the obtained spectra didn't show any changes for control, soil mixed with oilseed rape and sand pots. Initial soil composition spectra showed more intense absorption at 3278  $\text{cm}^{-1}$  length indicating the presence of O-H hydroxyl group. Next highly intensive vibrations belongs to Si-O at 1028  $\text{cm}^{-1}$  and 776  $\text{cm}^{-1}$ . Although during the decomposition of the plants residues the soil composition didn't change for all the treatments.

## Conclusions

This study reflects that different types of plant residues can have a different effect on soil aggregate stability. The wheat straw had a greater transient effect on soil structure in the 10<sup>th</sup> day comparing to soil mixed with rye and oilseed rape. Although in all the treatments the aggregate stability decreased slowly, the wetting procedure decreased the aggregate stability for wheat straw and increased the aggregate stability for other treatments. Nevertheless the plant residues didn't had any effect on the soil biochemical composition according to FTIR results. It can be concluded that plant residues even it had minor effect on aggregate stability it was transient and not significant to be identified by FTIR analysis. But also there can be other experimental factors that lead to such results, such like soil to plant residues quantity proportion and plant residues quality, microbial activity and fast carbon mineralization.

## References

- Abiven, S. *et al.* (2007) 'Dynamics of aggregate stability and biological binding agents during decomposition of organic materials', *European Journal of Soil Science*, 58(1), pp. 239–247. doi: 10.1111/j.1365-2389.2006.00833.x.
- Abiven, S., Menasseri, S. and Chenu, C. (2009) 'The effects of organic inputs over time on soil aggregate stability – A literature analysis', *Soil Biology and Biochemistry*, 41(1), pp. 1–12. doi: 10.1016/j.soilbio.2008.09.015.

## Controlled Traffic Farming “light”- A way to improve soil structure?

Annett Latsch<sup>1\*</sup>, Urs Zihlmann<sup>2</sup>, Thomas Anken<sup>1</sup>

<sup>1</sup>Agroscope, Tänikon 1, 8356 Ettenhausen, Switzerland

<sup>2</sup>Agroscope, Reckenholzstrasse 191, 8046 Zürich, Switzerland

\*corresponding author: [annett.latsch@agroscope.admin.ch](mailto:annett.latsch@agroscope.admin.ch)

### Introduction

An intact soil structure is crucial for crop establishment and plant growth, but field traffic with agricultural machinery, which became larger and heavier over the last decades, increases the risk of soil compaction (Hamza and Anderson, 2005). As a consequence, infiltration rates and water storage capabilities as well as soil ventilation and root growth are reduced, resulting in yield losses and higher risks of water erosion. Traffic induced soil compaction and the associated negative effects on soil structure and soil functions have been shown to be significantly reduced by the use of permanent traffic lanes for all field vehicles, known as Controlled Traffic Farming or CTF (Chamen, 2011).

With regard to a sustainable management of agricultural soils CTF could also be an interesting approach for Switzerland. Adapted to the small-scaled agriculture, a simplified version with permanent lanes only for heavy machines (contact pressure > 0.8 bar) used for crop protection, fertilisation and harvesting should be evaluated. Three-year trials (2015-2017) on 17 fields in the Swiss Central Plateau were used to investigate the practicability of such a “CTF-light”-system with standard machinery and to examine the effects of permanent lanes on soil physical properties and yields under climatic and farming conditions in Switzerland.

### Material and methods

Fields selected for this study were located in the cantons Bern, Zurich and Thurgau at an average altitude between 400 m and 600 m asl. Meteorological data show an average annual temperature between 7.5°C and 9.5°C and 900-1200 mm precipitation. The soils are predominantly characterised as fertile Cambisols from sandy loam or loam. With the exception of two conventionally tilled fields all sites have been cultivated by minimum tillage methods (depth max. 10 cm) for many years.

For every field a “CTF-light”-concept with permanent lanes for crop protection, fertilisation and harvesting was developed, based on working and track widths as well as tyre dimensions of the existing machinery. Farming according to this concept was first implemented during the harvest season 2015 and maintained until the end of the project in autumn 2017.

Soil and yield surveys were carried out in four replications within and between harvest lanes. Penetration resistance was determined in spring 2016 and 2017 using the Eijkelkamp penetrometer (Eijkelkamp, Netherlands). Per replication 10 penetrations up to a depth of 80 cm were done. Simultaneously to the penetration measurements the rate of water infiltration was determined as duration of time for lowering the water level in a single-ring infiltrometer (28 cm diameter) by 2 cm. Infiltration rate was measured twice per replication. Soil core samples (100 cm<sup>3</sup>, 3 per replication at 10-15 cm depth) from three selected sites were taken in spring 2017 to determine bulk density and macropore volume. In addition, field measurements of volumetric soil moisture and water tension were performed at the same three sites between April and June 2017 to determine soil water desorption curves. TensioMark sensors (ecoTech, Germany) and Drill & Drop probes (Sentek, Australia) were used to collect the data at depths of 10 cm and 20 cm. Measurements of soil moisture and water tension were replicated only three times within and between harvest lanes. Yield data were collected every year just before harvesting. Per replication two areas of 1 m<sup>2</sup> (0.5 x 2.0 m) were sampled.

Statistical analyses were performed using the statistical software R (R Development Core Team, Austria). Data passing Shapiro-Wilk Normality Test were analysed with fixed-effects ANOVA, otherwise Wilcoxon Rank Sum Test was used.

### **Results and discussion**

Harmonisation of wheel tracks was challenging and required intense planning, particularly in case of varying harvesting technology, but “CTF-light” could be realised on all sites. The trafficked area was between 36 % and 61 % depending on crop rotation and machine working widths. A crop sequence with winter barley, winter rapeseed and winter wheat generated the lowest level of trafficking, a two-step sugar beet harvesting process the highest.

After three years of controlled trafficking an incipient differentiation of soil physical properties within and between harvest lanes could be observed. More than half of the study sites showed positive effects due to reduced soil compaction, though differences often remained small. In untrafficked areas there was a tendency to decreased penetration resistance in the topsoil (0-30 cm). Infiltration rate was significantly increased (up to 150 %). Laboratory analyses of soil core samples confirmed the results of the field measurements. Without trafficking bulk density was in tendency decreased and macropore volume increased. Soil water desorption curves, obtained by field measurement of water tension from saturated to dry conditions, revealed no obvious results. Measuring errors caused by air-filled pores at the beginning of data logging might be an explanation.

“CTF-light” had a significant positive effect on maize yield (+13 %), which is known to be very sensitive to soil compaction. The observed yield advantage might be attributed to a better root penetration due to reduced soil compaction. In contrast to regular CTF systems no consistent yield differences could yet be determined for other field crops.

### **Conclusions**

“CTF-light” was the approach to adapt CTF benefits to Swiss agricultural conditions. Only heavy machinery was supposed to use permanent traffic lanes. Considering that soil regeneration is a very slow process, results indicate that soil structure and soil functions can be improved by “CTF-light”. However, the technical and organisational effort to realise permanent traffic lanes for heavy standard machines is not to be underestimated. Therefore, this could be a concept to be used by agricultural contractors.

### **References**

Chamen, W.C.T., 2011. The effects of low and controlled traffic systems on soil physical properties, yields and the profitability of cereal crops on a range of soil types. Cranfield, 305 p.

Hamza, M.A. and Anderson, W.K., 2005. Soil Till. Res.,82, 121-145.

# A prototype multi-sensor kit for soil bulk density measurement using combined frequency domain reflectometry and visible and near infrared spectroscopy

Raed A. Al-Asadi<sup>1</sup>, Abdul M. Mouazen<sup>2\*</sup>,

<sup>1</sup> Department of Environmental Health, Al-Qasim Green University, Babil, Iraq

<sup>2</sup> Department of Environment, Ghent University, c, 9000 Gent, Belgium

E-mail of corresponding author: [abdul.mouazen@ugent.be](mailto:abdul.mouazen@ugent.be)

## Abstract

Soil compaction created by different human and natural factors causes multiple environmental and agronomical problems. Many studies indicated increases in soil strength, bulk density (BD), and tillage draught requirement as a result of soil compaction, while decreases in soil total porosity, soil aeration, water infiltration and saturated hydraulic conductivity are evidence of soil compaction (Hamza and Anderson, 2005). A key requirement to manage soil compaction is the measurement of related properties that should be done quickly and cost effectively in the field without the need for laboratory analyses that are time consuming, difficult and slow procedures. Quraishi and Mouazen (2013a) introduced a multi-sensor platform, which enabled the assessment of BD from the fusion of data on penetration resistance measured with a load cell and gravimetric moisture content ( $\omega$ ), clay content and organic matter (OM) measured with a near infrared spectroscopy (NIRS) sensor. This multi-sensor does not measure volumetric moisture content ( $\theta_v$ ), necessary for the direct assessment of BD. Therefore, there is a need for a modified penetrometer sensing kit that enables simultaneous measurement of both  $\theta_v$  and  $\omega$ , and then derive BD values using Eqn. (1) (Wijaya *et al.*, 2004):

$$BD = \theta_v / \omega \quad (1)$$

Where: BD is the soil bulk density in  $\text{g cm}^{-3}$ ,  $\theta_v$  is the volumetric moisture content in  $\text{cm}^3 \text{ cm}^{-3}$  and  $\omega$  is the gravimetric moisture content in  $\text{g g}^{-1}$ . The aim of this paper was to design and evaluate a CPSP, consisting of NIRS and FDR sensors. The developed CPSP kit will be tested for the measurement of the top soil BD under field measurement conditions

A combined-penetrometer sensor prototype (CPSP) for the measurement of topsoil BD was developed and tested under field conditions. The prototype consisted of a standard penetrometer, equipped with a NIRS (1650-2500 nm) to measure  $\omega$  and a frequency domain reflectometry (FDR) to measure  $\theta_v$ , while BD was assessed by the combination of both sensors' data. The CPSP was tested *in situ* at five arable and two grass fields of different soil texture classes in Silsoe, Bedfordshire, UK, during the period from June to December 2013. Artificial neural networks (ANN) were used to predict  $\omega$  and  $\theta_v$  based on data fusion of NIRS diffuse reflectance spectra and FDR output voltage ( $V$ ), and the predicted values were substituted in Eqn. (1) to predict BD. The CPSP showed more accurate BD assessment in grass fields (RMSEp) of 0.077 g

$\text{cm}^{-3}$ , compared to the arable fields (RMSEp of  $0.104 \text{ g cm}^{-3}$ ), as shown in Table 1. A collective BD model produced for arable and grass fields' soils provided a moderate accuracy with a RMSEp of  $0.102 \text{ g cm}^{-3}$ . It can be concluded that the new CPSP can be used successfully to measure BD in the topsoil by combining the NIRS and FDR techniques through ANN-data fusion approach.

Table 1. Prediction results of volumetric moisture content ( $\theta_v$ ), gravimetric moisture content ( $\omega$ ) and bulk density (BD), obtained by using the combined-penetrometer sensor prototype (CPSP) in arable fields, grass fields and collective land use soils.

	Arable fields	Grass fields	Collective
<b><math>\theta_v</math></b>			
R <sup>2</sup>	0.97	1.00	0.94
RMSEp, $\text{cm}^3 \text{ cm}^{-3}$	0.024	0.005	0.039
RPD	5.80	13.72	3.67
<b><math>\omega</math></b>			
R <sup>2</sup>	0.97	0.96	0.96
RMSEp, $\text{g g}^{-1}$	0.019	0.011	0.023
RPD	5.46	4.73	4.56
<b>BD</b>			
R <sup>2</sup>	0.34	0.47	0.52
RMSEp, $\text{g cm}^{-3}$	0.104	0.077	0.102
RPD	1.08	1.36	1.21

R<sup>2</sup>: coefficient of determination. RMSEp: root mean square error of prediction; and, RPD: residual prediction deviation, which is the standard deviation of laboratory measurement divided by RMSEp.

#### References:

- Hamza, M.A. and Anderson, W.K., 2005. Soil compaction in cropping systems: A review of the nature, causes and possible solutions. *Soil & Tillage Research*, 82(2), 121-145.
- Quraishi, Z. and Mouazen, A.M., 2013a. A prototype sensor for the assessment of soil bulk density. *Soil & Tillage Research*, 134, 97–110.
- Wijaya, K., Nishimura, Y., Kato, M. and Nakagawa, M., 2004. Field estimation of soil dry bulk density using amplitude domain reflectometry data. *Journal of Japanese Society of Soil Physics*, 97, 3-12.



## Assessment of the long term impact of intense tillage on the chronoséquence of olive groves in south of Tunisia

M. Hazzoug<sup>1\*</sup>, P. Podwojewski<sup>1,2</sup>, M. Abichou<sup>3</sup>, M. Moussa<sup>1</sup>

<sup>1</sup> *Institute of Arid Regions (IRA), Laboratory of Eremology and Combating Desertification, Medenine, Tunisia, Université de Carthage, Tunis, Tunisia*

<sup>2</sup> *IRD France Nord, UMR IEES-Paris, Bondy, France*

<sup>3</sup> *Institute of Olive, (IO), Zarzis, Tunisia*

\* corresponding author: [mariem.hazoug@gmail.com](mailto:mariem.hazoug@gmail.com)

### Introduction

Tunisia is the most important olive oil producer country of the Southern Mediterranean. More than 30 % of its cultivated land is devoted to olive growing; Tunisia is the 4<sup>th</sup> world producer of olives and the second exporter of olive oil representing 2/3 of the agronomical exports of Tunisia. (Karray *et al.*, 2009). The olive growing sector occupies thus a strategic place in the Tunisian economy.

In the district of Medenine in the south of the country, and in the whole coastal region, olive orchards occupy over 80% of the agrarian surface. With an average rainfall < 200mm year<sup>-1</sup>, these rainfed olive trees are the only sustainable agricultural production of the area. It is the first economical incomes for many small holders.

If the production of olive oil is noticed for thousands years, the trees were located in mountain terraces or in valleys where water harvesting was possible. A new type of plantation was introduced during the colonial time in 1901 in littoral plains and spread to the whole district, in vast plantations on flat areas, with trees spaced by 24 meters (17 trees ha<sup>-1</sup>).

In these olive orchards, intensive tillage (from 4 to over 8 operations per year) at a depth of 15 cm with a “swallow tail” plough is processed to eradicate weeds and to limit the soil evaporation by stopping the capillary rise. Soils are generally poorly differentiated aerosols, composed by aeolian quartz sands (over 90% sand in which 50% of the grain size is between 80 and 100 µm in diameter), 50cm-thick, overlaying a calcareous frangipan. The tillage practice has considerably altered these fragile soils, which are particularly depleted in organic carbon. They have a very weak soil structure leading to crusting rapidly especially in the low part of the furrows and are compacted with a plow pan 15cm depth limiting the infiltration of scares rains. The important question to be solved in the sandy soils of southern Tunisia is the following: how intense is the impact of the intensive tillage with the various ages of olive plantations?

### Material and method

In the office of federal land plantation in Chammakh, Zarzis (33°35'40''N, 10°59'34''E), we compare the soil organic carbon (SOC) status of different plots, from grazing open areas and plantation of 1, 7, 15, 35 and over 110 years of age respectively. C and N were analyzed by combustion in each horizon of complete soil profiles (in the analytical platform of Bondy).

**Results and discussion**

Results show that soil organic carbon decreases after tillage from 3 g kg<sup>-1</sup> in the soil reference to <1 g kg<sup>-1</sup> in cultivated area. The soil carbon content decreases in the whole profile. We found very low values of C stock (0-30cm) from 954 g m<sup>-2</sup> in the grazing open areas to 140 g m<sup>-2</sup> in groves of 110 years (Figure 1). Same decrease has been observed in surface horizon in an other site (Dar Dhaoui) with uncultivated areas sine 1976 compared to olive grove (Table 1). Results also show that N values are below of the limit of detection in many horizons of 110 years old plantations. In these soils depleted in organic matter, tillage may have a negative impact not only on the organic carbon but also on the soil biologic activity.

**Conclusion**

Soils under intensive tillage seem also more prone to wind erosion and degradation (demonstrated in the site of Dar Dhoui). This intense tillage is only momentarily adapted for olive orchards, but is not sustainable in long term. Old olive trees show premature signs of ageing with lower yields. In this context what are the possible alternatives? If we change the usual tillage method, what would be the consequence on the plant water availability? The local alternatives to restore the soil organic matter stock and limit their intense loss could be the solution. However there is no systematic production of compost in these areas.

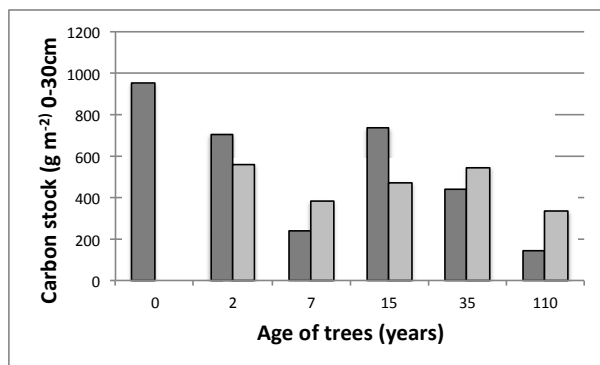

Figure 1: Carbon stock in the first 30 cm in olive orchards of different age.

Age (Years)	C (g kg <sup>-1</sup> ) in surface horizon				
	0	2	7	15	35
0	3.11	0.58	1.45	0.41	3.78
2	1.76	1.34			
7	0.32	0.75			
15	0.99	1.39			
35	1.14	0.72			
110	0.44	0.85	0.87	0.36	

Table 1: Carbon content in surface horizon in olive orchards of different age  
Site of Dar Dhaoui in gray (N33°17'42" E010°47'00")

*References*

**Karray B., Kanoun .F. 2009.**Potentiel de production et d'exportation d'huile d'olive tunisienne au marché européen: une analyse prospective. Série Etude 01/2009, 71 pages.

## Evolution of Agricultural Tire technologies and their impact on soil compaction

P.Vervaeet\*<sup>1</sup>, M. Stettler<sup>2</sup>, F. Pinet<sup>1</sup>,

<sup>1</sup> *Manufacture Française des Pneumatiques Michelin, 63000 Clermont-Ferrand, France*

<sup>2</sup> *Bern University of Applied Sciences, School of Agricultural, Forest and Food Sciences HAFL, Länggasse 85, CH-3052 Zollikofen, Switzerland*

Modernisation of agriculture has led to a continuous increase of the size of farms in the past decades. To be able to manage those farms, bigger implements were needed requiring higher pulling force from the tractor. As there is an optimal ratio between the pulling force and the weight of the tractor<sup>3</sup>, this situation implied the usage of always heavier tractors.

Consequently, this increase in vehicle weight has a major impact on the risk of soil compaction. To limit these risks, there have been many evolutions in the agricultural tire technology and design.

The major steps in the last 50 years were

- The transition, since 1970 for agricultural tires from bias (fig 1) to radial (fig 2) structure : in the radial tires, there is a clear separation of the functions of the tread and the sidewall leading to a stability of the contact patch and an homogeneous distribution of stresses in the contact patch

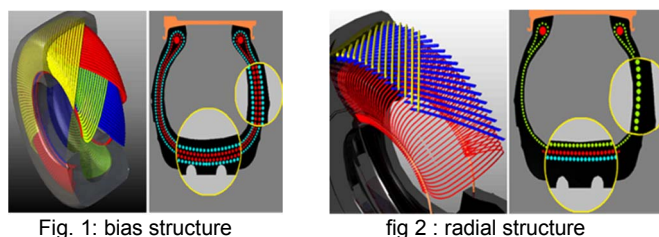

Fig. 1: bias structure

fig 2 : radial structure

- The evolution of aspect ratios (height of the sidewall as a percentage of the tire width – fig 3) of the tires. For example, for a given tire diameter (1850 mm) and rim diameter (38”), there has been an evolution in the years 1990 from 520/85 R38 to 580/70R38 then 650/65 R38 leading to an increase of the tread width in contact with the soil and a reduction of the pressure needed to carry a given load. For this range of tire, the needed pressure to carry 3800 kg at 40 km/h being respectively 1,6 - 1,4 and 1,2 bar<sup>7</sup>

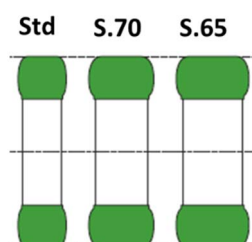

Fig. 3: Tire aspect ratio for given diameter Series 85 (std) – 70 and 65

- The evolution from standard to 'IF' and 'VF' tires was introduced on the market in 2004. For a given tire dimension the IF tires can carry an additional 20% load at the same pressure. The gain is 40 % with VF tires (fig 4). This gain can also be used to generate a reduction of pressure needed for a given load. For example : a standard 650/65 R42 can carry 4250 kg at 1,6 bars while a VF 650/65 R42 can carry 6000 kg and only need 1 bar for the same 4250 kg.<sup>8</sup> This reduction of pressure bringing a gain in the size of the contact patch and in the stress in the agricultural soil.

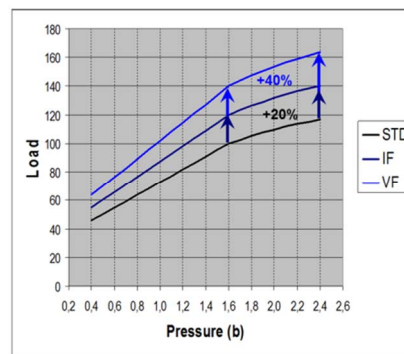

Fig. 3: Pressure/load capacities of standard, IF and VF tires

- The usage of Central Tire Inflation Systems (CTIS). A CTIS is a system installed on the vehicle which, through a system of compressor and rotary union can manage in real time the inflation pressure during operations. The first retrofit solutions appeared some 20 years ago but it is only since 2013 that major tractor manufacturers are implementing this system as original vehicle equipment. With this system, it is possible to differentiate the inflation pressure that is use in the various usages of the tractor and, in particular, to use always in the field the lowest possible pressure (higher pressures being needed in road usage due to the higher speed of operation). For example, a 710/70 R42 carrying 5600 kg has to be inflated at 1,6 bar to stand a 65 km/h usage, this pressure can be reduced to 1 bar when operating at less than 10 km/h on the field<sup>4</sup>.
- The latest of these technical evolutions is the 'adaptive tire', a tire that is able to change its shape when changing from road to field usage. This technology is illustrated with the new Michelin EvoBib<sup>4</sup>, fist showed in 2017. It consists of a tire that, under the action of a CTIS, dramatically changes its shape to adapt its performances from road to field.
  - o For field usage, this tire increases its effective tread width by a 'hinge' effect in the sidewall (fig. 4). The contact patch surface is increased by more than 20% compared to a similar tire at the same load and pressure. Depending on the soil conditions, it brings a potential increase of 20 to 50% of traction force at a given slip ratio and limit the ballast needed for a given traction force thus reducing the risk of soil compaction.<sup>4</sup>
  - o For road usage, the tire presents a narrower tread and its design is completely different from the classical 'V-lug shape'. In this case, the rolling resistance of the tire is reduced by some 15% compared to classical tire at the same pressure; the comfort and wear performances are also optimized. (fig. 5)

Fig. 4: Tire shape and contact patch in field configuration

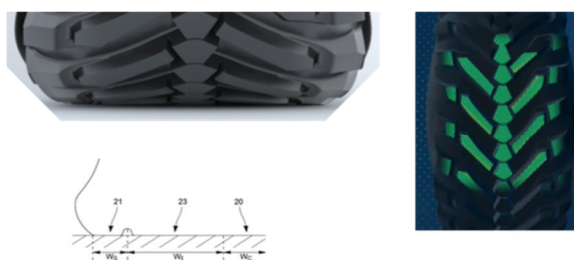
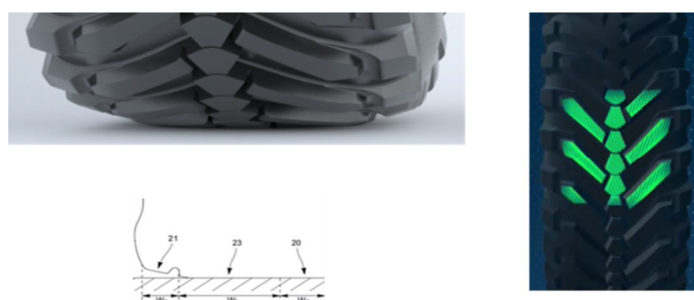

Fig. 5: Tire shape and contact patch in road configuration



The impact of these evolutions on the soil stresses can be evaluated with the ‘Terranimo’ model<sup>5</sup>. This model evaluates the bulb of soil stress distribution as a function of the load, the tire, the pressure and the soil characteristics. The results of this simulation are presented

To confirm experimentally those results, we proceeded in 2018 to field testing in collaboration with Agroscope and then Universities of Aarhus and Bern. The results are presented in the ISTRO conference<sup>6</sup> (also in poster session)

The positive impact of these evolutions on the global crop yield has been studied and showed on specific studies conducted at Harper Adams (UK) and University of Illinois (USA) significant improvements in crop yields on corn and wheat with up to 4% gains.<sup>10,11</sup>

[3] F. Zoz and R. Grisso : ‘Traction and tractor performance’ ASAE distinguished lectures series, tractor design 27, 2003

[4] ‘2 in 1 tire’ technology to allow maximal efficiency of the transmission chain in both road and field usage (P. Vervaet, M. Gandillet – EurAgEng November 2017)

[5] Terranimo ® - a web-based tool for evaluating soil compaction. (Stettler M., Keller T., Weisskopf P., Lamandé M., Lassen P., Schjønning P.) Landtechnik, 69, (3), 2014, 132-137.

[6] The contribution of tyre-evolution to the prevention of soil compaction (L. ten Damme, M. Stettler, F. Pinet, P. Vervaet, T. Keller, L. J. Munkholm, M. Lamandé)

[7] Michelin tire Databook 2017 : 520/85 R38 AgriBib – 580/70 R38 OmniBib – 650/65 R38 MultiBib

[8] Michelin tire Databook 2018 : 650/65 R42 MultiBib – VF 650/65 R42 AxioBib 2

[9] Michelin tire Databook 2017 : 710/70 R42 MachXBib

[10] Effect of tire inflation pressure on soil properties and yield in a corn-soybean, rotation for three tillage systems in the Midwestern United States (Shaheb\*, Grift, Godwin, Dickin, White1 and Misiewicz)

[11] A. Millington, Harper Adams University: The effect of low ground pressure and controlled traffic farming systems on soil properties and crop development for three tillage systems, 2016

## Assessing the effect of different pasture improvement managements on soil pore functions, soil mechanical strength, and pasture production dynamics

José Dörner<sup>1,2,\*</sup>, Rainer Horn<sup>3</sup>, Dorota Dec<sup>1,2</sup>, Iván Ordóñez<sup>2,4</sup>, Felipe Zúñiga<sup>2,5</sup>

<sup>1</sup>*Instituto de Ingeniería Agraria y Suelos, Facultad de Ciencias Agrarias, Universidad Austral de Chile, Valdivia, Chile*

<sup>2</sup>*Centro de Investigación en Suelos Volcánicos, Universidad Austral de Chile, Valdivia, Chile* □

<sup>3</sup>*Institute for Plant Nutrition and Soil Science, Christian Albrechts University zu Kiel, Hermann Rodewaldstr. 2, 24118, Kiel, Germany*

<sup>4</sup>*Institute of Agriculture and Environment, Massey University, Palmerston North, New Zealand* □

<sup>5</sup>*Doctorado en Ciencias Agrarias, Escuela de Graduados, Facultad de Ciencias Agrarias, Universidad Austral de Chile, Valdivia, Chile*

\*corresponding author: josedorner@uach.cl

### Introduction

The pastures in Chile are mainly sustained on volcanic ash soils. They cover an area of 1,340,000 ha and 44% of them are degraded. In order to increase the pasture productivity, different strategies have been implemented, which considered various kinds of soil managements e.g. soil fertilization without or with conventional tillage (Ordóñez et al., 2018). The aim of this work was to evaluate the impact of the different pasture improvement managements (PIMs) on soil porosity, water content dynamics, soil mechanical strength and pasture productivity of a volcanic ash soil under sheep grazing.

### Material and Methods

The experiment was established on a Duric Hapludand and considered: i) four types of PIMs (fertilised-naturalised pasture [NFP], cultivated pasture [CP], direct-drilled pasture [DP], diverse-direct drilled pasture [DDP]) and ii) the initial pasture situation (non-fertilised naturalised pasture [NFNP]). An additional site, usually trampled by sheep, was also considered and used as a reference for maximal level of soil compaction. Pastures were arranged as a complete block design (5 treatments and 3 blocks) and grazed by sheep. The penetration resistance was measured at 135 points considering 9 parallel rows, which were divided into a 9- by 15-point grid. Undisturbed soil samples were collected near to each grid-point (2–8 cm; 27 per treatment), to study the effect of PIMs on the spatial variability of bulk density (BD), air capacity (AC), air permeability ( $k_a$ ) and pre-compression stress ( $P_c$ ). The volumetric water content (5TM sensors) and matrix potential (MPS-2 sensors) were continuously registered (30 minutes intervals) at 10, 20 and 60 cm soil depth in the differently improved pastures. The herbage mass production was measured in the field.

### Results and Discussion

In the short term, the bulk density increased as a function PIMs reaching values near to  $0.75 \text{ Mg m}^{-3}$ , which are lower than those ones observed in the trampled site ( $0.85 \text{ Mg m}^{-3}$ , Fig. 1 a). The maps (Fig. 1 d and e) inform about the effect of soil management and grazing on the spatial variability of BD and  $P_c$ . When analysing the spatial variability of BD, it can be seen, that BD reached values near to  $0.85 \text{ Mg m}^{-3}$  in specific zones of improved pastures, reflecting the effect of intensive grazing compared to NFNP. On the other hand, zones with higher BD are related to zones with higher  $P_c$ . An increase in  $P_c$  was assessed in the trampled site as compared to all pastures (Fig. 1 b), which is related to a significant

decrease in AC and  $k_a$  (Fig. 1 c). The fertilisation of degraded naturalised pastures, without soil structure disturbance, improved the pasture yield (140%), reaching values comparable to those improved with conventional systems, which included soil tillage, fertilization and seeding. The pasture yield is closely related to the water content dynamics in the soils. The conservation of soil structure plays an important role in water accessibility by plants, so that fertilised-naturalised pastures were able to absorb water up to 60 cm depth.

## Conclusions

Pasture improvement managements that allow a conservation of soil structure improved the water accessibility by plants and pasture yield. The more intensive grazing in the improved pastures induce an increase in BD as compared to the NFNP but without detrimental effects on soil mechanical strength and air permeability. The latter, however has to be further investigated in order to define specific critical values of soil compaction for volcanic ash soils, which also include the impact on crop and/or pasture yield.

The research was funded by the FONDECYT grant 1130795. Dr. José Dörner thanks the Alexander von Humboldt Foundation for the Grant “Georg Foster Fellowship for Experienced Researchers” which allowed a research stay at the Christian Albrechts University zu Kiel, Germany.

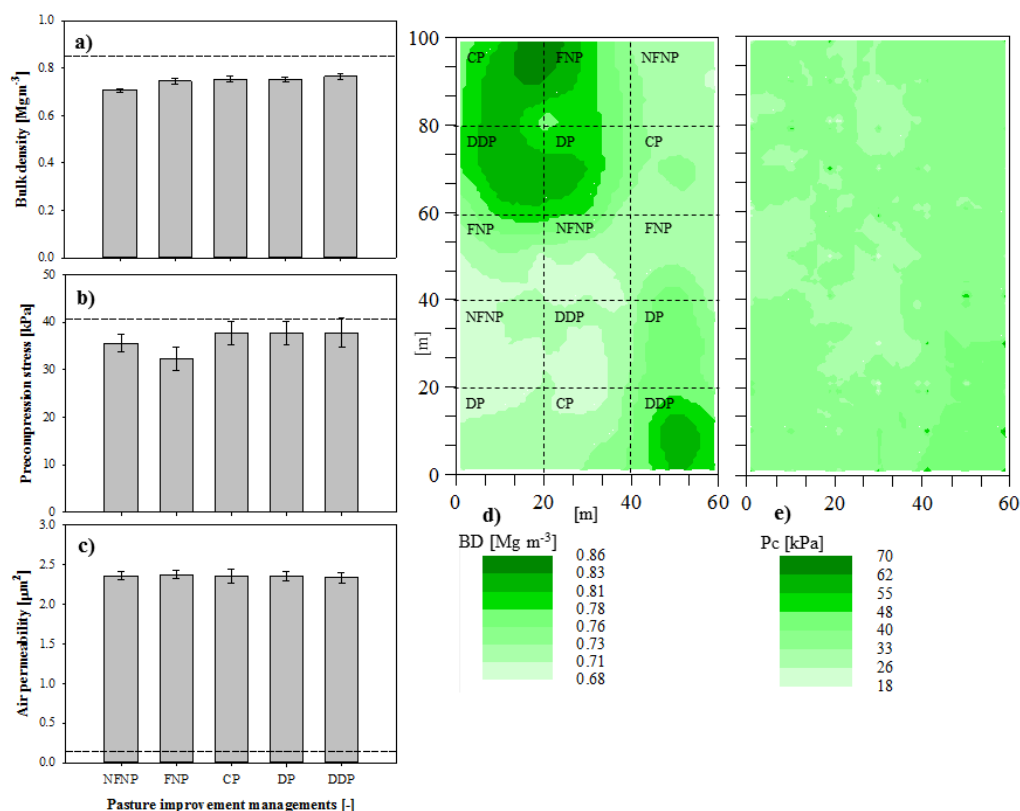

**Figure 1:** Effect of PIM's on BD (a), Pc (b) and  $k_a$  (c). Dashed lines indicate measured values in the trampled site. Spatial variability of bulk density (d) and precompression stress (e) measured from samples collected from the different pastures.

## References

Órdóñez, I., López, I., Kemp, P., Descalzi, C., Horn, R., Zúñiga, F., Dec, D., Dörner, J. 2018. Effect of pasture improvement managements on physical properties and water content dynamics of a volcanic ash soil in southern Chile. *Soil and Tillage Research* 178: 55-64.

## **Soil Compaction Caused by Four-Wheel Tractor with Disc Plow Attachment in an Upland Soil Condition**

Mharicar A. Torino<sup>1</sup>, Rossana Marie C. Amongo<sup>2</sup>, Arthur L. Fajardo<sup>2\*</sup>, Delfin C. Suministrado<sup>3</sup> and Romulo E. Eusebio<sup>4</sup>

<sup>1</sup>*BSAE graduate*, <sup>2</sup>*Associate Professor*, <sup>3</sup>*Professor, Agricultural Machinery Division, Institute of Agricultural Engineering (IAE), College of Engineering and Agro-industrial Technology (CEAT), UP Los Baños (UPLB), College, Laguna 4031, Philippines.*

<sup>4</sup>*Engineer, AMTEC, College of Engineering and Agro-industrial Technology (CEAT), UP Los Baños (UPLB), College, Laguna 4031, Philippines.*

\* corresponding author: alfajardo@up.edu.ph

### **Introduction**

The use of four-wheel tractor in farming operation may enhance soil compaction. The rapid mechanization of the agricultural sector has brought a serious environmental problem, among which is soil compaction. Soil compaction is one of the major problems facing modern agriculture (Hamza and Anderson, 2005). It affects seed germination, seeding emergence, root growth and all phases in crop growth and production. Moreover, soil compaction affects the soil workability and capacity to produce good quality crops. It is one important factor that causes soil degradation because of the heavy equipment being driven or pulled repeatedly across the soil. However, because of the highly complex character and almost infinite variability of soils and of the natural and man-imposed forces acting on soils, understanding the soil compaction process has challenged both the best practical farmers and the most capable agricultural scientists (McKibben, 1971). This paper evaluates soil compaction caused by primary tillage operation in upland soil condition using four-wheel tractor attached with two-bottom disc plow.

### **Materials and methods**

Field test was conducted using a four-wheel tractor (33.1kW) at different forward speeds (3.0, 3.5, 4.0kph) with a two-bottom disc plow (63cm diameter) as implement. Bulk density, penetration resistance (proving ring penetrometer) and moisture content were measured. Measurements were made on the area (Lipa clay loam) beneath where the disc plow and tractor wheel passed, and control (without operation). The data obtained were analyzed using analysis of variance (ANOVA) and pairwise mean comparison (independent t-test) at 5% level of confidence.

### **Results and discussion**

The summary of the results of the field test conducted using the tractor at different forward speeds is presented in Table 1. It could be observed that at 3.0 kph, bulk density was highest (1188.12 kg/m<sup>3</sup>) in disc plow area (DP) and in disc plow+tractor wheel (DPTW) (1231.84 kg/m<sup>3</sup>). The highest average penetration resistance of 4.45 kg/cm<sup>2</sup> in DP and 4.69 kg/cm<sup>2</sup> in DPTW were observed at 3.0 kph. There was a small variation among the average values of



moisture content for all points measured at different forward speeds. On the other hand, there were also significant differences in bulk density and penetration resistance among the forward speeds. Using pairwise comparison, the bulk density and penetration resistance were significantly different at different forward speeds.

Table 1. Summary of measurements for moisture content, bulk density and penetration resistance.

	3.0kph		3.5kph		4.0kph		Control
	DP <sup>a</sup>	DPTW <sup>b</sup>	DP <sup>a</sup>	DPTW <sup>b</sup>	DP <sup>a</sup>	DPTW <sup>b</sup>	
Average moisture content (%)	39.41	37.24	38.56	38.59	41.11	38.42	44.65
Average bulk density (kg/m <sup>3</sup> )	1188.1	1231.8	1147.0	1184.83	1122.26	1150.11	1081.35
Average penetration resistance (kg/cm <sup>2</sup> )	4.45	4.69	4.23	4.64	4.07	4.34	1.94

Note: <sup>1</sup>disc plow area; <sup>2</sup>disc plow + tractor wheel area

### Conclusion

Forward speed of 3.0 kph has the greatest soil compaction and the compaction due to disc plow and tractor wheel was greater than the compaction done by disc plow alone. Soil compaction decreases with increasing forward speed.

### References

- Hamza, M.A. and Anderson, W.K. (2005). Soil Compaction in Cropping Systems. A Review of the Nature, Causes and Possible Solutions. *Soil and Till. Res.*, 82: 121-145.
- McKibben, E.G. (1971). *Compaction of Agricultural Soils*. The American Society of Agricultural Engineers. USA.

## Use of different procedures to determine pre-compression stress from soil compressing test data in four different soil textural classes

S. B. Mousavi<sup>1\*</sup>, E. Peth<sup>2</sup>, D. Uteau<sup>2</sup>

<sup>1</sup> *University of Maragheh, Department of Soil Science, Maragheh, Iran*

<sup>2</sup> *University of Kassel, Department of Soil Science, Kassel, Germany*

\*Corresponding author: [mosavi@maragheh.ac.ir](mailto:mosavi@maragheh.ac.ir)

### Introduction

Soil compaction in farm lands can reduce crop growth and cause environmental impacts. Regarding its durability, compaction of underlying soil can be a long-term threat to soil productivity. Therefore, it is important to provide advice to farmers on how to prevent soil compaction. Recommendations can be compressed based on empirical studies or predictions from mechanical models (Arvidsson and Keller, 2004). Soils are regularly exposed to different types of external loads that are usually constant, but in fact they are very dynamic during loading time. Soils under cultivation require the annual movement of agricultural machinery. Various agronomic operations and the multiplicity of agricultural machinery indicate frequent loading conditions on the soil (Mordhorst et al., 2012). In several studies, the effect of repeating the movement of wheels on soil deformation processes has been investigated by simulating loading in the field and in the laboratory (Botta et al., 2006). In this paper, we have tried to compare different procedures for determining the pre-compression stress in different soil textures and to highlight the interactions between procedures, pre-treatments, and soils with different texture classes to estimate the desired parameter.

### Methods and Materials

In this study, four soil samples with different particle size distribution having silt, silt loam, sandy loam, and clay texture classes were prepared by repeated experiments with increasing distilled water to make the samples uniform having matric potential of 60 hPa. Then preloading of 60 kPa and 120 kPa and reloading of 0, 10, 15, 22, 34, 51, 76, 114, 171, 256, 384 and 575 kPa stresses (kPa) in 10-minute intervals in continuous mode (without release) were performed in four replications using Odometer. Finally, graphical method of Casagrande, the mathematical functions of the van Genuchten- Mualem equation and logit function were used to determine the pre-compression stress.

### Results and discussion

The results of analysis of variance showed that the pre-compression stress in different texture classes significantly ( $P \leq 0.01$ ) was affected by the main effects of preloading with 60 and 120 kPa and different procedures of estimating pre-compression stress as well as their interaction effect (Table 1). The highest pre-compression stress was 181.7 kPa related to the sandy loam texture class and the lowest was 59.2 kPa subjected to silt texture class. The pretreatment interactions on prediction pre-compression stress showed that pre-treatment of 120 kPa significantly increased ( $P \leq 0.01$ ) pre-compression stress by 50% compared to pre-treatment of 60 kPa. The interaction effects of pre-compression stress estimation procedures on soil textural classes showed that van Genuchten- Mualem equation procedure significantly ( $P \leq 0.01$ ) had the

highest estimate of pre-compression stress (154 kPa) compared to other procedures, while the graphical estimation method of Casagrande showed the lowest pre-compression stress (108 kPa), and the Logit function was between these two values (121 kPa). The three-way interactions between estimating procedures of pre-compression stress with pre-treatment factor and soil texture classes showed that the highest pre-compression stress of 348 kPa was related to the van Genuchten- Mualem equation procedure and preloading with 120 kPa in sandy loam texture class and the lowest pre-compression stress of 28 kPa was related to the van Genuchten- Mualem equation procedure and preloading with 60 kPa in silt texture class.

Table 1- The result for analysis of variance of the effects of soil texture classes, pre-treatment, and different procedures on determining pre-compression stress

Source of Variance	df	Mean square	F
Texture (T)	3	56940.74**	115.11
Pretreatment (P)	1	55911.37**	113.03
Method (M)	2	14021.08**	28.34
T*P	3	3771.53**	7.62
T*M	6	12441.71**	25.15
P*M	2	5985.66**	12.10
T*P*M	6	3062.56**	6.19
Error	68	494.67**	

CV (%)=17.46

\*\* : Significant at the 1% probability level

## Conclusion

The results of this study showed that with increasing the amount of sand in soil texture classes from 4% in the silt texture class to 61% in the sandy loam texture class, the numerical value of the pre-compression stress is strongly increased, around 300%, and this indicates the role of sand particles in preventing soil compaction, so that soil with sandy loam texture is about three times more resistant to stress with a silt texture class. In contrast, by increasing the amount of clay in different soils from 7% in soil with sandy loam and 45% clay in soil with clay texture class, it increases the susceptibility of soils to compression, which increases of the sensitivity is exactly equal to the increase of the amount of sand particles. These results are deduced from the average estimation of different procedures for determining pre-compression stress. If only a predetermined amount of stress in soil is determined by one procedure, the results may not be accurate and the results of this experiment also showed that there is a significant difference between the methods of estimating pre-compression stress ( $P \leq 0.01$ ). Therefore, in compaction management of different soils, better results will be obtained if the mean of different procedures of estimating pre-compression stress is used.

## References

- Arvidsson, J., Keller, T., 2004. Soil precompression stress. I. A survey of Swedish arable soils. *Soil and Tillage Research* 77, 85–95.
- Botta, G., Jorajuria, D., Rosatto, H., Ferrero, C., 2006. Light tractor traffic frequency on soil compaction in the Rolling Pampa region of Argentina. *Soil and Tillage Research* 86, 9–14.
- Mordhorst, A., Zimmermann, I., Peth, S., Horn, R., 2012. Effect of hydraulic and mechanical stresses on cyclic deformation processes of a structured and homogenized silty Luvic Chernozem. *Soil Tillage Res.* 125, 3–13.

## **Subsoil Compaction as a Tool to Impact on Seepage in Recultivation Areas.**

E. J. Murer

*Federal Agency of Water Management, 3252 Petzenkirchen, Austria*

*Corresponding author: erwin.murer@baw.at*

### **Introduction**

According to the Austrian Landfill Regulation (DVO 2008) it's permit to cover residual waste landfills with a soil layer, to reduce the seepage rate to 5% of precipitation. This is possible in areas with negative water balance. For areas with higher precipitation, an equivalent technical solution is sought.

### **Material and method**

At the end of 2013, a lysimeter station with three lysimeters (5 m x 2 m x 1.5 m) was constructed on a recultivation area with 9% surface slope to measure the seepage. Construction details of the lysimeters vary, one variant consists of a uniform continuous soil texture without compaction and a second variant was established with a compacted loam layer with low permeability at the bottom. The third variant uses a drainage layer of coarse gravel above the compacted loam layer. The seepage water above the loam layer can be drained from the lysimeter laterally.

### **Results**

There have been measurements of seepage for four years now, with different rainfall distributions of the single years. These results can be used to estimate the changes in leachate volume due to soil compaction on arable land.

### **References**

DVO, 2008. 39. Verordnung des Bundesministers für Land- und Forstwirtschaft, Umwelt und Wasserwirtschaft über Deponien (Deponieverordnung 2008).

Murer E., Jachs Ch., Schuster M., Thürriedl K., 2017. Modifizierte Wasserhaushaltsschicht für Deponien in Regionen mit positiver klimatischer Wasserbilanz. Österreichische Wasser- und Abfallwirtschaft, Volume 69, Issue 5–6, pp 275–282.

## Effect of tillage on soil compaction in black soil of Northeast China

H. B. Zheng<sup>1,2\*</sup>, J. Y. Zheng<sup>1,2</sup>, Y Luo<sup>1,2</sup>, R. P. Li<sup>1,2</sup>, H. Wang<sup>1,2</sup>, W. R. Liu<sup>1,2</sup>

<sup>1</sup>Research Institute of Agricultural Resources and Environment, Jilin Academy of Agricultural Science, Changchun, P.R. China

<sup>2</sup>Key laboratory of Crop Ecophysiology and Farming System in Northeast China, Ministry of Agriculture, Changchun, P.R. China

\* Corresponding author: hongbingzheng@126.com

### Introduction

Farmland soils are the material basis of agricultural development and their quality directly affects the yield and quality of farm produce (Lal et al., 1991). One of the necessary conditions for obtaining high yields is proper cultivation of soil. However, cultivation changes the physical and chemical properties of soils (Huang et al., 1999; Batey, 2006). Soil compaction is part of the overall deterioration of land and one of the three biggest threats to agricultural production, the other two being soil erosion and depletion of soil organic matter (Soane et al., 1995; Zhang et al., 2008). Soil compaction also has a negative effect on soil quality and crop growth (Shi et al., 2010). North-eastern China is the country's major grain-producing region and enjoys a higher level of agricultural mechanization than other regions. The increasing use of large and heavy machinery will inevitably lead to soil compaction. Therefore, the present study focused on soils that had been tilled by different methods as part of many long-term experiments (since 1983) conducted by the Jilin Academy of Agricultural Sciences to provide theoretical foundations to encourage reasonable and less intrusive or less destructive farming techniques in north-eastern China.

### Material and method

The research area is part of a testing site of the Jilin Academy of Agricultural Sciences in Gongzhuling, in Jinlin province (43° 45' N, 125° 01' E). The experiment began in 1983 and involved four methods of tillage, namely NT (no-tillage), PT (plough tillage), ST (spacing tillage), and CT (conventional tillage), with NT serving as a control, laid out in randomized block design with three replications (plots). The degree of soil compaction (kg/cm<sup>2</sup>) was measured with a soil compaction meter (SC-900) in the top layer (0-45 cm) of the soil at different stages of the crop from sowing to harvest as follows: a) a few days after harvesting (22 Oct. 2009, 18 Oct. 2010, 21 Oct. 2011), b) at maturity (13 Sept. 2012, 4 Sept. 2013), c) before sowing (3 May), d) when the plants had 6, 8, and 14 fully expanded leaves, e) flowering (21 June), teaseling (23 June), early filling (10 August), mid-filling (20 Aug.), f) harvest (9 Oct. 2013), and g) before sowing (21 Apr. 2014). The device takes the readings automatically at depth intervals of 2.5 cm. For each spot, we repeated the process of taking measurements 5 times, moving the device by 10 cm horizontally each time. We used Excel 2003 for data analysis and SPSS ver. 13.0 for testing the least significant difference (LSD), analysis of variance (ANOVA).

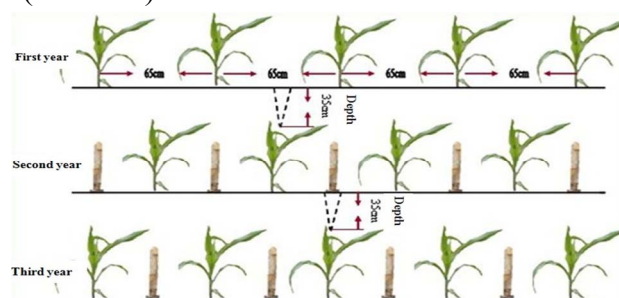

Figure 1: Conservation tillage system with high stubble.

A no-tillage planter was used for sowing in spring and fertilizers were applied near the roots when the crop was in its elongation stage. Subsoiling (30-35 cm) along with top dressing was carried out at the elongation stage of maize. The stubble height was 30-45 cm, and the straw was left in situ after the harvest.

### Results and discussion

Generally speaking, rotary tillage loosens the topsoil and increases its diffusivity but can also lead to the formation of a hard pan. Furthermore, the subsoil becomes severely compacted over time, particularly in the layer 30-60 cm below the surface (Jiao et al., 2009). Our study indicated that NT over a long term made the topsoil (0-25 cm) more compact but loosened the deeper (25-45 cm) layers. Both ST and PT significantly lowered the degree of compaction compared to NT and CT, probably because the surface layer remains undisturbed under NT. Moreover, NT can increase the number of earthworms, and their greater activity loosens the subsoil (Mcgarry et al., 2000). Meanwhile, our study showed that the degree of compaction at different depths (0-25 cm and 25-45 cm) under different methods of tillage kept changing as the crop was grown. Moreover, changes in compaction were more marked in the top layer (0-25 cm) than in the lower layer (25-45 cm). However, rainfall may exert a greater effect on soil compaction along with the stage of development (Lopez et al., 1996). The soil under ST treatments was less compact during the middle and late growth stages, largely because of the residual effect of subsoil tillage and the higher soil moisture content. Thus, soil compaction can be alleviated to some extent (Hill et al., 1990). In addition, soil compaction increased significantly with depth in the top layer (0-20 cm) and the differences among the treatments were also greater in that layer. Soil compaction gradually increased with depth and was therefore much greater in the 15-30 cm layer than that in the topsoil. At last, freezing and thawing affects soil compaction and thereby influences the arability of soil (Vyn et al., 1993). Moreover, compaction is the soil property most sensitive to alternate freezing and thawing. Our study also indicated that alternate freezing and thawing reduced soil compaction significantly. The greatest decline (148.9%) was observed under ST, followed in that order by NT (41.9%), PT (58.4%) and CT (3.3%).

### Conclusion

The compaction in the upper layer was significantly higher than that in the lower layer. The degree of compaction also varied with the growth stage of maize. Freezing and thawing loosened the soil, the effect being the most pronounced under ST and the least pronounced under CT. Therefore, ST can make the soil less compact and thus make it more arable and can be recommended as an effective method to address the problem of soil compactness.

### References

- Soane B.D., Ouwerkerk V. C., 1995. Implications of soil compaction in crop production for the quality of the environment. *Soil and Tillage Research*, (35):5-22.
- Batey T., McKenzie D. C., 2006. Soil compaction: Identification directly in the field. *Soil Use and Management*, (22):123-131.
- Lopez M. V, Arrue J. L., Sanchez-Giron V. A., 1996. Comparison between seasonal changes in soil water storage and penetration resistance under conventional and conservation tillage systems in Aragon. *Soil and Tillage Research*, (37):251-271.

## Ameliorating the Structure of a Degraded Vertisol Using Mechanical and Biological Tillage under a South African Sub-tropical Climate

SA. Materechera<sup>1\*</sup>

<sup>1</sup>Faculty of Natural & Agricultural Sciences, North-West University, Mmabatho 2735, South Africa

\*corresponding author: albert.materechera@nwu.ac.za

### Introduction

Vertisols and soils with vertic properties are characterised by a heavy texture and expanding clay minerals which hampers their workability due to stickiness when wet, and hardness when dry (Jutzi et al, 1988). Despite these limitations, vertisols constitute an important resource for crop production among smallholder farmers in South Africa (Fey, 2010). Since these soils are difficult to till by hand, the trend has been to use heavier tractor drawn machinery and equipment. Although deep tillage is often used by cotton growers to restore the structure of degraded soils, however, it is expensive in equipment, fuel and time. There is evidence that deep drying of a profile in cracking clay soils can result in shrinkage that produces cracks which may constitute the initial faces of soil aggregates, and, can also help disrupt compact layers (Dexter, 1991). The primary objective of this study was to compare mechanical loosening (deep tillage) and deep drying by deep rooting crops (biological tillage) as methods of restoring soil structure in a degraded cracking clay soil; a secondary objective was to compare the effects of Safflower (*Catharmus tinctorius*) and Lupin (*Lupinus angustifolius*) on the structure of the degraded clay soil.

### Material and methods

The study was conducted at a research farm outside Rustenburg town in the North West Province, South Africa (25.67°S, 27.24°E, 1171m asl). Rustenburg has a temperate subtropical climate with warm summers (Dec-Feb) and mild winters (June-August). The soil is a self-mulching cracking clay classified locally as a Rensburg form. The land had been under continuous irrigated cotton for the past twelve years. The whole experimental field was disc plowed to 0.15 m in December 2015 and in February 2016, it was divided into four 1.0 hectare plots. Each plot was further divided into sub-plots measuring 20x10 m to which four treatments were allocated utilizing a randomized complete block design. The trial consisted of four treatments (T), viz: cultivated fallow (control) (T1), deep tillage (T2), deep drying by roots of Safflower (*Catharmus tinctorius cv* Gilla) (T3), and Lupin (*Lupinus angustifolius cv* Gunguru) (T4). T1 was maintained in a bare fallow, T2 was deep tilled to 0.5 m in two directions with a tine on a heavy tractor. The seeds of Safflower and Lupin were sown at rates 10% higher than recommended in order to increase the root density. The crops were not irrigated In order to encourage deep cracking.

Soil structural condition and water content were assessed in the profile of each plot at the end of the year (October-December) by measuring aggregation, soil strength, bulk density and air filled porosity, gravimetric water content and shrinkage. Soil strength was measured by penetration resistance using a stainless steel hand operated soil cone penetrometer (model 29-3739) with a dial gauge conical probe of 30° and a cone diameter of 12.8 mm at 10 mm interval to 0.5 m. At the same time when penetrations were made, core and clod samples were extracted from the same depths from backhoe pits dug in each plot and used for the determination of gravimetric water content, bulk density and shrinkage. Clods were coated with paraffin wax immediately after collection to prevent drying and shrinkage. The wax was peeled off when ready to proceed. Disturbed soil samples were collected in each layer using a spade and were used to measure the distribution of aggregate sizes in the profile. All data were subjected to a

one-way analysis of variance (ANOVA) using the PROC GLM command of the SAS statistical package. The Tukey's test ( $p < 0.05$ ) was used to evaluate significant differences between treatments means.

### Results and discussion

The distribution of aggregate sizes in the profiles showed a significantly higher ( $p < 0.05$ ) proportion of micro-aggregates (0.16-0.5 mm) at depths of (20-35 cm) in Safflower (61%) and Lupin (56%) compared to the fallow (26%) and deep tillage (38%). The soil penetrometer resistance in all the profiles started to show significant differences ( $p < 0.05$ ) after 20 cm depth which is the usual depth of tillage by tractors (Fig. 1a). The strength between 20-30 cm layer was in the order fallow > deep tillage > lupin > safflower. A strength of >2.54 kPa was experienced at this depth in the fallow plots implying impedance to cotton root growth. There were significant differences in the gravimetric water content of the treatments (Fig. 1b). Biological tillage has significantly ( $p < 0.05$ ) lower moisture content than fallow and mechanical tillage throughout the profiles. Safflower dried the soil profile more than Lupin, particularly at the depth of 30 cm.

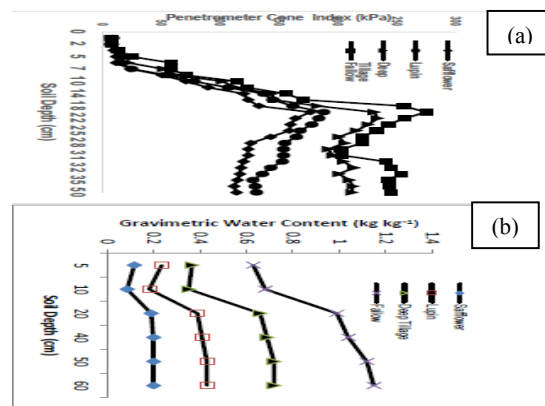

Figure 1: Soil strength (a) and gravimetric water content (b) in the profile of the treatments

The bulk density increased with depth within all the treatment profiles. However, the bulk density was slightly higher in the deep tilled than biologically tilled plots at a depth of 0.25 m. Air-filled porosity of the aggregates followed a similar pattern. The air-filled porosity at 0.30m in the fallow reached 0.14 m<sup>3</sup> m<sup>-3</sup> which is critical level for adequate oxygen diffusion. Safflower increased the air-filled porosity more than Lupin even though the difference was not significant. The results of shrinkage and specific volume of clods suggest significant worsening structure in the fallow compared to tilled treatments below 0.05 and 0.25 m. The values of specific volumes of intact soil clods were higher under biological tillage than mechanical tillage and fallow indicating less compaction in the former. Safflower had superior specific volume than Lupin.

### Conclusion

The study has shown that previous tillage effects can persist under bare fallow. Drying a profile by vigorous crop growth can promote good structure in cracking clays. *Catharmus tinctorius* was superior in drying clay soil and contributes higher aggregation. Crop rotation with such crops is therefore recommended for improving the structure of degraded cracking clay soils.

### References

- Fey, M. 2010. Soils of South Africa. Cambridge University Press, Cape Town, South Africa  
 Jutzi, S.C., Haque, I., McIntire, J., Stares, J.E.S. (Eds.). 1988. *Management of Vertisols in sub-Saharan Africa*. ILCA, Addis Ababa, Ethiopia.  
 Dexter, A. R. 1991 Amelioration of soil by natural processes. Soil Tillage Res. 20, 87–100.



## Finite Element Simulation of Soil Stress Measurement by Load Cell Transducers

M. Naderi-Boldaji<sup>1\*</sup>, T. Keller<sup>2,3</sup>

<sup>1</sup> Department of Mechanical Engineering of Biosystems, Faculty of Agriculture, Shahrekord University, Shahrekord 88186-34141, Iran

<sup>2</sup> Agroscope, Department of Agroecology and Environment, Reckenholzstrasse 191, CH-8046, Zürich, Switzerland

<sup>3</sup> Department of Soil and Environment, Swedish University of Agricultural Sciences, Box 7014, SE-75007, Uppsala, Sweden

\* Corresponding author: [naderi.mojtaba@agr.sku.ac.ir](mailto:naderi.mojtaba@agr.sku.ac.ir); [m.naderi@ut.ac.ir](mailto:m.naderi@ut.ac.ir)

### Introduction

In soil compaction research, an accurate estimate of stress propagated under tire traffic is a fundamental step to model the induced soil deformation. Load cell transducers (i.e. housings containing load cells) with a variety of designs have been widely used for soil stress measurement. The soil stress transducers include the two main types of stress state (known as SST) and vertical stress transducers (Kirby, 1999). One or several of them are placed into the soil at given depths and the stress is measured under the passage of a wheel or track on the soil surface. Despite their popularity, one serious issue with the load cell transducers is whether they provide an accurate estimate of true stress in soil (Keller and Lamandé, 2010). Stress concentration induced by insertion of a transducer into the soil would generally result in stress overestimation. The stress concentration is attributed to the transducer geometry and the stiffness of the transducer which is much larger than that of the surrounding soil. Moreover, inelastic behavior of soil is a second reason for stress concentration. A systematic way of correcting the measured stress by the load cell transducers needs insights to the stress field around the transducer as affected by transducer geometry and soil mechanical properties. This paper deals with finite element simulation of a disc-shaped vertical stress transducer at different depths subjected to circular uniform loading on the soil surface and looking at the effect of some geometrical dimensions and soil mechanical properties on the stress measured by the transducer.

### Material and method

A two-dimensional axisymmetric finite element model was developed in ABAQUS (6.10) (Fig. 1a). The model consists of two parts: (1) rigid disc-shaped transducer and (2) deformable elastic soil. The transducer was modelled with the initial dimensions shown in Fig. 1b. it was composed of two independent parts (housing, and stress sensing surface). The transducer dimensions (i.e. housing diameter, housing height and sensing surface diameter) were then changed and the resulting measured stress was investigated under the impact of transducer dimensions. The radius of the axisymmetric domain (cf. Fig. 1a) was selected based upon a series of sensitivity analyses on the effect of side boundary conditions. Surface-surface contact was defined between the soil and transducer with a 0.3 coefficient of friction. The vertical reaction force on the sensing surface of the transducer was selected as the model output. The measured stress was then calculated by dividing the reaction force the area of the sensing surface. The load on the soil surface was applied on a circular plate (100 mm diameter). Different loads were applied, creating stresses between 100-300 kPa. Several simulations were made to quantify the impact of

transducer depth (5, 10, 15 and 20 cm depths) on the transducer measured stress in relation to the stress at the same depth if no transducer was present. Further simulations were made with including a 30 mm thick hard pan layer between the transducer and soil surface and the measured stress was investigated with changing the hardpan depth and mechanical properties.

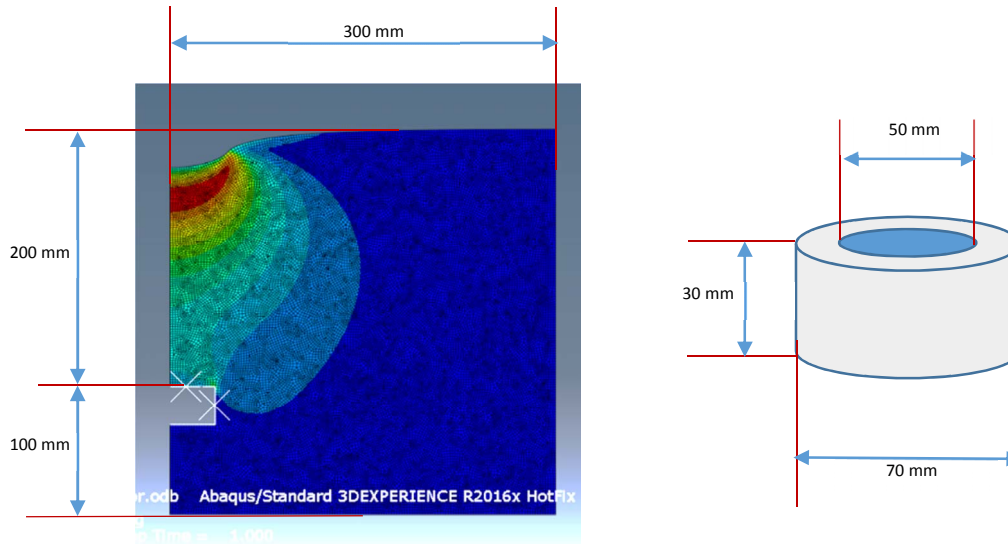

Figure 1: (a) Finite element model of soil-stress transducer interaction and (a) disc-shaped transducer.

## Results and discussion

The results showed that for a pure-elastic soil, the measured stress by the transducer was overestimated as compared to the analytical Boussinesq's solution. The overestimation ratio (i.e. the ratio of measured stress by transducer to the stress calculated without the transducer) noticeably varied with depth. Transducer-induced stress concentration decreased with increasing the ratio of housing /sensing surface diameter. Inclusion of a hardpan layer between the surface and stress transducer highly affected the measured stress.

## Conclusion

For a true estimation of stress in soil by load cell transducers, the stress concentration due to the insertion of the transducer into the soil should be accounted for. The stress concentration needs to be modelled as a function of transducer shape and size and the soil mechanical properties. As a practical conclusion, a higher ratio of housing to sensing surface diameter decreases the transducer-induced stress concentration.

## References

- Kirby, J.M., 1999. Soil stress measurement: Part I. Transducer in a uniform stress field. *J. Agric. Engng. Res.* 72, 151-160.
- Keller, T., and Lamandé, M., 2010. Challenges in the development of analytical soil compaction models. *Soil Till. Res.* 111, 54-64.

## Changes in Soil Compaction Characteristics with Soil Water Suction and Texture

M. Naderi-Boldaji<sup>1\*</sup>, T. Keller<sup>2,3</sup>

<sup>1</sup> Department of Mechanical Engineering of Biosystems, Faculty of Agriculture, Shahrekord University, Shahrekord 88186-34141, Iran

<sup>2</sup> Agroscope, Department of Agroecology and Environment, Reckenholzstrasse 191, CH-8046, Zürich, Switzerland

<sup>3</sup> Department of Soil and Environment, Swedish University of Agricultural Sciences, Box 7014, SE-75007, Uppsala, Sweden

\* Corresponding author: [naderi.mojtaba@agr.sku.ac.ir](mailto:naderi.mojtaba@agr.sku.ac.ir); [m.naderi@ut.ac.ir](mailto:m.naderi@ut.ac.ir)

### Introduction

Soil compaction characteristics are derived from the compaction curves of uniaxial confined compression test (oedometer). Some parameter related to the packing state of soil, such as void ratio, is expressed versus stress in a logarithmic scale. The important characteristics derived from the compaction curve are the recompression or swelling index ( $C_s$ ) (i.e. the index of soil resilience), the compression index ( $C_c$ ) (a measure of soil resistance to compaction) and the pre-compression stress ( $\sigma_{pc}$ ) (a measure of the soil load support capacity). For planning agricultural field operations and making decisions about specific traffic situations in the field, the risk of soil compaction needs to be assessed, e.g. with help of soil compaction models (Keller et al., 2011). For this, knowledge on the changes in soil compaction characteristics with water suction and soil texture is needed. This paper investigates soil compaction characteristics as a function of initial soil water suction for seven Swiss soils covering a wide range of soil textures.

### Material and method

Confined compression tests were carried out on undisturbed cylindrical soil samples (in total 63) taken from seven Swiss soils with clay contents between 160-600 g kg<sup>-1</sup>. The samples were saturated, drained to water suctions of either 30, 100 and 300 hPa on sand tables, and subjected to stepwise compression with stresses of 20, 30, 40, 50, 60, 80, 100, 125, 150, 200, 250, 400, 600, 800 and 1000 kPa, with three-minute loading steps. Initial water content and bulk density of each sample was obtained from the weights before compression test and after drying the compressed sample in an oven. Standard proctor tests were carried out for each soil texture to find the reference (i.e. maximum) density. In order to compare different soils, a relative bulk density ( $\rho_{reli}$ ) and relative void ratio ( $e_{reli}$ ) was calculated as the ratio of the initial bulk density to the Proctor maximum density and initial void ratio to the void ratio at maximum density, respectively. The Gompertz (1825) equation as proposed by Gregory et al. (2006) was fitted to the experimental soil compression data ( $\sigma$ ,  $e$ ) by non-linear least squares fitting (Eq. 1).  $C_s$  was calculated as the slope of the curve between 0-30 kPa,  $C_c$  as the slope of the virgin compression line and  $\sigma_{pc}$  as the stress at the point of maximum curvature. Stepwise regression analyses were performed to develop equations for compaction characteristics and the parameters of the Gompertz equation (i.e.  $a$ ,  $b$ ,  $c$ ,  $m$ ) as functions of soil initial properties.

$$e = a + c \exp\{-\exp[b(\log \sigma - m)]\} \quad (1)$$

## Results and discussion

Pre-compression stress ( $\sigma_{pc}$ ) increased with increasing matric suction ( $h$ ) for all the tested soils, except for an organic soil (with  $170 \text{ g kg}^{-1}$  organic matter). The increase in  $\sigma_{pc}$  with  $h$  was found to be a function of silt + clay ( $R^2_{adj} = 0.63$ ,  $RMSE = 0.032$ ). Table 1 presents models developed by stepwise regression analyses for the soil compaction characteristics and the Gompertz function parameters.  $\rho_{reli}$  and  $e_{reli}$  were found suitable for prediction of compressive properties across different soil textures. It was found that only  $C_s$  is a function of water suction.

Table 1. Regression models for soil compaction characteristics and Gompertz function parameters.

Soil Characteristic	Model variables	Coefficient	std. error	$R^2_{Adj}$	RMSE
$C_s$	Constant	0.004	0.004	0.93	0.0025
	OM ( $\text{g kg}^{-1}$ )	0.00014	0.00001		
	$h$ (hPa)	-0.000018	0.000004		
	$e_{reli}$	0.009	0.003		
$C_c$	Constant	2.85	0.45	0.57	0.195
	$\rho_{reli}$ (%)	-0.03	0.005		
$\sigma_{pc}$ (kPa)	Constant	58.01	33.75	0.5	29
	Clay ( $\text{g kg}^{-1}$ )	-0.15	0.04		
	Silt ( $\text{g kg}^{-1}$ )	0.12	0.06		
$a$	Constant	-0.01	0.003	1	0.007
	$e_i$	0.98	0.01		
	Clay ( $\text{g kg}^{-1}$ )	0.00009	0.00002		
$b^*$	-	-	-	-	-
$c$	Constant	2.95	0.36	0.7	0.155
	$\rho_{reli}$ (%)	-0.03	0.004		
$m$	Constant	1.56	0.49	0.2	0.213
	$\rho_{reli}$ (%)	0.014	0.006		

\* No significant model was found for  $b$ .

## Conclusion

It was concluded that  $\rho_{reli}$  and  $e_{reli}$  were more suitable than  $\rho_i$  and  $e_i$  for describing soil swelling index and compression index irrespective of soil texture. Pre-compression stress was described as a function of silt and clay concentrations. The increase in pre-compression stress with suction was found to be a function of silt + clay. Only soil swelling index was found to be significantly impacted by suction.

## References

- Gompertz, B., 1825. On the nature of the function expressive of the law of human mortality, and on a new mode of determining the value of life contingencies. *Philos. Trans. R. Soc. Lond.* 115, 513–585.
- Gregory, A.S., Whalley, W.R., Watts, C.W., Bird, N.R.A., Hallett, P.D., Whitmore, A.P., 2006. calculation of the compression index and precompression stress from soil compression test data. *Soil Tillage Res.* 89, 45–57.
- Keller, T., Lamadé, M., Schjønning, P., Dexter, A.R. 2011. Analysis of soil compression curves from uniaxial confined compression tests. *Geoderma* 163, 13–23.

## Crop damage and yield responses from wheeling with multiple paths vs. multiple drives

Alevtina Evgrafova<sup>1\*</sup>, Søren Kirkegaard Nielsen<sup>1</sup>, Mette Walter<sup>2</sup>, Søren Boldsen<sup>2</sup>, Mathieu Lamandé<sup>3</sup>, Claes Dühring Jæger<sup>1</sup>, Lars Munkholm<sup>3</sup> & Ole Green<sup>1,3</sup>

<sup>1</sup> Agro Intelligence Aps, Agro Food Park 13, Skejby, 8200 Aarhus N, Denmark

<sup>2</sup> Danish Technological Institute, Technology and Analysis, 8200 Aarhus N Field Trials, Denmark

<sup>3</sup> Aarhus University, Department of Agroecology, Blichers Allé 20, Tjele, Denmark

\*[aev@agrintelli.com](mailto:aev@agrintelli.com)

### Introduction

In order to reduce negative impacts on soil and crop yield, the development of less heavy agricultural machinery is a priority task (Lal & Shukla, 2004). The research goal was to assess and compare the yield loss and crop damage induced by multipath and multidrive in-field biomass (e.g. hay bales, straw, grain, or silage) transport trailers. The concept trailer was designed using an offset steering system, which allows the rear wheels to not track directly behind the front wheels, thus, creating the multiple trailer paths. The research hypotheses of this study were that (i) the multipath in-field transport trailer (*i.e.* the concept trailer with the offset steering system active) will increase the wheeled area, thus, may cause higher crop damage and yield loss compared to either multidrive transport trailer or no harvesting activities and (ii) the estimation of yield (*i.e.* fresh biomass) will be improved by including the spatial variability of soil properties (*i.e.* soil clay content), track width, or/and wheel load.

### Materials and methods

A field experiment was conducted in West Jutland, Denmark (56°3'34.09"N, 8°22'6.99"E) on loamy sand soils in spring-summer 2016. The effects on yields and changes in fresh biomass after four treatments (*i.e.* traffic systems) such as driving with the new concept trailer either with the offset steering system active (multipath) or inactive (multidrive), the standard biomass transport trailer and no driving were compared. Using a 4-factor randomized block design with eight repetitions, *i.e.* 256 plots (14 x 6 m), however, only four repetitions were harvested completely for each treatment (Figure 1). The wheel load data was recorded as the maximum and accumulated loads within the studied field. The latter was defined as the sum of loads by all previous traffic (*i.e.* grass cutter, grass rake, slurry trailer) starting from the crop seeding time. The soil electrical conductivity was measured using the EM38 sensor (Model EM38 RT, Geonics Limited Mississauga, Canada). In order to include the variation of track width, clay content, and maximum/accumulated loads within the study field while estimating crop yields, the generalized additive models were applied.

*Figure 1.* The field experiment design, indicating the eight repetitions (Rep. 1-8) for the four treatments such as the concept trailer with the offset steering active (grey) or inactive (orange), the standard trailer (yellow), and No drive (blue) as well as the harvested plots (background with dots). The treatment direction was perpendicular to the tramline directions.

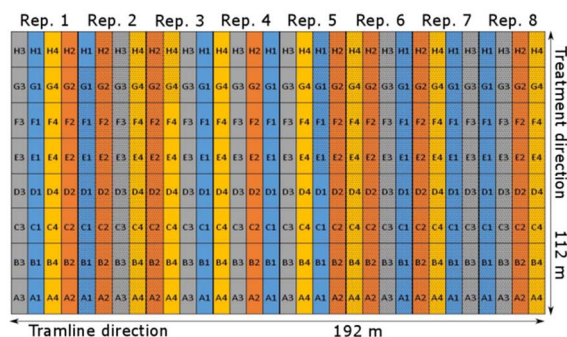

### Results and discussion

Although no significant difference between the amount of fresh biomass harvested per hectare after the four different treatments was detected, a trend towards a decrease of mean fresh biomass was observed from the standard trailer, followed by comparable yield for the concept trailer with the offset steering system inactive, no driving situation, and the concept trailer

with the offset steering system active. Higher crop yield after the standard trailer treatment could be explained by enhanced water and nutrient transfer to the active plant root zone as a result of significantly higher applied pressure force and, thus, enhancing grass regrowth (Alakukku, 1999). The total load and track width of the standard trailer and the concept trailer with the offset steering inactive were not significantly different, whereas the trailer with an active offset steering system had a significantly higher track width and, thus, a significantly lower total load per track width (Table 1). Though, the relationship between the crop yield and soil compaction induced by trailer systems should be further studied.

*Table 1.* The loads and wheel-soil contact width by the standard trailer and concept trailer either with an active or inactive offset steering system.

Parameters	<i>Standard trailer</i>	<i>Concept trailer, offset steering inactive</i>	<i>Concept trailer, offset steering active</i>
Tractor, total load, kg	8,860	9,880	9,880
Trailer, total load, kg	12,020	12,060	12,060
Total load, kg	20,880	21,940	21,940
Track width, cm	133	142	284
Total load per track width, kg/cm	157	155	77

The impact on yield driven by the four treatments had no significant difference, meaning that the yield variations could not be explained if only the treatment type is taken into account. However, the yield spatial variation was partially explained if the spatial variation of maximum or accumulated loads, soil clay content, and track width is taken into account as spatial correction factors. Previous studies also demonstrated that the estimation of grain yield and, thus, yield response to soil compaction due to wheel tracks could be improved by taking the within-field spatial variability into account (Usowicz & Lipiec, 2017), *i.e.* the spatial variability of soil properties and pressure loads on soil surface induced by the agricultural traffic. A better model fit was confirmed by a lower Akaike information criterion and, thus, 73% to 75% of the spatial variation of dry matter yield could be explained compared to 65% to 67% when only the maximum or accumulated load was included. The difference of dry matter yield between the standard trailer and the concept trailer with the offset steering system inactive and active were estimated at 0.67 t/ha and 0.71 t/ha if the maximum load is used as a correction factor, and at 0.66 t/ha and 0.70 t/ha if the accumulated load is included.

## Conclusion

The yield variations within the study field can be better explained if spatial correction factors such as the spatial variation of maximum or accumulated loads, soil clay content, and/or track width are taken into account in addition to trailer specifications. Based on yield estimation, the multipath in-field transport trailer did not cause higher crop damage and yield loss comparing to multidrive transport trailers. The difference between crop yield harvested using the two track systems was not significant. Nevertheless, the further long-term assessment of multipath and multidrive transport trailers on soil compaction, associated soil water fluxes and, hence, crop yield, should be provided for the studied field. The multipath trailer may cause less soil compaction, especially if long-term trailer operation is taken into account.

## References

- Alakukku, L. (1999). Subsoil compaction due to wheel traffic, 8(June), 333–351.
- Lal, R. & Shuka, M.K. (2004). Principles of Soil Physics. Marcel Dekker, New York, 716 pp.. ISBN 9780824753245
- Usowicz, B., & Lipiec, J. (2017). Spatial variability of soil properties and cereal yield in a cultivated field on sandy soil. *Soil and Tillage Research*, 174, 241–250, 10.1016/j.still.2017.07.015

## Agricultural traffic effect on maize (*Zea mays* L.) yields in the Argentinean Pampas

M.J. Masola<sup>1,2</sup>; C.A. Alesso<sup>3</sup>; M.E. Carrizo<sup>1</sup>; S. Imhoff<sup>1,2\*</sup>.

<sup>1</sup>*Departamento de Ciencias del Ambiente, Facultad de Ciencias Agrarias, Universidad Nacional del Litoral, Kreder 2805, S3080HOF, Esperanza (Santa Fe), Argentina.*

<sup>2</sup>*CONICET, Kreder 2805, S3080HOF, Esperanza (Santa Fe), Argentina.*

<sup>3</sup>*Departamento de Ciencias Básicas, FCA-UNL, (Kreder 2805), Esperanza (Santa Fe), Argentina.*

\*corresponding author: simhoff@fca.unl.edu.ar

### Introduction

In the Argentinean Pampas agricultural soils are degraded. In recent decades, a widespread alternative to recover degraded lands was the adoption of the direct sowing system (DS). However, after many years of continuous DS, crop yields tend to decrease. This decrease results from the use of randomized traffic and the increase of the machinery weight that caused soil compaction to increase. The adoption of controlled traffic farming was proposed as an alternative to recover the soil quality. This system confines all traffic compaction to the least possible area called permanent traffic lanes. However, soil compaction may extend to the sides of the traffic lanes and reduce root growth and thereby crops yield. Consequently, differences in crops yield may depend on the distribution of soil compaction in the traffic lanes and surrounding areas. In Argentina, maize is grown mainly in loamy-clay and silty-loam soils, which are very susceptible to compaction. Despite this, there is no information about how compaction in the traffic lanes and surrounding areas affects crop yield. The objective of this study was evaluate how the distribution of compaction caused by controlled traffic farming affects maize yield in an Argiudol of the Argentinean Pampas region.

### Material and methods

#### *Experimental site and crop operations*

The work was carried out on a Typic Argiudoll located in the State of Santa Fe (Argentinean Pampas). The soil at the experimental site has been under direct sowing for 10 years in a typical crop rotation: winter wheat (*Triticum aestivum* L.) followed by soybean (*Glycine max* L.) and then maize (*Zea mays* L.) in summer. The maize variety used was “Dkb 7210 VT3PRO”, the seeding date was 7 January 2016 with a rate of 80000 plants ha<sup>-1</sup>. The space between lines was 70 cm. The accumulated precipitation during the cycle of the crop was 951 mm, which represents the total rainfall in a normal year in the region.

#### *Treatments*

At the beginning of the experiment, field compaction was eliminated by subsoiling the soil. Then, nine plots (50 x 7 m each) were defined. Afterward, permanent traffic lanes with different compaction levels were generated in each plot. For that, different numbers of passes of a harvester were made. Thereby, 3 treatments with 3 replicates were defined: T0: without passing the harvester (the traffic line was defined for the seeding operation); T1: lines compacted until reaching 2 MPa; T2: lines compacted until reaching 4 MPa. After that, maize was seeded using direct sowing system and all treatments received the same management.

#### *Determinations*

The equivalent of 1 m<sup>2</sup> was harvested manually in different positions related to the traffic lanes (*a*: crop located in the traffic lane; *b*: crop located in the border of the traffic lane; *c*: crop located between traffic lanes- without compaction). Undisturbed soil samples (5 cm x 5 cm cores) were collected in each position to determine bulk density (Bd) in the surface horizon (3-8 cm) (Blake and Hartge, 1986). Relative soil compaction (RC) was calculated relating the measured soil bulk density at each position to the soil critical density determined



by the Proctor test (ASTM, 1982). The statistical analyses were performed with Infostat software (Di Rienzo et al., 2015).

### Results and discussion

Machinery traffic effectively resulted in soil compaction, evidenced by significant changes in RC between lane positions and non-traffic zones (Table 1). Soil critical bulk density was  $1.43 \text{ Mg m}^{-3}$ . The average of RC of *a*, *b* and *c* positions were: 98, 96 and 88%, respectively. Significant differences were only found between *a* and *c* positions, being RC in *a* 10 % greater than in *c*. No significant differences were found between positions *a* and *b*, and *b* and *c*, indicating soil compaction gradually decreases from the center to the side of the traffic lines.

The effect of soil compaction by agricultural traffic on maize yield varied between treatments and positions. The lowest yield was found in T2 position *a*, whereas no significant differences were found between *b* and *c* positions in this treatment. Similar behavior was observed in T1 even though in the *a* position maize yield was significantly greater than in the *a* position of T2. In T0 no differences in maize yield were found amount positions, and no differences in yield were found in the *a* position between T0 and T1. The lack of difference between *b* and *c* positions indicates that plants located in the *b* position somehow compensated the negative effect of soil compaction. They probably developed a greater root system to the side without compaction, which allows plants uptake sufficient resources (water, light and nutrients) for producing a yield similar to those of plants located in the *c* position. This kind of compensation was found in experiments carried out in greenhouses in pots by Kelvin et al. (2001).

Table 1. Maize yield ( $\text{Mg ha}^{-1}$ ) for three treatments and crop line positions, and relative compaction (%) for positions.

Maize yield ( $\text{Mg ha}^{-1}$ )				Relative compaction (%)		
Position	T0	T1	T2	Contrast position	p- value	
a	5.88 ab	4.49 b	2.13 c	a vs b	0.93	0.747
b	7.11 a	7.05 a	6.37 ab	a vs c	10.00	0.004
c	6.59 ab	7.27 a	6.93 a			

Different letters indicate a significant difference for the different traffic treatments and crop line positions ( $p < 0.05$ ).

### Conclusion

The distribution of the soil compaction caused by controlled traffic farming affected differentially maize yield according to the compaction intensity and the position in relation to the center of the traffic lane.

### References

- ASTM, 1982. *Standard test methods for moisture relations using a 5.5 lb (2.5 kg) hammer and 12 inch (304.8 mm) drop*. In: *ASTM Standards in Building Codes*. Philadelphia, pp 836-842.
- Blake, G.R., Hartge, K.H., 1986. *Bulk density*. In: Klute, A., (Ed.) *Methods of soil analysis: physical and mineralogical methods*. Madison, United States of America, pp. 363–375.
- Di Rienzo, J.A., Casanoves, F., Balzarini, M.G., Gonzalez, L., Tablada, M., Robledo, C.W. 2015. *InfoStat versión 2015*. Grupo InfoStat, FCA, Universidad Nacional de Córdoba, Argentina. URL <http://www.infostat.com.ar>



## **Modelling soil deformation due to vehicular traffic - comparison and evaluation of approaches used for military, agricultural and forestry applications.**

\*Maria Sandin<sup>1</sup>, Jori Uusitalo<sup>2</sup>, Kersti Vennik<sup>3,4</sup>, Philippe Ruch<sup>5</sup>, Noémie Pousse<sup>6</sup>, Thomas Keller<sup>1,7</sup>

<sup>1</sup>*Swedish University of Agricultural Sciences, Department of Soil & Environment, Box 7014, 75007 Uppsala, Sweden*

<sup>2</sup>*Natural Resources Institute Finland (Luke), Green Technology/Production and Information Technology Group, Kaironientie 54, 39700 Parkano, Finland*

<sup>3</sup>*Estonian University of Life Sciences, Department of Soil Science and Agrochemistry, Kreutzwaldi 1a, 51014 Tartu, Estonia*

<sup>4</sup>*The Estonian National Defence College, Riia 12, 51013 Tartu, Estonia*

<sup>5</sup>*The French Institute for Forest-based and Furniture Sectors, 10 Rue Gallilé, 77420 Champs-sur-Marne, France*

<sup>6</sup>*National Forests Office France (ONF), Departement RDI, 11 Rue de l'Ile de Corse, 54000 Nancy, France*

<sup>7</sup>*Agroscope, Department of Agroecology and Environment, Reckenholzstrasse 191, 8046 Zürich, Switzerland*

\*Corresponding author: [maria.sandin@slu.se](mailto:maria.sandin@slu.se)

### **Introduction**

Vehicular traffic during agricultural and forest management operations as well as off-road traffic for military, construction or recreational purposes may lead to soil deformation if the stresses exerted by the vehicle exceed the soils inherent strength (bearing capacity). Such deformation includes development of wheel ruts, soil compaction (reduction in soil porosity) and changes in the geometry of soil pores, which can have severe negative effects on soil ecology and productivity as well as environmental quality in addition to compromising the efficiency or even success of both current and future vehicle operations. Hence, the ability to predict soil trafficability (the extent to which the soil permits vehicular traffic), vehicle mobility (the extent to which a vehicle can move through the terrain) and the risk of detrimental soil deformation such as compaction is essential for effective planning and execution of vehicle operations as well as for sustainable utilization of natural resources. Several models describing wheel-soil interactions as well as more empirical tools for rut depth prediction have been developed to this end, primarily within the agricultural, forestry and military sectors. However, although these activities all deal with soil deformation due to vehicular traffic, and despite the fact that the mechanics of soil is indisputably unaffected whether an agricultural, forest or military vehicle is driving on it, different theoretical approaches and modelling frameworks for predicting soil deformation have been developed. This may be partly explained by different vehicle properties and operation modes, by differences in soil properties between arable, forest and natural soils and by different purposes of predicting soil deformation.

While the main concern for agricultural applications has generally been soil compaction and associated effects on crop productivity (and to some extent also environmental quality), vehicle mobility and soil trafficability prediction have generally been the main focus for the military sector, whereas both vehicle mobility/soil trafficability and compaction induced effects on productivity and environmental quality are of concern for the forestry sector. However, we also note that “parallel” research communities have developed (perhaps due to historical reasons), with limited exchange. We believe that interaction between scientific communities and combination and integration of different modelling frameworks could advance our understanding of soil deformation due to vehicular traffic.

### **Review of modelling frameworks and evaluation of model performances**

The presented study aims to review theory and modelling concepts applied in different research fields (agricultural, forestry and military) that deal with soil deformation due to vehicular traffic and to compare predictions of soil deformation obtained with different approaches. Existing models range from relatively simple and purely empirical tools to complex mechanistic models that can simulate the full 3D stress and deformation fields. Empirical and semi-empirical models estimate wheel sinkage from vehicle and soil parameters. A relatively large group of empirical/semi-empirical (partly analytically based) rut depth prediction models used by the military for mobility assessments and also developed for trafficability and environmental impact assessment during forest logging operations originate from the models initially developed by the U.S. Army Corps of Engineers at Waterways Experimental Station. These models estimate rut depth based on dimensionless wheel or wheel-soil numerics calculated from wheel load, tire characteristics and soil strength represented by the penetration resistance measured at some critical depth. Another group of semi-empirical models use the concepts originally developed by Bekker (1956) whereby rut depth is predicted based on measured pressure-sinkage relationships. More mechanistic models calculate the soil stress state and strains under the loaded wheel, using either analytical or numerical approaches. Analytical models are based on the classical Boussinesq (1889) solution for calculation of stress propagation in the soil and then apply stress-strain relationships to estimate soil deformation. Such models are widely used for compaction risk assessments for agricultural applications (e.g. Keller & Lamandé, 2010). Numerical approaches employ either finite element (FE) or discrete element (DE) methods to calculate 2D or 3D deformation fields underneath vehicle tires. FE models consider the soil as a continuum divided into incremental elements connected by nodes for which stresses and strains are calculated simultaneously using the principle of virtual work. DE models instead simulate soil as a large number of individual particles, simultaneously calculating the movement of all particles from external and inter-particle contact forces. The relatively small number of required input parameters makes simpler empirical or semi-empirical models an attractive option for practical applications such as planning of military or forest operation where, in particular, detailed data on soil properties are often lacking and trafficability/mobility assessments need to be made more or less “on the go”. More mechanistic models require a larger number of input parameters, some of which are difficult or even not possible to measure, which makes them unsuitable for routine practical applications, but they have great potential as tools for hypothesis testing and development and could provide a better understanding of the mechanisms and processes involved in soil deformation.

In this talk, we will present the different modelling frameworks, and compare the predictive performances of a subset of the reviewed models, covering a wide range of approaches. The models are evaluated using comprehensive datasets from wheeling experiments conducted with military, forest and agricultural vehicles under varying soil conditions in France, Sweden, Finland and Estonia. A better understanding of the potentials and limitations of different modelling frameworks and their predictive capabilities in different contexts could help develop and select suitable tools for planning and risk assessment purposes as well as for research aiming to improve our theoretical understanding of soil deformation due to vehicular traffic.

### **References**

- Boussinesq, J., 1885. Application des Potentiels à l'étude de l'équilibre et du Mouvement des Solides Elastiques. Gauthier-Villars, Paris, pp. 30.
- Bekker, M.G., 1956. Theory of land locomotion. The mechanics of vehicle mobility. Ann Arbor: The Univ. Michigan Press.

Keller, T., Lamandé, M., 2010. Challenges in the development of analytical soil compaction models. *Soil Till. Res.* 111, 54–64.

## **Estimation of Soil Compaction by Using Penetrometer in a Long-term Tillage Experiment.**

T. Rátonyi<sup>\*</sup>, P. Ragán, J. Nagy, A. Széles, P. Fejér, E. Harsányi

*Institute for Land Utilisation, Technology and Regional Development, University of Debrecen, H-4032 Debrecen, Hungary*

\* corresponding author: [ratonyi@agr.unideb.hu](mailto:ratonyi@agr.unideb.hu)

### **Introduction**

In the past decades, increasing environmental stress has affected soils. On the one hand, the harmful effects of the environment damage the soil and on the other hand, the damaged soil itself also has a negative impact on other elements of the environment. Natural factors and human activities can all cause degradation in the physical condition of soil, but mechanization and conventional soil tillage systems are the primary reason for these. Heavy and high-power machinery used in agriculture significantly contributed to the formation of thicker and more compacted soil layers starting from the soil surface. Soil tillage systems that are suited to soil conditions allow the satisfaction of the needs of the cultivated plant and serve the interest of soil protection. Penetrometer-measured mechanical resistance is one of the most frequently applied method for the analysis of soil compaction, depth position and dimension of compacted layers and the spatial/temporal changes of soil physics conditions. Penetration resistance as measured by cone penetrometers depends on several parameters, but it is mostly affected by the soil moisture content and bulk density (Vaz et al., 2001). Penetration resistance of soil is inversely proportional to moisture content and directly proportional to bulk density of soil (Chapman et al., 1991). In the case of a given moisture content, penetration resistance it increases with increasing bulk density and declines with increasing moisture content in the case of fixed bulk density; multiple authors have found linear correlations amongst soil parameters (Paul et al., 1985).

### **Material and methods**

The aim of our research is to estimate soil compaction from penetration resistance and soil moisture content by using hand-operated cone penetrometer in the polyfactorial long-term maize field experiment at the trial site of the University of Debrecen (Hajdúság loess plateau, 47° 30' N, 21° 36' E, 121 m elevation) in 2017. The soil type of the experimental site is a lowland calcareous chernozem, which is one of the major soil types of the region. The experiment was arranged in split-split-plot, on the main plots there were three tillage and two irrigation varieties. Maize hybrids were planted onto the primary sub-plots with a plant number of 60-80 thousand ha<sup>-1</sup>, while non-fertilized and fertilization treatments take place randomized on the secondary sub-plots. The investigated tillage treatments were moldboard ploughing (MP) to a depth of 0.3 m, strip tillage (ST) to a depth of 0.3 m and ripping (RP) to a depth of 0.45 m. Soil penetration resistance and soil moisture content were measured by a hand operated static cone penetrometer (PENETRONIC) combined with capacitive soil moisture sensor until 0.70 m depth after the harvest of maize. The device recorded the GPS coordinates of the sampling points. In every tillage treatments blocks (1.2 ha/treatment) we have measured the penetration resistance and soil moisture content in 450 different points. A model was created to estimate dry soil bulk density (BD) from penetrometer readings.

Distribution maps of dry soil bulk density (soil compaction) for different layers were created using the coordinates of sample points with *Golden Software Surfer*.

## Results and discussion

Significant deviation is typical of penetration resistance values, measured with penetrometer even if the measuring points are relatively close to each other. The deviation in penetration resistance is significantly influenced by the variability of soil parameters that are in close correlation with penetration resistance: moisture content and bulk density. For the correlation between these soil parameters a multiple linear regression equation can be fitted. Estimated soil bulk density increases with depth and reaches its maximal value in the compacted plough-pan layers in moldboard ploughing layer tillage treatment. Precision strip tillage and ripping tillage treatments significantly eliminate the compaction zones, which were formed due to the previous years of ploughing tillage (Figure 1.). In irrigated conditions, a greater re-compaction of the soil has an increasing effect on the estimated soil bulk density in conservation strip tillage and ripping treatments.

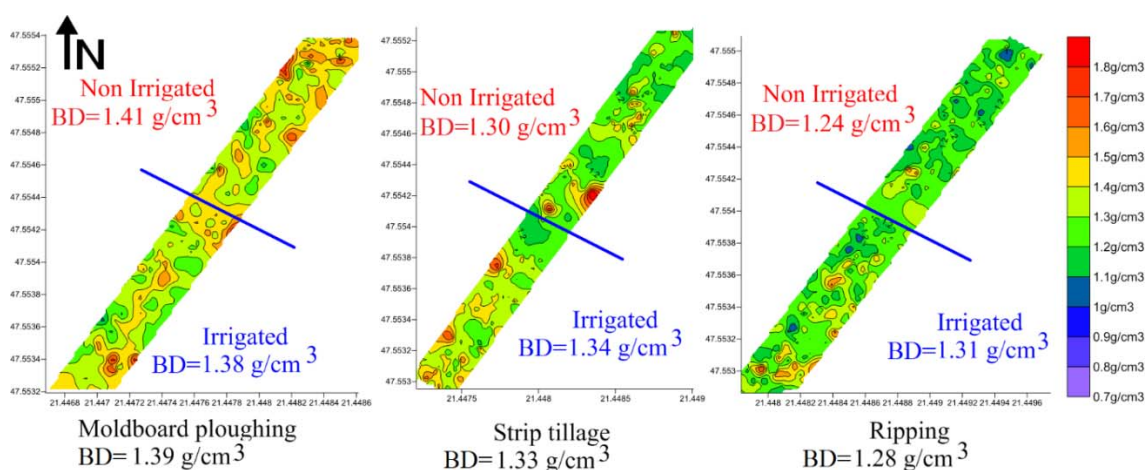

Figure 1: Map of soil bulk density of the 30-40 cm soil layer in the long-term tillage experiment

## Conclusion

Horizontal and vertical distribution of soil compaction can be estimated from the readings of penetrometer and soil moisture sensors using by multiple linear regression model. Generated map of soil bulk density of the 30-40 cm soil layer indicates that compacted zones within the soil profile can be eliminated by conservation tillage practices.

## References

- Vaz, C.M.P., Bassoi L.H., Hopmans J.W., 2001. Contribution of water content and bulk density to field soil penetration resistance as measured by combined cone penetrometer-TDR probe. *Soil Till. Res.*, 60, 35-42.
- Chambell, D.J., O'Sullivan, M.F., 1991. The cone penetrometer in relation to trafficability, compaction, and tillage. *Soil Analysis (Physical Methods)* K. A. Smith, C.E. Mullis. (Eds), pp. 399-429.
- Paul, S.B., Graham, J.P., Armstrong, V.J., Ward, M.A., Howse, R.K. Dawson, C.J., Butler, A.R., 1985. Compaction of a silt loam soil by wheeled agricultural vehicles. I. Effects upon soil conditions. *Soil Till. Res.*, 7, 97-116.

## Assessing the physical quality degradation of Aquands in a gradient land uses in southern Chile

Dorota Dec<sup>1,2</sup>, José Dörner<sup>1,2</sup>, Felipe Zúñiga<sup>2,3</sup>, Oscar Thiers<sup>2,4</sup>, Leandro Paulino<sup>2,5</sup>, Susana Valle<sup>1,2</sup>

<sup>1</sup>*Instituto de Ingeniería Agraria (IIAS), Facultad de Ciencias Agrarias, Universidad Austral de Chile (UACH)*

<sup>2</sup>*Centro de Investigación en Suelos Volcánicos (CISVo), Universidad Austral de Chile (UACH)*

<sup>3</sup>*Doctorado en Ciencias Agrarias, Escuela de Graduados, Facultad de Ciencias Agrarias, Universidad Austral de Chile, Valdivia, Chile*

<sup>4</sup>*Instituto de Bosques y Sociedad (IBOS), Facultad de Ciencias Forestales y Recursos Forestales, Universidad Austral de Chile (UACH)*

<sup>5</sup>*Departamento de Suelos y Recursos Naturales, Facultad de Agronomía, Universidad de Concepción, Campus Chillán, Chile*

Email: [dorora.dec@uach.cl](mailto:dorora.dec@uach.cl)

### Introduction

Aquands are soils developed from modern volcanic ashes, which are located in southern Chile and locally called Ñadi. They are rich in organic matter and are characterized by shallow soil profiles due to the presence of a placic horizon (a discontinuous impermeable layer of Iron from 2 to 4 mm). The latter means soil water logging during the high rainfall months (about 1200 mm between may and august) and intensive soil drying when the rainfall level decreases and temperature increases (Dörner et al., 2017). These shallow deep soils were subjected to an intensive land use change in the last 150 years affecting its physical properties. The aim of this work was to analyse the impact of the current land use on the spatial and temporal variability of soil physical properties.

### Material and method

We studied a Duric Histic Placaquands (41° 26' 72'' S, 73° 7' 70'' O, 73 m a.s.l.), which underwent land use change from secondary native forest (sNF) to naturalized grassland (NG) due to forest fires in 1980. The spatial variability of the soil depth across the field was studied in defined points using a gouge auger. Thereafter, groundwater wells were installed in the same holes. The spatial and temporal variability of the water table depth (WT) was measured. The volumetric water content (WC), penetration resistance (PR) and air conductivity (KI) were measured next to each groundwater well. Additionally, undisturbed soil samples were collected to determine the precompression stress (Pc), air capacity (AC) and air permeability (ka) in the laboratory. To study the soil water dynamics, sensors were installed and soil samples were collected at different depths. The spatial variability structure was analyzed using the geostatistical software GS+ v. 9.0. Soil depth changed as follows: sNF (71.0 ± 1.85 cm depth) > NG (58.0 ± 2.12 cm depth).

### Results and discussion

The bulk density of the soils ranged between 0.15 till 0.65 Mg m<sup>-3</sup> across de gradient of land use, where the mean values of sNF reached 0.28 ± 0.02 Mg m<sup>-3</sup> and for NG 0.39 ± 0.02 Mg m<sup>-3</sup>. The soil depth decreased as a function of the gradient of land use, reaching mean values of 69.9 cm in sNF and 58.6 cm in NG. WT fluctuated according to the spatial variability of the soil depth, reaching contrasting values during June (23 cm, CV = 57%) and December (45 cm, CV = 32%). The field water content dynamics reflected the high total porosity of these soils (70-90%) and was strongly related to the water



table height ( $P < 0.01$ ), influencing the penetration resistance and field air conductivity of the soil as observed in maps of spatial variability. Regarding the mechanical properties of the soil, the  $P_c$  values ranged between 10.9 and 109.6 kPa, presenting a well-defined effect of the current land use.

## Conclusions

The land use change from the sNF to NG induced a degradation of soil physical properties, which implies a decrease in soil depth, air capacity and air permeability. On the other hand, the bulk density increases as well as the soil mechanical strength. The degradation of the soil physical quality of Ñadi soils is a relevant problem due to their shallow soil profile. Both low BD and mechanical strength imply a high deformation potential so that when this soils reached bulk density of  $0.65 \text{ Mm}^{-3}$  can be considered as compacted due to very low values of air capacity and permeability.

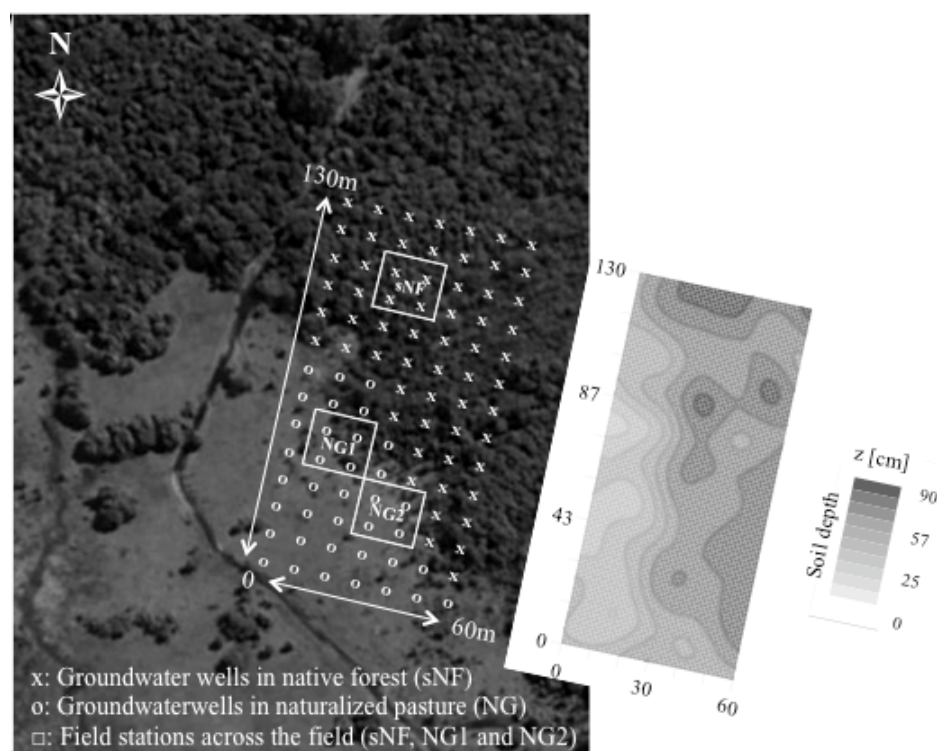

Figure 1: Experimental site. Across the gradient of land use groundwater wells were installed and the soil depth was measured. At each point the water table depth was registered. Adapted from Dörner et al. (2017).

The research was funded by the FONDECYT grant 1130546. Dr. José Dörner thanks the Alexander von Humboldt Foundation for the Grant “Georg Foster Fellowship for Experienced Researchers” which allowed a research stay at the Christian Albrechts University zu Kiel, Germany.

## References

Dörner, J., Horn, R., Dec, D., Wendroth, O., Fleige, H., Zúñiga, F. 2017. Land use dependent change of soil mechanical strength and resilience of a shallow volcanic ash soil in southern Chile. *Soil Science Society of America Journal* 81: 1064-1073.

## **Influence of three types of organic mulch on the bulk density and total porosity of a durostoll of a dry sub-humid area of northern Ecuador**

G. Yaguana<sup>1\*</sup>.

<sup>1</sup> GI-MARESUAG, Ingeniería en Recursos Naturales Renovables, Universidad Técnica del Norte, Av. 17 de Julio Nro. 5-21, Ciudadela Universitaria, Ibarra, Ecuador

\*corresponding author: [gnyaguana@utn.edu.ec](mailto:gnyaguana@utn.edu.ec)

### **Introduction**

One of the biggest problems affecting farmers in dry areas is the difficulty to capture and store water in the soil profile, which becomes the main constraint for the development of vegetation in general and crops in particular. In Ecuador, according to the Atlas of Drylands of Latin America and the Caribbean, drylands occupy 34% of the country's territory (UNESCO, 2010). The incorporation of these areas, when they have a certain agricultural potential, is related to the addition of organic matter. One of the alternatives is the use of organic mulch (straw, herbs, branches and other plant waste) placed on the surface, which according to Brechelt (2004), influence the physical, chemical and biological characteristics of the soil, increasing its productivity. The apparent density and porosity are physical properties that depend on the texture and structure of the soil; that condition the movement of water and air inside the soil and the tillage. The study evaluated the changes in the density and porosity of the soil on which was placed crop residues (straw) of *Pisum sativum*, *Hordeum vulgare* and *Phaseolus vulgaris* with a thickness of 5 cm, compared to a control treatment without mulch, in the associated corn-pea crop (*Zea mays-Pisum sativum*).

### **Material and method**

The investigation was carried out in an Entic Durostoll soil, located at 2452 meters above sea level, with average annual precipitation of 603mm, loam (42% of sand, 34% of silt and 24% of clay). Experimental plots distributed according to the Design of Random Complete Blocks were installed, with four treatments and four repetitions. These soils are tilled with disc harrow changing the structure. They have a content of less than 2% of organic matter, 34% slope and little vegetation. The crops were alternately associated within the same row, using corn seeds of the Mishca variety and Lojana pink pea. The mulch was placed after the removal of soil to the crop. Subsequent measurements of bulk density were made for each treatment after the mulch remained in the field for five months.

### **Results and discussion**

The bulk density (apparent density) before installing the test showed a value of 1.21 g/cm<sup>3</sup>. The values of apparent density determined five months after the application of the much registered differences of magnitude between the control treatment and mulch treatments (Fig1). In the control treatment (T0), there was a higher bulk density, remaining the same as the initial value of 1.21 g/cm<sup>3</sup>; while the treatments with the lowest apparent density were pea mulch (T1) and barley mulch (T2) with 1.18 g/cm<sup>3</sup>. Regarding the total porosity, determined by calculation, a similar trend was observed, registering the highest value in the control treatment (51.19%); and, the lowest in the treatment with mulch of beans (T3).



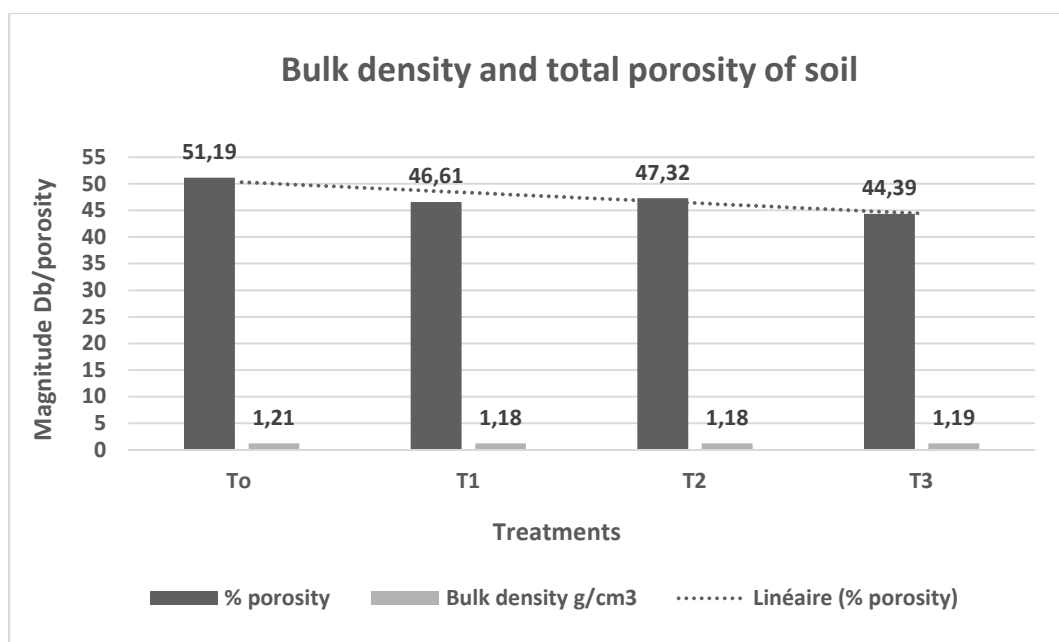

Figure 1: Bulk density and total porosity of the soil after five months placed mulch.

By decreasing the bulk density the soil will be looser, less compact, which allows better tillage, aeration, moisture retention and microbial activity.

### Conclusion

From the results it is inferred that the organic mulch, from harvest residues, in hardened soils reduces the compaction and improves the porosity of aeration, making them more sustainable for crop production.

### References

- Brechelt, A. (2004). Manejo Ecológico del Suelo . República Dominicana.  
 UNESCO, 2010. “Atlas de Zonas Áridas de América Latina y el Caribe”. Dentro del marco del proyecto “Elaboración del Mapa de Zonas Áridas, Semiáridas y Subhúmedas de América Latina y el Caribe”. CAZALAC. Documentos Técnicos del PHI-LAC, N°25.

## Effect of Dairy Treated-Waste Application on the Penetration Resistance and Effective Stress of an Argiudoll

Imhoff, S.<sup>1,2\*</sup>

<sup>1</sup>Departamento de Ciencias del Ambiente, Facultad de Ciencias Agrarias, Universidad Nacional del Litoral, Kreder 2805, S3080HOF, Esperanza (Santa Fe), Argentina.

<sup>2</sup>Consejo Nacional de Investigación Científica y Tecnológica (CONICET) Kreder 2805, S3080HOF, Esperanza (Santa Fe), Argentina.

\*corresponding author: simhoff@fca.unledu.ar

### Introduction

In the central region of the Argentine Flat Pampas, soil deterioration is increasing associated with the reduction of the organic carbon content. This has negative consequences on the infiltration and movement of water and aeration capacity of the soils, as well as on the resistance to root penetration of root (RP) (Imhoff et al., 2016). As soil bulk density (Bd) increases, the contact between particles also increases, increasing the energy required to penetrate the soil. Similarly, soil drying produces an approach of its particles and favors the formation of new connections between them and between the microaggregates of the soil, which increases the energy of water retention by the soil matrix (matric potential). In these cases, RP is produced by the combined effect of water content and matric potential on the inter-particle and inter-aggregate bridges, a process known as effective stress. The application of organic waste in the soils is an alternative to increase the content of organic matter and thus, to improve its properties. In general, dairy treated-waste contains a significant amount of organic matter and nutrients, reason why they could be an important source for recovering degraded soils. It is well known that high values of RP and effective stress affect crop growth. However, there is little information about the impact that the dairy treated-waste application has on the aforementioned physical properties. The objective of the study was to determine the effect of the application of different doses of dairy treated-waste on RP and the effective stress of the soil.

### Material and method

The study was carried out in a farm located at Cavour, Santa Fe province (31°21'59 " S; 61°00'28 " O). The soil is classified as typical Argiudoll, Rincón de Ávila serie, with a productivity index of 62. The experiment consisted of four treatments: control (0 m<sup>3</sup> ha<sup>-1</sup>) (T0), application of low dose of dairy treated-waste (T1 = 60 m<sup>3</sup> ha<sup>-1</sup>), medium dose of dairy treated-waste (T2 = 120 m<sup>3</sup> ha<sup>-1</sup>) and high dose of dairy treated-waste (T3 = 180 m<sup>3</sup> ha<sup>-1</sup>), with three repetitions per treatment, according to a design in random blocks. Disturbed samples were collected in each plot 3 weeks after seeding to evaluate organic matter (MO), Nt, P, SO<sub>4</sub>, pH, CE, Ca, Mg, Na, K. Table 1 shows the nutrient content applied with the treatments.

Table 1. Amount of dry matter (DM) and nutrients applied with the treatments.

Doses (m <sup>3</sup> ha <sup>-1</sup> )	DM (kg ha <sup>-1</sup> )	N (kg ha <sup>-1</sup> )	P (kg ha <sup>-1</sup> )	Ca (kg ha <sup>-1</sup> )	Mg (kg ha <sup>-1</sup> )	Na (kg ha <sup>-1</sup> )	K (kg ha <sup>-1</sup> )
T1 (60 m <sup>3</sup> ha <sup>-1</sup> )	4002	58	5	184	130	236	460
T2 (120 m <sup>3</sup> ha <sup>-1</sup> )	8004	116	10	368	260	473	920
T3 (180 m <sup>3</sup> ha <sup>-1</sup> )	12006	14	15	551	389	709	1381

Undisturbed samples (6 per treatment, 2 per replication) were collected from 0 to 10 cm with cylinders of 5x5 cm of height and diameter to determine soil bulk density (Bd), water retention curve (equation 1) and penetration resistance (RP), which was measured with electronic penetrometer in the center of each sample.

$$\theta = a \cdot \psi^{-b} \quad (1)$$

Where:  $\theta$ =volumetric water content (cm<sup>3</sup> cm<sup>-3</sup>),  $\psi$ = matric potential (kPa), "a" y "b" are parameter of the model.

The effective stress ( $\sigma$ , kPa) was estimated as the product between relative saturation and matric potential, in absolute value (equation 2).

$$\sigma = \theta_{sr} * |\psi_m| \quad (2)$$

Where:  $\theta_{sr}$  is the relative saturation (quotient between the volumetric water content in the applied potential and the volumetric water content in saturation;  $\theta_{sr} = \theta/\theta_s$ );  $|\psi_m|$  is the matric potential. The relationship between effective stress and RP (kPa) was established by fitting a linear model. Analysis of variance and comparison of means with the Tukey test at 5% significance and regression analysis were performed using the INFOSTAT program.

## Results and discussion

Dairy treated-waste application increased the concentrations of almost all nutrients from 0 to 10 cm, with the exception of pH, while from 10 to 20 cm there were no changes. The content of OM in T1, T2 and T3 increased 3%, 11% and 23% with respect to T0 (MO = 3%). The content of Ca in T1, T2 and T3 increased 3%, 6% and 10% with respect to T0 (Ca = 9.6 cmolc / kg). Bd and RP decreased significantly in T2 and T3, while there were no differences between T0 and T1.

Figure 1 shows that the increase of  $\sigma$  caused RP also increase in all treatments although the magnitude of the RP- $\sigma$  ratio depended on the dose of dairy treated-waste. In T0 and T1 for each unit of variation of  $\sigma$ , the increase in PR is markedly greater than in T2 and T3. The coefficient (a), which mainly represents the effect of cohesion due to the presence of cementing substances, shows a small increase probably due to the aggregation effect of the OM and the Ca on the soil particles. The coefficient (b) (slope) is determined by the effect of friction between particles and the effect of the forces acting on the capillarity, which increase with soil densification. The higher doses of dairy treated-waste induced a notable decrease of the parameter (b). This result suggests that the dairy treated-waste induced a decrease in the friction forces between particles and the adhesion forces between particles-water (meniscus effect), which is corroborated by the decreases of Bd.



Figura 1. Relationship between the effective stress ( $\sigma$ ) and resistance to root penetration (RP) in the treatments: control (0 m<sup>3</sup> ha<sup>-1</sup>) (T0), application of low dose of dairy treated-waste (T1 = 60 m<sup>3</sup> ha<sup>-1</sup>), medium dose of dairy treated-waste (T2 = 120 m<sup>3</sup> ha<sup>-1</sup>) and high dose of dairy treated-waste (T3 = 180 m<sup>3</sup> ha<sup>-1</sup>).

In treatments T2 and T3 RP values remained below the critical threshold (2 MPa) throughout the range of  $\sigma$  measured. This indicates that as the soil water content decreases, the resistance that opposes the matrix of the soil to undergo deformation does not become restrictive for the growth of the roots.

## Conclusion

The use of dairy treated-waste in adequate doses is a valid alternative to contribute to the sustainable management of livestock systems due to their incorporation increased the content of OM and nutrients while Bd, RP and  $\sigma$  decreased.

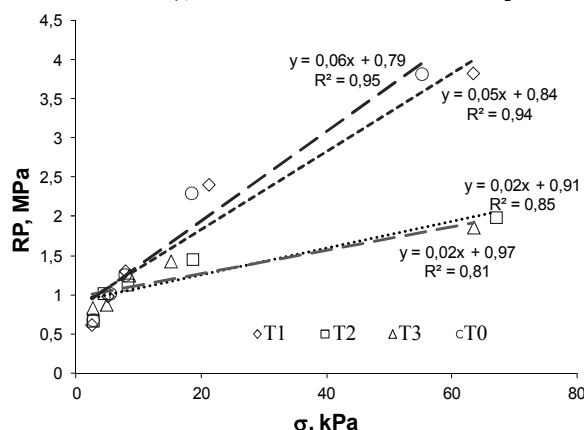
## References

Imhoff S., Pires Da Silva A., Ghiberto P., Tormena C., Pilatti M.A., Libardi Pl., 2016. PLOS ONE. San Francisco: PUBLIC LIBRARY SCIENCE. ISSN 1932-6203. <https://doi.org/10.1371/journal.pone.0153827>.

## Effects of tractor speed on soil compaction under different soil water contents

K. Chiheb<sup>\*1,2</sup>, A. Khaoula<sup>1,3</sup>, A. Roua<sup>1</sup>, R. Lidong<sup>2</sup>, C. Sayed<sup>1</sup> and C. Wim<sup>2</sup>

(1) Higher Institute of Agricultural Sciences, Sousse University, 4042 Chott Meriem, Tunisia

(2) Faculty of Bioscience Engineering, Ghent University, 9000 Ghent, Belgium

(3) Higher School of Engineers, Jendouba University, 9070 Medjez El Bab, Tunisia

\* corresponding author: khemischihab@gmail.com / Chiheb.Khemis@ugent.be

### Introduction

The world population is projected to exceed 9 billion by 2050 (FAO, 2015) with an expected double increase in Africa. This implies that food production has to increase by 70 percent. In order to reach this goal, intensive agriculture using heavy machinery will increase considerably the risks of soil compaction. This problem was estimated as one of the major factors of soil degradation affecting an area of 68 Mha (Oldeman et al., 1991). It is one of the principal causes of environmental and agronomic problems (flooding, erosion, leaching of chemicals to water bodies, runoff of water and pollutants to surface waters, movements of nitrate and pesticides into groundwater, emission of greenhouse gases) (Soane and van Ouwerkerk, 1995). Soil compaction caused by vehicular traffic affects the essential ecological soil functions (Alaoui et al., 2011; Nawaz et al., 2012). It reduces also total porosity, air capacity, saturated hydraulic conductivity, water infiltration and the proportion of larger pores that play a crucial role in water movement and solute transport, nutrient availability, aeration, and crop yield (Rostek, 2000). Among the factors conditioning the degree of compaction, several are related to the tractor (tyre inflation pressure, wheel width, axle load, number of passes, speed, tyre architecture,...). However, our understanding of the effect of tractor speed on soil compaction and its impact on arable soils is still limited. In soil compaction research, the major focus has been on the effect of axle load, number of passes and tyre inflation pressure. The main objective of this study was to examine the impact of some of these factors on physical and hydraulic properties of soil under different soil water contents.

### Material and method

The experimental site was at the Higher Institute of Agronomic Sciences Chatt-Mariem, Sousse University, Tunisia (35°54'40.2"N 10°33'24.3"E). The soil has a silty loam texture (21% clay, 30 % silt, 48 % sand) down to 300 mm depth. The main crop of the field was a biological potato. Conventional tillage was used to till the soil. Climate is dry with warm summers, annual precipitation of 558 mm and a mean annual temperature of 21°C. Soil organic matter or content at the experimental site was 1.2%. Two external loads, two tyre pressure and two speed of tractor under three water contents conditions were used in a completely randomized design (27 treatments) as follows: (C1: load 1, C2: load2, C3: tyre pressure 1, C4: tyre pressure 2, C5: speed 1, C6: speed 2). Two type of tractor were used for this experiment having a standard wheel-drive with a single rear tires. The small tractor was a Kubota L3430 with a total weight of 1.500 kg and a power of 25.2 kW, the medium tractor was a Foton TA700 with a total weight of 3.100 kg and a power of 51 kW. The measurements were made and samples were collected from the same field in the Higher Institute of Agronomic Sciences Chatt-Mariem. Undisturbed soil cores (5 cm high and 5 cm in diameter) were randomly collected at depths of 10,20 and 30cm. Thus, in total 243 soil cores were taken. Penetration resistance was measured at depths of 10,20,30,40 and 50cm. In some cases, especially for H0, the soil was too dry and strong below the normal depth of tillage (around 30 cm) for penetrations to be carried out. In these cases, only the plough layer was measured. The organic matter content was measured by wet oxidation. Sample collection for

measurement of bulk density and water content were made on an area of approximately 1.5 m<sup>2</sup>. Penetrometer measurements were made on an area of about 3 m radius from the center of the sample collection area for each treatment. Therefore, all samples and all measurements were made as nearly as possible, to reduce the effects of spatial variability to a minimum.

### Results and discussion

The results shown on Table 1 confirmed that soil compaction level and the moisture content significantly affected the bulk density.

Depth (cm)	Humidity (%)	Bulk density (g cm <sup>-3</sup> )			Particle density (g cm <sup>-3</sup> )	Sand 0.05–2 mm (%)	Silt 0.002–0.05 mm (%)	Clay <0.002 mm (%)
		C0	C1	C2				
0 - 10	H0 4.8	1.38	1.44	1.44	2.65	60	30	10
	H1 12.7	1.32	1.6	1.72				
	H2 9	1.41	1.47	1.52				
10 - 20	H0 5.4	1.48	1.56	1.62	2.65	68	21	11
	H1 10.2	1.55	1.64	1.74				
	H2 10.2	1.5	1.55	1.66				
20 - 30	H0 5.5	1.45	1.55	1.54	2.65	69	21	08
	H1 6.8	1.57	1.58	1.65				
	H2 9.3	1.68	1.71	1.79				
		C0	C3	C4				
0 - 10	H0 2.54	1.32	1.35	1.39	2.65	78.2	6.81	10
	H1 12.1	1.35	1.7	1.74				
	H2 7.4	1.33	1.55	1.59				
10 - 20	H0 4.24	1.43	1.5	1.55	2.65	78	6.13	11.35
	H1 9.4	1.47	1.66	1.74				
	H2 8.01	1.5	1.64	1.66				
20 - 30	H0 4.35	1.52	1.57	1.62	2.65	77.70	5.9	12.03
	H1 5.3	1.53	1.57	1.64				
	H2 8.3	1.73	1.75	1.79				
		C0	C5	C6				
0 - 10	H0 3.89	1.38	1.44	1.44	2.65	60	30	10
	H1 12.02	1.32	1.6	1.72				
	H2 9.75	1.41	1.47	1.52				
10 - 20	H0 4.95	1.48	1.56	1.62	2.65	68	21	11
	H1 10.3	1.55	1.64	1.74				
	H2 10.25	1.5	1.55	1.66				
20 - 30	H0 5.08	1.45	1.55	1.54	2.65	69	21	08
	H1 7.62	1.57	1.58	1.65				
	H2 9.38	1.68	1.71	1.79				

### Conclusion

Results of this study showed that heavy tractor corresponding to load C2, tyre pressure C4 and the speed C5 resulted in significant soil compaction, especially for wet conditions. Bulk density and the permeability measurement confirmed these results. Even under water contents below or near field capacity, substantial top and subsoil compaction was induced after one tractor pass. Tyre inflation pressure and tractor speed had a significant effect at 10 cm depth and a little influence in the subsoil layer which was confirmed by Arvidsson and Keller (2007). In contrast, wheel load had a large influence on subsoil stresses.

Arvidsson, Johan, and Thomas Keller. "Soil stress as affected by wheel load and tyre inflation pressure." *Soil and Tillage Research* 96.1 (2007): 284-291.

FAO (Food and Agriculture Organization of the United Nations) (2015), Soil is a non-renewable resource. Available: <http://www.fao.org/3/a-i4373e.pdf>

## Impact of tillage intensity on clay loam soil structure

Omar Daraghmeh <sup>\*1</sup>, Carsten Petersen<sup>1</sup>, Lars Munkholm<sup>2</sup>, Liubava Znova<sup>3</sup>, Peter Bilson Obour<sup>2</sup>, Søren Kirkegaard Nielsen<sup>3</sup>, Ole Green<sup>3</sup>.

\*Corresponding author, email: [o.daraghmeh@plen.ku.dk](mailto:o.daraghmeh@plen.ku.dk)

<sup>1</sup> Department of Plant and Environmental Sciences, Section for Environmental Chemistry and Physics, University of Copenhagen, Thorvaldsensvej 40, 6. Sal, T645, 1871 Frederiksberg C, Denmark.

<sup>2</sup> Department of Agroecology, Aarhus University, Research Centre Foulum, Blichers Allé 20, P.O. Box 50, DK-8830 Tjele, Denmark

<sup>3</sup> AGROINTELLI, Agro Food Park 13, Skejby, 8200 Aarhus N, Denmark.

### 1. Introduction

Soil structure and structural stability are key parameters in sustainable soil management and optimum cropping practices. Reduced and traditional tillage often results in substantial temporal and spatial variability of soil structure (e.g., Daraghmeh et al., 2009). However, locally and temporally adapted precision tillage may reduce such variability and thereby improve crop performance while at the same time reduce environmental impacts. Excessive dispersion of clay and silt particles from destabilized aggregates near the surface including not least wheel track areas will accelerate clogging. Clogging and slow infiltration may lead to surface runoff, water erosion and pollution of surface waters (Czyż and Dexter 2015; Petersen et al., 2016). Precision tillage based on accurate and online information about the soil has only to a limited extent been adopted so far, but novel sensors and data integration techniques may pave its way (Pedersen, 2004). We conducted a field experiment on a clay loam soil with seedbed preparation by rotovation after winter ploughing and with the following factors: operational speed, rotovation speed, wheeling after rotovation, and soil moisture content. All factors were varied within realistic and practical limits. The objective was to investigate the potential of regulating soil structure and structural stability by regulating tillage intensity.

### 2. Materials and methods

A field experiment with seedbed preparation by rotovation was conducted 20 km west of Copenhagen in the spring and summer of 2017. Treatments were applied in a randomized complete block design with three blocks and two main factors on April 19 at “optimal” soil moisture content (ca. 22 g/g), i.e. operational speed (OS) at two levels (2.9 and 6.3 km/h) and rotovation speed (RS) at three levels (450, 545, and 630 rpm). Three extra treatments were included, i.e. rotovation (OS= 2.9 km/h; RS=545 rpm) followed by wheeling at “optimal” and “high” soil moisture contents, respectively, and rotovation (OS= 2.9 km/h; RS=545 rpm) at “high” soil moisture content without wheeling. Rotovation depth was kept constant at approximately 8.0 cm. The ratio of the amount of clay- and silt-sized particles dispersed by shaking to the estimated total amount of clay- and silt-sized particles in the sample based on the texture analysis from the specific plot (g/g) was used to express soil dispersibility. Portions representative subsamples were air-dried and subjected to standardized, gentle shaking on a nest of sieves with apertures: 32, 16, 8, 4 and 2 mm to determine aggregate size distribution. The degree of fragmentation after tillage was expressed as geometric mean diameter.

### 3. Results and discussion

The specific energy input was significantly larger with low operation speed (OS1=2.9 km hr<sup>-1</sup>) than with high operation speed (OS2=6.3 km hr<sup>-1</sup>) (on average 116 and 52 J kg<sup>-1</sup>, respectively), and significantly larger for the high rotation speed than the low rotation speed (105 J kg<sup>-1</sup> for OS3 compared to 54 J kg<sup>-1</sup> for RS1). The proportion of large aggregates (<32 mm) tended to be smaller for the high operation speed treatment than the low operation speed. This could be interpreted as low operation speed, may have resulted in kneading of the smaller soil particles rather than crumbling due to relatively high soil moisture content (Lernik, 1990). Soil moisture condition is one of the important soil properties that influence soil fragmentation during tillage (Obour et al., 2017). Soil dispersibility was larger right after tillage (at T1) reaching at least 0.6 g/g after 40 min than after 45 days (at T2) when the dispersibility was less than 0.4 g/g for all treatments except in wheel tracks. Results showed a significant increase of soil dispersibility (R<sup>2</sup>=0.54) with increasing the rotation speed at the higher operation speed (OS2) until a breaking point 79.8 J Kg<sup>-1</sup>, subsequently a slightly reduction of the dispersibility with increasing the rotation speed at the highest energy input (OS1) was found. Our results agreed with Watts et al. (1996) findings, that the amount of mechanically dispersible clay was a function of both soil water content and specific energy input. Results showed that increasing tillage intensity resulted in a clear increase of proportion medium (8-16 mm) aggregate fraction until a breaking point 73.0 J Kg<sup>-1</sup> whereas, after this point results showed a slight increase in these aggregate fraction. Results indicated that increasing tillage intensity resulted in a clear reduction of the small aggregate proportion until a breaking point 79.7 J Kg<sup>-1</sup> whereas, after this point results showed a slight decrease in these aggregate fraction. A highly significant negative correlation (R<sup>2</sup>=0.69) between the soil dispersibility and the specific area of the aggregate was recorded. Increasing specific area resulted in decreasing the soil dispersibility. This increase of specific area is a direct result of increasing the fraction of the aggregates <4 mm, as it is indicated in the negative correlation (R<sup>2</sup>=0.71) between the soil dispersibility and fraction of aggregate less than 4 mm. Increasing geometric mean weight diameter resulted in decreasing the soil dispersibility (R<sup>2</sup>=0.66).

### 4. Conclusions

Results showed a clear impact on topsoil structure produced by either intensive tillage or wheel machine compaction. Increasing energy input resulted in reducing soil structure stability as represented by soil dispersibility. Operation speed and rotation speed have either as individual or combined significantly affect topsoil soil structure characteristics. Wheel machine compaction clearly resulted in differences in aggregate size distribution, tensile strength, rupture energy, soil dispersibility, and air permeability.

### 5. References

1. Czyż, E. and Dexter, A. (2015). Mechanical dispersion of clay from soil into water: readily dispersed and spontaneously dispersed clay. *International Agrophysics*, 29(1), pp. 31-37.
2. Daraghmeh O.A., Jensen J.R., Petersen C.T. (2009): Soil structure stability under conventional and reduced tillage in a sandy loam. *Geoderma*, 150: 64–71.
3. Obour, P. B., Lamandé, M., Edwards, G., Sørensen, C. G. and Munkholm, L. J. (2017), Predicting soil workability and fragmentation in tillage: a review. *Soil Use Manage*, 33: 288-298.

## Root traits effect on soil traffic-induced shear in agroecosystems, the case of cover crops

\*Matthieu Forster<sup>1,2</sup>, Carolina Ugarte<sup>1</sup>, Mathieu Lamandé<sup>2,3</sup>, Michel-Pierre Faucon<sup>1</sup>

<sup>1</sup>AGHYLE, UniLaSalle, 19 rue Pierre Waguet, 60026 Beauvais, France.

<sup>2</sup>Aarhus University, Department of Agroecology, Research Centre Foulum, Blichers Allé 20, PO Box 50, DK-8830 Tjele, Denmark.

<sup>3</sup>Norwegian University of Life Sciences, Faculty of Environmental Sciences and Natural Resource Management, Campus Ås, Universitetstunet 3, 1430 Ås, Norway

\* corresponding author: Matthieu.forster@unilasalle.fr

### Introduction

Soil compaction is known as one of the major threats to soil quality in Europe. Soil compaction results from two processes: compression and shear. Compression lead mainly to a decrease in soil porosity for the whole profile. While in the topsoil, disturbance induced by traffic lead mainly to a loss of pore continuity due to shearing (Berisso et al., 2013). Conventionally, tillage decrease temporarily topsoil disturbance induced by traffic. Consequently, one of the main challenges of sustainable soil management in conservation agriculture is to mitigate soil disturbance induced by traffic and conserve soil porosity and pore continuity on reduced tillage or no-till systems. Shear strength in the topsoil can be increased by roots as shown by studies dealing with the protection of slopes or river bank from landslides or erosion (i.e. Stokes et al., 2009). This suggests that roots of crop species could play a role in increasing soil shear strength in the topsoil. Functional trait approach, which is used to understand soil processes and ecosystem services (Faucon et al., 2017), could be applied to characterise root effects on soil shear strength in agroecosystems. The aim of this study was to investigate the effects of root functional traits of cover crops on the shear strength of an arable soil, and to test their ability to maintain soil physical quality during traffic.

### Materials and methods

In a field experiment located in the North of France on a Luvisol, the effects of a range of morphological and architectural root traits of cover crops on soil shear strength were tested using an *in-situ* direct shear apparatus. Twelve species were selected to obtain the range of traits: *Secale cereale*, *Avena strigosa*, *Brassica napus*, *Vicia faba*, *Lathyrus sativus*, *Linum usitatissimum*, *Brassica juncea*, *Brassica rapa oleifera*, *Pisum sativum*, *Trifolium incarnatum*, *Vicia sativa* and *Melilotus officinalis*. All species were cultivated for three months in a randomized design with three blocks. Each block included 16 plots of 2.5 m × 2.5 m: one plot per species and four plots with bare soil as control. The direct shear tests were performed *in situ* on undisturbed soil cores of 15 cm diameter and 10 cm height with a shear plane at 15 cm depth. For each species, two shear tests were performed for each six normal loads (30, 60, 90, 120, 150, and 180 kPa) randomly dispatch in the three blocks. Morphological, architectural and chemical traits (Table 1) were measured for six individuals for each species. To test the ability of roots to protect soil physical quality, air permeability was measured on undisturbed soil cores (100 cm<sup>3</sup>) sampled at 15 cm depth and at three distances from the centre of track (0, 30 and 60 cm). Three soil cores were sampled at each distance for each plot.



Table 1 : Functional traits measured

Categories	Functional trait	Description
Morphological trait	Root thickness	Distribution of root diameter in class : very fine, fine, thin, thick
	Specific root length	Root length per root dry mass (cm/g)
Architectural trait	Root length density	Root length per unit volume of soil (cm/cm <sup>3</sup> )
	Root angle insertion	Distribution of root angle insertion in the shear plane (0-30° ;30-60°; 60-90°)
	Root area ratio	Proportion of soil of the shear plane occupied by roots (cm <sup>2</sup> /cm <sup>2</sup> )
	Branching	Number of nodes on the primary and secondary roots
Chemical	C/N	C/N composition of the root
	DMC	Dry matter content of the roots (%)

### Hypotheses

Experiment has not been done yet but results will be available for the conference. Nevertheless, solid assumptions could be done according to the literature: (1) Functional trait approach combined with the modified Mohr-Coulomb failure criterion equation could allowed to highlight root traits involved in the additional cohesion bring by plants and thus highlight roots traits involved in soil shear strength. (2) Air permeability could be positively correlated to the additional soil shear strength bring by plants. (3) Some functional root traits that have positive impact on soil shear strength could be negatively correlated between them.

### Perspective

Highlighting functional root traits involved in the soil shear strength could constitutes an important application in conservation agriculture to select cover crop species to mitigate shear stress in reduced tillage and no-till systems. As functional root traits negatively correlated could present a positive effect on soil shear strength, perspective could be to study functional diversity effect of multispecific intermediate crops on soil shear strength.

### References

Berisso, F.E., Schjønning, P., Lamandé, M., Weisskopf, P., Stettler, M., Keller, T., 2013. Effects of the stress field induced by a running tyre on the soil pore system. *Soil Tillage Res.* 131, 36–46.

Faucon, M.-P., Houben, D., Lambers, H., 2017. Plant Functional Traits: Soil and Ecosystem Services. *Trends Plant Sci.* 22, 385–394

Stokes, A., Atger, C., Bengough, A.G., Fourcaud, T., Sidle, R.C., 2009. Desirable plant root traits for protecting natural and engineered slopes against landslides. *Plant Soil* 324, 1–30

## Soil temperature and moisture as affected by mulching and cover crop management in saffron (*Corocus sativus* L.)

M. Jafarimoghadam<sup>1\*</sup>, E. Ghasemi<sup>2</sup> and N. Khalesi<sup>2</sup>

<sup>1</sup> *Ph.D in Agriculture, Tehran Researches and Sciences University, Iran*

<sup>2</sup> *Ph.D Student of Agronomy, Azad Birjand University, Iran*

\* Corresponding Author: [m.jafari\\_m@yahoo.com](mailto:m.jafari_m@yahoo.com)

### Introduction

Saffron, as a slow-growing crop does not provide an acceptable canopy, thus soil is uncovered majority of the time. As a result, water losses and increasing soil temperature can occur naturally. Therefore, some management strategies such as cover crop cultivation and mulching systems support saffron yield by improving its needs in soil. It has been reported that persian clover and bitter vetch as cover crops, improve saffron flowering and other agronomic traits, due to modified received radiation and soil physical and biological properties (Koucheki et. al., 2016). Kader et. al., (2017) illustrated during the hot summer, soil temperature increases that causes soil water loss and negative impacts on crop yields. Applying mulch with suitable materials may reduce these unfavorable conditions and provide suitable soil microclimate for crop cultivation. Crop residues at the soil surface could lead to better root growth and higher yields. Mulumba and Lal (2008) observed that soil moisture contents at field capacity and the plant available water capacity were positively affected by mulching rates. Therefore, the hypothesis was “a relationship between soil temperature and available water content relations with morphological characteristics of saffron. Based on this, we conducted a two years experiment to investigate the effects of different mulches and cover crops on soil available water and temperature and their relationships with agronomic traits in saffron.

### Material and methods

This study was carried out in a randomized complete block design with four replications at the research farm in Torbat-Heydariyeh, Razavi-Khorasan, Iran, during 2011 to 2013. The experimental treatments were: Control (Bare), vetch and barley as cover crops, and crop residuals of wheat straw and barley straw as mulch. Saffron corms were planted in plots of  $5.5 \text{ m}^2 \times 3 \text{ m}^2$  with 15cm depth in June 2011, and the field was irrigated in early October. Other irrigations were performed four times during a season and fertilization was given based on soil tests. After picking saffron flowers, cover crops were planted between rows, followed by irrigation. These mentioned plants were returned to the soil in mid-May in both years. Crop residuals were applied at the same time with  $5 \text{ t.ha}^{-1}$  for mulching treatments. In October, the total number of flowers and stigma dry weights were collected and counted for all plots for two years during flowering. The flowers and stigmas were stored at room temperature until performing the analyses. In saffron root zone, core samples were obtained in three soil layers (0-10, 10-20 and 20-30 cm) for this loamy soil. The soil temperature was measured in three depths 5, 15 and 25 cm. Soil moisture of samples from each layer was obtained through centrifugation and the available water capacity was calculated as the difference in moisture retention between 33 and 1500 kPa. Finally, SAS 9.1 software was used for data analysis and means were separated using the least significant difference method (Protected-LSD).

### Results and discussion

Management systems could change soil temperature during two growing years, especially in the summer. Control (bare) treatment showed the highest temperature among treatments in 2012 and 2013, with more than 22 (°C). In the first year, mulching systems could reduce soil temperature by up to 2 (°C), and it followed with higher reduction in the next year. In 2013, the declines in soil temperatures compared to the control plots in all management systems were similar. The straw mulching management decreased soil temperature because of high surface radiation reflectance and low thermal conductivity (Kader et. al., 2017). Significant effect of vetch as a cover crop on the soil available capacity was observed in the first year (Table 1). In this growing season other treatments did not show any change on this parameter. In the second year, apart from vetch, other management systems showed higher total available water content compared to the bare treatment (Table 1). Similar observations were made by Mulumba and Lal (2008). The mulching systems, by buffering the extreme fluctuations in soil moisture, improved crop root growth and probably increased the root exudates that, enhanced soil moisture capacity. In addition, results represented that mulching and cover crop systems enhanced stigma dry yield and flower number compared to the control treatment. However, in the first year, cover crops were superior compared with mulching treatments (Table 1). This could be due to higher moisture contents in soils that, caused increasing flower number, and better final stigma yield.

Table 1. Effects of various management systems on soil and agronomic traits during two consecutive years.

Treatment	2012				2013			
	T (°C)	TAW (mm)	FN (m <sup>2</sup> )	Y (kg.ha <sup>-1</sup> )	T (°C)	TAW (mm)	FN (m <sup>2</sup> )	Y (kg.ha <sup>-1</sup> )
Control	22.1 <sup>a</sup>	31 <sup>b</sup>	100 <sup>c</sup>	4.1 <sup>c</sup>	22.9 <sup>a</sup>	30 <sup>b</sup>	119 <sup>c</sup>	5.12 <sup>c</sup>
Vetch	22 <sup>a</sup>	34 <sup>a</sup>	109 <sup>a</sup>	4.61 <sup>a</sup>	20.1 <sup>b</sup>	35 <sup>a</sup>	129 <sup>a</sup>	6.03 <sup>a</sup>
Barley	21.3 <sup>ab</sup>	31 <sup>b</sup>	106 <sup>ab</sup>	4.53 <sup>a</sup>	20.2 <sup>b</sup>	34 <sup>a</sup>	127 <sup>ab</sup>	5.74 <sup>ab</sup>
Wheat straw	20.6 <sup>b</sup>	31 <sup>b</sup>	103 <sup>b</sup>	4.43 <sup>b</sup>	19.8 <sup>b</sup>	33 <sup>ab</sup>	126 <sup>ab</sup>	5.68 <sup>ab</sup>
Barley straw	19.9 <sup>b</sup>	30 <sup>b</sup>	104 <sup>b</sup>	4.4 <sup>b</sup>	20 <sup>b</sup>	34 <sup>a</sup>	125 <sup>b</sup>	5.52 <sup>b</sup>

T: The Temperature at 15cm depth; TAW: Total Available Water Content (the average amount of three depths) ; FN: Flower Number; Y: Stigma Dry Yield.

Values followed by the same letter are not significantly different at  $p \leq 0.05$ .

## Conclusion

The results demonstrated all measured traits were significantly affected by mulches and cover crops. The mean temperature during the summer season decreased for all management practices than the bare soil. In addition, the management practices succeed to improve soil physical properties, enhanced flower number and stigma dry yield. Soil temperature reduction and increasing in available water content due to mulching systems during summer, lead to improvement of traits.

## References

- Koocheki A., Rezvani Moghaddam P., Fallahi H.R., 2016. Effects of Planting Dates, Irrigation Management and Cover Crops on Growth and Yield of Saffron (*Crocus sativus* L.). *J. of Agroecology*, 8, 435-451 (In Persian).
- Kader M.A., Senge M., Mojid M.A., Nakamura K., 2017. Mulching type-induced soil moisture and temperature regimes and water use efficiency of soybean under rain-fed condition in central Japan. *International Soil Water Conservation Res.*, 5, 302-308.
- Mulumba L.N., Lal R., 2008. Mulching effects on selected soil physical properties. *Soil Till. Res.*, 98, 106-111.

## Modeling effects of straw mulching on soil water and temperature regimes in rainfed soybean field of central Japan

M.A. Kader<sup>1\*</sup>, K. Nakamura<sup>1</sup>, M. Senge<sup>2</sup>, S. Kawashima<sup>1</sup>

<sup>1</sup>Graduate School of Agriculture, Kyoto University, Kyoto, 606-8502, Japan.

<sup>2</sup>Faculty of Applied Biological Sciences, Gifu University, Gifu City, 501-1112, Japan.

\*corresponding author: [kader@rda.gov.bd](mailto:kader@rda.gov.bd)

### Introduction

Mulching materials influence on soil environment by modifying moisture and temperature regimes that enhance the suitable plant growing conditions in the dryland areas (Kader et al., 2017). To assess these altered growing conditions, numerical studies are required under various crops and climates. HYDRUS-1D is a popular model based on Richards equation (Šimůnek et al., 2013) which can simulate soil water and heat as well as nutrient dynamics. Optimum selections of boundary condition and soil hydraulic parameters ( $\theta_r$ ,  $\theta_s$ ,  $\alpha$ ,  $n$  and  $K_s$ ) are critical for simulations using HYDRUS-1D under mulching. Although soil moisture simulations by HYDRUS under plastic film were done by many studies, there is no research related to straw materials effects on soil water and heat as well as soil water consumption. In this study, the water retention function of straw material is introduced into a numerical model to consider the effect of mulching. A new strategy, that is adopted, is to add a layer of straw material, optimize the hydraulic parameter of straw mulching and validate with field data of soil moisture and temperature regimes within soil rooting zone for two consecutive years. Moreover, we focus the effects of straw mulching on soil water consumption and soil moisture extraction patterns compared to bare soil in the rainfed soybean fields of central Japan using numerical simulations.

### Materials and methods

Field experiments were conducted at central Japan (Gifu Prefecture) during two years in a sandy loam soil for cultivating of rainfed soybean (*Glycine max*) with two treatments of rice straw mulching ( $0.5 \text{ kg m}^{-2}$ ) and no-mulching. Numerical simulations of water and heat flow were performed for the periods of 12 June to 27 August (77 days) in 2015 and 5 May to 14 August (101 days) in 2016. Relevant climatic data like air temperature, rainfall, solar radiation, relative humidity and wind speed were measured for both years. The soil moisture content was measured hourly at 5, 15 and 25 cm soil depths from each treatment using TDR probes and hourly soil temperature recorded from four (0, 5, 15, 25 cm) soil depths by thermocouple sensors. The soil physical properties like water retention function, soil texture, bulk density were analyzed at laboratory for the soil profile of 0–30 cm at an interval of 10 cm and van Genuchten-Mualem model was used to get soil hydraulic parameters. Numerical simulations were performed using HYDRUS-1D to solve the soil water and heat flow (Šimůnek et al., 2013) where Levenberg–Marquardt method is used for inverse optimization and Feddes model is used to analyze the root uptake functions. Input parameters were imposed by daily data of rainfall, air temperature, net radiation and potential evapo-

transpiration. We optimized the soil hydraulic and thermal properties parameters of soil layers

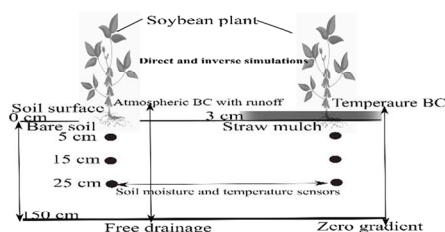

Figure 1: Conceptual diagram of HYDRUS-1D simulations including boundary conditions.

by inverse solution and trial-error approaches for best fitting of monitored soil moisture and temperature data. Afterward, consider a layer of straw mulch at 0-3 cm and calibrated  $\theta_r$ ,  $\theta_s$ ,  $\alpha$ ,  $n$  and  $K_s$  for straw mulching which were validated with different treatments and years by both inversion procedure and trial-error approaches. The effects of straw mulching were analyzed by estimating soil water consumption and moisture extraction from measured and simulated data. Statistical indicators like  $R^2$ , MAE and RMSE are used to analyze the performance of model.

### Results and discussion

The shape parameters ( $\alpha$  and  $n$ ) of van Genuchten model and hydraulic conductivity ( $K_s$ ) are largely influenced for straw layers than the soil layer. Modeling study showed that straw mulching preserved higher soil water of three (0-10, 10-20 and 20-30 cm) layers in the effective soil rooting zones of soybean compared to bare soil. There was a good agreement between observed and measured soil moisture and temperature at 5, 15 and 25 cm soil depths for both years. The RMSE and  $R^2$  values of simulated soil moisture and temperature at 5, 15 and 25 cm depths were acceptable ranged for both model calibration and validation periods. Thermal properties of soil were optimized by inverse solutions and soil temperature was simulated with the measured data of two treatments which exhibited good agreement for straw than bare soil. The daily soil temperature at different depths was significantly higher with greater fluctuations in the bare soil than the straw mulching. Both measured and simulated daily soil water consumptions were reduced by straw mulching for two years compared to no mulching.

### Conclusion

The model performed well in predicting the coupling of soil water and heat flow regimes of straw mulch, which can be used to enhance hydro-thermal environments of soil for increasing crop yields. The results of simulations can be useful for designing optimum water and temperature management of straw mulching field in rainfed cultivations.

### References

- Kader, M.A., Senge, M., Mojid, M.A., Ito, K., 2017. Recent advances in mulching materials and methods for modifying soil environment. *Soil Till. Res.*, 168, 155–166. doi:10.1016/j.still.2017.01.001
- Šimůnek, J., M. Šejna, A., Saito, H., Sakai, M., Genuchten, M.T. Van, 2013. The HYDRUS-1D Software Package for Simulating the Movement of Water, Heat, and Multiple Solutes in Variably Saturated Media, Version 4.17, HYDRUS Software Series 3, 343.

## Effect of Conservation Soil Tillage and Nitrogen Fertilization on Selected Soil Properties and Crop Productivity

Danijel Jug<sup>1\*</sup>, Irena Jug<sup>1</sup>, Márta, Birkás<sup>2</sup>, Vesna Vukadinović<sup>1</sup>, Jerzy Lipiec<sup>3</sup>, Bojana Brozović<sup>1</sup>, Boris Đurđević<sup>1</sup>

<sup>1</sup> *University of J.J. Strossmayer, Faculty of Agriculture in Osijek, Vladimira Preloga 1, Osijek, Croatia*

<sup>2</sup> *Szent Istvan University, Faculty of Agricultural and Environmental Sciences, Gödöllő, Páter K. u. 1, H-2103 Gödöllő, Hungary*

<sup>3</sup> *Institute of Agrophysics, Polish Academy of Sciences, P.O. Box 201, ul. Doswiadczalna 4, 20-290 Lublin, Poland*

\* corresponding author: [djug@pfos.hr](mailto:djug@pfos.hr)

### Introduction

Conservation soil tillage practise is different and specific for every European country mainly because of different agroecological conditions, different acceptance of new scientific approaches and technological innovations, and of course because of different approaches to soil tillage systems. However, in most of the countries conservation tillage is still not accepted in proportions which are to be expected according to their natural conditions and possibilities. Old and traditional paradigms include statements that implementation of conservation soil tillage can be successful only on high quality soils and only under favourable weather conditions. Nevertheless, conservation soil tillage can express its full potential even on unfavourable soil types, especially in climatically unfavourable years, and can also largely mitigate the unfavourable aspects of conventional tillage systems based on ploughing (Jug et al., 2017). By implementing proper approach, conservation soil tillage can be the most efficient soil management practice for obtaining high (optimal) yields, and at the same time conserve soil and water resources (Chaghazardia et al., 2016). The main aim of this study, which was conducted under different agroecological conditions, was to test the effects of different tillage systems on some physical soil properties along with testing different nitrogen fertilization rates on productivity of maize and winter wheat crops.

### Material and Methods

Stationary field experiment was established in 2009 at two experimental stations on two different soil types in eastern Croatia. Location Cacinci (Long. 17.86336 E, Lat.45.61316 N) Stagnosols soil type and location Magadenovac (Long. 18.70648 E, Lat.45.55555 N) Gleysols soil type. Data presented in this manuscript was collected in the years 2013–2014. Maize was sown in spring of 2013 and winter wheat in autumn of same year. As the main experimental factor, five different soil tillage treatments were applied: CT-conventional (based on mouldboard ploughing, up to 30 cm), and four conservation soil tillage treatment (CST); SS-subsoiling (35-40 cm), CH-chiselling (up to 25 cm), DH-disk-harrowing (10-15 cm), NT-no-till. The second experimental factor was fertilization with three different nitrogen rates: N1-reduced by 30% according recommendation; N2-according recommendation and N3-increased by 30% according recommendation. The experiment was set up on RCBD design with four repetitions. The size of basic experimental plot for each individual tillage treatment was 600 m<sup>2</sup> and 195 m<sup>2</sup> for each individual fertilization treatment. Except for the soil tillage and nitrogen fertilization, all the other technology sequences: sowing, P and K fertilizing, pests control, machinery and equipment used were identical in all the treatments. From all the investigated soil properties, measurement of bulk density and penetration resistance should be particularly mentioned. For crop productivity measurement we used the following indicators: crop residues, crop biomass, yield components and yields. All collected data were statistically

processed by package Statistica v.10 (StatSoft, Inc., 2011) in order to establish correlation of researched parameters for soil tillage treatments and nitrogen fertilization.

### Results and discussion

At the Cacinci location significant positive correlations have been found between soil tillage depth and bulk density for CH-CST ( $r=0.499^*$ ) and NT-CST ( $r=0.501^*$ ) and very significant positive correlation for CT ( $r=0.628^{**}$ ). As expected, bulk density and soil moisture were negatively correlated. At the Magadenovac location, bulk density and soil moisture were, unexpectedly, in positive but not in significant correlation. DH-CST resulted with significant positive correlation between soil tillage depth and compaction, expressed as bulk density ( $r=0.527^*$ ), with soil moisture content ( $r=0.477^*$ ). On both locations bulk density was higher with depth ( $\rho_v=1.43-1.64 \text{ g cm}^{-3}$ ). Measurement of soil penetration resistance has shown an unusual state of soil compaction during both vegetation years (wet and dry soil conditions). The measured penetration resistances ranged from 1 to 9 MPa for a very short period of time, and very large differences in soil compactness were also measured with depth during the same measurement period. Higher values of penetration resistance were measured on surface layer, and lower in deeper layers of soil (with a difference of 3 to 5 MPa). Crop biomass was significantly influenced by weather conditions (the highest values were measured in the period of increased humidity), nitrogen fertilization (increased fertilization rate resulted in intensive growth of vegetation organs) and soil tillage treatment (the highest values were measured on the SS and CH-CST). According to the results obtained for maize in the first year of research (2013) average yields were significantly different between research sites, with higher yields achieved on location Magadenovac (gleysols soil type) and lower on location Cacinci (stagnosols soil type). The difference was at the level of 30%. The highest average yields of maize were recorded on the SS-CST, which compared to the CT was at a significant level. The lowest yields of maize were recorded on the NT treatment (significant lower in comparison with CT). Average winter wheat yields (in 2014) indicate a statistically significant difference between research sites, and higher yields were achieved on gleysols soil type. Differences between soil tillage treatments were not significant, although there was a tendency of yield decrease with the decrease in depth, but also with the reduction of soil tillage intensity. Measured yield on nitrogen fertilization treatment were, as expected, highest on N3 treatment but without any significant difference in comparison to N2 treatment. Differences of nitrogen treatments on significant level were found only between locations and higher yields were recorded on gleysols soil type.

### Conclusion

According to the presented results, all of investigated conservation soil tillage treatments can be highly recommended for maize and winter wheat production. This statement is especially evident in dry conditions, when conserving effect of soil tillage provide significantly more water for crops. All main investigated soil parameters (bulk density, penetration resistance) and indicators of crop productivity (crop residues, crop biomass, yield components and yields) were highly influenced by agroecological conditions (mainly weather conditions and soil type).

### References

- Chaghazardia, H.R., Jahansouza, M.R. Ahmadi, A., Gorji, M., 2016. Effects of tillage management on productivity of wheat and chickpea under cold, rainfed conditions in western Iran. *Soil Till. Res.*, 162 (2016) 26–33. DOI: 10.1016/j.still.2016.04.010.
- Jug D., Jug I., Vukadinović V., Đurđević B., Stipešević B., Brozović B., 2017. Conservation soil tillage as a measure for climate change mitigation. University textbook (in Croatian). Croatian Soil Tillage Research Organization, Osijek, Croatia, pp. 176. ISBN: 978-953-7871-61-1.

## Using the Hydroseeding Method to Establish Plant Vegetation Cover in the Eroded Areas of Burdur in Turkey

E. Alim<sup>1\*</sup>, A. Okudan<sup>2</sup>, S. Basaran<sup>3</sup>, H. Ibrahim Yolcu<sup>4</sup>, M. Terzi<sup>2</sup>

<sup>1</sup>Bati Akdeniz Agricultural Research Institute, Antalya, Turkey

<sup>2</sup>Regional Forestry Directorate, Antalya, Turkey

<sup>3</sup> Regional Forestry Directorate, Erzurum, Turkey

<sup>4</sup>Bati Akdeniz Forestry Research Institute, Antalya, Turkey

\* corresponding author: alimesra@hotmail.com

### Introduction

Turkey is a country with a lot of erosion areas. Hydroseeding is used mostly to check soil erosion and to ensure soil covering. Hydroseeding provides protection against soil loss by bringing together seed, mulch, adhesive and other components. Hydroseeding can be used in banks of rivers, reservoirs, and barren lands to avoid topsoil depletion and even for residential plots or for commercial areas. The process includes the use of a seed, fertilizer, wood fiber and water mixture, which is combined in hydroseeding equipment and then sprayed over areas where it is required. Any type of seed can be used, ranging from grass seeds to wild herbs and even seeds of woody plants. Hydroseeding is a planting process which utilizes a slurry of seed and mulch. The slurry is transported in a tank, either truck or trailer mounted and sprayed over prepared ground in a uniform layer. Hydroseeding is an alternative to the traditional process of broadcasting or sowing dry seed. It promotes quick germination and inhibits soil erosion (Oakes, 1958).

This research has aimed to contribute to the erosion controlling practices under effect of erosion in Burdur region. The aim of this project is to contribute the studies of erosion control on fields, under erosion conditions in Burdur Region using a few herb species and hydroseeding method at different aspects, besides remediation of spoilt ecosystem, and struggle with desertification.

### Material and method

The study has been conducted in Burdur-Bügdüz region, by using Hydroseeding method on *Astragalus micropterus* Boiss, *Amelanchier parviflora*, *Berberis crataegina*, *Convolvulus compactus* L. species at different aspects.

This study carried out in Bügdüz-Burdur Erosion Region, which has been under strong effects of water and wind erosion and failed with classical erosion control methods. Land observation about seed germination performed at processed parcels with hydroseeding and without hydroseeding. Study has been established as separately divided randomized block experimental design with 3 replications, on a total area of 600 m<sup>2</sup> (for each species 1.5 m wide and 10 m long trial plots) at both North and South aspects where the slope is greater than 60°.





Hydroseeding applications

### **Results and discussion**

As a result, the Hydroseeding applications at autumn and spring were unsuccessful, in terms of seed germination. At the autumn application, applied material dragged down the slope due to the heavy rains. No germination was observed in those of spring. But at the end of the application, pre-existing perennial plants at the area have been observed more advanced under the effect of mulch materials and fertilizers.



After Hydroseeding applications

### **Conclusion**

The effects of mulch material, fertilizer and water have been observed to be higher in soil-borne bodies of annual and perennial plants that were already in the fields.

### **References**

OAKES, H., 1958. Turkey Territories. T.Y.Z.M.B. Publication, Issue: 18, İZMİR.

## The influence of main and cover crops in organic farming on soil water-stable aggregate stability in Estonia

M. Are<sup>1\*</sup>, T. Kaart<sup>2</sup>, A. Astover<sup>1</sup>, K. Kauer<sup>1</sup>, A. Selge<sup>3</sup>, E. Reintam<sup>1</sup>

<sup>1</sup> *Estonian University of Life Sciences (EMÜ), Institute of Agricultural and Environmental Sciences (PKI), Chair of Soil Science, Tartu, Estonia*

<sup>2</sup> *EMÜ, Institute of Veterinary Medicine and Animal Sciences, Chair of Animal Breeding and Biotechnology, Tartu, Estonia*

<sup>3</sup> *EMÜ, PKI, Chair of Crop Science and Plant Biology, Tartu, Estonia.*

\*corresponding author: [mihkelare@gmail.com](mailto:mihkelare@gmail.com)

### Introduction

The popularity of organic farming in Estonia has been steadily increased since millennium and now its proportion within agricultural land is one of the highest in EU countries. This is caused by: (i) the EU policy by subsidizing organic farming, (ii) the increased living standard of Estonians by enabling to afford more expensive agricultural products and (iii) the consumer awareness of healthier pesticide free food. Therefore, the popularity of organic farming rises also in the future. However from an agricultural point of view, organic farming does greatly differ from conventional farming due to lack of synthetic fertilizers. This means fewer resources are available for soil input and greater emphasis must be put on crop rotation, but also to the use of cover crops and farmyard manure, to ensure a sustainable soil management. This all affects the soil structure, which is held up by different sized soil aggregates. Soil structure is important because it is directly affecting other soil physical, chemical and biological properties. From an agricultural point of view especially valuable are those aggregates that have the ability to withstand external stress caused by wetting, therefore being water-stable. However the aggregation process is complex and different studies can give controversial results due high amount of variables. Due the high proportion of organic land use and the poorly studied aggregation process in organic farming at Estonian pedo-climatic conditions, this study was conducted to study the effects of different main crops with and without cover crops and manure applications especially on soil water-stable aggregate (WSA) stability as it is closely related with other soil physical properties.

### Material and method

The study was conducted in Estonia, Tartu in 2012–2015 on an organic farming experiment, established in 2008 on sandy loam *Albic Stagnic Luvisol*. The crop rotation, in four replications, consisted: (i) potato → (ii) barley with red clover under sown → (iii) red clover → (iv) winter wheat → (v) pea. The experiment was divided into three different treatments: T0 – control, without cover crops and farmyard manure; T1 – cover crops; T2 – cover crops with farmyard manure (40 Mg ha<sup>-1</sup>). For cover crops rapeseed and rye were used before barley, potato and pea. Soil samples were taken in spring from 5–10 cm (topsoil) and 30–35 cm (subsoil). The WSA was determined by wet sieving method (Kemper and Rosenau, 1986) with 0.25 mm sieve opening, which has been modernized and slightly modified by Eijkelkamp. Statistical significance on all tests set on 95%.

### Results and discussion

The results showed that WSA was significantly ( $p < 0.01$ ) affected by years, depth and different treatment, although main crops ( $p = 0.167$ ) did not affect the WSA. If topsoil and subsoil were analyzed separately, results revealed, that main crops do affect WSA. Although results, during the study period, are controversial: in topsoil WSA was lowest in potato (57.1%) while in subsoil it was the highest (51.4%), in both cases the differences compared

with other main crops, were significant. This contrast in potato, compared with other main crops, was most likely caused by the increased number of tillage operations. In topsoil the more intensive tillage caused more disturbances in soil structure and therefore reducing WSA, while in subsoil it helped to loosen the soil. This study also found between WSA and soil bulk density a moderate significant negative (-0.55) correlation and between WSA and air-filled porosity a weak significant positive (+0.26) correlation of which the last is similar to the weak significant positive correlation (+0.27) between WSA and soil organic carbon. Additionally, a noticeable main crop was pea, in topsoil it had the highest (61.7%) and in subsoil it had the second highest (48.7%) WSA. Although results in topsoil on winter wheat (61.6%) and barley (61.5%) and in subsoil red clover (48.0%) and barley (47.7%) were similar and did not significantly differ from pea. The mean WSA from all main crops did highly differ between years, being lowest in 2014 (50.3%) and highest in 2012 (58.2%), the same pattern occurred in both depths. This most likely was caused by the differences between annual temperature and precipitation variations in different years, which in turn affects the plant growth and by this the soil physical properties. The study also found that the sole use of cover crops, especially in subsoil, without additional farmyard manure, significantly decreased WSA even when compared with control. The reason for this could be the additional tillage operations needed to grow cover crops, which could counteract the benefits.

### **Conclusion**

Aggregation process is complex. Although some main crops can be more beneficial than others, especially in certain depths, the differences in most cases are not significant. Additionally the effects are not constant over the years. Also the use of cover crops without manure applications seems not beneficial to the WSA. Therefore, further research on main and cover crop effects on WSA in a longer time scale are needed.

### *References*

Kemper, W.D., Rosenau, R.C., 1986. Aggregate stability and size distribution. In: Klute, A., Campbell, G.S., Jacson, R.D., Mortland, M.M., Nielsen, D.R. (Eds.), *Methods of Soil Analysis. Part I*. ASA and SSSA, Madison, pp. 425-442.

## Timing, tillage and temperature determine the effect of soil structure liming on aggregate stability

Jens Blomquist\*, Kerstin Berglund

\*Corresponding author: jens.blomquist@slu.se

*Department of Soil and Environment, Swedish University of Agricultural Sciences, PO Box 7014, SE-750 07 Uppsala, Sweden*

### Introduction

Soil aggregate stability can be influenced by applying different forms of lime, e.g. calcium carbonate ( $\text{CaCO}_3$ ), oxide ( $\text{CaO}$ ) or hydroxide ( $\text{Ca(OH)}_2$ ). The mode of action is probably a result of both chemical form and the calcium ion per se. When  $\text{CaO}$  or  $\text{Ca(OH)}_2$  encounters clay, different reactions take place on microaggregate level. These include cation exchange, flocculation and agglomeration, carbonation and cementation through pozzolanic reactions.  $\text{CaCO}_3$  can also influence aggregate stability, probably through cation exchange and flocculation, but not through carbonation and pozzolanic reactions. The reactions with clay increase aggregate stability, giving a more resilient soil that is resistant to stresses such as slaking and crusting. Structure liming can also result in finer aggregate size distribution in the seedbed (Blomquist et al., 2017).

There are also environmental benefits from improved aggregate stability. Aggregates that do not disintegrate when waterlogged, but remain intact, are less prone to losing particulate phosphorus bound to clay surfaces, losses that contribute to eutrophication. In the period 2010-2016, approximately 40,000 hectares in Sweden were structure-limed with blends of  $\text{CaCO}_3$  and  $\text{Ca(OH)}_2$  in order to reduce phosphorus losses. This measure qualified for a national environmental subsidy of up to 40-50 percent of the cost.

The recommended rate of lime application increases with increasing clay content and is reasonably well-known. Less is known about combined soil management, e.g. timing, soil tillage, cultivation depth and optimal aggregate size distribution. Soils are often more friable and workable in early rather than late autumn, resulting in a finer tillage. Soil temperatures are also higher in early (August) than late (September) autumn, providing better conditions for pozzolanic reactions, which are temperature-dependent. Date of spreading can therefore be a proxy for the effect of structure liming on aggregate stability.

### Material and method

Structure lime as the commercially available product Nordkalk Aktiv Struktur was spread at a normal application rate of  $8 \text{ t ha}^{-1}$  in four field trials on two different occasions in autumn 2015. The product contained approximately 80 percent calcium carbonate ( $\text{CaCO}_3$ ) and 20 percent calcium hydroxide ( $\text{Ca(OH)}_2$ ). On average for the four trials, the first date of spreading was 20 Aug (early) and the second was 14 September (late), giving an interval between early and late liming of 25 days. Immediately after each application of structure lime, the plots were cultivated to normal depth (12 cm) by 2-3 passes with tine and disc cultivators in a similar way on the two occasions. Directly after cultivation operations, working depth and aggregate size distribution of the tillage (eight different classes) were measured.

Structure lime was spread in the gap between harvest of the preceding crop (winter oilseed rape; harvested 2015) and drilling of the following crop (winter wheat, harvested 2016). Soil characteristics at the four different trial sites are summarised in Table 1.

**Table 1.** Characteristics of topsoil (0-20 cm) at the four trial sites. Sampled in August 2015 prior to spreading of lime

Trial site	pH <sub>H2O</sub>	Ca-AL, <sup>*</sup> mg kg <sup>-1</sup>	Soil organic matter, %	Clay (<2 µm), % of material <2 mm
Krageholm	6.3	2660	3.2	34
Krapperrup	7.4	3310	3.7	21
Råbelöf	6.6	3610	4.1	41
Kornheddinge	7.8	4200	3.0	24

<sup>\*</sup>Extraction with 0.1 M ammonium lactate + 0.4 M acetic acid, pH 3,75

Temperature sums were recorded at nearby climate/weather stations from early liming until one month after late liming.

Following harvesting of the winter wheat crop and shallow tillage in 2016, the worked soil was sieved and aggregates in the 2-5 mm average diameter fraction were sampled. These aggregates were subjected to two rainfall events in a rain simulator, with 24 hours between events. The turbidity of collected leachate was measured after each rain event, to estimate aggregate stability.

### Results and discussion

The aggregate size distribution at the two liming dates was very different. The tilth was much finer after early liming, with approximately 44 percent of aggregates in the two smallest size fractions (8-16 mm and <8 mm), while the corresponding proportion at late liming was only 25 percent. The two coarse fractions (>64 mm, 32-64 mm) constituted less than 33 percent at early liming and more than 57 percent at late liming, i.e. the tilth was coarser on the latter occasion. The finer tilth at early liming probably allowed the structure lime to mix better with the soil and provided a larger surface area for contact between soil and lime. Early liming also had a temperature advantage compared with late liming. The temperature sum between early and late liming was just under 400 degree-days, with a base temperature of 4 °C, at which pozzolanic reactions are hampered (Bell, 1996).

Turbidity (after sedimentation of material coarser than clay) was significantly lower (by 10 percent) with early liming compared with late. The finer tilth combined with the higher temperature sum probably partly explain the increased aggregate stability at early liming. Winter wheat yield was 3 percent higher after early compared with late liming, but this difference was not statistically significant.

### Conclusions

Early spreading of structure lime (August) coincided with a finer tilth in the soil and higher soil temperatures compared with late spreading (September). The more favourable conditions resulted in a significant decrease in turbidity, indicating increased aggregate stability. Early liming is therefore recommended, as it increases the efficiency and return on investment from structure liming.

### References

- BELL, F.G. 1996. Lime stabilization of clay minerals and soils. *Engineering Geology*, 42, 223-237.
- BLOMQUIST, J., SIMONSSON, M., ETANA, A. & BERGLUND, K. 2017. Structure liming enhances aggregate stability and gives varying crop responses on clayey soils. *Acta Agriculturae Scandinavica, Section B—Soil & Plant Science*, 1-12.

## The legacy effect of greenwaste compost application on crop performance in a long running UK field experiment (Poster Presentation)

D. Clarke\*, N. Morris and E. Stockdale

NIAB, Morley, Wymondham, Norfolk. NR18 9DF, UK

\*corresponding author: [david.clarke@niab.com](mailto:david.clarke@niab.com)

### Introduction

The New Farming Systems (NFS) soil amendments study is a long term study at Morley Farms, Norfolk, UK on an Ashley series (sandy loam) soil. The experiment is delivered through NIAB TAG, supported by The Morley Agricultural Foundation and the JC Mann Trust and guided by an independent steering committee. The aim of the experiment is to investigate the benefits and legacy effect of organic amendments on crop performance and soil physical, chemical and biological properties. This paper presents findings on the impact of four years (2008-2011) of 35t ha<sup>-1</sup> greenwaste compost (referred hereafter as compost) application on wheat yields and soil organic matter (SOM). Wheat yields were higher for 7 out of the 10 years in plots receiving compost (*cf.* continuous wheat without compost), with a positive yield response still seen 6 years (2017) after the final compost application. Compost application has also given a recordable increase in SOM on these sandy loam soils.

### Material and Methods

In autumn 2007 the amendment trial was established at Morley, Norfolk, consisting of 3 rotations with and without 35t ha<sup>-1</sup> of compost (applied annually between 2008 and 2011) giving a fully factorial design made up of 6 treatments. The soil is a stagnogleyic argillic brown earth (Ashley Series) with sandy loam topsoil texture. The entire trial uses a disc and/or tine shallow non inversion (c.10-15cm) cultivation approach. Over winter, soil samples are taken and sent for laboratory analyses of SOM (0-10 and 10-20cm), available soil nutrients (P, K, Mg) (0-10cm) and soil mineral nitrogen (SMN) (0-60cm (post-harvest)). The laboratory testing practice for SOM switched during the study from wet oxidation (2011-2013) to loss on ignition (2014-2016). Yield is measured using a Sampo plot combine with a minimum of one full cut per plot (2009 was hand harvested due to lodging). This paper presents the long-term results for yield (t ha<sup>-1</sup>) and relative yield (%) for the continuous wheat rotation (mixture of spring and winter varieties) with and without compost. SOM data are presented as a % of dry matter and a relative % (*cf.* continuous wheat without compost).

### Results and discussion

Across all years (omitting 2009 due to different harvesting method) the use of compost resulted in a significant mean yield increase of 6% (l.s.d 4.1%) in a continuous wheat rotation, with a positive yield response in seven out of the ten years (*Figure 1*). Yield responses of 11% and 10% in 2016 and 2017 respectively demonstrates a positive legacy effect which has lasted up to 6 years after the last compost application. In part, this is likely to be a response to increased soil nutrient content associated with amendment use. In 2016 extractable phosphorus, potassium and magnesium (0-10cm) were higher in the compost plots than those without compost. Increased levels of SOM have also been observed following the application of 4 years of 35 t ha<sup>-1</sup> of compost (*Table 1*). Some caution must be taken when interpreting the SOM data due to the considerable variation across years i.e.

ranging from 2.3% to 5.2% in the compost treatment; this variation may be a result of sampling inconsistencies (e.g. different levels of residue in the sample), variations in trash distribution from cultivation, or variability resulting from laboratory analysis. SOM is important for sustaining soil fertility, improving structural resilience, improving aeration, increasing infiltration rates and allows the soil to store more water (Morris *et al.* 2010). In 4 out of the 5 years sampled SMN in plots with compost (*cf.* without compost) was less than 15 kgN/ha higher. All treatments receive optimum N fertilizer rates for yield (220kgN/ha for winter wheat) therefore this small increase in SMN is unlikely to affect yield considerably.

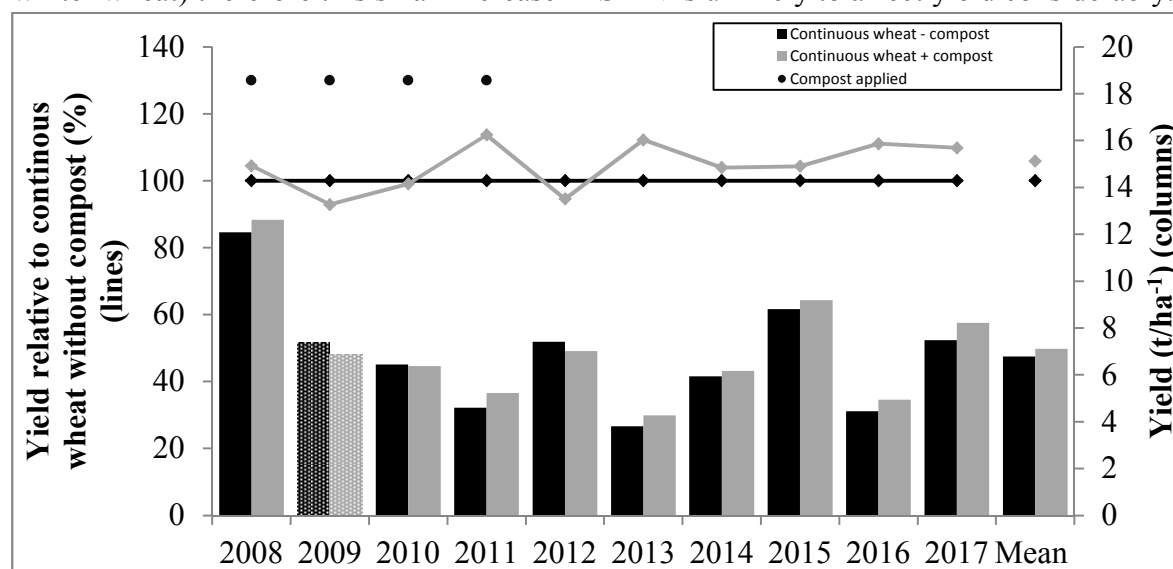

Figure 1. Yields (%) for the continuous wheat with compost relative to continuous wheat without compost (line and points) and yield ( $t/ha^{-1}$ ) for the continuous wheat with and without compost treatment (columns). Compost was applied annually from 2008 until 2011. Mean excludes 2009 due to different harvesting method

Table 1 Soil Organic Matter (% of dry matter (0-10cm)) and relative increase compared with the use of compost in a continuous wheat rotation

Treatment	SOM % of dry matter (0-10cm)						
	2011	2012	2013	2014	2015	2016	Mean
Continuous wheat without compost	1.7	1.4	4.1	2.5	3.4	2.5	2.8
Continuous wheat with compost	2.3	2.8	5.2	2.9	4.8	3.2	3.8
Increase in SOM with compost application (%)	35	100	27	16	41	28	41

## Conclusions

Findings suggest that repeated applications of  $35t\ ha^{-1}$  compost can significantly improve yields in a continuous wheat rotation for at least 6 years after the final compost application. This yield response is likely a result of a combination of higher levels of available nutrients (phosphate, potassium and magnesium) and benefits from increased SOM.

The authors would like to acknowledge the support of The Morley Agricultural Foundation and the JC Mann trust for their support of the New Farming Systems Project.

## References

- Morris, N., Miller, P., Orson, J. and Froud-Williams, R. (2010) The adoption of non-inversion tillage systems in the United Kingdom and the agronomic impact on soil, crops and the environment – A review. *Soil and Tillage Research* **108**: pp. 1-15.



## Least Limiting Water Range Under Integrated Production Systems -ICL and ICLF.

K. M. V. Cavalieri-Polizeli<sup>1\*</sup>, D. M. do Nascimento<sup>1</sup>, A. H. da Silva, N. Favaretto<sup>1</sup>

<sup>1</sup>Federal University of Paraná, Soils and Agr. Eng. Department, 80035-050 Curitiba, Brazil

\*corresponding author: karina.cavalieri@ufpr.br

### Introduction

The degradation of the pastures culminates with the rupture of the natural resources. The pastures recovery and the soil physical characteristics improvement are achieved through the inversion of this degradation process, as it happens with integrated systems. The objective of this study was to evaluate the least limiting water range (LLWR) in Integrated Crop-Livestock (ICL) and Integrated Crop-Livestock Forestry (ICLF).

### Material and method

The study was carried out at Fazenda Modelo-IAPAR, Ponta Grossa-PR unit. The soils found in the ICL area are the Red Latosol and the Haplic Cambisol, and in the ICLF area is the Red Latosol, both of them with loamy sand texture. The experimental design was a randomized complete block design, with two treatments and three blocks of variable size. The areas of ICL and ICLF were used for pastures conventional (extensive) and of low forage value. In 2006, the soils were tilled by plowing, disking and incorporation of 3 t ha<sup>-1</sup> of dolomitic limestone for the establishment of integrated systems. In the ICLF system, eucalyptus (*Eucalyptus dunnii*), red mastic (*Schinus terebinthifolius* Raddi) and grevillea (*Grevillea robusta*) were planted in single lines with a spacing of 14 m x 3 m, allocated transversely to the predominant slope for control of the runoff and for the displacement of machines and animals to be predominantly transverse to the direction of slope. The production areas were managed by the years under no tillage system. In November 2012, the following layers were sampled: 0.00-0.05; 0.05-0.10; 0.10-0.20 and 0.20-0.30 m with undisturbed soil samples to determine the LLWR (Silva et al., 1994).

### Results and discussion

The mean values of LLWR, were for ICL significantly higher at layers 0- 0.05 and 0.20-0.30 m and lower at layers 0.05-0.10 and 0.10-0.20 m. Some negative effect on LLWR came from penetration resistance (PR), reducing the LLWR at 0.00-0.05 m layer for ICL and 0.05-0.10 and 0.10-0.20 m layer for ICLF, presenting alert soil bulk density ( $\rho_{BA}$ ). In general, the LLWR was higher in ICL compared to ICLF, in which the ICLF had higher reductions in higher bulk density ( $\rho_B$ ). Besides the negative effect of PR on reducing the LLWR in the ICLF, corroborating to the detriment of the soil physical quality in this system, this reduction has not been abrupt. The variation of the LLWR as a function of  $\rho_B$  showed that in range of the values of  $\rho_B$  obtained, both systems were not close to the critical soil bulk density ( $\rho_{BC}$ ) (LLWR = 0). The  $\rho_{BC}$  indicates more restrictive physical conditions to the development of plants (Silva et al., 1994). Then, these results can indicate that the studied systems keep the soil physical quality. Despite worst performance of the ICLF, it may be related to the forest component, which generates shading of certain areas, and can reduce the soil cover in these areas, by the so-called shading effect, leaving it unprotected. The results obtained in this study corroborate Silva et al. (2015) who studied water and soil losses and nutrient concentration and losses in surface runoff, in the same study area, and concluded that losses were higher



throughout the study period evaluated in the ICLF system. In according to authors physical degradation in the 0.05-0.10 m layer may have influenced water and soil losses and consequent nutrient losses, indicating greater care in the integrated systems.

## Conclusion

The LLWR was considered adequate for the integrated systems ICL and ICLF. However, it was verified that the tree component adversely affected the soil physical quality in comparison to the ICL, mainly in the 0.05-0.10 m layer.

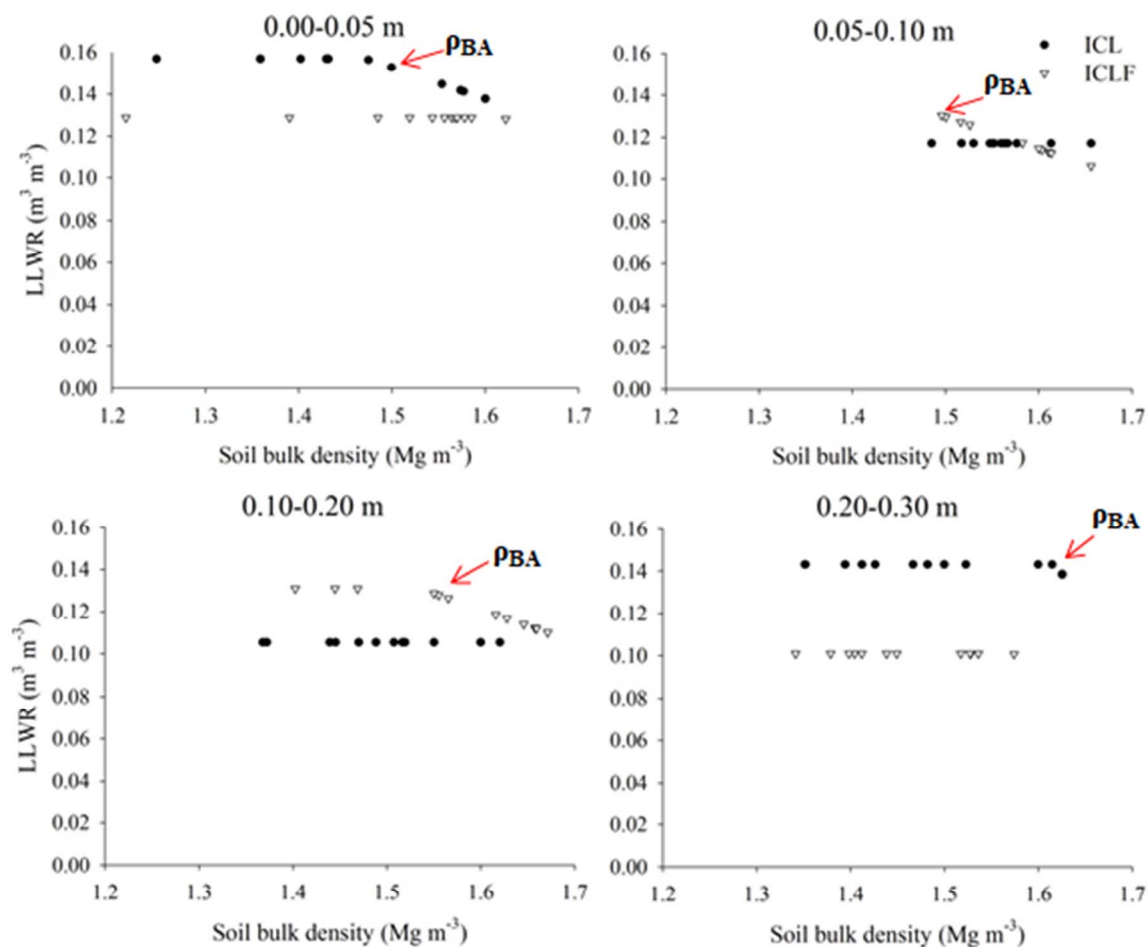

Figure 1: Least limiting water range (LLWR) affected by soil bulk density for ICL and ICLF in each soil layer,  $\rho_{BA}^*$ = alert soil bulk density.

## References

Silva AH, Favaretto N, Cavalieri KMV, Dieckow J, Vezzani FM, Parron LM, Cherobim VF, Marioti J, Neto HF. 2015. Atributos físicos do solo e escoamento superficial como indicadores de serviços ambientais. In: Parron LM, Garcia JR, Oliveira EB, Brown GG, Prado RB, (Eds), Serviços ambientais em sistemas agrícolas e florestais do Bioma Mata Atlântica. Brasília: Embrapa, p.71-83.

Silva AP, Kay BD, Perfect E. 1994. Characterization of the least limiting water range. Soil Sci. Soc. Am., 58, 1775-1781.

# Effects of long-term conversion tillage on least limiting water range and soil macrostructure of subsoil in North China Plain

Meng Tian<sup>1</sup>, Tusheng Ren<sup>1</sup>, Hu Zhou<sup>2</sup>, and Weida Gao\*<sup>1</sup>

<sup>1</sup>College of Resources and Environmental Sciences, China Agricultural University, Beijing China, 100193

<sup>2</sup>State Key Laboratory of Soil and Sustainable Agriculture, Institute of Soil Sciences, Chinese Academy of Sciences, Nanjing, China, 210008.

\*Corresponding author: weida\_gao@cau.edu.cn

## Introduction

North China Plain is an important grain production base in China, where the soil fertility declines following long-term intensive cultivation systems (two seasons and moldboard plough) due to decreasing soil organic matter (SOM) content. Therefore, conservation tillage management is employed in this area recently. However, the adverse effects of conservation tillage on physical properties of subsoil layers were also observed, such as soil compaction and higher penetration resistance that impede root elongation into deep soil layer (Muñoz-Romero et al., 2010). Soil compression changes the pore morphology and least limiting water range (LLWR). In this study, the objective was to investigate the changes of LLWR and soil macrostructure of subsoil after conversion from conventional to no tillage in North China Plain.

## Materials and methods

The field experiment was started in 2001 in Hebei Province, China. The average annual temperature and precipitation are 12.5°C and 494 mm in this area, respectively. The content of sand, silt and clay of the topsoil (0-20 cm) are 13.8%, 66.3%, and 19.9%, respectively. Three tillage practices were used in this study, including no-tillage (NT), rotary tillage (RT) and moldboard plow with maize residue (CT). Soil samples were collected from 5-10 cm and 15-20 cm layers in June 2016 at winter wheat harvest. The intact soil cores were sampled with stainless rings (5 cm high and 5 cm in diameter) and were divided into three groups for determining soil water release curve (SWRC), penetrometer resistance and X-ray CT analysis. The image processing was completed with the software ImageJ 1.51k. The method proposed by da Silva et al. (1994) was used to calculate the LLWR.

## Results and discussions

Compared with RT and CT treatments, the bulk density was significantly greater in both soil layers ( $P < 0.05$ ). However, no obvious differences in soil bulk density between RT and CT treatments were observed (Table 1). For 5-10 cm layer, RT treatment yielded the greatest LLWR ( $0.20 \text{ cm}^3 \text{ cm}^{-3}$ ). There was no significant difference in LLWR between NT and RT. For 15-20 cm layer, the values of LLWR under RT and CT treatments were significantly greater than that under NT treatment.

The differences in pore morphology between the tillage treatments were visualized in 3D images (Fig. 1). The total porosity of 3D under three tillage treatments ranged from 9.6% to

21%. However, there were no significant differences in total porosity in each soil layer under three tillage treatments. Under NT treatment, large and round pores were observed, especially in 15-20 cm layer, which were probably biopores by earthworms and roots. In 5-10 cm layer, RT and CT practices create some cracks and fragmented pores.

**Table 1 Soil Bulk density ( $\rho_b$ ) and least limiting water range (LLWR) of subsoil layers under No-tillage (NT), rotary tillage (RT) and moldboard plow with maize residue (CT). Different lowercase letters indicate significant differences between the treatments ( $P < 0.05$ )**

Soil depth (cm)	$\rho_b$ (g cm <sup>-3</sup> )			LLWR (cm <sup>3</sup> cm <sup>-3</sup> )		
	NT	RT	CT	NT	RT	CT
5-10	1.32a	1.19b	1.22b	0.16b	0.20a	0.18ab
15-20	1.56a	1.50b	1.47b	0.03b	0.07a	0.08a

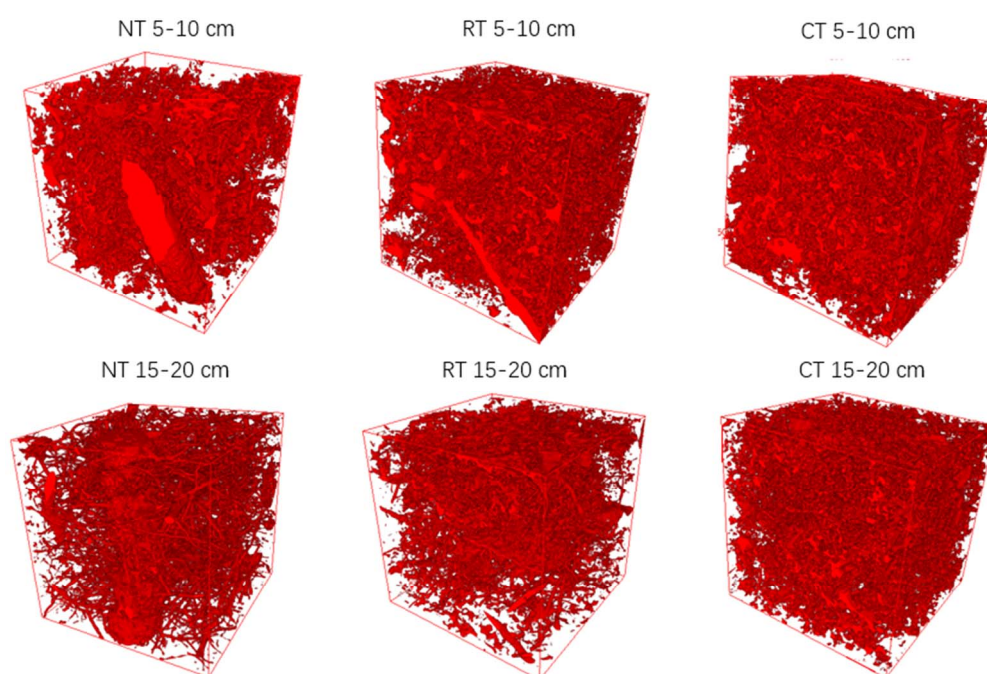

**Fig. 1. 3D porosity X-ray  $\mu$ CT visualizations of soil cores collected at two depths under No-tillage (NT), rotary tillage (RT) and moldboard plow with maize residue (CT)**

### Conclusion

The bulk density of subsoil layers increased following long-term no tillage, which contributed to a lower LLWR. However, larger biopores were observed under NT practices, which can provide the channels to plant roots for elongating into deeper soil to utilize more water and nitrogen

### References

- da Silva, A.P., Kay, B.D., and Perfect, E., 1994. Characterization of the least limiting water range of soils. *Soil Sci. Soc. Am. J.* 58:1775-1781.
- Muñoz-Romero, V., Benítez-Vega, J., López-Bellido, R.J., Fontán, J.M., and López-Bellido, L., 2010. Effect of tillage system on the root growth of spring wheat. *Plant Soil.* 326: 97-107.

## **Subsurface Banding vs. Surface Broadcasting of Poultry Litter Effects on Nutrient Losses to Runoff from a No-tillage Maize Cropping System.**

Dexter B. Watts\* and Thomas R. Way

*United States Department of Agriculture – Agricultural Research Service, 411 S. Donahue Dr. Auburn, AL 36832.*

\*corresponding author: [Dexter.Watts@ars.usda.gov](mailto:Dexter.Watts@ars.usda.gov)

### **Introduction**

Nutrient losses to surface water runoff from poor fertilization practices have been linked to water quality degradation. These losses have accelerated trophic levels of receiving waters of rivers, lakes, and streams, negatively impacting the aquatic ecosystems. Consequently, research is being developed on new technologies that can be implemented to increase nutrient retention in soil.

Phosphorus is the most critical nutrient posing a threat to eutrophication of freshwater (USEPA, 1996). There is evidence that the growing US animal industry is a contributor to eutrophication (USEPA, 2001), primarily through manure management. This has generated concerns in areas where animal production has become concentrated. For instance, the broiler industry which is highly concentrated in the southeastern US has come under increased scrutiny in recent years because the most common practice for poultry litter (PL) management has been to surface broadcast apply the litter on pastures and, to a lesser extent, cropland as a fertility source. Surface broadcasting PL concentrates nutrients at the soil surface, thereby significantly increasing P loss in surface water runoff (He et al., 2009). Previous, research has shown that incorporation of manure through tillage generally reduces the potential for P loss in runoff (Eghball and Gilley, 1999). However, this practice is not possible in a strict no-till system where tillage for incorporation would destroy soil structure and increase the susceptibility to erosion.

Subsurface applying manure by injecting slurry in subsurface bands has been shown to reduce N and P losses and increase yields (Baker and Lafen, 1982). However, subsurface band application equipment for dry manure such as PL is not presently available for widespread use. Recently, a prototype implement was developed to subsurface band-apply PL in soil (Way et al., 2013). Research is needed to evaluate the impact this implement has on reducing nutrient loss in surface water runoff under different management practices. Thus, the objective of this study was to evaluate the effectiveness of subsurface banding PL compared with the standard surface broadcasting practice in a maize (*Zea mays* L.) cropping system managed under no-tillage.

### **Materials and Methods**

The study was established on a hillslope with a uniform gradient of approximately 5-6% slope on a soil type common to the US Piedmont region (a region dominated by broiler production). The soil type was a Pacolet sandy loam (Fine, kaolinitic, thermic Typic Kanhapludults). Climate in this region is humid subtropical (mean precipitation is 1350 mm and mean temperature is 18 °C).

Experimental plots were laid out in a randomized complete block design with treatments being replicated in each of the triplicate blocks. Corn rows within each plot were planted perpendicular to the slope. Treatments consisted of surface banded PL, subsurface banded PL (3-5 cm below the surface), broadcasted PL, broadcasted commercial fertilizer (CF; urea and triple superphosphate [TSP] blend) and a nonfertilized control. Both the PL and CF treatments were

applied at a rate of 168 kg total N ha<sup>-1</sup>. For the CF treatment phosphorus was supplied as Triple Super Phosphate at 45 kg ha<sup>-1</sup> based on crop recommendations for the region. Rainfall simulations were conducted to create a 40-min runoff event. Runoff water samples were collected at 10 min intervals (0, 10, 20, 30, and 40 min) and analyzed for dissolved and total N and P concentrations.

### Results and Discussion

Sediment losses observed from this study were minimal. Differences between dissolved reactive P and total P were relatively low also suggesting that there was a minimal P contribution from sediment loss. Thus, most of the P loss from this study was in a dissolved form with a minor contribution coming from organic and sediment P loss. An evaluation of temporal changes over time showed that in general mean P losses were greatest shortly after runoff began and decreased over time. The greatest loss for dissolved reactive P, and total P occurred with surface broadcast PL application followed by, surface banded PL, broadcasted CF, and subsurface banded PL = control. These results suggest that subsurface banding PL to a 3-5 cm depth could greatly reduce the nutrient loss susceptibility by placing the litter P beneath the soil surface, thereby decreasing the interaction zone between the PL and surface water runoff. Reducing the interaction of litter P with surface water runoff in agricultural fields would not only reduce P loss; it would also increase the availability of P for future crops.

### Conclusions

Overall, data from this study suggest that subsurface band applying poultry litter can be used as a potential management practice in no-till crop production to reduce the susceptibility of P loss to surface water runoff.

### References

- Baker, J.L., Lafen, J.M., 1982. Effects of corn residue and fertilizer management on soluble nutrient runoff losses. *Trans. ASAE*, 25, 344–348.
- Eghball, B., Gilley, J.E., 1999. Phosphorus and nitrogen in runoff following beef cattle manure or compost application. *J. Environ. Qual.*, 28, 1201–1210.
- He, Z., Honeycutt, C.W., Tazisong, I.A., Senwo, Z.N., Zhang, D., 2009. Nitrogen and phosphorus accumulation in pasture soil from repeated poultry litter application. *Commun. Soil Sci. Plant Anal.*, 40, 587–598.
- USEPA. 1996, Environmental indicators of water quality in the United States. EPA 841- R-96-002. USEPA, Office of Water (4503F), U.S. Gov. Print. Office, Washington, DC.
- USEPA. 2001, National pollutant discharge elimination system permit regulation and effluent limitations guidelines and standards for concentrated animal feeding operations; proposed rule. *Fed. Regist.*, 66, 2960–3145.
- Way, T.R., Watts, D.B., Tewolde, H., Sistani, K.R., and Torbert, H.A., 2013. Implement with adjustable band spacing for subsurface band application of poultry litter. *Appl. Eng. Agric.*, 29, 831–839.

## Soil Acidity Correction with a Liquid Conditioner in the Center-West of Santa Fe-Argentina

R. Martel<sup>1</sup>, A. Valinotti<sup>1</sup>, S. Imhoff<sup>1,2\*</sup>

<sup>1</sup>*Departamento de Ciencias del Ambiente, Facultad de Ciencias Agrarias, Universidad Nacional del Litoral, Kreder 2805, S3080HOF, Esperanza (Santa Fe), Argentina.*

<sup>2</sup>*Consejo Nacional de Investigación Científica y Tecnológica (CONICET). Kreder 2805, S3080HOF, Esperanza (Santa Fe), Argentina.*

\*corresponding author: [simhoff@fca.unl.edu.ar](mailto:simhoff@fca.unl.edu.ar)

### Introduction

Soil acidification is a kind of degradation process that includes natural factors (edaphic, climatic and biological) and anthropogenic factors that produce an increase of the natural acidity of the soil (Campillo & Sadzawka, 1999). In the Pampas Region of Argentina, the acidification of the productive soils is mainly caused by the differential nutrients extraction, especially calcium and magnesium, by crops (Urricariet & Lavado, 1999). In Argentina, conditioners for correcting soil acidity are defined for the IRAM 22451 norm in Argentina. These conditioners are normally solid although some new are liquid. The latter have a strong and quickly reaction in the soil but their behavior were not checked. Liquid conditioners get into the market of Argentina under the form of suspension of nanoparticles, which also act as fertilizer. Neither their chemical effects nor the depths of action are known. Based on the available information in other countries we hypothesized that the application of a liquid conditioner will increase soil pH and the available amount of Ca, Mg and P in the surface and subsurface layers. The objective of this research was to verify the changes induced in the surface and subsurface layers due to the application of different doses of a suspension of nanoparticles formulated to correct soil pH.

### Material and method

The experiment was conducted in a silty-loamy Typic Argiudol San Justo serie (clay 223 g kg<sup>-1</sup>, silt 671 g kg<sup>-1</sup>, sand 106 g kg<sup>-1</sup>) in a farm near the Ramayón City (60° 19' 16'' W, 30°41'14'' S), Argentina in September 2016. Twelve plots (13 x 500 m) were delimited in the experimental area. The experiment was arranged in a randomized complete block with three replicates. A liquid soil conditioner with 30.4% of calcium oxide, 21.7% of magnesium oxide and 47.9% of carbon dioxide was sprayed after sowing corn together an herbicide because the conditioner is compatible with other products. The treatments were T0=0 L ha<sup>-1</sup>, T1=1.5 L ha<sup>-1</sup> and T2= 3 L ha<sup>-1</sup>. Soil disturbed samples (10 per plot and depth) were taken at two depth (0-5 cm and 5-10 cm) to evaluate pH, available P, exchangeable Ca and Mg, and their percentage of saturation in the cation exchangeable capacity (CEC). Corn yield was measured in each plot using a harvester with monitor of yield. Statistical analysis were performed with INFOSTAT software. Analysis of variance (ANOVA) was performed to verify the effect of the treatments. The Tukey's test was used to compare the means ( $\alpha=5\%$ ).

### Results and discussion

The results of the study are shown summarized in Table 1 and 2.

Table 1. Results of ANOVA test for the soil variables analyzed in the surface layer (0-5 cm).

Treatment	Doses (L ha <sup>-1</sup> )	pH (1:2.5)	P (mg kg <sup>-1</sup> )	Ca <sup>2+</sup> (mg kg <sup>-1</sup> )	Mg <sup>2+</sup> (mg kg <sup>-1</sup> )	Ca <sup>2+</sup> (% in CEC)	Mg <sup>2+</sup> (% in CEC)
T0	0	5.8a	11a	1645a	203a	52a	10a
T1	1.5	6.1b	16b	1814b	229a	56b	12a
T2	3	6.1b	15b	1820b	219a	55b	11a

CEC: Cation Exchange Capacity

Table 1 shows that pH, P, absolute content of Ca<sup>2+</sup> and its percentage in the CEC increased significantly in T1 and T2 without differences between T1 and T2. On contrary, the content and the percentage of Mg<sup>2+</sup> in the CEC did not vary. These results suggest that the soil conditioner had a direct positive effect on soil acidity. In addition, it seems to have a positive indirect effect on the soil fertility by increasing the available P content. This finding was rather surprising because the pH variation, although significant, was not very marked.

Table 2. Results of ANOVA test for the soil variables analyzed in the subsurface layer (5-10 cm).

Treatment	Doses (L ha <sup>-1</sup> )	pH (1:2.5)	P (mg kg <sup>-1</sup> )	Ca <sup>2+</sup> (mg kg <sup>-1</sup> )	Mg <sup>2+</sup> (mg kg <sup>-1</sup> )	Ca <sup>2+</sup> (% in CEC)	Mg <sup>2+</sup> (% in CEC)
T0	0	5.9a	10a	1718a	221a	49a	10a
T1	1.5	6.2b	13a	1824b	237a	53b	12a
T2	3	6.2b	13a	1858b	229a	52b	11a

CEC: cation Exchange capacity

In the subsurface layer, the analyzed variables have shown a behavior similar to that observed in the surface layer although the increases were less important. These results indicates that the soil conditioner has some mobility in the soil. The content of P did not vary probably because of the decreasing effect of the soil conditioner.

Despite the positive effect of the soil conditioner on the soil acidity, corn yield did not vary amount treatments. The yield in T0, T1 and T2 was 8588, 8762 and 8843 kg ha<sup>-1</sup> respectively. The lack of effects on the yield could be attributed to the short duration of the experiment. Therefore, more research is necessary to verify the effects of the soil conditioner on the soil and crop production in a long term.

## Conclusion

The applied soil conditioner had a positive effect on the acidity and fertility of the soil by increasing Ca<sup>2+</sup>, pH and P in the surface layer, and pH and Ca<sup>2+</sup> in the subsurface layer. No effect was observed on Mg<sup>2+</sup> and corn yield. More research is required to determine the benefit of spraying liquid soil conditioner on the physical-chemical soil properties and crop yield in a long term.

## References

- Campillo, R. and Sadzawka, A., 1999. *La acidificación de los suelos, origen y mecanismos involucrados*. <http://www.inia.cl/medios/biblioteca/serieactas/NR33853.pdf>.
- IRAM (Instituto Argentino de Normalización y Certificación), 2006. Norma Argentina 22451/1997. *Materiales calcáreos para uso agropecuario*. 18p.
- Urricariet, S. and Lavado, R., 1999. *Cien Suelo*, 17, 37-44.



## **Participative Quality Index (IQP) of No-Till System and its applications in different Brazilian regions.**

J. Galende<sup>1\*</sup>, R. Ralisch<sup>2</sup>

<sup>1, 2</sup> *Universidade Estadual de Londrina (UEL) – CCA, Rodovia Celso Garcia Cid, Pr 445 km 380, 86057-970, Londrina, PR, Brasil.*

\*corresponding author: [galendejuliana@gmail.com](mailto:galendejuliana@gmail.com)

### **Introduction**

The No-Till System (NTS) developed in Brazil since 1972, which has as starting point the experiments carried by the farmer Herbert Bartz, verified the necessity of changes in the conventional method of sowing, due to the great losses of soil caused by the erosion that used to occur. The NTS has evolved and is defined by minimum soil disturbance, keeping soil permanently covered and crop rotation. The advantages were not limited to the environmental scope, being extended to the social and economic sphere and spread throughout Latin America (FEBRAPDP, 2014). The partial adoption of the NTS concept by the farmers and the absence of policies to induce or favor its full adoption - in Brazil's case became a limitation to the system. Its consequence is the vulnerability of the environment when facing the production systems adopted, the increase in production costs - reducing the profitability of producers - and the shorter durability of other phytosanitary technologies adopted, with an increase in the use of chemical pesticides (GALENDE, 2018).

In order to encourage the full adoption of NTS by the farmers, the Participative Quality Index (IQP) of NTS was developed by the Brazilian Federation of NTS (FEBRAPDP)-initially seeking to establish the technical criteria and fundamentals of the system. The IQP was developed for a specific Brazilian region and this study aimed to evaluate the possibility of adapting the criteria to another region. The results showed that it is possible to adjust the IQP to other regions and that the participation of farmers is fundamental to their adoption.

### **Material and method**

The index aims at a cycle of continuous improvement, proposing in a participatory way the self-evaluation of the agriculturist, further enabling it to be widely used with easy to interpret results. It can be applied as a comparison between similar situations, as a history data of the same situation, and further as a simulator of effects of specific practices. Part of the fundamental principle of DPS allows and predicts its adequacy to different production systems and realities of interest. The methodology is based on obtaining results in the medium term. The index consists of a series of indicators that aim to predict the impacts of future scenarios - in a qualitative or trend-oriented manner - making it possible for the agriculturist to use it as an easily accessible tool and parameter for decision-making. The indicators that compose the PQI were grouped according to crop rotation (1), soil rotation (2), soil and water conservation (3), plant nutrition (4), and time of DPS use by the producer (5) (FEBRAPDP, 2011).



The first group: Rotation Intensity (IR), Rotation Diversity (DR), and Persistence of Straw (PR). Second group: Frequency of Soil Preparation (PF). The third group: Correct Terrace (TC) and Conservation Assessment (CA). The following group is composed of Balanced Nutrition (NE), and, finally, the Producer History (HC). The IQP is calculated by the sum of the indicators multiplied by the respective weights, in order to generate values from 0 to 10 - quantities that can be easily understood by the producers.

$$IQP = (1,5 \times (\Sigma IR DR FP PR) + (\Sigma TE FE AC TA))$$

Initially, the IQP was developed for the West of the Brazilian state of Paraná. It is aimed to be adapted to different regions and this study proposed to do so for the North of Paraná, data on the producers and available information in the literature about the region were collected. According to the specific characteristics of the environment, specific indicators were developed with the purpose of bringing information about the NTS that is applied in the fields and in the region as a whole, in order to adapt the IQP for this purpose (FEBRAPDP, 2011).

The Coefficient of Variation of the indicators was calculated and compared to each other, indicating the version of the IQP<sub>NPR</sub> that holds the highest number of indicators that could accurately measure the local data. Subsequently, a regression analysis was applied comparing the IQP II currently applied by public agencies to the IQP I (first version of the index) and the IQP<sub>NPR</sub> (GALENDE, 2018).

### Results and discussion

The critical points found are, according to the average of all producers and in relation to the critical level of each, the indicator of Intensity of Rotation, Rotation Diversity, Persistence of Scallop and Conservation Assessment Among these, the first three are part of the pillars of the NTS. The scores ranged from 5.25 to 8.07, with the indicator with the lowest overall score being the Persistence of Straw (PR) indicator, followed by indicators related to the Rotation of Cultures. A brief socioeconomic analysis of the region identified an imbalance between the environmental, social, and economic factors in the families, showing the producer's exclusive great dependence on agriculture and its oscillations. A questionnaire on the producer's view of the index showed the producer's lack of knowledge about the usage and application of the IQP in decision-making, as well as the lack of a connecting point between the scientific aspect of production and the practice. Finally, there was a greater need for feedback and availability on the part of the agencies responsible for applying the questionnaire to farmers, generating a greater demand at this point (GALENDE, 2018).

### References

- FEBRAPDP – Federação Brasileira de Plantio Direto e Irrigação. Metodologia Participativa para Avaliação da Qualidade do Sistema Plantio Direto na Bacia do Paraná 3. *Manual de Campo*. FEBRAPDP. Ponta Grossa, PR. 99 p., 2011.
- FEBRAPDP 2014. *Evolução do Plantio Direto no Paraná*. Disponível em: <[http://febrapdp.org.br/download/EVOLUCAO\\_DO\\_SPD\\_NO\\_PARANA\\_2014.pdf](http://febrapdp.org.br/download/EVOLUCAO_DO_SPD_NO_PARANA_2014.pdf)>. Acesso em: 11 de julho de 2016.
- GALENDE, Juliana. *Adaptation of participatory quality index of no-tillage to the north of Paraná (IQP)*. Master's degree in agronomy – Universidade Estadual de Londrina, Londrina, 2018.

## **Influence of Conservation *versus* Conventional Tillage on Physical Properties of a Cultivated Chernozem in Southern Romanian Plane**

Burtan Lavinia<sup>1</sup>, Anca Rovena Lăcătușu<sup>1\*</sup>, Coronado M.<sup>2</sup>, A. Vrînceanu<sup>1</sup>, M. Dumitru.<sup>1</sup>

<sup>1</sup>*National Research and Development Institute for Soil Science, Agrochemistry and Environment – ICPA Bucharest, Blvd. Mărăști no. 61, 011464, Bucharest, ROMÂNIA*

<sup>2</sup>*SC Quality Crops Agro SRL, Str. Aron Cotrus no. 53, Bucharest, ROMÂNIA*

\* corresponding author: [anca.lacatusu@gmail.com](mailto:anca.lacatusu@gmail.com)

### Introduction

Physical degradation of soil through compaction and crusting under conventional intensive agricultural systems is affecting 83 million ha worldwide, of which, 33 million ha are spread over Europe. In Europe, beside compaction that affects 4% of the agricultural area, over 30% is under high risk of secondary compaction (Eckelman et al., 2006), while erosion is one of the most serious processes of soil and environmental degradation. The minimum soil tillage system and direct sowing is a priority for drought adaptation by accumulating and conserving larger amounts of water in the soil (Van den Akker, 2002). In Romania, intensive farming for decades has led to the emergence and intensification of the soil aridization phenomenon, especially in the southern parts of the country covered by large areas of arable lands (Vrinceanu et al., 2017). This paper presents the results of research conducted in an experimental field with conservation *versus* conventional agricultural systems, belonging to Drăgănești Vlașca Research and Development Agricultural Station in the southern Romanian Plane, and focuses on the effects on physical properties of the soil.

### Material and method

The experimental field was installed in 2016 on a plane area of 4 hectares and divided into two equal parts. In the first experimental plot, the soil was worked under a conservation system (direct sowing), and in the second under a conventional system (classic sowing). Each experimental plot included three replicates, of which, at the end of the growing season of cultivated plants (corn) soil samples were collected at three depths (5-10 cm, 25-30 cm, and 45-50 cm) in order to determine the evolution of soil quality in the two soil tillage systems. The soil samples were analyzed to determine the main physical (texture, bulk density, total porosity, soil penetration resistance, saturated hydraulic conductivity, soil water content, water-holding capacity, available water capacity, permanent wilting point), chemical (pH, total organic carbon, total nitrogen, mobile forms of phosphorus and potassium), and microbiological (total bacterial and microfungi numbers and the soil respiration) properties by ISO and STAS system analytical methods. This paper only presents the soil physical properties.

### Results and discussion

After the first two experimental years, a clear trend in most of the analyzed parameters was observed. In the first year (2016) the experimental plot under conservative tillage shows values of bulk density indicating severe compaction for our soil of interest (Table 1), while the conventional tillage resulted in loose soil with low bulk density in the upper layer. After one year, bulk density values under conservative tillage declined to values near the threshold for soil compaction in the top layer and were even below this limit in the deep layer (45-50 cm). The most relevant results were recorded for soil penetration resistance and saturated hydraulic conductivity (Table 1, Figure 1).

Table 1. Soil physics properties under conservation and conventional tillage

Soil tillage system	Soil depth (cm)	Bulk density (g/cm <sup>3</sup> )		Soil penetration resistance (Kg.f/cm <sup>2</sup> )		Saturated hydraulic conductivity (K sat mm/h)		Total porosity (% v/v)		Permanent wilting point (% g/g)		Water-holding capacity (% g/g)		Available water capacity (% g/g)		Soil water content (% g/g)	
		2016	2017	2016	2017	2016	2017	2016	2017	2016	2017	2016	2017	2016	2017	2016	2017
		CONSERVATION TILLAGE	5-10	1.42	1.34	74.33	35.00	3.58	7.67	46.40	49.67	16.27	16.80	26.07	27.30	9.47	10.50
	25-35	1.42	1.37	68.00	53.67	3.47	9.27	46.30	48.20	16.07	18.17	26.67	25.77	9.10	7.60	32.53	35.13
	45-50	1.42	1.29	72.33	59.67	1.00	3.71	46.13	51.57	16.37	20.20	24.80	25.53	8.43	5.33	32.73	40.27
CONVENTIONAL TILLAGE	5-10	1.25	1.05	33.00	32.33	30.45	6.97	52.70	60.40	17.03	16.77	28.80	29.63	11.77	12.87	42.20	57.43
	25-35	1.36	1.36	52.33	56.00	18.21	5.05	48.80	48.77	16.93	17.40	26.20	25.67	9.23	8.27	36.20	35.90
	45-50	1.31	1.29	61.67	65.00	7.18	7.99	50.47	51.37	16.53	20.13	25.63	25.53	9.13	5.40	38.63	39.73
Standard deviation		0.08	0.13	16.22	16.75	15.90	5.51	3.08	4.94	0.45	1.61	1.63	1.70	1.26	2.94	4.50	8.79

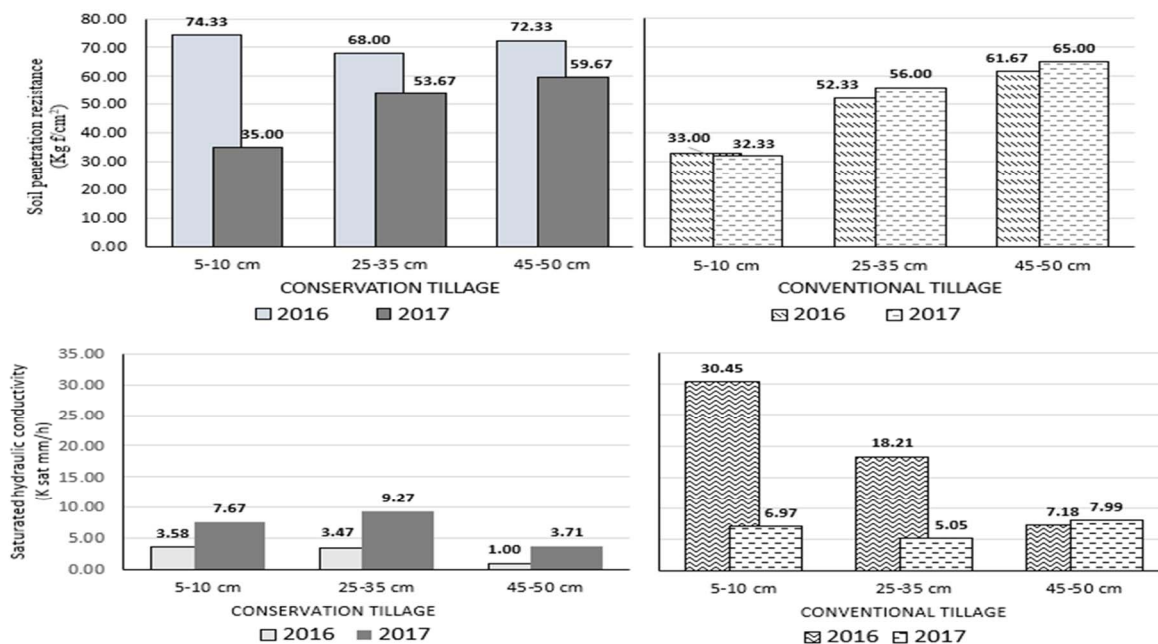

Figure 1. The effect of conservation and conventional tillage on some soil physical properties

Conclusion

After only two years of field experiments with two different soil tillage systems, a tendency in the improvement of physical and hydrophysical properties of a Chernozem was observed under conservative tillage, materialized in a decreasing soil bulk density and increasing total porosity, total water soil content and saturated hydraulic conductivity. Confirming these positive trends on soil quality through further experimentation will lead to the greater confidence of Romanian farmers in conservation agriculture.

References

Eckelmann, W., R. Baritz, S. Bialousz, P. Bielek, F. Carré, B. Houšková, R. J. A. J.A. Jones, M. Kibblewhite, J. Kozak, C. Le Bas, G. Tóth, T. Tóth, G. Várallyay, M. Yli Halla and M. Zupan, 2006, Common Criteria for Risk Area Identification according to Soil Threats, Research report no. 20, Soil Information Working Group (SIWG), European Soil Bureau Network (ESBN)

Van den Akker, J.J.H., 2002. Determination of the susceptibility of subsoils to compaction and ways to prevent subsoil compaction. In: Pagliai, M., Jones, R. (eds). Sustainable land management - environmental protection: A soil physical approach. Advances in GeoEcology 35. Catena Verlag, Reiskirchen, Germany, pp 291-304.

Vrinceanu G.A., Anca-Rovena Lacatusu, C. Simota, M. Dumitru, P.Ignat, 2017. The influence of climatic conditions in the appearance and the intensification of the aridity phenomenon on the soil-land resources in the Bărăgan Plain, SGEM 2017, Book 3: Water Res. Forest, Marine and Ocean Ecosys. Issue 32, vol 17, ISSN 1314-2704, p. 609-624

## Stability of Soil Aggregates Affected by soil tillage and organic and inorganic fertilization in long-term field experiments

Attila Dunai – Zoltán Tóth

University of Pannonia, Georgikon Faculty, Department of Crop Production and Land Use, H-8360 Keszthely, Festetics u. 7.

Corresponding author: [dunai@georgikon.hu](mailto:dunai@georgikon.hu)

### Introduction

The aggregate stability of soils, as the extent of the resistance against different types of soil degradation processes, are at the forefront of the soil physical researches. The aggregates themselves can be considered as gathering of primary soil particles; inside of these, the components bond higher forces together than to other soil particles around them.

Higher aggregate stability values are essentially important for the maintenance and increase of soil fertility. From an agronomical aspect, besides the erosion processes, soil tillage and fertilization systems can influence the aggregate stability of soils. The effect of these management methods can be investigated reliably only in long-term field experiments. However, in the literature, only a few results can be found from long-term field trials (e.g. Aoyama et al. 1999, Blanco-Moure et al. 2012).

The aim of our investigations was to study the effects of soil tillage, farmyard manure application and straw+green manure incorporation as well as the increasing doses of inorganic N-fertilization on the macroaggregate stability of soil, in two long-term field experiments.

### Material and method

A study was conducted in a 46 years old maize-winter wheat bicultural tillage experiment and in the 35 years old International Mineral and Organic Nitrogen Fertilization Trial (IOSDV) located in Keszthely, Hungary. The soil tillage experiment has two factors; the main factor is tillage, with three different cultivations: deep winter ploughing (conventional tillage system), shallow winter disking (shallow tillage system) and disking just before drilling (minimum tillage system). The second factor is fertilization, the mineral N-rates in case of maize are 0-120-180-240-300 kg ha<sup>-1</sup>. The trial was arranged in a split-plot design with four replications.

The IOSDV trial is a bifactorial experiment which has a strip-plot design with three replications. The two factors are the complementary applications of different forms of organic fertilizers and increasing rates of mineral N fertilization. The organic fertilizers have 3 different variants: no organic fertilizer application (control, straw is removed), farmyard manure (FYM) application (35 t/ha, in every third year, straw is removed), straw/stalk (St) incorporation. After winter barley on the St plots, an extra green manure (GM) is applied (*Raphanus sativus* var. *Oleiformis*). The N rates are 0-70-140-210-280 kg ha<sup>-1</sup> in case of maize.

During the vegetation period, samples were collected from the selected maize plots three times: firstly two weeks after emerging, secondly after flowering in August, lastly before harvesting in October.

During the investigations, a „Wet Sieving Apparatus” distributed by Eijkelkamp Agrisearch Equipment (The Netherlands) was used. For the examinations, 4 grams of soil samples were measured. The samples were treated with 0,1M Sodium pyrophosphate for „sand” correction. The measurements were carried out with three repetitions in all of the sampled plots. For the statistical evaluation, ANOVA with Duncan post-hoc tests were performed.

## Results and discussion

As a function of different soil tillage systems, aggregate stability decreased with the increasing intensity of soil tillage. Conventional ploughing resulted in the lowest, while minimum tillage resulted the highest values of stability. The stability values significantly decreased with sampling dates.

Considering the IOSDV trial, the additional application of FYM didn't result in a significant difference compared to the sole NPK treatment, even slightly lower values were measured. Opposing this, St+GM application significantly increased the stability of soil macroaggregates in the average of all sampling dates and N-supplies. When averaged over the variants of nitrogen fertilization and organic matter supply, with the time of sampling the WSA values increased, however, this increase was more considerable in the first half of the vegetation period.

## Conclusions

Conventional ploughing resulted in significantly lower stability values as minimum and shallow disking tillage system. Increasing of the N-fertilizer doses significantly decreased the stability of aggregates.

Residue incorporation resulted in significant increase in WSA-values, while in contrast FYM application reduced WSA-values in case of higher N-fertilizer rates.

As concluded from the results, application of reduced tillage systems could be effective to maintain higher stability values. Besides, residue incorporation is proved to be a very effective tool to sustain and increase the stability of soil macroaggregates on arable land when soil is regularly disturbed.

## References

- Aoyama M., Angers D.A. and N'dayegamiye A., 1999. Particulate and mineral-associated organic matter in water-stable aggregates as affected by mineral fertilizer and manure applications. *Can J Soil Sci*, 79: 295–302.
- Blanco-Moure, N., Moret-Fernández, D. and López, M.V., 2012. Dynamics of aggregate destabilization by water in soils under long-term conservation tillage in semiarid Spain. *Catena* 99: 34-41.

## Acknowledgements

The research leading to these results has received funding from the European Union under Horizon-2020 Programme grant agreement No. 635750 (iSQAPER project, [www.isqaperproject.eu](http://www.isqaperproject.eu)), and by the Hungary's Economic Development and Innovation Operative Programme GINOP-2.3.2-15-2016-00054.

## Subsurface Drainage in an aquic Argiudoll at the Central Region of Santa Fe

G. F. Camussi<sup>1</sup>; R.P. Marano<sup>1</sup>; S. Imhoff<sup>12\*</sup>.

<sup>1</sup>*Departamento de Ciencias del Ambiente, Facultad de Ciencias Agrarias, Universidad Nacional del Litoral, Kreder 2805, S3080HOF, Esperanza (Santa Fe), Argentina.*

<sup>2</sup>*Consejo Nacional de Investigación Científica y Tecnológica (CONICET). Kreder 2805, S3080HOF, Esperanza (Santa Fe), Argentina.*

\*corresponding author: [simhoff@fca.unl.edu.ar](mailto:simhoff@fca.unl.edu.ar)

### Introduction

Water excesses are one of the main causes of crop losses in the central region of Santa Fe. The mole drain is an underground drainage technique of limited use in Argentina due to the lack of information about the conditions of use and operation. The technique consists on the construction of circular galleries, at a soil depth where texture has more than 35% clay, by pulling a ripper blade with a cylindrical foot attached on the bottom through the subsoil. In addition, the implement generates cracks in soil, which facilitates the water movement to the drain. The spaces between drains depend on the soil hydraulic conductivity and on the hydraulic gradient exists between the drain and the water table. The objective of this research was to evaluate the mole drain operation with the purpose of generating information that allows determining its usefulness in different situations.

### Materials and methods

The experiment was carried out in a commercial farm located in Pilar (31° 24' 33" S, 61° 14' 54" W). The soil is classified as Aquic Argiudol, Pilar series. The B2t horizon (0.30 to 0.70 m depth) contains about 35% clay. The topography was measured with geodetic GPS. A mole drain with an 8 cm foot and a 10 cm expander was used for the construction of the drains. The spacing between drains was calculated using the Hooghoudt equation (1940), obtaining the discharge of them from the difference between the precipitation design and runoff. The depth of the water table was measured by using freaticimeters with access up to 1.6 m. Soil water content was measured up to 2 m deep with capacitance probe calibrated regionally (Divinner 2000). Experimental plots of 38.2 m<sup>2</sup> with a drain in its center were established at the ending of the drains by building embankments 30 cm high. An excavation was made downstream of each drain to collect the drained water. The drains were built following the slope (0.16%) at a constant depth of 0.70 m and with a spacing of 4 m between them. The precipitation design was 115 mm. Two sheets of water were applied consecutively on the same day to totalize the precipitation design. The value obtained from runoff was 50 mm.

### Results and discussion

The volumetric moisture of the soil prior to the water sheets application was 0.39 m<sup>3</sup> m<sup>-3</sup> (average up to 1.6 m) because of the rainfall that occurred in previous days. Drainage began 40 minutes after the first water sheet application, and 20 minutes after the second. In the two water sheet applications, the end of the drainage coincided with the end of the infiltration. The depth of the water table before applying the water sheets was 1.3 m, increasing at the time of the experience up to 1.17 m deep. The volume of water drained during the second water sheet application was 3.4 times higher than in the first one (Table 1). The water began to flow quickly

towards the drain when the soil reached field capacity due to the existence of preferential channels or fissures, which correspond to large air spaces where water moves by gravity (Robinson and Beven, 1983). These fissures were probably formed when the drain was built and as consequence of the phenomena of expansion-contraction, which is characteristic of clay horizons.

Table 1. Information of the water applications in the experimental plots.

Information	Application 1	Application 2
Surface of the plot (m <sup>2</sup> )	38,28	38,28
Sheet (mm)	46,5	60
Volume applied (L)	1780	2297
Flow rate (L s <sup>-1</sup> )	0,69	0,65
Application time (min)	43	57
Intensity of simulated rain (mm h <sup>-1</sup> )	65	65

The coincidence of ending of the infiltration and drainage processes indicates that the cracks reached the entire experimental plot. Therefore, the spacing between drains of 4 m was adequate to remove excess water from the entire plot.

At the start of the second water-sheet application, the soil was already wet. Thus, the water potential of the soil matrix was higher than that of the cracks explaining the greater amount of water drained during this application.

The applied water contributed to the water table with 0.009 m taking into account that the effective soil porosity was about 0.07 m<sup>3</sup> m<sup>-3</sup> (Marano et al., 2009) and the depth of the water table after the applications increased 0.13 m. In addition, the mole drain allowed the removal of a 0.010 m water-sheet.

## Conclusions

The mole drain resulted very useful for removing the excess water. Drainage was greater when the soil was wet. The existence of channels that allowed for the preferential movement of water was evidenced by the coincidence of the ending of the infiltration and drainage processes.

## References

- Hooghoudt S.B., 1940. *Landbouwk. Onderz*, 46, 14. B. 's Gravenhage.
- Marano R.P., Miretti M.C., Serafin N., Rossi M., Rodríguez L., 2009. *Dinámica hídrica y recarga de un acuífero libre en condiciones de lluvia extraordinaria en el centro de la provincia de Santa Fe*. In: *Asociación Internacional de Hidrogeólogos, Grupo Argentino 1º ed.*, 33-41pp. ISBN 978-987-1082-39-1.
- Robinson M., Beven K.J., 1983. *J. Hydrol.*, 64, 205-223.



## Effect of Qum landfill leachate on soils chemical composition

Shahrzad Khoramnejadian <sup>1\*</sup>, Mahdieh Khorasanyzadeh<sup>1</sup>

<sup>1</sup>Department of Environment, Damavand Branch, Islamic Azad University, Damavand, Iran.

\* Corresponding author: [khoramnejad@damavandiau.ac.ir](mailto:khoramnejad@damavandiau.ac.ir)

### Introduction

Disposal of solid waste is one of the most important issues for urban management. Leachate leakage in land fill caused many problems. During the collection, transfer and disposal of solid waste leachate is created. Leachate contains various pollutants, including heavy metals and toxic materials. Leachate composition and contaminants in waste that goes out often depends on the volume of infiltrated water to the landfill. The study to determine the chemical composition of Qom and its effect on soil leachate waste landfill on Alborz (landfill in Qom) on leachate formed from the accumulation of waste and soil landfill leachate was affected was performed.

### Materials and Methods

The study of 10 samples taken from the soil leachate and landfill site Alborz is random. Parameters of nitrate, nitrite, phosphate, water holding capacity, Electrical conductivity, soil reaction, total soluble salts, available potassium, sodium, chlorine, soluble lead, cadmium absorbable and absorbable on samples taken were recognized and impact each burial place was on the ground, measuring the electrical conductivity and total dissolved solids using the electrical conductivity meter to determine the concentration of hydrogen ions using a pH meter, sodium and potassium by flame photometer, phosphorus by spectrophotometry, chloride anion with silver nitrate in the presence of potassium chromate, lead is absorbed, cadmium is absorbed and the absorption was measured by atomic absorption spectrometry. Leachate infiltration in the context of the soil decreases or increases the concentration of hydrogen ions. The acidity or alkalinity of the soil as a result of changes in hydrogen ion concentration outcomes such as pollution of groundwater and impair plant growth will follow. The results showed that the leachate compounds in soil organic matter decomposition of weak organic acids and Carbon dioxide is produced that can be alleviated soil pH. Soil pH changes at different depths shows that due to the decomposition of organic matter in the soil leachate and combinations of weak organic acids and carbon dioxide reduced and thus limit the amount of in-depth psychological will increase, but in the plastic limit there is not much change in the soil, thus increasing soil plasticity index, but in greater depth its value increase Will.

### Result and discussion

Different points on random soil samples were collected along with leachate collected at the site. Sample soil at a depth of (1-4) meters and weighs about 1 kg of leachate collected in plastic packaging for measuring sodium (salt), electrical conductivity, total dissolved solids, the

concentration of pH, Pb, the Cd was performed. Ec, PH, Cl, Na, Zn, Pb and Cd levels in soil 7/48, 7/325, 191/9, 149/397, 5/46, 3/9 and 0/06. The metals leak into the lower layers of soil to accumulate, the hydrogen ion concentration of different factors such as soil and water, redox potential, soil type, concentration and competing ions, the presence of organic or inorganic ligands, organic matter content exchange capacity cation, clay minerals, calcium carbonate, iron oxides, manganese, ionic strength, soil type, specific adsorption, absorption and desorption characteristics of plants and soil particle size depends metals (Egiarte, 2006). Sludge into the soil to reduce the concentration of hydrogen ions and increasing the electrical conductivity, which reduce the concentration of hydrogen ions increases the solubility of metals in groundwater and therefore they are (Otis, 2006). Based on the location of the site Alborz in hot, dry and mineral soil due to having to play heavily buffered acidity is neutralized leachate. The concentration of hydrogen ions in the soil play an important role in the uptake of soil phosphorus and as the results show the amount of phosphorus in the soil is exceeded.

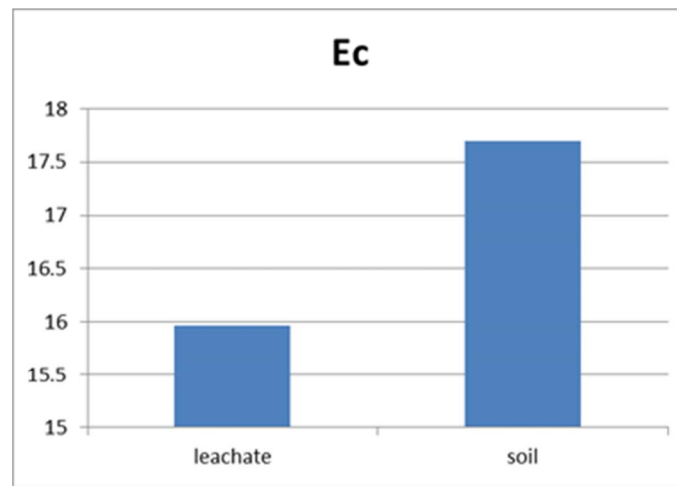

Figure1. electrical conductivity in soil and leachate samples.

## Conclusion

Qom is located in arid area. Effect of leachate on soil chemical properties were analyzed and results shown the amount of some parameter of soils were increased. as the results showed that leachate is not suitable for agriculture due to high salinity in soil leachate pollution whose influence it is better to avoid impermeable layer, drainage layer, or protective layer is impermeable layers can be fine materials such as clay soil with the proper thickness of the layers of impermeable synthetic produced or manufactured in the factory and geomembranes are known types of polymers used to make more use of impermeable soil layers and synthetic compounds is common. This layer is also responsible for the protection and prevention of impermeable geomembranes are responsible puncture.

## References

Egiarte, G., Camps Arbestain, M., Ruiz-Romera, E., Pinto M., 2006. *Chemosphere*. 65(11):2456-67.

Otis, O., Alcañiz, J., 2006. *Bioresource Technology*. 97(4):545-52.

## Indigenous Tillage Practices in Anambra State, Southeast Nigeria: Implications for Soil and Water Conservation.

<sup>1</sup>Nnabude, P.C. and Onunwa, A.O.

Failure of research and innovation to capture, profile and promote indigenous practices in agriculture in mainly African countries has hindered the emergence of well-developed and locally acceptable production processes and by implication limited sustainable agricultural production. An investigation of tillage practices in Southeast Nigeria shows that several of these practices have enormous potentials for soil and water conservation and can be developed and promoted for sustainable agricultural production. Prominent among these practices are the *high mound* tillage, the *basin* tillage and the *tied ridge-mound* system. The high mound tillage operates in two contrasting moisture environments, the wet and dry conditions. Under wet conditions, it provides well drained soil environment for root growth and development. In dry conditions, it stores moisture for longer periods thereby making it possible for crops to thrive under mild drought conditions. The basin tillage traps water during the early rains and stores the same for early crop take off. The basin ponds water and allows greater time for infiltration thereby seriously reducing run off. The tied ridges reduce the speed of run-off water and the mini-mounds within them provide moist and unhindered space for root development. Best results are achieved when these practices are combined with mulching. The basin and ridge-mound system equally provide space for manure application and this enhances the water holding capacity of the soil.

Key words: *mounds, basin, tillage, ridge, drought conditions and infiltration.*

---

<sup>1</sup>Department of Soil Science and Land Resources Management, Nnamdi Azikiwe University, Awka, Anambra State, Nigeria

## Seasonal dynamics of the physical quality of volcanic ash soils under different land uses in southern Chile

Susana R. Valle<sup>1,2\*</sup>, José Dörner<sup>1,2</sup>, Felipe Zúñiga<sup>1,2,3</sup>, Dorota Dec<sup>1,2</sup>  
Valdivia, Chile.

<sup>1</sup>Instituto de Ingeniería Agraria y Suelos. Facultad de Ciencias Agrarias. Universidad Austral de Chile.

<sup>2</sup>Centro de Investigación en Suelos Volcánicos (CISVo).

<sup>3</sup>Graduate School. Faculty of Agricultural Sciences. Universidad Austral de Chile.

\*Corresponding author: [susanavalle@uach.cl](mailto:susanavalle@uach.cl)

### Introduction

In Chile, volcanic soils were developed under almost all the humidity and temperature regimes as they occupy from the Arid Mediterranean area to the Wet Zone of the southern zone. Due their andic properties, they exhibit characteristics completely different from the other soil types in the world. The soil physical quality (SPQ) is strongly related to the functions of pore system (Dörner et al., 2013). Thus, soils characterized by a good SPQ have the ability to store and conduct water, air and nutrients promoting both: maximum crop yield and minimum environmental degradation (Topp et al., 1997). Important progress has been made concerning the storing and conducting water and air functions in volcanic soils. However, soil physical quality indicators and their temporal changes had been less studied. Thus, the objectives of this study were: i) to assess the impact of land use change on physical quality of three main volcanic soils groups in Chile, ii) to quantify the magnitude of their temporal changes and iii) to compare these results with threshold values from literature.

### Material and method

Three soils derived from volcanic materials formed under different conditions and with different development degree, were sampled, on five sampling dates, under three land uses intensities: native forest (NF), prairie (P) and crops (C). Undisturbed samples were taken at two soil depths: 0-15 cm and 15-30 cm, in metallic cylinders of 230 cm<sup>3</sup> of volume, and then covered with caps and plastic film to prevent mechanical disturbance and evaporation. In these samples was measured and /or calculated: air capacity (AC), plant available water capacity (PAWC), relative field capacity (RFC), bulk density (dB), air conductivity (kl), pore connectivity indexes (C2 and C3), coefficient of linear extensibility (COLE) and saturated hydraulic conductivity (Ks). Differences and among land uses and seasons were assessed by an analyses of variance. Also a principal component analysis (PCA) was performed to associate the SPQ indicators.

### Results and discussion

Land use change and seasonal changes affects the soil physical quality. Results for dB showed marked differences among soil types where mean values reached 0.26-0.69 Mg m<sup>-3</sup>, 0.54-0.79 Mg m<sup>-3</sup> and 0.77-1.23 Mg m<sup>-3</sup> for HUI, OSR and CUD soils, respectively. PAWC ranged among 13% to 48% for Andisols and 7.2% to 29% for Ultisol. AC values for HUI and OSR (Andisols), NF land use showed higher than P and C land uses. The decreases for AC considering NF land use as reference ranged between 50-90% and 56-90% for HUI and OSR, respectively. The air conductivity (kl) values ranged among -3.87 to -5.91 log (m s<sup>-1</sup>), -3.79 to -5.78 log (m s<sup>-1</sup>) and -3.97 to -5.45 log (m s<sup>-1</sup>) for HUI, OSR and CUD, respectively. Mean values of Ks ranged among

1.54-3.53 log (cm d<sup>-1</sup>), 1.69-3.51 log (cm d<sup>-1</sup>) and 0.68-3.28 log (cm d<sup>-1</sup>) for HUI, OSR and CUD soils, respectively.

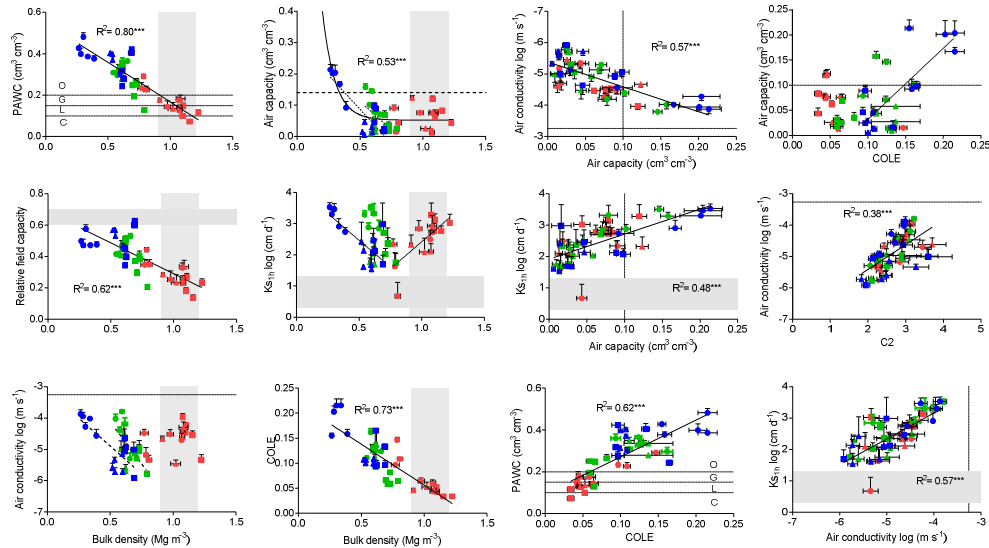

Figure 1. Relationship between soil physical indicators in Huiti (blue symbols), Osorno (green symbols) and Cudico (red symbols) soils under different land uses: NF (circles), P (triangles) and C (squares) at the five sampling dates (undifferentiated). Gray bars and dotted vertical or horizontal lines indicates threshold values for different physical indicators; O, optimal; G, good; L, limited; C, critical range values for PAWC (Reynolds et al., 2008, 2009; Horn and Fleige, 2009).

Results of this study showed that dynamics of SPQ indicators depended on the soil type, season, their development degree, clay content and type and organic carbon. Higher intrinsic variations were found in the intensity than capacity SPQ indicators. When values of SPQ indicators were compared with critical and/or threshold values from literature, the indicators of dB and RFC were wide out of the range considered as for the mineral soils that were proposed.

**Conclusion**

SPQ in Chilean volcanic soils exhibit a strong component of capacity, structure, conductivity and connectivity of their properties. However, there still are several questions about which are the critical values of these soil properties in volcanic soils. More work it is necessary to establish the critical value for this widely used soil property (dB) as an estimator of other functional soil quality indicators, which are also related to de pedological evolution of soils.

**References**

Dörner, J., Dec, D., Zúñiga, F., Horn, R., López, I., Leiva, C., Cuevas, J. 2013. Changes in the physical quality of an Andosol under different management intensities in Southern Chile. *Adv. Geoecology*. 42, 262-281.  
 Horn R., Fleige, H. 2009. Risk assessment of subsoil compaction for arable soils in Northwest Germany at farm scale. *Soil Till. Res.* 102, 201–208.  
 Reynolds, W.D., Drury, C.F., Yang, X.M., Tan, C.S.2008. Optimal soil physical quality inferred through structural regression and parameter interactions. *Geoderma*. 146, 466–474.  
 Reynolds, W.D., Drury, C.F., Tan, C.S., Fox, C.a., Yang, X.M., 2009. Use of indicators and pore volume-function characteristics to quantify soil physical quality. *Geoderma*. 152: 252-263.  
 Topp, G.C., Reynolds, W.D., Cook, F.J., Kirby, J.M., Carter, M.R. 1997. Physical attributes of soil quality. *Developments in Soil Science*. 25, 21-58.

## The impact of the slope on the organic and minerals amendments in the salinity of soil in the south Tunisian

Souad MAATOUG<sup>1\*</sup>, Abdessatar HATIRA<sup>1</sup>

<sup>1</sup>University of Tunis El Manar, Department of Geology, Faculty of Sciences of Tunis, 2092 Tunis, Tunisia.

\* Corresponding author: [maatoug1986@gmail.com](mailto:maatoug1986@gmail.com), Tel: +216 94800350

### 1. Introduction

Arid and semi-arid areas cover about 41% of the Earth's surface, and they are home to 35% of the world's population (Sparks 2012). The increase in dry land area is mainly due to land degradation caused by poor land management and drought (Dregne 2002). The mixed organic/soil mineral amendment appeared as a means to mitigate the effects of degradation and especially the decline of soil fertility in the ancient oases. The sandy soil of the dunes has been used as an amendment for oasis soils to improve water dynamics, soil aggregation and cations exchange capacity. The amendment of agricultural manure is considered as an excellent source of OM that improves soil chemistry, water retention and hydraulic conductivity. The main objective of this study is to examine the viability of the amendment since three years (2015) on the salinity of the different horizons of soil (de 0 à 120 cm). The aim of this work is to see the effect of the slope on the studied plots: parcel located upstream (north part) with high slope and the other plot closer to the chott located downstream (*southern part*) at low slope.

### 2. Materials and methods

The GEONICS Limited EM38RT probe was placed on the ground surface to provide a reliable, fast and instantaneous geospatial measurement of electromagnetic conductivity and to map the spatial distribution of soil salinity. The electromagnetic conductivity data processing consists in calculating the correlation between the real value of the saturated paste electrical conductivity and the apparent value of the electromagnetic conductivity meter. Geonics location, according to the vertical configuration of the coils, can integrate scanning of about 2 m deep.

ECa: The apparent electrical conductivity measured by the Geonics.

EC: The actual electrical conductivity of medium depth 0-200 cm of wet paste.

The affine equation of the linear regression is written:

$Y_i(x) = a X_i + b$ ; Let  $X_i = \text{ECa}$  (S/m à 25°C) and  $Y_i = \text{EC}$  (S/m à 25°C).

\* For the upstream amended soil, we have the following equation:  $\text{ECa} = 0,811 * \text{EC} + 1,08$

\* For the downstream amended soil, we have the following equation:  $\text{ECa} = 0,87 * \text{EC} + 1,545$

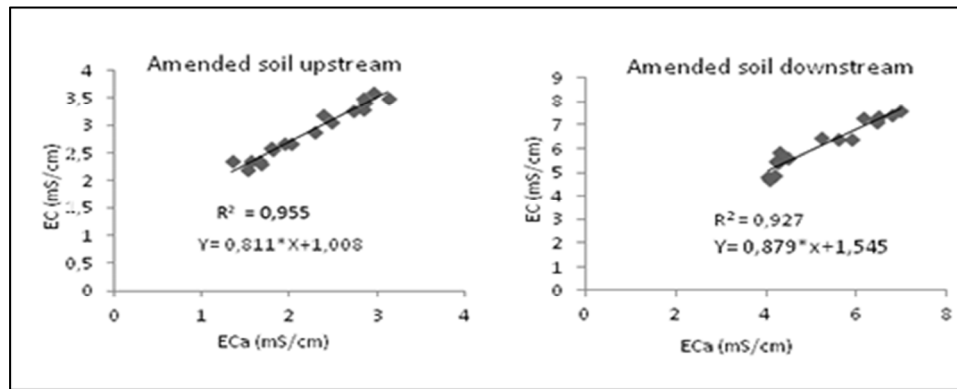

Fig1. Correlation between CECa and EC

### 3. Results and discussion

The mapping of the salinity at the level of our oasis reveals a large spatial variation for the two plots concerned.

- Upstream parcel amended: The salinity varies between 1.5 and 3.9 mS/cm. The spatial variability of the salinity observed seems to be linked to the topographical parcel context and the oasis location in relation to the natural flow network. This parcel is characterized by a surface with a slope greater than 3%. The salinity could also be explained by the occupation of the ground and by the farmers managing mode of their parcels. In effect, the irrigation has contributed to the decrease of the soil salinity at this parcel level.

- Downstream parcel amended: The salinity observed is higher than that observed at high slope ground level. It varies between 4 and 6 mS/cm. The latter presents a distribution as a function of the virtually flat topography, which affects water dynamics and salts transfer. The Om Rouss oasis development is toward the low-lying areas and is only stopped by a hypersalty and a hydromorph depression composed by fine alluvium (Sebkha).

### 4. Conclusion

Soil salinity, at the oasis level, has a high spatial variability. (Askri, 2002) .Their spatial distributions seem to be related to the geomorphology of the perimeter. The northern parts of the oasis (high slope) are well drained. On the contrary, downstream zones (low slope) are zones of salt accumulation located in the southern part of the oasis, where the nappe is outcropping and the salinity is very high. According to the intensity of these phenomena, this sequence of processes has repercussions on the palms that are less productive or completely absent in slight slope soils. In addition, the low salinity observed in the north of the oasis (soil with a steep slope) compared to the southern part (sloping soil) could be explained by the fact that the latter is closer to the Chott.

### References

B.Askri. 2002. La modélisation des processus de salinisation des sols irrigués en zones arides, cas de l'oasis de Segdoud. Thèse, Ecole Nationale d'Ingénieurs de Tunis, 165 p.

Dregne, H. E. 2002. « Land Degradation in the Drylands ». *Arid Land Research and Management* 16 (2): 99-132. <https://doi.org/10.1080/153249802317304422>.

Sparks DL. 2012. *Advances in Agronomy*. <https://doi.org/10.1016/B978-0-12-800137-0.09989-1>.



## Some Soil Quality Indicators and Their Relations under Different Tillage in a Clay Soil of Semi-Arid Mediterranean

Z. B. Barut<sup>1\*</sup>, I. Celik<sup>2</sup>, M. M. Turgut<sup>3</sup>

<sup>1</sup> Çukurova Univ., Faculty of Agriculture, Dept. of Agr. Mach. and Tech.Eng. 01330, Adana-Turkey

<sup>2</sup> Çukurova University., Faculty of Agriculture, Department of Soil Science, 01330, Adana-Turkey

<sup>3</sup> Dicle Univ., Faculty of Agriculture, Dept. of Agr. Mach. and Tech.Eng, 21280, Diyarbakır-Turkey

\* corresponding author: [zbburut@cu.edu.tr](mailto:zbburut@cu.edu.tr)

### Introduction

Soil quality indicators such as soil organic carbon, porosity, number of mycorrhiza spore, microbial CO<sub>2</sub> production can be defined as the soil processes and properties that are sensitive to changes in soil functions. Soil organic matter plays important key roles in many aspects of soil quality, such as soil structure, soil water relations, soil compaction, water infiltration, and erosion protection together with chemical and biological fertilities (Gregorich et al., 1994). The rate of infiltration is controlled by the pore size distribution and the continuity of pores or pathways (Lipiec et al., 2006). Infiltration of water increases water storage for plants and groundwater recharge and reduces erosion. Microbial biomass differences as a result of soil management are sometimes greater than the differences in organic matter. Therefore, microbial biomass may be a better indicator of changes induced by tillage (Carter, 1992).

This study was performed to determine the effects of conventional, reduced and no-tillage practices on soil organic carbon (SOC), total porosity (TP), number of mycorrhiza spore (NMS) and microbial CO<sub>2</sub> (MCO), and relationship between them in wheat-corn-wheat-soybean rotations in a clay soil under semi-arid Mediterranean climatic conditions.

### Materials and methods

This study was carried out at the Agricultural Research Area of Cukurova University located near Adana, Turkey (37°00'54'' latitude N, 35°21'27'' longitude E, 32 m above sea level) in 2006 and 2009. The soil structures of the study area were 18% sand, 32% silt, 50% clay, pH 7.8 and organic carbon content 0.9%. The soil with a slope of about 1% had a pH of 7.82, bulk density of 1.31 Mg m<sup>-3</sup>, total organic carbon of 8.76 g kg<sup>-1</sup>, CaCO<sub>3</sub> of 244 g kg<sup>-1</sup>, and electrical conductivity of 0.15 dS m<sup>-1</sup>. The experiment was a randomized complete block design with three replications. The treatments were conventional tillage with residue incorporated in soil (CTS), conventional tillage with residue burned (CTB), reduced tillage with heavy tandem disc-harrow (RTD), reduced tillage with rotary tiller (RTR), reduced tillage with heavy tandem disc harrow for the first crop + no-tillage for the second crop (RNT), and no tillage (NT). The crop rotation was wheat (*Triticum aestivum* L.)-corn (*Zea Mays* L) in the 2006-2007, wheat-soybean (*Glycine max.* L.) in the 2007-2008 and wheat in the 2008-2009 growing seasons, respectively. At the beginning of the experiment, the mean soil organic carbon, total porosity, number of mycorrhiza spore and microbial CO<sub>2</sub> production values of tillage treatments were 8.75 g kg<sup>-1</sup>, 0.52 cm<sup>3</sup> cm<sup>-3</sup>, 30,83 spores 10g<sup>-1</sup> and 16.09 µg 100 g<sup>-1</sup> 24 h<sup>-1</sup>, respectively.

### Results and Discussions

The effects of tillage systems on SOC, TP, NMS and MCO production were significantly different. The lowest SOC, NMS and MCO production means were obtained with conventional tillage without residue. However, the highest mean values were in NT. The highest mean of total porosity values were obtained with  $0.61\text{cm}^3\text{ cm}^{-3}$  in CTB although the lowest mean values were founded in NT as  $0.48\text{ cm}^3\text{ cm}^{-3}$ . There is a linear relationship between MOC and NMS with SOC. There is an inverse linear relationship between TP with SOC. The increasing of total porosity causes to decrease soil organic C (Figure 1). Since many of the soil quality parameters are generally related to soil organic matter content and its quality (Gregorich et al., 1994), it is of prime importance to increase or preserve the soil organic matter content for the physical, chemical and biological qualities of the soil.

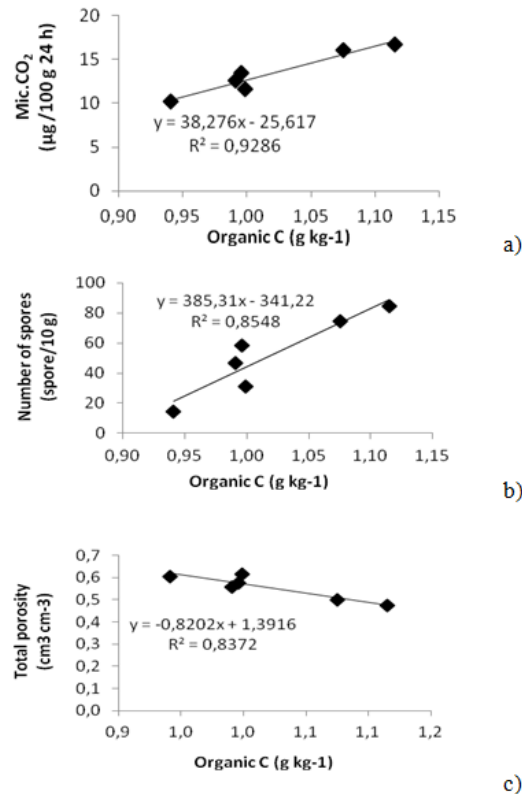

Figure 1: The relationship between TP, NMS and MCO with SOC

## Conclusions

Conservation tillage systems (RT and NT) were resulted in higher soil organic carbon, number of mycorrhizea spore and microbial CO<sub>2</sub> production but lower total porosity than conventional tillage systems for heavy clayey soils under semi-arid climate conditions. The relationship between total porosity, number of mycorrhizea spore and microbial CO<sub>2</sub> production with soil organic C are very important. There are linear relationships between number of mycorrhizea spore and microbial CO<sub>2</sub> production with soil organic carbon, but opposite relationship with total porosity.

## References

- Carter M.R., 1992. Influence of reduced tillage systems on organic matter, microbial biomass, macro-aggregate distribution and structural stability of the surface soil in a humid climate. *Soil Till. Res.*, 23, 361-372.
- Gregorich E.G., Carter M.R., Angers D.A., Monreal C.M., Ellert H.H., 1994. Towards a minimum data set to assess soil organic matter quality in agricultural soils. *Can. J. Soil Sci.* 74, 367-385.
- Lipiec J., Kuś J., Słowińska-Jurkiewicz A., Nosalewicz A., 2006. Soil porosity and water infiltration as influenced by tillage methods. *Soil Till. Res.*, 89, 210-220.

## 49-years of no-tillage and crop residue retention on a Vertisol in north-eastern Australia: lessons learnt

Yash Dang<sup>1\*</sup>, Ram Dalal<sup>1</sup>, Steven Reeves<sup>2</sup>, Greg Thomas<sup>2</sup>, John Thompson<sup>3</sup>, Kathryn Page<sup>1</sup>, Weijin Wang<sup>2</sup>, Jayaraman Somasundaram<sup>1</sup>, Nikki Seymour<sup>4</sup>, Garry O'Leary<sup>5</sup>

<sup>1</sup>The University of Queensland, School of Agriculture and Food Sciences, St Lucia, Australia

<sup>2</sup>Department of Science, IT and Innovation, Dutton Park, Australia.

<sup>3</sup>University of Southern Queensland, Toowoomba, Australia.

<sup>4</sup>Department of Agriculture and Fisheries, Toowoomba, Australia

<sup>5</sup>Department of Economic Development, Jobs, Transport and Resources, Horsham, Australia

\*Corresponding author: [y.dang@uq.edu.au](mailto:y.dang@uq.edu.au)

### Introduction

No-till (NT) agriculture represents a widely adopted sustainable soil management practice. Research on NT has often occurred within the context of conservation agriculture (CA), which relies on the application of three inter-linked principles: minimal soil disturbance, permanent soil cover and crop rotations. The adoption of CA farming systems has resulted in tangible advantages in economics, the environment and soil quality compared to conventional farming systems. CA continues to hold tremendous potential for all sizes of farms and agro-ecological systems. However, there is a paucity of information on the long-term effects of no-tillage and crop residue management (CRM) on productivity, soil health and the environment.

### Material and method

A long-term field experiment was established in 1968 to study the effects of tillage (no-tillage, NT, vs conventional tillage, CT), CRM (stubble retained, SR, vs stubble burnt, SB) and fertilizer N application (0, 30 and 90 kg N/ha) on a Vertisol (soil pH<sub>H2O</sub>7.3; clay 68%; organic C 1.7% in 0-0.1 m soil) at Hermitage Research Station, Queensland, Australia (28.2°S, 152.001°E) (Marley and Littler, 1989). The site is the second longest continuously maintained no-till research experiment in the world. The treatment under CT generally involved 3-4 tillage operations with a chisel plough during the fallow period each year, while NT treatments were sprayed with herbicide to control weeds. Wheat was grown in most years and barley for 3 years. Grain yield and grain protein were measured for each crop. Soil sampling to 1.5 m was usually carried out prior to sowing for determination of nitrate-N and soil water. Soil organic carbon (SOC in 0-0.1, 0.1-0.2 and 0.2-0.3 m soil depth) was measured after 13, 31, 40, 45 and 47 years. Additional samplings were also carried out periodically to determine effects on the soil's physical, chemical and biological properties.

### Results and discussion

In general, NT with SR resulted in greater water storage efficiency by the end of the fallow period and stored more water (15-25 mm) in the soil profile at sowing. However, there was lack of grain yield response to improved water storage under NT, caused by greater levels of yellow spot disease (*Pyrenophora tritici-repentis*) in wet seasons and greater numbers of root-lesion nematodes (pre-1992). With the introduction of nematode-tolerant cultivars (post-1992), NT yielded significantly higher than CT in most years (Fig.1a), with this more pronounced in the years with low in-crop rainfall. In the 45 cereals crops grown over the 49 years, average grain yield was significantly ( $p=0.001$ ) higher under NT (2.57 t/ha) than CT (2.47 t/ha), with no significant differences between SR and SB. However, SB had significantly ( $p=0.001$ ) higher grain protein (13.1%) compared to SR (12.5%), although it

was unaffected by tillage (NT vs CT) treatments. Nitrogen fertilization (NF) significantly ( $p=0.001$ ) increased both grain yield and protein (Fig. 1b). Pre-sowing soil nitrate-N levels were generally lower under SR and NT than SB and CT. SOC stocks measured over time showed a decrease (0.29 t/ha.year to 0.3 m soil profile) across the experimental treatments, and more so in the top 0.1 m under SB and CT compared to SR and NT (Page *et al.* 2013). In addition, SOC and total N concentrations and stocks were significantly higher under NT, SR and NF than CT, SB and N0. Aggregate stability of topsoil was generally higher under NT and SR. Chloride concentration measured over time indicated that drainage rates were greater under NT and SR than CT and SB. Earthworm populations were greatest under NT and SR with no significant changes in vesicular arbuscular mycorrhizae (VAM). Annual N<sub>2</sub>O emissions were significantly higher in NF than NO, but were lower under NT compared to CT because of increased rates of leaching and lower under SR compared to SB due to greater immobilisation of N. There were no significant differences in CH<sub>4</sub> emissions for any treatment. Data from the experiment over time has provided valuable information to allow validation of the APSIM crop simulation model and its simulation of grain yield, soil water and SOC (O’Leary *et al.* 2015).

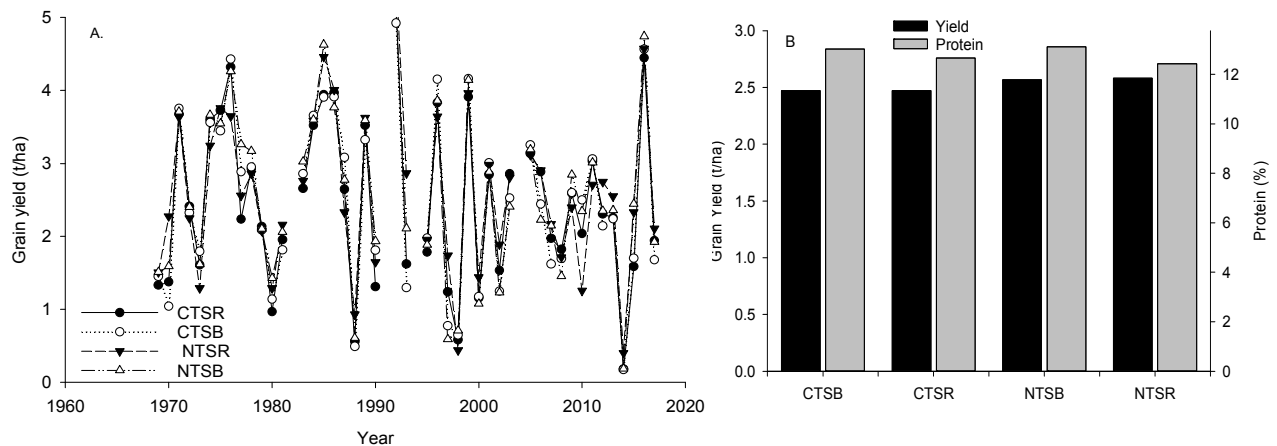

**Fig. 1.** Grain yield pattern from 1969-2017 (A) and mean grain yield and mean protein of 45 cereal crops (B) under conventional tillage (CT) and no-till (NT) with stubble burnt (SB) and stubble retained (SB) on a Vertisol in north-eastern Australia.

## Conclusion

The results have demonstrated the potential of NT with SR to improve soil quality, environmental sustainability and cereal productivity in most years, especially those with low in-crop rainfall when using nematode-tolerant cultivars. The experiment has provided a valuable resource of information for understanding the long-term effects of tillage, crop residue management and nitrogen application on crop production, soil biology, physical, nutritional and water dynamics in a sub-tropical environment.

## References

- Marley JM, Littler JW (1989) Winter cereal production on the Darling Downs - an 11 year study of fallowing practices, *Australian Journal of Experimental Agriculture*, 29, 807-827.
- O’Leary G, Liu D, Ma Y, Li F, McCaskill M, Conyers M, Dalal R, Reeves S, Page K, Dang YP, Robertson F (2015) Modelling soil organic carbon 1. Performance of selected APSIM crop and pasture modules in rotations against long-term experimental data. *Geoderma* 264: 227-237
- Page KL, Dalal RC, Pringle MJ, Bell M, Dang YP, Radford B (2013) Organic carbon stocks in cropping soils of Queensland, Australia, as affected by tillage management, climate and soil characteristics. *Soil Research* 51, 596-607.

## Effects of Conservation Tillage based Agro-geo-textiles on Resource Conservation in Sloping Croplands of Indian Himalayan Region.

Raman Jeet Singh<sup>1\*</sup>, N. K. Sharma<sup>1</sup>, J.S. Deshwal<sup>1</sup>, B.N. Ghosh<sup>2</sup>, N.M. Alam<sup>1</sup>, Uday Mandal<sup>1</sup>, Gopal Kumar<sup>1</sup>, Trisha Roy<sup>1</sup>, Ranjan Bhattacharyya<sup>3</sup>, P.K. Mishra<sup>1</sup>

<sup>1</sup> ICAR- Indian Institute of Soil and Water Conservation, Dehradun, 248 195, India

<sup>2</sup> ICAR- National Bureau of Soil Survey and Land Use Planning, Kolkata, 700 091, India

<sup>3</sup> ICAR- Indian Agricultural Research Institute, Pusa New Delhi 110 012, India

\*Corresponding author: [rdxsingh@gmail.com](mailto:rdxsingh@gmail.com)

### Introduction

Frequent occurrence of extreme rainfall events ( $>80-100 \text{ mm hr}^{-1}$ ) is predicted under changing climate scenario of Indian Himalayan Region (IHR) and recent estimates indicate that nearly 39% area of IHR has a potential soil erosion rate of more than  $40 \text{ Mg ha}^{-1} \text{ yr}^{-1}$ , which is much higher than the specified soil loss tolerance limit of  $10 \text{ Mg ha}^{-1} \text{ yr}^{-1}$ . India loses about 13.4 Mt food grains, worth US \$2.5 billion (2008-09) due to soil erosion by water in rainfed areas. Estimated loss in maize (*Zea mays* L.) productivity is  $8.0-10.3 \text{ kg ha}^{-1}$  due to loss of each mm of topsoil (Ghosh et al., 2012). Preliminary investigations suggest agro-geo-textiles (AGT) could be an effective and inexpensive soil conservation method, with enormous global potential (Bhattacharyya et al., 2010). However, limited quantitative data are available on the erosion-reducing effects of AGT in field conditions and their effects on crop productivity.

### Material and methods

Field experiments (probably first of its kind) were conducted on zero tilled maize crop planted in rainy seasons of 2015 and 2016 to evaluate the conservation effects of AGT prepared from *Arundo donax* (Rag-weed) and maize stover; and comparisons were made with coir-geo-textile, cowpea and grass weed vegetative filters (all placed at 1 m vertical interval on 4% land slope, 100 m length of plots) on crop productivity, runoff and soil loss reduction on 4% sloping arable lands in the IHR (Figure 1).

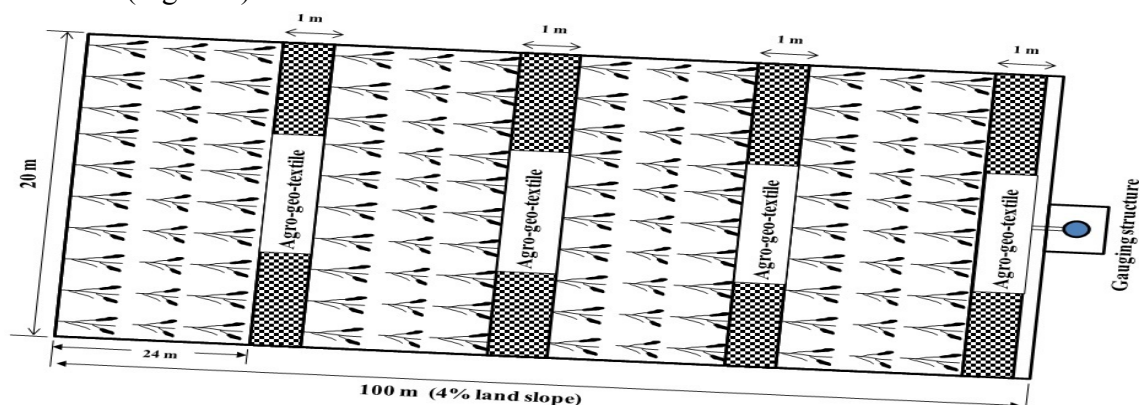

Figure 1: Typical view of AGT barrier in maize crop (1 m vertical interval).

### Results and discussion

During two years of experimentation, a total of 35 runoff events were observed in the zero-tilled maize crop grown in rainy months of June to September. The results revealed that the highest maize grain yield ( $2.8 \text{ Mg ha}^{-1}$ ) was recorded in *Arundo donex* AGT treatment which was 36% higher than maize crop raised without AGT. This treatment also reduced 24% runoff and  $8.22 \text{ Mg ha}^{-1}$  soil loss (18 runoff events) than without AGT (35 runoff events). Seeds and seedlings can be damaged or even washed away, so vegetation growth on steep erodible slopes is limited due to sheet erosion of top 5 cm fertile soil. During this period of high erosion risk, AGT or erosion control mats are a possible temporary alternative for insignificant vegetation cover and can offer immediate soil protection on moderate to steep slopes (Hann and Morgan, 2006). AGT reduces the direct impact of raindrops, enhance water infiltration into the soil surface and thereby reduces runoff generation and soil detachment.

### Conclusion

Conservation tillage practices along with AGT (conservation agriculture plus) are more profitable than only conservation tillage practices on a 4% land slope of IHR. If harvested correctly, these resources are readily available and can be used in the long-run. These AGT can be constructed locally at an economically viable price and also have the potential of reuse after one or two seasons due to their slower degradation.

### References

- Bhattacharya R., Smets T., Fullen M.A., Poesen J., Booth C.A., 2010. Effectiveness of geotextiles in reducing runoff and soil loss: A synthesis. *Catena*, 81, 181-195. <https://doi.org/10.1016/j.catena.2010.03.003>.
- Ghosh B.N., Sharma N.K., Dogra P., Dadhwal K.S., 2012. Effect of integrated organic input management in maize- wheat cropping system in sloping lands of north-west Himalayas. *Indian J. Soil Conser.*, 40 (1), 84-89.
- Hann M.J., Morgan R.P.C., 2006. Evaluating erosion control measures for biorestation between the time of soil reinstatement and vegetation establishment. *Earth Surface Processes Landforms*, 31, 589–597. Doi: 10.1002/esp.1353

## Topsoil macroporosity as affected by long-term crop sequence and manure use

A. Palojärvi<sup>1</sup>, E. Ketoja<sup>2</sup>, L. Alakukku<sup>3\*</sup>

<sup>1</sup> *Natural Resources Institute Finland (Luke), Itäinen pitkäkatu 4 A, FI-20520 Turku, Finland*

<sup>2</sup> *Natural Resources Institute Finland (Luke), Planta, FI-31600 Jokioinen, Finland*

<sup>3</sup> *Department of Agricultural Sciences, Koetilantie 5, FI-00014 University of Helsinki, Finland*

\*corresponding author: [laura.alakukku@helsinki.fi](mailto:laura.alakukku@helsinki.fi)

### Introduction

In sustainable crop production, good soil quality is a key issue when the target is to produce high yields with low environmental emissions. Effects of different cropping systems, like organic/conventional farming and crop/animal production, on soil quality have seldom been reported in fields of farms in boreal conditions. Soil quality has not often been examined by using a broad spectrum of soil physical and biological variables as indicators of good soil quality. In the present study, we addressed the question by investigating the chemical, structural and microbiological properties of Finnish mineral soils on farms having used either organic or conventional farming system. Our aim was to examine the effects of long-term crop sequence and manure use on the quality of field topsoil. In this presentation, the results of soil structural properties are focused.

### Material and method

In Southern Finland, ten pairs of organic and conventional fields on farms were selected for the study. The fields within the pairs were situated directly next to each other and have similar soil texture. The clay (particle size < 0.002 mm) content of the topsoil (0–20 cm) of the fields was 14 to 72%. Organic farming had been continued more than 10 years before the study. Organic farming system contained regularly grass in crop sequence and manure as fertilizer. In conventional farming system, cereals were cultivated either as monoculture (mineral fertilizing) or in crop sequence with grass (manure and mineral fertilizing used).

A 30 by 30 m sampling area was selected from these fields. Soil samples (PVC pipe diameter 15 cm, height 25 cm) for soil physical determinations were taken from five points from a sampling area (sampling layer 0–20 cm). Samples were taken in two consecutive springs. From soil samples dry bulk density, saturated hydraulic conductivity and volume of macropores (> 0.03 and 0.3 mm) were determined. Soil clay and carbon contents were determined from separate samples. The statistical analyses of the data were based on generalized linear mixed models (Gbur et al., 2012).

### Results and discussion

Long-term grass cultivation in crop sequence and manure use affected soil macroporosity (Figure 1). Compared to conventional cereal production, soils with manure use and grass in crop sequence had significantly greater macroporosity (> 0.3 mm and > 0.03 mm). Likewise, the saturated hydraulic conductivity of soils in organic farming was significantly greater than that of conventionally cultivated soil without grass and manure. This was in agreement with the results of Puerta et al. (2018) who reported the positive effects of ley included in crop sequence and manure use on soil structure in the layer of 0–6 cm.

Differences in topsoil dry bulk density between cultivation systems (organic/conventional) or grass/manure compared with cereal monoculture were, however, not significant. In conventional farming, grass cultivation and manure use did not affect markedly on topsoil C



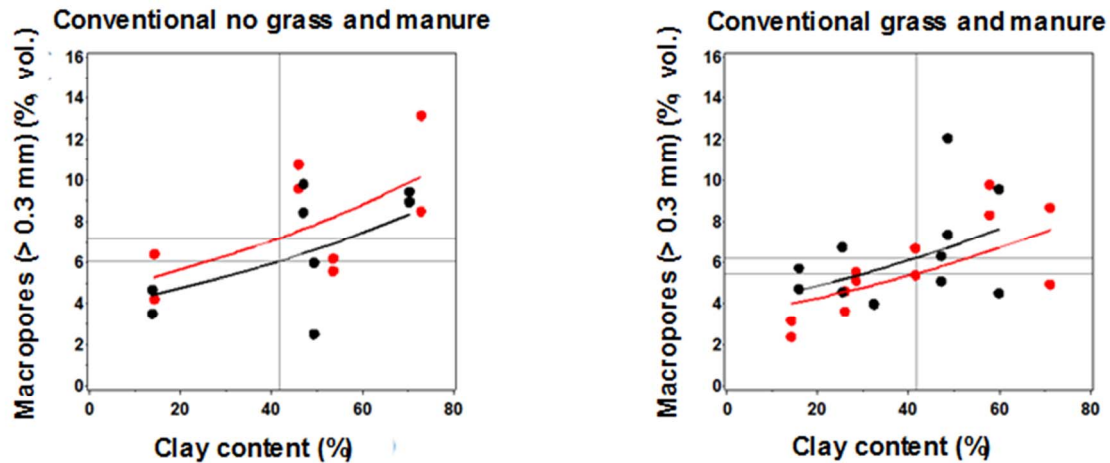

Figure 1: Organic farming (marked in red) was compared to conventional farming (marked in black) with either cereal monoculture (no grass and manure) or fields having crop sequence with grass and manure used. In the layer of 0–20 cm, mean volume of macropores (> 0.3 mm) was statistically significantly larger in organic farming when only cereals were growth in conventional farming, but the difference between organic farming and conventional farming with grass and manure was not statistically significant. Topsoil macroporosity tended to increase as clay content increased.

content (3.9%) compared to cereal cultivation (3.4%). The difference in soil C content in organic farming (3.8%) and conventional farming (3.7%) was not significant, either.

### Conclusion

Physical quality of mineral topsoil can be improved by crop sequence including grass and using manure as organic fertilizer. Topsoil macroporosity and saturated hydraulic conductivity were greater when grass was included in the crop sequence and manure was used compared to cereal monoculture. Changes in soil properties and quality occur slowly. Thus, long-term field studies are obligatory when the effects of different cultivation systems on soil quality are examined.

### References

- Gbur, E.E., Stroup, W.W., McCarter K.S., Durham, S., Young, L.J., Christman, M., West, M., Kramer, M., 2012. *Analysis of Generalized Linear Mixed Models in the Agricultural and Natural Resources Sciences*, American Society of Agronomy, Madison.
- Loaiza Puerta, V., Pujol Pereira, E.I., Wittwer, R., van der Heijden, M., Six, J., 2018. Improvement of soil structure through organic crop management, conservation tillage and grass-clover ley. *Soil Tillage Res.*, 180, 1-9.



## Quantifying soil displacement and tillage erosion rate by different tillage systems in dryland northwestern Iran

Mehdi Kouselou<sup>1</sup>, Sanaz Hashemi<sup>1</sup>, Iraj Eskandari<sup>2</sup>, Blair M. McKenzie<sup>3</sup>, Esmail Karimi<sup>1</sup>, Abbas Rezaei<sup>1</sup>, **Mehdi Rahmati<sup>1\*</sup>**

<sup>1</sup> Department of Soil Science and Engineering, Faculty of Agriculture, University of Maragheh, Maragheh, East Azerbaijan, Iran; <sup>2</sup> Dryland Agricultural Research Institute, Agricultural Research, Education and Extension Organization Maragheh, East Azerbaijan, Iran; <sup>3</sup> The James Hutton Institute, Invergowrie, Dundee DD2 5DA, UK;

Corresponding author: [mehdirmti@gmail.com](mailto:mehdirmti@gmail.com)

### Introduction

The quantity of soil moved by tillage is often overlooked, but it is large. For example, moldboard ploughing a hectare of soil with bulk density of 1300 kg/m<sup>3</sup> to 0.25 m depth displaces over 3 Gg of soil. Tillage usually drags topsoil along with the tillage implement (Barneveld *et al.*, 2009). Such displacement, supplemented by movement down slope due to gravity, is described as tillage erosion (Blanco-Canqui & Lal, 2008). Redistribution of soil particles by the force applied by tillage is a major factor in soil degradation of agricultural land. Decreasing tillage intensity can reduce the amount of soil displaced and the distance moved and hence may reduce rates of erosion. To understand the relative importance of erosion we tabulated machine, soil and landform properties likely to be involved. Tillage erosion and soil displacement change the field's topography and significantly affect productivity in the long-term. Therefore, the aim of this study was to assess and quantify forward (in line with tillage direction) and lateral (perpendicular to tillage direction) soil displacements and tillage erosion rates (net soil movement down slope) in dryland conditions of the Maragheh-Hashtroud plain, northwestern Iran under different systems used to establish cereal crops.

### Materials and Methods

We compared soil displacement and tillage erosion rates under different systems, including moldboard ploughing (conventional tillage), chisel ploughing (reduced tillage), stubble cultivator (minimum tillage), and no-tillage under dryland agriculture in northwestern Iran (latitude 37°12' N; longitude 46°20' E; 1730m a.s.l.). The area was undulating and so all tillage took place along contours. Metallic tracers were buried in the soil at known locations and depths and their recovery after tillage provided a measure of soil displacement and tillage erosion.

### Results and Discussion

Figure 1 summarize the key achievement in this research. The results showed that conventional tillage along a contour line had significantly greater soil displacement (~57 cm) in the direction of tillage than reduced and minimum tillage systems (~20 cm and ~15 cm, respectively). Conventional tillage also caused more lateral soil displacement (downwards in the main direction of slope, the tillage erosion rate) than reduced or minimum tillage systems (48 cm and 152 kg/m for conventional tillage vs. 5 and 4 cm and 16 and 7 kg/m for reduced and minimum tillage, respectively).

The only previous study of event-base tillage erosion rate in Iran (Azadegan *et al.*, 1999) reported 40 to 100 kg/m plough width for moldboard ploughing in different directions. Our results are greater than this under contour tillage. Differences may be due to drier soil condition at the time of tillage operation. Alternatively, Azadegan *et al.* (1999) applied tillage operations with 15 cm depths and 3.5 km/h while plough depth and tillage speed in our research were varying between 15 to 25 cm and 6 to 8 km/h, respectively. The tillage erosion rates under the

reduced and minimum tillage systems used here reveals that it is possible to decrease tillage erosion rates by 3 and 4 times compared with conventional ploughing. For a much better comparison, it is important to define as many as possible factors.

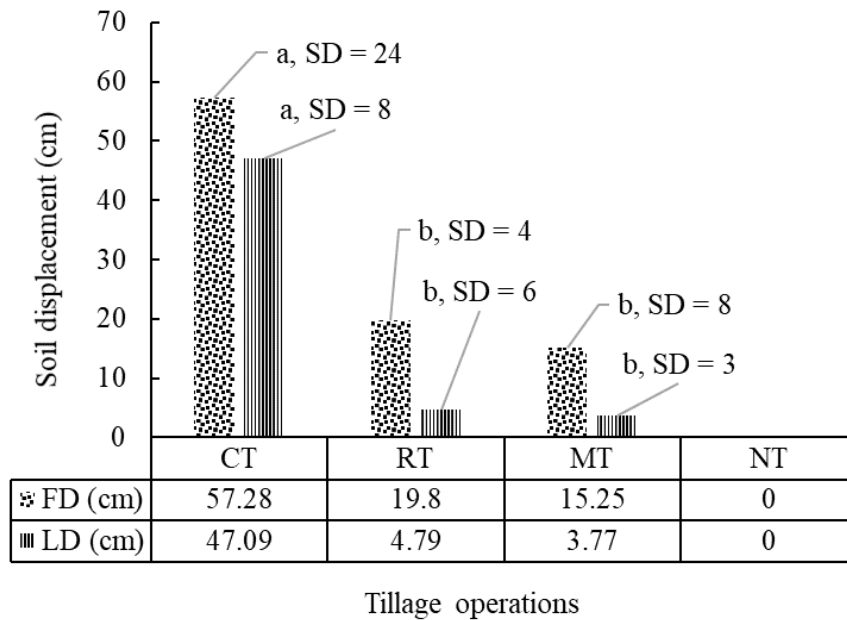

Figure 1- Mean forward (FD) and lateral (LD) displacements under different tillage operations. CT is conventional tillage, RT is reduced tillage, MT is minimum tillage and NT\* is no-till.

**Conclusion**

Based on these results, we conclude that NT system with no or negligible disturbance is the best way to prevent tillage-induced erosion when establishing cereal crops. However, adoption of the NT is not always easy or appropriate for all soils and regions (Blanco-Canqui & Lal, 2008). The performance of any tillage system depends on multiple factors including soil type, climate, and crop rotation and management (Blanco-Canqui & Lal, 2008). The adoption of no-till systems may be restricted by access to equipment, which is a major factor in this area of Asia. Therefore, although multi-year data are needed to recommend tillage systems, we suggest more investigations to evaluate the benefits of adoption adopting of RT or MT as a practical way to decrease tillage erosion whilst fitting with other farming constraints. As there is no significant difference of tillage erosion between RT and MT, the choice between them can be made on the basis of parameters including energy efficiency, economics, availability of the implements, and their effects on crop productivity and other environmental services. In the near short-term, chisel plough (RT) is more likely to be adopted than MT in north western Iran based on the machinery availability.

**References**

Azadegan, B., Rafahi, H., Shahooi, S. & Tabatabaei-far, S. A. 1999. Moldboard Plowing effects on soil displacement and erosion on agricultural steep lands (metal tracers method). *Iranian Journal of Agricultural Science*, **30**, 799-806.

Barneveld, R., Bruggeman, A., Sterk, G. & Turkelboom, F. 2009. Comparison of two methods for quantification of tillage erosion rates in olive orchards of north-west Syria. *Soil and Tillage Research*, **103**, 105-112.

Blanco-Canqui, H. & Lal, R. 2008. *Principles of soil conservation and management*, Springer Science & Business Media.

## **A plot study to characterize the effects of water-induced channel, tillage operation and their interaction on water erosion in subsequent runoff events**

F. Zheng<sup>1,2</sup>, S. Li<sup>1,2\*</sup>, D. Lobb<sup>2</sup>

<sup>1</sup>*Fredericton Research and Development Center, Agriculture and Agri-food Canada, Fredericton, NB, E3B 4Z7, Canada*

<sup>2</sup>*Department of Soil Science, University of Manitoba, MB, R3T 2N2 Canada*

\* corresponding author: [Sheng.Li@agr.gc.ca](mailto:Sheng.Li@agr.gc.ca)

### **Introduction**

Water erosion is a major form of soil erosion in many cultivated fields. Water-induced channels are often observed on bare surface after water erosion events. Some channels can develop to a size too large to be filled by tillage operation (termed classic gullies). In subsequent runoff events, existing channels can be a major source for sediment due to channel development. Meanwhile, they also serve as major pathways for transporting sediment to the field edges. Tillage operation is another erosive process which can cause soil redistribution in the field. It can also change soil erodibility for the subsequent water erosion event. Apparently, most cultivated fields are subject to both water and tillage erosion processes. There are linkages and interactions between these two forms of erosion (Li, et al, 2007). One example of such linkage and interaction is with water-induced channels. The question is: will water erosion differ with and without tillage on fields with and without water-induced channels? The objective of this experiment is to characterize such effects.

### **Materials and Methods**

The study was conducted on a ~10% slope at the experiment farm of the Fredericton Research and Development Centre in New Brunswick, Canada. The study was carried out on four plots with four treatments, T0: no channel, no tillage (control); T1: with channel, no tillage; T2: no channel, with tillage, T3: with channel and tillage. The experiment was repeated for four times and treatments were assigned to the plots using Latin Square design (time as one dimension). The size of each plot was 2 m by 2 m and the boundary was delineated with galvanized metal sheets. A tube was installed at the lower side of the plot to direct runoff water out of the plot. A rainfall simulator, equipped with two continuous, downward-flow, wide-angle full-jet stainless steel nozzles, was used to reproduce simulated rainfall. For each run, the rainfall lasted for one hour after steady runoff initiation. Runoff water samples were taken at the outlet of the tube using a 1-liter cup at 5 minutes intervals. In total, there were 13 water samples for each plot. A timer was used to record both runoff initiation time and elapsed time for sample collection. Weight and volume of each water sample were measured with a scale and a graduated cylinder, respectively. Sediment in each sample was determined gravimetrically by drying samples at 120-degree for 24 hours. Both runoff and cumulative sediment amount were interpolated to at 30 mins, 40 mins, 50 mins and 60 mins after rainfall simulation starts. Statistical analysis was conducted with SAS statistical package. Overall effects of treatment were analyzed with ANOVA under Latin Square Design; differences between treatments were tested with multiple Comparisons of treatment means; and treatment interactions were tested with contrasts.

### **Results and discussion**

Under the T0 treatment, the runoff initiation time was averaged 22.4 min with a coefficient of variation (CV) of 35%. The cumulative runoff amount increased from 18.0 L to 99.2 L with the

elapsed time from 30 mins to 60 mins after rainfall simulation started. Meanwhile, the CV decreased from 117% to 52% with time. Similar trend was observed for the cumulative sediment yield. The averaged cumulative sediment yield increased from 171.7 g to 1244.7 g with time, whereas the CV decreased from 115% to 69%. Under the T1 treatment, the runoff initiation time was ~ 9 minutes shorter than T0, probably because of the existence of channel, which enhanced the concentration of water flows. The cumulative runoff amount increased from 15.4 L to 71.4 L with time, which was close to those of T0 statistically. For the cumulative sediment yield, averaged value increased from 249.7 g to 2364.4 g with time. At 40 min and 50 min, cumulative sediment yield of T1 was significantly higher (~80%) than those of T0. This is probably because of the collapse of channel walls. Under the T2 treatment, the runoff initiation time was at similar level as T0. For the cumulative runoff amount with time, it increased from 2.0 L to 51.9 L. Averaged cumulative runoff amounts of T2 were constantly lower than those of T0. Unlike T1, at 60 mins, the cumulative runoff amount of T2 was significantly lower than that of T0. This is probably because chisel plow tends to increase soil porosity, as a result, more water can be temporarily stored in the till layer. For the cumulative sediment yield, averaged value of T2 increased from 36.8 g to 604.2 g, which were consistently lower than those of T0. In addition, at 40 mins, the cumulative sediment yield of T2 was significantly lower (~50%) than that of T0. Under the T3 treatment, the runoff initiation time was close to T0. The cumulative runoff amount and sediment yield increased from 6.3 L to 64.9 L and from 120.6 g to 1060.2 g, respectively. Although these values were consistently lower than those of T0, there was no significant difference between them. The contrast test suggests that the interaction effects of cumulative runoff amount and sediment yield between water-induced channel and tillage operation were not significant.

### **Conclusion**

We found that water-induced channel can significantly increase the sediment yield for the subsequent water erosion event, whereas tillage operation can significantly decrease the sediment yield for the subsequent water erosion event. However, the interaction effects between water-induced channel and tillage operation was not significant. It is recognized that the data was highly variable and the effects of channel may be under represented due to the small plot size.

### **Reference**

Li, S., Lobb, D. A., Lindstrom, M. J., & Farenhorst, A., 2007. Tillage and water erosion on different landscapes in the northern North American Great Plains evaluated using 137 Cs technique and soil erosion models. *Catena*, 70, 3, pp. 493-505.

## Soil Conservation and Sustainable Landuse Designs, Based on Inventory of Land Degradation, in Some Small Watersheds in Eastern Romania.

Cosmin Hurjui<sup>1\*</sup>, Nelu Popa<sup>2</sup>, Gabriel Petrovici<sup>3</sup>

<sup>1</sup>Research and Development Station for Soil Erosion Control "Mircea Motoc" Perieni (RDSSEC "MM" Perieni), 737405 Perieni, Romania

<sup>2</sup>RDSSEC "MM" Perieni, 737405 Perieni, Romania

<sup>3</sup>RDSSEC "MM" Perieni, 737405 Perieni, Romania

\*corresponding author: [cosmin.hurjui@cesperieni.ro](mailto:cosmin.hurjui@cesperieni.ro)

### Introduction

The application of Law 18 from 1991, regarding the reallocation of the agricultural land to previous landowners, in Romania, had two main negative consequences: a huge fragmentation of the agricultural land and the arrangement of a great number of long and narrow plots, according to local tradition, following the up-and-down hill direction. These two consequences are totally incompatible with a conservative agriculture. Farmers in Banca watersheds (Eastern Romania) are facing another huge problem, too: land degradation by gullies and deep-seated landslides. This paper summarizes the results of studies and inventories of gullies and landslides in some small watersheds in Banca area, illustrates the actual structure of agricultural land ownership, including the land consolidation that took place during the last decade, the solutions designed for land organization, land reclamation, soil conservation, and sustainable land use.

### Material and method

Within the framework of a research project, the Geographical Information System (GIS) of an area of 12,975 ha was realized. The GIS included layers such as: geology, relief, hydrology, vegetation cover, land use, road network, landslide and gully inventory, and the parcel and actual farms map. The actual geomorphological parameters of land degradation forms (landslides and gullies) were updated upon the most recent aerial photos and by means of professional GPS equipment. Based on the latest aerial photographs, the parcel map (plot plan) was digitized and each individual plot was identified by its landowner, administrator, or farmer. A landslide hazard map was also prepared according to the Romanian regulations. The entire GIS, including the plot plan and the landslide hazard map were used to make several designs containing solutions of land organization, land reclamation, soil conservation, and for sustainable land use.

### Results and discussion

The surveys regarding gullies and landslides in the studied area, based on maps resulted from different approaches, such as geomorphological surveys, cadastral maps (OCPI Vs., 1983), observations on aerial photographs, and measurements by professional GPS equipment, gave us an image of the dynamics from 1960 until 2017 and the amplitude of processes of land degradation: a) the area affected by landslides in 1960, of 81.19 hectares (0.6% of the total studied area), increased to 632.99 hectares (4.9%) in 2017; b) the huge number of gullies, of 1,680 in 1960 (94% of them being ephemeral gullies), occupying an area of 178.96 ha (1.4%), slightly increased to 1731 in 2017, and occupy an area of 450.47 ha (3.5 % of the total). By the same time, we have drawn a parcel map (plot plan) illustrating about 5,051 individual plots on 6,975.42 hectares of arable land in the area, from which 2,999 plots (4,141.07 ha – 59.4%) are exploited in a more or less consolidated manner by 18 entrepreneurs, and 2,053 individual plots (2,834.35 ha – 40.6%) are exploited individually, being very unlikely to get consolidated in the near future.



All these figures led us to compare the situation in Banca area with that very much different situation in Baltati (Hurjui et al, 2017) in terms of geology-geomorphology-landuse, in one hand, and degree of land consolidation, on the other hand, which is highly important when it comes to design the soil erosion control measures (the relatively small degree of land consolidation in Banca case is a limitative factor). We have found this deterministic chain: the geology/lithology has a decisive role on morphology and dynamics of gullies and/or landslides (Hurjui, 2008), which in turn has a decisive impact on the density of drainage network. The higher values of the density of drainage network have an important influence on fragmentation of relief/landscape and, on the social plan, on the process of landowners' association. The designs for soil conservation and sustainable landuse referred to some low-cost solutions, which can be easily carried out by the land owners, such as: correcting/moulding of torrents, rills, or ephemeral gullies, stabilizing of gully banks and thalwegs, tracing of grass strips separating the strip crops, designs of grassed water ways, correcting the technological earthen roads, plantation of shelter belts, etc. Some of these are illustrated in Figure 1.

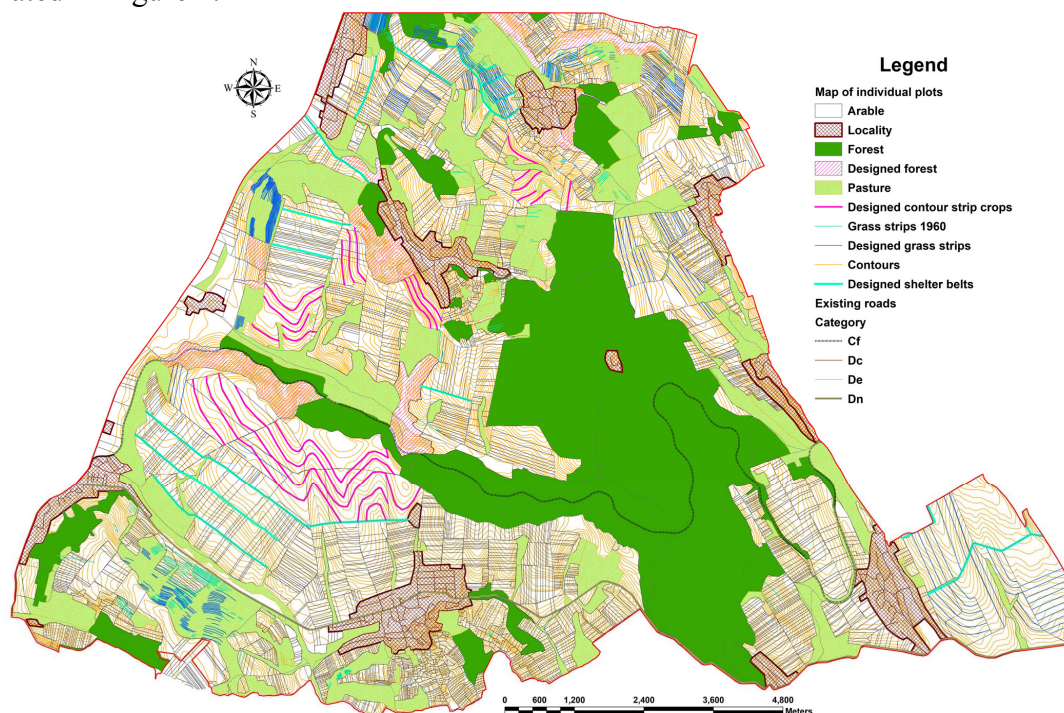

Figure 1. Some soil erosion control measures designed in Banca watersheds.

## Conclusion

The geological structure, geomorphology, and climate conditions which determined the actual distribution of landslides and gullies in Banca region, and the fragmentation of the relief, had a great negative influence, on the social plan, on the process of landowners' association. That is why the designs of soil erosion control measures were drastically limited to a few areas that allowed such intervention.

## References

- Hurjui C., 2008. The Role of Sedimentary Rocks in Morphology and Dynamics of Gullies. Case Studies in the Moldavian Plateau. Alfa Eds., Iassy, ISBN 978-973-8953-74-1, 300 pp. (in Romanian, based on PhD Thesis).
- Hurjui C., Popa N., Filche E., Petrovici G., 2017. Land degradation by gullies and landslides, soil conservation and sustainable landuse under the climate change perspective, in a small watershed in Eastern Romania", Extended abstracts CONSOWA, Lleida, 12-16 June, 2017, pp. 23-26, ISBN: 978-84-697-2909-0.
- OCPI, Vaslui, 1983. Cadastral maps at the scale 1:10.000, Office for Cadastre and Land Registration (OCPI), Vaslui.

## **Soil Health Assessment: Past Accomplishments, Current Activities, and Future Opportunities**

\*Douglas L. Karlen<sup>1</sup>, Kristen S. Veum<sup>2</sup>, and John F. Obrycki<sup>3</sup>

<sup>1</sup> *USDA-Agricultural Research Service (ARS), National Laboratory for Agriculture & the Environment (NLAE), 1015 N. University Boulevard, Ames, IA USA 50011-3611*  
[doug.karlen@ars.usda.gov](mailto:doug.karlen@ars.usda.gov)

<sup>2</sup> *USDA-ARS, Cropping Systems and Water Quality Research Unit, Room 232, ABNR University of Missouri, Columbia, MO 65211*

<sup>3</sup> *ORISE Fellow with the USDA-ARS, NLAE, 1015 N. University Boulevard, Ames, IA USA 50011-3611*

### Introduction

Excessive or inappropriate tillage has been implicated as a factor contributing to soil degradation and thus decreased soil quality/health. As a global organization whose very name [International Soil Tillage Research Organization (ISTRO)] and identity have been questioned by some who would prefer ISTRO to change its name to the “International No-Tillage Research Organization,” focusing on soil quality or soil health may be somewhat disconcerting. However, we are confident that most ISTRO members recognize that in addition to excessive tillage, soil degradation is caused by many disruptive factors (Karlen and Rice, 2015). Soil resources can be degraded by over-grazing, excessive crop residue removal, inadequate soil protection against wind and water erosion, poor nutrient management, and large-scale non-agricultural activities (*i.e.*, mining, deforestation, construction, or urban sprawl). Soil quality/health has become an international topic of research because of the range of inherent and dynamic properties that globally respond to soil and crop management in different ways. As evidenced by the 2018 ISTRO post-conference soil quality monitoring and assessment tour, our organization has the international expertise to address the complex challenges associated with the soil quality/health concept. This presentation is intended to stimulate discussions regarding how can soil health/quality be most effectively assessed, monitored, and if necessary restored.

### Materials and Methods

We begin by briefly reviewing development of the soil quality/health concept and discussing factors contributing to current soil health activities. We then project future needs and challenges associated with using soil quality/health assessment and monitoring as a tool to more rapidly identify and help mitigate global soil degradation. More specifically, our presentation will focus on three important points: (1) the current concept of soil health did not spring up overnight, (2) several critical soil quality/health milestones have indeed been achieved during the past 25 years, and (3) there are many tools available to help identify both challenges and opportunities associated with achieving the soil and crop management changes needed halt degradation and sustain our soil resources for current and future generations.

## Results and Discussion

Multiple soil conservation and land use principles and practices now embodied in the concept of soil quality/health have been recognized for centuries, but the specific concept of “soil quality/health” first appeared in the literature following a 1977 intensive agricultural production conference in Japan. This coincided with observations by an ISTRO founder (Voorhees, 1979) that increased size and weight of farm tractors and other implements, coupled with decreased use of crop rotations, were having a negative effect on soil tilth and creating a soil that was “more difficult to till” than in the past.

During the 1990s, there were numerous publications focused on defining, assessing, and quantifying changes in soil quality. Those efforts led to creation of the Soil Management Assessment Framework (SMAF), Visual Effects of Soil Structure (VESS) assessment, and other tools such as the Cornell or Comprehensive Assessment of Soil Health (CASH). The SMAF was used to evaluate sustainability of various conservation practices within ARS Conservation Effects Assessment Project (CEAP) watersheds, bioenergy feedstock production sites, and long-term tillage and crop production studies in the U.S. It was also used for various sustainability studies in Spain (Apesteguía, et al., 2017), Turkey, India, and in Brazil (Cherubin, et al., 2017).

Since approximately 2012 there has been a global explosion in public and private support for soil health projects. In the U.S. alone, this includes creation of the Natural Resources Conservation Service (NRCS) Soil Health Division, development of the Soil Health Institute (SHI), implementation of the Soil Health Partnership (SHP) to stimulate on-farm soil health investigations, and a focus on “Healthy Soils, Thriving Farms” by the Foundation for Food and Agricultural Research (FFAR). Many new biological indicators and tools have also been identified and multiple state-led, on-farm efforts are being carried out to quantify soil health across the country.

## Conclusions and Recommendations

Public and private support for soil quality/health research and technology is very strong and must to be sustained by providing high-quality, science-based assessments. Emotional or advocacy perspectives that are not supported by science-based soil biological, chemical, and physical property and process studies should be avoided. Globally, ISTRO scientists are well poised to provide international leadership for not only mitigating soil degradation but also meeting food, feed, fiber, and fuel needs of an increasing world population.

## References

- Apesteguía, M., I. Virto, L. Orcaray, P. Bescansa, A. Enrique, M.J. Imaz, and D.L. Karlen. 2017. *Tillage Effects on Soil Quality after Three Years of Irrigation in Northern Spain*. *Sustainability* 9, 1476-1496.
- Cherubin, M.R., A.L.C. Franco, R.M.L. Guimarães, C.A. Tormena, C.E.P. Cerri, D.L. Karlen, and C.C. Cerri. 2017. *Assessing soil structural quality under Brazilian sugarcane expansion areas using Visual Evaluation of Soil Structure (VESS)*. *Soil and Tillage Research* 175:64-74.
- Karlen, D.L., and C.W. Rice. 2015. *Soil Degradation: Will Humankind Ever Learn?* *Sustainability* 7:12490-12501.
- Voorhees, W.G. 1979. *Soil tilth deterioration under row cropping in the northern Corn Belt: Influence of tillage and wheel traffic*. *Journal of Soil and Water Conservation*. 34:184-186.



## Recovery of soil quality after application of long-term tillage treatments

J.M.Cloy\*, B.C. Ball and G.A. Miller

*Scotland's Rural College, West Mains Road, Edinburgh, UK*

\*Corresponding author: [Joanna.cloy@sruc.ac.uk](mailto:Joanna.cloy@sruc.ac.uk)

### Introduction

No- or minimum-tillage compared to conventional tillage practices are often advocated for improving soil organic matter (SOM) and soil organic carbon (SOC) content, water holding capacity, aggregate stability and structure. The continuous conventional cultivation of organic soils in particular can result in large amounts of OM being lost due to decomposition and erosion each year but converting arable land to grassland can allow soil quality functions to recover over time.

### Aim

The current state and recovery of soil quality and function from previous tillage treatments at historic tillage plots was assessed approximately 20 years after tillage treatments were stopped and arable land was converted to grassland and conventional soil management.

### Materials and methods

Soils from historic plots at a field site near Edinburgh, Scotland, where a long-term tillage experiment was conducted from 1967 to 1992 to study soil and barley responses to mouldboard ploughing, chisel ploughing and direct drilling (zero tillage), were re-identified and resampled. Focussing on physical properties (shear vane, cone resistance, bulk density and water infiltration rates) and visual evaluation of soil structure (VESS) measurements, well documented/published historic soil quality data collected during tillage treatments were compared with resampled data. In addition, using archived (1975) and recently (2014) resampled soils, measured changes in SOC stocks and SOC fractions isolated using the Zimmermann *et al* 2007 fractionation method were assessed.

### Results and discussion

Values of physical soil properties showed no differences between former treatments, indicating that tillage treatment effects had disappeared. Soil quality ranged from good to moderate condition. The VESS scores depended on later management and indicated soil degradation as a result of wet soil conditions in autumn and winter 2015/2016. Topsoil and subsoil VESS methods were effective simple tools for detecting such soil degradation. Soil quality was best in March 2015 (VESS 2.4), poorer in October 2015 (VESS 3), one month after grass re-seeding, and poorer still in September 2016 (VESS 4) showing evidence of machinery/trampling compaction under the grass. This was confirmed by bulk densities that increased from 1.1 to 1.3 g cm<sup>-3</sup> between October 2015 and September 2016. Poor subsoil (SubVESS 3.5), very low infiltration rates and high penetration resistances were also found in 2016 for one of the former plots. Historic 1988 assessments indicated that soil structure was most favourable under the shallow ploughed treatment and least under the direct drilled

treatment where some soils were very compact. Corresponding assessments in 2013 suggested good soil structural quality for both of these former treatments, though this was only moderately good in 2016. Using the same double-ring infiltrometer method, surface infiltration rates measured in 2016 for a former deep ploughed plot (range 1.6 – 4.8 mm min<sup>-1</sup>) exceeded those measured in 1981 (range 0.003 – 1.5 mm min<sup>-1</sup>) for direct drilled and shallow ploughed treatments, suggesting enhanced soil macroporosity and water movement after tillage treatments stopped. Soil bulk densities for former plots were similar (range 1.1 to 1.3 g cm<sup>-3</sup>) to historic measurements (range 1.2 to 1.5 g cm<sup>-3</sup>) across tillage treatments. In contrast, cone resistance values at 80 mm depth measured across former plots in 2016 were generally higher (range 800 – 5000 kPa) than historic cone resistance values measured in Oct 1998 (980-2040 kPa) and April 1981 (~ 2500 kPa). Similarly vane shear strength values at 60 mm depth measured in 2016 were higher (range 77 – 110 kPa) than those recorded in April 1981 (61 kPa for direct drill and 14 kPa for shallow plough). The higher soil strengths in 2016 are likely caused by the binding action of grass roots and recent grassland compaction from machinery/grazing or possibly drier soil conditions when measurements were taken. Tillage treatment effects have disappeared and soil structural quality and function in the no-tillage treatments has generally recovered but higher soil strengths and poorer structural qualities in 2016 than in the 1980s/90s may be due to soil degradation as a result of the wet 2015/2016 winter, illustrating the sensitivity of agricultural soils to difficulties of soil management under wet soil conditions.

Soil OC stocks generally increased between 1975 and 2014 but both reductions and increases in SOC stocks were observed for former treatment plots. The overall effect was an equilibration of SOC stocks across all plots. The labile fractions (particulate and dissolved OM) were most sensitive to land-use change in all tillage treatments, but were more sensitive in low impact tillage plots (2.3-5.3 times more sensitive than the whole soil) than inversion tillage plots (1.1-2.2 times more sensitive than the whole soil). The chemically resistant fraction was surprisingly sensitive to land use change (0.6-1.3 times more sensitive than the whole soil).

### Conclusion

Overall this study shows that physical soil functions have now recovered from previous tillage treatments but suffered as a result of wet winter and waterlogging conditions. As expected, soil C stocks determined in 2014 were high (ranging from 150-170 Mg C ha<sup>-1</sup>) but the degree of sensitivity to land-use change of SOM fractions with different levels of stability varied between different tillage management practices.

### References

Zimmermann, M., Leifeld, J., Schmidt, M.W.I., Smith, P. and Fuhrer, J., 2007. Measured soil organic matter fractions can be related to pools in the RothC model. *Eur. J. Soil Sci.* 58, 658–667.

## Soil Nutrient Management and Crop Production under Conventional and Conservation Tillage System in Dryland Farming System of Pakistan

Muhammad Sharif<sup>1</sup>, Shahzada Sohail Ijaz<sup>2</sup>, Muhammad Ansar<sup>2</sup> and Syed Abdul Sadiq<sup>3</sup>

<sup>1</sup> Department of Soil Science Balochistan Agriculture College Quetta, Pakistan

<sup>2</sup> PMAS-Arid Agriculture University Rawalpindi, Pakistan

<sup>3</sup> Balochistan Agriculture College, Quetta, Pakistan

[Corresponding author's e-mail: sharifbaloch84@yahoo.com](mailto:sharifbaloch84@yahoo.com)

### Introduction

Soil nutrient depletion due to land degradation and low contents of organic matter are serious challenges for crop production in dryland farming systems of Pakistan. Unfortunately, the conventional farming system through intensive tillage by moldboard plough and residue removal is further worsening the situation. All these problems ultimately affecting crop production and due to that, potential yields are very low. As a result of worldwide recognition of huge problems associated with conventional tillage systems, now it is the need of time to explore alternative systems which not only sustain the quality of soil but also provide sufficient crop yield. Conservation tillage system is being advocated worldwide for sustainable crop production by leaving crop residues on the soil surface and minimum soil disturbance. The term includes minimum tillage, direct drilling, zero tillage etc under its umbrella (FAO, 2015). The potential advantage of conservation tillage practices over conventional practices is due to leaving residue on the soil surface that reduces erosion by providing barrier against rain-splash and runoff, reduces evaporation and increases infiltration (Franzluebbers, 2002). Residue also increases soil organic carbon (Lal, 2006) that improves soil aggregation (Madari *et al.*, 2005) soil water availability (Unger, 1994; Drury *et al.*, 1999), number of biopores (Francis and Knight, 1993) that may facilitate root growth (Martino and Shaykewich, 1994) and water holding capacity. In short, conservation tillage with the presence of residue on soil surface interfaces all soil ecology (Huang *et al.*, 2008). This system also saves time and fuel cost (Baker *et al.*, 2007) which is very important for smallholder farmers of developing countries like Pakistan. However, the benefits of conservation tillage are dependent on soil properties, climatic condition of the area and the number of the years since the tillage system has been implemented (Rhoton, 2000). Therefore the following study was conducted with the objective i) to evaluate different variants of conservation tillage with conventional intensive tillage system for soil nutrient concentration, crop production and economic returns for dryland farming system of Pakistan.

### Materials and Methods

Conservation tillage experiment was initiated in 2016 on a silty loam soil at Balochistan Agriculture College, Quetta (latitude 30° 10' 59.77"N, longitude 66° 59' 47.22"E) in arid dryland, Balochistan, Pakistan. The experiment was initiated on an area of 6000 m<sup>2</sup> with treatments arranged in a split plot design having four replications. The main plot treatments were tillage systems i.e. Conventional Tillage (CT), Minimum Tillage (MT), Reduced Tillage (RT) and Zero Tillage (ZT). The sub plot-treatments involved residues retained (R<sup>+</sup>) and residues removed (R<sup>-</sup>). One year earlier than installation of treatments, the

field was left without tillage and crop to offset the residual effects of previous tillage practices. In CT plots, the soil was ploughed with moldboard plow at the start of monsoon followed by 8-10 time shallow cultivation with tine cultivator applied after each major rainfall for weed control and moisture conservation. Wheat sowing in these plots was done with seed-cum-fertilizer drill. In MT, the field was also ploughed with intensive moldboard on the onset of monsoon and four time cultivation with tine cultivator, while sowing was done with conventional seed-cum-fertilizer drill. In RT, one time chisel plough was applied at the start of monsoon and then during fallow period weeds were controlled with roundup herbicide (Glyphosate @ 1 L acre<sup>-1</sup>) and wheat was sown through direct drilling with zero tillage drill. In ZT, field remained undisturbed for entire fallow period and weeds were controlled with roundup herbicide when needed. Winter wheat was directly sown with zero tillage drill. In sub-plot treatments +R involved just harvest of the previous crop spikes and retention of all the stubbles in field. In case of -R the crop was harvested with reaper and there was no crop residues left in field. The recommended doses of fertilizer NPK i.e. 100-60-30 in the form of urea, diammonium phosphate (DAP) and sulfate of potash (SOP) were used. Wheat was planted at seed rate of 100 kg ha<sup>-1</sup>. TOC was measured by (Walkley, 1947) N-Nitrogen by (Anderson and Ingram, 1993) Available P by (Kuo, 1996) and extractable K by (Richards, 1977) method.

### Results and Discussion

The experimental results in the 0-20 cm indicates that total organic carbon, nitrate-nitrogen and available phosphorus contents were significantly higher under ZT and CP with retention of crop residues and their values were respectively (15.6, 16 kg ha<sup>-1</sup>), (5.2, 5.6 mg kg<sup>-1</sup>), (3.95, 4.5 mg kg<sup>-1</sup>) with comparison of conventional tillage without retention of crop residues and were 12 kg ha<sup>-1</sup>, 4 mg kg<sup>-1</sup>, 3.2 mg kg<sup>-1</sup>. Crop biomass and yield was higher under CT (6.02 Mg ha<sup>-1</sup>, 3.32 Mg ha<sup>-1</sup>) and was statistically same to MT and CP with retention of crop residues while significantly lower under ZT (4.33 Mg ha<sup>-1</sup>, 2.02 Mg ha<sup>-1</sup>) without residues retention. The gross margins were highest under RT with crop residues (Rs. 109375) and lower under ZT (Rs. 7187) without residue and alternatively efficiency coefficient was highest under ZT (4.13). Crop residue management is an important pillar of conservation tillage systems, crop residues increase organic material which ultimately helpful for the improvement of nutrient in soil and enhance crop production (Huang et al. 2008).

### Conclusion

The study concludes that conservation tillage practices, especially the chisel plough with retention of crop residues showed promising results to improve soil nutrient availability, economic benefits by reducing input cost while provide sufficient yield in dryland of Pakistan.

### References

- FAO. 2015. What is Conservation Agriculture? Available at: <http://www.fao.org/ag/ca/1a.html>.
- Huang, G. B., R. Z. Zhang, G. D. Li, K. Y. Chan, D. P. Heenan, W. Chen, M. J. Unkovich, M. J. Robertson and B. R. Cullis. 2008. Productivity and sustainability of spring wheat -field pea rotation in a semi-arid environment under conventional and conservation tillage systems. *Field Crop. Res.*, 107: 43-55.
- Lal, R. 2006. Enhancing crop yield in the developing countries through restoration of soil organic carbon pool in agricultural lands. *Land Degrad. Dev.*, 17: 197-209.

## Innovative Cover Cropping Systems for Sandy Loam Soils in the Mid-Atlantic Region, USA.

M.S. Reiter<sup>1\*</sup>, B.R. Wolters<sup>2</sup>, and C.L. Lawrence<sup>3</sup>

<sup>1</sup>Department of Crop and Soil Environmental Sciences, Virginia Tech Eastern Shore Agricultural Research and Extension Center, Painter, Virginia, 23420, USA.

<sup>2</sup>Department of Crop and Soil Environmental Sciences, Virginia Tech, Blacksburg, Virginia, 24060, USA.

<sup>3</sup>USDA-Natural Resources Conservation Service, Richmond, Virginia, 23229, USA.

\*corresponding author: [mreiter@vt.edu](mailto:mreiter@vt.edu)

### Introduction

Soils in the coastal plain of the mid-Atlantic region USA are sandy in texture, many were farmed and tilled intensely for more than a century, and now have low organic matter (OM) and poor soil quality. Soil quality can be improved by reducing disturbance caused by tillage and by adding OM back into the soil via innovative crop rotations (Gruver and Weil, 2007; Nakajima et al., 2016). Cover crops, or other crops treated as cover crops, can add OM back to the soil system, sorb nutrients that might otherwise be lost to the environment, and may ultimately change soil physical structures (Reicosky and Forcella, 1998; Nakajima et al., 2016). The objective of this study is to quantify system changes after a 3-year high-residue cover cropping system was introduced to low OM sandy loam soils. After 3-years we evaluated: 1. aerial cover crop biomass produced, 2. resulting nitrogen (N) and sulfur (S) fixation and uptake from cover crops; 3. soil compaction at depth; and 4. maize (M; *Zea mays*) yield.

### Materials and Methods

In Fall 2014, we established a cover crop system focused on the traditional M-wheat (W; *Triticum aestivum*)-soybean (S; *Glycine max*) grain system with 12 cover crop treatments following intensively tilled potatoes (*Solanum tuberosum*) in Painter, Virginia, USA on sandy loam soils (coarse-loamy, mixed, semiactive, thermic Typic Hapludults). Each system had different cover crops with varying modes of action (legume, grass, and brassica) and all systems were no-tilled, except treatment 1. Species included in system were: M, cereal rye (R, *Secale cereale*), hairy vetch (V, *Vicia villosa*), 9-species mix (9C), 3 species mix (3C), summer mixes (SM), a perennial mix (P), along with fallow (F) plots. Established systems labeled as winter 1 – summer 1 – winter 2 – summer 2 – winter 3 – summer 3 included: 1. F-M-F-M-F-M and tilled; 2. F-M-F-M-F-M; 3. R-M-R-M-R-M; 4. V-M-V-M-V-M; 5. 9C-M-9C-M-9C-M; 6. F-M-F-S-F-M; 7. V-M-R-S-V-M; 8. F-M-W-S-F-M; 9. 3C-S-W-SM-3C-M; 10. 3C-SM-3C-S-3C-M; 11. W-SM-3C-SM-3C-M; and 12. PM-PM-PM-PM-PM-M. In year 3, each rotational treatment was divided into subplots and fertilized with 0, 56, 112, and 168 kg N ha<sup>-1</sup> to test for N cycling and potential fertilizer supply within the system. Cover crops were terminated at 100% heading/flowering in late April to allow optimal biomass production and N fixation. The overall experimental design in year 3 was a strip plot design in a factorial arrangement of main plots comprised of cover crop system with subplots as maize N. All plots were replicated four times and means separated using  $p = 0.10$ .

### Results and Discussion

In spring 3 at desiccation, system #11 (W-SM-3C-SM-3C-M) had highest biomass (10,087 kg biomass ha<sup>-1</sup>) and most N uptake and assimilation (274.1 kg N ha<sup>-1</sup>) (Table 1). Inversely, the monoculture M system that was no-tilled with no cover crops had lowest aerial biomass (1,030 kg biomass ha<sup>-1</sup>) and N accumulation (32.3 kg ha<sup>-1</sup>). Overall cover crop N fixation and accumulation can be expressed by a linear relationship where:  $y = 0.0274B + 3.513$ , where y

= kg N ha<sup>-1</sup> uptake/fixation and B = kg biomass ha<sup>-1</sup> ( $R^2 = 0.94$ ). When no N fertilizer was applied, highest M yield occurred when legumes were in the cropping system (rotations #4, 7, and 9), as expected, indicating N fixation and cycling over years. Lowest yields occurred when no cover crops were included (rotations #1, 2, 6, 8) and for monoculture R cover crop systems (rotation #3) due to higher C:N ratios in biomass and soils (data not shown). Sulfur accumulation was highly correlated to aerial drymatter produced, as expected. In these S poor sandy loam systems with little atmospheric deposition, it is interesting to note the amount of S scavenging possible. Cover crops can recover and protect soil S from being lost from the system. Soil compaction measurements varied from root limiting pressures in a wide range that spanned 7.0 to 20.3-cm deep (Table 1). Soil resistance likely varied greatly from soil water content differences (data not shown). Rotations with greater soil resistance at shallower depths also had low cover crop biomass production, N and S assimilation, and low M yield (rotations #6 and 8, for instance).

Table 1. Impact of cover crop system rotations on cover crop biomass, N and S accumulation, maize yield, and soil compaction at maize planting in year 3 for sandy loam soils.

Rotation	Cover crop			Maize‡	Compaction¶
	biomass†	N Accum.	S Accum.		
---#---	-----kg ha <sup>-1</sup> -----				---cm---
1. F-M-F-M-F-M	1,168 k	36.0 k	4.0 k	3,701 cd	12.1 bcd
2. F-M-F-M-F-M	1,030 l	32.3 l	3.6 l	2,133 d	9.3 bcd
3. R-M-R-M-R-M	4,039 g	112.6 g	12.1 g	3,450 cd	12.7 bcd
4. V-M-V-M-V-M	4,936 f	136.6 f	14.6 f	9,786 a	16.5 ab
5. 9C-M-9C-M-9C-M	7,029 c	192.4 c	20.5 b	5,144 bc	20.3 a
6. F-M-F-S-F-M	1,264 j	38.5 j	4.2 j	1,756 d	7.0 d
7. V-M-R-S-V-M	3,518 h	98.7 h	10.6 h	10,539 a	14.4 abc
8. F-M-W-S-F-M	1,994 i	58.0 i	6.3 i	2,635 d	7.0 d
9. 3C-S-W-SM-3C-M	7,091 b	194.1 b	20.7 a	9,849 a	16.5 ab
10. 3C-SM-3C-S-3C-M	5,159 e	142.5 e	15.2 e	5,583 bc	11.0 cd
11. W-SM-3C-SM-3C-M	10,087 a	274.1 a	19.1 c	7,151 b	15.2 abc
12. PM-PM-PM-PM-PM-M	6,259 d	171.9 d	18.3 d	5,081 bc	10.8 cd

†Aerial biomass dried to a constant weight in spring 3.

‡No-fertilizer check plots in summer 3.

¶Depth to digital penetrometer resistance of 350 PSI at field capacity in spring 3.

## Conclusion

In conclusion, plant growth and soil parameters varied greatly within rotations after 3 years of study implementation on these low OM and historically highly tilled sandy loam soils. Many different rotational strategies had positive impacts on M yield and soil resistance measurements. As expected, including legumes in the production system's rotation had a positive impact on N cycling and allowed crops to persist with less need for inorganic fertilizer applications. We look forward to continuing this project for another 3-year crop rotation cycle to better understand soil and crop parameter changes over time.

## References

- Gruver, J.B., and R.R. Weil. 2007. Farmer perceptions of soil quality and their relationship to management-sensitive soil parameters. *Renew. Agric. Food Syst.* 22(04): 271–281.
- Nakajima, T., R.K. Shrestha, and R. Lal. 2016. On-Farm Assessments of Soil Quality in Ohio and Michigan. *Soil Sci. Soc. Am. J.* 80(4): 1020-1026.
- Reicosky, D.C., and F. Forcella. 1998. Cover crop and soil quality interactions in agroecosystems. *J. Soil Water Conserv.* 53(3): 224–229.

## Sustainable intensification alternatives to Rice-Pasture system in Uruguay: Impacts on rice yield and soil organic C during the transition.

I. Macedo<sup>1\*</sup>, V. Pravia<sup>1</sup>, J. Castillo<sup>1</sup>, J. A. Terra<sup>1</sup>

<sup>1</sup> Instituto Nacional de Investigación Agropecuaria, INIA, 33000, Treinta y Tres, Uruguay

\* corresponding author: [imacedo@inia.org.uy](mailto:imacedo@inia.org.uy)

### Introduction

Soil organic matter (SOM) is key soil quality indicator. Reach high yield is critical to maintain soil quality. In Uruguay, rice typically rotate with perennial pastures (mix of grasses and legumes) used in beef production systems. This allows farmers to sustain high productivity, preserve natural resources, diversify incomes and minimize the use of pesticides and fertilizers (Pittelkow et al., 2016). Rice yield is one of the top in the world, showing a sustained increase from approximately 5 Mg ha<sup>-1</sup> in the late 80's to more than 8 Mg ha<sup>-1</sup> in last years. However, rice farmers have a growing interest to intensify their production systems with the aim to increase profitability. The goal of this study was to evaluate the impact of different rice rotation intensification pathways on rice yield and SOM during the stabilization of a prospect long term experiment.

### Material and method

A field-scale long term experiment was initiated in 2012 in a Natraquoll located in eastern Uruguay (33° 16' 23" S; 54° 10' 24" W; 22 MASL). It was used a basic design, in a randomized complete block with three replications and all phases of each rotation presented simultaneously (Patterson, 1964). Treatments were established in a 30 years rice-pasture rotation field and included: 1) Rice-Rice-Long Pasture of *Festuca arundinacea*, *Trifolium repens* and *Lotus corniculatus* (RLP) (5yr); 2) Rice-Short Permanent Pasture of *Lolium multiflorum* and *Trifolium pratense* (RSP) (2yr); Rice-Soybean-Short Permanent Pasture of *Festulolium spp.* and *Lotus corniculatus* (RSySP) (6yr); Rice-Soybean-Rice-Sorghum (RSyRSg) (4yr); Rice-Soybean (RSy) (2yr) and Continuous Rice (CR) (1yr). Cover crops were sown in winter between cash crops in all rotations. Permanent pastures of RLP, RSP and RSySP were grazed with lambs. Crop management practices, including nutrients, pest and weeds control and cultivars seeded were chosen specifically for each rotation, and were not necessarily the same. Rice yield (13%H) was determined in each 1200 m<sup>2</sup> plot, using a combine and a wagon with a digital balance during 2015-16 and 2016-17 season. Soil quality indicators evaluated were: soil organic carbon (SOC), total nitrogen (N), particulate organic carbon and nitrogen (C-POM and N-POM respectively), mineral associated organic carbon and nitrogen (C-MAOM and N-MAOM) in 0-15 cm depth in Sept. 2016 and May 2017. Treatment effect were analyzed with general liner model. Source of variation included, rotation, year, block and their interactions. Rice yield means were separated with a least significant difference (P≤0.05). Contrasts with Scheffe's test (P≤0.05) were used to evaluate rotation effect on soil indicators.

### Results and discussion

No differences were found on rice yield between rotations. Average yield was 10.3 Mg ha<sup>-1</sup>, the highest yield was observed in the RSyRSg (10.7 Mg ha<sup>-1</sup>) and the lowest in CR (9.7 Mg ha<sup>-1</sup>). Season 2015-16 had 5.3 % lower yield than season 2016-17 (10.6 Mg ha<sup>-1</sup>). After five years, no SOC and TN differences were found between rotations (29.3 Mg C ha<sup>-1</sup> and 3.16 Mg N ha<sup>-1</sup>). Neither in C-MAOM and N-MAOM, also when RLP was compared with RSP or RSySP no changes were found in C-POM and N-POM.

However, RLP had 18% and 19% greater C-POM and N-POM compared with RSy and RSyRSg (6.06 Mg C ha<sup>-1</sup> and 0.48 Mg N ha<sup>-1</sup>; respectively), representing around 23.6% and 20% of SOC for RLP and RSy-RSyRSg, respectively (Table 1).

Table 1. Difference and standard error in particulate organic carbon and nitrogen contents for contrasts evaluated.

Contrasts	C-POM			N-POM		
	Difference	Std. Error	Significance	Difference	Std. Error	Significance
	Mg ha <sup>-1</sup>					
1) RLP vs RSP	0,91	± 0,37	NS	0,082	± 0,033	NS
2) RLP vs RSySP	0,70	± 0,27	NS	0,037	± 0,024	NS
3) RLP vs (RSyRSg and RSy)	1,07	± 0,27	*	0,089	± 0,024	*
4) (RSyRSg and RSy) vs CR	-0,51	± 0,48	NS	-0,034	± 0,042	NS

\*Significative with a p-value ≤ 0,05. NS= no significative. Rice rotating with: long pastures (RLP), short pastures (RSP), with soybean and short pastures (RSySP), with soybean and sorghum (RSyRSg), with soybean (RSy) and under continuous rice (CR).

Probably, the contribution of residues provided for rice straw and roots of high productivity as well as the residues of other crops, cover crops and/or shorter pastures have supplied the input of long pastures substituted in more intensive systems. Higher contents of C-POM and N-POM in RLP respect to RSyRSg and RSy can be explained by the quality and quantity of residues provided for roots of perennial pastures (Benintende et al., 2008).

### Conclusion

The results from this study indicated that, for soils under rice-pasture rotations in temperate climates, there are alternatives for soil use intensification that allows sustain productivity without losing SOM at least in the midterm. However, the elimination of perennial pastures from the rice rotation may make SOM more vulnerable to lose and soil less resilient to these changes in the future.

### References

- Benintende, S. M., Benintende, M. C., Sterren, M. A., & De Battista, J. J. 2008. Soil microbiological indicators of soil quality in four rice rotations systems. *Ecological indicators*, 8(5), 704-708.
- Patterson, H.D., 1964. Theory of cyclic experiments. *J. R. Statist. Soc.* 26, 1-45.
- Pittelkow, C. M., Zorrilla, G., Terra, J., Ricetto, S., Macedo, I., Bonilla, C., & Roel, A. 2016. Sustainability of rice intensification in Uruguay from 1993 to 2013. *Global Food Security*, 9, 10-18.



## Evaluation of surface runoff and soil loss in conservation and conventional tillage in a degraded Inceptisol of Ecuador

Ingrid Martínez<sup>\*</sup>, Carolina Velastegui, Doreen Brown, María José Romero, Carlos Arcos, Julia Prado, Miguel Gómez

*Universidad Técnica del Norte, Facultad en Ciencias Agropecuarias y Ambientales FICAYA, Av. 17 de Julio N5-21, Ibarra, Ecuador*

\*corresponding author: [immartinez@utn.edu.ec](mailto:immartinez@utn.edu.ec)

### Introduction

In Ecuador, water erosion and inappropriate soil management are the major cause of soil degradation. Around 47% of the soils in the country are eroded with significant economic and environmental impacts. According to the land capability classification, 67% of the soils have slopes over 30% (OEA, 1984). In this context, it is important to include soil conservation measures to mitigate erosion and farmer's perception on the practices. However, the lack of scientific investigation in the area of soil conservation, as well as the availability of equipment and training has caused intensification of these erosive processes. As a result, in the north of the country, the 78% of the soils are in process of erosion. The objectives of this study were to compare minimum tillage system with the traditional tillage in terms of i) soil loss, and ii) surface runoff.

### Materials and methods

The study site was located in the northern Ecuador (0° 35'N, 78° 12'W, 2386 m.a.s.l.). Experimental runoff plots of 200 m<sup>2</sup> (10 m x 20 m) were established on a hillside with a 25% of slope in a degraded Inceptisol (Fig. 1). An oat (*Avena sativa* L.) crop was established under minimum tillage (MT) with contour plowing at a distance of 7 m, compared to conventional tillage (CT). Surface runoff and sediment losses were determined by placing two collector tanks of water with 223 liter capacity. The first tank had 18 runoff orifices, one of them connected to the second tank. The surface runoff was measured during rainfall events. The runoff coefficient (Kr) was calculated as the percentage between the surface runoff and rainfall per month. Soil loss was determined in the laboratory from a sample of 100 ml of runoff water with suspended sediments, taken after removing the water from the tank.

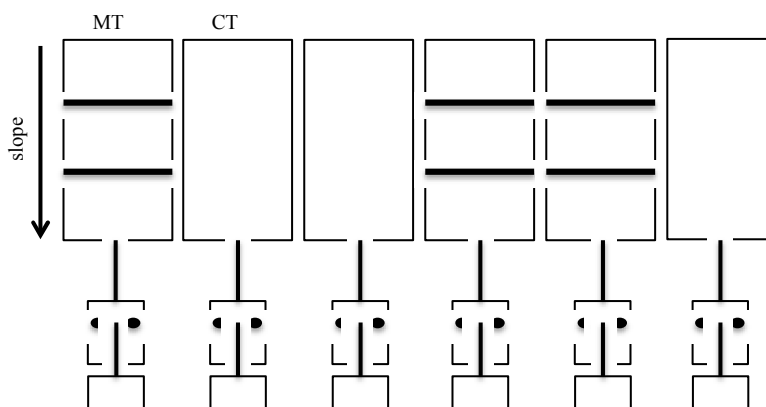

Fig. 1. Map of experimental site.

**Results and discussion**

Rainfall during the study site was variable in distribution and intensity during rainy season. The relationship between accumulated soil loss, showed that the CT system reached a soil loss higher in a 85%, compared to MT (Table 1). Surface runoff was negligible in the first months; however, in May CT reached a Kr of 17%, in contrast to the MT, wich ranged 7% (Fig. 2). Our results indicate that MT reduced soil erosion by water in degraded soils (Martínez et al., 2012).

**Table 1**  
Soil loss and accumulative soil loss during rainy season 2018.

Rainfall event	Date	Rainfall (mm)	Soil loss (kg ha <sup>-1</sup> )		Accum soil loss (kg ha <sup>-1</sup> )	
			MT	CT	MT	CT
1	15-01-18	1.27	0.01	0.03	0.01	0.03
2	17-01-18	7.79	0.01	0.02	0.02	0.05
3	24-02-18	33.45	0.19	0.17	0.21	0.22
4	27-03-18	12.42	0.03	0.08	0.24	0.30
5	12-04-18	73.26	0.55	1.70	0.79	2.00
6	04-05-18	59.57	5.3	14.95	6.09	16.95
7	05-05-18	47.43	302.54	1736.28	308.63	1753.24
8	10-05-18	55.76	1.66	312.59	310.29	2065.83

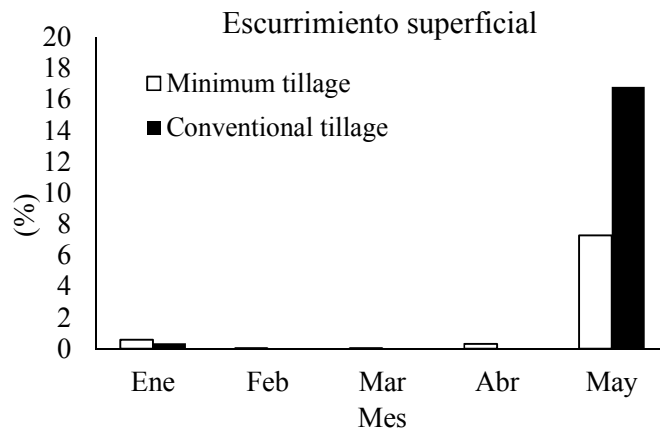

Fig. 2. Percentage of monthly runoff coefficient (Kr) for minimum tillage (MT) and conventional tillage (CT).

**Conclusion**

These results showed the importance of minimum tillage systems to mitigate water erosion in the study area.

*References*

Martínez, I., Prat, C., Ovalle, C., del Pozo, A., Stolpe, N., Zagal, E. 2012. Subsoiling improves conservation tillage in cereal production of severely degraded Afisols under Mediterranean climate. Geoderma 189-190, 10-17.

OEA. 1984. República del Ecuador. Planificación para el Desarrollo de la Región I (Provincias: Imbabura, Carchi, Esmeraldas). Publicación N° 35. Plan de Desarrollo Regional. Quito, Ecuador.

## Effects of soil tillage intensity and compost application in ecological management systems on soil aeration and mechanical stability

D. Uteau\*<sup>1</sup>, U. Roskopf<sup>1</sup>, M. Finckh<sup>2</sup>, S. Peth<sup>1</sup>

<sup>1</sup> Department of Soil Science, Faculty of Organic Agricultural Sciences, University of Kassel, Witzenhausen, Germany.

<sup>2</sup> Department of Ecological Plant Protection, Faculty of Organic Agricultural Sciences, University of Kassel, Witzenhausen, Germany.

\* corresponding author: uteau@uni-kassel.de

### Introduction

Conventional soil tillage include practices to enhance plant nutrient acquisition by modifying several soil properties mostly on the topsoil, but often to the detriment of subsoil properties. No-tillage may improve top/subsoil structure by natural recovery, but often at a high cost because of the slowness of this process. The use of minimal tillage, subsidiary crops and organic mulches could accelerate the natural regeneration of soil physical functions by enhancing biological activity and related soil structure formation. Within the EU-Research Project OSCAR, which main goal is the development of improved conservation tillage systems based on subsidiary crops, we want to assess improvements in terms of mechanical stability and aeration.

### Material and Method

We analyzed soil physical properties (air conductivity, bulk density and precompression stress) in undisturbed soil samples taken in a field experiment at the experimental station Neu-Eichenberg (University of Kassel). Two factors (tillage and compost) were analyzed in a randomized setup with four field replicates. The levels for tillage were (1) standard plow to 30 cm depth and (2) light grubbing to 5 cm depth with light tractor for seedbed preparation. Both tillage levels were prepared with and without application of compost, thus achieving four treatments in total. The samples (n=32) were taken one year after start of the experiment.

### Results

Results show a high influence of the tillage treatments in the topsoil on soil physical properties, especially macroporosity and air conductivity. We observed a lower macroporosity in the minimal tillage treatments, although this did not decrease air conductivity. Thus, it can be interpreted as a loss of those macropores which show low transport functionality. There was a lower bulk density and lower mechanical stability at the tilled treatments which reflects the rupture of soil structure. Macroporosity of minimal tillage treatment was less affected after the compaction test, showing a higher resilience in terms of mechanical stability. There were no differences in soil physical properties with the application of compost. Also no differences were detected in the measured properties below a depth of 40 cm.

### Conclusions

Conventional tillage may improve physical properties in the short term and only in the topsoil. In the long term the loss in soil structure can be measured by a loss in functionality expressed e.g. in terms of air conductivity and mechanical stability. Reduced tillage may also maintain functionality of subsoil properties in the long term, hence emphasizing the need for further monitoring those properties during longer periods.

Key words: structure, oscar, organic farming, agromachinery, wenz

## Structure Stability of Long-term Cultivated Soils in the Ethiopian Highland: Effect of Lime and Polyacrylamide

A.I. Mamedov\*, H. Fujimaki and A. Tsunekawa

*Arid Land Research Center, Tottori University, 680-0001 Tottori, Japan*

\*corresponding author: mamedov@tottori-u.ac.jp

### Introduction

Land degradation is the critical agricultural challenges in highland of Ethiopia, characterized by a monsoon climate. Long-term conventional tillage with an inadequate soil conservation practices intensified soil organic matter depletion, deterioration of soil structure and infiltration capacity, and consequently on-site nutrient loss and off-site soil loss (Mengistu et al., 2016). Actual adoption of conservation measures and simultaneously application of alternative practices, such as using specialized chemical compounds (e.g. anionic polyacrylamide, PAM), can securely improve soil health. Conversely, using only the former method can take several years to achieve substantial soil organic matter level and soil physical quality. Extensive changes in the physical conditions (e.g. pore structure and crusting) of the soil tilled layer, by both management and raindrop impact, influences various hydrological and biological processes; yet, the resilience of soil structure to changes imposed by external forces largely depends on soil genesis and associated properties (Kutilek, 2004; Roger-Estrade et al., 2009). The paper (i) displays results obtained from structure stability experiments of long-term cultivated Ethiopian highland soils using the High Energy Moisture Characteristics (HEMC) method, and (ii) links contribution of soil type, slaked lime and PAM application to soil pore size distribution (PSD) for the development of effective soil conservation practices.

### Material and Methods

Samples of six soil types (Acrisols, Cambisols, Leptosols, Luvisols, Regosols, Vertisol) from tilled layer of three Ethiopian watersheds (Dibatie, Aba Gerima and Guder), characterized by acidic reaction, low organic matter and base saturation, loamy or clayey texture, and mixed and or predominant smectite/kaolinite clay mineralogy, were used. Three sets of experiments were conducted to evaluate the role of soil type and wetting rate, lime ( $1.6 \text{ g L}^{-1}$ ) and PAM ( $200 \text{ mg L}^{-1}$ ) application on soil structural stability indices, expressed in terms of near saturation soil water retention (suction 0-50 cm  $\text{H}_2\text{O}$ ), using the sensitive HEMC approaches (Mamedov and Levy, 2013). In this method, (i) the wetting rate is accurately controlled, and energy of hydration and entrapped air are the main forces responsible for breaking down of aggregates, and (ii) water retention parameters and structure stability indices are inferred from changes in the PSD following wetting. The water retention curves of samples were characterized by a modified van Genuchten model that provides (i) parameters  $\alpha$  and  $n$ , which represent the location of the inflection point, and the steepness of the water retention curves, and (ii) a composite soil structure stability index ( $\text{SI} = \text{VDP}/\text{MS}$ ; VDP-volume of drainable pores, MS-modal suction). Deionized water (DW) or ethanol was used for wetting of aggregates; use of nonpolar liquid-ethanol eliminate aggregate slaking, and could be reference for various treatments.

### Results and discussion

All treatments considerable altered the shape of the water retention curves (Fig. 1), and subsequently model parameter and stability indices ( $\alpha$ ,  $n$ , SI, VDP and MS); however, the shape of curves were soil type dependent, since mixed changes were observed in the various range of representative macropores size (60-125; 125-250,  $>250 \mu\text{m}$ ). The VDP, SI and  $\alpha$  increased, MS and  $n$  decreased significantly with lime and PAM application, and the decrease

in soil wetting rate. Changes in soil structure following aggregate breakdown, resulted in the formation of a larger number of aggregates of smaller sizes than the original ones, causing the inter-aggregate PSD to shift toward a greater number of smaller pores. Model parameters  $n$  and  $\alpha$  were greatly modified by the lime and PAM treatments accordingly. Fast wetting of PAM-treated soil and slow wetting of not-treated soil produced comparable SI (Fig.1). The SI of treatments were in the followings order: Control (non-treated) < Lime < PAM. Control soils with mixed and/or predominant smectite clay mineralogy, and higher clay activity and dispersibility (Vertisol, Luvisols, Leptosols, and Regosols) had much lower SI (0.006-0.015), and higher susceptibility to crusting and sheet erosion (Ebabu et al., 2018), than Acrisol and Cambisol, with predominant kaolinitic clay mineralogy (SI=0.022-0.025). Soils treated with PAM showed 2-5 times higher SI (0.026-0.040) than control, where the effect was smallest, but considerable, in two kaolinitic soils. The SI of the non-treated soils wetted with ethanol showed 3-10 times higher SI (0.065-0.090) than control, indicating to the higher level of slaking in the latter during wetting with DW (e.g. rainwater). Correlation and regression relationship between model parameters of water retention curves and structural indices were analyzed, and contribution of treatments, and mechanism responsible for soil structure modification, is discussed in the paper.

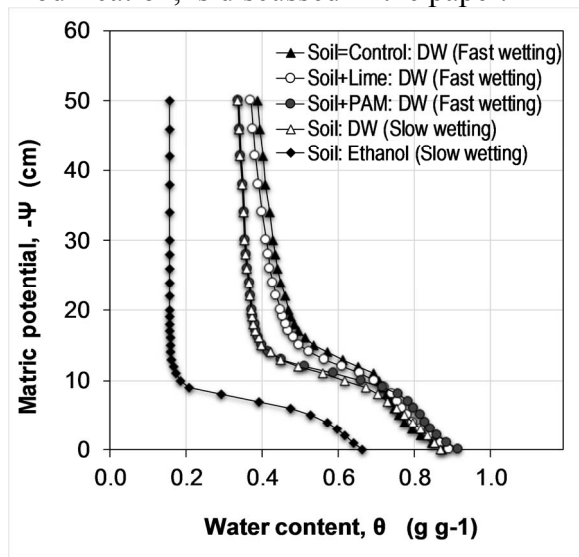

Figure 1. Water retention of clay Luvisols, control, treated with slaked lime ( $1.6 \text{ gL}^{-1}$ ) and polyacrylamide (PAM= $200 \text{ mgL}^{-1}$ ), and wetted (fast or slow) with deionized water (DW) or ethanol.

## Conclusions

The results reveal that for sustaining soil physical quality and erosion control, soil type, predominant clay mineralogy, cultivation history and wetting condition (e.g. rain intensity) should be considered. Parameters of HEMC model can be related to measured soil properties, and therefore soil structure stability can be derived from certainly measured field soil characteristics. For effective soil structure improvement, crusting and erosion control, application of PAM should be associated with other amendments and electrolyte sources, such as gypsum and lime (e.g. soil physical quality and health management), which are traditionally not used in the studied area for conservation practices.

## References

- Kutilek, M., 2004. Soil hydraulic properties as related to soil structure. *Soil and Tillage Research*, 79,175–184.
- Mamedov A.I., Levy G.J., 2013. High energy moisture characteristics: linking between some soil processes and structure stability. In: S. Logsdon, M. Berli, and R. Horn, (eds). *Quantifying and Modeling Soil Structure Dynamics: Advances in Agricultural Systems Modeling*. SSSA, Madison, WI 3, 41-74.
- Mengistu, D., Bewket, W., Lal, R. 2016. Conservation effects on soil quality and climate change adaptability of Ethiopian watersheds. *Land Degradation and Development*, 27, 1603-1621.
- Roger-Estrade J., Richard G., Dexter A.R., Boizard H., Tourdonnet S. de, Bertrand M., Caneill J., 2009. Integration of soil structure variations with time and space into models for crop management. A review. *Agronomy for Sustainable Development*, 29, 135-142.
- Ebabu, K., Tsunekawa, A., Haregeweyn N., Adgo, E., Meshesha, D.T., Aklog, D., Masunaga, T., Tsubo, M., Sultan, D., Fenta, A.A., Yibeltal, M. 2018. Analyzing the variability of sediment yield: A case study from paired watersheds in the Upper Blue Nile basin, Ethiopia. *Geomorphology*, 303, 446-455.

## The link between cropping system and overland flow dynamics: the $I_{DR}$ -tool for farmer advice and its validation

P. van Dijk<sup>1\*</sup>, M. Sivacheva<sup>2</sup>, R. Koller<sup>2</sup>

<sup>1</sup>*Chambre Régionale d'Agriculture Grand Est, 67300 Schiltigheim, France*

<sup>2</sup>*Association pour la Relance Agronomique en Alsace, 67300 Schiltigheim, France*

Corresponding author: [paul.vandijk@grandest.chambagri.fr](mailto:paul.vandijk@grandest.chambagri.fr)

### Introduction

Overland flow and related environmental hazards in central Europe have often been related to soil characteristics (i.e. loess soils with high silt content), crop type (i.e. row crops, spring-sown crops), and topographical features (i.e. slope steepness, upstream area, valley bottoms). Most existing tools (such as the USLE, STREAM, LISEM, MESALES, PESERA, etc.) account for these factors. However, farmer experiences provide evidence that crop rotation and related agricultural practises can strongly influence the overland flow and erosion risk. Most overland flow models do not account for the details of crop successions, the calendar of technical operations during the rotation, and the cross links of these cropping system features with the rainfall calendar. The DIAR tool (Martin et al., 2010) addresses these issues but does not model crop growth, and uses a concept with a time discretisation of 6 phases to describe the dynamics of soil (surface) conditions in the field. It applies the curve number SCS-CN approach to translate each of these 6 phases into overland flow production. The curve number method does not account for rainfall intensity which is a key factor in the generation of hortonian overland flow.

We therefore developed a continuous field scale indicator (or operational model) for overland flow simulation during a crop rotation which implements the Philip infiltration equation. The tool is called  $I_{DR}$  (Indicateur de la Dynamique du Ruissellement). The objectives of  $I_{DR}$  are (1) to identify risk periods for overland flow during the crop rotation, and (2) to provide solutions to farmers to limit overland flow by adapting the considered cropping system. These solutions can be composed of (a) modifications of crops in the rotation, (b) inserting cover crops, (c) changing tillage tools and their settings (such of tillage depth) and (d) changing crop residue management. This communication describes the  $I_{DR}$ -tool and presents validation results of about 60 overland flow events. These events were measured in the period of 2006 to 2015 on 2 equipped fields with different tillage strategies in the village of Geispitzen in the Haut-Rhin (France).

### Concepts of $I_{DR}$

The concepts of  $I_{DR}$  are summarized in Figure 1. Excess rainfall is calculated by comparing for each day the time-dependant soil infiltration capacity to event rainfall characteristics. The excess rainfall can become overland flow once its depth exceeds the surface depression storage capacity. As shown in Figure 1, cropping system features influence several soil (surface) states such as surface roughness and topsoil porosity either directly (through tillage for instance) or indirectly (for instance through surface protection by vegetation at a given date which depends on the chosen crop). Precipitation influences soil surface states by inducing the processes of slaking, crusting, and consolidation after tillage. The entire set of soil (surface) states (including porosity and structure), together with soil texture and organic matter content, determine the infiltration capacity, which therefore shows strong temporal variations on arable land. Furthermore, rainfall sequences and temperatures influence the initial soil water content, therewith impacting the infiltration process. Finally, soil characteristics like texture and organic matter content, determine the soil structural stability

which controls the rate at which surface degradation due to rainfall takes place. In  $I_{DR}$ , all the mentioned processes are described with continuous equations taken (and sometimes adapted) from literature.

As event characteristics of rainfall are generally not available,  $I_{DR}$  uses a stochastic approach to generate them. As a result, the only climate input data to be prepared by the user are monthly data on rainfall and temperature. Using a Monte Carlo approach, the behaviour of overland flow during the rotation can be simulated for several hundreds (user's choice) of rainfall years thus revealing dominating periods of overland flow.

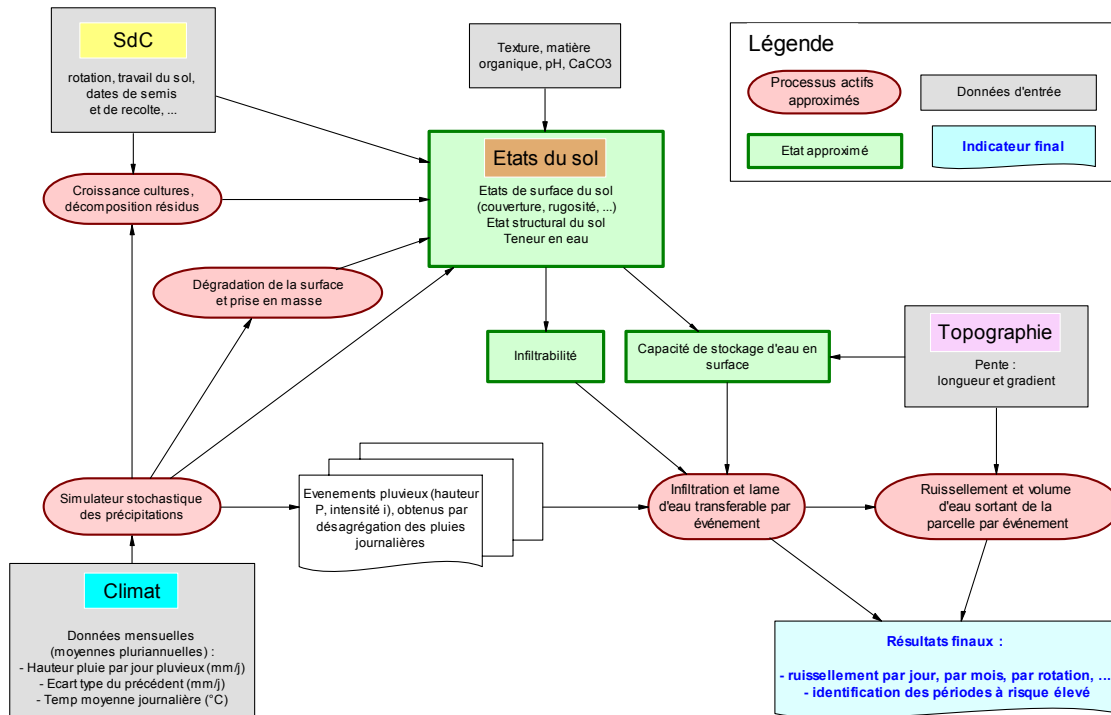

Figure 1. Input data, simulated processes, and simulated soil states of  $I_{DR}$ .

## Model validation

Overland flow measurement data of about 60 events were used to validate the indicator. Besides, a large dataset of soil surface state observations was used to validate several submodules: (1) crop residue cover, (2) surface roughness, and (3) topsoil bulk density.

## Conclusion

$I_{DR}$  fulfils a need for an operational tool to guide farmers faced with overland flow related problems in adapting their cropping systems to reduce overland flow. It also serves research needs and has been used to initialise parameters of the distributed event model LISEM. The validation study has led to improvement of several submodules. A major future challenge concerns the implementation of a soil biological module.

## References

Martin P, Joannon A, Piskiewicz N. (2010). Temporal variability of surface runoff due to cropping systems in cultivated catchment areas: Use of the DIAR model for the assessment of environmental public policies in the Pays de Caux (France). *Journal of Environmental Management*, 91(4): 869-878.



## Water Erosion Reduction using Various Soil Tillage Approaches.

V. Smutný<sup>1\*</sup>, L. Neudert<sup>1</sup>, P. Vrtílek<sup>1</sup>, T. Dryšlová<sup>1</sup>, M. Handlířová<sup>1</sup>, P. Nerušil<sup>2</sup>, L. Menšík<sup>2</sup>, D. Kincl<sup>3</sup>, J. Srbek<sup>3</sup>, A. Šedek<sup>4</sup>

<sup>1</sup> Department of Agrosystems and Bioclimatology, Faculty of AgriSciences, Mendel University in Brno, 613 00 Brno, Czech Republic

<sup>2</sup> Crop Research Institute Prague, Research Station Jevicko, Czech Republic

<sup>3</sup> Research Institute for Soil and Water Conservation Prague, Czech Republic

<sup>4</sup> P & L, Ltd., Biskupice, Czech Republic

\* corresponding author: [vladimir.smutny@mendelu.cz](mailto:vladimir.smutny@mendelu.cz)

### Introduction

In the Czech Republic, according to the Research Institute for Soil and Water Conservation, up to 51% of agricultural land is threatened by water erosion. Soil erosion deprives agricultural soils of the most productive part, i.e. topsoil (Kadlec et al., 2014). According to EU and national legislation, the restrictions are concerned to cultivation of wide-row crops in areas seriously and slightly endangered by erosion. In seriously endangered areas, wide-row crops (maize, sugar beet, potatoes, sunflower, bean, soybean and sorghum) are not allowed. In slightly endangered areas, growing of wide-row crops is allowed, but using conservation tillage, where a minimum crop residue coverage has been defined. More often than before, there will be an increased risk of soil erosion and loss of organic matter in soil and problems with water shortages may occur. Conservation tillage systems with their modification are increasingly being introduced under the economic pressure in the agricultural praxis (Smutný et al., 2018). The paper examines the productivity level of different soil tillage systems for maize and their ability to reduce soil erosion.

### Material and methods

Various soil tillage systems for maize were compared in two small-plot experiments. In a first one, conventional tillage (ploughing to depth of 0.24 m) was compared with minimum tillage (disking or chiselling, depth of 0.15 m) in Zabcice (South Moravia, flat area, altitude 179 m). In a second, conventional tillage was compared with strip-till and direct sowing into rye stubble (Jevicko, slightly endangered area, altitude 386 m). Yield of grain maize was assessed in Zabcice, whereas in Jevicko yield of silage maize biomass and soil loss was measured using a field rainfall simulator.

### Results and discussion

The results from first Zabcice are in Figure 1.

experiment carried out in

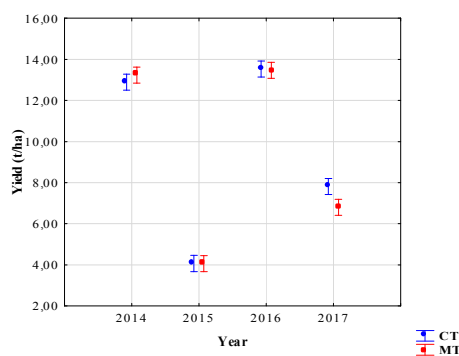

Figure 1: Yield of grain maize under conventional CT and minimum tillage MT (Zabcice; 2014 – 2017).

At Jevicko, the four year results showed that usually there is no any significant yield difference between conventional (CT) and minimum (MT) tillage. Only in 2017 the highest yield was on CT (difference 1.01 t/ha). Year is a more important factor than tillage. The results differed in 2016 and 2017 (Table 1), but the lowest yield was when strip-till into rye was applied. Direct sowing into rye stubble had higher yield in 2016, but lower in 2017 in comparison with conventional tillage with row distance 0.75 m. Both conservation practices effectively reduced water erosion, with soil loss being 86% lower.

Table 1: Biomass silage maize and soil loss in various soil tillage systems.

Year	Parameter	Soil tillage system						
		conventional		strip-till into rye		direct sowing into rye stubble		
				spring	autumn			
	row distance (m)	0.75	0.375	0.75	0.75	0.75	0.375	
2016	biomass yield (in dry matter; t/ha)	19.27	20.75	18.90	16.46	20.19	21.49	
	relation (%) to conventional/0.75	<b>100</b>	<b>108</b>	<b>98</b>	<b>85</b>	<b>105</b>	<b>112</b>	
	soil loss (t/ha)	1 <sup>st</sup> measurement	7.01	5.06	0.03	0.08	NA	NA
		2 <sup>nd</sup> measurement	2.54	2.91	0.48	1.43	0.10	0.24
<b>average</b>		<b>4.78</b>	<b>3.99</b>	<b>0.26</b>	<b>1.12</b>	<b>0.10</b>	<b>0.24</b>	
2017	biomass yield (in dry matter; t/ha)	21.78	23.60	18.55	20.10	17.27	21.55	
	relation (%) to conventional/0.75	<b>100</b>	<b>108</b>	<b>85</b>	<b>92</b>	<b>79</b>	<b>99</b>	
	soil loss (t/ha)	1 <sup>st</sup> measurement	3.30	3.01	0.69	0.23	NA	NA
		2 <sup>nd</sup> measurement	1.54	1.43	0.36	0.66	0.42	0.31
<b>average</b>		<b>2.42</b>	<b>2.22</b>	<b>0.53</b>	<b>0.45</b>	<b>0.42</b>	<b>0.31</b>	

NA = not available data

## Conclusion

Conservation tillage systems are a solution to reduce water erosion in the Czech Republic. The basic principle is that the soil surface is covered by some organic mulch. Strip-till looks might be promising in sloped areas, with only strips being tilled in which the crop is sown. Standing residue of the previous crop or a targeted sown intercrop acts as a mulch. However, in almost all cases these systems need herbicide application which kill “healthy” biomass.

## Acknowledgement

Supported by the Ministry of Agriculture of the Czech Republic, Project No. QJ1610547 and QJ1510119.

## References

- Kadlec V., Žížala D., Novotný I., Heřmanovská D., Kapička J., Tippl M., 2014. Land consolidations as an effective instrument in soil conservation. *Ekológia*, Vol. 33, No. 2, p. 188-200.
- Smutný V., Neudert L., Dryšlová T., Lukas., Handlířová M., Vrtílek P., Vach M., 2018. Current Arable Farming Systems in the Czech Republic – Agronomic Measures Adapted to Soil Protection and Climate Change. *Agriculturae Conspectus Scientificus*. Vol 83, No 1 p. 11-16.

## Short-term impacts of conservation and traditional agriculture on natural resources in the Peruvian highlands

J.A. Ocaña Reyes<sup>1\*</sup>, O. Zelarayán Muñoz<sup>1</sup>, R.C. Girón Aguliar<sup>2</sup>, P.D. Vergara Jimenez<sup>2</sup> L. Suarez-Salas<sup>3</sup>

<sup>1</sup> CARE-PERU

<sup>2</sup> National Institute for Agrarian Innovation

<sup>3</sup> Geophysical Institute of Peru

\* Corresponding author: jimmyunheval@gmail.com

### Introduction

Crop production in the Peruvian highlands is carried out under the principles of traditional agriculture (TA), intensive tillage and cultivation are expensive, tedious and harmful to natural resources. UN environment programme, ICCI, CARE-PERU and NIAI are developing the Black Carbon Mitigation Project with the aim of reducing agricultural burning, applying the principles of conservation agriculture (CA) and comparing the two agricultural systems. Production costs, crop yield, bulk density ( $D_b$ ), volumetric water content ( $\theta_v$ ), erosion and microbial activity (MA) were analyzed. The t-student test with 20 replications of crop yield,  $D_b$  and  $\theta_v$  samples was designed. A completely randomized design with three replications of 50 erosion pins and the averages comparison for MA was designed. Land preparation cost of TA plot was greater than in CA plot. Soil  $D_b$  was more constant in CA than in TA plot. Soil  $\theta_v$  of CA was greater than in TA. Erosion was greater in TA soil than CA soil, being statistically significant. Corn yield will be analyzed on May end. The results showed that CA practices are more beneficial than TA with natural resources.

### Materials and methods

The project is being developed in the Junín region – Peru, which has a cold climate. The soil is loam with a slope that varies between 2 to 36 %. The experiment was set up on a slope of 36%, sowing San Jerónimo amyloseous corn. Experimental plot has 6724 m<sup>2</sup>, with abundant presence of weeds; it was divided into two parts to compare CA and TA effects. In TA plot, tillage operations were done, weeds were removed and furrows were designed for sowing; In CA plot, shallow and narrow cuts were done to deposit seeds and fertilizers and a non-selective herbicide immediately was applied and a corn selective herbicide was applied 20 days after sowing (das). The t-student test with 20 random samples was designed to analyze corn yield,  $D_b$  and  $\theta_v$ . Corn yield, for each sample, was evaluated on plants in 10 m of furrow.  $D_b$  and  $\theta_v$  were determined by cylinder and volumetric method, respectively, at 30, 55, 95 and 120 das, evaluated at two depths 0-10 and 10-20 cm. MA was determined from mixture of 10 sub-samples of soil at 10 cm depth, before TA and CA practices were done. Which was the reference of both sowing systems, to compare CFU averages of mesophilic organisms, microbial respiration and microbial mass. Soil erosion was determined by the method of erosion pins. Iron pins 35 cm long with 2.4 mm in diameter were used. Each erosion pin was marked in the middle, being initial position at the soil surface, installed at the beginning the corn sowing. Distance between each erosion pin was 40 cm. A completely randomized design with two treatments and three replications was used. Fifty pins in groups of 5 x 10 were hammered into the soil perpendicular to the slope, in the AT and AC plot. Algebraic sum of erosion (+) and sedimentation (-) was done at 55, 68, 94 and 120 das. Total erosion was calculated by multiplying eroded height (mm) by the  $D_b$  and by 10. The values obtained from erosion pins evaluation were further

processed using ANOVA. The averages were compared by multiple comparison test of Tukey's honestly significant difference (HSD) with a significance level of 5 %.

### Results and Discussion

Land preparation cost by draught animal traction in TA plot meant 132.4% more money than in CA.  $D_b$  in TA plot is lower than in CA plot in both depths, due to soil tillage.  $D_b$  in TA and CA plot at the lower layer increased through time, probably due to easier loss porous space of plowed soils due to trafficability (Table N ° 1). Soil  $D_b$  in CA and TA plot at 10 - 20 cm depth is denser than in their respective first 10 cm, even at different times.

**Table N° 1.  $D_b$ ,  $\theta_v$ , and erosion averages at two soil depths and stages, under CA and TA**

Study variables	Depth (cm)	CA		TA	
		das			
		30	53	30	53
$D_b$ (g cm <sup>-3</sup> )	0 - 10	1.28 ns	1.28 ns	1.23 ns	1.20 ns
	10 - 20	1.42 ns	1.48 ns	1.29 ns	1.35 ns
$\theta_v$ (m <sup>3</sup> ha <sup>-1</sup> )	0 - 10	150.6 ns	179.8 ns	126.8 ns	160.9 ns
	10 - 20	165.1 ns	174.1 ns	152.0 ns	209.8 ns
Erosion (t ha <sup>-1</sup> 94 days <sup>-1</sup> )		35.82 b		66.53 a	

a - b: values within a row followed by the same letter are not statistically significant for Tukey's HSD.

Volumetric water content of CA soil at 30 das, at two depths, contained 23.8 and 13.1 m<sup>3</sup> ha<sup>-1</sup> more than TA soil, respectively; however, they were not statistically significant, a greater dry weed cover on CA soil decreased evapotranspiration could explain this effect. The same context, but at 53 das, showed 18.1 and -35.7 m<sup>3</sup> ha<sup>-1</sup> more than AT soil, respectively. Accumulated erosion at 94 das was 35.82 t ha<sup>-1</sup> in CA plot, which represents 30.71 t ha<sup>-1</sup> less than TA plot, being statistically significant. Similar results were found in the erosion on the slopes of 22 micro-basins, with native vegetation and undisturbed soil, in the Peruvian highlands, 45.04 t ha<sup>-1</sup>year<sup>-1</sup> (Vásquez A., Tapia M., 2011). MA initial analysis showed 5.50 x10<sup>4</sup>, 1.00 x10<sup>4</sup>, and 6.30 x 10<sup>3</sup> CFU g<sup>-1</sup> of dry soil of bacteria, actinomycetes and fungi, respectively, with a microbial respiration of 0.06 mg CO<sub>2</sub> g<sup>-1</sup> dry soil day<sup>-1</sup> and with a microbial biomass of 0.36 mg C g<sup>-1</sup> of dry soil. At the harvest end, on May end, MA analysis and corn yield of CA and TA plots will be done.

### Conclusions

Results showed that corn planting under the CA principles is more economical than TA;  $D_b$  in the first cm of the soil is constant through time. In addition, it stores more  $\theta_v$  and reduces erosion even with little cover, which decreases raindrops impact and gives more time to them for a greater water infiltration in the soil. In short term, CA demonstrated a high potential for better management of natural resources.

### References

Vásquez A., Tapia M., 2011. Quantification of surface water erosion in the semiarid slopes of the Peruvian highlands. Journal of Engineering UC, 18(3):42-50 (in Spanish)

## SOIL EROSION ASSESSMENT AND MONITORING IN THE SOUTH HIGH ATLAS OF MARRAKECH USING REMOTE SENSING AND GIS.

Zouhair OURHZIF1 ; Ahmed ALGOUTI1; Abdellah ALGOUTI1 ; Mohamed Ait Mlouk1 ; Fatiha Haddach1

Laboratory Earth Science, Geotourism, Natural Hazard and Remote Sensing, Faculty of sciences Marrakech Morocco.

Email: ourhzifz@gmail.com

### Introduction:

The main goal of this research was to investigate the spatial patterns of the soil erosion risk. Natural factors itself are very suitable for development of such erosion: from mostly erodible rocks and soils on the mountainous slopes around the depressions, to the generally continental, semi-arid climate and slight vegetation cover. Because of that, there are sites with severe erosion and deposition like those in the catchments of Imini River, Elmaleh and Ounilla River, three torrential tributaries of Draa watershed. In these catchments there are varieties of erosion-related landforms: rills, gullies, badlands, landslides, as well as valley-type alluvial fans and huge alluvial plains.

We studied soil erosion processes in a mountain watershed using modelling techniques implemented in a Computer Graphic environment. According to calculated results the coefficient of erosion and sediment yield (z) for this watershed divided to moderate and heavy erosion class.

### Material and method:

The catchment of Imini ,Elmaleh and Ounila River, situated in the Draa basin upstream between 30°56' - 31°23' North latitudes and 7°30' - 7°00' East longitudes South High Atlas of Marrakech Based almost entirely over the north of the Ouarzazate prefecture ,possesses an intricate system of mountain ranges which are the result of successive compression movements of the earth's crust. (Fig.1).

The basin is mountainous, with intense topographical variations. It has an almost circular shape covering an area of 1510.1 Km<sup>2</sup>. The elevation ranges from 1191 to 3350 m with the mean elevation being 1840.9 m. The catchment has a dense hydrographic network including three main streams, emanating from the High Atlas mountain range. Imini wadi is main and longest one 53 Km followed by the Elmaleh wadi with 41.8 km and the smallest ounilla wadi was 34.6 km.

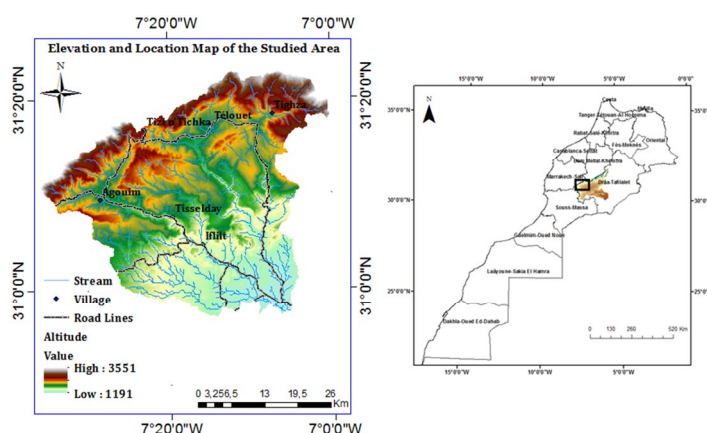

Figure1: The geographical situation of the study Area

**EPM model:**

A widespread empirical model is the Erosion Potential Model (EPM), also known as Gavrilovic method (Gavrilovic, S., 1962; 1970; 1972), as long as its modifications (Lazarevic, 1968a; 1985). The method takes under consideration six factors, depending on surface geology and soil properties (y coefficient/ erodibility factor), topographic features (mean slope, J), climatic factors {mean annual rainfall (h), mean annual temperature (t)}, land use type and distribution (x coefficient/ soil protection factor) and the catchment’s degree of erosion ( $\phi$ , erosion and stream network development coefficient). It has been widely implemented throughout many countries, providing reliable results on qualifying soil erosion severity, estimating mean annual soil loss/ sediment yield as well as implementing torrent regulation and other erosion control measures.

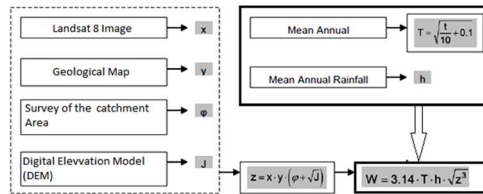

Figure2: EPM Flowchart

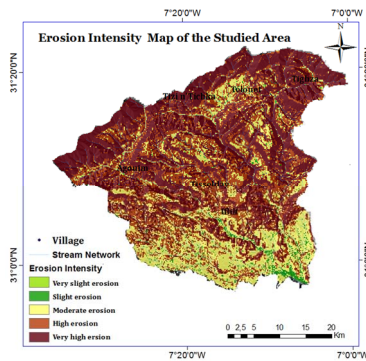

Figure9: The Intensity Erosion Map using EPM model in the watershed

Sub-Watershed	Mean of Sediment Rate
Imini	1619.45 m <sup>3</sup> yr <sup>-1</sup>
Elmaleh	1237.87 m <sup>3</sup> yr <sup>-1</sup>
Ounilla	1580.10 m <sup>3</sup> yr <sup>-1</sup>

Table1: The Mean sediment rate of each sub-watershed

**Conclusion:**

The EPM is suitable for estimating soil erosion risk in different arid to semi-arid land uses, primary evaluation of sedimentations that will be stored behind dams as well as estimation of the annual sediment in rivers with no hydrometric data. Numbers of coefficients used in this model are limited and easily estimated. However, the scoring of input parameters strongly depends on expert judgment and how accuracy watershed is visited. The new approaches were elaborated to calculate the land use and observed erosion coefficients through partial calibration. The canopy percentage and slope were used to estimate land use coefficient; also the canopy percentage, drainage density, climatic index, geology indicator were applied to calculate the observed erosion coefficient. The GIS and RS techniques have properly been used extensively in this research.

**References:**

Fannetti D. and Vezzoli L. (2007), *Sediment input and evolution of lacustrine deltas: The Breggia and Greggio rivers case study (Lake Como, Italy)*, *Quaternary International*, 173-174(SUPPL.), 113-124.

Gavrilovic Z. (1988), *The use of empirical method (Erosion Potential Method) for calculating sediment production and transportation in unstudied or torrential streams*. In: White, W. R. (ed.), *International Conference on River Regime*. John Wiley & Sons, Chichester, p. 411–422.

LAZAREVIĆ, R., 1968a: Erozija u slivu Gvozdačke reke – prilog metodici za izradu karte erozije (Erosion in the Gvozdačka reka river basin – supplement to the instructions for erosion map elaboration). Glasnik Srpskog geografskog društva, 49, 2, 75-98.

## Weed response to tillage and cover crop tactics in contrasted crop sequences within long-term experiments

Pascale Métais<sup>1</sup>, Jérôme Labreuche<sup>1</sup>, Guillaume Adeux<sup>2</sup>, Stéphane Cordeau<sup>2\*</sup>

<sup>1</sup> ARVALIS Institut du végétal, Boigneville, France

<sup>2</sup> Agroécologie, AgroSup Dijon, INRA, Univ. Bourgogne Franche-Comté, Dijon, France

\* Corresponding Author: stephane.cordeau@inra.fr

### Introduction

Tillage is an important tool for managing weeds in a wide array of cropping systems. The aim of this study was to investigate the role of tillage strategies (ploughing, shallow-tillage, no-till), crop rotation (monoculture vs. diversified crop sequence) and cover crop presence on weed communities through the analysis of long-term factorial or cropping system experiments.

### Material and Methods

#### *Boigneville long term soil tillage factorial experiment*

Since 1971, a factorial long-term experiment was carried out in Boigneville (Essonne, France) in order to compare three levels of soil tillage intensity in a split-plot design. Crop rotation was the main plot factor in which was nested the tillage type: ploughing (20 cm), shallow cultivation (5 cm) and no-till. (i) Boigneville-A1 followed a two-year Wheat/Maize crop rotation. From 2002 to 2015, the sub-plots were divided into two parts: cover crop vs. bare soil. (ii) Boigneville-A2 followed a four-year crop rotation (sugar beet, winter wheat, oilseed rape and spring barley). (iii) Boigneville-C was a wheat monoculture from 1971 to 2010 on which 5 crops were rotated after 2010. Weeds were surveyed each year at crop maturity between 2012 and 2015 by 6 to 12 0.25m<sup>2</sup> quadrats.

#### *INRA-Dijon Integrated Weed Management cropping system experiment (PIC Adventices)*

The experiment was located at the INRA experimental farm in Dijon (Epoisses), eastern France and lasted from 2000 to 2017. The four IWM systems (S2, S3, S4 and S5, 6-year crop rotations) were compared to a reference conventional system (S1, 3-year oilseed rape/winter wheat/winter barley rotation). S1 (reference) was designed to maximize financial returns (using herbicides). S2 (conservation agriculture) reduced labour requirement. S3 only implemented chemical weeding with reduced doses whereas S4 allowed the use of mixed weeding (mechanical and chemical weeding). Finally, S5 excluded the use of any herbicides. The weed flora was surveyed each year with 32 0.36 m<sup>2</sup> quadrats. From 2007 to 2017, the fields were divided in two parts (fallow period with cover crop or false seedbed before spring/summer crops) in S3, S4, S5 systems. Thus, cover crops vs. false seedbed strategies could be pairwise compared in 13 field-year cases.

### Results and discussion

*Tillage*- Soil tillage had a significant effect on weed density and species richness. In the Boigneville-A1 and -A2 experiment, weed density was lower in ploughed plots than in no-tilled plots. In the Boigneville-C experiment, ploughed plots also presented the lowest weed density, except for rye-grass density. In the Boigneville-A1 experiment, *Echinochloa crus-galli* or *Setaria viridis* occurred in 10 % of the quadrats in ploughed plots whereas they occurred in 40 and 56% of the quadrats in shallow tilled and no-tilled plots, respectively. At



INRA-Dijon, it was difficult to disentangle the effect of tillage from the other components of the systems on density and richness. However, the weed communities occurring in the five cropping systems clearly differed according to tillage and herbicide gradients. Surprisingly, the relative abundance of annual/perennial weeds did not vary across tillage levels on both locations (Boigneville and Dijon).

*Crop rotation* - At Boigneville, weed community composition differed across crop rotations. In the Boigneville A1 wheat/ maize crop rotation, *Echinochloa crus-galli* and *Setaria viridis* were the dominant species. In the Boigneville-A2 four-year crop rotation, species able to germinate all year round were the most frequent. In the Boigneville-C wheat monoculture, the density of *Lolium multiflorum* increased up to a point which harvest was impossible in shallow tillage plots. Hence, the wheat monoculture was replaced by a rotation including 5 different crops. Seven years after crop diversification, the density of *L. multiflorum* was low (less than 10 plants/m<sup>2</sup>) across all tillage levels. At INRA-Dijon, the species richness was 3 times higher in the IWM systems than in the reference, which can be attributed to the crop diversification, but also to the reduction in herbicide use (S3, S4, S5) and/or change in tillage strategies (S2).

*Cover crops* - Cover crops affected weeds that emerged in the cover crop but not those emerging in the succeeding crop. Cover crop effects were less pronounced when tillage intensity increased. At Boigneville, even though not significant, the difference of weed density between cover crops and bare soil was more important in no-tilled and shallow tilled plots than in ploughed plots. In the INRA-Dijon experiment, the cover crop/no-cover crop pairwise comparison did not show any significant effect.

### **Conclusion**

Weed density decreased when tillage intensity increased with inconsistent effects on weed community composition. Cover crops affected weeds less than tillage. Monoculture led to a predominance of grasses; in such a way that harvest was no longer possible. In the latter, diversification of the crop rotation helped to reduce weed density and more specifically, dominance of grasses.

**Acknowledgement:** This study was founded by the project CoSAC (ANR-15-CE18-0007) and Casdar Vancouver.

## Evaluation of archaeal, bacterial and fungal diversity in a long-term wheat-pea rotation under different tillage practices in the Loess Plateau, China

Eunice Essel<sup>1,2,4</sup>, Lingling Li<sup>1,2\*</sup>, Renzhi Zhang<sup>1,3</sup>, Zhuzhu Luo<sup>1,3</sup>, Liqun Cai<sup>1,3</sup>, Junhong Xie<sup>1,2</sup>

<sup>1</sup>*Gansu Provincial Key Lab of Arid Land Crop Science, Lanzhou, P.R. China*

<sup>2</sup>*College of Agronomy, Gansu Agricultural University, Lanzhou, P.R. China*

<sup>3</sup>*College of Resource and Environment, Gansu Agricultural University, Lanzhou, P.R. China*

<sup>4</sup>*Department of Applied Biology, University for Development Studies, Tamale, Ghana*

\*corresponding author: [lill@gsau.edu.cn](mailto:lill@gsau.edu.cn)

### Introduction

Agricultural management practices have the potential to alter the diversity and function of microbes in the soil ecosystem and environment (Detheridge et al. 2016). In the soil ecosystem, microbial communities play integral roles in virtually all soil processes (Barrios, 2007), to the extent that microbial abundance, activity and composition largely determine sustainable crop production in the agricultural land. Sustainable soil use has been achieved through the adoption of conservation tillage principles such as no-tillage or minimal soil disturbance, high crop residue return, and crop rotation (Lal 2015). No-till and residue retention influence soil organic carbon (SOC) storage and other major soil nutrients. No-till improves carbon storage through reduced soil disturbance and slow decomposition of SOC. Similar to other organic amendments; stubble retention provides nutrients for plant growth and organic carbon source of energy for soil microbial activity. Therefore, the need for sustainable use of land in agriculture requires maintenance of soil quality and knowledge of how different agricultural management practices may alter microbial communities. The aim of the study was to evaluate archaeal, bacterial and fungal species diversity and abundance in a 15 years wheat-pea rotation-tillage experiment and to explore the underlying relationships with different tillage practices soil chemical properties.

### Materials and methods

The present study was conducted in 2016 on the long-term Rainfed Agricultural Experimental Station (35°28'N, 104°44'E, elevation 1971 m above sea level) of the Gansu Agricultural University, Dingxi, Gansu Province, Northwest China which was setup in 2001. The experiment is a two factorial design (T; Tillage effect and S; Stubble effect) with two phases of rotation (W→P→W and P→W→P sequence) and four tillage treatments. The treatments included conventional tillage with stubble removed (T), no-till with stubble removed (NT), no-till with stubble retained (NTS) and conventional tillage with stubble incorporated (TS). Soil samples were collected before seeding the field Pea phase (W→P→W) of the experiment in 2016. Genomic DNA extraction from soil samples was done by the use of MoBio PowerSoil® DNA Isolation Kit (MoBio Laboratories, Solana Beach, CA, USA). PCR amplification of V3V4 of archaea and bacteria 16S rRNA genes (480bp with barcode) was executed using the primers 338F 5'-ACTCCTACGGGAGGCAGCA -3' and 806R 5'-GGACTACHVGGGTWTCTAAT-3'.

Amplification of fungal internal transcribed spacer (ITS2) region (350-450bp with barcode) was also done with PCR primer ITS3F 5'-GCATCGATGAAGAACGCAGC -3' and ITS4R 5'- TCCTCCGCTTATTGATATGC-3'. Illumina Hiseq high-throughput sequencing platform was employed to sequence archaea and bacteria 16S rRNA (V3V4) and fungi ITS (ITS2) region genes in 0-10 cm and 10-30 cm soil depths. Soil chemical properties such as total organic carbon, NO<sub>3</sub>-N, NH<sub>4</sub>-N and Olsen Phosphorus were analyzed by various standard protocols. Soil microbial biomass carbon and nitrogen were also measured.

### Results and discussion

The abundance profile results showed that the dominant bacterial phyla identified at 0.03 cutoffs (97% similarity) across both depths of treatments were *Proteobacteria* (26.3%), *Actinobacteria* (25.1%), *Acidobacteria* (15.0%) and *Gemmatimonadetes* (8.8%) and the fungal phyla were *Ascomycota* (85.8%) and *Basidiomycota* (8.0%). The main archaeal phyla were *Crenarchaeota* (96.9%), *Euryarchaeota* (2.4%) and *Parvarchaeota* (0.04%). Generally, treatment effect (T, TS, NT and NTS) determined by PERMANOVA (P- value <0.05) analysis did not show significant effect on the microbial communities. Non metric Multidimensional Scaling (NMDS) analysis showed clear grouping of microbial communities according to depths but weak grouping by treatments. NTS and NT had significantly ( $p < 0.05$ ) high microbial diversity indices however, NTS had the highest total organic carbon, soil microbial biomass carbon and nitrogen, NO<sub>3</sub>-N and NH<sub>4</sub>-N in 0-10 cm soil. Soil chemical properties, Tillage and stubble effects had significant correlation with some bacterial phyla such as *Proteobacteria*, *Actinobacteria*, *Gemmatimonadetes*, *JL-ETNP-Z39*, *Nitrospirae*, *Chloroflexi*, *Firmicutes* and other identified and unidentified minor bacterial and fungal phyla. However, the main archaeal phyla identified in the 0-10 cm soil did not correlate significantly with any of the factors nor chemical properties in 0-10 cm depth but in 10-30 cm soil depth, significant correlations were recorded with NO<sub>3</sub>-N and NH<sub>4</sub>-N.

### Conclusion

No-till and residue retention practices influenced archaeal, bacterial and fungal species diversity and abundance through improved soil chemical properties which have potential to affect the habitat and activity of soil microbes. Therefore, no-till and stubble retention could be used to improve soil quality and promote sustainable agriculture in the rain fed loess plateau of northwest China.

### References

- Barrios, E., 2007. Soil biota, ecosystem services and land productivity. *Ecol. Econ.*, 64, 269-285.
- Detheridge, A.P., Brand, G., Fychan, R., Crotty, F.V., Sanderson, R., Griffith, G.W. and Marley, C.L., 2016. The legacy effect of cover crops on soil fungal populations in a cereal rotation. *Agric. Ecosyst. Environ.*, 228, 49-6.
- Lal, R., 2015. Sequestering carbon and increasing productivity by conservation agriculture. *J. Soil Water Conserv.*, 70, 55-56.

## Relationships between physical and biological indicators in natural and agricultural soils of the semiarid Argentinean Pampa.

R. Fernández<sup>1</sup>, I. Frasier<sup>1</sup>, A. Quiroga<sup>1</sup>, E. Noellemeier<sup>2\*</sup>

<sup>1</sup> INTA Anguil, Anguil, La Pampa, Argentina.

<sup>2</sup> Facultad de Agronomía UNLPam, Santa Rosa, La Pampa, Argentina.

\* Corresponding author: [enoellemeier@gmail.com](mailto:enoellemeier@gmail.com)

### Introduction

The search for soil quality indicators has a long history (Karlen et al., 1997). The goal of these studies was to identify variables that describe soil functions which are essential for plant growth and other ecosystem services in a qualitative manner so as to establish threshold and baseline values for evaluating and monitoring soil management and –use. The present study was carried out with the objective to characterize the underlying relationships among these variables, in order to understand the processes of soil degradation and their effect on the pore system and its relation with biological indicators.

### Materials and methods

The study was carried out in two natural vegetation (NV) and two agricultural (A) sites, all petrocalcic Paleustolls with similar clay contents, but different organic matter concentrations of the semiarid Argentinean Pampa. Four soil pits were dug at each site, spaced at approx. 30 to 50 m. For a detailed description of the sites and soil properties see Fernández et al. (2017). On undisturbed soil samples taken at depth intervals of 0-0.6, 0.6-0.17, 0.17-0.30 m in each soil pit particle size distribution, aggregate instability index (IIE), volumetric aggregate weight (VAW) (Fernandez et al., 2016), bulk density (BD), organic carbon (OC), microbial biomass carbon (MB-C), total porosity (TP) and macroporosity (Ma), and least limiting water range (LLWR) were determined. Proctor test was carried out to obtain maximum bulk density (MBD) and susceptibility to compaction (CS). Cumulative C respired at 54 days of incubation (Resp) was measured, and the metabolic quotient ( $qCO_2$ ) was computed as the ratio between Resp and MB-C. Soil resistance was measured with a cone penetrometer at different moisture contents, in order to determine soil resistance at 25% of water holding capacity (PR25), and infiltration assays were set up to determine infiltration rate (IR) and hydraulic conductivity (K). Another set of undisturbed samples was taken for the preparation of thin sections and images of these were taken at 10x magnification and analyzed with *ImageJ* software to obtain pore size frequency distributions for each sample. Pores were classified according to their morphology into elongated (Eg), irregular (Irr) and round (Rnd). Data were analyzed by principal component (PCA)-, regression- and correlation analysis using InfoStat® software.

### Results and discussion

The two agricultural sites showed great differences to the baseline values obtained in the NV soils for almost all studied variables. The bi-plot of the PCA clearly divided the sites according to these indicators, with A sites showing higher CS, BD, MBD, VAW, IIE and Rnd, whereas NV sites had higher IR, Resp, TP, Ma, BM-C, OC, and Irr and Eg pores.

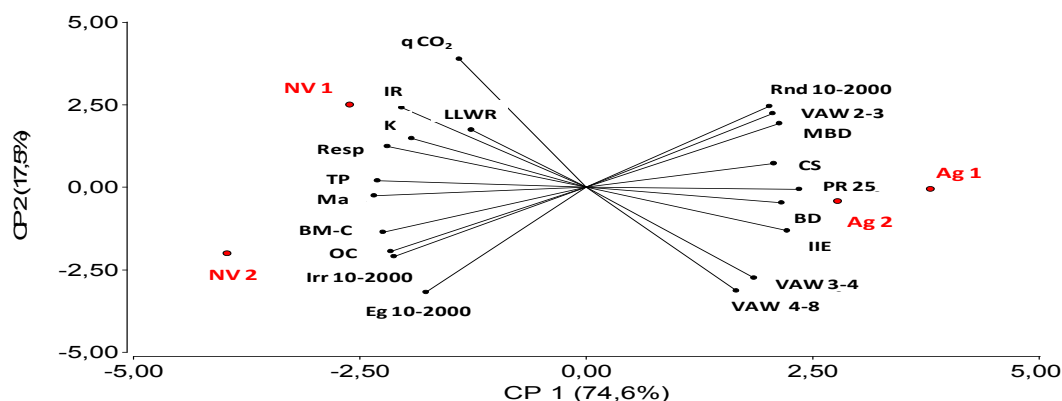

Figure 1: Principal component analysis for physical and biological indicators under agriculture (Ag 1 and Ag 2) and natural vegetation (NV 1 and NV 2) soils.

Organic C was positively correlated with TP ( $r=0.88$ ), IR ( $r=0.59$ ), Ma ( $r=0.93$ ), Eg ( $r=0.95$ ) and MB-C ( $r=0.98$ ). The LLWR was poorly represented in this analysis and only correlated with K ( $r=0.92$ ). Eg and Irr pores were strongly associated to CO ( $r=0.95$  and  $0.99$ , respectively), whereas Rnd pores were correlated with BD and MBD ( $r=0.70$  and  $0.96$ , respectively). Resp was highly correlated with K, IR and Ma ( $r=0.97$ ,  $0.95$ ,  $0.94$ , respectively) while BM-C correlated with CO, Ma, Eg and Irr ( $r=0.98$ ,  $0.97$ ,  $0.91$ ,  $0.99$ , respectively). These relationships show that OC content is the key property that defines soil physical condition which in turn strongly affects biological activity. Macroporosity and the presence of Eg and Irr pores apparently determined a favorable habitat for soil biota, as found in NV sites. On the contrary, in A sites, Rnd pore morphology was associated to degradation of soil structure shown by high BD, MBD and PR25, resulting in low MB-C ( $r=-0.97$ ). These results reflect a relationship between pore morphology and earthworm activity previously reported by Lamandé et al. (2003) for different agricultural management. However, it is difficult to assess if there exists a causal relationship, or whether the differences in pore morphology arise from the presence or absence of microbial colonies and organic substrate in the porous space.

### Conclusion

Soil degradation by agricultural use led to changes in porosity and pore morphology, brought about by the loss of OC, which reduced physical and biological ecosystem functions as shown by the concomitant decrease in physical and biological indicators. Soil quality changes are apparently driven by OC contents and the variation in pore morphology due to OC loss possibly creates a poorer habitat for the soil biota.

### References

- Fernandez, R., Quiroga, A., Alvarez, C., Lobartini, J.C., Noellemeyer, E., 2016. Volumetric weight of aggregates as an indicator of soil quality. *Ciencia Del Suelo*, Arg. 34, 279–292.
- Fernández, R., Quiroga, A., Lobartini, C., Noellemeyer, E., 2017. Determinación del intervalo hídrico óptimo en Ustoles de la Región Semiárida Pampeana. *Ciencia Del Suelo*, Arg. 35, 215–227.
- Karlen, D.L., Mausbach, M.J., Doran, J.W., Cline, R.G., Harris, R.F., Schuman, G.E., 1997. Soil Quality: A Concept, Definition, and Framework for Evaluation (A Guest Editorial). *Soil Science Society of America Journal* 61, 4. doi:10.2136/sssaj1997.03615995006100010001x
- Lamandé, M., Hallaire, V., Curmi, P., Pérès, G., Cluzeau, D., 2003. Changes of pore morphology, infiltration and earthworm community in a loamy soil under different agricultural managements. *CATENA* 54,

637–649. doi:10.1016/S0341-8162(03)00114-0

## Nature Farming: New Trends of Organic No-till System in Japan

Rahmatullah Hashimi<sup>1</sup> and Masakazu Komatsuzaki<sup>2\*</sup>

<sup>1</sup>*Faculty of Agriculture, Shaikh Zayed University, Khost 2504, Afghanistan*

<sup>2</sup>*Center for International Field Agriculture Research & Education, Ami, Ibaraki, Japan*

\* corresponding author: [masakazu.komatsuzaki.fsc@vc.ibaraki.ac.jp](mailto:masakazu.komatsuzaki.fsc@vc.ibaraki.ac.jp)

### Introduction

The current high rate of biodiversity loss warrants concern, particularly in agroecosystems under regular disturbance from agricultural practices. Tillage in agroecosystems causes physical disturbance of above- and belowground species; other disturbances include aboveground biomass removal, fertilizer inputs, and application of pesticides and herbicides. Natural farming (no-till with weed cover mulching) is a unique method that was developed by Fukuoka (1978) has recently become a grassroots farming movement in Japan and some other Asian countries. The aim of this study was to determine the effect of nature farming on (1) the distribution of water-stable aggregates, (2) MWD, (3) soil organic C in the aggregate size fraction, and (4) microbial activities in the soil and (5) soil biological diversity..

### Material and Method

The study site was at the Center for Field Science Research and Education, Ibaraki University, Japan. This long-term organic farming research experimental site was established in October 2009 on volcanic ash soils in the Kanto region of Japan. The soil type is typical Andosol, with a sandy loam texture in the upper surface that changes to clay with increasing depth.

We used a split-split-plot experimental design, with the tillage system (conventional rotary tillage with clean weeding (CT) and no-tillage with weed cover (NT)) included as the main factor, and the mulch application (CM at 7.2 Mg ha<sup>-1</sup> with a C/N ratio of 20.7 in 2014 and 25.5 in 2015, and no mulch (NM)) as the subfactor. There were four replications per treatment, giving a total of sixteen 12.5-m<sup>2</sup> (2.5 × 5 m) plots. In the CT plots, the rotary tillage was conducted in the top 0–15 cm of the soil prior to sowing on April 03 and May 20, 2014 and 2015. In the NT plots, weeds were mowed using a hammer-knife mower once per year in early May 2014 and 2015. Eggplant seedlings were transplanted in the field at a spacing of 1 × 1 m on May 29, 2014 and May 27, 2015. For the CM treatment, we applied clipped weed mulch around the base of the eggplants at a width of 120 cm and a depth of 12 cm on June 05, 2014 and June 01, 2015. In CT plots, weeds were removed by hoe each month. Soil sampling for 30 cm soil layer were also done after eggplant planting.

### Results and Discussion

Tillage had a significant effect on the distribution of water-stable aggregates, with aggregates >4 mm being 46.8% higher with NT in June and October 2014 and 52.4% higher with NT in 2015. In contrast, 0.55- and 0.25-mm aggregates were 22.1% and 33.5% higher, respectively, with CT in 2014 and 22.4% and 24.4% higher, respectively, with CT in 2015. The use of CM increased the water-soluble aggregates, with the >4-mm aggregate fraction being 6.5% higher with CT than with NM in 2014 and the >4-mm and 2-mm aggregate fractions being 23.9% and 34.9% higher, respectively, with CT in 2015. MWD was higher with NT than with CT, and CM increased this in October, although this increase was not statistically significant. NT also exhibited the highest contents of soil organic carbon (SOC) and nitrogen, and CM further increased these in both tillage systems in October of both years. In both tillage systems, the >4-mm aggregate fraction had a higher SOC content than the microaggregates. Finally, NT plots also exhibited a higher microbial SIR than CT plots in both years. These results indicate that adopting NT can increase water-stable macroaggregates, MWD, SOC, and microbial activities, whereas the use of weed residue mulch requires a longer period to result in these changes in both tillage systems.

Eggplant yields were significantly lower in NT without CM than CT and NT with CM, but yield in NT with CM showed similar values compare with CT.

### Conclusion

The use of nature farming would be very valuable in organic farming, as it is a suitable management practice for increasing water-stable macroaggregates, MWD, SOC, and microbial SIR compared with a conventional tillage system. The NT organic system enhanced the soil aggregate stability by increasing soil microbial SIR, and stabilized SOC in the aggregates, whereas CM increased MWD, SOC, and TN in both tillage systems, albeit non-significantly. Traditionally, organic systems often require intensive tillage practices to eliminate weeds. However, the use of NT in combination with clipped weed mulch represents an alternative approach that will improve the soil quality and ensure a good crop yield, whilst also enabling successful weed control.

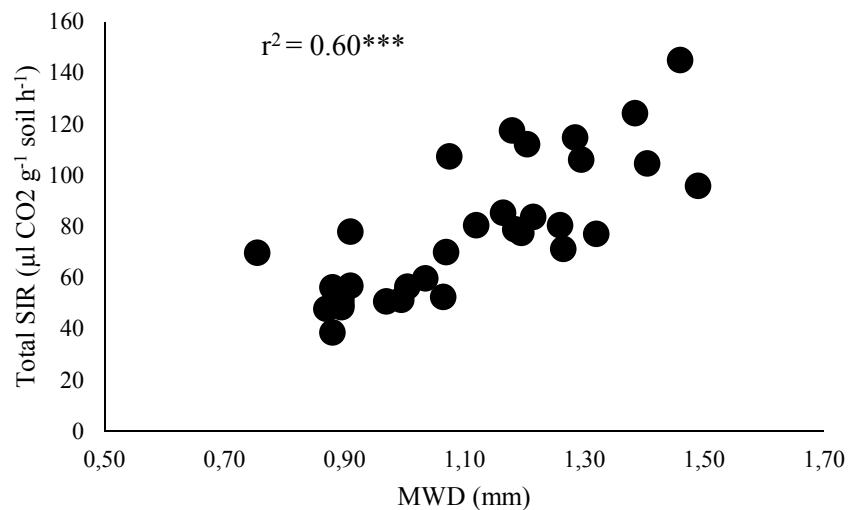

Fig. Correlation between mean weight diameter (MWD) and substrate-induced respiration (SIR). \*\*\* indicate significance at  $P < 0.001$ .



## Assessing soil diversity and function in organic and conventional minimum tillage plots

\*[Julia Cooper](#), Tianer Feng, Neil Gray, Shreiya Kumar, Peter Leary, Salisa Suchitwarasan, Luxi Xu

*School of Natural and Environmental Sciences, Newcastle University, Newcastle Upon Tyne, UK*

\*corresponding author: [Julia.cooper@ncl.ac.uk](mailto:Julia.cooper@ncl.ac.uk)

### Introduction

Areas of land under min-till in the UK are currently estimated to be ~40% but yields are frequently limited due to poor soil function, resulting in establishment problems for winter cereals in wet autumns and poor early season growth in spring sown crops. Min-till organic farmers face additional challenges due to the risk from increased weed pressure and inadequate nutrient supply from mineralisation of organic sources.

The Nafferton Factorial Systems Comparison trials (est. 2001) are designed to assess the agronomic, food quality, and ecological impacts of organic and conventional rotation, crop protection and fertility management practices, with tillage introduced as a factor in 2012. In this study we used a range of techniques to assess the impact of reduced tillage (shallow non-inversion "min-till" versus deep mouldboard "con-till") on decomposition, carbon metabolism and microbial diversity in both organic and conventional systems. The factorial nature of the experimental design allowed main and interaction effects due to tillage system, fertility management (compost versus NPK fertilisers) and crop protection practices (+/- pesticides) to be assessed.

### Materials and Methods

The study focused on the plots in the Nafferton long-term field trials described above sown to wheat in 2016 and spelt in 2017. Each experimental plot is 6 m x 24 m in size; there are a total of 8 treatments representing all combinations of the three main effects: tillage (min-till, con-till), fertility management (compost, NPK) and crop protection (+/- pesticides) which are replicated 4 times in the field. The topsoil at the site is a sandy clay loam with ranges of organic C: 2.2-2.3%, pH: 6.6-6.8, Olsen's P: 18-21 mg kg<sup>-1</sup>, ammonium nitrate-extractable K: 75-123 mg kg<sup>-1</sup> measured in 2017.

The Tea Bag Index (TBI) was determined using green and rooibos Lipton tea bags buried (8cm) in three locations in each plot in May 2016 & 2017 (Keuskamp et al., 2013). After 90 days the bags were extracted, dried and weighed, and the stabilisation factor (*S*) and decomposition rate (*k*) calculated. In 2017 samples collected at the same time as tea bag insertion were used for MicroResp<sup>TM</sup> microbial physiological profiling with seven C substrates: L-asparagine, L-glutamine, L-malic acid, oxalic acid, D-glucose, D-mannose and syringic acid (Campbell et al., 2003). Bacterial and fungal plate counts were determined using the dilution plate method and selective media for bacteria: Tryptic soy agar, and fungi: Rose Bengal agar. Diversity of the soil bacterial and fungal populations was characterized using terminal restriction fragment length polymorphism (T-RFLP) (Cooper et al. 2011).

### Results and Discussion

TBI results for each year were inconsistent with no effects due to tillage in 2016, but higher rates of decomposition in min-till plots in 2017. In 2017 min-till practices enhanced respiration of all added substrates (MicroResp™ results). The higher respiration of glucose was indicative of a higher microbial biomass in min-till plots that may have contributed to enhanced decomposition rates in the field.

Fungal diversity was higher under con-till with ~8 OTUs detected compared to ~5 OTUs under min-till based on T-RFLP analysis. These differences were reflected in the PCA analysis which showed all min-till treatments grouped tightly together, while the community structure under con-till was much more divergent depending on the fertility management and pest control strategies (Fig. 1). The impact of this difference on soil function is not clear and will be further explored using NG-sequencing approaches and functional classifications.

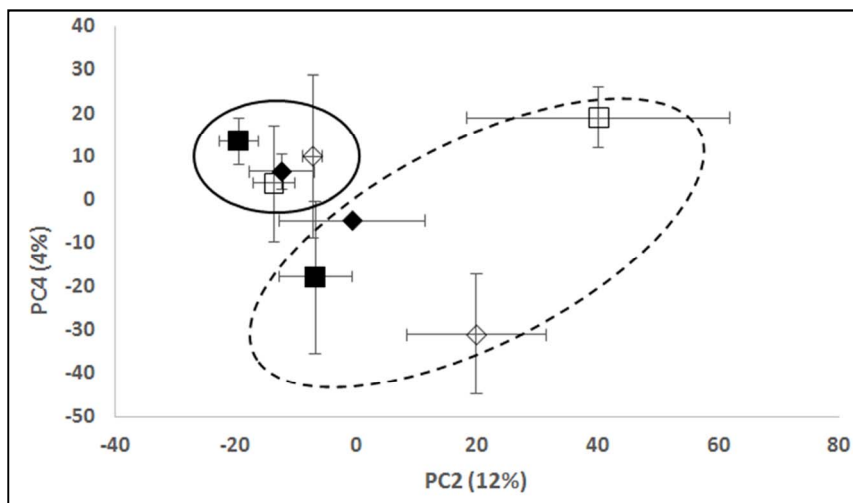

**Figure 1. Variability in 2017 T-RFLP profiles for fungi. Solid black line encircles all min-till plots and dashed line encircles all con-till plots. Solid black squares: compost,+pesticides, open squares: NPK fertilisers,-pesticides, solid black diamonds: fully conventional management (NPK fertilisers, +pesticides), open diamonds: fully organic management (compost, -pesticides).**

## Conclusion

Our TBI results did not indicate a reduction in microbial activity during the study period due to min-till. Further research needs to be conducted on decomposition processes year-round, particularly during late winter/early spring, to determine if negative impacts of min-till on microbial function are seasonal. Fungal organisms seem to be more sensitive to management practices than bacteria, suggesting that more attention needs to be paid to the role of fungi in decomposition, particularly in min-till systems.

Campbell, C.D., Chapman, S.J., Cameron, C.M., Davidson, M.S., Potts, J.M., 2003. A rapid microtiter plate method to measure carbon dioxide evolved from carbon substrate amendments so as to determine the physiological profiles of soil microbial communities by using whole soil. *Appl. Environ. Microbiol.* 69, 3593-3599.

Cooper, J.M., Burton, D., Daniell, T.J., Griffiths, B.S., Zebarth, B.J., 2011. Carbon mineralization kinetics and soil biological characteristics as influenced by manure addition in soil incubated at a range of temperatures. *Eur. J. Soil Biol.* 47, 392-399.

Keuskamp, J.A., Dingemans, B.J.J., Lehtinen, T., Sarneel, J., Hefting, M.M., 2013. Tea Bag Index: a novel approach to collect uniform decomposition data across ecosystems. *Methods Ecol. Evol.* 4, 1070-1075.

## Short-term dynamic of soil properties and soil organisms under contrasting tillage systems

Sékou FM Coulibaly<sup>1,3\*</sup>, Amira Aschi<sup>1,3</sup>, Michaël Aubert<sup>1</sup>, Nicolas Brunet<sup>2</sup>, Marc Legras<sup>3</sup>  
Fabrice Bureau<sup>1</sup>, Matthieu Chauvat<sup>1</sup>

<sup>1</sup> Normandie Université, UNIROUEN, Ecodiv URA/EA1293, IRSTEA, FED Scale CNRS 3730, France

<sup>2</sup> INRA, UPR1158 AgroImpact, 80200 Estrées-Mons, France

<sup>3</sup> UniLaSalle, Aghyle Unit UP2018.C101, FED NORVEGE 4277, Normandie Université, 3 rue du tronquet, 76130 Mont-Saint-Aignan cedex, France

\*corresponding author: [sekou-fanta-mad.coulibaly@univ-rouen.fr](mailto:sekou-fanta-mad.coulibaly@univ-rouen.fr)

### Introduction

Achieving sustainability is a worldwide current concern in agriculture that brings important challenges but also opportunities for rethinking agroecosystems. While many studies focused on tillage effects upon soil organisms (Laval, 2009, Boizard, 2017), few of them have considered a temporal framework. In an experimental study conducted in actual field conditions, we evaluated at short-term (7 months) dynamic of some soil properties and soil fauna under contrasting tillage systems. We hypothesized that reduction and especially the stopping of the mechanical perturbation lead (i) to an increase in the density and the specific richness of Collembola and earthworms and then (ii) that differences between tillage systems depend on the sampling date.

### Material and Method

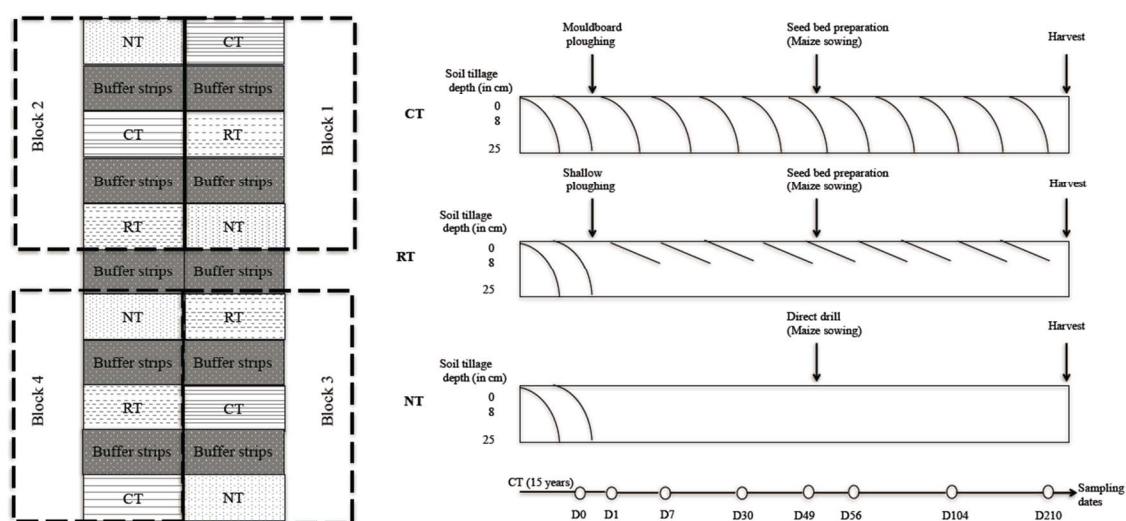

Figure 1: Set-up design and samplings schedule. 12 sub-plots, each 9m long and 6m wide

We used a field set-up held on the INRA experimental station of Estrées-Mons (North of France). Three tillage systems were investigated: CT conventional tillage (with the soil inverted up to 25 cm depth), RT reduced tillage (limited to the first 7- 8 cm depth) and NT no-tillage. Each treatment was replicated 4 times randomly (3 x 4 =12 plots in total). Collembola and earthworms were sampled at each plot using standard methods. Collembola were extracted, collected, counted and identified. During the course of the experiment, two perturbations were performed one in mid-March and one in mid-May. Samplings of soil fauna were performed on a regular basis according to tillage operation: 1 day before, and respectively 1 ; 7 ; 30 ; 49 ; 56 ; 104 ; 210 days after (Figure 1). Abiotic parameters (bulk density, pH, SOC stock, MWD and aggregates size) and microflora (microbial and fungal biomass and their activity) were also monitored and used as explaining factors.

## **Results and discussion**

In three system, relationships between soil fauna, soil physico-chemical parameters and microflora are discussed.

Our findings showed that slightly reducing the intensity of soil mechanical perturbation, did not impact soil fauna. But, when stopping tillage, population sizes of earthworm and Collembola increased (NT vs. CT). This change in the endogenous compartment is related to the improvement of the distribution of, and accessibility to, organic matter as a basic food source (SOC stock, microbial and fungal biomass and their potential C mineralisation activity), the physical structure of the soil and the distribution of pore sizes as a space life (bulk density, MWD and aggregates size). Our kinetic study has shown that the different groups of fauna in the soil do not have the same response to mechanical soil disturbance. Overall, conservation tillage can foster one of the numerous services provided by the soil compartment, namely the soil biodiversity and therefore improve soil quality and health.

## **Conclusion**

Assemblages of earthworms and Collembola do not have the same answer according the three systems of tillage over time. This suggests the resistance of smaller organisms to the effect of tillage, thus, Collembola assemblages were more resilient due to the role of external driving factors like climate or vegetation growing.

## *References*

- Boizard H., Peigné J., Sasal M.C., de Fátima Guimarães M., Piron D., Tomis V., Vian J.F., Cadoux S., Ralisch R., Tavares Filho J., Heddadj D., De Battista J., Duparque A., Cezar J. Franchini, Roger-Estrade J., 2017. Developments in the “profil cultural” method for an improved assessment of soil structure under no-till. *Soil and Tillage Research*, 173, 92-103.
- Laval K. , Mougín C., Akpa M., Barray S., Dur J-C., Gangneux C., Lebrun J., Legras M., Lepelletier P., Plassart P., Taibi S. et Trinsoutrot-Gattin I., 2009. Nouvelles avancées vers la compréhension des données biologiques. *Etude et Gestion des sols*, 16, 275-287.

## Does the soil structure affect the distribution of soil biological activities in a soil profile?

D. Piron<sup>1\*</sup>, P.-A. Maron<sup>2</sup>, E. Franc<sup>2</sup>, H. Boizard<sup>3</sup>, N. Cheviron<sup>4</sup>, D. Cluzeau<sup>1</sup>, L. Ranjart<sup>2</sup>

<sup>1</sup> *University of Rennes1, UMR EcoBio, F-35380 Paimpont, France*

<sup>2</sup> *INRA ; UMR 1347 Agroécologie, Dijon BP 86510, Dijon, France.*

<sup>3</sup> *INRA, UPR1158 AgroImpact, F-80200 Estrées-Mons, France*

<sup>4</sup> *UMR ECOSYS, INRA, AgroParisTech, Université Paris-Saclay, 78026, Versailles, France*

### Introduction

Ecosystem services provided by soil biota are receiving increasing attentions. Soil biological activities are implicated in key soil functions as the turnover of soil organic matters, the dynamic of the soil structure. Biological activities are controlled by many soil parameters as the pH, the availability of soil organic matters and also deeply affected by agricultural practices such as soil tillage and fertilisation. Many studies showed that soil biological functions can be significantly affected by a degradation of the soil structure due to soil compaction. Nevertheless, the soil structure appears rarely homogeneous; compacted soil structures moved and are packed with loosened structures in soil profile. The response of biological activities remains poorly investigated according to the organisation of soil structures. At these end, we assessed the heterogeneity of biological activities within a soil profile under two tillage treatments in French experimental designed: Conventional CT and Reduced tillage NT.

### Material and method

The “profil cultural” is the visual assessment method employed to delimit morphological units (MUs) on the face of soil profile and then to characterised loosened ( $\Gamma$ ) or compacted soil structure ( $\Delta$ ) (Boizard et al. 2017). Then, MUs have been characterized by a type of earthworm bioturbation: presence/absence of biostructures, the presence of burrows or casts (Piron et al., 2017). Morphological units have been sampled (i) in order to extract the soil DNA and assess the microbial biomass and the microbial genetic diversity (ii) and measure enzymatic activities. Microbial diversity have been determined by a fingerprint technique (B-ARISA and F-ARISA) after the amplification of restrictive fragment of DNA (Ranjard., 2001).

### Results and discussion

Soil structures have been differently impacted by earthworms: compacted structures were affected by the burrowing activities of anecics while loosened soil structures were rather affected by the casting activities of endogeics. In our study, few MUs were unconcerned by bioturbation whatever the soil tillage treatment.

Our study showed that the distinction of soil structures did not allowed a differentiation of microbial biomass under CT and NT. Under conventional tillage, the PCA analysis allows a clear differentiation of bacterial community between  $\Gamma$  and  $\Delta$  structures. Under NT, no difference of community appeared between soil structures if the depth of MUs was taking into account. Furthermore, microbial communities under NT were close of  $\Delta$  structures under CT. Under NT, the microbial biomass is significantly higher in  $\Gamma$

structure sampled at 0-5cm compared to  $\Gamma$  structure at 5-20cm. However no difference of microbial biomass has been measured between  $\Delta$ . Microbial communities differed between depths of localisation. The microbial community of  $\Gamma$  differed from this of  $\Delta$  in 0-5cm, but not in 5-20cm.

There was no difference of enzymatic activities between depths under CT while phosphatase, glucosidase, urease and arylsulfatase decreased with the depth under NT. no difference appears under CT if take into account soil structure. Under NT, the impact of soil structure was detected only for urease with a lower concentration in  $\Delta$  structures in 0-5cm.

### **Conclusion**

From this study, we concluded that the quality of soil structure is one important driver of microbial communities. These changes of community did not affected microbial biomass or enzymatic activities. The intensity of microbial activity is probably more controlled by soil organic matters and oxygenation conditions which are higher near the soil surface. Microbial communities are more contrasted under CT treatment due to high contrast between compacted soil structures and loosened soil structures that was generated by mouldboard ploughing. Homogeneity of microbial community could be explained by earthworm activities since all MUs are concerned by bioturbation as a vector of microbial colony thorough a soil profile.

### *References*

- Boizard H., Peigné J., Sasal M. C., Guimarães M. de F., Piron D., Tomis V., Vian J.-F., Cadoux S., Ralisch R., Tavares Filho J., Heddadj D., De Battista J., Duparque A., Franchini J. C., Roger-Estrade J. 2017 Developments in the “profil cultural” method for an improved assessment of soil structure under no-till. 173,92-103
- Ranjard, L., Richaume, A. 2001. Quantitative and qualitative microscale distribution of bacteria in soil. *Research Microbiology. Res Microbiol* 707-716.
- Piron D., Boizard H., Heddadj D., Pérès G., Hallaire V., Cluzeau D. 2017 Indicators of earthworm bioturbation to improve visual assessment of soil structure. *Soil Till. Res.*, 173: 53-63

Soil microbial community control the response of soil CO<sub>2</sub> emission and crop yield to drought under conservation tillage

Shuxia Jia

Abstract

Climate change induced drought events have increased in frequency, and have resulted in marked reductions in crop growth and grain yield. Strategies will be required for adaptation to climate change reduce its impact on the soil resource and crop yield in agriculture system. Soil CO<sub>2</sub> efflux, temperature and soil microbial community were measured in a long-term (15 years) tillage study in the Northeast Farming Region of China. Tillage practices included no tillage (NT) and conventional tillage (mouldboard plough: MP). Compared with NT, MP decreased maize yield by 11.3% ( $P>0.05$ ) and 47.1% ( $P<0.05$ ) in the dry years 2012 and 2015, respectively. The annual CO<sub>2</sub> emissions were not significantly different between MP and NT. Soil temperature under MP was higher than NT from March to June, but was lower than NT from November to February over the 2011-2016 years. In the dry year, soil temperature under MP was significantly higher by 8.0% and 7.0% than NT in June and July ( $P<0.05$ ) respectively, soil moisture at 22 cm under MP was significantly lower by 40% (average value) than NT from July to August. Soil total, bacterial, fungal PLFA contents under MP were significantly lower than NT from April to September at the 0-5 cm soil depth. Soil microbial PLFA contents in dry year were lower than those in normal year except for June both in MP and NT. The difference of soil total, bacterial and fungal PLFA contents between dry year and normal year under NT were higher than those under MP. The SEM revealed that the predictors explained 46% and 62% of the variation in maize yield and soil CO<sub>2</sub> flux. The soil moisture was associated with maize yield through soil microbes. These results suggested that NT significantly enhanced maize yield by improving the soil water content

and soil microbial community function in a dry year, indicating that conservation tillage is a positive adaptation strategy to cope with drought under monoculture maize in the black soil of China.



## Cover crops replace fallow in semi-arid durum cropping systems.

B.L. Allen<sup>1\*</sup>, J.D. Jabro<sup>1</sup>

<sup>1</sup> United States Department of Agriculture – Agricultural Research Service, Northern Plains Agricultural Research Laboratory, Agricultural Systems Research Unit, 1500 North Central Avenue, Sidney, MT 59270

\*corresponding author: [brett.allen@ars.usda.gov](mailto:brett.allen@ars.usda.gov)

### Introduction

The traditional cropping system in the semi-arid (330 mm annual precipitation; 80% occurring from April to September) northern Great Plains (NGP) region of North America is a two-year rotation with spring wheat (*Triticum aestivum*) followed by summer fallow. The practice of fallow is intended to bank precipitation for the subsequent year's cropping season, thus a cash crop (wheat) is only grown in alternate years. Historically, weed control during the fallow period was accomplished with several tillage passes (till fallow), though this practice has been largely displaced by adoption of herbicides for chemical weed control (chem fallow). Although summer fallow helps decrease the risk of crop failure in the short term, persistent long-term consequences include soil C depletion, formation of saline-seeps, degraded environment for soil microbiology, loss of habitat for fauna including pollinating insects, reduced soil water holding capacity, and inefficient precipitation storage during fallow with about 60 to 85% of precipitation lost due primarily to surface evaporation (Hansen et al., 2012). Consequently most of the current dryland research in the NGP focuses on cropping systems that reduce fallow, exclude tillage (i.e. no-till), and diversify rotations with cover crops, cool-season oilseeds, and pulse crops. This paper discusses the first three years of an ongoing durum (*Triticum durum*) cropping systems field study conducted near Froid, MT, where a cover crop mix replaces the fallow phase in a 2-yr durum-fallow rotation.

### Materials and methods

In 2014 a no-till cropping systems study was initiated that included a 10-species cover crop mix planted in rotation with 'Grenora' durum wheat. Durum planted in rotation with chem fallow served as the control treatment. Cover crop seeding rate was adjusted to 10% of the recommended monoculture seeding rate for each of the 10 individual species which included buckwheat (*Fagopyrum esculentum*), cowpea (*Vigna unguiculata*), flax (*Linum usitatissimum*), foxtail millet (*Setaria italica*), lentil (*Lens culinaris*), pea (*Pisum sativum*), radish (*Raphanus raphanistrum* subsp. *sativus*), sorghum (*Sorghum bicolor*), turnip (*Brassica rapa* var. *rapa*), and winter canola (*Brassica napus*). Each phase of the rotation was present every year. Treatments were replicated three times. Field plots were 6-m wide by 15-m long. Durum and cover crop plots were planted in mid April to mid May. Cover crop plots were harvested for forage at the bloom stage of radish, allowing a 10-cm stubble height. Three samples from each plot were obtained for forage quality analysis. Cover crop plots were allowed to regrow and were terminated by frost kill in late fall. Thereafter two 0.5 m<sup>2</sup> subsamples were obtained to estimate

above ground biomass and species composition. Durum plots were harvested in the fall. Though not reported in this abstract, the study also measures durum yield and quality, crop water use, N use, C and N pools, insects, weeds, and soil microbiology via PLFA and NLFA analysis. The intent of this abstract is to report on the yield potential and species composition of a cover crop mix planted in place of fallow in 2-yr durum rotations.

## Results and discussion

Forage harvest of the cover crop mix at radish bloom occurred in early July for the years of 2014, 2015, and 2016. Biomass at forage harvest ranged from 2.7 to 3.8 Mg ha<sup>-1</sup> (dry weight basis) and biomass just after a killing frost ranged from 3.1 to 6.9 Mg ha<sup>-1</sup>. The 3-yr average yield and species composition for biomass at forage harvest and after a killing frost which typically occurred late September to mid October is shown in Figure 1.

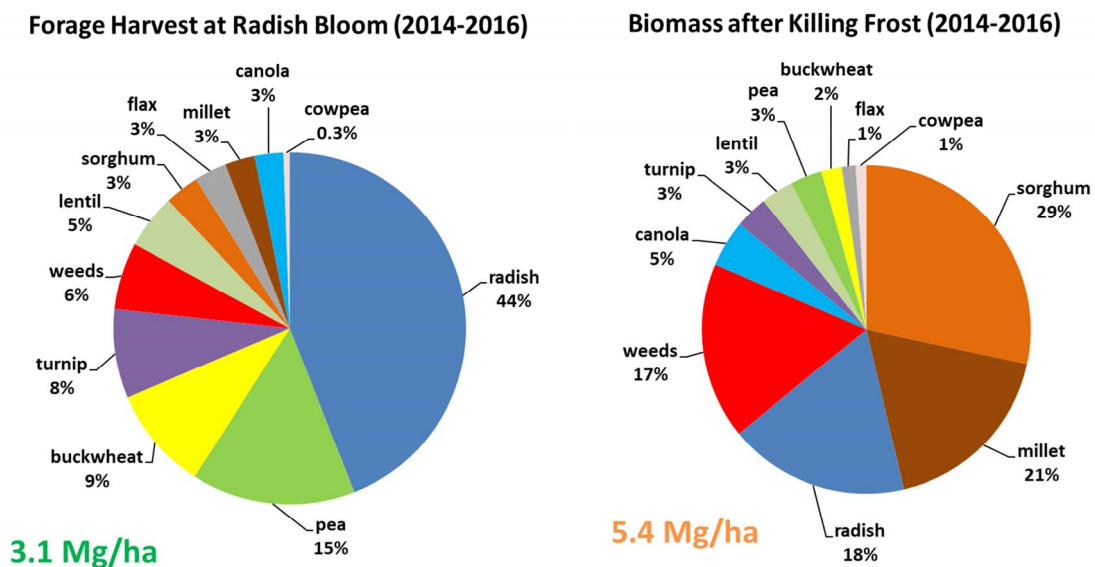

Figure 1. Average cover crop biomass at forage harvest and after a killing frost, 2014-2106.

At forage harvest, radish dominated the species mix, followed by pea, buckwheat, and turnip. After regrowth for 2-3 months and following a killing frost in fall, the greatest proportion of biomass consisted of sorghum, millet, radish, and weeds (mainly Russian thistle and kochia).

## Conclusion

Planting a cover crop mix in place of fallow in 2-yr durum rotations provided on average 3.1 Mg ha<sup>-1</sup> of high-quality forage and an additional 5.4 Mg ha<sup>-1</sup> biomass left in place that increased ecosystem services compared to fallow. Overall cropping system productivity and water use efficiency still need to be evaluated to determine viability of cover crops as a fallow replacement.

## Reference

Hansen N.C., Allen B.L., Baumhardt R.L., Lyon D.J., 2012. *Field Crops Res.* 132, 196-203.

## The response of maize yield to tillage depth and straw incorporation in a Mollisols in Northeast China

Wenxiu Zou, Xiaozeng Han, Xinchun Lu

*Northeast Institute of Geography and Agroecology, Chinese Academy of Science, 150081, Harbin, China*

Corresponding author: [zouwenxiu@iga.ac.cn](mailto:zouwenxiu@iga.ac.cn)

### Introduction

Aggregate in virgin soil was formed by the reaction among plant, microbe, animal and soil, which build different volumes of soil porosity and controlled exchange of water, air and heat, and development of root. However, aggregate stability was destroyed after virgin soil was reclaimed, which deteriorated soil porosity structure and limited the exchange of water, air and heat. Tillage practices were adopted to improve soil structure, adjust the relationship between of water, fertilizer, air and heat, enhance crop growth and soil production (Lipiec et al., 2015). But suitable indicators related to soil tilled depth and frequency were lack. Unreasonable tillage practice could future deteriorate soil physical structure and decreased the content of soil organic matter and soil fertility. Soil water storage and soil organic carbon storage in 0-100 cm soil layer were decreased by 17.6%-30.8% and 23.71% after virgin black soil being reclaiming with unsuitable tillage practices (Han et al., 2005). Meanwhile, more chemical fertilizer was applied in order to obtain higher crop yield in soil with thin cultivated layer resulted from the small power tractors being used. Straw incorporation also is an important way to improve soil structure and increase crop yield, but it is limited how many depths straw should be incorporated to, with higher crop yield in a Mollisol in Northeast China. Therefore, the objectives of this study were to (1) identify the suitable tilled soil depth and frequency, (2) determine optimum soil depth incorporated straw.

### Material and method

This study was conducted at the National Field Research Station of Agro-ecosystems (126°38'W, 47°26'N; 240 m above sea level) at Hailun County, Heilongjiang province in Northeastern China from 2009 to 2011. The climate in Hailun County is described as a temperate continental monsoon type with an average annual precipitation from 1953 to 2008 of 550 mm; approximately 60% of rainfall occurred between July and September. The annual mean air temperature is 1.5°C with an annual frost-free period of about 120 days. The soil is described as Black soil (Mollisol in American Soil classification system), derived from loam loess, with approximately 40% clay content. One crop was grown per year. The experiment was established in 2008 after harvesting, each replicated four times with a randomized block design. Each plot had an area of 60 m<sup>2</sup>. The main treatments were the depths of tilled soil including zero tillage (D0), shallow tillage depth with being tilled soil depth of 0-15 cm (D15), medium tillage depth with being tilled soil depth of 0-20 cm (D20), deep tillage depth with being tilled soil depth of 0-30 cm (D30) and 0-50 cm (D50). Each tillage treatment was separated to parts with and without straw incorporation, the treatments were labeled as D15+S, D20+S, D35+S and D50+S for straw incorporation treatments. Maize straw at 10000 kg/hm<sup>2</sup> was applied to all plot with straw incorporation. 150 kg/hm<sup>2</sup> N, 75 kg/hm<sup>2</sup> P<sub>2</sub>O<sub>5</sub> as urea and (NH<sub>4</sub>)<sub>2</sub>HPO<sub>4</sub> was applied for maize in experimental years. Soil samples within 0-200 cm soil layers with 20 cm interval was collected for measured soil water contents before sowing and after harvesting in experimental years. Soil water contents within 0-35 cm was measured

every ten days in growing seasons. Maize yield was measured in fall 2009, 2010 and 2011.

### Results and discussion

Tillage practice has function of adjusting the soil environment and root development of crops by regulating water, fertilizer, air and heat in soil. The significant difference has been observed that different tilled soil depth impacted corn yield (Fig 1). Zero tillage has significantly reduced corn yield ( $p < 0.05$ ) with mean value of  $5943 \text{ kg/m}^2$  in 2009, 2010 and 2011, compared with being tilled treatments. The yield of corn has been significantly increased by 12.75%, 36.55%, 51.43% and 27.59% for D15, D20, D35 and D50 treatments, respectively, compared with zero tillage (D0), indicating that corn yield did not increase with the increased of being tilled soil depth, and reached the highest value in D35 treatment. Straw incorporation also impacted the corn yield, and the highest corn yield of  $9655 \text{ kg/hm}^2$  was observed in D35+S treatment, was increased by 71.91%, 33.11%, 24.53% for D15+S, D20+S and D50+S, respectively, indicating that the different ratio of straw and soil resulted in the difference of corn yield among treatments with straw incorporation. When soil depth of straw incorporated was less than 20 cm soil layer, straw incorporation reduced corn yield, however, soil depth of straw incorporated was more than 35 cm soil layer, straw incorporation increased corn yield, by the comparison of corn yield of treatments with and without straw incorporation.

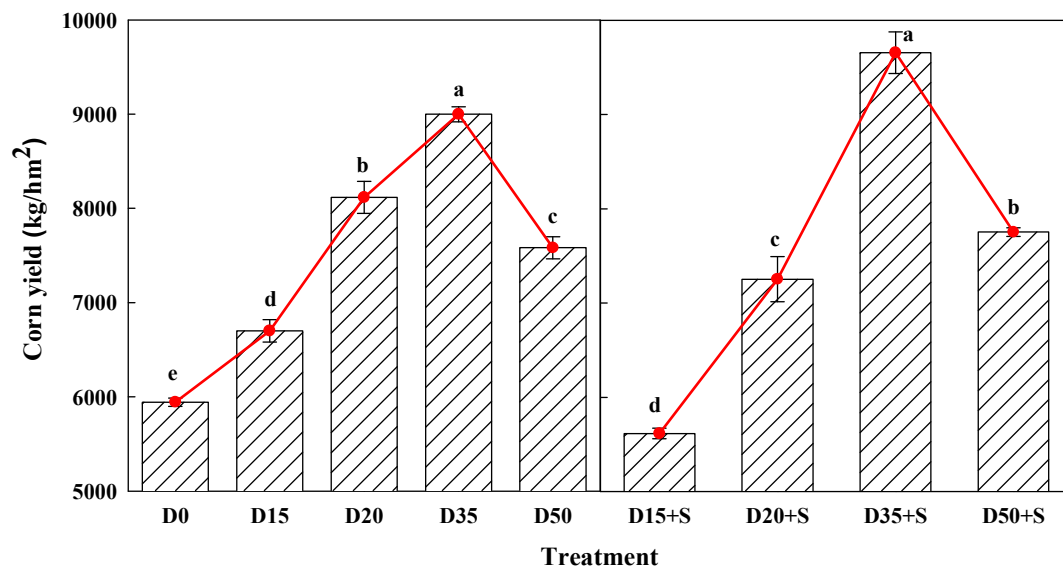

Figure 5. The combination of cultivation depth and straw incorporation impacted on maize yield

### Conclusion

The depth of tilled soil and straw incorporation both could significantly corn yield. Tilled soil depth of 0-35 cm was optimum for corn growth in study site. Straw incorporation into soil depth of < 0-20 cm showed negative impact on corn yield, but straw incorporation into soil depth of > 0-35 cm showed positive impact on corn yield, indicating that soil tilled depth and soil depth of straw incorporation were both very important for crop growth. We recommended soil tilled depth of 0-35 cm coupled with straw incorporation to black soil in Northeast China.

### References:

Han X., Wang S., Song C., Qiao Y., 2005. Effects of land use and cover change on ecological environment in black soil region. *Scientia Geographica Sinica*, 25(2): 203-208 (In Chinese with English abstract).

Lipiec J., Turski M., Hajnos M., 2015. Pore structure, stability and water repellency of earthworm casts and natural aggregates in loess soil. *Geoderma*, 243-244: 124-129.

## Nitrous Oxide Emission from a Silty-Loamy Soil due to on surface and subsurface application of Pig Slurry

M.E. Carrizo<sup>1</sup>, J. Nicolier<sup>1</sup>, M.J. Masola<sup>1,2</sup>, V. Gregorutti<sup>3</sup>, S. Imhoff<sup>1,2\*</sup>

<sup>1</sup>*Departamento de Ciencias del Ambiente, Facultad de Ciencias Agrarias, Universidad Nacional del Litoral, Kreder 2805, S3080HOF, Esperanza (Santa Fe), Argentina.*

<sup>2</sup>*Consejo Nacional de Investigación Científica y Tecnológica (CONICET) Kreder 2805, S3080HOF, Esperanza (Santa Fe), Argentina.*

<sup>3</sup>*INTA, Ruta 11 Km. 12,5, Oro Verde (Entre Ríos), Argentina.*

\*corresponding author: simhoff@fca.unledu.ar

### Introduction

Nitrous oxide (N<sub>2</sub>O) is a potent greenhouse gas that can be emitted by agricultural soils, with a global warming potential 298 times greater than carbon dioxide. Livestock industry has been identified as a significant sources of N<sub>2</sub>O. Emissions of N<sub>2</sub>O are inevitable and derive from urine and feces deposited in the animal stables, manure store, manure treatment systems and manure application to the soil. Animal manure contains organic and inorganic nitrogen, carbon and water that provide the essential substrates required for the microbial production of N<sub>2</sub>O during the nitrification and denitrification processes (Chadwick et al. 2011). The impact of the manure application strategy on the soil N<sub>2</sub>O emission is variable and depends on the physical state of the manure, between other factors. In Argentina the use of manure as fertilizer, like the pig slurry, is increasing due to the continuous increase of pig production. However, information on N<sub>2</sub>O emissions from pig slurry in soils under no-till in Argentina is still scarce and differences on N<sub>2</sub>O emission caused by the use of different systems of application were not studied. The aims of this study was to quantify the N<sub>2</sub>O emission from a silty-loamy soil of Argentina due to pig slurry application throughout different systems.

### Material and method

The experiment was conducted in a silty-loamy Typic Argiudol (clay 265 g kg<sup>-1</sup>, silt 705 g kg<sup>-1</sup>) from the Los Cardos Series at agricultural field in El Trebol City (60° 43.13 'W, 30°10.10' S), Argentina in May 2017. Twelve plots (40 x 80 m) were delimited in the experimental area. The experiment was arranged in a randomized complete block with three replicates. Corn was seeded one week after applying the pig slurry. The treatments consisted in (1) without application of pig slurry through sprinkler irrigation (SI, 0 kg N ha<sup>-1</sup>), (2) with surface application of pig slurry through sprinkler irrigation (SI, 380 kg N ha<sup>-1</sup>), (3) without application of pig slurry through injection system (IN, 0 kg N ha<sup>-1</sup>) and (4) with subsurface application of pig slurry through injection system (IN, 270 kg N ha<sup>-1</sup>). Pig slurry was injected at 10 cm depth.

The flux of N<sub>2</sub>O from the soil surface was measured after pig slurry application using vented chambers. Gas samples (20 mL) from inside the chambers were collected by syringe at 0, 15, and 30 min after placement on the chambers. The gas samples were injected into 20-mL evacuated vials. The N<sub>2</sub>O collected was analyzed with a gas chromatograph (GC 6890 Agilent Technologies Network).

### Results and discussion

The application of pig slurry increased N<sub>2</sub>O emissions compared with the controls treatments (0 kg N). The N<sub>2</sub>O emission varied between the application systems (Figure 1).

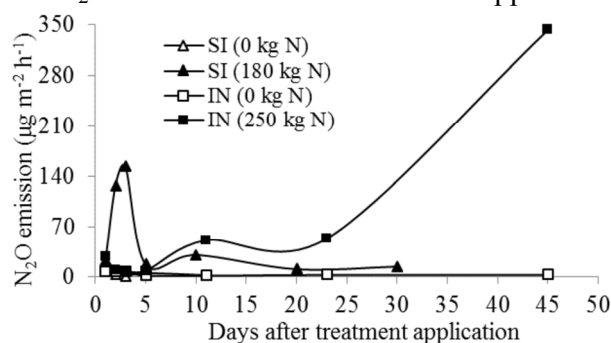

Figure 1. Nitrous oxide emissions from the soil due to the application of pig slurry on surface and subsurface through sprinkler irrigation (SI) and injection system (IN).

The N<sub>2</sub>O emissions in the SI treatment were much higher ( $P < 0.05$ ) than in the IN treatment between day one and day five. This finding can be attributed to differences in the soil water-filled pore space (WFPS) between the treatments. During the first five days of the study, the soil WFPS was  $0.49 \text{ m}^3 \text{ m}^{-3}$  in SI and  $0.34 \text{ m}^3 \text{ m}^{-3}$  in IN. The higher level of the soil WFPS in the SI treatment may have promoted the process of denitrification and, thus, the emission of N<sub>2</sub>O. There were no significant differences in N<sub>2</sub>O emissions between treatments from day 5 to day 20 after. The N<sub>2</sub>O emissions in the IN treatment increased from day 20 until day 45 after the application. The later N<sub>2</sub>O emissions in this treatment may result from the subsequent mineralization of the organic nitrogen that provided N available for denitrification. This delayed process seems to be very important in silty-loamy soils, such as the studied, because they have very small macroporosity (average total porosity:  $0.51 \text{ m}^3 \text{ m}^{-3}$ ; average macroporosity:  $0.04 \text{ m}^3 \text{ m}^{-3}$ , according to Ghiberto et al., 2015). A consequence of this problem that should be considered in order to correctly measure N<sub>2</sub>O emissions is the duration of the experiments because they can be finalized in advance, as happened in this study. The delayed N<sub>2</sub>O emissions were also observed by Sistani et al. (2010).

## Conclusion

The application system of pig slurry have a significant influence on N<sub>2</sub>O emissions. The magnitude and the moments of greater emission varied between the application systems. However, other factors, such as soil moisture, soil type and compaction state, should be considered in order to quantify N<sub>2</sub>O emissions.

## References

- Chadwick, A., Sommer, S., Thorman, R., Fangueiro, D., Cardenas, L., Amon, B., Misselbrook T., 2011. *Anim. Feed Sci. Tech.*, 166–167, 514–531. doi:10.1016/j.anifeedsci.2011.04.036
- Sistani, K.R., Warren, J.G., Lovanh, N., Higgins, S., Shearer, S., 2010. *Soil Sci. Soc. Am. J.*, 74, 429–435. Doi:10.2136/sssaj2009.0076
- Guiberto, P., Imhoff, S., Libardi, P., Pires da Silva, A., Tormena, C., Pilatti, M.A., 2015. *Sci. Agricola*, 72, 167–174. <http://dx.doi.org/10.1590/0103-9016-2013-0414>.

## Tillage system effects on weed seedbanks in a clay soil in Algeria.

M.A Feddal<sup>1\*</sup>, M. Amara<sup>1</sup>, L. Boudhar<sup>1</sup>, Z. Mohammedi<sup>1</sup>

<sup>1</sup> *Ecole nationale supérieure agronomique, EL HARRACH, Alger, Algérie.*

Corresponding author : [feddalamine@gmail.com](mailto:feddalamine@gmail.com)

### Introduction

In Algeria, the cereal lands are increasingly covered by weeds and their numbers are increasing. (Rahali et al. 2011). The choice of a new tillage system must be based on its compatibility with the soil and climatic characteristics of the farm. There is no single system of tillage that is best for all situations encountered. In fact, there could be a rotation of tillage systems as there is crop rotation. So we could choose the tillage system best suited to the crop (Beuret, 1980). No-till has the best potential for reducing tillage costs even though it adopts a totally chemical weed control. The composition of a weed seed bank represents not only the coming weed flora but also the past – the history of the weed flora. The dates of the investigations of the weed seed bank show weed diversity better than does assessment of germinated weed, because some weeds are destroyed through agricultural practice (Auškalnienė and Auškalnis, 2009). Changes in the soil weed seed reserve depend on soil tillage, crop rotation, and implements of weed control. Long-term cultivation and differing tillage systems produce important changes in the composition and density of soil seed banks. The effect of different tillage systems becomes evident quickly. One point of view: different tillage systems rapidly produce differences in the density and composition of the soil seed bank and systems causing less soil disturbance allow the buildup of larger and more diverse soil seed banks. The objective of this study is to estimate the weeds density of surface relative to the viable **weed seedbanks** under the effect of three tillage systems: conventional tillage, minimum tillage, and no-Till.

### Material and method

Data that is used in this project were collected at the experimental station of ENSA (High National School of Agronomy), of Algiers. The trial was set up on a ground texture clay loam (clay-loam) according to USDA classification with a clay content of 36 %, 23 % fine silt and 2.2 % coarse silt, sand as it is of the order of 16 % and 26.08 % between sandy and coarse sand. Three cultivation techniques have been compared : Conventional tillage (CT); moldboard plow (30 cm deep) + cover crop + harrow + roller; Minimum tillage (MT); Chisel (20 cm deep) + harrow + roller; and No-Till system (NT).

For the weeds seedbank estimate, soil samples were taken on 19/12/2016 from each micro-plot at 06 samples of two depths, 0-15 and 15-30 cm. The dimensions of each sample are 20 × 20 × 15 cm. Samples are washed through three screens of 3.25mm, 0.5mm and 0.20mm mesh. The refusal of the second sieve is spread in terraces of 18 × 10 cm, filled with sterilized potting soil. The terrines are installed in a culture chamber with a cycle comprising 14 hours of illumination at 21 ° C. and 10 hours of darkness at 18 ° C. As soon as the aerial parts of the plants appear, they are put in an experimental greenhouse. For eight weeks, sprouted seedlings are identified and counted. For the seeds that did not germinate, due to their dormancy, we installed them during one month in the dark, at 4 ° C to lift the dormancy, then they are put back in growing chamber for eight weeks, sprouted seedlings are identified and counted. The terrines are irrigated regularly so that the substrate remains moist.

### Results and discussion



The results showed that each cropping technique induces a particular evolution of the seed bank. Mechanical weeding increases the long-term and regular long-term seed bank, in contrast to the minimum tillage that concentrates it in the first centimeters of the soil, while direct seeding leaves it on the surface. In the case of a conventional technique, tillage begins with stubble cultivation, burying residues from the previous crop, and weed kernels that may exist on the soil surface. So a false seeding before plowing is very effective, for the reduction of the annual seed bank. In simplified techniques, the mechanical fight can be used only in the case of a minimum tillage by the realization of a false seeding.

The tillage regime influences the evolution of the weed flora. By ensuring a deep burial of weed seeds, conventional plowing significantly reduces the viability of the seed bank, it would destroy about 85% of the seeds of foxtail.

The adoption of no-till techniques induces progressive changes in the flora. In addition, these techniques also modify the activity of root herbicides. However, it remains necessary to be attentive at the beginning of cultivation, because the competition of weeds or regrowths is marked faster than plowing.

In permanent no-tillage, a failed weeding can have important consequences in the following crops, sometimes involving several rotations: In the short term, the weed nuisance can cause falls of yield of 5 to 10%. In the longer term, significant fouling increases the risk of herbicide-resistant of weeds. In addition, the surface seed bank is likely to cause difficult control of weeds for at least two to three seasons. This is why vigilance must be increased, and autumn weeding is essential in many cases. The latter makes it possible to intervene in several fractional passages, at lower doses and at a lower cost than a single spring weeding always expensive, especially in very dirty situations. Nevertheless, we must be careful about the chemical treatment, which is not 100% effective against the seed bank, indeed, 90% of efficiency on a population of 100 feet of weed leaves ten plants still capable of generating many seeds, thus increasing the seed potential of the plot.

## Conclusion

In conclusion, it is advisable to plow at least once on the rotation, or once every 3 or 4 years where the rotations are not regular. Despite the efforts we have made and the results we have obtained, the study of the dynamics and evolution of weeds requires a follow-up over several years, so that the results become representative by the spreading of the prospecting campaigns over several years in order to make a global analysis of the entire floristic procession and to follow the evolution and dynamics of this flora.

## Références

Auškalnienė O and Auškalnis A., 2009. The influence of tillage system on diversities of soil weed seed bank. *Agr Res* 7 (Special issue I), 156–161, 2009.

Beuret E. 1980. Influence de la monoculture et des méthodes de travail du sol sur la flore adventice et le stock grainier du sol. In : Lorenzoni N. G. G., Barralis G. et J. P. Lonchamp (Eds.). VIe Colloque International sur l'Écologie, la Biologie et la Systématique des mauvaises herbes : Evolution des populations et des peuplements (Session III). Actes, Tome II : 389 -399.

Rahali A., Makhlof M., Benkherbache N., 2011. Influence de l'itinéraire technique sur le stock semencier de mauvaises herbes de la zone semi- aride de Sétif. *Rencontres Méditerranéennes du Semis Direct*. Zaragoza : CIHEAM / ATU-PAM / INRAA / ITGC / FERT, pp : 153- 162.

## The effect of reduced tillage on weed infestation in the stand of spring barley in South Moravia Region

J. Winkler<sup>1\*</sup>, V. Smutný<sup>2</sup>, L. Neudert<sup>2</sup>

<sup>1</sup>Department of Plant Biology, Faculty of AgriSciences, Mendel University in Brno, Zemedelska 1, 613 00 Brno, Czech Republic

<sup>2</sup>Department of Plant Biology, Faculty of AgriSciences, Mendel University in Brno, Zemedelska 1, 613 00 Brno, Czech Republic

\* corresponding author: [winkler@mendelu.cz](mailto:winkler@mendelu.cz)

### Introduction

Tillage has a great influence on subsequent weed infestation of crops. The soil can be processed through so called minimum tillage, which greatly expanded mainly due to usage of the high-performance agricultural machineries. MOHLER (1993) addressed the question of increased germination of weeds in the model experiment with three different tillage methods. The results of his study indicate, that while the largest amount of sprouted weeds was recorded in the first year when no tillage was applied, the following years report significantly fewer seeds. The result can be induced dormancy of seeds surviving just below the surface.

According to BUHLER (1995), there are number of factors causing the higher weed infestation when reduced tillage such as different weed species, soil environment, or the quality and the quantity of crop residues. Even though most authors concluded that minimum tillage leads to the expansion of the perennial weeds, some believe that this dependence is not that clear. Contrarily, they argue, that occurrence of perennial species was effected by their chemical control

The long term and continuously using of reduced tillage can change conditions of soil. These changes can influence growing and occurrence of weeds at the given location. In the incoming year there can be changes in the intensity of weed infestation as well as variations in the weed species spectrum. This contribution is focused on reaction of weed on reduced tillage.

### Material and method

The experimental plots are located in the cadastral of municipality Žabčice (Moravia, Czech Republic) which belongs to the geomorphological areas of Dyjsko-Svratecký valley. Žabčice is located in the corn production area in flatlands of an altitude 184 m a.s.l. The geographical surrounding of Žabčice can be considered as warm and dry. According to weather station, the annual precipitation in the last 30 years was around 483.3 mm with the average annual temperature of 9.2 °C.

The field experiment was established in Autumn 2003. For the purpose of this field experiment we use the seven-step crop rotation system: gourd alfalfa (*Medicago sativa*) – the first year, alfalfa wheat – the second year, winter wheat (*Triticum aestivum*), forage maize (*Zea mays*), winter wheat, sugar beet (*Beta vulgaris*), spring barley (*Hordeum vulgare*).

**Factors of the field experiment:** i - **Conventional tillage:** After the harvest of the previous crop, the plowing was applied to a depth of 0.2 to 0.24 m (medium deep), which was carried out by a rotatable plow called Lemek and followed by sowing in the spring season by using a sowing combination called Accord and subsequent (beset) with cambridge cylinder. ii - **Minimum Tillage** - is a shallow tillage right after harvesting the previous crop carried out by chisel plow called Kverneland to a depth of 0.1 m and followed by sowing in the spring season by using a sowing combination called Accord and subsequent (beset) with cambridge cylinder. iii - **Direct sowing** - after harvesting the previous crop the soil surface is not being cultivated. A direct sowing in an uncultivated soil is then carried out through sowing by using

a sowing combination called Accord and subsequent (beset) with cambridge cylinder. It should be noted, that only maize and sugar beet requires pre-sowing soil preparation in the depth of sowing.

The monitoring of weed infestation was carried out between years 2004 (establishing a field experiment) to 2015. The evaluation of actual weed infestation was done before the application of herbicides (in Spring) in the stands of spring barley. Counting method was applied, the number of weeds was on 1 m<sup>2</sup> area, in 24 replications.

### Results and discussion

During the monitoring (years 2004 to 2015), 34 species of weeds were identified and some significant differences were registered in representation of respective species. Table 1. shows the average number of spring barley weeds in different soil tillage. Generally, it can be stated that persistent species are on the rise, as well as species from Asteraceae family for all treatments. For example bindweed (*Convolvulus arvensis*) was a species with a stable, as well as increasing representation. For creeping thistle (*Cirsium arvense*) there was an upward trend during the first five years, then a decrease in its representation occurred. Similar trend was present for a common dandelion (*Taraxacum officinale*). It is clear from the results that the level of weed infestation of spring barley had changed considerably and developed during the observation period. On all three variants there are clear trends of significant increase of weed infestation. These can be caused by weather conditions in individual years, the level of weed infestation previous crop in the previous year or the amount of weed seeds in the soil.

Table 1. Average number weed of spring barley in variety soil tillage (individual.m<sup>-2</sup>)

Soil Tillage	year											
	2004	2005	2006	2007	2008	2009	2010	2011	2012	2013	2014	2015
Conventional tillage	5.0	3.5	15.9	2.3	12.0	5.5	9.4	5.5	1.9	5.8	2.3	8.9
Minimum Tillage	2.5	4.0	19.3	5.2	13.4	3.2	23.3	3.9	2.6	5.1	3.6	4.9
Direct sowing	2.8	1.8	20.0	8.2	29.6	5.1	27.9	9.0	2.5	19.3	5.2	17.0

### Conclusion

These results clearly suggest, that the level of weed infestation in spring barley was significantly changing and developing during the monitoring. So, in reduced tillage, we can expect a significantly higher weed infestation in some incoming years. Therefore, it is necessary to regular and systematic monitoring of weed and then according to the species spectrum, create appropriate control of weed infestation.

### Poděkování

This work was financially supported by project NAZV no. QJ1530373: „Integrated pest management of cereal crops against pathogens, weeds and insects for sustainable production of food, feed and raw materials“.

### References

- MOHLER, C. L., 1993. A model of the effects of tillage on emergence of weed seedlings. *Ecological Applications*, 3: 1, p. 53-73
- BUHLER, D., D. 1995: Influence of tillage systems on weed populations dynamics and management in corn and soybean in the central USA. *Crop Science*. 35, p. 1247-1258.

## Ecological functions of soil actinomycetes of Mongolia

J. Norovsuren<sup>1\*</sup>, I.V. Boykova<sup>2</sup>, V.I. Savich<sup>3</sup>, G.M. Zenova<sup>4</sup>

<sup>1</sup>*The Institute of General & Experimental Biology, the Mongolian Academy of Sciences, 13343, Ulaanbaatar, Mongolia*

<sup>2</sup>*All-Russian Institute of Plant Protection, 196608, St. Petersburg, Pushkin, Russia*

<sup>3</sup>*Russian State Agrarian University - Moscow Timiryazev Agricultural Academy, 127550, Moscow, Russia*

<sup>4</sup>*Faculty of Soil Science, Moscow State University, 119991, Moscow, Russia*

\*corresponding author: norvo@mail.ru

### Introduction

Mongolia is a developing country for which agricultural production is very important. Actinomycetes are involved in the processes of humus formation; the products of their vital activity have a certain complex-forming and structure-forming ability. They determine the acid-base and oxidation-reduction state, mobility of elements and antipathogenic function of soils. Of great importance in the transformation of substances in the soil is the information function of microorganisms, concluded in the interrelationships of microorganisms with the properties of soils and factors of the external environment, in the adequacy and speed of the response of the microbiological population of the soil to external influences. From our point of view, the influence of microorganisms on the genesis and fertility of soils is due, first of all, to the following factors: the energy content in the biomass of microorganisms; their quantity and activity in the transformation of rocks, organic and mineral parts of the soil. Of great importance is the antipathogenic function of microorganisms, the stimulating ability of their exmetabolites, the ability to lower the activation energy of reactions and selectivity for individual reactions (Savich et al., 2007; Norovsuren, 2009).

In this paper we present a search for actinomycetes synthesizing biologically active substances with antagonistic activity against phytopathogenic fungi, bacteria and other test organisms.

### Material and method

The samples of soils of mountain-forest, steppe and desert-steppe ecosystems of Mongolia served as objects of the study. For the most complete isolation of actinomycetes from the soil, a combined method of Humus - vitamin agar and casein - glycerol agar, consisting of selective methods aimed at suppressing the growth of non-micellar bacteria, fungi, was used. Chemotaxonomic prizes of actinomycetes were observed in the hydrolysates of whole -cells LL- or meso-DAP (diaminopimelic acids) and the antagonistic activity of actinomycetes was determined. For the species identification of streptomycetes, cultural, morphological and physiological-biochemical indices were used, according to the determinant of Gause. The phytopathogenic fungi and bacteria stored in the State Collection of Microorganisms VIZR and RSAU-MTAA, as well as other test organisms stored in the IGEB of MAS, were used as a test object.

### Results and discussion

Soil fertility is largely determined by the structural interrelationships between soil properties, in the soil-plant system and the environment, in the soil system - microorganisms, in the soil, as in a biocosm body. In this case, microorganisms which carry out the most rapid transfer of information, are necessary link in the implementation of the bioco-soil functions of soils.

Microorganisms (actinomycetes) in separate horizons of soils play the role of selective geochemical barriers. Microorganisms in different parts of the catena, in the landscape perform the role of selective geochemical barriers of a higher hierarchical level and determine the development of the whole biogeocenosis.

For microbiological and enzymatic processes in various conditions, the main direction is the introduction of certain microorganisms into the root zone of plants, injecting them with roots or leaves not only substantially increase the yield, but also contribute to the plant's resistance to certain diseases.

For the plant protection from pathogens and pests, it is necessary to create conditions in which soil accumulates antagonists of pathogens under agricultural crops and increases the participation of microorganisms of various groups in soil processes.

The main producers of antibiotics in the fight against plant pathogens are actinomycetes of the genus *Streptomyces*. The number of reports of new antibiotics produced by actinomycetes is increasing every year. In addition, actinomycetes are able to form antibiotic substances that inhibit enzymes, and also are immunomodulators, herbicides, insecticides. They can synthesize other biologically active compounds.

The biological method of combating pathogens is the use of microorganisms with antagonistic properties or products of their vital activity for the destruction or inhibition of the development of pathogenic organisms. This method is receiving increasing attention in forest and especially agricultural phytopathology, since the widespread use of chemical compounds becomes harmful to human health and disrupts a number of important processes in living nature. However, the currently known biological methods in practice are very limited (Savich et al., 2007, 2010; Norovsuren, 2009).

An antagonism of microorganisms plays an important role in the formation of genesis and fertility of soils. According to our data, strains of actinomycetes isolated from the soil suppress the growth of the following microorganisms: *Bacillus subtilis*, *Escherichia coli*, *Staphylococcus aureus*, *Saccharomyces cerevisiae* and *Aspergillus niger*, strains of streptomycetes suppress the growth of *Xanthomonas campestris pu. Campestris*, *Alternaria raphanii brassicae*, *Alternaria solani*, *Alternaria alternata*, *Botrytis cinerea*, *Colletotrichum lagenarium*, *Sclerotinia sclerotiorum*, *Sphaeropsis malorum*, *Fusarium culmorum* and *Fusarium oxysporum f.sp. lycopersici*.

Summing up, it is necessary to emphasize that as a result of the work done, prospective strains have been identified for further study in connection with their pronounced antagonistic action against test organisms. Microbiological preparations based on highly effective strains, unlike synthetic preparations - pesticides - are less toxic, rapidly decompose, do not accumulate in food, are hypoallergenic, cheap and convenient for industrial application.

## Conclusion

The strains studied can serve as a basis for the development of new, practically valuable antibiotic drugs that can be used in medical practice, as well as for the creation of environmentally safe biologics for combating phytopathogenic fungi and bacteria of agricultural plants and subsequent preservation of the crop.

## References

- Norovsuren J. 2009. Geographical distribution actinomycetes in soils of Mongolia. Moscow. Publishing house RSAU - MTAA. 170 P.
- Savich V.I., Sychev V.G., Zamaraev A.G., Syunyaev N.K., Nikolsky Yu.N. 2007. Energy assessment of soil fertility. Moscow. Publishing house ASRIA. 500 P.
- Savich V.I., Bulgakov D.S., Vukolov N.G., Raskatov V.A., Vasiliev A.A., Syunyaeva I.O., Chanyshev I.O. 2010. Integral assessment of soil fertility. Moscow. Publishing house RSAU - MTAA. 347 C.

## Effects and mechanism study of electrokinetic remediation of soil polluted by oxytetracycline

H. N. Li<sup>\*</sup>, Y. L. Tian, J. Ye, C. X. Zhu, B. X. Li, Z. G. Zhang

(Agricultural Clear Watershed Group, Institute of Environment and Sustainable Development in Agriculture, Chinese Academy of Agricultural Sciences, Beijing, China 100081)

\* corresponding author: lihongna828@163.com

### Introduction

Antibiotics have been extensively used for several decades to protect human health, decrease disease, and promote the growth of livestock and poultry. Since most antibiotics are water-soluble, as much as 30-90% of the parent compounds used can be released into the environment through discharge via feces and urine, posing potential risks to human health and ecosystems. However, few studies have reported on countermeasures for antibiotics, ARB, and ARGs already existing in soil. The electrokinetic remediation technique is carried out with a low-level direct current, and the pollutants in soil can be transported and removed by the electric field. This works well even in soil with low permeability via electro-osmotic flow and electro-migration. It has already been frequently studied as an effective control measure for heavy metals, petroleum oils and polycyclic-aromatic hydrocarbons. We designed this study to seek an efficient solution for the problem of antibiotic pollution in soil.

### Material and method

The lab-scale electrokinetic setup is schematized in Fig. 1. It was made of transparent methacrylate with electrode compartments on each side (5.0 cm × 10.0 cm × 10.0 cm), and a middle tank (20.0 cm × 10.0 cm × 10.0 cm) filled with polluted soil. The electrode compartments were separated from the soil tank by a 0.5 mm nylon mesh and filter paper. The experiments were performed in potentiostatic mode with a voltage gradient of 0.8 V cm<sup>-1</sup> [1]. After 7-day remediation, the soil tanks were divided into ten 2-cm portions (0-2 to 18-20 cm), to investigate the influence of positions relative to the electrodes on the parameters. The concentration of oxytetracycline (OTC), the total number of bacteria, as well as the abundance of anti-OTC bacteria were all determined in the study.

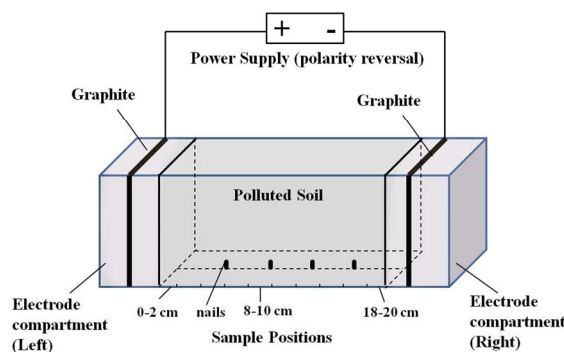

Fig. 1 Setup for electrokinetic remediation.

### Results and discussion

Antibiotics and corresponding antibiotic resistance is becoming more and more serious. In order to establish an effective way to remove antibiotics and antibiotic-resistant bacteria in soil, electrokinetic experiment was carried out to remediate contaminated soil with OTC as a characteristic pollutant. By reversing the polarity of the power every 12 h, it is ensured that the pH of electrolytes and soil is in the right range, which ensures both the smooth progress of electrochemical process and microbial reaction. After 7-day electrokinetic remediation, the average removal rate of OTC in soil reached 40.8%, which is mainly due to the direct and indirect effects of electric field, the role of indigenous microorganisms in soil and hydrolysis process [2]. In the treatment without electric field, the total number of bacteria and the number of anti-OTC bacteria in soil samples at 0-2 cm were  $2.45 \times 10^6$  and  $3.73 \times 10^6$  CFU g<sup>-1</sup>, respectively, which were significantly higher than those in electrokinetic treatment group ( $2.42 \times 10^6$ ,  $2.24 \times 10^6$  CFU g<sup>-1</sup>). The average inhibition rate of anti-OTC bacteria was 15.3%. The major taxonomic phyla found in the samples after treatment were *Proteobacteria*, *Bacteroidetes*, *Firmicutes* and *Acidobacteria*. And the distribution of *Actinobacteria*, *Cyanobacteria*, and *Chloroflexi* was greatly decreased compared with blank soil.

### Conclusion

Electrokinetic remediation can significantly remove antibiotics and antibiotic-resistant bacteria in contaminated soil, which will provide a new effective and feasible technology for the current situation of the remediation of antibiotics and drug-resistant bacteria worldwide.

### References

- [1] E. Mena, J. Villaseñor, M.A. Rodrigo, P. Cañizares, Electrokinetic remediation of soil polluted with insoluble organics using biological permeable reactive barriers: Effect of periodic polarity reversal and voltage gradient, *Chem. Eng. J.* 299 (2016) 30-36.
- [2] H. Li, B. Li, J. Ma, J. Ye, P. Guo, L. Li, Fate of antibiotic-resistant bacteria and antibiotic resistance genes in the electrokinetic treatment of antibiotic-polluted soil, *Chem. Eng. J.* 337 (2018) 584-594.

## Water Retention and Consistency Approaches for Determining the Water Contents for Tillage

Peter Bilson Obour<sup>1\*</sup>, Johannes L. Jensen<sup>1</sup>, Mathieu Lamandé<sup>1,2</sup>, Christopher W. Watts<sup>3</sup>, Lars J. Munkholm<sup>1</sup>

<sup>1</sup> Department of Agroecology, Aarhus University, Research Centre Foulum, Blichers Allé 20, P.O. Box 50, DK-8830 Tjele, Denmark

<sup>2</sup> Faculty of Environmental Sciences and Natural Resource Management, Norwegian University of Life Sciences, P.O. Box 5003 NMBU, 1432 Ås, Norway

<sup>3</sup> Department of Sustainable Agriculture Sciences, Rothamsted Research, Harpenden, United Kingdom

\*Corresponding author: [peter.bilson.obour@agro.au.dk](mailto:peter.bilson.obour@agro.au.dk)

### Introduction

Knowledge of the water contents for tillage is important in planning and scheduling tillage operations to avoid tillage-induced soil structural degradation, creating undesirable seedbed for crop establishment, and using high-energy input during because soil is not workable. It is, generally known that soil organic carbon (SOC) increases the range of soil water contents appropriate for tillage. Two of the approaches used for determining the water contents for tillage: upper (wet tillage limit,  $\theta_{WTL}$ ), optimum water contents for tillage ( $\theta_{OPT}$ ), lower (dry tillage limit,  $\theta_{DTL}$ ) and the range of water contents for tillage ( $\Delta\theta_{RANGE}$ ) are based on the water retention and the consistency approaches. However, information on the application and robustness of these methods for different soils is limited. The objective of this study was to evaluate the water retention and consistency approaches using soils with a range of SOC contents.

### Materials and methods

Soil samples were taken from two long-term field experiments; the Highfield long-term ley/arable experiment at Rothamsted Research, UK and the Askov long-term experiment on animal manure and mineral fertilizers at Askov Experimental Station, Denmark. Each experiment had a uniform soil texture, but a range of SOC. The soils from Highfield and Askov are silt loam and sandy loam, respectively. The treatments studied in Highfield were Bare fallow (BF), Continuous arable rotation (A), Ley-arable (LA) and Grass (G); and in Askov: unfertilized (UNF),  $\frac{1}{2}$  mineral fertilizer ( $\frac{1}{2}$  NPK), 1 mineral fertilizer (1NPK), and  $1\frac{1}{2}$  animal manure ( $1\frac{1}{2}$ AM). The water contents for tillage determined using the water retention approach is based on fixed points (water contents) generated from modelled water retention characteristics using the van Genuchten equation. The consistency approach is based on a combination of soil plastic limit and an estimate of tensile strength of aggregates in the 8–16 mm size class at different



water contents. More details on the measurements and how the water contents for tillage were determined from the two approaches are provided in Obour et al. (2018).

### Results and discussion

Results obtained using the water retention approach from the Highfield soil showed that the  $\theta_{\text{DTL}}$  was very dry, especially for the A treatment ( $0.08 \text{ kg kg}^{-1}$ ), whereas  $\theta_{\text{WTL}}$  was very wet (wetter than  $-100 \text{ hPa}$  matric potential) for the BF soil. The  $\theta_{\text{DTL}}$  and  $\theta_{\text{WTL}}$  estimated from the water retention approach were wetter than  $-100 \text{ hPa}$  for all the treatments studied in Askov. As for the consistency approach,  $\theta_{\text{WTL}}$  is estimated from remolded soil (where air-dry soil sieved to  $1 \text{ mm}$  was remolded) destroying the soil structure and therefore, does not represent soils with intact structure. Moreover, the consistency approach provides an arbitrary way for determining  $\theta_{\text{DTL}}$ . However, the consistency approach gave more realistic  $\theta_{\text{DTL}}$  and  $\theta_{\text{WTL}}$  than the water retention approach. Further, the SOC content explained 24% more of the variation in  $\Delta\theta_{\text{RANGE}}$  when using the consistency rather than the water retention approach for both sites.

### Conclusion

This study showed that the soil consistency approach provided more realistic estimates of tillage limits than the water retention approach because using the latter, soil was considered either too dry or too wet, and therefore may not be workable. However, we have also shown a new approach is needed to predict appropriate water contents for tillage. We suggest developing and evaluating new approaches based on a defined air-filled porosity for  $\theta_{\text{WTL}}$ , and using a fixed strength value for  $\theta_{\text{DTL}}$  above which more energy will be required to fragment soil clods.

### References

Obour, P.B., Jensen, L.J., Lamandé, M., Watts, C.W., Munkholm, L.J. (2018). Soil organic matter widens the range of water contents for tillage. *Soil & Tillage Research* 182, 57–65.

## Precision Nutrient Management: A Viable Alternative for Small-fragmented Land holdings in Changing Climate Scenario in South Asia

Sheetal Sharma\*<sup>1</sup> ([Sheetal.sharma@irri.org](mailto:Sheetal.sharma@irri.org)), Pauline Chivenge<sup>2</sup> & Sarah Beebout<sup>2</sup>

<sup>1</sup> International Rice Research Institute, New Delhi, India

<sup>2</sup> International Rice Research Institute, Los Banos, Philippines

Asian economies rely on agriculture and natural resources as primary income and climate change has been and will continue to be a critical factor affecting productivity in the region. In the last five years, there has been an increased occurrence of floods and drought, while water, soil and land resources are continuing to decline (IPPC, 2007). The increasingly complex challenge of enhancing agricultural productivity in the light of dwindling resources, climate change, and persisting poverty amongst the majority of smallholder farmers demands that we find innovative ways to break the trend in plateauing productivity. Agriculture production for major food crops like rice relies on the use of synthetic fertilizers in order to meet the increasing demand of food caused by the increasing population. Rice fields in Asia tend to be small—often about one hectare or less—with high spatial variability w.r.t. nutrient status, use of varieties and crop management by farmers. Soil conditions; fertility, moisture, etc. vary widely across fields and various parts within fields responded to different types of inputs, and cultural practices. However, since the introduction of Green Revolution in the 1960s, Asian farmers treated all fields in a region uniformly leading to over application of inputs in areas not needing them or where the crops cannot make full use of them. Field scale variability has been neglected in favor of the regional and national scales. There is an urgent need to develop science-based approach to enhance society's capability to understand, anticipate and cope with this variability, augmented with the impacts of climate, in order to improve human welfare and the environment. Opportunities exist to increase the effectiveness of fertilizer use and income for rice farmers through precision nutrient management. Precision Agriculture (PA) is not just the addition of new technologies but it is rather an information revolution, made possible by new technologies that result in a higher level, a more precise farm management system. PA is the application of a holistic management strategy that uses information technology to bring data from multiple sources to bear on decisions associated with agricultural production, marketing, finance, and personnel (Olson, 1998). Site-specific nutrient management (SSNM) for rice arose in the mid-1990s as an alternative approach for dynamic management of nutrients to optimize supply and demand of a nutrient within a specific field in a particular cropping season. The SSNM approach relies on the scientific principles determined during 15 years of research across Asia (Dobermann et al., 2002; Buresh et al., 2010) and enables rice farmers to tailor nutrient management to the specific conditions of their fields, and provides a framework for nutrient best management practices for rice.

Table 1: On-Farm evaluation SSNM approach on yield and net added benefit for Rice in Odisha & Rice and Wheat in Bihar & EUP

Parameter	Unit	Odisha- Kharif Rice		Odisha-Rabi Rice		Bihar- Kharif Rice		Bihar- Rabi Wheat	
Grain Yield	t ha <sup>-1</sup>	0.8	*	0.5	*	0.7	*	0.3	*
Net added Benefit	USD ha <sup>-1</sup>	155	*	104	*	147	*	63	*
* Significant at 0.05 level									

Source: CSISA II

A study conducted in two states of India (Odisha and Bihar) shows that paddy yield gains went up from 0.6 to 1.2 t ha<sup>-1</sup>, and income gains from \$100 up to \$170 ha<sup>-1</sup> season<sup>-1</sup>, either due to increase in yield or reduction in fertilizer use or a combination of both (Table 1). The tools can be integrated with real time weather information to mitigate the adverse effects of climate change. In order to extend the benefit of these tools to large number of farmers, pragmatic pathways need to be established for increasing the profitability and recovery efficiencies of small farms. Inclusion of scaling partners in early stages of development and evaluation of the tool, ensures confidence building and long-term commitment of these partners to disseminate the tool. Similar efforts in Odisha, India, accelerated scaling out field specific nutrient and crop management recommendations to ~43000 farmers in one season (Kharif 2017). Integrating the potential PA technologies with pragmatic scaling pathways, and efficient partnerships into a comprehensive framework can unfurl the benefits of these technologies to small-scale farmers.

References:

- Buresh, R.J., M.F. Pampolino, and C. Witt. 2010. Field-specific potassium and phosphorus balances and fertilizer requirements for irrigated rice-based cropping systems. *Plant and Soil*: 335 (1), 35-64.
- Dobermann, A., C. Witt, D. Dawe, G.C. Gines, R. Nagarajan, S. Satawathananont, T.T. Son, P.S. Tan, G.H. Wang, N.V. Chien, V.T.K. Thoa, C.V. Phung, P. Stalin, P. Muthukrishnan, V. Ravi, M. Babu, S. Chatuporn, M. Kongchum, Q. Sun, R. Fu, G.C. Simbahan, and M.A.A. Adviento. 2002. Site-specific nutrient management for intensive rice cropping systems in Asia. *Field Crops Res.* 74: 37-66
- Olson K .1998. Precision agriculture: current economic and environmental issues. Sixth Joint Conference on Food, Agriculture, and the Environment. 31 Aug-2 Sept 1998. University of Minnesota, St. Paul, MN.

## The impact of soil tillage on soil strength and winter wheat performance in a long running UK field experiment

N. Morris<sup>1\*</sup>, D. Clarke<sup>1</sup> and E. Stockdale<sup>1</sup>

<sup>1</sup> NIAB, Morley, Wymondham, Norfolk. NR18 9DF, UK

\*corresponding author: [nathan.morris@niab.com](mailto:nathan.morris@niab.com)

### Introduction

The STAR project (Sustainability Trial in Arable Rotations) is a long-term study at Stanaway Farm, Otley, Suffolk, UK on a Beccles/Hanslope Series (heavy) clay soil. Research is delivered through NIAB TAG, supported in part by The Felix Thornley Cobbold Trust (and historically the Chadacre Agricultural Trust) and guided by an independent steering group. The aim of this long running experiment is to examine different cultivation systems for sustainable arable production. This paper presents findings on the impact of soil tillage on soil strength data recorded using a narrow cone penetrometer over 12 years (2006-2017) and examines how soil strength may be impacting on winter wheat yield. Findings demonstrate that whilst shallow tillage resulted in tighter soils (*cf.* plough tillage), winter wheat yields remained relatively robust with respect to tillage approaches assessed on this site.

### Material and Methods

In autumn 2005 a field experiment was set up at Stanaway Farm, (Suffolk, UK), on a heavy Beccles/Hanslope clay soil to study different cultivation techniques within a series of arable rotations; this research project was termed the STAR project (Sustainability Trial in Arable Rotations). Four different methods of cultivation and four different types of rotation are used within the research project; giving a fully factorial design delivering 16 treatments. All rotations grow wheat every other year, the year between is a break crop/fallow year (Table 1). Cultivation approaches follow an annual plough (c. 25 cm) approach, a shallow (c. 10 cm) or deep (c. 20-25 cm) non-inversion approach and a managed approach (not reported here). Soil strength was recorded annually using a narrow cone penetrometer (12 mm cone diameter, *Solutions for Research*, Bedford, UK). Soil strength and yield were analysed for the 'consistent systems' (where treatments have remained the same over this time period) from cropping years 2, 4, 6, 8, 10 and 12. The results presented in this paper used a relative percentage of soil strength (1.5 MPa that is equal to 100%) to compare each cultivation approach. Soil mechanical strength exceeding 1.5 MPa has been shown to restrain root growth (Schjønning and Thomsen, 2006). Statistical analyses were performed with GenStat 18<sup>th</sup> Edition using ANOVA and REML with least significant differences (LSD) at  $P < 0.05$ .

### Results and discussion

The impact of tillage on soil strength for the 'consistent systems' are presented in Figure 1; this reports the mean data for 'all rotations'. Soil strength diverges at c. 7.5 cm in the shallow tillage (*cf.* plough tillage) and remains at around 20% tighter at depths between 15 and 35 cm. Long term regular use of winter wheat within the rotation allows the impact of tillage on wheat yield to be evaluated in the context of longer term data sets. Winter wheat yield data for the 'consistent systems' are presented in Table 2; this depicts the mean data for 'all rotations'. Yield differences are significant in three of the six seasons with P values of around 0.1 apparent in two further seasons. At the STAR study, year had a statistically significant impact on yield but cross season differences were not statistically significant.

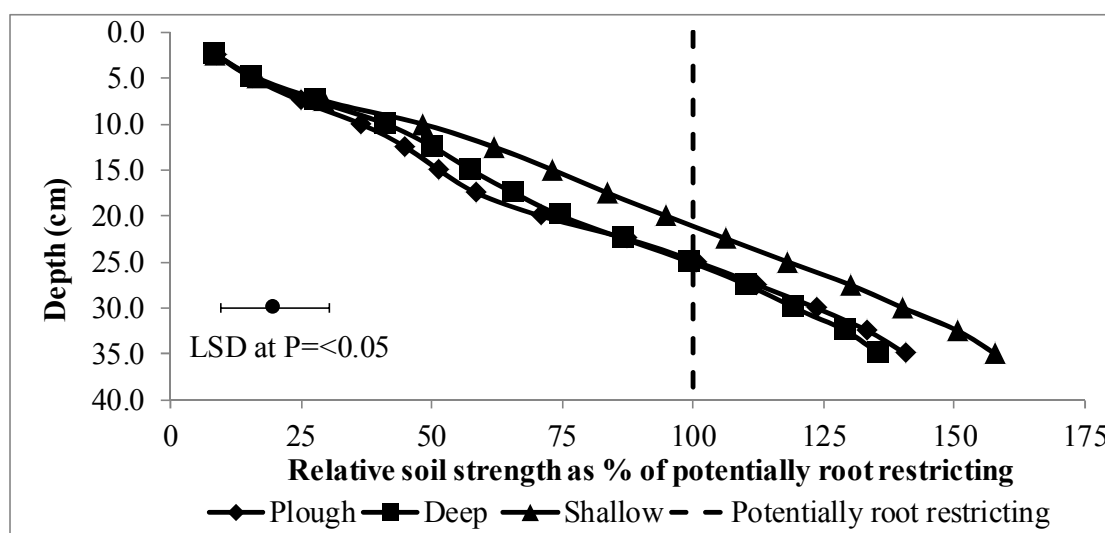

Figure 1. Mean soil strength (as a % of root restriction) with respect to tillage approach.

Table 1. Summary of STAR project rotation treatments.

Cropping	Yr 1	Yr 2	Yr 3	Yr 4	Yr 5	Yr 6	Yr 7	Yr 8	Yr 9	Yr 10	Yr 11	Yr 12
Winter	wosr	wheat	wbeans	wheat	wosr	wheat	wbeans	wheat	wosr	wheat	wbeans	wheat
Spring	sbeans	wheat	soats	wheat	sbeans	wheat	slinseed	wheat	soats	wheat	sbeans	wheat
Cont Wheat	wheat	wheat	wheat	wheat	wheat	wheat	wheat	wheat	wheat	wheat	wheat	wheat
Alt Fallow	Fallow	wheat	Fallow	wheat	Fallow	wheat	Fallow	wheat	Fallow	wheat	Fallow	wheat

Table 2. Winter wheat yield ( $t\ ha^{-1}$ ) data and tillage approach.

Tillage	Seasonal yield data ( $t\ ha^{-1}$ )						Mean yield ( $t\ ha^{-1}$ )	Yield (% of plough)
	Year 2	Year 4	Year 6	Year 8	Year 10	Year 12		
Plough	8.64	8.51	6.83	8.61	11.64	11.13	9.23	100
Deep	7.78	9.00	7.40	8.30	11.69	10.92	9.18	100
Shallow	7.52	8.80	7.32	8.01	11.62	11.60	9.14	99
Mean	7.98	8.77	7.18	8.31	11.65	11.22	-	-
LSD	0.45 ( $P<0.0001$ )	0.42 (NS) ( $P=0.14$ )	0.49 ( $P<0.05$ )	0.57 (NS) ( $P=0.11$ )	0.24 (NS) ( $P=0.69$ )	0.45 ( $P<0.01$ )	0.91 (NS) ( $P=0.98$ )	-

## Conclusions

Regardless of the statistical significance, findings suggest only small percentage yield reductions with shallow tillage (*cf.* plough systems) indicating that wheat yields are relatively robust with respect to tillage approaches assessed on this site. With regard to soil strength, the shallow tillage approach resulted in a tighter soil profile (>15 cm) compared with the plough or deep approaches although this has not resulted in any substantial yield loss in winter wheat. The authors would like to acknowledge the support of The Chadacre Agricultural Trust and The Felix Cobbold Trust for their support of the STAR project.

## References

- Schjøning, P. and Thomsen, I., 2006. Screening of reduced tillage effects on soil physical properties for a range of Danish soils. *In*: Anon. (Ed.), Tillage systems for the benefit of agriculture and the environment, 29-31 May 2006 Odense, Denmark: Nordic Agricultural Academy
- Stobart, R., Morris, N. and Fielding, H. 2017. The impact of soil management on crop yield, margin and working practices in long running UK field experiments, *Aspects of Applied Biology* **134**, *Crop Production in Southern Britain*: pp. 227-232

## Effects of Soil Tillage and Foliar Fertilization on Biomass Yield of Post-Harvest Seeded Sorghum Cultivars

B. Stipešević\*, B. Brozović, D. Jug, I. Jug, V. Vukadinović, B. Đurđević

Faculty of Agriculture in Osijek, Vladimira Preloga 1, 31000 Osijek, Croatia

\*corresponding author: [bojans@pfos.hr](mailto:bojans@pfos.hr)

### Introduction

High yields in modern agriculture are achievable due to genetic potential of crops and agrotechniques, where fertilization makes up to 50% of crop yield. Nitrogen is one of the most important nutrients used in agricultural systems and contributes strongly to the economical performance, sustainability, and improvement of cropping systems; however nitrogen use efficiency is usually reported to be lower than 50% (Newbould, 1989) and the losses of added nitrogen fertilizers can be very significant. One of the potential solutions which may contribute to reducing environmental pollution by excess nitrogen is foliar fertilizers application since the total amount of applied nutrients is significantly lower, with higher utilization ratio. Another way to reduced nitrogen pollution is the using of summer crops as catch crops in the period between cash crops (Anderson et al., 1986), thus reducing N leaching. Summer catch crops are usually grown in unfavorable weather conditions (precipitation deficiency), which requires reduce of conventional tillage systems (Stipešević et al., 2010). Therefore, the aim of this study was to determine effects of different soil tillage and foliar side-dressing cropping systems for sorghum cultivars (*Sorghum spp.*) sown in post-harvest cultivation.

### Materials and methods

The field experiments were carried out on the Family Agricultural Enterprise (FAE) "Stipešević Ivica" near Poljanci, Croatia, during summers 2015 and 2016. The soil type was the eutric brown soil, with favorable crop production properties. The preceding main crop was winter barley (*Hordeum sativum* L.). In both years, the agrotechniques for preceding crop included soil preparation by conventional soil tillage (based on autumn moldboard ploughing at 25-30 cm) and recommended fertilization (120 kg N, 100 kg P and 120 kg K per ha). Trial was set up as the split-split-plot design in four repetitions, with two levels of soil tillage, three sub-levels of side-dressing and ten sub-sub-levels of sorghum cultivar, with basic plot size for side-dressing of 2 m x 5 m. Treatments of soil tillage were as follows: MD) one passage with heavy disk harrow up to 15-20 cm, followed by two passages of light disk harrow and seedbed preparation with rotary cultivator; and SD) single passage by heavy disk harrow up to 15-20 cm, followed by seedbed preparation by rotary cultivator. Pre-seeding fertilization was omitted for post-harvest sown sorghum cultivars. Ten sorghum cultivars were used: KSH3723, KSH3724, Lemnos, Leonie, Merlin, Sammos, Santos, Sole, Tarzan and Zerberus. The seeding was performed with available cereal seeder at the depth of 1-3 cm. Sub-treatments of side-dressing were as follows: C) no-side-dressing control; B) Biological foliar fertilizer (Condi agro), with several aerobic and anaerobic microorganisms, including bacteria, actinomycetes, yeasts and mildews, in rate of 7 l ha<sup>-1</sup> in two sprayings; and M) Mineral foliar fertilizer (EcoTop Folimax) which contains both macro (N, P, K, Ca) and micro (B, Cu, Fe, Mn, Mo and Zn) nutrients, in rate of 5 l ha<sup>-1</sup> in two sprayings. Side-dressings were performed 4 and 6 weeks after the seeding in each year. Harvests were performed manually in the last week of October. The Fisher protected LSD means comparisons were performed for P=0.05 significance levels for year, soil tillage, side-dressing and their interactions.

## Results and discussion

The summer 2015 was hot, with unequal and unusual precipitation pattern; July was very dry, August and September had normal precipitation level, whereas October was extremely wet. On the other hand, the summer 2016 was slightly less hot, with very wet July, dry August, normal September and October. Both had about 300 mm of precipitations, which was sufficient for all sorghum cultivars. Soil tillage resistance (data not shown), measured after tillage operations, showed soil compaction layer on 30-35 cm depth, which is direct consequence of ploughing for many years. Applied soil tillages did not cause noticeable sub-tillage compaction. Since there was no statistical difference between soil tillage treatments, data was not shown separately (Table 1). Both foliar fertilizers treatments resulted with higher yield in comparison with control. The highest yield was recorded by cultivar Leonie, followed by Lemnos and KSH3724, whereas the lowest yield was recorded by Sammos.

Table 1. Average dry biomass yield ( $\text{kg ha}^{-1}$ ) of sorghum cultivars and applied foliar treatments, Poljanci site, years 2015 and 2016.

Cultivar	C	B	M	Cultivar mean <sup>†</sup>	Rank
KSH 3723	4894	5679	6602	5956 cde	7
KSH 3724	6534	6496	6436	6440 bc	3
Lemnos	6636	6680	7408	6878 b	2
Leonie	6844	7367	8254	7579 a	1
Merlin	5179	6018	5872	5697 def	8
Sammos	4668	5008	4936	4871 g	10
Santos	5499	6789	4861	6164 cd	4
Sole	5300	6153	6445	5975 cde	6
Tarzan	5588	5323	7405	6105 cd	5
Zerberus	5691	5288	4997	5262 fg	9
Foliars trt. mean	5683 a	6080 b	6322 b	6093	

<sup>†</sup>means labeled with the same lowercase letter for same Cultivar or Foliar side-dressing average in each Year or Means group are not statistically different at  $P > 0.05$  significance level.

## Conclusion

The present study of the effects of soil tillage and side-dressing systems on post-harvest sown sorghum cultivars in Northeastern Croatia suggests better effects with foliar fertilizers in comparison with control, regardless of used soil tillage preparation. The results indicate several cultivars (Leonie, Lemnos and KSH3724) which can be used as successful summer catch crops after winter barley.

## References

- Anderson R.L., Shanahan J.F. and Greb B.W. 1986. Effect of tillage systems on proso millet production. *Agron. J.* 78: 589-592.
- Newbould P. 1989. The use of nitrogen fertilizer in agriculture. Where do we go practically and ecologically? *Plant Soil* 115: 297-311.
- Stipešević B., Brozović B., Jug D., Stošić M., Jug I., Vukadinović V., Simić M., Mladenović-Drinić S., Toth B., Levai L. 2010. The influence of soil tillage system at germination of buckwheat, millet and sudan grass sown as post-harvest summer crops. Soil tillage-Open approach, Osijek, 09-11 September 2010. CROSTRO - *Croatian Soil Tillage Research Organisation*, 2010. 137-141.

## Estimation of available days for cultivation work: evaluation of J-Dispo tool using CHN dynamic crop model

Pascale Métais<sup>1\*</sup>, Pierre Bessard Duparc<sup>2</sup>, Robert Trochard<sup>2</sup>, Baptiste Soenen<sup>3</sup>

<sup>1</sup> ARVALIS Institut du végétal, Saint Beauzire, France

<sup>2</sup> ARVALIS Institut du végétal, La Jaillière, France

<sup>3</sup> ARVALIS Institut du végétal, Baziège, France

\* Corresponding author : [p.métais@arvalis.fr](mailto:p.métais@arvalis.fr)

### Introduction

Each cultivation work should be done according to two constraints: (i) the work should be done during a specific period, defined by other work to do (for instance, soil tillage should be done after harvest and before seeding) or crop phenologic stage to respect; (ii) during this period, only a part of these days are available, i.e. favorable to cultivation depending on climatic conditions and soil's readiness for tillage. Field's readiness results of the combination of trafficability (soil capability to support agricultural traffic without degrading soil and ecosystem) and workability (soil capability to support tillage) (Edwards *et al*, 2016; Müller *et al*, 2011). Knowing the number of available days is useful for different strategic choices like investing in tillage equipment or introducing cover crops. J-Dispo is a decision making tool designed in the 1990's in order to calculate the number of available days. In 2016, J-Dispo was reviewed and the 2016 updated version uses now the water balance model of a dynamic crop model, CHN (Soenen *et al*, 2018). CHN ability in simulating the moisture variation through the year was assessed first (Soenen *et al*, 2018). The second step is to evaluate the performance of J-Dispo in estimating the availability of days for cultivation works: it is the aim of this study.

### Materials and methods

#### *J-Dispo decision making tool*

J-dispo is a tool made to estimate available days. It uses decision rules to evaluate, for each cultivation work, if the trafficability and workability conditions are verified. These rules are based on both meteorological raw data and daily soil moisture simulations on layers 0-10 cm and 10-25 cm (Gillet, 1992). The first version used its own water balance model; the 2016 updated version uses now CHN water balance model, which provide better soil moisture simulations (Soenen *et al*, 2018).

#### *Data sets for the validation of J-Dispo*

The evaluation of the updated version of J-Dispo has been made on field assessment over 3 different sites and experimental design:

- In the region of Yvetot (Seine-Maritime, France), from 1983 to 1992, almost 30 farmers recorded the practicability of their field (mainly loamy soils), on a daily basis by assessing if a cultivation work was achievable, difficult or impossible. In this paper, J-Dispo simulations have been compared with these assessments for a ploughing during months from January to May.
- In Parisot, loamy soil, (Tarn, France), assessments of soil conditions for tillage operations have been done over 3 consecutive years from 1989 to 1991 during intercrop period, on 2 plots, one drained and the other not drained. Soil readiness notations were recorded on a scale between 1 (impracticable) and 4 (soil is ready) for the 0-10cm and 10-25cm layers of soil.
- In Montluel, loamy soil, and Confrançon, clay-loam soil, (Ain, France) during winter-spring 1989, a study of soil conditions has been carried out during intercrop period in 2 trials. Notations were made for each assessment day on soil clod behavior between fingers (related to workability) and soil bearing capacity (related to trafficability).



### *Statistical analysis of model performance*

In order to evaluate J-Dispo decision making tool, outputs of J-Dispo (2016 updated version using CHN soil humidity model) were compared to field notations. Contingency tables, which give concordance rates diagonally between observed and simulated available or unavailable days for 2 cultivation works (ploughing and shallow tillage), were built. To complete this evaluation, the model sensibility to the main soil parameters (n=10) was assessed using Morris's method.

### **Results and discussion**

J-Dispo performs well on the estimation of unavailable/risky/available days' fraction for ploughing on Yvetot region. For 41 dates measured during the 3 years trial at Parisot (20 assessments in 1989, 11 in 1990 and 10 in 1991), J-Dispo indicates adequate availability/unavailability of days in 88 percent of cases. In Confrançon, concordance rates are always higher than 74% while in Montluel they drop down to 44%. Observed unavailable days have been well predicted in Confrançon but not in Montluel, even more for shallow tillage. The model is mainly sensitive to clay soil content and percolation coefficient (proportion of rainfall that goes out of the 0-25 cm layer of soil within 24 hours).

For ploughing operation, the updated version of J-Dispo, using CHN soil humidity models gave better concordance rate than the previous J-Dispo version using its own water balance model. For shallow tillage, concordance rates are quite similar between two versions (76% with updated J-Dispo and 72% with previous version), and the updated J-Dispo gave as much false-positive as false negatives when previous version used to give almost only false-negative (consider day as unavailable when the day is available considering field notation).

All these differences may come from different causes: (i) the gap between visual assessments of soil conditions and decision rules based on moisture contents of 0-10cm and 10-20cm layers of soil, (ii) the subjective nature of field notations of soil tactile behaviour and bearing capacity, (iii) predictive performances of CHN soil humidity model... Sometimes, a threshold effect can appear with decision rules, which is not taken into account with field notations into categories. Moreover, it's important to put these results into perspective and to consider that visual and material estimations of soil conditions are subjective and may lead to introduce a bias due to individual appreciation.

### **Conclusion and perspective**

Using CHN water balance has globally improved prediction of available/unavailable days by J-Dispo. By looking at the results, J-Dispo updated version can be used as an operational tool to predict the number of available days for cultivation works. However, some improvement could be done. In the near future, a review of decision rules will be conducted on existing and new data. A better consideration of deep compaction risk is also needed. A frame to combine indicators from J-Dispo and Terranimo® (an international model focused on soil compaction due to agricultural traffic) is in project.

### *References*

- Edwards G., White D.R., Munkholm L.J., Sørensen C.G., Lamandé M., 2016. *Soil Till. Res.*, 155, 339-350.
- Gillet J.-P., 1992. Une méthode de calcul des jours disponibles. *Perspectives Agricoles*, 172, 95-98.
- Müller L., Lipiec J., Kornecki T.S., Gebhardt S., 2011. Trafficability and workability of soils. In : Springer (Eds), *Encyclopedia of Agrophysics*, 912-924.
- Soenen B., Bessard Duparc P., Laberdesque M., Piquemal B., Deswarte J.C., Bouthier A., Laurent F., Le Bris X., 2018. Piloter conjointement la fertilisation azotée et l'irrigation par le couplage d'observations sol/plante avec le modèle de culture CHN. In : Arvalis (Eds), *Phloème 2018*, 237-246

## Hydrological Evaluation of Tillage Practices in Dry-land Vineyards of Catalonia (NE Spain)

I. Pla-Sentís\*

*DMACS, Universitat de Lleida, 25198 Lleida, Spain*

\* corresponding author: [ipla@macs.udl.es](mailto:ipla@macs.udl.es)

### Introduction

Vineyards, for dry land grape wine production, are a traditional crop in the steeply sloping agricultural lands of Catalonia (NE Spain). In Catalonia, as well as in other regions of Mediterranean Europe, management of dry land vineyards has suffered great changes in the last decades. In part following EU policies, some cropped lands have been abandoned, but in others, with vineyards dedicated to production of high quality wine and cava, the cropped area has increased, with more intensive and highly mechanized agricultural systems. The removal of large volumes of soil, due to terracing and leveling with bulldozers to change the topography of slopes to facilitate water retention and mechanization, has changed the hydrological properties of the soils and the natural drainage of the lands, affecting the soil water regime, main responsible of wine production and quality. Tillage has been the traditional practice to resolve several, perceived, in-field problems: weed control, and the loosening of compacted and crusted surface soils to increase rain water infiltration, to reduce losses of water by evaporation and to improve the rooting depth of vines. The work reported here presents the actual and potential effects of these changes in land management and tillage practices on the soil water regime in two representative areas (Penedés and Priorat) of dry land vineyards in Catalonia.

### Material and methods

The study areas were located in commercial fields representative of two of the regions (Penedés and Priorat) of Catalonia, where the area under vineyards for high quality wine and cava production has increased over the last 20 years. Accompanying this large increase in vine area has been a drastic change from traditional practices, including the introduction of new varieties. The studies included evaluations of soil and land hydrological properties and processes, through field and laboratory measurements and field monitoring. Those evaluations were integrated, using a model (SOMORE) (Pla, 2002) based on hydrological processes, to deduce the potential effects on the soil moisture regime affecting the quantity and quality of grape and wine production, under changing scenarios of climate, land management and tillage practices. In both regions the climate is Mediterranean semiarid, with an average annual rainfall of approximately 600 mm, very irregularly distributed, and with large variability from one year to another. To proceed to a fully mechanized system there is a need for heavy land leveling (Penedés) or terracing operations (Priorat), with drastic changes in the surface drainage network and on the effective soil rooting depth and surface soil properties. In the Penedés region, the topography of the area is strongly undulated, with cropped fields on 4-20% slopes, in soils formed from calcareous marls, inherently low in organic matter, high in silt (40-60%) and very rich in calcium carbonate. In the Priorat region, the topography is mountainous with cropped areas on 10-80 % slopes. Soils are developed on slates and schist, are not calcareous, slightly acid, very poor in organic matter, and very stony (20-60% by volume), sometimes with a gravelly pavement in the soil surface.

**Results and discussion**

The results show that the the soil water regime under the different and variable climate, soils, land management and tillage practices of the study sites could be reasonably well predicted with the adequate simulation of the hydrological processes, based on climate information and on changes in the soil water balance derived from the soil hydrological properties properly evaluated under field conditions. It may be observed (Figure 1) that the recent changes in land and crop management, including tillage practices, in dry-land vineyards for wine production in the Mediterranean regions of NE Spain have mainly affected the hydrology of the cropped lands.

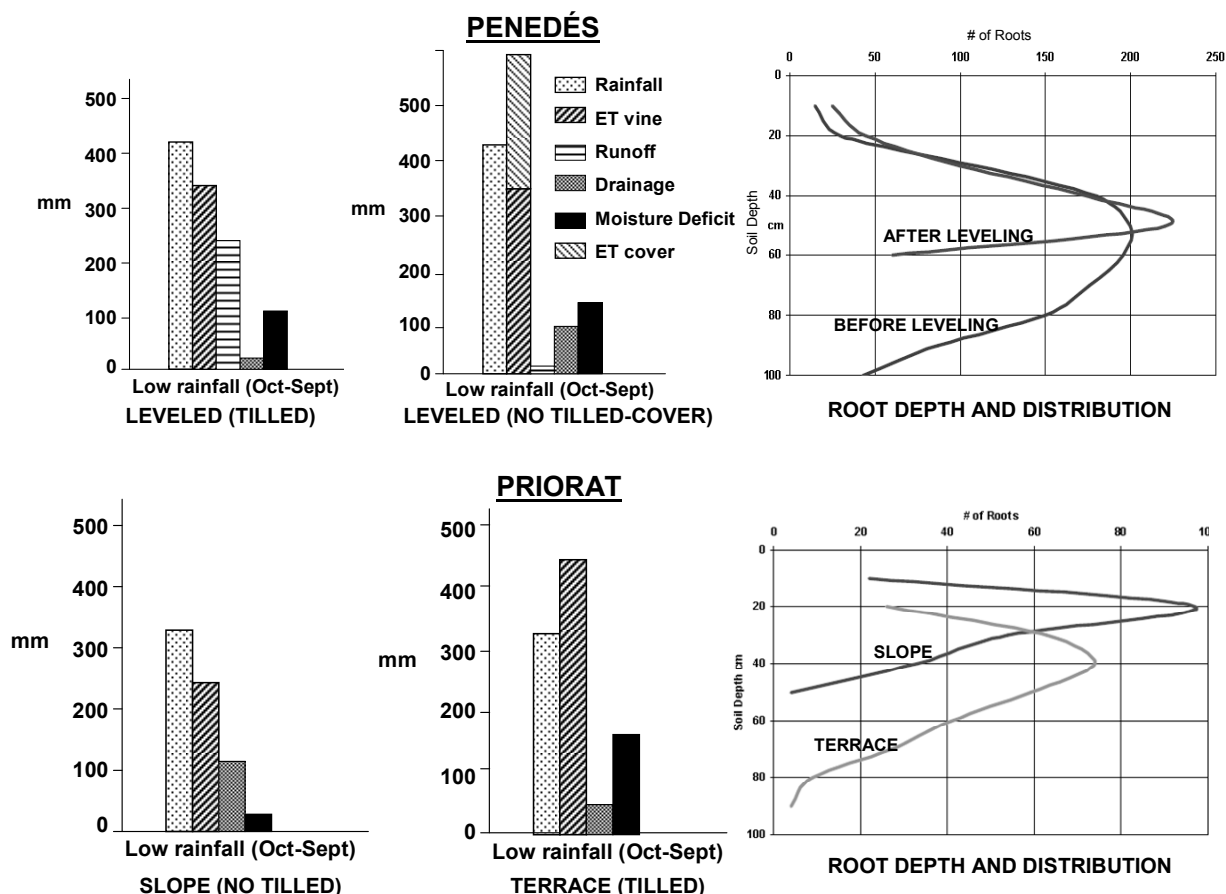

Figure 1: Rainfall and soil water balance components in rain-fed vineyards of the Penedés and Priorat regions in years with low rainfall (return period: 5 years) under different tilled and non tilled land conditions

**Conclusion**

It may be concluded that an analysis, based on appropriate *in situ* evaluations and modeling of climate characteristics and of soil hydrological properties and processes, may be very useful, and even indispensable, for an adequate planning of site specific, more sustainable, land management and tillage practices leading to a more regular production of grapes and high quality wines.

*References.*

Pla, I., 2002. Hydrological approach to soil and water conservation.. In:J.L.Rubio et al. (ed.) Man and Soil at the Third Millenium. Geoforma Ed. Logroño(Spain). 65-87

## Evaluation of a Harvest Logistics Fleet Optimisation Tool as a Soil Compaction Mitigation Strategy

Andrés Villa-Henriksen<sup>\*1,2</sup>, Nick Skou-Nielsen<sup>1</sup>, Alevtina Evgrafova<sup>1</sup>, Claus A.G. Sørensen<sup>2</sup>, Ole Green<sup>1,3</sup>, Gareth T.C. Edwards<sup>1</sup>

<sup>1</sup> *Agro Intelligence ApS, Agro Food Park 13, DK-8200 Aarhus, Denmark*

<sup>2</sup> *Aarhus University – Engineering, Inge Lehmanns Gade 10, DK-8000 Aarhus, Denmark*

<sup>3</sup> *Aarhus University – Agroecology, Blichers Allé 20, DK-8830 Tjele, Denmark*

\* corresponding author: [avh@eng.au.dk](mailto:avh@eng.au.dk)

### Introduction

Larger and heavier machines are operating in the fields as a response to the necessity of producing more with lower unit production costs. This tendency in modern agriculture has resulted in poor physical soil properties within many arable fields, which can also have negative effects on the crop yield (Lipiec & Hatano, 2003). There is, therefore, the need of reducing the intense heavy trafficking in the field.

Many soil compaction mitigation strategies have been proposed to reduce the negative effects of traffic intensity (Chamen et al., 2003): (i) selection and suitable settings of appropriate equipment, e.g. on-land ploughing or wider tyres, or low tyre inflation pressure; (ii) adequate soil management practices, e.g. improve soil drainage, increase soil organic matter or perform soil readiness evaluation before operating; (iii) selection of suitable crops and crop rotation schemes, e.g. introduce cover crops or intercropping; (iv) or by shifting to preventive field management practices that reduce the traffic intensity, e.g. conservation tillage, controlled traffic farming or optimised in-field route planning (ORP). Regarding field management strategies, some measures require acquiring new machinery, e.g. specialised seeding equipment for no-till farming. Whereas ORP can potentially reduce traffic intensity in multiple operations (Edwards et al., 2017) and does not require major investments as it can be applied with the existing machine fleet of the farm. Therefore, ORP is an important strategy to be considered, which may also reduce operational costs and time for the benefit of the farmer.

A harvest logistics fleet optimisation tool, i.e. an ORP tool for harvesting operations, has been used in this study to evaluate its effectiveness in reducing the traffic intensity. It is hypothesised that the fleet optimisation tool is able to reduce the traffic intensity in the field, and, thus, be used as a valid soil compaction mitigation strategy.

### Material and methods

A harvest logistics fleet optimisation tool that co-ordinately plans and optimises the route for each of the vehicles involved in the operation has been employed in order to simulate harvesting operations in a set of fields, where the actual harvest operations have been recorded. In this manner the traffic intensity of the two operations, i.e. simulated by the ORP and recorded, has been compared.

For calculating the traffic intensity, each field has been divided into a grid, where for each cell the number of passes, the accumulated vehicle weight, and maximum weight for specific times, have been calculated. The data set consists of 6 fields that were harvested in Havndal in Jutland, Denmark, in August and September of 2017. The vehicles involved in the operation were one combine harvester assisted by one tractor with grain cart.

## Results and discussion

The harvest logistics tool was able to reduce the number of passes per area (Figure 1). The accumulated vehicle weight as well as the maximum weight were also reduced. The tool confines the majority of the non-working traffic to the headlands, reducing consequently the traffic intensity in the main field area, where the crop is yielding the most. The in-field idle times of the grain carts were also considerably reduced, meaning an effective reduction of accumulated vehicle weight per area. This reduction in traffic intensity can potentially have a positive effect in the yield of a field over time.

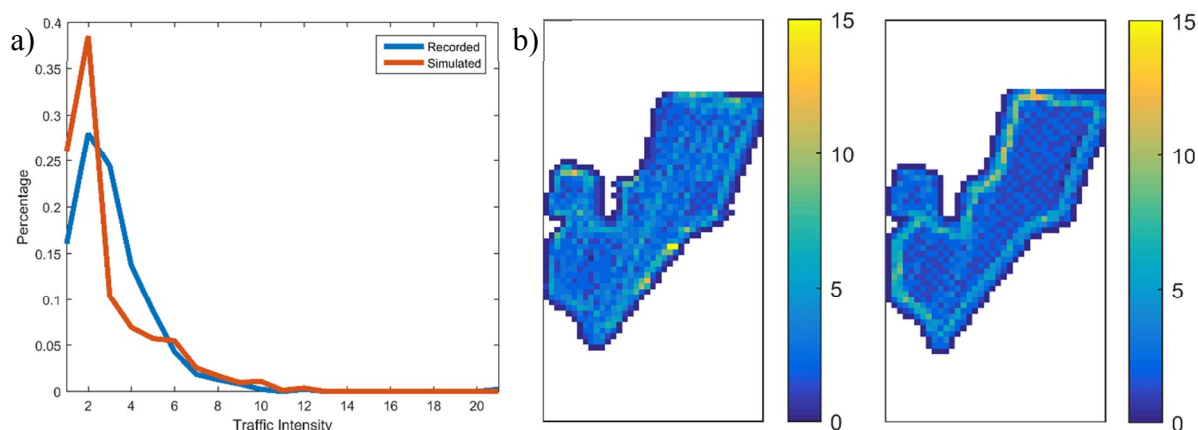

Figure 1a: Traffic intensity per area shown as percentage of passes.

Figure 1b: Number of passes distribution in a field of the recorded (left) and the simulated (right) operations.

Even though the tool is not directly intended for traffic intensity reduction, it is a viable strategy for soil compaction mitigation in harvest operations, which can be easily complemented with other measures. Furthermore, ORP can be combined with e.g. conservation or no-tillage practices, which adds an extra element to the farm strategy for reducing soil compaction. It is though still necessary to determine the extent of ORP as a measure for reducing traffic intensity in other operations as it is still in its early development stages and application in field operations.

## Conclusion

Besides contributing to higher operations efficiency, the harvest logistic fleet optimisation tool can also be considered a valid soil compaction mitigation strategy as it reduces the traffic intensity in the field, especially in the most productive field area.

## References

- Chamen, T., Alakukku, L., Pires, S., Sommer, C., Spoor, G., Tjink, F., Weisskopf, P. 2003. Prevention strategies for field traffic-induced subsoil compaction: a review. Part 2. Equipment and field practices. *Soil Till. Res.*, 73, 161-174.
- Edwards, G.T.C., Hinge, J., Skou-Nielsen, N., Villa-Henriksen, A., Sørensen, C.A.G., Green, O. 2017. Route planning evaluation of a prototype optimised infield route planner for neutral material flow agricultural operations. *Biosyst. Eng.* 153, 149-157.
- Lipiec, J., Hatano, R. 2003. Quantification of compaction effects on soil physical properties and crop growth. *Geoderma* 116 (1), 107-136.

## Intensified Mechanization for Improved Soil Productivity and Fertility in Paddy-dryland Crop Rotations

\**Ruiyin He*<sup>1</sup>, *Xinxin Chen*<sup>1</sup>, *Linan He*<sup>1</sup>, *Kerun Sun*<sup>2</sup>, *Qishuo Ding*<sup>1</sup>

\*Corresponding author: [ryhe@njau.edu.cn](mailto:ryhe@njau.edu.cn)

<sup>1</sup> Nanjing Agricultural University, Nanjing 210031, P.R.China

<sup>2</sup> Yinhua Chunxiang Agricultural Machinery, Lianyungang, Jiangsu, P.R.China

### Abstract

**Background and justification** In temperate regions, soil use is constrained by insufficient annual heat and radiation. Historically evolved paddy-dryland cropping systems in China, e.g. rice-wheat (R-W) or rice-canola rotations were proved effective in utilizing the limited natural resources and providing satisfactorily high crop yield. Paddy-dryland cropping systems were also found in other places of the world. Land output from rice-wheat rotation in the middle-lower reaches of the Yangtze River region in China amounted to 18 t/ha<sup>-1</sup> (Liu *et al.*, 2016). Estimated yield potential in this region was 21 t/ha<sup>-1</sup>. The pursuit of maximized profit is now appealing to the scaled commercial farms in order to exploit every possible means for improved output, including precision management on soil and crops; power machineries as well as larger implements for higher field capacity. This intensification of the farming systems has dramatically increased the intensity of field operations, presenting critical implications on the soil health and fertility. Apart from new technologies (e.g. short duration crop cultivation), the constraints from natural resources could not be resolved without intensified mechanization. The lifespan of R-W would surpass a calendar year by 27 days. This could only be solved with mechanized seedling nursery and transplanting, one-pass field operations etc. Rice seedling nursery and transplanting has pushed the paddy growing season 25 days forward. Intensified mechanization in R-W rotation was found effective for handling the excessive crop residues or seedbed preparation to facilitate speedy transition between the two crop seasons.

**Objective** Intensified mechanization could be applied as an asset safeguarding soil productivity and fertility, leading to improved sustainability of the farming system under paddy-dryland rotations.

**Methods** Literatures were reviewed and commercially available agricultural machineries were analyzed to illustrate the principles, products and practices which have been proposed to facilitate improved soil and crop residue management for soil fertility, crop care and residue management.

**Results and discussion** Today's emphasis on resource efficiency has largely increased the intensity of field operations. Scaled commercial farms have introduced more field traffic for split dressing or chemical spraying. Soil disturbance by the intensified field operations was found to be seriously alarming. Mechanized operations within paddy season alone were thirteen times more than expected. Despite the high land output, soil use under intensified mechanization is unsustainable with regard to soil health and fertility. It was observed that serious problems have already arisen, including totally damaged soil structure, degraded soil fertility, low NUE and WUE, excessive expenditure of energy and resource inputs. The complete burial of crop straw by ploughing also consumes a large amount of fuel, stimulating greenhouse gas emission. Quality control on finished seedbed has significantly increased

machinery's field hours. Forced drilling in wet soils totally ruined soil structures. Excessive straw (10,000 Kg/ha) intervention, heavy reliance on water for rice, as low as 30% of NUE, and identifiable root restrictions by the shallow soil layer (Chen *et al.*, 2017) are all making today's intensified mechanization no longer sustainable.

**Conclusion** Consolidating the positive role intensified mechanization plays and mitigating the negative effects of the current production system for intensification and sustainability are important issues for both soil scientists and engineers. Opportunities include:

1. Simplified cultivation technologies: In certain situations, avoiding machinery over-working in structurally vulnerable soils can be realized with simplified cultivation technologies, e.g. direct seeding of rice, no-till and seedling broadcasting, no-till drilling or no-till transplanting. Alternative approaches can also be made with renovated field operations, e.g. ditch-burial and straw incorporation, mechanized relay-seeding or ridge tillage.
2. Precision farming: The greatest opportunity for modern agriculture is the introduction of machineries with GPS and GIS merged guidance, providing the most possible precision care on both soil and crops. Precision management on soil, crop and straw is key for improved soil fertility. Advanced machinery operational pattern, e.g., controlled traffic farming or strategic tillage, can also be modified and incorporated into mechanized paddy-dryland rotations. In addition, precision sowing and transplanting has guaranteed a more uniform stand, leading to maximized expression of soil fertility. Mechanized precision placement of fertilizer and hill-seeding have also increased NUE by 50% (Pan *et al.*, 2017).
3. One-pass operation designs: One-pass operation was proved an effective measure in counteracting the negative effects of intensified mechanization. Rotary-till straw incorporation provides a one-pass-and-over solution in timeliness shifting from rice to wheat in wet, heavy-residue and structurally vulnerable soils. This tillage system was widely used and welcomed by farmers in China, Japan and Korea. Many more options of one-pass mechanized operations are awaiting future research for enhanced land output while maintaining soil health and fertility.
4. Light-weight and special chassis design: As field operations in wet or saturated soils are un-avoidable, reduced field trafficking effects can be achieved not only through agronomic reform, but also with light-weight and special chassis designs for agricultural machineries. Light-weight design is particularly promising in the paddy-dryland cropping systems for modern agriculture.

## References

- Liu X., Xu S., Zhang, J. et al., 2016. Effect of continuous reduction of nitrogen application to a rice-wheat rotation system in the middle-lower Yangtze River region. *Field Crop. Res.*, 196:348-356.
- Chen X., Ding Q., Blaszkiewicz Z. et al, 2017. Phenotyping for the dynamics of field wheat root system architecture. *Sci. Rep.*, doi:10.1038/srep37649.
- Pan S., Wen X., Wang Z., 2017. Benefits of mechanized deep placement of nitrogen fertilizer in direct-seeded rice in South China. *Field Crop. Res.*, 203:139-149.



## Controlled Traffic Farming (CTF) Reduces Soil Emissions, Saves Nitrogen, and Reduces other Environmental Impacts of Mechanised Cropping.

**C.A. Bluett<sup>1</sup>, \*J.N.Tullberg<sup>1,2</sup>, D.L.Antille<sup>1,2</sup>, C. Scheer<sup>3</sup>**

<sup>1</sup> *Australian Controlled Traffic Farming Association, HRZ Consulting, Buninyong 3357, Vic.*

<sup>2</sup> *University of Southern Queensland, National Centre for Engineering in Agriculture, Toowoomba 4350, Qld.*

<sup>3</sup> *Queensland University of Technology, Inst. for Future Environments, Brisbane 4000, Qld.*

\* Corresponding author: [jtullb@bigpond.net.au](mailto:jtullb@bigpond.net.au)

### Introduction

Controlled traffic farming (CTF) is a cropping system with all load-bearing wheels of field equipment restricted to permanent traffic lanes. This leaves most field area untrafficked, to be managed for optimal crop production. The permanent traffic lanes can be laid out for optimal drainage and logistics and managed for optimum trafficability and field access. The ideas behind CTF can be traced to the 19<sup>th</sup> century, but despite substantial R&D effort in many countries from the 1960s onwards, large-scale commercial application has occurred very slowly. This has changed since the 1990s in Australia, with a steadily increasing proportion of grain (now  $\approx 28\%$ ) being produced in CTF systems.

Important factors in this increase have been:-

- Research and on-farm demonstration of CTF, showing its benefits.
- A series of CTF conferences organised by ACTFA and its predecessors.
- Large-scale adoption of no-till, for which CTF is a natural companion.
- The development of RTK autosteer to provide the necessary precise guidance.

Farmer adoption has been driven largely by recognition of the on-farm productivity and economic benefits, but valuable promotion assistance has come from “environmental” organisations (e.g. “Landcare”) concerned with off-farm effects at catchment scale, and with coastal eutrophication. Encouragement of CTF adoption for environmental reasons might increase further now the significant emission reductions from CTF have been demonstrated.

### Emission impacts of CTF

Emissions were monitored using standard replicated chamber procedures (14 times/crop) at 6 sites over 3 years in rainfed grain crops in Queensland, Victoria and Western Australia. Sites included light and heavy soils, and growing season rainfalls ranging from 96 to 522mm. This work demonstrated that nitrous oxide (N<sub>2</sub>O) emissions from random-trafficked soil were consistently greater (more than twice, on average) than those of neighbouring non-trafficked soil, and that non-trafficked soil absorbed  $\approx 1.5 \text{ g ha}^{-1} \text{ d}^{-1}$  more methane (Tullberg et al. 2018).

The best Australian CTF systems reduce permanent traffic lanes to <10% of field area (commonly 12-15%), but non-CTF systems traffic  $\approx 50\%$  of field area. CTF should therefore reduce soil emissions by 30-55%, and emissions might be further reduced by avoiding N input to traffic lanes. More work is required, but a first estimate suggests that CTF should reduce annual soil emissions from Australian grain by 90 –150 kg ha<sup>-1</sup> CO<sub>2</sub>-e. This represents 20 - 30% of emissions of these low-input dryland cropping systems. The emission effects of CTF are likely to be greater in wetter environments with higher N fertiliser inputs.

These reductions in global warming potential take no account of the life-cycle emission effects of CTF systems, such as increased yields from more available water and reduced denitrification loss, reduced N fertiliser input, and the 25-35% reduction in fuel use.



### **Mechanisms.**

The largest soil pores are the major pathway for water and air movement, but they are also the least able to resist mechanical loads, and hence the first to be damaged when soil bulk density is increased by traffic compaction. Reduced pore volume and water transmission ensure that the upper profile of compacted soil becomes waterlogged more rapidly during rainfall events, and remains waterlogged for longer afterwards. Compacted soil thus provides the semi-anaerobic conditions conducive to denitrification and emissions when nitrate is available.

### **Other Environmental Impacts**

Loss of transmission pores obviously reduces infiltration rates. Multi-year CTF trials in Australia and China have demonstrated large reductions in run-off and off-site movement of soil, nutrients and agricultural chemicals. Compaction also reduces yield by inhibiting the ability of roots to fully explore the soil profile, an effect confirmed in many yield comparisons between conventional and CTF production.

Less obviously, wheel traffic compaction damages smaller storage pores, reducing available water capacity (McHugh et al. 2009). Compaction has also been shown to have large negative effects on soil biota, especially beneficial organisms. Whether a direct physical effect or a consequence of restricted aeration, the disease-suppressive capacity of CTF soil has been noted as a reason for use of permanent beds in horticultural and sugarcane production.

### **Conclusion.**

Soil compaction is a serious issue in most agricultural systems, occurring almost instantly under heavy load but ameliorating only slowly without deep tillage. The outcome is almost universal soil compaction in non-CTF systems, often extending well below normal tillage depths. This paper has summarised some of the negative environmental effects of compaction, but the economic and environmental costs of creating compaction are also important.

Compacting agricultural soil requires substantial energy. This can be observed as motion resistance to equipment movement, and it represents the largest single component of the mechanical energy (i.e. fuel) cost of no-till cropping. It is this energy that is dissipated in reducing the porosity, connectivity, available water capacity, health and productivity of trafficked soil. Travelling only on the permanent lanes of CTF substantially overcomes this problem, and also provides more timely access to fields.

Both research and on-farm practice have confirmed that CTF will normally increase crop yields and reduce costs, while overcoming some of agriculture's most significant environmental issues. Many Australian farmers can also confirm that it makes farming easier, providing system benefits in timeliness, weed management and crop uniformity. When CTF adoption costs are small – with planning – it is surprising that it is so rarely mentioned in the context of the soil-related production and environmental problems faced by farmers.

### **References**

- Tullberg, J.N., Antille D.L., Bluett, C.A., Eberhard, J., Scheer, C. (2018) Controlled traffic farming effects on soil emissions of nitrous oxide and methane. *Soil & Tillage Research* 176: 18–25
- McHugh, A. D., Tullberg, J. N., Freebairn, D. M. (2009). Controlled traffic farming restores soil structure. *Soil and Tillage Research* 104: 164-172.
- Tullberg, J. N., Yule, D. F., McGarry, D. (2007). Controlled traffic farming – From research to adoption in Australia. *Soil and Tillage Research* 97: 272–281.

## **A new soil spectral index to assess effect of soil tillage on soil water content**

I. Soltani<sup>\*</sup>, Y. Fouad, D. Michot, P. Breger, R. Dubois, P. Pichelin and C. Cudennec.

UMR SAS, AGROCAMPUS OUEST, INRA 35000, Rennes, France.

\* Corresponding author: [ines.soltani@agrocampus-ouest.fr](mailto:ines.soltani@agrocampus-ouest.fr)

Characterization of soil hydrodynamic properties is important for assessing soil water regime. *Ex-situ* measurements are costly and time consuming. Numerous studies recently demonstrated that reflectance spectroscopy can give a rapid estimation of several soil properties including soil water content (SWC). In this research study, we evaluate the ability of near-infrared spectroscopy (NIRS) to assess soil tillage impacts on SWC. The study was carried out on silty textured soil samples with  $11.9 \text{ gkg}^{-1}$  of organic carbon content and pHs of 5–6.5. Undisturbed soil blocks were collected from an experimental station located in Brittany, France. In 2012, the field was designed in a split-plot with two tillage practices (conventional and shallow tillage). Six undisturbed soil blocks were sampled from each depths (0- 15 cm and 15-25 cm) and each tillage practice. Soil sampling was conducted at two different dates: before starting the treatment (2012) and after 5 years of tillage application (2015). From each soil block, four aggregates with 3-4 cm diameter by 5-6 cm height were collected. The whole aggregates were set at different moisture contents (10 matric potentials), from saturation up to permanent wilting point ( $pF=4.2$ ). At given pressure head, soil samples were scanned in triplicate to acquire reflectance spectra between 400 nm and 2500 nm using a handheld spectroradiometer (ASD Fieldspec®). Reflectance spectra were converted to continuum removal to highlight the absorption features of soil samples. Then, we have focused on absorption band near 1920 nm, which is linked to combination vibrations of water. We defined a new index based on the full width at half maximum (FWHM) of this band. Our results showed a linear relationship between this NIR index and volumetric water content ( $R^2>0.9$ ), whatever soil aggregate. Moreover, our results showed that the parameter of this linear relationship were correlated with soil tillage and depth. Overall, our findings indicate that these parameters offer a new way to study agricultural practices impacts on hydrodynamic properties of soils.

**Keywords:** NIR index, NIRS, continuum removal, water retention, tillage.

## Study on Cloud-based Research platform for the Smart Greenhouse farming

Jeong Hyun Baek<sup>1</sup>, Pyoung Woo Yang<sup>1</sup>, Youngsin Hong<sup>1</sup>, Hyun Dong Lee<sup>1</sup>, Sang Cheol Kim<sup>1</sup>, and Jae Su Lee<sup>1\*</sup>

<sup>1</sup>Dept. of Agricultural Engineering, National Institute of Agricultural Sciences, RDA, Jeonju, 54875, Korea

\*corresponding author: [butiman@korea.kr](mailto:butiman@korea.kr)

### Introduction

The current domestic and international agricultural fields are undergoing various changes such as aging populations, a growing farmer population, rapid climate changes, and limited cultivation area. In order to address these changes, there is increasing interest in the smart greenhouse farming as to improve crop production and work efficiency through data collection and analysis (Baek 2014). However, the services applied to smart greenhouse are limited to on-site data monitoring for sensors and simple control management for actuators (Lee, 2016). This study proposes a smart greenhouse research platform that integrates and analyzes various data collected by sensors and actuators. Using common modules, the platform can provide a range of services promptly.

### Materials and methods

Data were collected from the smart greenhouse test bed created by the Rural Development Administration (RDA), which located in Jeonju, Jeollabuk-do. Tomatoes and strawberries were grown in the hydroponic soilless system. Temperature and humidity were 15 ~ 24°C and 8 ~ 20°C, 40 ~ 65% and 35 ~ 60%, respectively. EC were 2.5 dS/m and 1.0 dS/m, respectively. pH were 5.5 pH and 5.8 pH, respectively. Common modules consist of five categories: greenhouse environment data collection and management, crop growth, data analysis method, and operating platform. The platform provides a service that operates the five categories. In addition, considering the openness of the smart greenhouse operation platform and utilization of information service, a cloud-based research platform design that covers six modules for each function was proposed. In order to provide various smart greenhouse service research platforms, infrastructure is powered by OpenStack.

### Results and discussion

Figure 1 shows a common module that assists farmers to analyze, manage, and control information through the collection of various greenhouse environmental data. The data management infrastructure module stores and manages regular and irregular data of the smart greenhouse. The control and management infrastructure module integrates control of various indoor controllers through a complex environmental controller, using a proper crop environment model.

The collected various greenhouse environmental data was analyzed according to six common modules as shown in Figure 1. The design helps farmers manage and control information for the farm. Specifically, the data management infrastructure module stores and manages structured and unstructured data of the smart greenhouse. The control and management infrastructure module integrates control of various operators through an integrated environment controller, using a proper crop growth model and updating a growth model. The crop model management infrastructure module manages the results of the analysis using the

machine learning and artificial intelligence platform provided by the cloud according to the data processing method. The farm management model sets the environment of the smart greenhouse based on the inner environment control predictive model linked with the collected data. The knowledge based expert system provides the results analyzed in the smart greenhouse platform and the decision making support service through the agricultural experts. The farmers-oriented dashboard provides visualization services to the farmers through the web platform, such as the growth of crops, environment and control, and decision-making information analyzed through the cloud-based research platform.

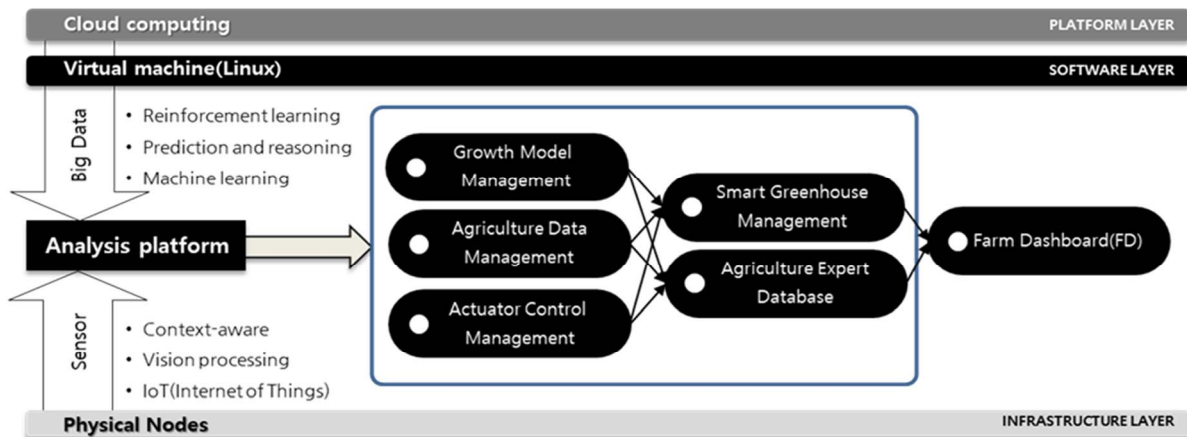

Figure 1: Platform modules for the design of Korean smart greenhouse

## Conclusion

Despite the complexity of the environmental control factors and the inadequacy of data analysis, the Korean smart greenhouse farming research has been developed for horticulture crops such as tomatoes and chrysanthemums since 2014 (RDA, 2016). A cloud-based smart greenhouse research platform is expected to accelerate the development of crop growth models and the provision of farm services. The cloud platform provides a unified environment for farm data collection and analysis. Therefore, smart greenhouse farmers will have access to a variety of greenhouse crop related services and greenhouse management information services.

## Acknowledgements

*This study was carried out with the support of "Cooperative Research Program for Agricultural Science & Technology Development (Project No.01295301)", Rural Development Administration, Republic of Korea*

## References

- Baek, J.H., and H.L. Lee. 2014. Design and implementation of crop-environmental control cloud systems based on growth patterns. The Korean Institute of Information Scientists and Engineers, Database Society Journal, 30(2):57-66 (in Korean).
- Lee, J.S., Y.G. Hong, G.H. Kim, D.H. Lee, S.R. Han, and D.H. Im. 2016. A study on development of cloud system for the smart greenhouse automatic control. The Korean Institute of Communications and Information Sciences, 19 Nov. 2016 Fall Conference. 61:559-560 (in Korean).
- Rural Development Administration (RDA), 2016, Big-data utilization for smart farm proper management (Tomato) p.66-72 (in Korean).

## Evaluation of Data Reliability for the Application of IoT (Internet of Things) Technology in Smart Greenhouse

Jae Su Lee<sup>1</sup>, Pyoung Woo Yang<sup>1</sup>, Youngsin Hong<sup>1</sup>, Hyun Dong Lee<sup>1</sup>, Sang Cheol Kim and Jeong Hyun Baek<sup>1\*</sup>

<sup>1</sup> Dept. of Agricultural Engineering, National Institute of Agricultural Sciences, RDA, Jeonju, 54875, Korea

\*Corresponding author: [butterfy@korea.kr](mailto:butterfy@korea.kr)

### Introduction

Recently, advanced technology has been developed into smart farms as intelligence information agriculture by combining artificial intelligence (AI) with ICBM (IoT, Cloud, Bigdata, and Mobile) technology, which are major trends of the fourth industrial revolution. Wireless sensor networks (WSN) are becoming increasingly important as technologies become more sophisticated due to the Internet of Things (IoT) and large-scale WSN deployments (Olasupo and Olasupo, 2017). WSN are used in smart farming in that information can be collected and automatically controlled (Hong *et al.*, 2017). In Korea, information and communication technology (ICT) is actively utilized in the development and research of the next generation Korean smart farm model. Although there was an attempt to apply wireless communication technology to the conservatory in the past, the majority of greenhouse sensors, screens, heat insulation and crops are currently using wire communication because of the lack of communication and difficulty in transmitting and receiving serious communication shields and materials. Therefore, in this study, wireless data transmission test was conducted to establish a wireless communication infrastructure to replace wired communication sensors in smart greenhouse with Internet (IoT) devices.

### Materials and methods

To test the wireless data transmission in the smart greenhouse, the Internet communication device (PLM101, PLNetworks, Korea) using LoRa module (SKT, Korea) with 900 Mhz and 2.4 GHz bandwidth was used. The test device has seven measuring instruments capable of testing three points at a height of 75 cm on a full 2 m stand. The smart greenhouse was a three bay greenhouse (width 21 m x height 4 m x length 80 m). In total, 90 measurements were taken for 15 minutes with one measurement per 10 seconds at 7 points (3 points per height, 21 points for 1 repetition) at a time interval of 3 m in width direction. The signal strength obtained by the data wireless transmission test is expressed as a received signal strength indicator (RSSI), which is not considered to account for the gain or loss of the antenna in the receiver by the number of inputs received from the receiver. The signal strength data of 168 points were collected and mapped in seven points in the width direction, eight points in the length direction and three points in the height direction in the smart greenhouse.

### Results and discussion

As a result of monitoring 900 MHz and 2.4 GHz receive sensitivity levels, the average receive sensitivity levels of 169 points in total were -62.6 dBm and -52.3 dBm, respectively in Figure 1 and 2. A sufficient receive sensitivity level was secured compared to the receive sensitivity of -130 dBm and -110 dBm for each radio frequency (RF) module used. The average reception level was -60.6 dBm, -49.9 dBm, respectively, and the receive sensitivity level was measured in the order of -65.1 dBm and -55.3 dBm in the lower level 60 cm, respectively. When the transmitting node is installed inside the greenhouse, communication is possible up

to a radius of about 200 m when the receive sensitivity level and the sensitivity of the receiving node are considered at the receiving node position.

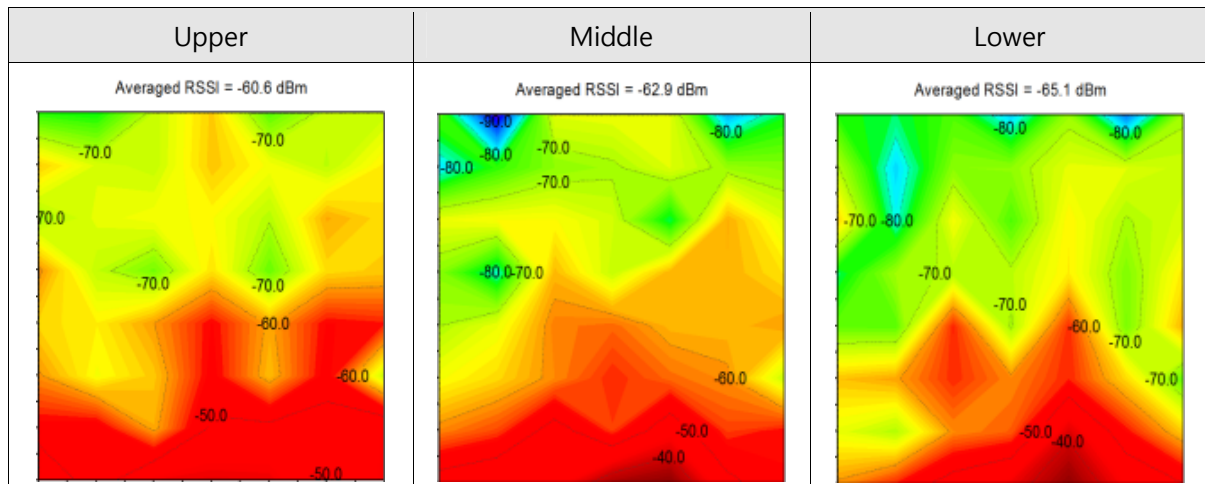

Figure 1: 900MHz receive sensitivity level by height

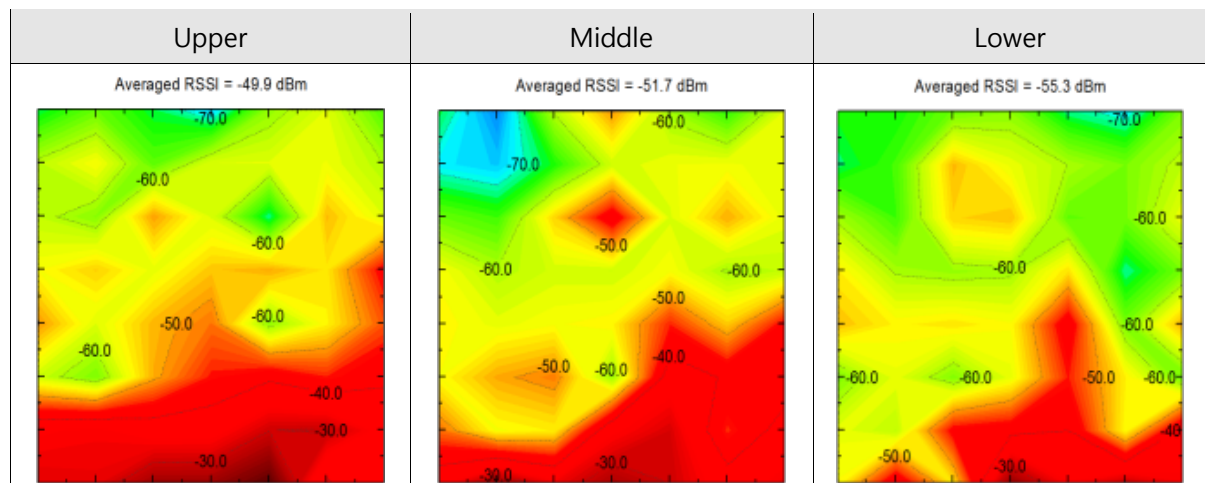

Figure 2: 2.4GHz receive sensitivity level by height

**Conclusion**

As a whole, it was found that there was no influence of the insulation or screen, and the reception level became higher as the distance from the receiving module increased. It is expected to provide reliability of sensors and actuators to which the IoT technology is applied for the establishment of wireless communication infrastructure in smart greenhouse.

**Acknowledgements**

*This study was carried out with the support of "Cooperative Research Program for Agricultural Science & Technology Development (Project No.01295301)", Rural Development Administration, Republic of Korea*

*References*

Olasupo, T. O. and Olasupo, K. O. 2017. Investigation of factors that determine the performance of wireless sensor systems for large-scale on demand deployment. *Universal Journal of Communications and Network*. 5(1):1-22.

Hong, Zhu., Li Shuang, Zheng Limin, and Yang Lu. 2017. Modeling and validation on path loss of WSN in pig breeding farm. *Transactions of the Chinese society of agricultural engineering*. 33(2):205-211.



## Evaluation of two methods measuring soil CO<sub>2</sub> emission in a tillage experiment

M. Dencső<sup>1</sup>, E. Tóth<sup>1\*</sup>, Á. Horel<sup>1</sup>, I. Potyó<sup>1</sup>, M. Birkás<sup>2</sup>, Gy. Gelybó<sup>1</sup>

<sup>1</sup> Centre for Agricultural Research, Hungarian Academy of Sciences, Martonvásár, Hungary

<sup>2</sup> Institute of Crop Production, Szent István University, Gödöllő, Hungary

\* corresponding author: [eszter.toth@agrar.mta.hu](mailto:eszter.toth@agrar.mta.hu)

### Introduction

Carbon-dioxide (CO<sub>2</sub>), an important greenhouse gas, plays a crucial role in formation of Earth's climate and soil CO<sub>2</sub> emission or soil respiration (Rs) is a significant element of the carbon cycle (Grace, 2004; Xu & Shang, 2017). Hence it is essential to develop and use adequate and accurate methods to determine the underlying causes of this phenomenon. Although the first measurements of Rs started more than 100 years ago, up till now there is many varieties of methods for quantifying soil CO<sub>2</sub> emission. There are several measurement techniques, from in situ measurements to laboratory analyses (Janssens et al., 2000; Schrier-Uijl et al., 2010; Jassal et al., 2012; Christiansen et al., 2015). Experiments using different methods for determining Rs are quite rare, especially under field conditions because it increases the costs. This paper presents the comparison of two different measuring techniques of Rs, using the techniques parallel during the growing season of 2017 in a tillage experiment.

### Material and method

Measurements were carried out in 2017 (and are continued in 2018 as well) in a long-term tillage treatment experiment. The experiment was set up on loamy chernozem soil in 2002 at Józsefmajor Experimental and Training Farm, in northeast Hungary (47° 41' 31.7" N 19° 36' 36.1" E, 110 m a.s.l.). Winter oat and soybean were sown in 2017 and 2018, respectively. In the present paper we focus on two tillage treatments, the no-till (NT) and the ploughing (P) with tillage depth of 26-30 cm. To determine Rs values we used the static chamber method (SCM) in 6 replicates in both treatments from the 20<sup>th</sup> of February till the 28<sup>th</sup> of October. The volume of the chambers was 0.006m<sup>3</sup>, with incubation time of 20 min. Gas samples were collected once a week from the headspace of the chambers, injected into evacuated exetainer vials and analyzed by Gas Chromatograph with Flame Ionization Detector (GC-FID). Parallel with the static chamber measurements, we used a portable infrared gas analyzer EGM4 (PP Systems, MA USA) between 19<sup>th</sup> of May and 8<sup>th</sup> of September in 6 replicates. The SRC-1 chamber was used with the EGM where the incubation time was set to 5 min. The different chambers of the two methods were placed right next to each other to reduce the effect of spatial heterogeneity as much as possible. Measurements were always carried out between 9 and 12 a.m. to avoid changes originating from the diurnal course of Rs. Soil water content (SWC) and soil temperature (Ts) were monitored with soil probes (Decagon 5TM) placed at 5-10 and 15-20 cm below soil surface. The soil moisture and temperature sensors were calibrated specifically to the soil used in the present study.

### Results and discussion

After analyzing the dataset of Rs, we found a very similar seasonal course by both measurement techniques; with a high peak in May, and with lower values in the second part of the growing season. In the NT treatment the Rs values varied between 0.04 to 0.21, and 0.04 to 0.23 mg CO<sub>2</sub> m<sup>-2</sup> s<sup>-1</sup> in case of SCM and EGM, respectively. In the P treatment the Rs values varied between 0.05 to 0.15 and 0.05 to 0.28 mg CO<sub>2</sub> m<sup>-2</sup> s<sup>-1</sup> in case of SCM and EGM, respectively. Hence there was no significant differences between the treatment not with

EGM nor with SCM.  $R_s$  measured by EGM were systematically higher compared to  $R_s$  measured by SCM, regardless of treatment types. As it is shown in Figure 1 we found a strong ( $r^2=0.85$ ) correlation between the two methods in the NT treatment, but in case of P the correlation was weak ( $r^2=0.39$ ).

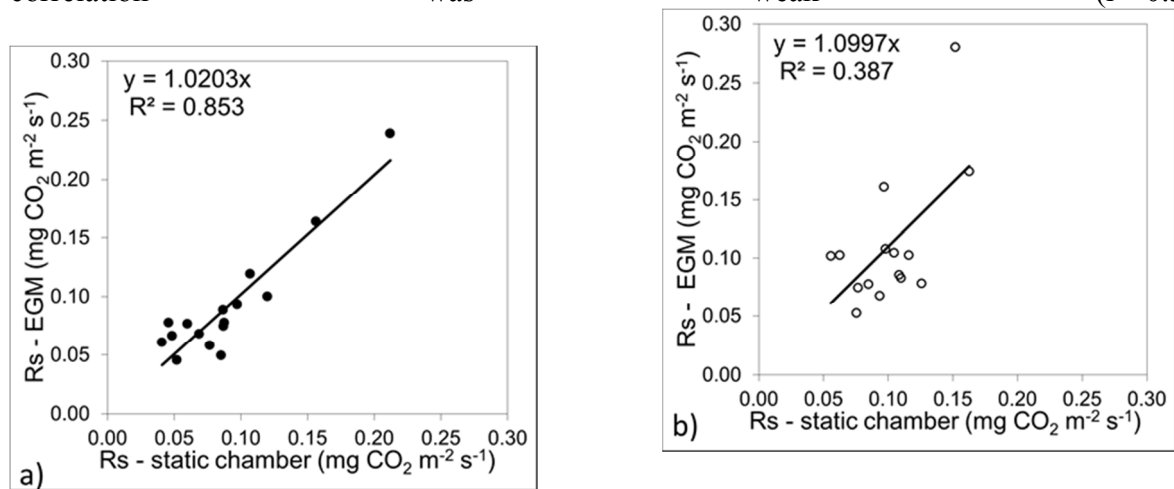

Figure 1: The  $R_s$  correlation between the two measurement methods in a) no-till treatment and b) ploughing.

We analyzed the EGM measurements and found that the standard deviation (SD) was substantially greater compared to the chamber measurements in the case of P treatment and the SD of EGM measurements were lower than chamber measurements in the case of NT treatment.

## Conclusion

Monitoring efforts need to be very cautiously handled when changing measurement techniques, or instrumentation. The migration from one technique to another need to be scientifically justified and checked to ensure data quality and comparability. In case of P treatment's  $R_s$  there was weak correlation between the two different methods, in contrast to NT where the correlation was good in 2017. These slightly contradicting results suggest the need for further investigation in 2018 supported with laboratory experiments to find out whether the spatial heterogeneity of the chambers, the different SWC and plant quality of the treatments or other factors are the reason of the weak correlation mentioned above.

## References

- Christiansen, J. R., Outhwaite, J., & Smukler, S. M. (2015). Comparison of  $\text{CO}_2$ ,  $\text{CH}_4$  and  $\text{N}_2\text{O}$  soil-atmosphere exchange measured in static chambers with cavity ring-down spectroscopy and gas chromatography. *Agricultural and Forest Meteorology*, 211–212, 48–57.
- Grace, J. (2004). Understanding and managing the global carbon cycle. *Global Change Biology*, 189–202.
- Janssens, I., Kowalski, A. S., Longdoz, B., & Ceulemans, R. (2000). Assessing forest soil  $\text{CO}_2$  efflux : an in situ comparison of four techniques. *Tree Physiology*, (5), 23–32.
- Jassal, R. S., Black, T. A., Nesic, Z., & Gaumont-Guay, D. (2012). Using automated non-steady-state chamber systems for making continuous long-term measurements of soil  $\text{CO}_2$  efflux in forest ecosystems. *Agricultural and Forest Meteorology*, 161, 57–65.
- Schrier-Uijl, A. P., Kroon, P. S., Hensen, A., Leffelaar, P. A., Berendse, F., & Veenendaal, E. M. (2010). Comparison of chamber and eddy covariance-based  $\text{CO}_2$  and  $\text{CH}_4$  emission estimates in a heterogeneous grass ecosystem on peat. *Agricultural and Forest Meteorology*, 150(6), 825–831.



Xu, M., & Shang, H. (2016). Contribution of soil respiration to the global carbon equation. *Journal of Plant Physiology*, 203, 16–28.

## An Empirical and Experimental Analysis of Interaction between Row Cleaner Parameters and Plant Residues in Strip Tillage

E. Šarauskis<sup>1\*</sup>, K. Lekavičiene<sup>1</sup>, V. Naujokiene<sup>1</sup>, S. Buragiene<sup>1</sup>

<sup>1</sup>*Institute of Agricultural Engineering and Safety, Aleksandras Stulginskis University, Studentu str. 11, LT-53361 Akademija, Kaunas distr., Lithuania*

\*corresponding author: [egidijus.sarauskis@asu.lt](mailto:egidijus.sarauskis@asu.lt)

### Introduction

Strip tillage is such a technology that can combine full-tillage, when the entire surface of the soil is cultivated, with the positive aspects of non-tillage technology. Strip tillage also has a significant effect on soil temperature and humidity. Experiments by Licht and Al-Kaisi (2005) show that the soil temperature increased in the top 5 cm under strip-tillage (1.2–1.4 °C) over no-tillage. In the technological process of strip tillage, row cleaners perform one of the most important functions, i.e., removing plant residue from the row. The purpose is to remove plant residue from the soil surface strips, in which the soil is prepared by other working parts for seeding other plants. Row cleaners in the form of discs are the most commonly used. The design of the row cleaners determines the width of the strip and the distance of the plant residues' relocation (Vaitauskiene et al., 2017), as well as the fuel consumption and CO<sub>2</sub> emissions from the agricultural machinery. Celik et al. (2013) analyzed the influence of the strip width on soil moisture, seed germination and yield. They found that soil moisture increases as the strip width decreases. A strip width of 22.5 cm preserved more moisture at 0–100 mm depth compared to the 30 and 37.5 cm strip widths. Plant residue between the strips reduces water evaporation from the soil. The main objective of this work is to determine the influence of the parameters of the row cleaners of strip tillage machines on the relocation of plant residue by taking advantage of field experiments and empirical analysis methods.

### Material and methods

Experimental field research was carried out in 2013–2014 at the Experimental Station of Aleksandras Stulginskis University, which is in the Kaunas District, (54°52' N, 23°49' E). The research was carried out in a soil in which uncultivated stubble was left after the harvest of spring wheat (*Triticum aestivum* L.). The length of the summer wheat plant residue was 100 ± 9 mm, moisture content was 25 ± 3% and the amount on the soil surface was 3700 ± 402 kg ha<sup>-1</sup>. The soil at the experimental site was classified as Eutric Endogleyic Planosol (Drainic). Soil moisture at a depth of 200 mm was 17 ± 1.4%, and the hardness was 1.0 ± 0.07 MPa.

The main object of the research, the row cleaners, consisted of two serrated discs placed at an angle to the direction of driving and had a diameter of 340 mm. The parameters of both row cleaners were identical, with 14 teeth each. To prevent the plant residue from clogging up between the discs, they were shifted by a distance of 130 mm in relation to each other in the direction of driving. Disc row cleaners had a working depth of 20 mm. Field experiments of removed portion of plant residue and distance of plant residue removal were carried out by changing various technological parameters of the row cleaners. Gaps between the row cleaner discs were set at 165 mm, 180 mm, and 195 mm, and rake angles of the row cleaner discs at 10°, 15°, and 22.5°. Driving speed is another very important technological parameter that also affects work quality of the machine parts. Experiments were carried out at four different driving speeds – 1.3 m s<sup>-1</sup>, 1.9 m s<sup>-1</sup>, 2.5 m s<sup>-1</sup>, and 3.1 m s<sup>-1</sup>. Using the three-factor experiment modelling method, we made regression equations for estimating the proportion of removed strip plant residue ( $M$ ) and the distance of plant residue from the centre of the strip ( $L_a$ ) depending on the gap between the discs ( $B_c$ ), the rake angle of the row cleaner discs ( $\alpha$ ) and the driving speed ( $v$ ).

## Results and discussion

According to the results of experimental studies, an empirical model was developed for analysing the interaction of the technological parameters of the process of plant residue removal from the strip and a background for their rational values (Figure 1).

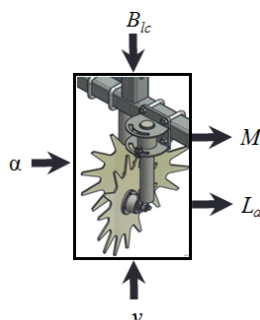

Figure 1: Diagram of empirical model of the process of removing plant residues from the strip:  $B_{ic}$  – gap between the row cleaner discs, in mm;  $\alpha$  – rake angle of row cleaner discs, in deg;  $v$  – driving speed, in  $\text{m s}^{-1}$ ;  $M$  – part of removed plant residues from the strip, in %;  $L_a$  – distance of removed plant residues from the centre of the strip, in mm.

Increasing the rake angle of the row cleaner discs from  $10^\circ$  to  $22.5^\circ$  at an interval of  $2.5^\circ$  and maintaining the driving speed at a constant ( $2.5 \text{ m s}^{-1}$ ) we estimated that the removed strip plant residue increased. In this case, the effect of rake angle was greater when compared to the driving speed or the gap between the row cleaner discs  $B_{ic}$ . When analysing the impact of the rake angle on the distance of removed strip centre plant residue it was found that when the rake angle decreased, a significant reduction in the removal distance was noticed only for the gaps of 180 mm and 195 mm, when the maximum rake angle of  $22.5^\circ$  was compared to smaller rake angles (of  $15^\circ$  and  $10^\circ$ ). In addition, empirical models have also shown that the distance of removed strip centre plant residue increases (approximately 20 mm on average), when gap  $B_{ic}$  is increased from 165 mm to 195 mm at an interval of 5 mm, when the rake angle of the row cleaner discs is unchanged.

## Conclusions

Field experiments and empirical analysis show that the most plant residue, i.e., 83%, is removed from the strip when row cleaners have a rake angle of  $22.5^\circ$  and the driving speed is  $3.1 \text{ m s}^{-1}$ . However, when using such parameters, it has been shown that the speed of  $3.1 \text{ m s}^{-1}$  for strip tillage machines with row cleaners is too fast, because the plant residue is thrown too far. By evaluating the amount and the distance of removed plant residue, we can see that the best results were obtained when the rake angle of the row cleaner discs was  $15^\circ$ , the gap between the discs was 180 mm and the driving speed was  $2.5 \text{ m s}^{-1}$ . With such row cleaner parameters, 75% of plant residue was removed from the strip, and the removing distance from the centre of the strip was 308 mm.

## References

- Celik A., Altikat S., Way, T.R., 2013. Strip tillage width effects on sunflower seed emergence and yield. *Soil Till. Res.*, 131, 20–27. Doi : 10.1016/j.still.2013.03.004.
- Licht M.A., Al-Kaisi, M., 2005. Strip-tillage effect on seedbed soil temperature and other soil physical properties. *Soil Till. Res.*, 80(1), 233–249. Doi : 10.1016/j.still.2004.03.017.
- Vaitauskienė K., Šarauskis E., Romaneckas K., Jasinskas A., 2017. Design, development and field evaluation of row-cleaners for strip tillage in conservation farming. *Soil Till. Res.*, 174, 139–146. Doi : 10.1016/j.still.2017.07.006.

## Field Performance of Tiller Using Tilling Wheel of Different Blade Shapes

Arthur Libang Fajardo

*Associate Professor, Agricultural Machinery Division, Institute of Agricultural Engineering (IAE), College of Engineering and Agro-industrial Technology (CEAT), UP Los Baños (UPLB), College, Laguna 4031, Philippines. alfajardo@up.edu.ph*

### Introduction

Land preparation under lowland conditions involves soil puddling. Puddling controls weeds, eases the transplanting operation, and reduces seepage and percolation. One of the equipment being used for puddling is the float-assisted tiller. This tiller was first developed by Villaruz (1986). It consists of a front-mounted tilling wheel with a flotation chamber on which the engine is mounted. The advantages of this tiller include: higher field capacity compare to hand tractor with implement; fewer passes are required; and ability to till edges and corners of the field (Calilung and Stickney, 1985). Different designs of float-assisted tiller for lowland application have been developed since Villaruz (1986) introduced the tiller. Some designs of float-assisted tiller are called floating tiller, turtle or “pagong” tiller, amphi (short for amphibious) tiller, UFO or saucer-type float tiller, and hydrotiller. Although these units have different features especially on the flotation unit, all of the tiller designs have the same soil-cutting unit: a tilling wheel with or without blades rotating at relatively high speed. Different designs of blades for the tilling wheel are being manufactured and used in Philippine lowland fields. This paper presents the field performance of float-assisted tillers using tilling wheels of different blade shapes and set ups.

### Materials and methods

The field performance test was conducted at the lowland rice farm of Agripark, CA, UPLB. The blade shapes and set ups used include triangular blades (original, 13° lug angle), rectangular blades (13° lug angle), no blades (13° lug angle) and triangular blades (radial, 0° lug angle). The tiller used has turtle shape float device. The primemover used was an air-cooled diesel engine with rated power of 5.97 kW (10 hp). Two operators alternately performed the field test. Three trial runs were conducted for each tilling wheel configuration. Two passes (three-day intervals) were done for each run. Plot size used for the test ranges from 645.15 m<sup>2</sup> to 647.7 m<sup>2</sup>. Parameters measured/determined were: average forward speed, fuel consumption, puddling index, actual field capacity, and field efficiency. The analysis of variance (ANOVA at 90% level of significance) were used to determine the main effects of blade shapes and number of passes as well as their possible interaction effects on the fuel consumption and field efficiency. Then mean comparisons using the Tukey’s Honest Significant Difference (HSD) test were applied (at p<0.10).

### Results and discussion

The tilling wheel with triangular blades at 0° lug angle has the highest performance index for both 1<sup>st</sup> and 2<sup>nd</sup> pass (Table 1). Compared with the laboratory test, the tilling wheel with triangular blades at 13° lug angle has the highest performance index in almost all settings (Fajardo et al, 2015). Based on results of statistical analysis, fuel consumption, puddling index, field efficiency and field performance index are significantly affected by the blade shape and number of passes. Moreover, the mean differences of fuel consumption and field efficiency between blade shape and number of passes were not significant. The mean differences of performance index were significant only between triangular (13°) and triangular (0°). This means that lug angle has an effect on the field performance of the tiller. On the other hand, the mean differences of performance index between passes were significant.

Table 1. Summary of average data from field performance test of different blade shape.

BLADE CONFIGURATION	FUEL CONSUMPTION (l/h)	PUDDLING INDEX (%)	THEORETICAL FIELD CAPACITY (ha/h)	ACTUAL FIELD CAPACITY (ha/h)	FIELD EFFICIENCY (%)	FIELD PERFORMANCE INDEX (%-h/l)
Triangular (13°)	1.3	23.2	0.3	0.3	72.7	18.1
Triangular (0°)	1.2	28.0	0.3	0.2	74.0	23.9
Rectangular	1.4	30.2	0.4	0.3	77.5	21.4
No blades	1.3	24.0	0.3	0.3	76.7	19.0

### Conclusion

The tilling wheel with triangular blades (0° lug angle) has the highest field performance index. It is interesting to note that most of the tilling wheel available in the Philippines has 0° lug angle. The lug angle has significant effect on the field performance of the tiller. Any blade shape and lug angle will not affect field efficiency.

### References

- Calilung E.J. and Stickney, R.E. 1985. Comparison of Land Preparation Equipment Used in Small Rice Farms in the Philippines. International Rice Research Institute, Los Baños, Laguna.
- Fajardo, A.L., D.C. Suministrado, E.K. Peralta, P.M. Bato and E.P. Paningbatan Jr. 2015. Effect of blade shape and shaft speed on the performance of a tilling wheel of float-assisted tillers. *Philipp Agric Scientist*, 98: 73-80.
- Villaruz, M.S. 1986. The floating power tiller in the Philippines. In: *Proceedings of the International Conference on Small Farm Equipment for Developing Countries: Past Experiences and Future Priorities*. International Rice Research Institute, Los Baños, Laguna. pp.173-178.

1 **Effect of tire inflation pressure on soil properties and yield in a corn -**  
 2 **soybean rotation for three tillage systems in the Midwestern United States.**

3 \*Md Rayhan Shaheb<sup>1,2,3</sup>, Tony E. Grift<sup>2</sup>, Richard J. Godwin<sup>1</sup>, Edward Dickin<sup>1</sup>, David R.  
 4 White<sup>1</sup> and Paula A. Misiewicz<sup>1</sup>

5 <sup>1</sup> Harper Adams University, Edgmond, Newport, TF10 8NB, UK;

6 <sup>2</sup> Department of Agricultural and Biological Engineering, University of Illinois at Urbana-  
 7 Champaign, Urbana, IL 61801, USA;

8 <sup>3</sup> Bangladesh Agricultural Research Institute (BARI), Gazipur 1701, Dhaka, Bangladesh

9 \*Corresponding author: [rshaheb@harper-adams.ac.uk](mailto:rshaheb@harper-adams.ac.uk)

10 **Introduction**

11 Compaction causes physical, chemical and biological changes in the soil that negatively affect  
 12 crop performance. A 40–50% corn yield reduction was reported with higher tire contact  
 13 pressures and multiple vehicle passes (Raghavan et al., 1979). Corn yield reductions of up to  
 14 55% were observed in a first cropping season with high compaction levels (Voorhees, 2000).  
 15 In fields subjected to annual heavy wheel traffic corn yield reduction may be permanent.  
 16 When alleviating soil compaction, higher draft forces are required, leading to higher energy  
 17 costs. Low ground pressure systems with agricultural tracks or with purposely designed tires  
 18 can reduce ground contact stress transmitted into the soil. Low ground pressure tire systems  
 19 matched to particular farming enterprises could be an option as a viable traffic management  
 20 system (Godwin et al., 2015). The studies reported here are aimed at better understanding the  
 21 effect of lower tire pressure systems on soil conditions and crop development and yield in a  
 22 typical Midwestern corn (*Zea mays* L.)/soybean (*Glycine max* L.) rotation.

23 **Material and methods**

24 This study was conducted in two adjacent 6.48 ha fields comprising Drummer (silty clay  
 25 loam) & Thorp soil series (silt loam) in Champaign County, Illinois (lat/lon: 40.070965, -  
 26 88.217538) from November 2016 to October 2017. The treatments comprised deep tillage  
 27 (DT, 450mm), shallow tillage (ST, 100mm) and no-till (NT). All machinery was fitted with  
 28 Michelin Ultraflex tires (Yieldbib and Cerexbib) run at standard (for radial tires) and low  
 29 pressures; the standard/low tire pressures were 0.14/0.07 MPa for the tillage tractor (JD  
 30 7930), 0.12/0.05 MPa for the planter tractor (JD 7700), and 0.21/0.14 MPa for the combine  
 31 harvester (JD 9410). The experiment was a split plot, factorial randomised complete block  
 32 design, with five blocks where the tire pressure and tillage systems were the main plots and  
 33 the 8 crop rows and a central non-trafficked inter-row were sub-plots. The unit plot area was  
 34 160m x 6m = 960m<sup>2</sup>. Deep tillage was conducted on the DT plots in autumn 2016. Shallow  
 35 tillage was applied in all DT and ST plots using the appropriate tire pressures, in May 2017  
 36 and the crops planted. Weather data, soil and crop growth related data, and yield data were  
 37 recorded. Yield data were adjusted to moisture contents of 15.5% for corn and 13% for  
 38 soybean. The data were analysed using the appropriate ANOVA for the soil properties and  
 39 yield and the Tukey multiple range test ( $\alpha = 0.05$ ) to determine the significant differences  
 40 among treatments.

41 **Results and discussion**

42 The results revealed that the tillage treatment had a significant effect on soil moisture content  
 43 (MC) in the soybean field ( $p=0.009$ ), and the cone penetrometer resistance (PR) in both corn  
 44 and soybean ( $p<0.001$ ). In general, trends of PR values were in the order of NT>DT>ST in  
 45 both fields. The central non-trafficked inter-rows always had a higher soil MC (%) and lower  
 46 PR values compared to others location ( $p<0.001$ ). Tire inflation pressure had no significant  
 47 effect on soil moisture content and penetrometer resistance in both corn and soybean fields.  
 48 Fig. 1a shows that tire inflation pressure had a significant effect on the grain yield of corn

49 ( $p=0.005$ ). The corn yield ( $15.02 \text{ Mg ha}^{-1}$ ) from the lower inflation pressure tires was 4.31%  
 50 higher than that of the standard tire pressure plots ( $14.40 \text{ Mg ha}^{-1}$ ). Whilst not as extreme,  
 51 these results are in agreement with Raghavan et al. (1979) and Voorhees (2000), and represent  
 52 typical field practice. Tillage and its interaction with tire pressure had no influence on corn  
 53 yield. In soybean, tillage system had a significant effect on the grain yield ( $p=0.001$ ), where  
 54 the highest grain yield ( $4.86 \text{ Mg ha}^{-1}$ ) was recorded in deep tillage, which was 2.74% and  
 55 4.51% higher than that of shallow tillage ( $4.73 \text{ Mg ha}^{-1}$ ) and no-till ( $4.65 \text{ Mg ha}^{-1}$ ),  
 56 respectively (Fig. 1d). Tire pressure and its interaction with tillage system had no significant  
 57 effect on the yield of soybean.

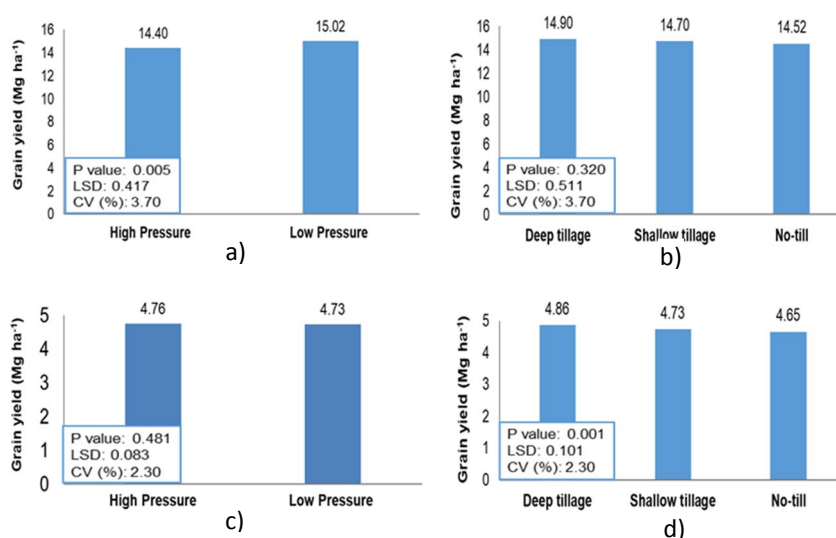

58 Fig. 1. Effect of tire inflation pressure and tillage systems on the grain yields of corn and soybean  
 59 (Figs. a&b are corn and c&d are soybean, respectively).

## 60 Conclusions

- 61 1. Reducing tire inflation pressure had a significant effect ( $p=0.005$ ) on the grain yield of  
 62 corn. The highest grain yield was recorded for low inflation pressure ( $15.02 \text{ Mg ha}^{-1}$ ),  
 63 which was 4.31% greater than the standard inflation pressure.
- 64 2. Increasing tillage depth had a significant effect ( $p=0.001$ ) on the grain yield of soybean.  
 65 The highest grain yield was recorded for deep tillage ( $4.86 \text{ Mg ha}^{-1}$ ), which was 2.74% and  
 66 4.51% greater than those of shallow tillage ( $4.73 \text{ Mg ha}^{-1}$ ) and no-till ( $4.65 \text{ Mg ha}^{-1}$ ),  
 67 respectively.
- 68 3. Soil moisture content and penetrometer resistance varied with the tillage system, but were  
 69 not affected by tire inflation pressure. The central non-trafficked inter-rows had higher soil  
 70 moisture contents and lower cone penetration resistance values than the crop rows.

## 71 Acknowledgements

- 72 1. Manufacture Française des Pneumatiques Michelin for funding this project.
- 73 2. Tim Lecher, University of Illinois for his invaluable assistance in all field operations.

## 74 References

- 75 Godwin, R., P. Misiewicz, D. White, E. Smith, T. Chamen, J. Galambošová, and R. Stobart. 2015. Results From  
 76 Recent Traffic Systems Research And The Implications For Future Work. *Acta Technol. Agric.* 18(3): 57–63.  
 77 Available at <http://www.degruyter.com/view/j/ata.2015.18.issue-3/ata-2015-0013/ata-2015-0013.xml>.
- 78 Raghavan, G.S.V., E. McKyes, F. Taylor, P. Richard, and A. Watson. 1979. The relationship between machinery  
 79 traffic and corn yield reductions in successive years [Damage to corn production by soil compaction generated  
 80 by vehicular traffic]. *Trans. American Soc. Agric. Eng.* 22(6): 1256–1259.
- 81 Voorhees, W.B. 2000. Long-term effects of subsoil compaction on yield of maize. *Adv. GeoEcol.* 32: 331–338.

## Survey of poor crop establishment in Danish winter wheat fields and an automatic seed drill depth control system

Søren Kirkegaard Nielsen<sup>1\*</sup>, Kathrine Hauge Madsen<sup>2</sup>, Lars Juhl Munkholm<sup>3</sup>, Michael Nørremark<sup>4</sup>, Mathieu Lamandé<sup>3,5</sup>, Frederik Foldager<sup>1,4</sup>, Alevtina Evgrafova<sup>1</sup>, Eskild Hohlmann Bennetzen<sup>2</sup>, Jens Erik Jensen<sup>2</sup>, Ole Green<sup>1,3</sup>

<sup>1</sup> Agro Intelligence ApS, Agro Food Park 13, Aarhus N, Denmark

<sup>2</sup> SEGES, Agro Food Park 15, Aarhus N, Denmark

<sup>3</sup> Aarhus University, Department of Agroecology, Blichers Allé 20, Tjele, Denmark

<sup>4</sup> Aarhus University, Department of Engineering, Inge Lehmanns Gade 10, Aarhus, Denmark

<sup>5</sup> Norwegian University of Life Sciences, Universitetstunet 3, Ås, Norway

\* Corresponding author: [skn@AgroIntelli.com](mailto:skn@AgroIntelli.com); Keywords: Seed drill, Coulter depth control system, Precision seeding; *Topic: 8. Tires, tillage and seeding equipment design*

### Introduction

An accurate and uniform seeding depth is crucial for homogeneous crop development as the depth affects the uniformity of crops, delay of emergence and germination rates. A homogenous crop density supports a robust crop development, which has a positive effect on the yield. There is, however, limited information on the extent and specific causes for poorly established field patches. Therefore, to get an indication of the causes and the effect on plant establishment, a survey was conducted among Danish crop production advisors for winter cereal fields, where seeding depth was included as one of the questions. Under practical conditions, considerable seeding depth variations can be observed for low-cost as well as high-end modern seed drills. These variations can be correlated to variable soil resistance affecting the drill coulters depths. The spatial field variability is caused by variations in the soil mechanical properties, e.g. variations in soil texture, water content, tillage treatment etc. The results of these factors are unwanted low-frequent coulter vibrations and, consequently, non-uniform and incorrect seeding depths. The aim of the study was to estimate the extent and causes of poor crop establishment in Denmark and to present an active control system in order to maintain a uniform coulter depth, regardless variable soil conditions.

### Materials and Methods

A survey was conducted among the Danish crop production advisors, who attended the Danish annual fertilisation seminar in the autumn of 2017. At the seminar, the advisors received a one-page questionnaire with 25 questions regarding the extent and causes of poor plant establishment in their respective geographical regions. The questionnaire was conducted by seventy-two advisors focusing on winter cereals. A previously developed and evaluated sensor-guided seeding depth control system is also presented in order to demonstrate how to minimise poor crop establishment, caused by incorrect seeding depths.

### Results and Discussion

The survey indicates that between 75% and 94% of the farmers established the desired seedbed and seeded at the optimal timing. Other causes e.g. effects from hilltops, field depressions, poor drainage, structural damage, suboptimal tillage strategy, were also found to impact the crop establishments. Almost half of the advisors perceive incorrect seeding depth as a cause for poorly established patches (Table 1). However, it must be emphasised that the survey is based on expert assessments and not measured data.

*Table 1.* From Danish survey on poor crop establishment in winter cereals.

Scale	The poorly established patches, caused by incorrect seeding depth
Not at all	0 %
To a small extent	52 %
To some extent	42 %
To a great extent	6 %



To obtain a correct seeding depth, a novel automatic coulters depth control system was developed, presented by Nielsen et al. (2016, 2017, 2018). The developed system consisted of a coulters measurement and control system for maintaining a consistent drill coulters depth. The investigation started in a soil bin (Nielsen et al., 2016), ending with a full-scale developed seed drill, verified in field experiments (Nielsen et al., 2017, 2018). The system was installed on a Kongskilde Ecoline (DK) single disc seed drill. The measurement system used eleven linear position sensors (“TX2”, Novotechnik U.S) measuring the coulters’ depths in relation to the traverse machine frame and two ultrasonic distance sensors (“P43”, PIL Sensoren DE) measuring the frame height relative to the soil surface (Fig. 1). By dynamically merging the sensor signals the system was able to measure the individually coulters operational depths (Nielsen et al., 2017). When using the sensor signal for active controlling the site-specific coulters pressure, the desired coulters depths were maintained, regardless variation in soil-coulters resistance (Nielsen et al., 2018). Without the control system activated, the seed drill measured a significant spatial coulters depth variation due to variability in soil mechanical properties (Nielsen et al., 2017, 2018). After smoothing data, this variation was still calculated up to  $\pm 8$  mm on average across the experimental blocks, which significantly was reduced to  $\pm 2$  mm after activating the control system (Nielsen et al., 2018). Overall, the developed depth control system improved the coulters depths accuracy by 15%, which means a more stabilised coulters depth were achieved in order to assist a homogeneous crop development.

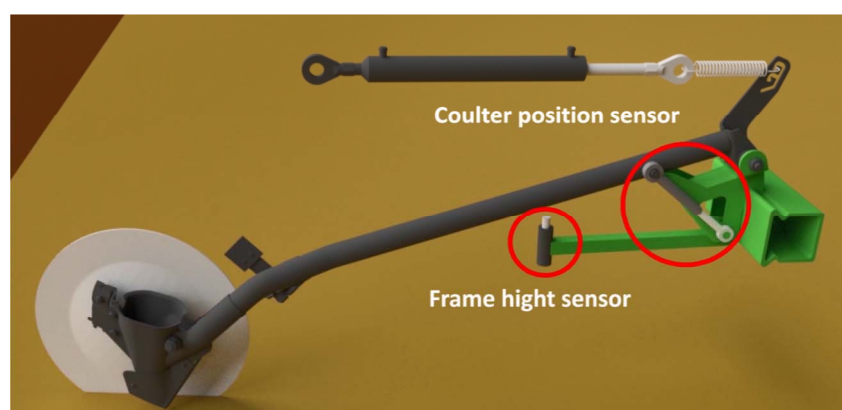

Figure 1. Single disc coulters with linear position sensor and the ultrasonic frame height sensor measuring the coulters depth, and a hydraulic actuator for coulters pressure control.

## Conclusion

The survey showed that suboptimal winter wheat establishment may account for considerable yield loss, on average, 8% of poorly established crop area. A poor crop establishment were induced by multiple reasons, including incorrect and undesirable variations in seeding depth. The presented coulters depth measurement and automatic coulters pressure control system improved the site-specific seeding operation by automatically controlling the coulters pressure, maintaining a consistent operation depth, regardless heterogeneous field conditions.

## References

- Nielsen, S. K., Munkholm, L. J., Lamandé, M., Nørremark, M., Edwards, G. T. C., & Green, O. (2018). Seed drill depth control system for precision seeding. *Computers and Electronics in Agriculture*, 144, 174–180.
- Nielsen, S. K., Munkholm, L. J., Lamandé, M., Nørremark, M., Skou-Nielsen, N., Edwards, G. T. C., & Green, O. (2017). Seed drill instrumentation for spatial coulters depth measurements. *Computers and Electronics in Agriculture*, 141, 207–214.
- Nielsen, S. K., Nørremark, M., & Green, O. (2016). Sensor and control for consistent seed drill coulters depth. *Computers and Electronics in Agriculture*, 127, 690–698.

## No-till transplanting and skidded rotating vanes for effective weed control in paddy fields

K. Shoji<sup>1\*</sup>, Y. Adachi<sup>2</sup>, N. Terai<sup>1</sup>

<sup>1</sup> Graduate School of Agricultural Science, Kobe University, Nada-ku, Kobe, 657-8501, Japan

<sup>2</sup> Shimane Agricultural Technology Center, Ashiwata-cho, Izumo, Shimane, 693-0035, Japan

\* corresponding author: [shojik@kobe-u.ac.jp](mailto:shojik@kobe-u.ac.jp)

### Introduction

Organic or non-chemical agricultural practices have been recently recognized world-wide, but the portion is very limited mainly due to difficulties in weed control. One of the reasons is attributed to the difficulties in intra-row (between the plants along the traveling direction of machines) weeding that requires selectivity between the weed and the crop. Another reason, in paddy fields for rice production in particular, can be the persistence of the weed species adapted to oxygen-poor environment (Kataoka and Kim, 1978) in the puddled soil such as *Monochoria vaginalis* and *Scirpus juncooides* (aquatic annual weeds), especially if the population control in these species is not sufficient during the growing season.

Yet there are solutions. Some advanced farmers practice no-till transplanting to preserve oxygen near the root zone and to avoid germination of the above weed species, either by manual transplanting, or by transplanters equipped with strip tillage device or narrow furrow openers. Free-rotating vanes for intra-row weeding have drastically decreased the population of *M. vaginalis*, although it is an aquatic weed, under deep water (Shoji *et al.*, 2013), from which the restriction in the rotation of the vanes (skidding) is hypothesized to increase the weeding efficacy. In this report, the efficacy of the farmers' no-till transplanting is confirmed through the experiments in the experimental station. The occurrence of the skidding is also confirmed of the rotating vanes associated with the depth of water, and the control in their rotational speed is attempted to increase the weeding efficacy in the intra-row spacing.

### Material and method

The transplanting trials were carried out in a paddy field in Shimane Agricultural Technology center, where no chemical had been applied for six years as of 2015. The field had been watered during winter in 2015 and for 22 days before transplanting in 2016. The "puddling" depth was 150 mm whereas "shallow puddling" 50 mm. As a variation of "no-till", only above-ground weeds were trimmed for "mower + no-till". Complete "hand weeding" was set on the puddling. Pot seedlings (leaf age 4.5 – 4.7, plant height 168 – 195 mm) were transplanted (Fig. 1), but this usage in no-tills was outside the warranty of the manufacturer.

An inclined rotating vane was examined as an intra-row weeding mechanism and was placed on a mobile frame (Fig. 2). The first trial was to observe the occurrence of skidding defined as  $1 - (\text{peripheral speed}) / (\text{traveling speed})$ , by changing the water depths and the soils (sandy loam and loamy sand) puddled 14 days before the run. The second was to control the rotational speed *i.e.* the skid of the vane by connecting it to a variable speed motor. The vane was applied to the loamy sand field where mainly *M. vaginalis* was rampant at the leaf age up to 4, and the weed plants were sampled within and outside the lane to calculate the removal rate on number basis. Lodging angle of the rice plants were measured in a similar condition of the vane for the plants of 400 mm- height and 100 mm- root length.



Fig. 1 The transplanter (LSP-2, Minoru)



Fig. 2 The weeder and the mobile frame

## Results and discussion

In no-till transplantings, the aquatic annual weeds were scarce as hypothesized, however, perennial weeds were not negligible (Table 1). Typical paddy hygrophytic weed such as *Echinochloa crus-galli* or *Cyperus difforis* was not observed. In conventional puddling, the aquatic weeds significantly increased in 2016, and more is expected for the repetition of the same practice. Grain yield was not correlated to total weed biomass ( $r = -0.02$ ), and this implies other unfavorable factors for no-till such as initial growth, which requires further study.

The skid increased with water depth especially in loamy sand soil, yet it was nearly double in sandy loam (Table 2), which agrees with the manufacturer's recommendation to be used in finer soil. Weed removal rate increased with skid, however, the optimum could be between 60% and 90% skid, where no portion of the rice plants is expected to suffer from complete lodging (Table 3).

Table 1 Tillage treatments affecting rice grain yield and weed plant biomass

Year	Treatment	Grain yield* (t/ha)	Dry whole-plant weed biomass at 50 days after transplanting (g/m <sup>2</sup> )							
			Total	<i>Monochoria vaginalis</i>	<i>Scirpus juncooides</i>	Other ann. weeds	<i>Cyperus serotinus</i>	<i>Eleocharis kuroguwai</i>	<i>Eleocharis pellucida</i>	<i>Eleocharis acicularis</i>
2015	No-till	3.80	13.5					3.2	10.3	
	Mower + no-till	3.96	5.7	1.4	0.3			1.7		2.4
	Puddling (conv.)	4.93	11.1	8.2	2.5			0.4		
	Shallow puddling	4.53	8.8	4.8	0.4	1.8		1.8		
	Hand weeding	5.12	2.0	1.5	0.4					
2016	No-till	4.55	31.6			16.4			15.1	
	Mower + no-till	3.90	15.2			0.1	8.8		5.1	1.2
	Puddling (conv.)	4.82	48.4	26.0	18.5	3.4	0.3			0.2
	Shallow puddling	4.78	35.3	17.8	7.4	1.9		8.0		
	Hand weeding	5.47	2.0	1.5	0.5					

\* Brown rice sieved on 1.85 mm- wide slits and the weight adjusted to 15% moisture content (wet base)

Table 2: Skidding of the free-rotating vanes under varied water depths and puddled soils

Depth / soil	Sandy loam	Loamy sand
0 mm	40.6%	12.9%
35 mm	43.5%	17.7%
75 mm	46.9%	23.6%
90 mm	47.7%	24.4%
100 mm	45.8%	27.9%

Table 3: Removal rate of weeds and lodging angle of the rice plants v.s. controlled skids of the rotating vane

Skid	Removal rate	Lodging angle
0%	23.0 ± 21.2%	10 ± 9°
30%	51.8 ± 14.0%	10 ± 9°
60%	74.0 ± 0.6%	23 ± 6°
90%	91.5 ± 1.7%	65 ± 18°

Standard deviation is denoted by ±

## References

- Kataoka T., Kim S.Y., 1978. Oxygen requirement for seed germination of several weeds. *Journal of Weed Science and Technology*, 12, 9-12. [In Japanese]
- Shoji K., Itoh K., Kawahara F., Yoshida Y., Yamamoto Y., Sudo K., 2013. Micro-elevations in paddy fields affect the efficacy of mechanical weeding: Evaluation of weeding machines to control *Monochoria vaginalis* in herbicide-free farming. *Weed Biology and Management*, 13, 45-52.

## Design Analysis of Soil Digging Components of a Tractor-Mounted Yam Harvester

Tajudeen I. Yusuf and Joshua O. Olaoye\*

Agricultural and Biosystems Engineering Department, University of Ilorin, P. M. B.  
1515, Ilorin 240001, Nigeria.

Corresponding Author: jolanoye@unilorin.edu.ng

### Introduction

Mechanical yam harvesters have greater potential to reduce manpower used, harvesting time and operation costs, while increasing work efficiency of yam harvesting operation. The design parameters of any root or tuber harvester affects the performance of the machine (Jiang (2010)). The objective of this paper was to carry the design analysis of a tractor-mounted yam harvester by investigating the tuber properties, soil physico-mechanical properties and operating parameters relevant to the design of Yam tuber harvester.

### Materials and Method

Digging components of a tractor-mounted mechanical yam (*dioscoreaspp*) harvester was designed and developed to reduce the drudgery and loss of time associated with manual harvesting. The field capacity of the harvester was determined as 0.2700ha/hr and the field efficiency was 75%. The performance of the harvester was evaluated at the National Centre for Agricultural Mechanization (NCAM), Idofian, Nigeria. The harvester was operated at rake angle of 20°, 25° and 30°, forward speed of 0.9m/s, 1.1m/s and 1.3m/s and the digging tool operated at depth of cut 40cm, 45cm and 50cm. These combinations were tested on a split-split plot design with three replicates and the results were analyzed using ANOVA at  $p \leq 0.05$  level of significance.

### Results and Discussion

The yam tuber harvester was developed with all its essential soil digging components. All the parameters of the tractor-implement performance were measured and recorded in line with the recommendations of RNAM test codes and procedures for farm machinery technical series (RNAM, 1995). Tables 1 represent the analysis of variance (ANOVA) of the performance of the yam harvester. The performance of the harvester was significantly influenced by the blade's rake angle but was not significantly influenced by the forward speed and depth (Akinbamawo *et al.* (2011)). Since there was no significant difference in the effects of both forward speed and depth of penetration of the harvester, the developed yam tuber harvester can be operated to give optimum performance at a rake angle of 25° forward speed of 1.0 m/s and depth of penetration of 50 cm as a compromise between high machine efficiency and a reduced draft force.

### Conclusion

The developed harvester digging blade was evaluated to be both functionally and cost effective for harvesting most of the yam varieties which are normally grown in the south-western part of Nigeria, especially the white guinea yam (*Dioscorea Rotundatum*). The performance efficiency of the harvester during the field test was estimated as 97.3%. The cost of harvesting per hectare was lower for mechanical harvesting compared to manual harvesting while reducing labour cost by 37.6%.

**Table 1: Effects of the speed of operation, depth of cut and lift angle on the a) lifted tuber and b) tuber damaged during field operations**

---

a) Source of Variance	Sum of Squares	Df	Mean Square	F	Sig.
Speed	1.407	2	0.704	1.583	0.215 <sup>ns</sup>
Rake Angle	8.667	2	4.333	9.750	0.000 <sup>s</sup>
Depth	0.296	2	0.148	0.333	0.718 <sup>ns</sup>
Speed * Rake Angle	0.593	4	0.148	0.333	0.854 <sup>ns</sup>
Speed* Depth	2.963	4	0.741	1.667	0.171 <sup>ns</sup>
Rake Angle * Depth	1.481	4	0.370	0.833	0.510 <sup>ns</sup>
Speed * Rake Angle * Depth	6.148	8	0.769	1.729	0.113 <sup>ns</sup>
Error	24.000	54	0.444		
Total	3566.000	80			
b) Source of Variance	Sum of Squares	Df	Mean Square	F	Sig.
Speed	0.074	2	0.037	0.125	0.883 <sup>ns</sup>
Rake Angle	2.889	2	1.444	4.875	0.011 <sup>s</sup>
Depth	0.222	2	0.111	0.375	0.689 <sup>ns</sup>
Speed * Rake Angle	1.926	4	0.481	1.625	0.181 <sup>ns</sup>
Speed * Depth	1.037	4	0.259	0.875	0.485 <sup>ns</sup>
Rake Angle * Depth	0.222	4	0.056	0.188	0.944 <sup>ns</sup>
Speed * Rake Angle * Depth	3.630	8	0.454	1.531	0.168 <sup>ns</sup>
Error	16.000	54	0.296		
Total	42.000	80			

<sup>n</sup> = significant at 5% level of significance, <sup>ns</sup> = not significant at 5% level of significance

## References

- Akinbamowo, R., Ogunlowo, A.S and Agbetoye, L. A. S. (2011). Development of a Tractor-Mounted Cocoyam (*Xanthosoma Spp.*) harvester. AJAE 2(3):82-89.
- Jiang, Z. (2010). The Research and Design of Cassava Harvester Digging Components. Guangzhou: Guangdong Ocean University.
- RNAM (1995). Regional Network for Agricultural Machinery Test codes and Procedures for Farm Machinery. Technical Series No.12. General Guidelines in the use of Test Codes.

## Optimising bentleg opener geometry for high speed no-till seeding using DEM simulations

Authors: James Barr\*, Jack Desbiolles, John Fielke, Mustafa Ucgul

University of South Australia – School of Engineering, Agricultural Machinery Research and Design Centre,

Corresponding Author: [james.barr@unisa.edu.au](mailto:james.barr@unisa.edu.au)

### Introduction

Tine-mounted narrow openers commonly used in Australia for no-tillage seeding operations cause excessive soil disturbance, which typically limits speed to 8-9 km h<sup>-1</sup>. In this study, the low disturbance bentleg opener (Barr, Desbiolles, & Fielke, 2016; Solhjoui, Fielke, Desbiolles, & Saunders, 2014) is investigated for its use in high speed no-tillage seeding. discrete element method (DEM) modelling was used to optimise performance and develop bentleg opener designs for integrated use in seeding systems.

### Method

A virtual soil bin was generated using DEM and the hysteretic spring contact model (Ucgul, Fielke, & Saunders, 2014). A voidage grid binning technique was developed to identify the loosened soil portion following a furrow tilling simulation and adapting DEM post processing to reflect common tillage assessment methodologies. The performance of bentleg openers and seeding systems was benchmarked against baseline straight openers in field trials on silty-loam and sandy-loam soils, by measuring parameters such as soil disturbance, tillage forces, seed placement accuracy, crop emergence and grain yield.

### Results and Discussion

DEM model results show soil disturbance with bentleg openers is minimised by streamlining the opener by reducing its thickness and maximising its leading chamfer. A curved – rather than angular- transition connecting the side leg to the vertical shank portion also reduces the extent of soil disturbance. The bentleg foot is the key feature initiating soil failure and driving soil loosening, draught and penetration forces. However, the vertical upheave caused by the foot increases soil throw at shallower settings (< 90 mm). Removing the foot reduces the loosened soil upheave height, minimising soil disturbance for shallow (60 mm) and high speed operation. These benefits come at the cost of furrow loosening capacity, limiting the operating range of footless bentleg openers to shallower depths (< 120 mm). However, a footless bentleg opener with a side-leg forward rake angle greater than 90° can offer benefits similar to steep rake angle straight openers, but without the associated penalties of reduced furrow size, increased draught and vertical up forces. . Benefits include the potential to lower field surface roughness, improve harvest-ability of crops and reduce the need for post seeding rolling operations in stony soils. In both DEM predicted and field experimental results in dry conditions (Fig. 1) the bentleg opener was able to operate with less soil throw at twice the operating speed (16 km h<sup>-1</sup>) relative to the straight opener (8 km h<sup>-1</sup>).

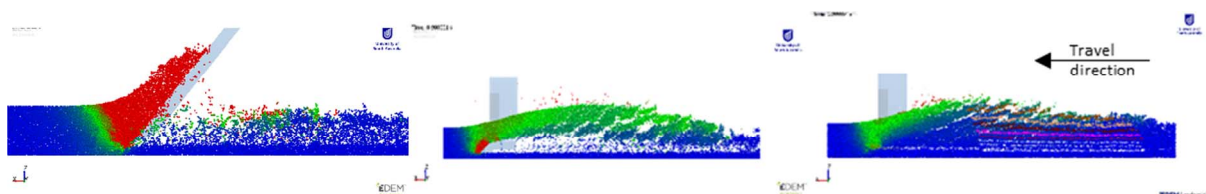



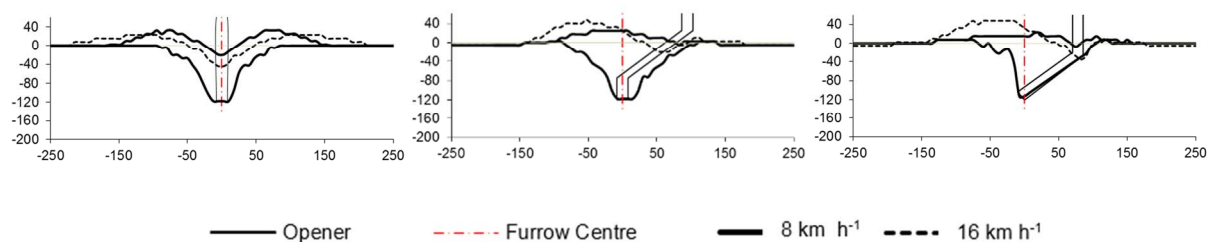

Fig. 1: DEM predicted soil failure with colours indicating vertical velocity gradient of soil particles (top) and cross-sectional furrow profile and soil throw boundaries (bottom) with straight (left), footed bentleg (middle) and footless bentleg (right) openers.

Two seed and fertiliser banding techniques were developed and evaluated in a field trial. The seeding system techniques placed seeds into furrow backfilling soil tilth using a furrow closing plate (SS2); or placed seeds on an undisturbed side-ledge within the furrow (SS3) and were compared to a district technology SS1). Results shown in Table 1 show both closer plate and side banding bentleg seeding systems can increase operating speeds by at least 50% (i.e. from 8 to 12 km h<sup>-1</sup>) with no penalty to wheat crop emergence or grain yield. In contrast, the straight opener seeding system SS1 increased seeding depth by 30.1 mm as a result of excessive soil throw at 12 km h<sup>-1</sup>, thus reducing crop emergence by 31% on the affected seed rows.)

Table 1: Effect of seeding speed and seed row stepping due to soil throw on seeding depth (LSD<sub>0.05</sub>=7mm) and wheat crop emergence (LSD<sub>0.05</sub>=12%).

Sandy-loam 2016 trial		Seeding depth (mm)		emergence (% seed rate)	
Treatment	Speed (km h <sup>-1</sup> )	- Stepping	+ Stepping	- Stepping	+ Stepping
SS1	8	41.0	52.7	98.9%	90.2%
	12	39.2	69.1	92.2%	61.3%
SS2	8	50.3	52.0	97.8%	88.4%
	12	46.7	57.7	92.4%	89.7%
SS3	8	47.9	52.1	96.8%	99.0%
	12	50.0	55.1	97.5%	91.1%

## Conclusion

The low soil disturbance characteristics of bentleg openers provide an unprecedented ability to increase operating speed of no-till tine seeders and therefore work-rate and timeliness of crop seeding. Further expected benefits such as improved performance in stony soils and lower weed seed germination should be validated in field trials.

## References

- Barr, J. B., Desbiolles, J. M. A., & Fielke, J. M. (2016). Minimising soil disturbance and reaction forces for high speed sowing using bentleg furrow openers. *Biosystems Engineering*, 151, 53-64. doi: <http://dx.doi.org/10.1016/j.biosystemseng.2016.08.025>
- Solhjou, A., Fielke, J. M., Desbiolles, J. M. A., & Saunders, C. (2014). Soil translocation by narrow openers with various bent leg geometries. *Biosystems Engineering*, 127, 41-49. doi: <http://dx.doi.org/10.1016/j.biosystemseng.2014.08.008>
- Ucgul, M., Fielke, J. M., & Saunders, C. (2014). Three-dimensional discrete element modelling of tillage: Determination of a suitable contact model and parameters for a cohesionless soil. *Biosystems Engineering*, 121(0), 105-117. doi: <http://dx.doi.org/10.1016/j.biosystemseng.2014.02.005>

## **Sowing unit and sowing technique performances for cereal and oilseed crop establishment**

D. Brun<sup>1\*</sup>, J. Labreuche<sup>1</sup>, P. Boillet<sup>1</sup>, S. Bureau<sup>1</sup>, A. Geille<sup>1</sup>, D. Gaudillat<sup>1</sup>

<sup>1</sup> ARVALIS Institut du végétal, Station expérimentale, 91720 BOIGNEVILLE, France

\*corresponding author : [d.brun@arvalis.fr](mailto:d.brun@arvalis.fr)

### **Introduction**

The main types of seed drills available on the market are numerous and it is difficult to make the right choice. There are several evaluation criteria for a drill : practical, economics and also agronomical. The behavior of the drill and its ability to promote seeds germination are essential, in both the soil type of the farm and with its tillage practices.

### **Material and method**

This study synthetizes the different drill field trials conducted from 1998 to 2017 in the Arvalis experiment site of Boigneville (France). Tillage practices have been focused on minimum tillage with shallow tillage (ST) (around 5cm) or deeper working depth (15cm) but also on no till in cereal stubble (NTCS) or in living cover crop. Those trials have been conducted on differents crops such as winter cereals, oil seed rape, spring malting barley or spring pea. For every trial, we have measured different variables :

- The intermediate emergence percentage : it is calculated by making the link between standing plants and sown seeds. Intermediate emergence is a counting of standing plants right after sowing about one or two weeks. It quantifies the quick germinated seeds because of good seed placement.
- The final emergence percentage takes into account tall of the standing plants one or two months after sowing.
- Yield and every yield component are also measured depending on the crop

### **Results and discussion**

By synthetizing the whole results on the twenty drill trials done, we have been confronted with a non-systematic presence of each drill in each test that's why we decided to do it by sowing unit or sowing technique. Despite this, there were some voids in terms of sowing unit or tillage pratices. We decided to use a linear mixed model to analyse the fixed effects (tillage pratices and sowing unit and interaction) and the random effects (tests, year and interaction). For our analysis to be statistically robust, we had to dismiss some sowing units (slanted discs, integrated sufflok coulter drill with power harrow) because of too low of a representation. About tillage practices, we have only kept two modalities : shallow tillage (ST) and the no till in cereal stubble (NTCS).

Concerning crop final emergence, the sowing unit factor ( $P < 0.001$ ) as the tillage practice factor ( $P < 0.001$ ) are statistically significant. However, there is no sowing unit x tillage practice interaction ( $P = 0.094$ ). To go further, we did a Tukey test to classify sowing unit and tillage practice into homogenous groups with a confidence level of 0.95 (Table 1 & 2)



Table1 : Sowing units Tukey test for the final emergence

Sowing unit or sowing technique	Final emergence (adjusted mean)	Group
Sowing under the soil projection with a rotor	82.02	a
Tine drill with soil preparation module	78.80	ab
Sowing under the soil projection with discs	77.65	ab
Rigid tine drill	74.90	ab
Integrated disc drill with power harrow	74.12	ab
Disc drill with soil preparation module	74.11	ab
Broadcast seeding + shallow tillage	71.64	abc
Sowing in the soil projection	71.22	abc
Precision drill	70.22	abcd
Spring tine drill	67.86	bcd
Single disc no till drill	67.61	bc
Double disc no till drill	63.41	cd
Broadcast seeding + roller pass	53.67	d

Table2 : Tillage practices tukey test for final emergence

Tillage practices	Final emergence (adjusted mean)	Group
ST	74.10	a
NTCS	68.55	b

Shallow tillage allows better emergence than no till seeding. The best sowing units are those with much soil disturbance that create a fine seedbed for seeds and also for weeds.

### Conclusion

Most of the time, emergence differences during the beginning of the growing cycle become lower in terms of ear count, for example, because of tillering. Branching for oilseed rape show approximatively the same phenomom. When it comes to harvest time, there are generally no significant yield differences in most cases.

## Track versus Ultra Flexible Tire, impact on subsoil compaction

J.J.H. van den Akker

*Wageningen Environmental Research, P.O. Box 47, 6700AA Wageningen, The Netherlands*

[janjh.vandenakker@wur.nl](mailto:janjh.vandenakker@wur.nl)

### Introduction

Subsoil compaction is one of the soil threats mentioned in the European Soil Strategy. In dry periods the limited rooting depth can cause severe yield reduction by draught damage. In wet periods a heavy rain can result in waterlogging and a too long period with anaerobic conditions for the roots or storage organs e.g. potatoes, which can result in a complete loss of the yield. Too wet conditions can also be a problem for trafficability and soil tillage. The completely saturated topsoil results easily in run-off and contributes to erosion and flooding. According to Schjønning et al., (2015) at least 25% of the subsoils in agricultural use in the EU are compacted. A main cause of subsoil compaction is too high soil stresses exerted on the subsoil by heavy agricultural equipment. Nowadays the highest wheel loads in agriculture are around 150 kN (15 tonnes). However, on the other hand flexible low pressure tires and tracks are developed for use under heavy agricultural equipment. A test was performed by Wageningen Environmental Research, CAH Vilentum, the Swedish Agricultural University (SLU) and the farmers magazine Boerderij, to compare the effectiveness of flexible low pressure tires and tracks to reduce the exerted soil stresses on the subsoil and to prevent subsoil compaction.

### Materials and Methods

The focus of the field test is on the subsoil of a marine silty clay soil with 26% clay. The test was performed end of November on a very moist soil, however, it was still possible to harvest the sugar beet. Three pressure transducers were installed at a depth of 20 cm, with upper side of the transducers in the interface between topsoil and subsoil. One transducer was situated in the centre below the tire or track during driving over. One at a distance of 45 cm out of the centre below the sidewall of the tire or the edge of the track and one transducer at a distance of 22.5 cm of the centre half way the centre and sidewall of the tire or track edge.

Two 4-wheeled Vervaet 617 harvesters fully loaded with sugar beet were used in the tests. One harvester was equipped in the front with Zuidberg-tracks and the other harvester with ultra flexible Michelin CerexBb-IF 900/60R38 tires with an inflation pressure of 170 kPa according to the recommendation of the tire manufacturer. In the rear both harvesters were equipped with the regular Michelin 900/60 R32 MegaXbib-tires, with an inflation pressure of 130 kPa, which is well below the recommended inflation pressure of 210 kPa. During the tests the harvest equipment was lifted. The width of tire and track were both about 90 cm.

Soil stresses were calculated with the SOCOMO model (Van den Akker, 2004).

Soil samples with a diameter of 10 cm and a thickness of 3 cm were collected at a depth of 20, 30, 50 and 70 cm nearby the test site, however, at a place of which we were sure that the soil was not wheeled during the harvest operation. The samples were tested in the lab in an uni-axial test with a loading speed which is the same as the loading speed in the field.

### Results and Discussion

The measured weight on the track proved to be 16.76 Mg (load 167.6 kN) and the weight on the tire 14.15 Mg (load 141.5 kN). The foot-print of the track was  $90 \times 195 = 17,550 \text{ cm}^2$  and of the tire  $92 \times 117 = 10,795 \text{ cm}^2$ . The figure presents the results of the stress measurements at a depth of 20 cm. Left the results of the measurements underneath the track with a load of 167.6 kN. The stresses exerted by each roller can be seen clearly.

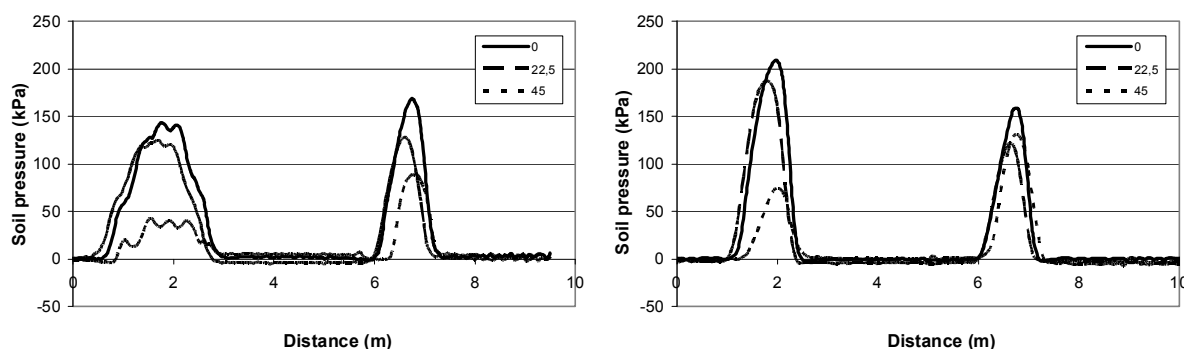

Soil pressures at a depth of approximately 20 cm underneath the centre and at 22.5 cm and 45 cm out of the centre of the track (left) or ultra flexible tire (right).

The maximum soil pressure is underneath the centre and is 142 kPa; at 22.5 cm out of the centre 121 kPa and at 45 cm out of the centre 42 kPa. This shows that the soil pressure distribution in a cross section under the track is certainly not even and has a more or less parabolic shape. Note that the maximum soil pressure underneath the rear tire is somewhat higher than underneath the track. In the figure right the soil pressures underneath the ultra flexible tire with an inflation pressure of 170 kPa and a load of 141.5 kN. The maximum soil pressure in the centre is 209 kPa; at 22.5 cm out of the centre 182 kPa and at 45 cm out of the centre 74 kPa. Also the soil pressure distribution in a cross section under the tire has a more or less parabolic shape. The soil pressures underneath the track are about 2/3<sup>th</sup> of the soil pressures underneath the tire.

With the SOCOMO model the maximum soil stresses underneath the centre of the track and the tire are calculated up to a depth of 100 cm. Calculated stresses at a depth of 20 cm agreed well with the measured values. A limit for soil pressure often used in the Netherlands is 100 kPa. Schjønning et al., 2012 proposed a 50-50 rule, which means that the traffic on agricultural soil should not exert vertical stresses in excess of 50 kPa at depths >50 cm. Considering these two rules of thumb, then both the track and the tire exceed the limit of soil pressure of 100 kPa at a depth of 20 cm and the 50-50 rule is exceeded more than 2 – 3 times. This suggests that although the track performs significantly better than the tire, the subsoil will still suffer severely from subsoil compaction.

The uni-axial test was performed on all soil samples collected at a depth of 20, 30, 50 and 70 cm with the soil pressures calculated with SOCOMO. All soil samples compacted and increased in dry bulk density.

## Conclusions

Both the ultra flex tire and the track have a large footprint which makes it possible to use heavy equipment on agricultural soils. Although the track is performing better than the ultra flex tire both will compact the subsoil considerably. The loads of 142 respectively 168 kN are just extreme and too heavy and exceed the bearing capacity of the subsoil.

## References

- Schjønning, P., van den Akker, J.J.H., Keller, T., Greve, M.H., Lamandé, M., Simojoki, A., Stettler, M., Arvidsson, J., Breuning-Madsen, H., 2015. Driver-Pressure-State-Impact-Response (DPSIR) Analysis and Risk Assessment for Soil Compaction—A European Perspective. In: Sparks, D.L. (Ed.), *Advances in Agronomy*, pp. 183–237.
- Schjønning, P., Lamandé, M., Keller, T., Pedersen, J., Stettler, M., 2012. Rules of thumb for minimizing subsoil compaction. *Soil Use and Management*, 28, 378–393.
- Van den Akker, J.J.H., 2004. SOCOMO: a soil compaction model to calculate soil stresses and the subsoil carrying capacity. *Soil & Tillage Research* 79, 113-127.

## Motion Study of Spike Entering the Soil of the Interlock Drive System

Volker Nannen<sup>1,2\*</sup>, Damian Bover<sup>1</sup>, David Reiser<sup>3</sup>, Dieter Zöbel<sup>2</sup>

<sup>1</sup> *Sedewa, Finca Ecologica Son Duri, 07250 Vilafranca de Bonany, Spain*

<sup>2</sup> *University of Koblenz-Landau, Universitätsstraße 1, 56070 Koblenz, Germany*

<sup>3</sup> *University of Hohenheim, Garbenstr. 9, 70599 Stuttgart, Germany*

\* corresponding author: [vnannen@gmail.com](mailto:vnannen@gmail.com)

### Introduction

Machines for intensive agriculture require drive power. Until now this has been generated mainly by frictional connection to the soil. A frictional connection needs weight to apply drive power. This weight shears and compacts the soil, reduces soil fertility, reduces water infiltration, increases water runoff and increases erosion. The generation of traction on a field is also possible via the interlock drive system, where narrow articulated spikes penetrate the ground at regular intervals and push the vehicle horizontally over the ground, avoiding the vertical pressure of wheels (Bover, 2011). The interlock drive system can provide high tractive power for productive agriculture using lightweight construction and little energy consumption, as has been demonstrated in over 30 prototypes (Nannen et al., 2016). Many of the fundamental working principles of this new drive system are not yet properly described. This makes it difficult to design a machine for specific soil and operating conditions without adjustment and refitting in the field. So, it is unclear until now whether an implementation with a few long spikes will operate more efficiently than an implementation with more but shorter spikes. It has also not been examined how the degree of compaction and the amount of soil moisture affect the efficiency of the spike and how the horizontal motion of a spike depends on soil conditions.

### Material and method

For the present study, we attached a spike with a lever to a movable joint as originally proposed by Bover (2011). When a horizontal backward force is applied to such an articulated spike, it rotates and penetrates into the soil until the opposing force of the soil halts the movement of the spike. A forward force pulls the spike out of the soil. The spike has a backward and downward inclination of 45° from horizontal when out of the soil, and an inclination of up to 80° from horizontal when penetrating into the soil. The system is self-regulating because the spike only penetrates as deep into the soil as needed to generate the required tractive force. For a full description see Nannen et al. (2016) or view the videos at <http://sedewa.com>. To study the motion dynamics of such an articulated spike when it enters the soil under force, an articulated spike was attached to a horizontal cable, such that a horizontal pull can be applied to the joint in a controlled manner. As the pull increases, the spike rotates into the soil. Its deepest point (the tip) moves both vertically and horizontally in the soil. During the experiment, the load was increased in increments of 50 N, and the degree of inclination of the lever and the horizontal motion of the joint was measured. From these measurements, the motion of the tip of the spike in the soil can be calculated with basic trigonometric functions. The experiments were done on silty clay loam in Vilafranca de Bonany, Spain. In total three different compaction levels of soil were investigated: loose, medium, and compacted soil. Each compaction level was investigated in dry and wet conditions, resulting in six different soil variations. Each variation was repeated three times and results were averaged.

### Results and discussion

Graphs a) and b) in Figure 1 show the horizontal and vertical (depth) motion of the tip in the soil as a function of horizontal pull applied to the spike. The ratio of pull force to tip motion is approximately but not exactly linear and diminishes with increasing pull. This is likely caused

by increasing soil strength with depth. a) shows that the effect of pull on horizontal tip motion depends on soil moisture and the degree of soil compaction. In dry soil the horizontal displacement of the tip measured up to twice as much as in wet soil. The maximum horizontal displacement of the tip was measured in dry loose soil and the minimum in wet loose soil. The depth of the tip reached -50 mm in dry compacted soil, while in loose and wet soil the tip went deeper into the soil, with a maximum of -250 mm for wet loose soil.

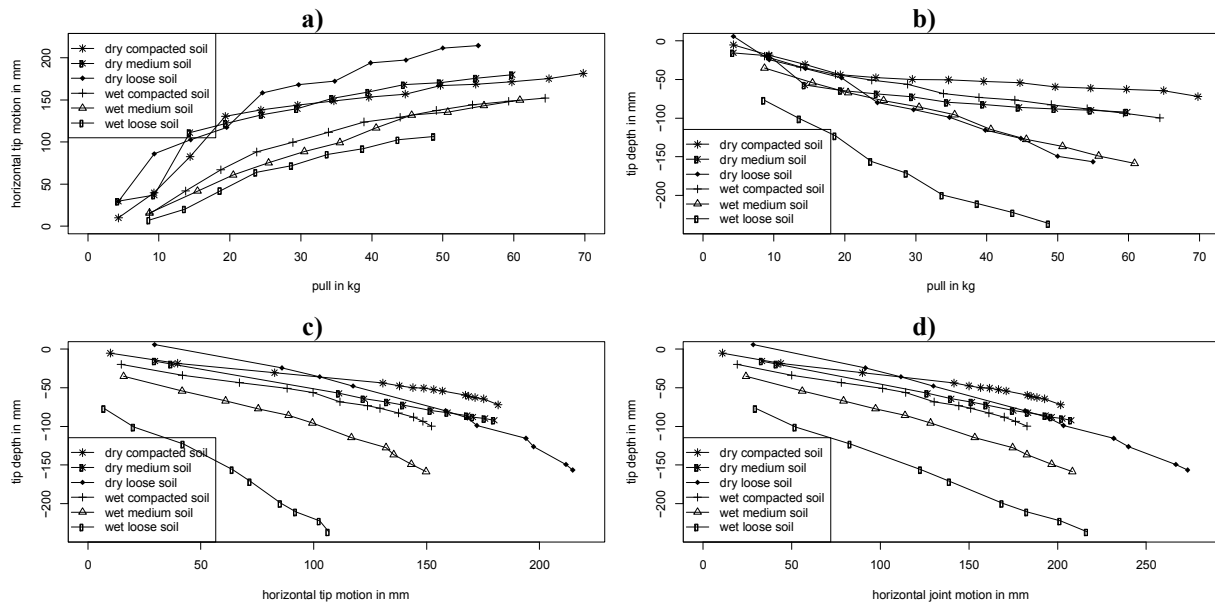

Figure 1: The horizontal x-axes show the applied pull force in N or the resulting horizontal motion in mm. The vertical y-axes show the corresponding horizontal or vertical (depth) motion of the tip in mm.

Graphs c) and d) show how the depth of the tip changes with the horizontal displacement of the tip and the joint. Despite the fact that the articulated spike rotates into the soil, the relation of horizontal to vertical tip motion in the soil is very linear for all soil types. Only the slope changes, especially for wet loose soil. c) and d) also show that for dry soil, the degree of soil compaction has little effect on the slope, while for wet soil, the slope increases with decreasing degree of soil compaction. Especially in wet loose soil, the tip can enter three to four times as deep as in dry loose soil for the same amount of horizontal tip motion.

## Conclusion

The results show a close to linear relationship between pull force and horizontal tip motion, as well as between pull force and vertical tip motion. This suggests that for a given pull force, the horizontal tip motion in the soil is inversely proportional to the number of spikes over which an implementation of the interlock drive system distributes the pull force. Likewise, the more spikes an implementation has, the less deep they will penetrate into the soil for a given pull force. The slope of this linear relationship is expected to be steeper in dry than in wet soil. Another conclusion is that the interlock drive system can generate pull on wet soil, and that it penetrates wet soil more than twice as deep as dry soil for the same pull force, which is a factor when designing for the maximum penetration depth of a spike.

## References

- Bover, D., 2011. Autonomous Self-Actuated Ploughing Implement. PCT WO2012010722, US Pat. 9,144,188, Span. Pat. ES2351140.
- Nannen, V., Bover, D., Zöbel, D., McKenzie, B. M., and Ben Avraham, M., 2016. UTOPIUS: A Novel Traction Mechanism to Minimize Soil Compaction and Reduce Energy Consumption. ISTVS 8th American Conference, Detroit.

## Waterjet cutting of crop residue using the *Aqua-Till*<sup>TM</sup> liquid coultter – A laboratory evaluation

Orang Taki<sup>1</sup>, Jack Desbiolles<sup>2\*</sup>, Greg Butler<sup>3</sup>

<sup>1</sup> Isfahan Agricultural and Natural Resources Research Center, AREEO, Isfahan, Iran

<sup>2</sup> University of South Australia – Agricultural Machinery R&D Centre, SA 5095 Mawson Lakes, Australia

<sup>3</sup> South Australian No-Till Farmers Association, Clare, SA 5453, Australia

Corresponding Author: [jack.desbiolles@unisa.edu.au](mailto:jack.desbiolles@unisa.edu.au)

### Introduction

The quality of no-till crop seeding outcomes is often reduced by the interactions of tine or disc style furrow openers with crop residue, inducing residue clumping or hairpinning, respectively, both hindering crop establishment. The *Aqua-Till*<sup>TM</sup> liquid coultter (<https://www.aquatill.com>) is an innovative adaptation of ultra-high pressure (UHP) waterjet cutting technology, recently developed in Australia for the no-till cropping sector. The technology uses a nozzle tool (Fig. 1a), placed ahead of the seeding system opener, producing a very fine liquid jet (<0.3 mm) under ultra-high pressure (up to 3,800 bar) to cut through large amounts of crop residue. The volume application rate (L/ha) is influenced by the nozzle flow rate (orifice size and pressure), seed row spacing and operating speed, and the ability to maximise the residue cutting capacity at the least volume rate has a critical influence on the adoption potential in no-till cropping contexts.

### Method

A laboratory study at the University of South Australia recently investigated the impact of stubble factors (moisture content  $m_c$ , bulk compression  $\Delta = 0$  to 62%, stem direction  $\beta = 90$  vs  $30^\circ$ ) and technology factors (nozzle size  $\phi = 0.15$  to  $0.30$  mm, forward speed  $v = 6$  to  $12$  km/h, stand-off distance  $s = 5$  to  $70$  mm) on the residue cutting capacity, with the aim to quantify the capabilities of this technology in its intended no-till context of use. A stem holder tray (Fig. 1b) was

designed and manufactured to hold a known quantity of uniform stems (calibrated to t/ha, dry conditions) of wheat straw in a controlled direction ( $\beta$ ) and under an adjustable compression level ( $\Delta$ ). The ‘wet’ straw batch was prepared just prior to testing with 45min soaking in water, 15min draining, and sealed storage until testing (the process thus increased  $m_c$  from 9% to 69%, wet basis). The tray was driven at a set speed under the powered UHP jet of a stationary nozzle, set at an accurate stand-off distance. The treatments were organised in a randomised block design (up to 4 replications) and data were acquired by carefully counting the numbers and levels (0-100%, in gradual steps) of stem cuts, expressed as a weighted proportion of the initial stem number, thus deriving an equivalent cut residue load which, at the maximum operating pressure ( $P_{\max} = 3,800$  bar), expresses the ‘residue cutting capacity’ of a nozzle, in dry residue t/ha.

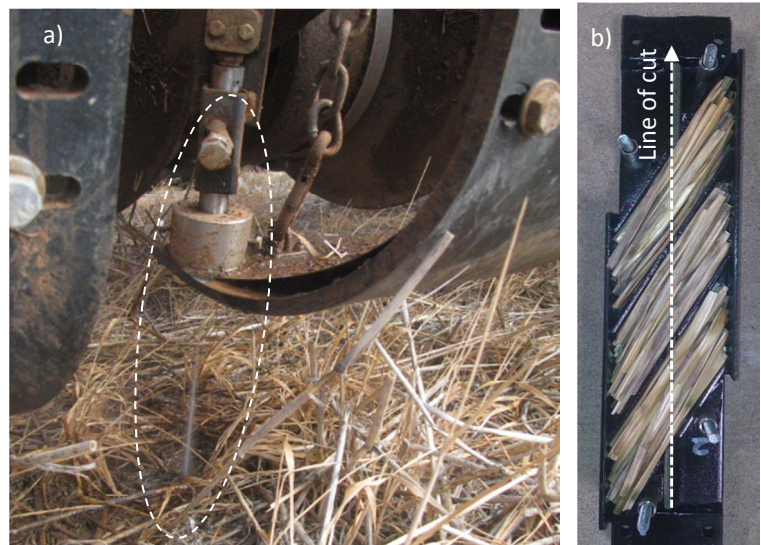

Fig. 1: a) *AquaTill* nozzle on ski holder with a disc seeder, b) top view of straw stem holder tray for  $30^\circ$  angle laboratory tests



## Results and discussion

The pressure and wheat stubble factor response data acquired for a common 0.2mm nozzle size ( $v = 6\text{ km/h}$  and  $s = 5\text{ mm}$ ) highlighted very significant benefits from both stubble compression and wet condition (in the order of: compressed+wet > compressed+dry > loose+wet > loose+dry) with an additional benefit measured under  $\beta = 30^\circ$ , but significant only in the uncompressed (loose) state. This ranking did not vary over the 1700-3800 bar experimental pressure range, and overall, the wheat residue cutting capacity of the 0.2mm nozzle could be increased from 8.5 t/ha to 20.2 t/ha (= 140% increase) solely by optimising timing (moisture), nozzle holder design (compression) and field operation (cutting direction), clearly indicating the importance of a best practice approach to boost the adoption potential of this technology in no-till cropping contexts.

Fig. 2 shows the nozzle summary data of dry residue cutting capacity vs volume rate per ha, indicating the relatively low impact of speed except in the mid-range nozzle size investigated (0.23-0.25mm), and the large impact of nozzle size. At a common seed row spacing (e.g. 0.3m) for winter crops in many regions of Australia, a 12 t/ha residue cutting capacity (i.e. sufficient for 6.5 t/ha wheat grain yield crop at average harvest index values of 0.35 to 0.4) is expectable under wet and compressed optimum stubble conditions with a smaller nozzle size (0.18mm). This is associated with

acceptable water volume rates (< 220 L/ha) at speeds above 8 km/h. Summer crop applications (e.g. row spacing 0.5-1m) would be able to support much higher residue cutting capacity (2-3 fold) for the same water volume rate per ha. Differences between laboratory and field conditions will require the above capacity values to be adjusted for field use with an efficiency factor (focus of continuing work), and matched to the maximum residue load found across often highly variable field stubble conditions, to ensure practical success in the field.

## Conclusions

A laboratory evaluation of UHP waterjet cutting technology confirmed very high residue cutting capacity and showed a great technology fit as a 'liquid coultter' for no-till cropping, operating at its most efficient under the normally most challenging wet residue conditions. The data suggest the need for a best practice approach optimising technology and field operations to maximise the efficiency of residue cutting in no-till contexts and facilitate industry adoption.

**Acknowledgments:** Funding from Australian Grains Research and Development Corporation and Iran government sabbatical scholarship, support from Flow International and technical assistance of Andrew Bird, Dean Thiele and Dr Ali Khosravani are all gratefully acknowledged.

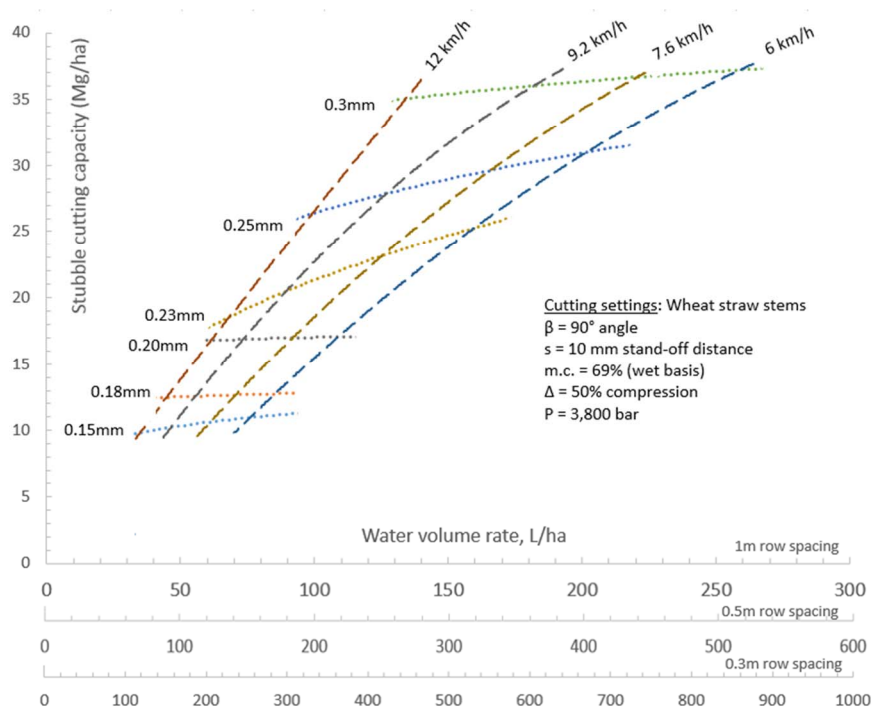

**Fig. 2: Mapping of residue cutting capacity vs volume rate at 3 row spacings for a range of nozzle sizes and forward speeds**

## Development and Performance Evaluation of a Reciprocating Weeding Machine for Commodity Crop Production

Adesoji Matthew Olaniyan<sup>1\*</sup>, Folasayo Titilola. Fayose<sup>1</sup>, Babatope Albert Alabandan<sup>1</sup>, Ayodele Anthony Fajimi<sup>2</sup>, Kayode Samuel Ogunleye<sup>2</sup>, Olanrewaju Johnson Omoju<sup>3</sup>, Oluwafemi John Aladejebi<sup>4</sup>, Oluwaseun Ayodele Ilesanmi<sup>1</sup>

<sup>1</sup>*Department of Agricultural and Bioresources Engineering, Federal University, Oye Ekiti, Nigeria*

<sup>2</sup>*Department of Crop Science and Horticulture, Federal University, Oye Ekiti, Nigeria*

<sup>3</sup>*Department of Soil and Land Resources Management, Federal University, Oye Ekiti, Nigeria*

<sup>4</sup>*Department of Agricultural Economics and Extension, Federal University, Oye Ekiti, Nigeria*

\* Corresponding author: adesoji.olaniyan@fuoye.edu.ng

### Introduction

Weed control is one of the most difficult tasks in agriculture that accounts for a considerable share of the cost involved in agriculture production. Manual weeding is till the common practice in most African countries. Although the use of chemicals for weeding has been adopted in several places, its side effects have been a major concern. In this study, a prototype of motorised weeding machine, actuated by a reciprocating mechanism was designed and fabricated for use on most commodity crops plots.

### Materials and Methods

While designing and in material selection, consideration was given to techno-economic status of the small scale farmers in the rural communities who are the intended users of the machine. The major components of the weeder include the cutting blade, main frame, speed reducing gear, stanchion, wheels, reciprocating arms, shafts, IC Engine, Chain and sprocket, coupler. The draft requirement for the blade was determined according to the general soil mechanics equation by Hettiaratchi et al (1966). The data required for the design of the cutting blade is as shown in Table 1

Table 1: Required Data for the Design of the Blade

---

Rake Angle,  $\alpha = 30^\circ$  [for minimum draught, weed cutting below soil surface, good disturbance of weed, both for sparsely and intensely distributed weeds].

Working depth of blade  $b = 2.54\text{cm}$

$\phi =$  angle of shearing resistance of soil  $= 30^\circ$

$\delta =$  angle of soil/interface friction  $= 10^\circ$

$c =$  cohesion  $= 10 \text{ KNm}^{-2}$

$C_\alpha =$  adhesion  $= 3.5 \text{ KNm}^{-2}$

$\sigma =$  soil unit weight  $= 17.3 \text{ kN/m}^3$

Surcharge pressure  $= 0$

It is assumed that the soil type is plastic loam.



The thickness of the blade was determined by assuming that the force on it will act at its centroid and that the thickness should be able to withstand any bending and rotation effects on the blade. Other machine elements were designed according to PSG TECH (2016) procedures. The reciprocation prevented the need to move the blades back and front as this action is automatically achieved in one process.

## Results

The first angle orthographic drawing of the weeding machine showing the front, side and plan projections of the machine is shown in Figure 1. The blades are three in number and are arranged in such manner as to allow for an effective width of cut of 28cm, spreading little beyond the width of the machine frame which is 25cm wide.

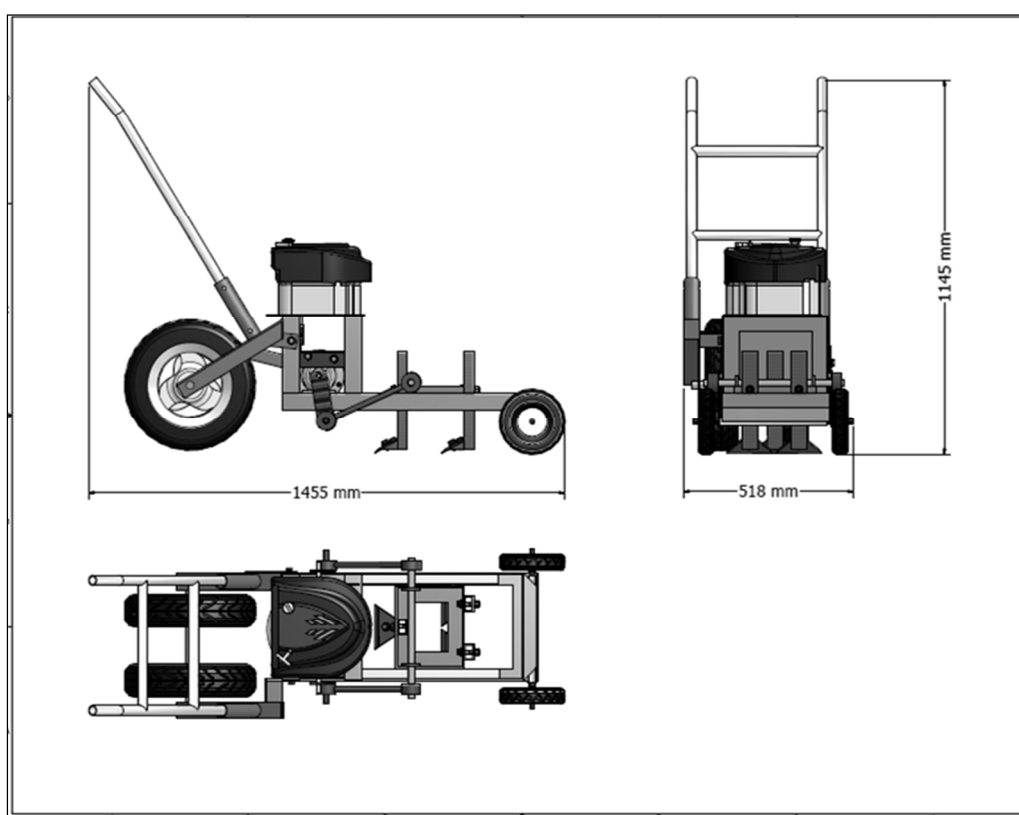

Figure 1: Orthographic Projection of the Reciprocating Weeding Machine

After fabrication and assembly, the machine was tested on a 1-hectare field planted with maize and test result indicated a functional efficiency of 98%, quality performance efficiency of 92.7% and field capacity of 0.03m<sup>2</sup>/s as against 0.01m<sup>2</sup>/s with manual weeding. The materials for the construction was sourced from locally available materials. Powered by a 5 kW compression-ignition internal combustion engine (CI-ICE), and a production cost of NGN 126, 000.00 (USD 380).

**Keywords:** Weeding, machine design, PSG TECH, reciprocating mechanism, Africa

## References

Hettiaratchi, D.R.P., B.D. Witney and A.R. Reece. 1966. *The calculation of passive*

*pressure in two-dimensional soil failure. J. Agric. Eng. Res. 11(2):89-107.*

*PSG TECH Design Data (2016). compiled by Faculty of Mechanical Engineering, PSG College of Technology, Coimbatore, India.*

## Trends in the Development of Cassava Stem Planter

\*M. O. Ale,<sup>1\*</sup> S. I. Manuwa<sup>2</sup>

<sup>1</sup>Department of Agricultural and Bio-Environmental Engineering, Rufus Giwa Polytechnic, Owo Ondo State, Nigeria.

<sup>2</sup>Department of Agricultural and Environmental Engineering, Federal University of Technology, Akure, Nigeria

\*Corresponding Email: alebosunenator@gmail.com

### ABSTRACT

Cassava is now grown throughout the tropical world with annual global production at approximately 276 million tonnes. Nigeria is the largest producer of cassava in the world accounting for 19 % of the global production. Cassava is mainly planted with cut stem at a spacing of 1m x 1m. Manual stake production is tedious and time consuming. The production rate per person is about 5000 stakes per day and about 100000 stakes are required per day for mechanized commercial planting. Some cassava planters have been developed but they have not been commercially available to farmers in Nigeria. There have been attempts made in research on mechanical planting of cassava stems. The prototype-planters from the previous research include cassava planter model PC-2; cassava planter model PMT-3; automatic cassava planter model 3; commercial prototype of model 3; Thailand cassava planter model; NCAM-developed cassava stem planter and a single-row cassava stem planter. However, this critical review has revealed that all the mechanical planters require extra labour for feeding of the stems for cutting and planting of the stakes. Therefore, projection for an improved mechanical planter named single-row cassava stem planter with semi-automatic metering system is recommended for research. This improved planter will eliminate the extra labour required by the existing mechanical planter as well as providing such labour for other farm operations for the present and future demand of cassava products

**Keywords:** cassava, planting, stem planter, mechanization, review

## The contribution of tyre-evolution to the reduction of soil compaction risks

L. ten Damme<sup>\*1</sup>, M. Stettler<sup>2</sup>, F. Pinet<sup>3</sup>, P. Vervaeet<sup>3</sup>, T. Keller<sup>4,5</sup>, L. J. Munkholm<sup>1</sup>, M. Lamandé<sup>1,6</sup>

<sup>1</sup> Faculty of Agricultural Sciences, Department of Agroecology and Environment, University of Aarhus, Research Centre Foulum, P.O. Box 50, DK-8830 Tjele, Denmark

<sup>2</sup> Bern University of Applied Sciences, School of Agricultural, Forest and Food Sciences HAFL, Länggasse 85, CH-3052 Zollikofen, Switzerland

<sup>3</sup> Michelin Ladoux, rue Bleue – ZI de Ladoux, 63118 Cebazat, France

<sup>4</sup> Agroscope, Department of Agroecology & Environment, Reckenholzstrasse 191, CH-8046 Zürich, Switzerland

<sup>5</sup> Swedish University of Agricultural Sciences, Department of Soil & Environment, P.O. Box 7014, SE-75007, Uppsala, Sweden

<sup>6</sup> Norwegian University of Life Sciences, Faculty of Environmental Sciences and Natural Resource Management, Campus Ås, Universitetstunet 3, 1430 Ås, Norway

\* corresponding author: [ltd@agro.au.dk](mailto:ltd@agro.au.dk)

The use of today's heavy machinery in agriculture brings a great risk of soil degradation by compaction. Subsoil compaction persists for decades, thus reduction of the risk of subsoil compaction is extremely important. The risk of compaction is governed by the soil capacity to resist stress (soil strength) and by the stress induced by a vehicle. The stress distribution in the contact area between the tyre and the soil is of primary importance for the stresses propagating in the soil. Hence, tyre characteristics affect soil stress and the risk of compaction. Tyre manufacturers develop new technologies and designs to respond to the increasing concerns for soil deformation during traffic. However, no objective evaluation of tyre evolution to the protection of soil structure has been performed yet. The objective of this study was to compare effects of five tractor tyres introduced between 1970's and 2017 on soil stress and soil structure. Contact stress distribution was estimated using the FRIDA model. Soil stress propagation and soil physical properties were quantified in a field experiment on a clay soil in Clermont-Ferrand, France in March 2018. A wheel load of 4,300 kg was chosen for all five tyres and the load-rated inflation pressures ranged from 0.6 – 2.4 bar. Bolling probes were installed to determine the mean normal stress at three depths (20, 40, and 60 cm) beneath the centre and at 30 cm outside of the centre, at the edge of the three newest tyres. Soil physical properties before and after one pass of each of the five tyres were measured on undisturbed soil cores (100 cm<sup>3</sup>) sampled at 30 cm. Preliminary results of stress measurements showed a lowest mean normal stress at all depths with newer tyres, both below the centre of the tyre as at the edge, even though the effect decreased with increasing depth. Air permeability at 30 cm depth showed no significant effect (P-value 0.068 at 5% significance level), but was low for all treatments and characterized by a narrow range. These preliminary results indicate that tyre design can play an important role in reducing soil stress for a given wheel load. Tyre design might then also help reducing the compaction risk for larger wheel loads and other soil conditions than tested in the present study.

## High speed planting : trial results and recommendations for maize

D. Brun<sup>1\*</sup>, P. Denis<sup>2</sup>

<sup>1</sup> ARVALIS Institut du végétal, Station expérimentale, 91720 BOIGNEVILLE, France

<sup>2</sup> Chambre d'agriculture de région Alsace, 4 rue Adolph Mohler, 67210 OBERNAI, France

\*corresponding author : [d.brun@arvalis.fr](mailto:d.brun@arvalis.fr)

### Introduction

For a maize grower, planting is certainly the most important operation because of all the consequences it entails: hybrid establishment, population, seeding depth, row width, starter fertilizer and so on... To obtain a good regular spacing, planting speeds traditionally range from 4 to 7 km/h. With new planter machinery, more and more manufacturers claim to be able to travel up to 15km/h while keeping the same planting accuracy.

### Material and method

From the year 2012 to 2016, we tested the high-speed planting concept with different makes of planter in order to be representative of the machinery offer. The trials were conducted on different soil types but with two seedbed types : very well prepared and more difficult conditions with stones or clods. We sowed different hybrids over the years but we use an analytical approach within a year between different planters : same sowing date, same density, same hybrids, same seeding depth objective and same settings between speed modalities. For the majority of trials, we have evaluated the high speed concept by comparing 7, 11 and 15 km/h. After emergence, we have measured the seeding performance within a row : coefficient of variation, the quality of feed index, the multiple index and the miss seeding index. Moreover, we checked the planting depth for certain trials and monitored these field trials up to the harvest with grain moisture, yield and thousand grain weight being measured.

### Results and discussion

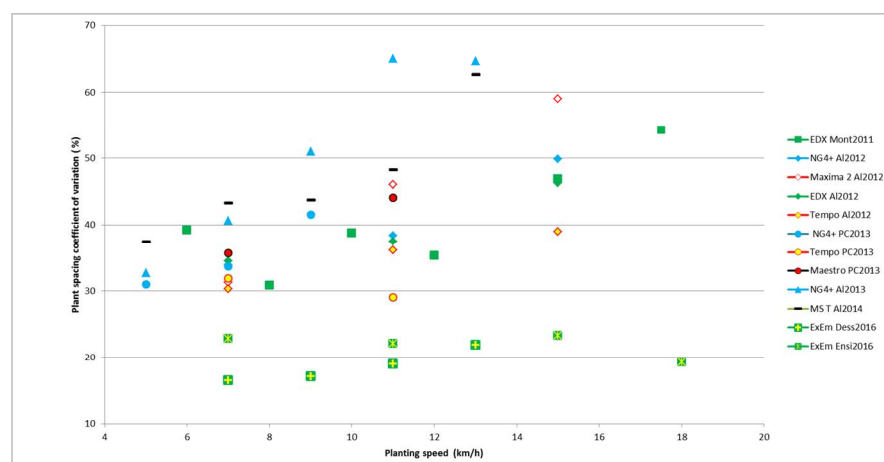

Figure1 : Plant spacing coefficient of variation for the different trials

Planter speed and planter brand influenced coefficient of variation of in-row plant spacings (Figure1). Increasing planting speed resulted in higher coefficient of variation which means a irregular plant spacing. This global trend does not affect the different planters in the same way : some of them such as *Väderstad Tempo* or *John Deere ExactEmerge* were able to keep a good precision level even at high speed. Logically, the classical planters (double disc opener and seed tube without air pressure or brush belt) have the worst performances because of seed bouncing in the seed tube. Planting depth is the other very important factor that can affect maize yield due to staggered maize emergence. Increasing planting speed resulted in shallower planting depth for classical row units whereas high speed planter row units are heavier or with variable down pressure so that they can keep the targeted depth even for high speed.

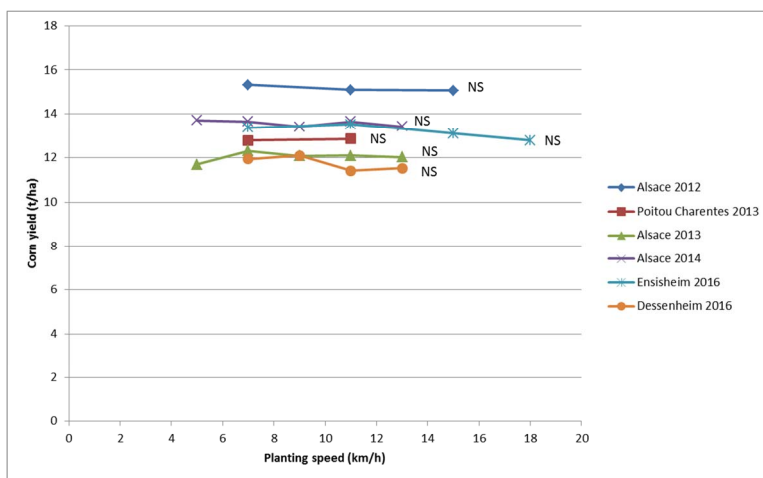

Figure2 : Maize yield for the different trials

(Figure2) For every trial, maize yields do not vary statistically between different planting speeds (Staggenborg et al, 2004). It means also that within row plant spacing variability does not affect grain yield.

**Conclusion**

With this new planting approach, farmers need to think differently because of a much greater operational field capacity linked with a higher power demand (Bertonha et al, 2014). Moreover, because of a higher price per unit, those planters warrant economic analysis before any investment (Dillon et al, 2017).

**References**

Bertonha R.S., Furlani C.E.A., Raveli M.B., Zerbato C and Cavichioli F.A., 2014. Planter speed and plant establishment in maize hybrids seeding. *Cientifica*. 42. 325-329.

Dillon R.C., Shockley J.and Mark T., 2017. The sensitivity of economic gains from high-speed planting. *Advances in Animal Biosciences*. 8. 662-667

Staggenborg SA., Taylor R.K. and Maddux, L.D., 2004. Effect of planter speed and seed firmers on maize stand establishment. *Applied Engineering in Agriculture*. 20(5). 573-580

## Evaluating the working quality of the universal trained seed drill KUHN ESPRO 6000 R.

E. Gojard<sup>1\*</sup>, G. H. Schuchmann<sup>2</sup>

<sup>1</sup> KUHN SA, 67706 Saverne, France

<sup>2</sup> DLG Test Center Technology and Farm Inputs, 64823 Groß-Umstadt, Germany

\* corresponding author: [eugenie.gojard@kuhn.com](mailto:eugenie.gojard@kuhn.com)

### Introduction

A “DLG-APPROVED test for individual criteria” quality mark is awarded to farm machinery that has passed a limited test programme within a DLG usability test which is conducted in accordance to independent and approved assessment criteria. The purpose of the test is to highlight a product’s specific innovations and key features. The test may be carried out either to criteria laid down in the “DLG Full Test” framework for technical products or may include further features and properties that confirm a specific value to the product. The minimum standards to be applied to the product, the test conditions and procedures as well as the criteria by which the test results are to be evaluated are defined in cooperation with a DLG group of experts. These parameters reflect the acknowledged state of the art as well as scientific findings and agricultural insights and requirements. After a product has passed the test, a test report is published and the quality mark is awarded and will remain valid for five years from the date of award.

### Material and method

The machine that was submitted to the “Work Quality Test” is the KUHN ESPRO 6000 R universal seed drill. The machine was tested on the test bench (laboratory test) where two parameters - metering accuracy and lateral distribution – were determined with rape, barley and wheat using a stationary positioned seed drill. Field tests began with rape sowing on August 25, 2016. Work quality data were collected and evaluated during sowing and three to five weeks later.

During the laboratory test, the metering accuracy and the seed distribution crosswise to the direction of travel are determined with a stationary machine with rape, barley and wheat for two different working speeds. Both parameters are determined for rape and barley with a horizontally levelled machine. For wheat, work on slopes is simulated additionally.

The “metering accuracy” test parameter determines whether the quantity metered by the seed drill is equal to the calibrated quantity. Rape seeding is simulated for one hectare, whereas the simulation area is reduced to 1/10 hectare for barley and wheat. A lower and a higher working speed is defined. Speeds are selected according to manufacturer’s recommendations. For wheat, the seed hopper is filled at two different levels (high and low level). For barley and rape, all tests are performed with a low level. The lateral seed distribution is determined for rape, barley and wheat, and is conducted with the machine in horizontally levelled as well as raised position. For rape and barley the parameter is only tested on level ground, while for wheat slope driving is simulated additionally. The seeds placed by each coulter are collected with a container and weighed. The coefficient of variation is calculated from the different quantities of collected seeds. The smaller the coefficient, the more uniform is the amount distributed by each coulter across the working width.

For a DLG field test, it is necessary to at least sow rape and wheat. During the test, the history of the field, the sowing conditions and the driving speeds are documented. The sown varieties are characterized by variety, breeder and thousand-seed weight. The germination capability of the seed is determined in the laboratory. For the description of the test conditions, soil samples are taken on the day of the sowing to determine the soil moisture in the seed bed. The

soil moisture is determined according to DIN 18121. During sowing, the metering accuracy is checked on each field. Three to five weeks after sowing, the field emergence is determined. Therefore, the plants are counted at several representative spots in the field. Afterwards, the field emergence is evaluated according to the DLG test framework. The germination capability determined in the laboratory is taken into account. Three to five weeks after sowing, the plant distribution in the direction of travel is determined. To do this, a measuring tape is positioned along a seed row, which is representative for the machine. Afterwards all wheat plants, which are emerged in sections of 5 cm each of the measuring tape are counted over a length of 15 meters. For rape, the longitudinal distribution is evaluated over a length of 30 meters. All plants located within 15 cm long sections are counted. The variation factor is calculated from the plant counts per section. It gives a clear indication on how uniformly the plants are distributed in the row. For wheat, the depth placement is determined through random sampling. Three to five weeks after sowing, 50 consecutive plants are uncovered in order to measure their hypocotyl section, which is located below the soil surface.

**Results and discussion**

Test criterion	Test result
Metering accuracy for wheat	Deviation from target and actual amount: very low
Metering accuracy for barley	Deviation from target and actual amount: very low
Metering accuracy for rape	Deviation from target and actual amount: very low
Lateral distribution for wheat	Good on level ground/good to satisfactory on the slope
Lateral distribution for barley	Satisfactory on level ground
Lateral distribution for rape	Very good on level ground

Table 1: Results of the laboratory tests (metering accuracy and lateral distribution)

Test criterion	Test result
Metering accuracy for rape sowing	Deviation from target and actual amount: very low (1.1 %)
Field emergence – rape	Good (87 %)*
Longitudinal plant distribution – rape	Very good (variation factor: 0.7)
Metering accuracy for wheat sowing	Deviation from target and actual amount: very low (2.2 %)
Field emergence – wheat	Very good (92 %)
Longitudinal plant distribution – wheat	Good (variation factor: 1.0)
Depth placement of wheat grains	Target depth: 3-4 cm Actually measured depth: 1.8-4.1 cm Average: 3.1 cm Standard deviation: 0.5 cm**

\* under rather dry sowing conditions

\*\* the smaller the standard deviation, the more even the depth placement of the seeds

Table 2: Results of the field tests with rape and wheat

**Conclusion**

The KUHN ESPRO 6000 R universal seed drill achieved satisfactory to very good results in the laboratory test. During the field tests very good and good results were achieved with winter rape and winter wheat. Based on the results obtained, the KUHN ESPRO 6000 R universal seed drill was awarded the test mark “DLG APPROVED” for the test criterion “work quality” in 2016.

*References*

Schuchmann G. H., 2016. *DLG Test report 6421*.













