



HAL
open science

Adapting DEXiPM model for ex post assessment of the sustainability of innovative cropping systems

Gabriele Fortino, Vasileios Vasileiadis, Frédérique Angevin, Elise Pelzer,
Antoine A. Messean

► To cite this version:

Gabriele Fortino, Vasileios Vasileiadis, Frédérique Angevin, Elise Pelzer, Antoine A. Messean. Adapting DEXiPM model for ex post assessment of the sustainability of innovative cropping systems. 12. Congress of the European Society for Agronomy (ESA12), Aug 2012, Helsinki, Finland. 600 p. hal-02749867

HAL Id: hal-02749867

<https://hal.inrae.fr/hal-02749867>

Submitted on 3 Jun 2020

HAL is a multi-disciplinary open access archive for the deposit and dissemination of scientific research documents, whether they are published or not. The documents may come from teaching and research institutions in France or abroad, or from public or private research centers.

L'archive ouverte pluridisciplinaire **HAL**, est destinée au dépôt et à la diffusion de documents scientifiques de niveau recherche, publiés ou non, émanant des établissements d'enseignement et de recherche français ou étrangers, des laboratoires publics ou privés.



Abstracts



**12th Congress of the
European Society for Agronomy**



Helsinki, Finland, 20-24 August 2012

ORGANISERS, SUPPORTERS, EXHIBITORS, SPONSORS



12th Congress of the
European Society for Agronomy
Helsinki, Finland, 20-24 August 2012

Abstracts



Abstracts of ESA12, the 12th Congress of the European Society for Agronomy, Helsinki, Finland 20-24 August 2012.
Edited by F.L. Stoddard and Pirjo Mäkelä.

Reviewers:

Marc Benoit	Jaume Lloveras
Olaf Christen	Donal Murphy-Bokern
José Paulo de Melo e Abreu	Sari Peltonen
Marcello Donatelli	Krystyna Rykacewska
Henrik Eckersten	Roxana Savin
Brian Fowler	Jaswinder Singh
Felix Herzog	Elizabeth Stockdale
Heikki Hokkanen	Hartmut Stützel
Kari Jokinen	Muriel Valantin-Morison
John Kirkegaard	Christine Watson
Jouko Kleemola	Jacques Wery
Kristina Lindström	Xinyou Yin

Helsinki, Finland: University of Helsinki, Department of Agricultural Sciences publication series, volume 14.

ISBN is 978-952-10-4323-9 (online)

ISSN 1798-744X (online)

ISSN-L 1798-7407

Layout:

Tinde Päivärinta/PSWFolders Oy

Parameterisation of a phenological model of winter oilseed rape

Böttcher, Ulf¹; Rampin, Enrico²; Flenet, Francis³; Kage, Henning¹

¹CAU Kiel, GERMANY; ²University of Padova, ITALY; ³CETIOM, FRANCE

Introduction

For many purposes a detailed description of phenological development is needed. It is essential for the timing of management measures, it is needed for an understanding of how weather conditions in different phases of the growth might influence the yield formation and also crop simulation models rely on an accurate description of development for the timing of different growth processes. For winter oilseed rape (WOSR) a detailed phenological model with high resolution is still missing. Furthermore in WOSR the concurrent development of vegetative, generative and reproductive organs on OSR plants makes OSR phenological surveys complicated and imprecise. In this study we aimed to achieve a robust parameterisation of a phenological model valid for a wide range of environments and varieties by using a very large data set without requiring too much precision of every single observation.

Material and Methods

The phenological model BRASNAP-PH (Habekotté 1997) was implemented in the object oriented modelling framework HUME (Kage & Stützel 1999) which allows for parameter optimisation using large data sets. Furthermore the model was

extended to calculate phenological development in a higher resolution using the BBCH coding system. Phenological development is mainly driven by the daily mean temperature above a base temperature of 3°C. In the phase from emergence until the end of stem elongation it is additionally influenced by the effects of vernalisation and photoperiodic response. The model was parameterised and validated using a large amount of data originating from different sources in Germany, France and Italy. The data are covering locations in all WOSR growing regions in Germany and France and one location in northern Italy. The data were collected from 1993 until 2010 and contain different varieties. The parameterisation was performed stepwise starting with parameters influencing the first development step and data relevant for this period and then going on to parameters in the later stages of development.

Results

The model is able to predict differences in the phenological development for different environments only based on differences in weather data with one common parameterisation for all locations. The comparison of one location in Germany and the Italian location shows that due to a much earlier sowing date the development advances further in Germany than in Italy before winter (Fig. 1). In spring however development is much faster in Italy due to higher temperatures. The overall prediction accuracy of the model for the validation data set is characterised by a root mean squared error (RMSE) of 2.8 BBCH stages or 21.2 days. The regression line of simulated vs. observed data is very close to the 1:1 line with an r^2 of 0.97 (Fig. 2). The highest deviation in terms of days between measured and simulated occurrence of the BBCH stages is in the phase from emergence to the beginning of stem elongation. All other phases have an RMSE of less than 9.5 days.

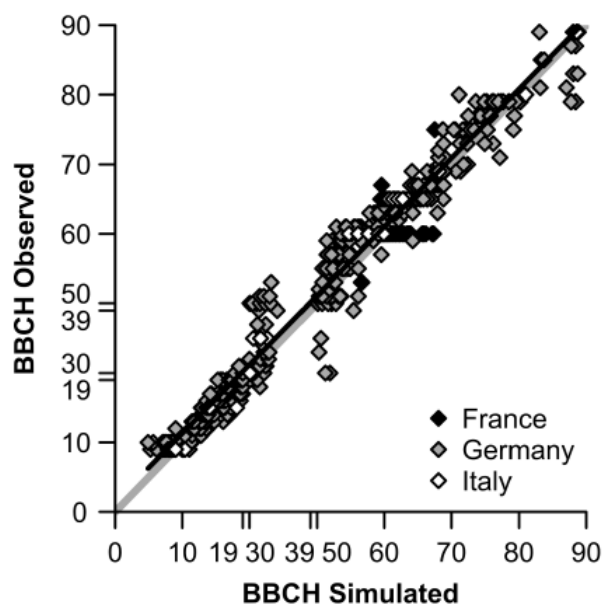

Figure 1: Overall model performance for arbitrarily chosen validation datasets of Germany (Gerswalde, 2002) and Italy (Legnaro, 2009).

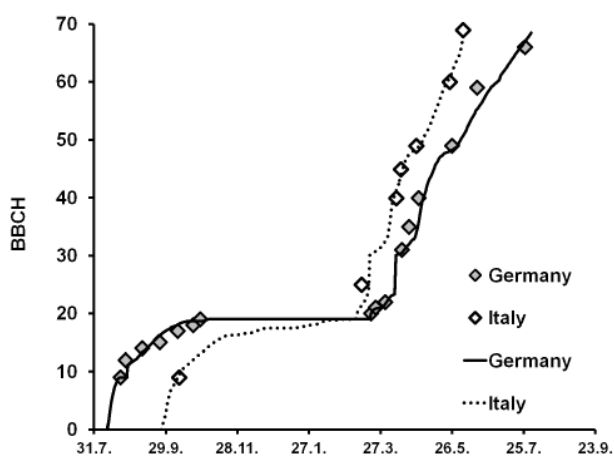

Figure 2: Simulated vs. observed BBCH stages for the validation data set. Solid line is the linear regression, dashed line the 1:1 line.

Conclusion

The model presented is an efficient prediction tool for the winter oilseed rape phenology according to the BBCH coding system. It was able to predict the crop development with a high degree of accuracy for a large range of years, sowing dates and locations across France, Germany and Italy.

References

- Habekotté, B., 1997: A model of the phenological development of winter oilseed rape (*Brassica napus* L.). *Field Crops Res.* 54, 127-136.
- Kage, H., Stützel, H., 1999. HUME: An object oriented component library for generic modular modelling of dynamic systems. In: Donatelli, M., Stockle, C., Villalobos, F., Villar Mir, M. (Eds.), *Modelling Cropping Systems*. European Society of Agronomy, Lleida, pp. 299-300.

Sink strength for S as a major parameter to model vegetative growth in oilseed rape (*Brassica napus* L.) under contrasting sulfur (S) supplies

Brunel-Muguet, Sophie¹; Goudier, Damien²; Trouverie, Jacques²; Avice, Jean Christophe²; Etienne, Philippe²; Mollier, Alain¹; Ourry, Alain²

¹National Institute of Agronomic Research (INRA), FRANCE; ²Université Caen Basse Normandie, FRANCE

Introduction

Oilseed rape (*Brassica napus* L.) production will be faced to an increasing demand in the next three decades because of higher worldwide needs for edible oil and biofuel industry. Besides, it is a high sulfur (S) demanding crop (Zhao et al., 1999). The dwindling occurrence of S deficiency due to reductions in (i) sulfur dioxide emissions from industrial activities and (ii) high S containing fertilizers (Blair, 2002) has led to consider S nutrition as a burning issue to maintain high yield and to meet nutritional and energetic objectives. In this study, a model of the vegetative growth has been developed to highlight the most important carbon (C) and S related processes that drive vegetative growth under contrasting S supplies.

Material and Methods

Plant cultivation and growth

Plants (n=3) cv.Yudal were grown in greenhouse under two contrasting S supplies (high S, HS and low S, LS) and collected at 4 harvest dates until early flowering corresponding to GS16, GS30, GS55, and GS65 (BBCH decimal system, Lancashire et al., 1991). At each harvest, leaf area of photosynthetic leaves (L_{Aph} including green and senescing leaves) and dry weight (DW) of each organ were measured and S amount (Q_s) was determined by mass spectrometry. Temperature and incident radiation were hourly recorded for thermal time (TT) and photosynthetically active radiation (PAR) calculations.

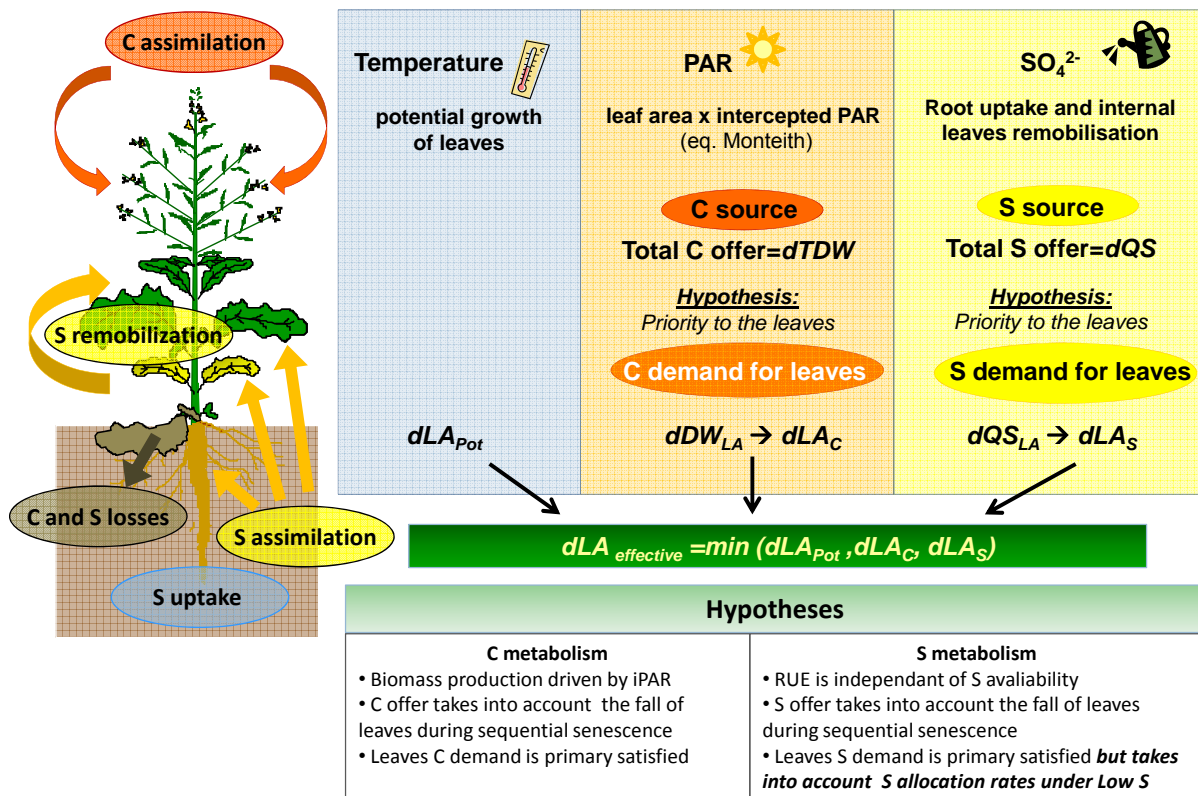

Figure 1. Modelling C/S whole-plant functioning.

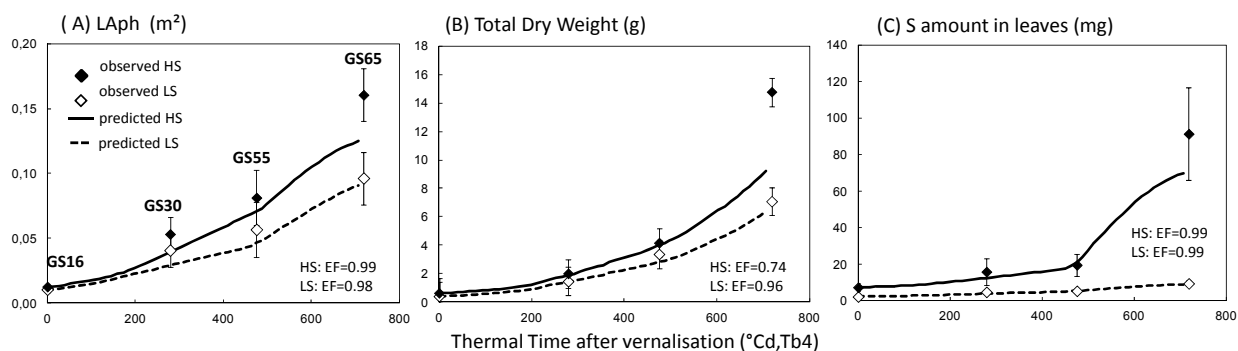

Figure 2 : Observations and predictions of (A) leaf area of photosynthetic leaves (LA_{ph}), (B) Total Dry Weight and (C) S amount in photosynthetic leaves under HS and LS. Model Efficiency (EF) is given for both S-treatments in insert.

Ecophysiological model construction

The build-up of the model was based on the dynamics of offer and demand as in other crop models which combine the effects of C assimilation (Monteith et al., 1977) and nutrient uptake and utilization (Brisson et al., 1998; Mollier et al., 2008). Effective LA_{ph} expansion rate ($LAER$) was determined as the minimum of (i) potential $LAER$ controlled by air temperature, (ii) $LAER$ allowed by C assimilation and (iii) $LAER$ allowed by S uptake. In our model, allocation rules were assigned to C and S demands of the leaves in order to test their sink strength for C and S throughout vegetative growth (Fig. 1)

Results and discussion

Model parameterization and evaluation

Formalism used for S demand and offer differ according to S-treatment

Similar formalisms underlying C offer and leaf C demand were used for both LS and HS unlike S offer and demand. Indeed, RUE values were not statistically different between HS and LS. Besides, leaf C demand is primary satisfied with similar C leaf allocation rates whatever S supply. By contrast, a sharp increase in S absorption was observed at inflorescence emergence under HS only, leading to different adjustment for Q_s uptake. Besides, S leaf allocation (% total Q_s) decreased from 85 to 65% for HS and 55% for LS. Thus, although leaf S demand was primary satisfied, leaf S allocation rates were introduced under LS to consider a significant lower sink strength. *Simulations of LA_{ph} , total DW and Q_s of leaves* For all the output variables, the modeling efficiency (EF) values indicated good accuracy (Fig. 2). Predictions underestimated observed values under HS at GS65 but differences between HS and LS observations were correctly simulated.

Differences in leaf sink strength were observed between S treatments from pod development

Difference in sink strength can be accounted for either sink size and/or sink activity. According to S supplies, S allocation differs unlike C allocation. Altogether, these results mean that leaf S allocation is not only driven by the sink size but also by the sink activity i.e. S storage activity. High residual amount of SO_4^{2-} (main storage form) in senescing leaves under HS support this hypothesis (data not shown).

Conclusion

Modeling vegetative growth is of major importance to determine the available pools of S and C for reproductive parts and to avoid damages on pods by rectifying S inputs. This simulation study allows the importance of S related physiological processes (e.g. storage and therefore capacity for remobilisation) to be focused on, by comparing plant responses to contrasting S supplies.

References

- Blair GJ, 2002. Sulphur fertilisers: A global perspective. Proceedings No.498. International Fertiliser Society, York.
- Brisson N, et al, 1998. *Agronomie* 18, 311-346.
- Lancashire PD, Bleiholder H, Langelüddecke P, Stauss R, Van Den Boom T, Weber E, Witzten-Berger A. 1991. *Annals Appl Biol* 119, 561-601.
- Mollier A, De Willigen P, Heinen M, Morel C, Schneider A, Pellerin S. 2008 *Ecological Modelling* 210, 453-464.
- Monteith JL. 1977. *Philos. Trans. R. Soc. Lond. B Biol. Sci.* 281, 277-294.
- Zhao FJ, Hawkesford MJ, McGrath S. 1999. *J Cereal Sci* 30, 1-17.

A new approach for calculating stomatal resistance of wheat as a step towards dynamic simulation of canopy temperature

Neukam, Dorothee; Boettcher, Ulf; Kage, Henning

University of Kiel, GERMANY

Introduction

Under given meteorological conditions canopy temperature (T_{crop}) depends on actual transpiration and therefore is an indicator of drought stress. Fast and easy detection of spatial and temporal drought stress variation with infrared thermometry offers useful applications for phenotyping, site specific management and decision support. For these purposes T_{crop} must be normalized by meteorological conditions according to the energy balance at the crop surface (Jackson et al. 1981). Then, assuming steady state and flux independent resistances, the ratio of actual to potential transpiration can be calculated, indicating stomata closure as consequence of limited water availability. For gaining information about the plant and soil parameters causing drought stress from T_{crop} a coupled soil crop atmosphere model capable to simulate daily courses of T_{crop} provides a promising framework.

Materials and methods

For model development and parameterization a plot experiment with wheat (*Triticum aestivum* cv. Dekan) within a rainout shelter was conducted in two years (2010, 2011) with three treatments (Wo non irrigated from beginning of march, W1 irrigated to 80% field capacity and W2 to 100% field capacity). Weekly measurements were made for volumetric water content at 5 depths (TDR), green area index (LAI 2000) and canopy height. Minutely measured T_{crop} , air temperature (T_{air}), relative humidity, wind speed and net radiation were averaged over an hour. An effective soil water potential within the rooted soil layer (Ψ_{root}) was derived from model calculations using measured water contents, soil texture and simulated root distribution. From May until July diurnal courses of stomatal conductance (g_s) for water vapour were measured (LI6400) on 4 fully expanded young leaves in one plot of each treatment. The reciprocal value of the measured g_s , converted from mole to velocity units (McDermitt 1990) and then averaged, gave the stomatal resistance (r_s). Evapotranspiration was calculated at an hourly time step using the model, coupling crop growth and soil water balance. In order to calculate actual transpiration and T_{crop}

directly from the energy balance a new function of r_s was derived and implemented.

Results and Outlook

Temperature differences between treatments are clearly detectable (Fig. 1) indicating the cooling effect of high transpiration rates for the W1 and W2 plots resulting in T_{crop} being lower than T_{air} in contrast to Wo, where transpiration decreased resulting in T_{crop} being higher than T_{air} . These findings are also reflected in the measured r_s (Fig. 2) being lower in the irrigated plots and not increasing until withholding of irrigation.

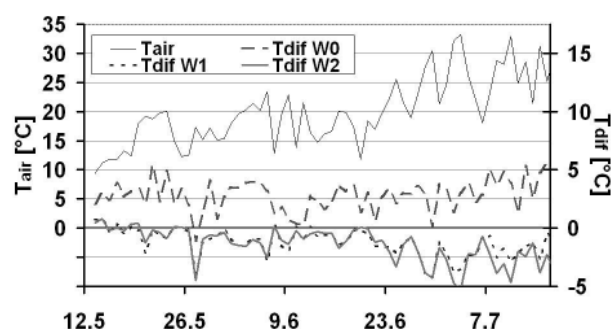

Fig.1 Midday air temperature (T_{air}) and canopy to air temperature differences (T_{dif}) in 2010.

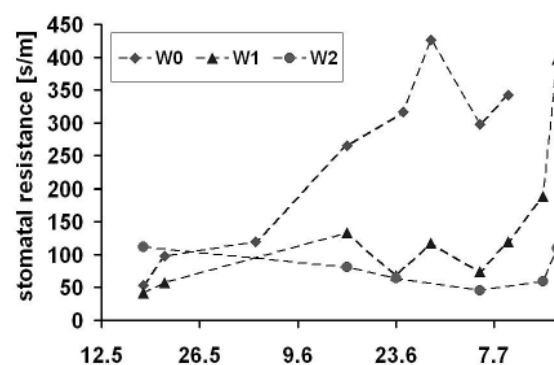

Fig2. Midday stomatal resistances (r_s) in 2010.

The shown midday values are only one detail of underlying distinct diurnal courses of measured T_{crop} and r_s . For simulation of high temporal resolution of actual transpiration and T_{crop} a function of r_s is deduced from the observations and implemented into the model. According to meteorological and soil conditions r_s is calculated as

$$r_s = \max(34 + a \cdot (25 - T_{\text{air}})^2, b - c \cdot \text{VPD} \cdot (d - \psi_{\text{root}}))$$

with VPD = vapour pressure deficit and a, b, c, d = fit parameters.

Under drought stress r_s depends on ψ_{root} and VPD, in absence of drought stress r_s depends on T_{air} as a main influence for the potential rate of photosynthesis. Now, further model parameterization is in progress concerning the scaling up from stomatal to canopy resistance and water transport and uptake resistances in order to simulate T_{crop} and water uptake from different soil layers.

References

- Jackson, R.D, S.B. Idso, R.J. Reginato & P.J. Pinter (1981) Canopy Temperature as a Crop Water Stress Indicator. *Water Resources Research* 17 (4), 1133-1138.
- McDermitt, D.K. (1990) Sources of Error in the Estimation of Stomatal Conductance and Transpiration from Porometer Data, *HortScience* 25(12), 1538-1548.

Explaining the yield advantage of wheat-maize intercropping from plant responses to available space using functional-structural plant modelling

Zhu, Junqi; Vos, Jan; van der Werf, Wopke; Evers, Jochem B.
Wageningen University, NETHERLANDS

Introduction

Intercropping is the simultaneous presence of two or more crop species on the same field. Intercropping is practised for various reasons, including higher aggregated yield per unit area, reduced risk in terms of income and food supply and suppression of pests and diseases. Spring wheat – maize is a common relay strip intercrop systems in north China. It is called a 'relay intercrop' because wheat is planted and harvested earlier than maize and 'strip intercrop' because sets of rows of wheat alternate with rows of maize. 'Overyielding', i.e. the yield benefit of the intercrop, compared to yield of sole crops (Willey, 1985), was reported for wheat-maize in China (Li et al., 2001), and also observed under Dutch conditions (unpublished). Many factors need to be considered in the optimization of such systems, e.g. row configuration, planting times, cultivar characteristics, supply of water and nutrients and agronomic measures (e.g. plastic mulch). Optimization of such systems is much helped if the mechanisms resulting in overyielding are identified.

Hypotheses

We hypothesize that overyielding arises from a larger amount of radiation being intercepted in intercrop systems as compared to sole crops. We also hypothesize that both structural and functional adaptation mechanisms of individual plants contribute to overyielding. Structural adaptations of wheat include the number of tillers produced, tiller death and perhaps leaf orientation. Structural adaptation in maize include changes in leaf orientation and leaf size. 'Leaf orientation' being the inclination of a leaf to fill a gap in the canopy where there is space, i.e. light. Functional adaptation would consist of higher nitrogen concentration – and associated photosynthesis rate – in leaves receiving more light. Also

the phyllochron could vary with growth conditions (Birch et al., 1998). We hypothesize that cessation of tillering is induced if the red : far red ratio of the light reaching the wheat plant's base drops below a threshold value (Evers et al., 2006). One research question is how the plant integrates red : far red signals from different directions.

Methodology

We are conducting experiments in the field as well as under controlled conditions to test and quantify these mechanisms. We use Functional-structural plant models (FSPM) that describe in quantitative terms the development over time of the three-dimensional structure of plants as governed by physiological processes and as affected by environmental factors such as temperature and the distribution of light (PAR or red and far red) (Vos et al., 2010). FSPM is the appropriate tool to model the structural and functional development of each individual plant – as these are related to the plant's light environment. Performance of the canopy arises from the behaviour of a limited collection of simulated individual plants. We use GroIMP as a simulation tool (Hemmerling et al., 2008). Analyses are foreseen to simulate system performance in relation to row configuration, planting times and other relevant environmental and agronomic factors.

Results

Preliminary results indicate that the prime mechanism of adaptation of wheat plants to available space is a variable number of tillers per plant. In maize several variables determining the foliar production depended on the plant spacing, including the phyllochron, leaf sizes and leaf rank of peak in leaf size.

References

- Birch, C.J., Vos, J., Kiriya, J., Bos, H.J., Elings, A., 1998. *Field Crops Research* 59, 187-200.
- Evers, J.B., Vos, J., Andrieu, B., Struik, P.C., 2006. *Annals of Botany* 97, 649-658.
- Hemmerling, R., Kniemeyer, O., Lanwert, D., Kurth, W., Buck-Sorlin, G., 2008. *Functional Plant Biology* 35, 739-750.
- Li, L., Sun, J., Zhang, F., Li, X., Yang, S., Rengel, Z., 2001. *Field Crops Research* 71, 123-137.
- Vos, J., Evers, J.B., Buck-Sorlin, G.H., Andrieu, B., Chelle, M., de Visser, P.H.B., 2010. *J. Exp. Bot.* 61, 2101-2115.
- Willey, R.W., 1985. *Experimental Agriculture* 21, 119-133.

A new generation of SUCROS-type models: an example for WOFOST and rice simulations

Stella, Tommaso; Negrini, Giorgio; Frasso, Nicolò; Bregaglio, Simone; Confalonieri, Roberto
University of Milan, ITALY

Introduction

The model WOFOST (van Keulen and Wolf, 1986) provides a detailed representation of the processes involved with crop growth and development; however it is characterized by a large number of parameters. Part of the parameters are organized into tables (AFGEN) describing changes in the values of some variables as a function of temperature or development stage (DVS). This leads to a considerable parameterization effort and exposes to risks during calibration: AFGEN tables could in fact lead to inconsistent parameterizations (e.g., partitioning to leaves increasing while cereals get close to flowering), and limit the possibility to couple the model with sensitivity analysis and automatic calibration tools. Another critical aspect, in this case related to modelling choices, is the division of the canopy in a fixed number of layers, with dead leaf area index (LAI_{dead}) distributed among all the layers according to the points of a Gaussian

Integration. In this way, LAI units at the top of the canopy (theoretically the youngest) die at similar rate as the oldest ones, with part of dead LAI units shading green ones.

Methodology

AFGEN were replaced with functions defined by one or few parameters with a clear biological meaning, e.g., the AFGEN accounting for thermal limitation to photosynthesis was substituted by a curvilinear function, with only three editable parameters (cardinal temperatures). This version of the model was named WOFOST_GT, from which another version (WOFOST_GT2) was developed to allow the model to explicitly consider the vertical dimension of the canopy, by including a model for plant height and another for increasing number of canopy layers (function of DVS). Leaves

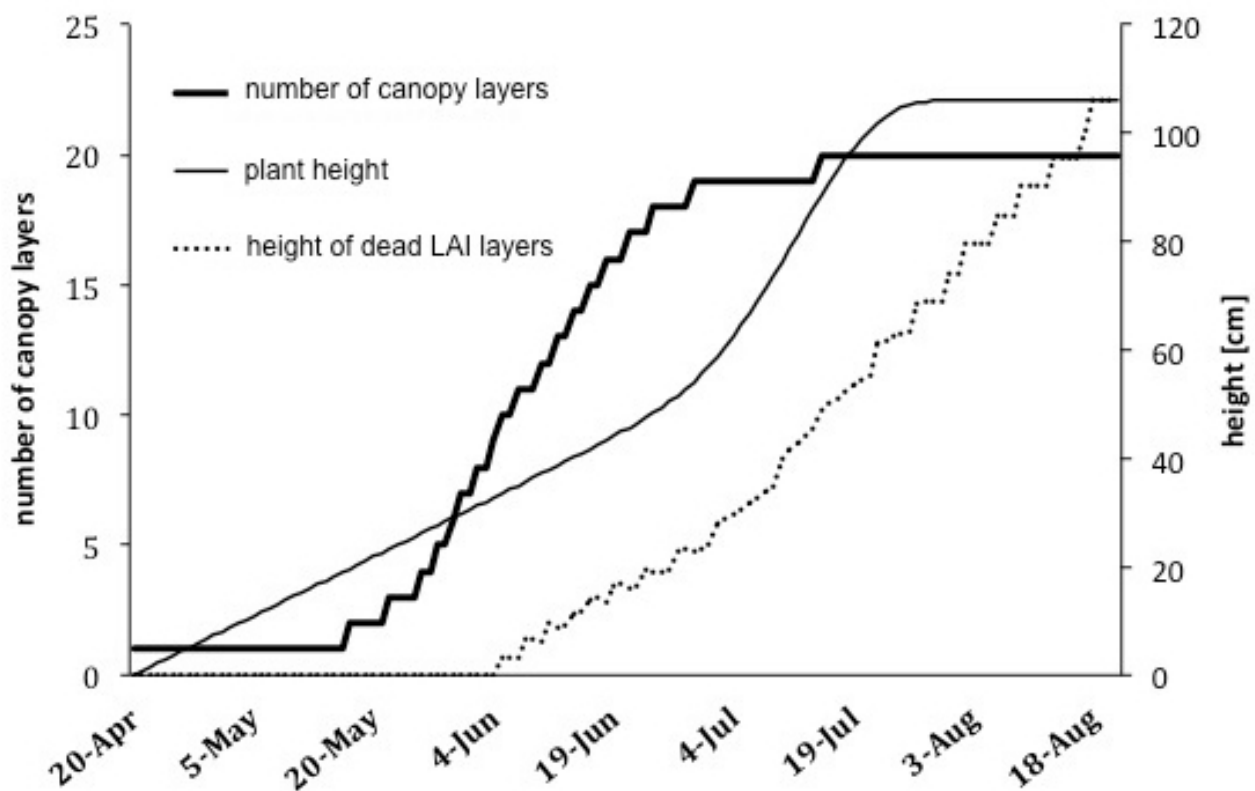

Figure 1. Total number of canopy layers, plant height and height of the dead-LAI layers.

Table 1. Performance indicators for the standard WOFOST and for the new versions.

Evaluation metric	WOFOST	WOFOST_GT	WOFOST_GT2
RRMSE (relative root mean square error, %)	25.9	19.8	23.3
EF (modelling efficiency)	0.929	0.939	0.920
I _R (robustness indicator, Confalonieri et al. 2010)	0.387	0.342	0.415
AIC (Akaike's Information Criterion, Akaike, 1974)	280.9	112.9	132.1
Total number of parameters for potential conditions	106	36	37

senescence, due to aging and self-shading, is simulated to occur from the bottom of the canopy towards the top by subtracting the LAI_{dead} to the total LAI of the lowest living layer(s) (Figure 1).

Results and discussion

The new versions of WOFOST were calibrated and evaluated with the datasets described by Confalonieri *et al.* (2009). Comparing simulated and measured values of aboveground rice biomass, WOFOST_GT achieved the best accuracy metrics although having only one third of the original number of parameters: these preliminary results indicate that the number of model parameters can be reduced without compromising the quality of estimates. WOFOST_GT2 showed similar performances, with an improved accuracy compared to the original version (Table 1).

Conclusions

This study allowed both to simplify the original version of WOFOST (36 parameters instead of 106 for WOFOST_GT, 37 for WOFOST_GT2) and to improve the representation of the canopy structure, potentially leading to a more adherent simulation of micrometeorology and other biophysical processes (e.g., biotic and abiotic damages), thus extending the model application domain (WOFOST_GT2). These changes increase the usability of the original model, without compromising the high level of detail in

representing biophysical processes. Further development will be the definition of other functions to replace AFGEN tables to adapt the model for other crop types.

References

- Akaike H., A new look at the statistical model identification. *IEEE Transactions on Automatic control* 19, 716-723, 1974.
- Confalonieri R., Acutis M., Bellocchi G., Donatelli M., Multi-metric evaluation of the models WARM, CropSyst, and WOFOST for rice, *Ecological Modelling*, 220 (11), 1395-1410, 2009.
- Confalonieri R., Bregaglio S., Acutis M., A proposal of an indicator for quantifying model robustness based on the relationship between variability of errors and of explored conditions. *Ecological Modelling*, 221, 960-964, 2010.
- Van Keulen H., Wolf J., Modelling of agricultural production: weather, soil and crops. Simulation monographs, Pudoc, Wageningen, 1986.

Soil-plant interactions and Australia's conservation farming revolution: sense, nonsense and roots to success

Kirkegaard, John; Hunt, James; Kirkby, Clive; Watt, Michelle; Rebetzke, Greg; Wasson, Anton; Peoples, Mark; Bissett, Andrew; Donn, Suzanne; Richardson, Alan
CSIRO National Sustainable Agriculture Flagship, AUSTRALIA

Introduction

Australia has doubled its broad-acre crop yields in the last 30 years and leads the world in the adoption of conservation agriculture (CA) principles (76% of arable land). Reduced (or no)-tillage, permanent surface cover and diverse rotations make sense in extensive dryland cropping on erosion-prone, structurally unstable soils. The evolution of these systems involved considerable pragmatism, not rigid principles, by understanding the soil-plant interactions driving crop response (1). We discuss selected examples of unexpected and often counterintuitive plant responses in CA systems and how understanding soil-plant-microbe interactions underpinned solutions to improve productivity in sustainable ways.

Strategic tillage

Soil properties are expected to improve under no-till systems and irreparable damage to soil from even occasional tillage has been claimed. Our long-term (22-yr) study showed that while many soil properties "improve", no-till systems can also favour root diseases (e.g. *Rhizoctonia solani*) and inhibitory bacteria that build up on the slow-growing root tips of wheat in hard, undisturbed soils (2). Narrow deep seeding tines that disturb only below the seed, earlier sowing or vigorous wheat varieties could all improve root vigour and yield. New DNA techniques revealed little evidence that the structure and function of the soil bacterial community was compromised under long-term tillage (3). The pragmatic concept of "strategic tillage" is practiced by a majority of Australian farmers, as it preserves the labour, fuel and water-saving benefits of no-till but accommodates occasional soil disturbance to deal with specific agronomic issues (4).

Stubble retention and C-sequestration

CA systems involving residue retention and no-till are also expected to increase soil organic carbon (SOC), but

SOC buildup is often nonexistent or frustratingly slow. We recently demonstrated the relatively constant ratios of C:N:P:S in the stable SOC (humus) for a wide range of soils, a consequence of its largely microbial origin (5). Supplementary nutrients added with incorporated crop residues according to these ratios significantly increased the C-sequestration revealing a nutrient rather than C-input limitation to C-sequestration. The microbial mechanisms involved are yet to be elucidated but the findings have significant implications for those promoting the merits of CA for C-sequestration.

Crop sequence

The diversity of legume and oilseed break crops has increased recently in Australia and the benefits to subsequent cereals in the rotation has been quantified (6). Beyond N-fixation and disease break benefits, other effects on soil biology related to the release of isothiocyanates from Brassica roots (biofumigation) and hydrogen released from legume nodules have also been investigated. The non-mycorrhizal status of the two most widespread break crops (canola and lupin) raised concern about possible impacts on the P-nutrition of subsequent cereals but we found little evidence that mycorrhizae were important for wheat production in Australia (7). Despite the increase in break crop area, intensive cereals dominate cropping systems (64-84%) and we have recently investigated the possibility that wheat cultivars vary in their performance in wheat monoculture as a result of rhizosphere biology.

Utilising subsoil water in CA systems

Improved capture and storage of soil water has been a major success of CA systems (8), and more effective use of the water stored is a priority. We have quantified the benefit of deep stored soil water (9, 10), demonstrated that deep roots in dense structured subsoils are located primarily in cracks and biopores (11) and investigated a range of management strategies and breeding targets to improve extraction of deep soil water by wheat crops (12).

References

- 1 Kirkegaard JA, Peoples MB, Angus JA and Unkovich M (2012) Diversity and evolution of rain-fed farming systems in southern Australia. In 'Rainfed Farming Systems' (Eds P Tow, I Cooper, I Partridge, and C Birch) pp. 715-754, Springer, Dordrecht, Netherlands.
- 2 Watt M, Kirkegaard JA and Passioura JB (2006) Rhizosphere biology and crop productivity. *Australian Journal of Soil Research* **44**: 299-317
- 3 Bissett A, Richardson AE, Baker G, Thrall P and Kirkegaard JA (2012) Microbial community response to tillage and nutrient addition in a long-term dryland wheat cropping system. *Journal of Microbial Ecology* (in press)
- 4 Kirkegaard J, Conyers M, Hunt J, Kirkby C, Watt M, Rebetzke G (2011). Sense and nonsense in conservation agriculture: Principles, pragmatism and productivity in Australia mixed farming systems. 5th World Congress of Conservation Agriculture, September 2011, Brisbane www.wcca2011.org.
- 5 Kirkby CA, Kirkegaard JA, Richardson AE, Wade LJ, Blanchard C, Batten G. (2011) Stable soil organic matter: a comparison of C:N:P:S ratios in Australian and International soils *Geoderma* **163**, 197-208.
- 6 Kirkegaard JA, Christen O, Krupinsky J, Layzell D (2008) Break crop benefits in temperate wheat production. *Field Crops Research* **107**: 185-195.
- 7 Ryan MH, Kirkegaard JA (2012) The agronomic relevance of arbuscular mycorrhizas in the fertility of Australian extensive cropping systems. *Agriculture, Ecosystem and Environment* (in press)
- 8 Kirkegaard JA and Hunt JR (2010) Increasing productivity by matching farming system management and genotype in water-limited environments *Journal of Experimental Botany* **61**, 4129-4143.
- 9 Hunt JR, Kirkegaard JA (2011) Re-evaluating the contribution of summer fallow rain to wheat yield in southern Australia. *Crop and Pasture Science* **62**, 915-929.
- 10 Lilley JM and Kirkegaard JA (2011) Benefits of increased soil exploration by wheat roots. *Field Crops Research* **122**, 118-130.
- 11 White R, Kirkegaard JA (2010) The distribution of wheat roots in a dense structured subsoil – implications for water uptake. *Plant Cell and Environment* **33**: 133-148
- 12 Wasson AP et al (2012) Traits and selection strategies to improve root systems and water uptake in water-limited field crops. *Journal of Experimental Botany* (in press)

WORMDYN : a dynamical model to predict earthworm populations and communities dynamics

Moreau-Valancogne, Pascaline¹; Bertrand, Michel¹; Pelosi, Céline²; De Oliveira, Tatiana¹; Roger-Estrade, Jean³

¹INRA Grignon, FRANCE; ²INRA Versailles, FRANCE; ³AgroParisTech, FRANCE

Introduction

It is established for long that earthworms play a key role on soil structure and fertility. More recently, they have been recognized to enhance plant growth and health. However, earthworms abundance and activity are affected by cultural practices, climate and soil conditions. Therefore, modelling population dynamics is necessary to forecast the effect of cropping in order to determine the best management practices maximising earthworm positive impact on soil fertility and plant growth.

We are developing a population dynamics model (Wormdyn) that predicts earthworm abundance changes with time and soil conditions (temperature and water content). The first version was focused on *Lumbricus terrestris* an anecic worm. In this study, we present a second version of the model, which was adapted from the first one to predict population dynamics of an endogeic species (*Aporrectodea caliginosa*).

Materials and methods

Earthworm life cycle is decomposed into four age-stages: cocoons, juveniles, sub-adults and adults (Fig. 1).

Wormdyn predicts the number of individuals per unit area, active within the ploughed layer of a cultivated

field, in each age-stage. Abundances in each age-stage are fixed by a Leslie matrix whose parameters are the probabilities to stay at a given age-stage, to move to the next or to produce cocoons. All the parameters of this matrix are dependent on soil conditions. Those conditions correspond to four soil condition classes, defined by a combination of soil temperature and water content thresholds.

We also took into account the density dependence. Using an application of the Verhulst function, an increase of earthworm density reduces the probability of transition from juvenile to sub-adult stage, and from sub-adult to adult stage.

Results and discussion

A. caliginosa abundances were measured in an experimental field in Northern France in 2010. They were rather well predicted by the model (Figure 2), even if the number of adults was underestimated at the end of the simulation period. In this field, population was dominated by juveniles, therefore, the total number of earthworms was not affected by the underestimation of adults. Simulations without density dependence (not shown) exhibited an explosion of the total abundance at the end of the simulation period.

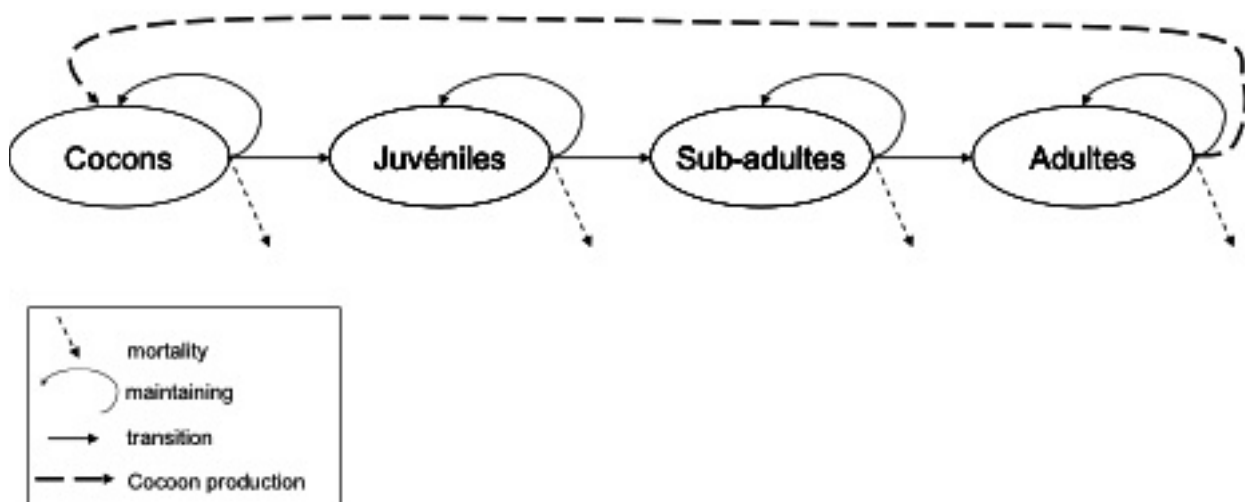

Figure 1: Conceptual diagram of the Wormdyn model, for *A. Caliginosa*. Arrows represent the different life events affecting the abundance in each age-stage.

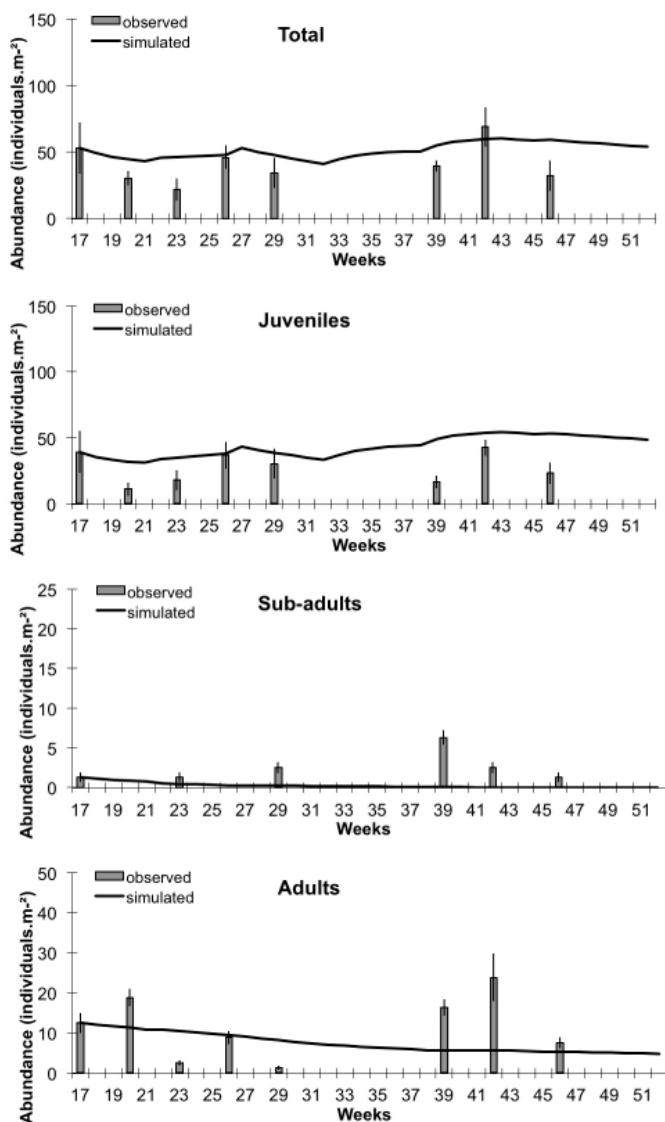

Figure 2: Observed and simulated values of the abundance of *A. caliginosa* in an experimental ploughed field under barley. The abscisse is the number of the week in the year (from april to december).

Perspectives

A third version is currently developed to simulate the dynamic of earthworm communities. Species were divided into the three ecological groups defined by Bouché (epigeic, anecic and endogeic; Bouché, 1972) differing in their life traits, food habits, localisation and impact on soil.

Acknowledgment

This work was supported by grants from Region Ile-de-France.

References

- Bouché M. B. (1972) Lombriciens de France: Ecologie et Systématique. INRA Ann. Zool. Ecol. Anim. Publication, France, 671 pp.
- Jones C. G., Lawton J. H., Shachak M. (1994) Organisms as ecosystem engineers. *Oikos* 69, 373-386.
- Pelosi C., Bertrand M., Makowski D., Roger-Estrade J. (2008) WORMDYN: A model of *Lumbricus terrestris* population dynamics in agricultural fields. *Ecol. Model.* 218: 219-234.

Exploitation of natural resources to increase soil health: BIO-INCROP, a project on organic fruit tree cropping systems

Manici, Luisa M.¹; Baab, G.²; Canet, R.³; Kaymak, S.⁴; Kelderer, M.⁵; Insam, H.⁶; Naef, A.⁷; Pinar, H.⁸; Rühmer, T.⁹; Whittle, I.⁶

¹C.R.A., ITALY; ²DLR Rheinpfalz, Rheinbach, GERMANY; ³IVIA, Valencia, SPAIN; ⁴EHRI, Isparta, TURKEY; ⁵Laimburg Research Centre, Ora (BZ), ITALY; ⁶University of Innsbruck, AUSTRIA; ⁷ACW, Wädenswil, SWITZERLAND; ⁸ALATA, Mersin, TURKEY; ⁹Haid, Graz-Haidegg, AUSTRIA

Introduction

The vast majority of apple production in Europe takes place in intensive orchards, this implies the need for intensive capital investment for support structures which then have to be used for a number of generations of trees. Consequently new orchards have to be replanted in the same place as previous plots. This causes soil sickness or yield decline of which “replant disease” is the main biological component. Resulting yield losses are difficult to assess; a recent study in South Tyrol, where 12% of total EU apple is produced, showed that growth reduction can vary from 20 to 60% in replanted orchard compared to fallow control. Severity of this etiology is mediated by plant vigour, physiological state of plants and abiotic factors. Therefore, its occurrence is actually an indicator for fruit growers of the degraded status of biological soil processes. The only effective strategy to control replant disease and crop decline in organic fruit tree orchards is to increase soil diversity, and consequently, the various

microbial processes involved in controlling soil borne pathogens, enhancing root growth and mediating plant nutrition.

Methods

BIO-INCROP, an European transnational project on organic farming, aims to increase knowledge about agro-management practices based on the study of microbial factors involved in soil suppressiveness and biological soil fertility. Project activities are planned on two reference crops: apple and citrus, which represent two main European agro-environments: apple growing areas of Central Europe (Switzerland, Germany, South Tyrol in Italy and Styria in Austria) and Mediterranean citrus growing areas (Valencia region in Spain and the East Mediterranean region of Turkey).

Research Actions of the project focus on exploitation of two main categories of natural resources in order to

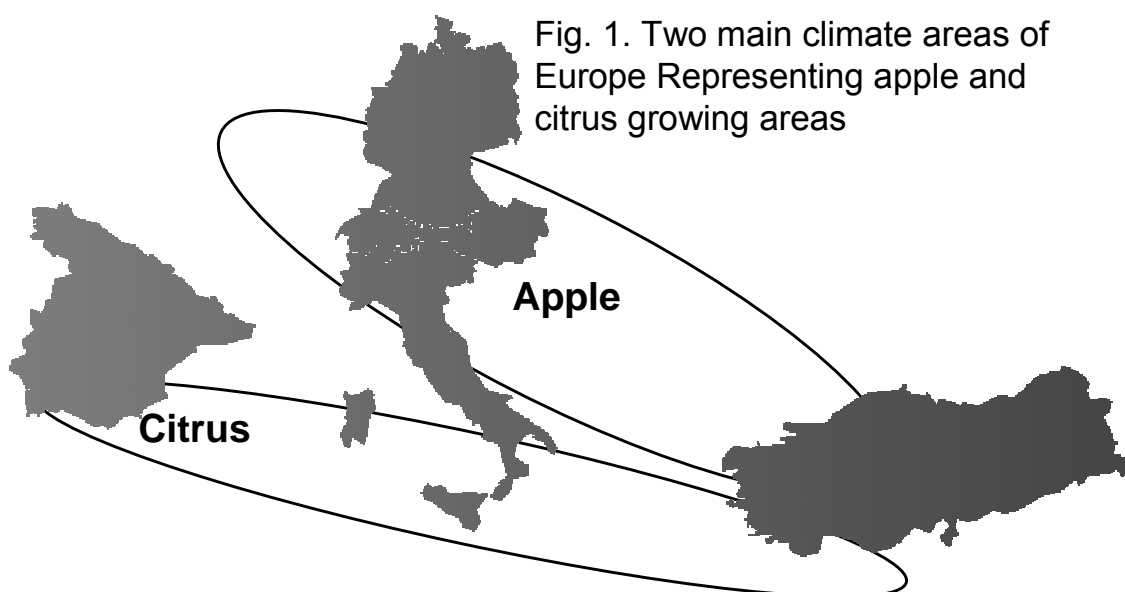

Fig. 1. Two main climate areas of Europe Representing apple and citrus growing areas

develop innovative cropping practices which will enable soil biodiversity preservation and exploit its biological features. They are:

1. Biological resources indigenous to the orchard soil represented by microbial communities and wild plants of natural vegetative covers.
2. Natural resources exogenous to the orchards; in particular, recycled organic materials and cover crops chosen from local germoplasm collections and wild plants.

Early evaluation of soil health based on plant response in greenhouse bioassay tests and culture-based and molecular methods for microbial response evaluation, are the integrated methodologies used to identify natural resources and techniques capable of increasing microbial biomass and diversity and selectively affecting beneficial and pathogenic microbial populations. Each country's activities is planned in close cooperation with regional agricultural research centres working on organic farming and laboratories with specific expertise.

Expected results

The main objectives and expected results of the project are:

1. To provide indicators of degradation status and risk for replant disease occurrence in the orchards.
2. To promote the use of indigenous or external resources for developing innovative management options aimed at i) selectively increasing the components of soil suppressiveness, ii) preserving and increasing soil microbial biomass and diversity.
3. To integrate the national guidelines for certified organic production with agro-management strategies based on eco-functional intensification of organic cropping systems.
4. To provide knowledge for supporting: i) critical adoption by farmers and local extension services of available organic amendments and bio-products ii) the development of soil management practices aimed at increasing soil suppressiveness according to available natural resources and environmental conditions.

Acknowledgements

Financial support for BIO-INCROP project provided by the CORE Organic II Funding Bodies, being partners of the FP7 ERA-Net project, (project no. 249667)

Change for 16 years of P status along soil profile in a French podzol in relation with different P fertilization under irrigated maize production

Denoroy, Pascal; Mollier, Alain; Morel, Christian; Niollet, Sylvie

INRA, UMR 1220 TCEM, F-33883 Villenave d'Ornon, France ; Bordeaux Sciences Agro, UMR 1220 TCEM, F-33175 Gradignan, France, FRANCE

Introduction

Podzols are low buffered soils regarding phosphate dynamics, thus they are difficult to manage to produce high yield without loss of potentially eutrophivating P. We study the evolution of soil P status and P balance of a podzol in south-west of France, fertilized at different P rates from 1995 to 2011.

Experimental layout

Five rate of superphosphate were replicated in 4 blocks. The reference rate P₁ (annual average: 23.1 kg P/ha) was close to annual P export by yield. Two low P rates (P_{0.5}, P_{0.75} ; 5.6 and 14.4 kg P/ha resp.) and two high P rate (P₂, P₄ ; 46.3 and 92.5 kg P/ha resp.) were to induce large gradients of P offer to crop and P soil balance.

Irrigated grain maize was grown every year excepted 2006 (bare fallow) and 2010 (carrot).

Crop yields and P content were determined every year for all plots.

Soil P dynamics along soil profile was estimated from analysis of the 3 soil layers (0-25, 25-50 and 50-75 cm) of each plot before spring fertilization. Amount of plant-available soil P was assessed by the Olsen extraction on 1995, 1999, 2003, 2007 and 2011 soil samples. Total-P (HF extraction) was determined on soil sampled in 1995 and 2011.

Data processing

P balance was estimated for all plots with two methods :

(a) an annual crop based input-output (I/O) balance of fluxes : amount of P in fertilizer minus P exported by yields.

(b) a pluri-annual balance of soil P stocks based on soil analysis. For every soil layer, the P stock was calculated as soil dry mass x analytical P content and they were summed to estimate the whole profile stock.

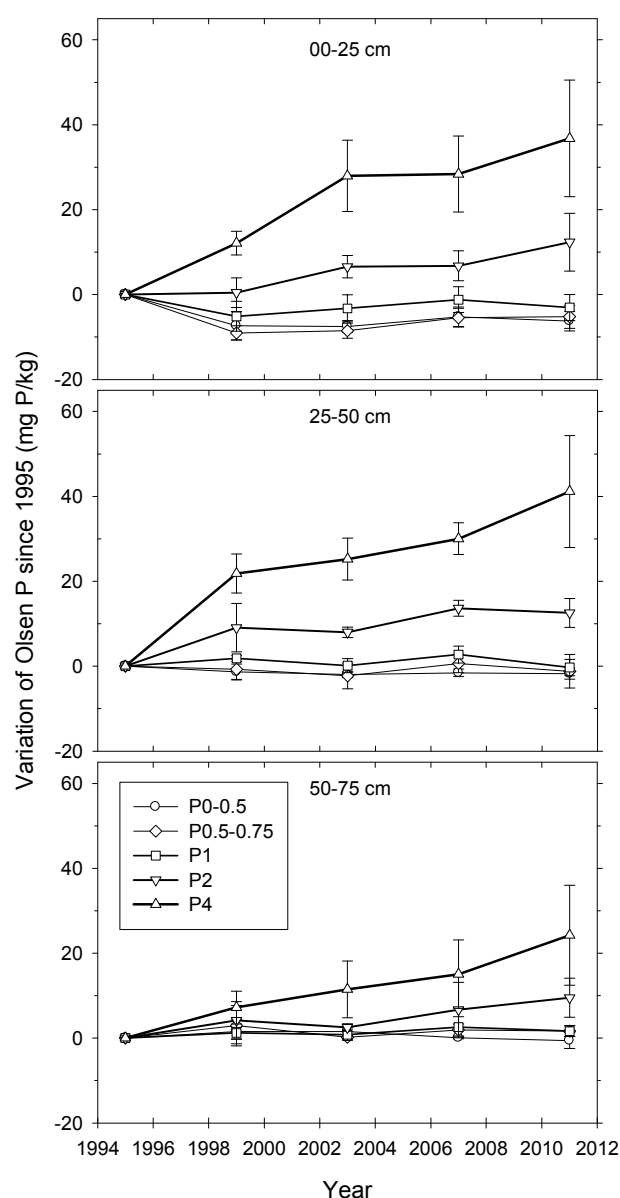

Figure 1 : Evolution of Olsen P soil content relatively to initial plot layer value. Average per treatment with standard-error bar

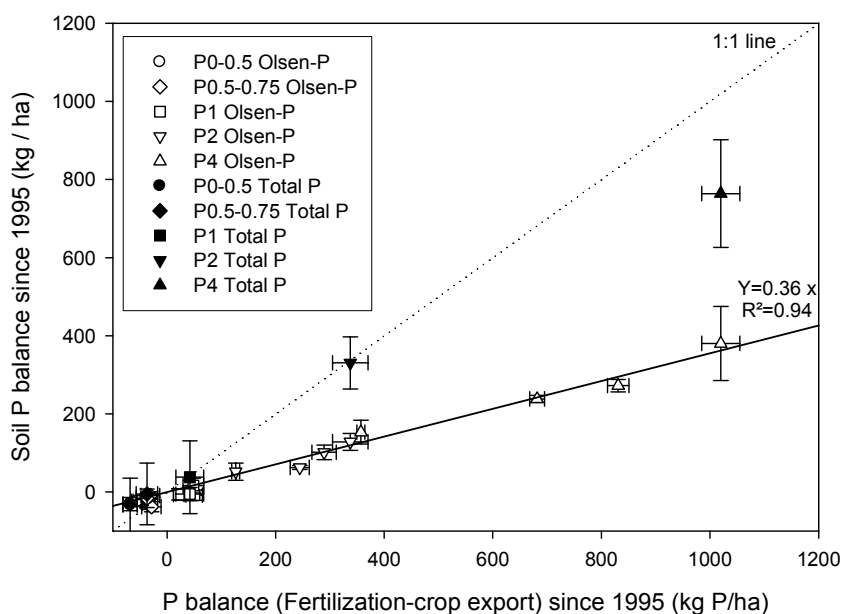

Figure 2 : Comparison of input-output (I/O) P fluxes balance and analytical soil P balance summed over the 3 soil layers. Average values and standard-error bars.

Results

Maize

In average for the 1995-2011 period, the P₂ and P₄ treatments produced respectively 13.1 and 13.4 T / ha, 85% dry matter (not statistically different) which are representative of the high yield in the region. On the opposite, yield was too strongly affected by no-P treatment in "Po.5" plots in a first phase (1995-2002), and the treatment was modified to low P rate in 2002. For Po.5 treatment average 1995-2011 grain yield was 7.6 T /ha, as it was 11.5 T /ha for Po.75. Average yield for P₁ treatment (12.5 T /ha) was significantly lower than in P₂ or P₄ treatments.

Grain number per ear and weight per grain were both affected by treatments, as well as grain P content, which was more reduced than yield in low P treatments.

Soil P

The treatments significantly affected the dynamics of the Olsen-P (fig. 1). During the 16 years the Olsen-P changed from 12 mg P/kg to a range from 2 to 66 mg P/kg in the ploughed layer (0-25 cm). It decreased and then remained constant for the Po.5 and Po.75 treatments, remained constant for the P₁ treatment and increased with the P₂ and P₄ treatments. Similar patterns observed for the deeper soil layers, although lesser, indicate downward P transfer for the P₂ and P₄ treatments.

Evolution of total-P soil content is consistent with Olsen P changes, but with a smaller relative range.

P balance

The change in soil total-P amount equals I/O balance for treatments Po.5 to P₂ but not for P₄ (fig 2). In P₄ treatment, phosphate leaching is on course (averaged rate : 10 to 25 kg P/ha/year). Up to now the vertical P transfer in P₂ plots did not induced substantial P losses under the bottom of the lower layer.

P Olsen soil balance calculated on the whole profile underestimates (I/O) balance by 2/3 for all treatments.

Discussion

The P fertilizer treatments induced large differences in P crop export through effects on yields and their P content, and subsequent effects on P balances. The higher P treatments induced P leaching and increasing the risk of eutrophication of surface waters.

P₁ treatment is environmentally safe and its yield, even if slightly lower than the potential, is still high. The lower P content of grain will help to avoid excessive P in manure. A somewhat higher level of P in soil is to be investigated to increase yield, as far as P grain export equals fertilizer import to avoid P accumulation and leaching.

Uncertainties in Maize Crop Model Responses to Climate Factors

Bassu, Simona¹; Durand, Jean-Louis¹; Lizaso, Jon²; Boote, Ken J.³; Makowski, David¹; Ruane, Alex C.⁴; Baron, Christian⁵; Basso, Bruno⁶; Biernath, Christian⁷; Boogaard, Hendrik⁸; Conijn, Sjaak⁹; Deryng, Delphine¹⁰; De Sanctis, Giacomo¹; Gayler, Sebastian¹¹; Grassini, Patricio¹²; Hoek, Steven B.⁸; Izaurralde, Cesar¹³; Jongschaap, Raymond⁹; Kemanian, Armen¹⁴; Kersebaum, Kurt Christian¹⁵; Müller, Christoph¹⁶; Nendel, Claas¹⁷; Priesack, Eckart⁷; Sau, Federico²; Shcherbak, Iurii¹⁸; Tao, Fulu¹⁹; Teixeira, Edmar²⁰; Timlin, Dennis²¹; Waha, Katharina¹⁶; Hatfield, Jerry L.²¹; Corbeels, Marc²²; Rosenzweig, Cynthia⁴; Jones, James W.³

¹INRA, FRANCE; ²Universidad Politécnica de Madrid, SPAIN; ³University of Florida, UNITED STATES; ⁴NASA-Goddard Institute for Space Studies, UNITED STATES; ⁵CIRAD, FRANCE; ⁶Michigan State University and University of Basilicata, UNITED STATES; ⁷Institute of Soil Ecology, GERMANY; ⁸Alterra, NETHERLANDS; ⁹WUR-Plant Research International, NETHERLANDS; ¹⁰University of East Anglia, UNITED KINGDOM; ¹¹Water & Earth System Science Competence Cluster, GERMANY; ¹²University of Nebraska-Lincoln, UNITED STATES; ¹³University of Maryland, UNITED STATES; ¹⁴University Park, UNITED STATES; ¹⁵Institute of Landscape Systems Analysis, GERMANY; ¹⁶Potsdam Institute for Climate Impact Research, GERMANY; ¹⁷Institute of Landscape System Analysis, GERMANY; ¹⁸Michigan State University, UNITED STATES; ¹⁹Chinese Academy of Sciences, CHINA; ²⁰The New Zealand Institute for Plant & Food Research Limited, NEW ZEALAND; ²¹USDA/ARS, UNITED STATES; ²²CIRAD-Annual Cropping Systems, BRAZIL

Simulation models can be used as strategic tools for evaluating the consequences of climate change on crop production and for evaluating possible adaptations of crop management practices. As many different crop models are available, it is important to compare several models in order to improve model functions and to assess uncertainties in the predicted crop response to climate change factors. Furthermore, the use of several models, already tested for maize, has a higher potential to capture the complexity of the multiple impacts of climate change on crops than using one single model. The Agricultural Model Intercomparison and Improvement Project (AgMIP) is a distributed simulation exercise for agricultural model intercomparison and future climate change assessments that has participation of multiple crop and economic modeling groups around the world. The goal of AgMIP is:

- To provide reasonable estimates of the impacts of climate change on crop yields of important crops of the world.
- To evaluate the uncertainty that comes from using different models in various climate and crop management situations and understand the causes of the different model responses to climate change factors.
- To improve our capacity for simulating the response of crops to yet unknown climates (combinations of extreme drought, temperatures and atmospheric CO₂ concentrations). Our work conducted in the AgMIP project for the maize crop first consisted of testing model output sensitivity to climatic factors over a large

ensemble of maize crop models and across four sentinel sites that are important contrasting pedoclimatic zones of maize production. Multiple maize modeling groups are involved in the work and run their models for the four sites of Lusignan (France), Ames (Iowa), Rio Verde (Brazil) and Morogoro (Tanzania), using measured daily weather records from 1980 to 2010 from each location. Modelers simulated the crop performances for baseline (1980 to 2010) and one single A2-Global Climate Model generated End-of-Century scenario (including 734ppm CO₂) for each location after calibrating their models on the basis of 1-year experimental data at each location. In addition, models were run with the 30-year manipulated weather files in order to compare their sensitivity to temperature (-3, 0, +3, +6, +9 °C), CO₂ (360, 450, 540, 630, 720ppm), and rainfall (-30% rainfall) for each sentinel site. The simulated maize crop yield simulated no response to CO₂ as expected, a clear trend in yield decrease with elevated temperatures (-3 up to +9 °C). Water appears to be a main source of variation in yields, but simulations indicate a possible strong interaction with nitrogen. With those general trends, results also showed that range of the simulated climate change effects on maize yield levels and interannual variations (Fig. 1) were highly dependent on the model and on the site.

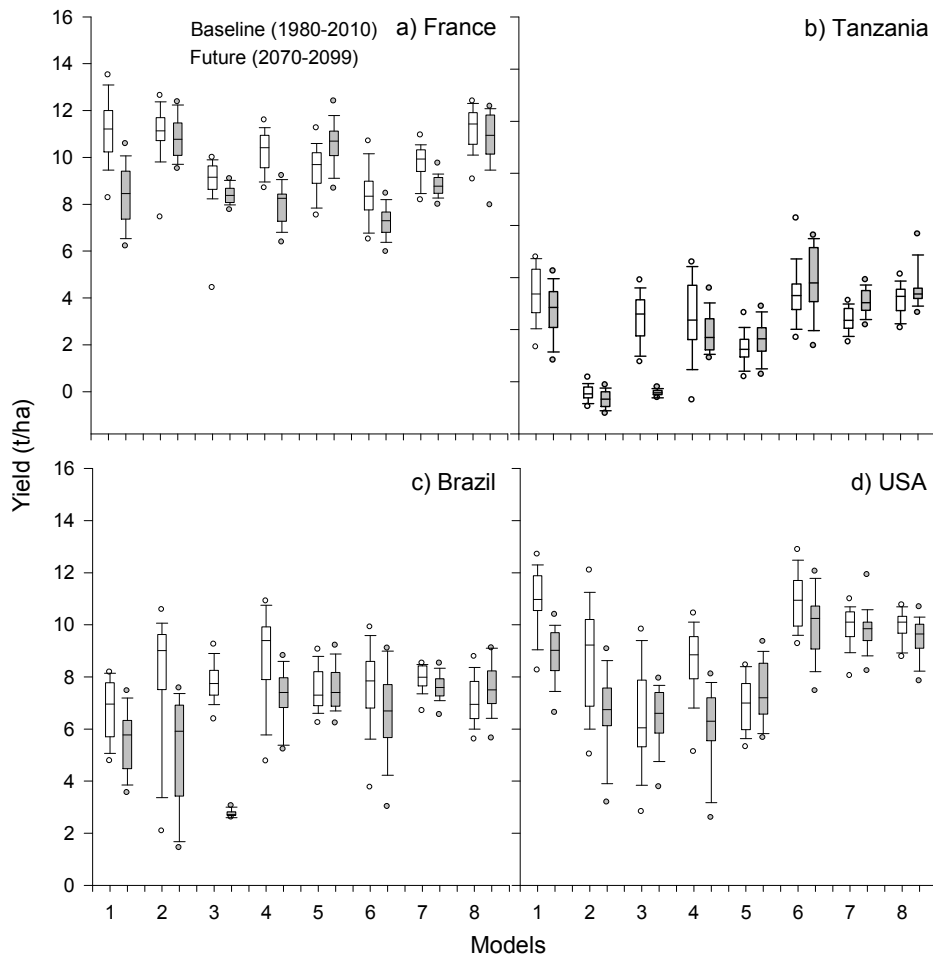

Fig. 1. Box-plots of grain yield estimated by eight models for the 30-year baseline (white boxes) and single A2-Global Climate Model scenario (grey boxes), at the irrigated sites of (a) France, and (b) Tanzania, and at the rainfed sites of (c) Brazil and (d) USA. Cccma cgcm3, inmcm 3.0, ncar ccsm3, mpi echam5 Global Climate Models were used for France, Tanzania, Brazil and USA, respectively, and future scenarios were created at each of the 4 sentinel locations using the Delta Method. Note that the different models are reported in the same order across the four sites. Edges of boxes represent 25 and 75% percentiles. Error bars represent 5 and 95% percentiles. The median (50% percentile) is represented by solid line in the boxes. The circles refer to the maximum and minimum values.

Comparison of modelling approaches to simulate the phenology of agricultural insect pests under future climate scenarios

Maiorano, Andrea¹; Bregaglio, Simone²; Donatelli, Marcello³

¹European Commission - Joint Research Centre, ITALY; ²University of Milan, ITALY; ³Agricultural Research Council, CIN, ITALY

Introduction

The phenological development of insects is simulated predominantly via models based on the response of the organisms to air temperature. Despite of a large body of literature supporting the evidence that the organism physiological response to temperature is nonlinear, including a declining phase, most of these models calculate the rate of development using a linear approach, assuming that air temperatures mostly does not fall outside of the linear region of response to temperature of the organism. Another simplification is represented by the calculation of the rate of development using daily mean air temperature, which has been demonstrated being a reliable method only in limited number of conditions. It can be hypothesized that the use of models based on linear developmental rates, which can be successfully applied under climate conditions to which organisms are well adapted, could be inadequate under either future climatic scenarios or when extreme events occur. In such

contexts, linear responses might lead to interpretations of climate effects not consistent with the real organism physiological response to temperature.

Materials and methods

In this work the case of *Ostrinia nubilalis* Hübner (European Corn Borer – ECB) development was taken as an example to compare i) a non-linear approach with hourly air temperature as input (HNL), ii) a linear based approach with hourly air temperature as input (HL), iii) a linear based approach with daily air temperature as input (DL), and iv) a linear based approach using an horizontal cutoff temperature (development continues at a constant rate at temperatures in excess of an upper temperature threshold) with daily air temperature as input (DLcutoff). The comparison was performed on a European scale for the IPCC (Intergovernmental Panel for Climate Change) emission scenario A1B, at three time frames: Baseline - 2000s, 2020s, 2050s. The SRES A1B was selected as one of those for which the projected raise of temperature is estimated to be one of the highest.

Results and discussion

Using degree-days (DD) as a proxy for the rate of development, results (Figure 1) showed that the DL approach predicts a higher accumulation of DD than the HNL in all the time frames in almost all Europe with the exception of Southern Italy and the Mediterranean coasts of France and Spain where the differences were negligible. These effects were due i) to the linear relationship used by the DL approach which do not take into account the stressful effects of temperature higher than the optimum, and partially ii) to the averaging operation that decrease the effects of high temperatures in regions with high (but not extreme) warm temperatures. The HNL and HL approach predicted the same pattern of degree-days accumulation in all Europe with the exception of the regions of Southern Iberian Peninsula (across all the timeframes), Balkans, and Turkey (under the 2050 scenario). This effect was due to the different HNL and HL accumulation of degree-days at temperatures higher than the ECB optimum temperature. The comparison

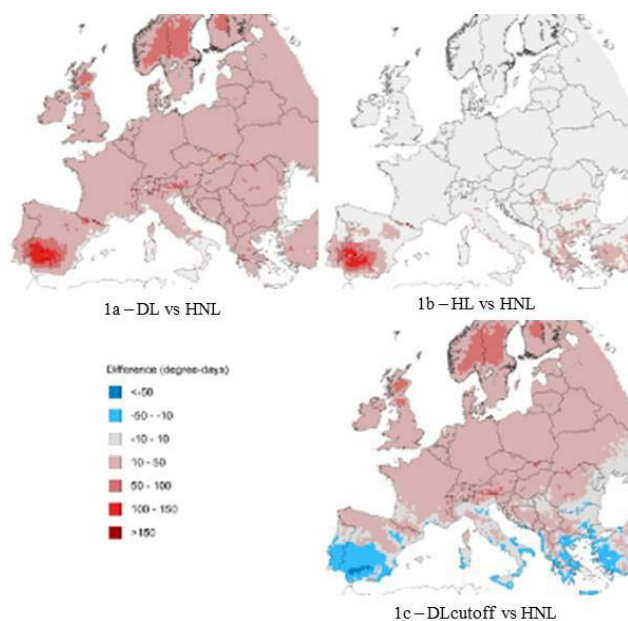

Figure 1. Differences between cumulated degree-days using DL vs HNL approaches (Fig 1a), HL vs HNL approaches (Fig 1b), DLcutoff vs HNL approaches (Fig 1c) in timeframe 2050s.

Table 1: Number of AEZ, average area per AEZ, average annual mean temperature (T_{mean}) and total precipitation per AEZ, and average rainfed maize area per AEZ (RF Maize). Within-zone standard deviations were averaged across all AEZ and are shown in parenthesis. Four AEZ classifications were considered: GAEZ, Licker, HCAEZ, and Gerber (see description above).

AEZ	# of AEZs	AEZ's area (Million km ²)	Annual T_{mean} (°C)	Annual total Precipitation (mm)	Avg. rainfed maize area per AEZ (Mha)	# zones to cover 80% global rf maize	# zones to cover 80% US rf maize
IIASA_LGP	16	20.2 (± 18.2)	12.6 (± 8.3)	1,002 (± 402)	7.5 (± 7.2)	7	4
HarvestChoice	21	15.3 (± 28.0)	13.5 (± 4.4)	858 (± 369)	5.8 (± 8.2)	6	2
Licker	100	2.7 (± 4.7)	16.3 (± 1.9)	807 (± 248)	1.2 (± 2.1)	28	5
Gerber	25	2.9 (± 2.0)	15.0 (± 2.4)	893 (± 120)	4.7 (± 1.2)	18	8

between the DLcutoff and the HNL approaches showed similar results as the DL vs HNL approach in central and Northern Europe, while in Southern Europe negative differences (more DD accumulated for the HNL approach) were observed: in regions characterized by high temperatures, the cutoff temperature, setting a limit to the maximum temperatures diminished the calculated average temperature and as a consequence the calculated degree-days.

Conclusions

The results of this work showed that according to the method chosen for simulations, different results can be obtained, hence leading to different conclusions about the effect of a warming climate on pest development. These results stress the need of reconsidering the appropriateness of models to be used, which cannot be assumed as correct on the basis of their effectiveness under current conditions.

Acknowledgements

This work was supported by a Marie Curie Fellowship (Project MIMYCS).

Estimating impact assessment and adaptation strategies under climate scenarios for crops in Europe

Donatelli, Marcello; Srivastava, Amit; Duveiller, Gregory; Niemeier, Stefan

JRC, ITALY

Policy makers at European and national level demand for estimates of agricultural production potential vulnerability specific to province level, articulated for crops. The base of such estimates is the biophysical representation of crop responses both under conditions of no adaptation, and exploring the level of adaptation which could be acted on autonomously by farmers. However, producing such estimates poses significant challenges due to the usability of climate inputs to simulation models, to reliability and completeness of data, to the level of abstraction to be chosen, and to technological aspects. This study provides an impact assessment of climate change scenarios on agriculture over EU27 focused on the time horizons of 2020 and 2030 with respect to a baseline centered on the year 2000. Potential and water-limited yields are simulated for 3 priority crops (wheat, rapeseed and sunflower) over a 25 by 25 km grid using the CropSyst model implemented within the BioMA modelling platform of the European Commission. Input

weather data are generated with a stochastic weather generator parameterized over RCM-GCM downscaled simulation from the ENSEMBLES project, which have been statistically bias-corrected. Two realizations of the A1B emission scenario within ENSEMBLES are used, based on the HadCM3 and ECHAM5 GCMs, which respectively represent the “warmer” and “colder” extremes in the envelope of the ensemble with regard to the air temperature trends, and different with respect to rainfall patterns. Alleviating the consequences of unfavorable weather patterns is explored by simulating technical operations which can be acted on by farmers, highlighting the limits of autonomous adaptation, hence estimating potential vulnerability hotspots. Data are presented focusing on the difference between the baseline chosen and the 2020 and 2030 time horizons. Both data (accessible via web services) and the simulation platform are available for non-commercial use.

A comparison of 27 wheat crop models for climate change impact: The AgMIP Wheat pilot study

Asseng, Senthil

University of Florida, UNITED STATES

S. Asseng 1, F. Ewert 2, C. Rosenzweig 3, J.W. Jones 1, J.L. Hatfield 4, A. Ruane 3, K.J. Boote 5, P. Thorburn 6, R.P. Rötter 7, D. Cammarano 1, N. Brisson 8,9,#, B. Basso 10,11,12, P. Martre 13,14, D. Ripoche 15, P. Bertuzzi 15, P. Steduto 16, L. Heng 17, M.A. Semenov 18, P. Stratonovitch 18, C. Stockle 19, G. O'Leary 20, P.K. Aggarwal 21, S. Naresh Kumar 22, C. Izaurralde 23, J.W. White 24, L.A. Hunt 25, R. Grant 26, K.C. Kersebaum 27, T. Palosuo 7, J. Hooker 28, T. Osborne 29, J. Wolf 30, I. Supit 30, J.E. Olesen 31, J. Doltra 32, C. Nendel 27, S. Gayler 33, J. Ingwersen 34, E. Priesack 35, T. Streck 34, F. Tao 36, C. Müller 37, K. Waha 37, R. Goldberg 3, C. Angulo 2, I. Shcherbak 11, C. Biernath 35, D. Wallach 38, M. Travasso 39, A. Challinor 40,41

1 University of Florida, Agricultural and Biological Engineering, USA, 2 Universität Bonn, Germany, 3 NASA Goddard Institute for Space Studies, USA, 4 USDA National Laboratory for Agriculture and Environment, USA 5 Department of Agronomy, University of Florida, 6 CSIRO Ecosystem Sciences, Australia, 7 Plant Production Research, MTT Agrifood Research Finland, 8 INRA, Grignon, France, 9 AgroParisTech, France, 10 University of Potenza, Italy, 11 Michigan State University, USA 12 Queensland University of Technology, Australia, 13 INRA, Clermont-Ferrand, France, 14 Blaise Pascal University, France, 15 INRA, Avignon, France, 16 FAO, Italy, 17 IAEA, Austria, 18 Rothamsted Research, UK, 19 Washington State University, USA, 20 Department of Primary Industries, Australia, 21 CCAFS, India, 22 Indian Agricultural Research Institute, India, 23 Joint Global Change Research Institute, USA, 24 USDA Arid-Land Agricultural Research Center, USA, 25 University of Guelph, Canada, 26 University of Alberta, Canada, 27 Leibniz Centre for Agricultural Landscape Research, Germany, 28 University of Reading, School of Agriculture, Policy and Development, UK, 29 University of Reading, NCAS & Department of Meteorology, UK 30 Wageningen University, The Netherlands, 31 Aarhus University, Denmark, 32 Agricultural Research and Training Centre (CIFA), Spain, 33 University of Tübingen, Germany, 34 Universität Hohenheim, Germany, 35 Helmholtz Zentrum München, Germany, 36 Chinese Academy of Science, China, 37 Potsdam Institute for Climate Impact Research, Germany, 38 INRA, Castanet-Tolosan Cedex, France, 39 INTA-CIRN, Argentina, 40 University of Leeds, UK

AgMIP- the Agricultural Model Intercomparison and Improvement Project (www.agmip.org) (Rosenzweig et al. (2012) aims to provide more robust estimates of climate impacts on crop yields and agricultural trade, including estimates of associated uncertainties. During the AgMIP Wheat Pilot Study 27 wheat crop simulation models were compared with detailed field experimental data from four contrasting environments (The Netherlands, Argentina, India and Australia) using standardised protocols to study the role of crop model-based variability in projections of climate change impacts. The four environments represent major wheat-producing regions of the world. A standardised sensitivity analysis was carried out with all models for each of the environments with a range of temperature, including heat stress, CO₂ changes, soil, management and seasonal variability. Differences in the variability in model responses indicated strengths

and weaknesses across crop models. Results from the model intercomparison will be presented. Implications for model applications to climate change and global food security assessments, for specific model improvement and for needed field experiments are discussed.

Reference

Rosenzweig C., Jones J.W., Hatfield J.L., Ruane A.C., Boote K.J., Thorburn P., Antle J.M., Nelson G.C., Porter C., Janssen S., Asseng S., Basso B., Ewert F., Wallach D., Baigorria G., Winter J.M. (2012) The Agricultural Model Intercomparison and Improvement Project (AgMIP): Protocols and pilot studies. *Agricultural Forestry and Meteorology*. (in press)

Dr. Nadine Brisson died during the study in 2011.

Testing extrapolation domains of weather stations for modeling maize yields at continental and global scales

van Bussel, Lenny¹; van Wart, Justin²; Wolf, Joost¹; Grassini, Patricio²; Claessens, Lieven³; Cassman, Kenneth²; van Ittersum, Martin¹

¹Wageningen University, NETHERLANDS; ²University of Nebraska-Lincoln, UNITED STATES; ³ICRISAT, KENYA

Introduction

Our planet is facing serious challenges: the climate is changing, biodiversity is decreasing, agricultural land degrades, and the global demand for food is rapidly increasing. To better understand future global food supply, simulation models are increasingly applied. Models used in these assessments are, however, generally developed for use at the field scale and assume homogeneous conditions over time and/or space. This assumption becomes questionable at larger scales, e.g. at large scales soil and weather conditions show considerable spatial variation (Hansen and Ines, 2005). To avoid incorrect model outcomes it is essential that such variation is reflected by the used input data, e.g. by using observed weather data from multiple sites within the region of interest. Yet, at large scales these data sources are often not widely available (Nonhebel, 1994). To overcome the problem of missing data the available data can be extrapolated (Ewert et al., 2011). For this, it is crucial to understand the extent of a valid extrapolation domain of the measured data, taken into account its intended use. Information about extrapolation domains of weather data intended for use in crop growth modeling at large scales is currently not available and is the subject of this study.

Methodology

We used the concept of climate zonation to establish the extrapolation domains of weather data. The climate zonation was combined with the assumption that, for the purpose of crop growth modeling, weather conditions within a climate zone can be represented by one weather station. To test this assumption we selected three regions/countries: US Corn Belt, Germany, and Kenya. In each region we derived a climate zonation (Van Wart et al., under review) and within each of the main climate zones, with respect to crop area, the available weather station datasets were identified. Maize yields were simulated for these datasets with the model Hybrid-maize (Yang et al., 2004). Per climate zone the simulated maize yields were compared. Applying an allowed difference in the

simulated maize yields of maximally 10%, we concluded whether the weather conditions within a climate zone could be represented by data from a single station.

Results and Concluding remarks

The found extrapolation domains of weather stations differ per studied region. Within the US Corn Belt and Germany the climate is rather uniform and hence, the extrapolation domains may cover large areas. In Kenya, where large differences in altitude and thus in climate prevail, the extrapolation domains of weather stations are often small. Knowing the extrapolation domain of weather station data allows for optimized search for or selection of actual weather data for use in modeling crop growth at large scales. This simplifies upscaling as well as provides a framework for the extrapolation of results of previous research.

References

- Ewert, F., van Ittersum, M.K., Heckeley, T., Therond, O., Bezlepkina, I., Andersen, E. (2011) Scale changes and model linking methods for integrated assessment of agri-environmental systems. *Agric. Ecosyst. Environ.* 142, 6-17.
- Hansen, J.W., Ines, A.V.M. (2005) Stochastic disaggregation of monthly rainfall data for crop simulation studies. *Agric. For. Meteorol.* 131, 233-246.
- Nonhebel, S. (1994) The effects of use of average instead of daily weather data in crop growth simulation models. *Agric. Syst.* 44, 377-396.
- Yang, H.S., Dobermann, A., Lindquist, J.L., Walters, D.T., Arkebauer, T.J., Cassman, K.G. (2004) Hybrid-maize - A maize simulation model that combines two crop modeling approaches. *Field Crops Res.* 87, 131-154.

Matching growth of wheat production and demand: shall we further increase yield potential or close the gap with actual yields?

Slafer, Gustavo

University of Lleida, SPAIN

It has been forecasted that the world population will be c. 9 billion by 2050. This means that, to maintain the current balance with demand, we must increase crop production by at least 50% in the next 40-50 years (most likely more than this, already huge, figure taking into account the expected increase in per-capita intake of calories associated with increased average income, and the likely allocation of part of the crop production to bio-fuels). Considering the world acreage, the production volume and the calorific input for the human world population, wheat is likely the most relevant crop for food security worldwide. As the growing area would hardly increase significantly, the required increase in production must come from increased global yields. This, in turn seems problematic as the rates of increase in yield during the last decades have been lower than those required matching the expected increase in demand, and it is expected that climate change will have a negative impact on wheat yields and will then make it more difficult to achieve gains. During most of the second half of the 20th century large rates of yield gain (which then actually exceeded the rates of population growth) were achieved due to genetic and management improvements. Much of the genetic improvements operated through substantial increases in potential yield whilst agronomic improvements mainly tended to reduce (or to avoid enlarging) the gap between potential and actual yields.

There is some debate on whether, in this context, we shall expect more benefits from further raising potential yield or whether it would be more favourable to reduce the yield gap. In general, for agricultural systems in which actual yields are close to (say they are c. 0.75-0.80 of) potential yields there is little hope that the gap might be further reduced, due to the law of diminishing returns it would likely imply a reduction in profitability (and eventually an increase in environmental damage). Chances are that attainable yields (those obtained with

best management but taking into consideration economic aspects of crop productivity) are c. 75-80% of potential yields. In these (mainly irrigated) systems, there is little doubt that future increases in yield would largely depend on further increases in yield potential, together with measurements tending to maintain the present low yield gaps (or perhaps increasing it slightly through improved predictability on the conditions for the growing season). In turn, these measurements may be virtually inexistent if improvements in yield potential are based on increased resource use efficiency rather than on an increased demand/responsiveness to resources. When the yield gap becomes larger (> 50%), which is the most common condition worldwide, it is easier to become enthusiastic about the prospects for achieving substantial increases in production through reducing the yield gap (through either breeding for tolerance to biotic/abiotic stresses or improving agronomic management); and simultaneously sceptical on the relevance of further raising yield potential, being this far larger than what farmers do actually achieve. For this enthusiasm/scepticism to be supported objectively we must know the reasons behind the gap (to determine how manageable they are) and to what degree potential and actual yields are independent (i.e. to determine whether attributes conferring yield potential would be constitutively affecting yield in a wide range of conditions and then would force a sort of parallelism between potential and actual yield).

In this presentation I will discuss on the plausibility of the two alternatives (further raising yield potential disregarding the level of the yield gap, and closing the gap particularly when actual yields are substantially lower than potential yield), 'scaling down' to attributes that might make it possible to further raise yield potential and to management practices which might be useful to closing the gap.

Review of agroecozones for use in yield gap analysis

Van Wart, Justin¹; van Bussel, Lenny²; Wolf, Joost²; Licker, Rachel³; Grassini, Patricio⁴; Cassman, Ken¹; van Ittersum, Martin²

¹University of Nebraska, UNITED STATES; ²Wageningen University, NETHERLANDS; ³University of Wisconsin-Madison, UNITED STATES; ⁴University of Nebraska, ARGENTINA

Introduction

Increasing demand for food expected during coming decades will require a substantial increase in crop production. Given limitations for massive expansion of cropland area, it is of critical importance to know where and how to increase crop productivity per unit of land (i.e., crop yields). This can be quantified through yield gap analysis, an examination of the difference between crop yield potential and current farm yields (Lobell et al., 2009).

'Point-based' estimates of yield gaps, either derived from research plots or simulation models, are available only for a limited number of sites due to economic and logistic constraints and lack of weather, crop, and soils data. Therefore, it is necessary to understand how a point-based estimate of yield gap from a specific location can be scaled up to a wider extrapolation domain. To define the extrapolation domain of a yield gap estimate, one can make use of agroecological zones (AEZ), defined as geographic regions having similar climate and soils relevant for agriculture. In this paper, four existing AEZ methodologies are reviewed focusing on their applicability to scale up a point-based estimate of yield gap to a larger geographic area.

Review of Agroecozone

The Global Agro-Ecological Zone assessment (GAEZ) uses multiple gridded soil, climate, and land-use data as input to model actual and potential yields (Fischer et al., 2012). Monthly weather data are used to derive 2 key AEZs: 1) thermal regimes (temperature sums during key months in crop phenology), and 2) length of crop growing period (LGP) (based on soil water balance and threshold growing temperatures). However, data from these AEZs is used as model input, rather than as a means of up-scaling results.

Licker et al. (2010) calculated growing degree days (GDD; sum of temperature above a crop-specific certain threshold) and annual soil moisture availability (ASM) for each 5 arc minute grid cell and divided the range of these 2 parameters into 10 equal smaller ranges. The intersections of these ranges formed a matrix of 100 unique GDD x soil moisture combinations. This AEZ methodology uses parameters fundamental to plant growth, but several zones have a range of GDD or ASM that are not suitable for crop production.

Attempts have been made to further improve GAEZ and Licker's AEZ classification. HarvestChoice AEZ (HCAEZ) consists in 21 zones, based on GAEZ LGP, thermal regimes, and temperature classes adjusted to

Table 1: Number of AEZ, average area per AEZ, average annual mean temperature (T_{mean}) and total precipitation per AEZ, and average rainfed maize area per AEZ (RF Maize). Within-zone standard deviations were averaged across all AEZ and are shown in parenthesis. Four AEZ classifications were considered: GAEZ, Licker, HCAEZ, and Gerber (see description above).

AEZ	# of AEZs	AEZ's area (Million km ²)	Annual T _{mean} (°C)	Annual total Precipitation (mm)	Avg. rainfed maize area per AEZ (Mha)	# zones to cover 80% global rf maize	# zones to cover 80% US rf maize
IIASA_LGP	16	20.2 (± 18.2)	12.6 (± 8.3)	1,002 (± 402)	7.5 (± 7.2)	7	4
HarvestChoice	21	15.3 (± 28.0)	13.5 (± 4.4)	858 (± 369)	5.8 (± 8.2)	6	2
Licker	100	2.7 (± 4.7)	16.3 (± 1.9)	807 (± 248)	1.2 (± 2.1)	28	5
Gerber	25	2.9 (± 2.0)	15.0 (± 2.4)	893 (± 120)	4.7 (± 1.2)	18	8

sea-level, (Pardey et al., 2010). Licker's AEZ was adopted and modified by James Gerber (2012): soil moisture availability was replaced by annual total precipitation and he only considered grid-cells where crop was harvested. Ranges of GDD and precipitation were determined such that 1% of global harvested area occurred in each zone.

Table 1 shows the range of climate found within zones of each AEZ classification (GAEZ, Licker, HCAEZ, Gerber), based on data on annual mean temperature (T_{mean}) and total precipitation at 30 arc second resolution (Hijmans et al., 2005). As an example of cropping density within zones, harvested area of rainfed maize within zones was also considered (Portmann et al., 2011). As can be seen in the table, larger zones capture more variable

climates, including cooler temperatures, making them less desirable for use in up-scaling.

Conclusions and Discussion

Yield gap analysis requires high quality data, but because these are difficult to obtain for every area of interest, extrapolation domains are a critical tool that allow for limited data collection in areas with greatest possible inference. An efficient AEZ scheme should contain large proportions of harvested area and low variation in climate within zones. Based on this framework, the Gerber AEZ appears the most effective, but might further be modified to be useful for all crop environments simultaneously, not just a single crop, as is now the case.

Yield Gap Analysis – what is the required spatial and temporal resolution for agronomic relevance?

Hochman, Zvi
CSIRO, AUSTRALIA

Introduction

A key pathway to achieving future global security is to exploit the gap between yields currently achieved on farms and those attainable by using the best crop and land management practices. Precise spatially explicit knowledge about yield gaps is required to identify regions with greatest potential to increase food supply and for effective prioritization of research, development, and intervention (Lobell et al., 2009). Given that agricultural production, especially in rainfed environments is spatially and temporally variable, the question of the appropriate level of aggregation of data for analysis must be addressed. van Ittersum et al. (2012) argued that, to achieve local relevance, yield gap analysis should be based on polygons that are sufficiently spatially explicit to use local, site-specific weather, soil and agronomic data and to allow validation of the estimated yield gaps. A framework for producing high resolution yield gap maps in data-rich environments has been developed and applied to wheat production in Australia's Wimmera region (Hochman et al., 2012). In this paper aspects of spatial and temporal variability and their implications regarding levels of resolution required for agronomically relevant yield gap assessment are explored.

Methods

Actual yields (Y_a) were estimated from annual statistical data for wheat aggregated up from individual farms to 11 regions in three agro-climatic zones. Remotely sensed Normalised Difference Vegetation Index (NDVI) captures the greenness of a pixel and these are combined with statistical data to provide a map of Y_a at 1.1 km² resolution. Simulation, using a locally validated cropping system model (APSIM) was used to determine water limited potential yields (Y_w) based on weather data from

56 stations from the Silo website and a map of the plant available water capacity of soils in the region from the ASRIS national soils database. For a full description of the assessment framework and methods used see Hochman et al. (2012).

Results and discussion

Annual variability of wheat yields at a range of levels of aggregation is indicated by coefficient of variation (CV) values in Table 1. CV values in the Mallee, Wimmera and Central North regions of the state of Victoria are much higher than for the state as a whole even though these regions produce almost all the wheat in this state. Similarly average yield in the different regions are quite different and these spatial differences mask temporal differences at state level. Experimenting with less year's data shows that while 21 years provides robust estimates of average regional yields and CVs, significant losses occur when less than 15 years are used. Table 2 shows Y_w , Y_a and the yield gap (Y_g) at a sub-regional scale in the Wimmera region in 2005. The sub-regional CV of Y_a is half as spatially variable as that of Y_w and the CV of Y_g is twice as variable again. These numbers and the trend for gaps to be smaller where Y_w is smaller suggest that farmers are more concerned with reducing risk of low yields than in exploiting their yield potential in better environments.

Conclusions

In a spatially and temporally variable environment, such as the Australian wheat zone, sub-regional analysis of yield gaps and about 20 years of data are required to obtain yield gap assessments with agronomic relevance for informing policy and local intervention necessary to bridge yield gaps.

Table 1. Mean Yields (Mg ha⁻¹) and Coefficients of Variation for the wheat-sheep zone in Australia, 5 mainland states and 3 Victorian regions for the years 1989 - 2009.

	Australia	QLD	NSW	VIC	SA	WA	Mallee	Wimmera	Central North
mean	1.68	1.33	1.88	1.68	1.60	1.61	1.58	2.22	2.08
CV	0.24	0.31	0.39	0.24	0.28	0.19	0.44	0.37	0.40

Table 2. Yield gap estimates based on simulated Y_w and statistically determined Y_a for the seven SLAs of the Wimmera Region of Victoria in 2005.

SLA	Y_w (Mg ha⁻¹)	Y_a (Mg ha⁻¹)	Y_g (Mg ha⁻¹)
Horsham	5.82	2.25	3.57
N. Grampians - St Arnaud	5.76	2.92	2.84
N. Grampians – Stawell	6.83	2.42	4.41
West Wimmera	6.23	3.02	3.21
Hindmarsh	3.88	2.92	0.96
Yarriambiack – North	2.70	2.10	0.60
Yarriambiack – South	4.74	2.54	2.20
Wimmera Region	4.65	2.43	2.22
CV	0.31	0.15	0.62

References

Hochman, Z., et al., 2012. Quantifying yield gaps in rainfed cropping systems: an Australian case study. *Field Crops Research* (in review).

Lobell, D.B., et al., 2009. Crop yield gaps: Their importance, magnitudes and causes. *Annu. Rev. Environ. Resour.* 34: 179-204.

van Ittersum, M.K., et al., 2012. Yield gap analysis with local to global relevance – a review. *Field Crops Research* (in review).

Yield gap reduction using Nutrient Expert recommendations for maize and wheat in Asia

Pampolino, Mirasol¹; Majumdar, Kaushik²; Jat, M. L.³; Ocampo, Apolonio⁴; Zaini, Zulkifli⁵; Satyanarayana, T.²; Bana, Anil²; Gupta, Naveen²; Pasuquin, Julie Mae¹; Kartaatmadja, Sunendar⁶

¹International Plant Nutrition Institute, MALAYSIA; ²International Plant Nutrition Institute, INDIA; ³International Maize and Wheat Improvement Center (CIMMYT), INDIA; ⁴University of the Philippines Los Baños, PHILIPPINES; ⁵Indonesian Center for Food Crops and Development, INDONESIA; ⁶International Plant Nutrition Institute, INDONESIA

Meeting the demand for more food in the next 20–30 years requires intensifying cereal cropping systems and increasing current yields to about 70–80% of the genetic yield potential. Current yields in farmers' fields are still less than 70% of their potential largely due to poor nutrient management practices. Nutrient Expert (NE) is a decision support software based on the principles of site-specific nutrient management (SSNM), which aims to supply a crop's nutrient requirements tailored to a specific field or growing environment. NE was developed jointly by researchers, extension agents, and other stakeholders using maize data from 19 locations in three countries and wheat data from 33 locations in five countries in Asia. NE enables crop advisors to develop SSNM recommendations using existing site information. In 2010–2011, Nutrient Expert for Hybrid Maize (NEHM) recommendations were tested against farmers' fertilizer practice (FFP) at five locations (n = 3–5 sites per location) in Indonesia and seven locations in the Philippines (n = 2–7 sites per location); while Nutrient Expert for Wheat (NEW) recommendations were tested against FFP at five locations in India (n = 4–15 sites per location). To determine the maximum attainable yield for selected growing environments, we included a fully-fertilized plot (NPK) without nutrient limitation in some of the maize and wheat sites. We used the difference between NPK yield and FFP yield to assess yield gap. At five locations with NPK treatment (n = 1–5 sites per location) in the Philippines, average maize yield with

NPK was 8.2–11.5 t/ha and average yield gap was 1.7–4.5 t/ha. NEHM recommendations increased yield over FFP by 1.0–3.0 t/ha, which reduced yield gap by 47–98% at those five locations. At all maize locations, NEHM increased yield over FFP by 0.9 t/ha in Indonesia and 1.6 t/ha in the Philippines. NEHM increased profit (over seeds and fertilizer costs) by 270 USD/ha in Indonesia and 379 USD/ha in the Philippines. Compared with FFP, NEHM recommendations in Indonesia reduced fertilizer P (–4 kg/ha), increased fertilizer K (+11 kg/ha), and did not significantly change fertilizer N; in the Philippines, NEHM gave higher rates of all three nutrients (+25 kg N/ha, +4 kg P/ha, and +11 kg K/ha). At two locations in India (with NPK treatment, n = 5–10 sites per location), average wheat yield with NPK was 4.7–4.8 t/ha and yield gap was 0.8–0.9 t/ha. NEW recommendations increased yield over FFP by 0.6–0.8 t/ha, which reduced yield gap by 73–119% at those two locations. Across all wheat locations, NEW increased yield by 0.9 t/ha and increased profit (above fertilizer costs) by 221 USD/ha. Compared with FFP, NEW slightly increased fertilizer N (+6 kg/ha), substantially increased fertilizer K (+52 kg/ha), and did not change fertilizer P. NE as applied to maize (NEHM) and wheat (NEW) is effective in providing site-specific fertilizer recommendations, which can help to reduce current yield gaps in farmers' fields. The NE recommendations can correct nutrient imbalances caused by current fertilization practices, and thereby minimize mining of nutrients (e.g. K).

Assessment of nutrient-induced maize yield gaps in smallholder systems in Africa

Zingore, Shamie¹; Okoth, Peter²; Huising, Jeroen²; Kihara, Job³

¹International Plant Nutrition Institute, KENYA; ²TSBF-CIAT, KENYA; ³TBF-CIAT, KENYA

Introduction

Maize yields in smallholder farming systems in sub-humid zones of sub-Saharan Africa (SSA) average less than 1.2 t/ha, mainly due to low use organic or inorganic nutrients (<13 kg/ha). Despite the current low maize productivity, analysis of potential yields for the sub-humid zones show that water limited yields of between 7-12 t/ha, indicating large yield gaps linked to poor nutrient and agronomic practices management (Waddington et al., 2009). Although N and P are considered to be the main limiting nutrients, there is increasing recognition of deficiencies of that K as well secondary and micro-nutrient (Sanchez and Leakey, 1997; Zingore et al., 2008).

Materials and methods

Multi-location nutrient omission trials were conducted across 102 sites to assess the nutrients limiting crop productivity and the potential supply of nutrients under variable soil fertility conditions. The experiments consisted of 6 main treatments as follows: control without any nutrients; P+K; N+P; N+K; NPK; N+P+K+Ca+Mg+S+Zn+B+Mn. An additional treatment with all nutrients and lime was included in fields where the soil pH was <5.3. All nutrients were applied at rates required to produce a maize yield of 10 t/ha. To assess the effects of soil fertility status on yield gaps, soil samples from experimental sites were analyzed for organic C, total N, available P, exchangeable basis, pH, CEC and particle size distribution. The soil analysis results were used to group fields into three categories of soil fertility status (high, medium and low).

Results

Results from the trials showed strong effects of soil fertility status on maize yields, with control yields and yields for the various fertilizer treatments increasing with increasing soil fertility status. Maximum attainable yields ranged from 6-9 t/ha in fields with medium and high soil fertility. N was shown to have the largest effects on maize yield, increasing yields by an average of 5.2 t/ha in fields of medium and high soil fertility. Sites dominated by high-

P-fixing acidic soils showed a strong response (average 3.4 t/ha) to application of P and lime. In high soil fertility fields, application of N and P was sufficient to reduce the yield gap by 80-100%. In medium fertility fields, addition of base cations (K, Ca and Mg) and micronutrients (Zn, B and Mn) was required to significantly increase crop yields above the N and P treatment and contributed 20-40% of the yield increase. On the low fertility fields, baseline yields were very low (<0.8 t/ha) and were increased to about 3 t/ha with all nutrients added. Under the low soil fertility conditions, increasing soil organic matter to increase retention of soil nutrients and water, better synchronization of nutrient supply with crop demand, and improvement of soil health through increased soil biodiversity may be required to further reduce the yield gap.

Conclusions

Strategically targeting fertilizer use to variable soil fertility conditions, as well management to increase soil organic matter is necessary to effectively reduce the large maize yield gap in SSA. Recognition of the soil fertility heterogeneity within smallholder farms will help designing more effective recommendations targeting various soil fertility niche.

References

- Tittonell P, Corbeels M, van Wijk MT, Vanlauwe B, Giller KE (2008) Targeting nutrient resources for integrated soil fertility management in smallholder farming systems of Kenya. *Agronomy Journal* 100:1511–1526.
- Waddington SR, Li X, Dixon J, Hyman G, Vicente MC (2009) Getting the focus right: production constraints for six major food crops in Asian and African farming systems. *Food Security* 2: 27-48.
- Zingore S, Delve RJ, Nyamangara J, Giller KE (2008) Multiple benefits of manure: The key to maintenance of soil fertility and restoration of depleted sandy soils on African smallholder farms. *Nutrient Cycling in Agroecosystems* 80:267–282

Why plants are not optimal for maximum production: a game theoretical analysis of plant traits

Anten, Niels

Wageningen University, NETHERLANDS

Understanding how vegetation structure and productivity arise from plant traits is a key question in crop science, and entails scaling up from leaf to canopy. Simple optimization has commonly been used to this end, with traits being assumed optimal when productivity of a vegetation stand is maximized. From an agronomical perspective where maximum yields per unit land area or other resource is often the objective, this approach makes sense. However, simple optimization ignores the fact that plants interact with each other; their leaves and roots influence each other's light and nutrient availability. In such cases game

theory (competitive optimization) is more appropriate. Focusing on leaf area, I will show that stands with an optimal structure for maximum productivity are not evolutionarily stable and can be invaded by a 'cheating' mutant that overinvests in leaf area. Natural selection thus leads to plants with non-optimal traits. I will argue that a mechanistic understanding of how these non-optimal traits arise in plants has important implications for crop selection. Particularly root growth, leaf nitrogen distribution and leaf area production can be targeted as traits for crop selection in this way.

The simulation of winter wheat yields in Thuringia, Germany, using meteorological data with different spatial resolution

Nendel, Claas; Wieland, Ralf; Mirschel, Wilfried; Specka, Xenia; Kersebaum, Kurt-Christian Leibniz
Centre for Agricultural Landscape Research (ZALF), GERMANY

Introduction

Crop models are widely accepted tools to predict crop yields under assumed climate and land-use scenarios. Their prediction error adds to the range of uncertainty produced by global scale climate models and the down-scaling procedures in climate change assessments. Part of the prediction error comes with the uncertainty of input information if soil, crop and weather data are not representative for the area addressed by the model.

Materials and methods

For the Federal State of Thuringia in Germany (16,172 km²) we tested fine resolution simulations (50m × 50m) at high (interpolated and altitude-corrected weather from 14 weather stations and 58 rain gauges, 1:10⁶ soil map, relief and groundwater), medium (nearest of 14 weather

stations, no altitude correction) and low (one weather station for the whole state, no altitude correction) information level against 1992–2009 average yield data for winter wheat at county level. The MONICA model has earlier been calibrated for winter wheat outside Thuringia (Nendel et al. 2011). In this study we used MONICA for the yield predictions without prior recalibration to local field experiments.

Results and discussion

We found that in this investigation (1) one representative weather station and one crop parameter set gave an estimate of the mean annual winter wheat yield in the region (7.0 t ha⁻¹) close to the long-term observed of 6.7 t ha⁻¹ (Fig. 1), (2) the other two—more sophisticated—approaches produced only slightly different results (6.6 t ha⁻¹ at medium information level, 7.4 t ha⁻¹ at high

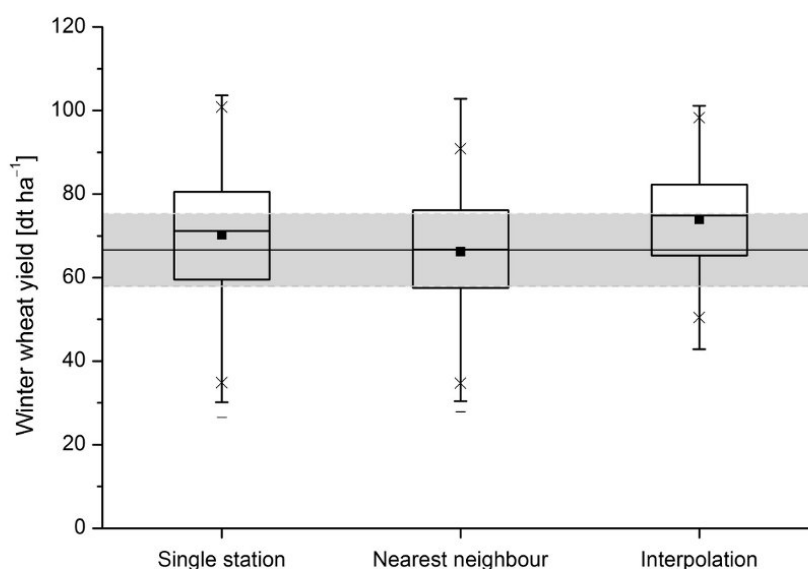

Figure 1: Box plot of 1992–2009 winter wheat yields across 17 counties of the Federal State of Thuringia, Germany, as simulated using the MONICA model with weather information from a single station (left), from the nearest of 14 weather stations (middle) and interpolated and altitude-corrected from 14 weather stations and 58 rain gauges (right). The black line and the grey band represent mean and standard error derived from official yield statistics.

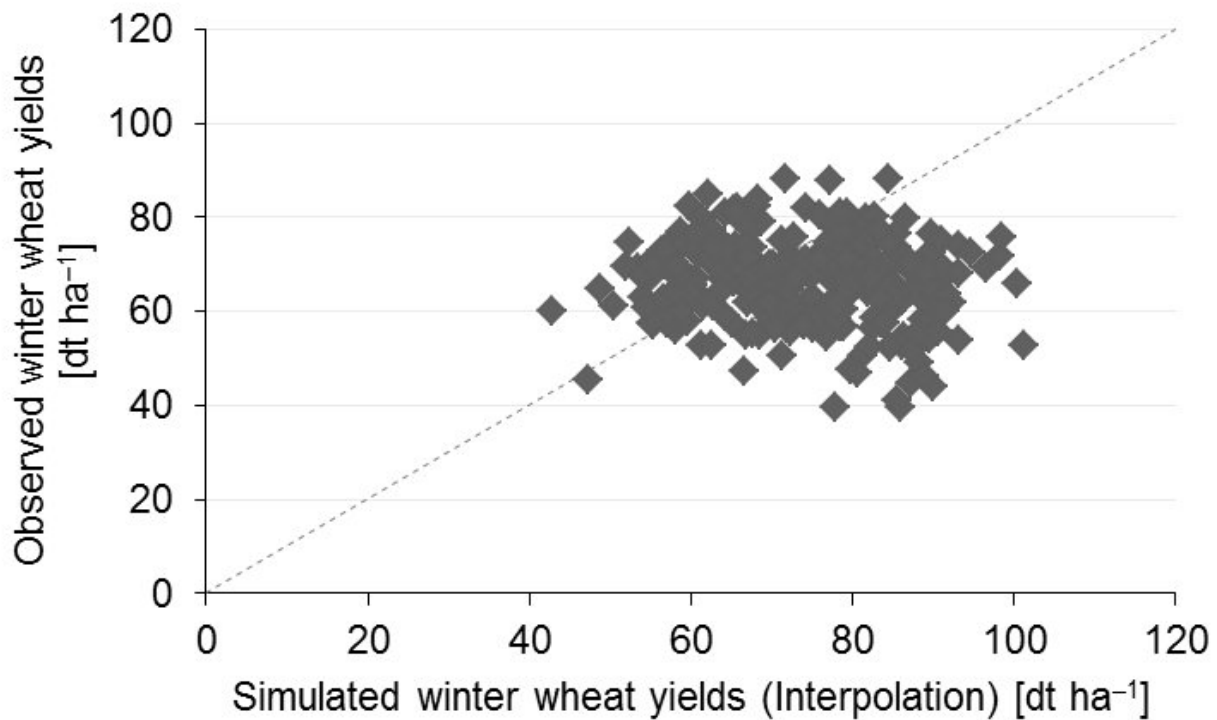

Figure 2: 1992–2009 winter wheat yields across 17 counties of the Federal State of Thuringia, Germany, simulated using the MONICA model with interpolated and altitude-corrected weather from 14 weather stations and 58 rain gauges vs. observed yields from official statistics.

level, Fig. 1) and (3) the yield dynamics over time at the county level (high information level) were simulated with a Nash-Sutcliffe modelling efficiency of -1.11 , which is below the acceptable range (Fig 2). Despite strong deviances in single years the county-level simulations meet the average yield levels on the long run. However, the fact that good simulation results on the regional level emanate from unacceptable simulations at the spatial level below should alert all modellers who attempt to validate their models on the regional level.

Reference

Nendel, C., M. Berg, K.C. Kersebaum, W. Mirschel, X. Specka, M. Wegehenkel, K.O. Wenkel and R. Wieland (2011): The MONICA model: Testing predictability for crop growth, soil moisture and nitrogen dynamics. *Ecol. Model.* 222 (9), 1614-1625.

Analysis and Modeling of spatio-temporal Patterns of CO₂ and H₂O Fluxes at Leaf and Canopy Scale in Crop Fields

Kupisch, Moritz; Stadler, Anja; Langensiepen, Matthias; Ewert, Frank

University of Bonn, GERMANY

Gas exchange of CO₂ and water vapour are important processes that determine crop growth and yield. These processes are affected by climatic and soil conditions and differ between crops (Arora et al., 2001; Monti et al., 2006). Changes in these conditions will therefore affect CO₂ and water exchange. The temporal variability of gas exchange in crops has extensively been studied (Reicosky et al., 1994; Mo and Liu, 2001; Wang et al., 2006), but less is known about the spatial variability. Particularly, the spatial variability within crop fields has received little attention so far. However, understanding the spatio-temporal variability of gas exchange is necessary for the modeling and estimation of soil-vegetation-atmosphere processes and crop growth and yield at field and larger scales, but most modeling efforts largely ignore the spatial variability of gas exchange and growth and development processes within a field. Detailed representations of plant physiological processes at a single point within the field are typically assumed to represent the entire field. Little work has been done on scaling up from the single point to the entire field, not least due to the limited experimental data available. Accordingly, the objective of this study is to analyse the spatio-temporal variability of CO₂ and H₂O fluxes at leaf and canopy level within fields of two crops, winter wheat and sugar beet and to test the effect of different upscaling methods. The results revealed a strong spatial heterogeneity of carbon and water canopy fluxes across the fields. While canopy measurements had a temporal variability with distinct diurnal and seasonal patterns, the temporal and spatial variability of leaf level photosynthesis and transpiration was comparably small. Further analysis suggests that the observed spatial and seasonal variability of canopy measurements was mainly caused by field heterogeneity in LAI and less by gas exchange rates per unit leaf area. However, both crops differed in their response to drought stress: while wheat responded mainly through irreversible reduction in green leaf area, the canopy assimilation rate of sugar beets decreases only temporarily with no observed

effects in LAI. Comparison of upscaling methods from canopy to field revealed differences of total cumulative fluxes of CO₂ and H₂O at field level of more than 100%. The obtained datasets from both years are the basis for parameterizing the crop growth model GECROS (Yin and van Laar, 2005). Our results indicate that it is important to consider field heterogeneity for parameterizing crop growth and large-scale soil-vegetation-atmosphere-transport models. We will show to which extent the simulation results at field scale are affected by the up-scaling method.

References

- Arora, A., Singh, V.P., Mohan, J., 2001. Effect of Nitrogen and Water Stress on Photosynthesis and Nitrogen Content in Wheat. *Biologia Plantarum* 44, 153–155.
- Mo, X., Liu, S., 2001. Simulating evapotranspiration and photosynthesis of winter wheat over the growing season. *Agricultural and Forest Meteorology* 109, 203–222.
- Monti, A., Brugnoli, E., Scartazza, A., Amaducci, M.T., 2006. The effect of transient and continuous drought on yield, photosynthesis and carbon isotope discrimination in sugar beet (*Beta vulgaris* L.). *Journal of Experimental Botany* 57, 1253–1262.
- Reicosky, D.C., Brown, P.W., Moran, M.S., 1994. Diurnal trends in wheat canopy temperature, photosynthesis, and evapotranspiration. *Remote Sensing of Environment* 49, 235–245.
- Wang, J., Yu, Q., Li, J., Li, L.H., Li, X.G., Yu, G.R., Sun, X.M., 2006. Simulation of diurnal variations of CO₂, water and heat fluxes over winter wheat with a model coupled photosynthesis and transpiration. *Agricultural and Forest Meteorology* 137, 194–219.
- Yin, X., van Laar, H.H., 2005. Crop systems dynamics. An ecophysiological simulation model for genotype-by-environment interactions. Wageningen Academic Pub.

Early growth in intercrops: an experimental and simulation approach for a range of species under different sowing conditions

Fayaud, Benoit¹; Coste, Françoise¹; Corre-Hellou, Guénaëlle¹; Gardarin, Antoine¹; Dürr, Carolyne²

¹LUNAM Université, Groupe ESA, FRANCE; ²INRA, IRHS, FRANCE

Introduction

Early growth is a critical phase of the cycle in intercrops because it determines the growth of each species and their subsequent interactions (Andersen et al., 2007; Naudin et al., 2010). Early growth before competition is exponential and can be described as follows:

$$DM_{TT} = DM_0 \times e^{(RGR \times TT)} \quad (1)$$

where TT is thermal time from emergence (°Cd); DM_{TT} is aboveground dry matter at TT (mg); DM_0 is aboveground dry matter at emergence (mg); RGR is relative growth rate ($mg \cdot mg^{-1} \cdot °Cd^{-1}$). Previous studies have shown that early growth could depend on seed mass, seedbed mineral content and time to emerge with differences between epigeal and hypogeal species (Dürr and Boiffin, 1995). To be able to model and better control intercrops, factors causing variation of DM_0 and RGR have to be identified and quantified. Early growth was measured on different species with contrasting seed and seedling traits. The potential consequences of the early growth variations on growth of two intercrops were studied by a modelling approach.

Materials and methods

Experiments were carried out in a glasshouse with: two monocots, durum wheat (*Triticum turgidum*) and tall fescue (*Festuca arundinacea*); two legumes: pea (*Pisum sativum*) and black medick (*Medicago lupulina*); and two non-legume dicots: sunflower (*Helianthus annuus*) and carrot (*Daucus carota*). Each species was studied separately using two nutrient levels (3.5 and 14 mM N) and three sowing depths. Four sampling dates were realized from emergence to 300–350°Cd (with specific base temperature for each species) to measure biomass. Statistical analyses were carried out using R version 2.8.1. Predictive equations of both DM_0 and RGR were built as a function of seed and seedling traits, mineral nutrition and time to emerge. Data were used to simulate growth of durum wheat – pea intercrop and durum wheat – black medick intercrop under different sowing conditions with a constant temperature of 15°C and assuming identical sowing times for each species.

Table 1: Variation of early growth parameters. ns: not significant; + : positive effect; - : negative effect and p-values.

Experimental factor	Cereals and pea			Other dicots	
	Large seeds		Small seeds	Large seeds	Small seeds
	pea	wheat	tall fescue	sunflower	black medick
Mineral nutrition	ns 0.43	ns 0.48	ns 0.93	Not tested	+
DM_0	Time to emerge	+	ns	ns	-
		2.10^{-4}	0.15	0.29	2.10^{-5}
Interaction	ns 0.72	ns 0.16	ns 0.50	Not tested	ns 0.20
Mineral nutrition	ns 0.70	+	+	Not tested	+
		2.10^{-16}	2.10^{-16}		2.10^{-16}
RGR	Time to emerge	ns	+	-	-
		0.88	2.10^{-7}	2.10^{-16}	2.10^{-15}
Interaction	+	ns	ns	Not tested	ns
	2.10^{-16}	0.91	0.05		0.12

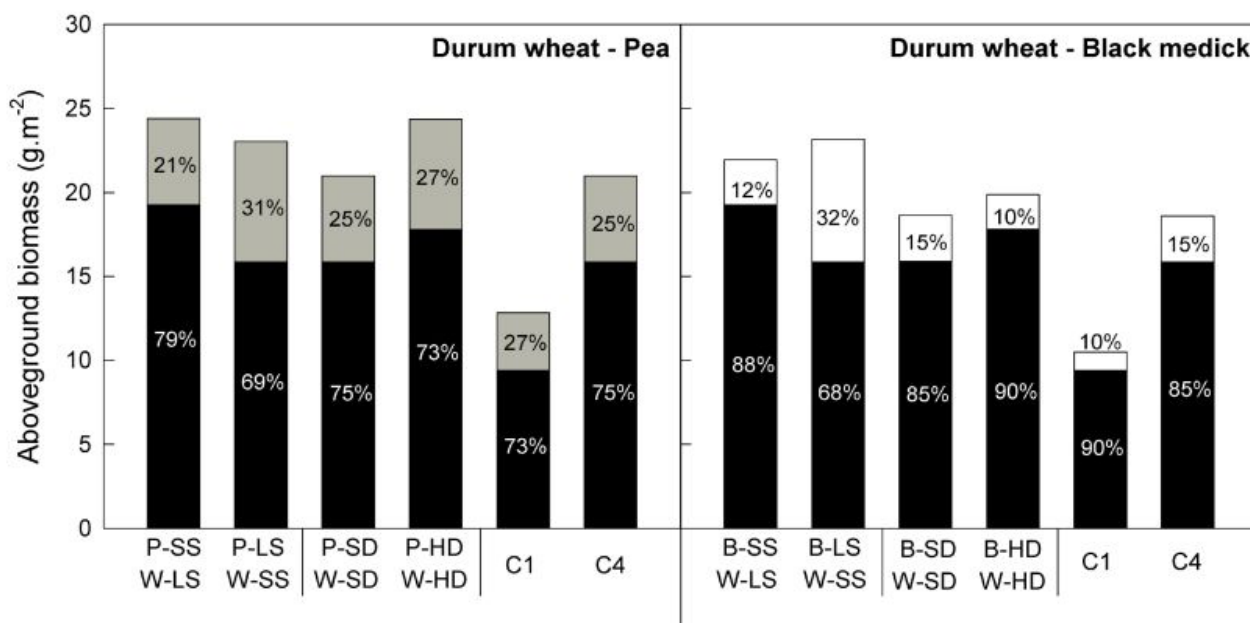

Figure 1: Simulated aboveground biomass (g.m⁻²) at 32 days after sowing. Durum wheat: W (black), pea: P (gray), black medick: B (white), small seed: SS, large seed: LS, shallow sowing depth: SD, high sowing depth: HD, limiting nutrition: C1, non limiting nutrition: C4. Default settings: SS, SD and C4.

Results

Equation 1 fitted aboveground biomass well. DM_0 was mainly correlated to seed mass (SM): for epigeal species $DM_0 = 0.651 \times SM^{1.1}$ ($r^2 = 0.99$), and for hypogeal ones $DM_0 = 0.346 \times SM^{0.84}$ ($r^2 = 0.99$). DM_0 of monocot species was not influenced by time to emerge while DM_0 of dicot epigeal species was negatively impacted because of the depletion of the cotyledons (Tab 1). At the opposite, DM_0 of pea was positively impacted by time to emerge due to a developing shoot during pre-emergence growth. RGR increased for all species with nutrients added. An increasing time to emerge can be critical for RGR in the case of small seeded species by contrast with the RGR of large seeded ones because of more developed shoots at emergence. Most contrasted simulations showed that seed mass had a major impact on species proportions while sowing depth had consequences on both total biomass and proportions depending on how RGR is impacted (Fig 1). Mineral nutrition had a strong impact on total biomass.

Discussion

This study provides data to understand early growth variations according to species and sowing conditions. Growth differences even before the beginning of competition due to early growth variations could lead to accentuated disparities when associated species start to interact. The present results contribute to build tools that predict intercrop performances.

References

Andersen, M.K. et al, 2007. Journal of Applied Ecology 44, 545-551.
 Dürr, C., Boiffin, J., 1995. The Journal of Agricultural Science 124, 427-435.
 Naudin, C. et al., 2010. Field Crops Research 119, 2-11.

Assessing the uncertainty in model-based evaluation of irrigation strategies

Wallach, Daniel¹; Keussayan, Nathalie¹; Brun, François²; Lacroix, Bernard³; Bergez, Jacques-Eric¹

¹INRA, FRANCE; ²ACTA, FRANCE; ³ARVALIS - Institut du végétal, FRANCE

A major use of crop models is to evaluate management strategies. An important question is how accurate models are for such evaluations. The purpose of this paper is to illustrate how to quantify the uncertainty in the evaluation of irrigation strategies, when that evaluation is based on a crop model.

The procedure for quantifying uncertainty has three steps. First, the sources of uncertainty are identified. Here we consider uncertainty in the model parameters and model residual error. Often uncertainty estimates consider only parameter uncertainty, but in fact it is important to also include residual error, which results from model inadequacy, residual variability and measurement error. Secondly, the uncertainty in each source is quantified. Here we use a Bayesian approach. This approach begins with a prior distribution, which describes our information about model parameters and residual variance before using the data available for the study. The Bayesian approach then combines that prior distribution with the data, to give a posterior distribution which describes our knowledge about the model parameters and residual variances after taking account of the data. Our specific algorithm is Metropolis-Hastings within Gibbs. The Metropolis-Hastings step creates the chain of model parameter values while the Gibbs step creates the chain of residual variance values. Finally, the uncertainties are propagated through to the quantities of interest. This includes two types of quantities. First, we calculate the uncertainties in simulating the data used in the study. The actual data should be reasonably probable with respect to that uncertainty. This is called posterior predictive checking in Bayesian analysis. Secondly, we consider the prediction of the criteria that are used for evaluating irrigation strategies. This is the main output

of the method. Very many criteria could be of interest. We consider several, including yield in a single year with known weather, yield averaged over years and the inter-annual variation in yield.

We apply this approach to model-based evaluations of irrigation strategies for maize in southwest France. Our data consist of measurements of LAI, aboveground biomass and yield from 81 site-year-irrigation cases. The model is a previously published crop model, slightly modified, coupled to a decision module, also published, which translates irrigation decision rules into dates and amounts of irrigation. The posterior predictive checks show that the data are consistent with the calculated credible intervals (the Bayesian analog of confidence intervals). The data include groups of cases from the same site and with similar amounts of irrigation. The calculated credible intervals for averages by group are substantially narrower than the intervals for individual predictions. This is also found to be consistent with the data. We then use the model to predict the outcomes from four different irrigation strategies at a particular site, and calculate the uncertainty in our evaluation criteria (average yield etc) for those strategies.

A major conclusion is that the uncertainty in predicting yield averaged over years (about 0.2 t/ha) is quite a bit smaller than uncertainty in predicting yield for a single year with given weather (about 1.3 t/ha). This suggests that crop models may be quite useful for comparing management strategies, if a major criterion of comparison is yield averaged over years. We also emphasize that it is essential to verify the reliability of uncertainty estimates using data, and that the conclusions only apply to the population of situations from which the data are drawn.

Sustainable Bioenergy Cropping

Thrän, Daniela; Bunzel, Katja; Witing, Felix

Helmholtz-Centre for Environmental Research (UFZ), GERMANY

Bioenergy, with a share of 70 %, is the backbone of the renewable energies in Europe. Beside the reduction of greenhouse gas (GHG) emissions and energy security, the energetic use of biomass also aims to promote rural development and technical innovations. In the agricultural sector, the production of energy crops can open up new markets for agricultural products and residues.

Bioenergy has many strengths as it can be utilised in a diverse range of performance domains and in combination with material use. Bioenergy is the all-rounder among the renewable energies. Furthermore, bioenergy is the only renewable energy carrier capable of substituting for all kinds of fossil based energy carriers (heat, electricity and fuels). In the aviation sector, for example, biofuels are the only option to substitute fossil fuel. Another advantage

of bioenergy is that, in contrast to wind or solar energy, it is a storable form of renewable energy and can be transported and utilized at any time.

In addition to the use of woody materials and residues, energy crops are of increasing importance. Several technologies utilising energy crops have been successfully launched into the market (e.g. bioethanol from sugar cane, biodiesel from rapeseed, biogas from maize). Already energy crops, especially for biofuels, are grown on about 30 M ha worldwide and this area will increase. Despite the multiple advantages of bioenergy, concerns have arisen regarding the social and ecological sustainability associated with energy crop production especially in countries outside the European Union. In Malaysia, for example, huge areas of tropical rainforest

	Renewable Energy Directive 2009/28/EC	Global Bioenergy Partnership (GBEP)
Environmental	<p>Sustainable Agriculture For EU only: compliance with cross compliance rules (standards in the areas environment and animal welfare, plant and animal health)</p> <p>Protection of ecosystems No production on land with:</p> <ul style="list-style-type: none"> High value for biological diversity (e.g. primary forest, protected areas, highly biodiverse grassland) High carbon content (e.g. peat and wetlands, continuously forested areas) <p>GHG reduction at least 35 %; 2017: 50 %; 2018 and for installations in which production starts after 01.01.2017: 60 % in comparison to reference fossil fuel (diesel or petrol)</p>	<ul style="list-style-type: none"> Life-cycle GHG emissions Soil quality Harvest levels of wood resources Emissions of non-GHG air pollutants, including air toxics Water use and efficiency Water quality Biological diversity in the landscape Land use and land-use change related to bioenergy feedstock production
Social	<p>Directive specifies a mechanism to monitor the potential social impact of biofuel production in source countries. European Commission bound to report on:</p> <ul style="list-style-type: none"> Impact of increased demand on biofuels on food prices and 'wider development issues' Respect of land-use rights Ratification and implementation of certain International Labour Organization (ILO) conventions, the Cartagena Protocol on Biosafety and the Convention on International Trade in Endangered Species of Wild Fauna and Flora (CITES) by source countries 	<ul style="list-style-type: none"> Allocation and tenure of land for new bioenergy production Price and supply of a national food basket Change in income Jobs in the bioenergy sector Change in unpaid time spent by woman and children collecting biomass Bioenergy used to expand access to modern energy services Change in mortality and burden of disease attributable to indoor smoke Incidence of occupational injury, illness and fatalities
Economic		<ul style="list-style-type: none"> Productivity Net energy balance Gross value added Change in consumption of fossil fuels and traditional use of biomass Training and re-qualification of the workforce Energy diversity Infrastructure and logistics for distribution of bioenergy Capacity and flexibility of use of bioenergy

were cut down to cultivate palm oil for the production of biodiesel. As a reaction to this criticism, sustainability criteria for the production of biofuels were integrated into the Renewable Energy Directive (RED), which came into force in December 2010 (Fig. 1). Compliance with these sustainability criteria has to be proven through the implementation of a certification scheme. So far, seven certification schemes are accepted by the EU and these are an important step in the right direction. However, critics claim that important aspects are missing, e.g., effects of indirect land use (iLUC) or negative social side effects such as displacement of smaller farmers due to increased land prices. Furthermore, the European Commission stated in 2010 that no binding sustainability scheme for solid and gaseous biomass sources were currently necessary. This decision was mainly justified by the fact that 90 % of the biomass consumed in the EU comes from European forests and by-products of other industries and that binding criteria would impose serious costs to European economic actors.

As a useful addition to the RED sustainable criteria, the Global Bioenergy Partnership (GBEP), a government-level organisation of 23 countries, established a set of 24

voluntary sustainability indicators that address all forms of bioenergy at the domestic level (Fig. 1). Measured over time, the GBEP sustainability indicators will provide valuable information for national-level policy analysis and development.

In the future, the energetic use of biomass should focus on those applications with a need for high and long-term stable reductions of GHG emissions (e.g. aviation and heavy vehicle transport). Current research addresses the development of new energy crops (such as the perennial *Silphium perfoliatum*), new management systems (crop mixtures or flower strips for the production of biogas substrate) and the sustainable use of brownfields and marginal lands (e.g. short-rotation coppice).

Not all problems connected with the production of bioenergy can be addressed by sustainability standards and certification. The cultivation of energy crops represents only a small share of the overall intensive agricultural production. Therefore, the discussion on sustainable biomass production has to be followed by a general discussion on sustainable agriculture.

Industrial Hemp (*Cannabis sativa* L.) – a High-Yielding Energy Crop

Prade, Thomas¹; Svensson, Sven-Erik¹; Mattsson, Jan Erik¹; Finell, Michael¹; Kreuger, Emma²

¹Swedish University of Agricultural Sciences (SLU), SWEDEN; ²Lunds University, SWEDEN

Introduction

Industrial hemp was studied as an energy crop for production of biogas and solid biofuel. Based on field trials, the development of biomass and energy yield, the specific methane yield and elemental composition of the biomass were studied over the growing and senescence period of the crop, i.e. from autumn to the following spring. The aims of the study were to investigate potential hemp biomass and energy yields per hectare at different harvest dates and to characterise hemp biomass as a solid biofuel for direct combustion. Furthermore, the potential net energy yields from hemp were evaluated in an energy balance.

Materials and methods

Field trials were carried out at three locations in southern and northern Sweden in order to determine biomass and energy yields as biogas substrate and solid fuel, respectively, (southern trials only), as well as to determine the chemical fuel properties of the biomass. In a modelling approach, the energy balance of energy production from hemp biomass was evaluated for 4 application scenarios.

Results & discussion

The energy yield of hemp for both solid biofuel and biogas production proved similar or superior to that of most energy crops common in northern Europe. The

high energy yield of biogas from hemp is based on a high biomass yield per hectare and good specific methane yield with large potential for increases by pretreatment of the biomass. The methane energy yield per hectare is highest in autumn when hemp biomass yield is highest. The energy yield per hectare of hemp for use as a solid biofuel is highest in autumn when the biomass yield is highest. However, important combustion-related fuel properties, such as moisture, alkali, chlorine and ash content and ash melting temperature, are significantly improved when industrial hemp is harvested in spring instead of in autumn. Major fuel properties of hemp are not significantly influenced by annual cultivation conditions, latitude or choice of cultivar. Net energy yields per hectare and energy output-to-input ratios of hemp are above-average in most applications, and are highest for use of hemp as solid biofuel. Use of hemp as a biogas substrate suffers from higher energy inputs and lower conversion efficiencies, but produces a high-quality vehicle fuel. Advantages over other energy crops are also found outside the energy balance, e.g. low pesticide requirements, good weed competition and suitability as break crop in cereal-oriented crop rotations. Improvements in hemp biomass and energy yields may strengthen its competitive position against maize and sugar beet for biogas production and against perennial energy crops for solid biofuel production.

Intercropping Jerusalem artichoke (*Helianthus tuberosus* L.) with legumes for energy purpose

Kenedy Etone, Epie; Zou, Ling; Santanen, Arja; Mäkelä, Pirjo; Stoddard, Frederick

University of Helsinki, FINLAND

Introduction

The recent trend to identify alternative energy sources to replace fossil fuel has led to increasing interest in, among others, Jerusalem artichoke (JA). This perennial crop is usually grown as an annual because its inulin-rich tubers are used directly for food and also for production of dietary fibre, sugar and bioethanol. There is little interest in growing the crop because tubers are difficult to harvest and store, and establishment costs are high. This situation could be improved if vegetative parts have more economic importance. The easily harvestable herbaceous biomass can be used for burning in combine heat and power plants and for ethanol and, most of all biogas production. To cultivate JA as a perennial energy crop needs nutrient replenishment. N fixed by legumes can be used by JA in an intercropped system, potentially reducing or eliminating nitrogen fertilizer use in biomass feedstock production, and leading to a positive net energy balance, an essential requirement for energy crops. Tops of JA has potential for bioethanol and biogas (Tuck et al., 2006) and heating value of 15.5 MJ/kg (Tencl & Sladky,

2001). Literature on the crop is centred on industrial transformation and quality of tuber sugar into bioethanol. Generally, studies to evaluate field performance are still scarce. Some cropping aspects such as intercropping with legumes and how this affects above ground biomass production and energy quality are relatively unknown. This study determines how intercropping JA with legumes affects growth, herbaceous biomass yield and energy qualities of the crop.

Materials & Methods

Field studies were conducted in 2009 and 2010 in Helsinki University, Finland (60°13' N 25°02' E) with silty clay loam soil. Mean temperature was above 10°C with average rainfall during the growing season. Seed tubers of JA were manually planted into 12 m² plots, 30 cm within and 60cm between rows. Five treatments were studied; sole-cropped JA fertilized with 60 kg N/ha yearly and four pre-inoculated legumes each sown into the JA plots. The legumes were goat's rue, red clover, sweet clover

Table 1. Growth, biomass yield and energy qualities of above-ground parts of Jerusalem artichoke intercropped with legumes in 2009-2010.

Year/Treatment	Height (cm)	LAI	TotalDW (t/ha)	Energy yield GJ/ha	Ash (%)	C:N ratio
2009						
JA+60kgN	202	9.2	17	276	6.8	59
JA+goat's rue	186	6.9	13	209	6.1	69
JA+red clover	185	6.1	13	203	7.7	53
JA+vetch	183	7.2	13	215	5.8	61
JA+sweet clover	185	10.6	11	177	6.6	80
LSD _{0.05}	11	2.1	ns	ns	ns	ns
2010						
JA+60kgN	145	9.2	17	266	7.7	58
JA+goat's rue	137	12.1	14	219	7.2	80
JA+red clover	133	8.5	15	244	7.2	78
JA+vetch	118	6.7	13	209	7.9	75
JA+sweet clover	138	8.3	16	254	8.2	68
LSD _{0.05}	ns	3.0	ns	ns	ns	12

and vetch sown at 23, 7, 20 and 49 kg/ha respectively. No fertilizer was applied in legume plots. Four replicates were arranged in a randomized complete block design. LAI was measured by a SunScan Canopy Analysis System (Delta-T Devices, UK). Tops were manually harvested from 1 m² per plot in October, dried in ovens at 70 °C for 3 days to obtain dry weight. The rest of the plots were cleared to allow regrowth to emerge in the following growing season. Dried samples were crushed and milled through a 0.5mm mesh and used for ash, energy value and C and N determination.

Results & Discussion

Fertilized plants grew taller than legume intercropped plants in both years, although significantly ($P < 0.05$) only in 2009. In 2009 and 2010, total above-ground dry matter and energy yields in fertilized plants were 27% and 15% higher, respectively, than in legume-intercropped plants. C:N ratio ranged from 53 to 80 and ash content from 5.8 to 8.2%. Carbon content was

high at harvest and tops could best be used for burning. Early harvested plants have C:N ratios less than 30, and could be good for bioethanol and biogas production. However, JA intercropped with legumes grew well and gave good yields equally as their fertilized counterpart. Although legumes were almost completely suppressed by JA in the second year, the lack of significant differences between intercropped and fertilized plants shows that legumes can potentially sustain Jerusalem artichoke in an intercropped system. This will reduce fertilizer costs for farmers and a cleaner environment.

Reference

- Tuck G, Glendining MJ, Smith P, House JI, Wattenbach M. 2006. The potential distribution of bioenergy crops in Europe under present and future climate. *Biomass & Bioenergy* 30:183–197.
- Tencl J & Sladky V, 2001. Effect of harvest time on moisture content and heating value of biofuels. *Research in Agric Eng* 47:1-5

The Increasing Competition for Biomass

Popp, József¹; Fülöp, Mihály²; Nábrádi, András²

¹University of Debrecen, HUNGARY; ²University of Debrecen, HUNGARY

Introduction

The worldwide potential of bioenergy is limited because all land is multifunctional and land is also needed for food, feed, timber and fibre production, as well as for nature conservation and climate protection. Bioenergy may compete with the food sector, either directly, if food commodities are used as the energy source, or indirectly, if bioenergy crops are cultivated on soil that would otherwise be used for food production. The additional impact on food prices of higher demand for crops as energy feedstock is of real concern.

Methodology

The total annual aboveground net primary production on the Earth's terrestrial surface is estimated to be about

1,260 EJ/year (Haberl et al. 2007), which can be compared to the current world primary energy supply of about 500 EJ/year (IEA Bioenergy, 2009). All harvested biomass used for food, fodder, fibre and forest products equals 219 EJ/year (Krausmann et al. 2008). The global harvest of major crops corresponds to about 60 EJ/year (FAOSTAT, 2011). Renewable energy accounted for 13% of the total primary energy supply in 2008 and the largest contributor with 10% points (50.3 EJ/year) was biomass. Discussion The food sector accounts for around 30% of global energy consumption and produces over 20% of global greenhouse gas (GHG) emissions. Around one-third of the food we produce, and the energy that is embedded in it, is lost or wasted (Gustavsson et al. 2011). The food sector can adapt to future energy supply constraints and to the impacts of climate change with rapid deployment

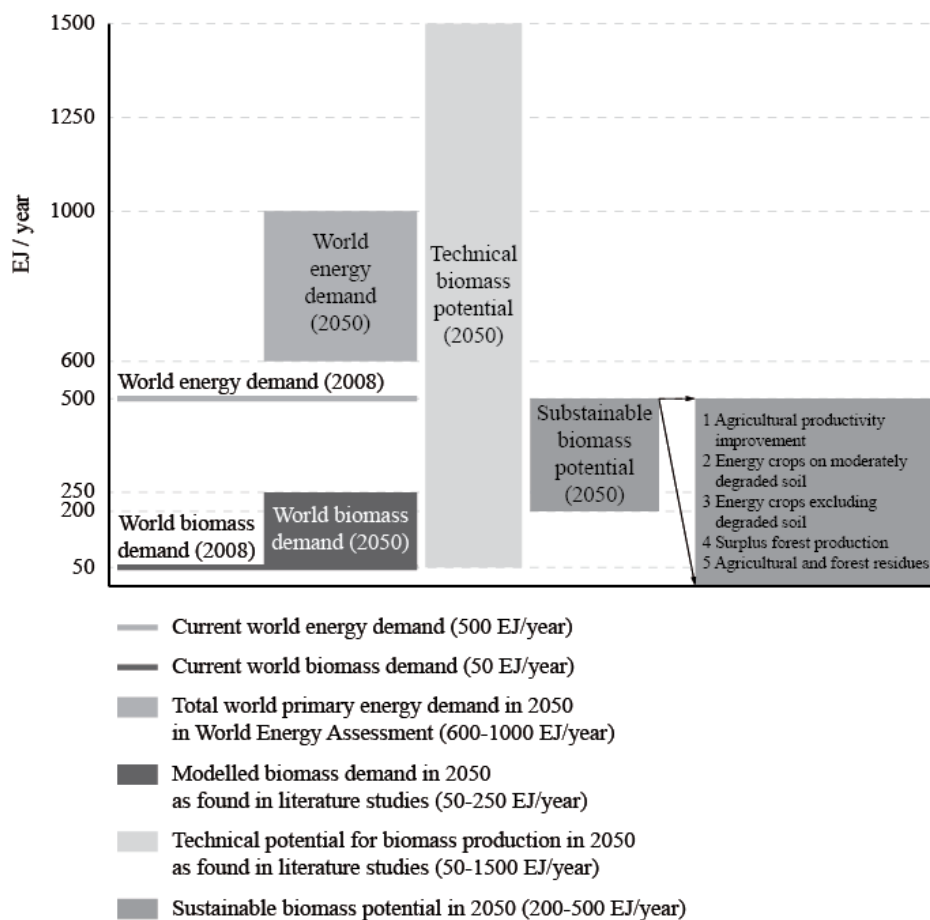

Figure 1: World primary energy demand by fuel in 2008. (Source: IEA Bioenergy 2009.)

of renewable energy technologies. More than 80% of the biomass feedstocks are derived from wood. The remaining bioenergy feedstocks come from the agricultural sector and from various commercial and post-consumer waste and by-product streams (Figure 1). Projected world primary energy demand by 2050 is expected to be in the range of 600 to 1000 EJ/year compared to about 500 EJ in 2008. The expert assessment suggests potential deployment levels of bioenergy by 2050 in the range of 100-300 EJ/year. Biomass could sustainably contribute between a quarter and a third of the future global energy mix (Figure 2). Availability of land for non-food crops will be determined by increased yield potential, reducing losses and wastes along the food chain and lower inputs. Limited biomass resources will be allocated to the sector that is most able to afford them.

Conclusion

The debate surrounding biomass in the food versus fuel competition, and growing concerns about other conflicts, have resulted in a strong push for the development and implementation of sustainability criteria and frameworks as well as changes in target levels and schedules for bioenergy.

References

- Haberl, et al. 2007. Quantifying and mapping the human appropriation of net primary production in earth's terrestrial ecosystems. *Proceedings of the National Academy of Sciences*, 104(31): 12942-12947.
- Krausmann, F. et al. 2008. Global patterns of socioeconomic biomass flows in the year 2000: A comprehensive assessment of supply, consumption and constraints. *Ecological Economics*. 65(3): 471-487.
- FAOSTAT. 2011. FAOSTAT. Rome: FAO. <http://www.faostat.fao.org/default.aspx> (accessed Febr.28 2012).
- IEA Bioenergy. 2009. A Sustainable and Reliable Energy Source. Main Report. Paris: International Energy Agency.
- Gustavsson, J. et al. 2011. Global food losses and food wastes – extent, causes and prevention. Rome: FAO http://www.fao.org/fileadmin/user_upload/ags/publications/GFL_web.pdf (accessed Jan.18 2012).

Figure 2: Global bioenergy sources. (Source: IEA Bioenergy 2009.)

Maize hybrids for biogas production in conditions of Latvia

Gaile, Zinta; Bartusevics, Janis
Latvia University of Agriculture, LATVIA

Introduction

Latvia (latitudes: N 55°40'–58°05' and longitudes: E 20°58'–28°14') is considered as marginal area for maize (*Zea mays* L.) growing. However, crop is grown for forage since 1954 here. In very recent years also maize growing for newly developed biogas production plants is in progress. Research results for last twenty years showed that hybrids characterized with FAO numbers up to 220 provided persistent yield with good quality for forage. Researchers from Austria (Amon et al., 2007) consider that hybrids suitable for local conditions for biogas production should be used and they should be harvested at milk till yellow ripeness stage. Other research data suggests that for biogas production a little later maturity (by 50 FAO units) hybrids than those traditionally recommended can be used successfully (Degenhardt, 2005, cited by Schittenhelm, 2008).

Our research aimed to test possibility to grow later maturity (FAO numbers above 220) hybrids for biogas production in Latvia.

Methodology

Trials were carried out during 2009–2011 in the Research and Study farm 'Vecauce' (latitude: N 56° 28', longitude:

E 22° 53') of Latvia University of Agriculture. Original seed of 29 maize hybrids in 2009, of 32 maize hybrids in 2010 and of 37 maize hybrids in 2011 with different maturity rating defined by FAO number (FAO 160–260) were used. Hybrids were from different breeding companies. Maize was sown on first ten-day period of May, and harvested at the last days of September or first days of October depending on year. Fresh maize and dry matter (DM) yields ($t\ ha^{-1}$) and DM content (samples were dried up to constant weight at 105 °C) was analyzed in this paper. ANOVA analysis of variance was used for yield data processing. Meteorological conditions were diverse during trial years: 2009 was overly cold, but seasons of 2010 and 2011 were warm and with good moisture supply.

Results and Discussion

Maize yield significantly ($p < 0.05$) depended on used hybrid in every trial year. To see the influence of hybrid maturity rating on yield and DM content at harvest all used hybrids in every year were grouped into five groups according the FAO number (Table 1). Results showed that average fresh maize yield, as well as DM yield of every succeeding group was higher than that of previous group in every trial year. Conditions of trial year also influenced the yield. Cold and dry weather in the early season of 2009

Table 1. Average yield ($t\ ha^{-1}$) and dry matter content of maize at harvest (%) depending on agro-meteorological conditions of trial year and hybrid maturity group (FAO number)

FAO number	Fresh maize yield			Dry matter content			Dry matter yield		
	2009	2010	2011	2009	2010	2011	2009	2010	2011
Below 179	n*=3 34.30	n=3 40.21	n=1 31.13	32.18	35.48	40.32	11.05	14.29	12.96
180-199	n=7 40.28	n=9 45.07	n=9 45.28	29.85	33.95	34.94	12.00	15.33	15.82
200-220	n=14 43.28	n=13 49.80	n=20 51.03	28.68	33.12	33.68	12.54	16.42	17.23
221-240	n=3 54.22	n=5 56.34	n=6 54.96	26.24	31.94	30.76	14.20	17.97	18.39
241-260	n=2 59.81	n=2 57.80	n=1 67.59	25.21	29.40	32.32	15.08	17.00	21.85

*- number of hybrids included into calculation

affected yield of maize in all maturity groups: DM yield (11.05-15.08 t ha⁻¹) was notably lower if compared with two succeeding years. Yield of maize hybrids included into later maturity groups (FAO number above 220) was by 1.66-2.54 t ha⁻¹ higher if compared with hybrids included into earlier maturity group (FAO 200-220). At the same time the average content of DM at harvest of every succeeding group decreased. Later maturity hybrids (FAO numbers above 220) provided DM content 25.21-26.24% in 2009. This is the lowest allowable DM content at harvest for making silage with satisfactory quality. Conditions in 2010 and 2011 were beneficial for maize growing that was reflected in higher DM yields (Table 1). Still the average yields of later maturity maize hybrids (FAO numbers above 220) were higher than that of group characterized by FAO 200-220 and in addition also DM content was above 29% which is appropriate for good quality silage making.

Conclusions

It was concluded that growers can take risk to use maize hybrids whose maturity group is characterized by FAO number up to 260 for biogas production in Latvia. Since performance of hybrids within a specific group depended on the genotype characteristics then only approved in local field trials hybrids should be used.

References

- Amon T. et al. (2007) Methane production through anaerobic digestion of various energy crops grown in sustainable crop rotation. *Bioresource Technology*, 98, p. 3204-3212.
- Schittenhelm S. (2008) Chemical composition and methane yield of maize hybrids with contrasting maturity. *European Journal of Agronomy*, 29 (2008), p. 72-79.

Ecological footprint of agriculture and crop protection: analyzing environmental impacts of crop protection methods within an integrated framework

Albajes, Ramon

University of Lleida,, SPAIN

Introduction

Among the several ways to respond to the increasing demand for agricultural goods, those that focus on enhancing crop productivity without losing sustainability occupy a major place. Recent evaluations show a potential 67.4% loss of yield but an actual 32.0% loss, caused by insect pests, plant diseases and weeds in world agriculture, thus meaning that current pest control methods are around 50% effective (Oerke and Dehne, 2004). Further analysis shows that the most severe losses are in western countries, in spite of their being the heaviest pesticide consumers. Pesticides are among the main causes of the high ecological footprint associated to agriculture so chemical savings to prevent pest impacts should favour sustainability of crop protection. However, crop protection methods implemented to replace pesticides in modern agriculture do not necessarily lead to improved sustainability when they are designed without considering the entire agroecosystem and how biological systems operate within it (Keurentjes et al. 2010). Thus it is necessary to assess risks for environment posed by new pest control methods. If agroecosystems are analyzed in their trophic interactions, crop yield is the result of complex relationships in which weeds, plant pathogens and herbivore insects play a major role that may be understood only if at least the tritrophic system composed of plants/ herbivores/ natural enemies is analyzed. Maize in Mediterranean conditions is used as an example of how the modification of herbivore insect populations by the application of pesticides or the alteration of weed flora composition, abundance, and phenology by using herbicide-tolerant maize may lead to more or less abrupt changes in insect pest densities. Leafhoppers (fam. Cicadellidae) are herbivore insects that colonize maize plants early in the season and reproduce until they reach relatively high densities that may delay plant growth if suppressing methods are not applied. Soon after leafhopper arrival, a generalist predatory insect, Orius spp. (fam. Anthocoridae) starts to forage on aerial parts of the plant for insect and mite prey, reproduces and remains in the crop at high densities

until plants dry. The maize arthropod fauna has other components but crop plant, leafhoppers and Orius spp have shown to be key elements in the early establishment of the trophic web in the maize system that usually prevent herbivore insect population outbreaks (Albajes et al. 2011). Any interference with the process of maize plant colonization by leafhoppers may therefore delay establishment of higher trophic levels, primarily Orius spp. and other generalist predators, and deterioration of biological control services that are provided by arthropod fauna in maize plantations thus leading to aggravated ecological footprint of this agricultural system. In the presentation, the plant- herbivore- predator relationship is used to predict the impact of dressing seeds with soil insecticides or growing two kinds of transgenic maize, Bt maize and herbicide-tolerant maize, on the biological control functions.

Methodology

The presentation includes results from three kinds of field trials. (i) insecticide seed dressing vs. untreated seeds; (ii) Bt maize vs. non-Bt maize, and (iii) glyphosate vs. conventional herbicide-treated maize with a transgenic herbicide-tolerant maize. With a randomized block design the different treatments were evaluated in multiyear trials where the populations of the principal arthropods were monitored along the season. Results were statistically analyzed.

Results and discussion

Results have been already published and readers are referred to the following references (Albajes et al. 2003, 2009, 2011; Poza et al. 2005).

Conclusion

The measurement of the impact of pesticides or GM crops on the environment should be done in the field where consequences of interfering with complex multiple interactions may be displayed.



References

- Albajes, R, López, C, & Pons, X 2003. Predatory fauna in cornfields and response to imidacloprid seed treatment. *J.Econ.Entomol.* 96: 1805-1813.
- Albajes, R, Lumbierres, B, & Pons, X 2009. Responsiveness of arthropod herbivores and their natural enemies to modified weed management in corn. *Env Entomol* 38: 944-954.
- Albajes, R, Lumbierres, B, & Pons, X 2011. Two heteropteran predators in relation to weed management in herbicide-tolerant corn. *Biol Cont* 59:30-36.
- Keurentjes, JJB & 9 others. 2010. Redefining plant systems biology : from cell to ecosystem. *Trends Plant Sci* 16: 183-190.
- Oerke, EC and Dehne, HW. 2004. Safeguarding production. Losses in Major Crops and the Role of Crop Protection. *Crop Prot* 23: 275-285.
- Poza, M de la, & 7 others. 2005. Impact of farm-scale Bt maize on abundance of predatory arthropods in Spain. *Crop Prot* 24: 677-684.

Temporary grasslands impact weed abundance and diversity

Médiène, Safia¹; Zhang, Wenxuan²; Doisy, Diana²; Charrier, Xavier²

¹AgroParisTech, FRANCE; ²INRA, FRANCE

Introduction

The introduction of temporary grasslands in arable crop rotations is a promising agroecological way to control weed populations (Meiss *et al.*, 2010). The aim of this work is to analyze how the insertion of temporary grasslands into cereal-based rotations affects the weed diversity and communities. Three levels of statistical analyses (α diversity, β diversity and functional diversity) are carried out in order to understand the weed diversity and

community composition changes in crops and temporary grasslands.

Materials and Methods

Weed flora observations are realized in the long-term experiment SOERE-ACBB (Observatory and Experimental System for Environmental Research - Agroecosystems, Biogeochemical Cycles, and Biodiversity) at the INRA research centre of Lusignan in

western France. Five treatments are differentiated by duration (0, 3, 6 and 20 years) and nitrogen fertilization (low or high) of grasslands in cereal-based rotations (maize/wheat/barley). The plant composition seeded in 2005 in grasslands is a mixture of *Lolium perenne*, *Festuca arundinacea* and *Dactylis glomerata*. Chemical weeding is applied to crops when required. Weed flora is observed at least once a year in spring using a modified Barralis scale for species notation. Species richness (S), abundance (A), and diversity indexes, namely Shannon (H) and Pielou (J) indexes, were computed from weed flora data. Analyses of variance and Tuckey tests were performed with R freeware. Specific methods were used to study β diversity and functional diversity (Analysis of Similarities : ANOSIM, Indicator Species Analysis : ISA). Results are presented for weed flora observed between 2005 and 2010. Ten groups are defined according to crop identity, age and N fertilization of grasslands. Initial flora observed in 2005 is also separated in a group.

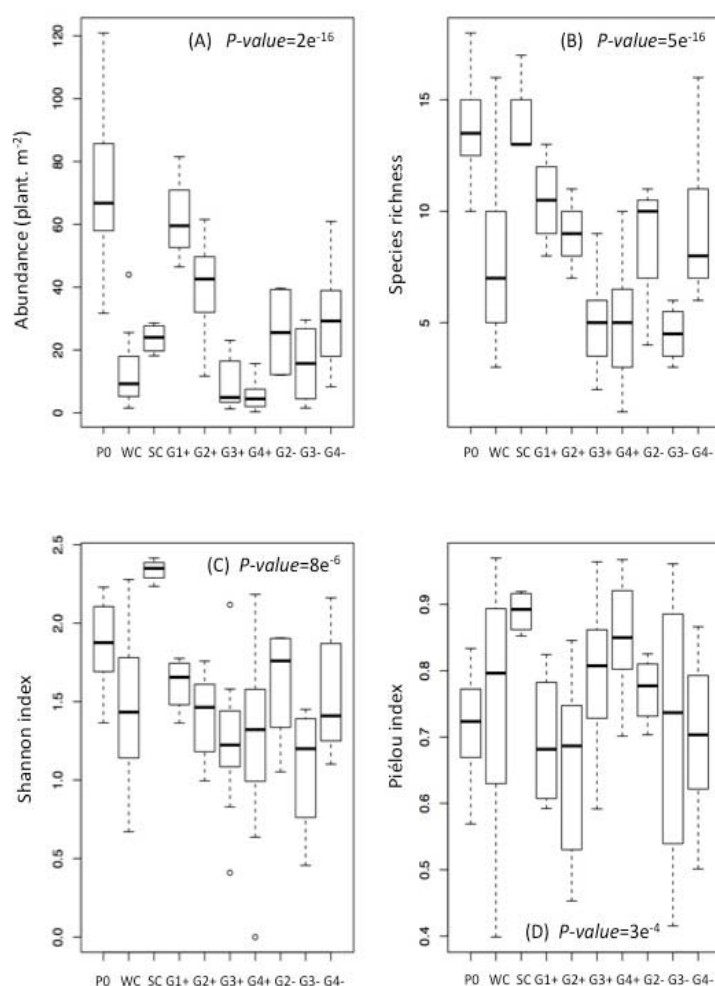

Figure 1. Weed species diversity measures for ten groups of fields. (A) Abundance, (B) Species richness (C) Shannon diversity index, (D) Pielou index (evenness). The ten groups correspond to: P0: Initial weed flora in 2005; WC: Winter crop; SC: Spring crop; G1+: High N, one-year old grassland; G2+: High N, two-year old grassland; G3+: High N, three-year old grassland; G4+: High N, more than three-year old grassland; G2-: Low N, two-year old grassland; G3-: Low N, three-year old grassland; G4-: Low N, more than three-year old grassland. Broad lines are medians, boxes show the interquartile range and whiskers extend to the last data point within 1.5 times the interquartile range, open circles are further outliers. *P*-values of ANOVA are given.

Results

Figure 1 presents species richness, abundance, and diversity indexes for the 10 groups. High abundance and α diversity are observed in initial weed flora. Crops have low weed abundance

Table 1. Pairwise comparisons of weed communities in the ten groups (only ANOSIM-R>0,20 and with significant *P-value* are shown). ANOSIM-R varies between 1 (groups do not share any species) and 0 (no differences between groups).

Group comparison	ANOSIM-R	<i>P-values</i>
Spring crop - High N, one-year old grassland	0,8663	< 0,001
Initial flora - Low N, three-year old grassland	0,8346	< 0,001
Initial flora - High N, one-year old grassland	0,8007	< 0,001
Initial flora - Spring crop	0,6694	< 0,001
Initial flora - Low N, two-year old grassland	0,6566	< 0,001
Initial flora - Low N, more than three-year old grassland	0,5119	< 0,001
Spring crop - Low N, two-year old grassland	0,4891	< 0,001
Spring crop - Low N, three-year old grassland	0,4776	< 0,001
High N, one-year old grassland - Low N, two-year old grassland	0,452	< 0,001
High N, one-year old grassland - Low N, three-year old grassland	0,4365	< 0,001
Spring crop - Low N, more than three-year old grassland	0,3596	< 0,001
Initial flora - High N, two-year old grassland	0,2969	< 0,001
High N, two-year old grassland - Low N, three-year old grassland	0,2881	< 0,001
Initial flora - High N, three-year old grassland	0,2879	< 0,001
High N, one-year old grassland - Low N, more than three-year old grassland	0,2428	< 0,001
Spring crop - High N, two-year old grassland	0,2287	< 0,001

(because of weeding) but quite high α diversity (especially in spring crops). A, S and H decrease with grassland age in high N grasslands whereas they remain stable in low N grasslands. J presents slight variations between groups. β diversity greatly differs between groups. Spring crops and initial flora have very different weed composition compared to the other groups (Table 1). High ANOSIM-R values are obtained for these groups when compared with the others. Comparison between low and high N grasslands also presents quite high ANOSIM-R indicating different weed composition. ISA analysis allows identifying species and functional groups specific to each group. At the functional level, perennial species benefit from the particular growth conditions in temporary grasslands. On the other hand, the conditions in annual crops favor annual broad-leaved species with an upright morphology. Legumes increase in the temporary grassland without nitrogen fertilization.

Conclusion

This study suggests two main effects of temporary grasslands on weed community. Firstly, temporary

grasslands allow reducing weed abundance to values similar to those in crops in which chemical weeding is applied. N fertilization increases plant growth making grasslands more competitive and efficient in weed control. Secondly, low N grasslands also decrease weed abundance but present higher species richness and functional diversity that may be interesting to support biodiversity in crop fields (Marshall *et al.*, 2003).

Acknowledgements

The present work was funded by ANR SYSTERRA ADVHERB (ANR-08-STRA-02).

References

- Marshall EJP, Brown VK, Boatman ND *et al.* (2003). The role of weeds in supporting biological diversity within crop fields. *Weed Research* 43, 77–89.
- Meiss H., Médiène S., Waldhart R., Caneill J., Bretagnolle V., Reboud X., Munier-Jolain N. (2010). Perennial lucerne affects weed community trajectories in grain crop rotations. *Weed Research* 50, 331-340.

Does grassland cover limit the replenishment of weed seed bank during seed rain?

Doisy, Diana¹; Colbach, Nathalie¹; Roger-Estrade, Jean²; Médiène, Safia²

¹INRA, FRANCE; ²AgroParisTech, FRANCE

Introduction

To limit environmental pollution, new cropping systems which are less reliant on pesticides are under study. Temporary grassland in a crop rotation could represent an agro-ecological way of regulating weed population. The weed seed bank is the primary source of weeds in cultivated soils. The model FlorSys predicts the effects of cropping systems on the dynamics of weed communities in annual crops (Colbach et al. 2010, Gardarin et al. 2012); however, it is not configured to predict the fate of seeds in permanent cover, which differs from annual crops because it constitutes a barrier preventing newly produced weed seeds from reaching the soil. We set out to quantify the percentage of weed seeds passing through grassland cover depending on seed morphology and cover height. The study involves the simulation of a weed seed rain under controlled conditions. How well does grassland cover retain weed seeds during seed rain, and to what extent does it limit the replenishment of the weed seed bank?

Materials and methods

Twelve weed species were chosen based on literature identifying the species most frequently found in the north of France, in addition to species observed in a long-term experiment (Médiène et al., 2008). Species were also chosen for different morphological characteristics (Table 1 for details). To mimic seed rain, weed seed was deposited on a plate perforated with holes. The plate was placed above a plot of grass or, for the control, bare soil.

The height of the plate was determined by calculating the average height of the adult plants of all twelve species (40 cm). The seeds which passed through the cover fell onto a tray placed on the soil. A light mechanical intervention was carried out to mimic wind and bring to the soil surface seeds about to fall. Seeds that did not reach the ground were not accounted for. Each seed drop was repeated three times for the twelve species. Two cover heights were tested: 19.5±2 and 31±4 cm. The effect of seed traits and cover height on the percentage of weed seeds reaching the soil relative to the control was determined with analyses of variance.

Results

Percentages of seeds reaching the soil in grassland cover relative to the bare ground control were analyzed with ANOVA to identify the pertinent seed traits (Table 1). The percentage Y can be predicted from seed traits and cover height as follows: $Y = \mu + \alpha \text{ size} + \beta \text{ weight} + \gamma \text{ shape index} + \delta \text{ cover height}$. The larger, the heavier, and the more elongated the seeds, the less able they were to pass through the cover. The taller the cover, the lower the percentage of seeds on the ground.

Discussion

We suppose that the smaller the amount of weedseed on the ground, the less likely the species is to grow in the grassland. A follow-up study will compare the experimental results with the evolution of species observed under real

Table 1: Results of ANOVA and parameter values for predicting the percentage of weed seed rain passing through a grass canopy.

	Pr(>F) ANOVA		Parameters significant	Estimate	Pr(>F) Estimate	
			(intercept) μ	127,38	<2e-16	***
Seed size	2.103e-08	***	α	-6,30	0.15	
Seed weight	0.0005789	***	β	-1,16	0.73	
Seed shape index	0.0110662	*	γ	-68,85	0.01	**
Seed attributes	0.1380126					
Seed roughness	0.5601900					
Canopy height	< 2.2e-16	***	δ	-1,53	< 2e-16	***

conditions in SOERE ACBB (Observatory Environmental Research “Agro-ecosystems, Biogeochemical Cycles, and Biodiversity”). Parameters of this linear model will be used to develop a new sub model for FlorSys to calculate the percentage of seeds reaching the ground with a grass cover, according to species traits. The amended FlorSys can then be used to simulate the dynamics of weeds in cropping systems involving temporary grasslands in the rotation.

Acknowledgements

The present work was financed by DIM ASTREA and ANR SYSTERRA ADVHERB (ANR-08-STRA-02).

References

- Colbach N., Gardarin A., Munier-Jolain, 2010. FLORSYS: a mechanistic model of cropping system effects on weed flora based on functional relationships with species traits. Proc. 15th International EWRS Symposium, 12-15 July 2010, Kaposvár, Hungary 157-158 (oral)
- Gardarin A., Dürr C., Colbach N., 2012. Modelling weed seed bank dynamics and emergence with species traits. Ecological Modelling.
- Médiène S., Charrier X., 2008. Weed flora dynamics during the first years of grassland establishment. 22nd General Meeting of the European Grassland Federation. Uppsala (Sweden), p. 278-280

An epidemiological modelling framework to help agronomists defining crop protection strategies-the risk of *R. solani* in sugar beet using biofumigation

Leclerc, Melen¹; Doré, Thierry²; Gilligan, Christopher A.³; Lucas, Philippe¹; Filipe, João A.N.³

¹INRA, FRANCE; ²AgroParisTech, FRANCE; ³University of Cambridge, UNITED KINGDOM

The management of biotic interactions is a promising strategy for improving pest management in agroecosystems (Médiène et al., 2011); however, this ecological-based approach requires knowledge of the functioning of these complex systems. In particular, it is crucial to understand and make predictable the key ecological and epidemiological processes involved in the spatio-temporal dynamics of pathogens.

Rhizoctonia solani AG2-2 IIIB is a saprotrophic soil-borne fungus prevalent in agricultural systems. Within short rotations of host crops, such as maize-maize-sugar beet, *R. solani* causes substantial damage to sugar beet through brown root (or crown rot) disease. When a host crop is present, an epidemic of *R. solani* can start from residual soil inoculum and spread through secondary infection from plant to plant creating a patchy pattern of disease. Although the main epidemiological processes are known, control of this pathogen is difficult and poorly understood, particularly in sugar beet.

From a disease management perspective, biofumigation presents an opportunity to exploit the intercrop period preceding the beet crop. Previous research has demonstrated that growing and incorporating mustard in the soil can decrease the impact of *R. solani* on sugar beet. However, from an epidemiological point of view the conditions for a successful use of biofumigation are not understood because of its multiple effects on the pathogen, some of which do not benefit control (Motisi et al., 2010).

Previous work on wheat-sugar beet rotation has demonstrated that biofumigation can decrease the incidence of root rot disease mainly through a decrease in primary infections (Motisi et al., 2009, 2012). Here we extend these modelling analyses by considering spatially-explicit dynamics, known to be important for this disease (Filipe et al. 2004, Gilligan 2008), and quantifying the variability in the efficacy of biofumigation treatments. Using recent knowledge on the spread of *R. solani* in conventional sugar beet crop, we derive a

stochastic individual-based model which describes the spatial patterns of disease observed in fields. Afterwards we estimate spatial rates of infection fitting a semi-spatial model to temporal data obtained in field trials (Filipe et al. 2004). Then we use the values of these parameters to parametrise our spatial model and run stochastic simulations considering, or not, a biocontrol by biofumigation. To finish with we analyse the model output to quantify the risk of using biofumigation for disease management.

In conclusion, we point out some new key factors of the spatio-temporal spread of the epidemic and its biocontrol by biofumigation that should be considered in a sustainable pest management assessment.

References

- Filipe, J.A.N., Otten, W., Gibson, G.J., and Gilligan, C.A. 2004. Inferring the dynamics of a spatial epidemic from time-series data. *Bulletin of Mathematical Biology* 66(2): 373-391.
- Gilligan, C.A. 2008. Sustainable agriculture and plant diseases: an epidemiological perspective. *Philos. Trans. R. Soc. B-Biol. Sci.* 363(1492): 741-759.
- Médiène S. et al., 2011. Agroecosystem management and biotic interactions. A review. *Agronomy for Sustainable Development* 31, 491-514.
- Motisi N. et al., 2009. Growing Brassica juncea as a cover crop and then incorporating its residues provide complementary control of Rhizoctonia root rot of sugar beet. *Field Crop Research* 113, 238-245
- Motisi N. et al., 2010. Dealing with the variability in biofumigation efficacy through an epidemiological framework. *Soil Biology & Biochemistry* 42, 2044-2057.
- Motisi, N., Poggi, S., Filipe, J.A.N., Lucas, P., Dore, T., Montfort, F., Gilligan, C.A., and Bailey, D.J. 2012. Epidemiological analysis of the effects of biofumigation for biological control of root rot in sugar beet. *Plant Pathology*, in press.

Development of winter wheat root and crown rot depending on soil tillage system and pre-crops

Ruza, Antons¹; Bankina, Biruta¹; Paura, Liga¹; Lapina, Liga²; Priekule, Ilze³; Bimsteine, Gunita¹

¹Latvia University of Agriculture, LATVIA; ²State Plant Protection Service, LATVIA; ³Latvian Plant Protection Research Centre Ltd, LATVIA

Introduction

Minimum soil tillage and monocultures are widespread technologies of winter wheat production in Latvia. Contradictory results have been reported in literature (Bockus&Shroyer, 1998; Holland, 2004). Minimum tillage saves resources, probably decreases erosion of soil and increases amount of soil organic material, but at the same time promotes development of harmful organisms. The aim of investigations is to estimate development of the winter wheat root and crown (stem base) diseases depending on soil tillage and crop rotation.

Methodology

Long-term field experimental plots were established at the Study and Research Farm «Peterlauki» of the Latvia University of Agriculture in the autumn of 2008. The experiments were carried out in conditions very similar to the actual crop production conditions; total plot area was 6 ha, area for each treatment – 0.25 ha.

Two-factor trials were established: A – soil tillage: 1) soil: conventional ploughing – plough tillage (0.22 – 0.23 m) with mouldboard plough, 2) minimal tillage – shallow (0.10 – 0.12 m) tillage with disc harrow; B – crop rotation: 1) wheat after wheat, 2) wheat after non-wheat.

Incidence of complex of stem base diseases (root and crown rot) was determined after wheat harvesting. Stubble of wheat was collected from two adjacent rows (each 25 cm long) in five randomly chosen places of each field – altogether about 300 stems. Stem-base and root diseases were determined visually, and incidence was calculated. Plant parts with disease symptoms were air-dried and prepared for identification of the causal agents of diseases. Potato dextrose agar (PDA) was used for initial isolation of plant pathogens.

The general linear model was used to evaluate significance of the factors which had influenced the incidence of the complex of stem-base diseases. Pairwise comparisons among factor levels were done using the Bonferroni test.

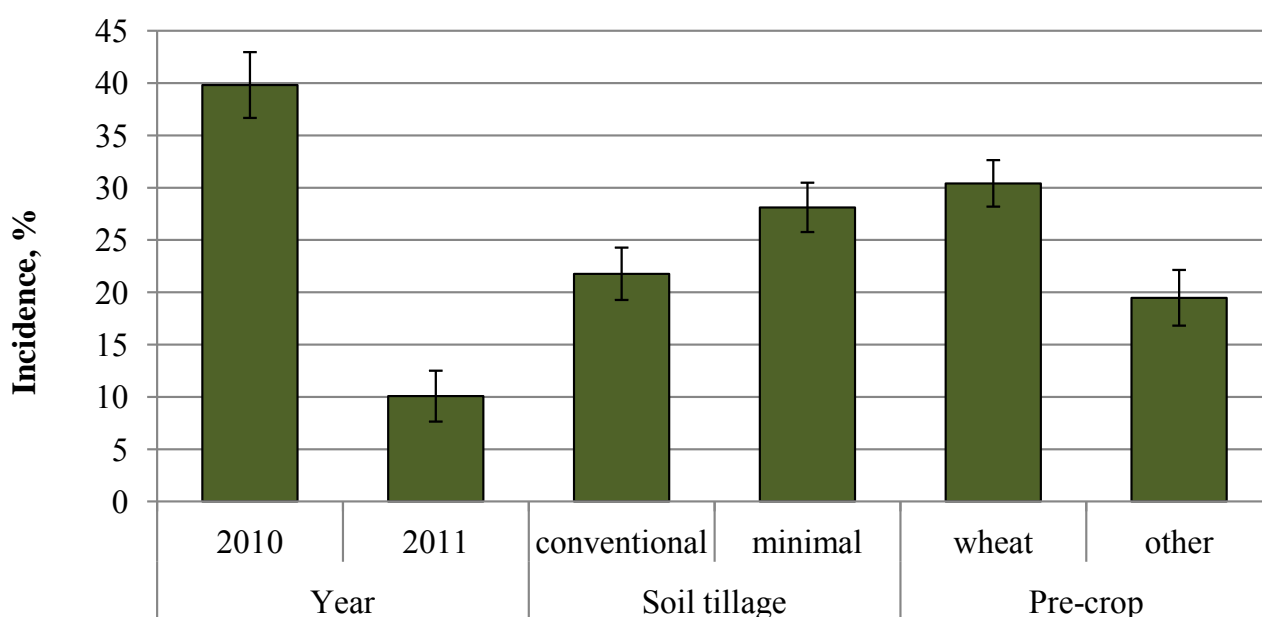

Fig. 1. Incidence of winter root and crown rot depending on agroecological conditions.

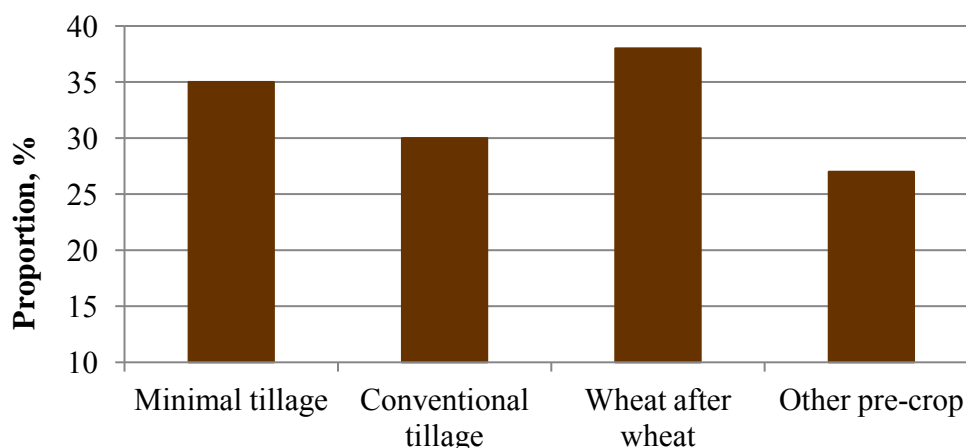

Fig. 2. Proportion of pathogens from genus *Fusarium* depending on agronomic measures

Results and Discussion

A high level of winter wheat root and crown rot development was determined in the first year of investigations: incidence of disease reached 71% in wheat fields under conditional soil tillage, and 82% in fields without ploughing. In further years the level of disease was lower. A year as a complex of meteorological and agroecological conditions is the most important factor influencing the development of root and crown rot under Latvian agro-climatic conditions ($p < 0.001$). Also soil tillage system ($p < 0.1$) and crop rotation ($p < 0.01$) demonstrated a significant influence on root and crown rot disease development (Fig. 1).

Full identification of pathogens has not been completed yet, but preliminary results have shown prevalence of pathogens from the genus *Fusarium* – *Fusarium avenaceum*, *Fusarium gramineum*, and *Fusarium culmorum*. The percentage of *Fusarium* spp. out of the total number of isolates varied from 11% to 58% depending on the year and the treatment. A higher percentage of *Fusarium* spp. was observed both in variants without crop rotation and with minimal tillage (Fig. 2).

The period of the present investigations has been too short for a complete evaluation of the different factors which influence the development of the wheat root and crown rot diseases. The investigations are still going on: influence of crop rotation and tillage systems on disease development is being evaluated, and causal agents are being identified.

Acknowledgement

The research was supported by the State research programme «Sustainable Use of Local Agricultural Resources for the Development of High Nutritive Value Food Products», subproject No.3.1 «Sustainable Use of Soil as the Main Resource for the Production of Safe and Qualitative Food and Feed from the Main Agricultural Crops».

References

- Bockus W.W., Shroyer J.P. (1998) The impact of reduced tillage on soilborne plant pathogens. *Annual Review of Phytopathology*, 36: 485–500.
- Holland J.M. (2004) The environmental consequences of adopting conservation tillage in Europe: reviewing the evidence. *Agriculture, Ecosystems&Environment*, 103(1): 1–25.

Crop rotation affects GHG-balances and energy-balances of oilseed rape

Christen, Olaf; Büttner, Mirko

University of Halle-Wittenberg, GERMANY

Introduction

Energy and GHG balances are important components in the sustainability assessment of crops for energy production. In European countries those criteria are even included in various legislation and directives which in some cases are necessary prerequisites if products are sold for energy purposes. The benchmarks, however, are only on the crop level and thus the rotational or the farm level are not considered.

Materials and methods

In a long term experiment (harvest years 2004 to 2020) winter oilseed rape (OSR) was grown in three different rotational situations. OSR was either grown after three years of winter wheat, one year of OSR or two years of OSR as preceding crops, representing extreme preceding crop situations. The experimental site is located near Halle, Germany in the state Saxony-Anhalt, which is characterized by fairly dry conditions (av. precipitation of only 420 mm/y and exceptional good soil conditions (black Chernozem). The calculations of the various parameters were done using the software REPRO (Deike et al. 2008; Küstermann et al. 2010).

Results

Depending on the preceding crop OSR yielded 4.22 t/ha (following winter wheat), 3.97 t/ha (following OSR once) and 3.71 t/ha (following OSR twice), mainly due to difference in the incidence in various pests and diseases. Those differences in yield had a strong effect on the energy and GHG balances. On a per ha basis, OSR following wheat produced 93 GJ/ha whereas OSR following OSR only yielded 86 GJ/ha and OSR following OSR twice only 80 GJ/ha. On a product basis the difference was even more pronounced. The calculations for the GHG emissions on a per unit yield basis showed a strong effect of the different rotational situations. Here the highest yields in the winter oilseed rape following wheat compared with winter oilseed rape following either one year of OSR or

two previous years of oilseed rape cropping caused a range of 35,0 kg CO₂e per cereal unit to 39,1 kg CO₂e per cereal unit.

Discussion

The results from the experiment at Saxony-Anhalt demonstrate clearly a strong effect of the rotational situation of winter oilseed rape on GHG and energy balances. This confirms results from a previous experiment at the same site (Rathke et al. 2005) and on other sites under different environmental conditions (e.g. Christen and Sieling 1995). Despite the current political and administrative approach we highly recommend to include rotational aspects in the calculation of GHG and energy balances in the concept of sustainability assessments. This, however, will cause some methodological changes in the way GHG balances are calculated, because the effect of differences in husbandry have to be considered in such a rotational situation.

References

- Christen, O., Sieling, K., 1995: Effect of different preceding crops and crop rotations on yield of oil-seed rape (*Brassica napus* L.). *Journal of Agronomy and Crop Science* 174, 265-271
- Deike, S. Pallutt, B., Christen, O., 2008: Energy efficiency in organic and integrated farming with particular regard to pesticide use intensity. *European Journal of Agronomy*, 28, 461-470
- Küstermann, B., Christen, O., Hülsbergen, K.-J., 2009: Modelling nitrogen cycles of farming systems as basis of site- and farm-specific nitrogen management. *Agriculture, Ecosystems and Environment*. 135, 70-80
- Rathke, G.-W., Christen, O., Diepenbrock, W. 2005: Effects of nitrogen source and rate on productivity and quality of winter oilseed rape (*Brassica napus* L.) grown in different crop rotations. *Field Crops Research*, 94, 103-113

Water drainage and nitrate leaching under contrasted biomass crops

Ferchaud, Fabien; Vitte, Guillaume; Mary, Bruno
INRA, FRANCE

Introduction

The development of biomass crops for energy production is expected to provide significant fossil energy substitution and greenhouse gas mitigation (Sims *et al.*, 2006). However environmental impacts of biomass crops are poorly known, including the effects on water resource and quality. In this study, we have investigated the effect of contrasted biomass crops on water drainage and nitrate leaching over 4 years.

Materials and methods

Six cropping systems with two rates of N fertilization (N- and N+, depending on species) are compared in a mid-term experiment: *Miscanthus x giganteus*, switchgrass, fescue and alfalfa in rotation, triticale and fiber sorghum in rotation. The experiment was established in 2006 in Northern France in a deep loamy soil (Ortic Luvisol). From 2007 to 2011, the mean annual rainfall was 630 mm and potential evapotranspiration was 731 mm. Soil water content (SWC) and mineral nitrogen (SMN) were measured twice a year (mid-March and early November) in 5 layers (30 cm thick) by coring down to 150 cm, each year from November 2007 to March 2011.

STICS model (Brisson *et al.*, 2008) was used to simulate SWC and SMN and calculate water drainage and nitrate leaching below 150 cm. Simulations were performed during each winter starting at the first measurement date (November used as initial data) until mid-April. We assumed that the crop had no effect on water and nitrogen dynamics during this period since plants were in dormancy. The soil nitrogen mineralization rate was calibrated in order to match the SMN profile measured in March.

Results and discussion

SWC in March was unaffected by the treatments and fairly constant between years, indicating that soil moisture was close to field capacity. SWC was lower in November and dependent on the previous crop. SMN in November was affected by the crop and N rate and their interaction. The highest SMN (mean of the 4 years) was found after miscanthus N+ (55 kg ha⁻¹) and the lowest after switchgrass N- (23 kg ha⁻¹). Simulated water drainage was dependent firstly on crop and secondly on N rate, with a small increase for the N- treatments (Figure 1). The mean water drainage was lower for miscanthus, fescue and alfalfa than for the other crops, in accordance with Mclsaac *et al.* (2010) who

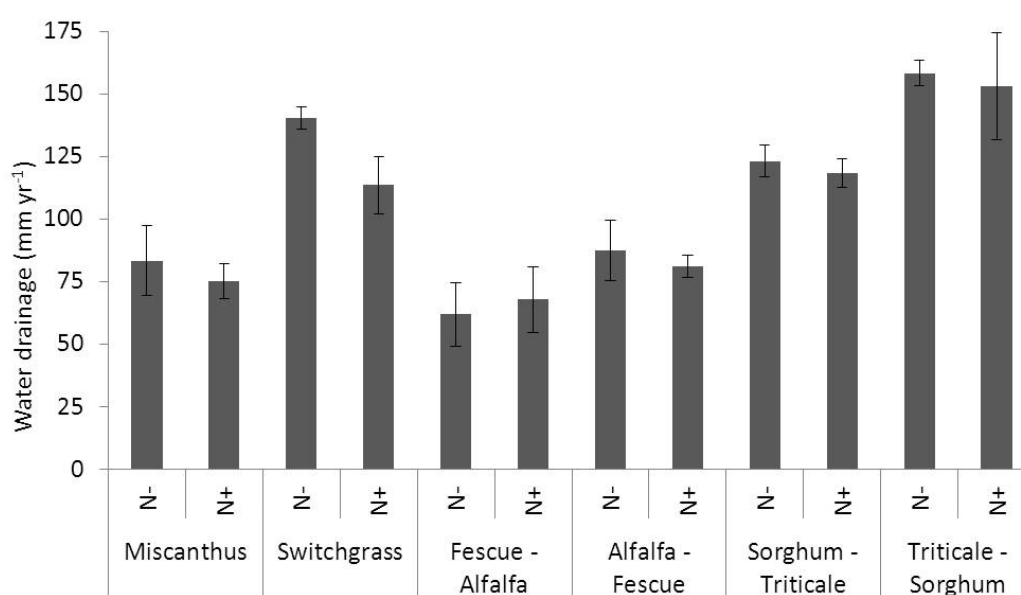

Fig. 1: Simulated water drainage (mean value of the period 2007-2011) in the various cropping systems. Bars represent standard error.

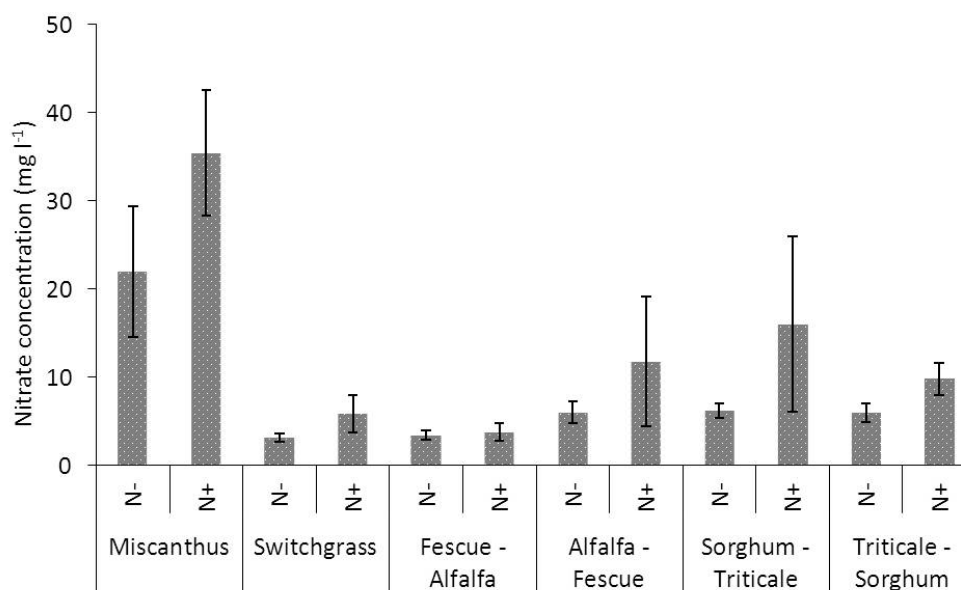

Fig. 2: Simulated nitrate concentration in the drained water (mean value of the period 2007-2011) in the various cropping systems. Bars represent standard error.

observed greater water consumption for miscanthus than for switchgrass and annual crops. Simulated nitrate leaching was dependent on crop and nitrogen treatments but was generally very low (2.4 kg ha⁻¹ yr⁻¹ on average).

Nitrate losses with miscanthus were particularly high during the first winter (2007-2008) and markedly decreased during the following years, as reported by Christian and Riche (1998). This is probably due to the low development of the crop during the first year which implies low N uptake. The average nitrate concentration was also dependent on crop and nitrogen treatments (Figure 2). It ranged from 3 mg l⁻¹ for switchgrass N- to 36 mg l⁻¹ for miscanthus N+.

Conclusion

All perennial and multi-annual crops except switchgrass reduced water drainage as compared to annual crops. Nitrate leaching was low for all crops and treatments, except for miscanthus during the first year of measurement. Differences in water consumption must be further investigated, as well as the entire nitrogen

cycle, including greenhouse gas emissions.

References

- Brissin N. *et al.*, 2008. Conceptual basis, formalisations and parametrisation of the STICS crop model. Editions QUAE, Versailles, 297 p.
- Christian D.G., Riche A.B., 1998. Nitrate leaching losses under Miscanthus grass planted on a silty clay loam soil. *Soil Use and Management* 14, 131-135.
- Mclsaac G.F. *et al.*, 2010. Miscanthus and switchgrass production in Central Illinois: impacts on hydrology and inorganic nitrogen leaching. *Journal of Environmental Quality* 39, 1790-1799.
- Sims R.E.H. *et al.*, 2006. Energy crops: current status and future prospects. *Global Change Biology* 12, 2054-2076.

Producing food and electricity in the same system: experimental evidence of agrivoltaic system potential

Marrou, Helene; Wery, Jacques; Dufour, Lydie; Dupraz, Christian
INRA, FRANCE

Introduction

There is now a worldwide agreement on the need to find a compromise between feeding the planet and providing it with energy. As an alternative to the misappropriation of arable lands for biomass production or electricity, we propose agrivoltaic arrays (AVA) (Dupraz et al., 2011). AVAs associate an upper layer of photovoltaic panels (PVPs) and a ground layer of crop on the same unit of land. The PVP layer can be designed with different densities and geometrical arrangements. This will directly impact the pattern and mean level of shade at the ground level. Our aim is to optimize the overall productivity of AVA (food + electricity), through the density of solar panels, and the choice of species or varieties.

Material and Methods

The experiment was conducted in Montpellier (southern France), with an AVA prototype where PVPs are arranged in narrow strips, orientated East-West and inclined southward (Marrou, PhD thesis in prep.). Two sub systems were compared to full sun control (CP): FD where there are as many PVP strips as in a conventional solar plant, and HD where half of the strips have been removed.

From July 2010 to September 2011, we tested vegetable crops (crisphead and cutting lettuces - five cultivars - French beans, cucumber) and durum wheat. Biomass accumulation and Leaf Area Index were monitored all along the crop cycles. Available radiation was predicted with a radiative model that was validated with field data. Determinants of AVA productivity were investigated through the Monteith approach, where final yield is the product of Light Interception Efficiency (RIE), Light Conversion Efficiency (RCE) and Harvest Index (HI, when relevant) (Marrou et al., submitted).

Results

Mean available radiation was respectively 50 % and 70 % of incident PAR, in FD and HD, compared to CP. For all the species, the same response to shade was observed. Yield decreased significantly down to 50% of control in FD, whereas it was hardly affected in HD (table 1), except for cucumber. For two varieties of lettuces, yield in HD tended to be higher in the shade than in full sun in 2011. Spatial heterogeneity of yield was not increased in the shade (Fisher tests for each variety), although available light varied from one location to another for a given day. For each species, the relative yield was higher than the



Figure 1: Experimental AVA in Montpellier (France). FD and HD subsystems are visible respectively on the left and the right parts of the picture. Photographie C. Dupraz, INRA.

Table1: relative mean available radiation (PAR), dry matter (DM) and yield (Y) for each tested species, over the two years. ** symbols indicate relative DM and Y that are significantly different from 1 with a risk alpha = 5% (LSD test).

species	cultivar	season	FD			HD		
			PAR	DM	Y	PAR	DM	Y
Lettuce	crisphead B0	summer 2010	0.57	0.53**		0.76	0.74**	
Lettuce	cutting FC+	summer 2010	0.57	0.65**		0.76	0.88**	
Lettuce	cutting FC+	spring 2011	0.49	0.99		0.67	1.08	
Lettuce	crisphead B-	spring 2011	0.49	0.75**		0.67	1.10	
Lettuce	crisphead B+	spring 2011	0.49	0.70**		0.67	0.91	
Lettuce	cutting FC-	spring 2011	0.49	0.76**		0.67	0.88**	
French Bean		summer 2010	0.54	0.46**	0.41**	0.76	0.71**	0.94
Cucumber		summer 2011	0.43	0.67**	0.48**	0.64	0.78	0.64
Wheat		2010-2011	0.44	0.55**	0.56**	0.63	0.91	0.95

relative available light, both in FD and HD. We found that plants maintained high yield under the shade of solar panels through increased RIE (Marrou et al., submitted). RCE was not significantly modified. In the case of wheat, HI increased significantly in HD only compared to full sun.

Discussion

Increased RIE is the main lever for plants to compensate at least partially the reduction in light resource in AVA systems. Species and cultivars with a high capacity to develop rapidly dense canopies should be preferred to optimize AVA. On the photovoltaic side, we showed that AVA should be designed to allow at least 70% of PAR₀ at the crop level in order to keep reasonable crop yields. At the same time, such a system would produce 420 kWh/year on 1 ha, and could supply 140 families with electricity. A smart suggestion would be to mount the PVPs on a mobile structure that would allow to

monitor the light transmission under the panels above the required threshold. During periods between crops, or when the crops need less radiation, PVPs could be set back to their optimum position for electricity production. These systems are currently investigated for their food and electricity production and their economic efficiency (Marrou, PhD thesis, in prep.).

References

- Dupraz, C. et al. 2010. Combining solar photovoltaic panels and food crops for optimising land use: Towards new agrivoltaic schemes. *Renewable Energy* 36 (10), 2725-2732.
- Marrou H., et al. Radiation Use efficiency of lettuces grown in the partial shade of photovoltaic panels. submitted to EJA.
- Marrou H. Conception et Optimisation de systèmes agrivoltaïques. PhD thesis. in prep.

Sorghum productivity as a consequence of limited and waste water irrigation in Southern Italy

Mastrorilli, Marcello; Campi, Pasquale; Modugno, A. Francesca; Navarro, Alejandra; Palumbo, A. Domenico
Agricultural Research Council – Research Unit for cropping systems in dry environments, ITALY

Introduction

The research focused on: 1) agronomic activities supporting the energy chain; 2) actions to safeguard Europe's water resources (EU, 2012). Several trials demonstrated the productive potential of Sorghum (*Sorghum bicolor* L., Moench) as an energy crop (Curt et al., 1995) but its adaptability in terms of water requirements in hot arid conditions are still under study. Therefore, to achieve better planning of available water resources and to determine irrigation strategies to optimize the yield of biomass, it is necessary to know the response of crops to deficit irrigation (Steduto et al., 1997). The purpose of the agronomic study was to evaluate the potential of Sorghum with limited irrigation by using waste water.

Materials and methods

The experiment was performed over a two seasons (2009 and 2010) at Trinitapoli (Italy) (lat: 41°24', long: 15°56', alt: 3 m asl) on three Sorghum commercial hybrids ('Pioneer 811', 'Pioneer 849', and 'KWS Bulldozer') submitted to two water regimes. Both seasons were characterized by low rainfall (<100 mm). Two irrigation treatments were compared (100ET and 50ET). They consisted in restoring 100% and 50% of crop evapotranspiration (ETc). ETc was calculated according to the FAO approach. ETc was monitored by using the simplified (Mastrorilli, 1999) water balance ($ET_c = \pm \psi W + P - D$). Soil water content (W) was daily measured through Time Domain Reflectometry (TDR) method. Sorghum plots were irrigated by using municipal waste water, after a lagoon treatment realized inside the farm (Table 1). The content of heavy metals and salts in the water irrigation was monitored. In both years, Sorghum was sown in early May and harvested in October.

Results

The adopted experimental design, in both years, allowed to clearly differentiate the water soil status as a function of supplied water volume; however, the wilting point was never attained. The seasonal evapotranspiration of sorghum grown under optimal conditions (100 ET) was 433 mm, while the deficit irrigation caused a seasonal evapotranspiration equal to 330 mm (average values of the two irrigation seasons). The hybrid 'Pioneer 811' yielded the highest amount of biomass (Table 2), which was found to be statistically different in 2010 (31.3 t ha⁻¹). The deficit irrigation did not result in a yield reduction in both years (26.1 vs 24,6 t ha⁻¹, respectively in 100 ET and 50 ET). The water analysis periodically carried out showed the absence of heavy metals.

Conclusions

The data confirmed a satisfactory tolerance of Sorghum even with reduced water supplies. As for the use of the waste water, results on productivity indicate that Sorghum does not show any reduction since the yield obtained in both seasons attains the highest production range of Sorghum crops growing in the Mediterranean area, if irrigation water is supplied. However, it is necessary to verify if the irrigation practice with waste waters does not compromise the soil properties, with particular regard to seasonal salt accumulation (Katerji et al., 2003).

Table 1. Main chemical characteristics of the waste water entering (in) and flowing (out) from the lagoon system.

	pH	EC	Cl ⁻	Ca ²⁺	Mg ²⁺	Na ⁺	K ⁺	NO ₃ ⁻	SO ₄ ²⁻	CO ₃ ²⁻
		dS/m	g/l	meq/l	meq/l	meq/l	meq/l	meq/l	meq/l	meq/l
in	8.23	2.41	0.57	1.02	2.22	16.71	1.36	0.08	0.07	8.00
out	8.17	2.50	0.68	2.51	2.55	9.17	1.16	0.05	0.07	6.28

Table 2- Above ground biomass obtained in two seasons by Sorghum growing under two water regimes.

Treatment		Dry matter yield (t ha ⁻¹)	
		2009	2010
IRRIGATION (I)	100%	24.39	27.84
	50%	23.37	25.78
HYBRID (H)	Pioneer 811	26.23	31.30 a
	Pioneer 849	22.98	22.72 c
	SKW Bulldozer	22.42	26.42 b
Significance (P<0.001)	I	ns	ns
	H	ns	***

References

Curt, M.D., Fernandez, J., Martinez, M. 1995 - Productivity and water use efficacy of sweet sorghum (*Sorghum bicolor* (L.) Moench) cv. 'Keller' in relation to water regime. *Biomass Bioenergy*. (8): 401–409.

Katerji, N., van Hoorn, J. W., Hamdy, A., Mastrorilli, M., 2003 - Salinity effect on crop development and yield, analysis of salt tolerance according to several classification methods. *Agric. Water Manage.*, 62, 37-66.

EU 2012 - http://ec.europa.eu/environment/water/blueprint/index_en.htm

Mastrorilli M. 1999 - Sviluppo di modelli idrologici per ambienti mediterranei. *Bollettino SIS*. 48(1): 245-250.

Steduto, P., Katerji, N., Puertos-Molina, H., Unlu, M., Mastrorilli, M., Rana, G. 1997 - Water-use efficiency of sweet sorghum under water stress conditions. Gas exchange investigations at leaf and canopy scales. *Field Crops Res.* (54): 221–234.

Effects of the removal of a 20-year old *Miscanthus* stand on GHG emissions, soil nitrate and carbon stocks

Dufossé, Karine¹; Drewer, Julia²; Gabrielle, Benoît¹; Drouet, Jean-Louis¹

¹AgroParisTech, INRA, FRANCE; ²Centre for Ecology and Hydrology, UNITED KINGDOM

Introduction

The share of renewable sources in the European energy mix is growing rapidly to meet the targets set for 2020 by the Renewable Energy Directive: an overall 20% share and a 10% share in the transport sector. These targets are expected to result in a sharp increase in the demand for lignocellulosic bioenergy feedstock. However, the sustainability of large-scale feedstock supply is a major challenge. Perennial crops are a particularly suitable type of feedstock from this standpoint due to their high yields, low input requirements, significant potential to sequester carbon in soils and low levels of N₂O emissions. Among these crops, *Miscanthus x Giganteus*, a perennial C₄-grass, emerges as one of the prime candidates for feedstock production in Europe. However, few experimental plots are older than a dozen of years, and studies dealing with the long-term cultivation of *Miscanthus* are scant. The life cycle of this crop must include the removal consequences on soil and atmosphere emissions as well as the carry-over effects for the following crop. Here, we report an experimental work aiming to evaluate the impacts brought about by the end of life of a 20-year old *Miscanthus* stand, with a three-fold objective: i) to assess the long-term effects on soil of perennial crop cultivation and of rotation of annual crops, ii) to monitor the CO₂ and N₂O emission rates, as well as changes in soil C and N stocks due to the removal and iii) to characterize the effects of removal on the following crop.

Methodology

The *Miscanthus* field (55 m x 6 m in size) used in this experiment has been cultivated since 1991 in Grignon, 40 km West of Paris (France). A three step removal method was carried out on the field: i) the above-ground biomass was crushed during the growing period (June), ii) Glyphosate was applied on the re-grown *Miscanthus* shoots (August) and iii) Soil was tilled in September before sowing the following crop (wheat). The *Miscanthus* field was divided into three treatments: i) two replicate plots with *Miscanthus* removal and wheat recultivation, ii) two

plots remained as bare soils after glyphosate application and iii) *Miscanthus* was continued for a 21st year in a control plot. Soil samples were analysed for soil organic C and N content, nitrate and ammonium, pH, phosphorus, potassium and moisture content at the end of the *Miscanthus* life-span in June 2011. An isotopic analysis (¹³C/¹²C ratio) was carried out in June 2011 to assess the fraction of CO₂ respiration originating from C₄ crop (*Miscanthus*) and from the C₃ barley crop in the adjacent arable field. Emissions of N₂O and CO₂ were measured with twenty manual chambers monthly and upon each operation in the removal of *Miscanthus* and subsequent sowing. Topsoil (0-30 cm) was sampled for moisture and inorganic N analysis on a similar basis from July 2011 to July 2012. This method is described in Flechard et al.³

Results and Discussion

A net increase of CO₂ was measured between July and mid-September 2011 with a peak at 158 µg C m⁻² s⁻¹, twice the CO₂ emission rates for in the *Miscanthus* control during the same period due to the re-grown of *Miscanthus* shoots (Fig. 1a). N₂O emissions were slightly higher on the bare soil plot, most certainly due to the presence of a higher amount of mulch on the soil surface than on the *Miscanthus* control plot and recultivated plots (Fig. 1b). However, these results have a large standard deviation due large variations in fluxes across chambers. In March 2012 the density and growth rate of wheat were lower than the control arable plot. Nevertheless, soil inorganic N dynamics were similar between both wheat plots. Measurements will be continued until the harvest of wheat in July, to confirm and explain the effects of removal on the following wheat culture and soil C and N stocks. These results will be presented at the conference.

Conclusion

This work provided the first references for considering the end of life of *Miscanthus* crop in the process of life cycle assessment. Therefore, the environmental balance of bioenergies supplied by this crop should be improved.

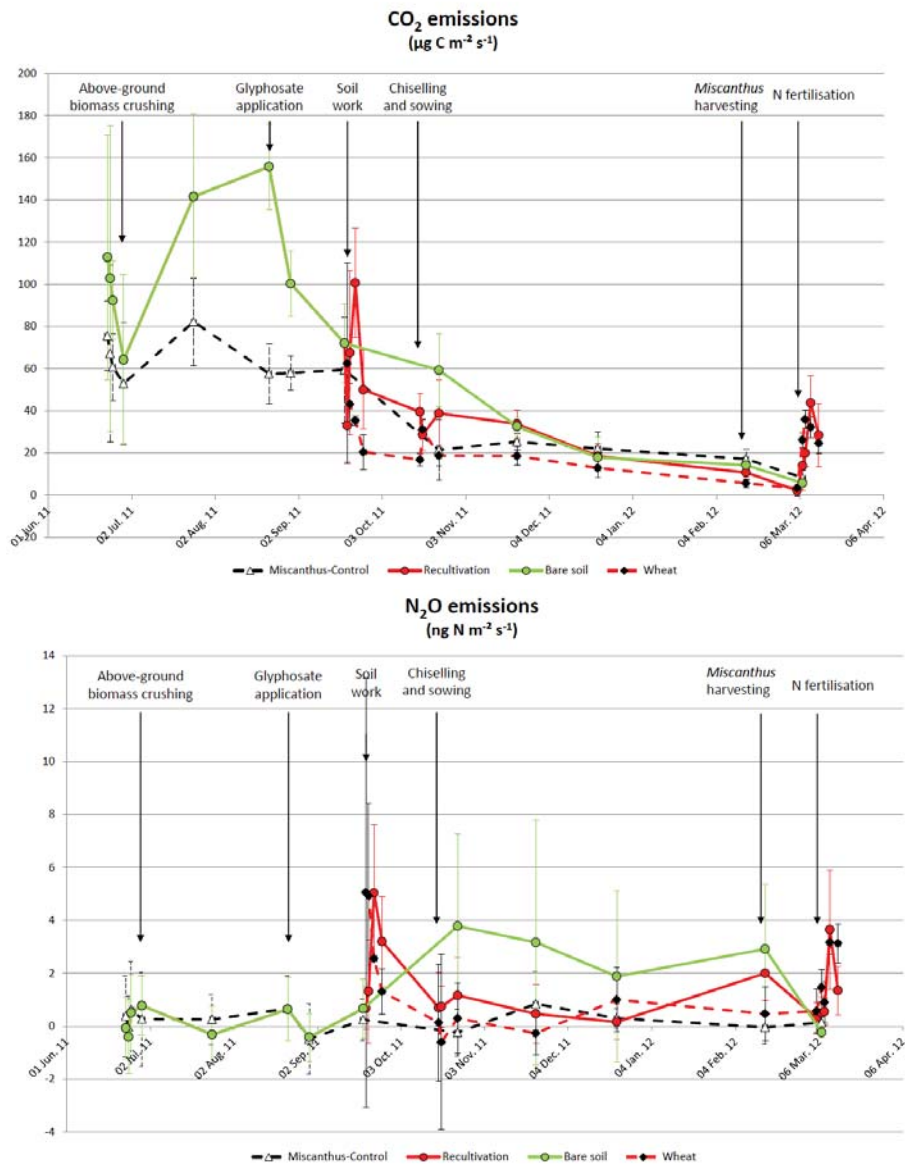

Figure 1: (a) CO₂ emissions (µg C m⁻² s⁻¹) and (b) N₂O emissions (ng N m⁻² s⁻¹) from June 2011 to March 2012 for all plots (Bare soil, Recultivation, Miscanthus-Control and Wheat-Control)

References

European Commission 2009: Directive 2009/30/EC of the European Parliament and of the Council of 23 April 2009
 Lewandowski I et al. 2000 Miscanthus: European experience with a novel energy crop, Biomass Bioenerg. 19: 209-227
 Flechard et al. 2005 Bi-directional soil/atmosphere N₂O exchange over two mown grassland systems with contrasting management practices, Global Change Biology 11:2114-2127

Dynamics of nitrogen uptake and remobilisation in *Miscanthus x giganteus* using ^{15}N -labelled fertilizer tracing

Strullu, Loïc¹; Mary, Bruno¹; Lebas, Guillaume²; Catterou, Manuella²; Beaudoin, Nicolas¹

¹I.N.R.A. unité Agro-Impact, FRANCE; ²Université P Jules Verne, FRANCE

Introduction

Only a few studies dealing with ^{15}N -labelled fertilizers applied to *M. giganteus* have been published (Christian et al., 1997, 2006). The authors showed that *M. giganteus* was able to store large amounts of N in belowground organs, but did not determine N uptake or remobilisation fluxes within the plant. Strullu et al. (2011) showed that N remobilisation is strongly dependent on N stocks in rhizomes. ^{15}N tracing is a powerful tool to characterize gross N fluxes which occur in soil (Mary et al, 1998) or in perennial crops (Millard and Grelet, 2010), it has not yet been used in *M. giganteus*. We used this method to quantify the kinetics of N uptake and remobilisation by *Miscanthus* plants in a 4 year established crop using a single pulse of ^{15}N labelled fertilizer.

Materials and methods

The experimental site is located in Northern France (49°52'N, 3°00'E) in a deep loamy soil (Ortic luvisol). *M.*

giganteus was planted in May 2006 at a density of 1.56 plants m⁻². Four treatments were established, varying in nitrogen fertiliser rate (0 or 120 kg N ha⁻¹) and harvest date (early E or late L harvest). On 16 April 2009, ^{15}N -labelled fertilizer (120 kg N ha⁻¹) was applied in fertilised treatments. The isotopic excess of UAN was 4.17%. Methods used to determine total biomass and dry weight of organs are given in Strullu et al. (2011). Plant organ total N concentration and ^{15}N abundance were determined using an elemental analyser (Flash EA 1112) linked to a mass spectrometer (Delta V Advantage, Thermo Electron). The use of ^{15}N tracer allows to calculate 4 gross N fluxes: N absorption allocated in rhizomes (Ar) or in shoots (Ap), N mobilisation from rhizomes to shoots (upwards: R) or vice versa (downwards: M). Calculation is based on the differential ^{15}N enrichment or dilution which appears in above and belowground organs. Hypotheses of our compartmental analysis are: i) ^{15}N mixes uniformly when entering a compartment, ii) remobilisation occurs either upwards (R) or downwards (M) but not simultaneously.

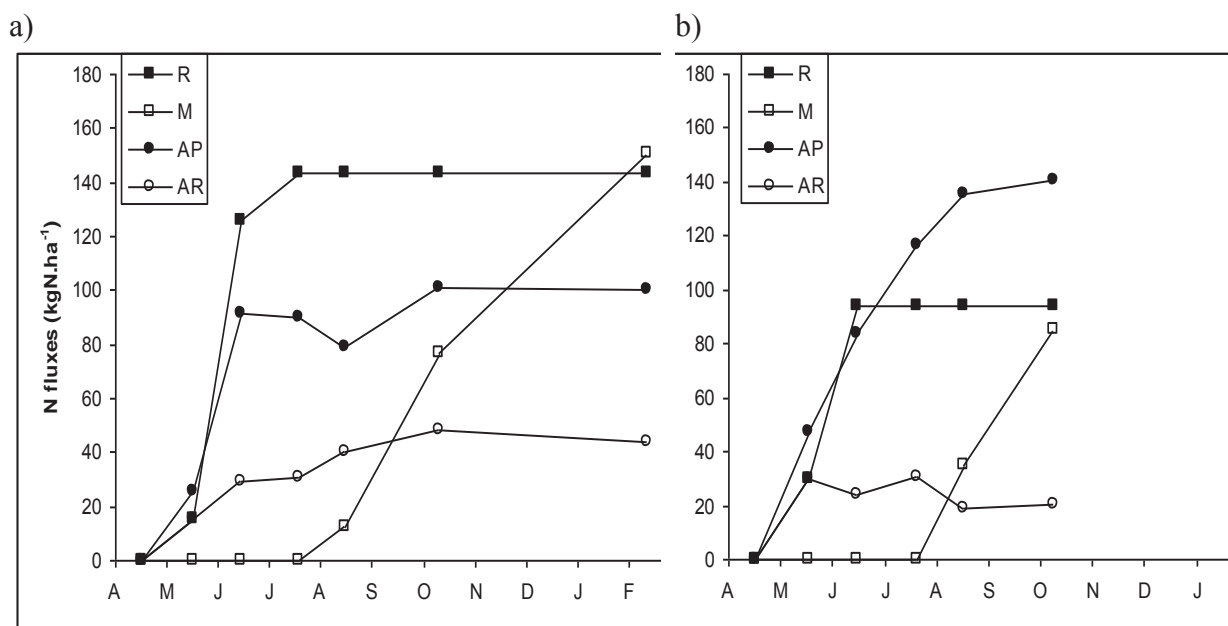

Figure 1: Cumulative gross fluxes (kg N ha⁻¹) within the plant during one growing season a) in L treatment and b) in E treatment. R = upwards N remobilization; M = downwards N remobilization; Ap = absorbed N allocated to shoots; Ar = absorbed N allocated to rhizomes.

Results In spring, the crop could remobilize upwards large amounts of N stored in the rhizome. The amount (R) was higher in L than in E treatment: 144 vs 94 kg N ha⁻¹ (Figure 1). Total N absorption by the crop (Ap + Ar) also occurred mainly in spring: it was higher in E (161 kg N ha⁻¹) than in L treatment (145 kg N ha⁻¹). A significant part of absorbed N was directly stored in rhizomes. The early harvested treatment tended to compensate the lowest N remobilization R by a higher allocation of absorbed N to the aboveground organs: in average 79% of absorbed N allocated to the aboveground organs in E treatment compared to 69% in L treatment. Downwards remobilization (M) started in July and continued until the end of year. It was much greater in the late (151 kg N ha⁻¹) than in the early harvest treatment (75 kg N ha⁻¹).

Conclusion

N uptake by the belowground organs during vegetation period allowed the crop to accumulate N reserves for subsequent years of growth. *M. giganteus* is able to keep almost close its internal N cycle between years. Further studies using the same methodology are needed to understand the effects environmental conditions on N remobilization.

References

- Christian DG et al., 1997. The recovery of ¹⁵N-labelled fertilizer applied to *M. giganteus*. *Biom. and Bioenergy* 12, 21-24.
- Christian DG et al., 2006. The recovery over several seasons of ¹⁵N-labelled fertilizer applied to *M. giganteus* ranging from 1 to 3 years old. *Biom. and Bioenergy* 30, 125-133.
- Mary B et al., 1998. A model for calculating nitrogen fluxes in soil using ¹⁵N tracing. *Soil Biol. and Bioch.* 30, 1963-1979
- Millard P, Grelet GA, 2010. Nitrogen storage and remobilization by trees: ecophysiological relevance in a changing world. *Tree Phys.* 30, 1083-1095.
- Strullu L et al., 2011. Biomass production, nitrogen accumulation and remobilisation by *Miscanthus x giganteus* as influenced by nitrogen stocks in belowground organs. *F. Cr. Res.* 121, 381-391.

Sustainability performances of innovative cropping management systems for winter oil seed rape in multi-local trials

Valantin-Morison, Muriel; Berder, Julie
 INRA, FRANCE

Introduction

Concerns about the adverse impacts of pesticides on the environment have increased since the 1960's. Nowadays, there is a great need to reduce the structural dependence on pesticides of intensive agricultural productions worldwide. In that context, the development of integrated weed management has become an important topic in agronomic research. Winter oilseed rape (WOSR) is a

break-crop widely used in French farming systems since it is of potential value in terms of market requirements and agronomic potential, but this crop is known to be very dependent on pesticide use. However, very few studies aimed at designing new low input or pesticide-free crop management. The purpose of this study is to present the economic and environmental assessments of innovative crop management systems.

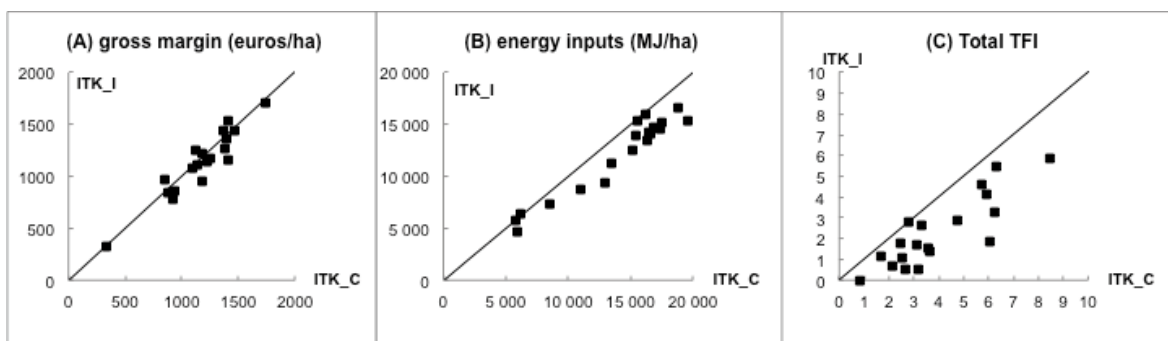

Figure 1: Distribution of gross margin (A), energy input (B) and treatment frequency index (C) for the integrated CMS (ITK-I) and current CMS (ITK-C).

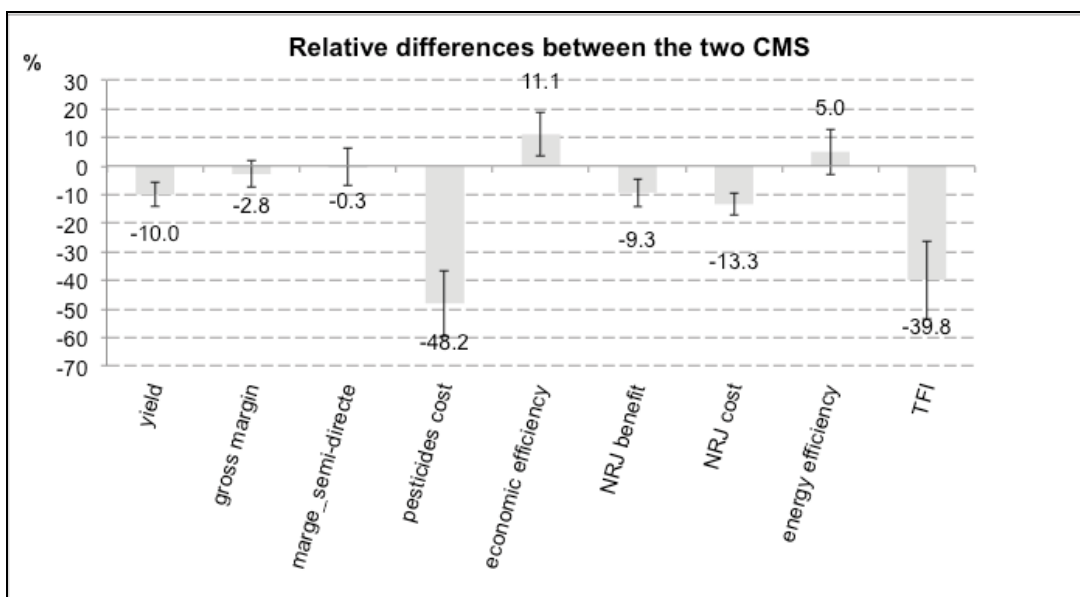

Figure 2: Differences in percentage for several indicators between ICMS and CCMS

Methodology

On the basis of knowledge from scientific literature and from experts of agricultural councils and research institutes, four different integrated CMS (ICMS) have been designed and adapted to several pedoclimatic conditions; they are partly based on organic strategies (Valantin-Morison and Meynard, 2012). Workshops have been organized to combine the scientific knowledge on crop-practices-pests-weeds interactions and the local expertise of advisers for three different areas of northern France. It resulted in four strategies of ICMS: (i) two CMS based on avoidance of pests and smothering effect on weeds with delay of date of sowing and mixed cultivar with or without field margin with turnip rape (ii) a third one based on avoidance of diseases and destruction of weeds before sowing with false bed and (iii) a fourth one based on mixing spring lentil with WOSR to induce weed suppressive effect and to restore nitrogen in spring. The choice of the strategy was depending on soil depth and soil nitrogen supply and pest pressure. Then, the current and integrated CMS have been implemented in a network of 19 farmers' plots distributed in three regions of France (North coast, West and North center). Large plots of current and integrated CMS were compared: yields have been measured on each plot and farmers have been interviewed to collect with precision the crop practices (pesticides, nitrogen doses and date...). Several economic and environmental indicators have been calculated: economic and energy efficiency, gross and direct margin and treatment frequency index.

Results and discussion

Integrated CMS in all the regions displayed lower TFI, lower energy input (Fig.1) than current CMS (CCMS) with gross margin and semi-direct margin almost similar to the CCMS (Fig. 2). TFI for ICMS ranged from 0,71 to 5,87 with a mean of 2,32 while for CCMS it ranged from 0,85 to 8,47 with a mean of 3,96. The reduction of pesticide use between the two crop management systems was mainly due to fungicides and herbicides. The insecticides were only slightly reduced, mainly because the only alternative provided by ICMS concerns pollen beetles. The results for CCMS are very low compared to the TFI of WOSR in France (6,1 in 2006, EcoPhyto R&D, 2009), mainly because of the decision of the farmers who have already engaged a reduction of pesticides. It is interesting to point out that despite a reduction of the yield for ICMS (from 1,3 t/ha to 5,2 with a mean of 3,5 t/ha, and a reduction of 0,39 t/ha compared to the CCMS), the gross margin (from 329€ to 1733€ with a mean of 1170€ for ICMS) and the economic efficiency (from 14 to 48 with a mean of 29 for ICMS) were equivalent or very slightly higher than for CCMS (Fig 2). In order to take into account the three dimensions of the sustainability of these CMS, quantitative results have been combined in a DexiIPM model (See poster from Fortino et al.).

References

Valantin-Morison M., Meynard J-M. 2012. A conceptual model to design prototypes of crop management : a way to improve organic Winter Oilseed Rape performance in a survey in farmers' fields. In Crop Management, ed In TECH, ISBN 978-953-307-646-1.

How to design and experiment new cropping systems with low pesticide inputs for perennial crops: framework development and application to vineyards

Métral, Raphaël¹; Lafond, David²; Gary, Christian³; Mérot, Anne³; Metay, Aurélie¹; Wery, Jacques¹

¹Montpellier SupAgro, FRANCE; ²IFV Val de Loire Centre, FRANCE; ³INRA, FRANCE

Introduction

Environmental concerns into agricultural production are increasingly promoted and regulated by public policies. The objective is to protect water resources, biodiversity and exposure of people to pesticides. EU and France aim at a 50% reduction of pesticides use 2018 (Ecophyto 2018 program). Assessment of current practices and simulation of alternative solutions indicate that this objective will not be reached without the “re-design” of current cropping systems especially in viticulture [3].

Methodologies have been designed for such type of objective in annual crops [1]. The objective of this work, conducted in the EcoViti project (ecoviti.vignevin.com), was to develop a prototyping methodology adapted to the specificity of vineyards systems (perennial crops, high number of techniques applied in one year, high pressure of pests and disease, diversity of objectives in quantity/quality/costs objectives).

Material and methods

The methodological framework is designed around a “define target-design-assess-adjust” progress loop in order to disseminate innovative grapevine cropping systems further adapted by farmers. We make the hypothesis that innovation can emerge from the combination of practices and their interactions for better pest and disease regulation and less reliance on pesticides while keeping high yield and quality. Three methodological tools have been developed (Fig.1) : (i) a conceptual modeling of the grapevine agrosystem (CmA Vine), (ii) a prototyping workshop, and (iii) a coordinated network of experimentations.

A *conceptual modeling* of the grapevine agrosystem was performed. The CmA Vine is the knowledge base shared by the experts of various regions and disciplines in the form of a functional representation of the relationships between the components of the agrosystems (soil, vine, other plants, pest and disease) and the performances of the system (production, ecosystem services) (Fig.2).

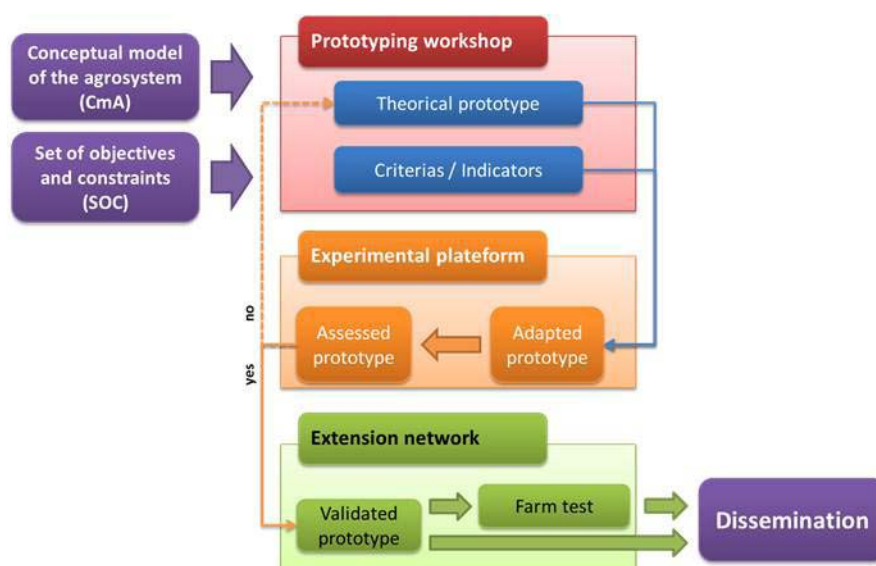

Fig. 1 : Global approach of the design cropping system methodology (adapted from EcoViti project)

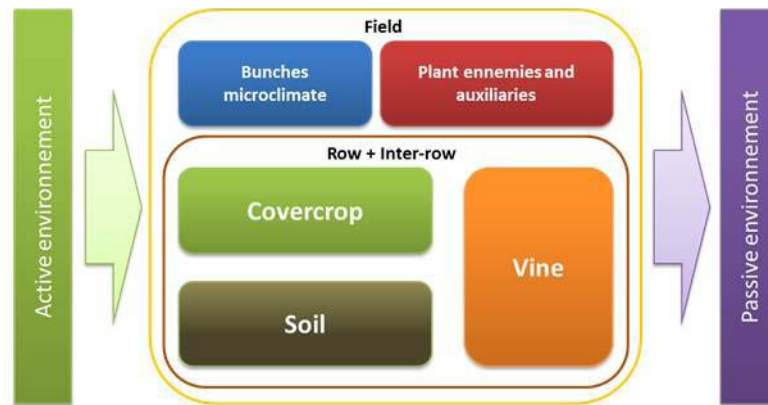

Fig. 2 : Main representation of the conceptual model of grapevine agrosystem (CmA Vine)

The *prototyping workshop* deals with the identification of the Set Of Constraints and Objectives (SOC) and the design of a theoretical grapevine cropping system, based on expert knowledge elicitation and integration with the CmA[2]. SOC specifies the expected performances of the cropping system and prioritizes them for the ex post assessment [1] of the prototypes using assessment indicators.

The theoretical prototypes for each SOC are described by a list of decision rules (DR) defining every tactical and operational action of the system as the product of a decision model using management indicators (Véry et al., this volume). DR allow technical operation management without expertise and without subjectivity of the operator. The same state of the system must generate the same decision. This form of representation of the technical system to be experimented in the field allows to integrate, in testable form, the effect of several techniques on the agrosystem functioning.

After field experiment of this prototype it can be assessed and adjusted using relevant indicators [4].

Results

The approach has been implemented in 2011 in the various French regions producing wine and led to implementation of systems experiment platforms in three pilot regions in 2012 (Mediterranean area, Bordeaux, and Loire valley). They have led to the identification of methodological problems, especially in the way to use the conceptualization of the system to produce innovative systems and the way to experiment the prototypes in a context of a SOC. Improvement are currently developed on these methodological aspects. Preliminary results will be presented during this conference.

References

- [1] Blazy, J.-M. et al., 2009. *Agr. Syst.* 101 : 30-41.
- [2] Lamanda N. et al., 2012. *EJA* 38:104-116.
- [3] Mezière D. et al, 2009. *Ecophyto R&D Report (Vol. III). MEEDDAT-MAP-INRA*, 57 p.
- [4] Rapidel B. et al, 2009. *ASD* : 29 545–556.

Adapting DEXiPM model for *ex post* assessment of the sustainability of innovative cropping systems

Fortino, Gabriele¹; Vasileiadis, Vasileios P.²; Angevin, Frédérique¹; Messéan, Antoine¹

¹INRA, FRANCE; ²CNR - Institute of Agro-Environmental and Forest Biology, ITALY

Introduction

Agricultural sustainability encompasses economic, environmental and social dimensions. In the design of innovative cropping systems (CS), several alternatives can be proposed to achieve a specific goal like pesticide use reduction. The DEXiPM model (Pelzer et al., 2012) was developed for the multi-criteria assessment of the sustainability of these CS in an *ex ante* way, in order to choose the most promising ones to be tested in field trials. Thereafter the model has been placed at the core of the European project PURE (<http://www.pure-ipm.eu>) supporting a multi-year loop which consists in the design, testing and adjustment of CS with reduced pesticide inputs (fig. 1). In this process, *ex ante* assessment of the proposed prototype systems and *ex post* assessment of their performance in the field are essential. Therefore DEXiPM has been adapted for *ex post* assessment, in order to allow every year the identification of practices that should be modified and to provide a global evaluation of a system implemented in a given context. We describe hereafter the approach adopted in the case of maize-based CS tested within PURE.

Methodology

DEXiPM is a hierarchical and qualitative multi-criteria model allowing the evaluation of the sustainability of CS. Model inputs are farming practices and context elements; this information is aggregated step-by-step generating a dashboard of sustainability indicators. Because of its holistic and **qualitative** nature, this tool fits very well to the *ex ante* assessment of CS defined on the basis of expert knowledge. However, the *ex post* assessment can be more precise by exploiting **quantitative** data that can replace the qualitative estimation of intermediate outputs of DEXiPM (e.g. yield). Thus, the first step of the adaptation of DEXiPM for *ex post* assessment is identifying all the links between data collected in the field and indicators estimated by DEXiPM. For this reason, experimental results from maize-based CS tested within PURE are analysed as well as the outputs of other two models used in the project: SYNOPSIS (Gutsche & Rossberg, 1997) and MEBOT (Schreuder et al., 2008). The final step is the identification of suitable indicators for exploiting the collected data (e.g. weeds biodiversity)

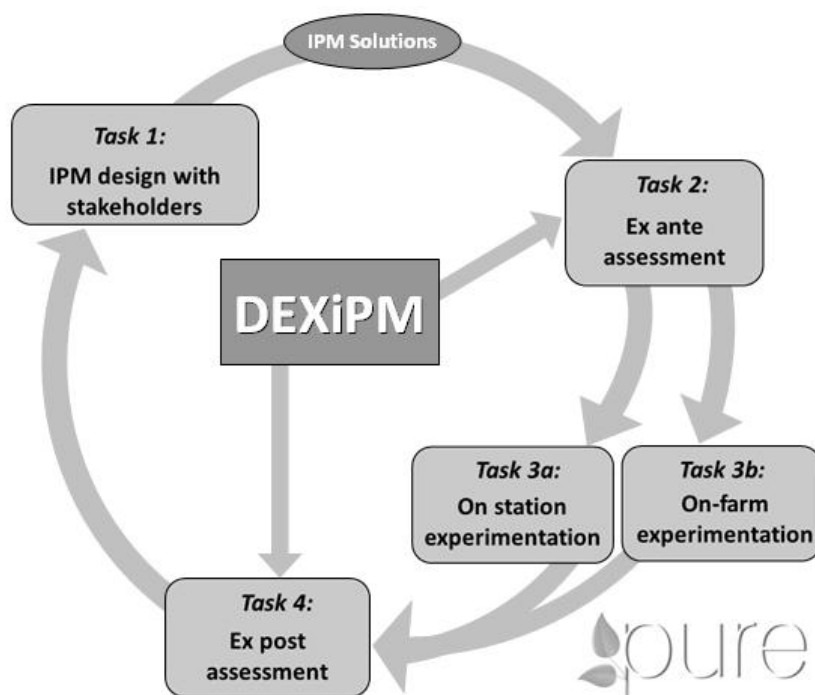

Figure 1. Role of DEXiPM model in the PURE project

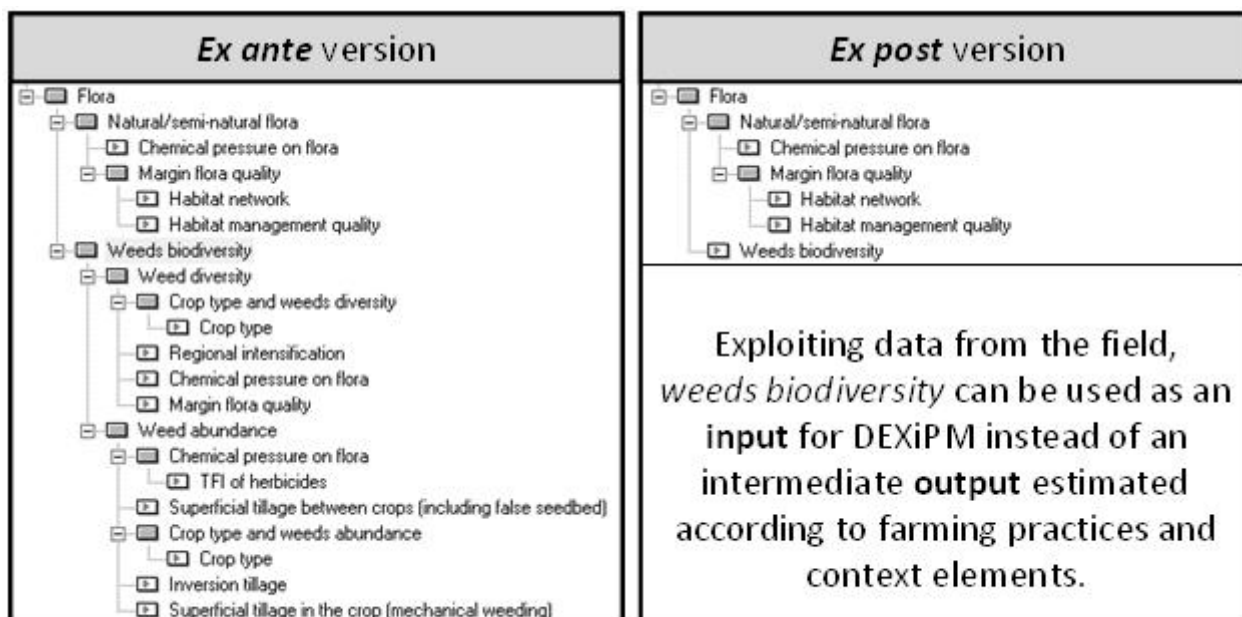

Figure 2. Example of adaptation of the model structure for ex post assessment

as well as thresholds for translating quantitative values into qualitative classes (e.g. *high*, *medium*, *low*).

Results and discussion

This prototype of DEXiPM for *ex post* assessment of maize-based CS has a simpler **structure**, obtained by the transformation of several intermediate outputs into inputs (fig. 2). They can be classed into three categories: measurements (yield), observations (biodiversity), calculations (profitability, environmental risk). Suitable **indicators** have been identified for all of them, linking also indicators calculated by MEBOT (economic) and SYNOPSIS (environmental), with the only exception of biodiversity parameters. Indeed, the use of the Shannon index and the choice of indicator for beneficial species are still under discussion, whereas **thresholds** for most of these inputs have to be defined according to the context of the assessment (e.g. what is the range of values for gross margin that can be defined as *medium* in a given context?).

Due to its holistic and flexible structure, it is possible to adapt DEXiPM for *ex post* assessment according to the data and calculation tools available. Preliminary results demonstrate the appropriateness and the usefulness of the model to support the design of innovative cropping systems in all the stages of the progress loop.

Acknowledgements

The research leading to these results has received funding from the European Community's Seventh Framework programme (FP7/ 2007-2013) under the grant agreement n° FP7-26586.

References

- Gutsche, V., Rossberg, D., 1997. *Agric Ecosyst Environ*, 64, 181–188.
- Pelzer, E., Fortino, G., Bockstaller et al. 2012. *Ecol indic*, 18, 171-182.
- Schreuder, R., van Dijk, W., Asperen, P. et al., 2008. *Mebot 1.01*, documents.plant.wur.nl/ppo/agv/mebot-2008.pdf

Possibilities of integrated disease management for winter barley in Latvia

*Bankina, Biruta; Gaile, Zinta; Kreita, Dzintra; Balodis, Oskars; Katamadze, Merabs
Latvia University of Agriculture, LATVIA*

Introduction

Winter barley is approved pre-crop for winter oilseed rape in Southern part of Latvia. Efficient control of winter barley diseases has become more important in connection with integrated growing management. It is very important to apply the first fungicide treatment in the right time due to the important role of winter barley lower leaves in formation of grain yield (Young et al., 2006). Sometimes one fungicide treatment (at GS 33-37) is established efficient enough (Gladders, Hims, 1994), but twofold treatment give contrary results. Task of Decision Support System (DSS) is to optimize use of fungicides for efficient, economical and environmentally friendly diseases control.

The aim of this research was to compare the efficacy of several fungicide treatment schemes against the main winter barley diseases in Latvia.

Materials and methods

Investigations were carried out according the equal methodology in the two research farms of Latvia University of Agriculture: «Vecauce» and «Peterlauki» during 2008-2010. Cultivar Carola was used in 2008-2009, but cultivar Fredericus in 2010. Plots were arranged in four times replicated randomised blocks. Fungicide treatment schemes: (1) Control without fungicide (C); (2) Standard 1 (S1) epoxiconazole plus fenpropimorph or boskalid plus metrafenon at GS 37-39; (3) Standard 2 (S2): epoxiconazole plus fenpropimorph at GS 31-32 and boskalid or boskalid plus metrafenon at GS 37-39; (4) DSS: fungicides were applied according to incidence of diseases and/or amount of precipitation; mentioned above fungicides were used depending on spread of diseases. Thresholds established during research in 1998-2000 were used for DSS (Bankina, Priekule, 2003). Incidence and severity of diseases were assessed weekly until the GS 75. Analysis of variance was used for processing the yield data.

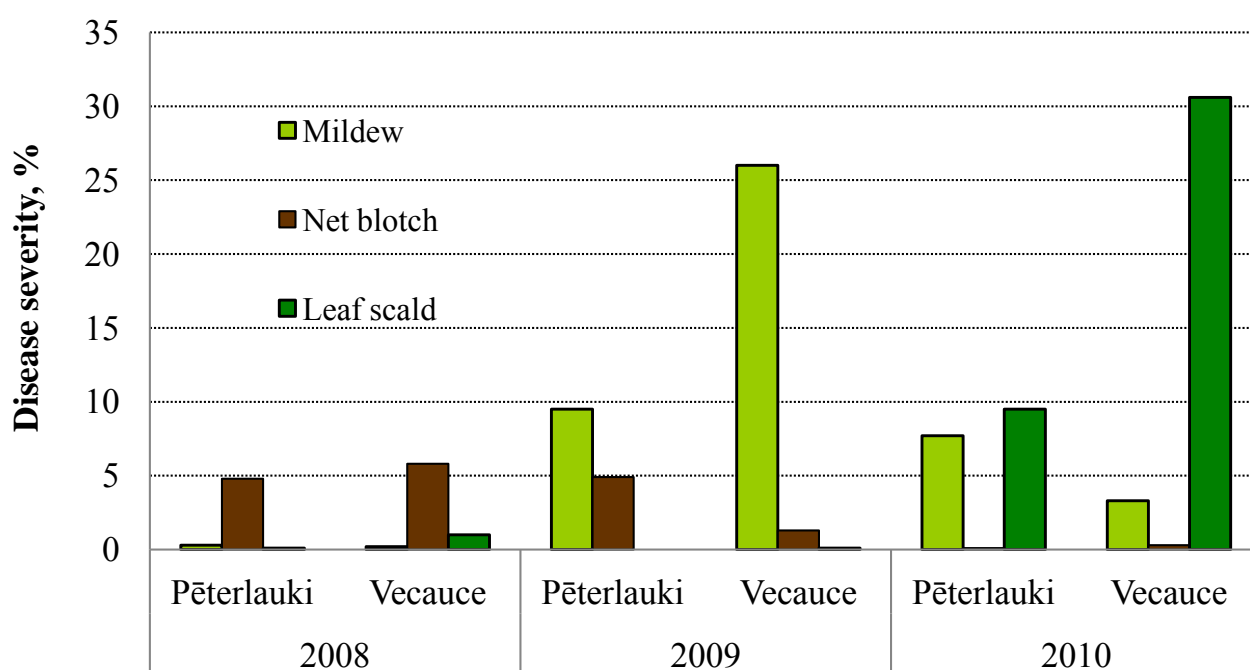

Fig. 1. Maximal severity of diseases depending on trial's place and year.

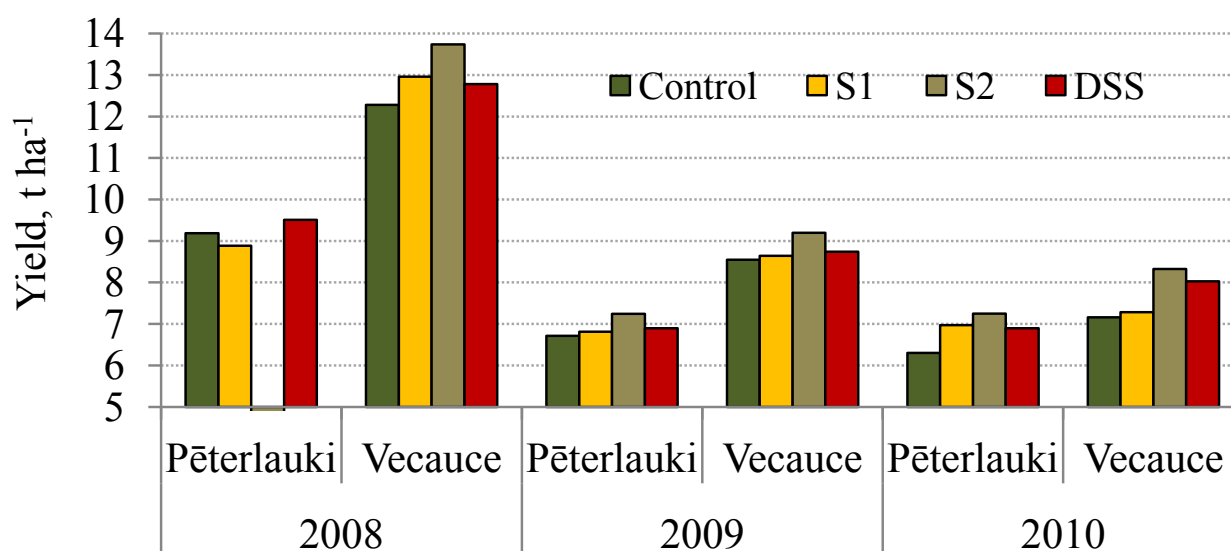

Fig. 2. Yield of winter barley depending on fungicide application scheme, trial's place and year.

Results and discussion

Net blotch was the most spread disease in 2008, prevalence of mildew was observed in 2009, especially in «Vecauce», but leaf scald dominated in both trial places in 2010 (Fig. 1).

Fungicides according the DSS scheme were applied only once per season, but the time of advice for application was diverse. In 2008 advice to spray was given after four rainy days and it agreed with S1 spraying. In 2009 advice was given due to very rapid development of mildew and fungicide was applied during stem elongation. In 2010 spraying according DSS was done too late in «Peterlauki» and due to this it was non-effective. Contrariwise in «Vecauce» it was done early in the season and gave more yield increase if compared with S1 (Fig. 2). High winter barley yield (6.3 - 13.7 t ha⁻¹; Fig. 2) was obtained during trial years, but the highest increase from fungicide application was observed in 2010 — 10% in comparison with 4% in 2008-2009.

Significant ($p < 0.05$) yield increase was gained in treatment S2 if compared with C. Fungicide application according the DSS gave significant yield increase only once per trial period – at «Vecauce» in 2010.

The most spread diseases during trial period were net blotch, mildew and leaf scald, but incidence and severity of diseases depended from trial year. Standard fungicide treatments were not effective enough. Also DSS was not accurate enough to conclude that this scheme is ready for use. Further research is needed to explain all the factors determining necessity of fungicide application.

References

- Bankina B, Priekule I. (2003) Experience of using reduced dosages of fungicides for cereal disease control in Latvia. DIAS Report, Plant Production, (96): 130-140.
- Gladders P., Hims MJ (1994) Improving spring and summer fungicide treatments for winter barley. *Crop Protection*, 13(8): 597-606.
- Young CS., Thomas JM., Parker SR., Paveley ND (2006) Relationship between leaf emergence and optimum spray timing for leaf blotch (*Rhynchosporium secalis*) control on winter barley. *Plant Pathology*, 55(3): 413-420.

Acknowledgement

Research was supported by Ministry of Agriculture of Latvia (projects 070410/S 35 and ELFLA 020311/C – 31).

Control of the most widely spread cabbage pest in white cabbages

Duchovskiene, Laisvune; Alma, Valiuskaite; Tamosiunas, Rimantas; Rasiukeviciute, Neringa; Surviliene, Elena; Bobinas, Ceslovas; Karkleliene, Rasa

Institute of Horticulture, Lithuanian Research Centre for Agriculture and Forestry, LITHUANIA

Introduction

In Lithuania cabbage is an important vegetable, which is attacked by various pests, including the cabbage aphid *Brevicoryne brassicae* and a number of lepidopterous species. Most harmful of them are *Plutella xylostella* and *Pieris rapae*. *B. brassicae* causes serious losses of yield in *Brassica* crops (Liu et al., 1994). Parasitoid *Diaeretiella rapae* can reduce the population of *B. brassicae* average 12.9 % (0.6 aphids /plant) if pesticides are not used (Duchovskiene et al., 2012). Larvae of *P. rapae* move onto inner cabbage leaves, eating and gnawing passages into it (Jõgar et al., 2008). To save infested plants, pest control is mostly always necessary (Gillespie, 2002).

Methods and conditions

Experiment was carried out in the experimental fields of the LRCAF Institute of Horticulture, (Central Lithuania 55° 60' N 23° 48' E) in 2004–2005. Insecticides Proteus 110OD (a.i. Thiacloprid 100 g/l and Deltamethrin 10 g/l), Actara 250 WG (a.i. Thiamethoxam 250 g/kg), Calypso 240 OD (a.i. Thiacloprid 240 g/l), Decis 50EW (a.i. Deltamethrin 50 g/l) and Fastac EC (a.i. Alpha-cypermethrin 100 g/l) were tested in this study. White cabbages of cv. Bielorusiska Dotnuvos were planted 70 x 50 cm, each replicate covered an area of 15 m², and the treatments were replicated

four times at a random plot distribution. Ten plants per plot were inspected for aphids, parasitized aphids and caterpillars. Biological efficacy (BE) was calculated using Abbott formula (1925).

Results

In 2004-2005 Proteus ensured highest control against *B. brassicae*. Also insecticide Proteus 0.6 l ha⁻¹ was effective against caterpillars of *P. xylostella* (BE varied between 85.7 and 81.2 %). Calypso gave lower control than Proteus (BE 81.2 and 75%) but higher than Actara in 2004. Proteus 0.75 l ha⁻¹ gave highest control against cabbage aphids, Proteus 0.6 l ha⁻¹ efficacy was lower compared with Proteus 0.75 l ha⁻¹, but higher than Decis and Fastac in 2005. All tested insecticides were efficient against *P. rapae* caterpillars. The effectiveness of insecticides with different modes of action against cabbage pests in the field conditions was not similar, but Proteus was most effective against them. Parasitisation of *B. brassicae* by *Diaeretiella rapae* was observed only in treatments, where Calypso (0.2 unt./plant), Decis (0.1-0.2 unt./plant) and Fastac (0.5 unt./plant) were applied. This work was carried out within the framework of the long-term research program "Horticulture: agro-biological basics and technologies" implemented by Lithuanian Research Centre for Agriculture and Forestry.

Table 1. Efficiency of insecticides against *B. brassicae* 2004-2005.

Treatment BE,%			
2004			
After application	3 days	7 days	14 days
Proteus 0,6 l/ha	82,35	78,57	71,43
Actara 0,2 l/ha	52,94	57,14	57,14
Calypso 0,3 l/ha	64,70	64,28	57,14
2005			
Proteus 0,6 l/ha	84.72	97.34	100
Proteus 0,75 l/ha	90.45	100	100
Decis50 0,15 l/ha	82.41	70.0	96.08
Decis50 0,125 l/ha	81.71	80.53	82.35
Fastac 0,2 l/ha	72.86	60.31	5.88

References

1. Abbott W. S. 1925. A method for computing the effectiveness of an insecticide. *Journal of Economic Entomology*, 18: 265–267.
2. Duchovskiene L., Surviliene E., Valiuskaite A., Karkleliene R. 2012. Effects of organic and conventional fertilization on the occurrence of *Brevicoryne brassicae* L. and its natural enemies in white cabbage. *Acta Agriculturae Scandinavica, Section B - Soil and Plant Science*, 62(1):16-22.
3. Gillespie D. G. 2002. Biological and integrated control in vegetables in British Columbia. The challenge of success. *Integrated control in protected crops, temperate climate*, 25(1): 73–76.
4. Jõgar K., Hiisaar K., Metspalu L., Ploomi A., Kuusik A., Men'shykova, Luik A. 2008. Abundance of small white (*Pieris rapae* L.) on different cabbage cultivars. *Zemdirbyste-Agriculture*, 95(3): 88-92.
5. Liu S. S., Hommes M., Hildenhagen R. 1994. Damage to white cabbage by the aphid *Brevicoryne brassicae* (L.): influence of aphid density and stage of plant growth. *IOBC/WPRS Bull.*, 17: 75–89.

Coping with the Special Features of the Extreme Northern Corner of Crop Production

Peltonen-Sainio, Pirjo

MTT Agrifood Research Finland, FINLAND

Finland is the northernmost agricultural country with 2.4 million hectares of arable land above 60°N. Agriculture at such high latitudes is possible due to the Gulf Stream. It favorably influences temperature conditions and facilitates use of a fairly diverse range of crops. In addition to grass crops, spring cereals and to a limited extent winter cereals together with some special crops (rapeseed, pea, faba bean, linseed, potato and sugar beet) are grown in the northern cropping systems. High latitude conditions combine unique features and constraints for crop production: e.g. harsh winters, exceptionally short growing seasons, long days during the summer months, cool mean temperatures during the growing season, high risk of early and late season night frosts, early summer drought and high risk of abundant precipitation close to harvests. As the northern growing season has strikingly low number of effective growing days, yields remain modest. Not only exceptionalities or handicaps per se, but uncertainty caused by substantial fluctuation in conditions represent biological and economic risks for farmers. Extreme climatic events may cause total crop failures, on average one per decade, and may correspond to even 45 % of total field area like in 1987. Farmers are used to face and cope with exceptionalities like narrow window for favourable sowing time. Well adapted crops and cultivars are the fundamental means to cope with short growing season, low number of effective growing days and harsh winters. Precipitation is unevenly distributed compared to requirements of many crops. Early summer drought accompanied by development-enhancing long days often interferes with plant stand establishment: only 30–60% of the precipitation needed at early summer for undisturbed yield formation fell on average over 30 years, which resulted in 7–17% yield losses. Despite abundant, high-quality water resources crop production is currently rainfed. In long days,

early summer drought induced yield losses cannot be compensated for by higher precipitation later in the season. Lack of compensation capacity associates with long-day-induced accelerated development and maturity processes of the crops. Because of long day induced unicum growth habit of spring cereals tillering as a plastic trait cannot compensate for harmful early summer drought effects contrary to lower latitudes. Furthermore, abundant precipitation typical during late summer may reduce quality and challenge harvests, and makes grain and seed drying necessary. On the other hand, risks of pest and disease outbreaks are lower as cool climates hold back reproduction of pests and diseases. Unique combination of exceptionalities evidently calls for special mechanisms and approaches when adapting to and coping with current conditions through plant breeding and development of management practices and cropping systems. Climate change may benefit northern European crop production and increase production capacities. This requires comprehensive, costly adaptation measures that will take time to implement and call for prompt launching activities. In case of not succeeding in adaptation, yield gaps may increase further. In this context, the key issue is not how a single trait or even several traits are tailored to a cultivar to improve e.g. resistance or resource use efficiency, but what is the outcome when all the essential measures (breeding, diversified crop rotations, water management systems, provision for emerging pests and diseases etc.) are up-scaled to agricultural systems level. Performance of cropping systems must be managed as a whole to be better prepared to face climate change, climate variability and extreme events, and this means landscape planning. Thereby, sustainable intensification of northern agricultural systems is an essential means to improve resilience to future climatic constraints.

Model-based cultivar testing with genotype parameters and weather conditions

Nkurunziza, Libère; Kornher, Alois; Halling, Magnus; Weih, Martin; Eckersten, Henrik
Swedish University of Agricultural Sciences, SWEDEN

Introduction

Multi-environment trials in cultivar testing maximize genotype-environment interactions and extend conclusions on the whole target population of environments (Ramburan et al., 2011). However, costs associated with field trials impose limited genotype-environment interactions and the applicability of the derived statistical evaluations becomes reduced. With climate change, functional relations between climate and crop performance are needed to guide cultivar choices.

The use of environmental inputs and physiological inputs to crop models can be a good way to support cultivar evaluation (Yin et al., 2003). In this study, we used a forage crop model based on weather data, plant and soil characteristics, MAISPROQ (Herrmann et al., 2005), to estimate genotype specific parameters of two forage maize cultivars (*Zea mays*) and to predict their future dry matter yield (DMY) and dry matter content (DMC).

Material and methods

We used two cultivars with different maturity rates, Avenir (180) and Jasmic (210), according to the FAO maturity index. The estimation of parameter was done with experimental data from 4 locations and 3 years. Data consisted of DMY and DMC of aboveground biomass at 4 times during the growth and development. Two locations in most north and south of the Southern and Central Sweden were chosen for simulation: Uppsala (59° N, 17° E) and Lund (55° N, 13° E). Daily weather data included mean temperature, global radiation, evapotranspiration and precipitation. The simulations were done for three future 27-year periods centered around 2024, 2054 and 2084, respectively. Two ATB climate change scenarios from the Swedish Meteorological and Hydrological Institute (SMHI, 2011) were scaled down to daily values using the Delta-method with 1961-1987 as a reference period and ensemble method was used. Regression of mean DMY and DMC at harvest, when 34% DM content is reached or latest on 31 October, was used to analyze changes over years.

Results

DMY and DMC at harvest were different between locations and cultivars (P value < 0.001). DMY at harvest in Uppsala are currently around 54 000 kg ha⁻¹ for both cultivars and the yearly increase is expected to be 55 kg ha⁻¹ for Avenir and about 90 kg ha⁻¹ for Jasmic. From current DMY around 10084 kg ha⁻¹ for Avenir and 12130 kg ha⁻¹ for Jasmic in Lund, the corresponding increase rates were almost zero for Avenir and only one third for Jasmic compared to Uppsala. The increase rates of DMC are of magnitude of 0.15 and 0.12% in Uppsala for Avenir and Jasmic against 0.01 and 0.13% in Lund. The current DMC are 23% (Avenir) and 14% (Jasmic) in Uppsala against 33.5% (Avenir) and 22% (Jasmic) in Lund.

Conclusion

Early maturing cultivar, Avenir, is not expected to increase significantly neither for DM yield nor for DM content in Southern Sweden. The late maturing cultivar, Jasmic, is expected to increase both DM yield and DM content for all main agricultural regions in Sweden and most in the northern parts. Predictions also suggest that future weather conditions might impose changes in the setup of field trials. On long term perspective, crop breeders can pursue crop improvement based on the expected effect of weather conditions. On short term perspective, predictions can indicate to advisors and farmers what cultivar that might reach high yield and/or quality.

Reference list

- HERRMANN, A., KORNIHER, A. & TAUBE, F. 2005. A new harvest time prognosis tool for maize production in Germany. *Agricultural and Forest meteorology*, 130, 95 - 111.
- RAMBURAN, S., ZHOU, M. & LABUSCHAGNE, M. 2011. Interpretation of genotype x environment interactions of sugarcane: identifying significant environmental factors. *Field Crops Research*, 124, 392-399.
- YIN, X., STAM, P., KROPFF, M. J. & SCHAPENDOK, A. H. C. M. 2003. Crop Modelling, QTL Mapping, and Their Complementary Role in Plant Breeding. *Agronomy Journal*, 95, 90-98.
- SMHI (2011) <http://www.smhi.se/klimatdata/klimatscenarier/scenariodata/1.6200>

Introduction of soya bean (*Glycine max*) cropping to Sweden

Fogelberg, Fredrik¹; Lagerberg-Fogelberg, Charlotte²; Lindahl, Lennart³

¹JTI - Swedish Institute of Agricultural and Environmental Engineering, SWEDEN; ²Ideon AgroFood, SWEDEN; ³Ideon Agro Food, SWEDEN

Soya bean (*Glycine max*) is one of the major crops in the world with Brazil, USA and Argentina as leading producers. Today there is a discussion on the drawbacks of soya production connected to GMO-varieties, deforestation and herbicide use. The soya bean is bushy annual herb. The pods are 25-75 mm long, 8-15 mm broad, yellowish brown with bristle hair containing 2-3 seeds. In general, soya is sensitive to photoperiod and most cultivars will only develop flowers when daylight is less than 14 hours. The cultivars are divided into 13 maturity groups; 000 (earliest) to X, based on their response to photoperiod. The 000-cultivars are adapted to production areas in Canada, Chile and southern parts of Argentine. These cultivars are also used for production in central Europe. In Sweden, soya is an important ingredient for feed. The idea of a domestic production was subject to plant breeding programmes in the late 1940's, but in spite of substantial efforts Swedish soya

cropping was never a success. The cultivar Fiskeby V, developed by breeder Sven Holmberg, is however a well-known, day length neutral and hardy variety, which partly have been used for later breeding purposes. Ongoing research has proved that soya is a crop with high potential for Sweden, most likely Denmark and possibly southern Finland. The Baltic countries should also be included in this group. Today, soya has by the authors been reintroduced as crop in Sweden.

Swedish soya re-introduced in the early 2000's

Modern Swedish soya research started in 2002-2003 with field trials using varieties from South Korea, Sweden and Switzerland. The results were quite poor. Yields were small and had general low protein content, 20-25 %. In 2006 demonstrations and field trials were conducted



Fig. 1. Soya beans maturing in field trials in Sweden, 2011. Cultivars differs in maturity time and yield. To the left an early, low yielding cv. with high protein content. To the right a late maturing, high yielding cv with normal protein content.

	Crop		
	Soya bean	Dry pea	Field bean
Protein (g per kg of DM)	426	231	338
Starch (g per kg of DM)	16	514	307
Methionin	5.8	2.3	2.1
Cystin	6.9	4.3	4.1
Treonin	16.7	9.4	11.3
Lysin	28.0	18.9	20.8

using Czech cultivars. In demonstrations on two farms, soya was grown to identify farmer opinion on cropping methods. In the trials we compared three 000-group cultivars in order to study yield. Demonstrations resulted in yields of 1.6 t ha⁻¹ with a crude protein content of 35-40 %. Generally the soya was easy to harvest with conventional combines. In one of the trials we had a severe infestation of nightshade (*Solanum nigrum*) which made the harvest and sorting quite difficult. The weed problem was, however, not connected to soya production per se but a general weed in the cropping area. The trial showed yield variations between 1.3 to 1.9 t ha⁻¹, which corresponds well with the more practical oriented farm demonstrations.

Ongoing field trials and results

Field experiments 2010-2012 focus on suitable seeding dates (mid of May until mid of June), row distances (12,5 cm; 25 and 50) and cultivars (4-5 cv each year). Along with these experiments farmers have taken part in the

development and today, 2012, about 40 hectares of soya are cropped in Sweden using various systems for soil tillage, seeding and maintenance during season. Yields in 2011 amount to 1.8 - 2.4 t ha⁻¹ with average protein content of 40-41%. Maximum protein content registered is 42.8 % (crude protein of DM). We use cultivars with Canadian origin suitable for food production. The cultivars can also be used as feed and all cultivars belong to the 000-group.

Future research and development

To further soya cropping in the Nordic countries, we have identified areas that need R & D;

- suitable rhizobium strains adapted to cool climate soils
- suitable cultivars for cropping in cool climate (50-60 ° N)
- cropping system with low resource input
- introduction of flexi-headers for harvesting close to soil surface
- roasting technology for feed production at farms.

Effects of vernalization on freezing tolerance and canopy structure of timothy (*Phleum pratense* L.)

Jokela, Venla¹; Luhtanen, Juha¹; Virkajärvi, Perttu²; Seppänen, Mervi¹

¹University of Helsinki, FINLAND; ²MTT, FINLAND

Introduction

Timothy (*Phleum pratense* L.) is the most widely grown perennial forage grass in Scandinavia and in other cool areas of Europe and North America (Stewart et al. 2011). It has good winter hardiness and the nutritive value and palatability of harvested biomass is good (Höglind et al. 2001). Timothy canopy consists of three different tiller types and flowering tillers are dominant in the primary growth (Virkajärvi et al. 2012). Timothy requires long day for flowering, but it has also been shown that vernalization accelerates flowering, although it does not have obligatory requirement for it (Seppänen et al. 2010). The ability of perennial grasses to harden and maintain cold hardiness throughout the winter is critical for winter survival and for the growth in the spring. The climate change will have a great effect on the growing season in northern areas, especially it has been predicted that mean temperatures will rise and winters will be rainier. Adaptation ability of plants to these changes and its dependence on genotype is of great importance (Baron & Bélanger 2007). The objective was to study the role of vernalization on freezing tolerance and canopy structure in timothy genotypes from different origin.

Materials and methods

The experiment was conducted at Viikki Research Station at the University of Helsinki (60°22'N, 25°01'E) during the three winters in years 2009-2012. Six to eight timothy genotypes were harvested monthly from field and the freezing tolerance was tested in cold bath (temp. from -2.5 °C to -30 °C in 2.5 °C/h interval). After freezing test plants were transferred to greenhouse, where plant survival, height, final leaf & tiller number and days to heading were determined.

Results

The length of autumn hardening period and the depth of snow cover varied between studied years. Winter 2011-2012 was shortest with long hardening period, whereas 2010-2011 was longest. Season 2009-2010 was intermediate form of those years. The freezing tolerance as LT₅₀ values varied from -6.8 °C to -15.1 °C among years and genotypes.

Southern genotypes had the ability to flower in greenhouse already in October and were able to produce flowering tillers throughout the year. Northern genotypes required longer vernalization time to flower. In spring months after the fulfilment of vernalization requirement, flowering was faster than in autumn and winter months. The vernalization requirement affected the canopy structure and final leaf number in timothy: prolonged vernalization decreased the final leaf number and reduced the height of tillers. This was due to faster developmental rate and shorter vegetative stage of the developing tillers.

Conclusion

These results suggest that vernalization has a great impact on the growth rate and canopy structure of timothy. Northern genotypes have a stronger requirement for vernalization, whereas southern genotypes may lack it. The autumn hardening period has a critical role for the freezing tolerance achievement in winter in northern latitudes.

References

- Baron, V, and Bélanger, G. 2007. Climate and forage adaptation. p. 83-104. In: Barnes, R. F. et al. Forages: The science of grassland agriculture. 6th ed. Blackwell Publ., Oxford.
- Höglind, M., et al. 2001. Timothy growth in Scandinavia: combining quantitative information and simulation modelling. *New Phytol.* 151: 355-367.
- Seppänen, M., et al. 2010. Vernalization response of *Phleum pratense* and its relationship to stem lignification and floral transition. *Annals of Botany* 106 (5): 697-707.
- Stewart, S.V., et al. 2011. *Phleum*. p. 257-274. In Kole, C. (edit.) *Wild crop relatives: Genomic and breeding resources, millets and grasses*. Springer-Verlag, Berlin.
- Virkajärvi, P., et al. 2012. Tiller Characteristics of Timothy and Tall Fescue in Relation to Herbage Mass Accumulation. *Crop Science*. 52: 970-980.

Effects of weather data resolution on crop yield simulations when using different models – A case study in Finland

Angulo, Carlos¹; Rötter, Reimund²; Gaiser, Thomas¹; Trnka, Miroslav³; Ewert, Frank¹

¹University of Bonn, GERMANY; ²MTT, FINLAND; ³Mendel University of Agriculture and Forestry Brno, CZECH REPUBLIC

Introduction

The regional application of crop-models is mainly limited by data scarcity (Faivre et al., 2004). Decreasing the resolution of input data is a common strategy used to overcome data scarcity; however changing the data resolution might incorporate more uncertainty in the yield simulation process (Trnka et al., 2007). Regional impact assessment of climate change and variability is an important application area of crop models, therefore, the choice of accurate resolution of weather input becomes decisive for achieving sound yield simulations (Hansen and Jones, 2000). This paper responds to the need for a systematic evaluation of the effects of spatial aggregation of input weather data on simulated yields. We assess the influence of spatial aggregation of weather input data

on distributions of barley grain yields simulated by four crop models in Yläneenjoki, south-western Finland. Since yield simulations are usually compared to aggregated observed yields, we also evaluate the influence of spatial aggregation on observed yields distributions.

Methodology

The models ACE (Ewert et al., 2011), DSSAT (Jones et al., 2003), EPIC (Jones et al., 1991) and WOFOST (Boogaard et al., 1998), are applied to simulate yields of spring barley in Finland. Crop input data for the models are sowing dates available from the Yläneenjoki Monitoring Database for 12 years between 1994 and 2005. Yields are calculated considering five weather data resolutions: weather station point data and grid cell data at resolutions of 10

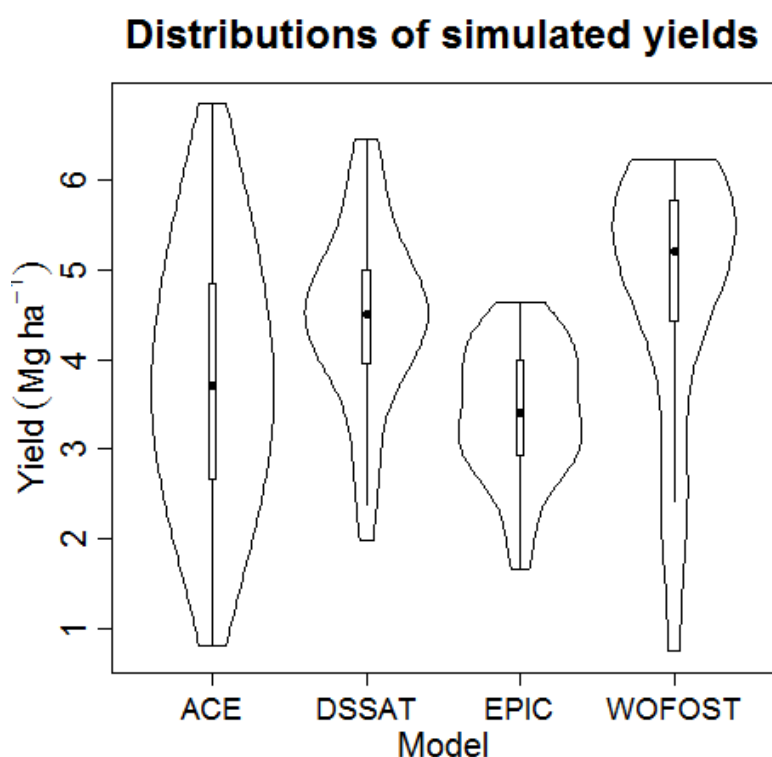

Figure 1. Distributions of yields simulated by 4 crop models for 12 year using weather station data.

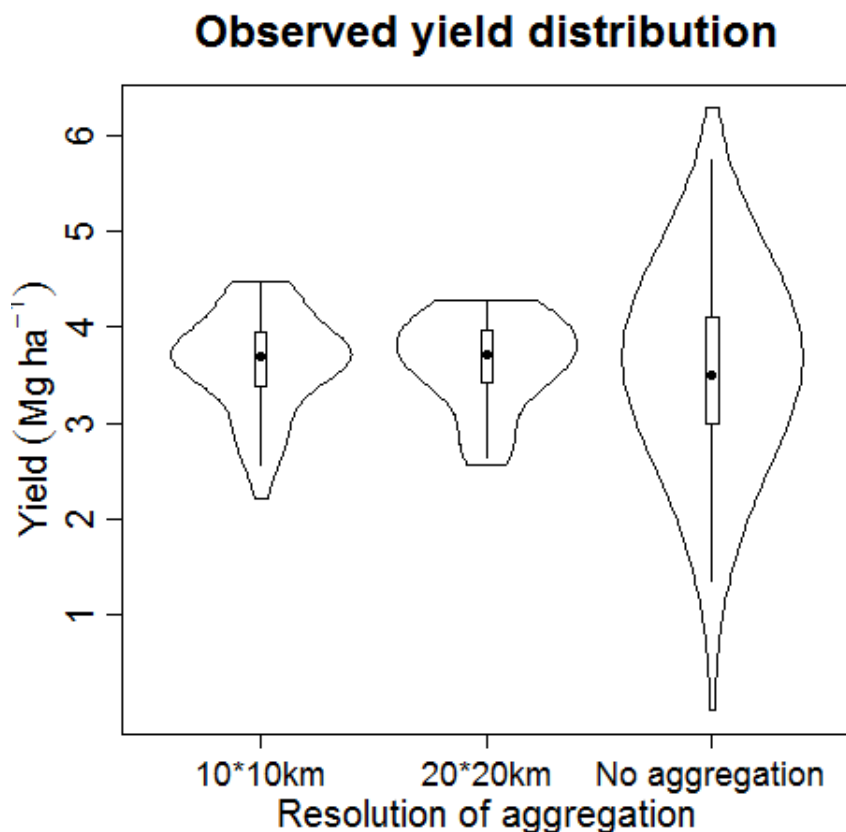

Figure 2. Form and modality of observed yields distributions as influenced by spatial aggregation .

km * 10 km; 20 km * 20 km; 50 km * 50 km and 100 km * 100 km (Venäläinen et al., 2005). Observed yields are spatially aggregated for two resolutions: 10 km * 10 km, and 20 km * 20 km. The distributions of both, simulated and observed yields are presented in form of violin plots, which combine the functionality of a box plot and a kernel density plot and considers both, quartiles and the frequency distribution (density trace).

Results and discussions

For each model considered in this study, the effect of weather input data resolution on yield simulations is minimal. The differences between models are larger than the effect of the spatial aggregation of weather data in the considered region. When the distributions of simulated yields are depicted as violin plots a characteristic density trace is differentiable for every model (Fig. 1). Irrespective of the spatial resolution of weather input data, the form of the density traces of the distribution of simulated yields remain almost unchanged for every model. The spatial aggregation of observed yields causes a deformation of the characteristic density trace (Fig. 2). We recommend to further evaluate the results of the present study in other regions with higher spatial heterogeneity in weather data. Furthermore our results point out the need of considering

different crop models in regional assessment studies since the model choice had the largest effect on the yield distribution. Finally, we advocate using non aggregated data of observed yields, if possible, to evaluate yield simulations, since aggregation of yields influences the form and modality of distributions.

References

- Boogaard, H.L., et al, 1998. WOFOST 7.1; user's guide for the WOFOST 7.1. DLO Winand Staring Centre, Wageningen.
- Ewert, F., et al., 2011. Scenario development and assessment of the potential impacts of climate and market changes on crops in Europe. AgriAdapt Project reports no. 2 & 3.
- Faivre, R et al., 2004. *Agronomie* 24, 205–217.
- Jones, C.A., et al., 1991. *Agric. Syst.* 37, 341–350.
- Jones, J.W., et al., 2003. *Eur. J. Agron.* 18, 235–265.
- Hansen, J.W., Jones, J.W., 2000. *Agric. Syst.* 65, 43–72.
- Trnka, M., et al., 2007. *Sensors* 7, 2330–2362.
- Venäläinen, A., et al., 2005. Reports 2005, 5–27.

Biodiversity indicators for European farms

Herzog, Felix¹; Arndorfer, Michaela²; Bailey, Debra¹; Balács, Katalin³; Dennis, Peter⁴; Dyman, Tetyana⁵; Fjellstad, Wendy⁶; Friedel, Jürgen⁷; Garchi, Salah⁸; Geijzendorffer, Ilse⁹; Jeanneret, Philippe¹; Jongman, Rob⁹; Kainz, Max¹⁰; Last, Luisa¹; Lüscher, Gisela¹; Moreno, Gerardo¹¹; Nkwiine, Charles¹²; Paoletti, Maurizio G.¹³; Pointereau, Philippe¹⁴; Sarthou, Jean-Pierre¹⁵; Stoyanova, Siyka¹⁶; Targetti, Stefano¹⁷; Viaggi, Davide¹⁷

¹Agroscope ART, SWITZERLAND; ²BOKU, Vienna, AUSTRIA; ³Szent Istvan University, HUNGARY; ⁴Aberystwyth University, UNITED KINGDOM; ⁵Bila Tserkva National Agrarian University, UKRAINE; ⁶NFLI, NORWAY; ⁷BOKU, AUSTRIA; ⁸INRGREF, TUNISIA; ⁹Alterra, NETHERLANDS; ¹⁰Munich Technical University, GERMANY; ¹¹University of Extremadura, SPAIN; ¹²Makarere University, UGANDA; ¹³University of Padova, ITALY; ¹⁴Solagro, FRANCE; ¹⁵INRA/ENSAT, FRANCE; ¹⁶Institute of Plant Genetic Resources K.Malkov, BULGARIA; ¹⁷University of Bologna, ITALY

Introduction

Farmland biodiversity is an important component of Europe’s biodiversity. Farms provide habitats, host specific species and make use of the genetic diversity of crop varieties and of husbandry animals. This biodiversity is increasingly valued. Governments offer agri-environmental programs to motivate farmers to conserve

farmland biodiversity and labels are created which claim that the farming practices for the label products are biodiversity friendly. Unfortunately not much is known about the effectiveness of agri-environmental programs and of label production. This is partly because measuring biodiversity as a whole is not possible and because a Europe wide set of accepted biodiversity indicators has been lacking.

		Field crops & horticulture	Specialist grazing livestock	Mixed crops - livestock	Permanent crops
Specific farm types	Genetic diversity	Origin of crops	Number and amount of different breeds per species	Number and amount of different breeds per species; Origin of crops	
	Species diversity				
	Habitat diversity	Crop richness Tree cover	Tree cover	Crop richness Tree cover	
	Farm management	Pesticide use	Average stocking rate per ha forage area; Grazing intensity	Average stocking rate per ha forage area; Pesticide use; Grazing intensity	Average stocking rate per ha forage area; Pesticide use
All farm types	Genetic diversity	Number and amount of different varieties per species			
	Species diversity	Vascular plants; Earthworms; Spiders; Bees			
	Habitat diversity	Habitat richness; Habitat diversity; Share of farmland with shrubs; Length per hectare of linear elements; Average size of habitat patches; Share of semi-natural habitats			
	Farm management	Area without use of mineral N-fertiliser; Total nitrogen input; Total direct and indirect energy input; Intensification/Extensification expenditures on fertiliser, crop protection and concentrate feed stuff; Field operations			

Figure 1: BIOBIO set of tested generic indicators which can be applied on all farm types and with indicators which only make sense for specific farm types.

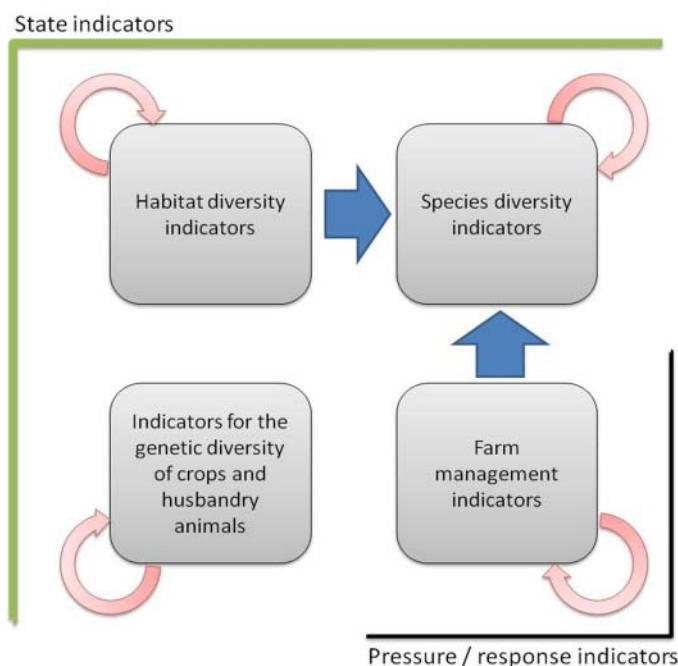

Figure 2: Correlations of indicators within the four main categories (red arrows) were tested and redundant indicators were removed. Both habitat diversity and farm management are expected to act on species diversity (blue arrows) and indicators which show this interaction were retained.

Methods

In the EU FP7 project BioBio (www.biobio-indicator.org) fifty candidate indicators were tested in 12 case study regions (CS) across Europe on, altogether, 196 farms. The selected case study regions represented conventional, organic and low-input farming with field crops and horticulture (3 CS), specialist grazing livestock (6 CS), specialist permanent crops (2 CS), mixed crops and livestock (1 CS). Indicators were measured applying standardized sampling procedures and farm interviews. Correlation analysis was used to eliminate redundant indicators. Repeated stakeholder consultation allowed to rate the indicators' attractiveness.

Results and discussion

15 indicators proved to meet scientific standards (can reliably be measured, not depending on expert judgment, sensitive to management) and to be attractive for stakeholders. Eight management parameters were also selected which deal with farming intensity (energy, nitrogen and pesticide input), stocking rate and grazing intensity and expenditures for inputs (Figure 1). The indicators allow for a consistent description of the farming systems and the related biodiversity. The BioBio indicator set has been tested for redundancies and correlations (Figure 2). Redundancies are minimal and not consistent across farm types and CS. Correlations between farm management indicators (which are based on data that is easily obtained through interviews) and

direct biodiversity indicators (namely habitat and species diversity indicators which need to be measured in the field) occur in specific farm types and CS. However, they are not consistent enough to use farm management indicators as surrogates for direct biodiversity indicators. Therefore, the BioBio indicator set cannot be reduced without losing valuable information on farmland biodiversity.

Conclusions

The BIOBIO indicators operate at the farm scale, not at the regional scale nor at the plot scale. The focus of the indicator set is on the actual state of biodiversity. As such it can complement existing indicator sets such as IRENA operation (Indicator Reporting on the Integration of Environmental Concerns into Agriculture Policy) and SEBI (Streamlining European Biodiversity Indicators), which mainly comprise pressure and response indicators and only few state indicators at a regional / national scale. As the indicators operate at the farm scale, they can be related to (socio-)economic indicators of the farm enterprise. The costs of indicator measurement have been recorded and recommendations for the implementation of a European monitoring scheme will be made, including estimations of cost and effort.

Acknowledgement

Part of this research was funded under the European FP7 project BIOBIO – Biodiversity for organic and low-input farming systems www.biobio-indicator.org

Assessing the pollination value of field margin flora by means of a predictive indicator

Bockstaller, Christian¹; Ricou, Charles¹; Schneller, Chloé²; Gaba, Sabrina³; Chauvel, Bruno³; Amiaud, Bernard⁴; Plantureux, Sylvain⁵

¹INRA, UMR 1121 Agronomie et Environnement BP 20507, 68021 Colmar, FRANCE; ²INRA, UMR 1121 Agronomie et Environnement BP 20507, 68021 Colmar, FRANCE; ³INRA, UMR 1347 Agroécologie, BP 86510, 21065 Dijon, FRANCE; ⁴Université de Lorraine, UMR 1121 Agronomie et Environnement BP 172, 54505 Vandoeuvre-lès-Nancy, FRANCE; ⁵Université de Lorraine, UMR 1121 Agronomie et Environnement BP 172, 54500 Vandoeuvre-lès-Nancy, FRANCE

Introduction

The work of the Millennium Ecosystem Assessment (2005) has highlighted the role of biodiversity in providing ecosystem services such as pollination, essential to ensure the sustainability of agricultural systems. In agroecosystems, the innovative management of field margins is one of the means to maintain biodiversity. The development of a management system that sustains such a service requires operational assessment tools in the form of indicators. Predictive indicators derived from a model present an acceptable trade-off between the feasibility and integration of processes, as well as *ex ante* assessment (Bockstaller et al., 2011). Here, we present the structure of a new indicator that assesses the pollination value of field margin flora, plus the first validation results.

Materials and methods

We used a functional approach to link floral traits to pollination. Based on a review of the literature, we selected three variables related to the *visual attractiveness* of flowers for the pollinator, *flower accessibility* for pollinator, and *reward* (quantity, and quality, of nectar and pollen). We based the indicator on a hierarchical decision tree to aggregate quantitative and qualitative variable sets in fuzzy subsets to avoid the knife-edge effect of classes. Each variable is assessed by specific traits through a decision tree. The indicator outputs are expressed on a scale ranging between 0 (low value) and 10 (high value). An evaluation of the predictive value of the indicator was run on a set of field margins from two locations: (1) fields with maize/wheat or maize/maize rotations from the

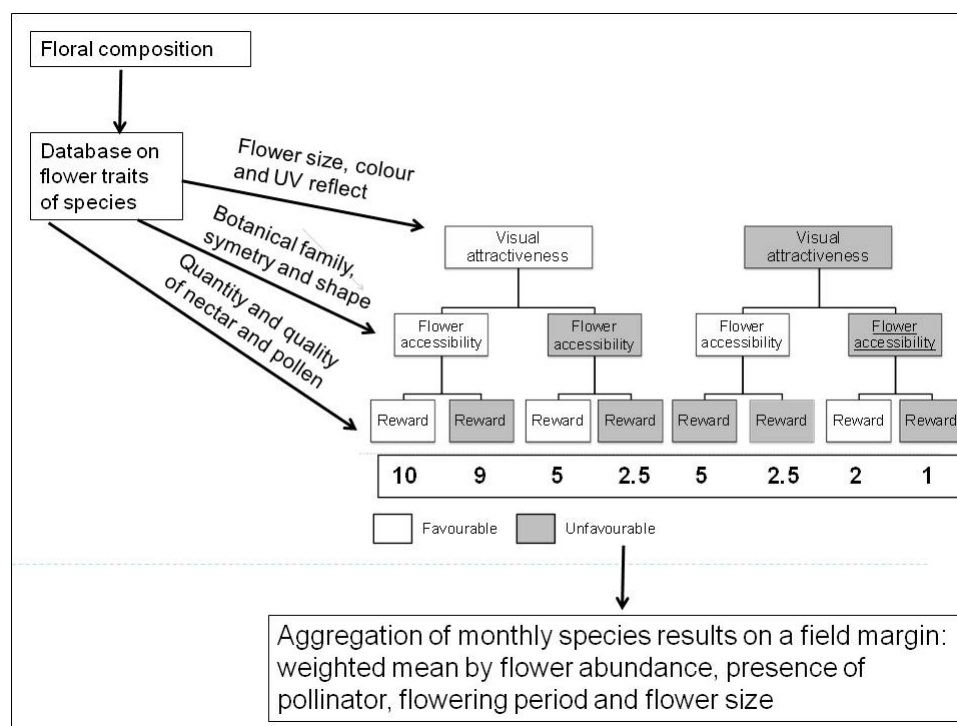

Figure 1: Overview of the pollination value indicator.

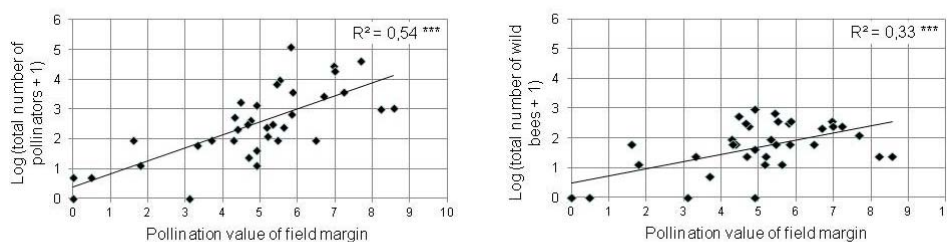

Figure 2: Evaluation of the predictive value of the indicator for total pollinators (left) and wild bees (right).

area of the INRA Experimental Station of Colmar (Alsace region), some of them with sown field margins; and (2) fields in the Fenay area close to Dijon (Burgundy region) with winter rapeseed/cereal rotations. We identified the floral composition of each field margin by means of a specific protocol (Roger, 2007) and floral abundance (number of flowers or inflorescences), as well as the abundance of four pollinator groups: honey bees, wild bees, bumblebees and hoverflies.

Results

We built a database containing the information necessary to calculate the indicator for 338 species, the main weeds of arable fields, as well as endangered weeds and species contained in seed mixtures for sown field margins. Figure 1 shows an overview of the structure of the indicator. The calculation was adapted to the specificities of wild bees, bumblebees and hoverflies. The analysis of the field observations showed significant positive correlations between indicator values for total pollinators and for each pollinator group, i.e., wild bees, bumblebees and hoverflies, with the exception of honey bees (Fig. 2).

Conclusions

The indicator presented here makes it possible to assess the pollination value on the basis of the floral composition of field margins in arable land. Those data are obtained by field observation but may also be predicted by a model (Ricou et al., 2011). The first results of validation are encouraging, except for honey bees. For this last group, landscape elements as well as the crop itself (e.g., rapeseed) may have a major attractive effect.

Acknowledgments

This work is supported by the ANR: project ANR-STRA-08-02 Advherb

References

- Bockstaller C., et al. Oléagineux Corps gras Lipides, 18, 137-144.
- Ricou C., et al. 2011. 4th workshop of the EWRS Working group Weeds and Biodiversity. Dijon (France), 28 February - 2 March 2011, AgroSup Dijon, INRA, p. 35.
- Roger J.-L., 2007. Cahiers Techniques I.N.R.A., 69-78.

How field biodiversity can enhance ecosystem services

Ekblom, Barbara

Swedish University of Agricultural Sciences, SWEDEN

Provisioning services are provided to humans and the ecosystem by agriculture. Production of food, fiber, and bioenergy is essential for our survival and welfare. Unfortunately agriculture can also be the source of ecosystem disservices such as loss of biodiversity, nutrient leaching, pesticide contamination, and greenhouse gas emissions. In order to restrict and remove ecosystem disservices ecosystem services in the agricultural ecosystem need to be promoted. Increasing delivery of soil based services can, for example, curb nutrient run off and loss of underground biodiversity. Ecosystem services such as pest control and pollination that can directly increase crop yield are often hampered by pesticide use and management practices. Enhancing

diversity within the field and in close proximity to the field can sometimes increase the delivery of some ecosystem services. Diversity enrichment can include an increase of plant diversity in time and space. This can often lead to increased diversity at both higher and lower trophic levels. A problem may arise if the interactions between ecosystem services are antagonistic. It is important to understand the impact of improving field biodiversity on the different ecosystem services and their interaction with each other. Examples of biodiversity enhancement in and around the field to improve the delivery of ecosystem services such as plant protection and pollination will be given.

Cost-efficiency of measuring earthworm diversity in a German case study at farm-scale: lessons for application in monitoring and agricultural practice

Wolfrum, Sebastian¹; Targetti, Stefano²; Viaggi, Davide²; Siebrecht, Norman¹; Papaja-Hülsbergen, Susanne¹; Lüscher, Gisela³; Kainz, Maximilian¹; Jeanneret, Philippe³; Hülsbergen, Kurt-Jürgen¹; Herzog, Felix³
¹Technical University of Munich, GERMANY; ²University of Bologna, ITALY; ³Agroscope ART, SWITZERLAND

Agricultural practices and farmland biodiversity are strongly related. Agriculture influences biodiversity through management activities whilst at the same time benefiting from services provided by biodiversity components. Knowledge about the level of biodiversity present on farmland and the relations to management is therefore crucial regarding both conservation and service provision. Measuring biodiversity is, however, a complex and laborious issue. One solution for this problem is the use of indicators. Still, biodiversity indicators for the level of the farm, which is the actual instance where most biodiversity relevant decisions are made, are lacking. The EU project BioBio (www.biobio-indicator.org) aims at closing this gap. In addition to scientific considerations, the cost-effectiveness of indicators is assessed. This is in particular important for indicator groups like earthworms, which can provide useful information on soils to farmers but which are also quite costly.

Given the fact that resources for monitoring are limited, the availability of cost data concerning the measurement of biodiversity indicators is of significant importance. Only few studies exist which provide empirical evidence about the cost of biodiversity indicator measurement.

Here we present data from the German case study, which focused on mixed dairy farms. The 16 selected farms are located in South Bavaria. In total 127 plots were sampled. Earthworms were assessed with a combination of an expellant solution and hand sorting procedure according to the BioBio standards (Dennis et al. 2010). All adult specimens found were identified to species level.

We used EstimateS software to calculate for each farm 100 resamplings (without replacement) of observed species numbers for each level of sampling effort. To estimate the expected total earthworm species number at

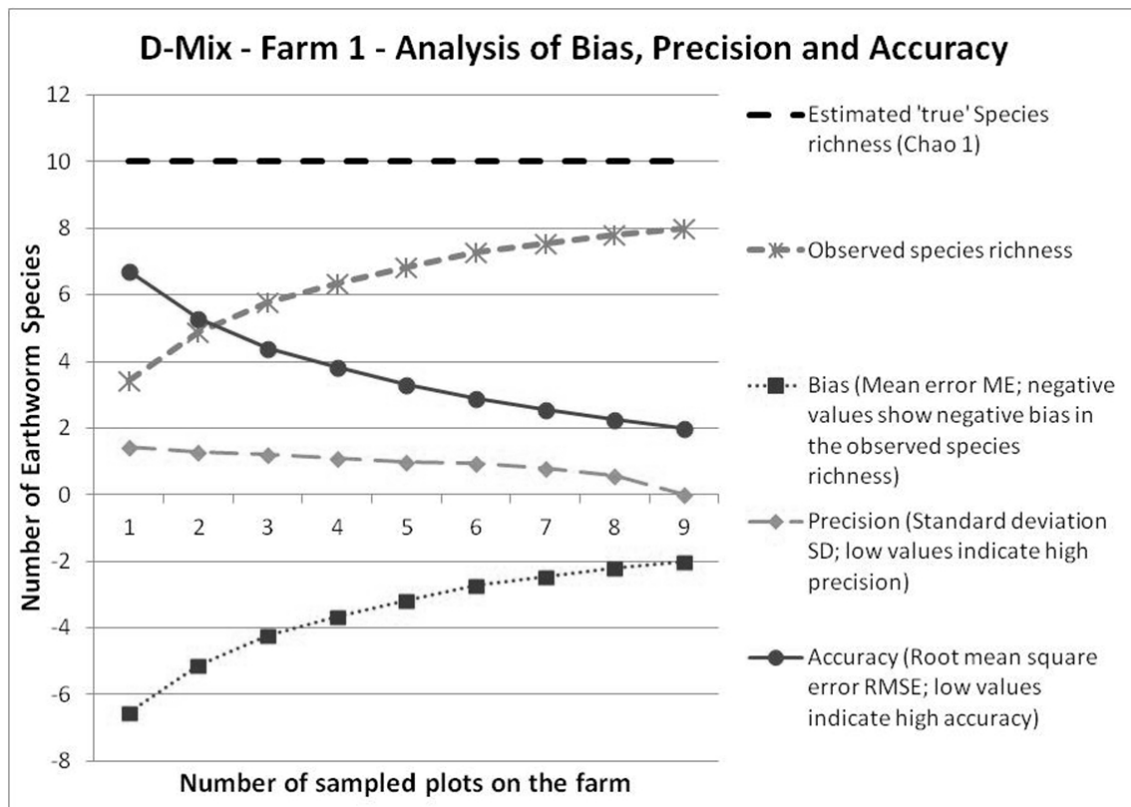

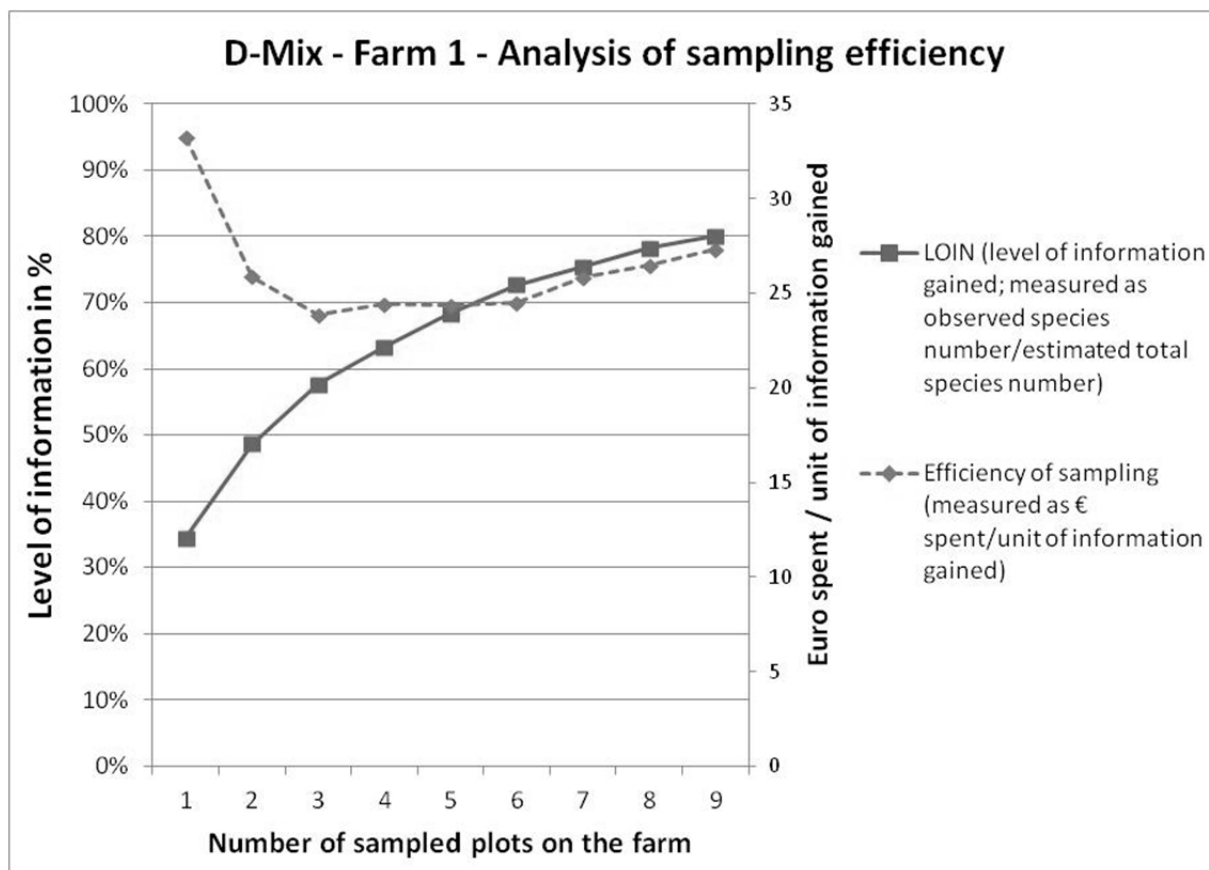

the farm level we used the Chao 1 estimator. We calculate measures of bias, precision and accuracy according to Walther and Moore (2005) for the resampling results. The quantity and change in information gained from different sampling levels was calculated as the relation of species found to species expected on the farm and from accuracy measures.

Measurement costs were calculated as the sum of monetary costs of resources consumed to measure the indicator and processing of data. These costs were estimated through direct information collection regarding resource use and unitary costs. The main cost categories were: i) labour; ii) equipment; iii) travel; iv) consumables; v) taxonomic identification. Each category considers specific resources and unitary costs and data collection was organised in order to trace the costs related to each day of the survey and to each single farm. Cost data collection was organised on a weekly basis during the field sampling activities.

Here we combine costs and information analysis to identify optimal levels of sampling effort, which is defined as the optimal level of € per percent of information. Costs are assessed through an empirical-based data collection

and the percent of information through a nonparametric species richness estimation method. Our results aim at the identification of the optimal ratio between monetary investment and information gained and on identifying necessary funds to reach a certain level of accuracy when using indicators to assess biodiversity in practice. Our approach can be used for other indicator species, too.

Acknowledgement

This research was funded under the European FP7 project BioBio.

References

- Dennis, P. et al. (2010): BIOBIO: Indicators for biodiversity in organic and low-input farming systems. D2.2. Selection and field validation of candidate biodiversity indicators, including field manual. Aberystwyth.
- Walther, B. A.; Moore, J. L. (2005): The concepts of bias, precision and accuracy, and their use in testing the performance of species richness estimators, with a literature review of estimator performance. *Ecography* 28 (6), 815–829.

Plant, earthworm, spider and bee diversity in agricultural fields of grazing and field crop farming systems in eight regions across Europe

Lüscher, Gisela¹; Arndorfer, M.²; Balazs, K.³; Bernhardt, K. G.²; Bogers, M.⁴; Bunce, R. G. H.⁴; Choisis, J.-P.⁵; Dennis, P.⁶; Dramstad, W.⁷; Eiter, S.⁷; Engan, G.⁷; Fjellstad, W.⁷; Frank, T.²; Friedel, J. K.²; Geijzendorffer, I.⁴; Gillingham, P.⁶; Herzog, F.⁸; Hülsbergen, K.-J.⁹; Jeanneret, P.⁸; Jerkovich, G.⁶; Jongman, R.⁴; Kainz, M.⁹; Oschatz, M. L.²; Papaja-Hülsbergen, S.⁹; Pointereau, P.¹⁰; Sarthou, J.-P.⁵; Schneider, M. K.⁸; Siebrecht, N.⁹; Wolfrum, S.⁹

¹ART Agroscope Reckenholz-Taenikon, SWITZERLAND; ²BOKU, Vienna, A-1180, AUSTRIA; ³Szent Istvan University, Godollo, HU-2100, HUNGARY; ⁴ALTErrA, Wageningen, NL-6700AA, NETHERLANDS; ⁵INRA/ENSAT, Castanet Tolosan, F-31326, FRANCE;

⁶Aberystwyth University, SY23 5AL, UNITED KINGDOM; ⁷NFLI, Aas, N-1431, NORWAY; ⁸Agroscope ART, Zurich, CH-8046, SWITZERLAND; ⁹Munich Technical University, Freising, D-85350, GERMANY; ¹⁰SOLAGRO, Toulouse, F-31076, FRANCE

Diversity of wild species living in agricultural fields is influenced by management practices and landscape characteristics. Factors acting on species diversity have contrasting effects on different species groups due to various dispersal abilities and resource requirements (Clough, Holzschuh et al. 2007).

The dataset of the EU-FP7 project BioBio was used to evaluate main drivers for plant, earthworm, spider and bee diversity in agricultural fields. In BioBio indicators for biodiversity in farmland were developed. The four species groups were selected as biodiversity indicators at the species level. Each species group fulfills distinct functions in the agricultural ecosystems. Plants act as primary producers and provide the food resource for all herbivores. Earthworms belong to the group of soil detritivores. Spiders are predators and have a potential role in the

control of agricultural pests. Bees perform pollination (Kremen, Williams et al. 2007). In this study, data from eight case studies are investigated: specialist livestock grazing in Hungary, Norway, Switzerland and Wales, field crop and horticulture farming systems in Austria, France and the Netherlands and a mixed farming system in Germany. All four species groups were surveyed in a total of 385 agricultural fields. Based on questionnaires, management information was provided by the farmers. Hence, the pesticide use, the nitrogen input and the number of mechanical operations were recorded for each agricultural field. Additionally, field characteristics were assessed. Furthermore, the landscape composition in a buffer of 250 m was estimated for each field from aerial photographs. These explanatory variables will be included in models to explain the species assemblages of plants, earthworms, spiders and bees on agricultural

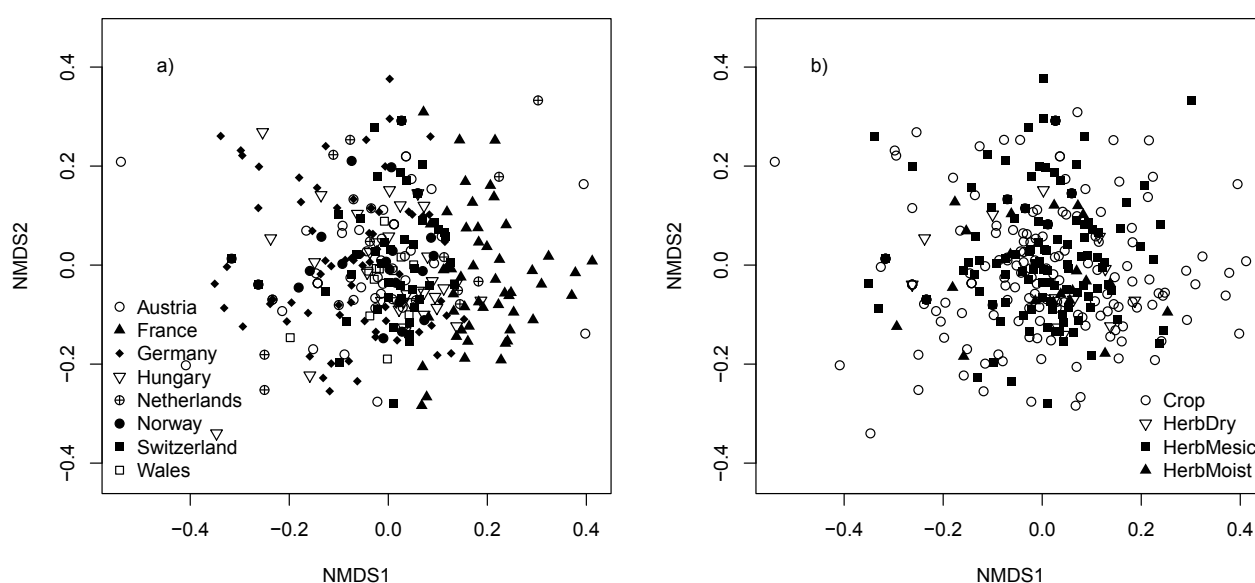

Fig. 1: One example of species assemblages. Non-metric multidimensional scaling of earthworm species, grouped by case studies (a) and main habitat types (b).

fields. Species assemblages are applied as response variable since it takes into account both species richness and species abundance (Fig. 1). If just species richness is considered as diversity measurement, the contribution of frequent and rare species to the diversity is counted equally. However, focusing on species assemblages also takes account of the distribution of the species and enables us to detect more detailed patterns.

Results based on analysis of the diverse farming systems and regions will reveal whether nitrogen input, herbicide use and the number of mechanical operations act on plant diversity as expected. While management variables of fields are assumed to be the main drivers for earthworm diversity, landscape features may play an important additional role for spiders, which are known to use perennial vegetation outside the field for overwintering (Schmidt and Tschardtke 2005). Similarly, we will test whether bee diversity is more related to the landscape composition in the surroundings of fields or to small scale field characteristics and management practices (e.g. insecticide use).

The findings of the study will show the main drivers for plant, earthworm, spider and bee species assemblages in agricultural fields with respect to various farming systems. Such detailed investigations of driving factors for biodiversity in farming landscapes are necessary to implement effective measures in agro-environmental schemes.

References

- Clough, Y., A. Holzschuh, et al. (2007). Alpha and beta diversity of arthropods and plants in organically and conventionally managed wheat fields. *Journal of Applied Ecology* 44(4): 804-812.
- Kremen, C., N. M. Williams, et al. (2007). Pollination and other ecosystem services produced by mobile organisms: a conceptual framework for the effects of land-use change. *Ecology Letters* 10(4): 299-314.
- Schmidt, M. H. and T. Tschardtke (2005). The Role of Perennial Habitats for Central European Farmland Spiders. *Agriculture Ecosystems & Environment* 105(1-2): 235-242.

Increasing the efficiency of water and nutrient use of crops by exploitation of novel germplasm, traits and technologies

Foulkes, MJ¹; Allard, V²; Martre, P²; Snape, J³; LeGouis, J²; Moreau, D²; Gaju, O¹; Bogard, M²; Griffiths, S³; Orford, S³; Pask, A¹; Sylvester-Bradley, R⁴; DeSilva, J¹

¹University of Nottingham, UNITED KINGDOM; ²INRA, FRANCE; ³John Innes Centre, UNITED KINGDOM; ⁴ADAS, UNITED KINGDOM

Introduction

There is a continuous need to develop crops with improved water- and nutrient-use efficiency to ensure resilience in the face of a changing environment. This paper provides an overview of traits and technologies for more effective use of water and nutrients by crops with a focus on resource-use efficiency in wheat. Our research has examined the usefulness of isotope-based screens for crop water use and transpiration efficiency (above-ground biomass / crop transpiration; TE). Carbon isotope discrimination ($\delta^{13}\text{C}$) has been used to screen for TE, e.g. in wheat (Rebetske et al., 2002) and ^{18}O enrichment ($\delta^{18}\text{O}$) has been shown in maize (Barbour et al., 2007) and wheat (Cabrera-Bosquet et al. 2009) to correlate with water use. Our research is quantifying the usefulness of these screens for predicting crop performance under drought.

Future agronomic strategies for raising N-use efficiency (grain yield / N available; NUE) may include crop monitoring through ground-based sensors or aerial or satellite imagery to target N rates. Our research has investigated strategies for improved NUE through optimization of canopy N dynamics affecting senescence patterns and grain protein deposition, as well as the development of remote-sensing techniques for field-based phenotyping.

Materials and methods

Water-use efficiency: 18 wheat cultivars were used to identify isotope-based screens indicative of water use, TE and drought tolerance. Cultivars were grown under irrigated and unirrigated conditions in field experiments at Nottingham, UK in 2011-12. Flag leaf samples at GS61

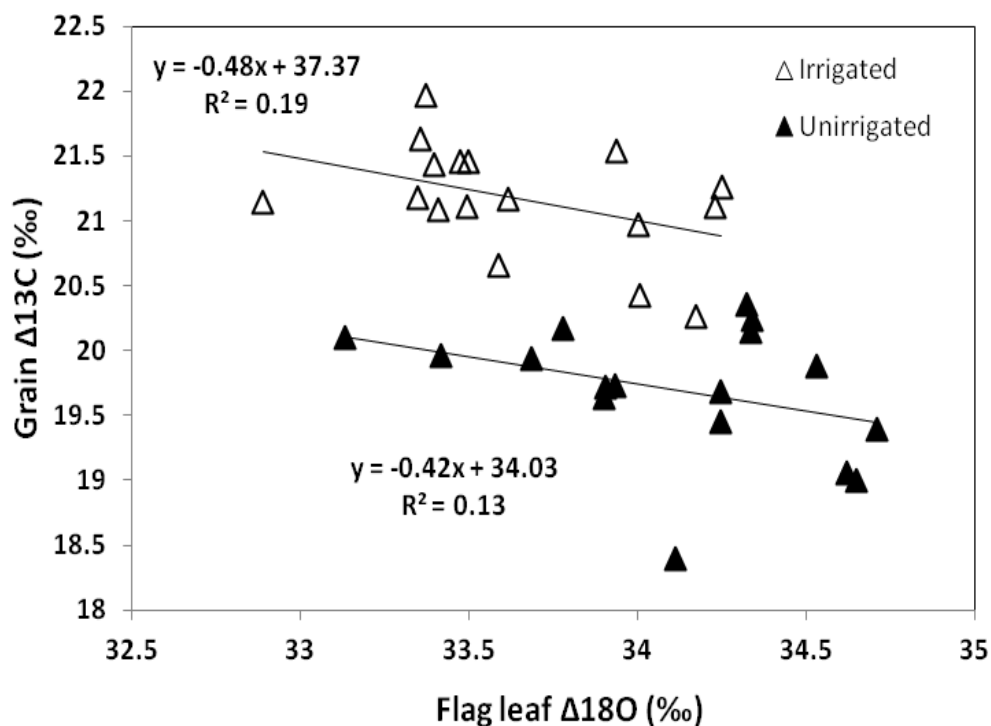

Fig. 1 Linear regression of grain $\delta^{13}\text{C}$ on flag-leaf $\delta^{18}\text{O}$ amongst 18 wheat cvs under irrigated and unirrigated conditions at Nottingham, 2009-10.

and grain samples were assessed for $\delta^{13}\text{C}$ and flag-leaf samples at GS61 for $\delta^{18}\text{O}$.

NUE: Three field experiments were carried out at Terrington, Norfolk, UK in 2006-7, and ICFR, Lincoln, New Zealand in 2007. In each experiment, a range of N treatments was applied to cultivar(s). Growth analysis and N determination was carried out as described by Pask et al (2012). Additionally, eight field experiments examining 16 wheat cultivars in the UK and France were carried out in 2007-8 to examine the relationships between canopy N dynamics, senescence and NUE as described by Gaju et al. (2011).

Results and Discussion

Results indicated grain $\delta^{13}\text{C}$ was positively correlated with yield under UK drought ($R^2 = 0.72$, $P < 0.001$) and flag-leaf $\delta^{18}\text{O}$ negatively correlated with water use and yield. Cultivars combining high TE with high water use were identified in the 18 cultivars (Fig. 1). Generally constitutive expression of isotope screens was observed, indicating these screens can be applied to select for drought-tolerance in non-drought seasons as well as under drought (Fig. 1).

We have developed a new N partitioning and remobilization quantitative framework in wheat to

estimate the crop requirements of N for structural (SN), photosynthetic (PN) and reserve N (RN) at anthesis. We use this framework to test for genetic variation in non-functional RN, and identify traits to help reduce fertiliser N inputs whilst maintaining grain yield. Our recent field experiments have confirmed an association between onset of canopy senescence amongst wheat genotypes and N remobilisation efficiency and NUE under low N. Approaches for phenotyping senescence profiles may therefore facilitate the discovery of the genetic and environmental basis of NUE for food and energy security.

Acknowledgements

Work supported by BBSRC and DEFRA

References

- Cabrera-Bosquet L, Sanchez C, Araus JL. (2009) *Plant, Cell and Environ* 32, 1487-1499.
- Barbour MM. 2007. *Functional Plant Biol* 34, 83-94
- Gaju, O, Allard, V, Martre P, Snape J, Heumez E, Le Gouis J, Moreau D, Bogard M, Griffiths S, Orford S, Hubbart S, Foulkes J. 2011. *Field Crops Res* 123, 139-52.
- Pask, A.J.D, Sylvester-Bradley, R., Jamieson, P.D. Rebetzke GJ, Condon AG, Richards RA, Farquhar GD. 2002 *Crop Sci.*, 42, 739-745.

Effects of shading on biomass production and N-dynamics in winter oilseed rape (*Brassica napus* L.)

Brunel-Muguet, Sophie¹; Beauclair, Patrick¹; Bataillé, Marie Paule²; Etienne, Philippe²; Ourry, Alain²

¹National Institute of Agronomic Research (INRA), FRANCE; ²Université Caen Basse Normandie, FRANCE

Introduction

Oilseed rape (*Brassica napus* L.) is a crop with a complex aerial architecture that determines light gradient over the foliage and causes self shading. It is also subjected to a high sowing density to reach yield potential which causes mutual shading between nearest plants. Therefore, lower leaves of the canopy face a reduction in Photosynthetically Active Radiation (PAR) absorption by lower leaves. In this work, shading treatments (ST) were applied within the canopy to simulate PAR limiting conditions with the aim of analyzing the impact of a light restriction on shoot architecture, biomass production and allocation, nitrogen (N) fluxes, and senescence- and N-assimilation-related genes expression.

Material and Methods

Plants (cv. Capitot) were collected from the field at the end of the vegetative period and grown in hydroponic conditions. Two partial ST were applied by setting one (Simple Shading, SS) or two (Double Shading, DS) cloths maintained at the same height. The extinction coefficient of PAR corresponded to 43.4% and 65.0% for SS and DS respectively. Plants were supplied with K¹⁵NO₃ in nutrient solution to measure N fluxes as in Rossato et al. (2001). Biomass, amounts of N and ¹⁵N were measured

for each organ at 5 harvests. Gene expression of *SAG12*, *Cab* (indicators of leaf senescence progression), *GS* and *GDH* (encoding enzymes involved in N assimilation) were analyzed on different leaf ranks.

Results

Effects of shading on biomass production, biomass partitioning and shoot morphology

Shading affected total biomass with higher values for SS plants at full and late flowering (GS65 and GS69) and seed maturity (GS99). Shaded plants exhibited higher allocation to the flowers and leaves at GS79 compared to control which suggests a delay in leaf senescence (Fig. 1a). Leaf area expansion was favoured i.e. increase in leaf number on the main stem and ramifications.

Effects of shading on N allocation

Higher N (in relative of total N, rQN) was allocated to the flowers and leaves under ST as a consequence of higher sink strength due to their biomass (Fig. 1a,b). Under DS, taproot accumulated N compounds that were not used for growth (GS99, Fig. 1b). Between GS59 and GS65, leaves, roots and taproots were sources while flowers were sink whatever the ST. Stem switched to source organ under SS allowing a temporary storage of N compounds before translocation to young leaves.

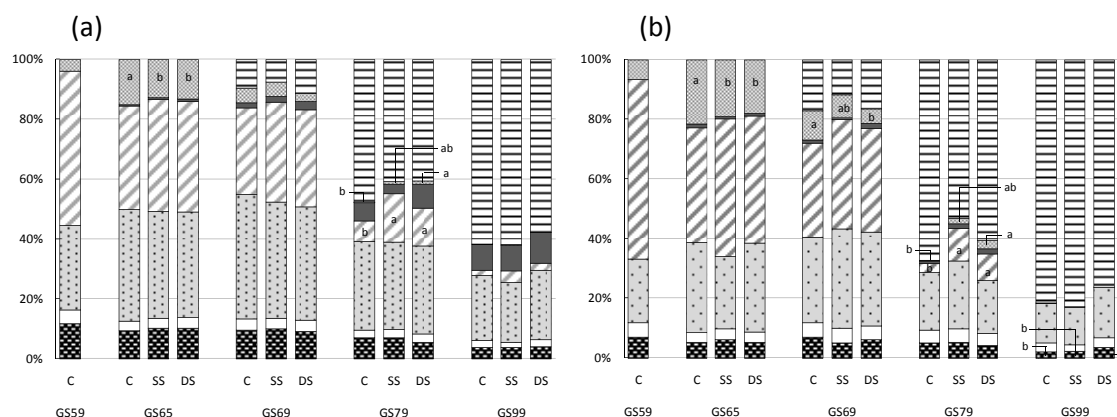

Fig. 1: Evolution of the relative allocation of (a) biomass and (b) Q_N (rQ_N) for the each organ (in % of total biomass and Q_Ntot respectively) i.e. fallen leaves, pods, flowers, leaves, stem, secondary roots and taproot for control, SS and DS plants (n=4). Bonferroni's comparison procedure ($\alpha=0.05$). Lower case letters indicate rankings between treatments. C: control, SS: simple shading, DS: Double Shading.

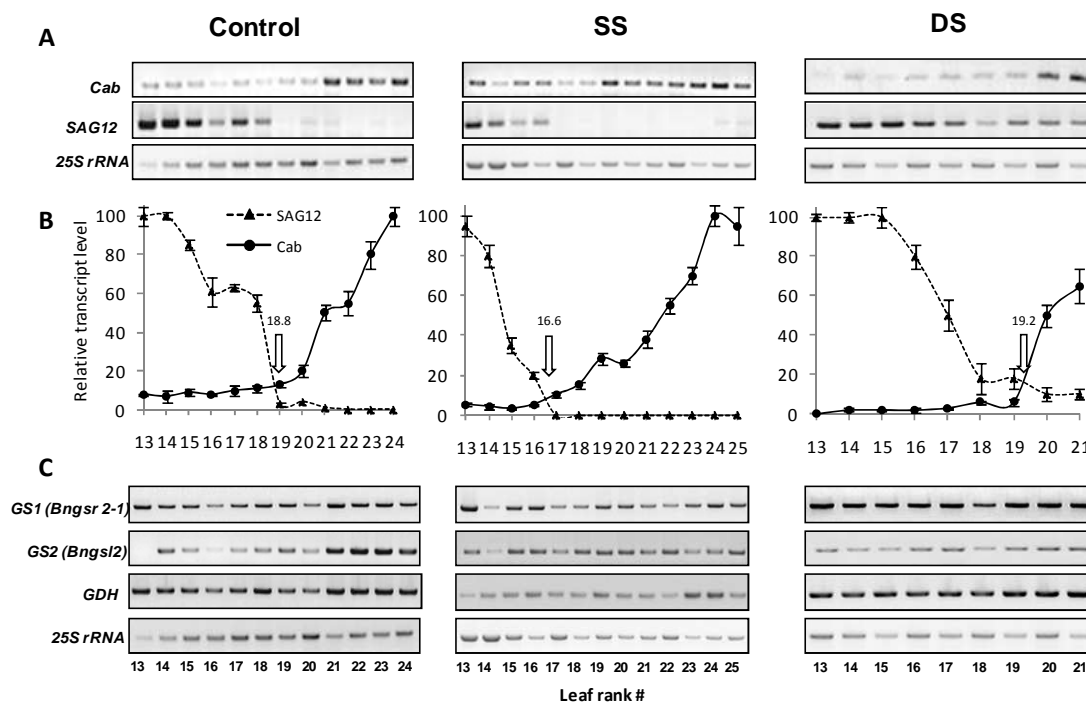

Fig. 2: RT-PCR analysis of *Cab*, *SAG12*, *GS1*, *GS2* and *GDH* gene expressions in leaf ranks 13 up to 25 at GS69. Total RNA was extracted from leaves at GS69. 25rRNA was used as cDNA synthesis and amplification control.

Impacts of shading on gene expression related to senescence and N assimilation pathways

Shading affects sequential leaf senescence progression

The expression pattern of *SAG12/Cab* was used to monitor the spatial progression of leaf senescence (Gombert et al., 2006). The theoretical leaf rank corresponding to sink/source transition for N was #18.8, 16.6 and 19.2 for control, SS and DS plants, respectively (Fig. 2A and B). SS induced a delay of leaf senescence whereas DS promoted a slight acceleration of leaf sequential senescence.

Shading affects NH_4^+ assimilation pathways

For DS plants, levels of *GS1* (cytosolic form of GS) transcripts were higher than SS plants (Fig. 2C). Concomitantly, the expression of *GS2* (chloroplastidial form of GS) was less affected for leaf ranks 15-20 of SS plants which did not undergo senescence. While SS plants used both N assimilation pathways, DS plants resorted to *GS1/GDH* pathway because of an acceleration of senescence leading to an impairment of chloroplastidial assimilation pathway.

Conclusion

Moderate shading induced leaf modifications to optimize light capture. N remobilisation fluxes were enhanced from leaves and stem (source) towards flowers (sink). The *SAG12/Cab* gene expression suggested a delay of leaf senescence under SS which is consistent of the up regulation of the chloroplastidial form of GS. In contrast, DS induced an acceleration of senescence and favoured the expression of the cytosolic form of GS. Profuse apical branching and late senescing varieties would be of interest to maintain high yield under high sowing density.

References

Gombert J, Etienne P, Ourry A, Le Dily F. 2006. The expression patterns of *SAG12/Cab* genes reveal the spatial and temporal progression of leaf senescence in *Brassica napus* L. with sensitivity to the environment. *Journal of Experimental Botany* 57: 1949-1956.

Rossato L, Laíné P, Ourry A. 2001. Nitrogen storage and remobilization in *Brassica napus* L. during the growth cycle: nitrogen fluxes within the plant and changes in soluble protein patterns. *Journal of Experimental Botany*, 361: 1655-1663.

The use of seed and straw N concentration to estimate NUE in perennial ryegrass for seed production – a case study from Denmark and New Zealand

Gislum, Rene¹; Chynoweth, Richard²; Boelt, Birte¹

¹Aarhus University, DENMARK; ²Foundation for Arable Research, NEW ZEALAND

Introduction

Denmark and New Zealand are two very important producers of perennial ryegrass (*Lolium perenne* L.). Application of nitrogen (N) is important to obtain a high seed yield but excess N application will have a negative economical and environmental effect. Therefore economical optimum N application rate (ECO-N) has been defined and is implemented as part of the advices for seed growers in Denmark and New Zealand. We know from several field experiments that ECO-N varies between fields, cultivars, management and pre-crops and maybe there are other alternatives to the use of ECO-N. Nitrogen use efficiency (NUE) is widely used to estimate utilization of available N in different agricultural crops. NUE has been extended to internal NUE (iNUE) defined as how efficient the crop is to produce a yield in relation to N taken up by the crop. The main difference between NUE and iNUE is then that NUE can be calculated as how efficient the crop is to produce a yield in relation to applied N, while iNUE is only for N taken up by the crop. Based on the facts that utilization of available N defined as applied N and N already available in the soil has both an economical and environmental effect this study aimed to

examine the association between NUE, iNUE and ECO-N in perennial ryegrass for seed production in Denmark and New Zealand. We focus on the differences in NUE, iNUE and ECO-N between the two countries, the difference between di- and tetraploid types and how our results can be used in advising seed growers how to increase utilization of available N to obtain a higher seed yield and a higher economical outcome, but also how these results can be used from an environmental point of view.

Methodology

Perennial ryegrass (*Lolium perenne* L.) were grown in 15 (id 1 to 15) field experiments in New Zealand (5 experiments) and Denmark (10 experiments) in the period from 2004 to 2008 using six different cultivars. Nitrogen (N) application rates varied from 0 to 321 kg ha⁻¹ using different application strategies. Soil N was measured at initiation of spring growth in experiments from New Zealand while a fixed soil N amount of 30 kg ha⁻¹ was used under Danish conditions. The experiments were all harvested using a trial combiner and seed yield (kg ha⁻¹), seed N concentration on a dry matter basis, seed N uptake

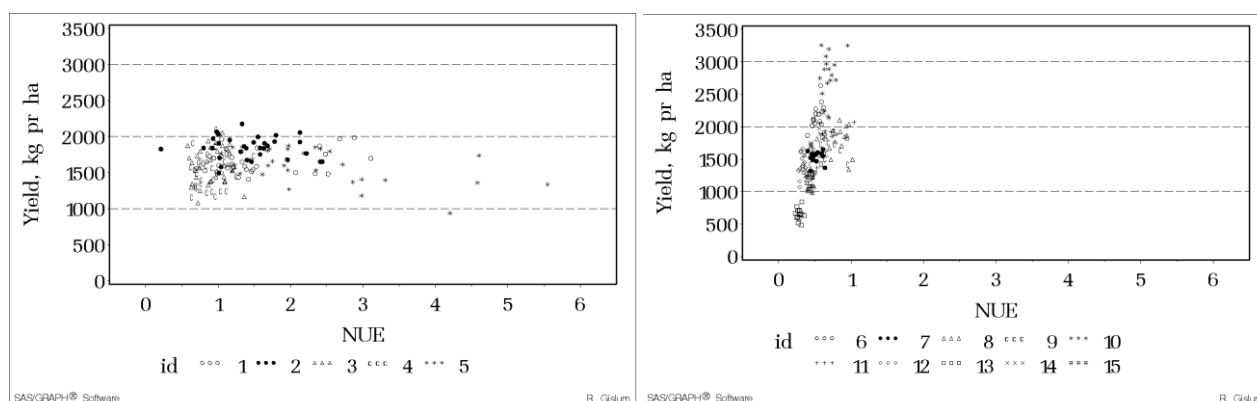

Figure 1. The relationship between seed yield and NUE in perennial ryegrass at 15 field experiments conducted in New Zealand (left) and Denmark (right).

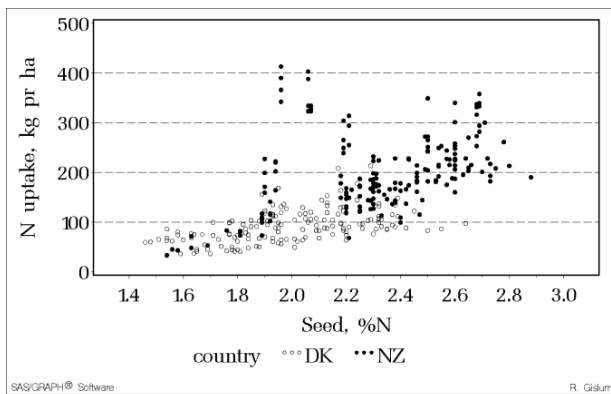

Figure 2. The relationship between nitrogen (N) uptake of perennial ryegrass and seed N concentration in New Zealand and Denmark.

(kg ha⁻¹), straw yield (kg ha⁻¹), straw N concentration on a dry matter basis, straw N uptake (kg ha⁻¹) were registered. NUE was calculated as 'kg crop N uptake/kg N applied' and iNUE was calculated as 'kg seed/ kg crop N uptake'. Crop N uptake is N uptake in seed plus N uptake in straw.

Results and discussion

NUE is considerably higher in New Zealand than in Denmark (figure 1) and this is due to a higher straw production and thereby a higher N uptake in New Zealand than in Denmark (data not shown). A higher N uptake was not synonymous with a higher seed yield but had a positive effect on seed N concentration (figure 2). Seed yield and N uptake showed a positive correlation

in Denmark while there was no correlation in data from New Zealand (data not shown). This is probably due to the two different management practices, a higher soil N content at initiation of spring growth in New Zealand and the restrictions in use of N under Danish conditions. All of these parameters will have an impact on NUE and iNUE.

Conclusion

The difference between New Zealand and Danish in most of the measured parameters has to be due to management of the crop. The fact that similar yield can be harvested at two or even three times higher N uptake indicate that N is not the limiting factor to obtain a higher seed yield.

Global climate changes and local changes in cropping systems: cropping system calendar changes in Lorraine (F) due to climate changes

Benoît, Marc; Fournier, Thomas

INRA, FRANCE

Introduction

The increasing of atmospheric greenhouse gas (GHG) concentration seems to be the most important cause of the origin of actual climate change. Crops phenology is driven by climate characteristic and since many years climatologists point out a general trend on temperature. We know that temperature increases may also have an impact on development of different crop (Alexandrov & Hoogenboom, 2000). What are the local effects on cropping systems of these global trends? Our hypothesis is: cropping systems designed by farmers are influenced by these trends, and agronomists have to study the multiple adaptations managed by farmers (Seguin, 2003). This study was conducted to determine whether the cereal crop cycles are modified by French farmers and experimental managers according to general climate change trends

Materials and methods

This study located in Lorraine (east of France) tries to test the hypothesis obtained in Finland: the sowing dates are earlier (Kaukoranta & Hakala, 2008). Cropping systems calendars are investigated with two methods: (i) surveys using 12 farmers monitoring booklets since 1978 (30 years length) and (ii) experimental data from Mirecourt research station since 1970 (40 years length). This cropping system data are related with climatic data from INRA climatological station.

Results and discussion

This study shows common trends for farmers and experimental data, between 1978 and 2008. For wheat, the beginning of the harvest is 18 days earlier, 8 days for the beginning of sowing, so, the total cycle is 10 days shorter. For barley, the beginning of the harvest is 21 days earlier, the beginning of sowing is 5 days later, and so, the total cycle is 26 days shorter. For corn only studied in experimental station, the sowing is 30 days earlier, the harvest is 25 days earlier despite using later cultivars (from 170 index to 260 index). More precisely, for wheat, the most cultivated crop, harvest date is 19 days earlier since 1978. However, during the same period,

sowing date is only 10 years earlier. Sowing date show an anticipation the 20 first days of our study period, but for 10 years the opposite trends appears. So, the phenological cycle of wheat is 9 days shorter during the last 30 years. We observe a high variability in the sowing and harvest day per year. This variability explains the small R^2 of our statistical regression. Statistical results are exposed in the table. At decade scale, harvest date is statistically earliest in the 00's than in the 90's, which is statistically earliest. These trends are related to two main climate changes in our temperate regions: increasing mean annual temperature (from 8.2 to 10.1 °C since 1967) and decreasing number of frozen days in winter (from 115 to 65 days/y since 1967).

Conclusions

To conclude, increasing temperature appears to modify cropping systems secondly affected by technical management changes in these farming systems. These results, obtained in medium latitude (45° in France) are closely related to Finland trends. The main critical point of this study is the availability of farmer practices records: a lot of fascinating data are collected, but also destroyed by farmers on their real practices. We show we are able to use them with help of statistical analyses. Now, for the future of agronomy on these questions of climate change adaptations, we have to build an European framework to "harvest these local data" on a large diversity of farms in our European territories.

References

- Alexandrov, V.A. & Hoogenboom, G. (2000) The impact of climate variability and change on crop yield in Bulgaria. *Agricultural and Forest Meteorology*, 104, 315-27.
- Kaukoranta, T. & Hakala, K. (2008) Impact of spring warming on sowing times of cereal, potato and sugar beet in Finland. *Agricultural and Food Science*, 17, 165-76.
- Seguin, B. (2003) Adaptation des systèmes de production agricole au changement climatique. *C. R. Geoscience*, 335, 569-75.

CLIMAGIE: A French INRA project to adapt the grasslands to climate change. <http://www.inra.fr/climagie>

Durand, Jean-Louis¹; Ahmed, Lina¹; Barkaoui, Karim²; Barre, Philippe¹; Chabbi, Abad¹; Combes, Didier¹; Cruz, Pablo¹; Decau, Marie-Laure¹; Escobar-Gutierrez, Abraham¹; Frak, Ela¹; Gastal, François¹; Ghesquière, Marc¹; Hazard, Laurent¹; Jouany, Claire¹; Julier, Bernadette¹; Litrico, Isabelle¹; Louarn, Gaëtan¹; Meuriot, Frédéric¹; Morvan-Bertrand, Annette³; Sampoux, Jean-Paul¹; Picon-Cochard, Catherine¹; Pottier, Julien¹; Prudhomme, Marie-Pascale³; Volaire, Florence¹

¹INRA, FRANCE; ²CNRS, FRANCE; ³Université de Caen Basse Normandie, FRANCE

Climate change in Europe is expected to provoke more frequent and more intense summer water deficits, with increased amplitude in temperatures, exposing the same perennial crops to frosts as well as to heat waves and severe droughts. Their impacts on sown monospecific grasslands have been assessed using crop models (Durand et al. 2010). In most of locations studied so far, grasslands might reveal resilient or resist, or even produce more, yet irregularly, under various scenarios of climatic conditions including increase of [CO₂]. However, the responses of plants to extreme droughts and heat waves are not well described in the current models. The future management of grasslands will be based on lower inputs (fertilisation, water) requiring the use of more genetically diverse grasslands that can use resources more efficiently and provide better ecosystem services (Darwin, 1859, De Schutter, 2010). The intra-specific genetic variability was less investigated so far. Hence both ranges of climate conditions and genetic variability must be deeper explored. Phenology and plant productivity responses to water, temperature and nitrogen in particular need to be re-assessed over the full range of temperatures projected in the future. The multidisciplinary INRA research program CLIMAGIE aims to improve our knowledge and provide innovations for adapting grasslands to climate change. Collaboration between community and functional ecologists, ecophysiologicalists and quantitative geneticists will provide new rules for species and cultivars ecotypes assembling. CLIMAGIE will build up a framework to propose a range of solutions depending on pedoclimatic conditions and grassland functions, enabling farmers and breeders to cope with uncertainties attached to future climate scenarios. That framework will be tested experimentally and *in silico* with the models under construction in our teams. It will contribute to the definition of new ideotypes and breeding schemes of major species for plant breeding, in close collaboration with seed companies on the one hand and directly with end users through participatory selection programs on

the other hand. Three integrated groups of tasks are defined: 1. Analysis of the genetic intra and inter-specific variability of the physiological responses to temperatures and droughts in grassland species (legumes and grasses). In particular, the morphogenetic response of various populations in 6 important grassland species to the full range of temperature (5-45 °C) will be studied. The evolvability of grass populations under severe drought conditions will be studied in grasses. New methodologies for measuring the genetic variability of water use, water use efficiency and summer dormancy will be tested. 2. Modelling of the dynamics of the long-term production of sown grasslands. Three models will be tested for: (i) spatially explicit tillering of multispecies grass swards, (ii) individual based competition including legumes and grasses, (iii) complex grassland communities' dynamics using functional ecological modelling. 3. Operational selection schemes, ideotypes and assembling rules for mixed grasslands. This includes (i) novel methodologies to assess and manage of both the *ex situ* and *in situ* genetic resources including biogeographical approaches, (ii) building of selections procedures for mixed sown grasslands (iii) construction of an internet dynamic data base for assembling cultivars under various management and climate conditions.

References

- Darwin C., 1859. The origin of species. Modern library Paperback Edition (1998).
- Durand J.L., Bernard F., Lardy R., Graux I., 2010. Climate change and grassland: the main impacts. In Brisson N. & Levrault F. (eds), Green book of the CLIMATOR project - Climate change, agriculture and forests in France: simulations of the impacts on the main species. ADEME. 181-190.
- De Schutter O., 2010. Report submitted by the special rapporteur on the right to food, Olivier de Schutter. UNO, GE.10-17850.



Fig 1. Models for 2 to 5 species under construction in the French INRA project CLIMAGIE. Modelling the interactions and competition for light (quality and quantity), water and nitrogen in mixtures using dynamic morphology and generic physiological functions (photosynthesis, respiration, transpiration, nitrogen absorption and fixation). Individual based simulation tools for testing genotype adaptation to projected extreme events (heat and drought) using species, population or genotype specific parameters for phenology, morphogenesis, and trophic functions. *Adapted from Barillot, R., Louarn, G., Escobar-Gutiérrez, A. J., Huynh, P. and Combes, D. 2011. Annals of Botany 108, 1013-1024.*

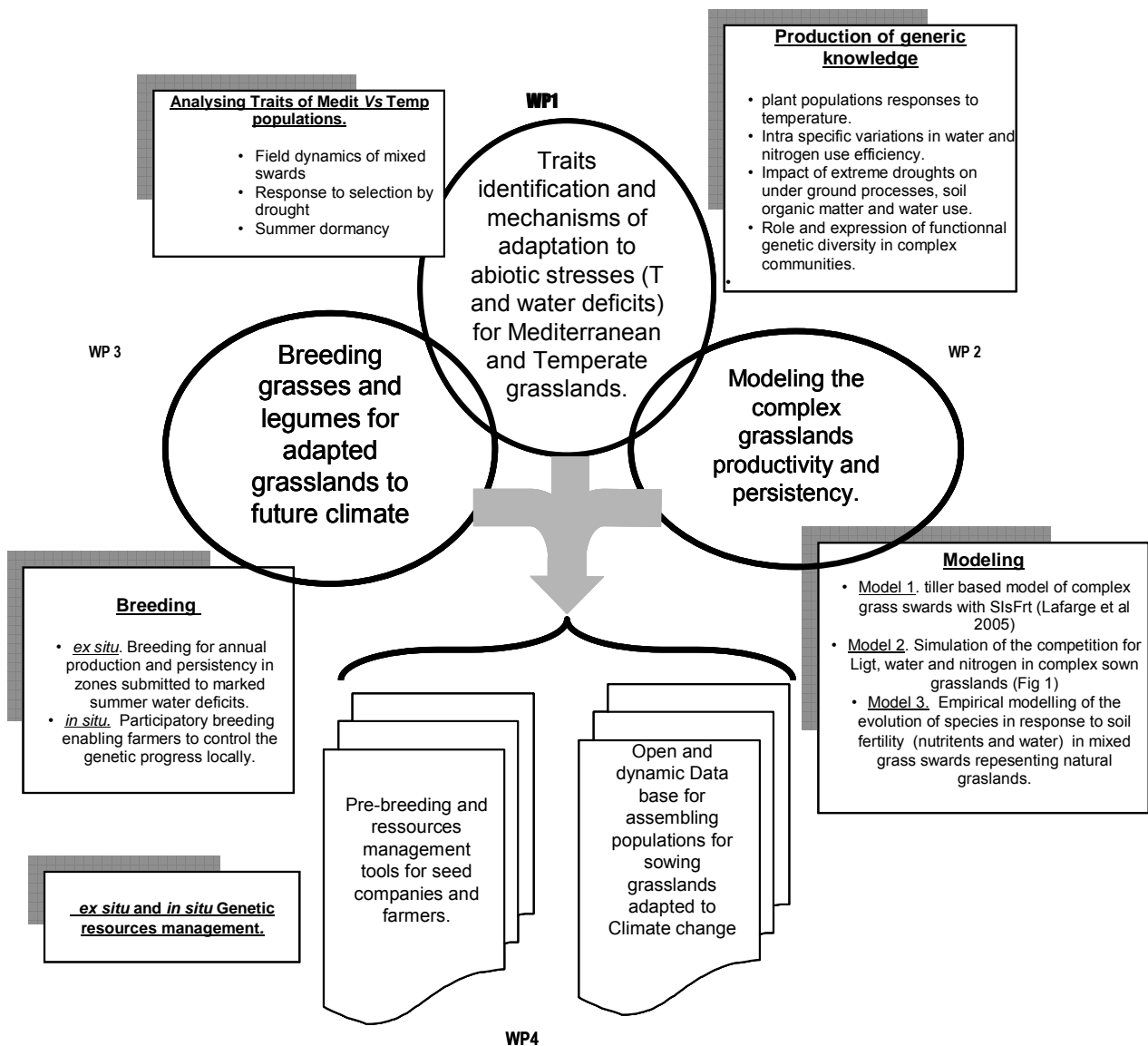

Fig 2. The Structure of the French INRA Project CLIMAGIE.

Adapting maize crop to climatic changes

Tokatlidis, Ioannis

Democritus University of Thrace, GREECE

Introduction

Maize grain production is tremendously influenced by the environmental yield potential, mainly on account of hybrids' attribute to exhibit a strong reliance on plant density. Because of the ongoing climate changes, drought periods on the one side and heavy rains on the other are becoming more and more common. Consequently, for agriculture to be sustainable in the future, it should be able to be adequately productive under highly diverse conditions.

Interactions among environments, hybrids and densities

Although breeding has succeeded spectacular achievements, hybrids suffer from density dependence, an agronomic weakness of prime significance especially for rain-fed cropping systems. The optimum density, i.e. the one that ensures the highest grain production, differs from location to location during the same season or from season to season at the same location even concerning the same hybrid. The problem is more acute at dryland maize production that involves highly diversifying conditions across seasons reflecting upon equally diverse optimum densities (Fig. 1a). According to the general conclusion emerging from the published data, the higher the yield potential is, the higher the due density should be. However, since at the time of sowing the forthcoming precipitations cannot be accurately predicted, it is very difficult to deduce the best density for a hybrid during a particular season, and thus farmers may sustain considerable yield loss (Fig. 1b).

Current crop management

As a remedy, the application of relatively low densities is usually suggested, in order to best adjust to the limitations of the driest seasons. In addition, short-season hybrids are preferred, because at the marginal seasons they require lower densities than the full-season ones to perform well and are also able to evade the severe drought stress during the critical grain-filling stage. Nevertheless, the reliability of this approach should be critically questioned in terms of whether a hybrid's maturity time alone is actually the crucial factor to determine which hybrid is the most suitable for dryland production. In fact, the sort-season hybrids currently available require much higher densities during favourable seasons as opposed to the densities required at the driest seasons. As a result, these hybrids are unable to take advantage of occasional high rainfalls, merely because they happened to be grown at low densities, seriously limiting the farmers' income in such cases.

Future crop management

In order to overcome the problem, breeding ought to switch to density-neutral hybrids, i.e. hybrids able to accomplish yield potential at a wide spectrum of densities and especially those of a low threshold level, i.e. with optimum densities starting at small numbers. If such hybrids are available, they could be cultivated at low densities, so as to meet the requirements of the driest environments, but at the same time be able to take advantage of occasional rainfalls, thus avoiding the risk of yield loss. Hybrids that combine density-

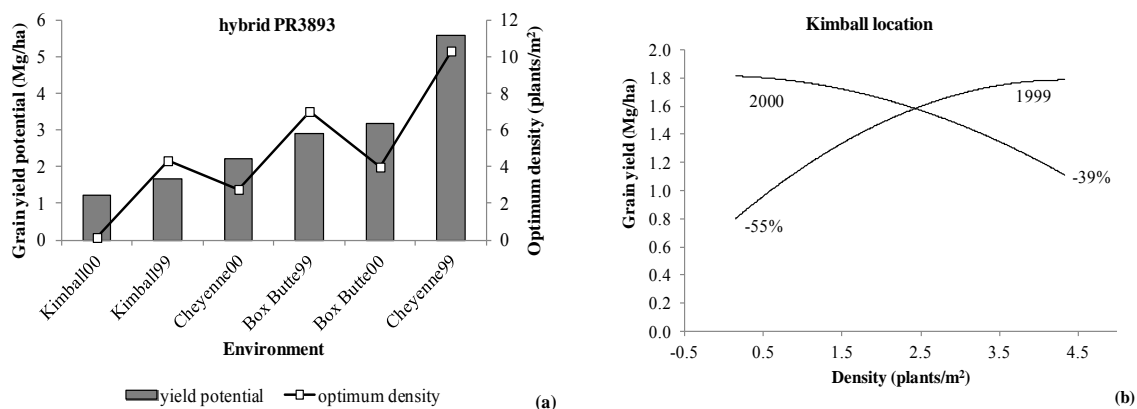

Fig. 1. Variability in environmental yield potential is accompanied by variability in optimum density (a) implying up to 39 and 55% yield loss for two consecutive seasons if density is the optimum for the other season (b). Data from Blumental et al. (2003).

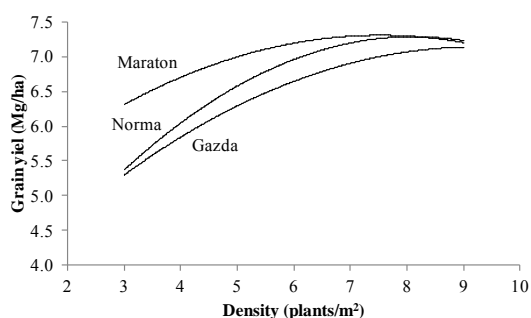

Fig. 2. Among three hybrids equivalent in grain yield potential Maraton is less density-dependent and thus more appropriate for diverse environments. Data from Berzsenyi and Tokatlidis (2012).

independence with a relatively short time to reach maturity constitute the ideal solution for drought-prone regions with insufficient rainfall in late-season. Therefore, two challenges arise. Firstly, among currently elite

hybrids the less density-dependent have to be qualified. Secondly, the development of density-neutral hybrids is a serious challenge for maize breeding serving the needs of sustainable agriculture. Experimental data (Thomison et al., 2011; Berzsenyi and Tokatlidis, 2012) are now available indicating that this could indeed be a realistic goal (Fig. 2).

Acknowledgements

Work co-financed by EU (ERDF) and Greek funds through the program code 09 ÓÓÍ -22-604 "SYNERGASIA2009 – Action I. Cooperative small- and mid-scale projects".

References

- Berzsenyi Z, Tokatlidis IS (2012). *Agron J* 104:331-336
- Blumenthal JM et al. (2003). *Agron J* 95:878-883
- Thomison PR et al. (2011). *Agron J* 103:1765-1772

Stress-Induced Limitations to Reproductive Success in Cotton

Oosterhuis, Derrick; Snider, John
University of Arkansas, UNITED STATES

Introduction

Cotton (*Gossypium hirsutum* L.) originates from hot climates, but does not necessarily yield best at excessively high temperatures, and a negative correlation has been reported between yield and high temperature during flowering and early boll development. Successful pollen tube growth and fertilization of the ovule is essential for the development of seeds and the fibers associated with the seed coat that are the basic components of yield in cotton. As pollen tube growth has a high energy requirement relative to vegetative tissues, any abiotic stress negatively affecting the availability of energy reserves in the pistil should negatively impact fertilization and decrease yield.

Materials and methods

To determine the effects of heat stress on source leaf activity, pistil energy reserves and *in vivo* pollen tube growth, cotton plants (cultivar ST4554 B2RF) were maintained at optimal day/night temperature regimes (30/20 °C) or exposed to heat stress (38/20 °C) conditions one week prior to flowering. Heat stressed pistils had significantly lower pollen tube to ovule ratios, decreased soluble carbohydrate contents, and lower ATP levels relative to the control.

Results

Subtending leaf photosynthesis, photochemical efficiency, and chlorophyll content decreased under heat stress. Comparisons of thermosensitive (cv. ST4554)

and thermotolerant (cv. VH260) cotton plants grown under optimal and high temperatures showed that the thermosensitive cultivar had decreased fertilization efficiency, soluble carbohydrates, ATP content and NOX activity, whereas water soluble calcium and glutathione reductase activity increased. In subtending leaves, heat stress decreased photosynthesis, quantum efficiency and chlorophyll content. High temperature did not affect fertilization efficiency in VH260 but lowered fertilization efficiency for ST4554. Antioxidant enzyme activity was significantly higher in VH260 pistils than ST4554 pistils under control temperature conditions. Also, total and water-soluble calcium and ATP content was significantly higher in VH260 pistils relative to ST4554 pistils. VH260 also exhibited more thermostable subtending leaf photosynthesis and quantum efficiency than ST4554. VH260 also had significantly higher optimal and threshold temperatures for Φ PSII, with innate high temperature threshold being dependent upon antioxidant activity.

Conclusions

We concluded that heat stress primarily limits reproductive success by decreasing *in vivo* pollen performance. The energy requirements of growing pollen tubes cannot be sufficiently met under heat stress as a result of decreased source leaf activity. In addition, pre-stress antioxidant enzyme activity, calcium content, and energetic status of the pistil are innate mechanisms of reproductive thermotolerance in cotton, and reproductive thermotolerance is closely associated with the thermostability of the subtending leaf.

Leaf temperature as a promising tool for evaluating drought adaptation in faba bean (*Vicia faba* L.)

Khazaei, Hamid¹; Stoddard, Frederick¹; Street, Kenneth²

¹University of Helsinki, FINLAND; ²ICARDA, P.O. Box 5466, Aleppo, SYRIAN ARAB REPUBLIC

Introduction

Leaf temperature is highly linked to stomatal conductance (g_s), which in turn represents the combinations of stomatal morphology (density and size) and behaviour and it is a certain physiological criterion for drought adaptation in plant species. Stomatal closure is one of the first steps in response to water deficit, leading to decreased g_s and stomatal transpiration and consequently an increase in leaf temperature (Kramer and Boyer, 1995). Thus, leaf temperature is an indicator of transpirational cooling and has been suggested as a surrogate for measuring g_s in some crops (Blum, 2011) including faba bean (Khan et al. 2007). A wide spectrum of genotypes was studied in order to validate this suggestion.

Methodology

Two sets of faba bean accessions, 201 from wet regions and 201 from dry regions, were studied in controlled

conditions during 2009-2010, in order to investigate the relationships of leaflet and canopy temperature (LT & CT) with leaf gas exchange traits and leaflet area (LA). The experiment was a randomized complete block design with four replicates. Two subsets of 10 and 9 accessions were chosen from the wet and dry sets, respectively, for analysis of response to drought stress conditions in 2011. Water stress was imposed at 5 weeks after sowing, by progressively allowing the potting mixture to dry at 2% moisture content per day. A portable photosynthesis system (Licor LI-6400) was used to measure photosynthetic rate (A_{net}), g_s , transpiration efficiency ($TE=A_{net}/g_s$), LT and transpiration rate (E). CT was measured by infrared thermometer (IRT, FLUKE® 574 thermometer gun). Leaflet area was measured using a LI-6200 leaf area meter. Photoperiod was adjusted to 14 h light and 10 h dark, and the temperature was 20°C day/15°C night $\pm 2^\circ\text{C}$. Photosynthetic photon flux density (PPFD) was about 300 $\mu\text{mol m}^{-2} \text{s}^{-1}$ at the canopy level. A constant humidity level of 60% was maintained.

Results and Discussion

There was a significant variation for LT and CT in all experiments ($P < 0.001$). LT and CT both had strong negative correlations with A_{net} , g_s and E, whereas TE showed the reverse trend (Table 1). LT was positively associated with CT (wet set: $r = 0.576$, $P < 0.001$, dry set: $r = 0.429$, $P < 0.001$). Also, the results showed that bigger leaflets had a cooler canopy. The dry-set accessions had cooler canopy under well-watered conditions and also they had higher rise in both LT and CT under drought stress compared to the wet set (Figure 1). This shows that accessions from dry regions kept their stomata closed for water saving under drought stress conditions, leading to warmer canopy, whereas accessions from wet zones did not use this ability. In the field, however, relatively lower canopy temperature under drought stress conditions, indicates the better capacity of taking water from deep soil and consequently better water status in plants.

Figure 1. Effects of water treatments on the leaflet (A) and canopy temperature (B) in the wet and dry set accessions. (Results represent the mean ± 1 S.E.M.)

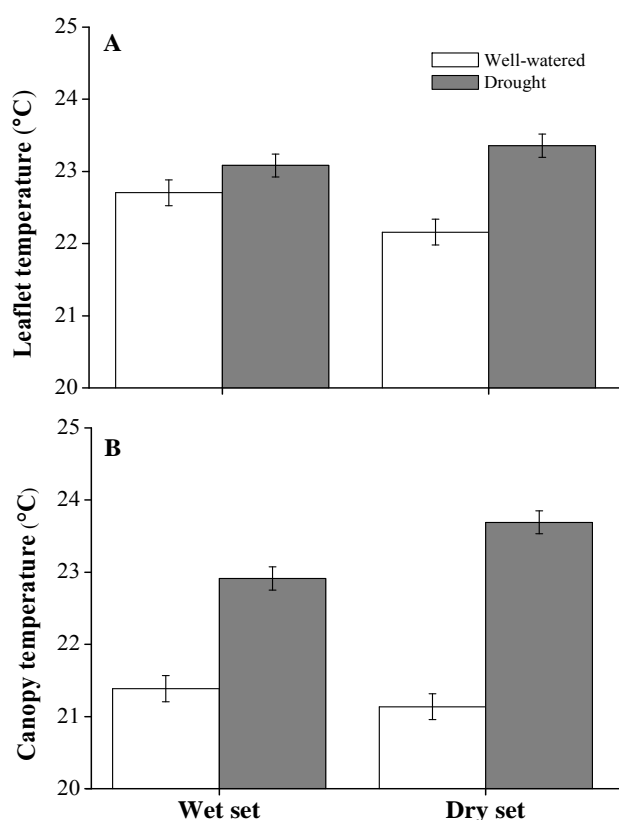

Table 1. Simple correlation coefficients of leaflet and canopy temperatures with leaf gas exchange traits and leaflet area ($n=201$). All correlations are significant at $P<0.001$.

		A_{net}	g_s	TE	E	LA
LT	Wet set	-0.506	-0.603	0.514	-0.592	-0.339
	Dry set	-0.685	-0.849	0.753	-0.825	-0.498
CT	Wet set	-0.308	-0.340	0.282	-0.348	-0.248
	Dry set	-0.387	-0.429	0.392	-0.443	-0.276

Conclusions

Leaf temperature measured by IRT could be introduced as an instant, easy and cost efficient alternative for preliminary screening method for drought adaption under controlled and uniform conditions in faba bean. The protocol of using the IRT (http://www.plantstress.com/methods/IRT_protocol.htm) should be followed carefully to avoid large variance error and non-repeatable results.

References

- Blum A. 2011. Plant breeding for water limited environments. Springer-Verlag, New York.
- Khan HR, Link W, Hocking TJH, Stoddard FL. 2007. Evaluation of physiological traits for improving drought tolerance in faba bean (*Vicia faba* L.). *Plant and Soil* 292, 205–217.
- Kramer PJ, Boyer JS. 1995. Water relations of plants and soils. Academic press, San Diego, CA, USA.

Cover crops are worthwhile in grain legume based rotation to valorise the biological N₂ fixation and concomitantly maintain the soil fertility

Passot, Sixtine; Nolot, Jean-Marie; Justes, Eric

INRA, FRANCE

Introduction

Facing the environmental consequences of agriculture intensification, diversifying crops over space and time like growing more grain legumes (GL) may be a solution. Indeed, they increase the potential amount of available N for the subsequent crop (Crews and Peoples 2004). As nitrate leaching may occur after GL, cover crops (CC) could be used to reduce nitrate losses (Moller and Reents, 2009). Moreover, the medium-term effect of GL in rotations on soil fertility, i.e. soil organic carbon (SOC) and soil total nitrogen (STN), is not well known as well as the joint impact of CC grown after GL. We then focused on SOC and STN assessment using medium-term prototypes of low N input arable farming systems with gradual level of GL and CC.

Methodology

A 6-year field experiment was conducted at INRA Toulouse (SW France) from 2003 to 2009 to study the rotational effects of GL and CC on the medium-term soil fertility in a pseudo two block replicates. The cropping system design was based on 6 different 3-year rotations in low input system containing none (GL0), one (GL1) or two legumes (GL2) and with or without CC (Table 1). Within each rotation, each crop was grown every year as a 'climate replicate'. Decision rules were adopted to adjust crop management to the soil and crop status and in particular adjusting N rates to the preceding crop and CC effect.

Results and discussion

The SOC evolution depended strongly on the crop rotation. While it was almost constant in GL0, it decreased in average by 0.7 t/ha/yr without CC in the GL1 and GL2 rotations (Table 2). On the contrary, CC generated a SOC increase in GL0 of 0.6 t/ha/yr, confirming previous results (Kuo et al 1995). With CC, the SOC depletion tendency was reduced in GL1 and cancelled in GL2. The depleting effect of GL on the SOC was due both to i) lower amounts of C returning to the soil (lower biomass produced) and ii) lower straw C/N ratio, leading to a faster GL residue decomposition than for non-GL crops. Concerning STN, results indicated that although it remained nearly stable in GL0, it slightly decreased in average by 40 kg N/ha/yr in GL1 and GL2 (Table 2). The CC allowed maintaining the STN in the 3 rotations. The N acquired by CC was in average of 35, 50 and 63 kg N/ha/yr respectively in GL0, GL1 and GL2, indicating that CC were efficient for N recycling with a triple effect. Firstly, the CC took up soil residual mineral-N after GL and then decreased nitrate leaching (data not shown) as shown by many authors (Hauggaard-Nielsen et al., 2009). Secondly, the CC residues were rapidly mineralised and a part of N (between 25 and 45% according to C:N ratio) was released and used by the subsequent cash crop. Finally, as a consequence, the CC allowed maintaining the STN because most of its N content was immobilised in the soil at short-term, even with rich-N CC (Justes et al., 2009). Our results are consistent with other studies showing the efficiency of CC to increase SOC and STN in medium and long-term in arable rotations (Constantin et al., 2010).

Table 1: Composition of crops and cover crops of the six three-year rotations tested

	GL0		GL1		GL2	
	bare	CC	bare	CC	bare	CC
Year 1		Sorghum (no CC)		Sunflower Mustard		Soybean Rape or (no CC)
Year 2		Sunflower Vetch		Winter Pea Mustard		Spring Pea Mustard
Year 3		Durum Wheat Oat + Vetch		Durum Wheat Oat + Vetch		Durum Wheat Mustard

Table 2: Soil Organic Content (SOC) and Soil Total Nitrogen (STN) change versus time (after the first and the second rotation)

		Initial SOC in the 0-30 cm (t/ha)	Soil Organic Carbon in g/kg			Evolution	Slope	
		mean (sd)	2003 mean (sd)	2006 mean (sd)	2009 mean (sd)	2003-2009	(g/kg/year)	p-value
GL0	CC	34,0 (2,0)	7,82 (0,47)	8,62 (0,58)	8,58 (0,76)	0,76	0,13	0,009
	bare	37,8 (5,5)	8,68 (1,26)	8,73 (0,89)	8,38 (1,20)	-0,30	-0,05	0,130
GL1	CC	39,1 (4,1)	8,98 (0,95)	8,83 (0,61)	8,13 (0,77)	-0,85	-0,14	0,028
	bare	36,5 (4,2)	8,38 (0,98)	8,33 (0,62)	7,43 (0,11)	-0,95	-0,16	0,004
GL2	CC	39,2 (3,1)	9,00 (0,72)	9,07 (0,75)	8,68 (0,82)	-0,32	-0,05	0,130
	bare	38,9 (3,6)	8,93 (0,83)	8,47 (0,59)	7,98 (0,81)	-0,95	-0,16	0,0004

		Initial STN in the 0-30 cm (t/ha)	Soil Total Nitrogen in g/kg			Evolution	Slope	
		mean (sd)	2003 mean (sd)	2006 mean (sd)	2009 mean (sd)	2003-2009	(g/kg/year)	p-value
GL0	CC	4,2 (0,17)	0,96 (0,04)	1,05 (0,05)	1,02 (0,10)	0,05	0,009	0,140
	bare	4,6 (0,67)	1,05 (0,15)	1,05 (0,10)	1,01 (0,13)	-0,04	-0,007	0,160
GL1	CC	4,7 (0,45)	1,07 (0,10)	1,10 (0,60)	1,05 (0,03)	-0,02	-0,004	0,630
	bare	4,5 (0,48)	1,04 (0,11)	1,03 (0,08)	0,97 (0,10)	-0,06	-0,010	0,048
GL2	CC	4,7 (0,44)	1,07 (0,10)	1,14 (0,11)	1,06 (0,10)	-0,01	-0,002	0,690
	bare	4,7 (0,47)	1,09 (0,11)	1,06 (0,09)	0,99 (0,11)	-0,10	-0,016	0,042

(sd) corresponds to standard deviation

Conclusion

This cropping system experiment showed that GL can induce a depletion of SOC and STN contents at medium-term. This effect was suppressed when CC are cropped after GL, because CC allow to save and recycle large amounts of soil mineral-N and trap more C each year by increasing the photosynthesis at the rotation level. The benefits of CC grown after GL are to go further than the mitigation of nitrate leaching and maintain or improve the soil C and N fertility on medium-term. Then CC are worthwhile in GL based rotations and can be considered as a solution to redesign cropping systems for a more sustainable agriculture.

References

- Constantin et al, 2010. *Agr. Eco. Env.*,135:268-278
 Crews, Peoples, 2004. *Agr. Eco. Env.*,102:279-297
 Hauggaard-Nielsen et al, 2009. *Nut. Cyc. Agr.*,84:281-291
 Justes et al, 2009. *Plant Soil*,325:171-185
 Kuo et al, 1995. *SSSAJ*,61:145-152
 Moller, Reents, 2009. *Plant Nutr. Soil Sci.* 172:277–287

Assessing the role of cereal-legume intercrops in low-input rotational cropping systems

Baddeley, John; Pappa, Valentini; Rees, Robert; Walker, Robin; Watson, Christine
 Scottish Agricultural College, UNITED KINGDOM

Introduction

The replacement of industrially-manufactured fertiliser nitrogen (N) by improved use of biologically fixed N (BNF) is frequently proposed as a route to creating more sustainable agricultural systems. While there is some progress in addressing this approach in the UK through the use of forage legumes, the greater integration of grain legumes into cropping systems has been relatively neglected. Intercropping is the simultaneous cultivation of two or more crops on the same area of land. It may increase yield compared with sole crops in low input systems, reduce the chance of crop failure and can reduce nitrous oxide and leaching losses of N. Intercropping of cereals with legumes can increase BNF within a rotation while not sacrificing a year of potential grain yield. Despite a high level of interest in intercrops, most studies have based their conclusions on data only from the season of intercropping. There is thus a need to assess the role of cereal/legume intercrops in rotational cropping sequences, where effects may be realised beyond the year of intercropping. The aims of this study were to: 1) investigate the hypotheses that any grain yield benefits of cereal/legume intercrops may occur in both the year of intercropping and in the following year and 2) assess the transfer of N from intercropped legumes to a following cereal crop.

Materials and methods

The experiment was carried out in near Aberdeen, Scotland. The plots (6 by 1.5 m) were on a sandy loam in a field which had been in grass/clover and grazed for three years. The treatments in 2006 consisted of monocrops of spring barley (*Hordeum vulgare*) or spring oats (*Avena sativa*), or cereal/legume intercrops of barley or oats with either spring pea (*Pisum sativum*) or clover (*Trifolium repens*). Monocrops of pea and clover were also grown. In 2007 spring oats were grown on all plots. In the intercrops, the seed rates for the cereals and legumes followed a 50:50 replacement design. Each treatment was replicated three times in a randomised block design. No fertilisers, herbicides or pesticides were used. Grain yields were measured at crop maturity. Nitrogen fixation by the legumes, and transfer of this N to cereals in both the year of intercropping and the following growing season, is currently being evaluated using the delta¹⁵N technique and will be reported when results are available.

Results

Cereal grain yields in 2006 were not significantly different between treatments but in 2007 there were significant treatment effects (Fig 1). The highest yields were from plots that had contained cereal/legume intercrops or

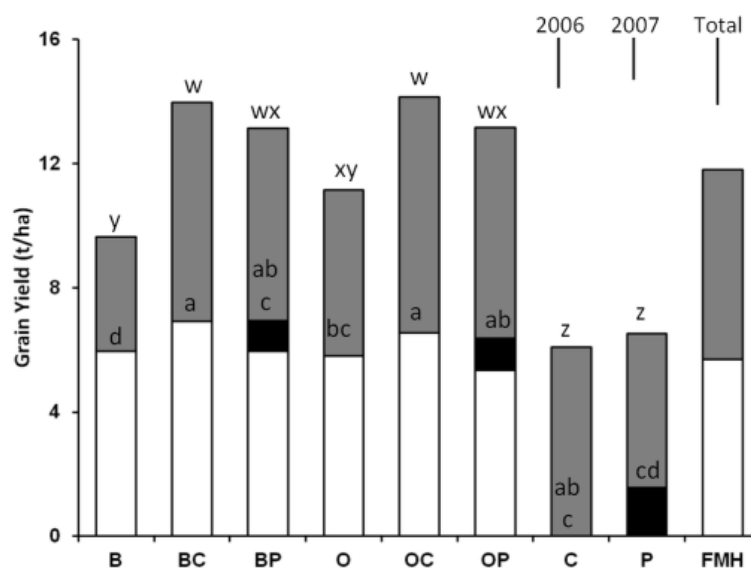

a clover monocrop, and the lowest yields were in plots that had cereal or pea monocrops. Total grain yields over the two years were significantly affected by treatment. The cereal/pea and cereal/clover intercrop treatments were not significantly different from each other but were significantly greater than the cereal monocrops. The total 2-year grain yields from the monocrops of peas and clover did not differ significantly from each other but were significantly lower than any of the treatments that had contained cereals in 2006.

Discussion

The lack of an effect of intercropping on yields in the first year of the experiment has been reported by similar studies. The differences in yield seen in the second year of

the experiment are readily attributed to the treatments of the preceding year. Despite generally being considered as a good second cereal, oats yields were lower after cereal monocrops than after cereal/legume intercrops. Thus the intercrops had at least as large an effect on the performance of the system in the year after they were grown than when they were in the ground.

Conclusions

This study shows the importance of taking a multi-year approach to assessing the value of intercrops, and that cereal/legume intercrops offer a practical solution to increase the application of legume-supported crop rotations without sacrificing a season of grain production.

Legume-supported crop rotations: A European perspective

Watson, Christine¹; Iannetta, Pietro²; Murphy-Bokern, Donal³; Rees, RM¹; Stoddard, FL⁴; Topp, CFE¹; Williams, Mike⁵; Zander, Peter⁶

¹Scottish Agricultural College, UNITED KINGDOM; ²James Hutton Institute, UNITED KINGDOM; ³Murphy-Bokern Konzepte, GERMANY; ⁴University of Helsinki, FINLAND; ⁵Trinity College Dublin, IRELAND; ⁶ZALF, GERMANY

The area of pulse crops in Europe declined by 70% between 1961 and 2005 (FAOstat 2012) and the forage legume crop area also declined significantly from 1980 to 2001 (Rochon et al. 2004). In 2011 the EU 27 produced 287 M t of cereals, 29 M t of oilseeds and only 2.7 M t of protein crops (EU 2012), but because of the importance of the livestock sector, Europe consumed the equivalent of 62 M t of imported soybean per year. Grain legumes occupy less than 2% of the agricultural land in Europe compared with 8% in Australia and western Canada. The decline in legumes has been enabled by the use of synthetic nitrogen fertilisers, on which European farming is now heavily dependent, with an average of 10.4 M t of nitrogen applied to European cropland (Fertilizers Europe 2010).

Thus Europe misses the substantial, particularly public, benefits, that legumes provide to farming systems and while some of these are easily recognisable from an economic perspective, others are longer-term and associated with the provision of ecosystem services. Including legumes in the farming system diversifies the crop rotation, breaking the cycles of cereal diseases and providing a wider range of habitats and hosts for beneficial organisms above and below ground. Legumes can fix large quantities of atmospheric N, up to 545 kg N ha⁻¹ in *Trifolium repens* (Carlsson & Huss-Danell, 2003), thus reducing dependence on manufactured fertilizers. Hence, legume crops themselves require little or no N fertilizer and, in a rotation, the N in their residues is available to the following crop, reducing further the need for fertilizer N. Reducing the use of N fertilizers helps to reduce greenhouse gas emissions and energy consumption associated with fertilizer manufacturing and application. From a livestock perspective, forage legumes not only provide protein but are rich in flavonoids and tannins providing nutritional and health benefits as well as influencing product quality (Dewhurst et al. 2009). Increasing the use of legume-supported cropping systems

for their ecological as well as their economic benefits requires not only recognition of these benefits by policy makers and producers but also the application of existing knowledge, changes to system design, improvements in plant breeding, and use and development of rhizobial inoculants (Crews & Peoples 2004). The challenges for scientists and technologists are numerous. Legume breeding has generally been neglected at the expense of cereal breeding, but modern genomics-assisted breeding methods could make rapid progress on important aspects such as yield stability and maturation date of grain legumes and persistence of forage legumes, along with disease and pest resistance, that would make the crops New varieties of both forage and grain legumes will require tolerance to more varied climatic conditions (e.g. cold/heat and flooding/drought) as well as more efficient N use to reduce environmental burdens. In forage legumes, improvements in the conversion of plant protein to livestock protein could reduce N excretion and loss.

In many parts of Europe, legume-supported rotations disappeared from conventional agriculture as synthetic fertilisers and pesticides became cheaper and more available and the price of imported protein dropped. Knowledge and understanding of legume-based rotation or cropping sequence design by farmers and advisors has also started to disappear but design of cropping sequences that can make effective use of the multiple benefits of legumes is required if growing legumes is to become more attractive to farmers. There are opportunities for knowledge exchange between the organic and conventional sectors, as legumes are a fundamental component of organic systems. However, there is room to improve the agronomic, economic and environmental performance of legume-supported cropping systems in both sectors. The proposed greening measures within the 2013 CAP reform provide an opportunity for change.

Assessing the Economic and Agronomic Potential of Legume-Supported Crop Rotations across Europe Using a Crop Rotation Generator

Reckling, Moritz¹; Hecker, Jens-Martin¹; Bachinger, Johann¹; Schläfke, Nicole¹; Topp, Kairsty²; Watson, Christine²; Zander, Peter¹

¹Leibniz-Centre for Agricultural Landscape Research (ZALF), GERMANY; ²Scottish Agricultural College (SAC), UNITED KINGDOM

Introduction

Legume crops play a decreasing role in European agriculture despite their potential benefits for the environment and farming system. Within the EU-funded FP7 project LEGUME FUTURES, potential benefits of legume-supported crop rotations are evaluated in five NUTS 2 case-study regions across Europe (South-Muntenia, RO; Calabria, IT; Eastern Scotland, UK; Western Sweden and Brandenburg, DE). To find positive interactions, crop rotations are generated and analysed by the N-budget. The approach aims to develop novel cropping systems that use less fossil energy and mitigate Nitrogen emissions through the inclusion of N-fixing grain- and forage legumes.

Materials and methods

Region-specific crop rotation rules were the basis for generating crop rotations of 3 to 6 years for each case study region. These represent agronomically feasible cropping options, including crops that are currently grown, and grain and forage legumes to be promoted.

In an iterative process with crop production experts, the following cropping rules were formulated: (i) sequence and (ii) frequency of crops, (iii) frequency of crop types, and (iv) suitability of crops per soil type (Table 1). These rules and additional restrictions, were applied in a database.

Table 1: Crop-specific frequency constraints and distribution across soil types in Brandenburg

Crop	Max. cropping frequency (%)	Min. break (years)	Distribution of crops per soil type ¹				
			Loam	Sandy clay loam	Sandy loam	Loamy sand	Sand
Alfalfa-grass [<i>medicago sativa</i>]	33	4	x	x	x		
Red/white clover-grass [<i>trifolium</i> spp.]	33	4			x	x	x
Serradella [<i>ornithopus sativus</i>]	50	4					x
Faba bean [<i>vicia faba</i>]	50	2	x	x			
Pea [<i>pisum sativum</i>]	20	4	x	x	x	x	
Lupins (all varieties) [<i>lupinus</i> spp.]	25	4		x	x	x	x
Potato [<i>solanum tuberosum</i>]	25	4			x	x	
Silage maize [<i>zea mays</i>]	66	0	x	x	x	x	
Spring barley [<i>hordeum vulgare</i>]	50	1		x	x		
Triticale [<i>x Triticosecale</i>]	33	0	x	x			
Oat [<i>avena</i> spp.]	25	3		x	x		
Winter wheat [<i>triticum aestivum</i>]	33	0	x	x			
Winter barley [<i>hordeum vulgare</i>]	50	1	x	x			
Winter oil seed rape [<i>brassica napus</i>]	33	0	x	x	x		
Winter rye [<i>secale cereale</i>]	100	0	x	x	x	x	x
Winter rye-vetch [<i>s. cereale/vicia lathyroides</i>]	100	0					x

¹ x indicates the suitability of crops per soil type

Table 2: Number of generated rotations across soil types in Brandenburg for 3- to 6-year rotations

Rotation length (years)	Number of rotations per soil type				
	Loam	Sandy clay loam	Sandy loam	Loamy sand	Sand
3	10	24	7	0	1
4	30	101	18	0	0
5	82	530	93	10	2
6	334	1561	1107	94	5

In the next steps, site and pre-crop specific crop production activities were defined with varying management of manure, tillage, crop establishment, and cover crop. Economic and agronomic criteria (e.g. gross margin, N-budget) will be applied to reduce the large number of generated rotations. Finally, the economically best performing and ecologically sound systems will be compared with statistical data and stakeholders confronted with the selection.

Agronomic evaluation of the proposed farming systems is based on a static, rule-based assessment of N-fixation, N-leaching, N-removal and N₂O emissions. It compares the N-efficiency of legume-supported rotations compared to non-legume rotations and calculates possible reductions in mineral fertilizer use. Economic evaluation takes place at field level via gross margins and cost-effectiveness. The performance of farming systems under different scenarios (changes in prices and policies) is analysed through linear programming based on a farm model. First results of this research approach are presented for the case study region Brandenburg (Germany).

In Brandenburg, the agro-environmental zonation distinguishes five zones based on soil types, ranging from sandy to loamy soils. Cereals and rapeseed are the most dominant crops, while grain- and forage legumes have almost disappeared in the last decade and are

only cultivated on around 2% of the arable land in 2010 (assuming a legume proportion of 50% in legume-grass mixtures).

Results/conclusions

The total number of generated crop rotations without applying any economic and agronomic sustainability criteria range from one 3-year rotation for the sandy soil type, up to 1 561 6-year rotations for the sandy clay-loam soil (Table 2). On the sand soils, 4 possible legume crops were identified, and only with 5- to 6-year sequences a significant number of possible rotations was found. On the loam soils, where 3 possible legumes were identified, rotations with grain legumes were modeled even for sequences of only 4-years. Thus, in order to promote legumes, influences of soil types need to be taken into account and a minimum rotation length of 4 and 6 years is needed for grain and forage legumes, respectively.

The rule-based approach offers great potential for assessing a large number and diversity of cropping systems, including current and potential novel farming systems. Generated farming systems could serve as an input for the environmental assessment by the DNDC model and life cycle analysis. Legume-supported cropping systems might be essential to cope with changing economic and political farming conditions in Europe.

Combining high yields and margins and low environmental impacts is possible with cereal-legume mixture

Pelzer, Elise; Bazot, Mathieu; Makowski, David; Jeuffroy, Marie-Hélène

INRA, FRANCE

Introduction

Intercropping is defined as the cultivation of two or more species in the same space and for a significant time. In cereal-legume intercropping, the optimised use of soil and atmospheric nitrogen and subsequent lower N requirements, and the reduction of pests and diseases, may allow a reduction of inputs and environmental impacts, and an increase in economical return. The aim of this study was to assess pea-wheat intercropping systems (Fig 1) in France through an experimental assessment, accounting for the agronomic, environmental, energetic, and economic performances. The experiments were carried out by several research institutes and extension services and their results were presented in details in Pelzer et al. (2012).

Materials and methods

Pea-wheat experiments were set up in nine French sites during two years, including conventional and organic management. Five treatments were tested: i) wheat sole crop with nitrogen fertilisation, ii) wheat sole crop without

nitrogen fertilisation, iii) pea sole crop without nitrogen fertilisation, iv) pea-wheat with nitrogen fertilisation, and v) pea-wheat without nitrogen fertilisation. Different criteria were assessed: yield (and proportion of each crop at harvest for intercrops), mineral fertiliser use per ton of harvested grain, wheat grain protein concentration, rate of biological N₂ fixation, amount of pesticides used, soil mineral nitrogen after harvest, energetic cost (INDIGO® method), and gross margin. The effect of treatments and site-years were investigated through a comparison of statistical models.

Results and discussion

Yields of pea-wheat intercrops (4.5 Mg ha⁻¹ with/without fertiliser) were higher than sole pea and close to conventionally managed wheat yields (5.4 Mg ha⁻¹). The amount of applied nitrogen fertiliser per ton of grains produced by both wheat and pea was 2.5 times lower with fertilised pea-wheat compared to fertilised wheat sole crop. The proportion of wheat at harvest was significantly higher in the fertilised intercrop than in the unfertilised intercrop. The land equivalent ratio



Figure 1. Pea-Wheat intercropping in an experimental field in Grignon (30 km West from Paris), France

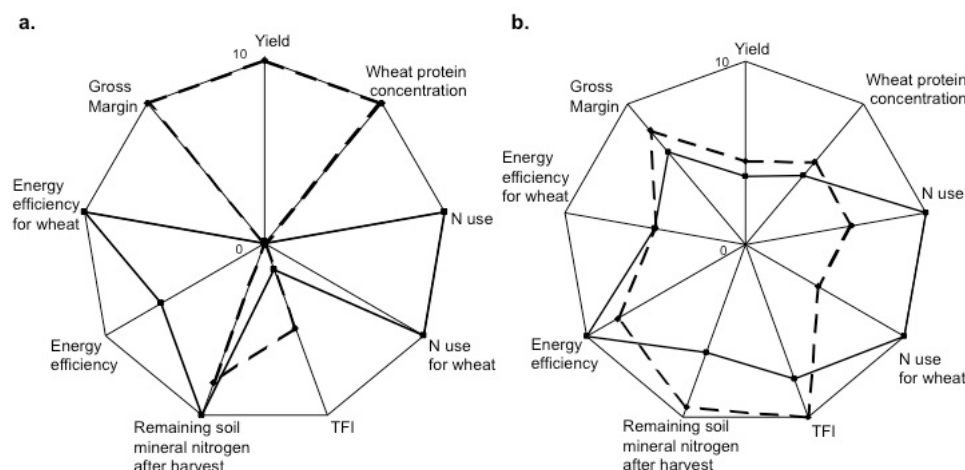

Figure 2. Multicriteria assessment of treatments. a. sole wheat with (dotted line) and without (full line) nitrogen fertilisation. b. pea-wheat with (dotted line) and without (full line) nitrogen fertilisation. The criteria have been transformed to 0-10 scale using minimum average values (Min) and maximum average values (Max) of each indicators, with 0 corresponding to the worst performance and 10 to the best performance: Scale = $10 * (\text{Value}-\text{Min})/(\text{Max}-\text{Min})$ for Yield, Wheat protein concentration and Gross margin, and Scale = $10 - [10 * (\text{Value}-\text{Min})/(\text{Max}-\text{Min})]$ for mineral N fertiliser use (N use), mineral N fertiliser use to produce wheat (N use for wheat), TFI, remaining soil mineral nitrogen at harvest, Energy use and Energy use for wheat (Energy use for wheat).

showed that the intercrop was more efficient than sole crops under unfertilised situations: the LER was 1.01 on average for fertilised intercrops and 1.28 for non-fertilised intercrops. The wheat protein concentration was higher in pea-wheat intercrops – with or without nitrogen (11.0 and 10.7 %) – than in wheat without nitrogen (9.4 %), but significantly lower than conventionally managed wheat (12.1 %). However, the amount of applied nitrogen was more than 2 times lower on average in intercrops (60 kg N ha⁻¹) than in wheat (140 kg N ha⁻¹). The proportion of total aboveground pea N derived from the atmosphere was significantly higher for the intercropped pea with or without nitrogen than for pea sole crop. The estimated amount of energy consumed per ton of harvested grains was two to three times higher with conventionally-managed wheat than with pea-wheat (fertilised or not). The use of pesticides was slightly lower in pea-wheat intercrops than in sole crops. Soil mineral N after harvest in fertilised pea-wheat intercrops was similar to the value obtained in fertilised wheat sole crop, and significantly

lower than the value measured in pea sole crop. The average gross margins were not significantly different between treatments.

Conclusion

Our results show that winter pea-wheat intercrop provides good performances compared to sole crops, not only in terms of yield and quality, but also in terms of remaining soil mineral nitrogen after harvest compared to pea sole crop, energetic efficiency compared to wheat sole crop, and gross margin compared to sole crops. Such multicriteria assessment (Fig 2) within a wide range of pedoclimatic conditions is useful for a global analysis of pros and cons of intercrops.

Reference

Pelzer E et al. 2012. Pea-wheat intercrops in low-input conditions combine high economic performances and low environmental impacts. *Eur. J. Agro.* 40, 39–53

Supporting design and co-innovation in farming systems - Actors, agroecological knowledge and landscape functions

Tittonell, Pablo

Wageningen University, NETHERLANDS

Beyond technical biophysical knowledge on the processes governing the functioning of the agro-ecosystem, the design of sustainable farming systems within a particular socio-ecological context calls for holistic approaches that consider at least three complementary dimensions: (i) the actor, agent of change, represented most often by the farmer itself immerse in a wider community, (ii) the local agroecological knowledge system, whether indigenous, inherited or foreign, and (iii) the physical landscape that hosts, shapes and is shaped by the farming system, and sustains ecological functions of local and global relevance. Challenges to integrate these dimensions in holistic methodologies for farming systems analysis and design are not minor, and several attempts have been made to accomplish this (cf. Doré et al., 2010; Belhouchette et al., 2011; Giller et al., 2011; Le Gal et al., 2011). Recent research and development projects have formalised methodologies for co-innovation involving farmers, researchers and knowledge management agents (e.g. Rossing et al., 2010; Dogliotti et al., 2010); systems analysis tools were developed for the aggregated assessment of farming system-landscape function interactions (e.g. the COMPASS framework – Groot et al., this conference); agent-based simulation and gaming approaches have been developed to formalise, understand and contribute to solve land use issues among stakeholders (e.g. Anselme et al., 2010) or to support farmers in the transition towards more sustainable ways of farming (e.g. Delmotte et al., this conference); systems analysis and systems thinking have been successfully included in the educational curricula of several agricultural universities. The objective of this contribution is to take stock of the diversity of methods and approaches available to support design and co-innovation in farming systems. Experiences, shortcomings and knowledge gaps will be examined in the hope that they can inspire further development of holistic system approaches to research and education. This presentation aims to serve as background for the follow-up meeting on the establishment of a community of interest around Farming Systems Design within the ESA.

References

- Anselme, B., F. Bousquet, A. Lyet, M. Etienne, B. Fady, C. Le Page., 2010. Modelling of spatial dynamics and biodiversity conservation on Lure mountain (France). *Environmental Modelling & Software* 25, 1385–1398.
- Belhouchette, H., Kamel Louhichi, Olivier Therond, Ioanna Mouratiadou, Jacques Wery, Martin van Ittersum, Guillermo Flichman, 2011. Assessing the impact of the Nitrate Directive on farming systems using a bio-economic modelling chain. *Agricultural Systems* 104, 135–145.
- Doré, T., Makowski, D., Malézieux, E., Munier-Jolain, N., Tchamitchian, M., Tittonell, P., 2011. Facing up to the paradigm of ecological intensification in agronomy: revisiting methods, concepts and knowledge. *European Journal of Agronomy* 34, 197-210.
- Dogliotti, S.; Pombo, C.; Scarlato, M.; Rossing W.A.H. 2010. Co-Innovation as a strategy to develop sustainable farm systems in South Uruguay. In: Proceedings of the Agro2010, the XIth Congress of the European Society for Agronomy, Montpellier, France August 28th – September 3rd, 2010. pp. 391-392. ISBN 978-2-909613-01-7.
- Giller, K.E., Pablo Tittonell, et al., 2011. Communicating complexity: Integrated assessment of trade-offs within African farming systems to support innovation and development. *Agricultural Systems* 104, 191–203.
- Le Gal P.Y., Dugué P., Faure G., Novak S.. 2011. How does research address the design of innovative agricultural production systems at the farm level? A review. *Agricultural systems* 104, 714-728.
- Rossing W.A.H., Dogliotti, S., Bacigalupe, G. F., Cittadini, E., Mundet, C., Mariscal Aguayo, V., Douthwaite, B., Alvarez, S., 2010. Project design and management based on a co-innovation framework. In: IFSA 2010, Viena, Austria. Pp 402 – 412. ISBN 978-3-200-01908-9.

Farming systems research; evaluation of current practice and the development of novel approaches within UK systems

Stobart, R M; Morris, N L
 NIAB TAG, UNITED KINGDOM

Introduction

The requirement for sustainable, resilient and productive farming systems has never been more important, but in future production scenarios it is likely that inputs will become increasingly restricted, energy more expensive and climate ever more variable. To this end NIAB TAG is delivering a series of ongoing farming systems studies in the UK seeking to both evaluate current systems (reflecting local practice within conventional farming systems) and to develop novel approaches to farming systems. These research platforms will better enable farmers to make informed decisions regarding their rotations and the further development of their farming systems. Two of these studies are outlined in this paper.

Method

The STAR project (Sustainability Trial in Arable Rotations) was initiated in 2005 at Stanaway Farm (Suffolk, UK) on a clay loam soil. The research is funded through the Felix Thornley Cobbold Trust and delivered through NIAB TAG. The trial is fully replicated on large plots using farm scale equipment and examines the interaction of four rotation and four cultivation methods. Cultivation techniques are annual ploughing, deep non-inversion, shallow non-inversion and a managed approach (selected annually). The rotational approaches are winter cropping (winter wheat and winter break crops), spring cropping (winter wheat and spring break crops), continuous wheat and alternate fallow (winter wheat and fallow).

Figure 1. The impact of cultivation approach on margin over years 1-6 of the STAR project. Base margin data is calculated on ‘spot prices’ for each season. Data is presented as the percentage response in each individual season; that is each cultivation approach is expressed as a percentage of the mean return for each season.

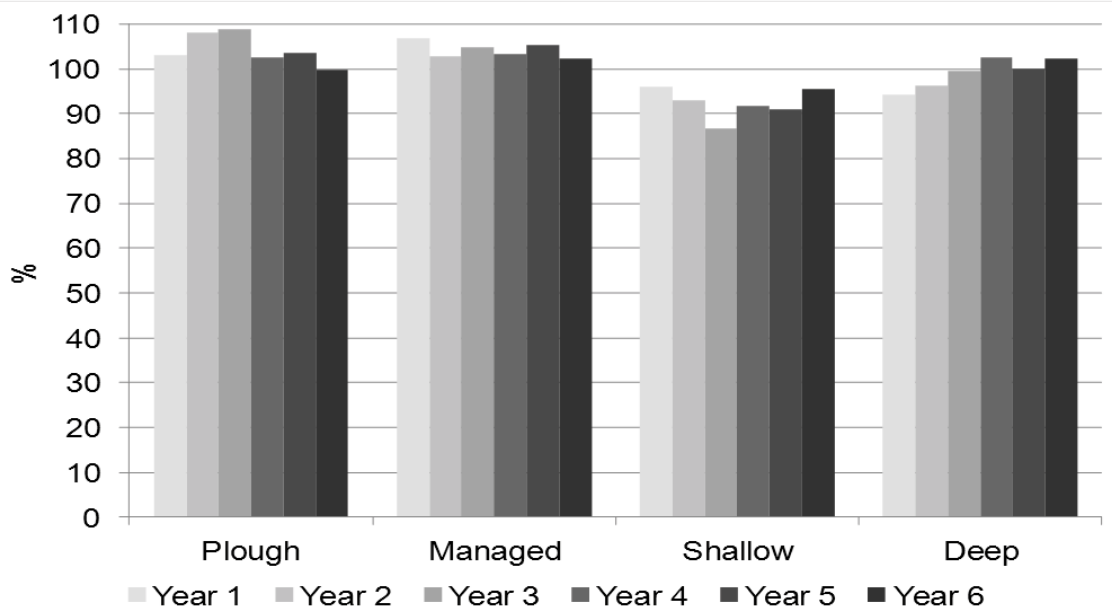

Table 1. Mean yield response (%) and cumulative margin over nitrogen (N) (£/ha) data comparing standard (local best) practice to approaches using a white clover bi-crop, a brassica cover crop or a legume mixture cover crop across a range of N doses in each crop. Responses were recorded over a break crop (spring oilseed rape) and winter wheat cycle. Based on £150/t for winter wheat, £375/t for oilseed rape and £0.75 kg N.

	Zero N	50% N	100% N	Average
Yield response (%)				
Standard practice	60	98	124	94
Cover crop (clover bi-crop)	66	98	124	96
Cover crop (fodder radish)	66	107	129	101
Cover crop (legume mixture)	70	108	130	103
Margin over nitrogen (£/ha)				
Standard practice	900	1351	1664	1305
Cover crop (clover bi-crop)	1069	1413	1685	1389
Cover crop (fodder radish)	967	1452	1701	1374
Cover crop (legume mixture)	998	1452	1718	1389

The New Farming Systems (NFS) study (funded by The Morley Agricultural Foundation and The JC Mann Trust) is being carried out through NIAB TAG at Morley (Norfolk, UK) on a sandy clay loam soil. This programme was initiated in 2007 and is re-examining approaches to rotations and inputs. Research is exploring the potential to reduce the footprint of current practice within conventional farming systems, while at the same time improving sustainability, resilience and output. The NFS programme is running a series of large scale, replicated experiments examining three related themes: fertility building, soil amendments and tillage systems.

Results and discussion

Stobart and Morris (2011a) outlined previously key agronomic findings from the STAR project and described the principle effects of the systems on yield and margin. When, considered cumulatively across the project results demonstrate that cropping systems based on winter break crops are delivering the highest margins. With regard to cultivation systems, the difference in cumulative margin between approaches is smaller. Trends in relative responses to cultivation practice are apparent over time (Figure 1), suggesting changes in the performance of systems in the longer term.

Within the NFS project Stobart and Morris (2011b) have previously detailed aspects of the research addressing the use of cover crops (including clover bi-crops, legume and brassica cover crops) and provided summary data on crop performance, soils, yield and margins. Ongoing NFS findings are demonstrating benefits to soil structure and rotational margins from the use of cover crops. Research highlights differences in system performance and margin depending on cover cropping approach and agronomic management regime (Table 1) and also suggests that interactions between these elements are apparent.

References

- Stobart R M & Morris N L (2011a) Sustainability Trial in Arable Rotations (STAR) project: a long-term farming systems study looking at rotation and cultivation practice, *Aspects of Applied Biology* 113, 67-74.
- Stobart R M & Morris N L (2011b) New Farming Systems Research (NFS) project: long term research seeking to improve the sustainability and resilience of conventional farming systems, *Aspects of Applied Biology* 113, 15-23.

Phosphorus flows, mineral fertiliser use and agricultural production systems: a regional perspective for France

Nesme, Thomas¹; Senthilkumar, Kalimuthu¹; Mollier, Alain²; Pellerin, Sylvain²

¹Bordeaux Sciences Agro / INRA, FRANCE; ²INRA / Bordeaux Sciences Agro, FRANCE

Introduction

Nitrogen (N) and Phosphorus (P) flows in the Biosphere are strongly influenced by fertiliser use, food and feed trade, food consumption and waste management (Canfield et al., 2010; Bennet et al., 2001). They are assessed through Substance Flow Analysis (Brunner, 2010) for which a given socio-system is broken down into different compartments (e.g. agriculture, industry, domestic, waste, environment) and the N and P flows among these compartments are quantified at regional (e.g. Mishima et al., 2010), national (e.g. Senthilkumar et al., 2012b) or global scales. Agriculture represents the major N and P flows in many socio-systems. On the other hand, agricultural production systems are increasingly specialised, together with spatial segregation of crop and animal production basins at regional scale. How does this specialisation influence the nutrient flows and the mineral fertiliser use at regional scale? In this abstract, we focussed on P which future availability at global scale is becoming obscure (Cordell et al, 2009) and losses to the environment may cause eutrophication.

Materials and methods

The 22 French regions were considered as a case-study since they exhibit large differences in regional agricultural production systems. In each region, agriculture was broken down into three compartments (soils, crops and

animals) and the P flows between these compartments were computed by multiplying the material flows (e.g. crop products, feed products, livestock effluent) by their respective P content (see Senthilkumar et al. 2012a). Additionally, the regional livestock density was calculated as the number of livestock unit divided by the regional agricultural area and was then compared to the regional mineral P fertiliser use. The results were averaged for the years 2002–2006.

Results and Discussion

The P flows were strongly influenced by the regional agricultural production systems (Figure 1): P flows through feed, fodder and animal excretion were much bigger in animal farming regions (e.g. Brittany) than in crop farming regions (e.g. Centre). On the contrary, the mineral P fertiliser use was only partially influenced by the livestock density (Figures 1 & 2). Since P in livestock effluent could largely compensate for crop P uptake in Brittany, the still positive mineral P fertiliser use in this region indicated an only partial substitution by P from livestock effluent. The resulting regional soil P budgets were balanced in crop farming regions thanks to mineral P fertiliser use whereas animal farming regions continued to accumulate P in soils. Therefore, the spatial segregation of crop and animal production basins limited the recycling of P from livestock effluents, resulting in

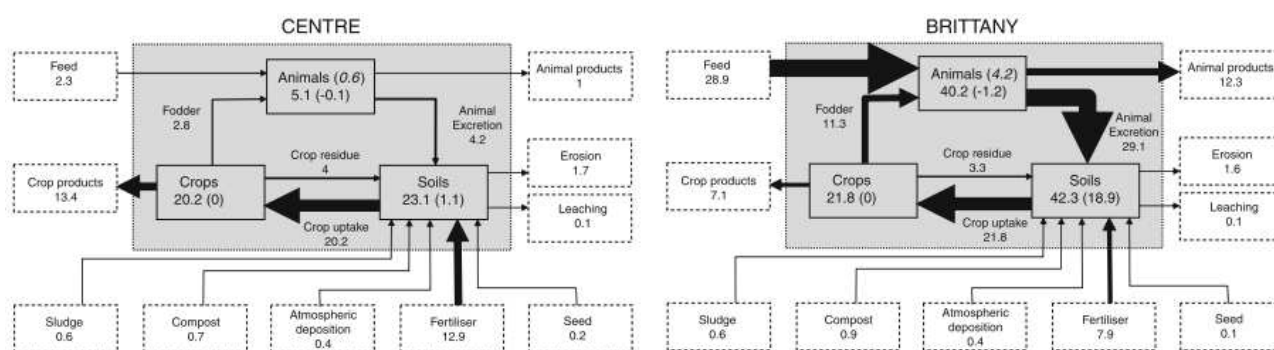

Figure 1: P stocks (values in italics), flows and budgets (values in parenthesis) in two different French regions (Centre: crop farming region; Brittany: animal farming region). All values are in kg P/ha/yr, averaged for the years 2002–2006. The width of the arrows indicate the magnitude of the flows. Adapted from Senthilkumar et al. (2012a).

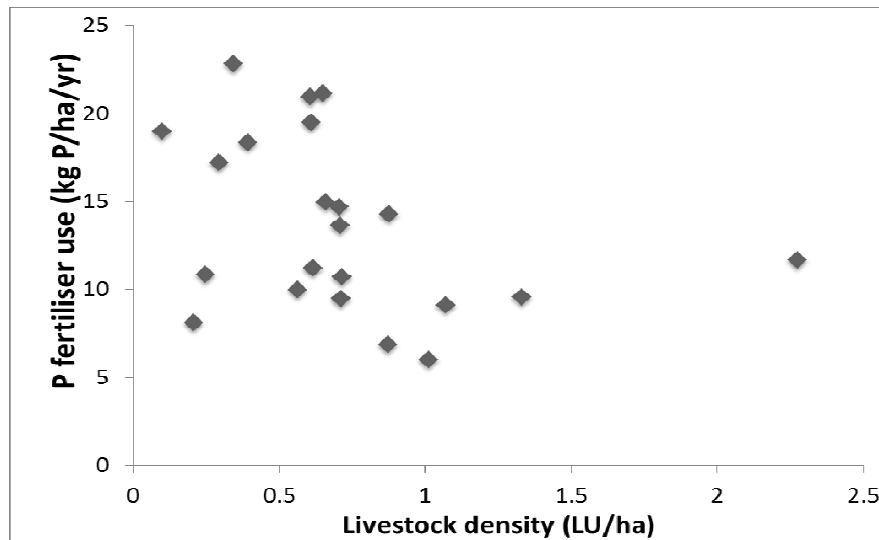

Figure 2: Fertiliser use (kg P/ha/yr) vs livestock density (livestock unit/agricultural area) at regional scale, averaged for the years 2002–2006. Each point represents a French region.

mineral P fertiliser requirements in crop farming regions. Indeed, intensive animal farming regions (>1 LU/ha) exhibited the lowest mineral P fertiliser use (Figure 2) due to partial substitution by livestock effluents. A higher mineral P fertiliser use was observed in low livestock density regions (<1 LU/ha) but with large variability perhaps resulting from intra-regional segregation of crop and animal farming systems.

Conclusion

Regional scale studies offer a comprehensive view of nutrient flow driving forces: spatial segregation of crop and animal production basins together with partial substitution of mineral fertiliser by livestock effluent enhanced mineral P fertiliser use. Innovative, multi-scale scenarios combining crop and animal production should be designed and assessed, as proposed in the Cantogather FP7 program.

References

- Bennet E. M. et al., 2001. *BioScience*. 51: 227-234
- Brunner, P.H., 2010. *J. Indus. Ecol.* 14: 870-873
- Canfield, D.E. et al., 2010. *Science*. 330: 192-196
- Cordell, D. et al., 2009. *Global Environ. Change*. 19: 292-305
- Mishima, S. et al., 2010. *Nutr. Cycl. Agroecos.* 86: 69-77
- Senthilkumar K., et al. 2012a. *Nutr. Cycl. Agroecos.* 92: 145-159
- Senthilkumar K., et al. 2012b. *Global Biogeochem. Cycles*, 26, GB2008

To what extent organic farming depends on artificial fertilisers?

A case study in South-western France

Nowak, Benjamin¹; David, Christophe²; Nesme, Thomas³; Pellerin, Sylvain¹

¹INRA, FRANCE; ²ISARA Lyon, Université de Lyon, FRANCE; ³Bordeaux Sciences Agro, Université de Bordeaux, FRANCE

Introduction

Organic farming (OF) may be considered as a prototype of sustainable farming. It excludes the use of artificial, water-soluble fertilisers. Instead, the principles of OF promote the recycling of organic products to limit the use of non-renewable resources. Farm-gate budgets have been widely used to assess the balance between nutrients inflows and outflows in OF (Watson *et al.*, 2002; Nesme *et al.*, 2012). Several authors have pointed out that OF partially imports nutrients from Conventional Farming (CF) through material exchanges like manures and straws (Kirchmann *et al.*, 2008). These imports represent an indirect dependency of OF on nutrients initially brought by artificial fertilisers. In this study, our objective was to assess the indirect dependency of OF on artificial fertilisers in a specialised agricultural region characterized by a high proportion of arable crops.

Materials and methods

Farm inputs and outputs for 2010 and 2011 were collected during 25 farmers interviews. These farmers were selected within the Lomagne region in the South-West of France (Midi-Pyrénées), characterised by a high proportion of arable crops (43% of the organic land-use under cereals, 25% under legumes and 18% under oilseeds crops) and a low level of livestock production. The sampled farmers represented 80% of the organic farmers of the region. Inputs were animal feeds, manures, fertilisers and biological N fixation (BNF). Outputs were animal and crop products. No other flow from or towards the environment were taken into account. The nutrients inflows and outflows were calculated by multiplying each input and output by their respective N, P and K concentrations (Agabriel, 2007; COMIFER, 2009). BNF was estimated with an empirical model (Høgh-Jensen *et al.*, 2004). The N, P and K farm budgets of the region were then calculated as

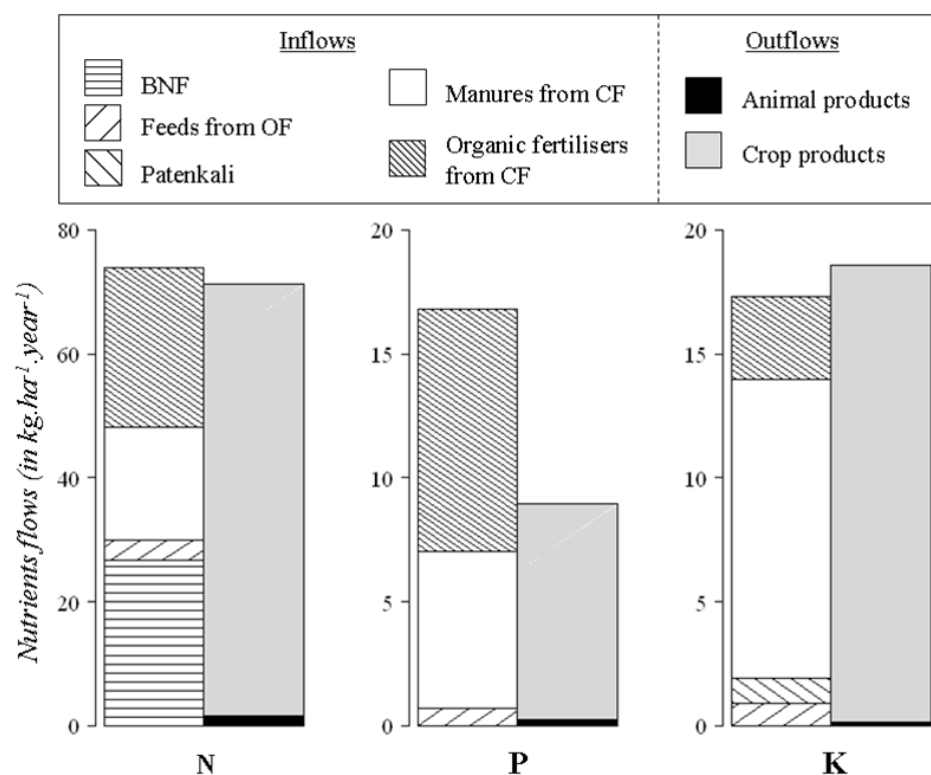

Figure 1 : Nutrients flows for the organic farms of Lomagne

Table 1 : Organic farm-gate budgets and dependency on CF in Lomagne

Year	Farm gate budgets (in kg ha ⁻¹ .year ⁻¹)			Dependency of OF on CF		
	N	P	K	N	P	K
2010	-2	+8	-5	58%	98%	90%
2011	+7	+8	+2	61%	94%	89%
Mean	+3	+8	-1	60%	96%	89%

the sum of nutrients inflows minus outflows, in kg per ha and per year. The dependency of OF on artificial fertilisers was approximated by the percentage of inflows coming from CF. We assumed that purchased organic fertilisers (e.g. feather and bone meals), originated entirely from CF, although some untreated mineral P is sometimes added to these products.

Results and Discussion

On average 74 kg of N, 17 kg of P and 17 kg of K entered the organic farms per ha and per year (Figure 1). The manures brought 18 kg of N, 6 kg of P and 12 kg of K, which corresponded to 25%, 38% and 70% of the inflows, respectively. These manures originated from neighbouring cattle and poultry conventional farms. The organic fertilisers accounted for 35%, 58% and 19% of the inputs of N, P and K. Budgets were close to the balance for N (+3 kg) and K (-1 kg) and positive for P (+8 kg). The dependency of OF on CF was lower for N (60%) than for P (96%) and K (89%) because of BNF (Table 1). These figures overestimated the dependency of OF on artificial fertilisers since all of the nutrients coming from CF did not derive from artificial fertilisers. Further studies are needed to discriminate between dependency on CF and dependency on artificial fertilisers.

Conclusion

Such a massive dependency of OF on CF may be determined by the regional farming context. Mixed regions with a higher proportion of organic livestock farms may offer opportunities for exchange of products among organic farms (e.g. straw vs manure) and may favour the use of legume in crop rotations.

References

- Agabriel, J., 2007. Alimentation des bovins, ovins et caprins. Editions Quae.
- COMIFER, 2009. Teneurs en P, K et Mg des organes végétaux récoltés. Comifer.
- Høgh-Jensen, H., *et al.*, 2004. *Agr Syst* 82, pp. 181–194.
- Kirchmann, H., *et al.*, 2008. *Organic Crop Production—Ambitions and Limitations*. Springer Netherlands, pp. 89–116.
- Nesme, T., *et al.*, 2012. *Nutr Cycl Agroecosys* 92, pp. 225–236.
- Watson, C.A., *et al.*, 2002. *Soil Use Manage* 18, pp. 264–273.

Changing agricultural practices modify the species and trait composition of the weed flora. A simulation study using a cropping system model

Colbach, Nathalie¹; Granger, Sylvie²; Guyot, Sébastien H.M.¹; Mézière, Delphine¹

¹INRA, FRANCE; ²AgroSup Dijon, FRANCE

Introduction

Cropping systems change over time to adapt to socio-economical and environmental constraints and to profit from technological innovations. These changes can result in unexpected side-effects which are difficult to determine in fields. The objective of the present study was to use a cropping system model to evaluate the impacts of modified agricultural practices *ex ante*. The study will focus on weeds as they are both a harmful pest and an important food source for many biotic components (e.g. pollinators, seed predators).

Material and methods

The FLORSYS model quantifies the effect of crop succession, management techniques and climate on multi-specific weed dynamics over the years; it was parameterized with functional relationships predicting model parameters (e.g. pre-emergent seedling mortality) from species traits (e.g. seed mass). Cropping systems

typical of three French regions were determined from farm surveys and the Biovigilance data base. These control scenarios as well as various management modifications were simulated in each region, using a weed flora consisting of seven major, mostly autumnal species (*Alopecurus myosuroides*: ALOMY, *Avena fatua*: AVEFA, *Capsella bursa-pastoris*: CAPBP, *Galium aparine*: GALAP, *Geranium dissectum*: GERDI, *Stellaria media*: STEME, *Veronica hederifolia*: VERHE). Each scenario was simulated over 27 years and repeated 10 times, by randomly choosing each year annual climate series measured in the tested region.

Results

The South-West control scenario (maize monoculture with annual mouldboard ploughing) presented a total maximum weed infestation of less than 0.01 plants/m² averaged over the simulation, consisting mostly of CAPBP and a few VERHE and AVEFA (Fig. 1). Weed density in the Burgundy control (winter oilseed rape (OSR) /

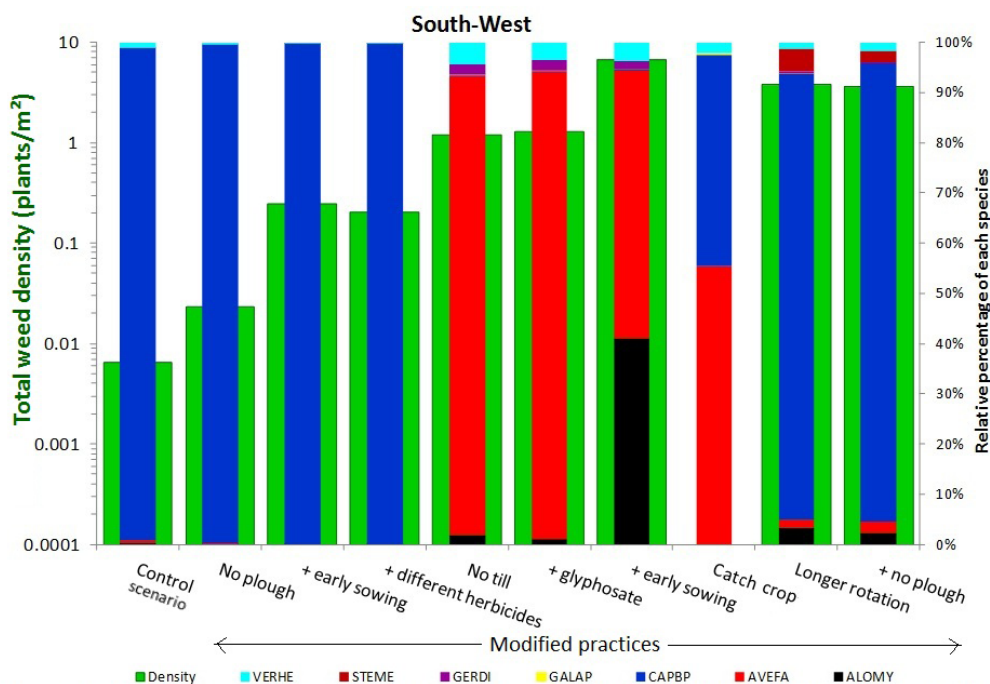

Figure 1. Weed flora in different cropping systems simulated with FLORSYS for the South-West (control = maize monoculture with annual mouldboard ploughing). Maximum weed density in crops averaged over the simulation and 10 repetitions. Sum for all species (green bars, left-hand axis) and relative proportion of species in the flora (multi-coloured bars, right-hand axis)

winter wheat / winter barley, with mouldboard ploughing before wheat) was similar, but the flora was more diverse (ALOMY, GERDI, STEME, and a bit of CAPBP, results not shown). The Poitou-Charentes control (OSR / winter wheat / sunflower / winter wheat, with mouldboard ploughing three years out of four) presented a 100-times higher infestation, consisting mostly of AVEFA and a few STEME (results not shown). Modifying management practices modified both weed density and composition. For instance, simplifying or abandoning tillage greatly increased weed infestation, and no-till moreover favoured grass weeds to the detriment of broad-leaved species (example of South-West in Fig. 1). Results were similar in the other regions except that temporary crops increased weed infestation in Poitou-Charentes; moreover the shifts in species composition depended on the initial flora (results not shown). Species densities could be related to species traits, and different traits were selected in different cropping systems (Table 1.A). For instance, species with heavy seeds were selected in scenarios with frequent ploughing (Table 1.A, Poitou-Charentes, South-West), probably because they can germinate and emerge even when deeply buried (Table 1.B).

Conclusion

The FLORSYS model can be used to evaluate prospective scenarios for their impact on weed flora in terms of density, species composition and trait selection. The latter was possible because of the functional relationships included in FLORSYS and makes the simulation results more generic. The present results are still partial and

Table 1. Weed species traits selected in different cropping systems and their functional relationships with life-cycle processes

A. Results of a linear regression analysing maximum species density in crops over 27 years simulated with FLORSYS (R² = 0.35)

	Seed traits (m)						
	Coat thickness	Weight	Shape index [#]	Lipid content	Area		
Control scenarios (r)							
Burgundy	OWB*	1 P/3 [‡]	0.0517	-0.219	-6.13	0.50	#
Poitou-Charentes	OWsW	3 P/4	0.0495	0.220	3.38	-2.84	-0.506
South-West	m	1 P/1	-0.0382	0.363	8.05		-0.284
Modified practices (average over the three regions) (l)							
No plough						1.77	
Less tillage			0.0209	-0.149	-7.70		0.306
No till			0.0313	-0.338	-6.85	1.81	0.491
Glyphosate						1.33	-0.023
Modified herbicides					2.19		
Early sowing			-0.0082				
Catch crop			0.0547	-0.349	-9.11	1.45	0.209
Shorter rotation					-0.023		
Longer rotation			0.0056	-0.0612			

$\mu = -4.79$, $\phi = 0.00004$ for r=Poitou-Charentes, parameters for region, are not shown.

[#] The higher this index, the more seeds are elongated and/or flattened.

* O = oilseed rape, W = wheat, B=barley, s=sunflower, m=maize; uppercase letters indicate winter crops, lowercase spring crops

[‡] Ploughing frequency, i.e. number of ploughing operations per number of years

[#] Empty cases indicate effects not significant at p=0.01.

The tested linear regression was $\log_{10}(\text{plants}_{jyear}) + 0.0001 = \mu + \text{region}_i \times \text{repetition}_j + \sum_{m=1}^5 \sum_{k=1}^5 \alpha_{m,k} \cdot \text{trait}_{k,m} + \sum_{l=1}^9 \sum_{k=1}^5 \beta_{l,m} \cdot \text{trait}_{k,m} + \phi_r \cdot \text{year}_i + \text{error}_{jyear}$, analysed with (PROC REG of SAS, selection = STEPWISE. plants_{jyear} is the maximum density in crops of species k observed for year i ∈ {1, ..., 27} in repetition j ∈ {1, ..., 10}.

B. Relationship between species traits and life-cycle processes in FLORSYS

Life-cycle process	Seed traits (m)				
	Coat thickness	Weight	Shape index [#]	Lipid content	Area
Seed mortality	—				
Seed dormancy	+	+ (young seeds)	—		
Germination onset		Heavy seeds germinate later		Seeds with a high content germinate earlier	Seeds with a high area germinate earlier
Germination speed				+	
Germination and emergence depth		+			
Pre-emergent seedling mortality		—			

+ (–): trait and processes are positively (negatively) correlated.

tentative insofar as only a small number of weed species was used. Moreover, FLORSYS is still being validated with independent field observations. The present results though appear logical based on our knowledge of weed floras and cropping system effects.

Acknowledgements

The present work was financed by INRA, ANR OGM VIGIWEED (ANR-07-POGM-003-01) and ANR SYSTERRA ADVHERB (ANR-08-STRA-02).

References

Colbach N., Gardarin A., Munier-Jolain N.M. (2010) In: Proc. 15th Int. EWRS Symposium. Kaposvár, Hungary, 12-15 July 2010

Gardarin A., Dürr C., Colbach N. (2012) Ecol Modelling, in press

Low-temperature stress in cereals: know the land - know your crop

Fowler, D. Brian

University of Saskatchewan, CANADA

Introduction

Low-temperature (LT) tolerance is a quantitative character determined by an integrated system of structural and developmental genes regulated by environmentally responsive, complex pathways. Cereals have the ability to LT acclimate allowing spring and/or winter habit forms of wheat, oat, barley and rye to be produced as primary food and feed energy sources in temperate environments throughout the world. Phenotypic and genetic analyses have shown that the LT induced protective mechanisms responsible for acclimation are developmentally regulated and involve processes that can be stopped, reversed and restarted. Full expression of LT tolerance genes only occurs in the vegetative stage and plants in the reproductive phase have a limited ability to LT acclimate. Photoperiod requirement is an adaptation that delays heading and, in regions with cold winters, vernalization requirement allows the plant to flower at the optimum time by postponing the transition from the vegetative to the reproductive phase. The major Quantitative Trait Loci determining LT tolerance have been identified. However, the genetic mechanisms responsible for small incremental effects that are important for regional adaptation have proven to be more elusive. Genome wide microarray analysis has identified over 12,000 genes that change expression due to exposure to LT and transposable, epigenetic, and small RNA elements have been implicated confirming the complexity of these responses.

Simulation models offer a means to integrate our understanding of plant functions that are expressed through complex, environmentally responsive mechanisms. Physiology and genomics studies have established the variables that influence winter hardiness and their relationships have been used to develop an online, interactive field validated winter survival model that complies with the LT responses of cereals. The model is based on a series of equations that describe

acclimation, dehardening, and damage due to LT stress consistent with our interpretation of LT gene regulation. A crop variety menu offers the choice of a wide range of species and cultivar options and the user can expand on these choices and experiment with different LT50 and vernalization values. The data files contain soil temperature records for locations that can be expanded when new data becomes available thereby allowing interested users to monitor the predicted crop condition on a regional basis. A Management Impact Calculator allows users to evaluate the effects of sub-optimal agronomic practices on LT tolerance of crops grown in western Canada. A large database that can be quickly and easily supplemented combined with a flexible, interactive model, which complies with the known LT responses of cereals, creates a teaching tool that allows production risks, cause-and-effect processes, and genetic theories to be systematically investigated by users throughout the world. It is also a valuable tool for crop improvement programs interested in identifying management systems and breeding program parental combinations that provide regional adaptation.

As this knowledge base was being accumulated, a research and development program was initiated with the objective of expanding the traditional North American winter wheat production area north and east into the higher winter stress regions of western Canada. The development and adoption of no-till seeding methods for snow trapping reduced the risk of winterkill and allowed for successful overwintering of wheat when hardy cultivars were grown using recommended management practices. Subsequent plant breeding improvements increased production potential and winter wheat is now western Canada's third largest wheat market class. This experiment in crop adaptation demonstrated that a coordinated approach combining programs in agronomy, plant breeding/genetics, information transfer, and market development are required for successful crop adaptation to a new or changing environment.

Selection of spring barley lines with respect to drought stress resistance

Pecio, Alicja¹; Wach, Damian²

¹Institute of Soil Science and Plant Cultivation - State Research Institute, POLAND; ²Institute of Soil Science and Plant Cultivation - State Research Institute, POLAND

Water balance in lowland Poland, calculated as the difference of rainfall and potential evapotranspiration is generally negative. Moreover, the distribution of rainfall during the whole year and particularly in the vegetation period is extremely heterogeneous and plants are superimposed to frequent water stresses. Spring barley due to its short vegetation period, extending for about 100 days and poor root system is very sensitive to drought stresses, even of temporary character. The barley strains and cultivars differ considerably in the response and adaptation to the stresses (Gorny 1999, Gorny 2001, Przulj and Momcilovic 2001). These differences are grounded genetically, which open the possibility for selection new forms showing higher resistance to drought stress. The purpose of the study was to determine the response of spring barley lines to drought stresses as a part of broad project focused on barley breeding.

Methods

In 2011 the pot experiment was carried out in Grabow Experimental Station of the Institute of Soil Science and Plant Cultivation - State Research Institute in Pulawy, Poland. Spring barley was cultivated in the greenhouse provided with mobile glass roof and walls, which enabled plants to grow under natural conditions and to protect them against rainfall. Over one hundred lines of spring barley included in the project have been tested against drought stresses lasted for 11 days at the tillering stage BBCH 23 (S1) or for 14 days at full flag leaf stage BBCH

45-47 (S2). In the control treatment (K) soil moisture was kept on the optimal level 13-15% w/w for the whole vegetation period and in the treatments S1 and S2 on the level of 5-6% w/w. Drip irrigation, of each pot individually was steered by a computer system and corrected using special balance. After harvest, biometrical analysis of plants had been made. Grain yield and yield components were analyzed by ANOVA, comparing the means by Tukey HSD test at the significance level $\alpha=0.05$, using Statgraphics Centurion XVI statistical package.

Results and conclusions

On the base of preliminary statistical analysis the quartile grouping resistant lines and the other one grouping sensitive to stress lines has been recognized. The analysis has been performed separately by the early and the late drought stress. The means of analyzed plant characteristics are presented in the below tables.

From the data analysis, the following conclusions were drawn:

1. Under optimal moisture conditions lines of spring barley sensitive to drought stress yielded higher than the resistant ones.
2. Spring barley shows higher resistance to drought stress at the tillering stage than at flag leaf stage.
3. Under the drought stress at the tillering stage resistant lines of spring barley increase plant productive tillering and productivity of the tillers.

Table 1. The response of spring barley plant to drought stress at the tillering stage (S1)

Stres	Grain yield g per pot	Grain yield g per plant	Productive tillering	Grain yield g per		Nr of grains per spike		Weight of 1000 grains g	
				main stem	tillers	main stem	tillers	main stem	tillers
Lines resistant to S1 stress									
K	60.39	4.03	4.13	1.18	2.85	23.45	19.72	50.53	46.10
S1	67.95	4.53	5.71	1.11	3.76	22.96	18.37	48.19	43.42
NIR	3.206	0.308	0.338	n.s.	n.s.	n.s.	0.945	n.s.	2.661
Lines sensitive to S1 stress									
K	63.82	4.25	4.70	1.13	3.12	23.75	19.80	47.43	42.63
S1	54.45	3.63	4.95	0.94	2.69	22.76	18.45	41.42	36.95
NIR	3.785	0.318	n.s.	0.080	0.423	n.s.	0.914	2.518	2.766

Table 2. The response of spring barley plant to drought stress at flag leaf stage (S2)

Stres	Grain yield g per pot	Grain yield g per plant	Productive tillering	Grain yield g per		Nr of grains per spike		Weight of 1000 grains g	
				main stem	tillers	main stem	tillers	main stem	tillers
Lines resistant to S2 stress									
K	54.03	3.60	4.50	1.03	2.57	24.83	20.46	41.36	35.99
S2	59.82	3.99	3.97	1.33	2.66	25.28	19.44	52.58	46.06
NIR	2.425	0.264	0.294	n.s.	n.s.	n.s.	0.700	2.619	2.188
Lines sensitive to S2 stress									
K	67.90	4.53	4.56	1.22	3.31	22.75	18.80	53.42	49.50
S2	54.28	3.62	3.84	1.23	2.39	22.17	16.68	55.55	50.44
NIR	3.247	0.288	n.s.	n.s.	0.461	n.s.	1.080	1.741	n.s.

4. Under the drought stress at flag leaf stage resistant lines increase main stem and the tillers' productivity as a result of higher weight of 1000 grains.

Acknowledgements

This work was supported by the European Regional Development Fund through the Innovative Economy Program for Poland 2007-2013, project WND-POIG.01.03.01-00-101/08 POLAPGEN-BD „Biotechnological tools for breeding cereals with increased resistance to drought”. The project is realized by POLAPGEN Consortium coordinated by Institute of Plant Genetics, Polish Academy of Sciences in Poznań. Further information about the project can be found at www.polapgen.pl.

References

- Gorny A.G. 1999. Genetic and physiological aspects of the adaptation to water and nutrient limitations in spring barley. *Advances of Agricultural Sciences Problem Issues* 469: 173-184.
- Gorny A.G. 2001. Variation and utilization efficiency and tolerance to reduced water and nitrogen supply among wild and cultivated barley. *Euphytica* 117 (1): 59-66.
- Przulj N., Momcilovic V. 2001. Genetic variation for dry matter and nitrogen accumulation and translocation in two-rowed spring barley. I. Dry matter translocation. *Eur. J. Agron.* 15: 241-254.

Mitigating drought stress in wheat with polymer sprays

Kettlewell, Peter; Heath, William; Haigh, Ian; Weerasinghe, Minuka; Grove, Ivan; Hare, Martin
Harper Adams University College, UNITED KINGDOM

Current agronomic methods for mitigating drought in arable crops include techniques, such as fallowing, for conserving water in the soil. Conserving water in the plant by the application of polymer sprays is, however, an agronomic method that has rarely been used in arable crops. Polymer sprays are able to reduce transpiration, but also reduce photosynthesis. For this reason, only plants and plant parts in which photosynthesis is less important than reducing water loss are routinely treated with polymers. Examples include Christmas trees and citrus fruits. Previously, polymer sprays had been assumed to be unsuitable for improving yield of droughted crops because photosynthesis is central to yield. Recently, however, polymer sprays have been shown to successfully increase yield of droughted wheat (Kettlewell et al. 2010). Three field experiments were conducted in 2003, 2004 and 2005. The polymer was sprayed at different development stages on unirrigated wheat plots with rain shelters placed over some of the plots from early stem extension to give more-severe drought than for uncovered plots. The variation in soil moisture deficit (SMD) at the time of spraying was accounted for by fitting SMD in a regression model to the increment in yield from polymer spray. The results indicate that, when SMD is statistically-controlled,

a polymer spray at Zadoks stages 37 and 39 (flag leaf) gives a large increase in yield, but that later sprays are less effective or detrimental. The damage to yield formation through reduced photosynthesis from sprays at flag leaf stages is inferred to be less than the reduction in drought damage through reduced transpiration. Conversely, after inflorescence emergence the damage to yield formation through reduced photosynthesis from polymer is inferred to be greater than the reduction in drought damage through reduced transpiration. Further field experiments in 2009, 2010 and 2011 have tested polymer sprays at earlier development stages. Data from these experiments is being analysed at the time of writing and results will be presented at the congress.

Reference

Kettlewell, P.S., Heath, W.L., Haigh, I.M. (2010). Yield enhancement of droughted wheat by film antitranspirant application: rationale and evidence. *Agricultural Sciences* 1:143–147. Available at: <http://www.scirp.org/journal/PaperDownload.aspx?paperID53106>

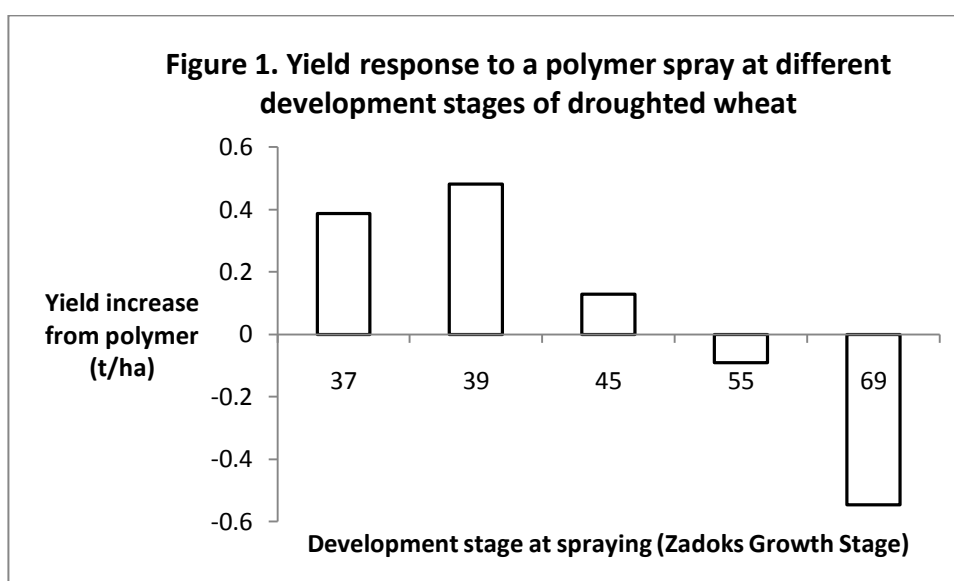

Impact of heat stress, drought and wetness on crop yield anomalies in Germany

Siebert, Stefan; Ewert, Frank

University of Bonn, GERMANY

Introduction

In well managed environments, with sufficient nutrient supply and control of pests, diseases and weeds, crop yield anomalies are often caused by unsuitable weather conditions during the growing period. Here we analyze the impact of three stressors (heat, drought and wetness) on yield anomalies of four crops (winter wheat, winter rapeseed, sugar beet and silage maize) grown in Germany between 1950 and 2010. To derive regional stress patterns, the analysis was performed for the 13 largest federal states.

Materials and methods

Crop yields for the period 1950-2010 (Mg ha^{-1}) were derived from statistical yearbooks. Time series of monthly mean precipitation sum per federal state (mm month^{-1}) and daily maximum of air temperature ($^{\circ}\text{C}$) were obtained from the German Meteorological Service (http://werdis.dwd.de/werdis/start_js_JSP.do).

The precipitation indicator IP was computed based on monthly precipitation anomalies (difference between monthly precipitation in the actual year and long-term mean precipitation of the same month). The heat stress indicator IH , computed here as temperature sum of daily maximum temperatures above a threshold of 30°C , was calculated for each region and period as average of heat stress in $1 \text{ km} \times 1 \text{ km}$ grid cells covered with cropland (according to the Corine Land Cover Classification 2006). To account for the moisture buffering effect of the soil and for cumulative effects over longer periods, we considered periods of a length between 1 month (actual month) and 5 month (actual month + 4 previous months). Time series of these meteorological indicators were then correlated with crop yield anomalies computed as difference between crop yield in the actual year and the 11-year moving average crop yield. Effects of heat and drought on crop yields are more severe when both stressors occur at the same time, e.g. during extended periods of high air pressure in late spring or summer. To distinguish the impact of both stressors we selected years with heat stress in the sensitive periods, performed linear regression analyses of drought stress and heat stress separately and combined on crop yield anomalies and compared the resulting regression coefficients R^2 .

Results

Positive precipitation anomalies during the growing season caused negative yield anomalies of winter wheat and winter rapeseed in north-western Germany and south-western Germany (negative values of indicator IP) while drought caused negative yield anomalies of these crops in eastern and central Germany (Fig. 1). Drought caused negative yield anomalies in all parts of Germany for silage maize and sugar beet (negative values of indicator IP). Heat stress occurs mainly in the River Rhine valley in the western part and in the southern part of eastern Germany (Fig. 2), but impacts of heat stress on crop yield

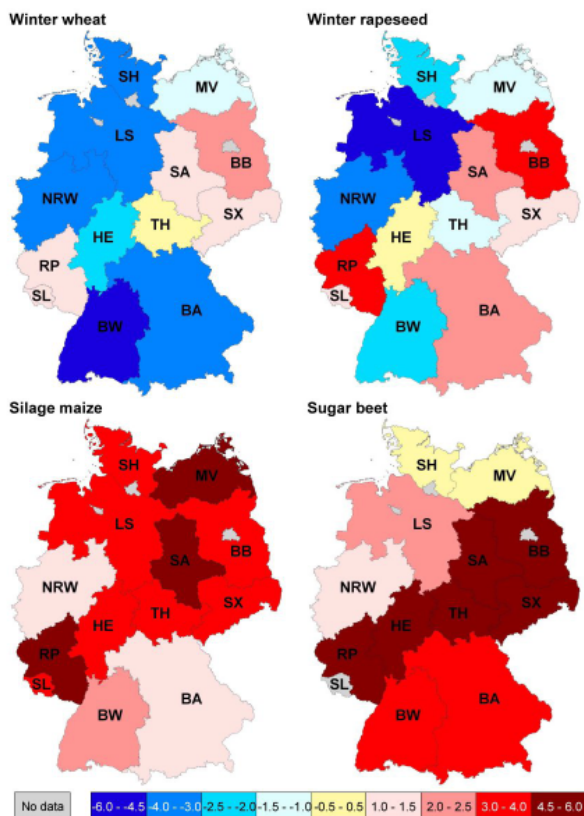

Figure 1. Impact of precipitation anomalies on yield anomalies in federal states of Germany for the period 1950-2010, negative values refer to wet conditions, positive values to dry conditions during the main growing season.

Figure 2. Mean annual sum of daily maximum temperatures above 30°C for the period 1950–2010 on cropland in Germany.

anomalies were only found for the heat stressed regions in western Germany. While sensitivity of winter wheat and rapeseed to heat stress was limited to June, the impacts of drought were most severe when negative precipitation anomalies accumulated in consecutive months (April–July for rapeseed, May–August for winter wheat, June–August for maize and June–October for sugar beet).

Conclusion

The results of the analysis show that the sensitivity of crop yields to precipitation and heat anomalies differs among crops and regions, even in a relatively small country like Germany. Therefore, differences among crops and regions need to be accounted for when assessing the impacts of climate variability and extreme events on crop productivity.

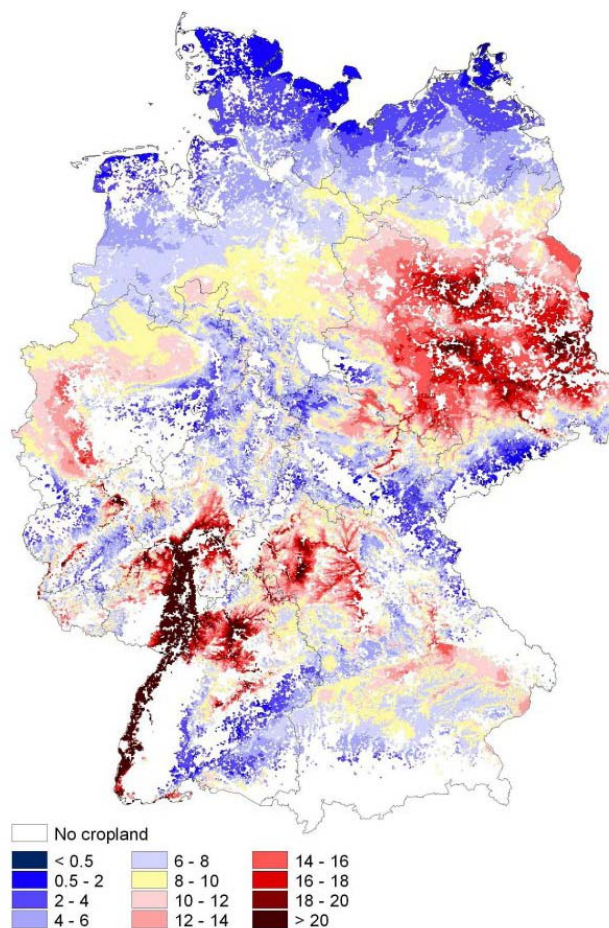

Nitrous oxide emissions of legume based agricultural systems in Europe

PAPPA, VALENTINI AGATHI¹; Pristeri, Aurelio²; Savvas, Dimitrios³; Toncea, Ion⁴; Kontopoulou, Charitini³; Rees, Robert M.1

¹Scottish Agricultural College, West Mains Road, Edinburgh, EH9 3JG, UNITED KINGDOM;

²University Mediterranea of Reggio Calabria, I-89060 Reggio Calabria, ITALY;

³Agricultural University of Athens, Iera Odos 75, 11855, Athens, GREECE;

⁴NARDI Fundulea, N. Titulescu 1, 915200 Fundulea/Calarasi, ROMANIA

Introduction

Nitrogen (N) availability remains one of the key drivers of crop productivity from arable farms in Europe. Most crops receive applications of synthetic N fertilisers but these can contribute to significant emissions of the greenhouse gas (GHG) nitrous oxide (N₂O). Legumes can potentially offer an opportunity to reduce GHG emissions

from the agricultural sector. It is argued that agricultural systems need to increase production whilst reducing environmental impacts. The main objective of this study was therefore to explore the extent to which different legume based agricultural systems across Europe could influence N₂O emissions per unit of grain production (emission intensity).

Experimental Sites				
	NARDI, Fundulea, Romania	Agrinion, Greece <u>Climatic characteristics</u>	San Marco Argentano, Italy	Edinburgh, United Kingdom
Latitude	44°30' N 24°10' E	38°35' N, 21°25' E	39°18' N, 21°12' E	55°87' N, -3°20' E
Annual average rainfall (mm)	578	955	550	930
Annual average air temperature	10.7°C	17.2°C	15°C	8.6°C
<u>Soil characteristics</u>				
Soil Type		Clay loam	Loamy	Sandy loam
<u>Measurements</u>				
Plant	Above ground biomass Grain yields Total N/C in crop (plant and grain)	Above ground biomass Grain yields Total N/C in crop (plant and grain)	Above ground biomass Grain yields Total N/C in crop (plant and grain)	Above ground biomass Grain yields Total N/C in crop (plant and grain)
Soil	Soil available N Nitrous oxide	Soil available N Nitrous oxide	Soil available N Nitrous oxide	Soil available N Nitrous oxide
<u>Crops</u>				
Legumes	Peas Lentils Soybean Beans (Mungobean) Phaseolus	Phaseolus	Peas Beans	Peas Beans
Cereal		Sweetcorn	Barley	Wheat
<u>Agricultural systems</u>				
Organic	Monocrops	Low Salinity Sweetcorn High Salinity Sweetcorn Low Salinity Phaseolus High Salinity Phaseolus		
Conventional			Monocrops (100) Intercrops Faba 100 : Barley 50 Intercrops Faba 50 : Barley 50 Intercrops Pea 100 : Barley 50 Intercrops Pea 50 : Barley 50	Monocrops

Table 2: Cumulative N₂O-N (g N₂O-N/t grain yield) for the four sites (Romania, Greece, Italy and UK) from the time of each crop sowing until the harvest.

Romania		Greece		Italy		UK	
Winter pea	120.36	Organic Low Sal Sweetcorn	75.93	Barley 100	38.95	Spring beans	43.38
Soybean	120.82	Organic High Sal Sweetcorn	138.74	Faba beans 100	60.20	Winter beans	149.42
Soybean after maize	198.55	Conventional Low Sal Sweetcorn	124.96	Faba 100 : Barley 50	15.12	Vining peas (fresh)	26.42
Lentil Georgia	264.77	Conventional High Sal Sweetcorn	166.58	Faba 100 : Barley 50 (II)	12.02	Vining peas (dry)	133.88
Lentil Black	265.79	Organic Low Sal Phaseolus	100.92	Faba 50 : Barley 50	33.03	Combinable peas	87.79
Soybean after alfalfa	337.95	Organic High Sal Phaseolus	179.99	Pea 100	49.66	Winter wheat nil N	298.16
Beans	640.77	Conventional Low Sal Phaseolus	125.00	Pea 100 : Barley 50	30.22	Winter wheat plus N	177.58
Lupin	985.79	Conventional High Sal Phaseolus	110.05	Pea 50 : Barley 50	58.94		

Materials and methods

Four sites were selected across Europe that represented different climatic regions: the Mediterranean (Greece and Italy), Continental (Romania) and Atlantic (United Kingdom) regions. The following leguminous crops were studied: winter faba bean, spring faba bean, spring pea, lentil, soybean and common bean (Table 1). Direct emissions of N₂O were measured using static chambers sealed for 40–60 minutes with an aluminium lid every 15 days and at key growth stages, from sowing to harvest at all sites. Gas samples were transferred to a portable evacuated glass vial and analysed by gas chromatography. For consistency, gas sampling was carried out between 10:00 and 12:00 hrs. Grain yields were also recorded for the calculation of N₂O intensities.

Results

The grain yield of soyabeans at the Romanian site was high when grown after alfalfa (5.0 t ha⁻¹). In Greece, both farming systems and the salinity treatment had a major effect on the green pod yield of common bean. Thus, organic management reduced the pod yield to approximately 70% of the equivalent conventional yield, while salinity resulted in a pod yield decrease of 19% in comparison with that obtained under non-

saline conditions. In Italy, the pea/barley intercrops had higher grain yields than the Faba bean/barley intercrops particularly for the replacement design (P50B50) where the reduction in grain yield of both intercrops compared to the respective monocrop was less than 20%. Finally in UK, the vining peas gave the highest yields (9.1t ha⁻¹) and the beans (spring and winter) were not significantly different in yield (5.3 t ha⁻¹ for both).

N₂O intensities in Romania of the winter peas and soybeans (120 g N₂O-N / t grain yield for both) were lower than other legumes and the unfertilised winter wheat (132 g N₂O-N / t grain yield). In Greece, common bean growing after sweetcorn with low salinity conditions was significantly different from crops grown under high salinity, where the organic system treatments had the lowest emission intensity (75 g N₂O-N / t grain yield). In Italy, the legume monocrops had higher intensities when compared with the cereal (barley) monocrop, but when the peas or beans were sown at 100:50 (legume:barley) (additive design), the intensities were reduced by 75% and 50% of the respective monocrops. Finally in UK, the vining peas had the lowest N₂O intensity (26 g N₂O-N / t grain yield) and all the legumes had lower intensities than the unfertilised winter wheat (298 g N₂O-N / t grain yield) under the same growing conditions.

A nitrogen-budget analysis of legume supported cropping systems from across Europe

Iannetta, Pietro¹; Begg, Graham¹; Young, Mark¹; Topp, Kairsty²; Watson, Christine²; Rees, Bob²; Squire, Geoff¹

¹The James Hutton Institute, UNITED KINGDOM; ²Scottish Agricultural College, UNITED KINGDOM

Introduction

The Legume Futures (www.legumefutures.de) research programme aims to develop and assess novel legume-supported cropping systems which raise the economic and environmental performance of European agriculture. As part of this research an N-budget analysis was carried out on existing datasets gathered by partners from across Europe. The data had been gathered from a diverse array of a crop-rotation or -sequence based agroecosystems, which did and did not include legume crops. The nitrogen-balance (N-balance), approach allowed a synthesis of data in terms which are relevant to legume performance, and despite major differences in the structure and original function of the original datasets. The main aim of this assessment was therefore to establish whether a common synthesis could be achieved of the nitrogen use efficiency, and relative to absolute levels of productivity, for systems supplied with nitrogen from either biological nitrogen fixation (BNF), or fossil-fuel derived nitrogen. By extension, the hypothesis being tested was, 'is the N-balance ($N_{in} - N_{out}$), and absolute productivity levels of an legume supported cropping system, that is a system which relies on the provision of nitrogen from BNF, sufficient to reduce agricultures reliance on fossil fuel derived fertiliser?'

Materials & Methods

Eight data sets gathered from across Europe and spanning a diverse array of crop-rotations (including grazing) were used, and the N-balances were calculated at a plot level, and for each crop year. Data averages were assimilated for 29 main crops, 59 main/sub-crop combinations and 29 crop sequences (rotations).

Results & Discussion

The averages for the crops sequences with and without legumes show that nitrogen balance of rotations (or crop-sequences), are relatively insensitive to the amount of legume cropping. More significantly, it was shown that BNF in legume based rotations more than compensates for the reduction in fertiliser use. There is a trade-off between BNF and the addition of fertiliser, the former decreasing as the latter increases. Furthermore, absolute productivity levels are greater in legume supported rotations despite the very low, or the complete absence of, added nitrogen containing fertiliser. Legume based rotations gave greater productivity in terms of nitrogen yield and biomass, and peaked at crop rotations (or sequences), in which legumes comprised approximately 50 % of the species in the rotation, or crop-sequence.

Conclusion

While the socioeconomic and environmental impacts have still to be determined, the data establishes a target (50 %), for the extent to which legume crops should be included within legume-supported crop sequences. Also, the approach and relationships which have been determined provide a model framework from which N-budget and productivity estimates may be made for novel crop-rotations or -sequences.

Acknowledgements

This work is supported by the European Union FP7 funded research project Legume Futures (www.legumefutures.eu), and the Scottish Government. **Corresponding author:** pete.iannetta@hutton.ac.uk

Conceptual models of mutual annual legume intercrops for forage production

Mikić, Aleksandar¹; Cupina, Branko²; Djordjević, Vuk¹; Antanasović, Svetlana²; Krstić, Djordje²; Mihailović, Vojislav¹; Stoddard, Frederick L.³

¹Institute of Field and Vegetable Crops, SERBIA; ²University of Novi Sad, Faculty of Agriculture, SERBIA; ³University of Helsinki, FINLAND

A study by the Institute of Field and Vegetable Crops and the Faculty of Agriculture of the University of Novi Sad defined four principles for intercropping annual legume for forage production (Cupina et al. 2011). The two crops growing together should have: (i) the same time of sowing; (ii) the similar growing habit; (iii) the similar time of maturing for cutting; and (iv) different standing ability (one good and the other poor). So far, four intercropping prototypes have been developed based on these principles. 1. 'Tall' annual legumes with good resistance to lodging, such as faba bean (*Vicia faba* L.) or white lupin (*Lupinus albus* L.), are sown in wide rows and offer favourable conditions for weeds. Others such as forage pea, vetches or grass pea (*Lathyrus sativus* L.), easily fight

weeds but have rather poor standing ability, with heavy forage losses and reduced forage quality. Intercropping these two groups of 'tall' cool season legumes is beneficial for both, with weeds reduced and photosynthetically active leaves preserved (Fig. 1, upper row). 2. 'Short' annual legumes with good standing ability, such as semi-leafless pea or fenugreek (*Trigonella foenum-graecum* L.), have a certain ability to fight weeds and generally have lower forage yields than the 'tall' annual legumes. Others, susceptible to lodging such as bitter vetch (*Vicia ervilia* (L.) Willd.) or lentil (*Lens culinaris* Medik.), easily match weeds but are prone to shading their own lower portions of canopy, resulting in poorer forage quality. If intercropped, both components profit, generally in higher

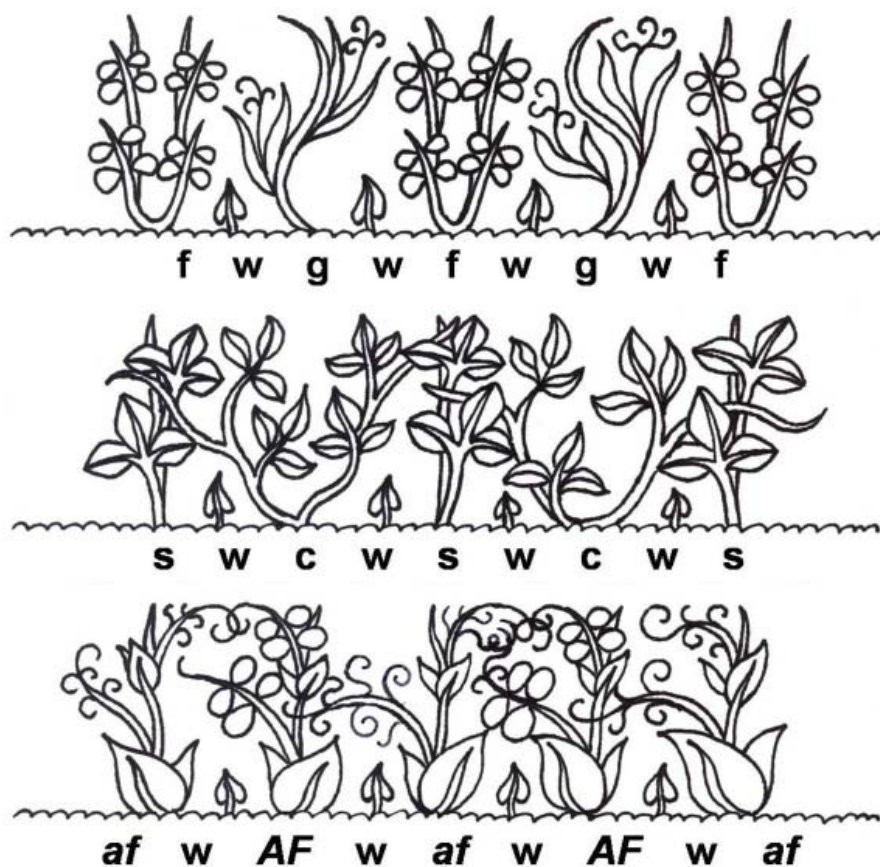

Figure 1. (upper row) intercropping 'tall' cool season annual forage legumes: faba bean (f) and grass pea (g); (middle row) intercropping warm season annual forage legumes: soybean (s) and cowpea (c); intercropping peas with different leaf type: normal-leaved (AF) and semi-leafless (af)

total forage yields and higher leaf proportion in plant mass. 3. All soybean maturity groups provide favourable conditions for rapid weed growth and development and thus as a rule demand advanced mechanical or chemical weed control. Many warm-season annual legumes, such as cowpea (*Vigna unguiculata* (L.) Walp.) or hyacinth bean (*Lablab purpureus* (L.) Sweet), have an exceptionally poor standing ability, developing a strong creeping cover able to eliminate almost all weeds and thus cause difficulties in cutting. If intercropped, soybean profit from reduced weed infestation and may carry cowpea or hyacinth bean stems and assists in preserving their leaves (Fig. 1, middle row). 4. It is commonly regarded that semi-leafless pea has significantly improved standing ability and profits from sunlight penetrating the whole stand. At the same time, it also offers good conditions for weed development. Normal-leafed pea controls weeds more easily, but is lodging-susceptible at early stages and is prone to disease infestation. When intercropped, semi-leafless and normal-leafed peas both profit: semi-leafless pea provides the whole intercrop with improved standing ability, while normal-leafed pea fills the available stand

volume and contributes to better utilisation of sunlight and better reduction of weed growth (Fig. 1, lower row). The presented intercrops of annual forage legumes do not increase sowing costs (reduced sowing rates), preserve high crude protein content in forage dry matter (unlike cereals), have short growing seasons, fit into various cropping systems, and are environment-friendly (neither demand synthetic fertiliser nor herbicides).

Acknowledgements

Project TR-31016 of the Ministry of Education and Science of the Republic of Serbia and FP7 project Legume Futures.

References

Cupina B, Mikic A, Stoddard FL, Krstic D, Justes E, Bedoussac L, Fustec J, Pejic B (2011) Mutual legume intercropping for forage production in temperate regions. In: Sustainable Agriculture Reviews 7: Genetics, Biofuels and Local Farming Systems (Ed. E Lichtfouse), Springer, Dordrecht, pp. 347-365

Field pea companion crop in sainfoin establishment

Ćupina, Branko¹; Krstic, Djordje¹; Antanasovic, Svetlana¹; Eric, Pero¹; Mikic, Aleksandar²; Pejic, Borivoje¹; Vasiljevic, Sanja²

¹University of Novi Sad, SERBIA; ²Institute of Field and Vegetable Crops, SERBIA

Introduction

Sainfoin (*Onobrychis viciifolia* Scop.) is a beneficial perennial herbaceous plant, cultivated mainly in temperate regions of Europe, Asia and North America (Carbonero et al, 2011). In agro-ecological conditions of Serbia, sainfoin is not cultivated to the same extent as lucerne or clovers. Few recent researches have demonstrated that field pea (*Pisum sativum* L.) could be companion crop in establishing of perennial legumes (Ćupina et al, 2011). Here field pea serves as a kind of bioherbicide, and significantly contributes to the forage yield in the first cut (Ćupina et al, 2011). Semi-leafless field pea genotypes provides better light penetration and better conditions for initial growth to perennial legume (Koivisto et al, 2003). The objective of this study was to determine the suitability of field pea for intercropping with sainfoin. Beside the selection of adequate field pea genotype, determination of optimum plant number of companion crop was included in the study.

Materials and methods

A small-plot trial was conducted in 2010 and 2011 at the Institute of Field and Vegetable Crops, Novi Sad, Serbia. Two field pea genotypes were used, namely normal-leafed cv. Javor, and semi-leafless cv. Jezero. Both varieties were sown at three rates, 30, 60 and 90

seeds m⁻², and at a row distance of 20 cm. The sainfoin cv. Makedonka was sown between the rows of field pea, as well as a pure stand (Control 1) and sown with oat (*Avena sativa* L.) as a traditional way of establishment (Control 2). In both years the sowing was done by the end of March. The trial was established as random block design with three replications. The first cutting was done in the stage of early flowering in sainfoin, in mid-June. Both field pea cultivars were in the stage of forming pods and filling grains. There were three cuttings in 2010 and two cuttings in 2011. The first cutting and total annual forage yield were determined in both years. Total yield is registered in order to assess the effect of the companion crop on the regeneration rate of the under sown crop.

Results

In the warmer and rainy growing season of 2010, establishing sainfoin with pea had the highest total annual forage yield (67.0 t ha⁻¹). Semi-leafless pea proved more successful than normal-leafed, with 68.4 t ha⁻¹ of the total annual forage yield. Among the different sowing rates, establishing sainfoin with 30 plants m⁻² of normal-leafed pea had the highest total annual forage yield (73.0 t ha⁻¹). In 2011, the second year of establishment (Fig. 1) the growing conditions were less favorable than in 2010, providing less accurate data on the performance of each factor. The total annual forage yield (33.8 t ha⁻¹)

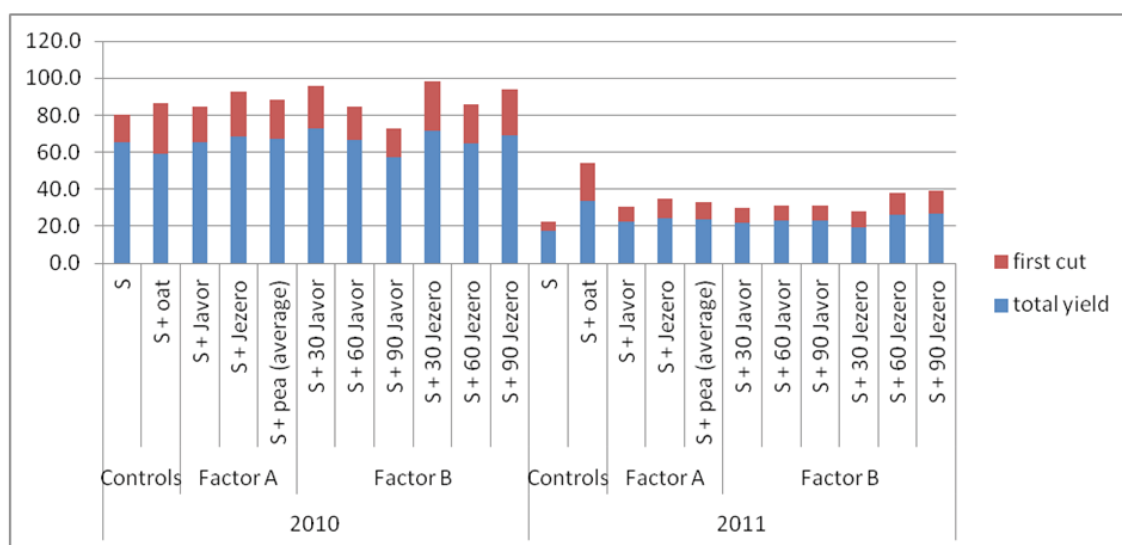

Figure 1. Effect of field pea cultivar and plant number on forage yield (t ha⁻¹) in intercropping with sainfoin

in sainfoin established with oat were higher than in pure sainfoin (17.2 t ha⁻¹) and sainfoin with pea (23.3 t ha⁻¹). The proportion of the first cut in total annual forage yield in both study years was the lowest in Control 1 and the highest in the Control 2 (Fig. 1).

Conclusion

Preliminary results encourage further research on establishing sainfoin with field pea companion crop. Intercropping with pea brought higher yields than control 1 (pure crop). Seeding rate of 30 plants per m² provided highest forage yields.

Acknowledgements

The research was supported by the project by Provincial Government of Vojvodina. It is also a contribution to the

projects FP7 Healthy Hay Sainfoin.eu and FP7 Legume Futures.

References

- Carbonero CH, Mueller-Harvey I, Brown TA, Smith L (2011) Sainfoin (*Onobrychis viciifolia*): a beneficial forage legume. *Plant Genet Resour Charact Util* 9:70–85
- Ćupina B, Mikić A, Stoddard FL, Krstić Đ, Justes E, Bedoussac L, Fustec J, Pejić B (2011) Mutual legume intercropping for forage production in temperate regions. In: Lichtfouse E (ed) *Sustainable Agriculture Reviews 7: Genetics, Biofuels and Local Farming Systems*. Springer, Dordrecht, 347–365
- Koivisto JM, Benjamin LR, Lane GPF, Davies WP (2003) Forage potential of semi-leafless grain peas. *Grass Forage Sci* 58:220–223

Diversification of crop production through crop rotations

Keskitalo, Marjo; Hakala, Kaija; Huusela-Veistola, Erja; Jalli, Heikki; Jalli, Marja; Jauhiainen, Lauri; Känkänen, Hannu

Agrifood Research Finland MTT, FINLAND

Introduction

Diverse agriculture may increase the resilience of farms towards global and climatic changes (Kahiluoto *et al.* 2012). In the present study we wanted to find out how diverse the crop cultivation is at a farm level, and what concrete benefits diverse cultivation could bring in terms of effects of crop rotations and different pre crops on yields.

Methodology

The study of crop rotations at farm and regional level was based on farm parcel statistics collected by TIKE (Information Centre of the Ministry of Agriculture and Forestry). Crop species diversity was evaluated through calculation of Shannon index. The effects of several special crops on wheat yield for two subsequent years were studied. Long term crop rotation experiment consisting of a continuous wheat monoculture and different rotations were studied as well.

Results and discussion

Farm production has diversified slightly since Finland joined the EU in 1995. The frequency of monoculture (barley, wheat, oats) and similar type of farming system

(two cereals in rotation) has decreased from 30 % to 25 % of the area of spring cereals during the last 10 years. Increased cultivation area of oil seed rape, turnip rape, pulses and different grasses played a major role in diversifying the rotations of cereals. The 15 Centres for Economic Development, Transport and the Environment (ELY-centres) of Finland differed in their crop diversity indices, which were between 1,41–2,14 and the lowest in grass production areas.

The pre crop experiments showed that the wheat yields differed little when sown directly after the different pre crops, but were clearly increased in the second year when compared to continuous wheat after wheat (Figure). The highest wheat yields were obtained after cultivation of faba bean, oilseed rape and blue lupin, but also buckwheat, linseed, oat and oil hemp increased the yields significantly. The contents of mineralized N and P of the soil varied after pre crops.

The lowest infection of tan spot (*Pyrenophora tritici-repentis*) was observed when wheat was cultivated after other pre crops than wheat, explaining partly the variation of wheat yields after pre crops. The same positive effect of diverse crop rotations was shown in the long-term crop rotation trial, where the wheat yield was

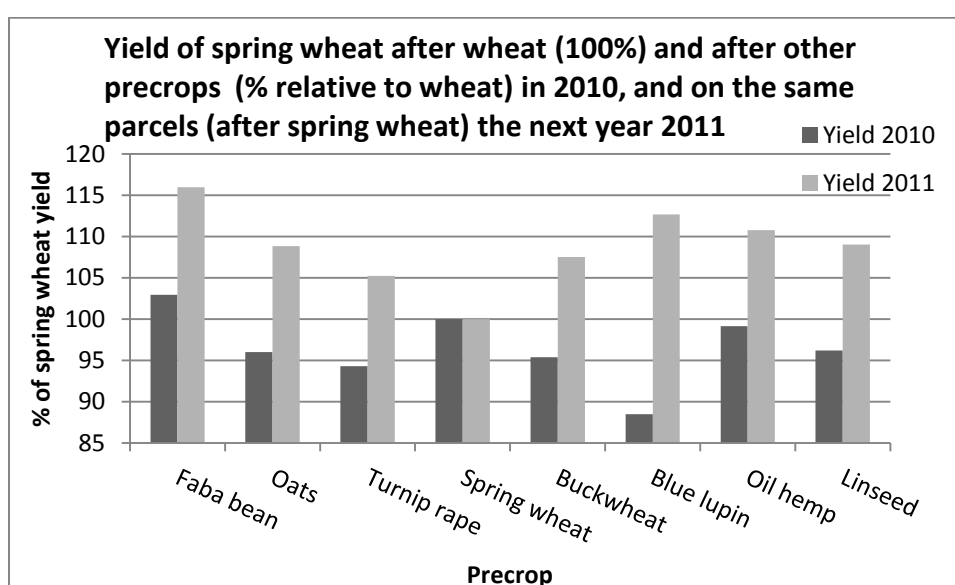

highest when wheat was grown only every fourth year. The climatic conditions had a significant effect on the frequency of pests and efficacy of crop rotations. Diverse crop rotations decreased especially the severity of tan spot in wheat in the long-term experiment. However, instead of just field-based crop rotation, an area-wide pest management is the most effective control method for many insect pests. A proper crop rotation improves the results of chemical weed control that becomes easier with wider herbicide palette connected to versatile crop arsenal. Also herbicide resistance is easier to avoid if one can use herbicides with different modes of action.

Another way of gaining benefits from diverse cropping could be undersowing. E.g. undersown in spring cereals, Italian ryegrass efficiently absorbed soil nitrate N in autumn and timothy in spring (Känkänen 2010). Red and white clover could be used to supply fixed N for cereals without markedly increasing risk of N leaching. A mixture of legume and non legume could be a good choice also to increase crop diversity. Grain yield response and the capacity of the undersown crop to absorb soil N or fix N from atmosphere, and the release of N are of greatest interest in the future.

Conclusions

Finland has developed towards more diversified agriculture in the past two decades. Diverse crop rotations and pre crops may increase yields and yield stability by better nutrient balances and reduced pest and pathogen pressure, however depending on climatic conditions.

Acknowledgement

This research was funded by MMM and MTT

References

- Kahiluoto, H. et al. 2012. MTT Raportti 43;
- Känkänen, H. 2010. MTT Science 8 (PhD thesis, 93 p.)

Modeling the spatial distribution of cropping systems at a large regional scale: a case of crop sequence patterns in France between 1992 and 2003

Xiao, Ying¹; Mignolet, Catherine¹; Mari, Jean-François²; Benoît, Marc¹

¹INRA, FRANCE; ²LORIA, FRANCE

Introduction

Over the past decade, the scientific interest of the location of cropping systems, including both crop sequences and crop management systems, has been increasingly noticed by researchers who associate crop rotations instead of a single crop to represent cropping patterns in their models (nitrogen fluxes, animal habitat preference, etc.) and to further analyze the environmental impacts of agricultural production systems. However, in existing modeling frameworks of land-use/cover change, especially agricultural land-use change, few models integrate agricultural land management practices such as crop rotations (Schonhart et al., 2011). The aim of this paper is to investigate crop sequence patterns at a large regional scale by performing statistical techniques on surveyed land-cover data.

Materials and methods

The land-cover data was derived from annual French national land-cover census data, Teruti, from 1992 to 2003. The land unit studied was the French agricultural district and all of the 430 agricultural districts were incorporated into this research. By combining the application of CARROTAGE (Le Ber et al., 2006), a second-order Hidden Markov Model based on stochastic theory and a classic statistical technique, principal component methods prior to agglomerative hierarchical methods (AHC) using the software R package FactoMineR (Husson et al., 2010), we developed a modeling approach to identify the spatial distribution of crop sequences at the French metropolitan scale. We considered 3-year crop sequences as distinct land-use types. Firstly, we applied CARROTAGE to extract the temporal regularities of land-use within

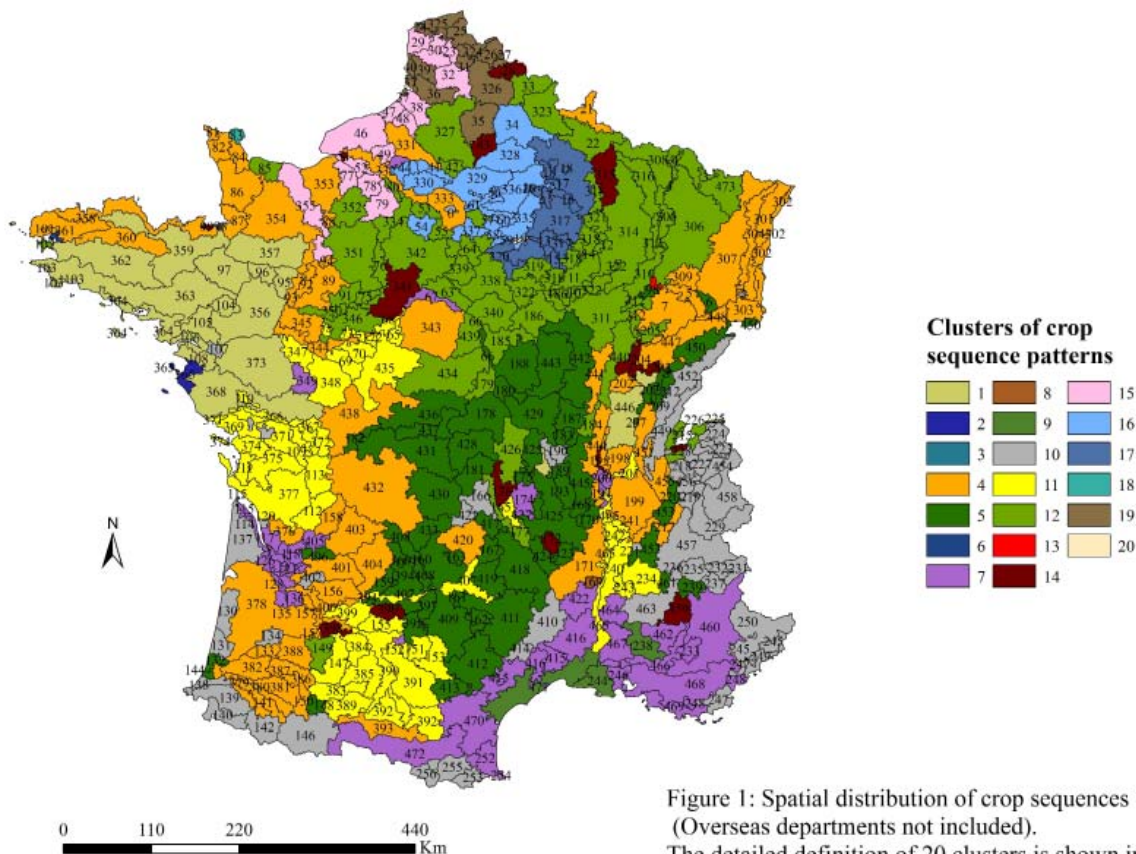

Table 1: Description of the partition into 20 clusters from the initial variables. Supplementary variables are in italics and underlined. Nomenclature used is: A (apple tree), B (barley), Bn (broad bean), F (forest), Fa (fallow), G (grassland), Gv (vegetable garden), H (herb area), M (maize), N (nursery), O (oat), Oc (other cereals), OS (other surface), Ol (oil crops), Ov (other vegetables), P (pea), Pa (artificial pasture dominant in alfalfa), Pm (mountain pasture), Ps (potatoes), Pt (temporary pasture), R (rapeseed), S (sunflower), Sb (sugar beet), St (stone area), Tx (textile crops), V (vineyards), W (wheat).

Cluster	Crop sequences
1	M-Oc-Pt, Pt-M-Oc, Pt-M-Pt, Pt-M-P, W-Pt-M, M-W-Pt, <i>M-Pt-M</i> , Pt-Pt-M, W-M-Oc, Oc-M-Oc
2	OS-OS-S, Ov-Ov-Ov, V-Ov-Ov, W-Pt-S, W-Oc-W, W-W-R, Ol-W-Ol, Pt-M-Pt, Pt-M-P, Ps-Ps-Ps
3	Pt-B-W, M-W-Ov, Pt-W-B, W-B-Ov, M-B-M, M-W-O, P-W-Ov, P-W-Pt, Pt-Fa-Fa, Fa-P-W
4	M-M-Pt, M-M-M, Pt-M-M, M-Pt-Pt, G-M-M, Fa-M-M, M-M-P, M-W-M, R-W-M, M-M-W
5	O-Pt-Pt, Oc-Oc-Pt, Oc-Oc-P, Pt-Pt-B, Pt-Pt-Pt, G-W-B, Pt-Pt-G, B-B-Pt, Oc-Pt-Pt, G-G-Oc
6	Ps-Gv-Gv, W-Oc-R, OS-Gv-Gv, S-Gv-Gv, Oc-R-W, R-W-Oc, W-B-Ps, R-W-O, OS-Fa-Fa, Pt-Pt-Fa
7	V-V-V, Fa-OS-OS, V-V-F, V-V-Fa, OS-OS-Fa, A-OS-OS, OS-Fa-Fa, Fa-Fa-OS, G-G-OS, G-OS-OS
8	W-Sb-M, S-M-W, B-M-S, W-Sb-S, M-S-M, Gv-Gv-OS, W-Fa-R, S-W-Ol, H-H-H, OS-OS-Fa
9	Oc-Oc-Oc, Oc-Oc-O, Oc-Oc-W, Ov-M-W, V-M-W, W-W-Ov, Pa-Pa-Pa, H-OS-OS, Ov-W-W, V-W-W
10	<u>St-St-St</u> , Pm-Pm-Pm, <u>OS-OS-OS</u> , OS-OS-O, H-H-H, Ov-M-M, V-M-M, B-B-Fa, B-B-F, Fa-Fa-Pt
11	S-W-S, W-S-Fa, W-S-B, Fa-Fa-S, R-W-S, Fa-W-S, S-Fa-Fa, W-S-W, W-S-S, S-S-W
12	W-W-B, B-R-W, Fa-W-R, W-B-R, W-Fa-W, R-W-B, W-R-B, P-W-B, B-Fa-W, Fa-W-B
13	G-S-W, M-W-R, B-Pt-Pt, Pt-G-G, Fa-W-M, Pt-Pt-G, B-Fa-W, Fa-R-W, W-B-Fa, W-B-F
14	W-M-Ov, Sb-W-O, S-M-S, B-W-Ov, Sb-W-Ov, Ol-Ol-W, P-W-Fa, B-M-O, Fa-W-Fa, W-M-O
15	P-W-Tx, B-W-Tx, Sb-W-Tx, B-Tx-W, W-B-Tx, Tx-W-W, Tx-W-B, Tx-W-Tx, B-Pt-W, W-Pt-W
16	N-W-Sb, Bn-W-Sb, P-W-Sb, W-Pa-W, Bn-W-S, Sb-W-Sb, B-W-Sb, P-W-S, W-Sb-W, B-Bn-W
17	B-Pa-Pa, Pa-Pa-W, W-Sb-B, Pa-W-S, W-B-Pa, Sb-B-B, Sb-B-R, Sb-B-P, B-B-Sb, Pa-W-B
18	Ps-Sb-W, Ps-W-Ps, S-W-Ps, S-Sb-W, Ps-W-P, Ps-W-M, Ov-W-Ov, Ov-W-O, S-W-P, W-Ov-Ov
19	Ps-W-Ov, P-W-Ps, Sb-W-Ps, B-W-Ps, S-W-Ov, W-Ov-W, Ps-W-B, M-W-Sb, W-Ov-P, W-Ps-W
20	R-W-Ov, B-Ov-W, P-W-Ov, Ov-W-B, V-W-B, Ov-W-Ps, Ov-W-P, Ps-W-Sb, Ov-W-Sb, W-W-M

each district. The probabilities of occurrences of 3-year land-use successions previously calculated were used as independent variables to build a table to classify districts. Secondly, we performed the Principal Component Analysis (PCA) on this table in which 510 principal crop sequences were used as active variables. In order to facilitate the interpretation of the clusters, we introduced six permanent non-agricultural land-use successions that contained forest, water, artificial area and stone area as supplementary variables. Finally, we performed a hierarchical clustering on the principal components using the 'HCPC' function integrated into FactoMineR, predefining the number of clusters between 20 and 30. We then mapped this classification with ArcGIS.

Results

The first 119 components of the PCA explained 80.2% of the total inertia and therefore were used for clustering. With the optimal level of division suggested by the HCPC function, a classification of districts into 20 clusters was produced. We observe the differentiation of crop sequences among regions (Fig. 1). We also detected the livestock farming system zone with crop sequences predominantly involving maize and temporary pasture, the cereal and vegetable farming systems zone including wheat, barley, sugar beet and pea-based crop sequences, etc. Details of the clusters' description are shown in Table 1.

Conclusion

We emphasize that the crop sequence patterns identified in this study seem plausible in comparison to the result of the farming systems survey, OTEX, published by the French Ministry of Agriculture in 2000. This modeling approach can be considered a generic approach tested at the French metropolitan scale, and it provides a useful tool for agronomists to represent past agricultural land-use patterns at the global scale.

References

- Le Ber, F., Benoit, M., Schott, C., Mari, J.F., Mignolet, C., 2006. Studying crop sequences with CARROTAGE, a HMM-based data mining software. *Ecological Modelling* 191, 170-185.
- Husson, F., Lê, S., Pagès, J., 2010. Exploratory Multivariate Analysis by Example Using R, Computer Science and Data analysis Series. Chapman & Hall/CRC, p. 228.
- Schönhart, M., Schmid, E., Schneider, U.A., 2011. Crop Rota - A crop rotation model to support integrated land use assessments. *European Journal of Agronomy* 34, 263-277.

Participatory design and evaluation of durum wheat - legume intercropping systems in Camargue, South of France

*Lopez-Ridaura, Santiago; Goulevant, Gael; Perez, Sarah
INRA UMR Innovation, FRANCE*

Introduction

Intercropping systems have shown advantages under experimental conditions in Europe. LER values above 1, indicating a benefit of intercrops over monocrops, have been reported for many grain legume-cereal intercrops. In Western France, previous studies indicated LER values superior to 1 in intercrops in conventional and organic farming systems (Naudin et al, 2007). However, despite the advantages of intercropping systems shown in experimental conditions, their low adoption in general and specifically with durum wheat in the Mediterranean basin, raises questions on the multiple obstacles for the implementation of these innovative cropping systems. Based on interviews to farmers, the main technical aspects hampering the development of intercropping were identified (Perez and Lopez-Ridaura 2010).

The objective of this study was to assess of intercropping systems in Camargue based on on-farm trials and participatory evaluation. Participatory design/evaluation of cropping systems is one appropriate form of education and extension, notably when agroecological alternatives are involved.

Methodology

Four farmers accepted to participate in the on farm evaluation of intercropping systems. In an initial collective meeting we presented to farmers the principles of intercropping systems and results obtained in experimental conditions. Farmer decided on the crops, the varieties and the cropping techniques they wanted to test. 34 intercropping trials were set during the 2009-2010 (17 trials) and 2010-2011 (17 trials) wheat growing seasons. Trials included an intercropping and its equivalent

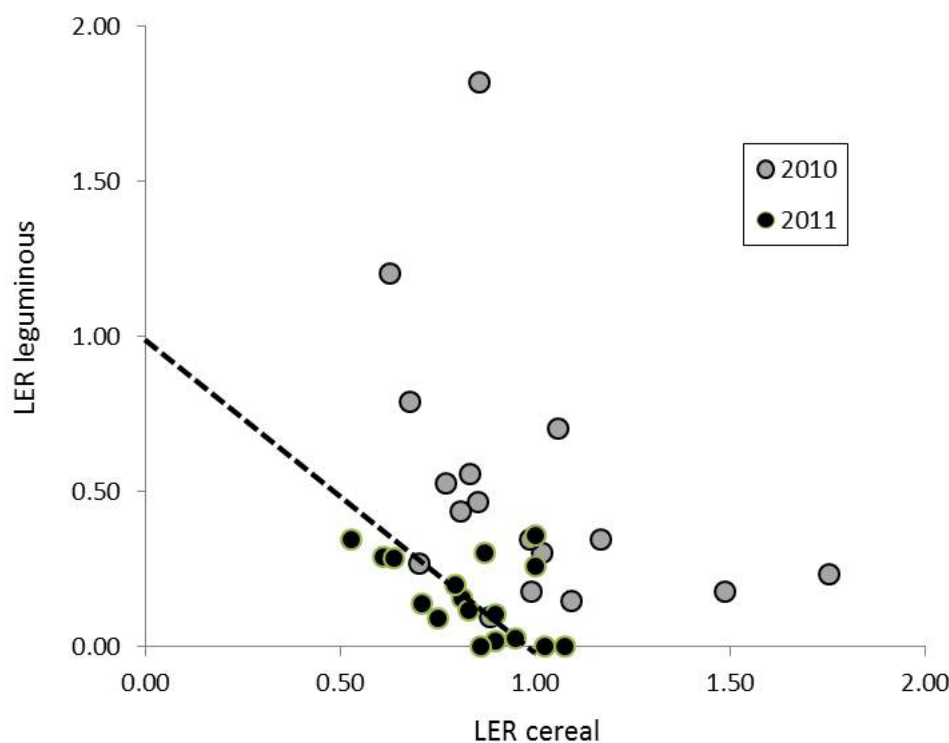

Figure 1. Partial LER for cereal and legumes in 34 intercropping systems in Camargue for two growing seasons

monocrops. The intercropping systems evaluated included durum wheat (23) barley (6) or triticale (5) combined with peas (18), faba bean (10) chick pea (4) or alfalfa (2). Trials occupied a surface of about half hectare split in 12 x 50 m treatments allowing specific mechanization practices. We monitored biomass production and grain yield. Around flowering, we organized a field visit with farmers and, after harvest we had individual meetings with each farmer and a collective session to analyze and discuss results.

Results and discussion

Figure 1 shows the performance of the different trials in terms of their LER, each axis represents the partial LER per component in the intercropping system and therefore all points above the 1:1 line have a LER of the intercropping systems > 1 indicating the yield advantage of intercropping systems. The main feature of these results is the large difference between the two seasons. The 2009-2010 growing season was a particularly bad climatic year, where autumn rains did not allow proper sowing dates and conditions. Yields were generally low in the region and intercropping systems showed a production advantage to monocrops.

Such feature of intercropping systems as a risk management strategy is commonly evoked in literature and here confirmed for cereal-legume intercrops in Camargue. On the contrary, the 2010-2011 season was a good year for cereal production and high yields in the region were obtained, in this case, intercropping systems did not show a clear advantage over monocrops. Results related to the economic performance of these trials and their nitrogen use efficiency will be presented along with a qualitative assessment provided by farmers and the main conclusions obtained from these trials.

References

- Perez S. and Lopez-Ridaura S. (2010) Opportunities and obstacles for durum wheat intercropping systems in Mediterranean France. Proceedings of AGRO2010, Congress of the European Society for Agronomy (ESA), 29/08- 3/09 2010, Montpellier, France
- Naudin C, Aveline A, Corre-Hellou G, Dibet A, Jeuffroy MH and Crozat Y (2007) Comparison of spring and winter cereal-legume intercrops in organic farming by analysis of interactions between species. 6th European conference of grain legumes, 12-16th Nov. 2007, Lisbon, Portugal.

Analysis of the statistical links between socio-systems, technical systems and vineyard durability in Loire valley

Thiollet-Scholtus, Marie¹; Valduga, Matéus²; Sarrazin, François³

¹INRA, FRANCE; ²Villaggio Grando Boutique Winery, BRAZIL; ³Groupe-ESA, FRANCE

Introduction

Recent changes of the demands of the markets for high quality food products make it necessary to adapt the organization of the farms. Terroir wines are defined by a combination of soil, sub-soil, climate and crop practices (OIV 2010). However, within the same field conditions, some vineyard areas are sustainable whereas others are not. Our hypothesis is that crop practices, combined to commercial strategies can explain these differences in vineyards areas. Research often consists, in studying the impact on the wine quality of a few practices but not the impact of the complete combination of the viticultural and oenological practices (Reynolds et al. 2007). Vineyards durability is often linked to the nearness of a consumer spot like a big city (Van Leeuwen et al. 2006). But in Loire valley, very cloth to Paris, very different vineyards areas exist: some are thriving and others are dying. Some studies emphasized how the social networks influence the adoption of more environmental friendly viticulture practices but rarely analyzed how to explain vineyards durability (Biarnes et al. 2011). We propose to analyze vineyards durability with regarding the vine system production as a sociotechnical system made up of technical and organizational elements, organized according to predefined objectives, here 'selling wines' (Chatzis 1993).

Material and methods

Vineyard durability is the vineyard variable represented by the evolution of the area and the price of one hectare of vineyard the last ten years (AGRESTE 2011), analyzed here, with a new method of pluridisciplinary. We studied four PDO vineyards areas in the Loire valley (Sancerre, Touraine, Chinon and Muscadet). First step of the method is a sociological survey of the farming systems (90 wineries) and a technical survey of the practices (79 plots). The second step is the combined analysis of the surveys: (i) A sociological typology of the farms was get performing a literal analysis. (ii) Next, plot practices were distinguished according to the sociological typology, thanks to univariate statistical analysis.

Results

We shown viticulture and oenology practices are not the same in the different sociological vineyard systems identified in the four areas in Loire valley. Touraine and Muscadet are vineyards where area and price of vineyard is decreasing, whereas area and price of vineyard are stable in Chinon and increase in Sancerre. These results show different practices between the four vineyard areas. For the red and the white wines of the four PDO vineyard, multivariate analysis of 20 viticulture and 28

Table 1. Sociological typology of winegrowers in the four Loire areas.

Areas	Touraine		Muscadet		Chinon		Sancerre		Total	
	Number	%	Number	%	Number	%	Number	%	Number	%
Premium ¹	5	16	2	7	6	43	12	80	25	28
Direct selling ²					6	43			6	07
Direct and bulk selling ³	14	45	17	57	2	14			33	37
Bulk ⁴	8	26	11	37					19	21
Members of a coop ⁵	4	13					3	20	7	08
Total	31	1	30	1	14	1	15	1	90	1

¹ Winegrowers use combinations of several business to sell their wines: to restaurants, by exportation, directly to the customers, and a very small part to wine merchants

² Most of the wines are sold directly to customers in the winery

³ Winegrowers use combinations of direct sell to the customers and to wine merchants

⁴ Most of the wines are sold to wine merchants

⁵ Most of the wines are sold to a wine coop

oenology practices show that the principal practices to distinguish a successful from an unsuccessful wineries are (i) oenology practices: harvest, blending tanks of wine, alcoholic fermentation temperature, duration and use of new oak for maturation of the wine, and then (ii) viticulture practices dealing with yield management, winter pruning, age of the vine, soil cover crop and vineyard canopy management. A second result is that five different sociotechnical systems are present but are not spread out equally in Loire valley. The sociological systems can be distinguished mainly by the marketing of the wines (Tab. 1). The relevance of the vineyard durability seems to be linked to the percentage of the wine that is sold to the bulk market (Touraine and Muscadet). On the opposite, Combining different markets with only a small part to wine merchants allow vineyard areas like Chinon and Sancerre to sell high value wines to good prices and get funds to invest and develop the winery.

Conclusion

Success of vineyard systems is a combination of technical and marketing strategy factors. The results could help designing more efficient vineyard systems combining quality wines and economically sustainability. Performance of linking vineyard durability to practices is important to make vineyard areas adapt to new constraints. But getting the data can be a limit of the pluridisciplinary method.

Up-scaling from field to farm scale : analysis of the conversion pathways to organic farming to support farmers Application to vineyard systems

Merot, Anne¹; Gary, Christian¹; Wery, Jacques²

¹INRA, FRANCE; ²Montpellier Supagro, FRANCE

Introduction

Concerned by the impacts of agriculture on the environment, the number of farms engaged in an organic conversion process has increased exponentially these last few years (in France from 1995 to 2007, organic vineyard areas have been multiplied by 4.6). Some advisers are worried about the sustainability of farms which convert without being sufficiently prepared, especially as the knowledge and tools needed to monitor such a change are not all operational. In fact, the result of the conversion would therefore depend on the way to convert the system. In the case of perennial vineyard systems, the question of how to convert is all the more substantial that these perennial systems are characterized by high inertia. Most of studies on organic farming proposed a comparison between conventional and organic farming (Lamine and Bellon, 2009). Not much attention has been given to the conversion pathway towards organic farming. In

this work, we presented the preliminary results of the analysis of conversion pathways focusing on technical and organisational changes from field to farm scale based on a hierarchical approach of the vineyard system.

Methods

15 vineyard farms (south of France) in the process of conversion to organic farming were surveyed. They were chosen so as to cover a diversity of soils, climates, pests risks, crop area and type of vine. The survey focused on five aspects: farm history and constraints, crop management, biophysical indicators used for vineyard management, farm layout and field diversity, changes between conventional and organic farming (each year from conventional to organic farming). A hierarchical analysis (Merot et al., 2009) was used as a framework to formalize changes in farmers' crop management sequence and organization in space and time.

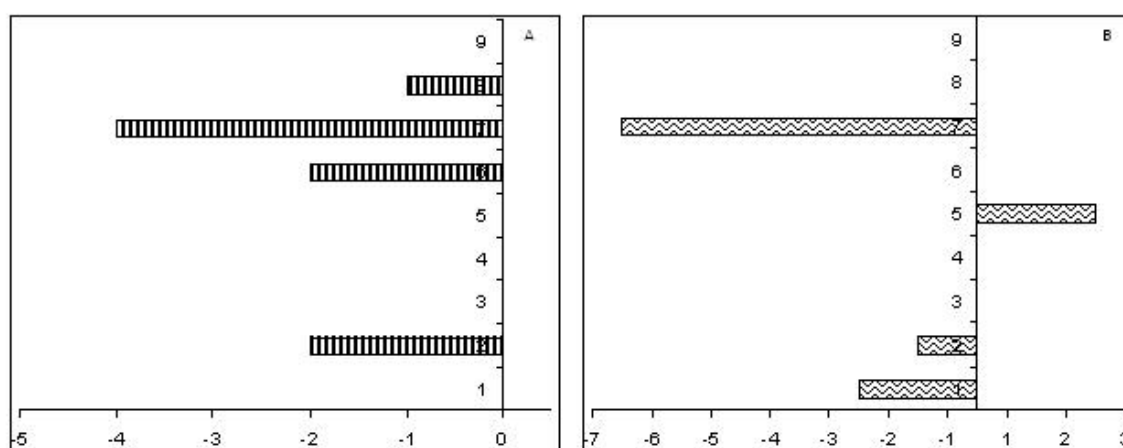

Figure 1: This figure presents for each of the farm surveyed the gap of FC² (figure 1a) and SCMS¹ (figure 1b) between conventional and organic organizational system.

¹ SCMS = number of specific management sequences

² FC = number of fields characteristics used to adjust average crop management sequence into specific management sequences which let to define the number of hierarchical levels of the cropping system

Results and Discussion

Based on the average crop management sequence in the farm, the variables taken into account by the farmer to adjust this average sequence into specific crop management sequences in the various fields were examined before and after conversion. We compared two organizational indicators SCMS₁ and FC₂ before and after conversion (Figure 1). The figure 1b showed that the number of crop management sequences SCMS tends to increase towards conversion to organic farming in particular for farms N° 6,7 and 8 which are associated to more intensively changed technical conversion. We identified nine main variables that implied adjustments of the average management sequence into specific crop management sequences : soil water characteristics, vegetative development of leaves and branches, powdery mildew sensitivity, windy pressure, distance between two rows, weeds pressure, micro-temperature, wine moth pressure vegetative development of buds. In fact, the field diversity (FC – figure 1a) taken into account by farmers in organic farming is more important for nearly half of the farms analysed. These farms are those who performed conventional practices far from organic farming.

Conclusion

We presented here the preliminary results of our study. In fact, the results still need to be analysed to relate these changes to technical changes and identify types of conversion pathways based on all these changes. However these results showed a complexification of the farm organization during the conversion according to the number of hierarchical levels in the system managed by farmers.

References

- Lamine, C., Bellon, S. (2009). Conversion to organic farming: a multidimensional research object at the crossroads of agricultural and social sciences. A review. *Agron. Sust. Dev.* 29 : 97–112
- Merot, A. et al. (2009) Designing innovative cropping systems requires the simulation of its biophysical and technical components in interaction: illustration on vineyards. *Farming System Design*, 21-23th August. Monterey, USA.

Agronomical analysis of Life-Cycle Assessment results (LCA) variability for different horticultural cropping systems at regional scale

Perrin, Aurélie¹; Basset-Mens, Claudine¹; Yehouessi, Wilfried²; Huat, Joël³; Gabrielle, Benoit⁴; Malézieux, Eric¹

¹CIRAD, FRANCE; ²Université d'Abomey – Calavi, BENIN; ³CIRAD, BENIN; ⁴AgroParisTech, FRANCE

At the regional scale, it is speculated that some practices existing in current cropping systems (CS) may be optimized to promote 'innovative' CS that result in better environmental outcomes. Since horticultural systems show peculiar conditions of production, especially for developing countries, researches are needed to investigate the room for improvement. This study examined the environmental impacts of CS representative of tomato production in the coastal area of Benin. The authors proposed to analyze the environmental impacts of their agricultural managements with the help of Life-Cycle Assessment and typology. By analyzing the factors governing the variability of environmental impacts across the diverse systems types, this study aimed to identify the CS specificities that were likely to influence environmental impacts of the tomato CS of Benin. The tomato production in the coastal area of Benin during the 2011 dry season was selected as a case study to explore the variability of CS at the regional scale. 12 fields were selected considering location and irrigation systems diversity. Each agricultural operation occurring in the field was quantified during the full crop-cycle, from nursery to harvest. LCA was performed for each of the 12 fields studied using the ReCIPE methodology. This study related all resource consumptions and emissions to 1 ha of land occupied by

tomato production. To construct homogenous groups of fields from their environmental impact, a two-step statistical treatment was used, involving Principal Component Analysis (PCA) and Hierarchical Clustering on Principal Component (HCPC). We finally performed LCA for the 4 clusters obtained from the HCPC. The PCA led to the identification of 11 major impact categories responsible for the environmental impact variability at the regional scale (table 1). LCA results of the 4 clusters allowed for identification of correlations between their environmental impact and their CS specificities (figure 1). Cluster 1 and 2 gathered fields with manual irrigation systems or hose irrigation systems with significantly lower value for the number of irrigation events and the amount of water supplied than the overall population ($V\text{-test} > |2|$). Cluster 1 showed the lowest impact for categories correlated to dim.2 and the second lowest impact for other impacts. Cluster 2 showed significantly higher values for insecticides rates and the frequency of fertilization. Cluster 2 also showed significantly lower values for sowing date. Cluster 2 ranked first for impact categories correlated to dim.2, second for FE and showed the lowest impact for other categories. LCA results analysis highlighted insecticide applications (Cypermethrin) and poultry manure N emissions as main contributors. Cluster 3 and 4

Table 1 Impact categories correlated to the 3 first dimensions of the variability (correlation factor ~ 1) expressed by the Principal Component Analysis

Impact categories		Units	Correlations		
			Dim.1	Dim.2	Dim.3
GWP	Climate change	kg CO2 eq	0.989	-0.127	-0.046
OD	Ozone depletion	kg CFC-11 eq	0.953	-0.283	0.075
HT	Human toxicity	kg 1,4-DB eq	0.937	-0.312	0.134
POF	Photochemical oxidant formation	kg NMVOC	0.972	-0.179	-0.12
TA	Terrestrial acidification	kg SO2 eq	0.395	0.782	-0.199
FE	Freshwater eutrophication	kg P eq	0.283	0.368	-0.816
ME	Marine eutrophication	kg N eq	0.308	0.822	-0.247
TET	Terrestrial ecotoxicity	kg 1,4-DB eq	0.017	0.859	0.35
FET	Freshwater ecotoxicity	kg 1,4-DB eq	0.079	0.894	0.285
MET	Marine ecotoxicity	kg 1,4-DB eq	0.946	-0.286	0.128
FD	Fossil depletion	kg oil eq	0.961	-0.269	0.007

Figure 1. Hierarchical tree presenting the 4 clusters with positive (+) or negative (-) variations for the dimensions of PCA (a) and associated environmental impact for categories of major concern for the variability at regional scale expressed as the percentage of the maximal impact obtained for

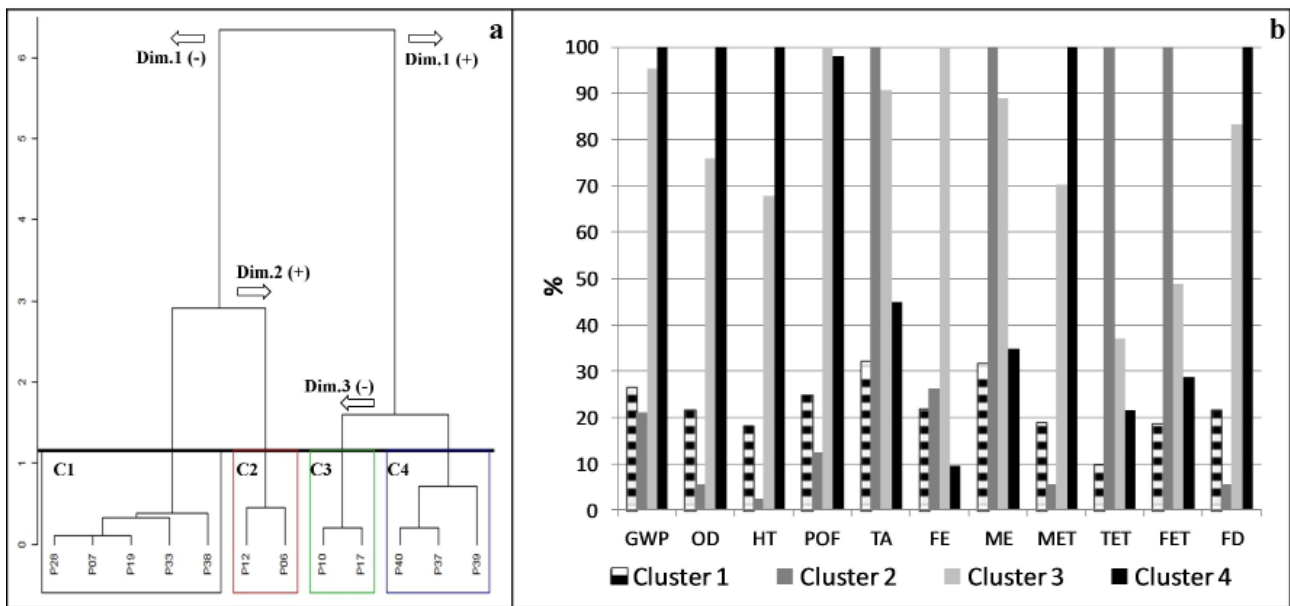

ranked first and second for impact categories correlated to dim.1. Cluster 3 showed significantly higher values for mineral nitrogen rates. LCA results analysis highlighted the high impact of NPK manufacturing along with irrigation machinery. Cluster 4 showed significantly higher value for the number of water pumping hours and the amount of water supplied. The contribution of irrigation machinery clearly dominated for most of impact categories. This study identifies irrigation systems, irrigation practices and sowing date as characteristics of major concern for the environmental impact of tomato cropping

systems at the regional scale. It also pinpoints specific inputs that are likely to influence the environmental performances of those systems. CS improvement should focus on timing and methods of application for those specific inputs to reduce the losses to the environment. Currently LCA is a limited tool to assess CS as methods do not consider timing and applications methods in the calculation of inputs losses. This study highlights the need for improved methods using models including daily-step dynamics depending on crop growth, soil type, climate and irrigation practices.

Roots as interface between crops and metal-polluted soils in phytoremediation

Bandiera, Marianna¹; Lucchini, Paola¹; Mosca, Giuliano¹; Vamerali, Teofilo²

¹University of Padova, ITALY; ²University of Parma, ITALY

Introduction

A recent branch of phytoextraction has involved crop species which can take up inorganic pollutants from contaminated soils, later removed through the harvestable biomass (Vamerali et al., 2010). It is well-known that soil management and agricultural practices may contribute greatly to plant establishment, and even more so under severe metal contamination (e.g., Marchiol et al., 2007). In particular, enhancement of root colonisation seems to be an essential trait (Vamerali et al., 2009), but little information is currently available on the real contribution of roots in phytoremediation. We present here some results on the root growth of field crops cultivated in soil contaminated by pyrite cinders and heavy metals, in order to establish possible criteria for species selection and soil management in phytoremediation programmes.

Materials and methods

Two experiments were carried out on severely metal-contaminated pyrite cinders collected from a site at Torviscosa (Udine, Italy) below a 0.15 m layer of unpolluted soil. Zinc was 2,410, Cu 2,726, As 892, Pb 495, Co 102 and Cd 5.1 mg kg⁻¹. Root growth of sunflower, alfa-alfa and fodder radish was studied in rhizoboxes with the same stratigraphy as that of the site (0.15 m of capping

soil), in comparison with cinders only and unpolluted soil (control). At the site, the roots of these species, together with that of Italian ryegrass, were studied under 0.3 m deep ploughing (mixing the layers) and ripping (maintaining stratigraphy, which led to lower metal pollution in the shallow layer). Root length was recorded by root traces in rhizoboxes, and destructive sampling and image analysis in both experiments.

Results

In pot cultivation, pollution caused a significant reduction in root length (-63%, mean of species) and of growth rate in pyrite alone, whereas the presence of the unpolluted capping layer generally minimised phytotoxicity (Fig. 1). Fodder radish showed the greatest root length in pots and Italian ryegrass in the field. In the capped treatment, roots tended to colonise the top 0.15 m layer more, with a length fraction of ~90% compared with 80% of pyrite alone and 50% of the control. This defensive behaviour was also observed in the field experiment, but seems to be counterproductive for metal capture. Both the total root length and the length fraction exploring the polluted layer were positively correlated with metal concentrations in shoots ($R^2 = 0.54$ and 0.56 , respectively). In the field, roots generally acted as a huge sink for metals and this fits the poor translocation to the above-ground compartment, except for Cd (28%) and Zn (14%). Tillage choice was not

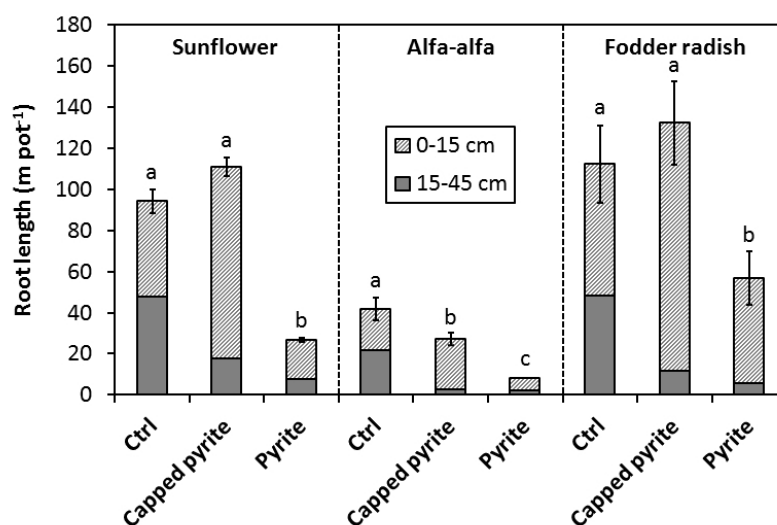

Fig. 1. Pot experiment: root length in 2 depth intervals for crop species ($n = 3$, \pm s.e., Newman-Keuls test).

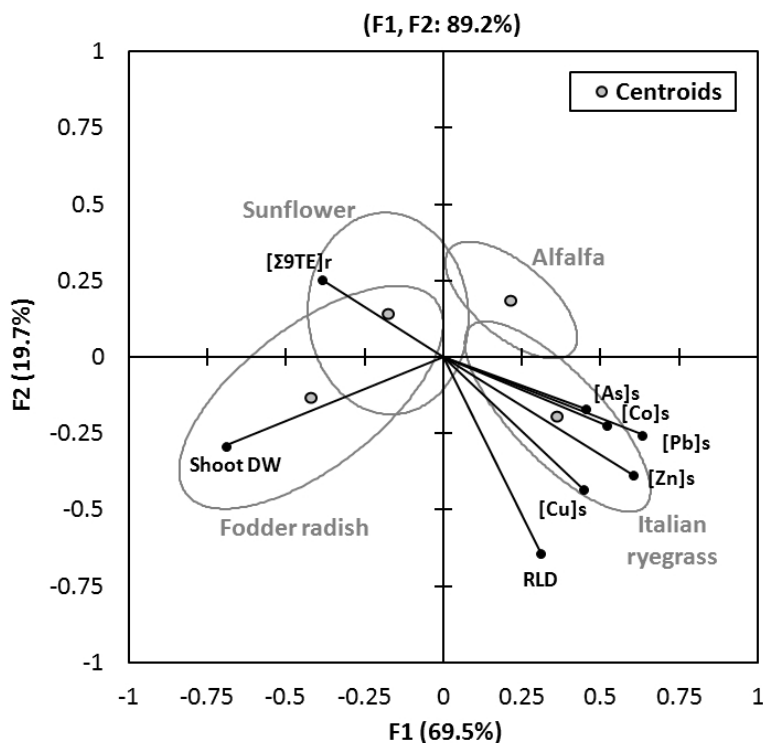

Fig. 2. Field experiment: principal component (black) and discriminant (grey) analysis for species in pyrite cinders. Variables analysed: shoot dry weight, root length density (RLD), shoot (s) metal concentrations, and summation of 9 metals in roots ($[\Sigma 9 TE]r$).

critical for root growth, but maximum depth was limited to 0.3 m. The best, but still poor, metal removal was achieved by fodder radish, thanks to good productivity (Fig. 2) and lower root sensitivity to pollution (higher root length standardised on the control).

Conclusions

Root development is clearly involved in mechanisms of adaptation of field crops in polluted sites. The greater relative RLD and above-ground productivity (with respect to the control) found in fodder radish, seem to be reliable tolerance indexes and criteria in selecting species for improving phytoextraction and at the same time guaranteeing better waste cover and stabilisation. In this regard, agricultural practices (e.g., humic acid and auxin applications) may help to overcome the poor root expansion which crops show in extreme soil conditions.

References

- Marchiol et al., 2007. Removal of trace metals by *Sorghum bicolor* and *Helianthus annuus* in a site polluted by industrial wastes: A field experience. *Plant Physiol. Biochem.* 45: 379-387.
- Vamerali et al., 2009. Phytoremediation trials on metal- and arsenic-contaminated pyrite wastes (Torviscosa, Italy). *Environ. Pollut.* 157: 887-894.
- Vamerali et al., 2010. Field crops for phytoremediation of metal-contaminated land. A review. *Environ. Chem. Lett.* 8: 1-17.

Use of leaf fluorescence and hydroponics for screening of waterlogging tolerance in barley

Bertholdsson, Nils-Ove

Swedish University of Agricultural Sciences, SWEDEN

Introduction

Barley is very susceptible to waterlogging and is one limiting factor influencing barley production worldwide. In China and Japan it is one of the major objectives in barley breeding programs and with expected climate changes its importance will increase also in Europe and other parts of the world. Today waterlogging is supposed to reduce yields with 20-25%, but could exceed 50% depending on stage of development. Similar to other abiotic stresses waterlogging tolerance is a complicated trait and the lack of useful efficient selection methods is an obstacle in breeding programmes. Any soil saturated with water became quickly anaerobic, a condition that can be devastating to barley growth at any growth stage. Genotypic variation for tolerance to waterlogging has been observed and methods used are mainly indices based on leaf chlorosis and germination ability. However, there is a need of more accurate and fast selection methods. Most studies are done with waterlogged soils, although the use of hydroponics could be an interesting alternative. Cultivation in O₂ depleted nutrient solution is the ultimate waterlogging system that can be carefully controlled contrarily to if soil is used. The objective of this study was therefore to develop a method based on hydroponically grown material.

Materials and methods

As a measure of effects of waterlogging or in this case low O₂ concentration, leaf fluorescence was used. Leaf fluorescence is a very fast way to observe stress effects on the photosynthetic pathways. A reference material of 12 cultivars with a difference of 40% in waterlogging tolerance based on studies in water logged soil was used when developing the screening method. A waterlogging index was calculated as the mean seedling weight of waterlogged plants/control plants x 100 in pots with soil. The index was then used to optimise the parameters of the hydroponic system until a good correlation ($r=0.93$, $df=10$) was obtained between the two different ways of measuring waterlogging tolerance.

Results and Discussion

Furthermore, in a screening of 205 Nordic old and new barley cultivars, interesting trends have been observed. In Sweden, the release of new cultivars until 1960th has resulted in less waterlogging tolerant cultivars. However, during the last 40 yrs this trend has changed. In Norway the increasing trend is even more obvious and could be related to the fact that the precipitation in April, May and June increased by 56% in e.g. the Trondheim area. These

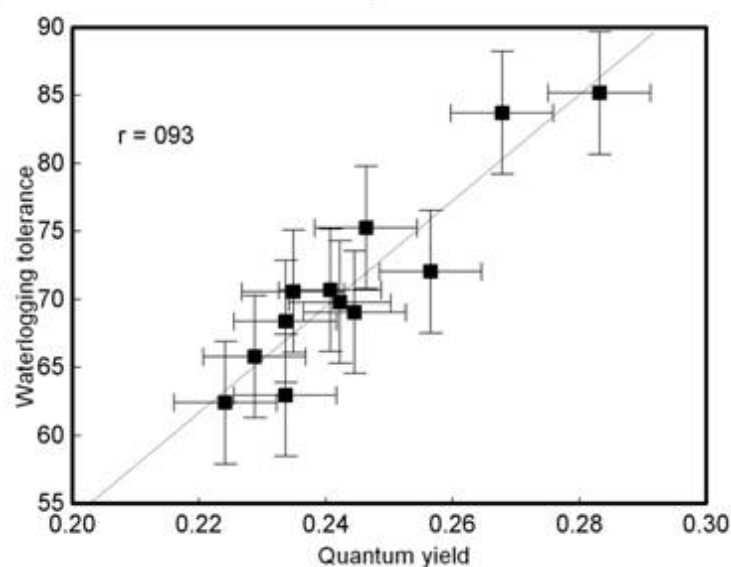

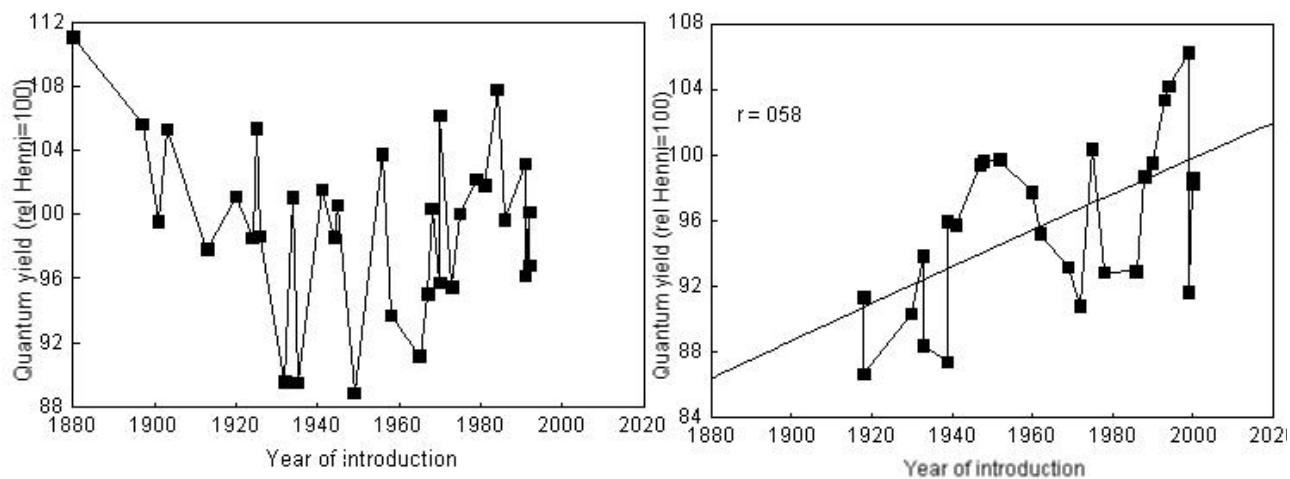

results support that breeding may inadvertently help adapting to changes in the climate, but a direct selection should probably be more efficient. Besides, there is no conflict between breeding for high yield and high waterlogging tolerance as shown by a positive relation

between grain yield and waterlogging tolerance index of 12 cultivars tested during five years official variety testing in Sweden ($r=0.67$, $df=10$). It is suggested that the hydroponic method could be used either for screening or for phenotyping of populations for developing QTL markers.

Winter Wheat Seedling Emergence from the World's Deepest Sowing Depths

Schillinger, William; Mohan, Amita; Gill, Kulvinder
Washington State University, UNITED STATES

Introduction

Farmers in the low-precipitation (<300 mm annual) region of the Pacific Northwest USA practice a 2-yr tillage-based winter wheat (*Triticum aestivum* L.) – summer fallow rotation. Winter wheat (WW) is sown deep into moisture in late August or early September and seedlings emerge through as much as 160 mm of dry soil cover. These are the deepest sowing depths for wheat anywhere in the world. Rain showers that occur after sowing create fragile soil crusts that the emerging first leaf often cannot penetrate.

Materials and methods

A rainfall simulator was used to conduct a 5-factor factorial laboratory experiment to evaluate emergence of WW sown deep in pots. Factors were: (i) rainfall intensity and duration (1.25 mm/hr for 3 hr, and 2.50 mm/hr for 2

hr); (ii) timing of rainfall after sowing (1, 3, and 5 d after sowing + controls); (iii) cultivar (standard-height vs. semi-dwarf), (iv) residue on the soil surface (0, 840, and 1680 kg/ha); and v) air temperature (21 and 30 degrees C).

Results and discussion

The high-intensity rain caused a 2.3-fold reduction in emergence compared to the low-intensity rain. Emergence improved proportionally with increasing quantities of surface residue. The standard-height cultivar had four times greater emergence than the semi-dwarf. Air temperature and timing of rainfall had no significant effect on WW emergence. Results show that sowing a WW cultivar with long coleoptile and first leaf as well as maintaining high quantities of surface residue to intercept rain drops will enhance WW stand establishment after rain showers to benefit both farmers and the environment.

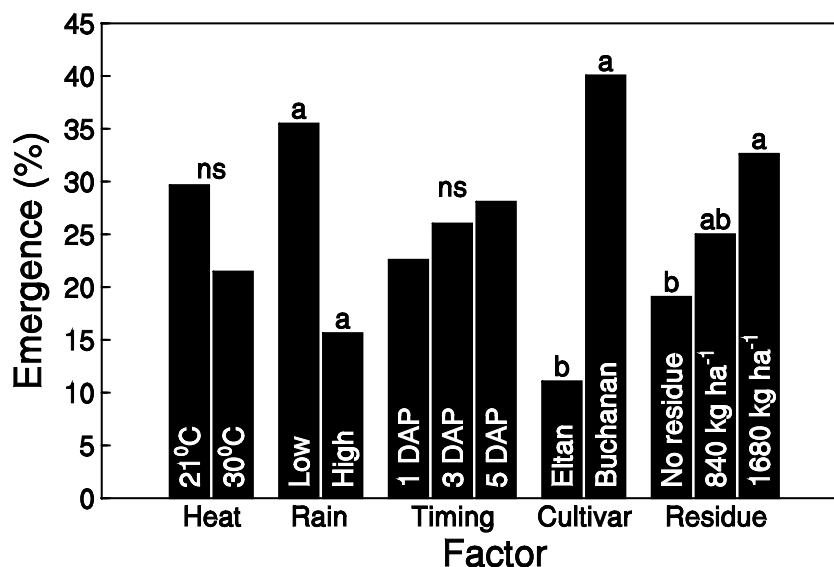

Figure 1. Percent emergence of winter wheat planted deep into pots as affected by air temperature (heat), rainfall intensity, rainfall timing, cultivar, and surface residue. Data are the average from three runs. Winter wheat emergence in the control pots averaged 86 percent. DAP = days after planting.

Conclusions

In conclusion, fragile soil crusts formed on silt loam soils after low intensity rainfall impede emergence of WW planted deep into summer fallow in eastern Washington. Crusts formed in this study were almost imperceptible and, although soil penetration resistance could not be measured with the available penetrometers, rainfall after planting had a marked negative impact on WW seedling emergence. Of the five factors evaluated, only cultivar selection and quantity of surface residue can be controlled

by the farmer. Data conclusively show that when rainfall occurs after planting and before emergence: (i) the stand-height cultivar had an overall four-fold increase in seedling emergence compared to the semi-dwarf cultivar, and (ii) greater surface residue led to improved seedling emergence. These results bolster work currently in progress to enhance WW seedling emergence from deep planting depths through plant breeding and other research and extension efforts to promote the adoption of conservation-tillage summer fallow.

Exogenous applied nitric oxide alleviates salt-induced oxidative stress in rice (*Oryza sativa* L.)

Zavareh, Mohsen; Asadi-Sanam, Samaneh; Hashempour, Abuzar; Ghasemnezhad, Mahmood
The University of Guilan, IRAN (ISLAMIC REP)

Introduction

Rice, as a salt sensitive species has long been affected by soil and water salinity. The loss in plant productivity due to salinity is a consequence of osmotic and ionic effects (Ashraf 2009) resulting in the overproduction of reactive oxygen species (ROS) such as superoxide ($O_2^{\cdot-}$). A large body of evidence has demonstrated that the antioxidant systems play important roles in protecting plants against oxidative damage induced by salt stress (Dionisio-Sese & Tobita 1998).

Nitric oxide (NO) is believed to act as a signal molecule mediating responses to both biotic and abiotic stresses in plants (reviewed in Crawford & Guo 2005) including oxidative stress (Shi et al. 2005). However, until now little is known about the influences of exogenous NO treatment on oxidative damage and antioxidant enzyme activities in leaves of rice under salt stress.

The aim of the study was to determine whether sodium nitroprusside (SNP), as an NO-donor, activates protective responses to salt stress by enhancing the activity of antioxidant enzymes and improving physiological responses. If successful, SNP can be used to alleviate plant damage caused by ROS.

Methodology

Seeds of two rice (*Oryza sativa* L.) cultivars (Khazar and Goohar) were surface-sterilized and placed on top of sterile filter paper moistened with deionized water and incubated at 27 °C for 72 h in dark to germinate. Germinated seeds then were sown in plastic pots containing perlite and allowed to grow in a growth chamber with 26/22 °C day/night temperature.

After 15-d growth, healthy and vigorous seedlings of both cultivars were selected to impose treatments (no added-SNP and -NaCl; 50 µM SNP; 50mM NaCl, and 50mM NaCl + 50 µM SNP) Each treatment was replicated at least three times with 100 seedlings. At three day after initiating treatments, the leaves of uniform rice seedlings were collected and immediately preserved in liquid N_2 and stored at -80 °C prior to assays of physiological parameters and antioxidant status.

The electrolyte leakage was determined as described by Dionisio-Sese and Tobita (1998). The level of membrane damage was determined by measuring malondialdehyde (MDA) as the end product of membrane lipid peroxidation. Enzyme activity was measured at 25 °C using a spectrophotometer. Superoxide dismutase (SOD), and Peroxidase (POD) activity of the leaves extracts as well as chlorophyll and proline contents, also were measured. Data were subjected to analysis of variance (ANOVA) followed by Duncan's multiple range test mean comparison at $p < 0.05$.

Results and Discussion

Results revealed that salt stress will lead to increase in electrolyte leakage, lipid peroxidation and proline content as well as to decrease in the chlorophyll content of both rice cultivars leaves. The inhibitory effects of NaCl stress on rice seedling were decreased when they treated with a combination of NaCl and SNP. This was supported by reduction in electrolyte leakage, malondialdehyde (MDA) content and proline accumulation as well as increasing in chlorophyll content. Meantime, the application of the nitric oxide donor increased the activities of antioxidant enzymes, including superoxide dismutase (SOD) and peroxidase (POX). This improved activity resulted to quenching the salt stress induced increase in reactive oxygen species. Overall, it could be concluded that exogenous nitric oxide can effectively protect rice seedlings from oxidative damage caused by salt stress.

References

- Ashraf M. 2009. Biotechnological approach of improving plant salt tolerance using antioxidants as markers. *Biotechnol. Adv.* 27: 84–93.
- Crawford NM & Guo FQ. 2005. New insights into nitric oxide metabolism and regulatory functions. *Trends Plant Sci.* 10: 195–200.
- Dionisio-Sese ML & Tobita S. 1998. Antioxidant responses of rice seedlings to salinity stress. *Plant Sci.* 135: 1–9.
- Shi S et al. 2005. Protective effect of nitric oxide against oxidative stress under ultraviolet-B radiation. *Nitric Oxide.* 13:1–9.

Avenues for improving the productivity of irrigation at different scales

Villalobos, Francisco¹; Orgaz, Francisco²; Testi, Luca²; Mateos, Luciano²

¹IAS-CSIC and University of Cordoba, SPAIN; ²IAS-CSIC, SPAIN

Irrigated agriculture demands more than 70–80% of fresh water in the arid and semi-arid areas. Management of irrigation in an era of water scarcity will have to maximize its productivity which we have analyzed at the crop and basin scales. Transpiration is coupled with carbon assimilation as stomata are the common pathway for water vapor and CO₂ fluxes. Tanner and Sinclair showed that the ratio of biomass accumulation and transpiration (Water Use Efficiency, WUE) is inversely related to Vapor Pressure Deficit (VPD). The productivity of applied water is defined as $IWP = HI WUE (AE - E/I)$ where HI is the Harvest Index, AE is the application efficiency, E is soil evaporation due to irrigation and I is applied water. Improvements of IWP may be achieved by changes related to the crop (HI, WUE) or to irrigation management and design (AE, E). The search for improved WUE at the leaf scale, including the promise of incorporating drought resistance using biotechnology, has received special attention for the past 30 years but its success is not clear. However, even with the same WUE at the leaf scale, we may take advantage of the effect of VPD on WUE by using available water when it is more efficient. For instance, olive trees under deficit irrigation (DI) show higher WUE than well irrigated trees at the daily scale while the instantaneous response is very small. This is explained by a different distribution of daily transpiration which is shifted to the morning (low VPD) in the case of deficit irrigation. The same applies for seasonal irrigation management as concentrating water deficit in the summer will improve the WUE of the crop.

Breeding programs should incorporate performance under cold conditions to allow growing crops when VPD is low. Improving maximum HI is no longer an option in breeding for most annual crops. DI may improve HI in indeterminate crops and tree crops by reducing vegetative growth. Poor crop management may be a key limiting factor of IWP by reducing HI below its potential value. AE is a function of irrigation uniformity and applied water. For maximum efficiency we need to

schedule irrigations to minimize losses. There is a trade-off between uniformity, water deficit and percolation. The lower the distribution uniformity the lower the AE required to not surpass a target deficit coefficient. Converting surface to pressurized irrigation serves both for increasing uniformity and for simplifying irrigation scheduling but requires more energy. Deficit irrigation increases AE by reducing losses, contributes to a higher soil water uptake, but may not be sustainable due to salinization.

Reduction of E may be achieved by lower irrigation frequency or smaller wetted area. The lower E of drip irrigation may be offset by a high irrigation frequency. However, subsurface drip irrigation systems with almost nil E have been adopted. The large variability in IWP implies that better management and DI will contribute to higher IWP by affecting HI, AE and E.

Israelsen defined irrigation efficiency (IE) as the ratio of the irrigation water consumed by the crops in an irrigation system to the water diverted into that system. The concept was revised when the potential value of water used but not consumed was considered. Objective assessment of IE must be based on a clear definition of the spatial and temporal boundaries of the system. Interventions or irrigation practices that improve system performance at the scale of a given domain may have little or no impact on irrigation performance at other scales. Global efficiency will increase along with on-field efficiency only if intra-system reuse is small. In closed basins (no discharges of usable water even in the wet season) the only way to increase water availability is reducing the consumptive use.

In conclusion, increases in the productivity of irrigation may come from improved management and better irrigation systems, taking into account irrigation performance at the basin scale.

Is intercropping an efficient solution to design low input systems?

The examples of durum wheat-grain legume and sunflower-soybean intercrops

Bedoussac, Laurent¹; Journet, Etienne-Pascal²; Tribouillois, H el ene²; V ericel, Gr egory²; Champclou, David²; Land e, Nathalie³; Justes, Eric²

¹ENFA, INRA, FRANCE; ²INRA, UMR1248 AGIR, FRANCE; ³CETIOM, FRANCE

Introduction

Increasing concerns about global change and environmental impacts of agriculture require transformation of actual cropping systems towards enhanced sustainability. One solution could consist in intercropping (IC) i.e. growing simultaneously two or more species in the same field for a significant period [1]. This practice aims at eco-functional intensification for increasing resources use efficiency by positive interspecific interactions, including facilitation [2]. Many studies have shown advantages of grain legume-cereal IC in comparison to their sole crops (SC) in low input systems [3; 4] while few papers are available about sunflower-soybean IC [5; 6]. IC efficiency is based on complementarity in resource use (light, nutrients and water) due to species differences in aerial and root system architecture, growth dynamics and the ability of the legume to fix atmospheric N₂. The main objective of our studies was to analyse the dynamic functioning of durum wheat-grain legume (pea or faba bean) winter IC and sunflower-soybean summer IC in order to further design adapted IC systems. Thus, we evaluated the potential advantages of these two types of IC for global yield, grain quality and N acquisition depending upon cultivars, species and sowing pattern.

Materials and methods

Durum wheat-grain legume field experiments have been carried out at INRA Toulouse (SW France) since 2005 using a wide range of IC combinations (wheat varieties, legume species and N treatments). In IC, species were sown at the same time at half of the SC densities and in alternate rows. Sunflower-soybean field experiments have been carried out at CETIOM and INRA (SW France) in 2010 and 2011 with cultivars of various precocities to modify species maturity gap. Two spatial patterns were sown, alternating 2 sunflower rows with 2 or 4 soybean rows.

Biomass production, grain yield and accumulated N were dynamically measured together with light absorption, grain protein content and the percentage of N derived from N₂ fixation (%Ndfa). The land equivalent ratio (LER) was calculated as an indicator of IC efficiency [7].

Results and discussion

Our results indicate that for both IC types the best performances were obtained with no or low amounts of N fertilizer. This is partially due to the high %Ndfa of the legume in the IC leading to: i) more soil mineral N available for the associated non-legume crop and ii) higher wheat grain protein content in IC vs. SC (12.7% vs. 11.8% on average; Fig 1). Conversely, in high N input conditions, LER was lower or equal to 1 due to strong interspecific competition of wheat or sunflower on legume, in particular for light. For cereal-grain legumes IC the highest LER values and

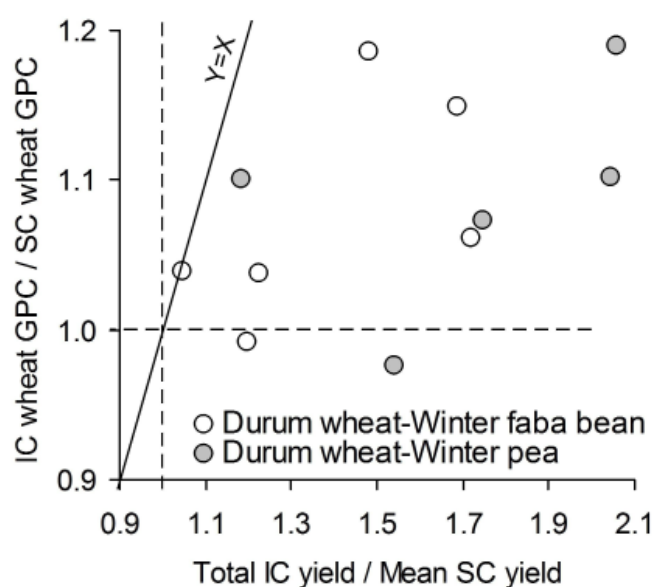

Fig 1. Durum wheat grain protein content (GPC) in intercrop (IC) divided by that in sole crop (SC) as a function of the total IC grain yield (durum wheat + legume in Mg ha⁻¹) divided by the mean grain yield of SC durum wheat and SC legume (faba bean or pea) for organic experiments in SW France. Values are means (n=3).

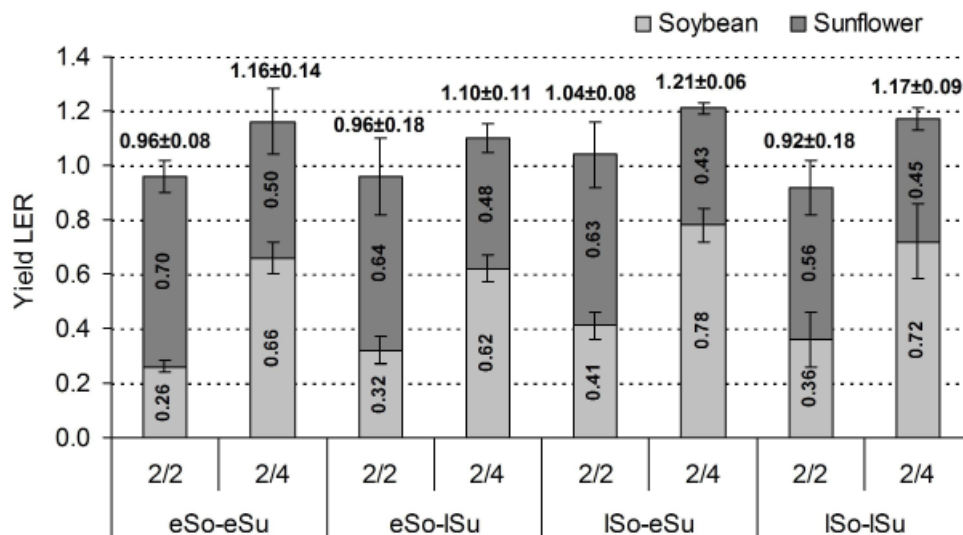

Fig 2. Partial land equivalent ratio (LER) for soybean (So) and sunflower (Su) for INRA Auzeville 2010 experiment calculated from grain yield for early (e) and late (l) cultivars for the 2 sunflower rows with 2 soybean rows pattern (2/2) and the 2 sunflower rows with 4 soybean rows pattern (2/4). Values are means (n=3) ± standard deviation.

wheat grain protein content were obtained when applying a late and moderate amount of fertilizer N together with using wheat cultivars of high protein content potential or not too competitive (small with few tillers). For sunflower-soybean IC, the 2-4 pattern combining the latest soybean and the earliest sunflower was the most efficient (LER = 1.21; Fig 2) because it allowed re-equilibrating interspecific competitions leading to resources use optimisation.

Conclusion

Our work confirms that IC is particularly suited to low N input systems due to the complementary use of N sources for both winter and summer intercrops. However, before proposing optimised cropping systems further research is still needed on genotype-environment interactions in order to analyse the effects on IC performances of: i) precocity, ii) aerial architecture, iii) row structure and iv) N management.

References

- [1] Willey and Osiru; 1972; J. Agric. Sc. 79: 517-529
- [2] Altieri; 1999; Agric. Ecosyst. Env. 74: 19-31
- [3] Bedoussac and Justes; 2010; Plant Soil 330:19-35
- [4] Hauggaard-Nielsen and Jensen; 2001; Field Crops Res. 72:185-196
- [5] Echarte et al.; 2011; Field Crop Res. 121:423-429
- [6] Olowe and Adebimpe; 2009; Biol. Agric. Hort. 26: 365-377
- [7] Bedoussac and Justes; 2011; Field Crops Res. 124:25-36

Multi-targeted assessment of reduced tillage cropping systems for the near future in European agriculture

Landé, Nathalie¹; Sauzet, Gilles¹; Dulos, Léa¹; Leterme, Philippe²

¹CETIOM, FRANCE; ²CETIOM, INRA, AGROCAMPUS-Ouest, FRANCE

Introduction

Environmental impacts of agriculture are an increasing concern that requires transformation of actual cropping systems with focus on enhanced sustainability. Agricultural policies are based on several directives and programs (see table 1) aiming to achieve certain environmental goals by managing farmers' practices. Thus, the cropping system seemed to be the most suitable scale to implement several technical solutions and to identify their synergies, antagonisms or cumulative effects [2]. The aim of our study is to evaluate how we can conciliate innovative technical solutions (e.g. reducing tillage, reducing mineral nitrogen fertilisation, modifying rotation, etc.) to achieve goals in agricultural policies such as improving energy efficiency, reducing greenhouse gas emission or pesticides use by designing innovative multi-targeted cropping systems.

Materials and methods

The user-centered method [1], applied to agronomical approaches [4; 2] was used to design, by prototyping, two innovative cropping systems which were implemented in 2009 in oceanic climate: i) a 6-year system in a sandy clay/lime soil (site 1) and ii) a 5-year system in a sandy silt loam soil (site 2). Each innovative cropping system was compared to its respective conventional cropping system using a randomized design with three replications. Each year, all crops of each cropping system were tested allowing multiyear comparison. According to assigned policy objectives, we established a minimum set of indicators (see table 1) to evaluate these cropping systems, then completed by performing a sustainability evaluation using MASC® model [3]. These indicators allow the overall assessment of the cropping systems and also their evolution by launching a second wave of design according to Vereijken's methodology.

Table 1: Policies, goals, main strategies applied, selected indicators with their assigned objectives and temporary results (temporary progression to objectives based on 2- year data (adjusted threshold = 100%), and cropping system values (INN = innovative, CON = conventional).

POLICIES PROGRAMS LOBBYING	GOALS	Main applied STRATEGIES	Selected INDICATORS and assigned objectives	2-year results (% objective achievement)	
				Site 1	Site 2
EUROPEAN DIRECTIVE 2009/28/EC	Energy efficiency	- Reducing tillage	Energy efficiency (/ha) = inputs (fuel, N, pesticides) / outputs (crop yield) <i>Obj: +20%</i>	243% INN: 8.8 CON: 5.9	20% INN: 9.5 CON: 9.1
	Less Greenhouse Gas emissions (GHGE)	- Reducing mineral N - Favoring N absorption	Greenhouse gas emissions (kg CO₂- eq/ha) <i>Obj: -50%</i>	63% INN: 1750 CON: 2547	43% INN: 1698 CON: 2168
ECOPHYTO 2018 : French program to reduce use of pesticides	Less pesticides	- Applying integrated pest management principles (IPM) - Modifying rotation	Pesticide use = number of pesticides full application <i>Obj: -50% of governmental regional reference</i>	38% INN: 4.4 CON: 5.4	7% INN: 3.7 CON: 3.8
NITRATES DIRECTIVE 91/676/EEC	Less nitrates	- Reducing mineral N - Favoring N absorption	Mineral Nitrogen input (kg/ha) <i>Obj: -30%</i>	116% INN: 109 CON: 168	80% INN: 99 CON: 130
European tendency: Eurostat survey – agricultural statistics	Less labour time	- Reducing agricultural practices: tillage, plant protection...	Hour income (€/h) = Labour time (h/ha) / Income (€/ha) <i>Obj: French legal minimum x 3 = 27 €/h</i>	0% INN: -46 CON: -33	808% INN: 218 CON: 208
French farmers' wishes	Maintain farmer income	- Maintaining or alternative productivity	Yield (% to reference) <i>Obj: 100%</i>	96% INN: 96 CON: 100	88% INN: 88 CON: 100
Brundtland report - United Nations	Sustainable development	<i>a posteriori</i> assessment	Global sustainability (MASC® value) <i>Obj: 100%</i>	60%	60%

Results and discussion

The complete assessment of cropping systems will be achieved in 2015, but based on midterm results (see table 1) we can already identify some methodological points that need particular attention. (a) Results show great sensitivity to the site conditions. We note that all the indicators shown in site 1 seem better than in site 2 (except for the economic one); this probably results from the indicators level achieved by the reference system which is always inferior in site 1. (b) Moreover, some indicators presented partial fulfillment of goals, e.g. reducing mineral nitrogen fertilisation, while others will need longer time to be achieved, e.g. reducing pesticides use. This is probably partly due to the fact that the biological processes that can be effective in the IPM strategy (natural regulation allowed by enhanced biodiversity) need a longer time to be implemented than the improvement of nitrogen fertilization through leguminous introduction. Thus, managing heterogeneous speeds of progress is a challenge in testing and improvement of cropping systems.

Indeed, we have to make the choice between two possible strategies for the further development of our cropping systems. We can (a) go on with the novel solutions already implemented to allow all the biological effects become effective or (b) abandon some of the currently implemented innovations as ineffective, and develop alternative innovations.

Conclusion

By testing and assessing global cropping strategies, our experiments will help policy makers and farmers in their choices. The assessment shows that the design methodology we have applied is effective, even if all goals cannot be achieved. Some important methodological points are highlighted which will contribute to the advancement of agronomic research.

References

- [1] ISO 13407: 1999; Human centered design processes for interactive systems
- [2] Debaeke *et al*; 2009; Agron. Sustain. Dev. 29:73–86
- [3] Sadock *et al*; 2009; Agron. Sustain. Dev. 29:447–461
- [4] Vereijken; 1997; Eur. J. Agron. 7:235-250

Indicating Processes and Performances of Agrosystems : a framework based on a conceptual model and its use in vineyards fields.

Wery, Jacques¹; Coll, Patrice²; Delbac, Lionel³; Guilpart, Nicolas⁴; Fermaud, Marc³; Metay, Aurélie¹; Smits, Nathalie²; Thiéry, Denis⁵; Mérot, Anne²

¹Montpellier Supagro, FRANCE; ²INRA, FRANCE; ³INRA ISVV, FRANCE; ⁴INRA IFV, FRANCE; ⁵INRA, ISVV, UMR 1065 SAVE, FRANCE

Introduction

Developing and managing eco-efficient cropping systems (4) that produce higher output with less input, requires agrosystems with the following attributes: (i) complexity due to the increasing number of biophysical components in interaction to be considered ; (ii) dynamic, in a changing environment at different time scales ; (iii) multiscale and hierarchy, combining biophysical and technical dimensions at field, farm and landscape levels. Their management and design requires sound indicators of their behaviour in the face of diversity (soils, climate, plant, pathogens, farm type).

Methods

We propose a framework to design, test and use such indicators, which is based on the conceptualization protocol of an Agrosystem (5) and currently implemented on vineyards in transition towards organic or integrated farming (AIDY project). The various types of indicators and their use are summarized in table 1 and illustrated with typical examples (Table 1). The basis of the framework is that an indicator must be designed with regards to (a) the specific aspect of the system for which it provides information, (b) the way to collect and analyse information and (c) the targeted actors/decision. Analysis Indicators must be evaluated for their ability to quantify the system basic processes, either in absolute term or in comparison with a reference system (8). Management Indicators need to improve the system management for a limited cost in term of observation, sampling and analysis.

Assessment Indicators must provide scientifically credible information on the performance of the system or on its impacts/services for other systems in a form that can be understood by a stakeholder or a decision maker.

Results and Discussion

Analysis indicators

Example 1a is a short term dynamic daily time step indicator of the soil water deficit experienced by a vineyard and its impact on source-sink relationships (7). It can be derived from field measurement or simulated with a model. Example 1b is an indicator of nitrogen stress experienced by the vine (NNI). It is calculated from the ratio between the actual N content of grapevine aerial parts and a minimal critical N content to elaborate a given biomass (2). Example 2 is a long term dynamic indicator of the soil quality, the Maturity Index, based on abundance and biodiversity of non pathogenic nematodes (3). It is obtained by field sampling and indicate the intensity of physical and chemical perturbations of the soil.

Management indicators.

Example 3 is an expert-based approach for the management of two of the major pathogens of grapevine: powdery mildew and downy mildew (6).

Assessment indicators

This type of indicators has been widely developed for the assessment of environmental performances of cropping and farming systems (for example 4 the Indigo method

Table 1: a framework to design, test and use indicators of a cropping system (XXX: importance of the criteria, ---:not needed).

Type of Indicator	Indicate...			To be assessed for...			Examples
	For Whom	For What	At which scale	Scientific relevance	Cost-Benefit efficiency	Communication effectiveness	
Analysis	Researcher	Understand system's processes/properties	Field, Landscape	XXX	X	---	Ex. 1 a and b Ex. 2
Management	Farmer, Adviser	Characterize system's behaviour	Farm	X	XXX	---	Ex. 3
Assessment	Adviser, Stakeholder, Policy maker	Assess performances and impact on other systems	Farm type, region	XX	X	XXX	Ex. 4 Ex. 5

recently adapted to vineyards, ref 1). Example 5 is the Evaluation Index of Damage in Cluster (EIDC) that can be used to assess the efficiency of crop protection strategy on grapevine cluster (Delbac et al., this volume).

Conclusion

This framework can be used to conceptualize, design and assess an indicator on the basis of its targeted use, its scientific relevance with regards to the aspect of the agrosystem it is supposed to indicate and the distance between the indicator and the functional variable best quantifying the process. It is currently tested in vineyards, in order to help monitor the transition of a farm toward organic farming (AIDY project) or to prototype low input systems (EcoViti project).

References

1. Bockstaller C. et al., 2008. ASD 28:139-149.
2. Celette F, 2007. PhD thesis, SupAgro, Montpellier, France.
3. Coll P. et al., 2012. Nematology (in press).
4. Keating B. et al., 2010. Crop Science 50:109-119.
5. Lamanda N. et al., 2012. EJA 38:104-116.
6. Léger B et al., 2010. pp. 246-269 In: B. Manos et al. Edts IGI Global, Hershey, USA,
7. Pellegrino A. et al., 2006. EJA 25 : 49-59.
8. Wery, J., 2005. AJAR 56:1201-1209.

Effectiveness of intercropping for plant disease suppression – a meta-analysis

Dong, Yan¹; Zhang, Chaochun²; van der Werf, Wopke³; Tang, Li¹; Zhang, Fusuo²

¹Yunnan Agricultural University, CHINA; ²China Agricultural University, CHINA; ³Wageningen University, NETHERLANDS

One of the benefits of diversified crop systems is a reduction in plant disease. But how large is the effect in different pathosystems (combinations of crop system and pathogen species)? We assembled 58 case studies from Yunnan province, China, and conducted a meta-analysis to estimate the size of the effect of intercropping on disease incidence and disease index, an ordinal measure for severity. Case studies were selected from international and Chinese peer-reviewed literature, and from MSc and PhD theses from reputed research groups. While there is very little peer-reviewed literature in English, a large number 53 of peer-reviewed articles in Chinese contained quantitative data that were amenable to meta-analysis. Data were analyzed, focusing on diseases in intercropping systems of glutinous and hybrid rice, wheat and faba bean, and maize and chili pepper. Twenty one different diseases were analyzed. The effect of intercropping on disease incidence was significant in 57 of the 58 studied

pathosystems. The grand mean reduction in disease incidence was 37.5 percent, with the largest effect identified for rice blast, caused by *Magnaporthe grisea*, on glutinous rice, *Oryza sativa*, in rice-rice intercropping. Disease incidence increased significantly with amount of nitrogen fertilizer in three out of 21 pathosystems, while the effect of intercropping on wheat powdery mildew, *Blumeria graminis f. sp. tritici*, changed significantly with amount of nitrogen fertilizer. The effect of intercropping was in most cases a delay in the epidemic, with the greatest effect sizes measured early or mid-way during the epidemic, and smaller effects measured later on. These results demonstrate that the effect of intercropping on disease incidence is not limited to few special cases, but is – in fact – a widespread phenomenon that holds promise for strengthening disease suppressiveness in modern sustainable agriculture.

New Cropping Systems under environmental constraints: First results of *ex post* assessment

Colnenne-David, Caroline¹; Grandeau, Gilles¹; Doré, Thierry²

¹INRA - UMR Agronomie INRA-APT, FRANCE; ²AgroParisTech, FRANCE

Introduction

To meet changing economical and agricultural goals, innovative cropping systems that account for actual on-farm constraints need to be proposed. Because models do not take into account all the components of agroecosystems, long-term field trials are necessary to assess performances (Debaeke et al., 2009). We are assessing *ex post*, through a long-term experiment, four innovative cropping systems designed to meet various environmental and yield objectives.

Material and methods

Three out of the four systems must (i) meet one of the following constraints (no pesticide use (No-Pest), or lessen by half greenhouse gas (GHG) emissions (L-GHG), or halve fossil energy consumption (L-EN), and (ii) be environmentally friendly as well as (iii) guarantee as high a yield as possible. A fourth system (PHEP) was designed to reach environmental and production goals with no major constraint. The far-reaching objective is to improve systems of cereal-based rotations in northern Europe. The innovative systems were conceived by prototyping (Loyce and Wery, 2006). The most relevant scenarios are being tested in a field trial, located in Grignon, France (N 48.84, E 1°57) on 6.5 ha simulating farm conditions over a 10-year period. Three replications of each system have been randomly distributed. First results involve data from 2008/09 to 2012 and analyzes were carried out only on an incomplete rotation (three out of the five or six crops have been evaluated). The GES'TIM database (2010) and IPCC coefficient (2007) were used to calculate GHG emissions as well as energy consumption. The INDIGO tool (v.1.9) was used to calculate six agro-ecological indicators. The agronomical performances of the cropping systems were recorded.

Results and discussion

In the L-GHG system plots, the aimed decrease in GHG was partly reached (mean = -23% over a 3-year period). In 2009 and 2011, unforeseen agronomic practices, such as some herbicide applications, or a minimum tillage before maize sowing, explained higher than estimated direct GHG emissions. In the L-EN system plots, the energy constraint was nearly fulfilled (mean = -42% over a three-year period). In 2009, direct energy consumption was higher than projected due to additional plowing. All four innovative cropping systems were environmentally-friendly in terms of crop biodiversity, nitrogen pollution, phosphorus applications, pesticide use, energy consumption, and soil fertility. Over the 2008/09-2012 period, all cropping systems reached the overall targeted yields; however, there were variations in this depending on the crops. Whatever the cropping system, cereals (except maize) and oleaginous crops yields were systematically higher than expected. On the contrary, faba bean yields were lower. For example, in 2011, in one No-Pest plot and one L-GHG plot, faba bean yields were respectively 0.3t/ha and 0.7 t/ha instead of the expected 4.7 t/ha, due to aphid attacks. Even if all measurements are not yet available (e.g. *ex post* assessments have been carried out on an incomplete rotation), the first results of *ex post* assessments were satisfying. The program will be discussed from agronomic and methodological points of view: (i) Is it possible to reach both high environmental and yield objectives? (ii) Are the given agricultural practices all that innovative? (iii) The available models and tools only partially take into account the biogeochemic mechanisms involved in these systems (i.e., N₂O emission): What sort of tool do we need to assess these systems?

References

- Debaeke et al., 2009. Iterative design and evaluation of rule-based cropping systems: methodology and case studies. *Agron. Sustain. Dev.* 29. 73–86
- Loyce and Wery, 2006. Les outils des agronomes pour l'évaluation et la conception de systèmes de culture. *L'agronomie d'aujourd'hui*, QUAE, 77-95

Effect of Residue Management and Nitrogen Fertilization on Maize Production

Biau, Anna; Santiveri, Francisca; Lloveras, Jaume
University of Lleida, SPAIN

Introduction

Crop residues incorporated into the soil favorably influences its organic matter (OM) contents, soil structure, nutrient storage and, other determinants of soil productivity (Parr and Papendick, 1978). Maize residues returned to the soil also contribute to carbon (C) sequestration and help to reduce the release of greenhouse gases emissions. However, it has been an increasing pressure to use maize stover for biofuels, without pays much attention to the sustainability of the agricultural soils (Wilhelm, et al., 2004). In Spain, maize producers have become increasingly concerned about nitrogen (N) use due to the regulations of EU nitrate directives and the increases in the price of N. Interactions between crop residue management and N fertilization could therefore help to improve N use efficiency and C sequestration while increasing crop production. The objective of this study was to evaluate the effects of incorporating or removing crop residues under maize production and their possible interaction with the N fertilization.

Methodology

Two field experiments (Field 1 and Field 2) were conducted for two years (2010 and 2011) under sprinkler irrigation

in the Ebro Valley (Spain). The maize residue (stover) management consisted in two treatments (incorporation or exportation). The N treatments consisted in 50 m³ ha⁻¹ of cow slurry (CS) (about 290 kg N ha⁻¹) and mineral N fertilization rates of 0 (control), 100, 200 and 300 kg N ha⁻¹. Maize grain yield, biomass at maturity, plant N uptake, soil NO₃-N and OM were measured before maize seeding and after harvest. In order to evaluate the cumulative effects, the plots were randomized in the first year and, each year received the same treatments.

Results and discussion

The initial maize stover was incorporated in the soil or removed in December 2009 (15100 and 16500 kg ha⁻¹ of dry matter in Field 1 and Field 2, respectively). The experiment results of 2010 were summarized because the stover management did not affect the maize production. The average grain production in 2010 was 14.2 Mg ha⁻¹ and 17.3 Mg ha⁻¹ in Field 1 and Field 2, respectively. The stover production (2010) was 15775 and 18890 kg ha⁻¹ in Field 1 and Field 2, respectively. In 2011, maize yield showed differences among N treatments (Table 1).

As far as the N fertilizer, in 2011 only treatment No with the residue incorporates (Field 2) had a significant lower production, 5 Mg ha⁻¹ less than the other mineral

Table 1. Effect of stover management (incorporated or removed) in maize grain yield production. Almacelles, 2011.

N Rates (kg ha ⁻¹)	Yield (Mg ha ⁻¹) Field 1		Yield (Mg ha ⁻¹) Field 2	
	Residue incorporated	Residue removed	Residue incorporated	Residue removed
0	14.2	17.5	11.0	13.8
100	15.1	18.6	17.1	18.6
200	18.8	18.8	20.0	18.8
300	18.6	18.8	20.0	19.9
Cow Slurry	19.1	20.3	16.7	18.1
Average	17.2	18.8	17.0	17.8
ANOVA				
Block	NS		NS	
Stover	NS		NS	
Error a	-		-	
N rate	0.002		0.0001	
Stover*N rate	NS		NS	

Table 2. Effect of stover management (incorporated or removed) and N fertilization in soil residual N-NO₃⁻ after harvest, Almacelles, 2011.

N Rates (kg ha ⁻¹)	Residual N-NO ₃ ⁻ (kg ha ⁻¹). Field 1		Residual N-NO ₃ ⁻ (kg ha ⁻¹). Field 2	
	Residue incorporated	Residue removed	Residue incorporated	Residue removed
0	154	280	143	97
100	228	451	80	85
200	601	521	116	115
300	752	648	237	249
Cow Slurry	276	272	133	144
Average	402	434	142	138
ANOVA				
Block	NS		NS	
Stover	NS		NS	
Error a	-		-	
N rate	0.0001		0.005	
Stover*N rate	NS		NS	

N fertilizer treatments. The grain yield in 2011 was excellent for our conditions (Table 1) mainly due to the mild temperatures during grain filling on July. The results for the other parameters measured followed the same tendency of grain yield. However, in soil residual NO₃⁻ N differences among N treatments were more evidence in Field 1 than Field 2 (Table 2). Soil OM content in the residue incorporated treatment increased slowly from 2.29% in 2009 to 2.60% in 2011 in Field 1 and, from 2.04% in 2009 to 2.20% in 2011 in Field 2.

Conclusions

In our high yield conditions, the incorporation of maize stover only affected maize yields in the low N treatments (0 and 100 kg N ha⁻¹), but not in the other treatments. The results can be attributed to the soil management during previous years; because the stover in Field 2 had been incorporated for more than 10 consecutive years, in contrast to Field 1. According to our results, the apparent benefits of incorporating crop residues, and converting them into stable OM available to the plants required

more than two years.

Acknowledgements

This research was supported by the Spanish Ministry of Education and Science. Project AGL2009-CO₂-00.

References

- Parr, J.F. and R.I. Papendick. 1978. Factors affecting the decomposition of crop residues by microorganisms. Crop Residue Management Systems. ASA Spec. Publ 31:101-129.
- Wilhelm, W.W., Johnson, J.M.F., Hatfield, J.L., Voorhees, W.B., Linden, D.R. 2004. Crop and soil productivity response to corn residue removal: A literature Review. Agron.J. 96:1-17.

Energy efficiency in cropping, including tillage systems

Pointereau, Philippe
SOLAGRO, FRANCE

Defining and developing the efficiency of agricultural systems is a priority for the future. The reason lies into the increasing energy prices -linked to the depletion of fossil fuel reserves- and the need to reduce greenhouse gases emissions. Meeting this objective requires both improvements in agricultural practices and of the management of farming systems. Regarding methodological issues, accounting and reporting procedures are key issues to assess the energy efficiency of agricultural systems. The main questions concern the energy boundaries taken into account, the farming system boundaries chosen and the indicators used. Similar methodologies have to be used in order to allow for a comparison of different results and it is also necessary to compare similar farming systems. Three scopes can be used to define energy boundaries:

- scope 1, direct energies used on farms (fuel, electricity, heat ...),
- scope 2, direct energies used by an external enterprise or collective irrigation system
- scope 3, indirect energy used to produce inputs such fertilizers, machinery or feedstuff.

The “GHG protocol corporate Accounting and reporting Standard” used to measure GHG emissions can be a reference. However, there remains uncertainty about how to include renewable energy production in the assessment (e.g.: solar dryer)? Farming system

boundaries can include crop production (e.g.: organic versus conventional, ploughing versus direct seeding and irrigated versus non-irrigated), conservation (e.g.: drying), processing (e.g.: cheese making) and marketing (e.g. : transport to the market). Different indicators can be used to measure energy efficiency. Efficiency refers to the energy consumption reported to production as tons of DM, tons of proteins or energy of the grains (e.g.: 22.73 MJ/kg of sun flower versus 13.77 MJ/kg of winter wheat) or to working unit (WU). But generally efficiency must be associated also to a production per ha of utilised agricultural area (UAA) including or not fallow, and its intensity (energy used per ha). The farm approach (multi-products) must be distinguished from the product-based approach using life cycle analysis (LCA) and allocation rules. As mineral nitrogen is the main input in cropping systems, special attention has to be paid to the fertilization and the ways to reduce mineral nitrogen. It is also necessary to clarify the energetic ratio (energy per kg of nitrogen) depending on the performance of the fertiliser factory and impacting highly the results. To analyse energy efficiency, various assessment methods exist and will be compared. Regarding the results, a great variability in energy consumption and efficiency does exist between cropping systems. These results will be analysed and compared. For example no-tillage systems reduce by half the fuel consumption. Organic cropping systems use less energy per ha of land and generally

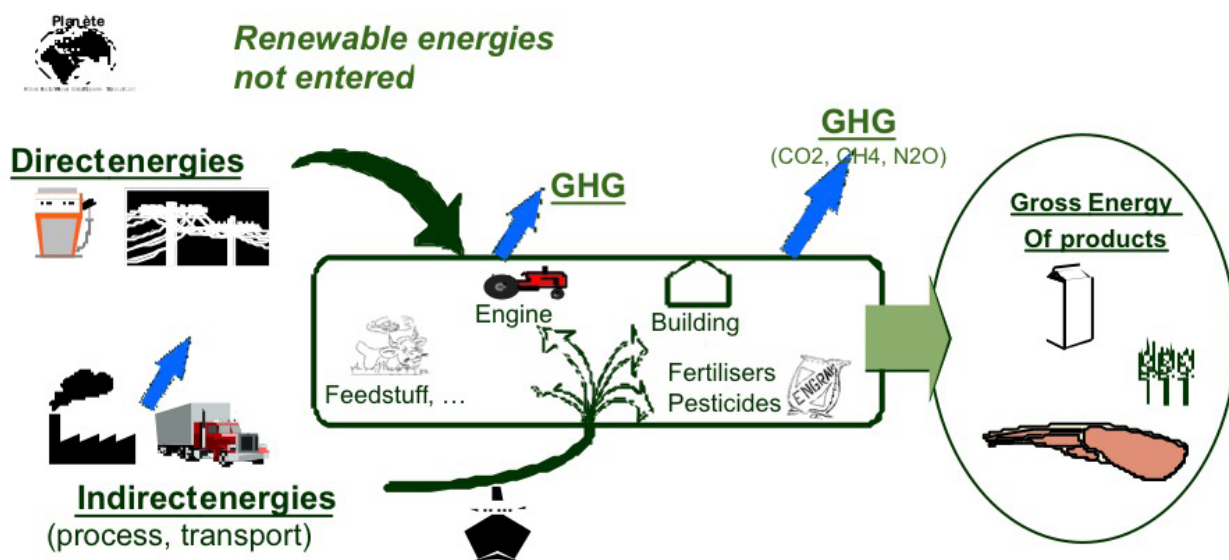

have similar or lower energy efficiency with lower yields. But efficiency also has a lot to do with the farmer's skills and interests, and global coherence of the farm. Similar conclusions apply when analysing the potential for reducing greenhouse gases emissions. Major challenges for future research concern:

- developing harmonised methodologies (boundaries, ratio, indicators)
- developing a multi-criteria analysis combining yield/energy efficiency/low input system/reduction of GHG emissions/carbon storage
- taking into account other environmental issues such as soil conservation, biodiversity and water quality, so as to not deal with energy and GHG in isolation from other environmental aspects.
- taking into account by-products (straw, green covers, agroforestry) which can be used for biogas production or in biorefineries
- identify to what extent legumes such as beans or soybean can improve a farm's energy efficiency
- Assessing mixed farming systems
- Proposing relevant climatic measures for the next CAP

An assessment of UK agriculture: emergy analysis

Topp, Cairistiona; Lamb, William; Watson, Christine
sac, UNITED KINGDOM

It is argued that the sustainability of modern day farming practices are significantly more inefficient in terms of energy use than the systems they have replaced. It is therefore key that we have tools that can be used to assess farming systems. One such tool is emergy analysis. It is a concept based in energy systems ecology and theory, and thermodynamics. In effect emergy measures the quality of different forms of energy. It expresses all the energy used (e.g. sunlight, water, fossil fuels, minerals, labour) to generate a product in units of one type of energy. It recognises the differences in quality of the energy in the different transformation processes. The key questions is whether emergy is appropriate for use in the agricultural context, both in terms of its scientific credibility and relevance to the stakeholders. Emergy analysis is similar to budgeting methods already used in agriculture. It requires that the boundaries and the flows (renewable, non-renewable, purchased and yielded emergies) are defined and performance is evaluated by a number of indices.

Here conventional agriculture has been compared with organic farming. The emergy analysis has been applied to 6 main crops managed conventionally, and a typical organic rotation (2 years red clover followed by winter wheat, winter oats, spring beans and spring barley). The overall performance of each system can be observed through their respective transformities (i.e. their efficiency in transforming energy inputs into energy yielding outputs), Fig 1. The cereal crops, in particular

winter wheat, appear to achieve the highest ratio of emergy to available energy. Sugar beet has the second lowest transformity despite a significant emergy resource burden, explained by its available energy, the highest of all the crop products. The cultivation, management and harvesting of potatoes is highly intensive and requires several high transformity resources. The organic rotation is comparable in terms of resource use to sugar beet, but as expected achieves only modest yields due to two years out of production during the ley, consequently it also has a high transformity. The results are entirely determined by the fraction of renewable resources, and the yielded emergy. The system performing highest in the fraction renewable ratio was spring barley; at 13% it draws most of its emergy from non-renewable sources, but still fares much better than the 5% achieved by maincrop potatoes. Similarly, this fraction determined the outcome of the environmental loading ratio, which was again lowest for spring barley and the cereals, and highest for the potato crop.

The emergy sustainability index considers both the environmental load and emergy yield of a process; the system performing best was again spring barley, although (excepting potatoes) there was little variation with the other crops. Despite its poor transformity, the organic rotation achieved similar results in terms of the three sustainability ratios to sugar beet and was only marginally poorer than the cereal crops in the emergy sustainability index. Yet, once economic values are taken into account

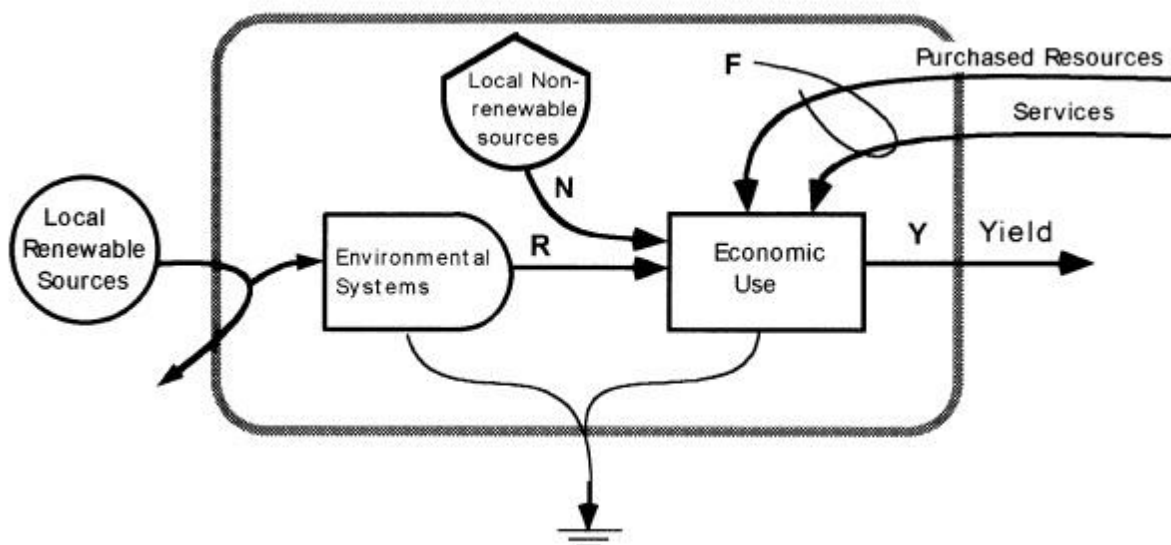

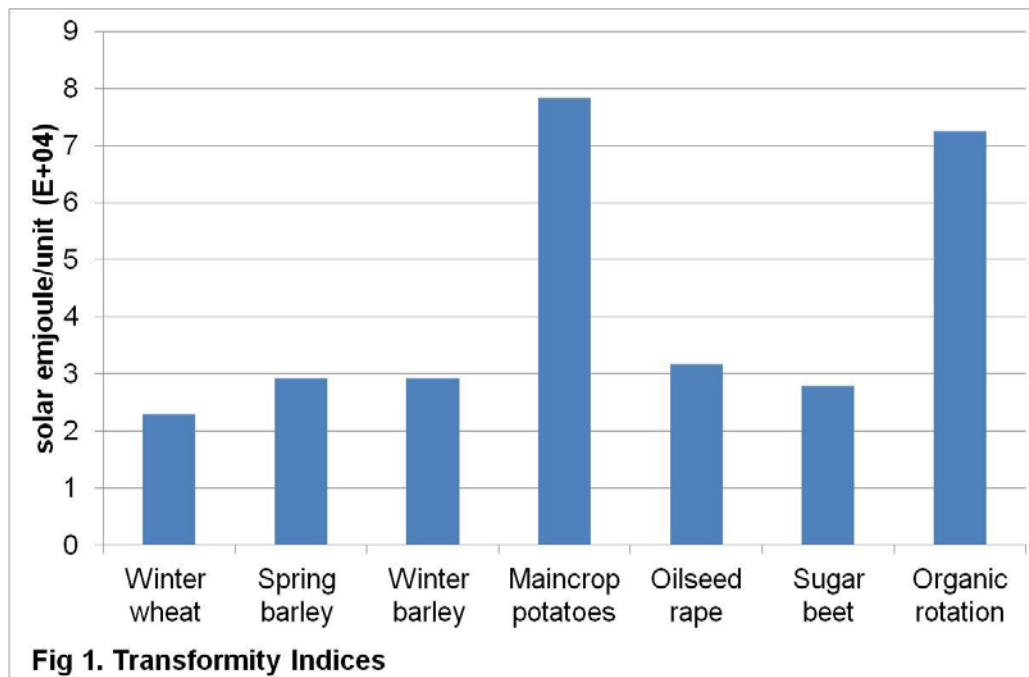

significant variation is shown. The emery exchange ratio measures the emery content per dollar of final product, using this ratio three systems appear to be undervalued for their environmental inputs: spring barley, oilseed rape and in particular, the organic rotation. Similarly, these systems achieved a low return on invested emery. A ratio less than 1 suggests less emery is paid for the yielded products than is required to run the system. Thus, oilseed rape and the organic rotation are "losing" emery to the economy, while other systems are gaining in trade,

particularly the potato and sugar beet crops. There are advantages in having a combined unit; yet there are also disadvantages as it is difficult to identify key areas for improvement of the farming system.

Reference

LAMPKIN et al 2008 Organic Farm Management Handbook, Ipswich, Farming Press.

Agroecosystem land quality and services analysis at the Central region of European territory of Russia

Vasenev, Ivan; Valentini, Riccardo; Savin, Igor

Russian Timiryazev State Agricultural University, RUSSIAN FEDERATION

Over 300-700 years of intensive agricultural land-use have caused strong agrogenic transformation of most soil cover patterns at the Central region of European territory of Russia (CRETR). The original spatial heterogeneity of forest and forest-steppe soils has been further complicated by a specific land-use history and different-direction soil successions due to environmental changes and human impacts. XXI century is characterized by aggravated conflict between different agroecosystem services and companies profitability in frame of permanent economic instability and global changes processes. Rural region sustainable development demands agroecosystem service-driven land-use planning and decision making with the quantitative analysis, modeling and prediction of agroecosystem soil cover patterns spatial variability, their principal environmental functions and land agroecological qualities. Succession analysis of modern agrogenic evolution of soils essentially increases accuracy of quantitative assessments of dominant soil forming processes (SFP) rate and potential, their influence on agrolandscape services and soil cover quality and diversity. Their results allow developing the regional and landscape adapted versions of automated systems of land agroecological evaluation (RASLEV) and demand-driven land-use DSS (LODSAL). On basis of long-term different-scale soil mapping, key plot agroecosystem investigation, land functions and agroecological quality evaluation in conditions of different land-use practices and soil-geomorphologic features the multi-factorial matrix has been developed for soil regimes, forming and degradation processes modeling with especial attention to greenhouse gases (GHG) emissions as integral indicator of agroecosystem health and principal services. Based on GIS-technologies and DD analysis the functional-agroecological typology of the zonal set of elementary soil cover patterns (ESCP) has been done in representative agroecosystems of the forest, forest-steppe and steppe

zones at the CRETR. The validation and ranging of the limiting factors of agroecosystem principal services, land functional qualities and agroecological state have been made for dominating and most dynamical components of ESCP regional-typological forms – with application of local GIS, regression kriging and correlation tree models. The outcomes of statistical modeling show essential amplification of dehumification processes due to current violation of traditional balances of organic matter. Especial attention has been done to Chernozems that unique natural features (around 1 m of humus horizon, increased content of C^{org} and favorable agrophysical features) help keeping mostly their potential fertility and agroecological functions in so unfavorable modern land management conditions. Their dehumification trend has been essentially activated for last 3-4 decades due to humus negative balance around $0.6-0.7 \text{ t ha}^{-1}\text{year}^{-1}$. “Standard” objects and generalized data showed 2-2.5 % humus lost during this period and active processes of CO_2 emission and humus eluvial-illuvial profile redistribution too. Forest-steppe Chernozems are usually characterized by higher stability than steppe ones. The ratio between erosive and biological losses in humus supplies can be tentatively estimated as fifty-fifty. These processes have essentially different sets of environmental consequences and ecosystem services that we need to understand in frame of agroecological problems development prediction. Quantitative analysis of principal agroecosystem services, active degradation processes and land qualities help developing different-scale projects for agricultural land improvement and rational land-use, taking into attention not only economical benefits but environmental functions too. The conceptions of agroecosystem services and local land resource management are becoming popular at the CRETR due to innovation application of basic agroecology and soil science achievements.

Residual soil phosphorus substantially decreases global P fertilizer requirements

Sattari, Sheida¹; Bouwman, Alexander²; Giller, Ken¹; van Ittersum, Martin¹

¹University of Wageningen, NETHERLANDS; ²Netherlands Environmental Assessment Agency (PBL), NETHERLANDS

Introduction

Significant improvements in agricultural productivity and efficiency of resource use are required to secure food production for the projected world population in 2050 (1). Phosphorus (P) is essential for plant growth and often a major limiting nutrient in agriculture (2). A substantial part of applied P fertilizer accumulates in the soil as “residual P” (2, 3) and can be taken up by crops for many years (2). Debate focuses on current P production rather than on the amounts of P required in future to feed the world.

Materials and methods

We applied the Dynamic Phosphorus Pool simulator model (DPPS) -a simple two-pool soil P model (3)- to reproduce historical continental crop P uptake as a function of P inputs (fertilizer and manure) and to estimate P requirements for crop production in 2050. Different sources of P inputs to the system have been defined in the model, i.e. fertilizer, manure, weathering and atmospheric depositions. Harvested crop P uptake and runoff are two outflows from the system. The residual P is the difference between these P inputs and P outputs(4). P inputs (excluding the runoff loss) are allocated to two dynamic P pools, namely the stable (P_s ; 20%) and the labile P pools (P_L ; 80%). Long-term crop yield, annual P fertilizer consumption and areas of arable crops (1965-2007) were obtained from FAO(5).

Results and discussion

Model simulations closely fit historical P uptake for all continents. Cumulative P inputs (4, 5) in Western Europe (1115 kg ha⁻¹) were much greater than the cumulative crop P uptake (350 kg ha⁻¹) for the period 1965-2007. Since the 1980s in much of Europe, P application rates have been reduced while uptake continued to increase. Over the same period, cumulative P input in Asia was close to 700 kg ha⁻¹, 500 kg ha⁻¹ in North and Latin America, but only 160 kg P ha⁻¹ in Africa. At the global scale, less than half of the applied P between 1965 to 2007 was taken up by harvested crops (550 vs. 225 kg P ha⁻¹). We estimate that to achieve the 2050 target production based on the Global

Orchestration scenario of the MEA(5), the cumulative P application (2008-2050) amounts to 1130 kg ha⁻¹ in Asia, 840 kg ha⁻¹ in Latin America, 690 kg ha⁻¹ in Oceania and 630 kg ha⁻¹ in North America.

Our analyses show that including residual P in the estimation of the fertilizer required to achieve the global target crop yields for 2050 leads to a reduced fertilizer requirement compared with other studies that did not account for residual P(6). In some regions, soil P status has been improved over the past decades by applying P fertilizer and manure. By contrast, in Africa due to the low rate of P input and depleted soils, more than a five-fold increase from 4 kg P ha⁻¹ in 2007 to 23 in 2050 is needed to achieve the target P uptake. We estimate that between 2008 and 2050 a global cumulative P application of 700-790 kg ha⁻¹ (1070-1200 Tg P) is required to achieve crop production according to the various MEA scenarios. We estimate that average global P fertilizer use must change from the current 17.8 to 16.8-20.8 Tg yr⁻¹ in 2050, which is up to 50% less than other estimates in the literature that ignore the role of residual soil P.

References

1. Koning NBJ, et al. (2008) Long-term global availability of food: continued abundance or new scarcity? *Netherlands Jour of Agri Sci* 55:229-292.
2. Syers JK, Johnston AE, & Curtin D (2008) Efficiency of Soil and Fertilizer Phosphorus Use. FAO.
3. Wolf J, De Wit C, Janssen B, & Lathwell D (1987) Modeling long-term crop response to fertilizer phosphorus. I. The model. *Agron Journal* 79:445-451.
4. Bouwman A, Beusen A, & Billen G (2009) Human alteration of the global nitrogen and phosphorus soil balances for the period 1970–2050. *Global Biogeochem Cycles* 23, 10.1029/2009GB003576.
5. FAO (2011) FAOSTAT database collections (<http://faostat.fao.org/default.aspx>).
6. Sattari SZ, Bouwman AF, Giller KE, & van Ittersum MK (2012) Residual soil phosphorus as the missing piece in the global phosphorus crisis puzzle. *PNAS*. doi/10.1073/pnas.1113675109.

Nitrous oxide emissions from white clover based grassland used for dairy production under moist maritime climatic conditions

Burchill, William¹; Li, Dejun²; Lanigan, Gary³; Williams, Michael⁴; Humphreys, James¹

¹Animal & Grassland Research and Innovation Centre, Teagasc, Moorepark, Fermoy, Co. Cork, IRELAND; ²Department of Botany and Microbiology, the University of Oklahoma, Norman, Oklahoma, UNITED STATES; ³Johnstown Castle Environment Research Centre, Teagasc, Johnstown Castle, Co. Wexford, IRELAND; ⁴Department of Botany, School of Natural Sciences, Trinity College Dublin, College Green, Dublin 2, IRELAND

Introduction

Nitrous oxide (N₂O) accounts for 35.6% of Ireland's agricultural greenhouse gas emissions (McGettigan et al., 2010). Grassland is an important land use in Ireland accounting for 90% of agricultural area and nitrous oxide emissions from grazed grassland is an important contributor to national emissions. There is uncertainty about the extent of annual nitrous oxide emissions from white clover-based grassland used for pasture-based dairy production. This is due to the large temporal variation attributable to varying climatic conditions and heterogeneity of N concentrations in the soil due to random distribution of excreta by grazing livestock. The objective of this study was to measure the annual N₂O emissions from white clover based grassland used for dairy production.

Materials and methods

The study was conducted at Solohead Research Farm. The predominant soils have a clay loam texture and are seasonally wet, waterlogged or flooded due to impeded drainage. Nitrous oxide emissions from (i) white-clover based dairy production system under management typical of dairy systems in Ireland and (ii) white clover-ryegrass plots receiving no input of N and not grazed (background emissions) were measured over three years between October 2009 and November 2011. The dairy production system consisted of three silage and three grazing paddock. The system was rotationally grazed by Holstein-Friesian cows at an annual average stocking rate of 2.35 cows ha⁻¹ and received annual fertilizer N inputs of 100 kg ha⁻¹. Silage paddocks were closed for first cut silage in early April, harvested in late May and used for grazing for the remainder of the growing season. Herbage

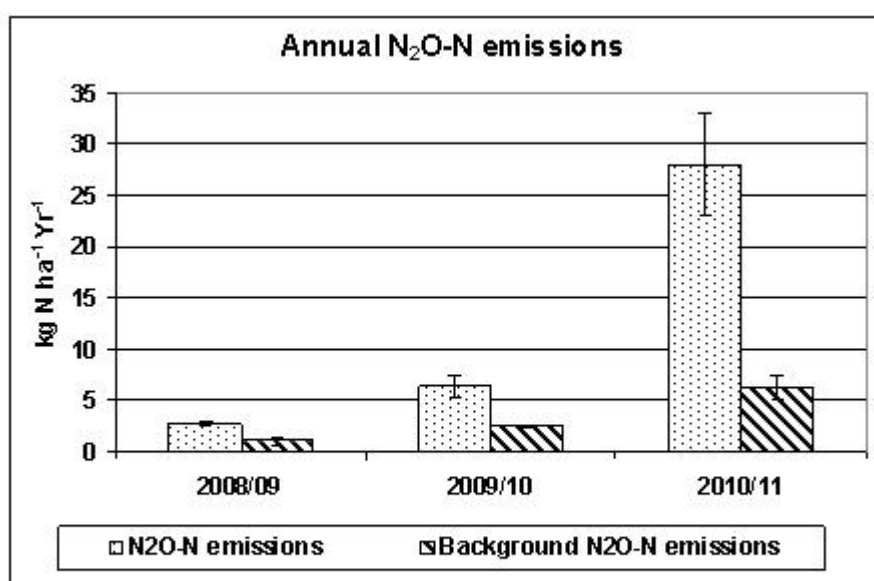

Figure 1. Annual N₂O-N emissions from the white clover based dairy system and white clover-ryegrass background plots. Errors bars represent the standard error of the mean.

was removed from the plots (11 × 3 m area) by cutting at monthly intervals. N₂O emissions were measured using five static chambers per paddock and one per plot. The N₂O sampling strategy consisted of weekly sampling with increased frequency following N fertilisation. Three gas samples per chamber were taken at 0, 15 and 30 minutes at each sampling event. Herbage mass was measured before each grazing event and the N content of herbage was subsequently determined and used to calculate annual N uptake in herbage dry matter (DM).

Results

Annual effective rainfall (mm) was 701 mm in 2008/09, 687 in 2009/10 and 394 in 2010/11. Mean annual soil temperature (°C) was 9.6, 9.2 and 8.6 for the three years respectively. Annual N uptake (kg ha⁻¹) in herbage from the dairy system was 249, 267 and 408 for the three years respectively; there was substantially higher mineralization of N in the soil in the year with low surplus rainfall (2010/11) compared with the two wetter years. This has a direct impact on annual N₂O emissions (kg ha⁻¹ of N), which were (mean ± SE): 2.7 ± 0.16, 6.4 ± 1.14 and 28.0 ± 5.01 for the three years respectively (Figure 1). N₂O emissions in year three was significantly higher ($P < 0.001$) than year one and two, which were not significantly

different from each other. Annual background N₂O emissions (kg ha⁻¹ of N) followed a similar trend with substantially higher emissions in 2010/11 (mean ± SE): 1.0 ± 0.50, 2.5 ± 0.12 and 6.3 ± 1.28 for the three years respectively. Annual N lost to groundwater was 21.3 ± 3.26 kg N ha⁻¹ with no difference between years.

Conclusion

Differences between years in annual rainfall impacted directly on the mineralization of N on this heavy soil with impeded drainage. The extent of mineralization of N in the soil was reflected in uptake of N in herbage DM and in N₂O emissions from the soil. The sharp contrast in annual emissions found in this study also suggests the need for long term studies when quantifying annual N₂O emissions from pasture-based livestock production systems.

References

McGettigan M., Duffy P., Hyde B., Hanley E., O'Brien P., Ponzi J., Black K. (2010) Ireland national inventory report 2010. Greenhouse gas emissions 1990-2008 reported to the United Nations Framework Convention on Climate Change.

Predicting olive phenology in Portugal in a warming climate

J Paulo De Melo-Abreu¹, António M Cordeiro², Frederico de Barros Maia³, Nuno W. G. Barba³, Flávio Barros², António C Ribeiro⁴, Alcinda Neves⁵, Francisco Villalobos^{6,7}, Luis F Nunes⁸, Rita M Cardoso⁹

¹ CEER, Instituto Superior de Agronomia, Technical University of Lisbon (TULisbon), Tapada da Ajuda, Lisbon, Portugal. jpabreu@isa.utl.pt, ² INRB IP. / L-INIA-URGEMP, Apartado 6, 7350-900 Elvas, Portugal, ³ Escola Superior Agrária de Santarém, São Pedro, 2000 Santarém, Portugal, ⁴ CIMO/Escola Superior Agrária de Bragança – Polytechnic Institute of Bragança, Bragança, Portugal., ⁵ FCT, Faculdade de Ciências e Tecnologia, University of Algarve, 8000-139 Faro, Portugal, ⁶ Univ. Córdoba, Apartado 3048, 14080 Córdoba, Spain, ⁷ Instituto de Agricultura Sostenible, CSIC, Apartado 4084, 14080 Córdoba, Spain, ⁸ Instituto de Meteorologia, Rua C do Aeroporto, Lisbon, Portugal, ⁹ Instituto Dom Luiz, University of Lisbon, Lisbon, Portugal

Introduction

Prediction of flowering of olive trees should account for chilling requirements, using an appropriate chilling unit for the accounting of chilling accumulation. After chilling requirements are satisfied, dormancy break takes place. Thereafter, the trees enter the forcing phase, in which the thermal time approach is used, but an appropriate base temperature must be determined. Such a model was developed, calibrated and validated for many olive cultivars (De Melo-Abreu et al., 2004).

After flowering, the occurrence of developmental stages may be predicted using a thermal time approach, but for warm regions a saw-tooth model, which is a model that reduces the effect of supra-optimal temperatures, is mandatory (Garcia-Huidobro et al., 1982).

According to the simulations of the model HadCM3, developed by the Hadley Centre, global climate warming will result in average temperature anomalies in winter, in Continental Portugal, of about 2°C, in SRES scenarios B1 and B2, 3°C in scenario A2, and 4°C in scenario A1FI, by the end of XXI century. (Miranda et al., 2006).

In this study, we discuss the prediction of flowering and subsequent phenological stages and calculate and map the times of occurrence of flowering under three warming scenarios. No flowering or abnormal flowering events are also predicted.

Methodology

The model used in the simulations of the dates of flowering and is presented in De Melo-Abreu et al., 2004. This model was included in an application, programmed in Visual Basic for Applications, that reads the temperature data and computes the date of dormancy break and full

flowering.

Maximum and minimum daily temperatures for a 30 year period (1981-2010) and 32 locations scattered around the continental part of Portugal were used as a control period (Sco). Global change scenarios compatible with SRES scenarios B1/B2, A2 and A1FI for winter in Continental Portugal (Miranda et al., 2006) were obtained by adding 2°C (Sc1), 3°C (Sc2) and 4 °C (Sc3) to both maximum and minimum daily temperatures, respectively. In Portugal, the daily temperature range has increased only in the last years (Miranda et al., 2006), and is almost undetectable in the simulations downloaded from the Ensembles Project. Also, the six 25 km-boxes that include Portugal show little differences both in maximum and minimum daily temperatures, within each scenario, in relation to longitude.

Results and Discussion

The effects of global warming on olive trees in the continental part of Portugal, for full flowering and under contrasting scenarios were presented and mapped.

The simulations show that warming, in general, results in advances of the date of flowering in all cultivars. However, responses are different for different cultivars and latitudes. In southern latitudes, for the warmest scenarios, the effect of global warming upon certain cultivars is higher than on other cultivars, and in some years no or abnormal flowering is likely to occur. 'Arbequina', 'Picual', 'Cobrançosa' and 'Galega' are likely to have an increasing number of years without flowering or with abnormal flowering. The last two cultivars are likely to have abnormal or no flowering events in more than half of the years, under Sc2 and Sc3, in most locations within the traditional olive tree growing areas.

Conclusion

In some years and scenarios, abnormal flowering or no flowering is likely to occur. 'Arbequina' and 'Picual' are likely to have less of these unfavorable events.

Acknowledgement

The present work was supported by Portuguese Foundation for Science and Technology (FCT) under Project Futurolive (PTDC/AGR-AAM/104562/2008).

References

- De Melo-Abreu, J.P., Barranco, D., Cordeiro, A.M., Tous, J., Rogado, B.M. & Villalobos, F.J. 2004. Modelling olive flowering date using chilling for dormancy release and thermal time. *Agric. Forest Meteorol.* 125: 117–127.
- GarciaHuidobro, J., Monteith, J.L. and Squire, G.R. 1982. Time, temperature, and germination of pearl millet (*Pennisetum typhoides* S. and H.). I. Constant temperature. *J. Exp. Bot.* 33: 288–296.
- Miranda, P.M.A., M.A. Valente, A.R. Tomé, R. Trigo, M. F. Coelho, A. Aguiar, E.B. Azevedo, O clima de Portugal nos séculos XX e XXI, in Santos e Miranda (eds), 2006, 47–113, Gradiva.

Simulation of climate change impacts on rice yield and pre-harvest quality in Latin America

Cappelli, Giovanni; Bregaglio, Simone; Confalonieri, Roberto
University of Milan, ITALY

Introduction

Process-based models are used to forecast the potential impacts of climate change on agricultural systems and to define adaptation strategies. In this context, crop quality represents an aspect not yet investigated (Porter et al., 2005), in spite of its importance in determining economic and nutritional product value. This study presents an assessment of pre-harvest rice quality under different climate change scenarios in Latin America. Crop quality were estimated via a collection of models relating rice grain quality with climatic factors during the ripening period. Quality variables considered were grain amylose and protein content, the occurrence of chalkiness and fissured grains, and some indices of the rice starch viscosity profile. This study intends to be exploratory with respect to rice product quality response to climate change scenarios: not considering quality could lead to possible underestimations of food security issues.

Materials and methods

The approaches found in literature were implemented in a dedicated software component (CropQuality), subsequently linked with the rice production model WARM (Confalonieri et al. 2010). Baseline climate (1989-2007) was obtained from ECMWF ERA-Interim data.

Climate change scenarios were derived for the IPCC AR4 emission scenarios A1B and B1 and two global circulation models (Hadley3 and NCAR). The analyzed time frames are centered on 2020 and 2050 (Confalonieri et al., 2012). Simulations were performed at 25x25 km spatial resolution for all Latin American rice production areas. Results were aggregated at national level using rice masks from the SAGE database. For each spatial unit and climate scenario, qualitative and quantitative aspects of rice productions were simulated considering the specific features of *Indica* and *Japonica* ecotypes.

Results

The presence of chalky grain is a negative quality factor, whereas high content of amylose and protein content increases the value of the product. Relative changes of chalky grains presence and amylose content due to climate change (A1B-2050 vs. baseline) are shown in Figure 1. On average, simulated crop yields remain practically unchanged (data not shown), whereas a general decay of rice quality variables is expected, especially in the areas where high thermal anomalies are foreseen (Brazil and Mexico). According to this study, climate change will lead to an improvement of rice quality in countries where the crop is currently experiencing sub-

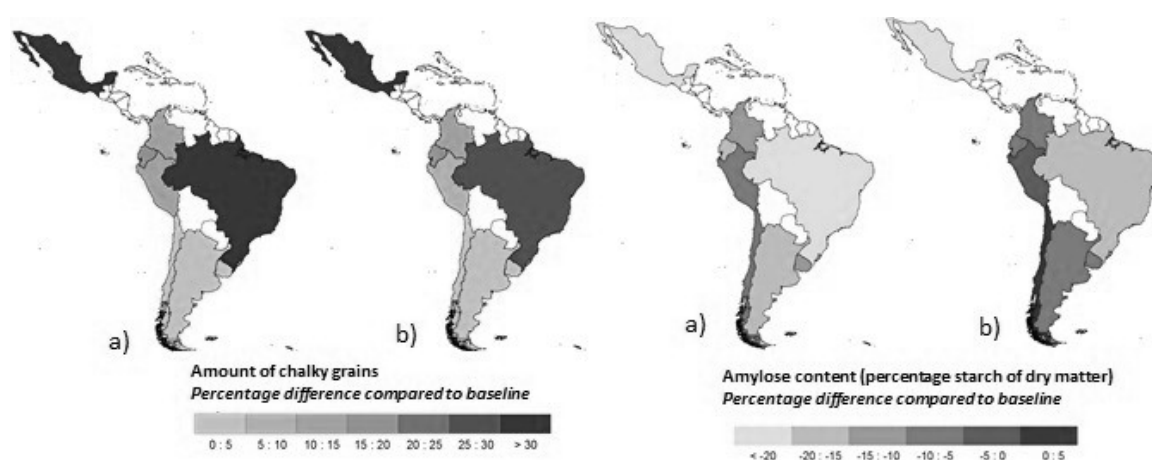

Figure 1. Percentage changes (compared to baseline 1989-2007) in chalky rice grains and amylose content for 2050 A1B scenario: a) Japonica and b) Indica ecotypes.

optimal thermal conditions (e.g., Chile). Under warmer conditions the starch composition of the *Japonica* ecotype appears more affected than *Indica*, due to the diverse optimal temperatures for starch synthesis of the two ecotypes. It can also be observed an overall increase in the occurrence of fissured kernels at harvest and in the percentage of damaged grains after milling.

Conclusion

The application of available models to assess rice quality under climate change scenarios allowed to explore the potential trend in rice quality in Latin America. Although the models used here are semi-empirical, this study demonstrated the usefulness of approaches to forecast crop quality and their potential for defining effective strategies to alleviate the expected decline in rice quality.

References

- Confalonieri, R., Donatelli, et al. Agroecological Zones Simulator: A component based, open-access, transparent platform for climate change – crop productivity impact assessment in Latin America. iEMSS 6th International Congress, Leipzig, 2012.
- Confalonieri, R. et al., 2010. A proposal of an indicator for quantifying model robustness based on the relationship between variability of errors and of explored conditions. *Ecol. Model.* 221, 960-964.
- Porter, J.R., Semenov, M.A., 2005. Crop responses to climatic variation. *Philos. T. R. Soc. B.* 360, 2021-2035.

Transition toward organic agriculture: using an agent-based model to assess possible trajectories of conversion

Delmotte, Sylvestre¹; Mouret, Jean-Claude²; Lopez Ridaura, Santiago²

¹INRA, UMR Innovation 0951 / WUR, Biological Farming System group, FRANCE; ²INRA, FRANCE

European agricultural systems face multiple challenges implying the need for ecological intensification. Organic farming (OF) has been presented as a potential alternative for such objective, however its development remain limited by technical and economic constraints (Kerselaers et al., 2007). In agricultural regions, local stakeholders who intend to support its development are in need of information about (i) the potential of conversion to OF of farmers in the region, and (ii) the impacts of such conversion on the functioning of the system (i.e. local supply chain and industry, environment and socio-economic aspects related to agriculture in the region). Also, to set-up appropriate local policies to support the conversion to OF, they need to know about the technical constraints and room for manoeuvre of the farmers. The objective of this study was to produce such knowledge to assist farmers and local stakeholders of an agricultural

region, the Camargue, southern France. To identify and assess transition pathways, we developed an agent-based model that was used with farmers to simulate, in the context of the common agricultural policy reform, different adaptation strategies. This agent based model, called IMPASIAS standing for Integrated and Multi-scale model for Participatory Assessment of Scenarios and their Impacts on Agricultural Systems (Delmotte et al., subm.), was designed for interactive simulations. The farmers play their own role by deciding for 7 to 9 consecutive years their land use (e.g. choice of area of each crop on each land) and their practices (e.g. the way the crop are grown: conventional, low input, organic). Indicators are calculated at farm and regional level after each decision, so that each farmer can analyze the results of its choice and adapt its strategy. Results for a given year depend on what was done the preceding year, as

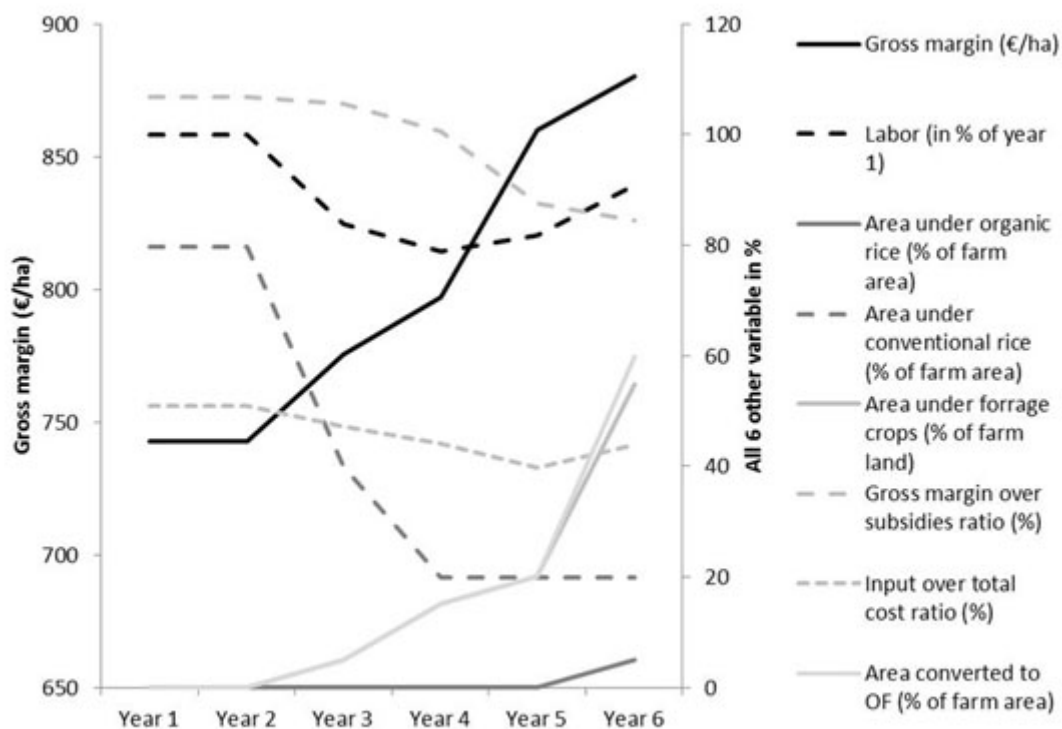

Figure 1: Evolution of seven indicators for one farm initially specialized in rice production during the conversion toward organic farming.

yield and technical practices depend on the preceding crop. 14 farmers used this model in the Camargue region to assess different strategies for the future of their farm. The figure 1 is an example of results of the model calculation that was used to discuss with the farmers of the possible strategies to convert. This example is the simulation by a farmer that was, at the time of the session, specialized in rice production (80% of its farm area in year 1 of the simulation). Its strategy to convert to OF has been to decrease the area under rice cultivation and replace it by alfalfa, which has nearly the same yield in conventional and organic farming and can be sold at a good price, which allowed him to increase the gross margin of its farm. At the end of the conversion period, he started to grow organic rice, and had decreased its dependence to inputs, subsidies and labor but also decreased its total rice production. The aggregated results (see Delmotte et al., subm.) of the different farmers' strategies through a farm typology were used to discussed with local stakeholders of the region on the advantages and drawbacks of having

more area converted to OF, which led to great discussions about the need to keep subsidies for the conversion and to support organic farmer after the conversion. In the communication during the congress, we will report with more details the different strategies assessed by the farmers as well as the discussions that these results created while presented to local stakeholders. We will conclude on the interests of such model to assess transition pathways toward agro-ecological systems in general.

References

- Delmotte et al., Subm. Multi-scale and participatory integrated assessment of scenarios of regional agriculture changes: an application to the impacts of the CAP reform in South of France. Subm. To Ag. Sys.
- Kerselaers et al., 2007. Modelling farm-level economic potential for conversion to organic farming. Ag. Sys. 94, 671-682.

Record: an integrated platform for agro-ecosystems study

Bergez, Jacques-Eric; Raynal, Helène; Garcia, Frédérick
INRA, FRANCE

Introduction

The French researcher community working on agro-ecosystems set up a 4-year project to develop an integrated modeling framework the RECORD platform (“REnovation and COORDination of agro-ecosystems modelling”). It aims at gathering, linking and providing models and companion tools to answer new society questions regarding agriculture and agro-ecosystems.

Materials and methods

During a 2-day seminar workshop gathering ca. 50 French researchers a number of requirements were raised:

1. Scope: Be able to simulate agro-ecosystems and interactions with the surrounding territory.
2. Users: i) Researchers working/designing agro-ecosystems and crop-management models, ii) Researchers using agro-ecosystem models to simulate some outputs iii) Extension service personnel to test new system proposals iv) Graduate students being trained in modeling.
3. Various formalisms: Dynamic with discrete time steps but also static and stochastic models and different formalisms.
4. Focusing on management: Be able to model technical operation sequences, competition among agricultural tasks, spatial distribution of agricultural practices and choice of crop rotations in a field.
5. Using existing models: Be able to integrate different types of models, either by recoding (i.e. completely rewriting new code) or by encapsulating existing code (i.e. dealing only with interface code).
6. Time steps: different time steps must be permitted, from minute simulation up to monthly.
7. Various spatial aggregations: from plot or a set of plots representing to farm and territory including, if necessary, interstitial areas.
8. Functioning and outputs: i) Implementation and use of optimisation methods by simulation, ii) Statistical methods for uncertainty, sensitivity analysis of models, parameter estimation and evaluating models, iii) Implementation and use of methods of multicriteria choice, iv) Comparison of cropping-systems models. Links with the R-statistical software appeared to be a key point issue for the platform.

Results and discussion

After a large survey of existing platforms we chose VLE (Virtual Laboratory Environment) (Quesnel et al., 2009) because of i) a modular approach that facilitates the reuse of modules to compose new models; ii) structural decomposition of the modeled system into sub-systems which makes management of system complexity and hierarchy easier iii) commonly-required services such as a simulation engine, numerical integration and management of inputs and outputs, iv) integration and coupling of models that are based on different formalisms, v) representation and simulation of complex systems and vi) ability to cover the entire modeling and simulation process. VLE is based on the Discrete Event System Specification formalism (Zeigler et al., 2000) that integrates two types of elementary object, “atomic” and “coupled” model. They exchange information in the form of “events”. A Graphical User Interface allows users to create and configure atomic models in the most appropriate formalism, import modules and couple models (“box and arrow”). Ordinary differential equations, difference equations, execution of activity plans based on decision rules and scheduling constraints are available. The dynamics are coded in C++, but this task is reduced thanks to code-generating plug-ins associated with the extensions.

Encapsulation methods allow integrating existing models e.g. STICS (Brisson et al., 1998). Various tools required to carry out the modeling and simulating work were missing from VLE. We developed a package enabling dynamic links between RECORD and the R statistical software and the work of calibration and evaluation of the models is done by using functions provided by the R libraries. A repository where models can be stored and accessed is also part of the RECORD project.

References

- Brisson et al. 1998 *Agronomie* 18: 311-346
 Quesnel et al. 2009 *Agronomie* 18: 311-346
 Zeigler et al. 2000 Academic Press, 510p

Bayesian calibration of the Pasture Simulation Model (PaSim) to simulate Swiss grasslands under climate extremes

Ben Touhami, Haythem¹; Lardy, Romain¹; Gilgen, Anna Katarina²; Buchmann, Nina²; Barra, Vincent³; [Bellocchi, Gianni](#)¹

¹INRA, FRANCE; ²Institute of Agricultural Sciences, SWITZERLAND; ³Clermont University, FRANCE

The Pasture Simulation Model (PaSim) is a process-based biogeochemical model for grasslands consisting of sub-models for plants, animals, microclimate, soil biology, and soil physics. It simulates water, carbon and nitrogen cycles and is used to investigate the impacts of climate change on grasslands' services in Europe. It is a parameter-rich model (~150 parameters), which is difficult to calibrate. In practice, most of the parameters are assumed to be fixed and identical for all model realizations. Other parameters, which are suitable to be fitted to the experimental data across a range of conditions, are empirically calibrated, considering the sensitivity of the model to their variation.

This study documents the calibration of 17 vegetation and site-specific parameters of PaSim (as screened and ranked for their sensitivity) at two experimental Swiss grasslands, one located in a lowland river valley (Chamau, 47° 12' 37" North, 8° 24' 38" East, 393 m a.s.l.), and the other one situated on an undulating pre-alpine plateau (Früebüel, 47° 06' 57" North, 8° 32' 16" East, 982 m a.s.l.). Bayesian calibration was chosen

because it applies to models of any type and combines model parameterization and uncertainty analysis. Prior parameter distribution (expression of current imprecise knowledge about parameter values) is updated to achieve a posterior distribution by incorporating the information contained in the measured data to reduce the uncertainty in parameters.

The Chamau grassland is intensively managed with six cuts per year, while the Früebüel grassland is moderately managed with typically one to two cuts per year and cattle grazing in autumn. At both sites, experimental manipulations of rainfall was carried out, including control plots (no manipulation) and treatment plots where precipitation was reduced using appropriately sized rain shelters. The following output variables, measured from 2006 to 2008, were used for the Bayesian calibration: leaf area index ($\text{m}^2 \text{m}^{-2}$), harvested yield (g m^{-2}), soil moisture ($\text{m}^3 \text{m}^{-3}$) and soil temperature (K) taken at three depths (0.05 m, 0.15 m and 0.30 m) and averaged at day time step.

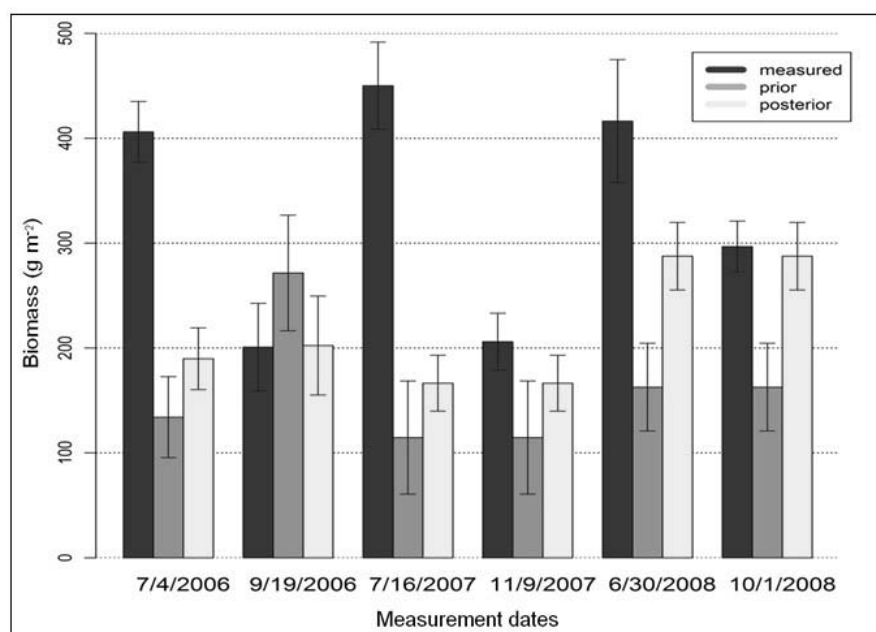

Figure 1. Uncertainty analysis for prior and posterior estimates of simulated biomass obtained at Früebüel for the treatment plots (vertical bars are standard deviations)

Table 1. Prior and posterior distributions for a sample of 13 parameters and the changes in CV values obtained at Frübüel (control plot)

Model parameter		Prior		Posterior		% in CV change
Symbol	Description	Mean	CV*	Mean	CV	
TypeA	Grassland functional type with high specific leaf area, high digestibility, short leaf lifespan and early reproductive growth	0.16	0.73	0.50	0.56	-24.01
TypeB	Grassland functional type with medium specific leaf area and high digestibility, long leaf lifespan and medium-to-late reproductive growth	0.08	1.92	0.52	0.54	-71.74
TypeC	Grassland functional type with low specific leaf area, medium digestibility, long leaf lifespan and medium-to-late reproductive growth	0.08	1.94	0.47	0.59	-70.02
zsb	Soil depth	1197	0.30	1162	0.17	-41.55
thetasatb	Saturated volumetric soil water content	0.55	0.30	0.42	0.08	-73.30
thetasfc	Volumetric fraction of the saturated soil-water content for field capacity	0.51	0.31	0.65	0.15	-52.17
thetasfpwp	Volumetric fraction of the saturated soil-water content for permanent wilting point	0.36	0.32	0.36	0.22	-28.72
psieb	Air-entry water potential	-216	-0.40	-201	-0.53	30.80
wshotcutinit	Shoot dry matter after cutting	0.14	0.34	0.18	0.26	-24.50
lcutinit	Leaf area index after cutting	0.37	0.66	1.03	0.39	-40.86
thetasbspring	Water content of the soil boundary layer in spring	0.32	0.30	0.23	0.19	-35.99
thetasbautomn	Water content of the soil boundary layer in autumn	0.32	0.30	0.29	0.18	-39.09
slaMax	Maximum specific leaf area	25.89	0.30	27.82	0.14	-52.59

*The coefficient of variation (CV) is the ratio of the standard deviation to the arithmetic mean. The sample size is 1000.

To explore the calibration results, we calculated prior and posterior means and coefficients of variation (CV) of the most influential parameters of PaSim. Here, we only show some illustrative results. At Frübüel, smaller CV values of most posterior parameter distributions showed that incorporation of more precise information reduced uncertainty on average by ~40% compared to the prior probability (Table 1). This improvement is reflected in the posterior estimates of output variables, which are closer to observations than using the prior distribution. For example, at Frübüel (Figure 1), the uncertainty associated with biomass estimates was reduced to ~30% of that of prior distribution. The root mean square error of soil moisture was reduced to 50% of its prior value for Chamau (for control) and to 25% of its prior estimate for Frübüel (for control and treatment). In general, we found that model improvement of prior to posterior distributions was stronger for Frübüel (of ~50%) than for Chamau. This may depend on differences in spatial site heterogeneity, management characteristics and climate.

In spite of differences between sites and treatments, the Bayesian framework was shown to be effective in improving the parameterization of PaSim under conditions of water stress. With few exceptions (e.g. air-entry water potential in Table 1), we observed an improvement of model performance and a reduction of uncertainty in the input parameters (negative values of CV changes), which is also reflected in the output variables. As a next step, we intend to update calibration with additional data until 2011, and extend the study to calibrate the model over long-term (≥ 6 years) observational studies at multiple European grasslands.

Acknowledgement

Research supported by FP7/2007-2013 CARBO-Extreme GA n°226701 and ANIMALCHANGE GA n°266018.

Agronomic test of fenugreek as alternative crop

Fauquet-Alekhine-Pavlovskaya, Elena¹; Nesterova, Irina²

¹Laboratory for Research in Sciences of Agronomy & Biology, FRANCE; ²Belarussian State Agricultural Academy, BELARUS

Background

Fenugreek (*Trigonella foenum-graecum* L.) is an annual crop of legume family. It is one of the oldest medical and spice plants in India and Mediterranean region [1]. Fenugreek can be interesting for cultivation as a forage crop for many reasons: as a legume crop, which can profit soil by fixing nitrogen from the atmosphere [2]; as a dryland crop [3], as forage crop for incorporation into short term rotations with other crops [4]. On the territory of France fenugreek is spread on a line from the Gironde to the border Italian, more rare and localized elsewhere. For Belarus it is new plant. Experimental cultivation has begun since 2004.

Materials and methods

Experiments were conducted to give comparable analysis of productivity of Hungarian selection varieties of fenugreek for cultivating forage and seed purposes in different agro-climatic zone: Northeast part of Belarus (sward-podzolic lightly loamy soils) and Central part of France (white limestone soil). Experiments have been carried out in the experimental fields of Belarussian State Agricultural Academy (Belarus) and Laboratory for Research in Sciences of Agronomy and of Biology (France). The varieties of Fenugreek Ovary-4 and Ovary Gold have been chosen. The Hungarian variety Óvári-4 was awarded with a state certificate in 1994 [5].

Results

In Hungarian conditions originator of varieties suggest to plant fenugreek at the end of March [5]. In the conditions of Northeast part of Belarus crop gave best yields when sown in middle of May. Actual seed productivity of fenugreek is about 0,8 t/ha. Optimum productivity can be obtained when fenugreek rows are spaced 40 cm. The first results of our test in Central part of France are shown than fenugreek variety Ovary-4 can give good yield of seeds. The highest seeds yield result (1,23 t/ha) was obtained where rows are spaced 30 cm apart and planted in the end of March or beginning of April. The

optimum sowing rate of the seed was 8-9 kg/ha. Variety Ovary-4 has matures in about 90 days when grown in Northeast part of Belarus and 95-100 days in Central part of France. Fenugreek is reported as insect and disease tolerant crop. Aphid has effected plants of fenugreek, which were planted in French experimental fields. In the years with high moist agro-climatic conditions fenugreek was affected by powdery mildew. In conditions of Belarus no effect of diseases or insects on the plants of fenugreek was indicated.

Conclusions

Our research showed that varieties of fenugreek Ovary-4 and Ovary Gold can be used as an alternative forage crop in the conditions of Northeast part of Belarus. In the conditions of Central part of France variety of fenugreek Ovary-4 give stable yield of seeds in water-limited environments.

References

1. Acharya, S., Srichamroen, A., Basu, S., Ooraikul, B. and Basu, T. 2006. Improvement in the Nutraceutical Properties of Fenugreek (*Trigonella foenum-graecum* L.), Songklanakarin J. Sci. Technol., 28 (1), 1-9.
2. Acharya, S.N., Thomas, J.E., and Basu, S.K. 2008. Fenugreek, an alternative crop for semiarid regions of North America. Crop science. vol. 48, 841-853.
3. Kumar, V., Yadav, J.S., Singh J. and Yadav, B.D. 2000. Irrigatiopn and Phosphorus Requirements of Fenugreek (*Trigonella foenum-graecum* L.) on Light Soil, Indian J. Agric. Sci. 70(8), 515-517.
4. Mir, Z., Mir, P.S., Acharya, S.N., Zaman, M.S., Taylor, W.G., Mears, G.J. and Goonewardene, L.A. 1998 Comparison of Alfalfa and Fenugreek Silages Supplemented with Barley Grain on Performance of Growing Steers, Canadian J. Animal Sci., 78, 343-349.
5. Makai, P.S., Makai, S., Kismanyoky, A. 2004. Comparative test of fenugreek (*Trigonella foenum-graecum* L.) varieties. Journal Central European Agriculture. Volume 5, No. 4, 259-262.

Simulation of catch crop efficiency to decrease nitrate leaching under various French pedoclimatic conditions using the STICS soil-crop model

Constantin, Julie; Justes, Eric

INRA, FRANCE

Introduction

The European Nitrate Directive and the French government promoted to grow catch crops in fallow periods to reduce the risk of nitrate-N leaching. Many studies have shown that catch crops are efficient to decrease nitrate concentration in drained water, but with a wide range of response, from 6 to 87% depending on the pedoclimatic context and catch crop species (Mesinger et al., 1991). The sowing period in interaction with climate can also determine this efficiency. The aim of this study was then to assess the efficiency to decrease nitrate leaching of 3 catch crop species according to their emergence and incorporation dates, representing the broad range of magnitude of French agricultural situations.

Material and Methods

24 contrasted region-sites were selected in the main arable cropping system zones in France (Figure 1). The STICS model (Brisson et al., 2008) was used to simulate the water and N dynamics between winter wheat and maize. Three soil mineral N levels (SMN) at the harvest of wheat were considered: 20, 60 and 100 kg N ha⁻¹. Mustard, Italian ryegrass and vetch were compared. For each, 5 emergence dates, from July 25 to September 25, were

tested; their incorporation was simulated on December 10. N accumulated in catch crops and nitrate leaching was then analyzed. 20 years were simulated from 1988 to 2008. Then 415000 situations were simulated.

Results

Drainage without catch crops (bare soil) varied widely from 0 to 1370 mm according to site, soil and year. Annual N leaching varied from 0 to 250 kg ha⁻¹ according to drainage volume. Leaching was also highly dependent on the SMN at the harvest of wheat. The mean nitrate concentration varied from 55 to 122 mg NO₃⁻/L according to initial SMN and sites.

N accumulated in catch crops

Mustard and ryegrass N uptake were 69 and 58 kg ha⁻¹ in average respectively, with a maximum of 200 kg ha⁻¹. Mean total N acquired by vetch was 59 kg ha⁻¹ whose 46% was symbiotic N₂ fixation. Sowing in July was not optimal to obtain highest N content except for vetch. It corresponded to dry period in the Southern sites which reduce catch crop growth. Sowing in September decreased N uptake for the 3 species, particularly in Northern sites due to cooler temperature. Mustard was the most efficient to uptake N in most cases, particularly for late sowing (September).

Figure 1: Location of the 24 French sites; maps of: (a) rainfall-PET (August to March period), (b) mean temperature (August to March period)

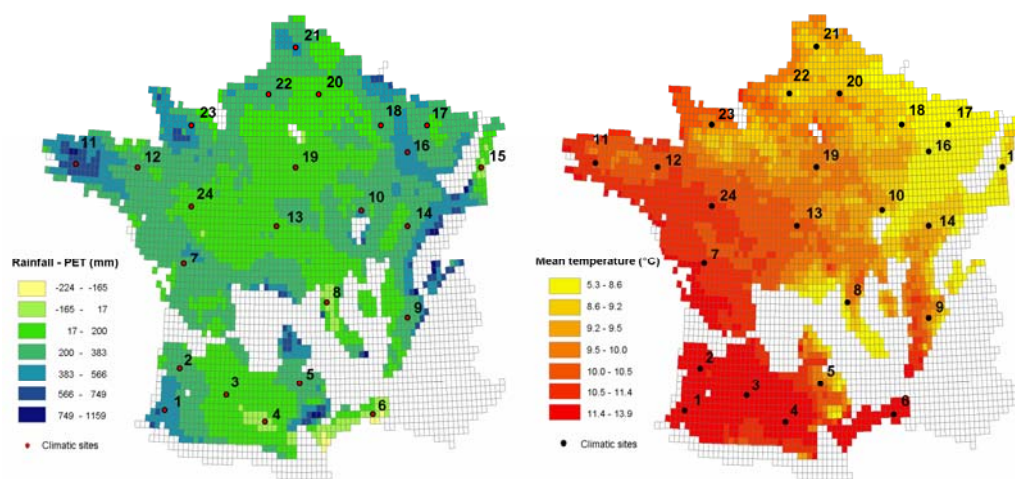
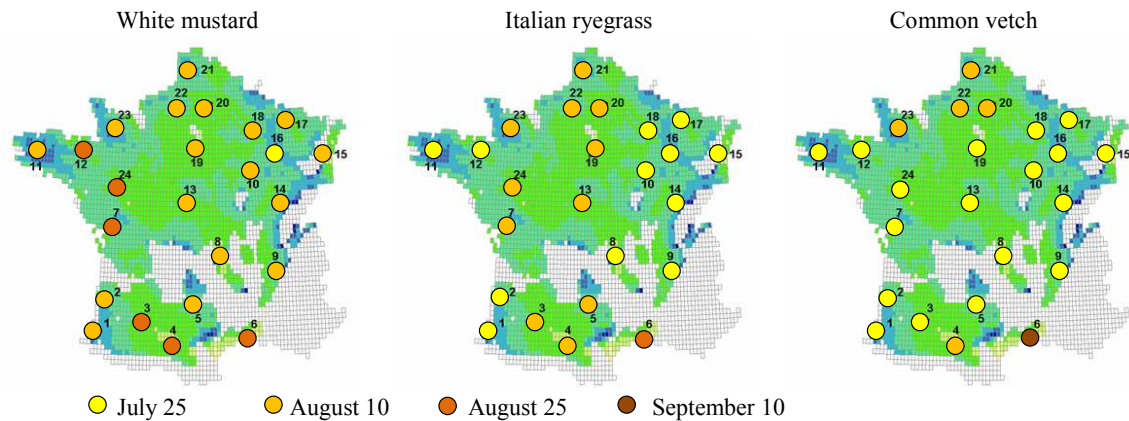

Figure 2: Optimal dates of emergence to decrease nitrate leaching according to sites and catch crop species

***N* leaching with catch crops**

Catch crops decreased N leaching by 50 kg ha⁻¹ in average but with a wide variability (0 to 150 kg ha⁻¹). The efficiency depended on species, sowing dates, SMN and sites. Mustard and ryegrass were largely more efficient than vetch in particular with initial high SMN. Mustard was more efficient when its emergence dates were in August 10 to 25, except for sites with cold temperature. Ryegrass had better tolerance to drought but growth more slowly than mustard. Both species were more efficient when its emergence was July 25 for rainy or cold sites. An optimal date was found on September 10 in the Mediterranean site due to severe drought in summer. Vetch was efficient at its earliest sowing date, except for Southern sites where drought inhibited crop growth (Figure 2).

Conclusion

Catch crops were efficient to decreased N leaching, particularly when SMN at wheat harvest was high and the catch crop was non-leguminous: it was between 31 and 79% according to site. Leguminous catch crop was quite less efficient, from 12 to 56%, in accordance with Mesinger et al. (1991). Sowing date should be adapted according to climate and specie to optimize catch crop efficiency. Other effects should be considered to verify than decreasing N leaching do not decrease crop yields or water resources.

References

- Brisson et al. (2008). Conceptual basis, formalisations and parameterisation of the STICS crop model. Editions QUAE, INRA, 78026 Versailles.
- Meisinger et al. (1991). Effects of cover crops on groundwater quality. In: Cover crops for clean water, eds. W.L. Hargrove, Jackson, Tennessee. Soil and Water Conservation Society, 57-68.

Challenges in developing tef (*Eragrostis tef* (Zucc.) Trotter) for temperate climates

Vos, Jan¹; van Delden, Sander H.²; Stomph, TjeerdJan¹

¹Wageningen University, NETHERLANDS; ²University of Applied Sciences HAS Den Bosch, NETHERLANDS

Introduction

Tef (*Eragrostis tef* (Zuccagni) Trotter) is a panicle bearing, small seeded C₄ cereal crop species. Traditionally tef (or: 'teff') is the primary food source in Ethiopia. However, the specific qualities of tef, i.e. the absence of gluten, inspired the start of a production and marketing chain of tef in the Netherlands. To be economically profitable, grain yields of at least 3000 kg ha⁻¹ are needed, but the initial Dutch tef yields were below this threshold. Tef ripening took place late in the season, this increased the risk of harvest failure due to the unfavourable weather conditions, i.e. wet and windy. Efforts were made to select early genotypes that are better adapted to northern climates. In parallel, ecophysiological properties, determining the performance of tef and the options for crop improvement, were assessed. These included:

- (i) Quantification of the response of germination rate to temperature and water potential;
- (ii) Phenology and agronomic yields;
- (iii) Effect of photoperiod on time to heading and plant structure;
- (iv) A study on the biomechanics of tef, to identify the weakest point of the plant and assess tef's lodging sensitivity.

This contribution presents data on the performance of tef in the Netherlands and summarizes research on the issues (i) to (iv) ([1], [2], [3]).

Materials and methods

Experiments were conducted in the field experiments or in climate controlled facilities at Wageningen (52° N), using the Ethiopian cultivars Gibe and Ziquala and the Dutch cultivars Ayana and O4T19.

Results and discussion

As a practical rule and for temperatures not close to the minimum, the heat requirement of tef can be summarized with a base temperature of ca 11 °C and a heat sum of ca 18 °C d. More detailed analyses, using a modified hydrothermal time model, revealed the mutual dependency of the minimum temperature and the minimum water potential for germination. As a result of a

successful selection for early genotypes by breeders, we found a large genetic variation in photoperiod sensitivity. Under short day photoperiods tef headed earlier than under long photoperiods. Leaf appearance rate was a conservative property regardless cultivar or photoperiod, thus early heading resulted in fewer main stem leaves than later heading [3]. In our experiments tef showed profuse tillering. Besides basal, rooted and potentially rooted tillers, tef also showed axillary tillers along the extended stem. Tiller numbers under short photoperiods were not significantly lower than under long photoperiods. Crop biomass was higher in late heading cultivars than in early heading cultivars, but grain yield was not clearly related to earliness. Biomechanical studies [2] indicated that root failure is the primary cause of lodging on sandy soils, but we hypothesize that on heavy clay soils breeding efforts for a stronger stem bases are equally important.

Conclusion

Though progress has been made in the performance of tef, there is scope for further genetic improvement of tef. Improved lodging resistance (through improved root anchorage, reduced stem length and thicker stems), reduced tillering, reduced variation in reaching maturity of panicles within a plant and of spikelets within a panicle, reduced seed shedding and improved partitioning of dry matter to seeds rather than to straw are seen as targets for breeding. As indicated, initially the yields were modest, around 1000 kg ha⁻¹, but progress in genetic improvement is being made, and 3000-3500 kg ha⁻¹ is a realistic target for attainable grain yields in the near future.

References

- [1] van Delden, S.H., 2011. On seed physiology, biomechanics and plant phenology in *Eragrostis tef*. PhD thesis Wageningen University, Wageningen, p. 185.
- [2] van Delden, S.H., Vos, J., Ennos, A.R., Stomph, T.J., 2010. *New Phytologist* 186, 696-707.
- [3] van Delden, S.H., Vos, J., Stomph, T.J., Brouwer, G., Struik, P.C., 2012. *European Journal of Agronomy* 37, 105-114.

Production of *Arundo donax* L. and *Miscanthus x Giganteus* Greef et Deu. to obtain second generation ethanol in two Italian environments

Florio, Giulia¹; Borin, Maurizio¹; Cirelli, Giuseppe Luigi²; Milani, Mirco²; Albergo, Roberto³

¹University of Padova, ITALY; ²University of Catania, ITALY; ³ENEA, ITALY

Introduction

The reuse of poor quality waters and the growth of vegetation in the marginal areas could be an interesting opportunity to create a chain with alternative renewable energies (Venendaal *et al.*, 1997). For that reason, the aim of our research is to study new potential herbaceous plants for energy transformation in order to combine the possibility to reuse the wastewater and to obtain second generation ethanol from biomasses. The results described in this paper belong to a research in progress and concerned the biomass production, the nitrogen uptake and the potential ethanol production of *Arundo donax* L. and *Miscanthus x Giganteus* Greef et Deu. obtained in 2010 and 2011 in two different Italian environments.

Methodology

The research was developed in two agronomic experimental sites (Borin *et al.*, 2011):

1- the experimental farm of Padova University, Faculty of Agricultural Science (PD), in the north of Italy, characterized by mean annual rainfall over 800 mm, moderately uniformly distributed throughout the year,

with a higher variability in September, October and November and by air temperature daily values vary from -5 to 17°C and from 5 to 30°C. The trial consisted of growth boxes, filled with fulvi-calcaric Cambisol FAO UNESCO soil. They were supplied with simulated slurry (corresponding to 400 kg N/ha) and controlled irrigations were applied from May to September (40 mm of water, supplied twice a week).

2- the Department of Agricultural Engineering of the University of Catania (CT), in the south of Italy, with a Mediterranean dry climate: annual rainfall is around 500 mm/year precipitation with a dry period from July to the middle of October and the daily values of minimum and maximum air temperature range from -3 to 19°C and from 8 to 40°C respectively. This research was performed in an open field with clay USDA soil, irrigated with municipal wastewater treated by full-scale constructed wetland. The volumes of water distributed were equal to 100% of evapotranspiration losses calculated with the Penman-Monteith formula. At time of harvest, dried samples of both locations have been sent to the biotechnology laboratory in order to characterize each species in terms of fiber (hemicellulose, cellulose and lignin), elements (C, N and S) and alkaline and alkaline-earth metals (Mg,

Table 1: Mean biomass productivity, nitrogen uptake and potential ethanol productivity of *Arundo donax* L. and *Miscanthus x Giganteus* Greef et Deu., obtained in 2010 and 2011 in the northern (PD) and the southern (CT) experiment.

	Dry matter production (t/ha)		N Uptake (kg/ha)		Ethanol production (kg/ha)	
	2010	2011	2010	2011	2010	2011
<i>Arundo donax</i> L.						
Location						
PD	32.7	87.9	382	439	1570	4219
CT	57.3	78.5	149	204	2750	3768
<i>Miscanthus x giganteus</i> Greef et Deu.						
Location						
PD	16.3	49.9	114	152	1223	3743
CT	34.0	44.6	51	67	2550	3344

Ca, K). Afterwards all of them were processed with a three-step chemical pretreatment to recover most of cellulose and make the biomass more accessible. This pretreated material was then hydrolysed with a mix of commercial enzymes and next fermented to obtain for each studied plant the yield of ethanol production.

Results and Discussion

In 2010 all the parameters analyzed resulted higher in CT than in PD site, while in 2011 the situation was opposite (**Table 1**). In the second year all the measures had better results than in the first year, for both species and both locations. *A. donax* gave higher values for dry matter production (57.3 t/ha in 2010 and 87.9 t/ha in 2011), nitrogen uptake (382 kg/ha in 2010 and 439 kg/ha in 2011) and ethanol production (2750 kg/ha in 2010 and 4219 kg/ha in 2011). Moreover, the content of nitrogen was lower in the CT trial.

Conclusion

From our first results, *A. donax* gave best performance for dry matter production, relative nitrogen uptake and ethanol production. This may be due to the different experimental conditions between the two locations considered, in particular to the content of the nitrogen of the wastewater. More exhaustive conclusions should be reached during the upcoming experiments.

References

- Borin M., Florio G., Barbera A. C., Cirelli G. L., Albergo R., Palazzo S., 2011. Preliminary evaluation of macrophyte wetland biomasses to obtain second generation ethanol. 19th European Biomass Conference and Exhibition: From Research to Industry and Markets, 6-10 June 2011, Berlin, Germany. Proceeding, pp. 642-648.
- Venendaal R., Jorgensen U., Foster C.A., 1997. European energy crops: a synthesis. Biomass and Bioenergy, pp.147-185.

Effects of free air CO₂ enrichment and drought on canopy development and biomass production of different sorghum genotypes as compared to maize

Manderscheid, Remy; Erbs, Martin; Weigel, Hans-Joachim

Johann Heinrich von Thuenen-Institut - vTI, GERMANY

Introduction

Given the future increase in temperature and the decrease in summer precipitation, sorghum could be an alternative energy crop besides maize due its better drought tolerance. However, it remains open how future elevated atmospheric CO₂ concentrations might affect these interactions. Here different sorghum genotypes and one maize cultivar were grown in the field under different water supply and CO₂ levels using the free air CO₂ enrichment (FACE) technique combined with rain shelters. The objectives of the study were to investigate (1) whether there is genetic variation in the growth response of the sorghum genotypes to the treatments and (2) whether sorghum genotypes perform better than maize under drought and elevated CO₂ concentrations.

Methodology

One maize (Simao) and 4 sorghum cultivars (*Sorghum bicolor* × *bicolor*: cvs. Bulldozer, Tarzan, Zerberus; *Sorghum bicolor* × *sudanense*: cv. Inka) were sown in plots (>20 m²) replicated in 3 rings (20 m diameter) with ambient CO₂ (=AMB; 385 ppm) and 3 FACE (596 ppm) rings. In each ring plants were grown in an irrigated northern half ("WET") and southern half equipped with a removable rain shelter to induce summer drought ("DRY"). Soil water content was recorded by TDR sensors. Canopy growth was measured non-destructively with the SUN SCAN-System-SS1 from Delta-T. Plants were harvested in July and October for growth measurements.

Results and discussion

The seasonal water supply to the WET plots (224 mm rainfall and 110 mm irrigation) was twice as large as to

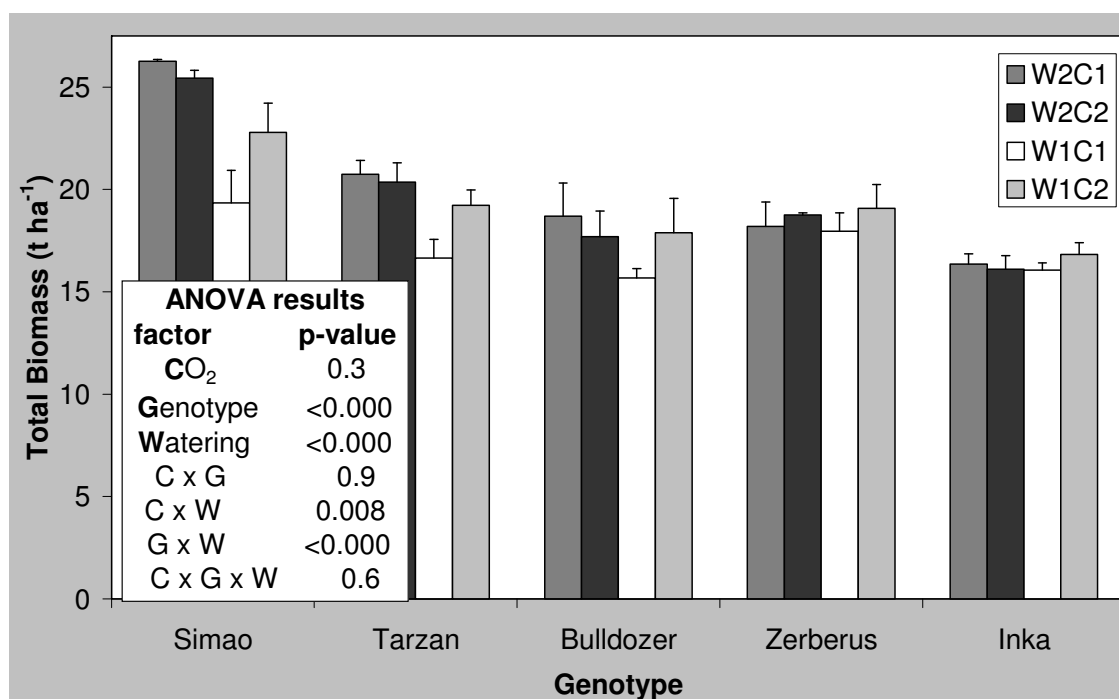

Figure 1: Effect of different water (W1: dry, W2: wet) and CO₂ supply (C1: 385 ppm, C2: 596 ppm) on final biomass yield of one maize (Simao) and different Sorghum cultivars. Bars represent means with standard error.

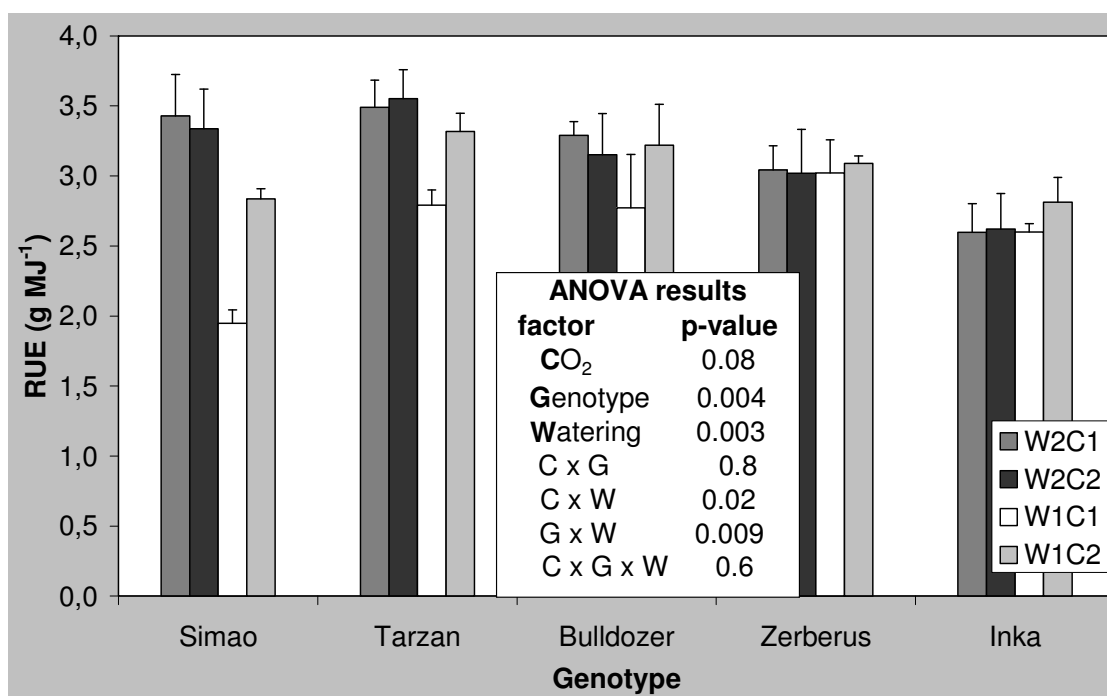

Figure 2: Effect of different water (W1: dry, W2: wet) and CO₂ supply (C1: 385 ppm, C2: 596 ppm) on radiation use efficiency (RUE) of above ground biomass production of one maize (Simao) and different Sorghum cultivars. Bars represent means with standard error.

the DRY plots (171 mm rainfall). Accordingly, available soil water capacity remained above 60% under WET but dropped below 10% under DRY AMB at the end of August. FACE plots always had a higher soil water content both under WET and DRY conditions due to the decrease in stomatal conductance and plant sap flow rate as measured for sorghum and maize. Final biomass yield was significantly affected by genotype and water supply and significant interactions of genotype x watering and CO₂ x watering were detected (Fig. 1). Maize showed the highest biomass yield under all growth conditions and the sorghum cultivar Inka the lowest one. Drought stress decreased plant growth and this effect was mitigated by CO₂ enrichment. The effect of CO₂ enrichment on biomass production under DRY varied between +4% (Inka) and +18% (Simao). The stronger the negative effect of drought the stronger was the positive CO₂ effect on crop growth.

Due to the faster leaf expansion of maize seasonal radiation absorption was about 20% higher as compared to sorghum, which is one mechanism contributing to the difference in biomass yield. Radiation use efficiency (RUE) was calculated from the growth data and this parameter

showed significant effects of genotype and watering, and significant interactions of genotype x watering and CO₂ x watering (Fig. 2). This indicates that CO₂ enrichment improves RUE only under drought and that the genotypes differ in RUE and its modification by drought. Zerberus and especially Inka had a lower RUE than Bulldozer and Tarzan, of which RUE was similar to maize. The small RUE of Inka as compared to Tarzan could not be attributed to differences in chemical composition. It rather seems that Inka needs warmer temperatures for optimum growth.

According to the experimental findings of this study maize performs better than sorghum under drought and CO₂ enrichment under today's temperature, since sorghum genotypes have a higher temperature requirement than maize for canopy expansion and optimum RUE. Thus, maize has a higher growth potential than sorghum and this necessarily leads to a higher water demand. Hence the water savings under CO₂ enrichment can be transformed in additional biomass production. The superiority of maize under drought and elevated CO₂ concentrations might disappear if sorghum cultivars available to the farmers will have a lower temperature requirement or if it is getting warmer during the vegetation period.

Climate impact of Finnish crops - a national method to estimate direct nitrous oxide emissions from mineral soils

Pulkkinen, Hannele; Regina, Kristiina; Katajajuuri, Juha-Matti

MTT Agrifood Research Finland, FINLAND

Direct nitrous oxide emissions from managed soils have a very significant role for climate impacts of cropping systems. Still, an IPCC default emission factor (IPCC 1996) is applied almost without exceptions in carbon footprint studies of agricultural products (Pulkkinen 2010) and only few nations are known to assess direct nitrous oxide emissions from managed soils with national defaults in National Inventory Reports. As interest in climate impacts of food is growing, a more detailed national method was developed for Finland. In the Finnish Foodprint programme, harmonised and practical guidelines to assess climate impacts of food products have been developed. As national defaults to estimate nitrous oxide emissions from organic soils in Finland have already been developed (Monni 2007), the new method was developed in the programme for mineral soils. According to different studies, direct nitrous oxide emissions from soils can contribute up to 65% of greenhouse gas emissions of field crop cultivation. Other significant contributors are, for example, fertiliser production and liming, if used. The uncertainties of nitrous oxide emissions from soils are remarkably high due to large spatial and temporal variation (Snyder et al., 2009). To reduce the uncertainty in national estimates, Regina et al. (submitted) have conducted research on nitrous oxide fluxes in Finnish conditions. Statistical mixed models were derived based on the measured emissions of nitrous oxide and background variables. It was possible to provide a method for estimating nitrous oxide fluxes from grass and annual spring crops from mineral soils for Finland with somewhat more precision than the IPCC default methodology. The crop type and fertilizer rate as the amount of mineral N applied were found to best explain the variation in nitrous oxide emissions. To estimate the burden caused by human activity only, the background emission of perennial crops was deducted from the derived emission estimates of both crops. The derived equations for estimating nitrous oxide flux from mineral soils are therefore N_2O flux (kgN₂O-N/ha/yr) = $10^{-0.2762 + 0.002848 * \text{minN}} - 0.529$ for perennial crops and N_2O flux (kgN₂O-N/ha/

yr) = $10^{-0.2762 + 0.002848 * \text{minN} + 0.58} - 0.529$ for annual spring crops. The estimates illustrate lower annual emissions of nitrous oxide from grass crops than from annual crops. The long non-vegetated period between harvesting and sowing in boreal conditions with long winter increases the emissions from annual spring sown crops. The new method gives larger emissions to annual crops compared to IPCC, makes a significant difference especially on products which have low climate impact, and increases total Finnish emissions. Acknowledging the high variation in nitrous oxide emissions from managed soils, developing new methodologies to estimate fluxes in more detail should be given much more attention urgently. Better knowledge is especially needed of food production in different climates.

References

- IPCC, 1996. Revised 1996 IPCC Guidelines for National Greenhouse Gas Inventories: Workbook. Volume 2. Intergovernmental Panel on Climate Change.
- Monni, S., Perälä, P. and Regina, K. 2007. Uncertainty in agricultural CH₄ and N₂O emissions from Finland - possibilities to increase accuracy in emission estimates. *Mitigation and Adaptation Strategies for Global Change* 12: 545-571.
- Pulkkinen, H., Katajajuuri, J.-M., Nousiainen, J., Silvenius F., 2010. Challenges in the comparability of carbon footprint studies of food products. In: *Proceedings of LCA food 2010*. Vol 2, 65-70.
- Regina, K., Kaseva, J. and Esala, M. 2012. Emissions of nitrous oxide from boreal agricultural mineral soils – statistical models based on measurements. Submitted to *Agriculture, Ecosyst. & Env.*
- Snyder, C.S., Bruulsema, T.W., Jensen, T.L., Fixen, P.E., 2009. Review of greenhouse gas emissions from crop production systems and fertilizer management effects. *Agriculture, Ecosyst. Env.* 133, 247 – 266.

On-farm evaluation of nitrogen leaching rates from organic crop rotations under consideration of the previous crop, with special emphasis on legumes

Fischer, Jenny; Boehm, Herwart

Johann Heinrich von Thuenen-Institut, GERMANY

Introduction

Legume supported crop rotations are of high importance in organic farming due to the biological nitrogen fixation as well as the high crude protein content, which is needed in animal production. The cultivation of legumes is depending on the farm management type, e.g. cash crop or dairy cow farm. For the evaluation of legume based cropping systems especially the risk of nitrogen leaching is important for a sustainable production. In this study the NO₃-N-load during the winter seepage period is evaluated for a cash crop and a dairy cow rotation that comprises different types and shares of legumes in mono- and intercropping.

Materials and methods

The seepage water was collected by an in-situ sampling with ceramic suction cups that allow continuous extraction of soil solution during the autumn/winter seepage period. The ceramic suction cups have been

installed at four georeferenced monitoring points after ploughing/seeding before winter. They were installed in 70cm depth to assess the leaching rate below the rooting zone with a threefold repetition at each of the four monitoring points per field. From the 3 suction cups per point and depth a mixed sample was taken weekly during the complete winter seepage period (7th Nov 2011 – 21st Mar 2012) to assess the nitrogen concentration in the seepage water. The ecological evaluation covers all fields of the cash crop and dairy cow farm. The analysis of the nitrate concentration is done by a photometric autoanalyzer to calculate the NO₃-N-load with help of the seepage rate that is assessed by a model of the German Weather Service (DWD). Data were analyzed using the GLM-procedure in SAS 9.2.

Results

In the first sampling period until the 11th January the accumulated seepage rate was 153mm, whereas most rainfalls occurred in December 2011. The field with the

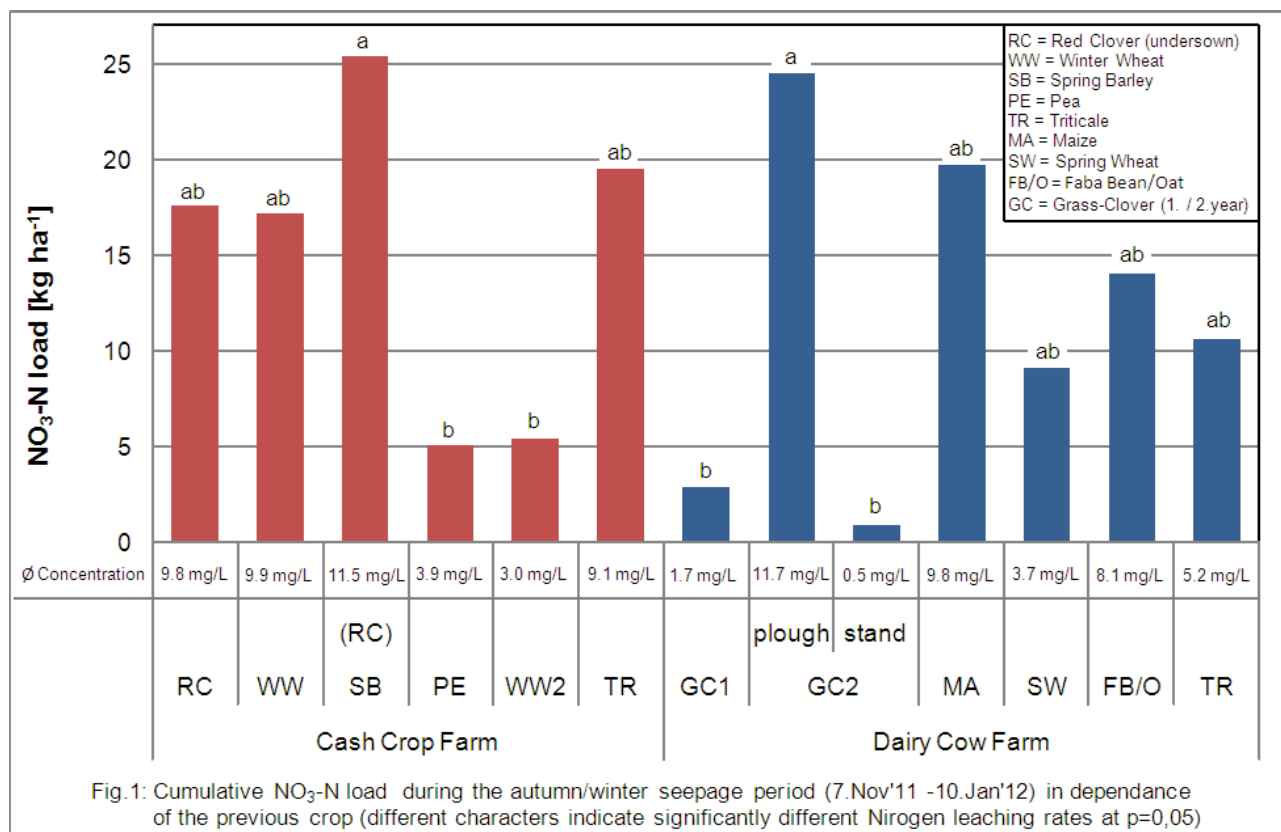

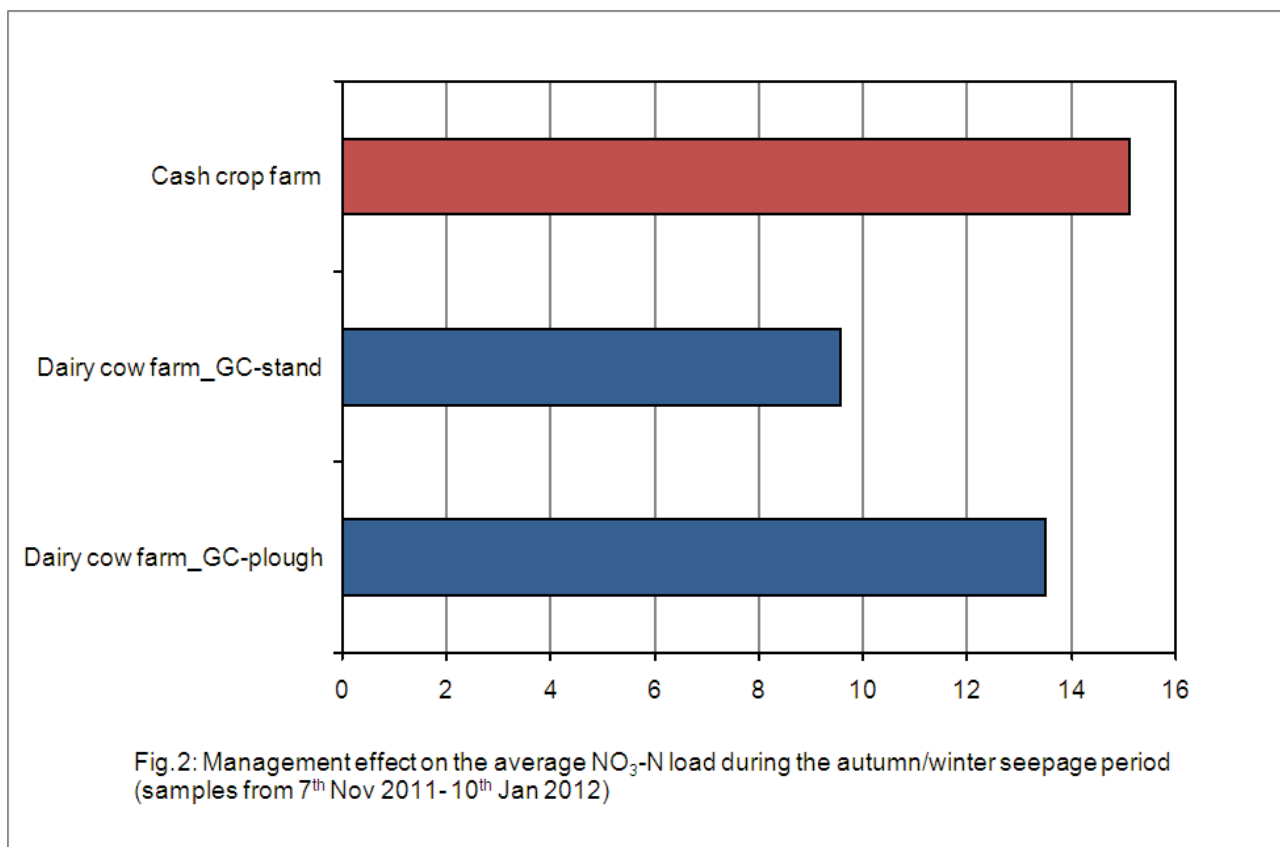

biannual grass-clover stand of the dairy cow rotation was divided up in two parts – the first one was ploughed in autumn, the second one in spring before the maize is sown. The significant highest N-load was observed after the autumn-ploughed biannual grass-clover (GC2-p), whereas the spring-ploughed biannual grass-clover (GC2-s) showed the lowest N-load, which was comparable to the grass-clover after the first year of cultivation (GC1) (Fig. 1). The negative effect on the nitrogen leaching by autumn ploughed grass-clover in comparison to spring ploughing is also apparent from the average leaching rates of the complete crop rotations under different management practices (Fig. 2). Though no fertilization is done in the cash crop rotation, the average nitrogen load is about 2 kg ha⁻¹ superior than in the dairy cow rotation with the autumn ploughed grass clover, but the differences between the different managed crop rotations were not significant for the calculated period (7th Nov. 2011 to 11th Jan 2012). This might be due to the extreme leaching rate after summer barley, caused

by a highly developed undersown red clover stand. In contrast, the pea (PE) and the winter wheat (WW2) field showed the lowest nitrogen loss. The low N-load of the pea field is a possible indicator of an insufficient biological nitrogen fixation and high export rates by harvest. In the first two years of the cash crop rotation the N-load after red clover (RC) and winter wheat (WW) was on a medium level and comparable to the N-load of triticale (TR) in the 6th year of the cash crop rotation.

Discussion

The present results reconfirm that the nitrate-nitrogen leaching rate could be reduced if grass-clover stands are ploughed in spring compared to ploughing in autumn, at the beginning of the seepage period. The cultivation of grain legumes showed no higher N-load compared to the other crops like wheat, maize or triticale. Further evaluations will be done when the sample analysis is completed.

Contribution analysis of reactive Nitrogen to N fertiliser application impacts in two different cropping system managements

Goglio, Pietro¹; Colnenne-David, Caroline²; Roche, Romain³; Doré, Thierry⁴; Gabrielle, Benoit³

¹INRA-AgroParisTech, UMR 1091 EGC, Thiverval-Grignon, FRANCE; Institut of Life Sciences, ITALY; ²INRA, UMR 211, Thiverval-Grignon, FRANCE; AgroParisTech, UMR 211, Thiverval-Grignon, FRANCE; ³INRA-AgroParisTech, UMR 1091 EGC, Thiverval-Grignon, FRANCE; ⁴AgroParisTech UMR 211, Thiverval-Grignon, FRANCE; INRA, FRANCE

Introduction

Soil Organic Matter (SOM) dynamics and emissions of reactive N (N_f) from soils (N_2O , NO , NH_3 and NO_3^-) are major sources of uncertainties in agricultural Life Cycle Assessments (LCAs) [1], the latter resulting in air and water quality impacts. Here, we estimated emissions of N_f to atmosphere and water bodies running CERES-EGC model over 30 years with the management planned for two cropping systems of the ICC trial (Innovative Cropping systems with Constraints), established near Paris in 2008. The objective was to analyze the contribution of N fertiliser inputs to the environmental impacts of these systems.

Materials and methods

CERES-EGC includes crop growth, soil water dynamics and SOM decomposition modules. It runs on daily basis with farm management, climatic and soil data and its prediction of N_2O emissions was successfully tested

against European datasets [2]. CERES-EGC was run from 1981 to 2011 with farming practices proposed for each cropping system prior trial establishment (Table 1).

LCA system boundaries encompass N fertiliser application impacts, including external inputs (e.g. diesel, lubricating oil, fertiliser, machinery) production and transport. Data were elaborated according to ISO standards [3], using SIMAPRO software [4] with other sources [5]. Hectares were used as functional units, because N_f are area-based [6]. The impact categories considered were energy consumption, GWP (Global Warming Potential with a 100 year horizon), Eutrophication potential (EP), Acidification potential (AP).

Results and Discussion

Results in table 2 showed that N_f contributed a significant part (> 24%) on GWP, AP and EP, indicating the importance of data estimation for these impacts (in particular N_2O , NO , NH_3) [1]; whereas N fertiliser industrial production and distribution highly

Table 1 Farm management for the two cropping systems (50%GHG: aiming at halving greenhouse gases emissions; PHEP: aiming at being Productive and achieving a High Environmental Performance)

System	Rotation	Frequency of N fertiliser application (y^{-1}) ^a	Average amount of N fertiliser N ($kg\ ha^{-1}\ y^{-1}$) ^a	Type of fertiliser	Farm Machinery
50%GHG	(cover crop) faba bean (<i>Vicia Faba var minor</i> (Harz) Beck)-rapeseed (<i>Brassica napus</i> L.)-(cover crop) winter wheat (<i>Triticum aestivum</i> L.)-(cover crop) winter barley (<i>Hordeum vulgare</i> L.)-(cover crop) maize (<i>Zea mays</i> L.)-triticale (<i>XTriticosecale</i> (Camus) Wittm.)	1.3	69.8	Ammonium nitrate (N 33.5%)	80.9 KW Tractor + spreader
PHEP	faba bean - winter wheat - rapeseed-winter wheat - white mustard (<i>Sinapis alba</i> L.) or black mustard (<i>Brassica nigra</i> L.) as catch crop, spring barley	1.4	78	Ammonium nitrate (N 33.5%)	80.9 KW Tractor + spreader

^aAverage value for 30 years

Table 2 Contribution analysis with the categories analysed: average values over 30 years of simulation (in brackets: contribution percentage for N fertiliser application)

Impact category	Cropping system	Reactive N emissions (Nr)	Machinery use during field application	Farm input production and transport	Fertiliser production and distribution	Total for N fertiliser application
Energy consumption (MJ ha ⁻¹)	50%GHG	0 (0%)	119 (3%)	309 (7%)	4278 (91%)	4707
	PHEP	0 (0%)	124 (2%)	323 (6%)	4781 (91%)	5228
GWP (100 year horizon) CO ₂ eq (kg ha ⁻¹)	50%GHG	193 (24%)	5 (1%)	8 (1%)	603 (75%)	809
	PHEP	261 (28%)	5 (<1%)	9 (1%)	674 (71%)	949
Eutrophication (kg PO ₄ ⁻³ ha ⁻¹)	50%GHG	595 (100%)	<1 (<1%)	<1 (<1%)	<1 (1%)	595
	PHEP	1220 (100%)	<1 (<1%)	<1 (<1%)	<1 (<1%)	1220
Acidification potential SO ₂ eq (g ha ⁻¹)	50%GHG	734 (29%)	27 (1%)	30 (1%)	1722 (69%)	2513
	PHEP	678 (25%)	28 (1%)	84 (3%)	1924 (71%)	2713

affected energy consumption (>91%). The use of CERES-EGC allowed to consider soil and climate interaction with farming practices [2]. The 50%GHG system succeeded in reducing GWP by 14.7% compared to PHEP system, nevertheless was much more effective in decreasing EP (by 51.2%), while for other impact categories the difference was lower. Total energy values were within range with prior research [6].

Conclusion

Contribution analysis revealed that N_r emissions caused much of the impacts due to N fertiliser applications. A better estimation of these emissions will increase reliability of agricultural LCAs. Our analysis should be complemented by the use of actual management data recorded in the cropping systems' field trial to provide more realistic estimates of N_r emissions and the environmental performance of cropping systems.

References

- [1] Guiné JB, Heijungs R, Voet E. A greenhouse gas indicator for bioenergy: some theoretical issues with practical implications. *Int J Life Cycle Assess* 2009;14(4):328–39.
- [2] Lehuger S, Gabrielle B, van Oijen M, Makowski D, Germon J-C, Morvan T, et al. Bayesian calibration of the nitrous oxide emission module of an agro-ecosystem model. *Agric Ecosys Environ* 2009;133(3-4):208–22.
- [3] ISO. SS- EN ISO 14040 Environmental management- Life Cycle Assessment, Principles and Framework. Geneva: International Organization for Standardization, 2006. International Organization for Standardization, p. 43.
- [4] SimaPro 7.2. PRé Consultants: Life Cycle consultancy and software solutions. 2010. Available at: <http://www.pre.nl/default.htm>, 2010 [last accessed on 11.6.2010].
- [5] Brentrup F, Kusters J, Lammel J, Barraclough P, Kuhlmann H. Environmental impact assessment of agricultural production systems using the life cycle assessment (LCA) methodology II. The application to N fertilizer use in winter wheat production systems. *Eur J Agr* 2004;20:265–79.
- [6] Nemecek T, Dubois D, Huguenin-Elie O, Gaillard G. Life cycle assessment of Swiss farming systems: I. Integrated and organic farming. *Agr Syst* 2011;104(3):217–32.

Model based assessment of agri-environmental measure effects concerning the reduction of nitrogen pollution regarding the Water Framework Directive

Kersebaum, Kurt Christian; Barkusky, Dietmar; Deumlich, Detlef; Reutter, Michaela; Steidl, Jörg; Zander, Peter
Leibniz Centre for Agricultural Landscape Research, GERMANY

Introduction

The European Water Framework Directive requires measures to improve the quality of surface and ground water resources. A major part of nutrient input originates from diffuse sources mainly from agricultural land use. The presented study aims to quantify the effects of different agri-environmental measures established in the federal state of Brandenburg/Germany regarding their reduction of nitrogen leaching. The agro-ecosystem model HERMES was used to simulate nitrogen leaching for crop rotation with and without measures.

Material and Methods

The model HERMES is an agro-ecosystem model which considers the processes of soil water dynamics, soil nitrogen dynamics and crop N-uptake. Nitrogen leaching was simulated for 5 soil groups with defined representative soil profiles from an aggregated soil map of Brandenburg. Each profile was considered with the mean, minimum and maximum organic matter content. 4 different groundwater levels (100, 150, 300 and 550 cm) and 5 climatic zones represented by 5 weather stations (annual precipitation 476-588 mm) were distinguished. Daily weather data (1990-2010) were used for simulation. The InVeKoS data from 2008-2010 for agricultural land were used to identify the most frequent 2-crop combinations in crop rotations. The 2-crop rotation was embedded in standardized previous and following crops analysing the central 2 year period. The following agri-environmental measures were implemented: a) reduction of N balance by 20-30 kg N ha⁻¹, b) introduction of catch crops for winter greening, c) conversion to permanent pasture d) extensification of grassland, e) conversion to organic farming. As the concept for the whole crop rotation is different for organic farming, 5-year crop rotations were defined for each soil group for organic farming and grassland and their conventional references for farms with and without animals. Management of the reference crop rotations was defined

according to the official rules for fertilization which considers an average crop specific target yield for each soil group and the corresponding N demand which is further modified by the type of previous crop and an mineral N equivalent of farmyard manure.

Results

In general N leaching increased with decreasing water holding capacity leading to an average annual N leaching of 36-40 kg N ha⁻¹ for the mostly sandy soils and 4-11 kg N ha⁻¹ for the loam and clay soils. Leaching losses were generally lower in the region with the lowest annual precipitation. However, the nitrate concentrations showed an opposite trend due to the dilution of nitrate concentrations with increasing seepage. Leaching losses and nitrate concentrations increased within soils with increasing humus content especially on sandy soils. The effect of groundwater level is different between soil groups. While more loamy soils show slightly lower N leaching due to higher capillary rise during summer the sandy soils showed higher N losses as downward flux is dominating the small capillary rise rates. For the reference rotations the highest N leaching was found for silage maize – silage maize or silage maize – winter cereal combinations with uncovered soil during winter and relative high application of manure. Regarding the effects of agri-environmental measures the reduction of nitrogen leaching by N balance reduction was relatively small if the reference follows strictly the official recommendations. However, the effect was higher if an over-fertilization of 30 kg ha⁻¹ was assumed. The reduction effect of introducing a catch crop was higher showing a better effect of winter hard catch crops compared to frost sensitive catch crops. The crop rotations of organic farming showed a distinctly lower N leaching compared to their conventional references. This was mainly due to the intensive cropping with nearly no fallow tile during winter and due to the N limitation of the system. The highest reduction was found if arable land was converted to permanent grassland.

The Importance of Changes in Dietary Habits of Poland Inhabitants in Reducing Greenhouse Gas Emissions

Bienkowski, Jerzy, Franciszek; Jankowiak, Janusz; Dabrowicz, Radoslaw; Holka, Malgorzata

Institute for Agricultural and Forest Environment, PAS, POLAND

Introduction

Existing ways of meeting nutritional needs through increased acreage of arable land, the size of herds and increasing intensity of agricultural production do not serve sustainability between the sphere of production and the sphere of consumption (Garnett, 2011). It is therefore important to develop nutritional strategies that will stimulate the sustainable pattern of agricultural production. The main option to limit the emission of greenhouse gases (GHG), in addition to technological progress, should be a public education on the environmental benefits of changes in the profile of meat types and reduced quantities of red meat in the daily diet (Popp et al., 2010). The principal objective was to assess quantitatively the overall GHG emissions under assumption of changes in eating habits. In order to achieve this it was necessary to investigate the structure of food consumption and the calorific value of food rations for Poland inhabitants and to develop on this basis the different scenario diets with reduced potential for greenhouse gas emissions.

Material and Methods

In order to estimate the impact of consumption structure in Poland on the GHG emissions an analysis of the

composition of the average daily food intake based on the FAO food balance sheet for 2007 was performed. Energy value of the major components of Polish mean diet was estimated. Based on the mean nutritional profile six diet scenarios were developed, taking as a major factor of diet diversification the energy content derived from different meat products. The following nutrition scenarios were distinguished: vegan, vegetarian lacto-ovo, meat eater, poultry, and diet of lower calorific value.

Results and Discussion

The shares of energy from animal- and plant-based products in the mean diet were equal to 27.2% and 72.8%. Red meat and dairy products in this diet supplied 11.8% and 10.3% of total energy consumption, respectively. The energy value of the average daily food intake was 3421 kcal per person. Making changes in the nutritional composition of food items in different types of diets, revealed differences in the levels of GHG emissions compared to the typical diet. Substantial variability in GHG emission was also observed for different hypothetical diets. According to this calculation the average diet entailed the per capita emission of 2.43 t CO₂ eq. per year (Fig. 1). The lowest GHG emission was linked to the vegan diet, with the emission being 5.5 times lower than for typical diet. Among the nonvegan diets, adopting the poultry

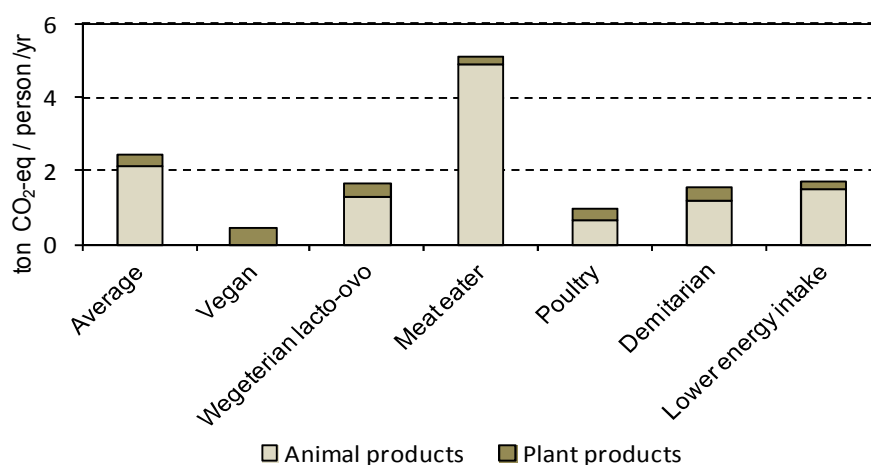

Fig. 1. GHG emissions with different plant- and animal-based diets in Poland

and demitarian diet was most beneficial for reducing the GHG emission from food consumption. For the poultry diet GHG annual emission was lower by 1.44 t CO₂ eq. per person. While the demitarian diet, that is recently gaining popularity in European countries because of its environmental and health rationale, resulted in reduction of GHG emissions by 0.89 t CO₂ eq., that is, by almost 36.6% lower compared with the mean diet of the Poland population.

Conclusions

The results clearly indicate to the significant environmental consequences made by daily diet choices. Relating the benefits of reduced emissions to the country scale as a result of adopting the demitarian principles of food composition, it would be possible to reduce food-

related GHG emissions by nearly 34 million t CO₂ eq. per year in relation to the average diet. Modifications to the food preferences by shifting to low-emission diets in future would affect consumption of red meat, which in turn may lead to change in structure of animal production and reducing the intensity of animal farming.

References

- Popp A., Lotze-Campen H., Bodirsky B. 2010. Food consumption, diet shift and associated non-CO₂ greenhouse gases from agricultural production. *Global Environmental Change* 20, 452–462.
- Garnett T. 2011. Where are the best opportunities for reducing greenhouse emissions in the food system (including the food chain)? *Food Policy* 36, 23–32.

Plant Phenotyping, a new field and opportunity for crop scientists

Tardieu, Francois

INRA, FRANCE

Plant phenotyping is essentially the same activity that crop and plant physiologists have performed for decades, namely to analyse the performances of genotypes in a set of environmental conditions, and to dissect them into simpler ('mechanistic') and more heritable variables. The main differences are

- The throughput. Phenotyping is usually associated with the characterisation of large panels of plants aimed at quantitative genetics, thereby requiring the measurement of thousands of plants,
- The techniques have progressed rapidly in the domains of (i) environmental sensors with increasingly autonomous and non-invasive methods, (ii) functional imaging that allow one to measure local fluxes (e.g. water or heat) or concentrations (e.g. N) of living organs or plants by using different spectra, (iii) plant architecture that can be inferred from images in both controlled or field conditions.
- The imposition of known environmental conditions to thousands of plants by using robots driven by sensors placed on the plant or on its immediate vicinity. This is essential when genetic differences generate differences in plant environment (e.g. plants with high vs low transpiration deplete soil water at different rates).

Platforms have emerged both in field and controlled conditions. Most of them aim at measuring traits associated with plant performances. They face the dilemma of (i) addressing relevant biological questions, often requiring very specific measurements, and (ii) being flexible enough to tackle the analysis of different species and biological questions, thereby justifying the high investment. Hence, the scientific community probably requires the access to several types of platforms with different principles and measurements, but with a common throughput of thousands of plants, including high throughput omic platforms. For that, platforms and groups interested in phenotyping are getting progressively organised at the national level (e.g. the Phenome and DPPN projects in France and Germany),

European level (UE FP7 EPPN) and international level (IPPN network).

These measurements generate very large datasets that require to be checked and organised so they can be shared by a large community of scientists, and analysed for genetic analyses of different traits. A new "bioinformatics" is emerging, with needs of artificial intelligence, information systems and ontologies.

New perspectives are open by these facilities, in particular the possibility to dissect plant performance of hundreds of genotypes into components. Variables such as sensitivity of growth to a given environmental condition, radiation use efficiency and its response to environmental conditions or changes in intercepted light due to genetic differences in plant architecture can now be analysed on large sets of plants. Their genetic and environmental determinisms can be analysed jointly. This in turn allows genetic analyses of each of these traits, and to compare the genomic regions that affect them. It can also results in yield prediction of a large range of genotypes in different climatic scenarios, in particular those associated with climate changes.

The same confusions of effects exist in these large datasets as in any other dataset, e.g. the confounding effect of flowering time or plant size that can affect many other measured variables. Hence, analysing these large datasets require the modelling tools that plant scientists have developed. Models serve first to disentangle the complexity of phenotypes and identify hidden variables such as sensitivities or ratios that are in many circumstances more heritable than raw data. Overall, plant scientists are needed to analyse these datasets. This is the right time: phenotyping has first been seen as the development of new techniques. It is increasingly felt that methods for data analysis and interpretation, with a sound biological background, will become the limiting step.

Barley genomics with maize Ac/Ds transposons

Singh, Jaswinder; Singh, Surinder; Tan, Han Qi; Singh, Manjit; Kaur, Ravneet
McGill University, CANADA

Introduction

Barley is a key ingredient in malting and brewing industry; therefore, gene discovery in relation to malting quality has an industrial perspective. A series of efforts have been undertaken to genetically dissect this trait and to localize individual quantitative trait loci (QTL) on the genetic map of barley. Two major quantitative trait loci (QTLs) affecting malting quality traits have been located on chromosome 4H (Cooper et al., 2004; Randhawa et al., 2009). One major QTL complex, QTL2 mapped on the short arm of chromosome 4H, affects several malting quality parameters. Given that chromosome 4H contains interesting malting quality QTLs, identification of the candidate genes harbored in these QTLs may lead to a better understanding of the genetic basis of malting traits including the development of functional markers for breeding. An alternative approach is targeted insertional mutagenesis using transposons, which is particularly valuable when no sequence data is available for the gene of interest. The maize Activator/Dissociation (Ac/Ds) system has been extensively used in heterologous species for insertional mutagenesis. In barley, the Ac/Ds transposon-based approach offers great potential due to a large genome size and limited success of genetic transformation. The bias of the Ac/Ds system towards genic regions and its tendency for localized transpositions can greatly enhance gene discovery in large genome cereals (Upadhaya et al., 2002; Singh et al., 2006). In the current study, we have targeted important QTLs with Ac/Ds transposons for identification of candidate genes effecting malting quality.

Material and Methods

Conventional hybridization: Crossing TNP-29 and TNP-79 lines separately with 25-B. Seeds of crosses TNP-29 α and TNP-79 α were allowed to self pollinate in order to obtain F₂ generation seeds. For the in vitro approach, Agrobacterium transformation was carried out using immature embryos as explants. F₂ generation from conventional approach and regenerated plantlets from tissue culture approach were used for DNA extraction and subsequently for genotyping the presence of Ds at new position in the genome. Sequence flanking to the Ds insertion were amplified using inverse-PCR and TAIL-PCR (Singh et al., 2012) and analyzed using bioinformatic tools.

Results

In this study, Ds was reactivated from parent transposition (TNP) lines, TNP-29 and TNP-79, in which the Ds was previously mapped in the vicinity of important malting QTLs. Reactivation of Ds was carried out both by conventional breeding and a novel in vitro approach. A total of 593 plants were screened from conventional approach and 110 embryos were successfully regenerated into shoots from tissue culture approach. Ds transpositions were observed to be 10.5% and 9.8%, in TNP-29 α and TNP-79 α populations respectively in case of conventional breeding and 34.7% and 39.06% using tissue culture approach (Table 1). Unique flanking sequences were identified, as Ds insertions in genes potentially associated with malting quality such as α -GAL1, α -amylase-like (Singh et al., 2012).

Table 1: Frequency of Ds transpositions in barley.

	Conventional approach		Tissue Culture	
	TNP-29X	TNP-79X	TNP-29	TNP-79
Total number of plants screened	370	223	46	64
Total New Ds Transposition	39	22	16	25
Stable New Ds Transposition	17	13	11	22
Unstable New Ds (with Transposase)	22	09	05	03
Reactivation Frequency	10.54%	9.80%	34.7%	39.06%

Hieroglyphs?

Conclusion

Maize Ac/Ds system is highly efficient in barley. Using this approach we are able to tag important genes including the α -amylase like gene and α -GAL1, which play important roles in malting and seed germination. This effort of saturation mutagenesis with Ds transposons will lead to a better understanding of malting quality traits and candidate genes that display quantitative variation.

References

1. Cooper L et al., (2004) Mol Genet Genomics 272:181–193
2. Randhawa HS, Singh J, Lemaux PG, Gill KS (2009) Genome 52:566–575
3. Singh, S., Tan, H-Q., Singh, J. (2012) Funct & Integrat Genom: Volume 12:131–141.
4. Singh J, Zhang S, Chen C, Cooper L, Bregitzer P, Sturbaum A, Hayes P, Lemaux P (2006) Plant Mol Biol 62:937–950
5. Upadhyaya, N et al., (2002). Funct Plant Biol 9:547–559.

Effect of wheat dwarfing alleles on grain yield and quality

Uppal, Rajneet; Gooding, Mike; Casebow, Richard
 University of Reading, UNITED KINGDOM

Introduction

The Norin-10, gibberellin insensitive (GA-I) reduced height (Rht) alleles, Rht-B1b and Rht-D1b are present in over 90% of the world's semi-dwarf wheat production. Despite widespread use, GA insensitivity can reduce fertility under heat stress (Law & Worland, 1985). Worland (1986) suggested that reduced selection of lines containing the Norin 10 alleles in S. Europe was due to increased likelihood of heat stress during meiosis. Climate change scenarios predict that such events could compromise wheat production further north. Sip et al. (2011) note a decline in the use of the Norin-10 alleles in C. Europe. There has been interest in investigating alternative Rht alleles that do not rely on GA-I, but a comparative lack of information on the implications for grain quality. We describe effects of near-isogenic lines (NILs) with GA-I and GA-S Rht alleles on grain yield and quality.

Methods

Field experiments from 2005/06 to 2010/11 were managed under different tillage and production systems. All 11 expts included 7 near isogenic lines (NILs) in a cv. Mercia background (GA-I: Rht-B1b, Rht-D1b, Rht-B1c, Rht-D1c; GA-S: rht(tall), Rht8c, Rht12); 7 expts also included NILs in cv. Maris Huntsman (rht (tall), Rht-B1b, Rht-D1b, Rht-B1c, Rht-B1b+Rht-D1b, Rht-D1b+Rht-B1c) and M. Widgeon (Rht-B1b, Rht-B1b+Rht-D1b, Rht-D1b+Rht-B1c). M. Widgeon rht (tall), Rht-D1b and Rht-B1c were included in 9 of the expts. Site, experimental design and husbandry are available (Addisu, 2009; Uppal, 2012). Data were subjected to REML analysis with fixed model of background x allele, and random model of Year/ System/Tillage/Block.

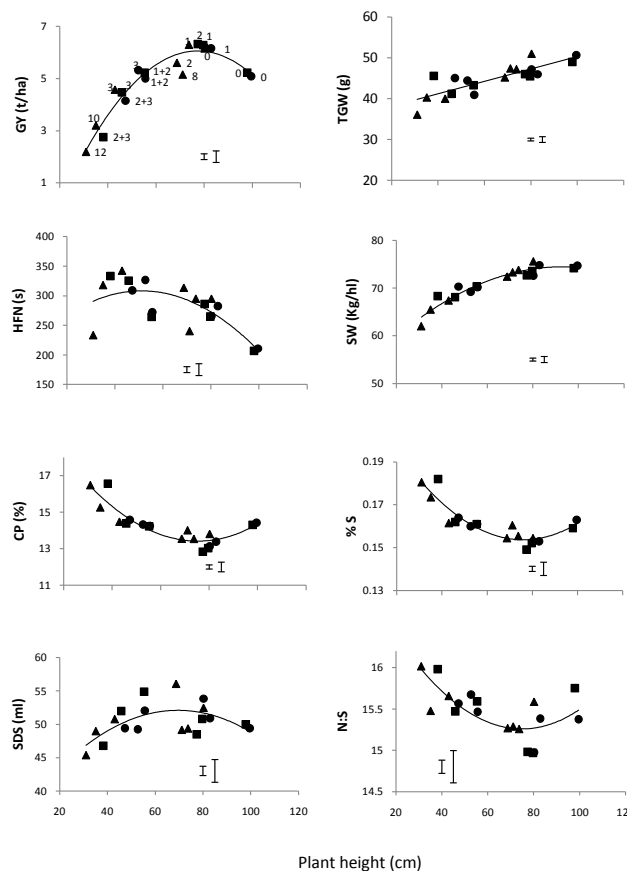

Fig. 1: Grain yield and quality against height (cm) of winter wheat in three varietal backgrounds (Mercia =triangles; Maris Huntsman = squares; M. Widgeon = circles). o = rht (tall); 1 = Rht-B1b; 2 = Rht-D1b; 3 = Rht-B1c; 8 = Rht8c+Ppd-D1a; 10 = Rht-D1b; 12 = Rht12). Error bars are min. and max. SEDs.

Results and Discussion

NIL interactions with production system and tillage method were minor compared to interactions between background and allele. Much of the latter could be explained on the basis of crop height. As with Flintham et al. (1997) we find that after removing the main effects of background there is a highly significant quadratic relationship between plant height and grain yield with an optimum height around 0.7-0.85 m. Semi-dwarfing alleles *Rht-B1b* and *Rht-D1b* significantly improved grain yield in taller backgrounds only. Grain yield was reduced by *Rht-D1b* and *Rht8c+Ppd-D1a* in Mercia despite having plant height near the optimum, possibly associated with *Fusarium* infection in the former and reduced resource capture in the latter (Uppal, 2012). Thousand grain weight and specific weights were reduced by shortening. The protein response to height was in contradiction to that for yield (Gooding et al. 2012a). We believe this is the first report of the effect of these *Rht* alleles on sulphur concentration. Although S concentration followed a similar response to height to that of CP it was not as sensitive, such that N:S ratio were

reduced at intermediate heights. As with N:S ratio, SDS-sedimentation volume also appeared to indicate possible improved breadmaking potential at heights optimal for yield. GA-insensitive alleles were generally beneficial for Hagberg falling number, contrasting with the effects of the GA-sensitive alleles (Gooding et al. 2012b).

References

- Addisu M. 2009. PhD thesis, The University of Reading.
- Flintham JE, Borner AB, Worland AJ, Gale MD. 1997. *J. Agric. Sci.* 128, 11-25.
- Gooding MJ, Addisu M, Uppal RK et al. 2012a. *J. agric. Sci.* 150, 3-22.
- Gooding MJ, Uppal RK, Addisu M et al. 2012b. *J. Cereal Sci.* doi 10.1016/j.jcs.2012.01.003
- Law CN, Worland AJ. 1985. PBI Annual Report 1984. Cambridge: Plant Breeding Institute. pp. 69-71.
- Sip V, Chrpova J, Zofajova A et al. 2011. *J. agric. Sci.* 149, 313-326
- Uppal RK. 2012. PhD thesis, The University of Reading.
- Worland AJ. 1986. *Euphytica* 35, 857-866.

Micro propagation and genetic transformation in *Brassica oleracea* var. *botrytis*

Al-swedi, Fadil; Al-Shamari, Magda; Rihan, Hail; Lane, Stuart; Fuller, Michael Paul
Plymouth university, UNITED KINGDOM

Introduction

Agrobacterium-mediated transformation system is the most widely applied method for plant genetic transformation (Poulsen, 1996). The presence of efficient micropropagation and transformation protocols are the basic needs in genetic improvement of a crop via *Agrobacterium*-mediated transformation. To realize a high frequency of *Agrobacterium*-mediated transformation, many essential factors that affect the transformation efficiency need to be optimized (Opabode, 2006). Pre-treatment of explants, inoculation conditions such as bacterial concentration (Zhao et al., 2002) and immersion time (Yujun Xing¹, 2007), co-cultivation conditions such as period of cocultivation (Vasudevan and Choi, 2007) and temperature conditions (Salas et al., 2001) are some of the important factors that need to be optimized in *Agrobacterium*-mediated transformation systems.

Methodology

Agrobacterium tumefaciens carrying an APX construct driven by a constitutive CaMV 35S promoter were used. The *A. tumefaciens* strain was grown on LB solid medium and incubated at 28°C for 48 hours. A sample from a bacterial single colony was assessed by PCR to confirm

the presence of APX gene. An efficient regeneration and transformation protocol was devised using micropropagation explants of cauliflower curd (Rihan et al., 2011). Genomic DNA was extracted from plant leaf tissue according to CTAB method (Manfioletti and Schneider, 1988).

Results

The total mean average of high concentration suspension CFU (colony forming unit /ml) was recorded for *Agrobacterium tumefaciens* strain (APX) growing on LB medium (Figure 1). The APX encoding sequences were detected after PCR amplification from bacterial colonies. PCR was also used to verify the presence of the introduction of APX gene in transgenic plants. Results indicated positive identification of the 478bp amplified DNA indicator segment (Figure 2).

Conclusion

The work presented demonstrated competency in the laboratory procedures for *Agrobacterium* transformation of cauliflower and successfully achieved transgenic lines carrying constitutively promoted APX gene.

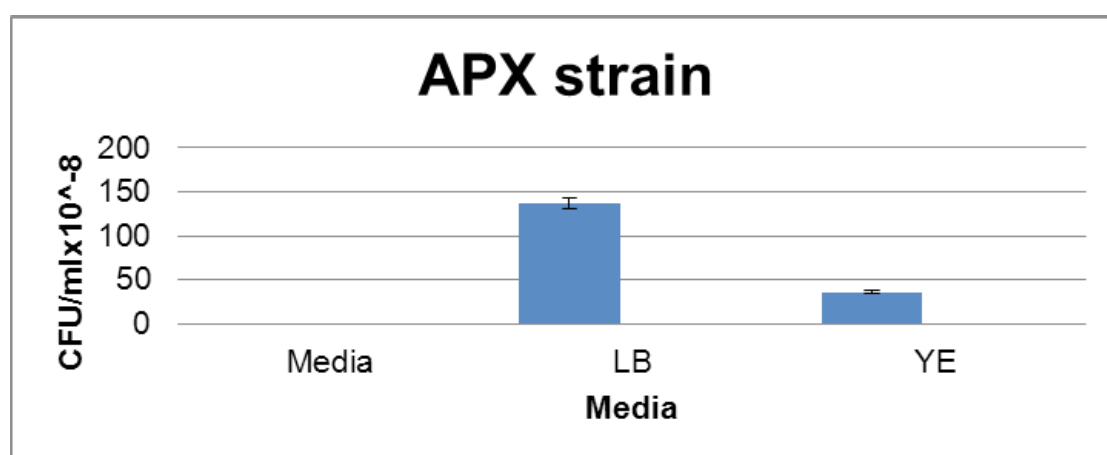

Figure 1. *Agrobacterium tumefaciens* (APX strain) growth on LB and YEY media.

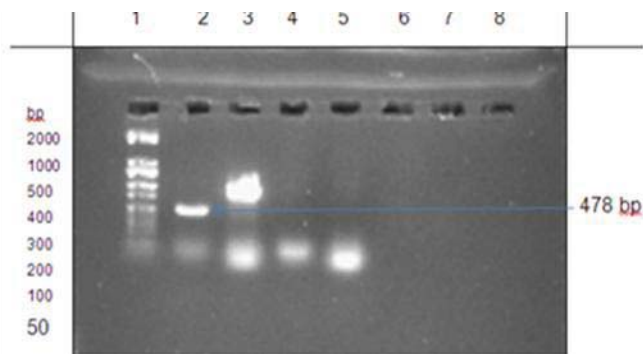

Figure 2. PCR analysis of the presence of APX gene in putative transgenic plant. DNA molecular ladder (lane 1), transformed plant carrying APX gene (lanes 2 & 3), negative control (non-transformed cauliflower leaves (lanes 4 & 5) and water (lanes 6 & 7).

References

- Manfioletti, G. & Schneider, C. 1988. A new and fast method for preparing high quality lambda DNA suitable for sequencing. *Nucleic Acids Research*, 16, 2873-2884.
- Opabode, J. T. 2006. *Agrobacterium*-mediated transformation of plants: emerging factors that influence efficiency. *Biotechnology and Molecular Biology Review* 1 12-20.
- Poulsen, G. B. 1996. Genetic transformation of Brassica. *Plant Breeding*, 115, 209-225.
- Rihan, H., Al-Issawi, M., Burchett, S. & Fuller, M. 2011. Encapsulation of cauliflower *Brassica oleracea* var *botrytis* microshoots as artificial seeds and their conversion and growth in commercial substrates. *Plant Cell, Tissue and Organ Culture*, 107, 243-250.
- Salas, M. S., Park, S. P., Srivatanakul, M. S. & Smith, R. S. 2001. Temperature influence on stable T-DNA integration in plant cells. *Plant Cell Reports*, 20, 701-705.
- Vasudevan, N. S. A. G. & Choi, C. W. 2007. *Agrobacterium*-mediated Genetic Transformation in Cucumber (*Cucumis sativus* L.), Science Publications.
- Yujun Xing, Qing Yang, Qin Ji, Yuming Luo, Yunfeng Zhang, Ke Gu and Dengzhan Wang 2007. Optimization of *Agrobacterium*-mediated transformation parameters for sweet potato embryogenic callus using a-glucuronidase (GUS) as a reporter. *African Journal of Biotechnology* 6, 2578-2584.
- Zhao, Z.-y., Gu, W., Cai, T., Tagliani, L., Hondred, D., Bond, D., Schroeder, S., Rudert, M. & Pierce, D. 2002. High throughput genetic transformation mediated by *Agrobacterium tumefaciens* in maize. *Molecular Breeding*, 8, 323-333.

Designing research projects for impact on stakeholders: an analysis of the co-innovation approach in EULACIAS

Rossing, Walter¹; Dogliotti, Santiago²

¹Wageningen University, NETHERLANDS; ²University of the Republic, URUGUAY

Volatility of food prices, concerns over attenuating yield increases in major food crops and increasing demand from a growing global population that is changing its dietary demands have re-fuelled interest in agronomy as a science for impact. To meet demands for increased production levels and meeting environmental requirements, innovations are needed which allow production systems to become less dependent on external, non-renewable inputs. Changes are also needed outside the farm gate as farming systems in many economies are deeply embedded in larger agricultural and societal systems. Involvement in such re-design efforts requires agronomists to reflect on how to achieve impact through their research projects. Projects constitute the major means of structuring research as most of the agricultural research budget is spent through projects. A project can be seen as a number of coherent activities brought together for a limited period of time to achieve a set of goals. Project management is part of undergraduate and graduate teaching, and there is an industry of consultancy companies that offer advanced training for project managers. The project concept has its origins outside agriculture, and there are gradual if not fundamental differences in the nature of problems within and outside agriculture. In contrast to other sectors (government, industry, services) organizational structures in agriculture are less clearly focused on a set of shared goals, interaction protocols are often negotiated and re-negotiated, and decision hierarchies are distributed. There is no generally accepted central management which can act as commissioner of research, there is no unambiguous list of departments to be involved in a project, and there is often as little agreement on objectives as there is on solutions and the knowledge underpinning them. These characteristics constitute considerable challenges for agronomy and call for reflection and learning on project design. In this paper we use the experiences in the EULACIAS (FP6) project which aimed to re-design smallholder farming systems in case studies in Argentina, Mexico

and Uruguay using a shared and documented process approach denoted as co-innovation. Co-innovation included three domains: a systems approach, social learning, and adaptive monitoring and evaluation. Reflection on project functioning took place at half-yearly and monthly time scales to guide and re-direct daily activities, and provide training on selected topics. Participants included members of the local teams, the local and international project team, and - during part of the meetings - farmers and local politicians. Meetings were guided by trained facilitators. 'Monitors' documented meeting outputs, partly captured in 'tools' such as problem trees, project theory and timelines. Participatory Impact Pathway Analysis (Douthwaite et al., 2007) provided a formal basis of activities. Drawing on the monitoring database we analyze the experiences using the conceptual framework of boundary work by Clark et al. (2011) and evaluate effectiveness in terms of credibility, saliency and legitimacy. A major change brought about by the co-innovation approach was in the area of legitimacy, where non-scientists felt taken seriously by researchers in the project, and where social scientists provided input equal to natural scientists. This was informed by the systems approach, which helped to see components of the social as well as of the production system and their interrelations. We will discuss the role of the three domains of co-innovation in relation to boundary work effectiveness.

References

- Clark WC, et al. (2011) Boundary work for sustainable development: Natural resource management at the Consultative Group on International Agricultural Research (CGIAR). *Proc Natl Acad Sci USA* doi: 10.1073/pnas.0900231108.
- Douthwaite et al. (2007) Impact pathway evaluation of an integrated *Striga hermonthica* control project in Northern Nigeria. *Agric Syst* 92:201-222.

Using Local Knowledge to assess Ecological Services in Complex Agricultural System at the Landscape Level

Birman, Delphine¹; Clouvel, Pascal¹; Lopez-Ridaura, Santiago²; Baudry, Jacques²; Hubert, Bernard²; Martin, Pierre¹; Titonell, Pablo¹

¹CIRAD, FRANCE; ²INRA, FRANCE

Introduction

Landscape is commonly considered as a “space” produced by heterogeneous socio-ecological processes with specific spatio-temporal properties. In western Kenya, as in many other country of Africa, land use and natural resources management involve individual and collective actions supported by local knowledge about ecological processes. Luo agricultural landscapes exhibit a high level of biodiversity due to complex social processes (≈ 1000 hab/km²). We conducted our research in Kajulu, a specific geographical region of 20 km² on the northern side of the Lake Victoria basin. The territory is characterized by a diversity of land use and neighboring

ecosystem (cultivated area, natural forest, urban area, hill-crest). Such situation provides an ideal laboratory for observation to capture local knowledge about ecological processes. We propose a methodological approach to describe and analyze landscape heterogeneity mobilizing local knowledge about ecological processes, and land resource management at farm level.

Methodology

Because of landscape complexity, landscape units were identified by landscape metric analysis using a supervised land use and land cover classification (Fragstat 3.2 software), and delimited according to

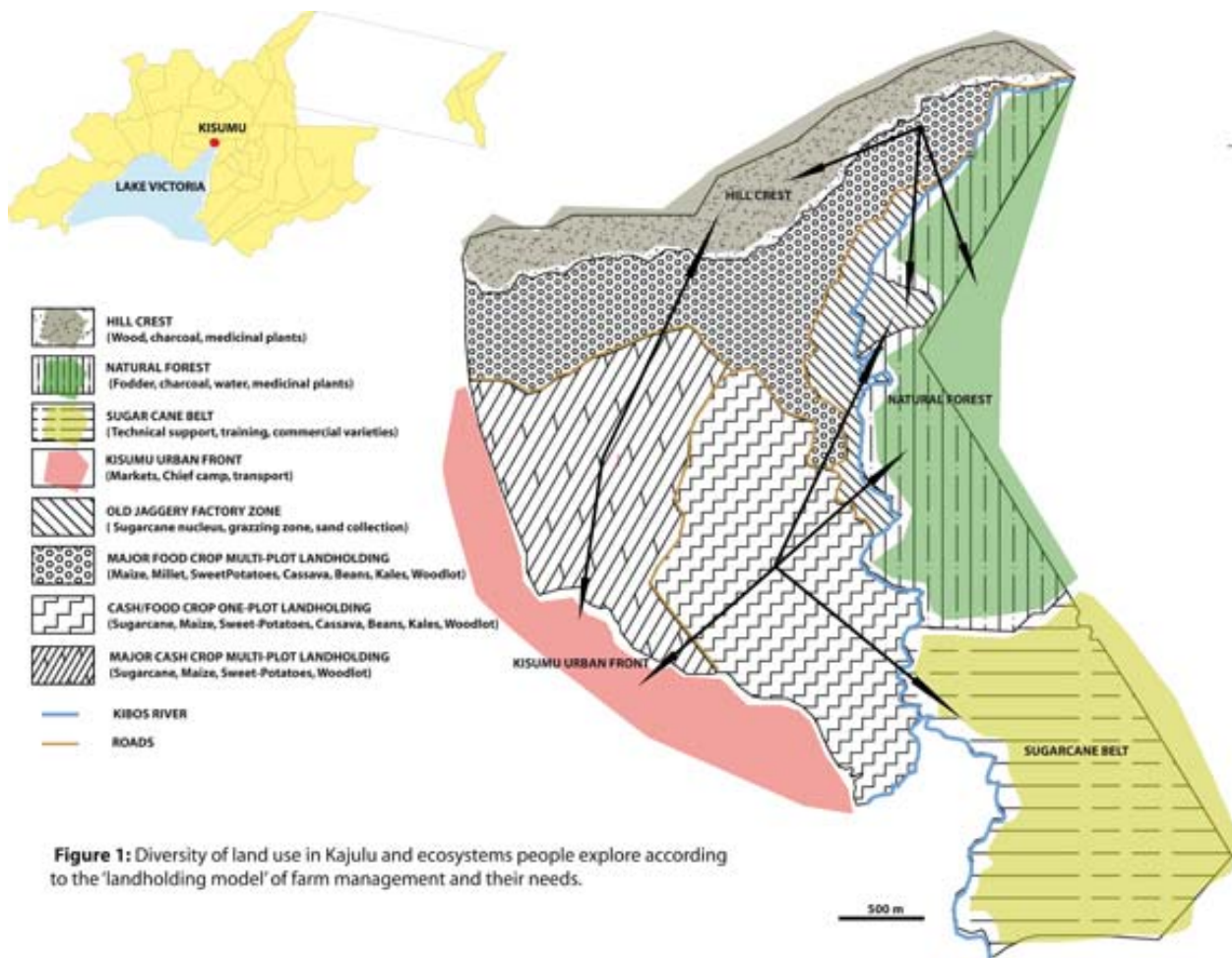

peoples' perception of their environment. Classification was established during collective meetings where community members and elders identified the landscape ecological functions they perceived. Individual surveys were conducted at farm level in each unit using "snowball strategy", based on the social network (neighbors, relative, owners of knowledge ...) and how people interact with landscape elements (hedge, tree, cultivated field, brook, etc...). In total, 80 households were visited, involving 124 peoples.

Results and discussion

At the farm level, socio-technical surveys show that Luo people experiment two different models of farming system: a traditional one corresponding to a 'multi-plot landholding model', already described by Shipton (2009), where farming is organized in space and time according to their local needs and the ecological dynamics. In this model part of farmers' strategy is to diversify the fields they farm to make sure they plant diverse crops with different requirements in terms of soil type, slopes, shading and drainage to guarantee harvest where drought and floods are twin risks, and to avoid food shortage that may happen throughout the year. Because of rapid population growth and scarcity of land, that model is slowly replaced by a second one,

corresponding to a 'single plot landholding model' mostly concentrated around the homestead. Our results show that part of people who manage a 'single plot landholding model' tend to overpass farm boundaries exploring neighboring ecosystems for natural resources (medicinal plants, fruits, fodder, etc...) and economical incomes such as labor in the sugarcane belt and markets in urban areas (Figure 1). At the landscape level we manage to characterize the ecological properties perceived for each landscape units by people through (i) knowledge system, (ii) local agricultural practices and (iii) local observations about pest regulation and soil fertility control.

We show that systems of knowledge mobilized for regulation services are composed by both empirical and scientific knowledge inherited from agricultural institutions (NGOs, Ministry of Agriculture...). From traditional practices (ash treatment, plant mixture for pest control, intercropping, crop rotation,...) to institutional advices (dilution effect, chemicals, commercial varieties, ...), interaction of both systems of knowledge contribute to produce specialized socio-ecological spaces where agricultural practices depend on local biophysical properties, farmers' observations and local knowledge acquired in time.

The COMPASS framework – Navigating agricultural landscapes for science-based innovation

Groot, Jeroen¹; Rossing, Walter¹; Dogliotti, Santiago²; Tiftonell, Pablo¹

¹Wageningen University, NETHERLANDS; ²Facultad de Agronomía, URUGUAY

To meet current and future global demands agroecosystems need to combine robustness with adaptability and resilience to changes in biophysical and socio-economic conditions. Agriculture based on ecological resources and processes represents a promising perspective to this end. Science-based analytical frameworks can support the analysis, re-design and adaptive management of such social-ecological systems (Groot & Rossing 2011). Approaches should be able to address the complexity arising from interactions among multiple spatial and temporal scales, multiple actors and levels of organization, and multiple objectives in agricultural landscapes.

The COMPASS (Co-innovation and Modeling Platform for Agro-eco System Simulation) framework that integrates modeling tools at field, farm and landscape scales (Fig 1) has been developed to support experiential learning and decision-making in participatory settings. The framework

is particularly suitable to support innovation systems approaches in which a diversity of actors interact and learn together.

The field-scale modules of COMPASS quantify effects of management of soil, crops, grasslands and semi-natural landscape elements, and comprise complete technology packages including crop choices and rotations and their management. Resulting indicators include e.g. crop yields, soil carbon and nutrient dynamics, water balances and soil erosion (Fig 2a; Dogliotti *et al* 2004). Model outcomes at field scale can be aggregated to farm-scale modules, which may be spatially implicit or explicit, static or dynamic, and can use different optimization methods (Fig 2b; Groot *et al* 2012). Typical farm level indicators such as nutrient balances, productivity, and economic and environmental performance are quantified and their dynamics simulated (Fig 2c; Groot *et al* 2012). Indicators at landscape level may be derived from aggregation from

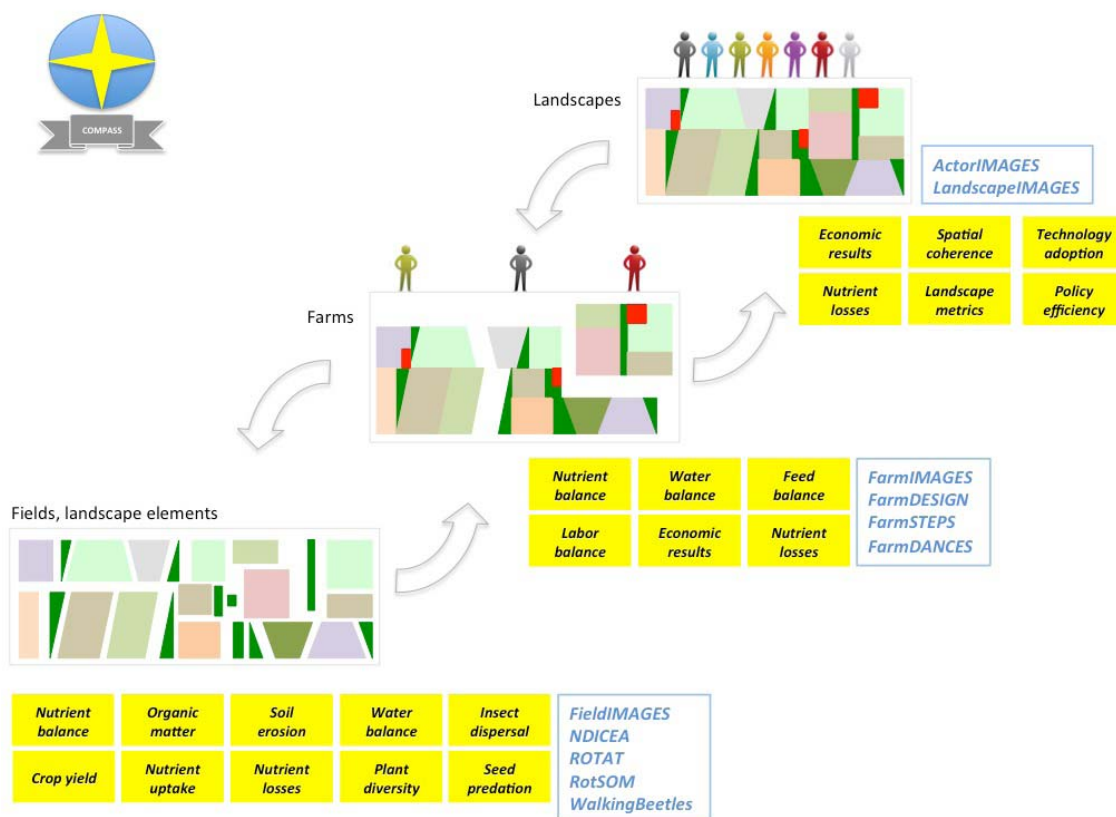

Fig. 1. Overview of the COMPASS framework. The yellow boxes are example indicators. In blue names of individual models.

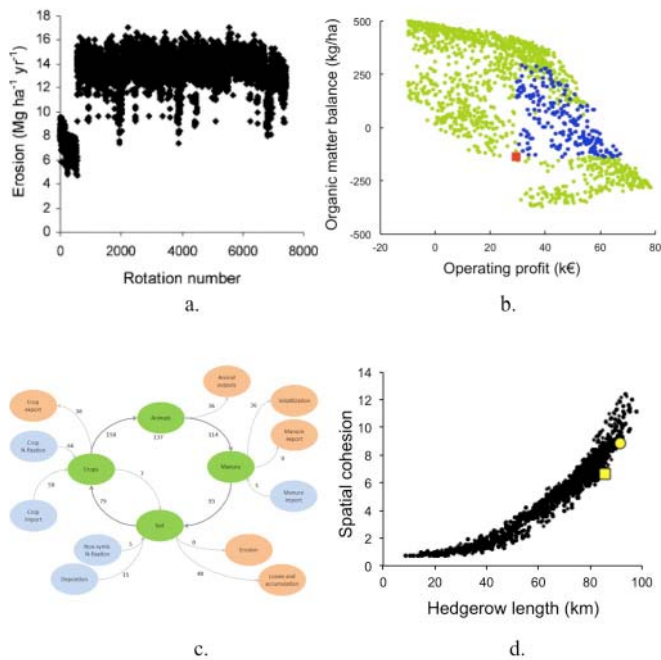

Fig. 2. Typical outcomes of COMPASS modules operating at the levels of field (a. erosion for 7,500 generated rotations), farm (b. result of multi-objective optimization of a mixed farm; c. farm nitrogen cycle) and landscape (d. relation between hedgerow length and spatial cohesion).

field and farm scales indicators, or represent emerging properties that are only relevant at landscape level, such as the spatial coherence of landscape elements, or indicators of landscape quality (Fig 2d; Groot et al 2010). At the farm level farmers and their advisors are the main stakeholders, whereas at the landscape level a large range of stakeholders can be identified, such as cooperatives and governmental and non-governmental organizations. The diversity of farm types and styles is captured through functional typologies, while biophysical dynamics at higher scales can be explicitly coupled in COMPASS to socio-institutional dynamics represented in agent-based models.

The comprehensive COMPASS framework is an integrated, yet flexible methodology, which has shown strong potential to support learning and collective decision-making processes concerning sustainable agroecosystem management.

References

- Dogliotti S, Rossing WAH, van Ittersum, MK, 2004. Systematic design and evaluation of crop rotations enhancing soil conservation, soil fertility and farm income: a case study for vegetable farms in South Uruguay. *Agric Syst* **80** 277-302.
- Groot JCJ, Jellema A, Rossing WAH, 2010. Designing a hedgerow network in a multifunctional agricultural landscape: balancing trade-offs among ecological quality, landscape character and implementation costs. *Eur J Agron* **32** 112-119.
- Groot JCJ, Oomen GJM, Rossing WAH, 2012. Multi-objective optimization and design of farming systems. *Agric Syst*. DOI: 10.1016/j.agry.2012.03.012.
- Groot JCJ, Rossing WAH, 2011. Model-aided learning for adaptive management of natural resources – An evolutionary design perspective. *Meth Ecol Evol* **2** 643–650.

Assessing farmers' objectives: implications for adaptation

Mandryk, Maryia; Groot, Jeroen C.J.; Kanellopoulos, Argyris; Reidsma, Pytrik; van Ittersum, Martin K.
Wageningen university, NETHERLANDS

Introduction

Considerable changes in climatic trends and in the frequency and severity of weather anomalies are expected during the coming decades. Farmers will have to make many changes to their farming systems to adapt to these climate changes. Considering the wide diversity in the structural characteristics, objectives and economic and environmental performances of European farming systems, a large heterogeneity in preferred adaptation measures is expected. Here we investigate the differences in these preferences between current farmers, which differ in their production orientation, focusing on either primary production, nature conservation or multifunctional activities (Mandryk et al. 2012). The aim of our study is to demonstrate how different objectives influence farmers' current decision-making, that in turn may affect the choices for adaptation measures to climate change for the different farm types in the future. We try to establish to what extent adjustments in farm plans are aligned with the stated objectives of farmers.

Methodology

To deal with multiple conflicting objectives, we based our methodological approach on Multi-criteria Decision Modeling approach (MCDM) as defined by Romero

and Rehman (2003). We included the following steps in our study: a) identification of farmers' objectives from literature review and interviews with farmers and experts; b) ranking of objectives by interviewing farmers and deriving weights for the objectives (w_i); c) generation of alternative farm plans (Groot et al. in press) and calculation of trade-offs between objectives (Figure 1); d) selection of the most preferred alternative farm plans by farmers and deriving weights for different objectives from trade-offs (w_t); e) comparison between ranking of objective weights w_i and w_t . In the final step, we linked the derived objectives to farm structure and resources using a farm typology from Mandryk et al. (2012). We investigated how farmers' objectives, farm structure and available resources influence the choice for most preferred alternative farm plans, or the choice for adaptation.

The case study area for the research is the province of Flevoland in the North of the Netherlands. We decided to model typical arable farms that represent a group of farms rather than formulate prototypes based on averaging farm characteristics. Modeling typical farms provided opportunities to obtain case study specific input for the model, to receive feedback on the modeling results from farmers, and to perform model validation

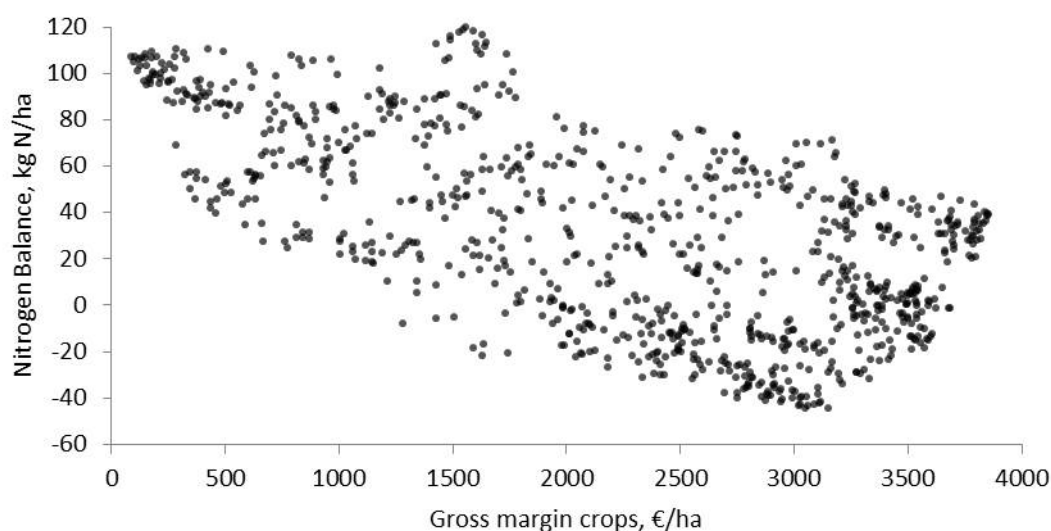

Figure 1. Performance of alternative farm plans generated by the model from Groot et al. (in press) presented in terms of gross margin of crops and nitrogen balance (two out of five objectives used in the study)

through multiple iterations with farmers. We thoroughly surveyed 9 typical arable farms from different farm types.

Results and discussion

Our study results demonstrate that farmers' intentions are not always reflected in their practical decision-making. Next to farmers' objectives, other factors, such as farm structure and available resources, influence the adaptation preferences in the current situation. This will be taken into account for the follow-up study. The different weights for objectives will be included in scenarios to assess adaptation strategies for different farm types towards future changes, such as climate change.

References

- Groot JCJ, Oomen GJM, Rossing WAH. Multi-objective optimization and design of farming systems. *Agricultural Systems*. In press DOI 10.1016/j.agsy.2012.03.012
- Mandryk M, Reidsma P, van Ittersum M (2012). Scenarios of long-term farm structural change for application in climate change impact assessment. *Landscape Ecology* 27(4):509-527. DOI 10.1007/s10980-012-9714-7
- Romero C and Rehman T (2003). *Multiple criteria analysis for agricultural decisions*. Elsevier: Amsterdam, Original publication in 1989

Factors affecting soil organic matter conservation in Mediterranean hilly cropping systems: a case study on 43 cropping systems in Tuscany (Italy)

Debolini, Marta¹; Marraccini, Elisa²; Di Bene, Claudia¹; Bonari, Enrico¹

¹Scuola Superiore Sant'Anna, ITALY; ²INRA, FRANCE

Introduction

Soil organic matter (SOM) conservation is a relevant issue in Mediterranean hillside landscapes due to their vulnerability. Such vulnerability is accentuated by the recent dynamics, e.g. the transition from the traditional polycultural cropping systems to simplified rotations mainly based on rainfed autumn-winter cereals. Therefore from the 90's a high number of studies have been developed to assess the sustainability of cropping systems to maintain a proper level of soil fertility. The SOM balance is one of the main indicators of environmental sustainability and functionality of cropping systems. In this study we aim to analyze different Mediterranean hillside cropping systems in terms of their capability of SOM conservation. The study is particularly relevant in light of the post-2013 CAP because it fosters the understanding of the main determinants of SOM, which are supposed to be improved by the CAP.

Materials and methods

The study area is the hilly inland of the Grosseto Province (Italy), characterized by soil ranging from silt-loam to clay and skeleton, as well as by a Mediterranean climate (annual rainfall 800 mm, average temperature 14°C). We identified two sub-areas corresponding to two cooperatives (Colline Amiatine and Pomonte) differing for: (i) the services provided to farmers; (ii) the collected

products; and (iii) the farming systems. Moreover, polycultural and mixed farming are predominant, but one cooperative is oriented toward cattle-cereal while the other leans toward sheep-grazing. We applied the Hénin and Dupuis SOM equation (1945) with the adjustments by Mary and Guérif (1994) and Bechini and Castoldi (2009), as this is one of the most used to evaluate the effect of agricultural practices on the evolution of the SOM pool also in Mediterranean environment (Bertora et al., 2009; Di Bene et al., 2011). The Kruskal-Wallis test was applied to test some factors related to the farm location and organization to discriminate the SOM balance among cropping systems. These factors were also combined in order to evaluate the interactions.

Results and discussion

We found a general negative SOM balance for the analyzed cropping systems ($-877 \text{ kg ha}^{-1} \text{ yr}^{-1} \pm 221$). The main results of the single factor analysis are showed in Table 1.

Significant factors influencing SOM balance were: a) the belonging to different cooperatives, with a positive balance in the case of the Colline amiatine cooperative; b) the farming system (sheep or cattle farming), which was less negative in the first case; and c) the rotation length, which was less negative in the case of rotations >3 years. Surprisingly, the share of winter wheat did not seem to

		OM inputs (kg ha ⁻¹)		SOM mineralization (kg ha ⁻¹)		SOM balance (kg ha ⁻¹)	
Cooperatives of product delivery	Colline amiatine (N= 15)	677 ± 204	ns	-666 ± 116	***	11 ± 243	***
	Pomonte (N= 28)	823 ± 157		-2176 ± 200		-1353 ± 276	
Livestock production	Present (N= 33)	885 ± 167	*	-1739 ± 185	ns	-854 ± 284	ns
	Absent (N= 10)	399 ± 97		-1352 ± 238		-953 ± 181	
Livestock type	Cattle (N= 9)	951 ± 306	ns	-481 ± 125	***	470 ± 313	**
	Sheep (N= 24)	860 ± 181		-2210 ± 227		-1350 ± 319	
Crop rotation length	≥ 3 years (N=12)	1014 ± 241	ns	-1077 ± 295	*	-63 ± 401	**
	< 3 years (N=21)	811 ± 201		-2117 ± 264		-1306 ± 352	
Ratio of winter cereals	> 50% (N=11)	900 ± 208	ns	-1703 ± 354	ns	-804 ± 429	ns
	≥ 50% (N=22)	877 ± 209		-1756 ± 276		-879 ± 374	

Table 1: Effect of the tested single factors on the annual SOM balances of local cropping systems (mean ± standard error, ns indicates P > 0.05).

		OM inputs (kg ha ⁻¹)		SOM mineralisation (kg ha ⁻¹)		SOM balance (kg ha ⁻¹)	
Pomonte	Winter cereals > 50% (N=5)	455 ± 99	*	-1689 ± 466		-1233 ± 233	
	Winter cereals ≤ 50% (N=19)	868 ± 157		-2347 ± 255	ns	-1381 ± 384	ns
Colline amiatine	Winter cereals > 50% (N=2)	872 ± 236		-708 ± 496		164 ± 332	
	Winter cereals ≤ 50% (N=7)	964 ± 397	ns	-417 ± 110	ns	557 ± 370	ns
Pomonte	Presence of livestock (N=24)	860 ± 181		-2210 ± 228		-1350 ± 319	
	Absence of livestock (N=4)	600 ± 139	ns	-1968 ± 368	ns	-1368 ± 317	ns
Colline amiatine	Presence of livestock (N=9)	951 ± 306	*	-481 ± 125		-470 ± 313	**
	Absence of livestock (N=6)	265 ± 107		-942 ± 178	ns	-676 ± 142	
Pomonte	Rotation length > 3 years (N=3)	582 ± 272		-2347 ± 597		-1366 ± 709	
	Rotation length ≤ 3 years (N=21)	900 ± 204	ns	-2191 ± 249	ns	-1291 ± 354	ns
Colline amiatine	Rotation length > 3 years (N=12)	829 ± 236	*	-627 ± 135		202 ± 237	
	Rotation length ≤ 3 years (N=3)	68 ± 14		-820 ± 237	ns	-705 ± 214	ns
Rotation length > 3 years	Presence of livestock (N=11)	932 ± 248		-1000 ± 312		-68 ± 440	
	Absence of livestock (N=5)	491 ± 170	ns	-1196 ± 371	ns	-1098 ± 224	ns
Rotation length ≤ 3 years	Presence of livestock (N= 22)	861 ± 198	*	-2108 ± 252		-1247 ± 340	
	Absence of livestock (N=5)	307 ± 96		-1508 ± 325	ns	-1201 ± 268	ns
Rotation length > 3 years	Livestock density > 1.6 (N=2)	2470 ± 42	*	-606 ± 397		1464 ± 440	
	Livestock density ≤ 1.6 (N=9)	590 ± 118		-1088 ± 374	ns	-497 ± 404	*
Rotation length ≤ 3 years	Livestock density > 1.6 (N=4)	1164 ± 230	*	-3034 ± 501		-1869 ± 600	
	Livestock density ≤ 1.6 (N=18)	794 ± 236		-1902 ± 269	ns	-1108 ± 393	ns
Winter cereals > 50%	Rotation length > 3 years (N=3)	1164 ± 230		-715 ± 286		-45 ± 472	ns
	Rotation length ≤ 3 years (N= 7)	794 ± 236	ns	-1504 ± 455	ns	-1158 ± 375	
Winter cereals ≤ 50%	Rotation length > 3 years (N=13)	823 ± 221		-1141 ± 285	*	-318 ± 376	*
	Rotation length ≤ 3 years (N= 20)	902 ± 215	ns	-2169 ± 260		-1266 ± 359	

Table 2: Effect of the tested multiple factors on the annual SOM balances of local cropping systems (mean ± standard error, ns indicates P > 0.05).

influence the SOM balance. The differences between the two cooperatives could be due to local farming practices, such as tillage depth and the absence of bare soil protection practices by mulches, since no differences have been retrieved on environmental conditions (soil, climate, topography).

Considering the multiple factors analysis (Table 2), we found a significant positive SOM balance in the interaction between the rotation length >3 years and the livestock density. The length of the rotation positively influenced the SOM balance also when the amount of winter cereal was above 50%. The presence of livestock influenced SOM balance only in the case of longer

rotations. This could be explained by the fact that short rotation management not allows the real beneficial effect of the manure in the soil.

In this paper we showed: (i) the unexpected role of livestock which does not appear to favor SOM conservation, although its effect varies significantly depending to the livestock system; (ii) the role of winter wheat which, although presenting a high share, does not seem to significantly contribute to SOM loss. These effects seem to differ from what we could expect from the literature and from the currently agro-environmental measures for the studied area. Further research could support the local application of the 2013 agro-environmental policies.

The agri-environmental implications of food choices

Murphy-Bokern, Donal¹; Williams, Adrian²; De Marco, Alexandra³; Leip, Adrian⁴; Rood, Trudy⁵; Wagner, Susanne⁵; Westhoek, Henk⁵

¹Murphy-Bokern Konzepte, GERMANY; ²Cranfield University, UNITED KINGDOM; ³Italian national agency for new technologies, energy and sustainable economic development, ITALY; ⁴Joint Research Centre, ITALY; ⁵PBL Netherlands Environmental Assessment Agency, NETHERLANDS

Introduction

This contribution provides a review of research examining the life-cycle emissions from food and studies of the relationship between consumption in the food system, greenhouse gas emissions, nitrogen emissions, and land needs. Debate about the link between food consumption and greenhouse gas emissions and other global environmental problems is now mainstream in the policy community in Europe. This is an overview of how this debate has developed, highlighting the agricultural and environmental science underpinning it.

Methods

The presentation is based on five studies: Life-cycle assessments of agricultural commodities. Estimates of emissions from the UK food system (including land-use change). A study on the effects of UK dietary change on land needs. A study setting out a wider European perspective ('The Protein Puzzle' study). An analysis of the relationship between the European food system and N cycle. The studies use a combination of life-cycle assessment of food production and the Common Agricultural Policy Regionalised Impact (CAPRI) model framework. The work focuses on analyses of scenarios in which livestock product consumption is reduced by 50% on a dietary energy supply basis. Results These studies show the following: From a consumption perspective, the UK food system is directly responsible for about one fifth of all UK consumption-related greenhouse gas (GHG) emissions. Emissions from producing crops and animals are dominated by nitrous oxide and methane from biological processes. The scope for addressing emissions from primary food production (i.e. up to the 'farm-gate') with engineering and other technical solutions is limited. Consumption change, particularly reducing the consumption of livestock products, is a robust approach to mitigation of emissions from the food system. Consumption change to reduce GHG emissions is aligned with other objectives: the reduction of other emissions such as nitrate and ammonia from agriculture, and public health goals. A shift to a more plant-based diet will lead to a large decrease in the nitrogen footprint of EU diets. A 50% reduction in livestock product consumption and production reduces the agricultural reactive nitrogen

emission from the current 6.5 million tonnes to 3.8. and would reduce the need for arable land. The requirement for imported soybeans (as meal) is reduced by 75%. Depending on the consumption change scenarios, 9 to 14.5 million hectares is made available for other use such for bioenergy or cereals for export.

Conclusion

The evidence that consumption change in the food system can significantly support reductions in consumption-related greenhouse gas emissions is compelling. A shift towards a low carbon food system (which is aligned to healthy eating guidelines) is likely to reduce the need for all types of agricultural land. The alternative use of this land has a crucial effect on the environmental outcome. Using grassland 'released' by consumption change for biofuels from annual crops is likely to increase overall emissions in the first decades after conversion due to losses of soil carbon. In contrast, conversion (or reversion) to forest is likely to increase soil carbon stocks.

References

- Audsley, E., Brander, M., Chatterton, J., Murphy-Bokern, D., Webster, C., and Williams, A. (2009). An assessment of greenhouse gas emissions from the UK food system and the scope for reduction by 2050. How low can we go?. WWF-UK and the FCRN.
- Audsley, E., Chatterton, J., Graves, A., Morris, J., Murphy-Bokern, D., Pearn, K., Sandars, D. and Williams, A. (2010). Food, land and greenhouse gases. The effect of changes in UK food consumption on land requirements and greenhouse gas emissions. The Committee on Climate Change.
- Westhoek, H., De Marco, A., Leip, A., Murphy-Bokern, D., Rood, T., Millward, J., Wagner, S. (2012). European Nitrogen Assessment. Special report on nitrogen and food. In review in public: <http://www.clrtap-tfrn.org/>

Climate uncertainty: What response is needed from vegetable agronomists worldwide?

Keatinge, J.D.H (Dyno); Ledesma, D.; Keatinge, F.J.D.; Hughes, J. d'A.

AVRDC - The World Vegetable Center, TAIWAN

Introduction

AVRDC - The World Vegetable Center has a global mandate for the improvement of vegetable systems to combat malnutrition and poverty in the developing world. Climate uncertainty over the next 15 years will have a substantive influence research subjects along the entire vegetable value chain. The IPCC's report on temperature change (Folland et al. 2001) is highly complex. In contrast, we strive to provide simpler and more practical guidance for agronomists by adopting a simple approach to predicting future air temperatures based on measured long term data from AVRDC and its partner research centers. Efforts to provide genetic adjustment to warming and other abiotic stress resistances in vegetables have been summarized by de la Peña et al. (2011). Adaptation of vegetable crops to climate uncertainty is quite possible using modern agricultural science.

Materials, methods, results

long runs of annual average air temperature were collected from different locations worldwide. The stations selected, their locations and elevations above mean sea level are presented in Table 1. The period 1975-2011 was

chosen as the comparator reference time series as this is the longest run available for AVRDC's headquarters in Taiwan and it apparently coincides with the end of a phase of cooler weather favorable to vegetables in North America documented by McKeown et al. (2006). All the data sets which had at least 30 year runs were subjected to regression analysis using a linear model and tested for significance. The data are presented in Table 1 and Figure 1.

Discussion

The IPCC reports concerning air temperature clearly indicate that climate change is characterized by substantive variability at a local level and this is further reflected in the results presented in this paper. Nevertheless, at the majority of sites there is a predominant trend of increasing average temperatures. There are also exceptions which show no significant change (eg. WARDA, Benin) in the last 30+ years. Site specificity thus clearly remains a key challenge to vegetable scientists. For example, at AVRDC, Taiwan where tomatoes and peppers are being bred for global use, is likely to experience rather faster warming than most other locations in this study with projected average

Table 1. Location and trend analysis of average annual air temperature ($^{\circ}\text{C}$) for at least 30+ years (from 1975 to 2011) and projected for 2011 and 2025 from the equations shown

	Latitude	Longitude	Elevation (m)		
WARDA/IITA, Cotonou, Benin	06° 24' N	002° 20' E	025		
IITA, Kano, Nigeria	12° 03' N	008° 34' E	487		
ICARDA, Breda, Syria	35° 56' N	037° 10' E	300		
AVRDC, Shanhua, Taiwan	23° 00' N	120° 17' E	009		
CIMMYT, Toluca, Mexico	19° 23' N	099° 55' W	2585		
	Years	Slope	Intercept	R ²	Sig
WARDA/IITA, Cotonou, Benin	1979-2011	0.002	23.74	0.00	ns
IITA, Kano, Nigeria	1975-2011	0.03	-33.33	0.23	**
ICARDA, Breda, Syria	1980-2011	0.045	-72.75	0.25	**
AVRDC, Shanhua, Taiwan	1975-2011	0.045	-65.88	0.50	**
CIMMYT, Toluca, Mexico	1975-2009	0.039	-65.22	0.24	**
	Years	2011 [^]	2025	2025-2011 [^]	
WARDA/IITA, Cotonou, Benin	1979-2011	27.8			
IITA, Kano, Nigeria	1975-2011	27.0	27.4	0.4	
ICARDA, Breda, Syria	1980-2011	17.8	18.4	0.6	
AVRDC, Shanhua, Taiwan	1975-2011	24.6	25.2	0.6	
CIMMYT, Toluca, Mexico	1975-2009	13.2	13.8	0.6	

Where:

WARDA/IITA (West African Rice Development Association – Shared campus with IITA)

IITA (International Institute of Tropical Agriculture)

ICARDA (International Center for Agricultural Research in the Dry Areas)

AVRDC (The World Vegetable Center)

CIMMYT (International Wheat and Maize Improvement Center)

* = $p < 0.05$

** = $p < 0.01$

ns = $p > 0.05$

[^] = Value projected from the equation in the table

Figure 1. Average annual air temperatures at five agricultural research centers distributed worldwide

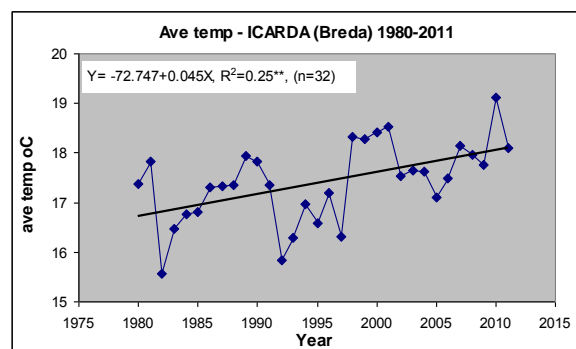
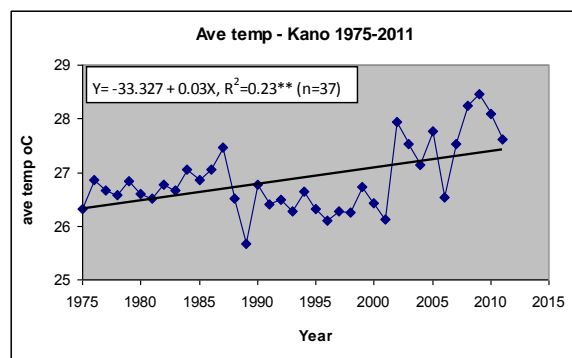
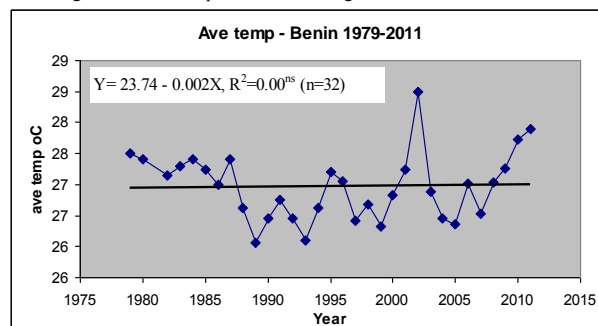

annual temperature in 2011 set to increase by 0.6 °C to 25.2 °C by 2025 (Table 1 and Figure 1). More effort now needs to be placed on abiotic stress tolerance research and to find ways by which improved crop agronomy can help reduce environmental constraints to production. AVRDC has been making a substantive investment in research designed to introgress heat, drought and salt tolerance genes from wild species into cultivated types and in other crop management technologies to meet the growing challenges of climate uncertainty including better targeted water use technologies, better protected agriculture and a more intelligent-use of grafting. Moreover, one option, always available to the vegetable production community, in response to increasing temperatures, is to switch from a crop with less heat tolerance to one with already existing adaptation. The AVRDC genebank alone now possesses more than 430 species of vegetables with at least some of these capable of growing irrespective of the niche agricultural environment being considered.

References

- De la Peña RC, Ebert AW, Gniffke, PA, Hanson P. & Symonds RC (2011). Genetic adjustment to changing climates: Vegetables. In *Crop Adaptation to Climate Change*, pp. 396-410. New Delhi: John Wiley
- Folland CK, Karl TR, Christy JR, Clarke RA, Gruza GV, Jouzel J, Mann ME, Oerlemans J, Salinger MJ & Wang S-W 2001. Observed Climate Variability and Change. In: *Climate Change 2001: The Scientific Basis*. pp. 99-181. Cambridge: Cambridge University Press.
- McKeown AW, Warland J & McDonald MR (2006). Long-term climate and weather patterns in relation to crop yield: A mini-review. *Canadian Journal of Botany* 84, 1031-1036.

Relationships between grain yield, grain nitrogen concentration and leaf senescence in Swedish spring wheat

Asplund, Linnéa; Bergkvist, Göran; Westerbergh, Anna; Weih, Martin

Swedish University of Agricultural Sciences, SWEDEN

Introduction

The efficiency of crop plants to utilize nitrogen fertilizer is important for environmental reasons as well as food security. Wheat varieties often differ in both nitrogen use efficiency (NUE) and other agronomically important traits. Therefore, knowledge on how variety traits are related to NUE could be useful in the breeding for more nitrogen use efficient varieties.

An important aspect of NUE is the redistribution of N to the developing grain during leaf senescence. This is related to both the quality of the grain (high protein concentration) and yield. It has been shown that wheat varieties with later onset of senescence reach higher yields, under low N field conditions in France (Gaju et al., 2011). That functional link to yield makes senescence interesting from a breeding perspective, and possible connections to NUE should be further explored.

We studied the relationship between flag leaf senescence and NUE by measuring leaf senescence, and relating it to plant biomass and nitrogen. The major hypothesis is that later start of senescence is associated with higher grain yield, because of extended period of photosynthetic carbon assimilation, and that earlier onset of senescence is associated with higher grain N concentration.

Materials and methods

Forty-one varieties of Swedish spring wheat (*Triticum aestivum* L.) were grown until maturity in a climate chamber in a randomised complete block design with four replications and pot as experimental unit. Chlorophyll measurements (SPAD-502, Konica Minolta) were taken from the main stem flag leaves of each plant (two plants per pot) twice a week. The plants were harvested at maturity. The biomass was divided into grain and straw, and N concentrations were analyzed in both fractions. A line was fit to the SPAD data of each pot. The line was composed of one horizontal segment connected to one linearly decreasing segment (Piegorisch and Bailer, 2005), with the joint as onset of senescence (in days after anthesis). Variables were analyzed with ANOVA and regression analysis.

Results

The varieties differed in onset of senescence ($p < 0.0001$), rate of senescence ($p < 0.0001$) and grain yield ($p = 0.003$). They also differed in grain N concentration ($p < 0.0001$), one of three major components of NUE according to Weih et al. (2011), and total grain N ($p = 0.07$). Grain N concentration varied between 1.7 and 2.5 % N dw^{-1} . The relationship between onset of senescence and grain yield was not significant, but positive ($p = 0.405$, $R^2 = 0.018$). The relationship between grain N concentration and onset of senescence was non-significant and negative ($p = 0.332$, $R^2 = 0.024$). Varieties that started senescence later had a faster rate of senescence ($p < 0.001$, $R^2 = 0.52$).

Discussion

The preliminary results indicate that the varieties differ in important nitrogen use efficiency and senescence traits. However, in spite of the many varieties used we have so far not been able to confirm a clear link between later start of senescence and higher grain yield. Neither could we show that an earlier start of senescence results in higher grain N concentration. The trends were in the hypothesized direction, but not statistically significant. A more thorough analysis of this material, e.g. using multivariate methods, will explore the relationships between timing and length of the senescence period, grain N concentration and NUE across the 41 wheat varieties used here.

References

- Gaju, O., V. Allard, P. Martre, J.W. Snape, E. Heumez, J. LeGouis, D. Moreau, M. Bogard, S. Griffiths, S. Orford, S. Hubbart, and M.J. Foulkes. 2011. Identification of traits to improve the nitrogen-use efficiency of wheat genotypes. *Field Crops Research* 123(2): 139–152.
- Piegorisch, W.W., and A.J. Bailer. 2005. Analyzing environmental data. Wiley, Hoboken, NJ, pp. 44–48.
- Weih, M., L. Asplund, and G. Bergkvist. 2011. Assessment of nutrient use in annual and perennial crops: A functional concept for analyzing nitrogen use efficiency. *Plant Soil* 339(1): 513–520.

Modeling crop adaptation to atmospheric CO₂ enrichment based on protein turnover and optional use of mobile nitrogen for growth or photosynthesis

Biernath, Christian¹; Bittner, Sebastian¹; Klein, Christian¹; Gayler, Sebastian²; Hentschel, Rainer³; Hoffmann, Peter¹; Högy, Petra⁴; Fangmeier, Andreas⁴; Priesack, Eckart¹

¹Helmholtz-Zentrum München, German Research Center for Environmental Health, GERMANY; ²WESS - Water & Earth System Science Competence Cluster, GERMANY; ³Leibniz-Zentrum für Agrarlandschaftsforschung e. V., GERMANY; ⁴Universität Hohenheim, GERMANY

Crop models are frequently used for extrapolation of crop biomass production and yield quality under changing environmental conditions, e.g. under elevated CO₂ concentration in the atmosphere. For decades the effect of CO₂ enrichment was analyzed in various experimental systems with a wide range of crop species and under various environmental conditions (Amthor, 2001). At least in the case of C₃ plants one would expect that atmospheric CO₂ enrichment is beneficial for biomass production because photosynthesis is not CO₂ substrate saturated under current atmospheric CO₂ concentration. However, due to multiple interactions of elevated CO₂ with other environmental factors the characteristics of

crop acclimation vary strongly in range and comprise higher biomass production, lower tissue nitrogen concentrations, altered yield quality, and increased water and nitrogen use efficiencies (Högy and Fangmeier, 2008). The lower tissue nitrogen concentrations are widely seen as a key factor in plant adaptation. Therefore, various hypotheses exist to explain the decreased tissue nitrogen concentrations but the mechanisms in terms of elevated CO₂ are still not clear. Also how to model crop adaptation is not sufficiently solved, yet. Therefore, we developed a model to test the 'down regulation of photosynthesis' hypothesis. Based on the GECROS model (Yin and van Laar, 2005) we developed a new canopy model that accounts for the dynamic turnover of photosynthetic active nitrogen in the leaf. Mobile nitrogen derived from protein degradation is then available for redistribution within the plant. In this way the plant can then optionally use the re-mobilized nitrogen either for growth or for the synthesis of new photosynthetic active nitrogen. Both the original and the new model were tested against data of spring wheat (*Triticum aestivum* L. 'Triso') grown in a mini-FACE system at Stuttgart-Hohenheim in the southwest of Germany (Högy et al., 2012). The sensitivities of both models to CO₂ enrichment were analyzed. In the scenario study in which the atmospheric CO₂ concentration was increased from 400 to 700 ppm, the new model simulated a 5% higher above ground biomass and 3% higher grain yield. However, the simulated grain nitrogen concentrations decreased by 0.005 % ppm⁻¹ using both models (Figure 1). We (i) discuss the simulation results and (ii) show that a dynamic nitrogen allocation in the

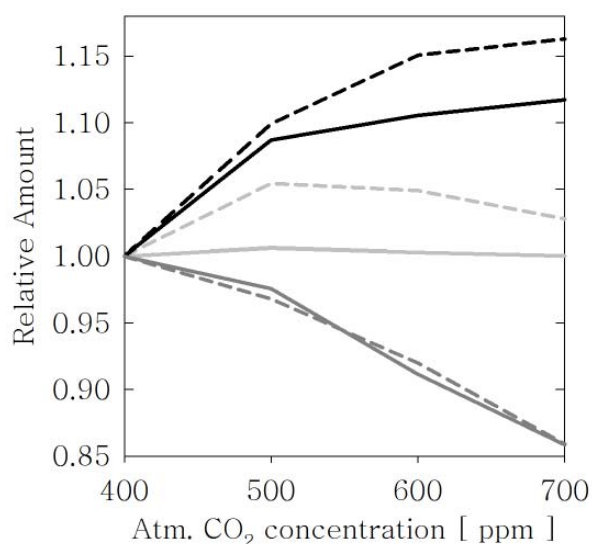

Figure 1: Responses of wheat growth simulations to increasing atmospheric CO₂ concentrations using either the GECROS model (continuous lines) or the new model (dashed lines) that extends GECROS by the turnover of photosynthetic active nitrogen and optional use of mobile nitrogen for growth and photosynthesis. Black, grey and dark grey lines represent the above ground biomass, the grain yield and the yield quality, respectively. The y-axis values are dimensionless fractions. The results were normalized to the simulation values at 400 ppm. For the study the plant modules of the GECROS model were implemented in the Expert-N model system (Priesack et al., 2006) to describe soil mineralization, solute transport and energy transfer by selected process based models.

plant could better explain crop acclimation to elevated CO₂ than the assumption that the photosynthetic nitrogen distribution is generally proportional to the light distribution in the canopy.

References

- Amthor, J., 2001. *Field Crops Res.* 73, 1–34.
- Högy, P., Brunnbauer, M., Koehler, P., Schwadorf, K., Breuer, J., Franzaring, J., Zhunusbayeva, D., Fangmeier, A., 2012. *Environ. Exp. Bot.* accepted for publication.
- Högy, P., Fangmeier, A., 2008. *J. Cereal Sci.* 48, 580–591.
- Priesack, E., Gayler, S., H.P., Hartmann, 2006. *Nutr. Cycl. Agroecosys.* 75, 1–13.
- Yin, X., van Laar, H., 2005. *Crop Systems Dynamics*. Wageningen Academic Publishers, Wageningen.

The proportion of different factors shaping yield, grain size, and quality of winter wheat in Estonian conditions

Koppel, Reine; Sooväli, Pille; Kangor, Tiia; Koppel, Mati
Jõgeva Plant Breeding Institute, ESTONIA

Introduction

Although Estonia is small by area, the soil of agricultural land and microclimate in different areas is very varied. In relation to aforementioned reasons, researches in Jõgeva, in collaboration with farmers, have conducted field trials on farmers' fields over several years to clarify the variety list suitable for the local area and to study how different genotypes react to growing technologies in varied conditions. Consulting local farmers and getting feedback from them during Field Days in various Estonian agricultural regions, is important as well.

Materials and methods

Field trials were carried out in 2010 and 2011 in six different growth locations. The varieties were 'Ada', 'Fredis', 'Ramiro', 'Mulan', 'Olivin', and LIA 00134. The varieties for trials were selected in collaboration with farmers. The trial plots were located in farmer's winter wheat field and the soil, cultivation, precrops and fertilizers were chosen by farmer. One half of the trial plots were treated with same fungicide as the main field. The other half was not treated and was used as a control plot. Winter damages and the spread of diseases were assessed during vegetation period. Yield (Y), thousand-kernel weight (TKW), protein (PC) and gluten content (GC) were determined. Factorial ANOVA was used to study the influence of different factors and their concurrence on yield, grain size and quality.

Results

Winter wheat had excessive winter damage in both years, mostly by snow mould. The extent of winter damage differed in trial locations. The influence of precrops on winter damage was evident – the damage was smaller after using legumes and winter oilseed rape, and slightly bigger after growing cereal. Minimal tillage in autumn also reduced the risk of damage. Plants were destroyed mostly in plots where precrop was cereal, fallow and plough-based cultivation was used.

Weather conditions during vegetation period were unfavourable for the spread of diseases in both trial years. In 2010, the scarce spread of *Septoria nodorum*, DTR and, in some trial locations, *Erysiphe graminis* occurred. Leaf spots appeared on early ripening varieties above average. In 2011, leaf spot levels were relatively low and powdery mildew appeared at low level. The average data, collected from all trial locations and varieties in two years, indicated that using fungicide did not increase Y or TKW. No significant influence on PC and GC occurred. The use of fungicides rather caused stress in plants and thus reduced crop yield and quality. Yearly analysis indicated that the use of fungicide increased Y in 2010 and decreased in 2011. TKW was dependent equally on growth location and genotype in 2010. In 2011, the growth location had bigger influence than variety. In both years, the use of fungicide had no significant influence on TKW. The use of fungicide reduced PC and GC as well, less in 2010 and more in 2011. The growth location had the biggest influence on crop Y and PC, GC both in average of two trial years and in years separately. In 2011, the significantly lower average Y of all trial locations and varieties was in the fungicide variant. Besides soil and climatic conditions, the growth location factor includes the type of fungicide, tillage, precrop, and fertilizer usage. This is the reason why growth location has such a big influence on different characteristics of winter wheat.

Conclusions

Scientific study has been successful when the results reach the practical field. Breeders tested different genotypes in six Estonian regions. The results of two-year study indicated that growth location had the greatest influence on crop yield, grain size and quality. The use of fungicides may not always increase the crop yield and quality. The trial continues in following years. Since 2011, the collaboration between Jõgeva PBI and farmers (Kevili Agricultural Association) is supported by Rural Development Plan submeasure 1.7.1

Modelling N balances in Legume Based Rotations

Angelopoulos, Nickolas¹; Topp, Cairistiona F.E.¹; Pappa, Valentini A.¹; Chirinda, Ngonidzashe²; Rees, Robert M¹
¹SAC, UNITED KINGDOM; ²Aarhus University, DENMARK

It is well established that legume crops have a role to play in European farming as they can fix atmospheric nitrogen. They also can replace other food, feed, fibre and fuel crop products that are imported from other continents. While grains may be consumed directly, the leaf material is either used as a green manure to fertilise soil, or processed to feed animals, commonly livestock and more recently fish. Nevertheless, EU with a funded research project wants to enhance the presence of legume based rotations in European agriculture. Legume Futures is an international research project in the EU Framework Programme 7. One of the aspects of the project is to provide an assessment of the effects of relevant farming system changes on greenhouse gasses. A dynamic and deterministic model of the soil carbon and nitrogen cycles and plant growth process (UK-DNDC; U.K. DeNitrificationDeComposition)

will be used to assess contribution of the legumes within the context of the crop rotation to greenhouse gas emissions. Data from a network of sites across a wide variety of agricultural regions of Europe growing a variety of legumes crops, will be used to validate UK-DNDC, and identify any weaknesses in the ability of the model to predict N losses and N loss pathways. Currently, data from a three years low input rotation including four different treatments located at Bush Estate, Edinburgh and 4 years conventional system located at Foulum, Denmark will be used. The ability of UK-DNDC to predict carbon dioxide and nitrous oxide emissions will be tested. The model is validated against the grain yield, total yield carbon, nitrogen, nitrates, ammonium.

The Diseases framework: software libraries to simulate a fungal airborne plant disease and its impacts on crop production in climate change scenarios

Bregaglio, Simone¹; Donatelli, Marcello²; Confalonieri, Roberto¹

¹University of Milan, ITALY; ²Joint Research Centre of European Commission, ITALY

Introduction

The development of generic disease forecasting models suitable for simulating different epidemics is a crucial issue researchers are facing (Magarey and Sutton, 2007), specifically for the assessment of crop productivity under climate change scenarios. In fact, reviews on the possible effects of biotic stresses (e.g., Goudriaan and Zadocks, 1995; Ghini et al., 2008) indicate that climate change could modify the known patterns of plant diseases by means of altered spread of some species and introduction of new

pathogens, leading to modified dynamics and shifts in geographical distribution. To perform such analyses, process-based simulation offers the capability to capture the non-linearity of the responses of biophysical processes to boundary conditions. Models have been marginally used to estimate scenarios of plant diseases impact on crop production, because of their scarce availability. This work presents a framework for the simulation of a generic plant airborne disease to be coupled with a crop simulator to assess the levels of crop productions under climate change scenarios, and its application in a case study

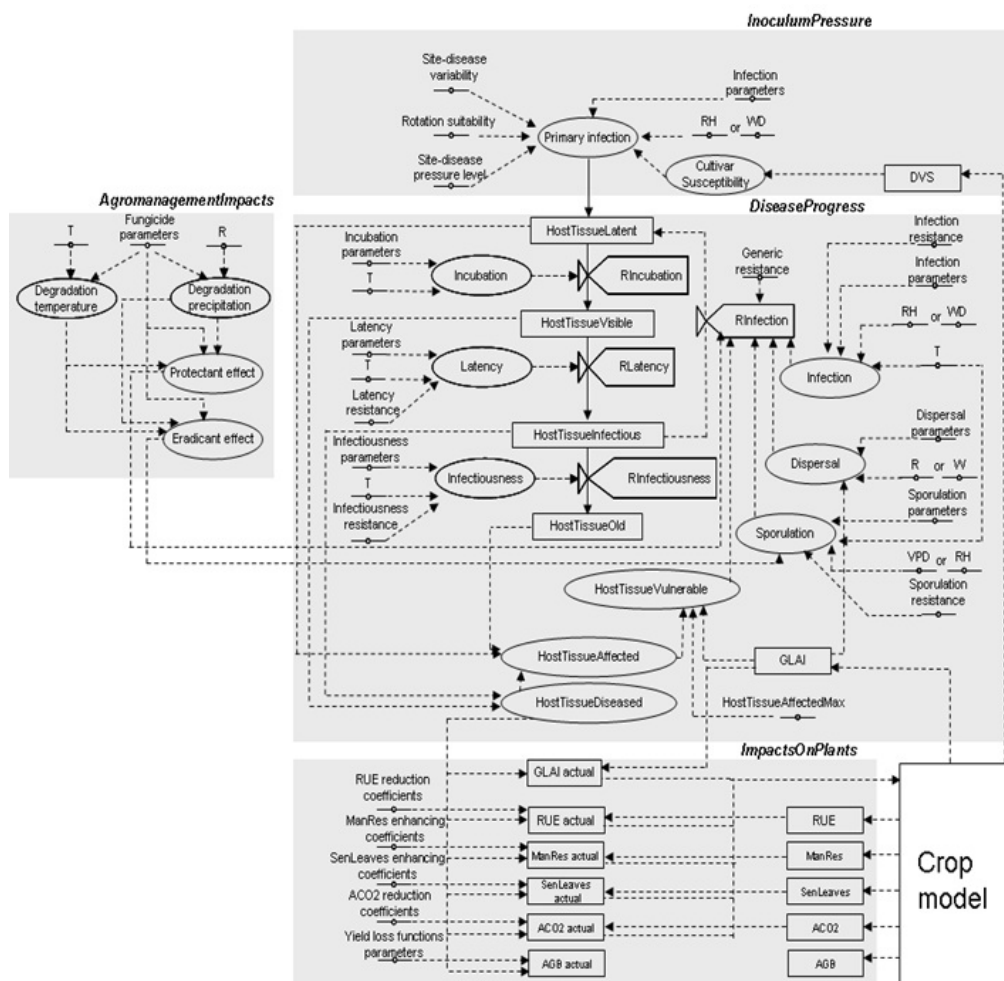

Figure 1. Flow diagram of the Diseases modelling framework.

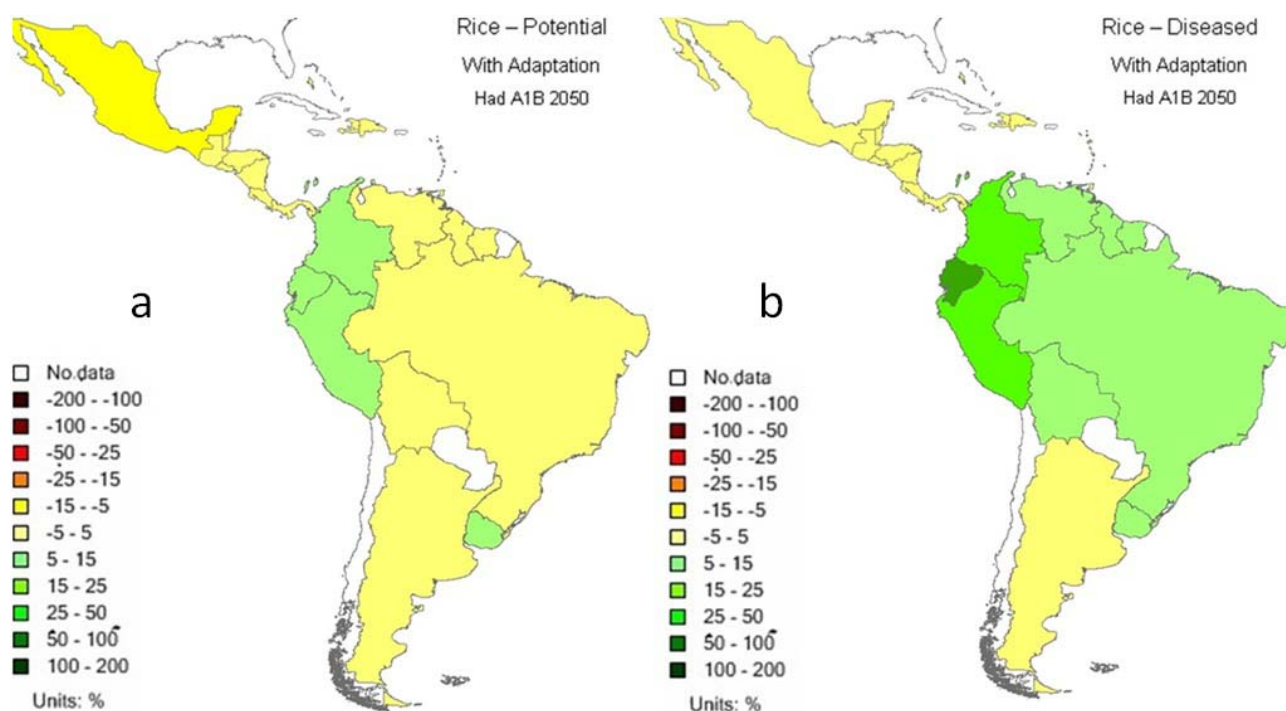

Figure 2. Percentage of differences in rice production in Latin America (Hadley A1B–2050 versus baseline) considering potential (a) and disease limited (b) levels.

Materials and methods

The Diseases components (flow diagram in Figure 1) are four software libraries implementing models to (i) simulate initial conditions for the epidemic (InoculumPressure), (ii) reproduce the epidemic progress in time (DiseaseProgress), (iii) estimate the impact of plant diseases on crop production (ImpactsonPlants) and (iv) consider the effect of phytosanitary treatments on epidemic development (AgromanagementImpacts).

Results and discussion

The framework was parameterized for pathogens of four highly cultivated crops in Latin America, and run under climate change scenarios, by considering adaptation strategies (cycle length, shift in sowing dates). Figure 2 presents the simulated differences between potential and biotic limited production level on rice (blast disease, pathogen *Pyricularia oryzae*) using IPCC A1B scenario versus baseline.

Results indicate that future conditions will be favorable for rice, and that the consideration of blast disease could lead to a decidedly lower impact on crop productivity. The implementation of adaptation strategies led to indirect benefits in terms of crop exposure to pathogens, thus reducing the pressure of blast disease on the crop. This could suggest a reduction of agrochemicals in important rice producing countries, like Brazil, and the need of investing efforts in developing blast-resistant varieties.

Conclusions

Although the importance of modelling diseases in crop production was set decades ago, the focus has been on tools to assist tactical decision making by farmers. As for other aspects of the crop performance and agricultural management, robust, but empirical and crop specific models have been developed, which cannot be used in conditions different from the ones in which they were developed, precluding exploring new environments and climatic conditions. The Diseases framework has allowed running analysis under scenarios of climate change which could not be run otherwise. This work is one of the many steps to move beyond both statistical models and a misuse of process based model via calibration which leads to data fitting, instead of forecasting models.

References

- Ghini, R., Hamada, E., Bettioli, W., 2008. Climate change and plant diseases. *Sci. Agr.* 65, 98-107.
- Goudriaan, J., Zadocks, J.C., 1995. Global climate change: modelling the potential responses of agro-ecosystems with special reference to crop protection. *Environ. Pollut.* 87, 215-224.
- Magarey, R.D., Sutton, T.B., 2007. How to create and deploy infection models for plant pathogens, General concepts in integrated pest and disease management, Springer, The Netherlands, pp. 3–25.

Application of CROPWAT model to assess climate change impact on crop evapotranspiration and irrigation requirements in Italy

Buono, Vito; Todorovic, Mladen

Mediterranean Agronomic Institute of Bari, ITALY

Introduction

According to IPCC 4th Assessment Report, higher temperatures (T) and increased variability of precipitation (P) would lead to an increase in crop water requirements (Parry *et al.*, 2007). These predictions are generally confirmed by several studies, although results mostly depend on the scale level, and whether the effect of climate change (CC) on crop growth is considered or not. With respect to Italy, former studies have specifically addressed this topic at local level, so the aim of this work is to produce a first assessment of CC impact on crop evapotranspiration (ETc) and net irrigation requirements (NIR) at national level.

Materials and methods

Climate data of EU-project CIRCE (A1-B emission scenario) have been considered, with a spatial resolution of 80 km. At each node, 30-years monthly averages have been calculated to build a "baseline" and a "future" climate scenarios, centered respectively on years 2000 and 2050. The values of monthly reference evapotranspiration (ETo) have been estimated according to FAO Penman-

Monteith equation (Allen *et al.*, 1998), and a "climatic water deficit" index (CWD) has been calculated as $ETc - P$. ETc and NIR of field crops have been computed for both climate scenarios by applying the CROPWAT model (Smith, 1992) at each node, and suitable crop parameters have been selected from scientific publications. A linear model based on the "growing degree days" concept has been used to evaluate the potential effect of higher temperatures on the shortening of growing cycles, in order to consider two different cycles under "future" scenario, the "current" and the "shortened" one. Finally, results have been displayed in thematic maps by using the ESRI ArcView GIS software.

Results

According to climate projections and simulation results, the following changes have been assessed at national scale under "future" scenario: i) an increase of mean annual air T of $2.1 (\pm 0.4)^\circ\text{C}$; ii) a reduction of mean annual P of $46.8 (\pm 44.2)$ mm; iii) an increase of mean annual ETo of $60.2 (\pm 12.9)$ mm; iv) an increase of mean annual CWD of $85.4 (\pm 53.8)$ mm (fig. 1); v) an increase of ETc and NIR for all the selected crops and areas (with values up to 50 and 120 mm respectively), if the "current" length of cycles is considered (fig. 2); vi) on the contrary, with the "shortening" of cycles (estimated from 11 to 18% of the "current" length, depending on crop type and location), ETc is projected to remain stable or to decrease; at the same time, NIR variation shows a higher variability, depending on the specific seasonal variation of P.

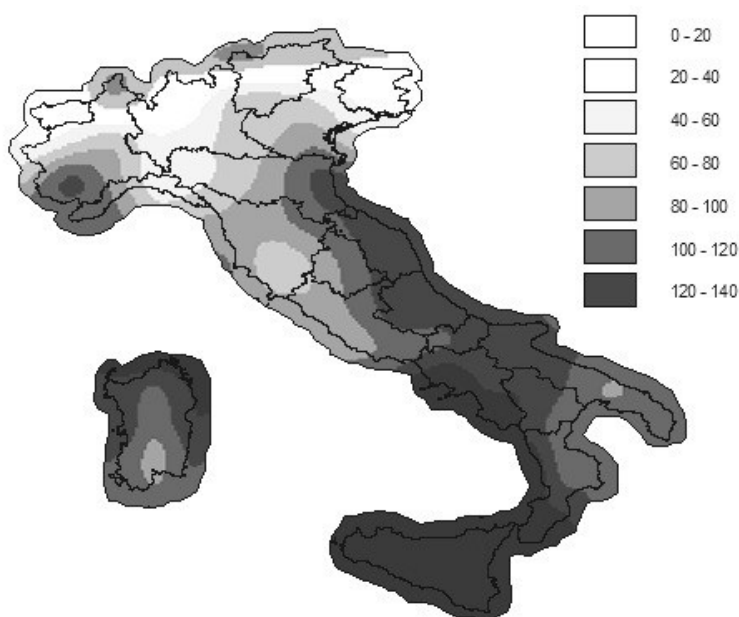

Fig. 1 - Projected increase of annual "climatic water deficit" (CWD, in mm) under "future" climate scenario.

Conclusions

In Italy, if future climate warming will affect the duration of crop cycles, the projected increase of CWD would not necessarily lead to an overall increase of total ETc and NIR. In fact, the effect of higher temperatures on the shortening of crop cycles should compensate or overcome the projected increase of daily ETo, while NIR will be more dependent on the seasonal P variation at local level. These results are in

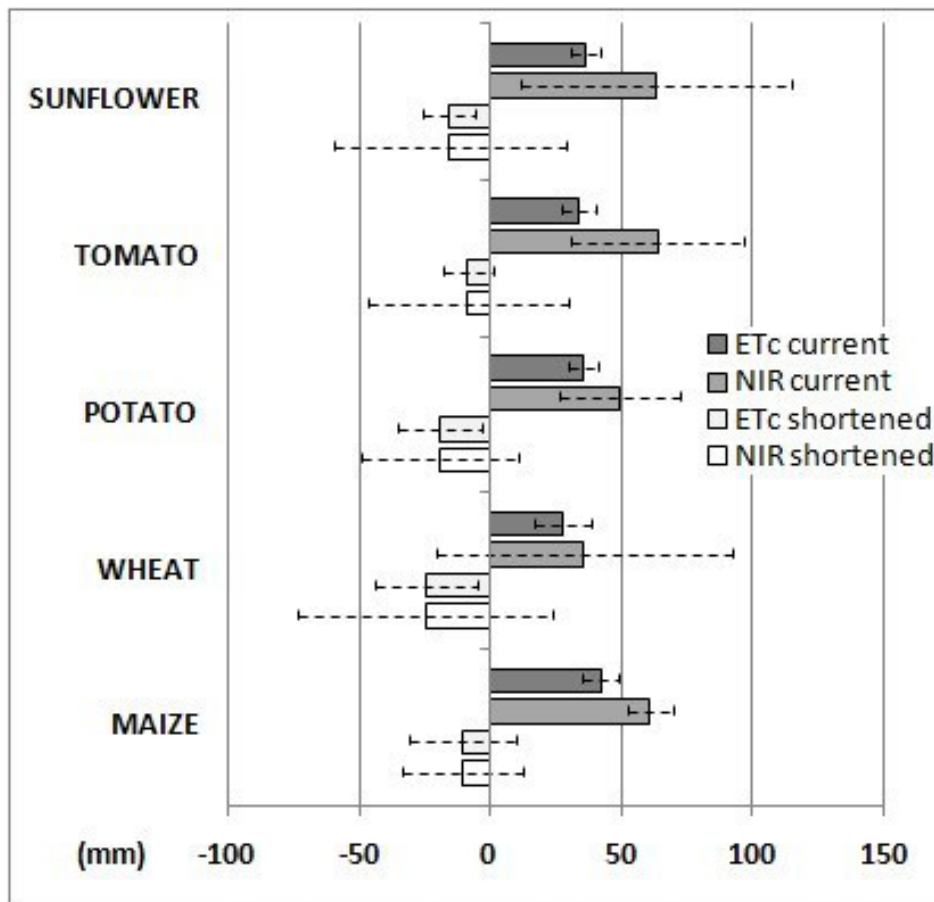

Fig. 2 - Projected ETc and NIR variation (average and standard deviation) under "future" scenario, with "current" and "shortened" crop cycle length.

line with those obtained by former researches and trend analysis (e.g. Lovelli *et al.*, 2010; Supit *et al.*, 2010). For further studies, the effect of adaptation strategies (e.g. variety selection, shifting of sowing date, etc.) as well as the impact on crop yield has to be evaluated.

References

- Allen R.G., *et al.* (1998). *Crop evapotranspiration. Guidelines for computing crop water requirements*. FAO, Rome. FAO Irr & Drain Paper, 56.
- Lovelli S., *et al.* (2010). Effects of rising atmospheric CO₂ on crop evapotranspiration in a Mediterranean area. *Agr Water Manag*, 97 (9): 1287-1292.
- Parry M.L., *et al.* (2007). *Climate Change 2007: Impacts, Adaptation, and Vulnerability*. Cambridge University Press, Cambridge, UK.
- Smith M. (1992). *CROPWAT – A computer Program for Irrigation Planning and Management*. FAO, Rome. FAO Irr & Drain Paper, 46.
- Supit I., *et al.* (2010). Trend analysis of the water requirements, consumption and deficit of field crops in Europe. *Agr Forest Meteor*, 150: 77-88.

An online toolset for dynamic geomorphic and agroecosystem modeling analysis across spatial and temporal scales

Chatskikh, Dmitri¹; Kuzmin, Igor²

¹Catholic University of Louvain, BELGIUM; ²University of Saint-Petersburg, RUSSIAN FEDERATION

Introduction

Inclusion of landscape features of agricultural fields is an important and challenging task in the agroecosystems analysis. Updating existing agroecosystem models with geomorphic component might help to improve its confidence level at several spatial and temporal scales. However, to simulate the geomorphic and the agroecosystem content of agricultural fields as a single unit dynamically some "spatial and temporal bridges" must be invented to link existing models in a conceptually new manner. According to the Geomorphic-Agroecosystem Modeling (GAEM) approach the basic complication consists of (1) differences in primer presentation of data for the modeling (incl. different layouts of point and spatial data in GIS and climatic data, quantitative description of scenarios and decision-making tools etc.) and (2) accessibility the data storages and automation of data processing considering its different sources. Our aim was development and testing of a GAEMWEB toolset for supporting of the agroecosystems analysis by inclusion of geomorphic component at several spatial (plot/catena/slope/field) and temporal (vegetation period/crop rotation) scales.

Materials and methods

Within a framework of the EU project GAEMASS we have developed a tool to support the multi-variant scenario analysis for dynamic geomorphic and agroecosystem models in the semi-automatic/automatic mode, taking into account common standards existing for spatial tools (OGS) and agroecosystem models (ICASA). The toolset has been programmed in C++/C# using cross platform open source .NET development framework (Mono). The tool consists of a comprehensive distributed database, which is filled with (1) the modeling algorithms, (2) the experimental data and (3) the outputs. To carry out data analysis a model manager had been designed. The modeling part is based on well validated point/spatial

models (CAMASE register). To validate the models and to check tool's operability we have used experimental data collected in several projects (incl. NitroEurope, Teron) on agricultural fields located in Europe. First example includes an application of the AgroSiTo model at different spatial scales in Northern and Central Europe. Secondly, we have applied dynamically linked agroecosystem (FASSET) and geomorphic (Watem/Speros) models to simulate crop distribution and N management under continued erosion at catena/field scales. Thirdly, a set of models of different complexity has been used to analyze GHG emissions at the field scale.

Results

Firstly, we have compared crop production of spring crops generated by well-validated dynamic agroecosystem model using climatic projections generated by RCM with complex statistical model calibrated using regional data. While both models showed that in Central Europe the costs of irrigated spring crop production increases, GAEM approach allows to estimate weights of water supply and erosion factors in details in various computer experiments. Secondly, soil redistribution significantly affected crop yields and N cycle in the simulations using coupled geomorphic-agroecosystem model. With inclusion of water effects the model was able to capture the observed effects on crop yields and soil N. Continued erosion-driven soil redistribution in combination with intensive tillage has increased maximally spatial variability in crop yields and N losses at different soils and climates. Thirdly, we have evaluated the effects of using site-specific N₂O emissions derived from the dynamic agroecosystem model (daily step), two statistical models (annual step) and weekly measured fluxes to estimate nitrous oxide uncertainties. The analysis showed that inclusion of dynamic model is preferred while estimate nitrous oxide cumulative fluxes out of rare measurements, while to explain interannual emissions combination of statistical and dynamic models might be needed.

MASC, a model to assess the sustainability of cropping systems: Taking advantage of feedback from first users

Craheix, Damien¹; Angevin, Frederique¹; Bergez, Jacques-Eric²; Bockstaller, Christian³; Colomb, Bruno²; Guichard, Laurence⁴; Reau, Raymond⁴; Doré, Thierry⁴

¹INRA, FRANCE; ²INRA/ENSAT, FRANCE; ³INRA/Université de Lorraine, FRANCE; ⁴INRA/AgroParisTech, FRANCE

Introduction

The MASC model has been designed by seven agronomist researchers for the *ex ante* assessment of the sustainability of arable cropping systems (CS). The initial purpose of this model was to select newly designed CS before testing them in field trials. Different users tested MASC in various contexts and commented its use and its usefulness. We recorded comments from these users in order to gain greater insight of their requested needs and in order to improve the model.

Materials and methods

MASC is a qualitative multi-criteria model to assess the sustainability of CS (Sadok et al., 2009). It is based on criteria that are hierarchically organized into a decision tree. These criteria are aggregated in order to assess the three usual dimensions of sustainability (economic, social and environmental). Two types of criteria can be distinguished in this tree: (i) basic criteria which correspond to the inputs of the model; and (ii) aggregated criteria which are located at a higher level in the hierarchical tree, depending on those at lower levels. Aggregations are based on weights (%) according to utility functions defined by "If-Then" decision rules. After a test of the model in real situations for three years by various users, designers gathered feedback from them by organizing a workshop, sending out a survey, interviewing users and holding a consultation meeting.

Results and discussion

Thanks to its flexibility and its ease of use, MASC was used for much more varied purposes than the one initially planned by the designers. Table 1 presents the initial purpose as well as the new purposes the users came up with.

The feedback also revealed that first users had handled the model in somewhat differently than expected. First, to lead *ex ante* assessment, basic criteria of the MASC model are filled thanks to simple indicators based on the description of planned practices. This feature turned out to be particularly useful because it allowed first users to carry out rather quickly *ex post* assessments where information was easy to come by, thereby enlarging the scope of MASC. Secondly, in over half of the *ex post* assessments, users replaced at least one of the proposed indicators with another available indicator better suited to their context (such as field measurements) indicating the importance of a flexible model. Thirdly, most users modified the set of weights to integrate both local issues and their own perception of sustainability. Users deemed the adaptation of the weights to be an important step in sharing stakeholders' point of view and in involving them in the assessments (Craheix et al. 2012). Moreover, thanks to this investigation, users had the opportunity to suggest that designers could add a set of new criteria to enhance the relevance of the model. Finally, analysis of users' feedback has led to the development of a second

Table 1: Initial purpose and new purposes the model served

Purposes of the assessment	Actors implicated*	Ex ante/Ex post	Number of projects
Assessment and selection of CS defined with expert knowledge before testing in situ	E-R-F	Ex ante	6
Diagnostic/Assisting strategic thinking of farmers on the evolution of their CS	E-F	Ex post	4
Diagnostic/communication of results obtained on CS field experiment	E-R	Ex post	5
Assessment of farmers' CS in a prospective approach	E-R	Ex post	1
Identification of barriers to adoption of innovative CS	E-R-F	Ex ante/Ex post	2
Training about the application of the sustainability concept at the CS level	E-F-R-S	Ex ante/Ex post	+10

*E = Extension workers; F = Farmers; R = Researchers; S = Students

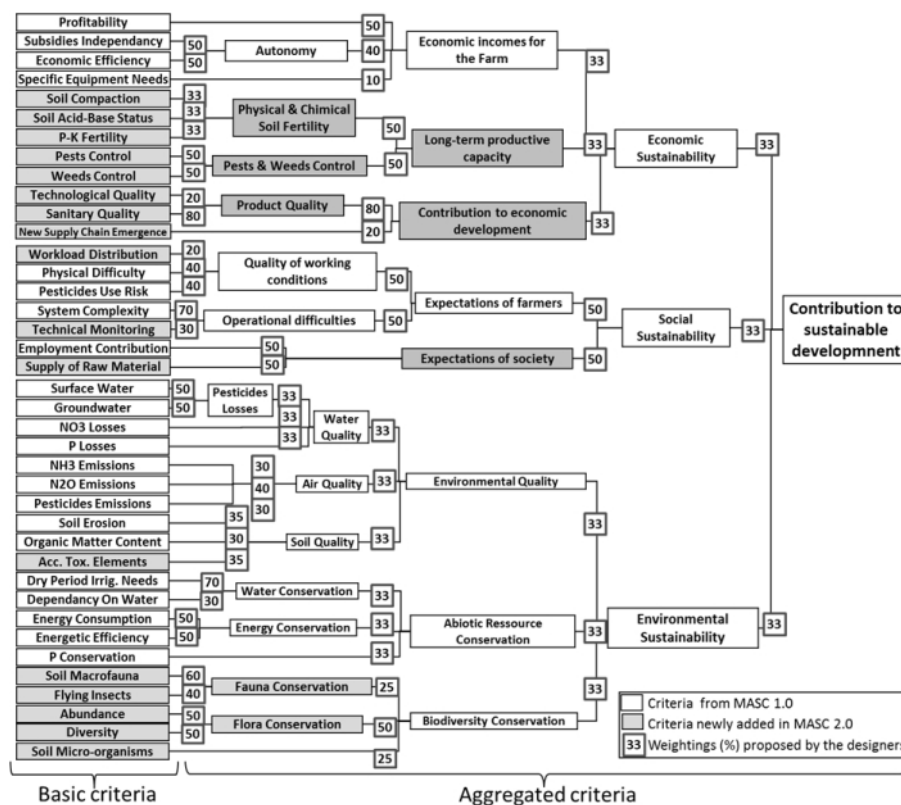

Figure 1: MASC 2.0 : decision tree, proposed weights and new criteria

version of the MASC model (Craheix et al., 2011). The newly designed decision tree is presented in the figure 1.

Conclusions

Analysis of users’ feedback played here a key role in the development of the MASC model. The main improvements have involved specifying the domain of validity, extending the range of concerns by adding new criteria, and facilitating adaptations of settings to the local socioeconomic and pedoclimatic context. Through this experience, we highlight the importance of seeking user experience in order to improve an assessment model of sustainability.

References

Craheix et al., 2011. INRA–APT–GIS GCHP2E, 49 p. Available at: http://www5.versailles-grignon.inra.fr/agronomie/Productions/logiciels_et_modeles/MASC

Craheix et al., 2012. Xth European IFSA Symposium, 1-4 July 2012, Aarhus, Denmark, 8p (in press).

Sadok et al., 2009. Agron Sustain Dev., 29(3), 447-461

From crop model to decision-support system: developing tools for variety assessment and scenario analysis in sunflower

Debaeke, Philippe¹; Casadebaig, Pierre¹; Champolivier, Luc²; Mestries, Emmanuelle²; Rouse, Nathalie¹; Thiard, Jérôme¹

¹INRA, FRANCE; ²CETIOM, FRANCE

Introduction

Numerous crop models have been developed for scenario analysis and yield prediction. Their application often met two difficulties: the estimation of plant parameters at variety level and the easy use by crop advisers. This paper presents an approach addressing these two problems.

Development of a sunflower crop model

SUNFLO (Casadebaig et al., 2011) is a daily time step crop model with genotypic parameters which simulates grain yield and oil concentration of sunflower as a function of climate, soil, and management. The objective is to represent the genotype (G) x environment (E) x crop management (M) interactions dynamically. The model simulates the main soil and plant processes: soil N and water content, N uptake and transpiration, root depth and leaf area establishment and senescence, biomass

accumulation. Thus, the simulated G x E x M interactions result from the impact of genotypic traits (phenology, architecture, biomass allocation) on the capture of environmental resources (water, nitrogen, light) and on the responses of genotypes to environmental constraints in a dynamic feed-back. Each genotype is described by 13 parameters, measurable at field and greenhouse level for every new released variety (Debaeke et al., 2010).

SUNFLO was first developed on a commercial modelling platform (ModelMaker®) then it was implemented on the RECORD platform from INRA (Bergez et al., 2012). The SUNFLO model was initially intended to be used for:

- (i) the simulation of the impact of individual traits or ideotypes on final production;
- (ii) the characterization of the abiotic stresses (mainly water stress) experienced by each variety;
- (iii) the search for adapted crop management – variety combinations in given environments.

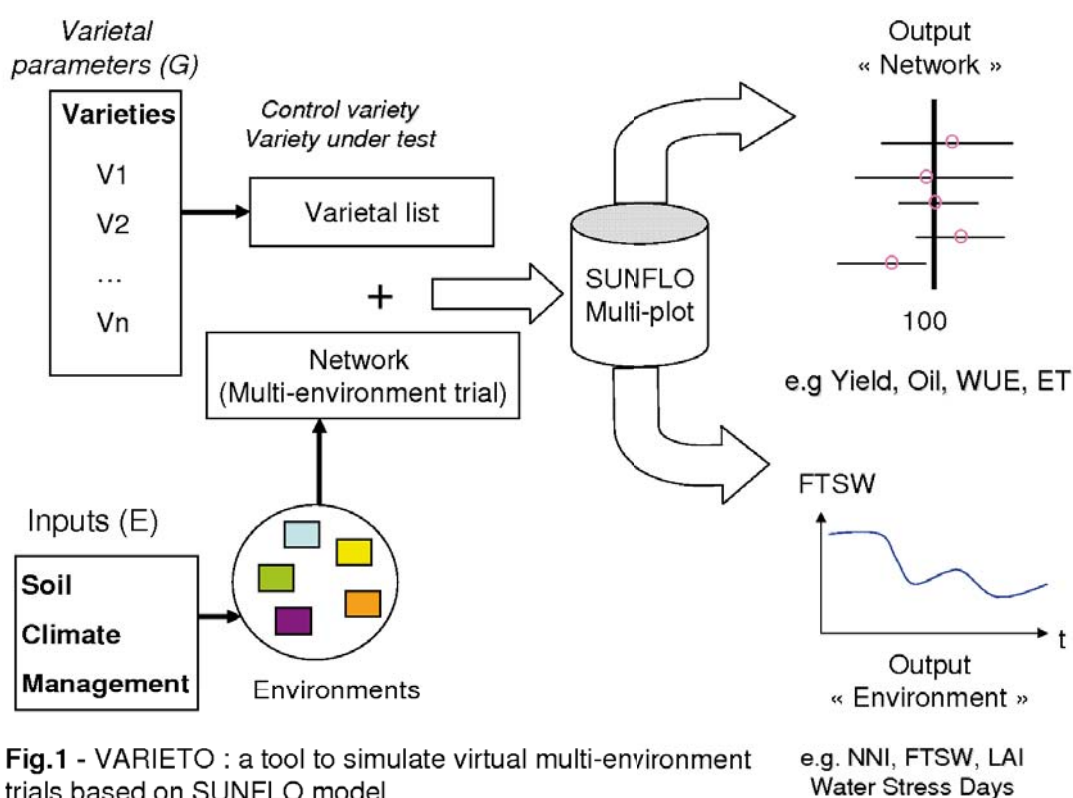

Fig.1 - VARIETO : a tool to simulate virtual multi-environment trials based on SUNFLO model

Development of related decision-support tools

SUNFLO was built in close cooperation with CETIOM (the technical institute for oilseed crops) but two decision support tools were necessary to facilitate the practical use of the model by crop advisers. The initial plot model was completed by a multi-plot model and an aggregation procedure. This made it possible to simulate production on a supplying area composed of relevant production situations but also to represent a variety assessment network. Then two web interfaces were built to simulate multiple crop responses to biotechnical scenarios:

(a) COLLECTO was developed to simulate oil yield at grain supplying area level and evaluate the profitability of different technical scenarios for farmers and cooperatives (Champolivier et al., 2012).

(b) VARIETO (Fig.1) was developed to simulate virtual and actual multi-environment (locations, years) trials (METs) for variety assessment with three functionalities :

- providing an agronomic diagnosis based on dynamic crop modelling for each environment;
- evaluating lists of varieties as compared to reference genotypes;
- comparing and improving the nature of METs to better represent the target population of environments.

Results and conclusions

The final end-users of SUNFLO under RECORD are researchers concerned by bridging the gap between agronomy and genetics while the targets of the two decision support tools are private and public breeders, engineers in charge of official variety assessment or farmer's advisory, and technical services of the cooperatives.

References

- Bergez J.-E. et al., 2012. An open platform to build, evaluate and simulate integrated models of farming and agro-ecosystems. *Env Mod Softw* (under press).
- Casadebaig P. et al., 2011. SUNFLO, a model to simulate genotype-specific performance of sunflower crop in contrasting environments. *Agric For Met* 151, 163-178.
- Champolivier L. et al., 2012. An evaluation of sunflower production strategies in a supplying area of an agricultural cooperative using the simulator COLLECTO. *Proc.18th Int. Sunflower Conf., Mar del Plata (Argentina)*, pp. 742-747.
- Debaeke P. et al., 2010. Simulation de la réponse variétale du tournesol à l'environnement à l'aide du modèle SUNFLO. *OCL* 17 (3), 143-151.

Modelling forage rotations for increasing resource-use efficiency in dairy farming in Cantabria (North Spain)

Doltra, Jordi¹; Salcedo, Gregorio²; Olesen, Jørgen E.³

¹Centro de Investigación y Formación Agrarias (CIFA), SPAIN; ²I.E.S La Granja, SPAIN; ³Aarhus University, DENMARK

Introduction

Cattle diet is the main cost of production for dairy farmers in the Cantabric region (N Spain) and this is mainly based on importing purchased feeds and concentrates. Silage maize (*Zea mays* L.) is the on-farm crop that contributes most to the forage supplied in the diet due to its high productivity. This crop is typically rotated with Italian ryegrass (*Lolium multiflorum* Lam.) as being the winter crop of the characteristic cropping system in the region. Cantabria is a south-Atlantic agroclimatic region with an average annual temperature and precipitation of about 14.4°C and 1200 mm, respectively. The combination of a mild and wet climate with fertile soils might allow growing winter crops more productive than Italian ryegrass to increase the overall system productivity. This would reduce the dependence of out-farm resources to feed the animals. Legume crops have been shown to increase productivity of crop rotations (Doltra and Olesen, 2012) and might also positively affect milk quality (Kalac, 2011). In this work we use the process-based model FASSET (Berntsen et al., 2003) for preliminary evaluation of triticale (*Triticosecale*) and pea (*Pisum sativum* L.) as winter crops in a maize-based rotation in terms of productivity and nitrogen (N) losses as indicators of farm resource-use efficiency.

Materials and methods

This simulation study uses data from the first year of an on-going experiment in Heras (N Spain) on a silty clay loam soil. The top soil has pH of 6.53, 1.73% OM and C/N ratio of 7.53. The cropping systems compared are maize-based rotations with Italian ryegrass, triticale and pea

as winter crops. Sowing and harvest dates were 20th October and 10th May and 18th April and 26th September for the winter crops and maize, respectively. The mineral N fertilizer was applied following the recommended rates: 70 kg N ha⁻¹ (40 kg N ha⁻¹ at sowing and 30 kg N ha⁻¹ at the end of winter) in ryegrass, 93 kg N ha⁻¹ (18 kg N ha⁻¹ at sowing and 75 kg N ha⁻¹ at the end of winter) in triticale, 18 kg N ha⁻¹ in peas and 93 kg N ha⁻¹ in maize at sowing. Winter crop residues were added to the soil by mid-April. The crops were not irrigated. The simulations were performed using the same initial soil conditions in all the systems.

Results

The modeling results in this study indicate the possibility of growing a cereal or a legume crop during winter to increase on-farm forage productivity and the N efficiency of the overall cropping system (Table 1). The rotation pea-maize would be the option with the highest N efficiency according to the simulations. These results although still preliminary are consistent with the first year observations that indicate higher rotation productivity with cereals and legume crops than with Italian ryegrass as winter crop.

Conclusions

Winter crops are important to increase rotation productivity. A proper selection of these crops might allow farmers to be less dependent of purchased out-farm forage and to reduce feeding costs. Process-based models are helpful tools to investigate cropping systems contributing to dairy farm sustainability.

Table 1. Total aboveground dry matter (Mg ha⁻¹) and N (kg ha⁻¹) for the winter crops and maize, and annual N losses (leaching and emissions, kg N ha⁻¹) from each crop rotation. The rotation nitrogen use efficiency (NUE, kg kg⁻¹ N) is also reported [(N_{crop} - N_{losses})/N_{fert}].

Rotation	Winter crop		Maize		N-NO ₃ leaching	N ₂ O emission	NUE
	Dry matter	N	Dry matter	N			
ryegrass- maize	2.1	29	12.6	166	117	4.1	0.45
triticale - maize	5.4	102	10.8	129	90	5.4	0.73
pea-maize	4.4	165	13.4	199	105	6.7	2.27

References

Berntsen, J., Petersen, B.M, Jacobsen, B.H., Olesen, J.E., Hutchings, N.J., 2003. Evaluating nitrogen taxation scenarios using the dynamic whole farm simulation model FASSET. *Agric. Syst.* 76, 817-839.

Doltra, J., Olesen, J.E. 2012. The role of catch crops in the ecological intensification of spring cereals in organic farming under Nordic climate. *European Journal of Agronomy*. doi: 10.1016/j.eja.2012.03.006 (in press).

Kalac, P., 2011. The effects of silage feeding on some sensory and health attributes of cow's milk: A review. *Food Chem.* 125, 307-317.

A European weather database of daily weather data derived from climate change scenarios for use with crop simulation models

Donatelli, Marcello¹; Fumagalli, Davide¹; Zucchini, Antonio¹; Duveiller, Gregory¹; Nelson, Roger²; Baruth, Bettina¹

¹JRC, ITALY; ²Washington State University, UNITED STATES

Global Circulation Models (GCM) estimate future climate under scenarios of greenhouse gases emissions. Such estimates include several meteorological parameters but the two direct outputs are air temperature at earth surface and precipitation. The estimates are spatially downscaled using different methodologies, but it is accepted that such data require further processing for use with simulation models. Daily values of solar radiation, wind, air humidity, and at times rainfall may have absolute values which are not realistic, and/or the daily record of data may prove not to be consistent across meteorological variables. The final problem is related to the fact that GCM estimate the dynamics of climate, providing one instance of data per date in time series. Typically, crop models are deterministic and run in a stochastic fashion, hence requiring multiple years of weather data representing each time horizon of interest. Furthermore, if the time horizons of interest

are very close (e.g. 2020 and 2030), sampling without overlap GCM outputs creates instability in means which may even show, in specific cases, apparent inversions of trends, creating artifacts also in the simulation via impact models. This paper presents a data base of daily weather data, with EU27 coverage at a 25 km grid, derived from the ENSEMBLES downscaling of the global circulation models HadCM3 and ECHAM5 realizations of the IPCC A1B emission scenario, in which solar radiation, wind and relative air humidity were estimated or collected from historical series, and derived variables reference evapotranspiration and vapour pressure deficit were estimated from other variables, ensuring consistency within daily records. Synthetic time series data were also generated using the weather generator ClimGen. All data are made available via web services in a data portal for free use by public institutions.

Optimization of the ICBM/2 Soil Organic Matter Simulation Model Using C Respiration Measurements and Near Infrared Data

Giovanni, Cabassi¹; Cavalli, Daniele²; Bechini, Luca²; Degano, Luigi¹; Marino Gallina, Pietro²; Fuccella, Roberto²

¹CRA-FLC, ITALY; ²University of Milan, ITALY

Introduction

The use of simulation models to study the turnover of soil organic matter (SOM) can support experimental data interpretation and the optimization of manure management. Icbm/2 (Katterer, 2001) is a simulation model that describes the turnover of SOM represented by three pools: one for old humified SOM (CO) and two for added manure, CL (labile C) and CS (stable C). C outflows from CL and CS and can be humified (h) or lost as CO₂-C (1-h). All pools decay with first-order kinetics with parameters kYL, kYR and kO (fig. 1). With this model of SOM turnover, during manure decomposition into the soil, only the evolved CO₂ can be easily measured. Near infrared spectroscopy has been proved to be a useful technique for soil C evaluation. Since different soil C pools are expected to have different chemical composition, it was proven that NIR can be used as a cheap technique to develop calibration models to estimate the amount of C belonging to different pools (Cabassi, 2008). The aim of this work was to calibrate ICBM/2 for the simulation of C respiration using optimal NIR prediction of CO and CL pools.

Materials and methods

We used measurements of 2 manure-amended soils from an incubation experiment (Bechini, 2009). Briefly, five liquid dairy manures were applied to two soils of different clay content (102 and 209 g/kg) but similar SOM content. Twelve treatments (5 manures plus unamended

soil x 2 soils) were established. A completely randomized experimental design was adopted with three replicates. The “nursery” method (Thuriers, 2000) was used with 12 sampling dates. NIR analyses were performed on the air dried grounded soils. Spectra were collected using an FT-NIR Spectrometer. All spectra were scatter corrected by extended multiplicative scatter correction for each soil. NIR calibration models were carried out using the SIMPLS algorithm. A six block cross-validation procedure was adopted for the validation of NIR prediction. Parameters calibration was done separately for each soil using the downhill simplex method. During optimization, parameters were allowed to vary within the ranges reported in Tab 1. For each manure, a C partitioning factor (Fi) was optimised; other parameters were supposed to be the same for all manures. In each optimization step simulated CL and CO were used as reference values for NIR predictions. At the end, the algorithm found those parameters that gave the lowest averaged error in the estimation of respired C and the lowest errors of NIR prediction of CO and CL content. The results are reported in Tab. 1.

Results and Discussion

All parameters had an optimal value within their range of variation, indicating that the algorithm did not try to force the exploration outside the imposed boundaries. The values for kCL are two-fold higher than those of kCS. The fractions Fi of manure C allocated to CL, showed a

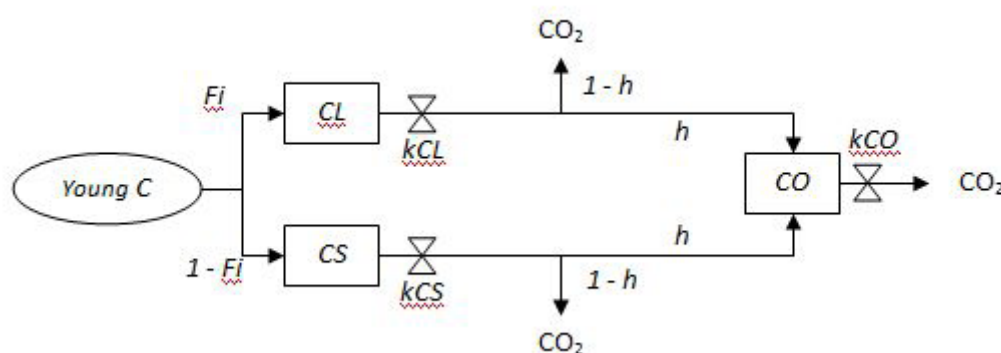

Optimized parameters								
	KCL	KCS	F1	F2	F3	F4	F5	h
	range of variation							
min	0.007	0.0002	0	0	0	0	0	0.001
max	0.3	0.006	1	1	1	1	1	0.3
	optimized value							
soil 1	0.212	0.005	0.563	0.273	0.472	0.925	0.677	0.199
soil 2	0.088	0.001	0.516	0.309	0.396	0.729	0.564	0.083
			min(mg/kg)	max(mg/kg)	SD(mg/kg)	R ² cv	RMSE(mg/kg)	PLS factors
soil1	evolved CO ₂		0	1634	400	0.9696	75	--
	CO		0	653	173	0.765	88	4
	CL		13280	14042	183	0.847	72	4
soil2	evolved CO ₂		0	1402	356	0.943	85	--
	CO		0	604	180	0.81	73	6
	CL		14277	14872	168	0.922	51	4

high collinearity (R^2 0.98) between soils. Optimisation on soil 2 resulted in a lower C humification rate and a lower mineralisation in the first weeks of incubation compared to soil 1. This can be due to a difference in the C adsorption power and protection due to the specific surface area (clay of soil 2 is twofold the clay of soil 1). Calculated errors of C respiration and NIR estimates indicate a general ability of the model to discriminate C pool at the beginning and the end of the mineralisation (as can be seen from the ratio RMSE/SD), together with a good prediction of C mineralisation.

Conclusions

These results enforce the possibility to investigate the further application of this methodology to other incubation experiments using a wide range of soils amended with organic materials.

References

- L. Thuriers et al 2000. Commun. Soil Sci. Plant Anal. 31, 289-304
- G. Cabassi et al 2008. J. Near Infrared Spectrosc. 16, 59-69.
- Bechini L, 2009. Soil. Sci. Soc. Am. J. 73, 2159-2169.
- T. Katterer et al., 2001. Ecol. Modelling. 136, 191-207.

Use of Weibull distribution in early first harvest above ground biomass of short-term forage crops in Asturias (N Spain)

Gorgoso, J. Javier; Oliveira, J. Alberto; Afif, Elias; Palencia, Pedro
 University of Oviedo, SPAIN

Introduction

The normal distribution is assumed when estimating forage biomass, but there are several problems that result from this assumption of normality (Shiyomi et al., 1984). Skewed distributions can be modelled by other distributions, such as the beta, log-normal, Johnson's SB, Gamma or Weibull distributions (Remington et al., 1994, Tsutsumi et al., 2002). The purpose of this study

was to evaluate the use of the three-parameter Weibull distribution in describing the frequency of above ground biomass in the early first harvest biomass of short-term forage crops fertilized with different doses of nitrogen.

Material and methods

Trial plots: Cultivar trials of short-term forage crops were established in in three trials (A1 = *Lolium hybridum*; A2= *Lolium multiflorum*, and B1 = *Lolium multiflorum* + *Trifolium pratense*) in Asturias (N Spain). The crops were fertilized with three different doses of nitrogen: 0, 40 or 80 Kg of N per ha, and with an additional slurry treatment in trial B1 (110 Kg of N per ha). In each N treatment, between 27 and 30 above ground biomass samples were collected in each plot at random within a square metallic frame of surface area 0.25 m² to enable modelling of above ground biomass.

The Weibull distribution:

The three-parameter Weibull distribution is obtained by integrating the Weibull density function: [1] where $F(x)$ is the cumulative relative frequency of above ground biomass, a is the location parameter of the function, and b and c are the scale and shape parameters, respectively. In this study intervals of above ground biomass of 30 g m⁻² were established for the fits of the function.

Fit of the Weibull distribution:

Parameters of the Weibull distribution were estimated by the method of moments: [2] [3] where x (mean) is the above ground biomass mean of the observed distribution, σ^2 the variance and $\Gamma(x)$ is the Gamma function for each point ($x = i$). Location parameter a was the minimum value of biomass production in each treatment.

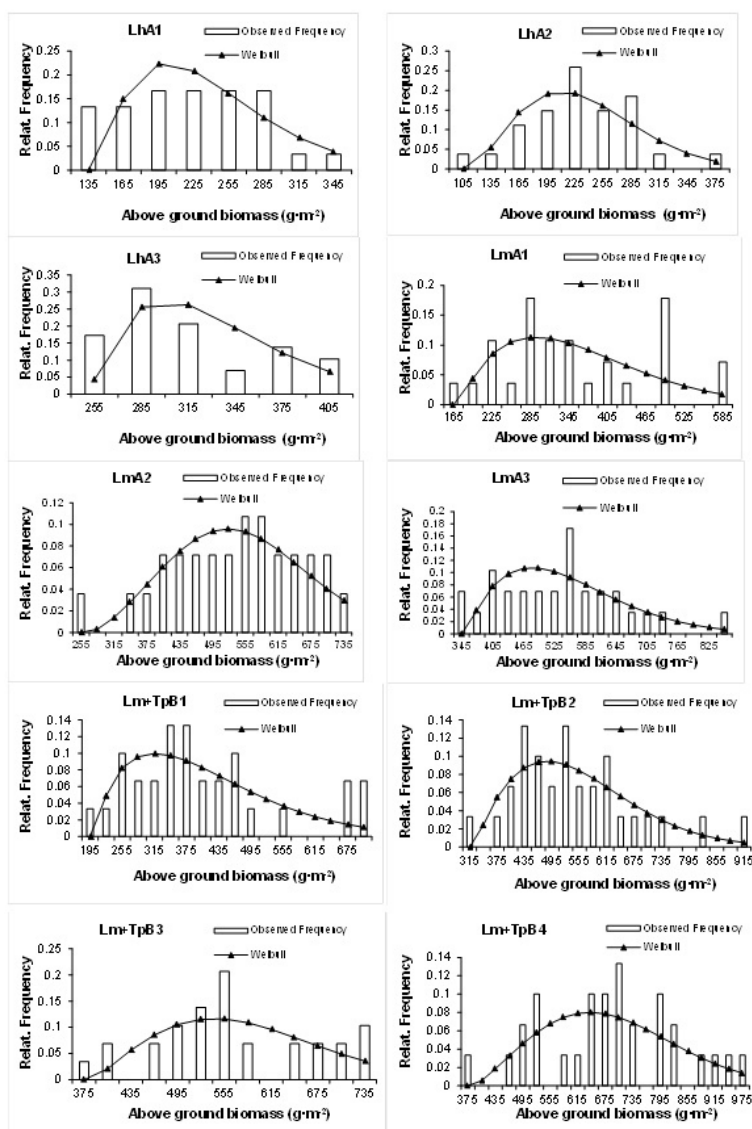

Figure 1. Observed distributions and corresponding Weibull distribution.

$$F(x) = \int_0^x \left(\frac{c}{b}\right) \cdot \left(\frac{x-a}{b}\right)^{c-1} \cdot e^{-\left(\frac{x-a}{b}\right)^c} \cdot dx = 1 - e^{-\left(\frac{x-a}{b}\right)^c} \quad [1]$$

$$b = \frac{x-a}{\Gamma\left[1+\frac{1}{c}\right]} \quad [2]$$

$$\sigma^2 = \frac{(x-a)^2}{\Gamma^2\left[1+\frac{1}{c}\right]} \cdot \left(\Gamma\left[1+\frac{2}{c}\right] - \Gamma^2\left[1+\frac{1}{c}\right]\right) \quad [3]$$

$\Gamma(x)$: is the Gamma function for each point ($x = i$).

Table 1. Weibull parameters (a, b and c) and 63rd percentile (a+b) for the estimated biomass (g m⁻²), values of the Kolmogorov-Smirnov statistic (D_n) and the critical value of Miller (1956) ($D_{n,\alpha}$) at $\alpha = 0.05$ for different levels of N fertilizer in the 10 distributions studied.

Trial	N applied (Kg ha ⁻¹)	Code	a	b	a + b	c	Data	D_n	$D_{n,\alpha}$
A1	0	LhA1	134.04	99.30	233.34	1.56	30	0.149	0.248
	40	LhA2	113.84	128.55	242.39	1.98	27	0.249	0.261
	80	LhA3	245.00	79.58	324.58	1.50	29	0.183	0.252
A2	0	LmA1	173.23	202.63	375.86	1.63	28	0.140	0.257
	40	LmA2	257.53	312.62	570.16	2.47	28	0.130	0.257
	80	LmA3	347.48	213.40	560.88	1.65	29	0.140	0.252
B1	0	Lm+TpB1	204.32	223.46	427.78	1.49	30	0.124	0.248
	40	Lm+TpB2	322.56	250.50	573.06	1.75	30	0.108	0.248
	80	Lm+TpB3	374.30	217.83	592.13	1.97	29	0.121	0.252
	110	Lm+TpB4	388.11	337.07	725.18	2.15	30	0.162	0.248

Goodness of fits:

The goodness of fit in each treatment was tested with the Kolmogorov-Smirnov (KS) test. The distribution is rejected by the test when the KS statistic (D_n) is higher than the critical value of Miller (1956) (D_n, α) at $\alpha = 0.05$.

Results

Results are showed in Table 1. The results of the KS goodness of fit show that there was not enough evidence to reject the null hypothesis that the 10 distributions of biomass follow a three parameter Weibull distribution. The results show, in general, an increase in the 63rd percentile of biomass production (a+b) with a higher level of fertilizer. Location parameter a also was generally related to the dose of fertilizer. Shape parameter c was always lower than 3.6 and all the Weibull distributions were skewed to the right. The 10 observed distributions of biomass production (g m⁻²) in relative frequencies and the distributions described by the three parameter Weibull function are shown in Fig. 1.

Conclusions

The results showed the great flexibility of the Weibull distribution for describing all above ground biomass distributions studied. These distributions have different skewness and kurtosis derived from the different nitrogen treatments and site conditions. The parameters a and b of the Weibull distribution are easy to relate to the values of the described variable and are easy to interpret.

References

Miller L.H., 1956. Tables of percentage points of Kolmogorov statistic. Journal of the American Statistical Association 51, 111-121.

Remington K.K., Bonham C.D., Reich R.M., 1994. Modeling the distribution of Agropyron cristatum biomass in a grazed pasture using the Weibull distribution. J Japan Grassl Sci 40(2), 190-197.

Shiyomi M., Akiyama T., Takahashi S., 1984. A spatial pattern model of plant biomass in grazing pasture II. J Japan Grassl Sci 30, 40-48.

Tsutsumi M., Shiyomi M., Sato S., Sugawara K., 2002. Use of Gamma distribution in aboveground biomass of plant species in grazing pasture. Grassland Science 47(6): 615-618.

C3-crop growth model for precision fertilization

Hautala, Mikko; Hakojärvi, Mikko

University of Helsinki, FINLAND

Introduction

The crop growth is highly dependent on growth conditions which vary from year to year and cannot be known in the very beginning of the growing season. In order to optimize the fertilizer dose according to the growth circumstances it is necessary to provide the nutrients for the growth of the crop in separate events. To make this kind of fertilizer adjustment feasible it is necessary to have information on the recent crop growth and a crop growth model which can be used to estimate the amount of nutrients for optimal growth.

Materials and methods

The analytical C₃ crop growth model was introduced by Hautala and Hakojärvi (2010). The crop growth model simulates the highest (maximum) attainable biomass yield in prevailing moisture and radiation conditions. At an early stage of growth, the biomass accumulation increases exponentially due to the expanding leaf area of the crop. At this stage, the model needs six parameters to describe the crop leaf area expansion, interception of radiation and daily growth. In the second phase, after the leaf area has expanded large enough to utilize all incoming radiation, the growth increases linearly over time. Independently of increased leaf area. There are effectively three model parameters that have an effect on

the crop growth at this phase. To make the model capable of simulating the water limited growth, an additional five parameters are needed to describe the water related processes. Altogether the parameters of the model have a clear basis in the physics, chemistry and crop physiology but also are measurable in field conditions.

Results

The model has been tested against measurements on wheat. Figure 1 compares the calculations with the measured biomass as a function of time in optimal growing conditions.

Discussion

A simple analytical crop growth model has been devised that is valid for C₃ plants when growth is limited by radiation or water. The strength of the model is that all its parameters are known or can easily be measured. The model gives the maximum biomass in prevailing circumstances. The results give confidence to the suitability of the model for its original purpose as a decision tool for precision farming. The model describes the crop biomass growth well during the early growth which is also the time when the additional fertilizer must be applied to have an effect on the crop growth.

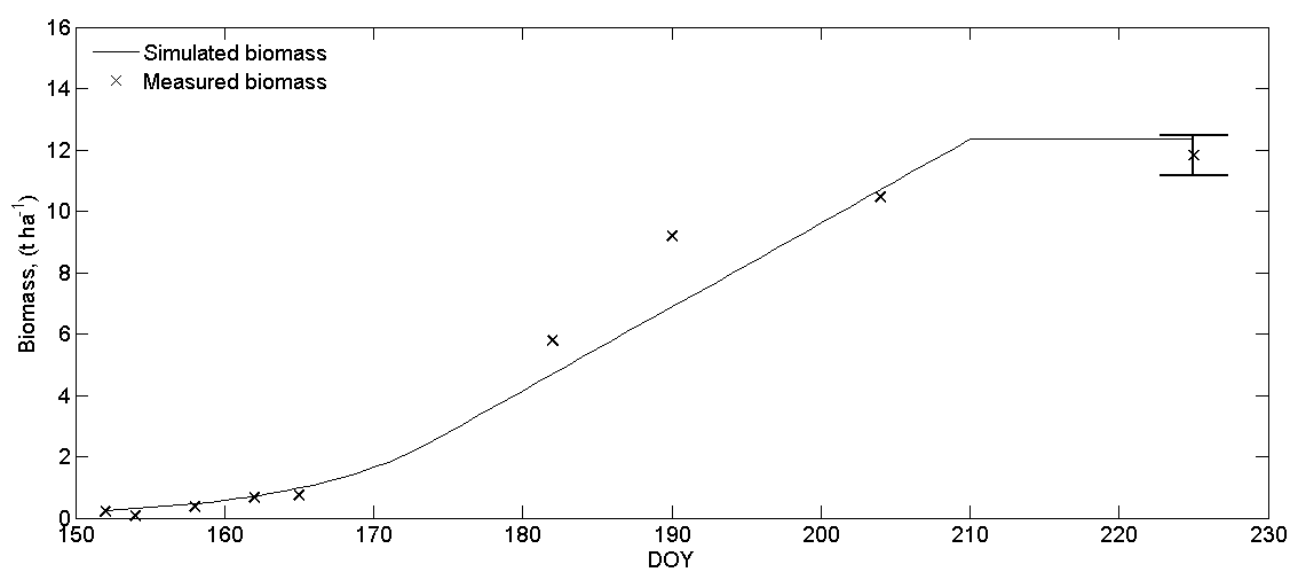

Figure 1. Comparison of the model biomass with experimental biomass as a function of time (day of year, DOY).

The model is the missing link in the apply-measure-decide-loop of precision management. Application of this model closes the loop and equipment developed for precision farming may be used more effectively with the application of this model. In fertilizer application the key factor is the amount of radiation used by the crop, which can be measured adequately and easily with two sensors placed ahead of a fertilizer, one above and one below the canopy. This gives the leaf area index (LAI) and from LAI the prevailing biomass at that site can be calculated. If biomass is less than the optimal biomass calculated by the model, the growth has not been optimal e.g. due

to drought or late seedling and therefore the site needs less additional fertilization for the incoming growth. Fertilizing applied according to the model should improve the nutrient use and reduce the amount of nutrients that can be leached from the soil.

References

Hautala, M., Hakojärvi, M., 2010. An analytical C₃-crop growth model for precision farming. *Precision Agriculture*. 12, 266-279.

Potential distribution and phenological development of the Mediterranean Corn Borer (*Sesamia nonagrioides*) under warming climate in Europe

Maiorano, Andrea; Donatelli, Marcello
European Commission - Joint Research Centre, ITALY

Introduction

Insects are poikilotherms (body temperature varies along with that of the environmental temperature), hence their development and geographical distribution are strongly influenced by ambient temperature. As a consequence, a warming climate has the potential to significantly modify the actual distribution and development of agricultural insect pests.

Materials and methods

In this work we analyzed the case of the Mediterranean Corn Borer (MCB) *Sesamia nonagrioides*, which is one of the most important maize borers in Europe. Its distribution and population levels are primarily determined by its sensitivity to sub-zero winter temperatures. In Europe it has been mainly reported from the coastal regions of the Mediterranean basin and of the Atlantic coasts up to the western Loire region of France. No study has estimated the potential spread of the MCB considering the overwinter survival including the fraction of larvae in the maize roots and linking survival to a MCB phenological model. This paper presents the preliminary results of a

study conducted to analyze the role of temperature in the potential distribution of the MCB in Europe under warming climate. The work was carried out in four phases: a) development of a winter survival model; b) parameterization of a temperature-based phenological model; c) application of the model in spatialized simulation runs to test MCB survival and development; and d) application of the model to future climate scenarios. Survival and development were studied under simulated warming climate at three time horizons (Baseline 2000s, 2030s, 2050s) in Europe (A1B IPCC emission scenario, ECHAM5-HIRHAM5 models, downscaled from the original ENSEMBLES data set by the same regional climate model to a 25 km grid resolution). Two modelling approaches were implemented and compared for the simulation of winter survival: the first one using air temperature as the only input, the second using both air temperature and simulated soil temperature as input that includes the simulation of larvae survival in the roots under the soil surface. The models were implemented in a software component composed of discrete model units, and it was used in the BioMA platform (<http://bioma.jrc.ec.europa.eu/>) of the European Commission.

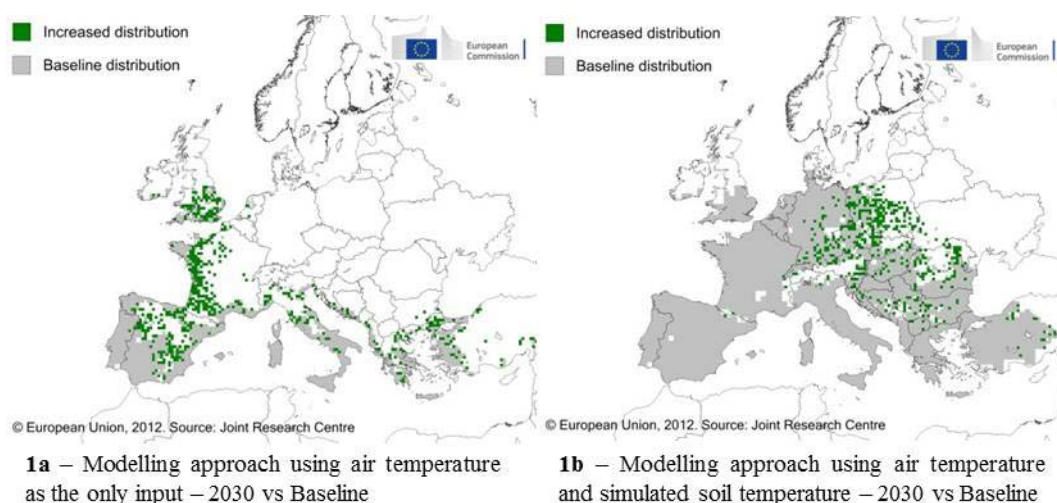

Figure 1. Difference in the estimated potential distribution between baseline (grey) and 2030 scenarios (green) estimated by the approach using air temperature only as input, (1a), and air temperature and simulated soil temperature as input (1b).

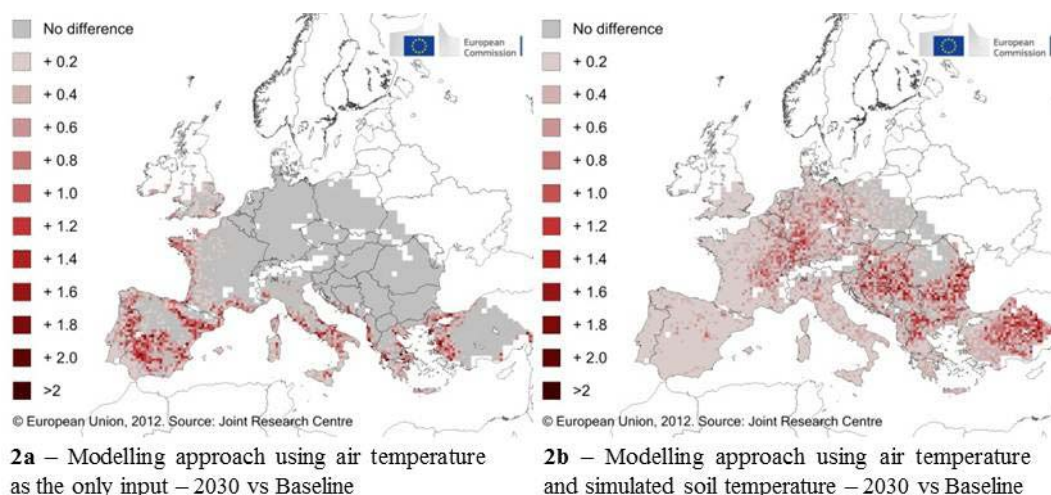

Figure 2. Differences in the potential number of generation between baseline and 2030 scenarios according to the approach using air temperature only as input, (2a), and air temperature and simulated soil temperature as input (2b).

Results and Discussion

Results of winter survival estimates suggest that mortality due to winter temperature is not a potential reason for reduced spreading of MCB in currently cold areas where it has never been reported. In fact results suggest that the potential survival of the fraction of larvae overwintering in the maize roots would allow the development of the MCB in those areas. These results indicate that low temperatures affecting overwinter survival might not be the most important limiting factor determining MCB distribution, and that other factors might be more important than expected by previous literature. The development model linked to the estimate of survival including larvae diapausing in the soil showed a potential increase of generations in the Balkans and Turkey, and, to a more limited extent, in Germany. On the contrary, the estimated increase is negligible in the Mediterranean basin, due to the potential stressful effects of high temperatures.

Results showed that both geographical distribution and phenological development are expected to increase under 2030 and 2050, but the main increase is expected under 2030 scenario. The results of this work suggest further investigation of other factors than winter mortality that control the MCB distribution range. This would allow more specific estimates of the potential distribution and development of the MCB in Europe, and consequently of the potential damage to maize crops. Thanks to the implementation technology used for developing the modelling approaches presented in this paper, such improvement can be easily implemented and integrated.

Acknowledgements

This work was supported by a 7th FP Marie Curie Fellowship (Project MIMYCS).

MIMYCS, A framework for simulating maize kernels mycotoxin contamination in Europe

Maiorano, Andrea¹; Donatelli, Marcello²

¹European Commission - Joint Research Centre, ITALY; ²Agricultural Research Council, CIN, ITALY

Mycotoxins are toxic compounds, produced by fungi and recognized as the main cause of chronic intoxications in the world. Maize is one of the crops subjected to the most critical mycotoxin problems throughout the world. Limitations set by the European Commission and by other nations of the world on the maximum levels of mycotoxins in cereal grain have had an important socio-economic impact on the global cereal market. As a consequence, producing maize grain with acceptable mycotoxin content and simultaneously maintaining profitability has become more and more difficult, with important socio-economic consequences. Mycotoxin contamination in maize grain is the result of a complex plant pathosystem (a system defined by parasitism and in which a plant is the host) formed by maize plants, toxigenic fungi and insect borers. Fungi development and mycotoxin synthesis is influenced by climatic conditions and by the fungi competitive relationships, which determine their prevalent geographical distribution. As a consequence, warming of the climate system could have an important impact on the pathosystem and the potential effects are very difficult to foresee.

The modelling of mycotoxin contamination in maize grain during the field phase represents a great opportunity for maize producers, policy makers, and for scientists, to manage the mycotoxin problem in maize and to study the pathosystem and the effects of climate change. The project MIMYCS (Maize Infection and MYcotoxin Contamination Simulator) started in 2010 and aims at the development of a simulation model system to simulate the complex pathosystem which leads to mycotoxin contamination in maize grain. The project aims at providing a first operational tool to simulate at EU scale mycotoxin contamination in maize grain in different climatic, environmental and agro-management

situations. In this context, the development of MIMYCS will allow an easy re-use of it for performing simulations (i) to inform European policy makers involved in food and feed safety of the effects of European mycotoxin policies and help them to fix safe and, at the same time, feasible contamination limits, (ii) to assess climate change scenario effects on the pathosystem and on future maize-based food and feed products safety, (iii) to assist maize producers in controlling mycotoxin contamination through agro-management and improving maize grain safety.

The MIMYCS model has been implemented as a component of the framework BioMA (<http://bioma.jrc.ec.europa.eu/>), the modelling platform used at the European Commission Joint Research Centre. MIMYCS has been developed as composed by three main model components: MIMYCS.Maize, MIMYCS.Borers, MIMYCS.Fungi. MIMYCS.Maize simulates maize phenological development and it implements the impact of the insect borer damage to the ears, fungi infection and mycotoxin accumulation in maize grain. MIMYCS.Borers simulate two maize borers (*Ostrinia nubilalis* and *Sesamia nonagrioides*) development and feeding activity which produces the damage to the ear, enhancing fungi growth and development. MIMYCS.Fungi simulates fungi development and their interactions, using information received from Maize and the Borers modules. Finally, the MIMYCS simulation system, will quantify mycotoxin contamination in maize grain, insect borers damage and fungi infection. The project has been developed in two years and it is funded by Marie Curie Intra-European Fellowships of the European Commission. The poster presentation will present the preliminary results of the project.

Modelling maize grain moisture content during maturation and post-maturity dry-down

Maiorano, Andrea¹; Donatelli, Marcello²

¹European Commission - Joint Research Centre, ITALY; ²Agricultural Research Council, CIN, ITALY

Maize grain moisture content during maturation and post-maturity dry-down are very important factors influencing harvest and post-harvest management, and the technological and safety of maize grain: it influences the harvest timing and the consequent drying process and drying costs, the feeding activity of some maize borers, and the development of toxigenic fungi. Thus, an improved understanding of the process of moisture loss during maize grain development would allow: i) to assess risk regarding weather factors that may impede harvest timing, ii) to evaluate the costs associated with an increased need for mechanical drying, iii) a better understanding of maize development during the field phase and the relationships with insect pests and diseases development.

Development of maize in the field can be partitioned into three phases: i) lag phase, ii) grain filling and maturation drying, iii) and post-maturity dry-down. The lag phase is characterized by a rapid increase in moisture content. During the grain filling and maturation drying phase moisture content decreases almost linearly until the reaching of physiological maturity. During post-maturity dry-down, moisture content decrease primarily due to water loss from the kernel.

Starting from the available knowledge about maize seeds development and maturation, a simulation model was developed to simulate moisture content of maize grain during maturation and in field post-maturity dry down. The model was developed according to the information found in literature: in fact it is known that while during the second phase of development, moisture decrease is due to a displacement of water based on an exchange between dry matter and water through the pedicel, after physiological maturity pedicel tissues cease to function and dry-down occurs primarily by evaporative loss from the kernel itself, mainly under the influence of temperature and relative humidity. Thus, the model was developed as composed by two main components: i) a component simulating moisture content during grain filling, and ii) a component simulating moisture content during post-maturity dry-down. The first phase was simulated as an exponential decay process in which moisture content decreases proportionally to its value and depends on the duration of the maturation process. The second phase was simulated following information coming from the industrial drying of maize grain where the process of grain drying has been studied in conditions of constant temperature and relative humidity: during the drying period, the moisture removal rate is inversely proportional to the moisture to be removed, which is

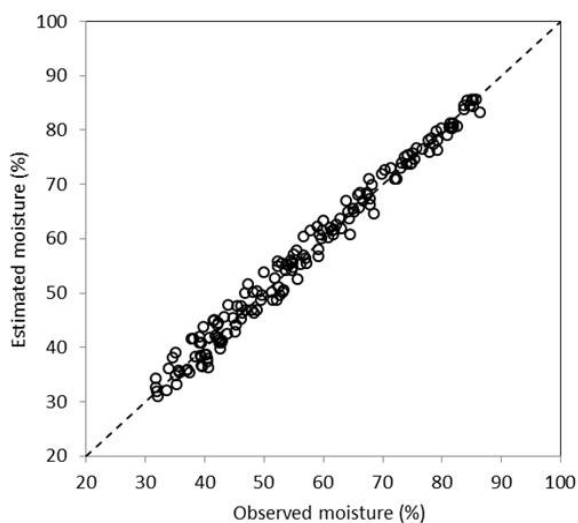

Figure 1. Observed vs estimated moisture content during the grain developmental phase. Data from field literature.

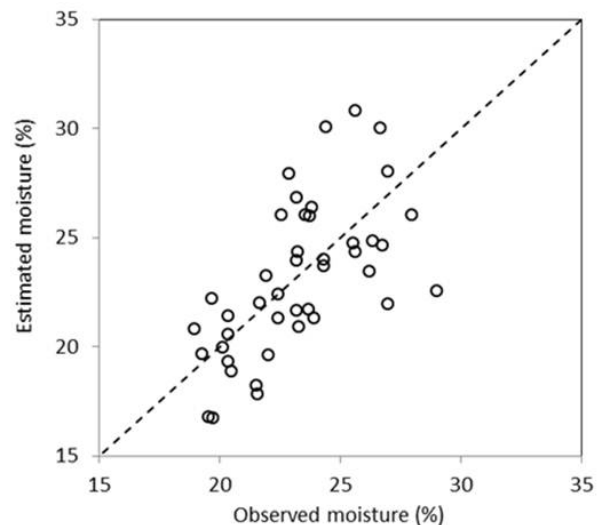

Figure 2. Observed vs estimated moisture content during the dry-down phase. Data from field surveys.

given by the difference between actual moisture content and equilibrium moisture content (tendency of a stored product toward a water content value that is controlled by the ambient environment). Parameters required by the model are: i) duration of lag phase, ii) degree-days to flowering and iii) to physiological maturity, iv) moisture at physiological maturity. Inputs required are air temperature and relative humidity. The models were implemented in a software component (MIMYCS.Maize) composed of discrete model units. This is one of the models of the framework MIMYCS (Maize Infection and MYcotoxin contamination Simulator – FP7 Marie Curie

Project) being developed at the European Commission JRC for the simulation of mycotoxin contamination in grain maize. The component based software implementation of MIMYCS models can be easily re-used in any framework based on the Microsoft .NET platform, and it was used in the BioMA platform of the European Commission. The model was tested using data of maize grain moisture during maturation (Figure 1) and post maturity dry-down (figure 2) from literature and field surveys. Preliminary results showed that the model was accurate in the explored conditions, reproducing correctly the loss of moisture during maturation and dry-down.

Modelling canopy photosynthesis and radiation use efficiency in olive orchards

Morales, Alejandro¹; Villalobos, Francisco²; Leffelaar, Peter³; Testi, Luca¹

¹Instituto de Agricultura Sostenible, SPAIN; ²University of Cordoba, SPAIN; ³Wageningen University, NETHERLANDS

Introduction

Olive trees (*Olea europaea* L.) represent an extended horticultural crop in Mediterranean regions, reaching 9.5 Mha worldwide in 2010 (FAO Statistics Division, 2012). Super-high density olive orchards are planted at a density of 1500-2000 trees ha⁻¹ in order to obtain high yields during the first years of establishment and the trees, are pruned to form continuous hedgerows suitable for mechanizing all operations. A generic, comprehensive model of radiation interception and canopy photosynthesis (Luo et al., 2001) was calibrated for irrigated olive trees using data from existing literature and then used to simulate canopy photosynthesis and radiation use efficiency of super-high density olive orchards.

Materials & Methods

The model Maestra (Luo et al., 2001) implements the method of Norman and Welles (1983) for radiation interception of three-dimensional canopies and scales photosynthesis from the leaf to the canopy level. Leaf photosynthesis is simulated using the model of Farquhar et al. (1980) coupled to a model of stomatal conductance (Leuning, 1995). Canopy respiration was calculated by estimating the biomass of the trees from measurements of leaf area and allometric ratios. This allowed for simulating the aboveground radiation use efficiency (RUE) defined

as biomass production per unit of intercepted PAR. The simulations of canopy photosynthesis by the model were tested against the values calculated from measurements of net CO₂ ecosystem exchange using eddy covariance, soil respiration using closed chambers and estimations of canopy respiration from published models, during the period Spring-Autumn 2011 in a super-high density olive orchard with LAI = 2.5 in Cordoba, Spain.

Results

The average RUE was 0.91 g DM (MJ PAR)⁻¹ with a range of 0.25-1.20 g DM (MJ PAR)⁻¹ (figure 1). These values are in good agreement with the average value of 0.88 g DM (MJ PAR)⁻¹ reported by Villalobos et al. (2006). The variations were linearly related to the daily average air temperature (R² = 0.7). The experiment-based values of canopy photosynthesis per unit of ground surface were quite similar to the predictions of the model (RMSE of 4.61 μmol CO₂ m⁻² s⁻¹), especially during clear-sky days, although the predictions were slightly biased with an average underestimation of 3.66 μmol CO₂ m⁻² s⁻¹. The predictions and the experiment-based calculations presented similar diurnal patterns during clear-sky days (figure 2) whereby the maximum rate of photosynthesis (ca. 25 μmol CO₂ m⁻² s⁻¹) was achieved early in the morning, with a slight decrease during the rest of the day, more pronounced in the simulations.

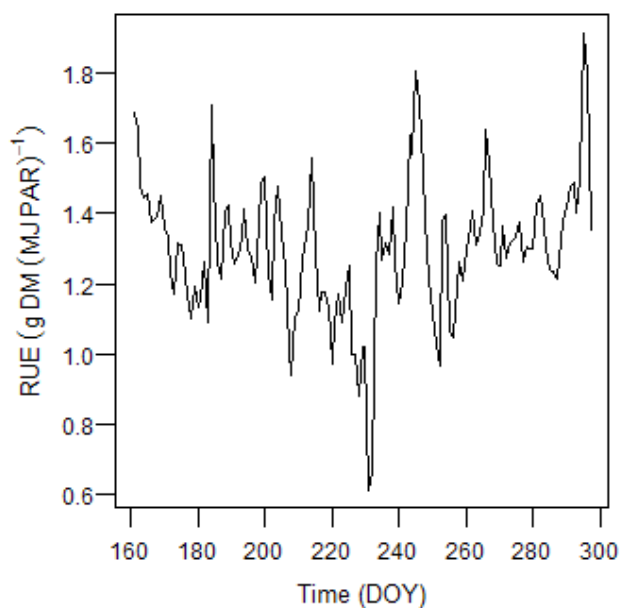

Figure 1: Daily aboveground radiation use efficiency (RUE, g DM (MJ PAR)⁻¹), calculated with the output of the model for a super-high density olive orchard in Cordoba, Spain.

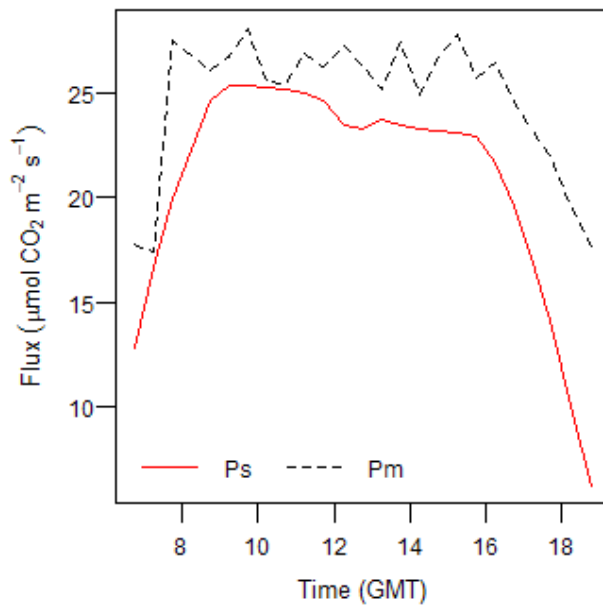

Figure 2: An example of the diurnal trend of simulated canopy photosynthesis (P_s , $\mu\text{mol CO}_2 \text{ m}^{-2} \text{ s}^{-1}$) and canopy photosynthesis calculated from the experiment (P_m , $\mu\text{mol CO}_2 \text{ m}^{-2} \text{ s}^{-1}$) for day 191 of the year.

References

- FAO Statistics Division, 2012. FAOSTAT, <http://faostat.fao.org>
- Farquhar, G. D., von Caemmerer, S. and Berry, J. A., 1980. A Biochemical Model of Photosynthetic CO_2 Assimilation in Leaves of C_3 Species. *Planta*, 149: 78-90.
- Leuning, R., 1995. A critical appraisal of a combined stomatal-photosynthesis model for C_3 plants. *Plant, Cell and Environment*, 18: 339-355.
- Luo, Y., Medlyn, B., Hui, D., Ellsworth, D., Reynolds, J. and Katul, G., 2001. Gross primary productivity in Duke forest: Modelling synthesis of CO_2 experiment and eddy-flux data. *Ecological Applications*, 11(1): 239-252.
- Norman, J.M. and Welles, J.M., 1983. Radiative Transfer in an Array of Canopies. *Agronomy Journal*, 75(3): 481-488.
- Villalobos, F.J., Testi, L., Hidalgo, J., Pastor, M. and Orgaz, F., 2006. Modelling potential growth and yield of olive (*Olea europaea* L.) canopies. *European Journal of Agronomy*, 24(4): 296-303.

Genotype-specific vernalization requirements in sugar beet bolting

Qi, Aiming¹; Chiurugwi, Tinashe¹; Holmes, Helen¹; Mutasa-Gottgens, Effie²

¹Rothamsted Research, UNITED KINGDOM; ²NIAB, UNITED KINGDOM

Introduction

Bolters in a commercial sugar beet crop can cause difficulties at harvest, reduce yield and beet quality, and create perennial weed-beet problems in the crop rotation if they are left to produce seeds. An effective way to prevent sugar beet from bolting is selecting bolting resistant varieties. The objectives of this paper are to quantify the vernalization requirement and bolting sensitivity in seven genotypes and to benchmark the vernalizing environment to which development of bolting resistant varieties should be targeted in UK.

Methodology

Plants of seven genotypes were transferred to a vernalization chamber with temperature set at 6°C and a photoperiod at 8h d⁻¹. Batches of 25 plants of each genotype were removed from the vernalization chamber at 10, 12, 14, 16 and 18 weeks and returned to glasshouse conditions with temperature set at 22-24°C and a photoperiod at 16h d⁻¹. Plants were examined for bolting (i.e. when bolters are at least 5 cm in height) six weeks later. Vernalizing hours (VH) were calculated and integrated with

hourly temperatures following Milford *et al.* (2010). The percentage of bolted plants (B%) is related to VH as below: $B\% = 0$ when $VH \leq VR$, but, $B\% = BS \cdot (VH - VR)$ when $VH > VR$ where VR is a genotype-specific constant quantifying the threshold vernalization requirement to induce a genotype to bolt, and BS is a genotype-specific bolting sensitivity quantifying the rate of increase in new bolters per unit of above threshold VR.

Results and discussion

Fig. 1 (modified from Chiurugwi *et al.* 2012) shows the percentage of bolted plants at various levels of vernalization. Only C600 from USDA and Roberta still had not achieved 100% bolting after 18 weeks in the vernalization chamber. Genotype did not differ significantly in BS ranging from 0.54 to 0.79. However, they differed significantly in the threshold VR ranging from 194 to 233.

Roberta was also investigated by Milford *et al.* (2010). Their estimated threshold VR and BS were, respectively, 147 and 0.55. Our estimated BS (0.54) was very similar to theirs. However, the threshold VR in our study was 230,

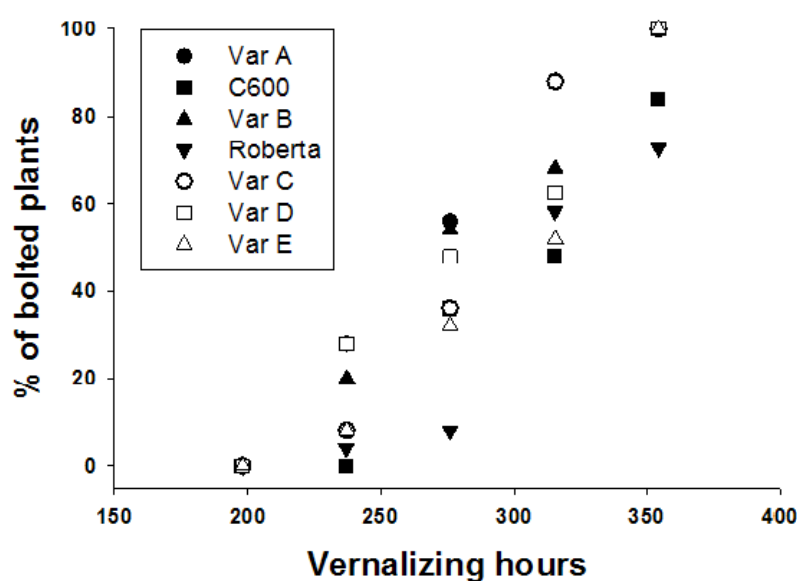

Fig. 1 The observed percentage of bolted plants in various genotypes versus different levels of vernalizing hours.

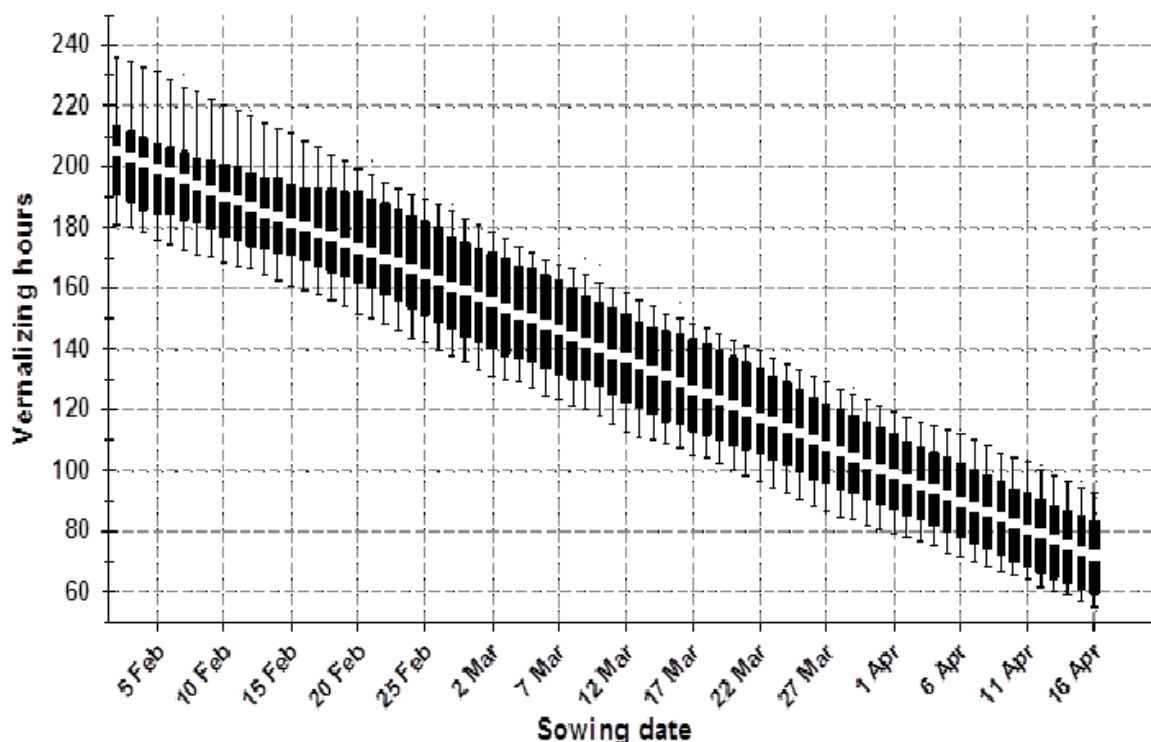

Fig. 2 Box plot showing the integrated vernalizing hours sugar beet crops would have experienced if sown on different dates from 1 February to 16 April. The bottom boundary of the boxes indicates the 25th percentile, a white dot within the box marks the median, and the top boundary of the boxes indicates the 75th percentile. Bars above and below the boxes indicate the 95th and 5th percentiles.

and about 60% higher under short days. This difference is probably due to the interacting effects between vernalization and photoperiod on bolting induction under field conditions.

Fig. 2 shows the integrated **VH** a sugar beet crop is likely to experience from various spring sowing dates until end of June using temperature records at Broom's Barn Research Station from 1965 to 2011. The risk of a variety to bolt can be assessed with its threshold **VR** against the **VH** accumulated on a given sowing date. If one in twenty years (i.e. at 5% chance) is considered to be a manageable risk, the current encouraged drilling date of 1 March in UK will require cultivars to withstand no fewer than 180 vernalising hours (Fig. 2). Latest recommended varieties in UK have on average a threshold **VR** of about 140 (Milford *et al.* 2010) so that the safe sowing date should be around 22 March. There would be a greater than 5% chance of bolting for current varieties sown earlier than 22 March.

Conclusions

The seven genotypes investigated here showed significant differences in threshold **VR** to induce bolting, but they did not differ significantly in **BS**. Differences in **VR** should be exploited in breeding bolting resistant beet varieties. It is also desirable that threshold **VR** should take precedence over **BS** as a selection target since the latter merely determines the rate at which new bolters appear once bolting is initiated but any bolters are undesirable in commercial crops.

References

- Milford *et al.* (2010). A vernalization-intensity model to predict bolting in sugar beet. *Journal of Agricultural Science* **148**, 127-137.
- Chiurugwi *et al.* (2012). Development of new quantitative physiological and molecular breeding parameters based on the sugar beet vernalization-intensity model. *Journal of Agricultural Science* (in press).

Simulating improved combinations tillage-rotation under dryland conditions

Soldevilla-Martinez, M¹; Martin-Lammerding, D²; Tenorio, J.L²; Walter, I²; Quemada, M¹; Lizaso, J.I¹

¹Technical University of Madrid, SPAIN; ²INIA, SPAIN

Introduction

The adequate combination of reduced tillage and crop rotation could increase the viability of dry land agriculture in Mediterranean zones. Crop simulation models can support to examine various tillage-rotation combinations and explore management scenarios. The decision support system for agrotechnology transfer (DSSAT) (Hoogenboom et al., 2010) provides a suite of crop models suitable for this task. The objective of this work was to simulate the effects of two tillage systems, conventional tillage (ConvT) and no tillage (NoT), and three crop rotations, continuous cereal (CC), fallow-cereal (FallowC) and legume-cereal (LegumeC), under dry conditions, on the cereal yield, soil organic carbon (SOC) and nitrogen (SON) in a 15-year experiment, comparing these simulations with field observations.

Materials and methods

The data used in this simulation study comes from a field experiment in La Canaleja located in Alcala de Henares (Madrid, Spain; Martin Lammerding et al., 2011). Genetic coefficients of the CERES-Barley model were calibrated using observed dates of planting, harvest and anthesis together with biomass and yield. Daily weather and soil parameters were measured at the site.

Results and Discussion

Barley biomass and yield were properly simulated with DSSAT. Both simulated and observed values showed

the same tendency through time (Fig. 1). SOC and SON were also satisfactorily simulated compared with the field observations (Fig. 2).

Barley grain yield was lower for continuous cereal than for the FallowC and the LegumeC rotations, for both tillage managements. However, CERES-Barley did not reflect that reduction consistently. Only some years showed reduced yield in the continuous barley simulations. The model however, simulated correctly higher yields in the ConvT than in the NoT. Simulations also suggested that N immobilized in soil was higher in NoT than in ConvT. This fact could explain the lower yield in NoT, since N available is lower in that management. The larger presence of weeds in the NoT plots also affected the yield, but this was not simulated with DSSAT. Observed and simulated SOC exhibited similar trends decreasing with depth. This reduction with depth was sharper in NoT than in ConvT. SOC in the top 15 cm of soil was higher with NoT management than with ConvT management in both simulated and observed values. The SON showed the same tendency as SOC. A higher concentration of SON in the first 15 cm of soil in NoT than in ConvT, and a reduction with depth in all the studied years was observed and simulated.

These results suggest that ConvT-LegumeC and ConvT-FallowC were the best combinations for the dry land conditions studied. However, ConvT had the lowest SON and SOC while NoT kept higher SOC and SON. This is an example of how models can be a very useful tool for

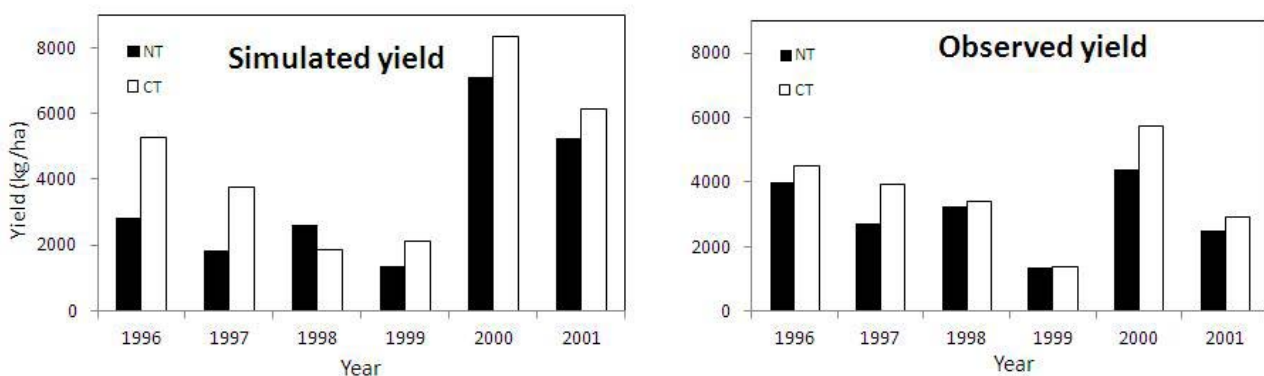

Fig1. Observed and simulated barley yield in no tillage (NT) and conventional tillage (CT).

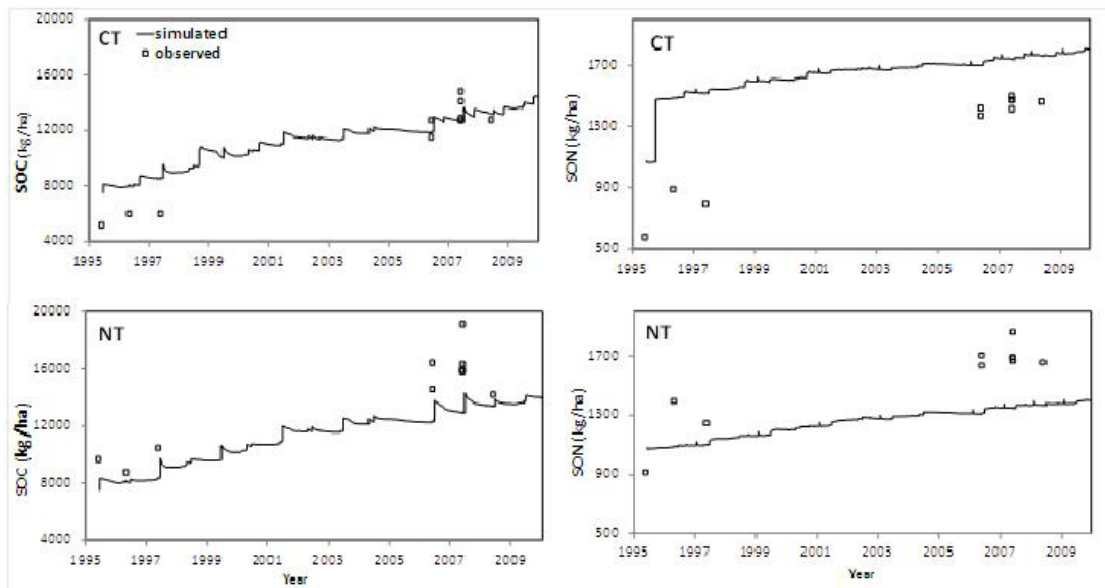

Fig 2. Observed and simulated SOC and SON in no tillage (NL) and conventional tillage (CT) in the top layer (0-15 cm)

assessing and predicting crop growth and yield under different managements.

Conclusions

In summary, ConvT-LegumeC and ConvT-FallowC provided the best yield but NoT treatments had the highest SON and SOC improving soil quality. Complementary economic and energy balance evaluations are needed to decide which are the best management practices for the area.

Acknowledgements

Financial support by Comunidad Autonoma Madrid (AGRISOST, S2009/AGR1630).

References

- Hoogenboom, G., J.W. Jones, P.W. Wilkens, C.H. Porter, K.J. Boote, L.A. Hunt, U. Singh, J.L. Lizaso, J.W. White, O. Uryasev, F.S. Royce, R. Ogoshi, A.J. Gijsman, and G.Y. Tsuji. 2010. Decision Support System for Agrotechnology Transfer (DSSAT) Version 4.5 [CD-ROM]. University of Hawaii, Honolulu, Hawaii.
- Martin Lammerding, D., Hontoria, C., Tenorio, J.L., Walter, I., 2011. Mediterranean dryland farming: effect of tillage practices on selected soil properties. *Agronomy Journal* 103 (2): 382-389.
- Martin-Rueda, I., Munoz-Guerra, L. M., Yunta, F., Esteban, E., Tenorio, J. L., and Lucena, J. J. 2007. Tillage and crop rotation effects on barley yield and soil nutrients on a Calciortidic Haploxeralf. *Soil & Tillage Research* 92: 1-9.

Improving crop growth simulations by taking into account soil heterogeneity

Stadler, Anja; Kupisch, Moritz; Langensiepen, Matthias; Ewert, Frank
University of Bonn, GERMANY

Introduction

Agricultural ecosystems depend on environmental factors, especially weather and soil characteristics. If these conditions vary within a field, it is assumed, that crop growth is strongly affected, causing a spatial variation in biomass, yield and leaf area index (Hutchings 2003). The effects of varying spatial conditions on crop growth are examined on different spatial scales. Several studies consider either a global or regional scale (Hu 2011), but just few pay attention to spatial heterogeneity at the field level (Batchelor 2002). These studies show that spatial heterogeneity within a field is a widespread phenomenon. Since crop growth models try to represent an image of the reality, they should also consider variations in field conditions, especially regarding small-scale simulations and precision agriculture (Sadler 2002). Batchelor et al. (2002) describe different strategies to analyze crop models' ability to reproduce spatial yield variability. They found that the models are able to represent the spatial heterogeneity within a field, if the parameters for environmental conditions are adapted. Therefore, we hypothesize that taking into account the effects of soil heterogeneity on plant water and nutrient uptake improves the accuracy of crop growth models on field scale.

Materials and methods

The crop growth model GECROS was applied using information from winter wheat and sugar beet field trials carried out near Jülich, in the central western part of Germany. These fields are all characterized by strong spatial variability in soil conditions and are managed according to standard agronomic practice. GECROS was calibrated separately for each winter wheat and sugar beet cultivar grown on these fields by adjusting the respective parameters with the help of crop physiological measurements at point level. The soil model was parameterized for different field sample points accounting for the spatial heterogeneity in soil conditions within each field. We detected the soil heterogeneity patterns using soil samples and measurements of apparent electromagnetic conductivity. The crop growth

model was then tested as to whether it could reproduce the observed spatial patterns of crop growth and development in the selected fields through consideration of the spatial variability in soil properties.

Results

Preliminary results show that observed leaf area development, biomass formation and yield distribution within a field are highly dependent on the given soil properties. For example, the spatial distribution of leaf area index values clearly correlates with soil heterogeneous patterns. Therefore, the soil model was adapted to simulate the variable crop growth within a field. Without adaptation of the soil model to the variable soil properties, the crop growth model is not able to reproduce the observed heterogeneity of crop growth.

Conclusions

Spatio-temporal variability in soil water distribution and its effects on nitrogen availability are likely the main factors causing spatial variable crop growth within the selected fields of the study region. Considering variable soil water transport and related nutrient dynamics in model scaling to the field level might thus improve the predictive quality of the crop growth model at the field scale.

References

- Batchelor, W.D. et al. (2002): Examples of strategies to analyze spatial and temporal yield variability using crop models. *European Journal of Agronomy*, 18, 141-158.
- Hu, S. & Mo, X. (2011): Interpreting spatial heterogeneity of crop yield with a process model and remote sensing. *Ecological Modelling*, 222, 2530-2541.
- Hutchings, M.J. et al. (2003): Toward understanding the consequences of soil heterogeneity for plant populations and communities. *Ecology*, 84(9), 2322-2334.
- Sadler, E.J. et al. (2002): Addressing spatial variability in crop model applications. In: Lajpat, R.A. et al.: *Agricultural system models in field research and technology transfer*, CRC Press.

Is imported Soya the most sustainable source of proteins in pigs' diet?

Tarsitano, Davide; Topp, Kairsty
SAC, UNITED KINGDOM

In the UK, the most important source of proteins in pig diets is soya, which is primarily imported from Brazil and Argentina, 47% and 34% respectively. Nevertheless, increasing concern for the environmental impact associated to soya production and its economic sustainability has made the industry and government to consider alternative sources of proteins. The Green Pig project aimed to investigate the impact that diets based on the use of home grown protein crops have on pork production and impact on climate change. The purpose of this work is to assess and compare the environmental impact of soya based diet to diets those using UK produced legumes, such as peas and beans. Therefore, the Life Cycle

Analysis (LCA) methodology has been implemented to estimate the global warming potential (GWP) per kg pork for each crop. In addition the differences in predicted GWP resulting from the implementation of the IPCC 2006 and the UKNI Rog have been assessed. The use of imported soya as the main source of proteins for pig diet has a considerable environmental impact. The CO₂eq (kg/kg pig) emission is 40% higher than for peas and beans. This is mostly caused by the carbon lost through the process of land use change. Moreover the comparison between the IPCC 2006 and UKNI Rog underlines the significant importance that biological N fixation has on the overall emission budget.

Assessment of DNDC ability to N leaching

Topp, Cairistiona; Sun, Yiyang
SAC, UNITED KINGDOM

Introduction

Nitrogen (N) is critical for plant growth. Losses through leaching and nitrous oxide emissions are key environmental concerns. DeNitrificationDeComposition (DNDC, Li et al., 2006) is a computer simulation model of carbon and nitrogen biogeochemistry in agroecosystems. It can be used for predicting crop growth, soil temperature and moisture regimes, soil carbon dynamics, soil nitrogen dynamics, methane and carbon dioxide. It has been used extensively to model nitrous oxide from agricultural landscapes, although it has not been used extensively to predict N leaching. The purpose of this study was to assess the ability of DNDC to predict N leaching from an arable site in Scotland.

Materials and methods

The experimental data that has been used in this study was from an experiment conducted in Edinburgh by Vinten et al. (1992; 1994) and Vinten (1999). The field management is shown in Tables 1 and 2.

Table 1 Field management and crops grown (Source from Vinten et al., 1992, 1994, 1999)

	1989	1990	1991	1992
sowing date	25/04/1989	05/04/1990	12/04/1991	05/05/1992
harvest date	29/08/1989	04/09/1990	05/09/1991	15/10/1992
ploughing	March	January	April	April
plot 1	spring barley	spring barley	Grass grass	
plot 2	spring barley	spring barley	spring barley	spring barley
plot 3	spring barley	spring barley	spring barley	spring barley
plot 4	spring barley	spring barley	spring barley	spring barley
plot 5	spring barley	spring barley	Bare fallow	Bare fallow
plot 6	spring barley	spring barley	spring barley	spring barley
plot 7	spring barley	spring barley	spring barley	spring barley
plot 8	spring barley	spring barley	Grass grass	
plot 9	spring barley	spring barley	spring barley	spring barley
plot 10	spring barley	spring barley	spring barley	spring barley
plot 11	spring barley	spring barley	spring barley	spring barley
plot 12	spring barley	spring barley	Bare fallow	Bare fallow

Table 2 N applications (kg ha^{-1}) and dates of application

Plot Number	25/04/1989	08/05/2989	05/04/1990	12/04/1991	05/05/1992
plot 1	32	96	150	0	0
plot 2	32	96	150	150	150
plot 3	32	96	0	0	0
plot 4	32	96	120	120	120
plot 5	32	96	150	0	0
plot 6	32	96	120	120	120
plot 7	32	96	90	90	90
plot 8	32	96	150	0	0
plot 9	32	96	180	180	180
plot 10	32	96	210	210	210
plot 11	32	96	150	150	150
plot 12	32	96	150	0	0

Results and Discussion

The results suggest that the model gives reasonable predictions of the N leaching, with a tendency to over-estimate it. The daily N leaching losses are shown in Fig 1 for plots 1 and 8, and the RMSE for the predicted and the modelled results for each plot are shown in Fig 2. Both the observed and simulated data display extreme amount of N leaching in some particular dates, thus reflecting the potential of the DNDC model to capture some of the extreme situations. For example, during December 1990 and January 1991, the prediction could reflect the extreme high leaching trend. The RMSE was lowest in plots 7, 3 and 4, which received lowest fertilizer during 1990 to 1992 (90, 0 and 120 kg N ha^{-1} respectively). The RMSE was highest in plots 10, 5 and 9, which received the highest fertilizer with 210 and 180 kg N ha^{-1} . This phenomenon could indicate the accuracy of DNDC decreases with high rates of fertilizer applications. Plots 5 and 12 were cultivated with grassland in 1991 and 1992. The RMSE of plot 5 was also quite high, which indicates that some further modifications of the parameters for grassland may be required, which would need more information, such as yield data, although not available from this study.

References

- Li C et al 2006 Ecological Modelling 196: 116–130
- Vinten, A et al. 1992 Proc, Fert. Soc., 329
- Vinten, A et al. 1996 Eur. J. Soil Sci., 47, 305–317
- Vinten, A 1999 J. Environ. Qual. 28: 988–996.

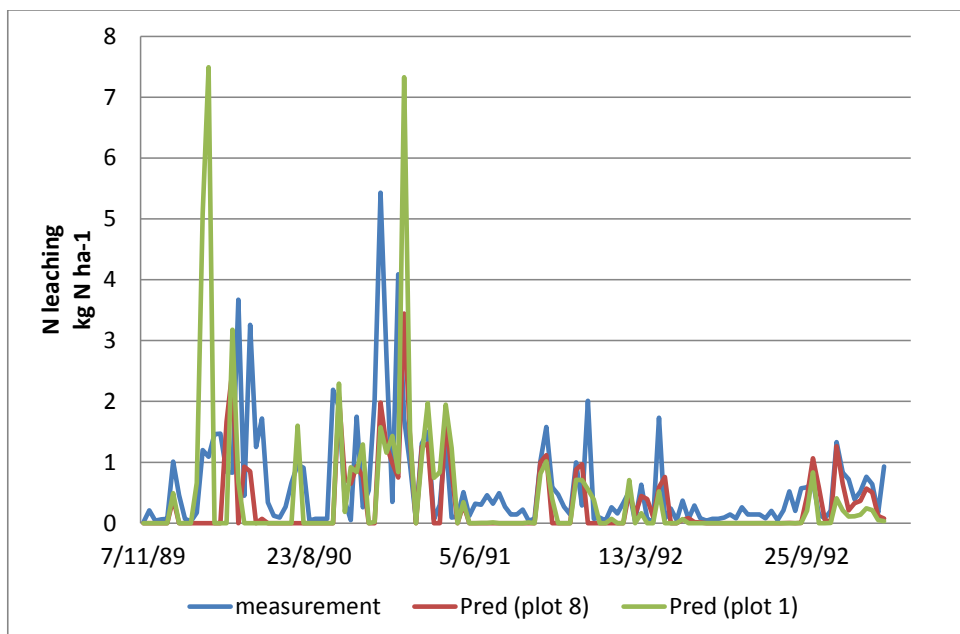

Fig 1. The measured and predicted N leaching for plots 1 and 8.

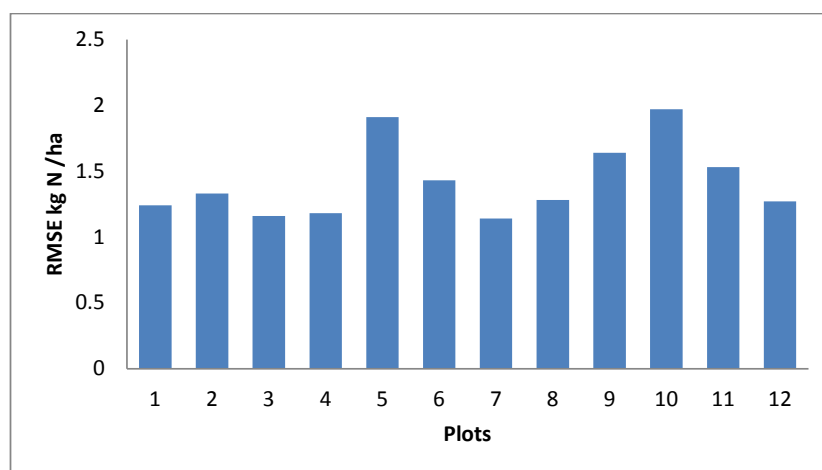

Fig 2. The RMSE for the measured versus the predicted N leaching

Climate change impacts on yield of different spring wheat cultivars: a modelling approach

Vignjevic, Marija; Wollenweber, Bernd; Olesen, Jørgen Eivind
Aarhus University, Faculty of Science and Technology, DENMARK

Introduction

Global warming is expected to have detrimental effects on crop production in regions with close to optimum conditions for wheat growth and development under today's climate. In contrast, positive effects on crop production can be expected in the higher latitudes resulting from a northward shift in optimum temperature conditions. Recent climate change studies suggest that more unpredictable weather patterns can be expected in the future. Increased frequency of extreme weather events will cause a more severe reduction in yield than can be expected from higher mean temperature alone. Different developmental stages in a crops' life cycle exhibit different sensitivity levels for environmental conditions, with the reproductive stage being the

most sensitive. At the time of flowering, above normal temperatures will result in a decrease in the number of grains that are formed, thus resulting in lower yield. High temperatures accelerate phenological development and cause a shortening of the green leaf area duration, resulting in a reduction in grain weight. Process based crop models are becoming increasingly used as a cost effective tool for assessing the effects of climate change on crop production. A new challenge for crop modellers comes from climate extremes that are proving to be more complex because of their nonlinear effects on yield forming processes. The purpose of this study is to identify key traits and mechanisms that will ensure stable wheat yields under future, more variable climate. A combined approach, based on experimental data and crop modelling is used.

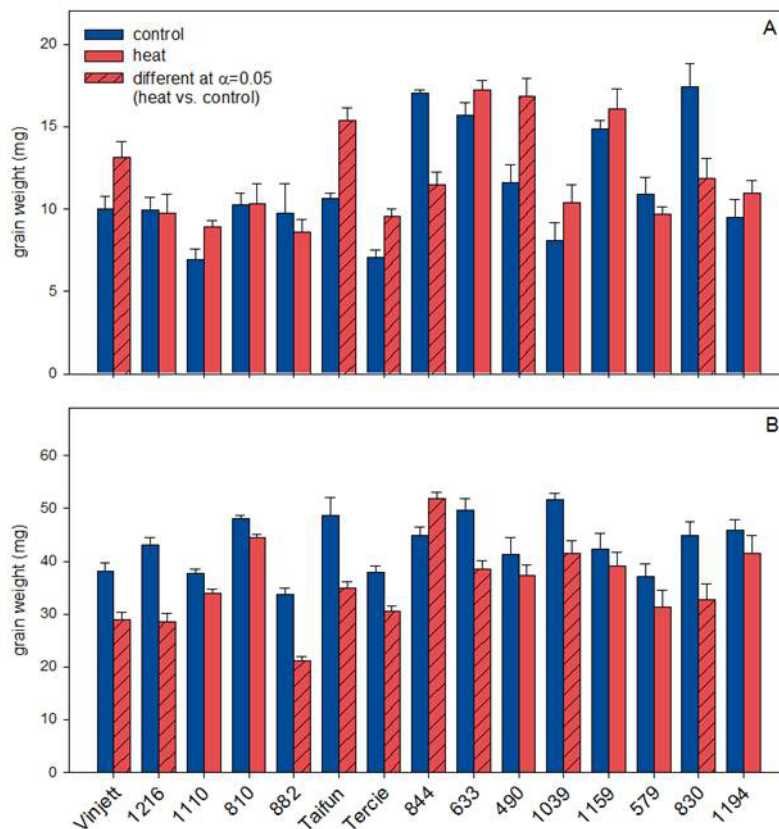

Figure 1: Average grain weight (mg) with standard errors in different spring wheat varieties (n=8) after heat treatment (A) and at maturity (B). Bars with pattern are statistically different at $\alpha=0.05$ level using the Tukey test.

Materials and methods

Two experiments with different spring wheat varieties were conducted during spring/summer of 2011 at Aarhus University, research Centre Flakkebjerg (55° 19'N, 11° 24'E). A field experiment with standard practices under Danish conditions was carried out with the aim to parameterize nine different cultivars in the Daisy model. The main parameters measured for model calibration were: phenology, light interception, leaf area index and green leaf area duration. Biomass accumulation in different plant organs was obtained during five developmental stages. The final yield was measured in order to validate the model against measured data. A pot experiment was conducted in order to investigate the effects of heat stress on yield of fifteen different spring wheat cultivars. In addition to the nine varieties used in the field experiment, additional six cultivars were investigated in the semifield facilities at research Centre Flakkebjerg. Plants were subjected to high temperature stress (35/26 °C) two weeks after flowering for a period of five days. Plants were sampled during the flowering stage, after the heat treatment and at maturity. Measured parameters included biomass accumulation, leaf area and grain number and weight. The obtained results are used to differentiate between the heat sensitive and more tolerant cultivars, as well as to identify key traits that enable heat tolerance. These traits will be calibrated in the Daisy model.

Results

Average grain weight of 15 different spring cultivars from the pot experiment is shown in Figure 1. In some of the varieties (Vinjett, Taifun, Tercie and 490) an increase in grain weight after the treatment was observed (Fig. 1-A). This could be explained by increased grain filling rate resulting from higher temperature. At maturity, most cultivars had higher grain weight under controlled conditions, with the exception of the '844' variety (Fig. 1-B).

Conclusions

These results illustrate the importance of the duration of grain filling in determining grain weight and yield. Despite the initial increased grain growth under heat stress, the final yield was higher under the control group, possibly due to a longer grainfilling period. Combining the experimental results with crop modelling will ensure a better understanding of the impact of future climate variability on wheat production as well as point to the possibilities for adaptation.

Analysis of yield determining weather conditions at certain growth stages for winter oilseed rape

Weymann, Wiebke; Böttcher, Ulf; Sieling, Klaus; Kage, Henning
Christian-Albrechts-University of Kiel, GERMANY

Introduction

In comparison with other main agricultural crops, for instance winter wheat, winter oilseed rape (WOSR) yield is highly variable. Weather conditions thereby may interact with yield formation by influencing sink-limitations (e.g. seeds/m²) and/or source-limitations. In our study we aim to analyse correlations between yield and weather conditions during certain growth stages.

Materials and methods

Yield and growth stages (GS, Schuette *et al.* 1982) of six WOSR field trials with different sowing dates, autumn N applications and N levels in spring (0–280 kg N ha⁻¹) were measured. The crops grew on the experimental farm Hohenschulen, Germany, during the years 1990 to 2011. From quadratic N response curves of the field trials, the maximum yield (Y_{max}) and its corresponding amounts of fertilizer N were estimated. The phenological model (Müller *et al.* 2009, Böttcher *et al.* 2011) simulated the growth stages, which were compared with the measured ones. Afterwards, correlations between Y_{max} and weather conditions, e.g.

radiation, during certain growth stages were investigated. Radiation measurements were performed with a SP-Lite pyranometer (Kipp & Zonen, NL), calibrated for the spectral range from 400 to 1100 nm.

Results

The phenological model showed a close correlation ($R^2 = 0.95$) between simulated growth stages and measured ones. The growth stages were simulated to test correlations between the estimated Y_{max} and the observed radiation sum during flowering (GS 60–70, Fig. 1) and seed filling (GS 69–79, Fig. 2). However, in the analysed data set, only weak correlations could be observed, indicated by low R^2 of 0.21 and 0.24, respectively. No significant correlations between mean temperatures during inflorescence emergence, flowering and seed filling and Y_{max} were found.

Discussion

Climatic conditions during critical growth stages are suggested to substantially affect seed yield of WOSR. In the present study, correlations between radiation

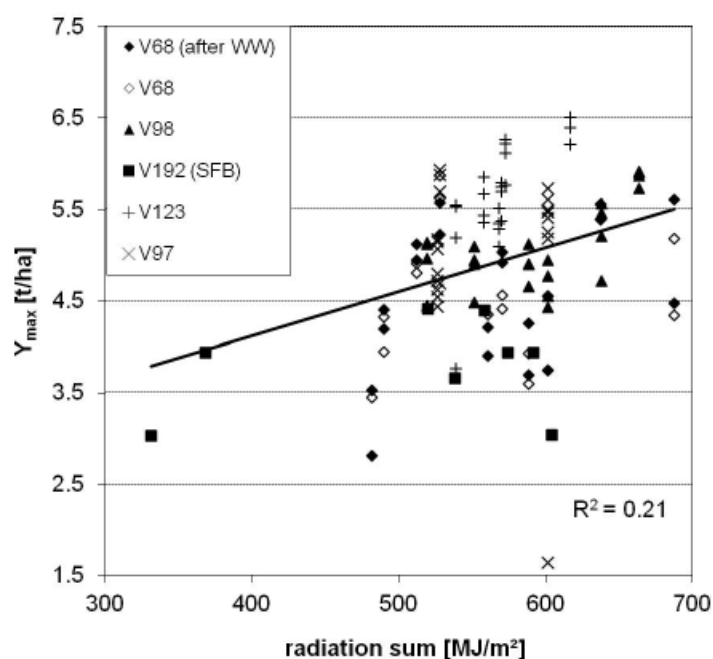

Fig. 1: Correlation between radiation sum during flowering (GS 60–70) and Y_{max} of WOSR

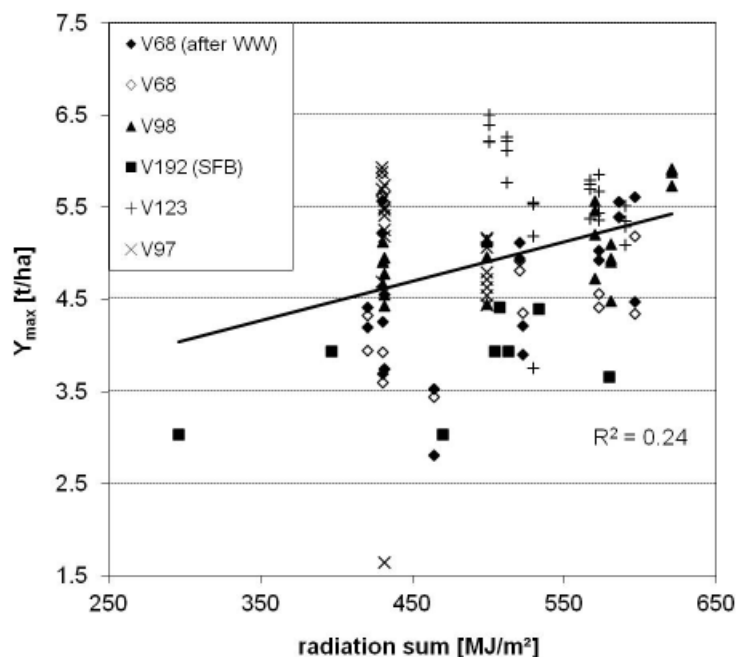

Fig. 2: Correlation between radiation sum during seed filling (GS 69-79) and Y_{max} of WOSR

sum during flowering phase and seed filling and Y_{max} were identified. Here, incoming radiation is almost equal to intercepted radiation, because of the usually almost complete soil cover by the WOSR crops during this period. Also Peltonen-Sainio *et al.* (2010) suggested that high incoming radiation during flowering increases yield due to a more successful pollination and onset of seed-filling processes. A high incoming radiation during seed filling may enhance the photosynthetic activity of pod walls, which may provide additional assimilates. Radiation sum during flowering seems to influence seed number per square meter soil surface and thereby sink capacity of WOSR crops whereas radiation sum during seed filling may have determined source strength.

In general, solar radiation influences seed yield of WOSR but more detailed interactions with further climatic variables as temperature and moisture have not been investigated, yet. Furthermore, possible effects of soil conditions and management procedures are not considered. The presented work will be continued in order to verify the first results and to explain better the high variability of WOSR seed yield.

References

- Böttcher, U. *et al.* 2011: A phenological model of winter oilseed rape according to the BBCH scale (unpublished).
- Müller, K. *et al.* 2009: Revision and parameterisation of a phenological model for winter oilseed rape (*Brassica napus* L.). In: Müller, K., Remote sensing and simulation modelling as tools for improving nitrogen efficiency for winter oilseed rape (*Brassica napus* L.), Dissertation (CAU Kiel), 32-58.
- Peltonen-Sainio, P. *et al.* 2010: Coincidence of variation in yield and climate in Europe. *Agriculture, Ecosystems and Environment*, 139, 483-489.
- Schuette, F. *et al.* 1982: Entwicklungsstadien des Raps. Biologische Bundesanstalt für Land- und Forstwirtschaft, Merkblatt Nr. 27(7).

Preliminary study on the use of NIR spectroscopy to determine nitrogen content in fresh leaves of corn

Fuccella, Roberto¹; Cabassi, Giovanni²; Cavalli, Daniele¹; Marino Gallina, Pietro¹; Borrelli, Lamberto²; Degano, Luigi²

¹Università degli studi di Milano, ITALY; ²CRA-FLC Centro di ricerca per le Produzioni Foraggere e Lattiero-Casearie di Lodi, ITALY

Introduction

Nitrogen is an important determinant of corn (*Zea mays* L.) productivity but at the same time it can pollute waters. Tools that can rapidly quantify the N content of corn are needed to diagnose crop nutritional status and to define appropriate application rates of N fertilizers during plant growth. This evaluation is of pivotal importance at the 6th fully expanded leaf stage in view of side-dressing before canopy closing. Wet chemistry methods to determine N concentration provide reliable results but unfortunately they are time consuming and expensive. To get estimations on the field, indirect methods based on leaf chlorophyll concentration were developed, with remote sensing techniques, but results were not reliable in the range of high N concentration and errors can be made because leaf chlorophyll concentration is also affected by other elements and soil conditions. NIR spectroscopy could be a useful technique because it demonstrated direct sensitivity to N compounds in the case of forages, soils and manures. The NIR region (1000-2500 nm) is dominated by two strong water absorption bands and by minor absorption features related to other foliar biochemical compounds including reduced N-containing products (Fourthy, 1996). NIR spectra are also affected by scattering phenomena arising from leaf structural characteristics and these latter also depend by the plants N nutritional status. The aim of this preliminary study was to investigate the potential use of NIR spectroscopy to estimate N content in fresh corn leaves.

Materials and methods

Three sample sets of corn leaf disks were obtained from a lysimeter experiment (SINBION, 2011), where six different fertilization treatments (6 replication) were compared.

Leaf disks ($\varnothing=18$ mm) were taken from the last unfolded leaf at the growth stage 16 in the BBCH scale. Each fresh disk was scanned in the NIR region in transreflectance mode, with a ceramic translector, using a FT-NIR. Concerning the reference analyses, fresh leaf weight per unit of area (FWpua) and dry matter content (DM) were determined on the first sample set while N content was determined on the other two sets after oven drying the disks at 60°C, using an elemental analyzer NA1500 (Carlo Erba). For the development of calibration models the sample sets were used as follows: the first to calibrate FWpua (mg/cm²) and DM (%); the second to calibrate Npua (mg/cm²); the third to validate the model of Npua. Calibration models were performed by partial least square (PLS) regression, using Matlab™ R2009b software and PLS Toolbox.

Results and Discussion

The attempts to develop prediction models using N concentrations on fresh or dry weight basis, failed, probably due to the different thicknesses of each leaf sample and the effect of this variable on the path length of NIR radiation. Therefore it seems mandatory to express N content as Npua. In order to achieve this goal, a calibration model with a cross-validation was developed for predicting FWpua and DM of disks using sample set 1. (mean and range of FWpua = 13.7 and 6.1 mg/cm²; mean and range of DM = 27.3 and 10.8 %). With this calibration model FWpua and DM of the samples of set 2 and 3 were estimated. Then a calibration to estimate Npua was developed with the second set and validate with the third set. The results obtained are shown in Table 1; the scatter plot of measured vs. NIRS predicted values of Npua are shown in Figure 1, separately per calibration set and validation set.

Table 1. Results of PLS calibration models

Model	Unit	R ²	RMSEC	RMSECV	RMSEP	Prediction Bias
DM	%	0.95	0.44	0.59	-	0.009
FWpua	mg/cm ²	0.96	0.19	0.24	-	-0.00001
Npua	mg[N]/cm ²	0.83	0.004	0.007	0.009	0.0053

R² = coefficient of determination

RMSEC = root mean square error of calibration

RMSECV = root mean square error of cross-validation

RMSEP = root mean square error of prediction

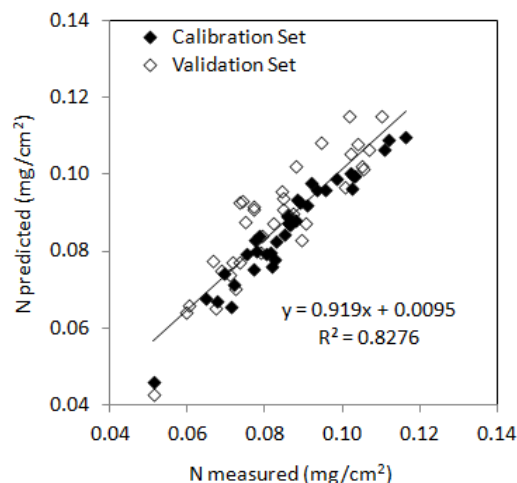

Figure 1. Scatter plot of measured versus predicted (NIR) values of Npua (mg/cm²)

Conclusions

This preliminary work shows the feasibility of a NIR approach to simultaneously estimate FWpua, DM and Npua on fresh corn leaves. These three parameters can be useful to diagnose N nutritional status of plants and to apply efficient strategies of N fertilizer management.

References

Fourty T., Baret F., Jacquemoud S., Schmuck G., Verdebout J. *Remote Sens. Environ.*, 56:104-117 (1996)

Acknowledgements

SINBION project supported by Ministero Politiche Agricole Alimentari e Forestali (2011-2013).

Post hydrothermal stress effects on photosynthetic apparatus efficiency and yield of miscanthus under static fertilizer experiment

Wyszynski, Zdzislaw; Dratkiewicz, Piotr; Horaczek, Tomasz; Pietkiewicz, Stefan; Stępień, Wojciech; Kalaji, Mohamed Hazem; Gozdowski, Dariusz
Warsaw University of Life Sciences-SGGW, POLAND

Introduction

Non-invasive instruments to study crop productivity revealed in situ e.g. an impaired relationship stomatal conductance vs photosynthetic rate under hydrothermal stress in differently N-fertilized triticale (Pietkiewicz et al. 1998). In 2011 chlorophyll *a* fluorescence (Kalaji et al. 2011) helped to analyse the effect of current hydrothermal stress and subsequent abundant rainfall on the activity of miscanthus photosynthetic apparatus and yielding.

Materials and methods

Miscanthus is grown since 2003 at the WULS Skierniewice Exp. Station in the frames of the long-term static fertilizer experiment design (Mercik and Stępień 2005). The field, without NPK since 1923, was provided with mineral N-90, P-26 and K-91 kg/ha at the start. CaNPK, NPK, CaKN, CaPN, CaPK and Ca (without NPK at all, control) treatments not irrigated were studied. HandyPEA fluorimeter (Hansatech, King's Lynn, Norfolk, UK) was used to measure Performance Index (P.I.) of Photosystem

II (PSII) at 3 terms for growth stages of 3 canopy layers: young, fully developed and old with 9 replicates. On 4th June air temperature was 30°C, the rainfall -40 mm. On 8th June it raised to 102 mm, temperature dropped to 20°C. On 9th July abundant rainfall 105 mm occurred. At harvest d. m. yield was determined. Data analysed with ANOVA (Statgraphics ver. 4.1) and Fisher procedure for LSD ($p=0.05$).

Results

The highest P.I. across the whole investigation period were in CaKN, CaNPK and NPK, while the lowest in CaPK and control. The values of P.I. depended on growth stage, position of leaf on stem, and treatment applied. The period of high temperature can significantly increase the amount of solar energy converted in photosynthetic apparatus. Intensive rainfall in July caused a significant decrease of P.I. Leaves of canopy upper layer showed the lowest values. Lack of basic macronutrients modified P.I. (Fig.1).

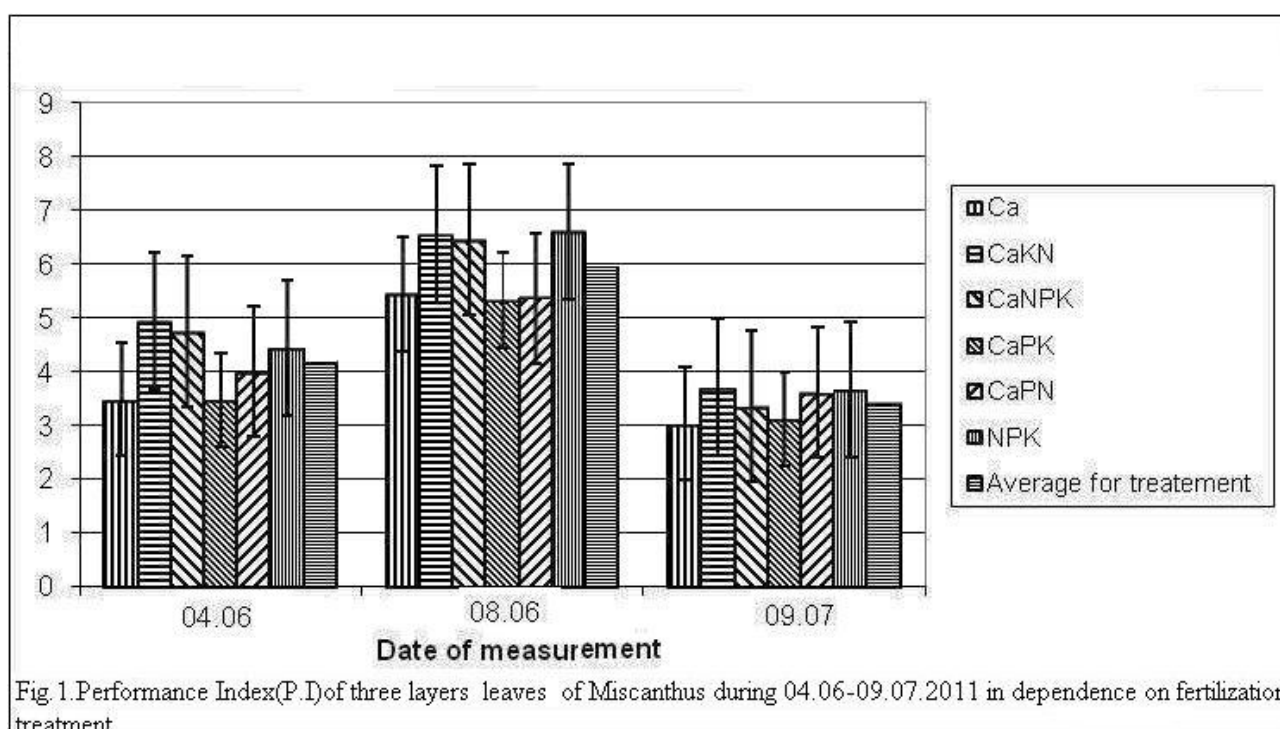

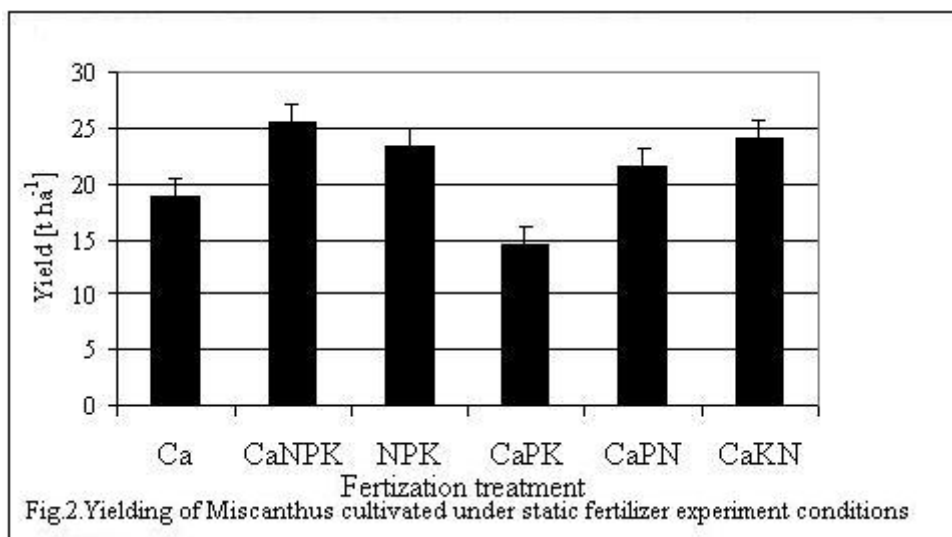

The highest P.I. had both fully fertilized and not fertilized with P treatments. This year and earlier data revealed the highest yield have been obtained for these objects, while the lowest for CaPK and Ca treatments. (Fig. 2, Lebioda et al. 2010)

Conclusions

Hydrothermal stress affects the operating photosynthetic apparatus. NPK fertilization can increase its P.I. by 2 units after short but abundant rainfall. In long term the apparatus did not fully recover its ability of PAR absorption despite of consuming much energy stored in short term. P.I. strongly depended on time course, canopy layer and fertilization applied. The high yielding treatments (full and without phosphorus) had the highest P.I.

References

- Kalaji M. H., Govindjee, Bosa. K., Koscielniak. J., Zukgolszewska. K. 2011. Effects of salt stress on photosystem II efficiency and CO₂ assimilation of two Syrian barley landraces. *Environ. Exp. Bot.* 73,64-72.
- Lebioda P, Pietkiewicz S., Stêpień .W, Horaczek T., Toborowicz-Borda I., Wszyński Z. 2010. Crop productivity indices and yielding of Miscanthus cultivated on soils without fertilization since 1923. 11th Congress ESA 733-734.
- Mercik S., Stêpień .W. 2005. The most important soil properties and yields of plants in 80 years of static fertilizing experiments in Skierniewice. *Fragm. Agron.*1(85),189-202
- Pietkiewicz S., Loboda T., Much R., Nalborczyk E. 1998. Effect of differentiated nitrogen fertilization and the use of retarding upon gas exchange of the plants of winter triticale cv. Presto under conditions of hydro-thermal stress. 2nd Int. Conf. Ecophysiological Aspects of Plant Responses to Stress Factors. *Acta Physiol. Plantar.* 20, 60

Acknowledgement

This work was funded by Grant of Polish Ministry of Science and Higher Education N310014 31/123

A model-based evaluation of the representativeness of multi-environment trials used for sunflower variety assessment in France

Debaeke, Philippe¹; Barbet-Massin, Claire²; Salvi, Frédéric³; Uyttewaal, Valérie⁴

¹INRA, FRANCE; ²EIP, FRANCE; ³CETIOM, FRANCE; ⁴GEVES, FRANCE

Introduction

The crop variety assessment process is commonly based on the analysis of multi-environment trials (METs). In France, a new cultivar is released after two years of field testing conducted by GEVES (in charge of official seed and variety testing) using METs. Then new sunflower cultivars are tested by CETIOM (the French technical center for oilseed crops) during one year over a wider area and with more trials (post-registration). However, this 3-yr process often results in (i) a poor sampling of the soil-weather-management conditions over the growing area and (ii) a lack of environment characterization of the METs. We assumed that dynamic crop simulation models could improve the efficacy of this assessment. The SUNFLO crop model (Casadebaig et al., 2011) was developed to

simulate the response of sunflower genotypes to various environments and management options (sowing date, plant density, N-fertilization, irrigation).

The aim of this study was to compare the pre- and post- registration METs with farmer’s actual practices and environments using SUNFLO model in order to evaluate the representativeness of the on-going variety assessment design used for sunflower in France.

Material and Methods

The 2006 and 2009 data from CETIOM surveys (~1900 farmers) were submitted to multivariate analysis and classification method to produce a typology of crop management systems for the main regions of production

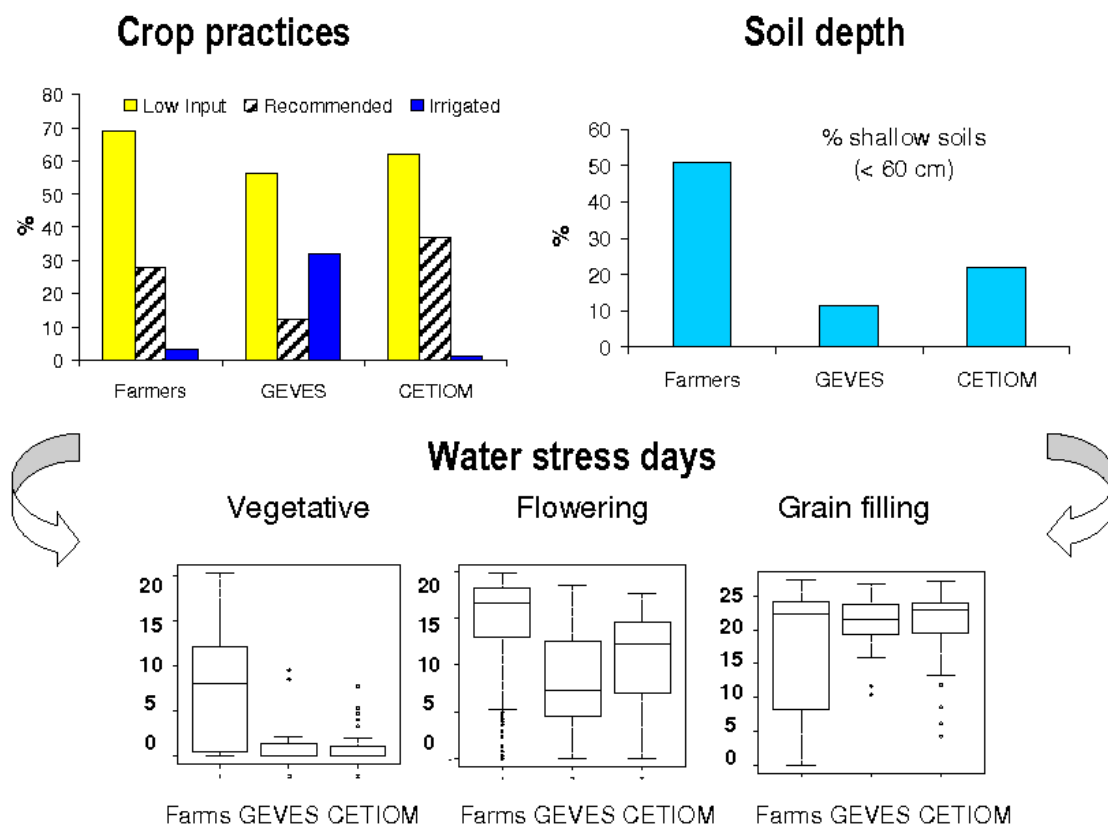

Fig. 1. Differences in distribution of crop practices and soil depths are responsible for different drought patterns between on-farm situations and variety assessment trials. WSD = number of days where ET/ETo < 0.6

in France. The INRA soil map (1/10⁶) was used to quantify the regional distribution of soils with available soil water content as the main discriminating variable. Only 16 climatic stations were kept to characterize the cropping area. The METs of CETIOM (96 trials) and GEVES (35 trials), set up in 2008 and 2009, were used to describe the practices, the environments, and the yield in variety trials. Then SUNFLO was run on the 3 networks for a standard variety using 2008-09 weather data. The numbers of water stress.days (WSD) were simulated for each growing period together with final grain yield.

Results

The farmer's practices were represented by 3 main types: 69 % of the farmers had low input management while 31 % followed technical recommendations (among them, only 3 % used irrigation). In GEVES, the 3 types represented 56 %, 12 % and 32 % of the trials; and 62 %, 37 % and 1 % for CETIOM. The three networks also differed by soil depth: 51 % of shallow soils for farms, but only 22 % for CETIOM and 11 % for GEVES.

Differences in soils, input levels and irrigation resulted in contrasting distributions of water stress patterns. Water stress before anthesis only occurred in farmer's situations and stress during anthesis was stronger. WSD during flowering was the lowest for GEVES as irrigation was

supplied in one-third of the environments. WSD during grain filling was the same in average on the 3 networks but the range of WSD values was extremely wide in farmer's fields. Total WSD averaged 45 days for farms (25 for GEVES and 30 for CETIOM). Consequently, simulated grain yield was 2.6 t.ha⁻¹ at farm level and 3.5 t.ha⁻¹ in variety trials.

Conclusions

Significant differences in crop practices, soils, and resulting stress patterns and yields between farms and trials were pointed out by this study. Water stress during flowering is one of the main factors explaining the yield differences between the networks which could be a bias for variety assessment. SUNFLO proved to be operational for the classification of drought stress environments in METs. Using this information, breeders, variety registration offices and technical institutes could improve the characterization of their METs and evaluate their representation of the target population of environments.

References

Casadebaig P. et al. 2011. SUNFLO, a model to simulate genotype-specific performance of sunflower crop in contrasting environments. *Agric. For. Met.* 151, 163-178.

Effect of tuber pre-planting treatments and humic preparation on tuber yield and quality

Eremeev, Viacheslav; Lääniste, Peeter; Tein, Berit; Lauk, Ruth; Alaru, Maarika
Estonian University of Life Sciences, ESTONIA

Introduction

Yield formation characteristics are greatly influenced by soil tillage, planting and harvesting techniques. These techniques are resulting in better growth, more stable yields and a much higher quality in terms of tuber-size distribution and physical tuber quality. The aim on this research was to study the effect of tuber pre-planting treatments and different HP quantities on the tuber yield and its quality.

Materials and methods

Field trials with the potato cv. 'Ants' (medium late) and 'Laura' (medium early) were carried out on the experimental fields of the Estonian University of Life Sciences. The soil of the experimental field was *Stagnic Luvisol*. The experiments were laid out in four replications. The humic preparation (HP) used in this experiment is a liquid extract from biohumus. *Factor A* (pre-planting treatment of seed tubers): T_0 (control), T_5 - thermal shock (seed tubers were kept before planting 5 days in a room with a temperature of 30°C) P_5 - pre-sprouting (seed tubers were kept before planting 26 days in a room with a temperature of 15°C and 10 days in a room with a temperature of 12°C). *Factor B* (humic preparation): HP_0 (control), HP_{25} and HP_{50} (the amount 25/50 l ha⁻¹ was sprayed on the surface of the soil before planting the tubers). Experimental data were analysed by Statistica 7.0 software (Anova, Fisher LSD test). The results are presented as the average of 2 years (2010-2011).

Results

Thermal treatments (TT) effect on cv. 'Ants'. Pre-planting with T_5 increased significantly the total tuber yield by 3.2 t ha⁻¹ compared with the control (T_0). The comparison of T_0 and P_5 effect on total yield or T_0 and T_5 effect on tuber marketable yields gave no statistically different results. T_5 increased statistically the number on tubers per plant but the average weight of tubers was significantly lower compared with the other two treatments. TT increased the tuber starch contents by an average of one percent

compared with the T_0 treatment. TT had no statistical influence on tuber nitrate contents 71.2-78.2 mg kg⁻¹, because the tuber nitrate content depends on cultivar. *TT effect on cv. 'Laura'*. P_5 increased significantly total tuber yield 3.2 t ha⁻¹ and marketable yield 3.8 t ha⁻¹ compared with the T_0 . T_5 and P_5 increased the average weight of tubers by 6.5 grams but TT had no statistical influence on number of tubers per plant. T_5 decreased significantly the tuber starch content 0.4%. TT had no influence on tuber nitrate contents 21.2-28.9 mg kg⁻¹. *HP effect on cv. 'Ants'*. Both humic preparations, HP_{25} and HP_{50} , increased significantly tuber total yields 5.8-6.4 t ha⁻¹ and tuber marketable yields 5.2-6.9 t ha⁻¹ compared with the HP_0 . HP did not increase the number of tubers per plant but HP_{50} increased statistically the average weight of tubers by 7.8 grams compared with the HP_0 . HP_{25} and HP_{50} increased significantly the tuber starch contents by 0.6-0.7%. HP had no influence on tuber nitrate contents that varied from 69.0-80.0 mg kg⁻¹. *HP effect on cv. 'Laura'*. HP_{25} and HP_{50} increased statistically tuber total yields 4.5-4.9 t ha⁻¹ and tuber marketable yields 4.2-4.4 t ha⁻¹ compared with the HP_0 . HP_{25} increased significantly the number of tubers per plant by 2.3 tubers, but HP different treatments had no statistical influence on average weight of tubers or on tuber starch contents. HP_{25} decreased statistically tuber nitrate contents.

Conclusions

T_5 increased tuber starch content and the number of tubers per plant on cv. 'Ants', but the average tuber weight remained lower. TT increased the average weight of tubers on cv. 'Laura'. TT had no statistical effect on tuber nitrate contents because it is cultivar-dependant. Both HP treatments increased the total tuber yields, marketable yields and tuber starch content (only on cv. 'Ants'). Tuber nitrate contents decreased on cv. 'Laura' at HP_{25} .

Acknowledgements

This study has been supported by ETF grant number 8495.

Responsiveness of the number of fertile florets and grain setting to nitrogen in contrasting modern durum wheat cultivars

Ferrante, Ariel¹; Savin, Roxana¹; Slafer, Gustavo²

¹University of Lleida, SPAIN; ²University of Lleida. ICREA, Catalanian Institution for Research and Advanced Studies., SPAIN

Introduction

As yield is linearly related to grain number per m², understanding the mechanisms controlling grain number determination may be relevant. As wheat is a cleistogamous species there is frequently a closed relationship between the number of fertile florets and grains. However, there is genetic variation in grain number determination due to differences in either spike growth during pre-anthesis or in fruiting efficiency (Pedro et al., 2011). It is not known to what degree these differences are associated with differences in number of fertile florets produced or to the likelihood of such florets to produce a grain in contrasting environmental conditions, particularly nitrogen (N) availability (which affect floret survival and number of fertile florets; Ferrante et al., 2010). We aimed to analyse genotypic variability within modern well adapted durum wheats and the effect of N on the number of fertile florets and the likelihood of grain setting in different spikelet positions.

Methodology

Experiments in micro-crops in large rectangular containers (1 m height and 1 x 1 m², filled with a sand:soil mix) were carried out at Lleida, Spain, during 2008-09 and 2009-10. Treatments in Exp. 1 were of four

cultivars (Claudio, Donduro, Simeto and Vitron) and two contrasting N availabilities (50 and 250 kg N ha⁻¹); while in Exp. 2 they were the two most contrasting cultivars for spike fertility response to N (Donduro and Vitron), the same two levels of N and two water conditions (IR, irrigated and RF, rainfed). Floret primordia were considered as in Ferrante et al. (2010). At maturity, in all spikelets on one side of the spikes the grains were counted and then weighed individually.

Results

In 2008-09, the number of fertile florets per spikelet at anthesis and/or the percentage of grain setting were increased by N fertilisation in all cultivars and spikelet positions (Fig. 1 exemplified for central spikelets). The increase in grain number did directly reflect the effect of N on the number of fertile florets in Claudio and Vitron while in Donduro it was mainly through increasing the percentage of grain setting and in Simeto the effect was due to both attributes (Fig. 1; left panel). In 2009-10 the overall pattern of response was largely consistent with 2008-09 (Fig. 1; right panel).

The likelihood of a fertile floret to set a grain in different spikelet positions varied depending on the cultivar, N and grain position (Fig. 2). Regardless of N availability,

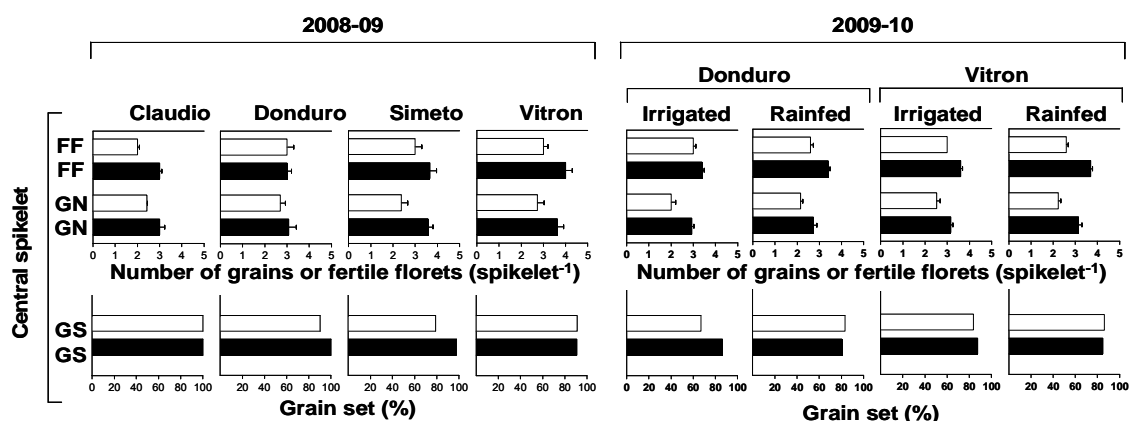

Figure 1. Number of fertile florets at anthesis (FF), number of grains at maturity (GN) and percentage of grain set (GS) in the central spikelets categories during 2008-09 (left panel) and 2009-10 (right panel). Closed and open bars correspond to high (N250) and low (N50) N availabilities, respectively.

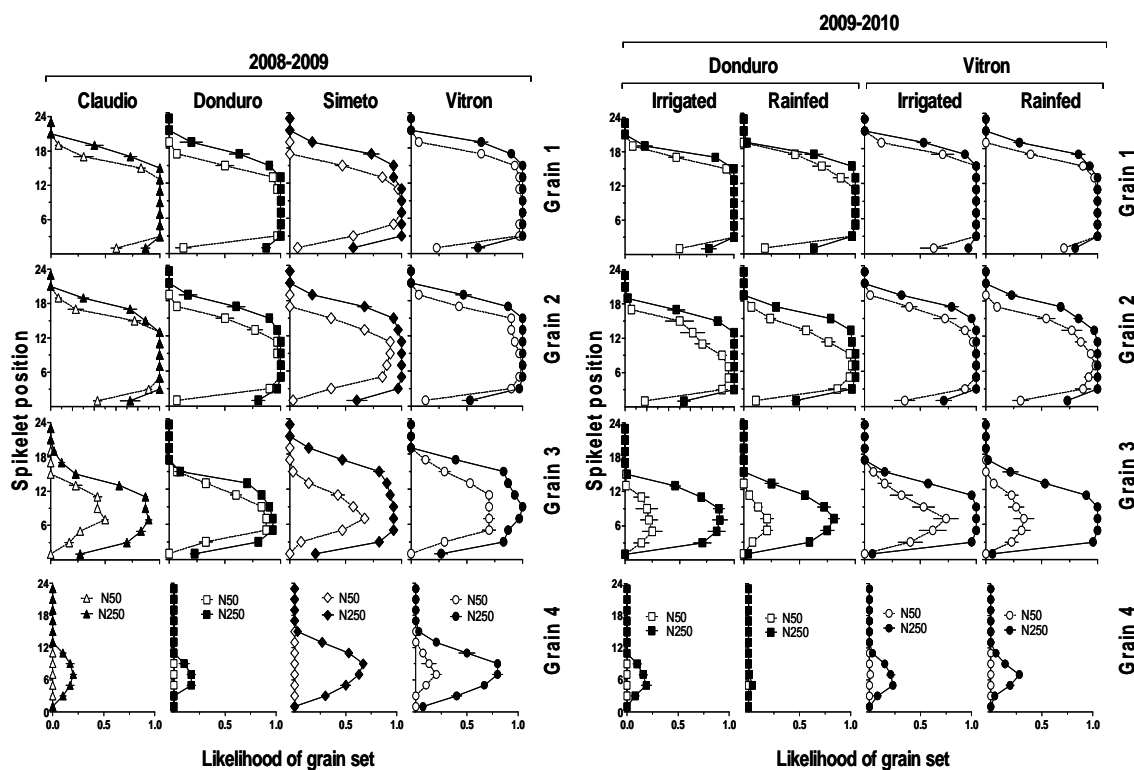

Figure 2. Likelihood of particular fertile florets (grains 1-4, from top to bottom rows of panels) to set a grain at each spikelet position (from spikelet 1, at the base of the spike, to the uppermost spikelet) for each cultivar x nitrogen treatment (left panel; exp. 1) or each cultivar x nitrogen and water availability (right panel; exp. 2). Closed and open symbols correspond to high (N250) and low (N50) nitrogen availabilities, respectively.

the two most proximal florets always set a grain in most spikelets and the effect of N fertilisation was restricted to extreme spikelet positions (Fig. 2). For distal positions, in which grains were occasionally set, there were clear increases in the likelihood of a floret to set a grain in most spikelets in response to N (Fig. 2). Only the cultivar Vitron occasionally set a fourth grain in N50, though with an extremely low likelihood (Fig. 2; left panel).

Discussion

Responsiveness to N seemed to have differed among cultivars. As spike growth was increased by increased N in all the cultivars, we speculate that the increased spike growth may result in an increased number of fertile florets or in having larger florets which would increase their likelihood of setting a grain (and likely producing compensation in potential grain size –due to heavier florets– for the reduced grain number). In this study we found that responses to N fertilisation were not restricted to the increase in the number of fertile florets but also increased the likelihood of these florets to set a grain, the relevance of each of these mechanisms depended upon the cultivar.

References

- Ferrante A, Savin R, Slafer GA. 2010. Floret development of durum wheat in response to nitrogen availability. *Journal of Experimental Botany* 61, 4351-4359.
- Pedro A, Savin R, Habash DZ, Slafer GA. 2011. Physiological attributes associated with yield and stability in selected lines of a durum wheat population. *Euphytica* 180, 195-208.

Overcoming yield barriers in maize through two novel selection equations: I. recombination of genes within a hybrid

Vasileios Greveniotis¹, Vasilias Fasoula², Ioannis Papadopoulos³, Penelope Bebeli⁴, Ioannis Tokatlidis¹

¹Democritus University of Thrace, Department of Agricultural Development, Pantazidou 193, 68200 Orestiada, Greece

²Center for Applied Genetic Technologies, Univ. of Georgia, 111 Riverbend Road, Athens, GA 30602, USA

³Technological Education Institute of W. Macedonia, Florina, 53100, Greece

⁴Agricultural University of Athens, Department of Crop Science, Iera Odos 75, 11855 Votanikos, Greece

Introduction

Plant yield potential of maize hybrids remained stagnant for the last quarter of the 20th century (Duvick, 2005), possibly because of the high productivity gap (40 to 50%) between inbred lines and hybrids. Fasoula and Fasoula (2005) suggested that the yield barriers in maize could be overcome if the productivity gap between inbreds and hybrids is reduced to zero. To test this hypothesis, two selection equations (Fasoula & Tokatlidis, 2012) were employed in order to identify the favourable recombination of genes in a particular hybrid; equation A (EqA) assesses the relative yield potential of individual plants and equation B (EqB) the relative yield potential of entries/lines, enabling the breeder to apply single-plant selection based on eqA within lines identified through eqB. Each equation consists of two parameters; the first measures the plant yield potential in eqA and entry yield potential in eqB, respectively, while the second estimates the entry's stability of performance and is common in both equations. Evaluation according to eqA and eqB is reliable only when individual plants and entries are assessed in the absence of the confounding effects of competition and soil heterogeneity, which is achieved through the honeycomb selection designs (Fasoulas & Fasoula, 1995) that enable the application of extreme selection pressures (1 to 0.5%).

Materials and methods

The two equations were applied at the ultra-low density of 0.74 plants/m² under open pollination conditions that result in the creation of half-sib lines (HS). The source material was the F₂ (HS₀) of the commercial maize hybrid Costanza and breeding was performed from the HS₀ to the HS₄ in two contrasting locations to identify superior HS lines.

Results

The best HS₄ breeding lines in either location lagged behind Costanza in crop yield potential by a gap of only 5.4% and 6.7%, respectively. It is notable that the best line in Location I was among the bottom lines in Location II and vice versa, suggesting that the two locations, contrasting in soil and climate, may be exploited by different sets of genes. Hybrids between such high-yielding and contrasting in adaptability lines might outperform current hybrids in crop yield potential. This perspective would also result in hybrid seed of drastically reduced cost. The successful exploitation of additive genetic action in the HS lines is shown by the reduction of the gap between the HS lines and hybrid for relative crop yield potential (Fig. 1), from 87% in HS₀ to 6% in HS₄ at Location 1 and to 5% in Location II. The respective

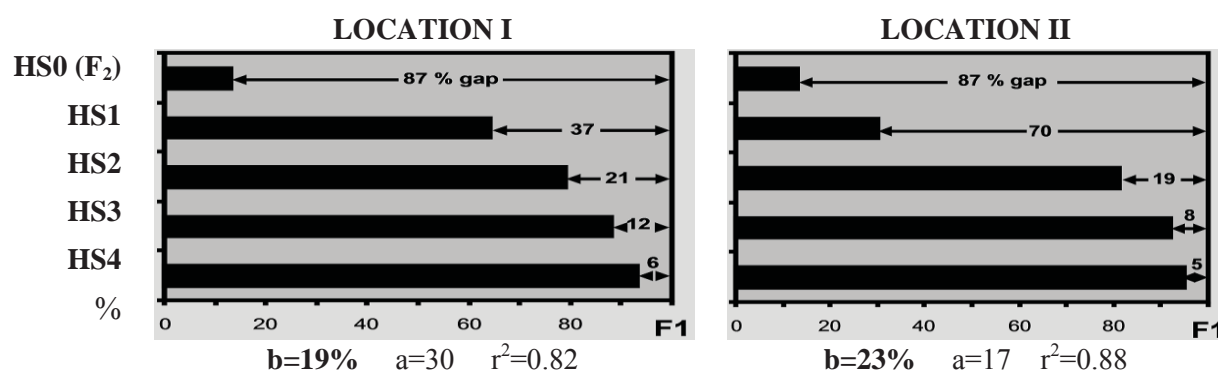

Fig. 1. The annual % genetic gain (b values), and the reduction of the gap between the best on the basis of Eq. B line, and the hybrid Costanza for relative crop yield potential.

genetic gain per annum was 19 and 23%. Moreover, the two top HS lines scored high for the second component of eqA and eqB, implying that the performance of the HS lines approximated that of the hybrid. This fact, together with the remarkably reduced anthesis-to-silking interval recorded for those lines, and taking into account the wide interplant distance used, points towards their genetic homogeneity.

Conclusion

Single-plant selection in the absence of competition based on the application of the two equations described could facilitate the reduction of the productivity gap between inbred lines and hybrids in maize. In order to overcome the crop yield barriers in maize hybrids, the improvement of the crop yield potential of inbreds should precede that of the hybrids (see also Tzantarmas et al., this congress).

Acknowledgement

Work co-financed by the European Union and Greek funds. Research Funding Program: Heracleitus II.

References

- Duvick DN (2005). *Adv Agron*, 86:83–145.
Fasoula DA, Fasoula VA (2005). *Maydica*, 50:49–61.
Fasoulas AC, Fasoula VA (1995). *Plant Breed Rev*, 13:87–139.
Fasoula VA, Tokatlidis IS (2012). *Agron Sustain Dev*, 32:161–180

Yield increase and the gap between actual and potential yield of cereals in Poland

Tadeusz Oleksiak

Plant Breeding and Acclimatization Institute, 05-870 Błonie, Poland

Introduction

Agricultural land use in Poland has declined about 19% over the last five decades but it did not result in reduction of harvests. At the same time, mainly due to improved technology, yields increased considerably. The growth rate of yields in the trials significantly exceeded the increase in production fields. As a result we have a bigger and bigger yield gap, defining as the difference between the yields obtained under optimum technology level in post-registration variety trials and yields obtained in farmer fields (Neumann 2010). The aim of this study was to evaluate grain yield rate and identify the factors determining the growth and its utilization.

Materials and methods

The paper presents changes in the yield of cereals within the years 1966-2010. The study is based on the variety trials results and those received from cultivation under production conditions. We used the official statistics as well as own survey data collected directly from farms. The evaluation of the effects of breeding progress was done by modified method proposed by Feyerherm (1989). Differential yielding ability [DYA] computed from differences between cultivars and long term checks were calculated for particular varieties and in the next step, taking into consideration varietal production structure, for particular years. Differences between DYA values in trials and in production for successive years were used as a measure of yield increase; theoretical and practical (Krzymuski 1997).

Table 1 Yield increase of main cereal species and effects of breeding progress in Poland

Species	1966-2010			1991-2010		
	Rate of yields increase	Effects of breeding progress	Share of breeding progress in yield increase	Rate of yields increase	Effects of breeding progress	Share of breeding progress in yield increase
	kg/year	kg/year	%	kg/year	kg/year	%
Winter wheat	114	40	34,9	71,6	61,7	86,2
Spring wheat	71,7	23,6	32,9	13,9	14,3	100
Winter barley	111,9	35,6	31,8	53,4	56,2	100
Spring barley	67,5	28,3	41,9	40,3	21,2	52,8
Rye	89,5	15,5	17,3	59,6	24,6	42,1
Oats	71,1	17,5	24,6	36,7	12,4	33,9
Cereals average *	93,9	26,9	28,6	61,2	39,7	64,9

*) – weighted by share in production

Results and discussion

Table 1 Yield increase of main cereal species and effects of breeding progress in Poland.

Advances in technology associated with improved crop management has resulted in an increase of the yield obtained by farmers. The importance of breeding as the yield growth factor has increased significantly. Large increase of yield potential of cereal has been due to breeding progress (Table 1). The average share of breeding progress in increasing grain yields over whole tested period amounted to 28.6% and in the last 20 years 64.9%. During the last two decades the yield growth rate dropped considerably. So, it is very important to be defined properly and used, still existing opportunity of growth.

References

- Feyerherm A. M., Kemp K. E., Paulsen G. M. 1989 Genetic contribution to increased wheat yields in the USA between 1979 and 1984 *Agronomy Journal* 81: 242-245.
- Krzymuski J., Oleksiak T. 1995. Breeding progress in small grain in Poland and its utilization in production. *Fragmenta Agronomica* XII Nr 2 (46): 74-75.
- Krzymuski J., Oleksiak T., Krzeczowska A. 1997 Methods of biological progress estimation. *Advances in Biometrical Genetics. Proceedings of the Tenth Meeting of the EUCARPIA Section Biometrics in Plant Breeding.*
- Neumann K., Verburgh P.H., Stehfest E., Muller C. 2010 The yield gap of global grain production: A spatial analysis. *Agricultural Systems* 103 316-326.

Overcoming yield barriers in maize through two novel selection equations: II. recombination of genes across hybrids

Constantinos Tzantarmas¹, Metaxia Koutsika-Sotiriou², Athanasios Tsaftaris², Evangelia Sinapidou¹, Vasilios Greveniotis¹, Ioannis Tokatlidis¹

¹Democritus University of Thrace, Department of Agricultural Development, Pantazidou 193, 68200 Orestiada, Greece

²Department of Genetics and Plant Breeding, Aristotelian Univ. of Thessaloniki, 54124, Greece

Introduction

The cause of stagnation of plant yield potential for the last quarter of the 20th century in maize (Duvick, 2005) might be the productivity gap between inbred lines and hybrids. Bridging this gap could overcome the yield barriers (Fasoula and Fasoula, 2005). To address this hypothesis, two novel selection equations evaluating the individual plants under a very low density (i.e., without competition) were suggested by Fasoula and Tokatlidis (2012) (see also Greveniotis et al., this congress). These equations were used to apply selection and identify favourable gene recombination within half-sib (HS) lines originating from three hybrids. The hypothesis was that high-quality genetic material is fundamental in order to develop varieties displaying high crop yield potential.

Materials and methods

Experimentation was consistently conducted according to the honeycomb layout model (Fasoulas and Fasoula, 1995). First, seven commercially cultivated hybrids in Greece were evaluated and on the basis of equation B the three top relative values were 100% for PR1132 (ELE), 96% for PR31G98 (G98) and 51% for PR33A46 (A46). Then, based on equation A, single-plant selection was applied within the F₂s, as well as within double-cross hybrids of the aforementioned hybrids under open-pollination conditions, and at the very low plant density of 0.74 plants/m² to ensure absence of competition. The procedure led to HS1 and HS2 lines tested versus the control hybrid, i.e. ELE, for the Equation B values.

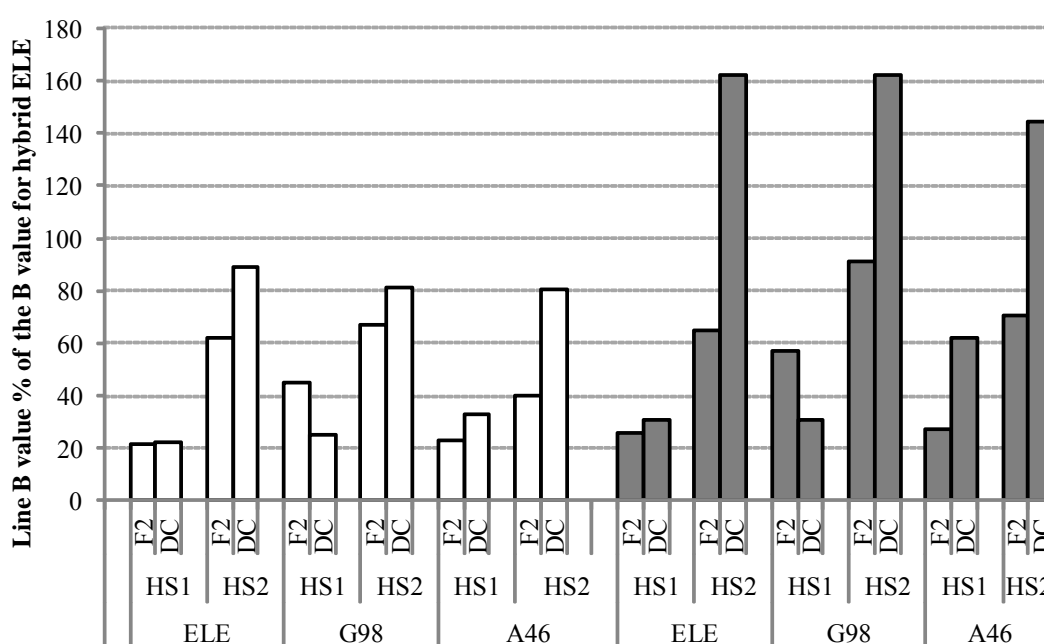

Fig. 1. The relative for B value performance of the HS1 and HS2 sister lines originated either from the F₂ or the double crosses (DC) of hybrids ELE, G98 and A46 (white columns for average line values and dark columns for the best line values).

Results

Evaluation in relation to the control hybrid revealed the following (Fig. 1). The HS1 and HS2 lines originating from the F₂ of ELE displayed relative crop yield (Equation B) values of 21% and 62% respectively, while the Equation B values of the respective lines of the double ELEX- crosses were 22% and 89%; the equivalent values for G98 were 45% and 67% for the F₂ and 25% and 81% for the double hybrids, while for A46 they were 23% and 40% for the F₂ and 33% and 80% for the double hybrids. The best performing HS2 lines of both the ELEX-, and G98x- crosses had Equation B values of 162%, while that originating from the A46x- crosses 145% relative to the control. Comparing the F₂s with the double crosses: (1) the greatest progress through selection was obtained in the first generation (HS1) of the F₂ in G98, which could be justified by the higher genetic variability in the crosses; (2) in contrast, in ELE and A46 higher response to selection was obtained in the double crosses, which highlights the effectiveness of the selection methodology from an early generation even within widened genetic pools; (3) in the second generation (HS2), the double crosses showed greater progress, which is an indication of favourable gene recombination. Additionally, (4) the fact that individual HS2 lines were identified within all three hybrids that outperformed the control is encouraging towards the prospect of bridging the productivity gap between hybrids and lines in. Finally, (5) the genetic background of the source material seems to be of particular importance, since the F₂ of A46 that had been initially found to have the lowest Equation B value among the three hybrids, produced HS2 lines also inferior to the respective ones of ELE and G98.

Conclusion

The results open the possibility of rapid bridging of the line-hybrid productivity gap through the strategy of recombining genes from elite hybrids on the basis of equations A and B in the absence of competition and improving yield potential and genetic buffering at the individual plant level.

References

- Duvick DN (2005). *Adv Agron*, 86:83–145.
- Fasoula DA, Fasoula VA (2005). *Maydica*, 50:49–61.
- Fasoulas AC, Fasoula VA (1995). *Plant Breed Rev*, 13: 87–139.
- Fasoula VA, Tokatlidis IS (2012). *Agron Sustain Dev*, 32:161-180.

Combined effect of water stress and *Macrosiphum euphorbiae* infestation on plant growth in tomato

Rivelli, Anna Rita; Toma, Irene; Trotta, Vincenzo; Fanti, Paolo; De Maria, Susanna; Battaglia, Donatella
University of Basilicata, ITALY

Introduction

Tomato is an economically valuable crop grown in open field and in greenhouse. Abiotic (water availability, fertilizers) and biotic (pests and diseases) factors may both affect tomato growth and yield. Most of tomato production areas are located in hot and dry climates (i.e. Mediterranean) where water stress is rather frequent. Tomato is classified as sensitive or moderately tolerant to water stress depending on cultivars, phenological stage in which the deficit occurs (Patané et al., 2011) and severity of stress (Candido et al., 2000). Among tomato pests, the aphid *Macrosiphum euphorbiae* (Thomas) is well known for direct damage (Walgenbach, 1997) and virus transmission (Kennedy et al., 1962). The single effects of water stress (Van Ieperen et al., 2003) and aphid infestation (Walgenbach, 1997) on the growth, development and yield of tomato are fairly well known,

while information about their interaction is limited. This study address the interactions among water stress, aphid infestation and tomato cultivars.

Materials and methods

Potted plants of the cultivars Scintilla, Beefmaster, and Rio Grande were used in the experiment. Twenty apterous adults of the aphid *M. euphorbiae* were moved to each plant, allowed to reproduce for 24 hours and then removed. New born F1 nymphs and new emerging F1 adults were counted, then only apterous adults were left on the plant and allowed to reproduce. F2 first instars were numbered daily and removed. All plants were well watered until aphid infestation (A), after that water stress was applied. Treatments were as follows: well watered plants (WW); well watered plants infested by aphids (WW+A); water stressed plants (WS), water stressed

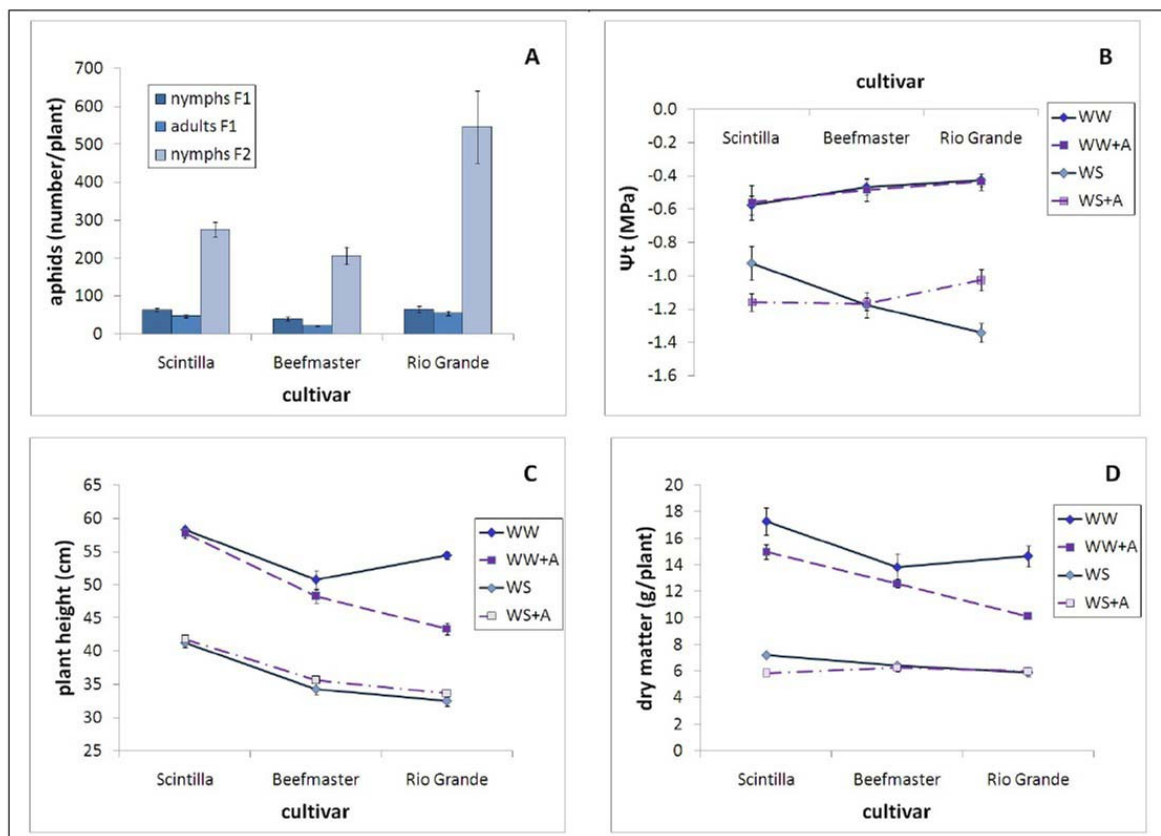

Fig. 1- Number of aphids (A), total leaf water potential (B), plant height (C) and dry matter (D) in relation to cultivars and water stress. Values are means ($n=3$) \pm s.e.; ww = well watered, ws = water stress, A = aphids.

	plant height				dry matter			
	d.f.	Mean Sq.	F	P	d.f.	Mean Sq.	F	P
Cv	2	271.7	110.9	1.5·10 ⁻¹²	2	14.7	5.9	0.0082
WS	1	2201.2	898.6	2.2·10 ⁻¹⁶	1	525.4	211.2	2.2·10 ⁻¹³
A	1	30.8	12.6	0.0017	1	22.3	9.0	0.0063
Ht₀	1	191.2	78.1	7.5·10 ⁻⁹	-	-	-	-
Cv × WS	2	5.5	2.2	0.1286	2	9.1	3.6	0.0413
A × WS	1	38.6	15.8	0.0006	1	11.1	4.5	0.0449
Cv × A	2	0.5	0.2	0.8240	2	1.9	0.7	0.4845
Cv × WS × A	2	2.2	0.9	0.4241	2	3.3	1.3	0.2828
residuals	23	2.5			24	2.5		

Tab.1- Full factorial analysis of variance of plant height and dry matter: Cv = Cultivar; WS = Water Stress, A = aphids; Ht₀= plant height at the beginning of the experiment.

plants infested by aphids (WS+A). Insect data were analyzed by applying the ANOVA (full factorial model including "cultivar" and "stress" as main fixed effects). F₁ nymphs were used as covariate for F₁ adults and F₁ wingless adults were used as covariate for F₂ nymphs. Plant data were analyzed by applying a full factorial model of ANOVA, including the presence of aphids besides "cultivar", and "stress" as main fixed effects. Plant height measured at infestation time was used as covariate for the analysis of final plant height.

Results

Aphids number significantly varied with cultivars (Fig. 1A) (F₁ adults: F_{2,11} = 19.2, P<0.001; F₂ nymphs: F_{2,11}= 6.3; P<0.05), whereas it wasn't significantly affected by water stress (Figure 1). Plant growth parameters (plant height and dry matter) were negatively affected by both water stress and aphid infestation (Tab.1). Nevertheless, when aphid infestation and water stress occurred together, water stress had the highest impact (Fig. 1 C and D).

Conclusions

Both water stress and aphid infestation reduced plant growth and their effect was not additive. On the contrary of what expected, damage caused by aphids didn't increase in stressed plants. In fact, water stress was the most important factor in relation to plant growth, at least at the level of stress imposed in this experiment. Results could change at milder stress conditions.

References

- Candido, V., Miccolis, V., Perniola, M., Rivelli, A.R., 2000. Water use, water use efficiency and yield response of "long time storage" tomato (*Lycopersicon esculentum* Mill.). Acta Hort. 537, 789-797.
- Kennedy, J. S., Day, M. F., Eastop, V. F., 1962. A conspectus of aphids as vectors of plant viruses. Commonwealth Agricultural Bureaux, London, United Kingdom.
- Patanè, C., Cosentino, S.L., 2010. Effects of soil water deficit on yield and quality of processing tomato under a Mediterranean climate. Agric Water Manage. 97, 131-138.
- Van Ieperen, W., Volkov, V. S., Van Meeteren, U., 2003. Distribution of xylem hydraulic resistance in fruiting truss of tomato influenced by water stress. J. Exp. Bot. 54 (381), 317-324.
- Walgenbach, J. F., 1997. Effect of potato aphid (Homoptera: Aphididae) on yield, quality, and economics of staked tomato production. J. Econ. Entomol. 90, 996-1004.

New indicators for multi pests and diseases assessment in Conventional, Organic and “in-Transition” vineyard systems

Delbac, Lionel¹; Thiéry, Denis¹; Smits, Nathalie²; Roudet, Jean¹; Mérot, Anne²; Wéry, Jacques²; Fermaud, Marc¹

¹INRA, FRANCE; ²INRA SupAgro, FRANCE

Introduction

The number of French wine farms converting to Organic Farming (OF) from conventional viticulture is growing rather quickly. Thus, a process of identification, description and evaluation of indicators to manage the transition towards OF or integrated farming systems has been developed by INRA (Merot et al., Wery et al., this volume). Assessment indicators are needed to evaluate the system performance in relation to winegrower and stakeholder goals. Among them, pest pressure evaluation on the system is important in order to reduce pesticide use without an increased economic risk. This work presents the development of a new integrative assessment indicator to measure attack intensity and damage in grape clusters caused by major pests and pathogens.

Materials and methods

We used data from a network of 20 plots in Bordeaux and Languedoc French regions. We distinguished three winegrower categories: i) “Conventional” production method, ii) OF production for over 5 years: “Organic” and iii) “in-Transition” growers undergoing conversion to OF within the last 5 years. Plant health observations were realized in 2011 on grape clusters for downy mildew, powdery mildew, Botrytis bunch rot and grape berry moths. We determined the periods when the greatest intensity of these pests and diseases occurred and we

integrated these severities on clusters into a single index, namely Evaluation Index of Damage in Cluster (EIDC). To account for the EIDC values, we calculated the Treatment Frequency Index (TFI) (Butault et al., 2010) per pest and pathogen using the pesticide treatment schedules in each farm in 2011.

Results and discussion

The EIDC index in Organic farms was the highest, whereas the in-Transition EIDC index was the smallest (Figure 1a). In Conventional viticulture, powdery mildew damage was the most important compared with that by moths; the reverse was true in Organic. For in-Transition farms, damage by moth and Botrytis rot were predominant.

The TFI index in Organic farms was the lowest (Figure 1b). Conventional growers treated slightly more against downy mildew than against powdery mildew. However, in OF and in-Transition categories, control of powdery mildew was clearly the most important. Lastly, the in-Transition phase was also associated with the greatest TFI against moths.

The Organic farmers may have suffered setbacks in downy mildew protection and maintain now traditional schemes limiting risk-taking. By contrast, powdery mildew damage was more significant, except for in-

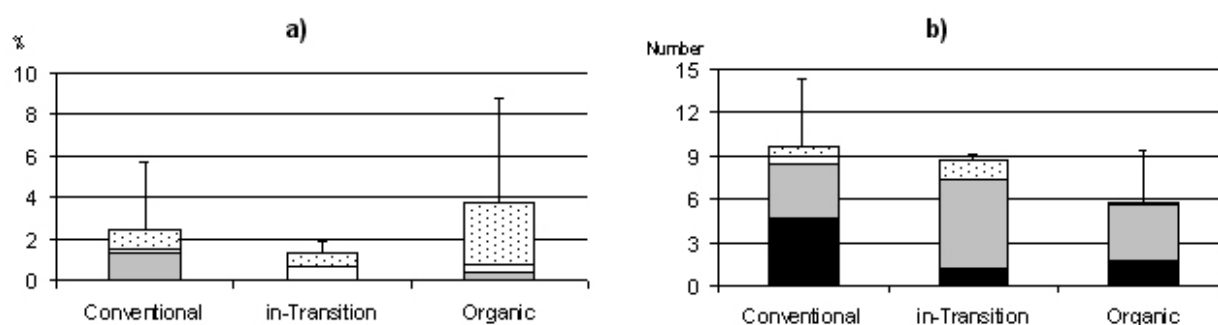

Figure 1 a) Evaluation Index of Damage in Cluster (EIDC) of downy mildew (black), powdery mildew (grey), Botrytis bunch rot (white) and grape berry moths (black spots) for each farm category; **b)** Treatment Frequency Index (TFI) for the same pests and diseases and farm categories.

Transition farms. In these farms, growers receive more supporting expertise and technical advice. Thus, the high in-Transition TFI against powdery mildew account for the lack of damage by this disease. For Botrytis bunch rot, in the quasi-absence of specific sprayings, the potential higher grapevine vigour may be hypothesized as a cause of increased disease intensity, notably in the in-Transition farms. Lastly, the in-Transition growers may be less reluctant to use insecticides against vine moths than Organic ones, thus limiting such damage.

Conclusions

Clear differences in damage levels due to the main pests and diseases (EIDC indicator) were shown according to

the viticulture category. The way of controlling these pests and diseases (TFI indicator) was also, as expected, very different. The in-Transition category is a learning phase involving try-errors strategy. This phase is associated with more security in pest control, particularly concerning powdery mildew. Another year of survey is needed to confirm these results. The Link between EIDC and yield will also be further investigated.

References

Butault et al., 2010. Synthèse du rapport d'étude Ecophyto R&D, MEEDDAT-MAP-INRA, 90 p.

The morphological features, weed infestation and yielding of selected winter rye varieties in organic farming system

Feledyn-Szewczyk, Beata

Institute of Soil Science and Plant Cultivation-State Research Institute, POLAND

Introduction

Weed management is one of the most significant problems facing organic arable production. The strategy of weed regulation in organic system is based on using direct and indirect methods such as crop rotation and choice of cultivars with bigger competitive ability against weeds. The results of other authors suggest that the competitiveness of cereals depends on overall shading ability, which is connected with the crop density, row width and the morphological features of varieties, such as height, tillering, early growth rate, leaf area and leaf angle. The aim of the research was the evaluation of the influence of morphological features and canopy parameters of four winter rye varieties on the competitiveness due to weeds and grain yield.

Material and Methods

The study was conducted in 2009 in the Experimental Station of Institute of Soil Science and Plant Cultivation – State Research Institute at Grabów (Warsaw voivodeship) [21°38 E, 51°23 N] on the field used in organic way since

2005. Four winter rye varieties were tested: Dańkowskie Diament, Caroa, Matador and Bojko. They were sown in the amount of 140 kg/ha, on the area of 0.4 ha each, in completely randomized blocks, in 4 replications. According to organic agriculture rules, any mineral fertilizers and chemicals were not used. Weeds were controlled in mechanical way, using a weeder two times: in autumn and spring, in tillering stage. The assessment of number of weeds and their dry matter in rye were carried out in tillering and dough stage. In the same stages the analysis of plant height, tillering, number of plants and crop dry matter were done. Moreover the grain yield of tested winter rye varieties and the weight of thousand grains were determined.

Results

The smallest number and dry matter of weeds was observed in Dańkowskie Diament (fig. 1). In this variety the highest density of plants per unit area was noted which could increase the competitiveness due to weeds (tab. 1). Low level of weed infestation was also observed in Matador canopy where the highest tillering and dry

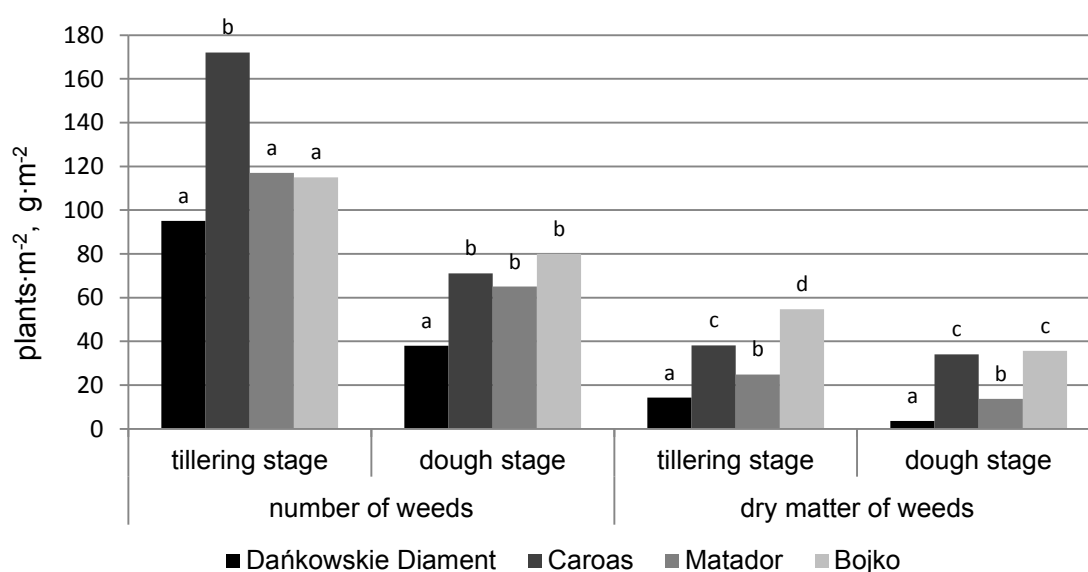

Fig. 1. Number of weeds and weed dry matter in winter rye varieties cultivated in organic system

Table 1. The growth parameters, structure of canopy and yielding of winter rye varieties cultivated in organic system

Parameters	Growth stage	varieties			
		Dańkowskie Diament	Caroas	Matador	Bojko
Tillering	tillering stage	5,7	5,8	6,0	5,3
Height (cm)	tillering stage	38,3	33,0	35,9	41,3
	dought stage	149	157	164	181
Dry matter of rye (g)	tillering stage	308	226	321	174
	dought stage	1038	1310	1392	1333
Number of plants per 1 m ²	tillering stage	300	211	261	191
Number of ears per 1 m ²	dought stage	405	417	460	303
The grain yield (t·ha ⁻¹)	after harvesting	5,4	5,0	5,4	3,8
The weight of thousand grains (g)	after harvesting	30,3	32,8	31,4	33,1

matter of rye were determined. Caroas and Bojko were characterized by the highest level of weed infestation, especially weed dry matter (about 35 g/m² in dough stage) and the smallest density of plants. Moreover Bojko had the smallest tillering and dry matter of rye but the biggest height. In all tested varieties number of weeds and their dry matter decreased during the vegetation season.

The grain yield was the biggest in Dańkowskie Diament and Matador (5,4 t·ha⁻¹) (tab.1). The smallest grain yield was noted in Bojko variety (3,8 t·ha⁻¹), probably because of the small density of plants and ears, but the weight of thousand grains was the highest. The weed infestation in all tested winter rye varieties was on the level that did not influence the grain yield.

Conclusions

- 1.The results showed that the competitive ability of winter rye depends firstly on plant density and later on morphological features of variety.
- 2.Dańkowskie Diament was characterized by the biggest density of plants per unit area and the largest competitiveness due to weeds.
- 3.The grain yield of winter rye cultivated in organic system was the biggest in Dańkowskie Diament and Matador.
4. Selecting of varieties for organic system both their yielding and morphological features should be taken into account.

References

- 1.Davies D. H. K., Hoad S., Boyd L. WECOF: A new project developing enhanced weed control through improved crop and plant architecture. In: Powell et al. (eds), UK Organic Research 2002: Proceedings of the COR Conference, 26-28th March 2002, Aberystwyth, pp. 299-302.
- 2.Seavers G. P., Wright K. J. 1999. Crop canopy development and structure influence weed suppression. *Weed Res.*, 39: 319-328.

Winter wheat cultivars and crop management systems: eight years of field experiment with integrated crop management

Félix, Irène¹; Rolland, Bernard²; Loyce, Chantal³; Omon, Bertrand⁴; Piaud, Sébastien⁵

¹ARVALIS-Institut du Végétal, FRANCE; ²INRA, FRANCE; ³AgroParisTech, FRANCE; ⁴Chambre d'Agriculture de l'Eure, FRANCE;

⁵Chambre d'Agriculture de Seine-et-Marne, FRANCE

Introduction

From 1999 to 2002, significant interactions between cultivars and crop management systems have been reported on a field experiment network in France, i.e. cultivars ranking differently according to crop management systems for a set of agronomic, economic and environmental indicators (Loyce, 2012).

Materials and methods

Following this work, a network of 189 field trials was set up by INRA, ARVALIS and the Chambers of Agriculture from 2003 to 2010 in the centre-west of France. These trials combined a set of cultivars and at least two Crop Management systems (CM) (table 1): CM2 a «conventional» crop management, designed to achieve high yield levels using decision support tools and local advices; and CM3, an integrated crop management based on low sowing density and lower and delayed nitrogen fertilization to reduce wheat susceptibility to diseases and lodging. Cultivars were chosen from those recently registered

on the French national list. Most of them are designated from «slightly susceptible» to «quite susceptible» to the main leaf diseases (Septoria leaf spot, brown and yellow rust). «Very susceptible» cultivars to these diseases were rarely included.

Results

Mean TFI (Treatment Frequency Index) values were 4 for CM2 and 2.5 for CM3, lower than those reported for French farmers practices in the studied regions (TFI=5). CM2 mean yield (8.5 t.ha⁻¹) was 0.8 t.ha⁻¹ higher than CM3 yield. With the market prices (grain and inputs) prevailing over the 8 years, economic performance (641 € ha⁻¹ for CM2 and 652 € ha⁻¹ for CM3 on the 2003-2010 period for the control cultivar Caphorn), yield variability and economic stability were similar for the two systems. Interactions between cultivars and systems for yield were found in only 37% of the trials in the network.

Disease and lodging intensities, observed on part of the trials (table 2), hardly differed between the two crop

Table 1 : simplified presentation of crop management systems ; the sowing date, phosphate and potassium fertilisation and weed control programmes are identical for the two systems.

	Crop Management	Sowing density	Nitrogen rate	Splitting of nitrogen	Growth regulators	Fungicide (4)
Reference	CM2	Local advice according to soil and sowing date	Balance method for a yield attainable 6 years in 10	3 applications	0 - 2 (2)	According to regional recommendations for a fairly susceptible to diseases cultivar (5)
Integrated protection	CM3	CM2 – 40 % (7)	CM2 – 30 N	2 applications : skip the one at tillering (1) ; a third of the total amount and at least 40 N at the last application around stem elongation	0 (3)	Programme targeted at (for ?) a quite resistant to diseases cultivar ; general case : a single intervention at the Stage of the final leaf unfurled (6)

(1) etc. refer to information given in the terms of the decision rules, enabling them to be adapted to different production contexts.

Table 2 : Effect of management systems on disease pressure – mean of trials which were scored – pairs of data correspond to observations made on one variety in one trial for each of the two management systems

	number of data pairs	number of trials	mean (1)		standard deviation	
			CM2	CM3	CM2	CM3
eyespot	57	15	11.6	13.7	15.8	19.7
yellow rust	202	14	0.0	1.0	0.2	5.0
brown rust	455	51	2.3	3.2	8.7	9.3
powdery mildew	119	15	4.2	4.0	12.1	10.9
septoria	616	79	8.7	12.5	14.0	17.1
fusarium	126	14	3.3	4.2	7.1	6.8
lodging	894	68	8.7	6.9	20.0	17.6

(1) eyespot : % of necrotic stem section (observation after stage Z71) ; leaf diseases : % of affected leaf area (mean of all observations for rusts and powdery mildew ; mean of observations after stage Z71 for septoria) ; Fusarium : % of affected spikelets; lodging : % of lodged area (mean of all observations)

management systems. Lodging was higher on CM2 than on CM3. For diseases, the highest difference was recorded for Septoria, with only 4% more leaf area necrosis in CM3 than in CM2. Differences in disease intensity were higher between cultivars than between crop management systems.

Discussion

These results illustrate the diseases and lodging control obtained in CM3 under the combined effect of reducing biomass and maintaining reduced fungicidal protection during the key period for canopy protection. They show how agronomic methods and cultivars can be used to complement fungicides with as much or even more efficiency.

In the areas where diseases are prevalent, it is nevertheless possible to offer some guidance concerning the choice of cultivars. For standard management systems (CM2), cultivars susceptible to lodging (and if possible, brown rust) should be avoided : problems arise, often inadequately controlled despite the objectives assigned to the management system. In CM3, cultivars slightly or moderately susceptible to Septoria and brown

rust and, only in high disease level areas, to yellow rust or Fusarium, have to be chosen. Thus, the priority criteria for breeding, from the point of view of susceptibility to diseases and lodging, evolve according to the growing conditions to which the cultivars will be subjected.

Research is carried further in order to find the most suitable genetic profiles for CM3, no longer for the threat of diseases which are finally under control, but for their adaptability to low-density, low-nitrogen stand in crop early life, these being critical for winter wheat integrated management.

References

Loyce C, Meynard J.M, Bouchard C, Rolland B, Lonnet P, Bataillon P, Bernicot M.H, Bonnefoy M, Charrier X, Debote B, Demarquet T, Duperrier B, Félix I, Heddadj D, Leblanc O, Leleu M, Mangin P, Méausoone M, Doussinault G, 2012. Growing winter wheat cultivars under different management intensities in France: a multicriteria assessment based on economic, energetic and environmental indicators. *Field crops research* 125, 167-178.

Using DEXiPM model to analyse performances of innovative cropping systems tested in multilocal trials

Fortino, Gabriele; Angevin, Frédérique; Berder, Julie; Valantin-Morison, Muriel; Pelzer, Elise; Messéan, Antoine
INRA, FRANCE

Introduction

In the design of innovative crop protection strategies, comparing the performances of widespread and alternative cropping systems is an important step for identifying bottlenecks and possible solutions. DEXiPM model allows the *ex ante* assessment of the sustainability of crop protection strategies and has been adapted to perform the *ex post* assessment using measurements carried out during field trials. In this paper we present how it has been used to compare current and Integrated Pest Management (IPM) strategies for winter oilseed rape (WOSR) and to perform a global analysis of multilocal trials (Valantin-Morison & Berder, in this book).

Methodology

In the framework of the French Picoblé project, workshops involving researchers and advisers have been organized in three areas of Northern France to define WOSR crop management systems (CMS) aiming at reducing the pesticide use. For each region a reference CMS has been selected for comparison with an IPM strategy. Both CMS have been implemented in a network of 19 farmers plots and data on the practices has been

collected. For each trial, the comparison has been carried out with DEXiPM, a multicriteria model allowing the evaluation of the sustainability of cropping systems (Pelzer et al., 2012). All the elements of the model are scored on a qualitative scale (e.g. *high, medium, low*) and model inputs are farming practices and context elements. This information is aggregated through successive steps into more complex indicators until the definition of economic, social and environmental sustainability. The model has been adapted in order to focus on a single CMS instead of a cropping system and to directly use as inputs measurements (yield) and calculated indicators (profitability, energy consumption) instead of determining some parameters through qualitative aggregation. To this purpose, quantitative thresholds have been set in order to adapt the qualitative scale to the local context.

Results and discussions

DEXiPM allowed highlighting significant differences in performances between current and integrated CMS. Indeed, the IPM systems obtained in most cases a higher value for at least one of the three sustainability indicators (fig.1).

site	ECONOMIC	SOCIAL	ENVIRONMENTAL	site	ECONOMIC	SOCIAL	ENVIRONMENTAL
Northern coast 1	=	↑	↑↑	Center-North 1	↑↑	=	=
Northern coast 2	=	↑	=	Center-North 2	=	↑	=
Northern coast 3	=	=	↑↑	Center-North 3	↑	↑	=
Northern coast 4	=	=	=	Center-North 4	↑	=	↑
Northern coast 5	=	=	=	Center-North 5	↑↑	=	=
Northern coast 6	=	=	↑↑↑	Center-North 6	↑	=	=
Northern coast 7	=	=	=	West 1	=	=	=
Northern coast 8	↑	=	↓	West 2	=	=	↑
Northern coast 9	=	=	=				
Northern coast 10	↑	=	=				
Northern coast 11	=	↑	↑↑				

Legend:

positive difference	no difference	negative difference
---------------------	---------------	---------------------

Figure 1. Global assessment results: differences in score between integrated and current CMS for economic, social and environmental sustainability. The number of arrows indicates the intensity of the difference in score.

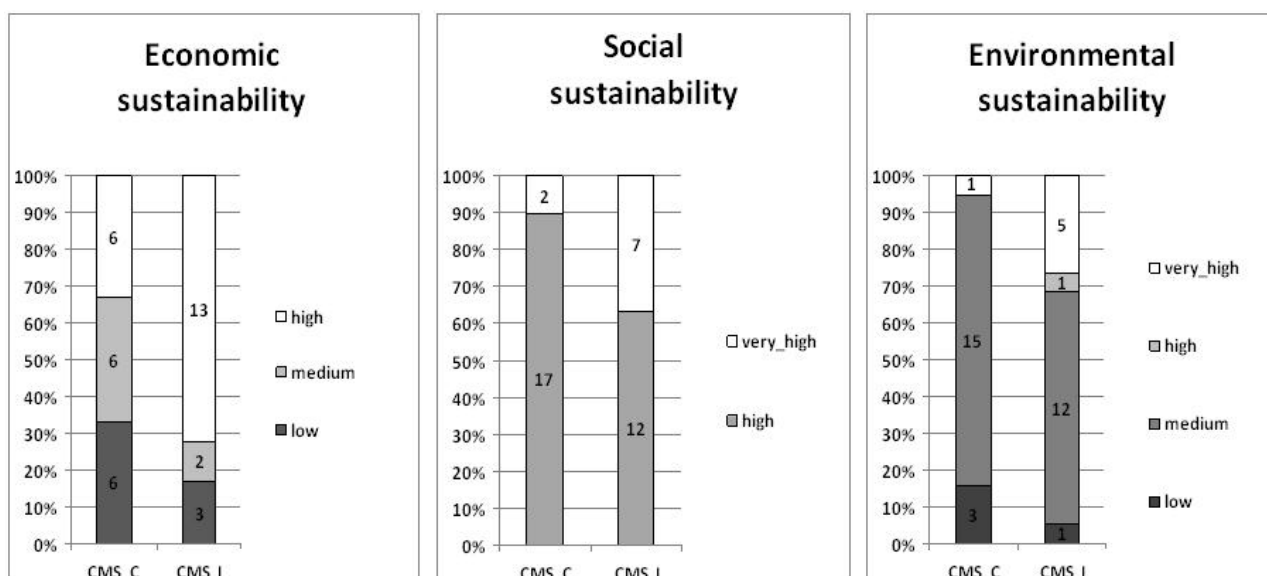

Figure 2. Proportion and number of trials per class for current (CMS_C) and integrated (CMS_I) crop management systems in the three sustainability pillars

The performances have been globally improved passing from current to integrated CMS (fig. 2). The number of CMS with a high value of economic sustainability increased from 6 to 13. The proportion of very high value CMS increased also from the social point of view. Nevertheless, considering the aim of the project, improvements of environmental sustainability are only partially satisfying as only in 6 trials the score is higher than medium.

Two possible reasons can explain this result. Firstly, the current CMS are characterized by a pesticide use already lower than the national average. Indeed, the farmers who tested the innovative cropping system were already engaged in pesticide use reduction. Secondly, in many cases, only one of the three components of the environmental sustainability (quality, resource use, biodiversity) has been improved, which is not sufficient to increase the aggregated value.

DEXiPM showed to be flexible enough to be adapted to the ex post assessment and to perform a global assessment

of CMS multilocal trials, taking into account the effects of the application of a strategy in different contexts. This case study showed also the importance of the definition of a reference CMS in order to fully appreciate the impact of the introduction of an alternative one. Furthermore, the integrated CMS could be (i) adjusted by aiming at improve all the environmental indicators and (ii) included in a crop rotation for assessing their effect at the cropping system scale.

Acknowledgements

This research has received funding from the European Community's Seventh Framework program (FP7/ 2007-2013) under the grant agreement n° FP7-265865 and by the French CASDAR project PICOBLE.

References

Pelzer E., Fortino G., Bockstaller et al. 2012. *Ecol indic*, 18, 171-182

Effects of chilling duration on seedling emergence of green foxtail, johnsongrass and velvetleaf: first year results

Loddo, Donato; Masin, Roberta; Zanin, Giuseppe

University of Padova, ITALY

Introduction

Cyclic variations of seed dormancy influence the range of environmental conditions suitable for germination (Batlla and Benech-Arnold 2004) and affect timing and magnitude of field emergence of weed seedlings. Improving the knowledge about environmental control of seed dormancy may allow to create more robust weed emergence model (Forcella et al 2000). Exposure to low temperatures (chilling) is a driving factor for dormancy release of summer annual weeds (Benech-Arnold et al 2000). Weed species may present different sensibility to chilling. Consequently, the exposure to similar periods of winter chilling may cause even contrasting effects in terms of magnitude and timing of seedling emergence for different weed species.

Materials and methods

Field experiments were conducted to analyze the effect of chilling duration on seedling emergence for green foxtail (*Setaria viridis*, SETVI), johnsongrass (*Sorghum halepense*, SORHA) and velvetleaf (*Abutilon theophrasti*, ABUTH). Weed seeds were collected in autumn 2008 from spontaneous populations in maize fields at Legnaro (northeastern Italy). Seeds were sown on three different dates to expose them to chilling treatments of different duration: 19th November 2008 (long chilling, treatment T1), 29th January 2009 (short chilling, treatment T2) and 3rd March 2009 (no-chilling, treatment T3). Emerged seedlings were counted and removed weekly. Emergence dynamic of each replicate was modeled using a logistic function from which the time of 50% relative emergence

(T50) was estimated. T50 was expressed as number of days after 1 January 2009. Factorial ANOVA ($P > 0.05$) was performed to analyze the effect of species, chilling treatment and their interaction on percentage of emerged seedling and T50. Post-hoc multiple comparisons were performed using Tukey HSD test ($P > 0.05$).

Results

Factorial ANOVA identified significant effects of species, chilling treatment and their interaction on emergence percentage and emergence T50. However, duration of chilling treatment influenced seedling emergence of the three species differently. Emergence percentage of velvetleaf was reduced by chilling period of long duration with significant differences among the three treatments. On the contrary, no differences were found for the emergence T50 values. Green foxtail and johnsongrass emergence was promoted by chilling. Green foxtail showed the most relevant response to chilling. Significant differences were identified among the three treatments for both percentage and T50 of emergence. Regarding johnsongrass, significant differences were detected only between the chilled (T1 and T2) and non-chilled (T3) treatments. Treatment T3 presented indeed significantly lower emergence percentage and later T50.

Conclusions

Velvetleaf seeds seem to have overcome their physical dormancy after few days of permanence in the soil, while prolonged chilling caused an increasing percentage of seed decay and death. Studying how chilling conditions

	ABUTH			SETVI			SORHA		
	T1	T2	T3	T1	T2	T3	T1	T2	T3
EMERGENCE %	35.7 c	50.3 b	63.0 a	59.3 a	49.3 b	20.7 c	35.3 a	41.3 a	17.0 b
EMERGENCE T50	91.1 a (02 Apr)	89.8 a (01 Apr)	91.2 a (02 Apr)	95.7 c (07 Apr)	111.9 b (23 Apr)	147.6 a (29 May)	101.9 a (13 Apr)	102.7 a (14 Apr)	115.8 b (27 Apr)

affect velvetleaf seed decay, and consequently magnitude of seedling emergence, could be therefore the central issue to improve emergence models for this species. Moreover, the findings indicate a greater sensibility and requirement of winter chilling for green foxtail than for johnsongrass. Anyway, considering the effect of winter chilling could be an appropriate improvement for emergence models for both species. However, further studies are required to replicate this experiment under different environmental conditions.

References

- Batlla D and Benech-Arnold RL 2004. Seed dormancy loss assessed by changes in population hydrotime parameters. Development of a predictive model. *Seed Sci. Res.* 14, 277-286
- Benech-Arnold RL, Sanchez R, Forcella F, Kruk BC and Ghera CM 2000. Environmental control of dormancy in weed seed banks in soil. *Field Crops Res.* 67, 105-122
- Forcella F, Benech-Arnold RL, Sanchez R and Ghera CM 2000. Modeling seedling emergence. *Field Crops Res.* 67, 123-139

Estimation of temperature thresholds of three weed species in maize in central-northern Italy

Gasparini, Valentina; Loddo, Donato; Masin, Roberta; Zanin, Giuseppe
University of Padova, ITALY

Introduction

Seedling emergence is a crucial step for an annual weed species and strongly influences crop-weed competition. The development of forecasting models to predicting seedling emergence seems to be a promising approach to improve control of weeds. The models are based on thermal or hydrothermal time, thus they quantify the effects of temperature and water potential on seed germination. The estimation of the temperature thresholds for seed germination is therefore the first main step for the construction of a emergence predictive model. The aim of this work was to assess the base temperature (T_b) for the germination of three weed species *Polygonum aviculare* L., *Polygonum lapathifolium* L., and *Solanum nigrum* L.

Materials and methods

Seeds of *P. aviculare* L., *P. lapathifolium* L. and *S. nigrum* L. were collected in autumn at the Experimental Farm of Padova University in Legnaro (N-E Italy). For T_b estimation, three replicates of 100 seeds for each species were incubated at alternating temperatures (12,5/5; 15/5; 17,5/7,5; 20/10; 22,5/12,5; 25/15; 27,5/17,5; 30/20; 32,5/22,5; 35/25 °C) and photoperiod of 12:12 h (light:dark), in plastic Petri dishes on filter paper moistened with 10 ml of deionized water. Germination was recorded daily until no further germination occurred for 10 days. The germination time course was analyzed using a logistic function as follows:

$$CG=100/(1+\exp(a \cdot (\ln(t+0,0000001)-\ln(b))))$$

where CG is the percentage of cumulated germination, t is the time (days), a represents the slope of the curve, and b the inflexion point. The time necessary for 50% of germination (b of the curve) was estimated. A linear regression, estimated

using the bootstrap method, provided the best fit of germination rate (reciprocal time to 50%) against incubation temperature (average value of night and day incubation temperatures). The T_b was estimated as the intercept of the regression line with the temperature axis.

Results

P. aviculare showed the lower base temperature, 2.0±0.98 °C (table 1). The low T_b of *P. aviculare* is confirmed by Batlla and Benech-Arnold (2003) who used a T_b of 0 °C to develop a thermal time model for this species in Buenos Aires area (Argentina). The T_b of *P. lapathifolium* resulted 4.7±0.49 °C (table 1), 1 °C lower than the value estimated by Gardarin et al. (2010) from a French population (5.8 °C). *S. nigrum* had T_b of 10±1.76 °C. The literature reports different values for this species: Guillemin et al. (2008) in the Dijon area (France) found a T_b of 11.5 °C, while T_b between 7.5°C and 10°C was found by Del Monte and Tarquis (1997) for three different seed lots of *S. nigrum*.

Table 1. Base temperatures estimated with the bootstrap method, variation interval (confidence level 95%), and coefficient of variation r².

Species	T _b (°C)	± var. interval	r ²
<i>Polygonum aviculare</i>	2.0	0.98	0.90
<i>Polygonum lapathifolium</i>	4.7	0.49	0.96
<i>Solanum nigrum</i>	10.0	1.76	0.84

Conclusions

The methodology of T_b estimation using germination test with alternating temperatures provided satisfactory results even with species characterized by seed dormancy. Thus, it may be adopted to improve the estimation of T_b for other dormant species which often reach low germination percentage at constant temperatures.

References

- Batlla D, Benech-Arnold RL (2003) A quantitative analysis of dormancy loss dynamics in *Polygonum aviculare* L. seeds: development of a thermal time model based on changes in seed population thermal parameters. *Seed Sci. Res.* 13: 55–68.
- Del Monte L.P., Tarquis A.M. (1997) The role of temperature in the seed germination of two species of the *Solanum nigrum* complex. *J. Exp. Bot.* 48 (12): 2087-2093.
- Gardarin A, Garuillemin JP, Munier-Jolain NM, Colbach N (2010) Estimation of key parameters for weed population dynamics models: Base temperature and base water potential for germination. *Eur. J. Agron.* 32: 162–168.
- Guillemin JP, Reibel C, Granger G (2008) Evaluation of base temperature of several weed species. 5th International weed science congress, IWSS, Vancouver, Canada.

Seed bank dynamics in crop rotations and temporary grasslands

Médiène, Safia¹; Decock, Simon²; Charrier, Xavier²

¹AgroParisTech, FRANCE; ²INRA, FRANCE

Introduction

Several studies showed important roles of temporary grasslands in agronomical issues by modifying weed community structure qualitatively and/or quantitatively of the emerged flora and seed bank (Bellinder *et al.*, 2004; Meiss *et al.* 2010). We hypothesized that this impact depends on weed community structure and dynamics in temporary grasslands. This study focuses on the impact of temporary grassland on weed flora considering more specifically seed bank. The results present initial weed seed bank abundance and diversity and after three years of crop rotation or grassland cover.

Materials and methods

Seed bank observations are realized in the long term experiment SOERE ACBB (Observatory and Experimental System for Environmental Research - Agroecosystems, Biogeochemical Cycles, and Biodiversity) initiated in 2005. Experimental design is composed of 4 blocks subdivided in 5 plots (0.4 ha). Five treatments are randomly applied per block. The treatments are differentiated by duration of grasslands from 0 (only crop rotation with maize/wheat/barley) to 20 years. The plant composition of grasslands is a mixture of *Lolium perenne*, *Festuca arundinacea* and *Dactylis glomerata*. Seed bank is measured every 3 years in three treatments (two with crop rotations and one with grassland cover). Soil seed bank was sampled in a square of 1 m² at six random locations in each plot. Five soil cores (6,8 cm diameter, 30 cm depth, one core per corner and one in the centre) were sampled in each location. Seeds were separated from soil to be placed in germination conditions. The emerging plants were identified and counted. Finally, the soil is removed and viable seeds remaining were identified and counted. Species richness (S), abundance (A), and diversity indexes, namely Shannon (H) and Pielou evenness (J) indexes, were computed from seed bank data at the location level. Abundance (number of seeds m⁻²) was calculated by adding up the total number of seeds per core and dividing by core surface. Non parametric analysis was performed for A, S, H and J distribution comparison between crop and grassland treatments (Wilcoxon test). Canonical discriminant analysis was used to represent seed bank composition changes in crop and grassland treatments.

Results

All variables significantly increased between 2005 and 2008 in both treatments (except for H and J in grasslands that remained stable) (Figure 1). The most important increase was observed for A and S in grasslands. A, S, H and J showed great variability in both crops and grasslands.

CDA indicated quite similar seed bank composition at the beginning of the experiment (Figure 2). Then, it seemed to differ in crop and grassland treatments. Changes were due to several species: *Capsella bursa-pastoris*, *Veronica hederifolia*, *Polygonum aviculare* and *Trifolium sp.* in grasslands and *Solanum nigrum*, *Amaranthus sp.* and *Poa trivialis* in crops.

Discussion

Seed bank in our study presents higher abundances than in previous studies (Bellinder *et al.*, 2004) because our methodology allow to estimate both germinated and non germinated seeds. Grasslands do not prevent abundance increase as expected in our hypothesis. Diversity indexes are low, especially J due to the dominance of two species *Polygonum aviculare* and *Juncus bufonius*. Grassland duration (three years in our study) seems not to be sufficient to improve these variables. Nevertheless, seed bank composition changes between crops and grasslands due to the discrimination of particular species. Functional analysis is required to characterize and explain response of seed bank species to agroenvironmental conditions.

References

- Bellinder, R. R., Dillard, H. R., and Shah, D. A. (2004). Weed seedbank community responses to crop rotation schemes. *Crop protection* 23, 95-101.
- Meiss H., Médiène S., Waldhart R., Caneill J., Bretagnolle V., Reboud X., Munier-Jolain N. (2010). Perennial lucerne affects weed community trajectories in grain crop rotations. *Weed Research* 50, 331-340.

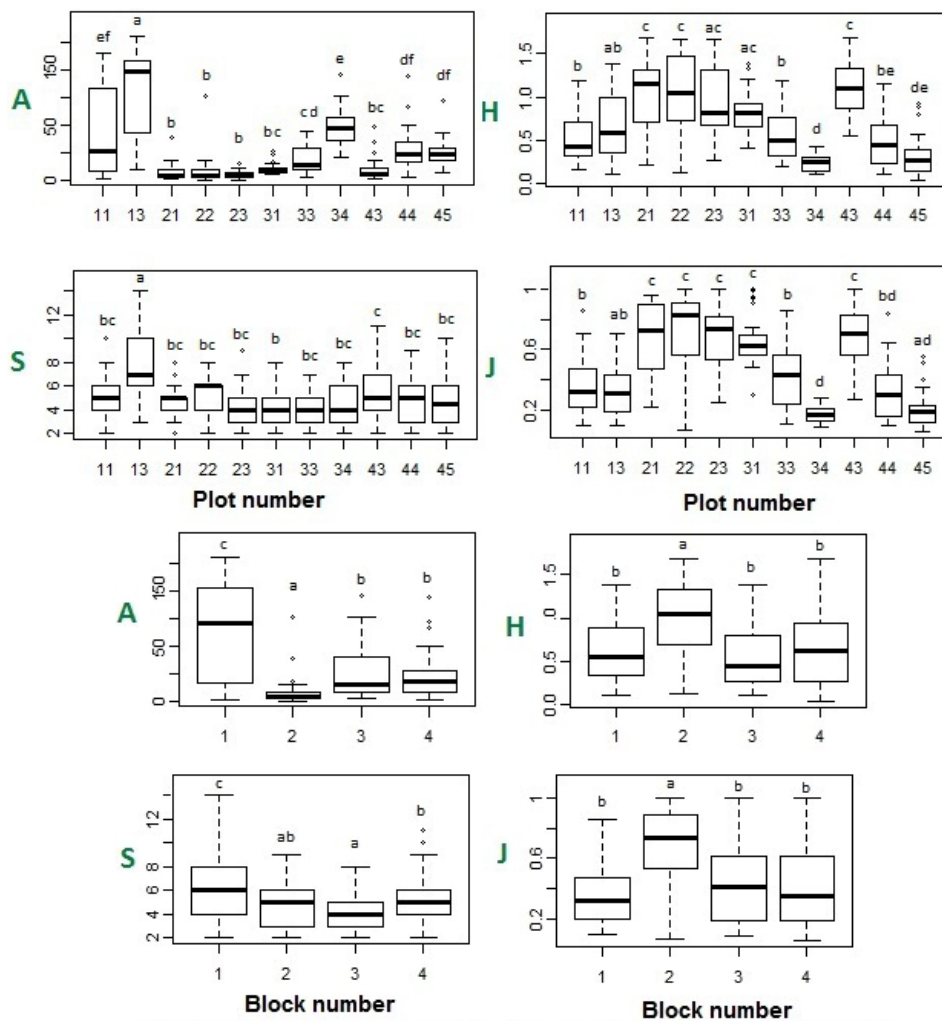

Figure 1 et 2 : Boxplots of total abundance of seed A (number of seed x 10³/m²), specific richness index S, diversity Shannon index H and evenness Pielou index J of the seed bank (2005). The input data for boxplot were calculated per core of soil. Within each index boxplot, the same lowercase letters are not different at the 5% probability level. Abscise label at plot scale is composed of 2 numbers (XX), respectively the block and the plot.

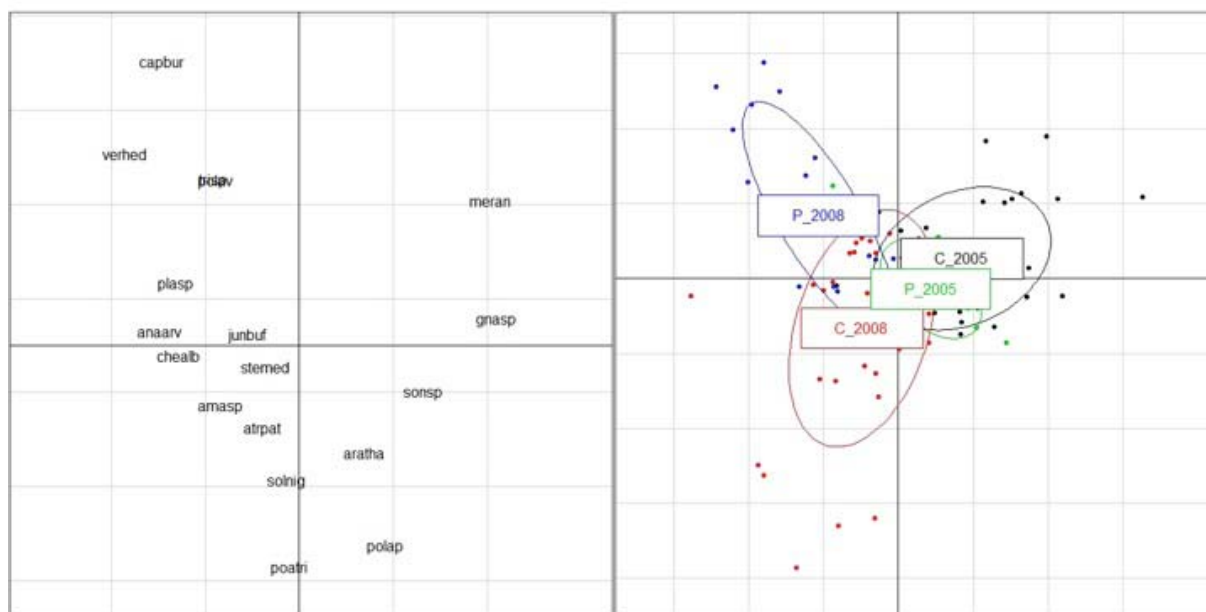

Figure 2: Canonical discriminant analysis of seed bank composition at the beginning of the experiment (2005) and three years later (in crop rotation: C_2008 and grassland: P_2008). Species are presented on the left and plot samples on the right. Eigenvalues are 55% for axis 1 and 29% for axis 2.

Improving stress tolerance of plants using beneficial bacteria

Meijer, Johan; Bejai, Sarosh; Johansson, Anna; Asari, Shashidar; Leelarasamee, Natthanon; Amein, Tahsein; Niazi, Adnan; Manzoor, Shahid; Bongcam-Rudloff, Erik
 Swedish University of Agricultural Sciences, SWEDEN

To support food safety and food security, durable solutions for crop protection and improved stress control are needed. Use of beneficial bacteria that support the plant is one strategy employed to achieve these goals. Certain microorganisms can promote plant growth (e.g. plant growth promoting bacteria, PGPB) and/or provide stress tolerance. Plant protection by beneficial microorganisms can be due to factors like competition with pathogens for space and nutrients, production of antibiotics or indirectly by priming of plant defence. Priming somehow precondition plants to respond more rapidly and strongly upon stress challenge. Primed plant defense to pathogens has been referred to as induced systemic resistance (ISR) and seems to depend on signaling by jasmonic acid and ethylene, but not salicylic acid in contrast to the classical SAR. Priming seems to be associated with a low fitness cost for the plant. We are exploring the use of *Bacillus amyloliquefaciens* strains to support crop production, mainly oilseed rape (*Brassica napus*) and wheat (*Triticum aestivum*), by making plants more resistant to abiotic and biotic stress. Earlier we have demonstrated protection of oilseed rape from fungal pathogens by beneficial bacteria (Danielsson et al. 2007), that *Bacillus* priming seems based on ISR (Sarosh et al. 2009) and also abiotic stress protection for wheat (Abd El-Daim et al., submitted). Earlier screens have reduced the number of control

bacteria to a set of genetically closely related *Bacillus* strains that show different stress protection properties. By using these strains we aim to gain a better understanding of their functional properties especially in combination with the model plant *Arabidopsis thaliana* because of its advanced molecular tool box. Several different steps are obviously needed to establish plant-bacterial interactions and we want to understand different stages ranging from chemotaxis to priming of stress tolerance. This includes studies of both plants and bacteria with respect to e.g. exudates, volatiles and effectors. Use of different plant genotypes provides information about plant properties that play a role for a beneficial interaction and may be used for breeding. Recently the genomes of several *Bacillus* strains were sequenced and are annotated to get more information about which genes that are present and may help to explain phenotypic differences. Future experiments include RNA sequencing analysis to study which genes that are expressed during different stages of plant-*Bacillus* interaction and also metagenomics analysis to study the effects of biocontrol agents on the soil microbiota. Ideally we should also be able to create mutants of biocontrol bacteria and plants to study gene function. The studies are supported by FORMAS, SI and HEC-Pakistan.

Effect of UK wheat cultivar, inoculation timing and anther extension on Fusarium head blight severity, DON concentration and yield under heat stress

Okereke, Victor; Gooding, Mike; Jones, Hannah

University of Reading, UNITED KINGDOM

Introduction

Fusarium head blight (FHB) caused by *F. graminearum* can significantly compromise both yield and quality due to contamination of grains with mycotoxins such as deoxynivalenol (DON) (Yoshida et al., 2007). There are conflicting reports as to the role of wheat anthers in FHB infection; some authors have indicated that anthers play a significant part in FHB infection (Pugh et al., 1933). With climate change scenarios, there is a need to understand the interactions between heat stress on FHB infection, mycotoxin production and flowering biology (Chakraborty and Newton, 2011).

Materials and methods

The design was a complete factorial combination of 8 cultivars, 9 inoculation treatments, 2 temperature regimes and 3 randomised replications. The cultivars (Alchemy, Claire, Gallant, Kingdom, Oakley, Soissons, Solstice and Xi19) were planted in 12.5 cm plastic pots on 28/01/2010. Plants were thinned to three plants per pot and male flowers assessed for anther extension at the start of flowering. Inoculation treatments used *E. graminearum* (5×10^5 spores/ml) isolated from maize.

Four of the treatments were Fusarium applied; to the ears at the start of anthesis (Zadoks GS 61); or four days later; or eight days later; or on all three occasions and control pots were sprayed with sterile distilled water (SDW) at the same timings. The other treatment was an unsprayed control, used for fine scoring of flower maturity. The 2 temperature regimes were achieved by transferring pots to cabinets set at either 23/15°C (ambient) or 28/20°C (hot) (day/night, 16 h day) seven days after spray treatment, for a duration of 14 days and FHB severity were assessed on a 1-9 scale.

Results

Cultivar differences in anther extension were associated with FHB susceptibility, with most anthers extended at 4 days after GS 61. This corresponds to the mid-anthesis and was the most effective spray timing for inducing FHB infection in most cultivars with Soissons and Oakley being the least and most susceptible cultivar respectively. Average FHB severity increased with the higher temperature. Except for Claire and Gallant, DON contamination exceeded the 1.25ppm DON European Union limit for bread wheat under the heat stress condition.

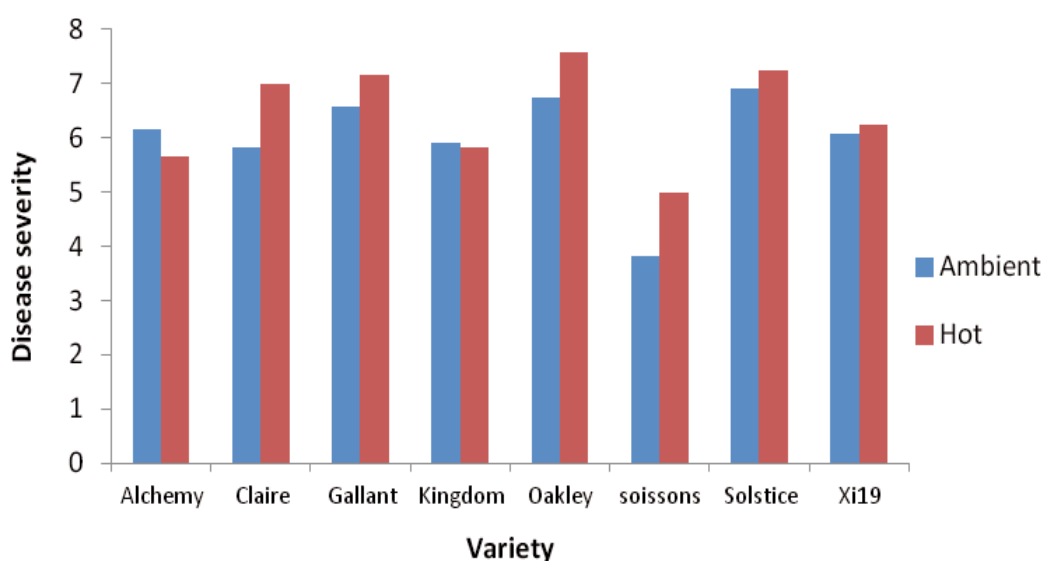

Fig. 1 Susceptibility of UK winter wheat varieties towards Fusarium Head blight incubated in growth cabinets at 23/15°C (ambient) and 28/20°C (hot) under 16 hour light.

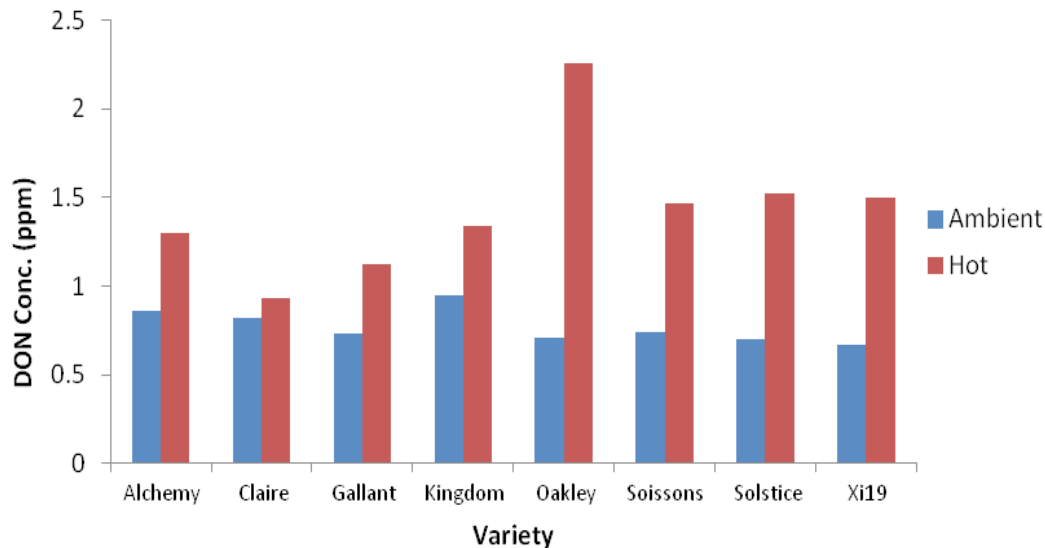

Fig. 2 Accumulation of DON (deoxynivalenol) in the kernels after harvest. DON was analysed using ELISA test kit.

Under heat stress condition, higher DON concentrations were produced particularly in Oakley, Solstice, Soissons and Xi19. The inoculated susceptible cultivar Oakley had significant grain abortion under heat stress when compared to the uninoculated control. A significant positive correlation was observed between FHB severity and anther extension of cultivars, while FHB severity and DON concentration showed no significant relationship.

Conclusions

Our results have obvious implication for FHB infection in the changing climate. Fusarium infection in susceptible wheat cultivars could exacerbate problems of poor grain set in wheat following high temperature stress. Claire shows moderate susceptibility but rather low DON accumulation, a useful trait for further breeding.

Breeders should also consider heat tolerance cultivars when assessing wheat cultivars for FHB resistance.

References

- Chakraborty, S., Newton, A.C. (2011). *Plant Pathology* 60: 2-14.
- Pugh, G.W., Jojann, H., Dickson, J.G. (1933). *J. of Agric Res.* 46: 771-779.
- Yoshida, M., Kawada, N., Nakajima, T. (2007). *Phytopathology* 97: 1054-1064.

Development of winter wheat leaf diseases depending on soil tillage system and pre-crops

Priekule, Ilze¹; Ruza, Antons²; Bankina, Biruta²; Bimsteine, Gunita²

¹Latvian Plant Protection Research Centre Ltd, LATVIA; ²Latvia University of Agriculture, LATVIA

Introduction

Winter wheat is one of the most profitable crops in Latvia. Minimum soil tillage and monoculture are becoming more widespread in Latvia. Most of the causal agents of winter wheat leaf diseases survive in crop debris, therefore an increase of disease development is possible under conditions of minimum soil tillage and monoculture of wheat (Carignano et al., 2008). The aim of the investigations was to evaluate the development of winter wheat leaf diseases depending on soil tillage and crop rotation.

Materials and methods

A long-term field experiment was established at the Study and Research Farm «Peterlauki» of the Latvia University of Agriculture in the autumn 2008. Two-factor trials were established: A — soil tillage: 1) conventional - ploughing (0.22–0.23 m) with mouldboard plough, 2) minimal—shallow (0.10–0.12 m) tillage with disc harrow; B — crop rotation: 1) wheat after wheat, 2) wheat after non-wheat. Severity of diseases was determined during the vegetation season, and AUDPC (area under disease progress curve) were calculated (Kranz, 2001).

Results and discussion

Tan spot (caused by *Pyrenophora tritici-repentis*) and septoria leaf blotch (caused by *Septoria tritici*) were the most harmful and widespread winter wheat leaf diseases in the research period. Severity of mildew (caused by *Blumeria graminis*) was lower than 1%, rusts (*Puccinia triticina* and *Puccinia striiformis*) were observed sporadically. Pre-crop and soil tillage methods influenced severity of the first symptoms of tan spot, average severity in the fields of wheat monoculture without ploughing reached 9.5% at the stage of stem elongation (BBCH 31–34), in other variants severity was less than 2.0%. Occurrence of the symptoms of other diseases did not depend on agronomical measures. Severity of tan spot development varied among years, but tendencies of disease progression were clearly estimated. The value of AUDPC gives full impression about the impact of the disease during the vegetation season. Soil tillage influenced development of tan spot, severity of the disease was lower in variants where conventional ploughing was used. Nevertheless, the most significant factor increasing the risk of tan spot was the lack of crop rotation (Fig. 1).

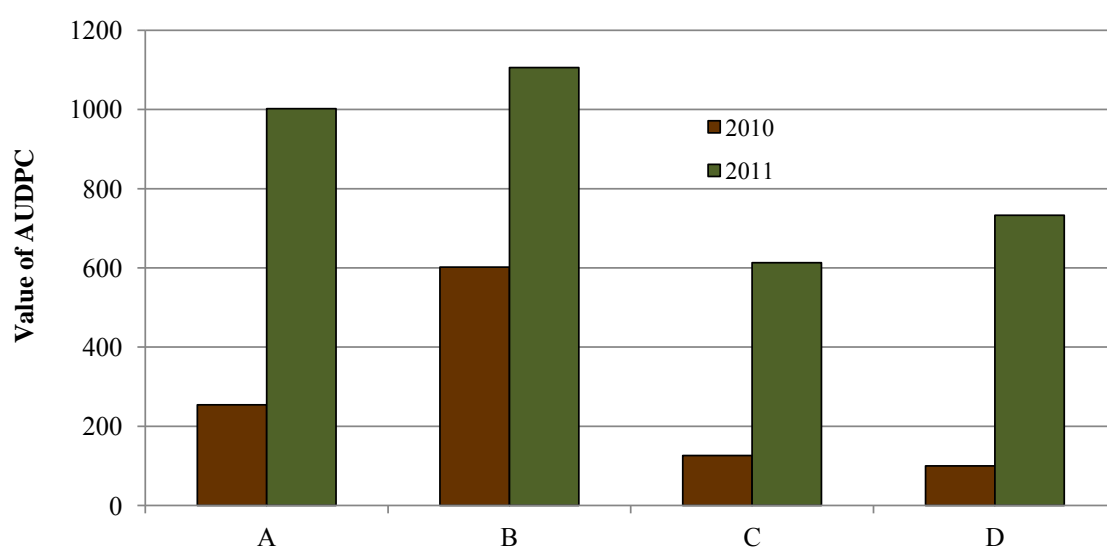

Fig. 1. Development of tan spot depending on crop rotation and soil tillage system, average in 2009 - 2011: A - wheat after wheat with ploughing; B - wheat after wheat without ploughing; C - other pre-crop with ploughing; D - other pre-crop without ploughing.

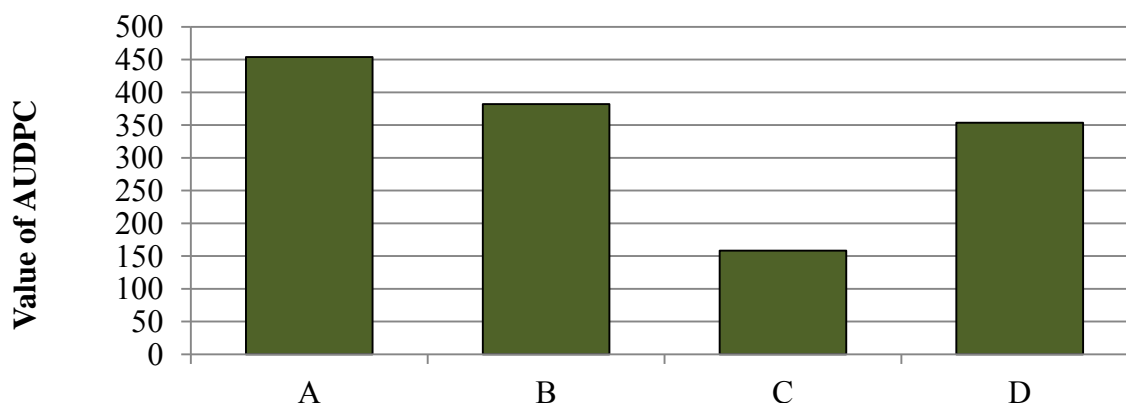

Fig. 2. Development of septoria leaf blotch depending on crop rotation and soil tillage system, in 2010: A - wheat after wheat with ploughing; B - wheat after wheat without ploughing; C - other pre-crop with ploughing; D - other pre-crop without ploughing.

Similar results have been obtained in Denmark, where the level of disease was higher in plots with non-ploughing tillage (Jørgensen & Olsen, 2007). In our investigations, agronomically important spread of septoria leaf blotch was observed only in 2010. The results of a single year are not completely sufficient to evaluate the influence of agronomical factors, but some tendency of an increasing disease development in wheat re-sowings was observed (Fig. 2).

Conclusions

Further investigations are necessary to evaluate the risk of wheat monoculture and the influence of minimal tillage on the development of wheat diseases. The three-year trial period clearly showed the risk of the development of harmful organisms under conditions of lack of crop rotation as well as the possible negative impact of minimal soil tillage. It is necessary to evaluate carefully and in detail the positive and negative consequences of these technologies. Another open question is the possibility of including or not including the minimal tillage in the system of integrated plant production.

References

- Carignano M, Staggenborg SA, Shroyer JP (2008) Management practices to minimize tan spot in a continuous wheat rotation. *Agronomy Journal*, 100: 145-153.
- Jørgensen LN, Olsen LV. (2007) Control of tan spot (*Drechslera tritici-repentis*) using cultivar resistance, tillage methods and fungicides. *Crop protection*, 26: 1606 – 1616.
- Kranz J (2001) Comparative epidemiology of plant diseases. Springer, 206. p.

Acknowledgements

The research was supported by the grant of the Ministry of Agriculture No. 070410/S36 «Influence of minimal soil tillage on its fertility maintenance, development and distribution of pests as well as crops yield and quality in re-sowings».

Effect of tillage systems on weed community present in a winter cereal field from 1995 and fifteen years later

Santín-Montanyá, M. I.; Zambrana-Quesada, E.; Tenorio-Pasamón, J.L.

Instituto Nacional de Investigación Agraria y Alimentaria (INIA), SPAIN

Introduction

The selections of weeds are constantly evolving in response to crop management practices. In drier areas, the most common soil tillage practice in recent decades has been minimum tillage, with minimal (25%) soil disturbance associated with seeding. In these conditions, Papaveraceae weed family (poppies) had been often observed in winter cereals crops (Torrá et al., 2010). In this study, the influence of three tillage systems on weed community, and poppies, were evaluated in a semi-arid agro system over fifteen years in continuous winter cereal cropping.

Materials and methods

The study was conducted at the INIA experimental farm “La Canaleja” located in Alcala de Henares (Madrid). The experimental site is characterized by a semiarid continental climate, with an average annual rainfall of 470 mm. The experiment was started to assess the effects of

three tillage systems on weed community: direct drilling (no-tillage, NT); chisel ploughing (minimum tillage 15 cm depth, MT) and mouldboard ploughing (traditional tillage 25 cm depth, CT). This paper compares the weed density recorded in 1995 and the observed between the years 2007-2010 in a field in continuous winter cereal cropping. Figure 1 shows the deviation from monthly average precipitation each year. The experiment consisted in a field (0.3 ha) divided in four randomized complete blocks with three different tillage systems and four replications. Analysis of variance was carried out on total weed density, relative density of poppies and biomass for the effect of the tillage system and year. All statistical analyses were performed using the software package STATGRAPHICS®.

Results and discussion

The weed community in this experiment was comprised by species typical of fields in the area. Partitioning of

Table 1. Analysis of the effect of tillage system and year on total weed density, poppies density (plants.m^{-2})^a, aboveground weed biomass (g.m^{-2})^a and comparison of mean values in winter cereal crop.

Source	Total density		Papaveraceae		Dry biomass	
	F-Ratio	p-value	F-Ratio	p-value	F-Ratio	p-value
Year	19.79	0.0000	11.18	0.0001	25.27	0.0000
Tillage System	8.25	0.0005	3.75	0.0287	7.35	0.0011
Year x Tillage System	6.60	0.0000	1.29	0.2647	2.12	0.0417

Tillage System ^b	Total density	Papaveraceae	Dry biomass
Conventional Tillage	9.17a	3.26 a	5.14 a
Minimum Tillage	12.21 b	4.87 b	8.05 b
No Tillage	10.09 a	3.90 ab	6.43 ab

Year ^b	Total density	Papaveraceae	Dry biomass
1994-1995	5.39 a	1.92 a	1.17 a
2006-2007	9.98 b	4.07 ab	4.88 b
2007-2008	10.36 b	2.57 ab	6.51 b
2008-2009	14.79 c	6.33 c	10.44 c
2009-2010	11.92 b	5.16 bc	9.68 c

^aData values were transformed (sqrt) prior analysis

^bIn each column means (back transformed) with different letters are significantly different at $P=0.05$ (Tukey HSD Test)

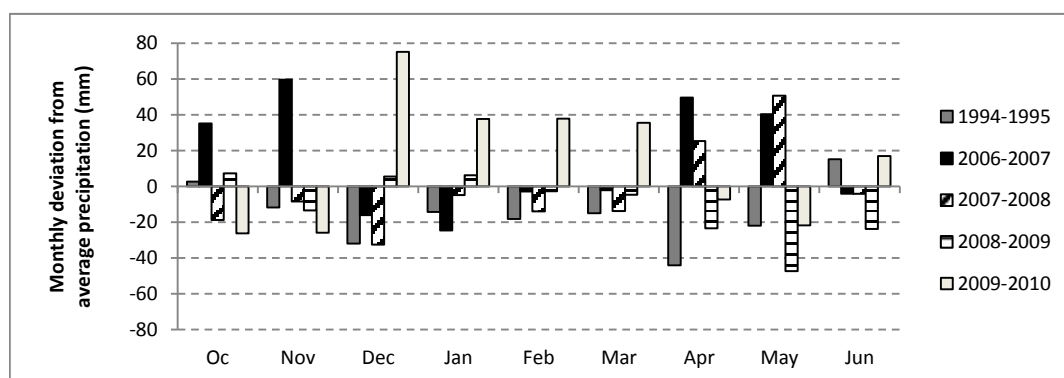
Figure1. Monthly deviation from averaged precipitation (mm)

the variance showed that tillage systems were the most important factor in determining total weed density (45.12%) and the effect of year accounted for 12% of the total variance (data not shown). Our results confirmed that tillage systems had influence on weed community in the field. After fifteen years of three tillage systems used in continuous winter cereal cropping, total weed density, poppies density and dry biomass of weeds present in minimum tillage were significantly higher than other systems (Table 1). According to our results, the research performed in this sense, have showed the tillage influence on weed composition and have described a long-term dependency to tillage system (Mas & Verdú, 2003). In this study, we observed an increased presence of papaveraceae weeds in 2009, exceeding 40% of the total weed density in minimum tillage system despite the lack of spring rainfall. The lesser degree of soil disturbance and the water soil content under minimum tillage generally results in an increase in the occurrence of poppies confirming an extended germination period and therefore it is difficult to control in arable cropping systems.

Conclusions

The fluctuations in total weed density and dry biomass

after fifteen years in a field with continuous winter cereal cropping showed a clear influence of tillage systems. In this sense, minimum tillage contributed to increase the total weed density and their biomass. This system could have favoured the relative abundance of papaveraceae weeds. Therefore, in minimum tillage it could be necessary a monitoring weeds species to prevent the development of problematic weeds to long term.

References

- Mas, M.T. & Verdú, A.M.C. (2003) Tillage system effects on weed communities in a 4-year crop rotation under Mediterranean dryland conditions. *Soil & Tillage Research* 74, 15-24.
- Torrá, J.; Cirujeda, A., Recasens, J.; Taberner, A. & Powles, S.B. (2010). PIM (Poppy Integrated Management): a bio-economic decision support model for the management of *Papaver rhoeas* in rain-fed cropping systems. *Weed Research* 50, 127-139.

Acknowledgements

This work has been funded by Project RTA2010-006-C03-02. We are grateful to members of the farm "La Canaleja" for helping managing the experiment.

Intercropping of pea and cereal - alternative method for weed control in an organic agriculture

Sarunaite, Lina; Deveikyte, Irena; Kadziulienė, Zydre
Lithuanian Research Centre for Agriculture and Forestry, LITHUANIA

Introduction

Many technological tools have been developed to enhance the competitive ability and productivity of agricultural and horticultural systems. Most weeds can be destroyed by herbicides, but this method brings drawbacks of selection pressure for herbicide resistance. Weed management is a key issue in organic farming system (Barberi, 2002). Mechanical weed control, the major alternative to herbicide use, also has negative environmental impacts due to energy consumption and additional traffic on fields. There is a great need to develop alternative methods for weed management. More attention should be paid to the development of cropping systems in which crops themselves are better able to compete with weeds (Mohler, 2001). The aim of this study was to determine the consistent pattern of intercrop productivity and competitive ability against weeds.

Materials and methods

The experiments were conducted in four subsequent seasons during 2007–2010 at the Lithuanian Research Centre for Agriculture and Forestry (55°24'N, 23°51'E). The experimental plots were laid out in a single-factor randomized complete block design. *Triticum aestivum* L., *Hordeum vulgare* L., *Avena sativa* L. and *x Triticosecale* Wittm. were grown as sole crops and intercrops with

Pisum sativum L. The intercrop design was based on the proportional replacement principle, with mixed pea grain and spring cereal grain at the same depth in the same rows at relative frequencies of half of the sole crops densities of each species (0.50:0.50). The air-dry mass, number and species of weeds were determined in an area of 0.25 m² in 4 settled places per plot at cereal growth stages of stem elongation and grain filling. The weed mass was weighed after separated weed species were dried in a natural condition and presented as air-dry mass. In order to normalize the data, the air-dry biomass of weeds was transformed to square root (x+1).

Results and Discussion

The total air-dry biomass of weeds was significantly less in cereal sole crops and intercrops than in the pea sole crop (Figure 1). There was little difference in the weed suppression of the cereal sole crops. With the exception of the pea-triticale intercrop and the pea sole crop, the biomass of annual weeds was less than that of perennial weeds. The weed biomass was greater in each cereal-pea intercrop than in the corresponding cereal sole crop and the increase came mainly in the perennial component.

Reduction of mass per weed decreases their viability and number of mature seeds (Liebman and Davis, 2009). When weed pressure is high, reduced weed air-dry mass translates directly into grain yield (Weiner et al., 2001).

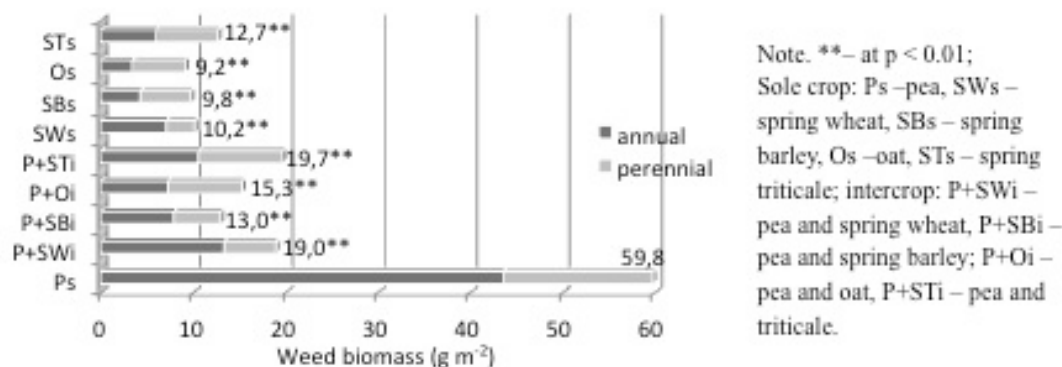

Figure 1. The influence of intercrops on the air-dry biomass of weed functional groups

Conclusions

Intercropping with cereals significantly reduced the total and annual weed air-dry biomass in pea. The reduction of weed mass was primarily that of annual weeds. According to reduction of weed number and air-dry mass crop groups can be ranked in the following order: pea > pea/cereal intercrops > cereal. Consistent and significant reduction of weed air-dry biomass was determined in pea/oat intercrop.

References

- Barberi P. 2002 Weed management in organic agriculture: Are we addressing the right issues? *Weed Res.* 42: 177–193.
- Liebman M., Davis A.S. 2009 Managing weeds in organic farming systems: an ecological approach. *Organic Farming: The Ecological System*. C.A. Francis ed.; American Society of Agronomy: Madison, pp 173–196.
- Mohler C.L. 2001 Enhancing the competitive ability of crops. *Ecological Management of Agricultural Weeds*, Liebman M., Mohler C.L., Staver, C.P. eds.; Cambridge University Press: Cambridge, UK, pp 1231–1269.
- Weiner J., Griepentrog H. W., Keistensen L. 2001 Suppression of weeds by spring wheat *Triticum aestivum* increases with crop density and spatial uniformity. *J Appl Ecol.* 38: 784–790.

New tasks in crop protection in Lithuania

Semaskiene, Roma; Deveikyte, Irena

Lithuanian research centre for Agriculture and forestry, LITHUANIA

A critical component of agricultural production is the management of insect pests, diseases and weeds. Diseases and pests can destroy over 50 percent of crop production and reduce its quality. Weed damage not only affects yield, but also increases the cost of harvesting. New farming technologies are based on reduced tillage, and mono-cropping is becoming increasingly common in conventional farms in Lithuania. These changes have altered the spectrum of undesirable organisms.

Some diseases and pest outbreaks, changes in pathogens, pests and weed populations have been observed in recent years. Leaf spotting diseases (*Mycosphaella graminicola*, *Pyrenophora tritici-repentis*, *Phaeosphaeria nodorum*) are now dominant in winter wheat crops, whereas 20-25 years ago powdery mildew (*Blumeria graminis*), Stagonospora leaf blotch (*P. nodorum*), yellow and brown rust (*Puccinia recondita* and *P. striiformis*) prevailed. Ramularia leaf spot (*Ramularia collo-cygni*) has become more common in spring barley in recent years. Sclerotinia stem rot (*Sclerotinia sclerotiorum*) and Phoma stem canker (*Leptosphaeria* spp.) are plant pathogens that cause severe attacks nearly every year and give significant yield losses in oilseed rape, because the area of this crop has greatly increased in Lithuania and close rotations are common in many farms. Alternaria spot caused by *Alternaria* spp. is another important disease of oilseed rape, especially in spring-sown crops.

Changes in weed species are seen also. Broad-leaved weeds dominated 30-40 years ago. Grass weeds have become an increasingly important feature, especially in cereal crops. Control measures for *Apera spica-venti* and *Avena fatua* require special attention. Among the broad-leaved weeds, *Lamium purpureum* is more common in cereals in Lithuania where it has benefited from the control of more competitive weeds.

Comprehensive research has been done on the development and evaluation of pest control measures in Lithuania. Some research has been focused on the integration of several control strategies. Nevertheless, the latest developments in crop production technologies, changes in pest population structures, the influence of warming climate on pests in many agro-ecosystems, pesticide resistance, and other related issues pose new questions for research in the field of crop protection. Integrated Pest Management (IPM) has been an important issue for a long time in many countries including Lithuania but the new EU directive (2009/128/EC) pushed the IPM development more intensively. The IPM is a program of prevention, monitoring, and control, which offers the opportunity to eliminate or drastically reduce the use of pesticides. The goal of the IPM is not to eliminate all pests. Rather, its aim is to reduce pest populations to less than damaging numbers. Research efforts should be concentrated in order to keep track of changes over time and continuously improve recommendations for Lithuanian farmers.

Spring wheat disease and yield responses to nitrogen fertilization and chemical treatment

Sooväli, Pille; Kangor, Tiia; Koppel, Reine; Ingver, Anne; Tamm, Ilmar
Jõgeva Plant Breeding Institute, ESTONIA

Introduction

High rates of nitrogen (N) fertilizers have indicated to induce foliar diseases. Less attention has been paid to the influence of the effect of growth regulators and leaf fertilizers on fungal pathogens. In our study we assessed the effects of basic fertilizer rates, different fungicides, leaf fertilizers, and growth regulators on spring wheat monoculture. We observed the appearance of foliar diseases and the effects of different variants on crop yield and economic profitability.

Materials and methods

Field trials were carried out during 2006-2008 in Jõgeva PBI. Spring wheat monoculture was cultivated. Seeds of the varieties 'Monsun' and 'Vinjett' were untreated. We used two kinds of treatments: T1 consisted of 4 different rates of basic fertilizer: N0=NoPoKo; N1=N60P13K23; N2=N100P22K39; N3=N140P31K54 kg ha⁻¹. T2 treatment consisted of same rates of basic fertilizers and in addition growth regulator, fungicides and leaf fertilizers. Foliar diseases were assessed visually on each plot in 10 randomly selected places on two upper leaves on three adjacent tillers 3 and 6 weeks after fungicide application. The net

yield kg ha⁻¹ was calculated by subtracting the amount of grain equal to the cost of inputs and its application from the harvest yield to analyze the economic benefit of inputs. The data were subjected to factorial ANOVA.

Results

Results of ANOVA indicated that in the basic fertilization conditions (T1) the severity of *B. graminis* infection correlated highly with weather conditions of the year and with a variety (Table 1).

Results of the effects of fertilizers on the infections of fungal diseases on spring wheat monoculture revealed that test years had the biggest influence on infection intensity of *B. graminis* ($R^2Y=50.7-59.2$) in T1 and T2 and on *P.tritici-repentis* in T2 ($R^2Y=31.6$), whereas infection of *C. sativus* was more dependent on year in T1 ($R^2Y =37.3$). Tan spot infection appeared in T1 No level every year. Genotype appeared to have high influence to tan spot in T2, which was similar to *B. graminis* in T1, but the highest influence has fertilizer level. Although the appearance of tan spot infection was low in T1, the relationship between the infection and fertilizer rate was statistically significant ($R^2F=30.6$).

Table 1. Determination coefficients of different factors (year, variety, fertilizer rate, interactions)

Variation	df	<i>P. tritici-repentis</i>		<i>B. graminis</i>		<i>C. sativus</i>		Yield	
		T 1	T 2	T 1	T 2	T 1	T 2	T 1	T 2
Y (R^2_Y)	2	3.3***	31.6***	50.7***	59.2***	37.3***	2.4***	14.6***	40.7***
V (R^2_V)	1	9.3***	15.3***	14.7***	5.5***	7.7***	2.9***	2.8***	0.2*
F (R^2_F)	3	30.6***	1.8***	3.4***	1.1***	2.9***	7.3***	60.2***	33.4***
VxY									
(R^2_{VxY})	2	3.9***	18.3***	10.1***	2.9***	2.7***	0.2*	8.5***	11.8***
YxF									
(R^2_{YxF})	6	8.6***	1.9***	4.2***	5.5***	11.1***	26.2***	5.2***	4.8***
VxF									
(R^2_{VxF})	3	4.7***	1.4***	1.7***	0.15*	2.9***	2.7***	3.1**	0.1*
R ²		0.60	0.70	0.85	0.74	0.65	0.42	0.94	0.92

Y - year, V - variety, F - fertilizer rate

***significant at $p < 0.001$; **significant at $p < 0.05$; * non-significant; T - treatment

Table 2. Yield profit of spring wheat varieties in monetary terms (€ ha⁻¹) in 2006–2008

Variety		Net yield kg ha ⁻¹			Net income €			Benefit in monetary terms € ha ⁻¹		
		N1	N2	N3	N1	N2	N3	N1	N2	N3
2006										
Monsun	T1	3931	4228	4732	904	972	1088	755	723	739
	T2	2902	2771	2418	667	637	556	442	312	131
Vinjett	T1	3002	3552	4400	690	817	1012	541	568	663
	T2	2347	1941	1690	540	446	389	315	121	-36
2007										
Monsun	T1	1937	2253	1895	446	518	436	297	268	87
	T2	1491	989	836	343	227	192	80	-136	-271
Vinjett	T1	3084	3454	3177	709	794	731	560	545	382
	T2	2175	1705	1559	500	392	359	237	29	-104
2008										
Monsun	T1	3712	3893	3731	854	895	858	705	646	509
	T2	4152	4456	4693	955	1025	1079	678	648	602
Vinjett	T1	4178	5017	5186	961	1154	1193	812	905	844
	T2	4381	4777	5077	1008	1099	1168	731	722	691

T – treatment, N – fertilization rate

Yield correlated highly with a fertilizer rate and year. In the treatment T₂ the yield depended more on weather conditions ($R^2Y=40.7$) and in T₁ the yield was more dependent on fertilization rate ($R^2F=0.62$). We found T₁ to be more economic as the optimum nitrogen rate varied from N 60 kg ha⁻¹ to N 100 kg ha⁻¹ and the benefit in monetary terms raised from 297 € ha⁻¹ ('Monsun' 2007) to 905 € ha⁻¹ ('Vinjett' 2008). In T₂ N rate 60 kg ha⁻¹ raised the monetary benefit from 80 € ha⁻¹ ('Monsun' 2007) to 731 € ha⁻¹ ('Vinjett' 2008) (Table 2).

The high price of inputs reduced the profit in the case of fertilizer N rates of 100 and 140 kg ha⁻¹ during 2007 when disease severity was low throughout the whole growth season. The cost of applications exceeded the benefit from 104 to 271 € ha⁻¹. The highest economic profit was gained by using low rates of fertilizer for 'Monsun' and higher rates of fertilizer for 'Vinjett'.

Conclusions

The results of this study clearly suggest that weather conditions of the year, intensity of agro-techniques and the interaction between these two have a significant influence on the appearance of foliar diseases. Although the infections were dependent on genotype as well, this factor had lesser effect. The prevalence of tan spot was also highest in low input variants. Powdery mildew was more detected in medium basic fertilization with chemical applications and spot blotch was more influenced by basic fertilization conditions. In the conditions of intensive use of leaf fertilizers, growth regulator, and fungicides the crop yield was more influenced by year, whereas in less intensive treatment the yield was more influenced by fertilization.

Seed propagation at very low density is effective in reducing the load of seed-borne viruses in lentil

Kargiotidou, Anastasia¹; Chatzivassiliou, Elisavet²; Sinapidou, Evangelia¹; Tzantarmas, Constantinos³; Tokatlidis, Ioannis¹

¹Democritus University of Thrace, GREECE; ²Agricultural University of Athens, GREECE; ³Democritus University, GREECE

Introduction

Lentil (*Lens culinaris*) can suffer extensive crop losses from infections from a wide range of viruses. Among them the insect-transmitted *Alfalfa mosaic virus* (AMV), *Bean yellow mosaic virus* (BYMV), *Broad bean stain virus* (BBSV), *Cucumber mosaic virus* (CMV) and *Pea seed-borne mosaic virus* (PSbMV) are also seed-borne. Seed propagation is usually conducted without any selection at plant densities similar or slightly lower than those used for commercial purposes. However, it has been shown that very low planting densities allow plants to reach maximum growth and grain yield but may also facilitate the identification of virus-infected plants (Makkouk and Kumari, 2009). We investigated the hypothesis that early multiplication at very low density could allow the detection of plants emerging from infected seeds; under those circumstances, seed collection only from healthy and high yielding plants may constitute an effective practice to produce a seed stock with reduced virus load.

Materials and methods

A field experiment including 1088 isolated plants (1.15 plants/m²) of a commercially cultivated landrace was established according to the honeycomb method (Fasoulas and Fasoula, 1995). The 100 highest yielding, symptomless plants were selected and their seeds were mixed to form the 1st-cycle sister population (1CSP). The following season, the same planting method and selection procedure was applied on 600 1CSP plants to form the 2nd-cycle sister population (2CSP). The 1CSP and 2CSP were also evaluated at the farming density of 160 plants/m² in a randomized complete block (RCB) replicated four times. In order to detect the presence of seed-borne viruses, seedlings were produced in the greenhouse and tested by Enzyme Linked Immunosorbent Assay (ELISA).

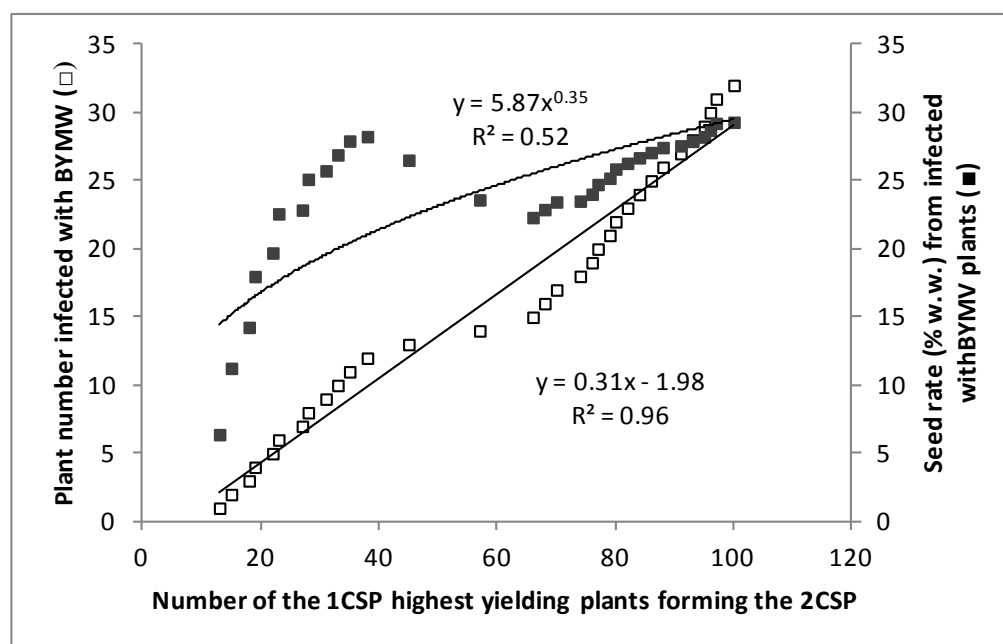

Fig. 1. The relation of the number of 1CSP highest yielding plants selected to contribute to the 2CSP with either the number of plants infected with BYMV (or their seed contribution in the formation of 2CSP). The linear correlation is significant ($r=0.67$, $P<0.001$)

Results and discussion

Using virus-free seeds is crucial in legumes. In this study 12% of the mother population seeds were infected by PSbMV. Infected seed is the primary source of PSbMV for an efficient spread by transient aphid species resulting in extreme losses (Coutts et al., 2009). After a selection round, PSbMV was detected in only one plant and eliminated afterwards. In the same way, viruses not present in the source material (BYMV, AMV), so originating from surrounding crops and invading the seeds, were also eliminated. The impact of the applied methodology is highlighted by the significant positive linear correlation ($r=0.98$, $P<0.001$) that was found between the number of the selected 1CSP plants to form the 2CSP and the number of them found positive for the BYMV. Contribution of these infected plants in the total seed weight of all the selected plants was also positively correlated to the number of selected plants (Fig. 1). Furthermore, evaluation of the sister populations showed that the mean yield per plant of the 2CSP was 128% higher than the respective one of the initial landrace, while at farming density conditions both sister populations gave higher grain yield by 6 and 9% respectively compared to the mother landrace.

Conclusions

The results suggest that ultra-low densities facilitate the identification of virus-free plants. In combination with the higher grain yield of the sister populations, they indicate that seed reproduction firstly at an ultra-low density to improve the sanitary status and then at dense stand to increase the amount of produced seed at the required levels could be an effective strategy for improved lentil seed production.

Acknowledgements

A work co-financed by EU and Greek funds through the program THALIS-DUTH-LENTILBREED

References

- Coutts BA et al. (2009). *Phytopathology*, 99:1156-1167.
- Fasoulas AC, Fasoula VA (1995). *Plant Breed Rev*, 13:87–139.
- Makkouk KM, Kumari SG (2009). *Virus Res*, 141:209–218.

Determination of the dominant weed species in maize during past 10 years in Latvia

Vanaga, Ineta

Latvian Plant Protection Research Centre Ltd, LATVIA

Introduction

Among the sown crops in Latvia, the area of maize increased gradually during the past 10 years (2002: 1.2 thousand ha; 2011: 10 thousand ha). Currently maize is grown not only for corn silage as a highly productive animal feed, but also for biomass to produce biogas. In growing the crop as an energy source it has become more and more important to achieve high yields of high-quality green biomass. Weed control has an important place in this production as weeds compete with the crop for nutrients, water and light and adversely affect the quality of the crop.

Materials and methods

The field trials were carried out in the Jelgava and Dobeles municipality. All the field trials were arranged in randomized blocks with four replicates; plot size: 15-30 m². Assessments of the weeds were done during the third 10-day period of June or the first 10-day period of July. Counts of weed species were done in the untreated plots at 3 random places. A rank for frequency of occurrence was assigned to each species based on relative density (plants m⁻²). Bayer codes for the recorded species: annuals: *Chenopodium album* L. (CHEAL); *Lamium purpureum* L. (LAMP); *Sinapis arvensis* L. (SINAR); *Capsella bursa-pastoris* (L.) Medik.; *Thlaspi arvense* L. (THLAR); *Veronica arvensis* L. (VERAR); *Galium aparine* L. (GALAP). The soil characteristics of the experimental field trials are shown in Table 1.

Results and discussion

In field trials where the previous crop was maize populations of dicotyledonous weeds in the untreated plots ranged from 95 to 215 plants m⁻². The most common species were annual dicot-weed species, but there were also some high populations of perennials like *Cirsium arvense* (L.) Scop and *Plantago major* (L.).

Where the previous crop was spring barley, no perennials were recorded as dominant weeds and the average numbers of plants were 69 to 600 m⁻².

The average density of dicot weed plants in the untreated plots ranged from 89 to 208 plants m⁻² in the trials where the previous crop was winter wheat. Here perennials like *Sonchus arvensis* (L.) and *Cirsium arvense* were assessed among dominant species.

Where the previous crop was winter oilseed rape, spring wheat or pea, the average density of dicot weed plants in the untreated plots ranged from 70 to 126 plants m⁻² and the perennial *Sonchus arvensis* occurred at high frequency.

The numbers of weed species recorded in each trial ranged from 7 to 24, and from 2 to 7 species were dominant (i.e. accounting for more than 75% of the population). The results of the trials showed that *Chenopodium album* and *Lamium purpureum* were among the most frequent weed species (Table 2).

Table 1. Previous crops and soil characteristics of experimental field trials of maize during 2001 - 2011

Previous crop	Maize	Spring barley	Winter wheat	Fallow	Spring wheat	Winter oilseed rape	Pea
Number of trials	5	8	8	2	1	1	1
Soil type	loam	loam, silt loam	loam, silt loam	sandy clay loam	loam	clay	silt loam
pH (KCl)	5.5-6.9	7.0-7.1	6.8-7.0	7.3	7.0	7.0	6.9
Organic matter (%)	1.9-2.3	2.1-3.2	2.0-2.9	1.9	2.0	2.3	1.7

Table 2. Previous crops and dominant species of experimental field trials of maize during 2001 - 2011

Previous crop	Dominant dicot-weeds according to their rank of occurrence						
	CHEAL	LAMPU	SINAR	CAPBP	THLAR	VERAR	GALAP
Maize	1	2	3	4	5	6	>7
Spring barley	3	2	>7	5	4	1	6
Winter wheat	2	1	5	>7	6	3	4
Fallow	2	3	>7	>7	>7	>7	1
Spring wheat	>7	3	>7	>7	>7	1	2
Winter oilseed rape	4	1	>7	>7	>7	2	3
Pea	3	1	4	>7	>7	5	2

Even where competitive species like *Chenopodium album* dominated, the total number of other species did not decrease. The biodiversity of weed species was more affected by the overall cropping system of the farm and by the weather conditions in the spring (May-June) which was extremely dry in some years (2006, 2008).

It was reported from maize trials in Lithuania that a total of 13 weed species was found in the experiments and *Chenopodium album* was one of the most dominant dicotyledonous weed species (Auskalnienė et al., 2006). The occurrence of *Galium aparine* has decreased during past 5 years, but in contrast *Veronica arvensis* increased. Species like *Viola arvensis* Murray and *Tripleurospermum inodorum* (L.) Sch.Bip. that are common in cereals, were very rarely seen in the maize trials.

Conclusions

In the maize trials annual dicotyledonous weeds: *Chenopodium album*, *Lamium purpureum*, *Sinapis arvensis*, *Capsella bursa-pastoris*, *Thlaspi arvense*, *Veronica arvensis*, *Galium aparine* were determined as the most frequent. The results of field trials in maize have shown that the previous crop was one of the factors influencing the infestation level in the field and greatly influenced the spectrum of dominant weed species.

References

Auškalnienė, O., Auskalnis A. 2006. Effect of sulfonyleurea herbicides on weeds and maize. Agronomy Research, Special issue, Vol. 4. pp.129-132.

Impact of different soil treatment and straw farming on weeds in long term spring barley monoculture

Winkler, Jan

Mendel University in Brno, CZECH REPUBLIC

Introduction

Long-term application of certain agricultural measures forms specific conditions for weeds. Reaction of individual species is different and can be reflected in a different weed infestation.

Materials and methods

A field experiment was established on field experimental station at Zabcice (Czech Republic) in 1970. The monoculture of spring barley has been grown in long-term experiment. The experiment consisting of two variants of soil cultivation. The first is conventional soil tillage variant (CT) where soil is ploughed to the depth of 0.22 m and the second is minimal tillage variant (MT) with soil cultivation by discs to the depth 0.12 cm. Moreover there were also three different straw managements – first with straw harvesting (SH), second variant with straw incorporation into soil (SI) and the third where straw was burned (SB) The size of each plot was 5.3 × 7.0 m. The evaluation of actual weed infestation was assessed in the period 2008 – 2011 in spring barley stand. Counting method was applied, the number of weeds was counted on 1 m² area in 8 replications for each variant of soil tillage, straw management and year. The obtained results were assessed using CCA multidimensional method in program Canoco 4.0 (Ter Braak, 1998).

Results

During the course of experiment 29 species were found. Mean number of weeds was 12.28 individuals per 1 m² CT variant. The most frequent species on this variant were *Silene noctiflora* (4.16 pcs m⁻²), *Galium aparine* (2.61 pcs m⁻²) and *Fallopia convolvulus* (1.21 pcs m⁻²). On MT variant mean number of weeds achieved 17.61 pcs. m⁻² and the most frequent species were *Galium aparine* (12.86 pcs m⁻²), *Fallopia convolvulus* (0.98 pcs. m⁻²) and *Lamium amplexicaule* (0.94 pcs. m⁻²). On the first SH variant mean number of weeds was 16.71 pcs m⁻² and the most frequent species were *Galium aparine* with 8.02 pcs m⁻², *Silene noctiflora* (3.50 pcs. m⁻²) and *Microrrhinum minus* (1.30 pcs. m⁻²). The second SI variant was characterized by mean number 19.45 weed species per 1 m² and *Galium aparine* (12.66 pcs m⁻²), *Silene noctiflora* (2.17 pcs m⁻²) and *Fallopia*

convolvulus (1.26 pcs m⁻²) were the most frequent. Mean number of species 8.67 pcs m⁻² and frequent presence of *Galium aparine* (2.53 pcs m⁻²), *Silene noctiflora* (1.52 pcs m⁻²) and *Lamium amplexicaule* (1.33 pcs m⁻²) characterized the third variant (SB). Results of CCA (P-value = 0.002) suggest that variants with minimal tillage and with straw incorporation enable higher occurrence weed species as follows: *Avena fatua*, *Cirsium arvense* and *Galium aparine*. The variant with conventional tillage and variant with straw harvesting showed higher and more frequent occurrence of weeds *Microrrhinum minus*, *Silene noctiflora*, *Veronica persica*, *V. polita* and *Viola arvensis*. *Anagallis arvensis*, *Fallopia convolvulus*, *Lamium amplexicaule*, *L. purpureum*, *Persicaria lapathifolia* and *Stellaria media* were more numerous and frequent on the variant with straw burning and on the variant with conventional tillage soil.

Conclusions

Long term application of the different soil cultivation has pronounced impact on species diversity and the intensity of weed infestation. Minimal tillage seems to offer better conditions for higher weed infestation but with lower species diversity. *Galium aparine* is the pronounced species on this variant. On the contrary lower weed infestation with more weed species were observed on the variant with conventional tillage. The lowest weed infestation was observed on SB variant with burned straw. Pronounced decline of individuals of *Galium aparine* together with higher occurrence of less noxious species was recorded here.

Acknowledgements

The results in paper are output of project of Internal Grant Agency, AF MENDELU, No. TP 9/2012.

References

Ter Braak, C.J.F. 1998. CANOCO – A FORTRAN program for canonical community ordination by [partial] [detrended] [canonical] correspondence analysis (version 4.0.). Report LWA-88-02 Agricultural Mathematics Group. Wageningen, 1998

Biodiversity of weed flora, morphological features and yielding of *Miscanthus* ssp. cultivated on light and heavy soil

Feledyn-Szewczyk, Beata; Staniak, Mariola; Matyka, Mariusz

Institute of Soil Science and Plant Cultivation-State Research Institute, POLAND

Introduction

The important issue related to the cultivation of energy crops and poorly recognized so far is their impact on environment, including biodiversity. Some authors suggest that cultivation of energy crops increases the diversity of agroecosystems and landscape, but others pay attention that the physical structure of the canopy, the growth rate, applied fertilization cause the energy plant habitats are not conducive to diversity of flora and fauna. Due to the unknown effects of many plant species used for energy purposes on the environment, there is a need for further intensive study in this field. The aim of the work was assessment of weed flora diversity, canopy structure and yield of miscanthus cultivated on two types of soil: light and heavy.

Materials and methods

The study was carried out on fields established in 2003, located in the Experimental Station of IUNG-PIB at Osiny, Lublin region (N:51°28, E:22°4). The research was conducted on two plots of about 200 m² on light loamy sand and heavy loam. Miscanthus (*Miscanthus sacchariflorus* Robustus x *M. sinensis* – M-115) was

cultivated at a density of 15 thousand. plants · ha⁻¹. Weeds were controlled mechanically in the first year after experiment establishment. The analysis of flora, started in 2010, was carried out using two methods: frame method (all weed species on the area of 0,5 m² were counted) and phytosociological releves (percentage cover of weeds on area of 25 m² was assessed). The surveys were done in mid-June and mid-August. Moreover the analysis of green and dry matter yield of miscanthus, some morphological features and leaf area index (LAI) were carried out.

Results

The results showed that weed species diversity in miscanthus was dependent on soil type. The biggest number of weed species were noted on heavy soil, where 23 species was found using frame method and 30 species using phytosociological method. on miscanthus cultivated on light soil only 14 weed species were observed, when the analysis were done with frame method and 20 species using phytosociological method. Number of weeds in June was similar on the two types of soils, 66-69 plants·m⁻², but in August the number of weeds was on the same level on heavy soil, but 3 times lower on light soil (20 plants·m⁻²) (fig.1) Despite of the similar number of weeds

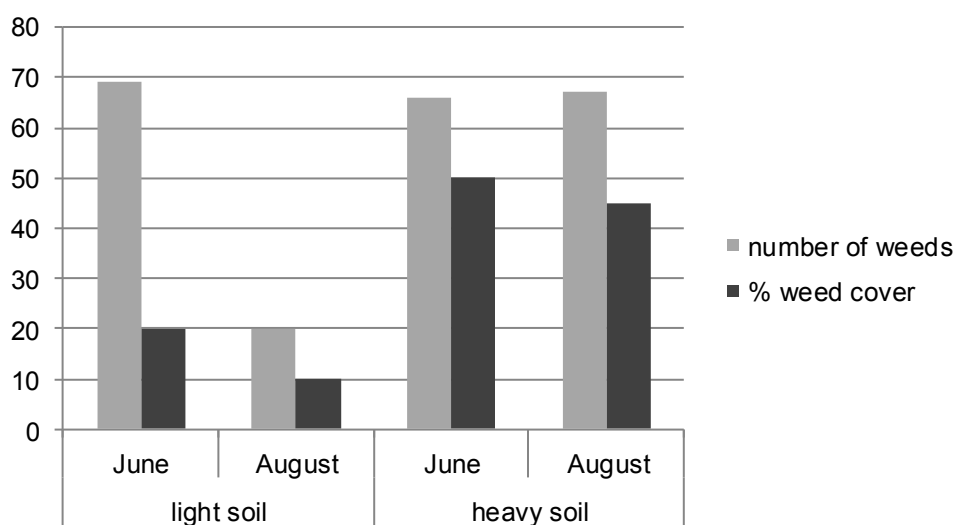

Fig. 1. Number of weeds (plants·m⁻²) and weed cover (%) in miscanthus cultivated on light and heavy soil

Table 1. The yield and morphological features of *miscanthus*

Type of soil	Green matter yield (t·ha ⁻¹)	Dry matter yield (t·ha ⁻¹)	Number of shoots per plant	Shoot length (m)	Diameter of shoot (mm)	LAI (Leaf area index)
Light soil	32,3	23,8	76	2,21	4,21	3,70
Heavy soil	28,3	19,8	103	2,56	6,68	5,30

on heavy and light soil in June, percentage weed cover was lower in *miscanthus* cultivated on light soil (20%) than on heavy soil (50%). In August the weed cover was lower than in June: 10% of weed cover on light soil and 45% on heavy soil.

On heavy soil, species typical for habitat rich in nutrients dominated (e.g. *Galinsoga parviflora*, *Chenopodium album*, *Galeopsis tetrahit*, *Capsella bursa-pastoris*), while on light soil species characteristic for poorer habitat occurred (*Coryza canadensis*, *Viola arvensis*, *Equisetum arvense*).

The green and dry matter yield was bigger in *miscanthus* cultivated on light soil (tab.1). Number of shoots, their length and diameter as well as was leaf area index were higher in *miscanthus* grown on heavy soil.

Conclusions

1. Diversity of weed species in *miscanthus* was high (20-30 species) and dependent on soil type.
2. Percentage weed cover was higher in *miscanthus* cultivated on heavy soil in comparison with *miscanthus* grown on light soil.
3. The green and dry matter yield was bigger in *miscanthus* grown on light soil.

References

1. Rola J., Sekutowski T., Rola H., Badowski M. Weed problems on the new *Miscanthus giganteus* plantations. Pam Pu³, 150: 233-246.
2. Sage R., Waltola G., Cunningham M., Bishop J. 2008. Head and around SRC plantations have potential to provide new habitats for plants and butterflies on farmland. Aspects of Applied Biology 90, Biomass and Energy Crops III: 303-309.

Acknowledgments

The research was supported from Polish Ministry of Science and Higher Education (NN310437738)

Importance of seminatural habitats for biodiversity of organic olive groves in CW Spain

Moreno, Gerardo¹; Juarez, Enrique¹; Lopez-Diaz, María Lourdes¹; Pulido, Fernando¹; Gonzalez-Bornay, Guillermo¹; Diaz, Mario²

¹University of Extremadura, SPAIN; ²CSIC, SPAIN

Introduction

Organic farming systems are expected to have less environmental impact than intensive agriculture, which is dependent on the standard use of pesticides and inorganic nutrient applications in the production of crops and animals. Among other environmental benefits, an increase of biodiversity is expected in organic farms compared to conventional farms. However, apart of management practices, the occurrence and abundance of organisms could also depend on the abundance, size and spatial location of different habitats.

Materials and methods

The EU FP7 research project BIOBIO - Indicators for biodiversity in organic and low-input farming systems has monitored the species richness and abundance of four biological key groups for agroecosystems functioning, plants (primary producers), bees (pollinators), earthworms (detritivores) and spiders (predators) in most representative organic farming system across Europe. Olive groves, with more than 250000 ha cultivated organically in Europe, were studied in Spain, where olive grove is the main organic farm system, with more than 100000 ha. Twenty farms were randomly selected in Central Western Spain (Tierras de Granadilla district; from lat 40.19 to 40.32 and long -6.28 to -6.13), comparing 10 organic farm with 10 conventional ones. The landscape in the district is dominated by olive plantations, with nearly 11,000 ha of olive plantations (83% of the croplands and 16.2% of the district surface). Above 7% of these olive plantations are organic (760 ha). For each farm 14 indicators of management practices were recorded by means of tabulated interviews to farmers, and 10 indicators of habitat diversity were calculated after mapping farm habitats and linear features (Bunce et al 2011). Within each farm, a randomly selected plot per each of described habitat or lineal feature was retained for further monitoring of biodiversity. In each plot (92 in total) plants, bees, earthworms and spiders were

monitored in spring 2010. Plant species and cover was surveyed in a 100 m² square (10 m² for lineal feature). Earthworms were sampled in three separated squares per plot combing the extraction with an expellant solution (AITC solution; 0.1 g/l) and then hand-sorting from a soil core (30x30x20 cm). Bees were sampled along a walked transect of 100 m length by plot with a handheld net in three dates (May-July). Spiders were sampled from 5 separated points (50 cm Ø) per plots in three different dates (May-July) by using a motorized leaf blower (inverted). Species richness at farm level was always higher in organic than in conventional farms (Figure 1). However, these differences are mostly explained by the higher habitat diversity and higher abundance of semi-natural habitats in organic than in conventional farms (Table 1). Indeed, when only productive/managed habitats are included, comparisons among organic and conventional farms were non-significant for any of the biological groups studied (Figure 1). Although some significant correlations among management indicators and biological groups were found, non-significant relationships were much more frequent. By contrast, plant and animal biodiversity correlated very significantly with the existence of a fine mosaic of habitats, including non-productive habitats and linear elements. Indeed, main productive habitats harbored only a low proportion of species. Semi-natural habitats that occupied a low percentage of farm surface harbored a high number of exclusive species, which depends on the maintenance of those non-productive habitats. The importance of these semi-natural habitats supports the EC measure of promoting Ecological Focus Areas pursued with the greening of the CAP. A next challenge will be to respond if the spatial pattern of non-productive habitats affect to the biodiversity of productive habitats.

References

Bunce RGH et al. 2011. Manual for Habitat and Vegetation Surveillance and Monitoring. Wageningen, Alterra report 2154, 106 pp

Figure & table missing

Ecological aspects of biodiversity of harmful organisms in crops of a white lupine

Shapkina, Yulia; Tsygutkin, Alexander; Vasenev, Ivan

Russian State Agrarian University – MTAA named after K.A.Timiryazev, RUSSIAN FEDERATION

Introduction

Currently seven varieties of white lupine are registered in Russia, six of which were bred by plant selectionists of Russian State Agrarian University - MTAA named after K.A.Timiryazev. The revival of the production of white lupine required to develop resource-saving and moisture-saving technologies of its cultivation. In order to create a system for plant protection, it is necessary to determine the structure of harmful organisms, including species composition of pests, diseases and a weed component.

Materials and methods

Species diversity of pests, diseases and weeds were studied in the Central Chernozem region of Russia. Seeding and industrial crop production was taken into account. The presence of harmful organisms was considered during route inspections in the fields occupied by white lupine. Insects were calculated using a method of cutting by an entomological net, while disease and weed component were accounted for in the calculation of averages in the samples and by applying the framework 50x50cm.

Results

White lupine sowing was characterized by a variety of weed component. However, the most dangerous were the annual grasses, annual dicotyledons and perennial root-sucker plants (Tab. 1). White lupine diseases were divided into three groups: primary, secondary and potentially hazardous. The most common and harmful diseases belong to the primary group (*Colletotrichum*; *Fusarium*; *Botrytis*), diseases from which harm is not notable relate to the secondary group (*Fusarium*;

Rhizoctonia solani, *Pythium*; *Ascochita*; *Alternaria*), while potentially hazardous diseases are capable of destroying the entire harvest in the presence of favorable conditions for the development of pathogens (*Erysiphe martii*). In Chernozem region anthracnose appears after flowering, affecting beans and to a lesser extent a stem. The affected ovaries stop growing and fall off. The spots are formed on the beans, at first the small brown ones and then they merge and turn into cankers in which fungus coating of pink orange colour appears. White lupine suffers from fusarium throughout the entire vegetative period, but particularly strongly during germination. Lighter leaf colour, reduced foliage, thinner stalk can serve as the external signs of lesion. Plant residues and soil can play a role of an infection source. White lupine sowings are affected by gray rot botrytis. Disease symptoms are revealed in damp weather at first in a form of vague greenish brown rot. The affected parts are softened, water out and a grey fungus coating develops on them. Distribution and harmfulness of the disease depends on weather conditions. White lupine is damaged by pests, mainly by polyphagous. According to our research, in fields where *Atriplex patula* and *Convolvulus arvensis* prevailed in weed component, cutworm (gamma, cabbage and alfalfa) was met more often. From a wax bean phase till full ripeness the lupine is damaged by pea moth. The lupine weevil is a specialized pest.

Conclusions

Agroecological assessment of the white lupine sowings conducted in the South-West and North-East of the Central Chernozem region of Russia showed that it is necessary to develop an integrated system of plant protection.

Figure & table missing

Table 1. The main types of weeds, found in white lupine sowing

Annual grasses Echinochloa crusgalli Setaria glauca Avena fatua Annual dicotyledons Atriplex patula Amaranthus retroflexus Capsella bursa-pastoris Galium aparine Chenopodium album Fallopia convolvulus Cyclachaena xanthiifolia Viola tricolor Lappula squarrosa Galeopsis ladanum Lamium purpureum Elygonum laphifolium Sinapis arvensis Perennial root-sucker plants Nirsium arvense Sonchus arvensis Lactuca tatarica Involulus arvensis Vicia villosa Agropyron repens Equisetum arvense

What to do with table text?

Weed species diversity of vegetable production under different production systems

Straus, Sasa; Bavec, Franc; Rozman, Crtomir; Bavec, Martina
University of Maribor, Faculty of Agriculture and Life Sciences, SLOVENIA

Introduction

Over the last century the global ecosystem has come under risk from the intensification of agriculture. Arable weeds are increasingly seen as an important source of biodiversity and as crucial for the functioning of production systems (Gibson et al. 2007). The aim of this study is to investigate the differences between weed species in production systems at the field level.

Materials and methods

Three production systems (conventional [CON], integrated [INT] and organic [ORG]) and control plots were arranged in a randomized complete block split-plot design with four replications during three years. The production systems differed mostly in plant protection and fertilization strategies. In the CON, the preventive use of pesticides is allowed; in the INT, only the curative use is allow; and in the ORG, only natural pesticides are allow. In the INT and the ORG, fertilizing is based on a soil analysis, while in the ORG, the fertilizers are organic. In the control plots, no fertilization or plant protection was used. The size of the weed seedbank was determined for the 0–20 cm soil layer of each plot using the greenhouse emergence method (Teasdale et al. 2004). Sampling occurred at the beginning of March and at the end of September. Weed seedlings per species were converted to a number per m² of field surface. Species diversity was

calculated for both seedbank and weed communities using the Shannon-Weaver diversity index ($H' = -\sum(P_i \ln P_i)$), where P_i is the proportional contribution of each species to the total species number (Wortman et al. 2010). The H' was than analyzed with a two-way ANOVA and Fisher's LSD test.

Results and Discussion

Species diversity, as determined by the H' , was greatest in the ORG. Averaged across all sampling methods and years, the weed diversity index of the ORG was 0.86, followed by the INT (0.74), the CON (0.66), and the control plots (0.38). The differences were significant (Table 1). Other studies (Hyanon et al. 2003, Hawes et al. 2010, Wortman et al. 2010) have also found that weed species diversity was significantly higher in the ORG. The weed composition in the CON and the ORG is different. With the reduction of mineral fertilizers and pesticides in the ORG, the nitrofilic species and grass decreased. More sensitive species increased (Hawes et al. 2010). In the CON and INT plots, the most abundant weed species was *Viola arvensis*, an in the ORG *Polygonum lapathifolium*. The analysis presented here suggests that weed diversity is a good indicator of field production intensity. Agricultural management should be directed toward developing a production system that maximizes biodiversity, while minimizing weed density and ensuring sufficient yields.

Table 1: Shannon-Weaver diversity index (H') for white cabbage and red beet.

Production system	White Cabbage H'	Red beet H'
Conventional	0.66 ^c	0.59 ^c
Integrated	0.74 ^b	0.64 ^b
Organic	0.86 ^a	0.81 ^a
Control	0.38 ^d	0.32 ^d

The letters (a–d) indicate statistically significant differences between the production system at $p < 0.01$ (Duncan's multiple range test).

References

- Gibson RH et al. 2007. Plant diversity and land use under organic and conventional agriculture: A whole-farm approach. *J. Appl. Ecol.* 44: 792–803.
- Hawes C et al. 2010. Arable plant communities as indicators of farming practice. *Agric. Ecosyst. Environ.* 138: 17-26.
- Hyvonen T et al. 2003. Weed species diversity and community composition in organic and conventional cropping of spring cereals. *Agric. Ecosyst. Environ.* 97: 131–149.
- Teasdale JR et al. 2004. Weed seedbank dynamics in three organic farming crop rotations. *Agron. J.* 96: 1429-1435
- Wortman ES et al. 2010. Increased weed diversity, density and above-ground biomass in long-term organic crop rotations. *Renew. Agric. Food Syst.* 25: 281-295.

The effect of the selenium soil application on selenium accumulation and yield of oilseed rape (*Brassica napus* L.) and wheat (*Triticum aestivum* L.)

Ebrahimi, Nashmin¹; Seppänen, Mervi¹; Hajiboland, Roghieh²; Hartikainen, Helinä¹

¹University of Helsinki, FINLAND; ²University of Tabriz, IRAN (ISLAMIC REP.)

Introduction

Selenium (Se) is a vital micronutrient for humans, animals and microorganisms. Selenium has beneficial effects on the growth and stress tolerance of plants (e.g. Hartikainen *et al.*, 2000 and Seppänen *et al.*, 2003), but Se has not been established as an essential micronutrient for plants. In Finland Se availability in the soil is low so Se-enhanced mineral fertilizers have been used since 1984 to secure the recommended content in feed and food (Seppänen *et al.*, 2010). Only 10% of the applied Se is translocated to harvested seeds. The rest is maintained in the soil, leached or to some extent also lost to the atmosphere by volatilization. The environmental fates of unabsorbed Se is not yet known. As the soils in Finland are low in Se, the only solution to increase the Se content of food chain in the future is by Se fertilization. The environmental impacts of Se fertilization could be reduced if the translocation from leaves to developing seeds could be improved and as a consequence, the level of Se fertilization could be reduced. *Brassica* species are more efficient in Se uptake than wheat, could be used as catch crops to increase the Se uptake efficiency in agricultural practices.

Materials and methods

Se application levels were 7.2 and 25 g/hectare (field) and 7 and 140 µg/kg soil (greenhouse). In both experiments the uptake and translocation of Se was monitored by harvesting the plants at the different growth stages and by analysing their Se content by ICP-mass spectrometry from each plant parts (leaves, yellow leaves, stems, heads/siliques, seeds and roots). In addition to inorganic Se application in the greenhouse the Se-enriched plant residue (leaves and straw) was applied into the soil in quantities corresponding to 7 µg of total Se per kg of the soil.

Results

In the field and greenhouse experiments, the different Se treatments affected dissimilarly the dry matter of various plant parts. In the greenhouse, the dry matter of siliques increased as response to the Se-enriched leaf residue by 31%, but decreased by 20% as response to the Se-

enriched straw residue. In the field fertilized with Se 25 g/ hectare, the maximum of Se concentration in the stems and roots was 41.4±9.7 and 9.6±4.2 µg/g DW, then at the last harvesting, because of the plant internal cycle of Se, it decreased. Selenium was translocated to siliques where the concentration increased from 11.9±6.9 to 71.4±14.4 µg/g DW. In the greenhouse, the total Se uptake by whole oil seed rape plant supplied with the Se-enriched leaves residue, Se-enriched straw residue, low and high dosage of inorganic Se treatments were 22, 7, 74 and 1154 µg per plant, respectively.

Conclusions

At the seed filling stage (the third harvesting time), oil seed rape had taken up 60.2% and wheat 32.2% of the applied Se. At the maturity stage (the last harvesting), the percentage of Se uptaken by plants decreased, indicating that it was circulated back to the soil. The results showed that the Se is translocated to heads/siliques more than the others parts of plants at the end of growth. The inorganic Se was efficiently absorbed by plants whereas Se bound in plant residue form was less bioavailable. However, the organic Se in the leaf material was more bioavailable than that in the straw residue.

References

- Hartikainen, H., Xue, T. and Piironen, V. (2000), Selenium as an antioxidant and pro-oxidant in ryegrass, *Plant Soil*. 225: 193-200.
- Seppänen, M., Turakainen, M. and Hartikainen, H. (2003), Selenium effects on oxidative stress in potato, *Plant Science*. 165: 311-319.
- Seppänen, M., Konttori, J., Lopez-Heras, I., Madrid, Y., Camera, C. and Hartikainen, H. (2010), Agronomic biofortification of *Brassica* with selenium-enrichment of SeMet and its identification in *Brassica* seeds and meal, *Plant and Soil*. 337 (1-2): 273-283.

Heavy metal stress responses in white lupin and fibre hemp grown on soils polluted with chromium, copper and arsenic

Egilmez, Petra; Hartikainen, Helinä; Santanen, Arja; Seppänen, Mervi; Stoddard, Frederick; Yli-Halla, Markku; Mäkelä, Pirjo
University of Helsinki, FINLAND

Introduction

Plant abiotic stress responses include changes in physiological and biochemical processes as well as morphological and development patterns. Stress exposure is associated with oxidative damage at the cellular level resulting increased production of reactive oxygen species (ROS) (Le Martret et al. 2011). Most heavy metals are phytotoxic (Potters et al. 2007) and strong oxidants (Gwozdz et al. 1997). Heavy metal ions readily generate ROS (Rucinska et al. 1999). A variety of enzymes are involved in defence mechanisms such as peroxidases, catalase, superoxide dismutase (SOD) (Chen et al. 2002) and glutathione (GSH) (Pastore et al. 2003). GSH is a metal chelator, being an important antioxidant as well as a precursor for phytochelatins (PC) (Seth et al. 2012), which are known to be responsible for metal tolerance in many plants (Grill et al. 1987). Another response to abiotic stresses, is the induction of architectural changes in plants (Pasternak et al. 2005). Inhibition of root elongation, enhanced formation of lateral roots, thickening of roots, increases in root density and root diameter are symptoms of exposure to heavy metals (Rucinska et al. 1999).

Chromated copper arsenate (CCA) is a wood preservative that has contaminated areas around the world with

chromium, copper and arsenic. The impact that these chemicals have on plants and their root systems is critical to understand, as it may contribute the phytoremediation of CCA contaminated soils. As a main entrance, the root system plays an important role in the defence mechanism to heavy metals stress. In present study we determined germination, seedling growth, root architecture, and root anatomy after having subjected seeds to different concentrations of Cu, Cr, and As. In addition, the production of antioxidant enzymes, glutathione, and H₂O₂ production will be measured.

Materials and methods

Three Petri-dish experiments were conducted by using white lupin (*Lupinus albus* L. cv. Amiga) and fibre hemp (*Cannabis sativa* L. cv. Chamaeleon). Seeds were disinfected and sown to Petri-dishes, supplemented with plant agar 2 % with 10 replicates and grown in the growth chamber. Pollutants were added into agar in three Cu-Cr-As mixtures: 50-50-15 mg kg⁻¹, 100-100-5 mg kg⁻¹ and 300-150-50 mg kg⁻¹. Different concentrations of each heavy metal existed also alone. Heavy metals used were Cu as CuSO₄, As as Na₂HAsO₄ and Cr as K₂Cr₂O₇. The controls did not contain any pollutants. The seedlings were collected after 10 days and the germination, shoot weights, root lengths, lateral root numbers and lateral

Table 1. Effect of Copper, Chromium and Arsenic on shoot weight, root length, lateral root number and lateral root density of fibre hemp and white lupin. Data are means of ±SE, n =30

Treatment mg kg ⁻¹	Shoot weight FW g ⁻¹	Root length cm ⁻¹	Lateral roots nr	Lateral root density lateral roots / cm ⁻¹
Fiber hemp				
Control	0.079±0.003	7.51±0.42	9.5±1.4	1.27
Cu 100	0.043±0.002	2.65±0.18	2.1±0.5	0.79
Cr 100	0.063±0.022	3.09±0.21	4.9±1.2	1.57
As 15	0.061±0.003	3.93±0.36	5.8±1.0	1.48
Cu100:Cr100:As5	0.047±0.002	2.94±0.21	2.7±0.9	0.91
White lupin				
Control	1.651±0.068	7.53±0.33	30.0±1.3	3.99
Cu 100	1.228±0.050	1.74±0.08	11.3±1.1	6.49
Cr 100	1.074±0.045	2.14±0.16	11.3±1.0	5.29
As 15	1.489±0.074	7.95±0.46	29.9±2.5	3.76
Cu100:Cr100:As5	1.195±0.048	1.54±0.11	11.2±0.8	7.27

root densities were determined. For anatomical studies of roots, cross-sections were cut with a microtome, stained, and photographed with a digital camera connected to a light microscope. Oxidative stress results are shown afterwards.

Results

When Cu, Cr, and As are in excess, the plants undergo major architectural changes (Table 1) in terms of lateral root number, lateral root density, primary root length, and root weight, in addition to anatomical changes in root epidermis, root cortex, and enhancement of lignification.

References

- Chen, E.L., Chen, Y.A., Chen, L.M., Liu, Z. 2002. *Plant physiol. Biochem.* 40:439-444.
- Grill, E., Winnacker, E.L., Zenk, M.H. 1987. *proc. natl. acad. sci.* 84:517-524.
- Gwozdz, E.A., Przymusinski, R., Rucinska, R., Deckert, J. 1997. *Acta Physiol. plant.*, 19:459-465.
- Le Martret, B., Poage, M., Shiel, K., Nugent, G.D., Dix, P.J. 2011. *J.Plant Biotech.* 9:661-673.
- Pasternak, T., Rudas, V., Potters, G., Jansen, M.A.K. 2005. *Environ. Exp. Bot.* 53:299-314.
- Pastore, A., Federici, G., Bertini, E., Piemonte, F. 2003. *Clinica Chimica Acta* 333:19-39.
- Potters, Pasternak, T.P., Guisez, Y., Palme, K.J., Jansen, M.A.K. 2007. *Trends Plant Sci.* 12.
- Rucinska, R., Waplak, S., Gwozdz, E.A. 1999. *Plant physiol. Biochem.* 37:187-194.
- Seth, C.S, Remans, T., Keunen, E., Jozefczak, M., Gielen, H., Opdenakker, K., Weyens, N., Vangronsveld, J., Cuypers, A. 2012. *Plant, Cell & Environ.* 35:334-346.

Do endogeic earthworms enhance N transfer in cereal legume intercrops

Joly, François-Xavier; Cannavacciuolo, Mario; Cassagne, Nathalie; Fustec, Joëlle

LUNAM Université, Groupe ESA, UR LEVA, FRANCE

Introduction

Biological fixation of legumes is a sustainable source of N that can help to complement or replace fertilizer inputs. Growing a legume with a non-fixing species leads to a more efficient use of soil resource, with positive effect on productivity (Corre-Hellou *et al.* 2007). In grasslands, it has also been shown that non-fixing species can benefit from N provided by the neighboring legumes (Pirhofer-Walzl *et al.* 2012). Earthworms increase mineralization in the soil, so they may enhance N transfer between plants (Zhang *et al.* 2010). We aimed i) to quantify N transfer between pea and durum wheat, and 2) to study the effect of endogeic earthworms on root morphology in intercrops.

Materials and methods

Pea plants (*Pisum sativum* L. cv. Frisson) and durum wheat (*Triticum turgidum* 'LA 1823') were grown alone (1 pea or 2 wheats) or intercropped in 10-l pots until seed maturity of peas (n = 20). Pots were filled with a N-poor soil (8 mg kg⁻¹ NO₃⁻) inoculated with *Rhizobium leguminosarum* bv. *viciae*. From the 6-leaf stage of pea, five earthworms (*Aporrectodea caliginosa caliginosa* Savigny (1826)) were added in half of the pots. Using the cotton wick method (Mahieu *et al.* 2009), peas were labelled with ¹⁵N-urea (99% atom ¹⁵N) in five pots of each treatment. At harvest, roots were separated from

the soil, and the different samples (shoots of pea and of wheat, roots of pea and of wheat, soil, earthworms) were dried, ground to a fine powder and prepared for ¹⁵N:¹⁴N mass spectrometer measurements. Unlabelled controls were used for assessing biological fixation (Hansen and Vinther 2001) and N transfer (Gylfadottir *et al.* 2007). In addition, intercrops (1 pea with 1 wheat) were grown in rhizotrons with or without earthworms; the development of roots was regularly surveyed during 45 days and analyzed with GIS (n = 4).

Results

In the pots in which the pea plant was labelled, ¹⁵N enrichment of *A. caliginosa* significantly increased (p < 0.001) indicating the earthworms were active during the experiment. Dry weights of pea and of wheat were not altered either by intercropping or by earthworm activity. Because of competition for the soil N, biological nitrogen fixation of pea was higher in intercrops than in sole crop (86.9 ± SE 3.5% and 77.5 ± SE 6.8% respectively, p < 0.01). However, the amount of N transferred from pea to wheat was weak, and we could not notice any significant effect of earthworms on that result: 3.14 mg N (SE 1.15 mg) and 1.90 mg N (SE 0.42 mg) were transferred from pea to durum wheat, with and without earthworms respectively (p > 0.05). After 45 days, the root length of wheats grown in rhizotrons with earthworms (451 ± SE 56 cm) was not different from that of those without worms (472 ± SE 44 cm, p > 0.05). Earthworms did not alter the number of secondary roots as well. Conversely, in pea, the root length was 23.7% lower in the rhizotrons with earthworms than in the others (p < 0.01). This difference in pea occurred from about a week after sowing, and went on increasing progressively until the end of the root survey (Fig. 1). The number of secondary roots of peas was lower in the rhizotrons with earthworms than in the others (p < 0.001).

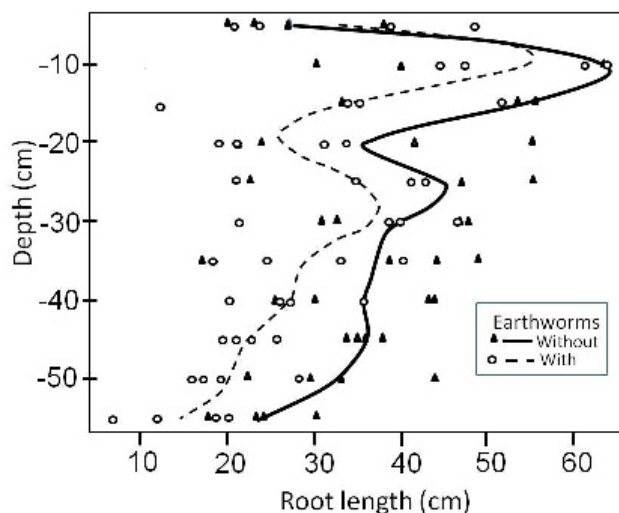

Fig. 1. Root length of pea plants intercropped with durum wheat at different depths

Conclusions

Despite the weak soil N availability, the amount of N taken up from pea by durum wheat remained low, so we did not measure any effect of earthworms on N transfer. *A. caliginosa* markedly affected root morphology, and may reduce intermingling of roots in intercrops. However, root intermingling has been shown to enhance N transfer in intercrops (Jensen 1996).

References

- Corre-Hellou *et al.* 2007. *Plant Soil* 282, 195–208.
- Gylfadottir *et al.* 2007. *Plant Soil* 297, 93–104.
- Hansen and Vinther 2001. *Plant Soil*, 230, 257–266.
- Jensen 1996. *Soil Biol. Biochem.*, 28, 159–168.
- Mahieu *et al.* 2009. *Soil Biol. Biochem.*, 41, 2236–2243.
- Pirhofer-Walzl *et al.* 2012. *Plant Soil* 360, 71–84.
- Zhang *et al.* 2010. *Agric. Ecosyst. Env.*, 139, 463–468.

Soil management effects on soil properties and yield components of an irrigated olive orchard

Caruso, Giovanni¹; Gucci, Riccardo¹; Pellegrini, Sergio²; Pagliai, Marcello²; Vignozzi, Nadia²

¹University of Pisa, ITALY; ²CRA-ABP Centro di Ricerca per l'Agrobiologia e la Pedologia, ITALY

Introduction

The sustainable use of resources is crucial in Mediterranean areas, where water scarcity and soil degradation are major threats to agricultural production. In this respect, tillage exposes the soil to erosion, structure degradation and acceleration of organic matter decomposition (Pagliai et al., 2004). On the contrary, the use of cover crops is currently the recommended practice for protection of the orchard floor because it decreases soil erosion and surface crusting and increases water infiltration and accumulation of organic matter in the soil (Pagliai et al., 2004).

Materials and methods

We compared performance of deficit-irrigated (about 50% of full irrigation) olive (*Olea europaea* L.) trees grown under either tillage (CT) or permanent natural cover (NC) in a sandy-loam soil over six years and determined changes in physical soil properties. The soil was tilled from the year of planting (2003) until October 2004, when both treatments were established. The CT treatment was kept weed-free by disking (about 0.10 m depth), whereas the NC was obtained by letting the natural flora grow. All trees were similarly irrigated from the year of planting

until the 2006-growing season, when deficit irrigation was started for both soil treatments. At harvest each tree was harvested individually by hand and 50-100 fruits were randomly sampled to measure average fruit weight and maturation index. The oil content of the fruit mesocarp of five fruits per tree was measured by nuclear magnetic resonance using an Oxford MQC-23 analyzer (Oxford Analytical Instruments Ltd., Oxford, UK). In 2010 soil macroporosity was measured in vertically oriented thin sections obtained from undisturbed soil samples collected at different depths along the soil profile. At the same position of undisturbed soil sampling, water infiltration rate was determined using a Guelph Permeameter 2800 (Soil moisture Equipment Corp., Santa Barbara, USA).

Results and Discussion

Soil macroporosity was significantly affected by soil management only at the surface (0-0.10 m) where NC showed higher (+61%) values than CT. This difference resulted mainly from the higher frequency of irregular and elongated pores in NC treatment with respect to CT ones. Water infiltration rate measured in CT plots was about eight times lower than that in the NC treatment. The fruit and oil yields of trees managed by tillage were significantly higher than those of trees grown with a

Table 1. Yield components, yield efficiency (Fruit yield/TCSA or Oil yield/TCSA), and maturation index (MI) of young olive trees (cv. Frantoio) subjected to two different soil management systems. Values are means of six years (2006-2011). Different letters within each column indicate least significant differences (LSD) at $p < 0.05$ after ANOVA ($n = 4-6$ trees per treatment).

Soil management	Fruit yield (g tree ⁻¹)	Fruit yield/TCSA (g dm ⁻²)	Fruits per tree	Fruits/TCSA (no dm ⁻²)	Oil yield (g tree ⁻¹)	Oil yield/TCSA (g dm ⁻²)	Fruit FW (g)	MI	Oil in mesocarp (% DW)
Natural cover	11528 b	10742	5616 b	5160 b	2394 b	2329	2.11 a	3.1	68.5
Tillage	17693 a	12331	10590 a	7242 a	3460 a	2461	1.75 b	2.6	68.1
LSD (0.05)	4024	3131	2517	1764	733	664	0.193	0.60	2.59

TCSA: trunk cross sectional area; FW: fresh weight; DW: dry weight.

permanent natural cover (154 and 145% of NC trees, respectively). However, when yields were expressed on a trunk cross sectional area (TCSA) basis, there were no significant differences between soil treatments. The number of fruits of the NC trees was significantly lower than that of the CT ones, whereas the oil content and the maturation index were similar for both treatments. In our trial the difference in soil macroporosity can be mainly attributed to the vegetation cover that protected the soil surface from the raindrop impact, thus reducing mechanical disruption of soil aggregates. The increase in fruit weight and the lack of an effect on oil content that we observed for the NC treatment were likely due to crop level (Gucci et al., 2007) rather than soil management practices. Similarly, Gomez et al. (1999) did not find any yield differences between olive trees grown with conventional tillage or no tillage under rain-fed conditions. In order to reduce the potentially negative effects on vegetative growth the establishment of permanent covers should be delayed to the third or fourth year after planting.

References

- Gómez J.A., Giraldez J.V., Pastor M., Fereres E., 1999. Effects of tillage method on soil physical properties, infiltration and yield in an olive orchard. *Soil Till. Res.* 52:167-175.
- Gucci R., Lodolini, E. Rapoport H.F., 2007. Productivity of olive trees with different water status and crop load. *J. Hort. Sci. Biotech.* 82:648-656.
- Pagliai M., Vignozzi N., Pellegrini S., 2004. Soil structure and the effect of management practices. *Soil Till. Res.* 79:131-143.

Soil management affects seasonal soil respiration rates in a high density olive orchard

Caruso, Giovanni; Gennai, Clizia; Gucci, Riccardo

University of Pisa, ITALY

Introduction

Carbon assimilation of fruit trees has been extensively studied, but little information is available on soil respiration. Soil temperature and moisture are major factors influencing soil respiration (Li et al., 2008). In addition, cultural practices affecting root distribution, plant growth and soil microbiological activity, such as irrigation and soil management (Carpenter-Boggs et al., 2003), may play a key role in C emission from the soil.

Materials and methods

We investigated the effect of two different soil management methods on soil respiration rate (R_s) in

an irrigated, high-density olive (*Olea europaea* L. cv. 'Frantoio') orchard in a sandy-loam soil subjected to either tillage (CT) or permanent natural cover (NC). The soil was tilled from the year of planting until the end of the second growing season, when both soil management treatments were established. The CT treatment was kept weed-free using a harrow with vertical blades (0.10 m depth), whereas the NC was obtained by letting the natural flora grow. Both treatments received full irrigation in the first three years after planting, then deficit irrigation (about 50% of full irrigation) was started for both soil treatments. Soil respiration rates were measured at approximately monthly intervals using a closed-chamber system connected to an infrared gas analyzer (Soil Respiration System, PPSystems, UK) at four sampling points below

Table 1. Soil respiration rate, soil moisture and soil temperature averaged over 3 month-periods (season) in an olive orchard subjected to two different soil managements: Natural cover, NC; Tillage, CT. Values are means of three replicate trees per treatment (n = 3). Different letters indicate least significant differences (LSD) between treatments after ANOVA within each season ($p \leq 0.05$).

Season	Soil management	Soil respiration rate ($\mu\text{mol CO}_2 \text{ m}^{-2} \text{ h}^{-1}$)	Soil moisture (% vol)	Soil temperature ($^{\circ}\text{C}$)
Summer 2010	NC	3.44 a	14.0	19.5
	CT	2.40 b	12.0	19.3
Autumn 2010	NC	2.64 a	27.3	6.7
	CT	1.69 b	23.5	6.6
Winter 2011	NC	1.57	27.7	2.5 b
	CT	1.25	24.6	3.4 a
Spring 2011	NC	2.18	18.6	13.8
	CT	1.50	18.6	14.5
Summer 2011	NC	2.49 a	2.5	22.4
	CT	1.68 b	2.2	22.0
Autumn 2011	NC	1.70 a	28.2	9.9
	CT	0.96 b	24.0	9.9
Winter 2012	NC	1.37 a	13.1	6.3
	CT	0.73 b	13.1	5.8

the canopy, varying in orientation and distance from the trunk, and at one sampling point in the inter-row. Soil temperature was measured at a depth of 0.08 m using the SRS probe, soil moisture at a depth of 0.06 m using a ThetaProbe ML2x (Delta-T Devices, UK). Treatment means were separated by least significant difference (LSD) after analysis of variance (ANOVA) using three replicate trees. Values for each tree were the average of the four below canopy measurements.

Results and Discussion

Soil R_s of the NC treatment was always higher than that of CT trees. The seasonal courses of R_s showed wide differences within each treatment due to changes in environmental conditions. Maximum and minimum R_s were 3.44 (summer 2010) and 1.37 (winter 2012) $\mu\text{mol CO}_2 \text{ m}^{-2} \text{ h}^{-1}$, for the NC treatment, respectively, and 2.40 (summer 2010) and 0.73 (winter 2012) $\mu\text{mol CO}_2 \text{ m}^{-2} \text{ h}^{-1}$ for CT, respectively (Tab. 1). A large difference between the two treatments was measured in winter 2012, when R_s of NC treatment was 88% higher than that of CT ones. In general, soil moisture and temperature were similar for both treatments. In winter soil respiration was limited by low temperature, whereas soil moisture was the main factor controlling respiration in the summer, as also evident in Mediterranean ecosystems where soil moisture becomes limiting during long periods of summer drought (Joffre

et al., 2003). Soil respiration includes root respiration, microbial respiration and decomposition of plant litter and root exudates. The presence of grass roots may have significantly contributed to increase CO_2 fluxes because of their respiration and decomposition. Carpenter-Boggs et al. (2003) reported that soil managed under permanent grass cover supported approximately 50% greater soil respiration than tilled soil, because of the higher contents of labile C compounds and microbial biomass. Our results are relevant because of the wide acreage (almost 10 million ha) where olive trees are grown worldwide and the trend towards using natural covers in orchards.

References

- Carpenter-Boggs L., Stahl P.D., Lindstrom M.J., Schumacher T.E., 2003. Soil microbial properties under permanent grass, conventional tillage, and no-till management in South Dakota. *Soil Till. Res.* 71(1):15-23.
- Joffre R., Ourcival J.M., Rambal S., Rocheteau A., 2003. The key-role of topsoil moisture on CO_2 efflux from a Mediterranean *Quercus ilex* forest. *Ann. For. Sci.* 60:519-526.
- Li H.J, Yan J.X., Yue X.F., Wang M.B., 2008. Significance of soil temperature and moisture for soil respiration in a Chinese mountain area. *Agr. For. Met.*, 148:490-503.

Plant microbe interaction to increase microbial diversity in permanent crops

Manici, Luisa M.¹; Caputo, F.¹; Terzi, V.¹; Kelderer, M.²; Stanca, M.³; Terzi, V.¹; Kelderer, M.²; Stanca, M.³

¹C.R.A., ITALY; ²Laimburg Research Centre for Agriculture and Forestry, ITALY; ³University of Modena and Reggio Emilia, ITALY

Introduction

Permanent crops such as fruit tree crops are affected by soil fertility decline (of which replant disease is a consequence) caused by progressive reduction of soil microbial biomass and diversity. The two main components of biological soil fertility, microbial biomass and diversity, are mainly affected by environmental conditions. Microbial biomass is proportional to Total Organic Carbon content in soil, whilst microbial diversity, is mainly affected by edaphic conditions and pH. Fungal and bacterial communities are primarily responsible for soil functioning processes. Soil filamentous fungi saprophytically living in soil can establish symbiotic relationships with host plants. Their impact ranges from mutualistic (beneficial effect) to pathogenic, varying in severity from decreased growth rates to the death of the plant, depending on host susceptibility and environmental conditions (Redman *et al.*, 2001). The pathogenic fungal root endophytes have a large host range; however, there is a partial specificity of those organisms. Cereals represent a typical “restoring” crop in rotation cycles; among many known positive features, cereals also show low specificity toward *Rhizoctonia* and *Cylindrocarpon* agents of root rot in apple and strawberry. Therefore a preliminary evaluation of cereals as cover crops, based on plant-microorganism relationship was carried out within the ENDOBIOFRUIT project funded by Mi.P.A.A.F.

Materials and methods

Barley and triticale varieties were chosen on the basis of their genetic characteristics, agronomic traits and tissue composition. A greenhouse trial was performed using soil samples (sandy loam soil with 2% organic matter content) taken from a third-generation apple orchard in North Adige Valley (Italy) affected by biological fertility decline corresponding to a 38% growth in comparison to a fallow control recorded in a previous bioassay test using M9 rootstock plantlets (Kelderer *et al.*, 2012). Soil samples were arranged in 18 pots 10 x 10 x 15 cm; barley cv. Tidone and triticale cv. Oceano were sown and grown for 70 days, then they were harvested and roots were subjected to analysis of colonization frequency and identification of species in laboratory. Biodiversity indices of fungal endophyte communities of barley and triticale were compared using PAST software available on web.

Results and discussion

Barley and triticale showed a significantly different root colonization frequency ($P > 0.05$), which was 52% for barley and 88% for triticale. Endophyte communities of barley showed higher diversity and balance than triticale as suggested by comparison of several biodiversity indices (Table. 1). The most abundant root colonizing species on cereals was *Pythium* spp, which represented 88% in triticale and 52% in barley. No fungal endophytes isolated from cereals belonged to the complex of pathogens able to colonize M9 apple rootstock grown in the same soil, among which *Cylindrocarpon* spp. and *Rhizoctonia* spp. had previously been found to be components of growth reduction. *Pythium* spp., known as potential agents of replant disease, showed high specificity toward triticale, whilst barley hosted endophyte communities



Fig. 1
Barley roots
after growing test
on soil from
apple orchards

Table 1. Diversity indices of endophytic fungal communities of barley and triticale

Diversity indices	Barley	Triticale	P*
Dominance	0,40	0,83	0.001
Shannon H	1,37	0,37	0.001
Simpson	0,60	0,17	0.001
Fisher alpha	2,44	0,73	0.001
Berger-Parker	0,61	0,91	0.001

* significance (P) according bootstrapping procedures evaluated using PAST program available in web

characterized by highest diversity. Therefore, findings of this preliminary study suggested that barley is more suitable than triticale to increasing microbial diversity and reducing aggressiveness of root rot fungal agents toward the fruit tree crops.

References

Kelderer M., Manici L., Caputo F., Thalheimer M. (2012) Planting in the 'inter-row' to overcome replant disease in apple orchards: A study on the effectiveness of the practice based on microbial indicators. in press *Plant and Soil* doi:10.1007/s11104-012-1172-0

Redman R.S., Dunigan D.D., Rodriguez R.J. (2001) Fungal symbiosis from mutualism to parasitism: who controls the outcome, host or invader? *New Phytol* 151:705–716

Soil Biological fertility: effect of two manure systems in two forage crop rotation under two mineral nitrogen inputs

Motta, Silvia Renata¹; Cabassi, Giovanni¹; Borrelli, Lamberto¹; Valagussa, Massimo²; Degano, Luigi¹

¹CRA, ITALY; ²Fondazione Minoprio, ITALY

Introduction

Soil carbon management arose to public attention because of its impact on soil fertility and atmosphere CO₂ regulator. In a warming world, soil fertility must be a primary goal as elevating temperatures increase soil respiration and N mineralization. Thus better practices to control depauperation of fertility and carbon accumulation need appropriate investigation. Because soil is a complex system ensuing from the interaction of a great number of physical, chemical, biochemical and biological parameters (Young and Crawford, 2004), the changes in soil characteristics due to managing organic matter, is not readily predictable. Agricultural long term experiment may provide valuable data to evaluate cropping systems and their possible threat to soil fertility decline.

Materials and methods

In 1993 a long-term agronomical experiment was initiated with the aim to evaluate intensive forage production systems and their effect on productivity and soil quality based upon the milk feed unit (MFU) able to maintain. Experimental site was located by the Baroncina experimental farm, south West of Lodi, Regione Lombardia, North of Italy. In the experiment we compared two forage systems, including different

nitrogen application and manure application. The system used as reference is a high input one with a 1-year rotation with double cropping of Italian ryegrass (*Lolium multiflorum* Lam.) followed by a silage maize (R1), and the more sustainable system is a 6-year rotation with Italian ryegrass- silage maize for three years followed by three years of alfalfa (R6) under four fertilization treatments: two different manures (farm yard manure FYM and semi-liquid manure SLM) with or without top-dressed urea (not applied to alfalfa). Plots were 10 x 15 m. The experimental design is a strip-split-plot with three replications. Soil samples were taken at 30 cm depth and analyzed for the main chemical-physical characteristics and soil biological fertility. Organic amendment was 57% on maize and 43% on Italian ryegrass, mineral nitrogen fertilizer was spread 67% on maize and the remaining 33% on the Italian ryegrass.

Results

The organic matter (OM) content increased with the use of FYM as well as total nitrogen (Nt) and the cation exchange capacity (CEC), while the ratio C/N did not change because both parameters increase by 20% by FYM. The basic saturation rate (BSR) was improved by FYM and by the interaction between nitrogen input and rotation: annual rotation and lower N input gave higher BSR value, likely because of the smaller productivity of

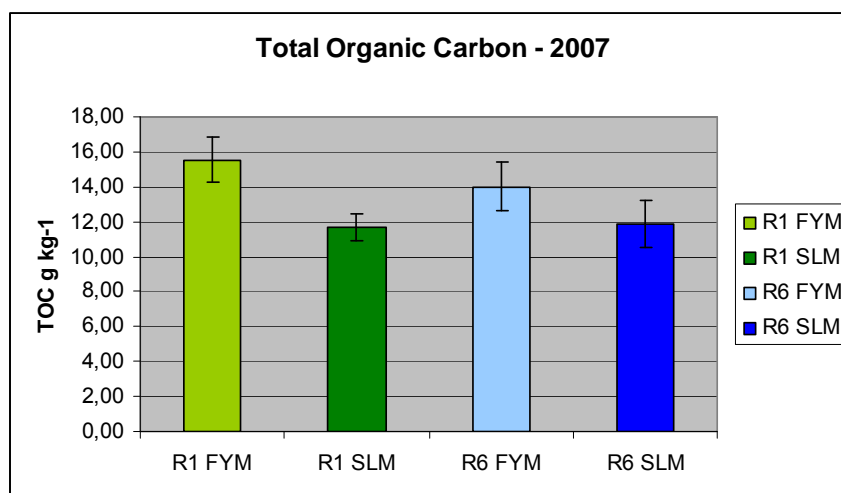

Figure 1 – Total Organic Carbon for Cropping system and input.

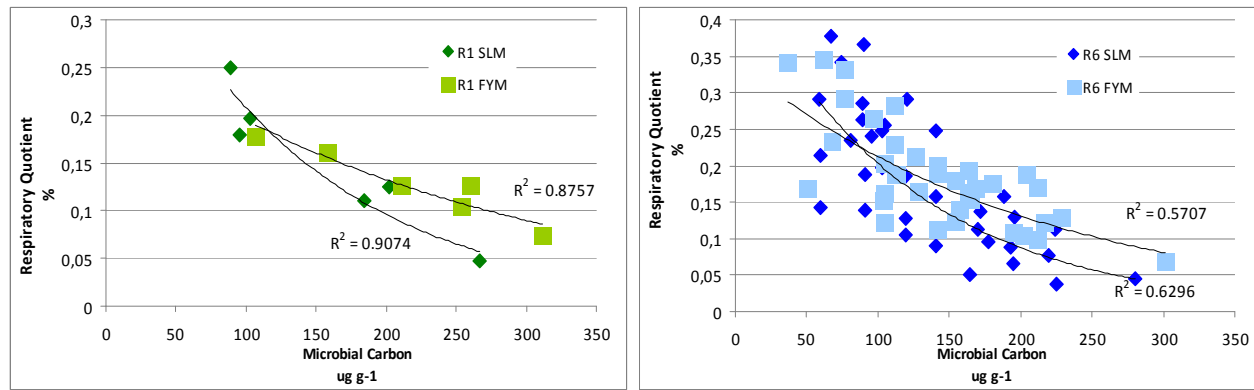

Figure 2 – Respiratory Quotient vs Microbial Carbon for different cropping system and organic fertilizer.

the crop. FYM affected positively Cumulative and Basal respiration and total extract carbon (TEC) and fertility index (IF). Liquid manure enhanced only the respiratory Quotient (QCO₂). Annual rotation favored Basal respiration, total organic carbon (TOC), TEC, Humic and Fulvic Acid (HAFA), humification index (HI), humification rate (HR) and Potential mineralized nitrogen (Npm). Low Nitrogen input enhanced Cumulative and Basal respiration as well as metabolic quotient. Metabolic Quotient (MQ) increased with suboptimal addition of nitrogen but was not dependent from organic addition or rotation, while respiratory quotient (QCO₂) is enhanced by SLM. Microbial carbon (Cmicr) and its ratio with TOC are unaffected by any of the factor tested, while TOC is positively affected either by annual rotation and optimal nitrogen input, both enhancing productivity and hence higher cultural residual returned to soil.

Conclusions

The results evidenced that the main effect on the soil fertility was given by the different organic fertilization while the effect of the crop rotation was minimized. The cattle farmyard manure was the best crop management practice, able to integrate the fertility of soil both in terms of Milk Feed Units (MFU) production and in maintaining a higher carbon level in soil.

References

Young I.M. and Crawford J. W., 2004. Interactions and self-organization in the soil-microbe complex. *Science* 304:1634-1637.

Nitrous oxide emissions and microbial communities in the rhizosphere of combinable pea cultivars

Pappa, Valentini; Zidou, Anastasia; Knox, Oliver; Fountaine, James; Rees, Robert M.
Scottish Agricultural College, UNITED KINGDOM

Introduction

Agriculture is the main source of nitrous oxide (N_2O) emissions released from soil to the atmosphere, representing the 60% of the global N_2O emissions. Nitrification and denitrification are the major microbial sources of N_2O in soil. N_2O accounts for 8% of the current greenhouse effect. Biological Nitrogen Fixation (BNF) is the major natural process that provides agricultural soil with a valuable form of nitrogen (N), through the use of legumes in cropping systems. The use of legumes in agricultural systems constitute a source of N_2O emissions that can be comparable to N fertiliser based systems despite the low external N inputs or in some cases greater. The emissions are attributed mainly to root exudates (nodules) during the growing season as well as to crop residue decomposition following the harvest rather than the actual BNF process. The aim of this study was to explore the relationship between the composition of microbial communities in nodules and soil rhizosphere and N_2O fluxes.

Materials and methods

A 36 microcosm greenhouse-based experiment was established including three different combinable pea cultivars (Crackerjack, Nitouche and Zero4) to measure GHG fluxes from below and above ground, extractable soil N content, WFPS, total N/C in soil and plants in relation to molecular techniques and identify the differences in the microbial composition between the cultivars and relate it with N_2O fluxes.

Results

Cumulative N_2O emissions from Crackerjack ($2.15 \text{ kg } N_2O\text{-N ha}^{-1}$) were significantly greater than those from Nitouche ($1.60 \text{ kg } N_2O\text{-N ha}^{-1}$) and Zero4 ($1.67 \text{ kg } N_2O\text{-N ha}^{-1}$). Nitrous oxide emissions were strongly correlated with the grain yield; highest in Crackerjack (10.12 kg ha^{-1}), followed by Nitouche (8.73 kg ha^{-1}) and Zero4 (8.20 kg ha^{-1}). Cumulative N_2O emissions from barley ($1.49 \text{ kg } N_2O\text{-N ha}^{-1}$) also indicated the crucial role of increased N availability which became apparent in the late growth stage of treatments. Findings of the amplified 16S rRNA in nodules suggested one band for all the treatments but also, one additional band in two replicates of Crackerjack. Genetic identification showed that all the species belonged to *Rhizobium leguminosarum*. However, the strains of Crackerjack and Zero4 belonged to the biovar trifolii and viciae, respectively. Differences between the treatments were recorded from RISA profiling of nodules, but mainly based on the species number. The Jaccard index suggested a different microbial structure between Crackerjack and Zero4.

Conclusions

Under the acknowledgement that the climate is changing, the investigation of microbial sources of N_2O emission is essential to implement more efficient mitigation strategies. This reflects the complexity to determine which legume based crop, even in a level of variety, is more efficient for a legume based system.

A short-term study on the influences of fertilizer sources on soils

Sardi, Katalin; Máté, Ferenc
University of Pannonia, Hungary

Introduction

Soil acidification is one of the main limiting factors of soil fertility in Hungary resulting from intensive land use, the improper use of fertilizers as well as acid rain and atmospheric deposition. Acid-producing fertilizers, especially several N fertilizers may produce chemical reactions in soils which may lead to rapid acidification processes and decreasing soil fertility by reducing the nutrient supplying capacity of soils especially for N and P.

Materials and methods

For studying the short-term influences of fertilizer sources on acidity in typical soil types of Western Hungary, pot experiments were carried out for 4 weeks under greenhouse conditions in 5 treatment combinations. Two crop species, alfalfa (*Medicago sativa* L.) and spring barley (*Hordeum vulgare* L.) were used as test plants. Potential (hydrolytic) acidity of soils (Y_1 value) was determined in a 1N Ca-acetate solution. pH_{KCl} values of soils were ranging between 4.7 and 5.9 whereas Y_1 values were between 1.58 and 13.5 (Table 1). Three soil types were used in the experiments: a lessivated brown forest soil, Haplic luvisol, labeled A, a pseudogleyic brown forest soil, Stagnic luvisol, labeled B and an acidic sandy soil, Chromic luvisol, labeled C.

Table 1. Main characteristics of experimental soils.

SOIL	pH _{H2O}	pH _{KCl}	Y_1	Humus %	N _{min} mg kg ⁻¹	AL-P ₂ O ₅ mg kg ⁻¹	AL-K ₂ O mg kg ⁻¹
A	4.9	4.7	13.5	3.9	33.5	29.7	152.7
B	5.9	5.7	9.2	2.3	9.8	39.7	86.6
C	6.02	5.9	1.58	0.99	14.07	215.9	61.4

Table 2 DM production of plants

Treatments	Alfalfa			Spring barley		
	Soil			Soil		
	A	B	C	A	B	C
1	2.39 a	1.44 a	0.68 a	3.23 a	1.34 a	1.29 a
2	3.60 b	1.46 a	0.85 ab	3.79 a	1.36 a	1.49 a
3	4.1 bc	1.75 b	1.09 ab	4.03 b	1.39 a	1.84 b
4	4.3 c	2.55 c	1.53 bc	4.26 b	3.49 b	2.34 c
5	4.4 c	3.1 d	1.65 c	4.46 b	4.55 c	2.97 c
LSD 4.5%	0.6	0.28	0.6	0.73	0.4	0.26

Table 3 Hydrolytic acidity (Y_1) after the pot experiment

Treatments	Alfalfa		Spring barley	
	Soil		Soil	
	A	B	A	B
1	12.1	6.02	14.1	6.9
2	12.7	6.3	14.3	8.2
3	12.9	6.8	14.9	8.6
4	11.7	5.8	13.5	7.2
5	10.1	5.3	12.6	6.9
LSD 4.5%	1.9	0.9	0.8	0.7

Treatments:

- 1 Unfertilized control
 - 2 N₁P₁K₁ acid-producing fertilizer forms (Ammonium sulphate, Superphosphate, Potassium Sulphate)
 - 3 N₂P₂K₂ acid-producing fertilizer forms, double rate
 - 4 N₁P₁K₁ alkaline fertilizer forms (Calcium nitrate, potassium dihydrogen phosphate)
 - 5 N₂P₂K₂ alkaline fertilizer forms, double rate
- Fertilizer rates: N₁ = 100 mg kg⁻¹ N, P₁ = 60 mg kg⁻¹ P₂O₅, K₁ = 90 mg kg⁻¹ K₂O.

At harvest, average DM production, amounts of nutrients taken up by plants were determined, actual (pHH₂O) and potential soil pH was measured before setting and at the end of the experiments.

Results and Discussion

Crop growth significantly responded to the properties of the soils and to the fertilizer sources applied (Table 2). Differences in DM production of plants were highly significant, evidently showing plant responses to fertilizer sources. With the application of alkaline fertilizer forms, dramatic increases could be observed in these

parameters. Influences of acid-producing fertilizers could be observed both in the tendencies of soil pH values and hydrolytic acidity of soils (Table 3).

Changes in pH were most significant in the Stagnic luvisol (soil B) where the decrease of potential/exchangeable acidity (pHKCl) after alfalfa: 1.27 pH value, resulted by the double rate of acidifying fertilizers. This is evidently related to soil properties and to differences between crop species in their ion absorption characteristics. At the same time, hydrolytic acidity (Y₁ value) was significantly higher in these treatments showing the rapid acidification process in experimental soils which could not be demonstrated from other soil parameters. Therefore, it was concluded that this parameter proved to be the most reliable indicator of rapid soil acidification. From these results it was evident that unfavourable impacts on soil may occur in a very short period when acid-producing fertilizers are used especially in soils having lower buffering capacities.

Acknowledgements

This paper was published with the support of the project TÁMOP-4.2.2./B-10/1-2010-0025.

Soil quality indicators in intercropped legume/barley systems in a Mediterranean area

Tortorella, Demetrio; Scalise, Antonella; Petrovičová, Beatrix; Monti, Michele; Gelsomino, Antonio
Università degli Studi Mediterranea di Reggio Calabria, ITALY

Introduction

Ecological services arise from the ecosystems' functions, and include the provision of products, the regulation of climatic factors and pedogenesis and the support in processes such as nutrient cycling and decomposition of necromasses. Legume plants can provide some important agro-ecological services, such as the atmospheric nitrogen fixation performed by the symbiotic bacteria in root nodules. Legume plants are efficiently usable for intercropping, in order to enhance the crops' utilization of light, water and nutrients for their conversion to crop biomass. Managing the agro-ecological resources is a main challenge for the European Community. Within the 7th Framework Programme (FP7, Knowledge Based Bio-Economy - KBBE), the Partnership Project named Legume Futures (<http://www.legumefutures.de>) focuses on evaluating cropping systems using legumes as providers of agro-ecological services. The quality of a soil represents its capacity to sustain biological productivity, maintain environmental quality and promote plant and animal health. Soil quality can only be evaluated through measuring some of its attributes considered as indicators.

Materials and methods

The aim of this study is to assess soil quality responses through an integrated analysis of chemical, biochemical and biological indicators in a Mediterranean area where a cereal (*Hordeum vulgare* L. cv Aldebaran) and two grain legumes (*Pisum sativum* L. cv Hardy and *Vicia faba* L. cv Sikelia) were intercropped at different densities, comparing the respective sole crop. The field experiment represents the first year of activity within the project Legume Futures, and was carried out in the 2010/11 cropping season at an experimental centre of the Regional Agency for Agriculture "ARSSA" located at San Marco Argentano (Italy). The following treatments were compared: 1) pea sole crop at a density of 90 plants/

m² (P100); 2) faba sole crop at a density of 40 plants/m² (F100); 3) barley sole crop at a density of 300 plants/m² (B100); 4) pea-barley intercrop in additive design at a crop density of 90 and 150 plants/m², respectively (P100/B50); 5) pea-barley intercrop in replacement design at a crop density of 45 and 150 plants/m², respectively (P50/B50); 6) faba bean-barley intercrop in additive design at a crop density of 40 and 150 plants/m², respectively (F100/B50); 7) faba bean-barley intercrop in replacement design at a crop density of 20 and 150 plants/m², respectively (F50/B50). At tillering, flowering and harvest of the legume crops, the following soil chemical and biochemical properties were analysed: total organic C (C_{org}), total N (N_t), inorganic N as exchangeable NH_4^+ -N and NO_3^- -N, extractable organic N (EON), microbial biomass C (MBC) and N (MBN), basal respiration (R_{bas}), potentially mineralisable C pool (C_o), and potentially mineralisable N (PMN). The following eco-physiological indices were then calculated: microbial quotient (MBC/C_{org}), metabolic quotient (qCO_2), mineralization coefficient (qM), and qCO_2/C_{org} ratio. Furthermore, a molecular analysis (DGGE fingerprinting) on soil bacterial community was performed.

Results

Chemical and biochemical analyses indicate that most of the analysed soil variables were significantly affected by crop and time, with C-related pools being more sensitive than N pools to the influence of the experimental factors. The molecular analysis on soil bacterial community showed a high number of equally abundant ribotypes appearing in the DGGE profiles, revealing that the molecular structure of the bacterial communities was resilient to the different vegetation cover, at least over the short-term. Ongoing research will focus on evaluating the impact of soil incorporation of legume crop residues on the abovementioned soil properties, following rotation with durum wheat.

Impact of different tillage systems on the functional diversity of soil biota

van Capelle, Christine; Schrader, Stefan; Brunotte, Joachim; Weigel, Hans-Joachim

Johann Heinrich von Thuenen-Institute - vTI, GERMANY

Introduction

An assessment of the functional and structural biodiversity in arable soils, considering the impact of different tillage systems, is needed in the aim of protecting and supporting biodiversity and the ecosystem services provided by organisms. Thus, a survey on scientific literature, published over the past six decades was conducted.

Materials and methods

The state of knowledge was analyzed with regard to the impact of conventional, conservation and no-tillage management on lumbricids, collembolans, mites, enchytraeids, nematodes and microbiota (Tab. 1). Interaction effects between tillage intensity and parameters characterizing the respective system (e.g. soil texture and crop) were considered. Besides abundance and biomass of organisms, species richness and individual densities of taxonomical and functional units, enzyme activities and various quotients indicating microbial-driven soil processes were included in the analysis. We concentrated on data from agroecosystems in Germany as they cover a wide range of different soils representative for temperate regions. The main criteria for the selection of datasets were: 1. beside conventional tillage, at least one system with reduced tillage intensity (conservation or no-tillage) is included; 2. effects of tillage

intensity can be distinguished from other treatment effects (e.g. fertilization); and 3. original data on relevant parameters describing soil fauna or microorganisms under field conditions are given or can be derived.

Results

Earthworms were strongly adversely affected by mechanical tillage. Their abundance, biomass and species diversity, therefore, increased significantly when tillage intensity was reduced. Mites and collembolans, by contrast, were less sensitive to mechanical injury and the preservation of enchytraeids, even, depends on a minimum of soil loosening measure (Tab. 1). Tillage-driven impacts on lumbricids and collembolans differed depending on soil texture (Fig. 1). Conservation and no-tillage systems, thereby, significantly promoted earthworm abundances in silty and loamy soils, but did not significantly change individual densities in sandy soils. Collembolan abundances, by contrast, increased in silty soils, but decreased in sandy and loamy soils when conservation instead of conventional tillage was applied (Fig. 1). Tillage effects on nematodes and microbial communities did not differ depending on soil texture, but varied depending on soil depth, indicating an optimum environment in the root zone under reduced tillage intensity. Moreover, functional groups within certain taxa showed differing tillage-induced

Tab. 1: Arithmetic means of soil faunal abundance and microbial biomass in conventional, conservation and no-tillage systems.

Indicator organisms	Tillage system		
	Conventional	Conservation	No-tillage
Earthworms [Ind. m ⁻²]	35.4	56.1	125.4
Enchytraeids [Ind. 10 ³ m ⁻²]	5658.7	6797.2	1050.0
Mites [Ind. 10 ³ m ⁻²]	16.4	11.2	0.9
Collembolans [Ind. 10 ³ m ⁻²]	13.1	11.2	5.6
Nematodes [Ind. 10 ³ 100g dw ⁻¹]	1.8	2.3	2.1
Microbial biomass [μ g C _{mic} g dw ⁻¹]	335.1	372.1	394.2

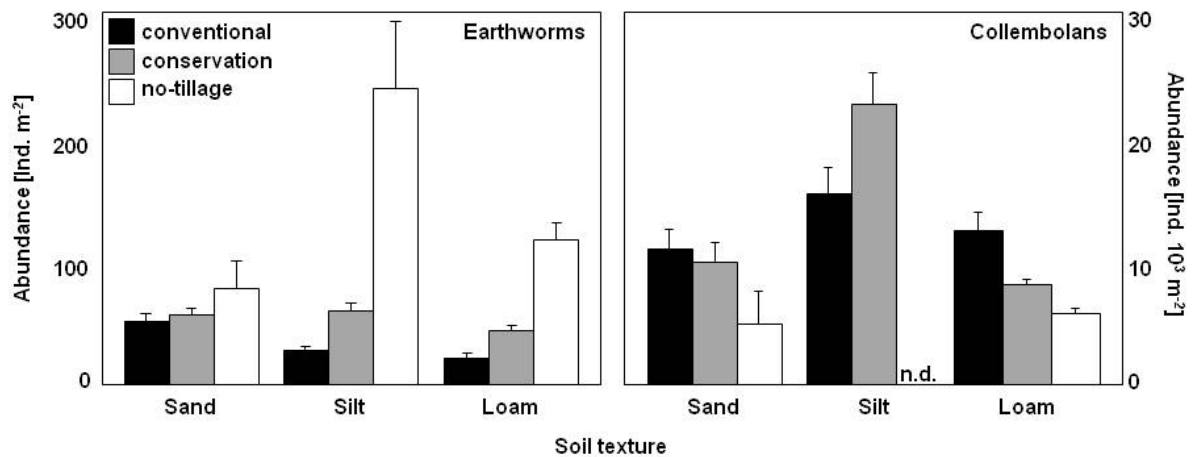

Fig. 1: Arithmetic means and standard errors of earthworm [Ind. m⁻²] and collembolan [Ind. 10³ m⁻²] abundances under conventional, conservation and no-tillage treatments in soils of different texture; n.d. = no data.

impacts. Abundances of anecic and endogeic earthworm species, for instance, reflected a stronger decrease in conventional tillage systems than epigeic ones. Euedaphic collembolan species, due to their restricted burrowing activity, were adversely affected by ploughless tillage in soils of fine texture. Bacterivorous, fungivorous and root-feeding nematodes were more strongly affected by tillage intensity than other feeding types.

Generally, the literature survey indicated that impacts of tillage intensity on soil organisms differ considerably depending on their body size, ability to burrow, adaptation to certain soil depths, trophic specification and habitat demands. Whereas soil texture exerts a strong impact on tillage-induced changes in communities of soil organisms which strongly depend on sufficient pore spaces (Fig. 1), the kind of crop plays only a minor role.

Conclusion

The integrative data analysis showed that the selection of a specific tillage system enables a directed promotion of certain organism taxa and functional groups, which are of major relevance for maintaining essential below-ground processes. However, to ideally manage soil biodiversity while reaching optimal soil health and sufficient production capacity, respective local conditions like soil texture have to be considered when selecting most suitable tillage systems.

Interaction between soil micro- and mesofauna regarding mycotoxin degradation in wheat straw as a function of soil texture

Wolfarth, Friederike¹; Schrader, Stefan¹; Oldenburg, Elisabeth²; Weigel, Hans-Joachim¹

¹VTI, GERMANY; ²JKI, GERMANY

Introduction

Besides well-known positive aspects of conservation tillage combined with mulching, a drawback may be the survival of phytopathogenic fungi like *Fusarium* species on plant residues. This may endanger the health of the following crop by increasing the infection risk for specific plant diseases like *Fusarium* head blight. In infected plant organs, these pathogens are able to produce mycotoxins like deoxynivalenol (DON). Against this background, a microcosm-study was conducted under laboratory conditions to assess the interaction between soil fauna (nematodes and collembolans) and DON. Our hypotheses were: (1) nematodes and collembolans reduce the DON content in infected wheat straw; (2) the species interaction of *Aphelenchoides saprophilus* and *Folsomia candida* enhances the degradation of DON concentration in wheat straw; (3) the degradation efficiency of nematodes and collembolans is affected by soil texture.

Materials and methods

Microcosms (n=5 for all treatments) were filled with soil of different texture (sandy loam, silt loam, clay loam) and finely chopped wheat straw (*Fusarium*-infected vs. non-infected). The microcosms were inoculated with *Aphelenchoides saprophilus* (Nematoda) and *Folsomia candida* (Collembola) in different combinations (single and mixed species, non-faunal control). After 2 and 4 weeks of incubation at 17°C in darkness, the individual densities in all soil faunal treatments were counted and the DON concentrations were quantified by using a competitive ELISA.

Results

After 2 and 4 weeks of incubation, the individual densities in all soil faunal treatments increased with highest individual numbers in the non-infected treatments in case of collembolans and in the infected treatments in case of nematodes. DON concentrations in remaining infected straw were reduced significantly compared to the initial concentration in all treatments after 4 weeks. According to RM ANOVA, the effect of the introduced soil fauna in degrading DON was significant. The highest reduction was found in mixed species treatments, whereas the lowest reduction of DON was measured in non-faunal control treatments (Tab. 1).

In sandy and silt loam soil, the DON degradation was significantly higher compared with clay loam in all faunal and non-faunal treatments. After 4 weeks still positive DON concentrations were determined in the soil of the infected treatments. The lowest DON concentrations were determined in sandy and silt loam of the mixed species treatments.

Conclusions

Collembolans and nematodes significantly contribute to mycotoxin degradation in wheat straw, especially in sandy and silty soils. We conclude that particularly interacting collembolans and nematodes play an important role in mycotoxin degradation as an ecosystem service. Accordingly, fungal feeding soil micro- and mesofauna might be able to promote compensating for the enhanced risk of fungal crop diseases and mycotoxin contamination of food and feed deriving from

Tab. 1 Relative DON degradation in *Fusarium*-infected wheat straw in presence of nematodes, collembolans, interaction of both groups and in a control regarding different soil texture after 4 weeks incubation.

	Nematodes	Collembolans	Interaction	Non-faunal control
Sandy loam	90%	67%	92%	83%
Silt loam	79%	88%	95%	65%
Clay loam	6%	34%	39%	20%

conservation tillage practices. In any case, soil texture matters in the provision of these ecosystem services by collembolans and nematodes. The given soil texture provided an environment, which significantly influenced the degradation of the mycotoxin in infected wheat straw. Especially in case of tight crop rotations, where

the time slot between harvest of the previous and sowing of the following crop is short, interacting soil fauna and, in addition, soil microorganisms might enhance and accelerate the degradation of soil-borne phytopathogenic fungi and their mycotoxins as ecosystem services for crop protection.

Assessment of soil fungal communities in barley-turnip rape cropping systems via LH (Length Heterogeneity) PCR

Zou, L.; Tuulos, A; Stoddard, F; Mäkelä, P; Lindström, K; Mikkonen, A
University of Helsinki, FINLAND

Introduction

Yield and quality of crops can be reduced by soil-borne pathogens. The massive use of synthetic fungicides has caused concerns about environmental degradation. Furthermore, the use of race-specific disease resistance in crop production puts selection pressure on the pathogen. For these reasons, resistant cultivars and fungicides should be used in a more sensible way and innovative methods are needed to complement existing methods. One of these methods is the use of natural chemicals with biocidal activity that exist in plants. Glucosinolate (GSL)-containing plants have been suggested to inhibit the growth of certain soil-borne pathogens (Van Dam et al., 2009). We therefore chose to investigate the effect of sowing turnip rape (*Brassica rapa* L. ssp. *oleifera* (DC) Metzg cv. Largo) after barley (*Hordeum vulgare* L. cv. Vilde) along with the interspecific mix and incorporation of turnip rape in the soil on the structure of soil-borne fungal flora.

Materials and methods

A field experiment was conducted including 5 treatments: 1. Mixed culture of barley and turnip rape sown in the middle of May; 2. Barley sown in mid-May followed by turnip rape sown in late July; 3. same as 1, but turnip rape was incorporated into the soil in autumn; 4. same as 1, but turnip rape was incorporated in the following spring; 5. Barley monoculture sown in middle of May, harvested in early August, and stubble left on the soil in 2009 and barley was sown on all plots in 2010. Top soil samples were taken periodically in the year 2009 and 2010; and the same experiment was repeated in the year 2010 and 2011 in a different site. Soil DNA was extracted by the commercial kit. PCR primers specific for the internal transcribed spacer (ITS-1F/ITS4) region of fungal rDNA and capillary-electrophoresis-based LH-PCR were used to distinguish genetic diversity (Bruns & Gardes 1993); ITS1F was labeled with FAM and 50 bp to 1000 bp Mapmarker® was used for size-calling of amplicons from soil. Curve-based analyses were conducted by BioNumerics® and Shannon index was calculated.

Results and discussion

MDS divided all the profiles into 2 groups depending on different sites where the 2 experiments were conducted. This suggests that the difference caused by different sites and seasons cannot be neglected. In the clustering analysis for all profiles (Ward was chosen as the algorithm), profiles of the same sampling date instead of the same treatment fell into the same cluster, showing that the season could affect the fungal flora more than different treatments. Hence, comparison of the effect of different treatments is more sensible in the profiles of the same sampling date. When curve-based, Ward clustering was conducted on the samples of the same sampling date, profiles did not form clusters depending on different treatments showing that the treatments did not influence soil fungal flora. The fungal diversity of soil under barley monoculture was lower than that in the other 4 treatments during the whole growing season in both experiments of 2 sites, according to the Shannon index. Soil fungal diversity of barley monoculture of both experiments was the lowest on the last sampling dates of both experiments. Dominant OTUs in these soil samples were 594 bp, 684 bp and 584 bp according to the averaged profile generated from BioNumerics. The lengths of 684 bp and 584 bp were from *Rhizoctonia solani* and *Fusarium culmorum* (reference strains), respectively. All the results combined indicated that barley monoculture had lower diversity index compared with other treatments on specific sampling dates. Any inhibitory effect of ITC produced from GSL of turnip rape was small, or affected by some unknown reasons in field conditions, since the presence of pathogen-related OTUs was detected in significant proportions in profiles of treatments of turnip incorporation. Higher diversity of monoculture treatment could result in a more competent environment for soil-borne pathogens.

References

Bruns, T.D. & Gardes, M. 1993. ITS primers with enhanced specificity for basidiomycetes---application to the identification of mycorrhizae and rusts, *Molecular ecology*, 2: 113-118.

Van Dam, N.M., Tytgat, T.O.G. & Kirkegaard, J.A. 2009. Root and shoot glucosinolates: A comparison of their diversity, function and interactions in natural and managed ecosystems, *Phytochemistry Reviews*, 8: 171-186.

Reed canary grass (*Phalaris arundinacea* L.) combustion capacity assessment

Adamovics, Aleksandrs; Platace, Rasma

Latvia University of Agriculture, LATVIA

Introduction

When use of the grass biomass is used for production of thermal energy, the main problems in the process of combustion should be described, which are related to the moisture content, ash content, calorific power and ash melting temperature. The aim of the study was to evaluate reed canary grass varieties which are most suitable for Latvian conditions, to evaluate their capacity of combustion performance and to make recommendations for using them to produce heat.

Materials and methods

The research analyzes different biomass fuel parameter indicators of reed canary grass (*Phalaris arundinacea* L.)-(RCG) cultivars 'Marathon', 'Bamse' and 'Pedja' depending on the harvest times (spring 2011 and fall 2011), to determine their suitability for thermal energy production. In accordance with standards the following parameters were identified: moisture volume – Wa (ISO 589, LVS CEN/TS 14774-2), ash content for dry materials – A (ISO 1171-81), calorific power – QA and QZEM (ISO 1928, LVS CEN/TS 14918), as well as ash melting temperature in the oxidizing atmosphere (according to ISO 540). Parameters were defined in the Ltd. «Virisma» laboratory for examination of waste products, fuel and tests.

Results

Moisture and ash content were established, as well as the highest and the lowest calorific power, and temperatures of different ash melting phases in oxidizing atmosphere. The average moisture content of RCG spring harvest was 8.9%, while for the autumn harvest it was 17.6% (Table 1).

RCG biomass ash content in the spring harvest was from 1.2 - 5.0%, but in the autumn harvest 3.7% - 5.5%. The highest calorific power of RCG biomass spring harvest was obtained from the variety 'Marathon' - 18.9 MJ/kg, but the lowest 15.5 MJ/kg; the autumn biomass harvest was the best from the variety 'Bamse' - 15.4 MJ/kg, but the lowest - 14.0 MJ/kg. Analyzing RCG varieties suitable for production of heat, it must be noted that their burning capacity characteristics are similar to wood, but burning biomass produces more ash, therefore when producing pellets, biomass should be mixed with sawdust and chips. The results obtained demonstrate that RCG biomass ash melting phase temperature indicators are sufficient to ensure quality operation of the boiler. The best indicators of ash melting temperatures of reed canary grass in all phases were obtained from the variety 'Bamse' (spring harvest), whose starting deformation temperature was 1240 °C, but the end temperature of the effluence phase- 1330 °C; the variety 'Pedja' produced the best results for fall harvest biomass

Table 1. Reed canary grass (*Phalaris arundinacea* L.) combustion capacity assessment.

Varieties	Moisture, %	Ash in DM, %	Heating Value (max), MJ kg ⁻¹	Heating Value (min), MJ kg ⁻¹	Deformation temperature (DT), (°C)	Sphere temperature (ST), (°C)	Hemisphere temperature (HT), (°C)	Flow temperature (FT), (°C)
Spring, 2011								
'Marathon'	10.8	1.2	18.9	15.5	1100.0	1140.0	1160.0	1200.0
'Bamse'	8.9	5.0	17.9	15.0	1240.0	1270.0	1290.0	1330.0
Autumn, 2011								
'Marathon'	17.1	4.3	15.2	13.8	1300.0	1320.0	1350.0	1390.0
'Bamse'	17.6	3.7	15.4	14.0	1220.0	1260.0	1288.0	1315.0
'Pedja'	15.7	5.5	15.1	13.7	1440.0	1460.0	1500.0	1500.0

– the beginning of deformation temperature is 1440°C and the end temperature of effluence phase- 1500 °C.

Conclusions

For the RCG biomass both to spring and autumn samples has a high ash content , on average 3.1% -4.5%. For the RCG spring samples the combustion capacity reached 18.4MJ/kg, therefore RCG is appropriate for processing to production of the biofuel pellets. Melting temperature of the RCG ashes at the beginning of deformation phase makes 1100-1440°C, which means that indicators of the ash melting temperature are within standards, and will not cause problems in the process of combustion in heating systems. RCG spring harvest has lower ash content and higher un combustion capacity, and it is recommended that RCG as an energy plant for production of thermal energy (pellets) shall be harvested in late autumn till spring.

Acknowledgements

Publication and dissemination of research results has been made due to the funding of the ERAF Project „Promotion of scientific activities of LLU”, Contract Nr. 2010/0198/2DP/2.1.1.2.0/10/APIA/VIAA/020 To Ltd. “Latgran” for cooperation.

References

Obenberger I., Thek G. (2010) The Pellet Handbook. The production and thermal Utilisation of biomass pellets. London, Washington, DC, pp. 548.

Productivity and yield quality of local hemp 'Purini'

Adamovics, Aleksandrs; Poisa, Liena; Sausserde, Rudite
Latvia University of Agriculture, LATVIA

Introduction

The hemp has long been known in Latvia. For many centuries they have been grown on farms and used production of seed and fiber from hemp. From local hemp seed is preparing tasty and healthy foods - hemp spread, butter, hemp milk, oil etc. Today the hemp has the widespread options of use: food, feed and alternative energy (biodiesel and solid fuel). From the stems technical fibre is obtained, but from the residue material (shive) it is possible to obtain hard fuel. This plant is a valuable rotation crop in organic farming (MTT, 2009). The aim of this study was to clarify productivity and yield quality of local hemp 'Purini'.

Materials and methods

The local hemp 'Purini' (*Cannabis sativa* L.) is an annual crop from the Cannabinaceae family which has been grown in Latvia for more than 200 years. The local hemp 'Purini' was sown on the 9th May 2008, and on the 4th of May 2009, and on the 13th May 2010 in the sod-podzolic loam soil but the harvesting was on the 23rd September 2008, and on the 21st September 2009, and 10th September 2010. The nitrogen supplementary fertiliser rates: No – control, treatments – N60, N100 kg ha⁻¹. N fertiliser (ammonium nitrate) was applied on the 11th June 2008, on the 10th June 2009, and on the 1st June 2010. The following parameters were tested: 1) moisture content, according to standard ISO 589-81; 2) gross

calorific value (Qgr.d) with V (volume)=constant for dried fuel at 105 °C, according to standard LVS CEN/TS 14918; 3) oil content in the seed samples was determined by the grain analyser Infratec 1241tm, which has a specially adapted system, built-in for the analysis of oil content for flax and hemp. The MS Excel programme was used for data statistical processing. The ANOVA method and correlation and regression analysis were used. The test of statistically significant differences (LSD 0.05) with the Fisher criterion (F-test) and factor density influence was used for the analysis of mean differences.

Results and discussion

Seed oil content of dry matter (DM) was in the range from 36.4% to 43.5%. N-fertilizer rates had the positive significant effect on the shive content of hemp 'Purini', but had the negative effect on the oil content (Poisa, Adamovics, 2010). The nitrogen fertilizer rate increase from No to N100 kg ha⁻¹ provided a significant (p<0.05) increase in dry matter (DM) for local hemp, as confirmed by other studies (Grabowska, Koziara, 2005; Poisa, Adamovics, 2010). The gross calorific value - for the local hemp was from 18.35 to 19.71 MJ kg⁻¹. Carbon is the main burning element in fuel. The carbon content (min – average – max) was 1.79–2.98–4.56 t ha⁻¹, the shive yield 4.54–5.86–8.64 t ha⁻¹, seed yield 0.87–1.53–2.56 t ha⁻¹, DM yield 4.62 – 8.01 – 11.90 t ha⁻¹ for the local hemp stems. Local hemp can be used for the production of hard fuel.

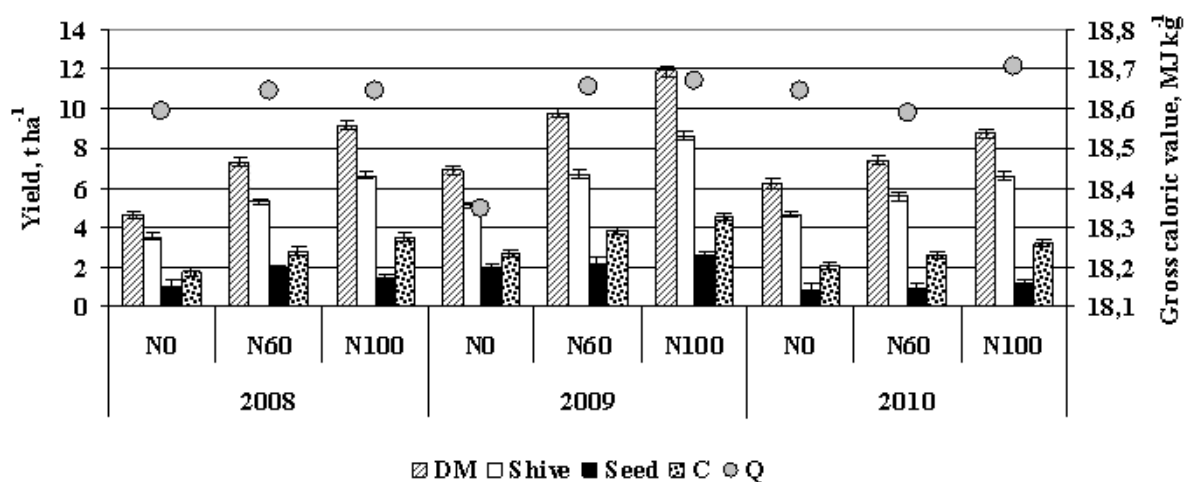

Fig. 1. Local hemp 'Purini' depending on the hemp growing year, and N-fertilizer rates, where DM – dry matter, C – carbon, Q – gross calorific value.

Conclusions

The shive, seed can be obtained from the local hemp 'Purini'. The largest shive content was applying N fertilizer rate N60, but the largest dry matter content - applying N100 kg ha⁻¹.

Acknowledgements

Publication and dissemination of research results has been made due to the funding of the ERAF Project „Promotion of scientific activities of LLU”, Contract Nr. 2010/0198/2DP/2.1.1.2.0/10/APIA/VIAA/020

The authors also would like to thank the Agricultural Science Centre of Latgale for assistance in hemp trial installation.

References

1. Grabowska L., Koziara W. (2005) The Effect of Nitrogen Dose, Sowing Density and Time of Harvest on Development and Yields of Hemp Cultivar Bialobrzeskie, *Journal of Natural Fibers*, Vol. 2. No. 4. pp. 1-18.
2. MTT (2009) Energy from field energy crops – a handbook for energy producers. MTT Agrifood Research Finland, 60 p.
3. Poisa L., Adamovics A. (2010) Hemp (*Cannabis sativa* L.) as an Environmentally Friendly Energyplant. *Scientific Journal of Riga Technical University. Environmental and climate technologies*. Vol. 5. pp. 80.-85.

Productivity and tensile endurance determine of hemp fiber

Adamovics, Aleksandrs; Kakitis, Aivars; Sausserde, Rudite; Zakrevskis, Sergejs

Latvia University of Agriculture, LATVIA

Introduction

Hemp (*Canabis sativa* L.) is a multipurpose crop which is grown for its fibers and seeds. The fiber is one of the most valuable parts of the hemp plant. It is commonly called bast, which refers to the fibers which grow on the outside of the plant's stalk. The fiber is one of the strongest and most tolerant natural fibers with high tensile strength, wet strength, and other characteristics that make it technically suitable for various industrial products. Therefore, Latvian hemp is seen as one of the most promising sources of renewable resources to replace non-renewable components for a wide range of industrial products.

Materials and methods

Field trial was carried out during 2010–2011 in the Research and Study farm "Peterlauki" of the Latvia University of Agriculture. The hemp varieties 'Bialobrzeskie', 'Futura75' and 'Tygra' were sown on the 5th May 2010 and on the 6th of May 2011 in stagnic – luvisol soils. The total seeding rate was 50 kg ha⁻¹. The harvesting was in September in both years. Three varieties were tested for natural hemp fiber (with splint) tensile strength. Samples to be measured were selected and sized in 50 mm long

pieces of fibers, for each thickness was measured in three places and its average value was calculated. Measurements were taken with digital calipers with the digital measurement error ± 0.1 mm. In order to secure the samples in the test machine, a previously elaborated method was used ensuring convenient fixing and correct disruption of the sample (Fig.1).

Samples were fixed in a cardboard frame with external size of 50 mm. Ends of the sample were stuck to the cardboard by gluing its ends between the cardboard pieces. After fastening of a sample in the frame, measurements of its width were taken using digital microscope Keyence VHX - 300. Width of the sample was measured at least in three places and the average value was calculated. To determine maximum disruption force for the sample, it was loaded under tension by using material testing machine Zwick 2500. The sample was placed in the machinery fastenings, by compressing the parts glued in the sample cardboards. After fastening the cardboard frame is cut on both sides (place of cutting 4, Fig.1). Then loading of a sample was performed and the tensile chart was shot, from which the maximum disruption force was defined. The rupture stress and the tensile strength of the fiber was calculated using software Test Expert.

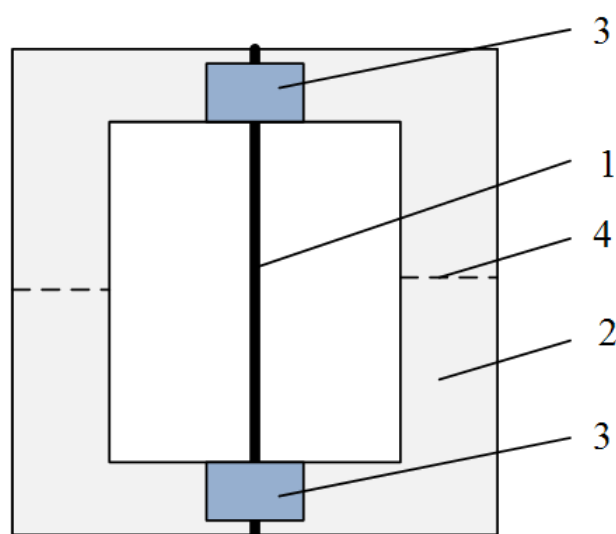

Fig.1. Layout of the sample fastening.

1 – fiber sample, 2 – cardboard frame, 3 – piece of cardboard for fastening, 4 – place of cutting.

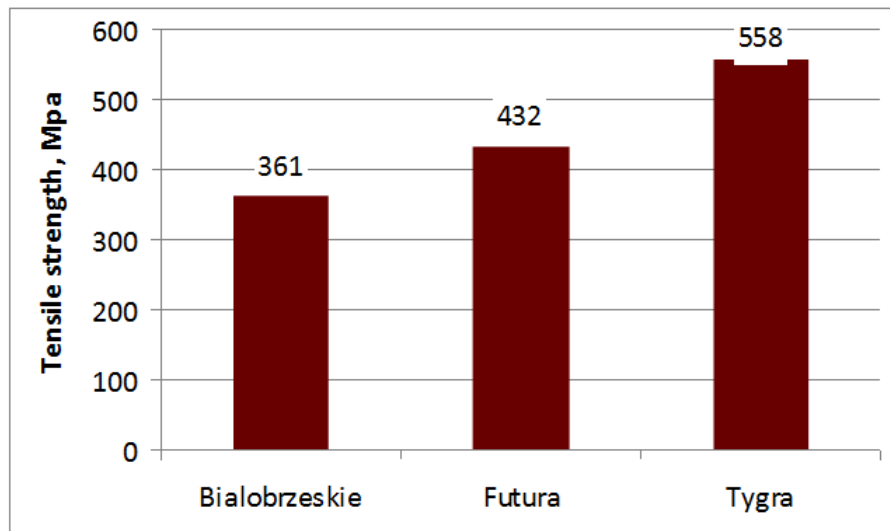

Fig.2. Natural hemp fiber (with splint) tensile strength.

Results

Field trials have established that the yield of hemp dry matter in Latvia's agro-climatic conditions depending on the variety was 6.5 - 12.4 t ha⁻¹. Dependence on the version being subject to inspection, the yield of dry matter for variety 'Futura' was 11.0 to 12.4 t ha⁻¹, 'Bialobrzekie' - 9.5 to 10.7 t ha⁻¹, but for 'Tygra' - 7.4 to 8.7 t ha⁻¹, and the total fiber yield - respectively 3.15, 2.65 and 2.40 t ha⁻¹. Results of the experiments were indicative of the cutoff stress of tensile strength for non-blanched fiber of three varieties of hemp with bast addition. As displayed in Figure 2, the 'Tygra' variety of fibers is having the greatest resistance. Their average tensile strength amounted to 558 MPa, which is equivalent to the tensile strength of high quality steel. It should be noted that the experiments have established a large distribution of the measurement

results. The tensile strength of individual samples ranged from no 715 MPa to 373 MPa. This is explained by the fact that hemp fiber is a non-homogeneous material, and its properties are varied within wide limits. It should be noted that tensile strength of fiber of all the varieties is large enough to allow it to be used for reinforcement of foam gypsum.

Acknowledgments

The research was supported by the European Regional Development Fund within the project 'Development of New Composite Materials on Foam Gypsum Basis with Fibrous Reinforcement and Their Systems Research'. Agreement No. 2010/0320/2DP/2.1.1.1.0/10/APIA/VIAA/107.

Apparent nitrogen efficiency in 10-year old stands of perennial biomass crops in Northern Italy

Capocchi, Lorenzo; Barbanti, Lorenzo; Vecchi, Angela; Grigatti, Marco

University of Bologna, ITALY

Introduction

The EU promotes the use of renewable energy sources (Directive 2009/29/EC), including energy crops. The amount of nitrogen and its use efficiency are key points in energy and environmental assessments of these crops. Among them, perennial herbaceous species are gaining interest, thanks to their low inputs. In this light, a long term experiment was begun in 2002 at the experimental farm, University of Bologna (44° N, 11° E), addressing field behaviour and N response of four biomass species: *Arundo donax* (A), *Miscanthus sinensis* x *Giganteus* (M), *Cynara cardunculus* (C), and *Panicum virgatum* (P). This study focuses on nitrogen use efficiency in mature stands (2011).

Materials and methods

The experiment was set up in a deep silty-clayey field under a semi-continental climate. The four species were combined with two levels of nitrogen in a completely randomized block design: No, unfertilized control; N₁, 120 kg ha⁻¹ yr⁻¹ of N as urea in A and P; 100 kg ha⁻¹ yr⁻¹ in M and C. At the 2011 harvest, dry biomass yield (DBY; Mg ha⁻¹), total kjeldahl nitrogen content (TKN; mg g⁻¹) and plant N uptake (kg ha⁻¹) were assessed. The apparent recovery fraction (ARF, %) of fertilizer N was calculated by the difference method (Huggins et al., 1993). Nitrogen utilization efficiency (NUE, kg kg⁻¹) was calculated as the

ratio of DBY to plant N uptake (Delogu et al., 1998). Data were subjected to ANOVA according to species, nitrogen level and their interaction.

Results and discussion

The main results are reported in table 1. DBY was undifferentiated among A, P and M, whereas C yielded about two third less biomass. In general, these DBY levels were close to those observed by other authors on mature stands of the same species (Angelini et al., 2009a and 2009b; McLaughlin et al., 2005). In contrast to DBY, C showed a much higher TKN than M, in turn significantly higher than P and A. N₁ exhibited an almost 30% and 20% increase over the No level in DBY and TKN, respectively. As the effect of opposite trends in DBY and TKN, ARF was undifferentiated among the four species, always lying at low trait levels (average, 21%). Conversely, NUE displayed decreasing levels in P, A, M and C. N fertilization determined a noticeable decrease in NUE. The effects of nitrogen on DBY, TKN and NUE were consistent across the four species, as the nonsignificant interactions prove. Based on these results, it may be argued that the amounts of N fertilizer commonly used are higher than the actual requirements of these crops, despite the fact that the No treatment used as comparison had been left without nitrogen for ten years. Low ARF's of the same species were also reported by Angelini et al. (2009a and 2009b).

Table 1- Effects of crop species and nitrogen fertilization on DBY (dry biomass yield), TKN (total kjeldahl nitrogen), ARF (apparent recovery fraction of fertilizer N) and NUE (nitrogen utilization efficiency). Different letters indicate significantly different means (LSD test).

Sources	Parameters			
	DBY (Mg ha⁻¹)	TKN (mg g⁻¹)	ARF (%)	NUE (kg kg⁻¹)
Species (S)				
Arundo donax	19.2 a	3.67 c	24.7	279 b
Panicum virgatum	17.5 a	3.18 c	20.0	320 a
M. sinensis x Giganteus	17.4 a	4.24 b	24.1	238 c
Cynara cardunculus	6.1 b	6.87 a	15.1	147 d
Significance	**	**	n. s.	**
Nitrogen (N)				
N ₀	13.2 b	4.13 b	-	264 a
N ₁	16.9 a	4.93 a	-	227 b
Significance	**	**	-	**
S x N significance	n. s.	n. s.	-	n. s.

Table 1- Effects of crop species and nitrogen fertilization level on DBY (dry biomass yield), TKN (total kjeldhal nitrogen content), ARF (apparent recovery fraction of fertilizer N) and NUtE (nitrogen utilization efficiency). Different letters indicate significantly different values (LSD test, $P < 0.05$).

<u>Sources</u>	<u>Traits</u>			
	DBY (Mg ha ⁻¹)	TKN (mg g ⁻¹)	ARF (%)	NUtE (kg kg ⁻¹)
Species (S)				
<i>Arundo donax</i>	19.2 a	3.67 c	24.7	279 b
<i>Panicum virgatum</i>	17.5 a	3.18 c	20.0	320 a
<i>M. sinensis</i> x <i>Giganteus</i>	17.4 a	4.24 b	24.1	238 c
<i>Cynara cardunculus</i>	6.1 b	6.87 a	15.1	147 d
Significance	**	**	n. s.	**
Nitrogen (N)				
N ₀	13.2 b	4.13 b	-	264 a
N ₁	16.9 a	4.93 a	-	227 b
Significance	**	**	-	**
S x N significance	n. s.	n. s.	-	n. s.

Conclusions

Nitrogen enhances DBY, but perennial herbaceous species could only take up a small fraction of the supplied nutrient, as the low ARF and declining NUtE prove. It appears, therefore, that N supply could be reduced with respect to the standard 100-120 kg N ha⁻¹, in order to enhance nutrient use efficiency, improve energy balance and reduce environmental impact of these crops.

Acknowledgements

Research carried out under the BIOSEA Project, funded by MIPAAF (Italy).

References

- Angelini LG et al 2009a. Long-term evaluation of biomass production and quality of two cardoon (*Cynara cardunculus*) cultivars for energy use. *Biomass Bioenergy* 33, 810-816.
- Angelini LG et al 2009b. Comparison of *Arundo donax* and *Miscanthus x giganteus* in a long-term field experiment in Central Italy: Analysis of productive characteristics and energy balance. *Biomass Bioenergy* 33, 635-643.
- Delogu G et al 1998. Uptake and agronomic efficiency of nitrogen in winter barley and winter wheat. *Eur J Agron* 9, 11-20.
- Huggins DR et al 1993. Nitrogen efficiency component analysis: an evaluation of cropping system differences in productivity. *Agron J* 85, 898-905.
- McLaughlin SB et al 2005. Development of switchgrass (*Panicum virgatum*) as a bioenergy feedstock in the United States. *Biomass Bioenergy* 28, 515-535.

Comparing contrasted biomass crops cultivated under different cropping managements

DEMAY, Charlotte; Cadoux, Stéphane; Ferchaud, Fabien
INRA, FRANCE

Introduction

Biomass from dedicated crops is expected to significantly contribute to the replacement of fossil resources. However, the development of these crops must not occur at the expense of either food production nor environment. The biomass crops and the cropping management will have to answer to these constraints. This paper aimed at comparing contrasted biomass crops cultivated under different cropping management in the same long term experiment.

Materials and methods

The long term experiment is located in Estrées-Mons in Northern France (50°N, 3°E). The soil is a deep silt loam. The climate is oceanic temperate (624mm, 10.7°C). Seven crops with 2 levels of nitrogen were compared (N- and N+): poplar (0 and 60 kg ha⁻¹), *Miscanthus x giganteus* (0 and 120 kg ha⁻¹), switchgrass (0 and 120 kg ha⁻¹), fescue (n*40 and n*80 kg ha⁻¹, n depending on the number of cut per year), alfalfa (no fertilization), triticale (60 and 120

kg ha⁻¹) and fiber sorghum (0 and 120 kg ha⁻¹). The poplars were cultivated in very short rotation coppice, harvested every 2 years. For miscanthus and switchgrass 2 harvest dates were also compared: early harvest in October (E) and late harvest in February (L). Biomass production and nutrient content (N, P, K) were measured at harvest.

Results and discussion

The hierarchy between crops in terms of biomass production was relatively constant over the years, with a superiority of the C₄ perennial crops, particularly when harvested early, then all annual and perennial crops and finally poplar (Fig. 1). There was a slight effect of N fertilization on the yield of miscanthus from 2008 in E treatments, and a significant effect on the yield of switchgrass from 2007 for both harvest treatments, but stronger in E treatments. The interaction between early harvest and fertilization is likely due to depletion in rhizome N reserves (Strullu et al., 2011). The trend for the yield of alfalfa and fescue was quite similar, with

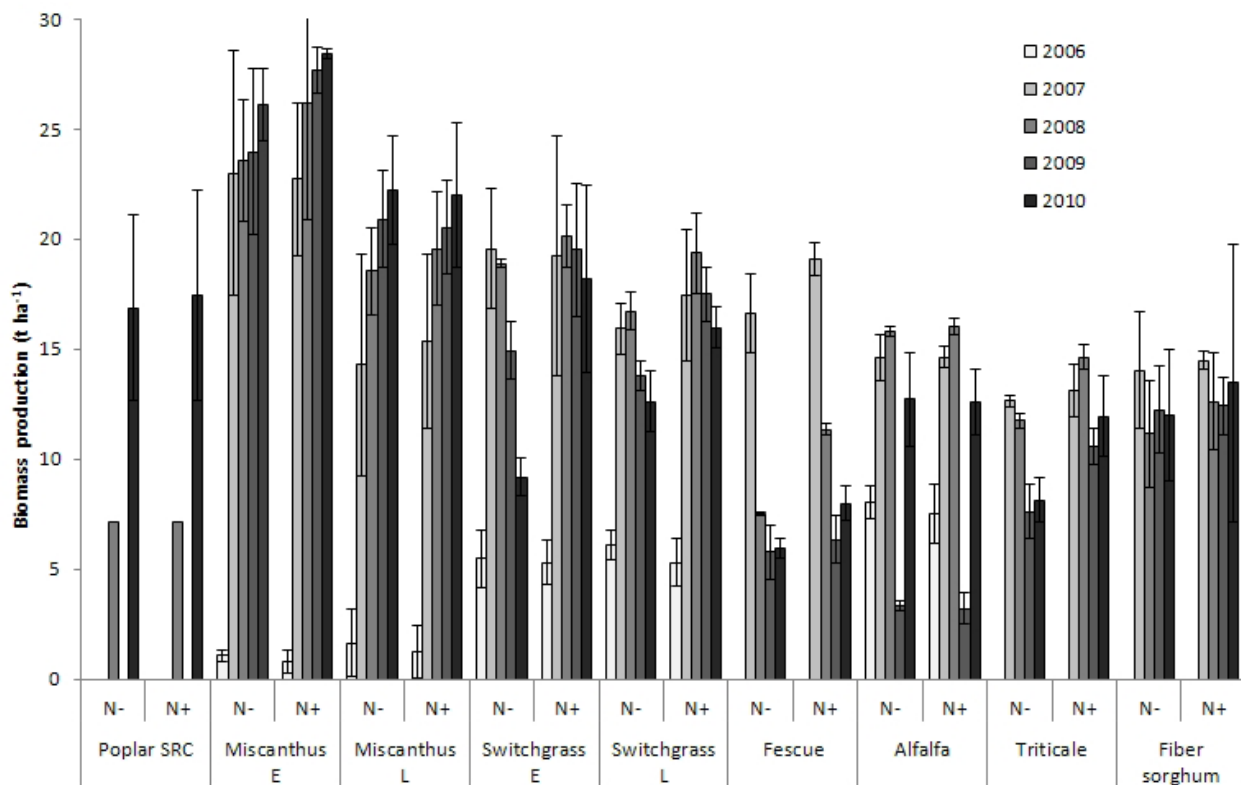

Fig. 1 Average (and 95% confidence intervals) biomass production of the different crops and for the different experimental treatments over the period 2006–2010

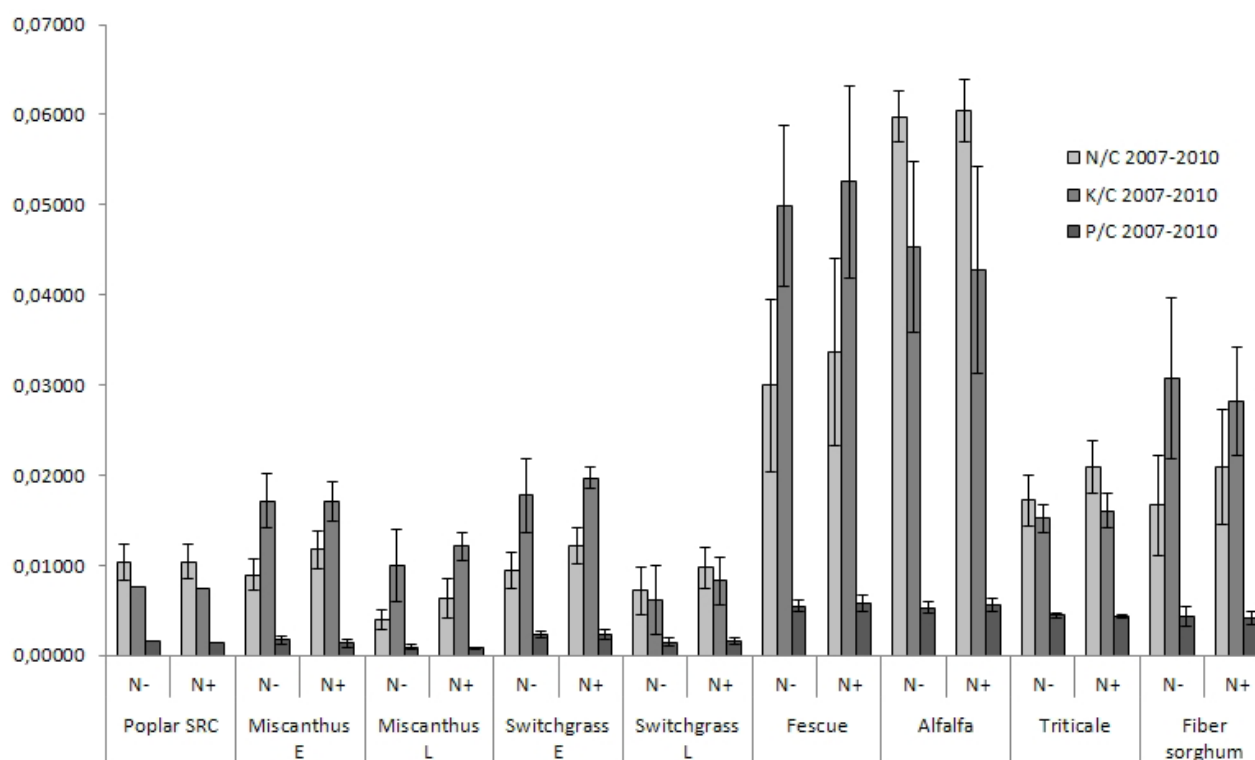

Fig. 2 Average (and 95% confidence intervals) nutrient/C ratio at harvest of the different crops and for the different experimental treatments over the period 2007-2010

a high variability between years. For both crops, the biomass yield never exceeded 20 t ha^{-1} , which is likely to be due to lower RUE of C_3 compared to C_4 crops. The yield of triticale was low, especially in N- treatments. The biomass production of fiber sorghum was low too, which is mainly due to its susceptibility to the low temperatures of Northern France. The biomass production of poplar was low compared to the other crops.

The nutrient content at harvest was expressed by unit of C produced to give efficiencies of nutrient removal. The nutrient/C ratio was low on average for miscanthus and switchgrass (Fig. 2) especially for L treatments, due to nutrient translocation during winter. The trend for poplar was very similar to the perennial C_4 crops. The nutrient/C was high for both pluriannual crops: it has been previously identified as a major disadvantage of using these crops for bioenergy (Ceotto, 2009). The nutrient/C ratio of both annual crops was intermediate, which was yet described by Scholz and Ellerbrock (2002).

Conclusions

Miscanthus and switchgrass, when harvested late, were able to conciliate high biomass production and low nutrient removal at harvest. For the other crops, the biomass production was lower and the amount of nutrient removed at harvest was higher. For perennial crops, concerns appeared especially on the large K removal. Further researches are needed to study the environmental consequences of these behaviors.

References

- Ceotto E. (2009) Grasslands for Bioenergy Production: A Review. Sustainable Agriculture, in: E. Lichtfouse, et al. (Eds.), Springer Netherlands. pp. 141-151.
- Scholz V., Ellerbrock R. (2002) The growth productivity, and environmental impact of the cultivation of energy crops on sandy soil in Germany. *Biomass and Bioenergy* 23:81-92.
- Strullu L., Cadoux S., Preudhomme M., Jeuffroy M.H., Beaudoin N. (2011) Biomass production and nitrogen accumulation and remobilisation by *Miscanthus x giganteus* as influenced by nitrogen stocks in belowground organs. *Field Crops Research* 121:381-391.

Effects of harvest time and frequency on giant reed productivity under different soil conditions in Mediterranean environment

Dragoni, Federico; Nasso Di Nasso, Nicoletta; Ragolini, Giorgio; Tozzini, Cristiano; Bonari, Enrico
Scuola Superiore Sant'Anna, ITALY

Introduction

Giant reed (*Arundo donax* L.) has gained attention as a potential energy crop in Southern Europe, where dry yields over 30 t ha⁻¹, in fertile soil with good water availability have been reported (Angelini et al, 2009). Information is lacking on suitability of giant reed to different harvest times and frequency, affecting both crop yields and management of bioenergy chains (e.g. logistics and conversion) (Ebadian et al, 2011). For these reasons, this study analyzed different harvest systems and soil types on giant reed productivity under Mediterranean conditions.

Materials and methods

Giant reed was established in 2008 on a sandy loam (SL) and on a loamy soil (L) in a Mediterranean environment (river Arno coastal plain, Tuscany, Italy). The soils differed in organic matter content (SL:1.0%; L:1.3%) and equal fertilizations were applied each year (100 kg ha⁻¹ of N, P and K) at the beginning of the growing season. For the first 2 years, giant reed was harvested once in late winter. In 2011, single harvest performed in late autumn (SH-A) or in winter (SH-W), were compared with double harvest, with first cut occurring in July (DH1), August (DH2) and September (DH3), while second harvest took place in autumn and winter, concurrently with SH-A and SH-W respectively. At harvest times, plants in a 4 m² area were harvested and weighed. Subsamples were dried to constant mass at 60°C and crop dry matter percentage was calculated, then ash content was determined in a furnace at 550°C. Dry yield was analyzed by two-way ANOVA considering soil type and harvest system as factors.

Results

Our preliminary results reported a significantly lower suitability of giant reed to grow on SL soil (14.5 vs 37.1 t ha⁻¹). About the harvest systems, no significant differences were recorded within the two soils (Fig. 1). Concerning SH, contrasting results were obtained in the two soils: from autumn to winter, yield seems to decrease in SL while it slightly increased in L. The highest productivity

of DH3 depended entirely from the 1st cut, where no regrowth was observed. In SL soil, regrowth occurred only in DH1, representing about 43% of the total yield. In L regrowth ranged from 40% to 15% of the total yield in DH1 and DH2 respectively.

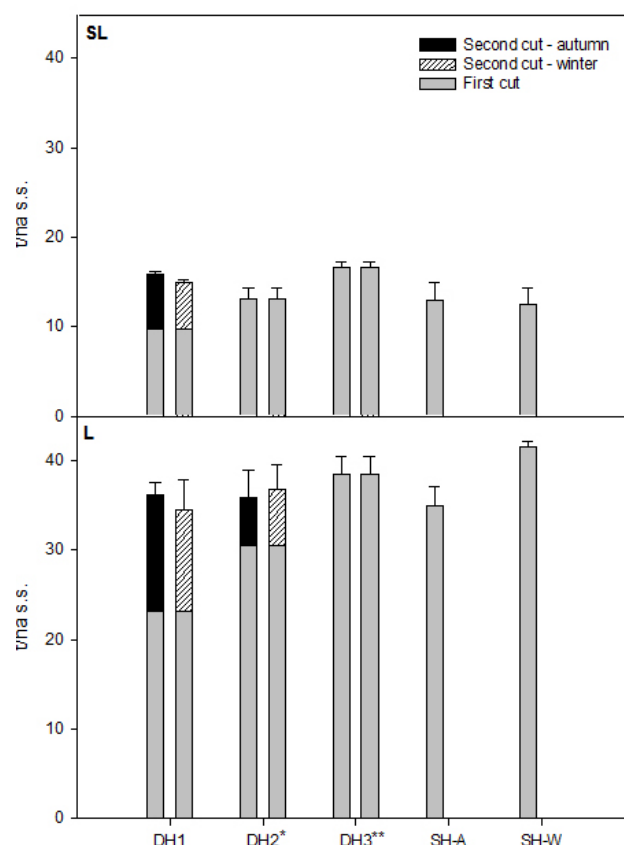

Figure 1: Aboveground dry yield in sandy loam (SL) and loam (L) soils under different harvest systems.

Dry matter content (DM) followed the same trend in both soils, increasing from July to January. In the first cut DM was lower than 40% only in DH1, while in the other DH systems was between 45% and 55%. In the second cut, DM was generally lower than those observed in SH systems. Ash content was higher in L (6.0 vs 4.8%) and decreased along the season. In general, second cut showed lower contents than first cut (Tab.1).

Table 1: DM and ash content of giant reed related to different soils, DH/SH and cut times.

Soil	Harvest system	DM%		Ash%	
		1 st cut	2 nd cut	1 st cut	2 nd cut
Sandy loam (SL)	DH1-A		37.3%		4.7%
		35.2%		5.9%	
	DH1-W		46.2%		4.7%
	DH2-A		-	5.6%	-
	DH2-W	44.5%			
	DH3-A		-		-
	DH3-W	48.4%		5.0%	
	SH-A	51.9%		4.5%	
	SH-W	49.2%		3.1%	
Loam (L)	DH1-A		42.3%		7.8%
		38.0%		6.6%	
	DH1-W		52.5%		6.2%
	DH2-A		34.3%		6.7%
	DH2-W	47.0%		6.4%	
	DH3-A		-		-
	DH3-W	51.1%		4.8%	
	SH-A	55.3%		4.4%	
	SH-W	52.9%		4.6%	

Conclusions

Our study confirms good yields of giant reed in fertile soils; however, interesting yields were achieved also on marginal lands (Lewandowski et al, 2003). The adoption of DH system instead of SH did not seem to significantly vary the overall productivity, thus representing an option both for logistics and farm management reasons. Variations of DM along the season may lead to hypothesize different end uses of biomass depending on harvest time. Further studies should be performed in order to assess long term effects on sustainability in terms of energy input, nutrient uptakes and yield stability over years.

References

- Angelini et al, 2009. Comparison of *Arundo donax* L. and *Miscanthus x giganteus* in a long-term field experiment in Central Italy: Analysis of productive characteristics and energy balance. *Biomass Bioenergy* 33:635-643.
- Ebadiana et al, 2011. A new simulation model for multi-agricultural biomass logistics system in bioenergy production. *Biosys Eng* 10:280-290.
- Lewandowski et al, 2003. The development and current status of perennial rhizomatous grasses as energy crops in the USA and Europe. *Biomass Bioenergy* 25:335-361

Effects of crop production factors on bio-ethanol production of maize in the polyfactorial long-term experiment

Harsányi, Endre; Erdei, Éva; Rátonyi, Tamás

University of Debrecen, HUNGARY

Introduction

The European Union has made a decision which is obligatory for the Member States to increase the proportion of bio-fuels within fuels to 10% by 2020. The EU member states that are unable to produce the necessary amount of ethanol by themselves require import, because the increasing of the proportion of ethanol is compulsory for them as well. Therefore both the ethanol that can be produced in Hungary and the maize necessary for it have stable markets on the long run. The primary tasks of the Hungarian maize production sector are the elimination of the quantitative extremities and the assurance of a sustainable production. Several research results have been published about the quality of maize, Singh et al. (2002) and Miao et al. (2006) concluded that nitrogen fertilization significantly increased yield and protein content, but it decreased oil and starch content.

Materials and methods

The objective of our investigation is to evaluate the effects of crop production factors on bio-ethanol production of maize in the polyfactorial long-term experiment in the 2011 crop season. Yield, starch content, starch yield and bio-ethanol yield per hectare of maize were investigated at the trial site of the University of Debrecen, Hungary. Soil of the experimental site was a lowland pseudomycelial chernozem (Mollisol-Calcicustoll or Vermustoll, silt loam). The climate is temperate continental, with an annual precipitation of 518 mm in 2011 of which 62,5% (324 mm) occurs during the growing season (from April to September). The trial is a polyfactorial long-term cultivation trial with a split-split-plot distribution. Irrigation and cultivation are in the main block, while fertilization is examined in randomized blocks with four repetitions. The yield of maize has been determined with a plot harvester. The starch content determination of the maize hybrids was carried out with a Foss InfratecTM 1241 type crop analyzing device. Bio-ethanol fermentation was carried out by SSF technology on a higher temperature by using the *Kluyveromyces marxianus* E1 thermotolerant mutant strain (Erdei et al., 2011).

Results and discussion

The increasing fertilizer doses decreased the starch content of the maize per dry matter. The highest starch content was obtained in non-fertilized control plots, whereas the lowest values were registered on plots on which N fertilizer doses 240 kg ha⁻¹ were applied (Figure 1a). The fertilizer doses increased the starch yield of maize parallel with the increase of grain yield, the maximum value was obtained in the case of 120 kg ha⁻¹ N level. The lowest bio-ethanol production (2880 liter ha⁻¹) resulted from 0 kg N ha⁻¹ fertilization level of spring ploughing treatment, the highest bioethanol production (5756 liter ha⁻¹) resulted from 120 kg N ha⁻¹ fertilization level of winter ploughing treatment (Figure 2b).

Conclusions

The amount of producible bio-ethanol from maize produced on a unit of area is determined by the genotypes of maize hybrids, agronomy factors and environmental factors. Based on our results, optimal treatment combinations can be determined that can be used to increase starch yield and bio-ethanol production of maize.

Acknowledgements

This research was supported by NKTH TECH-09-A3-2009-0227, BOKONV9.

References

- Erdei É et al. 2011. Trehalose overproduction affects the stress tolerance of *Kluyveromyces marxianus* ambiguously. *Bioresour Technol.* 102: 7232-7235.
- Miao Y., et al. 2006. Within-Field Variation in Corn Yield and Grain Quality Responses to Nitrogen Fertilization and Hybrid Selection. *Agronomy Journal* 98 (1-2): 129-140.
- Singh, M. 2002. Site-specific study of corn protein, oil, and extractable starch variability using NIT spectroscopy. ASAE Meeting Pap. 02-1111. ASAE, St. Joseph, MI.

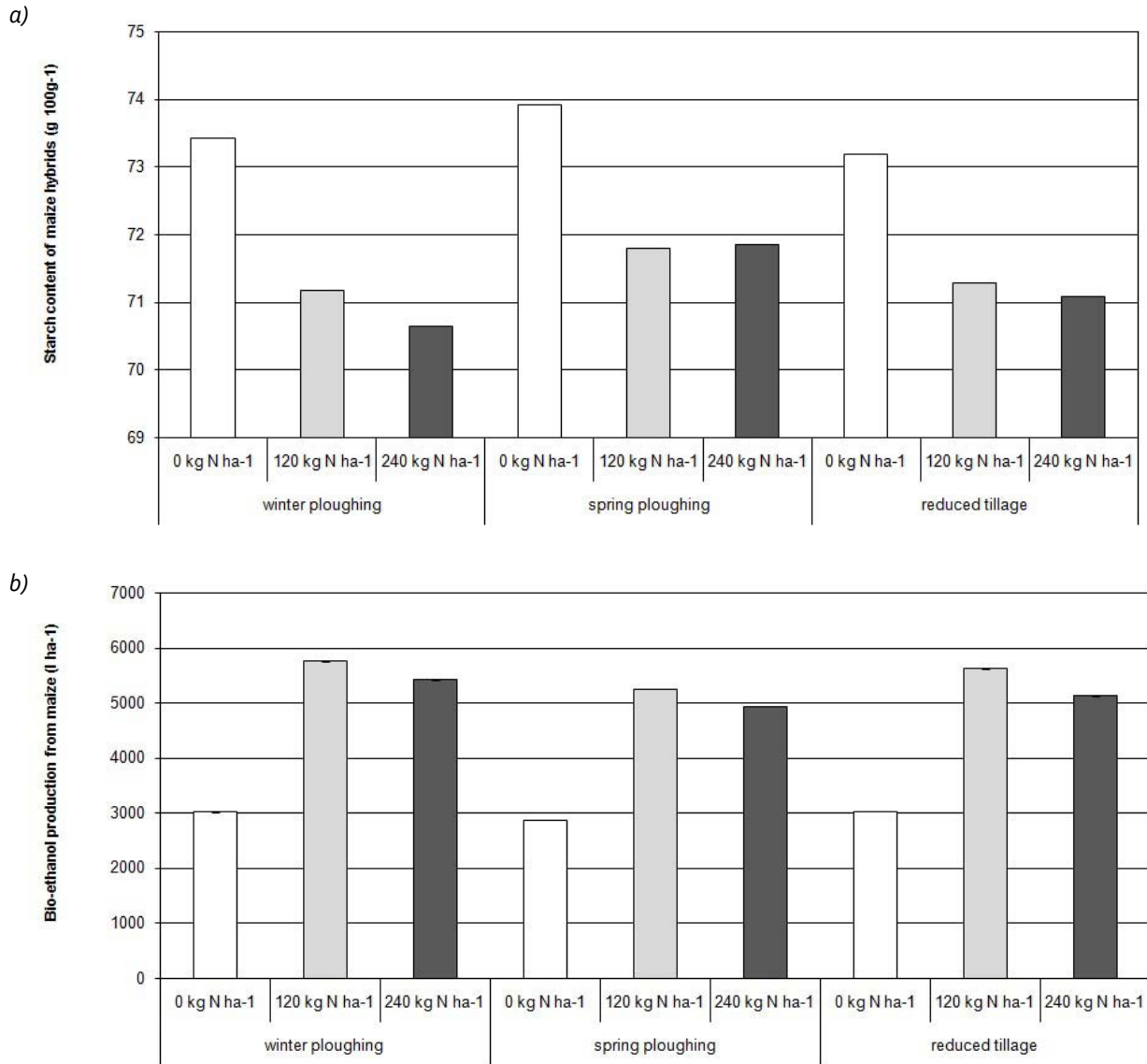

Fig. 1 Effects of tillage systems and fertiliser level on the starch content a) and bio-ethanol production b) of maize hybrids in the polyfactorial long-term experiment in Hungary

Biomass accumulation of alternative crops for bioenergy in Northern climate

Kadziuliene, Zydre; Sarunaite, Lina; Kryzeviciene, Aldona; Stukonis, Vaclovas; Slepetyts, Jonas; Tilvikiene, Vita; Dabkevicius, Zenonas

Lithuanian Research Center for Agriculture and Forestry, LITHUANIA

Introduction

Biomass plantations have the potential to become a significant source of renewable energy and perennial crops are more favoured than annual crops due to the relatively high yields per land unit, and are produced with less impact on the environment (Boehmel et al., 2008). Under more northerly climate conditions more confidence is placed on C₃ plants reed canary grass, tall fescue and others (Jasinskas et al., 2008; Hakala et al., 2009). The yield of dry biomass of perennial tall grasses in Lithuanian soils amounted to 6–9 t ha⁻¹ and only in favourable years it amounted to up to 12 t ha⁻¹ (Jasinskas et al., 2008; Tilvikienė et al., 2009). However, they are generally not very productive and their fuel quality does not match that of wood products. Maximization of the efficiency of biomass as an energy source, requires to search for some attractive alternative crops. The present study was aimed to evaluate the biomass productivity of perennial plants in relation to different plant supply with nitrogen.

Materials and methods

The herbaceous plant species were investigated in a small-plot experiment on sand with small stone and gravel admixture, Eutri-Cambic Arenosol (ARb-eu) in Lithuania (55° 24' N, 23° 52' E). The average long term temperature is 6.2 °C, rainfall - 661 mm. In 2007, the cocksfoot (*Dactylis glomerata* L.), *Miscanthus x giganteus*, cup plant (*Silphium perfoliatum* L.), Virginia fanpetals (*Sida hermafrodita* R.), mugwort (*Artemisia vulgaris*) and absinthe wormwood (*Artemisia dubia*) were established. Three nitrogen fertilization levels (0, 60 and 120 kg ha⁻¹) were explored from the second year of growing. The plants were harvested at the end of the growing season and the dry matter yield and the chemical composition of the biomass were determined. The research results were processed by analysis of variance (P<0.05).

Table 1. The biomass productivity of energy crops

	Rate of mineral nitrogen, kg N ha ⁻¹	DM yield, t ha ⁻¹			
		2008	2009	2010	2011
<i>Miscanthus giganteus</i>	0	4.62	11.22	4.88	0.46
	60	6.55	11.02	4.88	5.45
	120	6.82	12.24	7.8	6.48
LSD ₀₅		1.98	2.21	2.37	1.81
<i>Silphium perfoliatum</i>	0	3.39	11.85	4.54	3.74
	60	4.33	18.13	9.83	4.75
	120	3.8	18.2	6.76	4.24
LSD ₀₅		1.97	1.81	2.02	0.5
<i>Sida hermafrodita</i>	0	7	11.63	10.5	4.7
	60	9.55	12.37	14	5.15
	120	7.32	14.29	2.01	4.97
LSD ₀₅		2.84	2.85	2.01	0.81
<i>Artemisia dubia</i>	0	10.2	17.49	11.2	6.22
	60	15.6	24.12	13.38	8.81
	120	13.8	27.62	13.38	8.32
LSD ₀₅		5.37	0.41	1.11	1.26
<i>Dactylis glomerata</i>	0	6.11	4.42	2.36	1.97
	60	6.8	8.05	4.73	3.06
	120	8.29	6.21	7.02	5.26
LSD ₀₅		1.92	0.57	0.21	0.44

Results

The dry matter content of *Miscanthus* varied from 4.6 to 11.9 t ha⁻¹. The dry matter content of Virginia fanpetals increased each year from 7.00 to 15.1 t ha⁻¹ in the fourth year of growth, however in the fifth year of growth was as low as 4.70–5.15 t ha⁻¹. Without nitrogen fertilization, dry matter content of cup plant ranged from 3.39 to 7.94 t ha⁻¹ and fertilized, varied from 3.8 to 14.23 t ha⁻¹. Of other alternative crops, the best performer in terms of biomass growth was absinthe wormwood. When fertilized with N₆₀, in the second–fourth years of growth the plants accumulated on average 8–24 t ha⁻¹ biomass; however, in the fifth year the biomass amount averaged 6.21–8.81 t ha⁻¹. Cocksfoot biomass content, when fertilized with nitrogen fertilizer, during the four years of use varied on average from 3.0 to 8.3 t ha⁻¹ dry matter (Tab. 1).

The key energy indicator of solid fuel - calorific capacity is most adversely affected by too high ash concentration in the biomass. The least ash concentrations were noted for *Miscanthus*, Virginia fanpetals and absinthe wormwood. Considering not only potential relevance of the biomass growth research results but also a wide range of variation, research needs to be continued seeking to more comprehensively explore the feasibility of introduced plants' development and integration of non-traditional species into renewable energy sources.

References

- Boehmel C., Lewandowski I., Claupein W. 2008. Comparing annual and perennial energy cropping systems with different management intensities. *Agricultural Systems* 96:224–236.
- Hakala K., Kontturi M., Pahkala K. 2009. Field biomass as global energy source. *Agricultural and Food Science* 18:347–365.
- Jasinskas A., Zaltauskas A., Kryzeviciene A. 2008. The investigation of growing and using of tall perennial grasses as Energy crops *Biomass and Bioenergy* 32: 981–987
- Tilvikienė V., Butkutė B., Dabkevičius Z., Kadžiulienė Ž., Kryževičienė A. 2009. Nendrinio eraienio ir paprastųjų šunazolių biomasės kaita plaukėjimo ir žydėjimo tarpsniais. *Žemdirbystė-Agriculture* 96 (2):138–150.

Identifying the yield potential of giant reed (*Arundo donax* L): an assessment of biomass productivity and nutrient uptakes in stands of different ages

Nassi o Di Nasso, Nicoletta¹; Roncucci, Neri¹; Angelini, Luciana G.²; Bonari, Enrico¹

¹Scuola Superiore Sant'Anna, ITALY; ²Università di Pisa, Dipartimento di Agronomia e Gestione dell'Agroecosistema - DAGA, ITALY

Introduction

Among energy crops, giant reed (*Arundo donax* L.) seems promising owing to its high productivity and longevity and to its low nutrient requirement [1]. However, little is known on biomass and nutrient accumulation dynamic. For this reason, the following research questions were addressed: how biomass accumulation is affected by environmental conditions and crop age?; how much N, P and K are removed by giant reed crops during the growing season?

Materials and methods

A giant reed field trial was set up in 2006 at DAGA Experimental Centre (Pisa, Central Italy). The experimental design was a randomized block with three

replications. Fertilizers were distributed at a rate of 100 kg ha⁻¹ of N, P₂O₅ and K₂O. Samples were collected on 2 m² along 2006, 2007 and 2008 growing seasons. Subsamples were dried at 60°C to constant mass and crop dry matter percentage and yield were calculated. Experimental data were fitted to the Gompertz equation and Crop Growth Rate (CGR) was calculated to estimate the change rate of the total crop biomass over time. In 2008, on mature crops, further indices were determined: LAI by means of a plant canopy analyzer and Radiation Use Efficiency (RUE) as the slope of the relationship between aboveground biomass per square meter and cumulated intercepted photosynthetic active radiation (iPAR). N, P and K concentration were determined by the Kjeldahl method, by spectrophotometric analysis and flame photometry, respectively. Nutrient content was calculated as the product of nutrient concentration and dry yield.

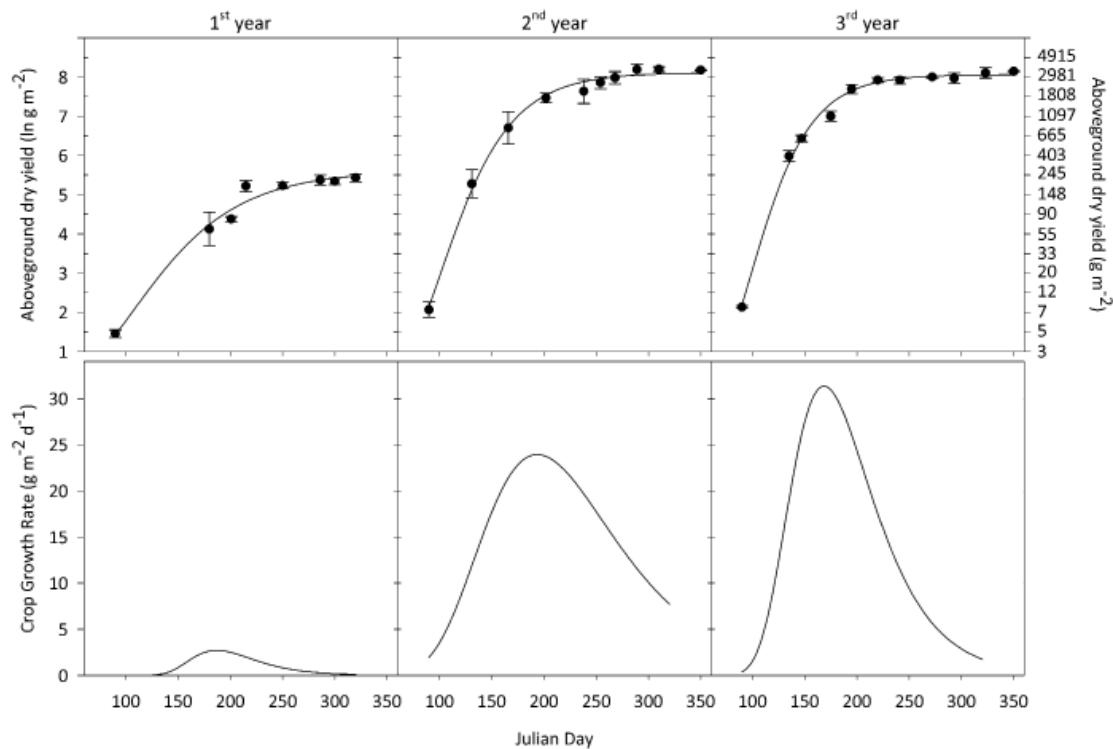

Figure 1. Mean predicted aboveground dry yield per ground area and CGR as a function of Julian day from 2006 to 2008. Solid circles indicate observed mean values (\pm SE).

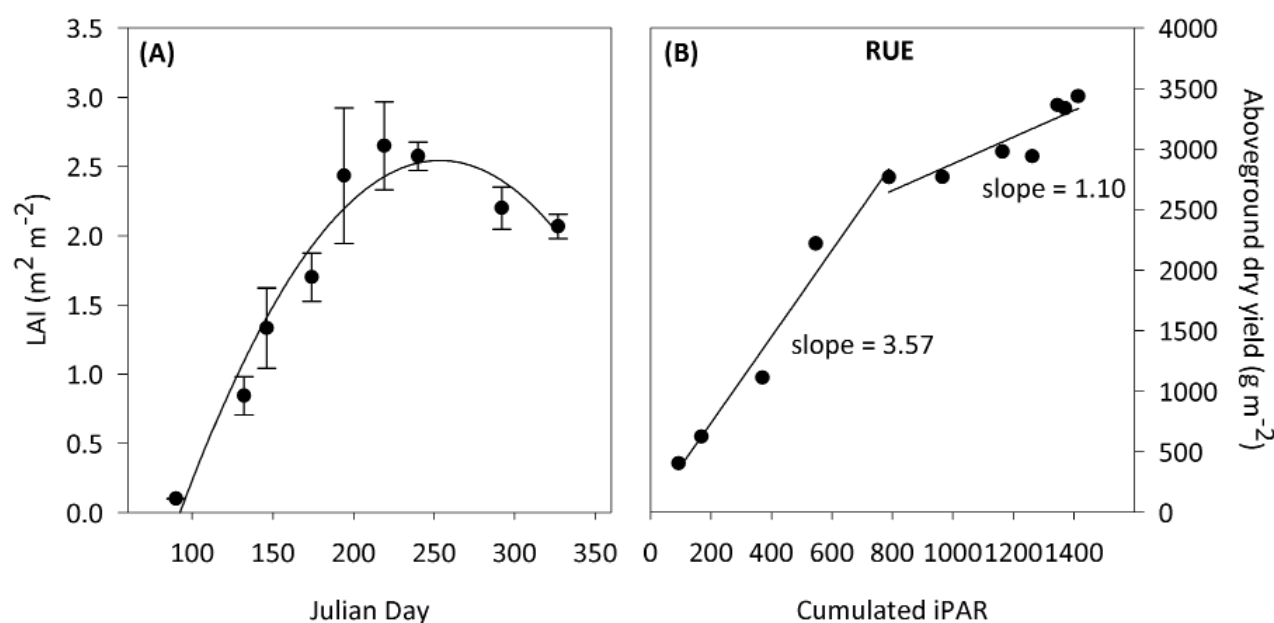

Figure 2. Predicted function of LAI and RUE in 2008. Solid circles indicate observed mean values (\pm SE).

Results

Regardless of crop age, giant reed biomass accumulation showed the same seasonal trend, with a growing cycle from the end of March to the beginning of November. The aboveground biomass accumulation of giant reed from the 1st to the 3rd year of growth (3.5, 37 and 32 $\text{t ha}^{-1} \text{yr}^{-1}$) is reported in Figure 1A. Crop age did not affect the timing of maximum CGR (about 180 JD, end of June), although it changed among the years (Fig. 1B). In year-3 maximum LAI was achieved 10 weeks following maximum CGR (Fig. 2A,B), as reported for mature crops [2]. However, in our experiment LAI values were lower than previously observed in mature crops, probably due to the lower stem density. In fact, the canopy closure ($\text{LAI} \geq 5$) was not achieved. Giant reed was characterised by high RUE ($\geq 3 \text{ g}_{\text{DM}} \text{ MJ}^{-1}$) until the accumulated biomass reached 25 t ha^{-1} ; then this value dropped to about 1 $\text{g}_{\text{DM}} \text{ MJ}^{-1}$.

In year-1 nutrient uptakes increased almost linearly until the end of the growing season, while from the 2nd year onwards they followed the trend previously described, reaching maximum values in late July and then decreasing until winter [2]. Nutrient uptakes were strongly related to dry yield, consequently in our experiment they were very low in year-1. On the contrary, from year-2 they increased substantially, with maximum values of about 150, 40, 350 kg ha^{-1} for N, P and K, respectively.

Conclusions

Giant reed seems to be characterized by the same growth strategy irrespectively of crop age. Moreover, the trend of crop total biomass accumulation and nutrient uptakes were not affected by crop age. However, further studies are necessary to better understand the role of rhizomes on nutrient dynamic in the fall-winter growing season.

References

- [1] Angelini *et al.*, 2009. Comparison of *Arundo donax* L. and *Miscanthus x giganteus* in a long-term field experiment in Central Italy: Analysis of productive characteristics and energy balance. *Biomass Bioenergy*, 33: 635-643.
- [2] Nasso o Di Nasso *et al.*, 2011. Seasonal nutrient dynamics and biomass quality of giant reed (*Arundo donax* L.) and miscanthus (*Miscanthus x giganteus* Greef et Deuter) as energy crops. *Ital J Agron*: 6:152-158

Biogas and fertilisation from clover leys

Nykänen, Arja¹; Kymäläinen, Maritta²; Lemola, Riitta¹

¹MTT Agrifood Research Finland, FINLAND; ²HAMK University of Applied Sciences, FINLAND

Introduction

On-farm bioenergy production is increasing in Finland, e.g. to reduce the dependency on fossil fuels. Here, biogas production from biomass of the leys by anaerobic digestion (AD) is an interesting option, but research on the fertilisation effect of the digested biomass is lacking. In AD, besides the biogas production, a part of the biomass organic nitrogen (N) converts into inorganic ammonium N (NH₄-N), easier available for plants. Green manuring with red clover-grass leys is common in organic farming but the problem there is that leys do not give marketable yields. In this study, the fertilization effect of the digested biomass was compared to green manuring as well as to commercial fertilisers.

Materials and methods

Two field experiments were established on organically (moraine soil) and conventionally (clay soil) cultivated fields to measure biogas production of silage cut red clover/clover-grass leys and to produce digestate for the fertilisation of spring wheat on next year. The experiments were designed so that one-year-old red clover-grass leys were grown in 2009 in two experiments (pure red clover on conventional field) and 2010 in other two experiments and subsequent spring wheat in 2010 and 2011, respectively. The treatments in the experiments were the different usage of leys: 1) mulched ley, 2) harvested ley for biogas and use of the digestate as fertiliser on the same plot next spring and 3) spring wheat with common fertilisation level as a control.

Leys for green manure were cut twice a year and the biomass was left over the surface. Leys for AD were harvested and preserved anaerobically without additives. All plots were measured for total yield, DM and total N (TN) content. The biogas production of the preserved leys was performed in a mesophilic process, in a reactor of 0.2 m³, fed once a day for about three months after which the reactor was kept without feeding for about 20–30 days. The digestate was stored in a cool storage to be used as a fertiliser, and TN and NH₄-N were analysed.

Spring wheat plots after leys were fertilised with digestate at the equivalent TN amount from 100 to 190 kg ha⁻¹. The N fertilisation of 80 kg N ha⁻¹ for control plots was added as meat bone meal on organic field and as mineral fertiliser on conventional field.

Results

The yields of the organic clover-grass leys were about 7 000 kg ha⁻¹ DM in both years and the TN amounts were 110 kg ha⁻¹. The conventionally cultivated yields were 7 000 kg ha⁻¹ DM for clover ley in 2009 and about 11 000 kg ha⁻¹ DM for clover-grass ley in 2010. The N amounts were 190 kg ha⁻¹ and 250 kg ha⁻¹ in 2009 and 2010, respectively.

The mean spring wheat yield (15% moisture content) in organic cultivation after clover-grass ley varied from 900 to 1 650 kg ha⁻¹ in 2010 and from 2 100 to 2 500 kg ha⁻¹ in 2011. In conventional cultivation after clover ley, spring wheat yields were higher varying from 4 700 to 4 900 kg ha⁻¹ in 2010 and after clover-grass ley from 4 100 to 4 550 kg ha⁻¹ in 2011. No statistical differences were found.

During biogas production, the TN content increased from 17 to 58 g kg⁻¹ DM (from organic clover-grass biomass to digestate) and from 33 to 73 g kg⁻¹ DM (from conventionally cultivated clover or clover-grass biomass to digestate) due to the loss of dry matter in the AD process. In the digestate, about half or two thirds of TN was in form of NH₄-N. The methane production from clover-grass biomass varied from 0.28 to 0.33 m³ kg⁻¹ DM, while from pure clover biomass it was 0.24 m³ kg⁻¹ DM. Calculated with biomass yields, the biogas production was 20 MWh ha⁻¹ for organic clover-grass, 37 MWh ha⁻¹ for conventional clover-grass and 17 MWh ha⁻¹ for pure clover.

Conclusions

The clover-grass biomass produced more biogas than pure clover, but production per hectare depends also on biomass yield. The benefit from AD of the green manure leys seem to be based more on bioenergy production than for higher cereal yields after AD.

Intercropping lignocellulosic crops with legumes to produce biomass for bioenergy

Pelzer, Elise; Bazot, Mathieu; Jeuffroy, Marie-Hélène
INRA, FRANCE

Introduction

A wide range of energy (or lignocellulosic) crops is available for biomass production from annual crops to perennial and woody crops. The type of energy crop and its insertion in cropping systems determines biomass production and quality. (Multi-)annual energy crops can achieve high yields, allow a combination of food and feed production in crop succession, and may therefore be more easily adopted by farmers. However, these energy crops suffer a major drawback compared to perennial ones due to their higher needs for fertilizer nitrogen, leading to higher N losses and energy costs (Boehmel et al. 2008). Intercropping energy crops with legumes offers the opportunity to reduce the use of N fertilizer while maintaining yields, thus improving the environmental and energetic performances of crops, such as nitrate leaching and energy consumption (Pelzer et al. 2012).

Materials and methods

An experiment was set up in Versailles (France, 30 km West from Paris; deep Luvisol, temperate climate, annual rain 640 mm and annual mean temperature 10.4 °C) to assess the agronomic, environmental and energetic performances of grass-legume intercrops. It included several species: annual winter crops (triticale, forage pea, vetch and red clover), annual spring crops (fibre sorghum, same legumes; no analysis due to climatic conditions leading to the legume death), and multi-annual crops (tall fescue, dactylis, alfalfa). Two N fertilizer treatments (with and without) were applied on sole grasses and grass-legume intercrops, no N on sole legumes. Agronomic performances were measured (biomass production and quality) as well as the N₂O emissions on non-fertilized treatments (static chambers), the nitrate leaching risk (soil mineral N content after harvest, as in Pelzer et al. 2012) and the energetic cost of production (based on INDIGO[®], cited in Pelzer et al. 2012). Lodging, diseases and weeds were also scored.

Results and Discussion

For annual winter and multi-annual crops, when comparing the same species, biomass production of

intercrops was significantly higher than sole crops. Dry matter content was higher for grasses than for legumes, and intermediate for intercrops. C and cellulose contents were not significantly different among treatments. N, S and lignin contents were higher for sole legumes than for sole triticale, and intermediate for intercrops. On the other hand, hemi-cellulose content was lower for sole legumes. For annual winter crops, ash content was higher for sole legumes and intermediate for intercrops, whereas no difference was observed between multi-annual crop treatments. N fertilisation had no impact on the biomass production but significantly increased the proportion of the grass. Its effect on quality criteria needs to be confirmed. Soil mineral N after harvest was higher for sole legumes, and lower for sole grasses and intercrops. Lodging, diseases and weeds were significantly decreased in intercrops compared to sole crops. N₂O measurements on multi-annual crops were significantly higher in sole alfalfa and intercrops compared to non-fertilised fescue, but this will be further investigated.

Conclusions

As suggested by Jensen et al. 2012, these preliminary results (that need to be confirmed with the second year) show the potential of legumes as feedstock for bioenergy production. Moreover, grass-legume intercropping present more favourable quality characteristics than sole legume, together with higher yields and lower environmental impacts compared to sole crops.

References

- Boehmel C et al 2008. Comparing annual and perennial energy cropping systems with different management intensities. *Agr. Syst.* 96, 224-236
- Jensen E et al 2012. Legumes for mitigation of climate change and the provision of feedstock for biofuels and biorefineries. A review. *Agr. for Sust. Dev.* 32, 329-364
- Pelzer E et al. 2012. Pea-wheat intercrops in low-input conditions combine high economic performances and low environmental impacts. *Eur. J. Agro.* 40, 39-53

Cultivation of *Miscanthus* in Mediterranean environment: preliminary results on productivity and soil CO₂ emissions under different crop management

Roncucci, Neri; Nasso, Nicoletta; Bosco, Simona; Ragolini, Giorgio; Bonari, Enrico
Scuola Superiore Sant'Anna, ITALY

Introduction

Among energy crops, perennial rhizomatous grasses are promising due to their high productivity, low nutrient requirement and great potential for C mitigation (Lewandowski *et al.*, 2003). Productivity of *Miscanthus* is largely related to precipitations and soil moisture (Kahle *et al.*, 2001). Moreover, longer-term field GHG measurement studies are sparse and few information are available on GHG emissions of energy crops (Drewer *et al.*, 2011). The objective of the study is to deepen the understanding of the influence of soil texture and of alternative agricultural intensification regimes on miscanthus productivity, soil CO₂ emissions and C dynamics.

Materials and Methods

The study was carried out in Central Italy on 2-year old crops. One trial (S) was characterized by two soil texture (silty clay (SIC) vs. sandy loam (SL)) as the main plot and three N levels (0, 50, 100 kg ha⁻¹) as the subplot. The other trial (IR) was set on a silty clay loam soil with two irrigation regimes (0% vs. 75% of the ET₀) as the main plot and three N levels (0, 50, 100 kg ha⁻¹) as the subplot. In both trials productive measurements were collected at three dates: flowering stage (FS), autumn (A) and winter (W). CO₂ emissions were taken twice a month via the dynamic method, using an IRGA (LICOR 820).

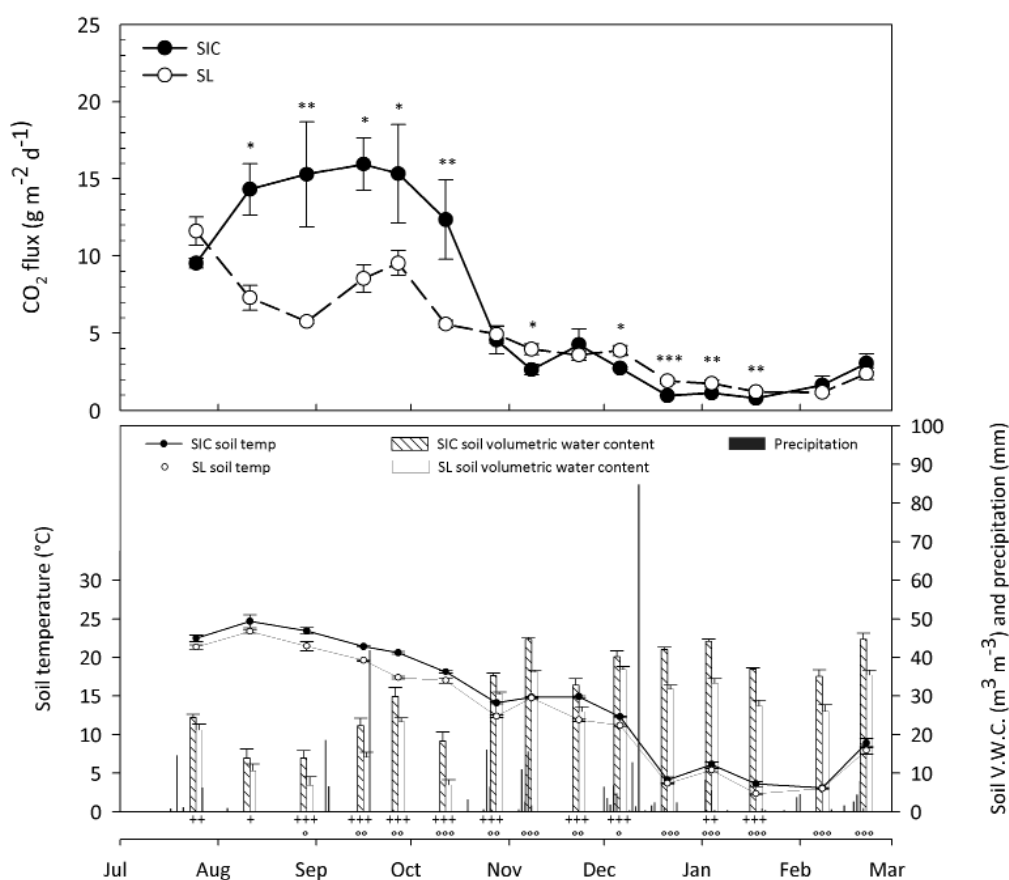

Figure 1. CO₂ flux, soil temperature and moisture content in the SIC and SL soils. *, +, ° represent significant differences for CO₂ flux, soil temperature and soil moisture, respectively. One, two or three symbols represent $p < 0.05$, 0.01 , 0.001 , respectively.

Results and discussion

Aboveground dry yield was influenced by both soil texture and date of harvest. In the S-trial, crop growing in SL soil attained a 57% yield reduction compared to that growing on SIC soil (19 t ha⁻¹). Our results are likely to be linked to the shallow water table that, coupled with the good capillary action of the SIC soil, could have guaranteed sufficient water to the crop needs. In addition, no yield differences were recorded in the IR-trial between the two irrigation treatments. In both trials, maximum yields were recorded at the FS (17.4 (S) and 22.4 (IR) t ha⁻¹), decreasing almost linearly to W (11.7 (S) and 15.6 (IR) t ha⁻¹), highlighting a 30% reduction consistent with results of Kahle *et al.*, (2001).

Significant differences in CO₂ fluxes between soil textures (S-trial) were recorded in 10 out of 15 dates (Fig. 1). Generally, CO₂ flux was higher in the SIC during the summer period; on the contrary it was slightly higher in the SL throughout the cold period. As expected, soil temperature and soil water content were often higher in the SIC than the SL. The overall parallel pattern between soil temperature and soil CO₂ flux may suggest an influence of the former over the latter; similarly to Jabro *et al.* (2008) an exponential relationship is well suited to describe this relationship. Finally, carbon returning to soil as litterfall was about 150 g m⁻², while C losses from July to February totaled about 462 and 309 g m⁻² in SIC and SL, respectively.

Conclusions

More years of study are required to better understand the importance of soil type, water and nitrogen availability on miscanthus productivity and carbon balance. The role of the belowground biomass seems fundamental to all these issues and it should be further investigated.

References

- Drewer J *et al.* 2011. How do soil emissions of N₂O, CH₄ and CO₂ from perennial bioenergy crops differ from arable annual crops?. *GCB bioenergy*, doi: 10.1111/j.1757-1707.2011.01136.x.
- Jabro JD *et al.* 2008. Carbon dioxide flux as affected by tillage and irrigation in soil converted from perennial forages to annual crops. *J Environ Manage*, 88:1478-1484.
- Kahle P *et al.* 2001. Cropping of *Miscanthus* in Central Europe: biomass production and influence on nutrients and soil organic matter. *Eur J Agron*, 15:171-184.
- Lewandowski I *et al.* 2003. The development and current status of perennial rhizomatous grasses as energy crops in the US and Europe. *Biomass Bioenergy* 25:335-361.

Biomass and leaf nitrogen content of maize grown with sludge

Seleiman, Mahmoud E; Mäkelä, Pirjo; Santanen, Arja; Stoddard, Frederick

University of Helsinki, FINLAND

Introduction

The disposal of sludge is considered as a serious environmental problem (Seleiman et al. 2012). Sludge contains a high level of essential plant nutrients for instance N and P (Katanda et al., 2007). Synthetic fertilizer N can be substituted with organic nitrogen sources partially or completely depending on crop growing conditions (Bozkurt et al. 2006). Maize (*Zea mays* L.) is one of widely cultivated energy crops (Ericsson and Nilsson, 2006).

The aim of this work was to investigate the effect of sewage and biogas sludge on biomass accumulation and leaf nitrogen content in maize.

Materials and methods

Maize (cv. Ronaldino) was grown at the Viikki experimental farm, University of Helsinki, Finland (60° 14' N., 25° 02' E) in 2011. The experiment included six different treatments (100% fertilizer, 50% + 50% fertilizer in a split application, 50% fertilizer + 50% sludge, 100% sludge, 150% sludge and 100% biogas sludge). Treatments were standardized on

the basis of total nitrogen needed for maize (120 kg N ha⁻¹). Fertilizer, sewage sludge and biogas sludge treatments were applied at sowing except 50% + 50% fertilizer which was split application (at sowing and at mid-season). The experiment was arranged in a randomized complete block design with four replicates. Plot area was 20 m². Sewage sludge was incorporated into the soil surface up to 7 cm depth. Precipitation accumulation was 491 mm. Soil pH was 6.2. N, P and K concentration in soil was 4.92, 1.65 and 8.05 g kg⁻¹.

To measure biomass accumulation, one m² was collected manually from each plot monthly during the growing season and dried at 65°C to get the dry weight. To analyze total leaf nitrogen content, leaves were collected at 30, 45, 60 and 75 days after sowing (DAS) and dried at 65°C. About 200 mg ground leaves was used to measure total leaf nitrogen content with Vario MAX CN (Elementar Analysensysteme GmbH, Hanau, Germany).

Results and discussion

The 100% sewage sludge application increased biomass accumulation, particularly at 90 and 120 DAS (Fig. 1). It

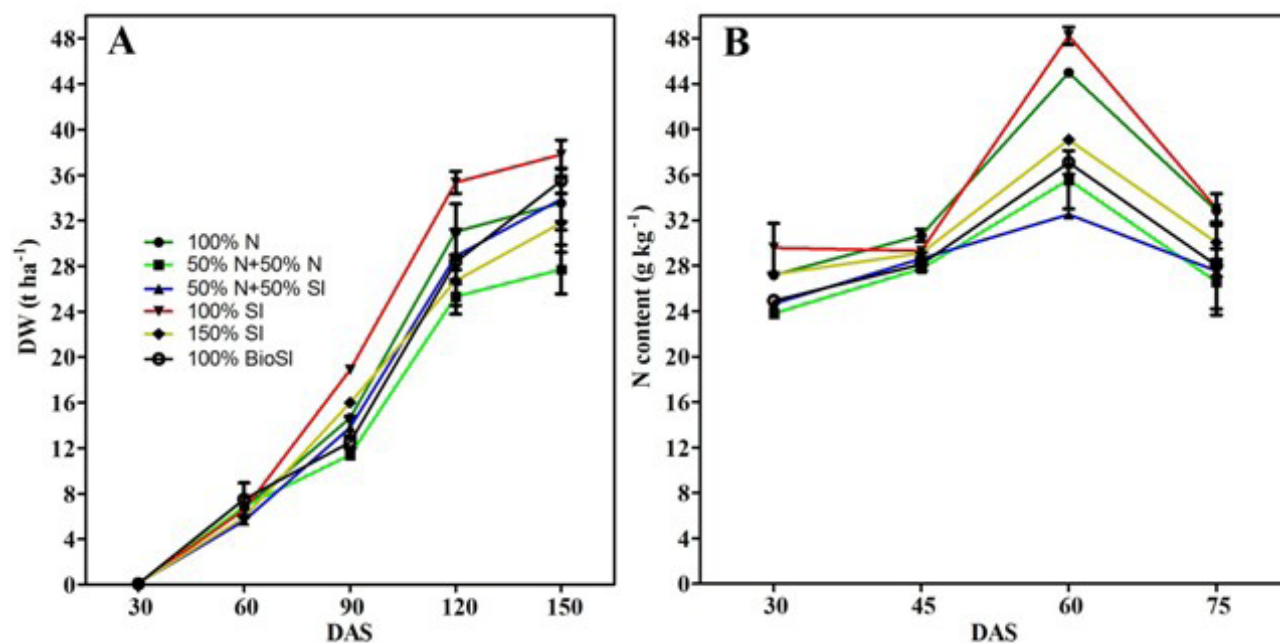

Fig. 1. Effect of sludge and nitrogen fertilization on biomass accumulation (A) and leaf nitrogen content (B) of maize during growing season 2011. Data shown are means \pm SE.

resulted in an increase of biomass by 29 and 14% at 90 and 120 DAS compared to fertilizer (100% N). The increase in dry matter of maize grown with 100% sewage sludge could be related to the improvement of soil conditions by nutrients and organic matter (Christie et al., 2001). In addition, 100% sewage sludge application resulted in higher leaf N content of the maize in comparison to other fertilizer and sludge treatments. The 100% sewage sludge application caused an increase of maize leaf N content by 7% at 60 days after sowing compared to 100% synthetic fertilizer. This might be related to the released N and the mineralization process from the sludge during the growth.

Conclusions

Sewage sludge application (100%) resulted in highest biomass accumulation and leaf nitrogen content consequently; it can be suitable nutrient source for maize instead of synthetic nitrogen fertilizer.

Acknowledgements

Suomen Kulttuurirahasto, Helsingin Vesi Oy and Envor Biotech Oy are acknowledged.

References

- Bozkurt MA et al. 2006. Possibilities of using sewage sludge as nitrogen fertilizer for maize. *Acta Agric. Scand., Sect. B - Soil Plant Sci.* 56: 143-149.
- Christie P et al. 2001. Agronomic value of alkaline-stabilized sewage biosolids for spring barley. *Agron. J.* 93, 144-151.
- Ericsson K & Nilsson LJ. 2006. Assessment of the potential biomass supply in Europe using a resource-focused approach. *Biomass Bioenergy.* 30: 1-15.
- Katanda Y et al. 2007. Effects of heavy metals contained in soil irrigated with a mixture of sewage sludge and effluent for thirty years on soil microbial biomass and plant growth. *Phys. Chem. Earth.* 32: 1185-1194.
- Seleiman MF et al. 2012. Feedstock quality and growth of bioenergy crops fertilized with sewage sludge. *Chemosphere*, in press.

The biomass potential of perennial energy grasses

Tilvikiene, Vita; Kadziuliene, Zydre; Dabkevicius, Zenonas

Lithuanian Research Centre for Agriculture and Forestry, LITHUANIA

Introduction

Considering the climatic conditions in northern countries, the most promising raw material for bioenergy is biomass and biomass residues (Monti et al., 2009; Borjesson et al., 2011). Perennials, used for bioenergy, have many advantages compared to annuals: they can be harvested for several years in succession without reseeding and give high biomass yield with satisfactory biomass quality (Kryževicienė et al., 2005; Seppala et al., 2009; Lehtomäki et al., 2011). The energy value of perennials is mostly influenced by the biomass yield (Prochnow et al., 2009). The highest influence on biomass productivity is based on agronomic technologies of biomass preparation.

The aim of this study was to evaluate the impact of mineral fertilizers and number of cuts on the biomass yield of perennial grasses used for biogas production.

Materials and methods

Cocksfoot (*Dactylis glomerata*), tall fescue (*Festuca arundinacea*) and reed canary grass (*Phalaris arundinacea*) were grown in Lithuania (55° 24'N) for biogas production. The soil of the experimental site was characterized as *Apicalcari - Endohypogleyic Cambisol*, light loam. Two levels of mineral nitrogen fertilizers N_{90} and N_{180} were applied two or three times per vegetation period, depending on number of the cuts per season. Swards

were cut two and three times per season, and the first cut was managed respectively at flowering stages or at heading.

Results

The average results of the 2-year experiment suggest that the biomass productivity of perennial energy grasses depend on grass species, fertilization and the number of cuts per vegetation season (Figure 1).

The most productive grass was tall fescue, cut twice per vegetation season. The average yield of swards fertilized with 90 kg N ha^{-1} was 9.4 t ha^{-1} and of those that were fertilized with 180 kg N ha^{-1} , 9.9 t ha^{-1} . Tall fescue and reed canary grass better yielded cut twice per season, cocksfoot when cut three times per season. The higher level of nitrogen fertilizers had positive effect on the biomass yield of all swards, but the increase was significant only in the case of reed canary grass.

Conclusions

The biomass yield of traditional grasses was influenced by the cutting frequency and amount of nitrogen fertilizer. In the two years of the experiment, the most productive were tall fescue and reed canary grass. More research is needed to evaluate the possibility to use these grasses as energy crops.

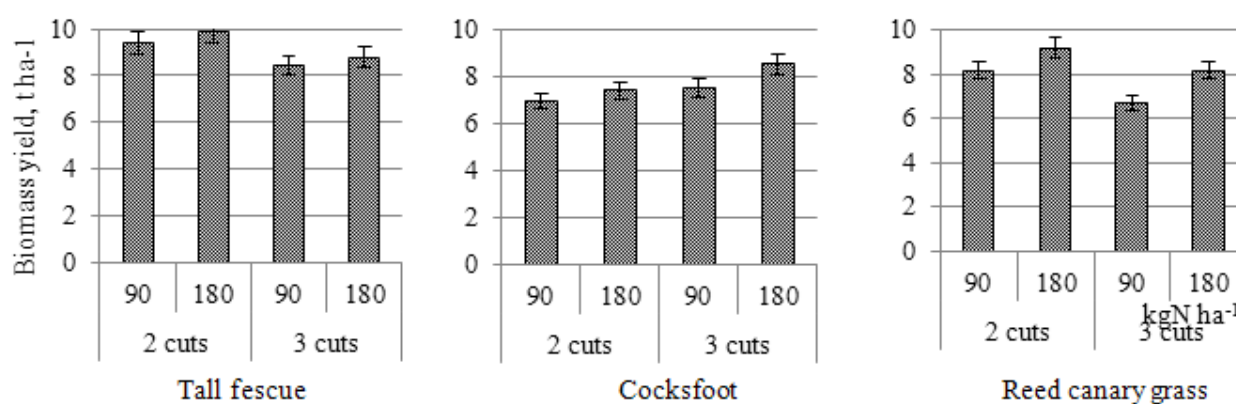

Figure 1. The variation of biomass productivity of tall fescue, cocksfoot and reed canary grass

References

- Monti A., Fazio S., Venturi G. 2009 Cradle-to-farm gate life cycle assessment in perennial energy crops. *Eur. J. Agron.* 31: 77–84.
- Borjesson P., Tufvesson L. M. 2011 Agricultural crop-based biofuels – resource efficiency and environmental performance including direct land use changes. *J. Cleaner Production* 19: 108–120.
- Kryževičienė A., Žaltauskas A., Jasinskas A. 2005 Daugiameiø žoliø auginimas ir naudojimas biokurui. *Žemės ūkio mokslai* 1: 40–49.
- Lehtomaki A., Viinikainen T. A., Rintala J. A. 2011 Screening boreal energy crops and crop residues for methane biofuel production. *Biomass Bioenergy* 32: 541–550.
- Seppala, M, Paavola, T, Lehtomaki, A, Rintala J. 2009 Biogas production from boreal herbaceous grasses—specific methane yield and methane yield per hectare. *Bioresource Technol.* 100: 2952–2960.
- Prochnow, A., Heiermann, M., Plöchl, M., Linke, B., Idler, C., Amon, T., Hobbs, P. 2009 Bioenergy from permanent grassland – A review: 1. Biogas. *Bioresource Technol.* 100: 4931–4944.

Root distribution and water uptake of contrasted biomass crops in a deep loamy soil

Vitte, Guillaume; Ferchaud, Fabien; Mary, Bruno
INRA, FRANCE

Introduction

Biomass crops development for energy production is expected to provide significant fossil energy substitution and greenhouse gas mitigation. Consequently, studies are mainly related to biomass production or nutrient budget, whereas few of them concern crops impact on water (Monti and Zatta, 2009). However, high yield biomass crops are likely to capture more water, what could impact hydrologic cycle. In this study we compare root systems of six biomass crops and their consequences on water uptake.

Materials and methods

A mid-term experiment was established in 2006 in Northern France in a deep loamy soil (Ortic Luvisol). It compares six biomass crops which are annual: fiber sorghum (SOR) and triticale (TRI); multi-annual: fescue (FES) and alfalfa (ALF); and perennial: *Miscanthus x giganteus* (MIS) and switchgrass (SWI) harvested in October. All crops except alfalfa received N fertilization. From 2007 to 2011, the mean annual rainfall was 630 mm and potential evapotranspiration was 731 mm. Soil water content (W) was measured every year in November by taking soil cores down to 150 cm (30 cm thick) in each plot (3 replicates). Plant water uptake is expressed by the "proportional water capture" (Monti & Zatta, 2009) defined as $pwc = (W_{fc} - W) / (W_{fc} - W_{wp})$, where W_{fc} and W_{wp} are the water contents at field capacity and wilting point, respectively. "Maximum proportional water capture" ($mpwc$) was defined for each layer by selecting the maximum pwc over the 5 years. Results were analyzed by analysis of variance and SNK test. In 2010, the vertical root distribution was characterized down to 300 cm using the trench profile method. Root distribution was observed on a 300 x 180 cm grid with cells of 1.9 * 1.9 cm, and expressed as "percentage of colonized cells" (Tardieu, 1988).

Results and Discussion

Rooting patterns showed large differences between species (Fig. 1). Maximum rooting depth exceeded 250 cm for MIS, SWI and ALF, whereas it was less than 200 cm

for other species. Root distribution also varied between species: MIS had the lowest percentage of colonized cells in the top soil (0-90 cm) and the highest below 200 cm, in agreement with results of Neukirchen *et al.* (1999). The proportional water capture (pwc) in layers 30-120 cm was significantly crop dependent in all years. The crop effect was only significant in 2010 and 2011 for the 120-150 cm layer. The maximum proportional water capture ($mpwc$) in the upper layer (30-60 cm) was significantly higher for MIS, FES and ALF crops (Fig. 2). It was higher for FES and ALF in layer 60-90 cm and for ALF in layer 90-120 cm. We found that $mpwc$ was positively related to root presence in all crops except for SWI, confirming the findings of Monti and Zatta (2009). Nevertheless, the relationship between root distribution and water uptake was crop dependent. For instance, FES had more than 150% more roots in layer 30-90 cm than MIS whereas its $mpwc$ was less than 15% higher.

Conclusions

The six biomass crops had various root distributions along the soil profile. They also exhibited significant differences in soil water content in autumn. There is a relationship between root distribution and proportional water capture which seems to be dependent on crop species. Indeed, others parameters such as root diameter or aboveground biomass production are likely to explain water uptake along with root distribution.

References

- Monti A., Zatta A. (2009) Root distribution and soil moisture retrieval in perennial and annual energy crops in Northern Italy. *Agriculture, Ecosystems & Environment* 132: 252-259.
- Neukirchen D. *et al.* (1999) Spatial and temporal distribution of the root system and root nutrient content of an established *Miscanthus* crop. *European Journal of Agronomy* 11: 301-309.
- Tardieu F. (1988) Analysis of the spatial variability of maize root density - I. Effect of wheel compaction on the spatial arrangement of roots. *Plant and Soil* 107(2): 259-266.

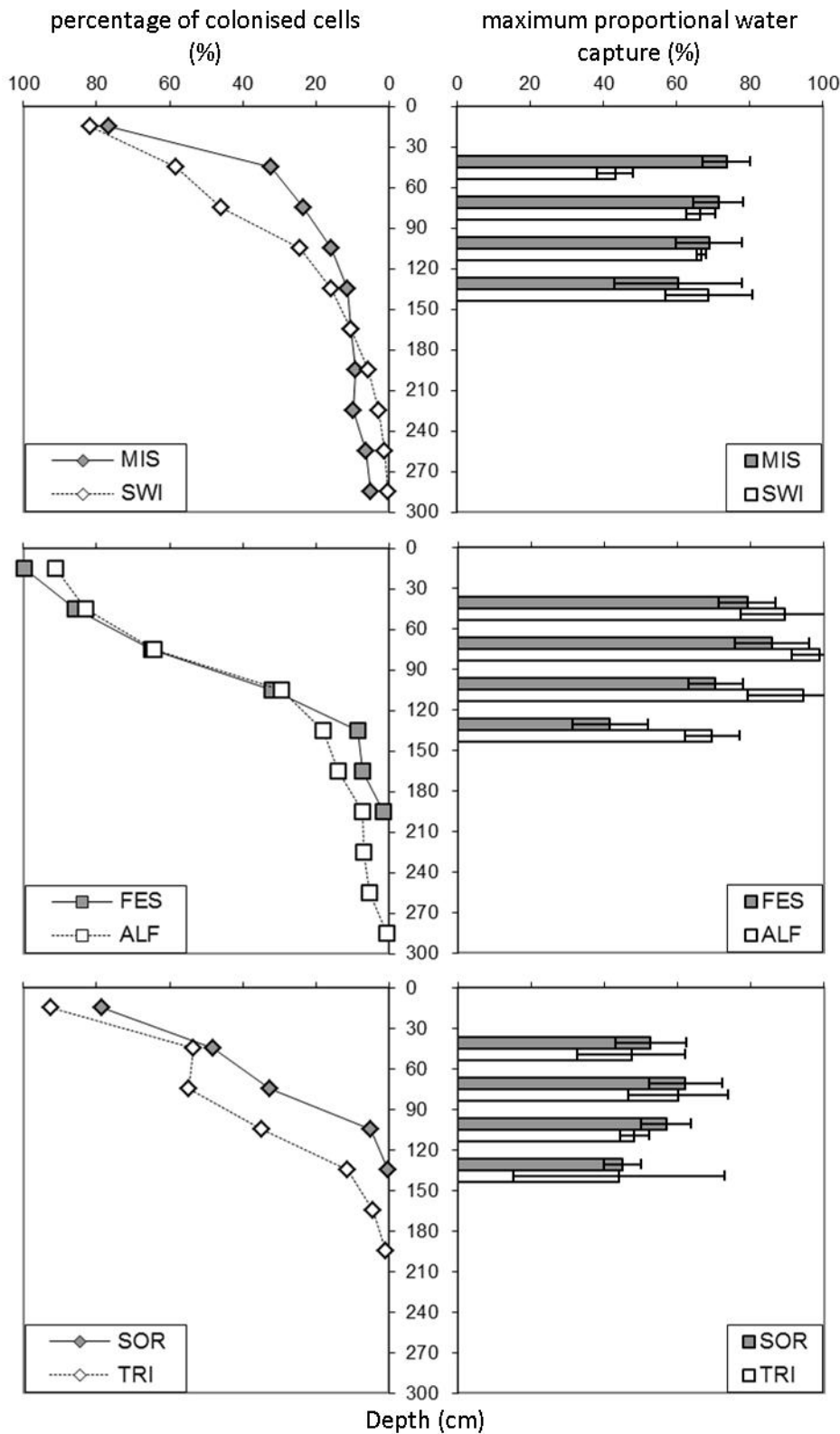

Fig. 1: Root distribution.

Fig. 2: Relative water uptake. Bars represent standard error.

Effect of biomass-ash amendments and nitrogen fertilization on above- and belowground biomass production of switchgrass

Zatta, Alessandro; Vecchi, Angela; Zegada-Lizarazu, Walter; Monti, Andrea
University of Bologna, ITALY

Introduction

Switchgrass is one of the most promising perennial energy crops. It could significantly contribute to limiting GHG emissions through replacing equivalent fossil fuels while sequestering a considerable amount of carbon in the soil. Nonetheless, the production of CHP from biomass generate large amounts of ashes which have to be opportunely allocated or profitably recycled, e.g. as nutrient amendments (Perucci et al., 2006). Therefore, the objective of this study was to evaluate the interactive effects of ash amendments and nitrogen fertilization on the above and belowground biomass production of switchgrass.

Materials and methods

The experiment was carried out at Poggio Renatico, Ferrara, Italy (5 m a.s.l., 44°37' N, 11°45' E) in silt loam soil (30% sand, 51% silt, 19% clay). Typically, the area is characterized by cold winters and hot summers, while the annual rainfall is about 646 mm (average of 30 years). Switchgrass (cv Alamo) was sowed on May 8th, 2007 at a sowing rate of 6 kg ha⁻¹ of PLS (pure live seeds). Three nitrogen fertilization levels (0 (N0), 50 (N1) and 100 (N2) kg N ha⁻¹) were factorized with two ash levels (0 and 500 kg ha⁻¹ of ashes, i.e. the equivalent ashes obtained by a complete combustion of the harvested biomass) with three repetitions. The aboveground biomass production was measured by weighting 7.5 m² of biomass per plot

cut at the end of the vegetative cycle. Root biomass was measured by collecting one soil core (74 mm diam., 1.2 m height) per plot at the end of the growing season in 2008, 2009, 2010 and 2011 using the same methodology described by Monti & Zatta (2009). From 2008 the soil CO₂ respiration was measured at monthly intervals with an infrared gas analyzer (SRC1/EGM4, PP-System) coupled with soil respiration chambers and soil temperature probes.

Results and discussion

No significant effect of the ash fertilization was found on root biomass. A three-year plant of switchgrass produced 1660 g m⁻² of root dry matter. Similarly, in spite of an apparently low soil fertility, the aboveground biomass was not affected by N-fertilization in the two first years. On the other hand, in the third and fourth year N-fertilization effects were clearly visible, especially in the last year (2011). Soil respiration peak was registered during the full flowering stage in 2011 (1.3 g CO₂ m⁻² h⁻¹). For not well understood reasons, ash-fertilized plots always showed lower soil respiration rates than plots without ashes (Table 2). A possible explanation could be the inhibitory effect of the ashes over the microbiological components of the soil (Perucci et al., 2006). In progress laboratory analysis will allow us to test this hypothesis. Remarkably, after three years of switchgrass cultivation the soil C content increased by 21 and 49% in shallow (0-30) and deeper (30-60 cm) layers, respectively, thus

Table 1: Aboveground and belowground biomass (Mg ha⁻¹) production of switchgrass under different nitrogen fertilization levels. Aboveground was affected by nitrogen fertilization and year (Tukey's test LSD_(p≤0.05)=4.8), while belowground biomass was influenced only by year (Tukey's test LSD_(p≤0.05)=3.4)

Year	Aboveground biomass (Mg ha ⁻¹)			Belowground biomass (Mg ha ⁻¹)
	N0	N1	N2	
2008	7.0	6.4	7.3	8.5
2009	11.0	9.0	10.0	10.4
2010	15.3	17.3	23.3	16.6
2011	8.2	14.4	18.6	22.5

Table 2: Soil respiration (g CO₂ m⁻²h⁻¹) and temperature (°C) during the growing period.

Date		No ashes	Ashes	Temp (°C)
		(g CO ₂ m ⁻² h ⁻¹)		
2008	May	0.45	0.34	18.7
	June	0.68	0.36	18.9
	July	0.91	0.85	23.3
2009	Jenuary	0.03	0.04	3.9
	May	0.76	0.61	21.0
	June	0.87	0.61	21.8
	July	1.28	0.96	22.2
2010	Jenuary	0.06	0.04	1.8
	May	0.39	0.25	17.5
	June	0.99	0.64	21.7
	July	1.18	0.84	22.1
2011	Jenuary	0.12	0.12	3.7
	May	0.80	0.57	20.2
	June	0.87	0.78	23.6
	July	1.41	1.19	28.1
2012	March	0.32	0.25	8.9

confirming previous results on the same crop (Zan et al., 2001; Sanderson, 2008).

Conclusion

This study confirmed the capacity of switchgrass to produce high amounts of above- and belowground biomass with low inputs. Ash amendments did not influence the aboveground biomass productivity, but showed inhibitory effects on soil respiration reducing the CO₂ flux to the atmosphere.

References

- Monti A & Zatta A. 2009. Root distribution and soil moisture retrieval in perennial and annual energy crops in Northern Italy. *Agric. Ecosys. Environ.* 132: 252-259.
- Perucci P et al. 2006. Effect of recycling wood ash on microbiological and biochemical properties of soils. *Agron. Sustain. Dev.* 26: 157-165.
- Sanderson MA. 2008. Upland switchgrass yield, nutritive value and soil carbon changes under grazing and clipping. *Agron. J.* 100: 510-516.
- Zan CS et al. 2001. Carbon sequestration in perennial bioenergy, annual corn and uncultivated systems in southern Quebec. *Agric. Ecosys. Environ.* 86: 135-144.

Response of three commercial biomass sorghum hybrids to cold stress in northern Italy

Zegada-Lizarazu, Walter; Vecchi, Angela; Zatta, Alessandro; Luna, Fernando; Monti, Andrea
University of Bologna, ITALY

Introduction

Sorghum (*Sorghum bicolor* L.) is a C₄ crop native to tropical areas, commonly used as a food and fodder crop (Zegada-Lizarazu & Monti 2012). Recently, alternative uses have attracted the interest of many sectors. Among these, the bio-ethanol use seems worth challenging given the instability of fossil fuels market, the urgent need to reduce GHG emissions, and new EU policies that establish a minimum 10% of biofuels to be incorporated into the transport fuel use by 2020. This means that millions of hectares will have to be efficiently dedicated to the production of bioenergy crops (Zegada-Lizarazu et al. 2010). In general, sorghum is cold sensitive, especially at seedling phase (Franks et al. 2006). Then, sorghum expansion into more temperate climates necessitates enhancing its cold tolerance through identifying new genotypes or physiological traits associated to cold tolerance and early vigour. The objective of this study was to determine the adaptability of biomass sorghum to cold conditions and early sowing under temperate climates in the Mediterranean area.

Materials and Methods

Three commercial hybrids (Bulldozer, Tarzan, and Zerberus) were sown in a silt loam soil on 24 March (I), 7 April (II), 19 April (III), and 9 May (IV) 2011. The soils were ploughed to 0.3m depth and tilled to seedbed preparation. Each plot was 21.6 m² with four repetitions. Row distance was 0.45 m and plant density 12 plants m⁻². Average minimum and maximum ambient temperatures during the growth season were 13.4 and 26.5 °C, about 1.3 and 2.6 °C above the long-term average. Total growth season precipitation was 256.4 mm, which is 167 mm below the long-term average. Plant growth and development was monitored every other week on an area of 0.45 m². Soil temperature was measured until the end of the emergence phase in each sowing time. At the final harvest, fresh and dry matter production was determined on an area of 7.2 m². Results All three hybrids showed an increased emergence speed as the soil temperature increased due to the advancement of the season from early to the end of spring. The range of days to full emergence at the earliest sowing dates (I and II) was 16-17 days, while at the latest sowing time (IV)

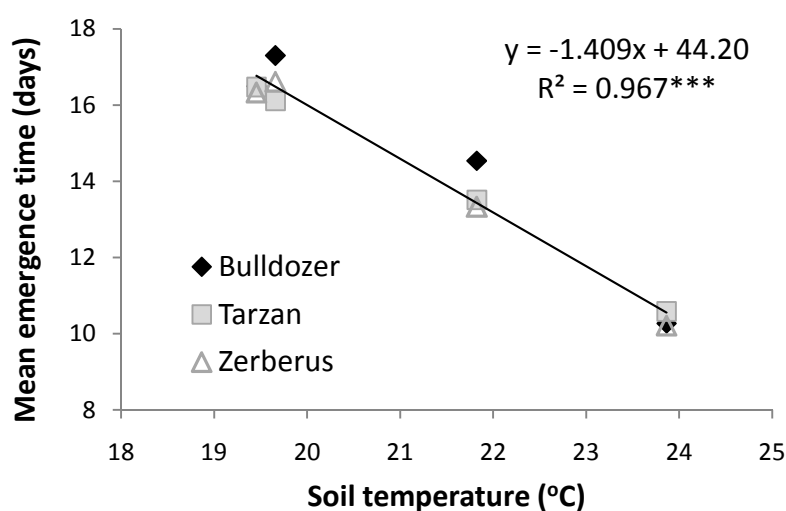

Fig. 1. Mean emergence time of three sweet sorghum hybrids sowed at four sowing times (I = 24 march; II = 7 April; III = 19 April; IV = 9 May, 2011)

Fig 2 missing?

plants required only 10 days to emerge (Fig. 1). Moreover, later sowing (IV) resulted in faster elongation rates, but no significant differences among hybrids were found. On the other hand, at the two early sowings, Bulldozer showed significant higher growing rates than Tarzan and Zerberus. In addition, Bulldozer produced the highest dry biomass when sown early in the season (Fig. 2).

Discussion

The adaptability of Bulldozer to cold (early sowing) is better explained by a higher accumulation of biomass in an extended season while higher growth rates do not offset the longer growing period. Then, compared to the other tested hybrids, Bulldozer seems to make a better or maximized use of the summer season suggesting the possibility of establishing it in European environments where sorghum is currently not cultivated because of its heat requirements. The increased growth speed at later sowing times did not necessarily result in an increased accumulation of biomass, probably because sorghum photosensitivity induced the translocation of photosynthates to the panicle.

Conclusion

The preliminary results suggest that Bulldozer is better suited for early sowing under suboptimal soil temperatures allowing to expand sorghum agro-ecological limits further north.

Acknowledgments

Study funded by the EU Project "Sweet sorghum: an alternative energy crop (SWEETFUEL)" - FP7-KBBE-2008-2B.

References

- Franks et al. 2006. A Comparison of U.S. and Chinese sorghum germplasm for early season cold tolerance. *Crop Sci.* 46:1371-1376.
- Zegada-Lizarazu W, Monti A. 2012. Are we ready to cultivate sweet sorghum as a bioenergy feedstock? A review on field management practices. *Biomass Bioenerg.* 40:1-12.
- Zegada-Lizarazu et al. 2010. Agronomic aspects of future energy crops in Europe. *Biofpr* 4:674-691.

Grain weight determination in contrasting hybrids of Maize

Antonio Ordoñez, Raziq¹; Savin, Roxana¹; Slafer, Gustavo A.²

¹University of Lleida, SPAIN; ²Univerty of Lleida, SPAIN; ²ICREA, (Catalonian Institution for Research and Advanced Studies), SPAIN

Introduction

In maize, unlike in wheat and barley, grain growth seems to be rather clearly source-limited. It has been frequently found that reductions in assimilate availability during post-silking (e.g. shading) produces parallel reductions in final grain weight (e.g. Borrás *et al.*, 2004). High temperature also reduced grain weight, though the causes have been scarcely studied under field conditions. A plausible hypothesis in maize may then be that as high temperatures accelerates leaf senescence the negative effect on final grain weight would operate through reductions in assimilate availability. If the hypothesis is right, under the expected increased temperatures in the near future breeding would need to identify sources of reduced senescence response to increased temperatures.

Materials and methods

We carried out field experiments in a cool (Pyrenees, Seu d'Urgell) and a warm location (Ebro Valley, Algerri). In each experiment treatments were the factorial combination of two contrasting hybrids (Pioneer 31N28, long cycle with large grains and Lapopi, short cycle with small grains), two contrasting N conditions (0 and 200 KgN ha⁻¹), and two levels of defoliations (a control and a treatment in which we removed leaves and only 4 were left) imposed 15 days after silking. In addition, in Algerri we added a treatment in which temperatures were increased by placing a structure with transparent polyethylene over the canopy from 15 days after silking onwards and its corresponding control as subplots. Treatments were arranged in a split-plot design (hybrids x N were the main plots and defoliations were sub-plots). At maturity we sampled all plants in 2 m central row, weighed them and took a sub-sample that was taken to the lab and from which we threshed all grains, dried (on force-air oven) and weighed them.

Results and discussion

Under un-heated conditions Pioneer had heavier grains than Lapopi. Grain weights ranged from 259 to 284 mg grain⁻¹ in Pioneer and from 200 to 230 mg grain⁻¹ in Lapopi. This was as expected as we selected the hybrids for their difference in average grain weight (see above).

Defoliating plants after silking markedly reduced grain weight, and imposing high temperatures during grain filling reduced grain weight (Fig. 1). The size of the effect was similar in both hybrids, and therefore largely independent of the size of the grains in the un-heated and un-defoliated controls (and then the difference in grain size between hybrids is constitutive and not a reflection of a differential capacity to fill the grains after silking).

As there was a slight trend to increase the magnitude of the response to defoliation under heat stress imposed during grain filling (in average open symbols are closer to the 1:1 ratio than closed symbols), the slope of the relationship between grain weight in defoliated vs. un-defoliated plants was smaller than 1 (0.74 ± 0.12 , Fig. 1), but again the origin of this seemed not to be a different responsiveness of the grains of the two hybrids in un-heated conditions (Fig. 1).

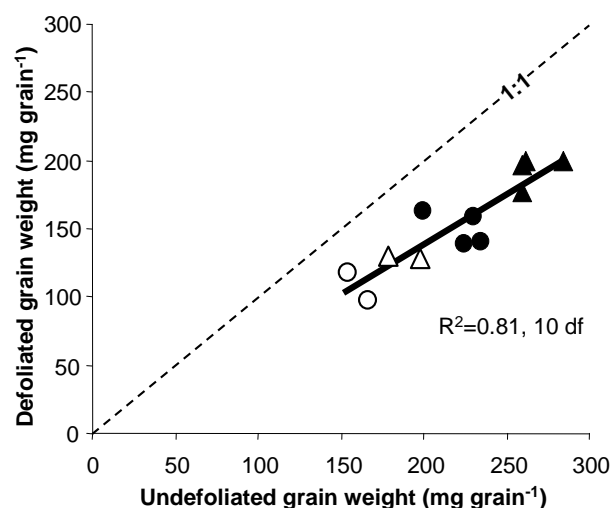

Figure 1. Grain weight for defoliated and control treatments for Pioneer (triangles) and Lapopi (circles), grown under 2 N availabilities in a cool (Pyrenees) and a warm (Ebro Valley) locations, and in the latter with two temperatures regimes (increased with chamber, open symbols) and ambient temperature (closed symbols). Dashed line represents the 1:1 ratio

The reductions in grain weight due to defoliation confirm that, for both type of hybrids, grain growth seemed largely source-limited in the very high-yielding irrigated conditions of Catalonia (as discussed in general for maize crops in Borrás *et al.*, 2004). But as the defoliation affected grain size less in the heat stress than in the unheated treatment, it seems unlikely that the effect of high temperature on grain size would have operated through accelerated senescence: if it would have been so, further restricting source strength through defoliation should

have reduced grain size more dramatically. Therefore, the effect of high temperature might have been direct on the intrinsic capacity of the grains to grow.

References

Borrás, L., Slafer, G.A., Otegui, M.E., 2004. Seed dry weight response to source-sink manipulations in wheat, maize and soybean: a quantitative reappraisal. *Field Crops Res.* 86, 131–146.

Genotypic and environmental effects on cereal crops and oilseed rape fatty acid profile

Baux, Alice; Mugny, Corinne; Levy, Lilia; Pellet, Didier
Agroscope, SWITZERLAND

Introduction

Fatty acid composition in oilseeds is highly influenced by climatic conditions, temperature being the most important parameter for oilseed rape (OSR) (Merrien *et al.*, 2007) and sunflower (Echarte *et al.*, 2010). Few studies also report that water stress affects oil composition, resulting in higher desaturation (Aslam *et al.*, 2008, Roche *et al.*, 2006). In cereal crops, variability of fatty acid composition is also observed among locations and years. The aim of this work was to assess the impact of temperature and low water availability on oil content and composition for a large range of genotypes of OSR, triticale and wheat.

Materials and methods

Several triticale, wheat and OSR varieties were sown, each species separately, in a randomized block design with 3 replicates in 1 to 4 locations in Switzerland, between 2001 and 2010 for oilseeds and 2007-2010 for triticale and wheat. Additionally, HOLL (High Oleic Low Linolenic) OSR, triticale and wheat were irrigated in spring 2008 and 2009 (OSR) and 2009 and 2010 (cereal crops) during seed filling, as compared to a control without irrigation. Oil content was measured by near infrared spectroscopy (NIRS). Fatty acid profile was evaluated by gas chromatography in OSR and by NIRS in cereal grains.

Results and discussion

Low temperatures have been shown to enhance desaturation in various oilseed crops. Our results confirmed this observation in conventional and HOLL OSR, with lower temperature during seed filling resulting in lower monounsaturated fatty acids (MUFA) and higher poly-unsaturated fatty acids (PUFA) contents, whereas very little impact was observed on saturated fatty acids (SAT) contents. In wheat and triticale, however, the increase in PUFA observed when low temperatures were registered during seed filling was associated with a decrease in SAT, with differences among genotypes. A smaller range of PUFA and MUFA content was observed in wheat, compared to triticale, when grown in the same environment. Besides, temperature impact was less clear. Water stress impact was evaluated in the field. In 2009,

that had a hot and dry spring, a strong decrease in water potential was observed in the control plots. This resulted in lower oil content in OSR and triticale. Whereas no significant effect on oil composition could be evidenced in wheat, some triticale varieties had more PUFA and less SAT in dry conditions. This effect was confirmed by a positive linear regression between cumulated precipitations during seed filling and SAT content in some triticale cultivars. 2008 and 2010 were cooler with more rainfall in spring, therefore no effect of irrigation could be observed.

Conclusions

Both temperature and water shortage resulted in modification of fatty acid profile. Generally, cold stress and water stress led to enhanced desaturation but differences in sensitivity appeared not only among species, but also among varieties.

References

- Aslam M. N., Nelson M. N., Kailis S. G., Bayliss K. L., Speijers J., Cowling W. A., 2009. Canola oil increases in polyunsaturated fatty acids and decreases in oleic acid in drought-stressed Mediterranean-type environments. *Plant Breeding*. 128(4) :348-355.
- Echarte M. M., Angeloni P., Jaimes F., Tognetti J., Izquierdo N. G., Valentinuz O., Aguirrezabal L. A. N., 2010. Night temperature and intercepted solar radiation additively contribute to oleic acid percentage in sunflower oil. *Field Crops Research* 119(1): 27-35.
- Merrien A., Krouti M., Dechambre J., Garnon V., Evrard J., 2007. Contribution to understand the fluctuation of linolenic acid profile in winter oilseed rape grown in France. *Proceedings of the 12th International rapeseed congress, held in Wuhan, China, 26-30th March 2007. Quality, nutrition and processing*, 92-95.
- Roche J., Bouniols A., Mouloungui Z., Barranco T., Cerny M., 2006. Management of environmental crop conditions to produce useful sunflower oil components. *European Journal of Lipid Science and Technology* 108(4): 287-297.

Utilising escape mechanisms to maintain yields threatened by heat stress events caused by a changing climate

Carney, John; Gooding, Mike

University of Reading, UNITED KINGDOM

Introduction

An increase in the frequency of extreme climate events such as heat waves, droughts and floods is predicted to be the greatest danger to agriculture. Temperatures of 30°C or higher prior to anthesis significantly reduces grain number and subsequently yield (Semenov & Shewry, 2011). Wheat is most susceptible to heat stress at booting (meiosis). The photo-insensitivity allele Ppd-D1a confers escape from the heat stress by bringing forward anthesis; however it is associated with early canopy senescence leading to early cessation of resource capture. Therefore it is important to increase time before senescence and maximise resource capture.

Materials and methods

64 double haploid (DH) progeny of cv. Savannah (S) (Rht-D1b, 1BL/1RS) × Renesansa (R) (Ppd-D1a, Rht8c) were used to assess the effects of genotypes on the canopy development. For agronomic information see Addisu et al (2009). REML analysis was used to predict means for each line using the random model block/ (column + row). These means were then analysed to determine any significant effects related to the presence or absence of allele markers as fixed effects.

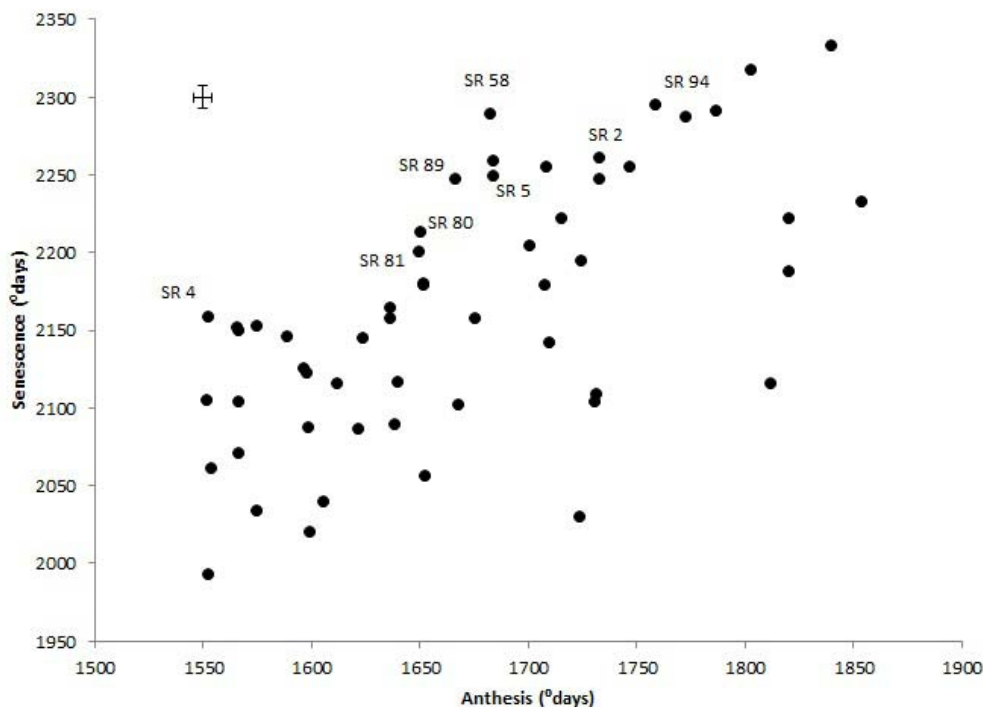

Fig1: TT to anthesis and senescence for a DH progeny of S × R in wheat. Points are line means. Error bars are SEDs.

Results and discussion

1BL/1RS was associated with an increase in thermal time (TT) to anthesis (1660 °days to 1700 °days d.f 51, S.E.D=16.9), pre-anthesis photosynthetically active radiation (PAR) interception (319.4 to 336.5 MJ/m²; 4.80) and biomass at harvest (14.27 t/ha to 15.63 t/ha; 0.476). Ppd-D1a was associated with a decrease in TT to anthesis (1735 °days to 1625 °days; 20.2), PAR interception (338.3 to 317.6 MJ/m²; 5.74) and biomass at harvest (15.64 t/ha to 14.26 t/ha; 0.569).

TT to anthesis was significantly associated with biomass production ($P = 0.02$) and Harvest Index ($P < 0.001$). Biomass production was significantly associated with pre-anthesis PAR interception ($P = 0.003$). The combination of these factors gave a compensatory effect on the yield of genotypes that produced low levels of biomass. The reduced biomass at harvest may be attributed to less TT to reach anthesis, brought forward by Ppd-D1a, leading to reduced pre-anthesis PAR interception.

SRen4 has a long canopy duration and early anthesis but does not significantly extend TT to senescence. SRen58

delays anthesis so cannot escape heat stress at booting. Six lines containing the Ppd-D1a allele had significantly delayed TT to senescence (Fig1); SRen2, SRen5, SRen80, SRen81, SRen86 and SRen94. Of these lines SRen80 and SRen81 significantly reduced TT to anthesis but significantly increased anthesis to senescence duration. These lines had the same allele markers present; Ppd-D1a, Rht8c, Rht-D1b and 1BL/1RS. Ppd-D1a is associated with a reduction in TT to anthesis; however these results suggest that the 1BL/1RS translocation may have compensated for this by increasing TT to senescence for resource capture. Increased HI along with early flowering and increased TT to senescence in SRen80 and SRen81 suggest that yield can be further increased by Ppd-D1a in winter wheat experiencing heat stress.

References

- Addisu, M; Snape, J.W; Simmonds, J.R; Gooding, M; (2009) *Euphytica*
- Semenov, M.A; Shewry, P.R; (2011), *Scientific Report*

Agronomic response of rice varieties to salinity

Dramalis, Christos¹; Katsantonis, Dimitrios²; Koutroubas, Spiridon¹

¹Democritus University of Thrace, GREECE; ²Hellenic Agricultural Organisation, GREECE

Introduction

Rice (*Oryza sativa* L.) is a salt-sensitive crop, particularly during the early seedling and pollination stages [2, 4]. Salinity stress not only reduces crop yield but also degrades grain quality. Several studies have shown a reduction in various yield components, and eventually in grain yield, due to salinity [1, 3]. The determination of the agronomic response of rice to salinity is necessary to develop better management practices for growing rice under salt conditions and to improve our understanding of the quantitative effects of salinity on rice cultivars. The purpose of this study was to investigate the effect of salt levels on various agronomic traits of eight rice varieties under field conditions.

Materials and methods

The experiment was carried out at the Kalochoiri's Experimental Station of the Cereal Institute, Thessaloniki, Greece. The soil is a silty loam with a pH of 7.5 and 1.6% organic matter. Seven varieties (Alexandros, Capataz, Kulon, Chipka, Selenio, Koral and Dimitra) with different level of susceptibility to salinity, together with a susceptible control variety (IR28) were sown in pots

on 13 May 2011. The seedlings were transplanted in the flooded field on 23-24 June 2011. Two salinity treatments consisted of low salt concentration (LSC) and high salt concentration (HSC) were applied. The experimental design was split plot with three replications. Salinity levels were arranged in the main plots and varieties in sub-plots. Salt concentration ranged from 0.9 to 1.3 dS/m in the LSC treatment and was achieved by applying standard water management practices in Greece [5]. In the HSC treatment the salt concentration ranged from 3.8 to 6.4 dS/m. These salt concentrations were achieved by not renewing the flooded field with fresh water. The following traits were studied: grain yield, plant height, number of fertile tillers per plant, panicle length, dry matter per plant at anthesis and maturity stage, and 1000 grain weight.

Results and discussion

All varieties grown in the HSC treatment had significantly lower grain yield compared to that obtained in the LSC treatment, as expected (Fig. 1). Furthermore, plants grown under HSC showed lower plant height compared

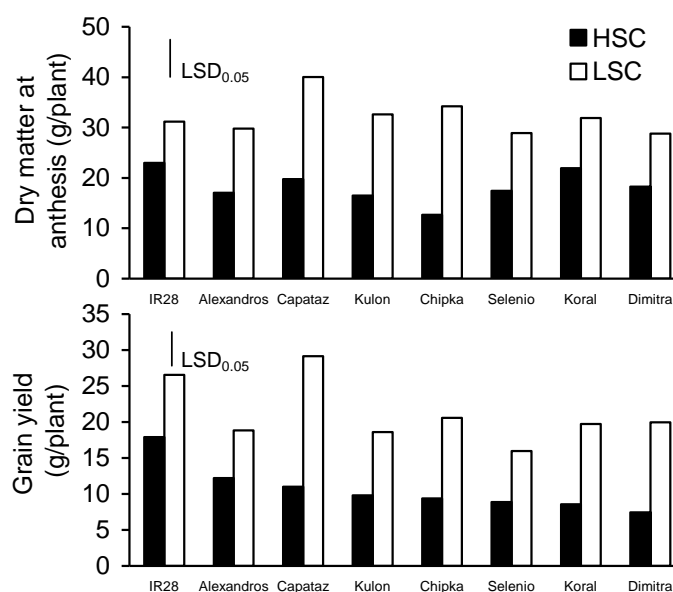

Fig. 1. Dry matter at anthesis and grain yield of rice cultivars as affected by salt concentration. (LSD_{0.05}: Least significant difference between salt levels in the same cultivar).

to the plants grown under LSC. The reduction in plant height due to salinity was significant for all varieties, except for one. Under HSC, plants showed lower number of fertile tillers per plant compared to plants grown under LSC, but the differences were significant only in two varieties. There were no significant differences between the two treatments as for the panicle length. Previous studies have shown that salinity reduced significantly both tiller number per plant and panicle length [1, 3, 6]. HSC treatment resulted in a significant reduction of 1000 grain weight and dry matter accumulation at anthesis (Fig. 1) and maturity.

References

- [1] Cui, H., Y. Takeoka & T. Wada. 1995. Effect of sodium chloride on the panicle and spikelet morphogenesis in rice. *Jpn. J. Crop Sci.* 64:593–600.
- [2] Khatun, S., & T.J. Flowers. 1995. Effects of salinity on seed set in rice. *Plant Cell Environ.* 18:61–67.
- [3] Khatun, S., C.A. Rizzo & T.J. Flowers. 1995. Genotypic variation in the effect of salinity on fertility in rice. *Plant Soil* 173:239–250.
- [4] Lutts, S., J.M. Kinet & J. Bouharmont. 1995. Changes in plant response to NaCl during development of rice (*Oryza sativa* L.) varieties differing in salinity resistance. *J. Exp. Bot.* 46:1843–1852.
- [5] Ntanos, D.A. & S.D. Koutroubas. 2002. Dry matter and N accumulation and translocation for Indica and Japonica rice under Mediterranean conditions. *Field Crop Res.* 74: 93–101.
- [6] Zeng, L., M.C. Shannon & C.M. Grieve, 2002. Evaluation of salt tolerance in rice genotypes by multiple agronomic parameters. *Euphytica* 127: 235–245.

Smart-Paddy: Smart on-line water salinity measurement network to manage and protect rice fields

Dramalis, C.¹; Pallas-Areny, R.²; Katsantonis, D.¹; Sola, E.³; Aliau, C.³; Serrano, E.²; Lopez, O.²; Mazel, B.⁴; Barbi, F.⁵; Cano, M.⁶; Begas, S.⁷; Basci, F.⁸; Llao, R.⁹

¹Hellenic Agricultural Organisation, GREECE; ²Innovacio i Recerca Industrial i Sostenible, SPAIN; ³EETAC, Campus Baix Llobregat UPC, SPAIN; ⁴Syndicat des Riziculteurs de France et Filieres, FRANCE; ⁵OSV, ITALY; ⁶Federacion de Arroceros de Sevilla, SPAIN; ⁷Begas SA, GREECE; ⁸LNL Technology Ltd, ODTU Teknokent, TURKEY; ⁹La Camara Arroquera del Monstia, SPAIN

Rice (*Oryza sativa* L.) is the main crop in wet areas such as river deltas and is an essential tool in Europe in managing protected ecosystems. Irrigation water is a key factor in the production of rice and water quality has a major impact on crop yield as a result of tolerance of rice to factors such as dissolved salts. Rice is more water consuming than many other crops: in continuous flooding cultivation it takes about 6 times the water required by wheat. Due to increased water use in coastal areas, the sea intrudes the water table and seawater floods nearby fields during storms in the Mediterranean area. The result is increased water salinity, which reduces yield in rice crops and increases soil salinity. Nowadays, water condition is for the most part assessed by visual inspection of the crops and, when excess water salinity is suspected, fields are irrigated by flooding them. In areas where water salinity is endemic, rice paddies are continuously irrigated with river water to reduce

water salinity. This is a remedial solution that requires enormous volumes of water and considerable energy to pump water. Water salinity can be accurately determined by measuring its electrical conductivity (EC). Measuring EC at the water inlet and outlet of each paddy field can help in monitoring the “washing” effect of irrigation. Moreover, measuring EC at points far from water inlets and outlets can help in assessing water salinity in a given paddy field and at different depths in drainage channels can help in managing water salinity in larger areas. This project will develop a wireless sensor network comprised of low-cost EC measurement nodes and an autonomous power supply based on energy harvesting, that will be capable of transmitting readings in real-time to a central server. This data will enable cultivators to effectively manage and protect of their paddy fields and greatly reduce flood water consumption.

Rapid screening test of 109 rice genotypes belonging into the European Core Collections

Dramalis, Christos¹; Katsantonis, Dimitrios¹; Koutroubas, Spiridon²; Lupotto, E.³; Ahmadi, N.⁴; Courtois, B.⁴; Piffanelli, P.⁵

¹Hellenic Agricultural Organization, GREECE; ²Democritus University of Thrace, GREECE; ³CRA-RIS, ITALY; ⁴CIRAD, FRANCE;

⁵Parco Tecnologico Padano, ITALY

Introduction

Salinity is defined as the presence of excessive concentrations of soluble salts in the soil solution. The salts are chlorides and/or sulphates of Ca, Mg, Na and K. Among those, chlorides are usually predominant. It is reported that salinity has a detrimental effect on rice yield at or above 3.0 dS m⁻¹ [2] and has a negative impact on a number of yield components including stand establishment, tillers, panicles, spikelets per plant, floret sterility, individual grain size, and even delayed heading [5]. The current study was conducted to rapidly and efficiently assess, at seedling stage, the variability to salt stress existing in a European rice core collection to identify the most salt resistant rice accessions.

Materials and methods

The screening test was performed at the Cereal Institute Thessaloniki, Greece in 2009. A total of 109 rice accessions and a highly susceptible control (IR-28) were screened according to Gregorio et al. [3]. The experiment was conducted in a glasshouse maintained at approximately 29°/22°C day/night and 70% relative humidity. Two germinated seeds were placed in each hole of a Styrofoam tray and each tested rice accession was replicated 8 times. The Styrofoam tray was placed in a plastic container and nutrient solution was added according to Yoshida et al. [4]. On the fourth day 3 g NaCl/L (electrical conductivity, EC 6 dS m⁻¹) was added in the nutrient solution, while 3 days later the amount of NaCl was doubled. The pH was calibrated at 5, while the nutrient solution was renewed every 8 days. The salt injury was assessed 10 and 16 days after the initial salinization (AIS) using an 1-9 scale: 1=normal growth (highly tolerant), 9=almost dead (highly susceptible). Additionally, ten days AIS the chlorophyll concentration index (CCI) was measured using chlorophyll meter (Opti-Science CCM-200).

Results and discussion

There was a great variability in response to salt injury and to leaf chlorophyll content. Similar results were obtained by others [1]. The salt injury recorded at 10 days AIS had a mean value (m.v.) of 4.8 and ranged from 2.3 (JUBILIENI) to 8.7 (PERLA and SHSS 381). The control variety IR-28 scored at 5.5. 52% of the accessions at 10 days AIS expressed symptoms less than 4.50. Salt injury assessing at 16 days AIS had a m.v. of 7.6 and ranged from 5.0 (CHIPKA and KORAL) to 9.0. The control variety was scored at 8.5 while 92% of the accessions expressed salt injury more than 7.0. The most salt tolerant accessions in both phenotypic assessments were KORAL, MUGA and CAPATAZ.

CCI measurements showed that the less reduction effect was appeared on PREVER (20.8%) and the highest on RONCOLO (75%). In 51% of the accessions the CCI was reduced less than 50%, while in the 23% of the accessions CCI reduction was higher than 60%.

Acknowledgements

The authors acknowledge the Financial Support from Community Programme on the Conservation, Characterization, Collection and Utilization of Genetic Resources in Agriculture-Council Regulation (EC) No 870/2004-DG Agriculture-European Union to the project AGRI GEN RES 049: Genotyping for the conservation and assessment of the European rice germplasm (EURIGEN).

References

- [1] Ahmadi, N., S. Negrão, D. Katsantonis, J. Frouin, J. Ploux, P. Letourmy, G. Droc, P. Babo, H. Trindade, G. Bruschi, R. Greco, M. M. Oliveira, P. Piffanelli, B. Courtois, 2011. *Theor Appl Genet.* 123(6):881-95.
- [2] Grattan, S. R., 2002. Rice is more sensitive to salinity than previously thought. *California Agriculture* 56 (6): 189-195.
- [3] Gregorio G.B., Senadhira D. and Mendoza R.D. (1997). Screening rice for salinity tolerance. IRR I Discussion Paper Series No. 22, pp.30.
- [4] Yoshida, S. Forno D.A., Cock J.H. and Gomez K.A. (1976). Laboratory manual for physiological studies of rice, 3rd edition International Rice Research Institute (IRRI), Los Baños, 61-65.
- [5] Zeng, L., M.C. Shannon & C.M. Grieve, 2002. Evaluation of salt tolerance in rice genotypes by multiple agronomic parameters. *Euphytica* 127: 235–245.

Phenological characterization of sunflower genotypes for winter planting

García-Tejera, Omar¹; Villalobos, Francisco J.²; Velasco, Leonardo¹; Fernández-Martínez, José María¹

¹Instituto de Agricultura Sostenible (CSIC), SPAIN; ²Instituto de Agricultura Sostenible (CSIC) & Universidad de Córdoba, SPAIN

Introduction

In Mediterranean climate regions sunflower is sown in mid-spring and develops until summer. Crop grows in a period of high evaporative demand and low precipitation regime, with high probability of water stress. Gimeno et al. (1986) found that winter sowing increases sunflower yields, although this strategy increases the risk of frost damage. To avoid this, a breeding program for sunflower cultivars adapted to winter sowing is under way at the Institute of Sustainable Agriculture (IAS) in Cordoba (Spain). The aim of this work was to calibrate the simulation model OilCrop-Sun (Villalobos et al., 1996) for different genotypes and use the model to analyze their response to sowing date.

Materials and methods

The experiment was carried out at the IAS (37.80 N, 4.80W). Seven genotypes were used: four developed at IAS (DAP1-4, DAP5-6, DAP34-15 and DAP2-17) two from Morocco, (Ichraq6 and Ichraq12) and a commercial hybrid (Transol). The plants were sown on three different dates (14 December 2010, 14 January and 3 March 2011). The appearance of leaves was recorded from emergence to bud visible to calibrate the duration of the juvenile phase and the photoperiodic sensitivity coefficient. In the simulations, a wheat-sunflower rotation was assumed in a 150 cm depth soil with 7.5 plants m⁻² and an application of 100 kg ha⁻¹ of N at sowing. Simulations were performed for 6 sowing dates from 1st October to 1st March at one-month intervals. As Oilcrop-Sun does not simulate frost damage, it was assumed that yield is lost whenever temperatures of -2 C or below were reached in a period of one week before and after anthesis (most sensitive stage) (Sneider & Melo-Abreu, 2010).

Results

Genotypes DAP1-4, DAP5-6 and DAP2-17 showed no yield reduction due to frost damage for any of the sowing

dates (Figs. 1 and 2). In these cultivars yields decreased after the October sowing (maximum yield 3000 kg ha⁻¹), to January (1500 kg ha⁻¹) and then they remained constant until March. DAP34-15 showed a small yield reduction (3626 to 3301 kg ha⁻¹) when sown in October, and then followed the same trend that as the other DAP genotypes. Genotypes Ichraq12 and Transol produced no yield in the October sowing and the same happened for Ichraq12 in November. From January to March sowings, no reduction of yield due to frost damage was observed (minimum for March sowing 1495 kg ha⁻¹ for Transol and 1248 kg ha⁻¹ for Ichraq12). Ichraq6 showed zero yield when sown before January and no yield reduction due to frost damage for later sowings (range from 1815 kg ha⁻¹ in January to 1301 kg ha⁻¹ in March).

Conclusions

Frost damage in winter sown sunflower crops is minimized by reducing the probability of frost during the most sensitive stages of the crop, which may be attained by developing cultivars with a long juvenile phase and a high photoperiodic sensitivity as the DAP genotypes developed at the IAS. Further research should be devoted

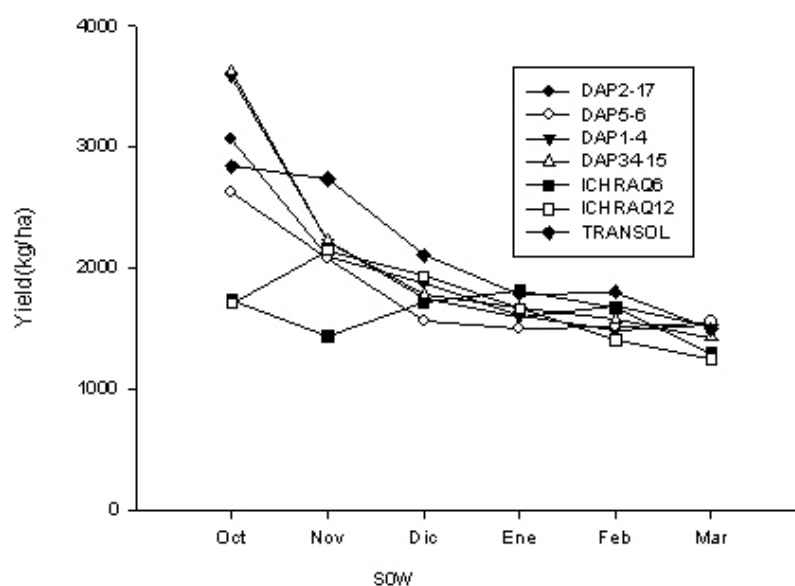

Fig1. Yield without frost damage

to improving the simulation of frost damage in sunflower and the possible negative effects of delayed flowering on the harvest index in dry years.

References

Gimeno,V; Fernández-Martínez, JM and Fereres,E.1989.Winter Planting as a Means of Drought Escape in Sunflower. *Field Crop Res*, 22.307-31

Snyder R.L. and de Melo-Abreu J.P.2010. Frost protection: fundamentals, practice and economics.FAO. ISBN 978-92-5-306504-2.73-95

Villalobos,F.J.; Hall, A.J.; Ritchie,J.T. and Orgaz,F.1996.Oil Crop Sun: a development, growth and yield model of the sunflower crop. *Agron*, J.88.403-415.

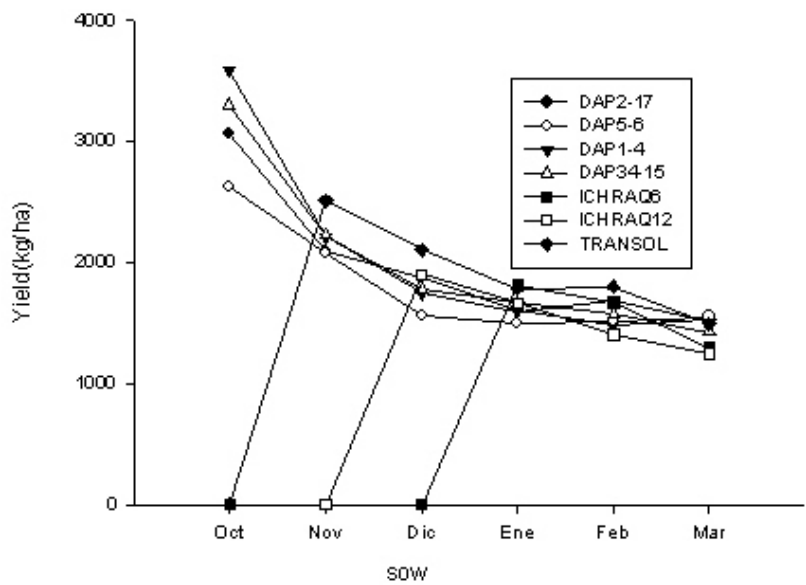

Fig2. Yield with frost damage

Agromorphological characterization and production in red clover (*Trifolium pratense* L.) accessions collected in the Cantabrian Mountains (N Spain)

Oliveira, J. Alberto¹; Lopez, J. Enrique²; Palencia, Pedro¹; Afif, Elias¹; Gorgoso, J. Javier¹

¹University of Oviedo, SPAIN; ²Agrarian Research Centre of Mabegondo, SPAIN

Introduction

Despite the importance of red clover (*Trifolium pratense* L.) as a livestock feed crop and soil improver (Taylor, 1990) use of red clover in Northern Spain has declined in recent times with increases in the use of fertiliser N and protein concentrates. The increasing use of sustainable forms of livestock production (González-Murua et al., 2003) has resulted in greater demand for red clover in recent years, but its main disadvantage is its low persistence. The aim of the present study was to characterize nine accessions of red clover collected in Northern Spain, by their morphology, flowering, powdery mildew tolerance and dry matter yield in two locations of the North of Spain.

Materials and methods

Nine red clover accessions from the Cantabrian Mountains, and a common cultivar, the diploid 'Marino', were grown as spaced plants in Galicia (NW Spain) and as a pure stand in sward plots in Asturias (N Spain). The origins and accession numbers of the nine accessions of red clover studied are listed in Table 1.

The spaced plant trial was established at the Agrarian Research Centre of Mabegondo, in Galicia (43° 14' 50" N, 8° 15' 45" W, 100 m.a.s.l.), on a silt loam soil. The site was arranged in a completely randomized block design with three replicates of 10 plants per accession and replicate with a distance of 0.5 m between lines and 0.5 m between plants. The following six agromorphological (UPOV, 1985) traits were evaluated during the 2-year period of the study (2008-2009): stem length, leaf length and width, flowering date, abundance of heads and powdery mildew tolerance. The plot trial was a randomized block design with three replicates in 1 x 1.5 m plots with a seeding rate of 20 kg/ha. The field (43° 35' 03" N, 5° 46' 56" W, 80 m.a.s.l.) was located in Carreño (Asturias), on a sandy clay loam soil. The plots were cut manually in one term to 7-8 cm above ground level, six times in the first year and five times in the second year. Analysis of variance of the agromorphological and dry matter yield data was performed considering the effects of replicate and accession. Separation of means was performed by the least-significant difference (LSD) test. Statistical analyses were computed with SPSS version 19 (SPSS, 2011).

Table 1. Inventory number in the Centro de Recursos Fitogenéticos (Madrid) seed bank (accession number in brackets) and origins of the nine accessions of *Trifolium pratense*.

Inventory number	Province	Location	Habitat	Lat	Long	Alt
NC079624 (1)	Asturias	Puertas	Grassland	43°19'N	04°52'W	347
NC079626 (3)	León	Pinos	Grassland	42°59'N	05°56'W	1495
NC079632 (7)	León	Riaño	Grassland	43°01'N	05°02'W	1118
NC079634 (8)	Asturias	La Garganta	Grassland	43°20'N	07°00'W	894
NC079635 (9)	León	Manzanal	Moorland	42°35'N	06°13'W	1194
NC079638 (11)	Asturias	El Naranco	Grassland	43°23'N	05°52'W	374
NC079640 (12)	Asturias	Faro de Tazones	Orchard	43°32'N	05°23'W	119
NC079642 (13)	Asturias	S. Roque de Tazones	Amenity	43°31'N	05°16'W	135
NC079643 (14)	Asturias	La Infiesta	Grassland	43°24'N	05°18'W	422

Table 2. Means (SD in brackets) for eight traits (Flo, flowering date, as the number of days after January 1st, Ain, abundance of heads per plant (0-9 scale, where 9 is the maximum), Stl, stem length (cm), Lfc, leaf length (mm), Afc, leaf width (mm), Enf, tolerance to powdery mildew (0-9, where 9=maximum tolerance), Dmy1 and Dmy2, as dry matter yield in t/ha in the first and second year, respectively, in nine accessions and one cultivar (Marino) during two years as spaced plants at Mabegondo (Galicia) and in sward plots at Carreño (Asturias); *** $p < 0.001$, ** $p < 0.01$, * $p < 0.05$, NS: $p > 0.05$. LSD = Least significant differences at 5% level.

Accessions	Flo	Ain	Stl	Lfc	Afc	Enf	Dmy1	Dmy2
1	109.3 (14.2)	5.9 (2.3)	67.7 (10.8)	2.7 (0.5)	1.2 (0.4)	5.1 (2.2)	8.0 (1.4)	8.2 (1.5)
3	136.6 (11.2)	6.5 (2.7)	57.8 (19.4)	1.7 (0.5)	0.6 (0.3)	5.6 (1.9)	5.5 (1.5)	5.2 (2.1)
7	105.9 (24.7)	7.2 (1.5)	57.1 (10.1)	2.2 (0.4)	0.9 (0.3)	5.3 (2.3)	9.1 (1.9)	7.4 (0.6)
8	140.3 (9.2)	5.5 (2.6)	39.6 (8.5)	1.2 (0.1)	0.5 (0.1)	8.3 (1.5)	6.9 (2.5)	5.6 (2.4)
9	133.5 (13.3)	6.1 (2.3)	58.1 (10.4)	2.0 (0.3)	0.6 (0.2)	4.6 (2.6)	6.6 (0.8)	6.5 (0.8)
11	70.5 (15.8)	6.0 (2.6)	42.7 (12.2)	2.6 (0.5)	1.3 (0.9)	4.9 (2.3)	8.7 (1.2)	9.9 (0.8)
12	80.8 (14.6)	6.9 (2.2)	30.9 (11.7)	1.8 (0.5)	0.6 (0.1)	7.9 (1.8)	9.3 (0.4)	10.3 (2.3)
13	73.7 (16.8)	8.1 (1.5)	34.0 (10.4)	2.5 (0.4)	1.1 (1.3)	6.7 (2.1)	7.3 (0.9)	9.3 (2.4)
14	86.4 (23.4)	6.0 (2.5)	59.9 (11.5)	1.9 (0.4)	0.6 (0.2)	3.7 (1.7)	7.1 (0.7)	6.8 (0.5)
Average	104.1 (30.9)	6.5 (2.4)	49.8 (17.1)	2.1 (0.6)	0.8 (0.6)	5.8 (2.5)	7.6 (1.7)	7.7 (2.2)
Marino	160.4 (3.5)	2.5 (2.7)	88.8 (19.9)	1.9 (0.5)	0.8 (0.3)	7.1 (2.2)	5.4 (1.7)	4.0 (1.1)
LSD ($p=0.05$)	10.2	1.2	7.8	0.2	0.3	1.1	2.0	2.4

Results

The mean values of traits and standard deviations for the accessions and the cultivar Marino are shown in Table 2. On average, the accessions flowered earlier, had more heads per plant, shorter stem length and longer leaf length than Marino; leaf width was similar in all plants. The mean dry matter yield for the nine accessions was 140.7% of that of the Marino cultivar in the first year, and 192.5% in the second year. In contrast, the mean score for powdery mildew tolerance of the nine accessions was overall 81.7% of that of the Marino cultivar (range 52.1% -116.9%). However, powdery mildew tolerance was higher in two of the accessions (no.s 8 and 12) than in Marino (116.9 and 111.3%, respectively). These two accessions had also higher dry matter yields than Marino in the two years of the study.

Conclusions

The findings of the present study confirm the potential usefulness of some of the accessions for initiating a breeding programme to create a red clover cultivar combining high dry matter yield and greater tolerance to powdery mildew.

References

- González-Murua C., González Moro M.B., Estavillo J.M., 2003. Nitrógeno, agricultura y medio ambiente. In: La Ecofisiología Vegetal: Una Ciencia de Síntesis. Reigosa, J.M. et al. (eds.). Ediciones Paraninfo S.A. Madrid, España, 387-412.
- SPSS, 2011. SPSS for Windows, vers. 19.0. SPSS Inc. 1989-2005.
- Taylor N.L., 1990. The true clovers. In: Advances in new crops. Janic J., Simon J.E. (eds). Timber Press. Portland (OR), USA, p. 177.
- UPOV, 1985. Guidelines for the conduct of tests for distinctness, homogeneity and stability. TG/5/4. Red clover (*Trifolium pratense* L.) International Union for the Protection of New Varieties of Plants. Genève. Switzerland.

Canopy temperature as a tool for the selection on drought tolerance in rye

Graß, Rikard; Böttcher, Ulf; Kage, Henning
Christian-Albrechts-University of Kiel, GERMANY

Introduction

Drought tolerance is an increasingly important trait in plant breeding, especially for crops like rye, known for its high ability to adapt to marginal environments. The breeding process is still mainly based on phenotypic selection but large G×E interactions thereby lead to low heritability of drought stress tolerance.

A model based interpretation of canopy temperature measurements may give additional and more specific information about plant physiological traits leading to drought stress tolerance than yield data from stress environments alone.

The aim of the presented work is to identify drought tolerance traits that may be detected by canopy temperature and their further interpretation by simulation modelling. Here we present first results from canopy temperature measurements within the year 2011.

Materials and methods

A number of 480 inbred lines and hybrids of rye were grown under irrigated and non-irrigated conditions, in a

split plot design on 3 drought stress prone environments in Germany and Poland. Canopy temperature (Apogee IR 120 sensor), leaf area index (LAI) (calculated from spectral reflection) and weather conditions were measured simultaneously and repeatedly between stem elongation and ripening. A georeferenced tractor based measurement system thereby was used to measure the complete field trial. Difference between canopy temperature and air temperature (Tdiff) was calculated which can be compared to calculations of theoretical canopy temperature after Jackson et al. (1988).

Environments were characterised by nearby climate stations and examination of soil texture and soil water retention.

Results

Although weather conditions were suboptimal to detect drought stress (warm but overcast sky) on 12 May (heading) there is a correlation between yield and Tdiff in the non-irrigated treatments for the sandy ($r^2 = 0.5$, $P < 0.001$) and loamy part ($r^2 = 0.4$, $P < 0.001$) (Fig. 1). On 30

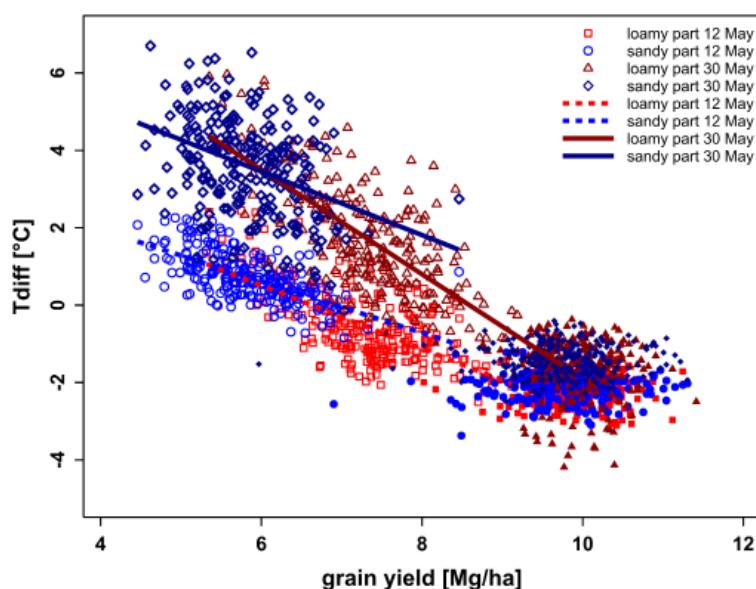

Fig. 1: Correlation between yield and Tdiff (canopy temperature – air temperature) for different genotypes in Wohlde (Germany) for 12 and 30 May, 2011 in irrigated (filled symbols) and non-irrigated treatments (open symbols). Regression lines are shown for non-irrigated treatments.

May (flowering) under clear-sky and warm conditions the correlation is higher for the more loamy parts of the trial ($r^2 = 0.7$, $P < 0.001$) while it is only weak for the sandy part. Tdiff was low for irrigated treatments with low variability and no correlation to yield ($r^2 < 0.04$, $P < 0.05$) on both dates.

Discussion

Canopy temperature measurements highly depend on environmental conditions, soil water status, and plant development. Hence, the regressions for both dates differ considerably. For 12 May the available soil water content is assumed to be similar for loamy and sandy parts. Conversely, for 30 May it was very low on the sandy part, thus drought stress was high for all genotypes with very low genotypic differentiation. On the loamy part the genotypes differed in their ability to use the remaining available soil water content.

Genotypic differences in root growth and stomata closure characteristics are supposed to be a main cause

for different reactions to drought stress. We hypothesize that a model based data analysis and interpretation for all locations and the whole time course can lead to an estimation of root parameters and stomata control characteristics for different genotypes. To relate these parameters to measurements, a description of plant growth (LAI, plant height) derived from reflection measurements will be connected with a potential based soil water and evapotranspiration model. In this model root growth parameters and the relation of stomata conductance to drought stress influence the calculation of canopy temperature and therefore can be estimated as genotypic parameters from the measurements.

References

Jackson, R.D., Kustas, W.P. & Choudhury, B.J., 1988. A Reexamination of the Crop Water Stress Index. *Irrig Sci*, 9, 309–317.

Photosynthetic pigments, proline and carbohydrate content of marigold (*Tagetes patula* L.) under salinity stress

Heidari, Mostafa; Akbari, Toktam
 university of Zabol, IRAN (ISLAMIC REP.)

Introduction

The detrimental effects of salinity on plant growth are associated with low osmotic potential of the soil solution (secondary drought), nutritional imbalances (nutrient disorders), specific ion effects (sodium or chlorine toxicity) or a combination of those factors. Responses of plants to salt stress have been studied at various levels of physiological parameters (Hurkman, 1992). Therefore the objectives of this research are to study the effect of salinity levels on plant growth, photosynthetic pigments and osmotic components in two genotypes of marigolds.

Materials and methods

This study was conducted in a greenhouse at the University of Zabol, Iran. The experiment was laid-out in a complete randomized factorial design with three replicates. Three salinity treatments ($S_0=0$ (control), $S_1=3$ and $S_2=6$ ds/m) were imposed by the nutrient solution after the plants were ten days old. Two genotypes of marigold were $M_1= Tagetes erecta$ and $M_2= Tagetes tenuifolia$. The culture solution was weekly renewed and its pH was initially adjusted to 6.5. Twenty days after salt treatment, the plants were harvested. The extracts of the leaves material were used to determine soluble soluble carbohydrates (Irigoyen et al., 1992). Free proline was estimated according to Bates et al. (1973). Chlorophyll 'a' and 'b' of leaves were determined according Arnon's method (1949).

Results and discussion

Increasing NaCl levels within the nutrient solution affected the fresh weight of the two marigold genotypes and caused a reduction in them. The reduction in root and shoot development may be due to toxic effects of the NaCl used as well as unbalanced nutrient uptake by the seedlings (Hajibagheri et al., 1989). The results showed,

whenever the salt concentration increased until 3 dS m^{-1} , chlorophyll 'a' content increased, but by increasing salt from 3 to 6 dS m^{-1} chlorophyll 'a' content decreased. In this study whenever the salt concentration increased, chlorophyll 'b' content in two cultivars increased and carotenoids decreased. The results regarding agree with results reported by Misra et al. (1997). The salt stress treatment caused a significant increase in the concentrations of proline and soluble carbohydrate in shoot of plants in all comparisons. Proline, sucrose, and other organic sugars in quinoa contribute to osmotic adjustment during stress and protect the structure of macromolecules and membranes during extreme dehydration (Prado et al., 2000). In this study between two genotypes, M_1 had better physiological parameters to salinity tolerance than M_2 . M_1 genotype had higher fresh weight, proline and soluble carbohydrate content in shoot tissue than M_2 genotype.

References

- Arnon, D. I. 1949. Copper enzyme in isolated chloroplasts. Polyphenol oxidase in *Beta vulgaris*. Plant physiol., 24: 1-15.
- Bates, L.S. Waldern, R. P. and Teare, L. D. 1973. Rapid determination of free proline for water use studies. Plant Soil., 39: 205-208.
- Hajibagheri, M. A. Yeo, A.R. Flowers, T. J. and Collins, J. C. 1989. Salinity resistance in *Zea mays* fl uxes of potassium, sodium and chloride, cytoplasmic concentrations and microsomal membrane lipids. Plant, Cell and Envir. 1989. 12: 753-757.
- Hoekstra, F. A. Golovina, E. A. and Buitink, J. 2001. Mechanism of plant desiccation tolerance. Trends Plant Sci., 9: 431-438.

- Hurkman, W. J. 1992. Effect of salt stress on plant gene expression. A review. *Plant Soil*, 146: 145–151.
- Irigoyen, J. Emerich, J. and Sanches-Diaz, M. 1992. Water stress induced changes in concentrations of proline and total soluble sugars and nodulated alfalfa plants. *Acta Botanica Sinica*, 46:921-927.
- Misra, A. N. Latowski, D. Stirzalka, K. 2006. The xanthophyll cycle activity in kidney bean and cabbage leaves under salinity stress. *Biomed. Life Sci.*, 53 (1): 102–109.
- Prado, F. E. Boero, C. Gallardo, M. and Gonzalez, J. A. 2000. Effect of NaCl on germination, growth, and soluble sugar content in *Chenopodium quinoa* Willd. seeds. *Bot Bull Acad Sin.*, 41: 27-34.

Using the compensated heat pulse method to monitor the stem water content in standing trees

Villalobos, Francisco J.¹; López-Bernal, Álvaro²; Testi, Luca²

¹Instituto de Agricultura Sostenible (CSIC) & Universidad de Córdoba, SPAIN; ²Instituto de Agricultura Sostenible (CSIC), SPAIN

Introduction

There is ample evidence that trees store water in sapwood during times of low evaporative demand and consume this water in transpiration when evaporative demand exceeds root water uptake. Thus, water stored in stems (θ) allows trees to maintain both higher transpiration and photosynthesis rates holding up stomatal closure during a drought. Despite its outstanding physiological interest, all the available techniques to measure θ exhibit major drawbacks. In this work, we present a new methodology to estimate θ along with sap velocity using the compensated heat pulse technique (CHP).

Materials and methods

One lab experiment was performed on several wooden blocks obtained from trunks and stems of three different fruit tree species including olive (*Olea europaea*), plum (*Prunus domestica*) and fig (*Ficus carica*). Samples were dried and their moisture loss was monitored by both weighing and CHP probes to contrast the validity of our methodology (VSH-CHP) over a range of water contents. In addition, a field experiment was conducted in an experimental olive (cv. 'Arbequina') orchard located in Córdoba, Spain (37.8 °N, 4.8 °W). The olive trees were planted in 1997, tree spacing was 7 m x 3.5 m and three different irrigation regimes including a full-irrigated control and two deficit-irrigated treatments were established from 2004 to 2006 (Iniesta et al. 2009). During 2006 some trees of each irrigation treatment were instrumented with two CHP sensors per tree in order to monitor sap flow and θ dynamics.

Results

In the lab test, the actual wood water content measured gravimetrically (θ_g) differed from the estimates yielded by the VSH-CHP method (θ_c). While θ_g values showed a clear curvilinear decay, θ_c patterns decreased only at the beginning of the experiment until stabilization occurred. However, the relative reduction in θ_g measured during the first hours of drying was in good agreement with that detected by our methodology suggesting that it could successfully track relative changes in the water stored for this interval (which should cover the range of θ expected in most living trees). The field experiment

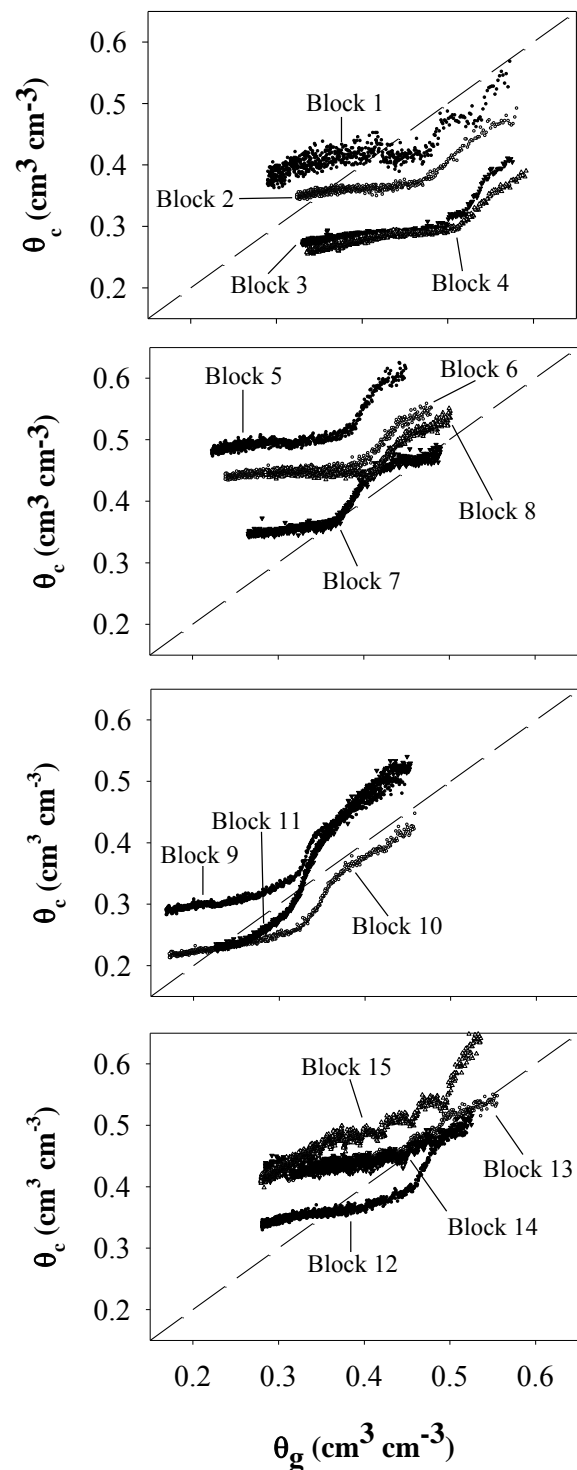

Figure 1.

showed a seasonal change in θ which was similar in shape and magnitude to those reported in the literature for olive and other Mediterranean tree species (Constantz and Murphy 1990; Nadler and Tyree 2008). On the other hand, differences in the seasonal patterns of θ between irrigation treatments followed those of sap flow and some leaf water potential measurements.

Conclusions

The present study shows a new alternative to monitor θ in living trees by using the CHP technique. Our lab and field experiments support that the VSH-CHP method can successfully track relative changes in the water stored. The technique is rapid, easy to automate and provides simultaneous information about tree transpiration. Nevertheless, it does not yield actual values of θ and its feasibility is uncertain for those trees with wide seasonal changes in θ , which deserves further research. Finally,

the results of this work evidence that seasonal changes in θ might be used as a long-term water status indicator and point out that the CHP technique is a valuable tool to obtain information about tree water relations.

References

- Constantz, J. and F. Murphy. 1990. Monitoring moisture storage in trees using time domain reflectometry. *J. Hydrol.* 119, 31-42.
- Iniesta, F., L. Testi, F. Orgaz and F.J. Villalobos. 2009. The effects of regulated and continuous deficit irrigation on the water use, growth and yield of olive trees. *Eur. J. Agron.* 30, 258-265.
- Nadler, A. and M.T. Tyree. 2008. Substituting stem's water content by electrical conductivity for monitoring water status changes. *Soil Sci. Soc. Am. J.* 72, 1006-1013.

Effect of the Mother Tiller Type in the First Cut on the Leaf Appearance of Regrowth Tillers in Timothy

Pakarinen, Kirsi; Hyrkäs, Maarit; Virkajärvi, Perttu
MTT Agrifood Research Finland, FINLAND

Introduction

Timothy (*Phleum pratense* L.) is a common forage species in the boreal areas. In silage swards, individual tillers are defoliated at several developmental stages, since the herbage is allowed to grow longer than in pasture swards. This can lead to variation in the growth processes during regrowth. The processes of primary growth of grasses are relatively well documented, but for the regrowth, the most important developmental events are not described in same precision.

In our study, we aimed to clarify the processes of summer regrowth in the tiller level in timothy grown for silage. We hypothesized that the developmental stage of the tiller during the first cut (i.e. mother tiller type) affects the development of its regrowth tillers. Here, we report results for phyllochron and the number of living leaves per tiller.

Materials and methods

This study was conducted on two typically managed field experiments with timothy (cv. Tammisto II) in three replicates during 2006 – 2009 at MTT Agrifood Research Finland, Maaninka. Levels of N, P and K fertilization were typical to the region and no irrigation or plant protection was used. Each year, cuts were taken in late June and in late August. The effective temperature sum above 0°C (°Cd) in regrowth was calculated using °Cd of first cut as zero point. Each year, tillers for measurements in the regrowth were marked before the first cut and for taking the effect of mother tiller type into account, they were determined as A) vegetative (VEG): pseudostem and leaves; B) elongating vegetative (ELONG): leaves and true stem; C) generative (GEN): leaves, true stem

and an inflorescence. Regrowth of tillers was measured approximately once a week for 8–10 weeks.

Data was used for calculating the maximum number of living leaves per tiller and the phyllochron, and the effect of mother tiller type on these parameters was analyzed having year, tiller type and year × tiller type –interaction as fixed effects using the Mixed procedure of SAS 9.2.

Results and discussion

As the regrowth habit of timothy is clonal, the tillers in the same plant have similar genetic performance (Doust, 2007). Nevertheless, the mother tiller effect was clear only for the maximum number of living leaves per tiller, as VEG and GEN mother tillers promoted the maximum leaf number in the regrowth tillers and differed from ELONG mother tillers (Table 1). For GEN this could be explained either by inherited superiority or larger carbohydrate reserves, while for VEG by the intactness and rapid recovery of the apical meristems after the cut. Compared to grazing experiments (Lardner et al. 2002), the average numbers of living leaves per tiller and the variation in their count were greater in this study, which is perhaps because we observed the regrowth for a longer time.

There was no effect of mother tillers on phyllochron i.e. leaf appearance rate, although we have found that the total tiller appearance and survival rate after the cut can be promoted by ELONG and GEN mother tillers (Pakarinen et al., 2011). In contrast to tillering in regrowth, leaf appearance may be more strongly regulated by environmental conditions.

Table 1. Effect of the type of mother tiller (vegetative, VEG; elongating vegetative, ELONG; generative, GEN) on the maximum number of living leaves per tiller and phyllochron of regrowth tillers in timothy during four growing seasons.

Type of mother tiller	Regrowth year	Maximum number of living leaves per tiller in regrowth	Phyllochron (°C) in regrowth	<i>n</i>
VEG	2006	4.8	167	8
	2007	3.0	154	2
	2008	3.7	135	3
	2009	4.0	178	1
	<i>weighted mean</i>	4.2	159	
ELONG	2006	.	.	0
	2007	3.5	138	4
	2008	2.8	127	4
	2009	4.1	129	11
	<i>weighted mean</i>	3.7	130	
GEN	2006	.	.	0
	2007	5.0	122	7
	2008	4.6	114	5
	2009	4.6	136	11
	<i>weighted mean</i>	4.7	127	
	SEM	4.64	34.9	
	<i>p-values</i>			
	year	0.16	0.43	
	tiller type	0.006	0.20	
	year × tiller type	0.50	0.83	

Conclusions

The number of living leaves per tiller in the regrowth of timothy was promoted by both vegetative and generative mother tillers compared to elongating vegetative mother tillers. Phyllochron was affected more by environmental conditions than the type of mother tiller.

References

- Doust, A. N. 2007. Grass architecture: genetic and environmental control of branching. *Current Opinion in Plant biology* 10: 21-25.
- Lardner, H., Wright, S., Cohen, R. 2002. Leaf development of eight grass species following grazing. *Canadian Journal of Plant Science* 82:747-750.
- Pakarinen, K., Virkajärvi, P., Hyrkäs, M. 2011. The developmental stage of the tiller in the first cut predicts the success of regrowth tillers in timothy and tall fescue. *Proceedings of the British Grassland Society 10th Research Conference* pp. 17-18.

Wheat (*Triticum aestivum* L.) yield stability and reliability in the Mediterranean semi arid environment

Randazzo, Biagio; Gristina, Luciano; Sarno, Mauro; Poma, Ignazio; Novara, Agata
University of Palermo, ITALY

Introduction

Common wheat (*Triticum aestivum* L.) represents, for dry areas of Italy, a very interesting species both for specific resistance to eyespot, and for its quality stressed by semi arid environment. Particularly Sicilian environment is characterized by warm winter allowing *fusarium* spp. attack, but lack of rain during kernel ripening allows a low deoxynivalenol content in grain yield. For these reasons grain yield and stability evaluation of new wheat varieties seems to be crucial for the semi arid Mediterranean environment. In this paper a four year trial carried out in two different sites are reported.

Materials and Methods

In two representative environments of Sicilian cereal production, different for annual rainfall and temperature (S. Stefano di Quisquina higher rainfall and lower temperature and Cammarata lower rainfall and higher temperature), using a randomized experimental block with three replications a 10 m² plot was seeded using 450 germinable seed m² after a leguminous crop. A

mouldboard tillage during summer and two light tillage were needed for seed bed preparation. In both sites seeding was between the end of November and the end of December. All varieties under evaluation were always present during the four-year trial. Yield reliability was evaluated according to Donatelli and Annicchiarico (1997), whereas yield stability according to Yan et al. (2000), considering yield as (PC₁) and genotype X environment interaction as (PC₂), considered the main variation origin for varieties evaluation in the semi arid Mediterranean environment. In a bidimensional space, values of varieties, years, sites and interactions yearsXsites are represented as vectors. Vectors start from origin (0, 0) up to final value determined by principal component. An angle to 270° between vector variety and vector year shows a positive response to the year, whereas an angle between 90° and 270° shows a negative response. Model SREG (Site regression Model) was used for biplot graphic connecting the highest varieties value.

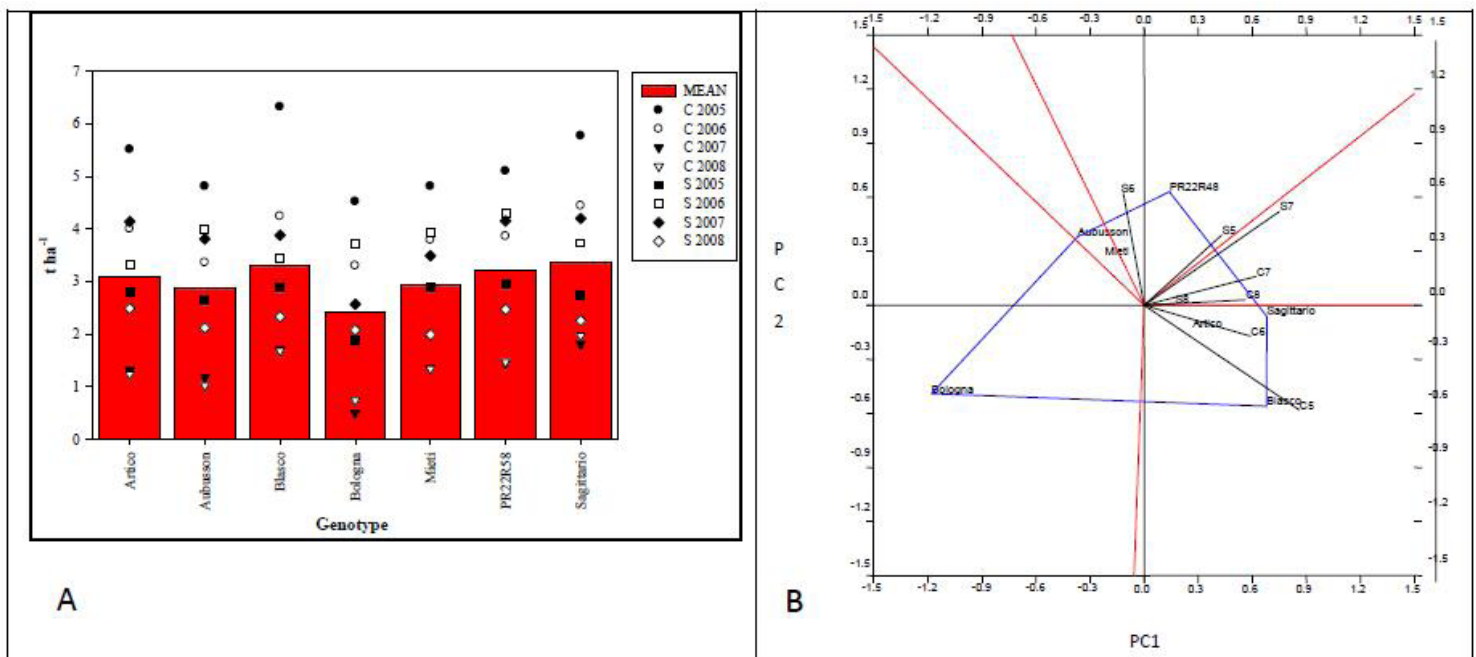

Fig.1: A =average yield during the four years trials in the two sites (C=Cammarata, S=S. di Quisquina). Bt = Biplot of the two main principal components

Tab.1: Reliability index of the varieties

Variety	Index	Average	Std.Dev.
Artico	96,1	101	8,2
Aubusson	86,4	93	9,4
Blasco	102,5	111	12,5
Bologna	60,2	74	20,6
Mieti	93,5	98	6,6
PR22R58	103,5	107	5,7
Sagittario	103,3	115	17,1

Results and discussion

Climatic trend during the trial was characterized by an high variability both for rainfall and temperature especially during winter and spring. Average yield of the varieties was 3.03 t ha⁻¹ ranging between 0.5 and 6.32 t ha⁻¹ (fig. 1 A); in Cammarata site the highest yield (year 2005 5.26 t ha⁻¹) and lowest (year 2007 1.31 t ha⁻¹) were recorded, whereas in S. Stefano di Q. site average yield was between 2.68 t ha⁻¹ e 3.77 t ha⁻¹. In fig. 1 B biplot graphic of the main component is represented. Variation due to the first factor showed a 74.2% of total variation, whereas the second one was only 15.5%. Sagittario cv yielded more than all variety specifically during 2006, 2007 and 2008 in Cammarata site and during 2007 in S.

Stefano; Blasco produced more in 2005 and PR22R48 in 2005 and 2006 in S. Stefano. Artico cv only in S. Stefano during 2008. Sagittario contemporary showed high productivity and stability. Reliability analysis of yield showed similar results (Tab. 1).

Conclusions

The trial allows us to study wheat varieties available in Italy adaptability in two different pedoclimatic Sicilian environment. Data shows the adaptability of some varieties and genotype X environment analysis confirmed an high stability of the tested genotypes.

References

- Burgueño, J., J. Crossa, and M. Vargas. 2004. <http://www.cimmyt.org/Research/Biometrics/bsu.htm>
- Donatelli, M., e P. Annicchiarico, 1997. Pubblicazione Speciale degli Istituti Sperimentali Agronomico e per le Colture Foraggere. Modena.
- Patterson R.E., 1950. *Agronomy journal*, n. 42: 509-511.
- Yan, W., L.A.Hunt, Q. Sheng, and Z. Szlavnic. 2000. *Crop Sci.* 40:597–605.

Comparative study of genotype-environment interaction of oat and triticale varieties in southern Italy

Poma, Ignazio; Randazzo, Biagio; Fiore, Maria Carola; Venezia, Giacomo
University of Palermo, ITALY

Introduction

Oat (*Avena sativa* L.) and triticale (X *Triticosecale* Wittmack), two minor cereals, are characterized for a widely adaptability to several pedo-climatic conditions. A large number of varieties are listed in the National Register of Varieties (Italy), while few genotypes are obtained under strict seed certification standards. In Sicily, areas cultivated with oats utilize old medium-late populations with low productivity, while only two varieties of triticale are cultivated in a very limited areas. Therefore, the study of genotype x environment interaction in these two minor cereals could allow to collect important results to speculate the introduction of more productive varieties, especially for the Sicilian environments. In this study we report the results of a four-year field experiments in two Sicilian environments.

Materials and methods

The data refer to the National Network of varieties comparison coordinated by CRA-Experimental Institute for Cereal crops of Lodi (Italy). Five oat genotypes and eight triticale genotypes were studied in two different areas, representative of internal region of Sicily, Cammarata (AG) and S. Stefano di Quisquina (AG), for four years (2005-2008). Differences across the two environments regard rainfall and temperature: indeed in S. Stefano di Quisquina total rainfall is higher compared to Cammarata, while in S. Stefano di Quisquina winter temperatures go often below zero with more relatively cool springs. The plot size was 10 m² and 400 seed per m² rate was used at each location for each year, according to a randomized block design with three replicates. In each season and each location, land management was done by a ploughing and two harrowing for a optimum seedbed preparation. Seeds were sown between 3rd week of November and 3rd week of December. In order to determine the yield stability Yan et al. (2000) procedure was used. The authors take into account the productivity (PC1) and the GE-interaction (PC2) as relevant sources of variation to varieties evaluation in semi-arid Mediterranean region.

Results and discussion

The climatic trends recorded in a four years field experiment were quite variable both in terms of total rainfall and temperatures. The average yield of triticale was 3.05 t ha⁻¹, range from 0.90 to 5.50 t ha⁻¹. The highest average yield (4.94 t ha⁻¹) was recorded in Cammarata during the 2005 growing season (C5, Fig.1), while the lowest average yield (1.38 t ha⁻¹) in S. Stefano di Quisquina during the 2008 growing season (S8, Fig.1). The average yield of oat was 2.58 t ha⁻¹, range from 0.24 t ha⁻¹ to 5.05 t ha⁻¹. The highest (4.33 t ha⁻¹) and lowest (0.70 t ha⁻¹) average yield were recorded, as well as triticale, in Cammarata in the same growing seasons (C5 and S8, Fig.1). The polygon view of the GGE bi-plot is reported in figure 2. Regarding triticale genotypes, the first two PCs explained 84% (PC1=50.9 %, PC2=33.1%) of the total GGE variation among data. Oceania genotype had higher yields in environments C7, S5, S6 and S8, Rigel in environments C5, C6 e S7 and Bienvenue in C8. Hamel has been the highest yielding oat genotype in environments S5 and S7, Donata in C7 and S6, Genziana in C5, C6 and C8. In this graph PC1 and PC2 explained 50.4% and 26.6% of total GGE variation respectively.

Conclusions

This study have allowed to evaluate crop yield results of different oat and triticale varieties in eight fields experimental conditions in Sicily. These results have identified a group of oat and triticale varieties that showed a well adaptation to the specific climatic conditions of southern Sicily. In particular, based on both mean and stability, Oceania and Donata resulted the best triticale and oat genotypes, respectively.

Reference

Yan, W. et al. (2000). Cultivar evaluation and mega-environment investigation based on GGE biplot. *Crop Sci.* 40(3): 597-605.

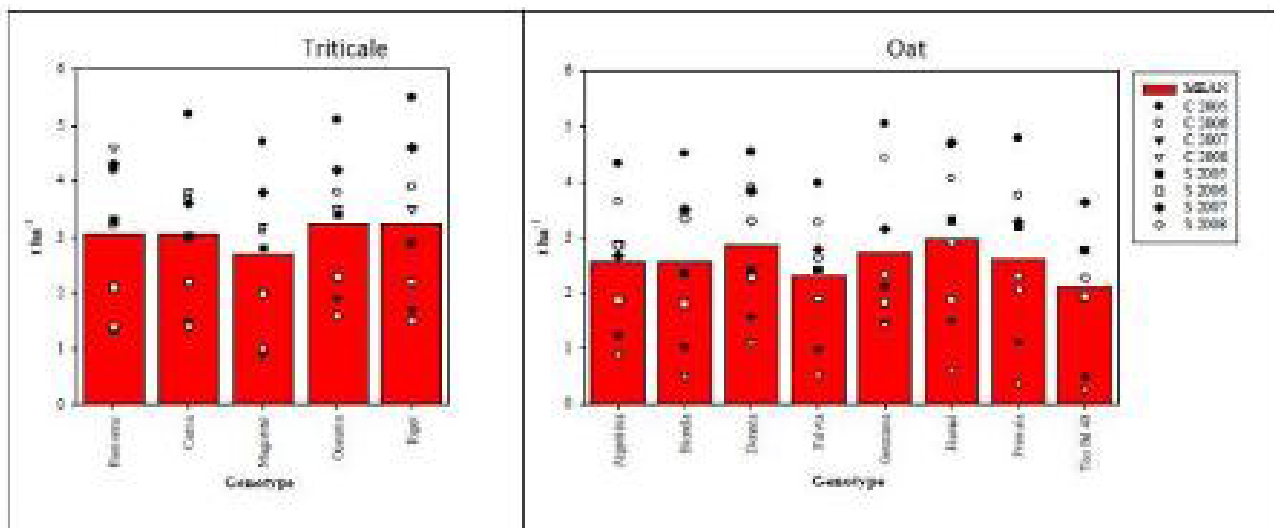

Fig. 1: Average yield of triticale (left) and oat (right) genotypes over all two different areas and 4-years field experiments (8 environments).

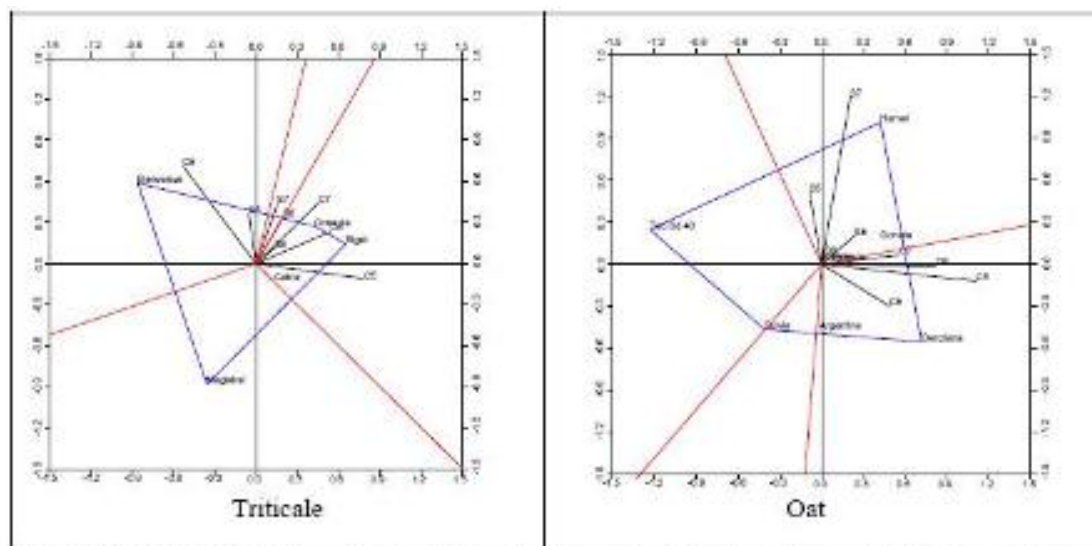

Fig.2 The GGE bi-plot view showing the performance of each oat genotype and triticale genotype in each environment. The environments are displayed by letters and number.

Evaluation of vetch (*Vicia sativa* L.) genotypes in semi-arid environment of Italy

Poma, Ignazio; Randazzo, Biagio; Fiore, Maria Carola; Bono, Giuseppe
University of Palermo, ITALY

Introduction

Vetch (*Vicia sativa* L.) is an important annual forage legume crop for dry area of southern Italy. The species is an annual crop for seed and forage either as a pure crop or as part of intercropping with cereal species (barley, oat, etc.). Although vetch provides a good seeds production in semi-arid environments of Italy, a large quantities of seed are imported from Turkey, Spain, Australia and Poland to match autumn winter cultivation needs (Saladino et al. 2006). The reason for this trend can be attributed to the inadequate refinement of cropping technique and use of genotypes most suitable for biomass production compared to seed production (Poma et al. 2004). There are real chances to increase the areas planted to vetch taking in account the Common Agricultural Policy (CAP) recently reformed. In order to increase the introduction of more productive vetch genotypes, especially for the Sicilian environments, the present study reports the results of 2-year field experiment.

Materials and methods

The study was carried out in a representative internal region of Sicily environment (Cammarrata-AG, Sicilia, 37° 37' N - 13° 42' E). Seventeen vetch genotypes, were

compared in a 2-year field experiment ('07-'09) according to a randomized block design with three replicates. Vetch genotypes were sown at a rate of 150 seeds per square meter and at 25 cm wide row on December, after a deep summer plowing and two harrow. The soil was fertilized with 90 kg ha⁻¹ of P₂O₅ during fall tillage. Each 20 m² plot was split to allow both forage harvest at full bloom and seed production at the end of May. The main agronomic and qualitative traits (Piccione 1989) were collected during two-year field experiments. Here we report only grain protein content, seed and biomass production results. Data were analyzed separately for each year by one-way ANOVA followed by Duncan's multiple range test for comparisons of different means.

Results

The climatic trends were quite variable during the two-year field experiments. The rainfall difference between the two years, 326 ('07-'08) and 596 mm ('08-'09), had a strong influence on the results. Seed production showed a variability among compared genotypes ranging between 0.85 t ha⁻¹ ('07-'08) and 1.05 t ha⁻¹ ('08-'09). A group of seven genotypes (Marianna, Francesca, Fillon, Mirabella,

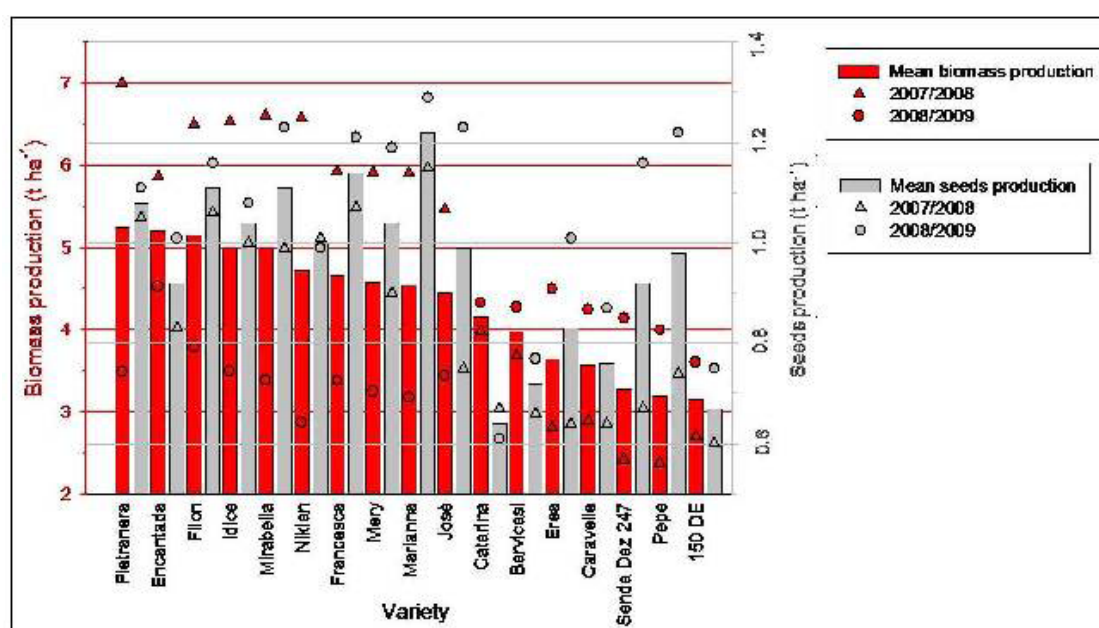

Fig. 1: Biomass (red) and seed production (grey) of vetch genotypes.

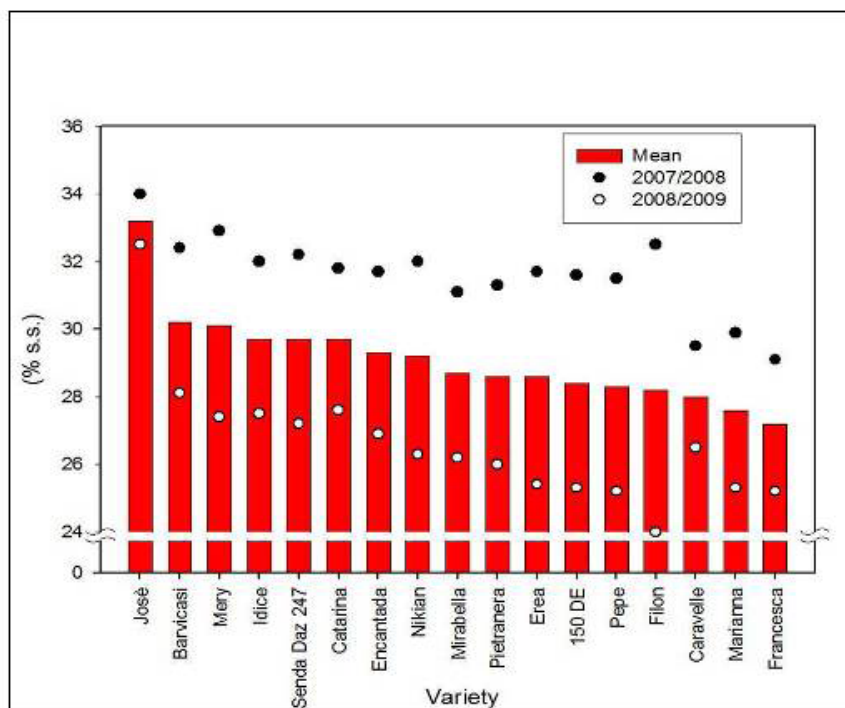

Fig.2. Grain protein content of vetch genotypes

Idice, Nikian and Pietranera) have recorded a seed production higher than 1.1 t ha^{-1} (Fig.1), not statistically different to each other (data not shown). Average biomass production across all two years was 4.33 t ha^{-1} . Pietranera, Encantada, Filon, Idice and Mirabella genotypes were much more productive than others (higher than 5 t ha^{-1}), while Pepe, Senda Daz 247, Erea, Caravelle, Barcavisi, 150 DE and Catarina have recorded a biomass production lower than 4.33 t ha^{-1} (Fig.1).

The highest values for the biomass production were obtained by Pietranera genotype (7.0 t ha^{-1}) in first year, statistically different from all other (data not show). Seed protein content (percentage on dry matter) was mainly influenced by the genotype and less by the year. Seed protein content (Fig.2) ranged from 29.1 to 30.4% in the first year and 24.0 to 32.5% in the second; the highest results were obtained by José genotype for both years.

Conclusions

This study have allowed to evaluate the yield potential of several vetch genotypes in a semi-arid sicilian environment. Special attention should be given to four genotypes, Idice, Pietranera, Filon and Mirabella, due to good yield level, good biomass production and high seed protein content. These results can be used by Agricultural Advisory Service to promote introduction and diffusion of vetch genotypes in semi-arid environment of Italy.

References

- Poma I. et al. (2004) Proceeding of VIII ESA Congress: 163-164.
- Piccione M. 1989 dizionario degli alimenti per il bestiame. Edizione Agricole: 912-913.
- Saladino S. et al. (2006) . Italus Hortus 13 (2): 448-451

Rainfed olive response to supplemental irrigation applied at different periods of fruit growth

Razouk, Rachid¹; Ibbijben, Jamal²; Kajji, Abdellah¹; Daoui, Khalid¹

¹National Institute of Agronomic Research, MOROCCO; ²Moulay Ismail University, MOROCCO

Introduction

In Morocco, rainfed olive orchards occupy 450.000 ha, equivalent to 60% of total olive area. Yield level in these orchards remains very low, varying between 1 and 1.5 t/ha, ensured by the low water reserves coming from autumn and winter precipitations and summer thunderstorms. The yield weakness is due to several constraints, reduction of rainfall is the major challenge. Supplemental irrigation is a promising way to increase olive yield in those conditions, especially when access to water resources is feasible and economically efficient. However, this technique requires hydro-agricultural investments that are to be deducted from production gains. Therefore, it is essential to determine the optimal periods to apply supplemental irrigation having high economic efficiency and giving the satisfactory production gain. It is within this context that this study was carried out aimed to quantify effects of seven types of supplemental irrigation applied on rainfed olive during different periods of fruit growth.

Materials and methods

The experiment was carried during two consecutive seasons using rainfed orchard olive (cv. Picholine Marocaine) thirty years old, planted at a distance of 8x6

m in north-center of Morocco. Treatments were: "Td": rainfed regime; "Ta": irrigation after two weeks of fruit set (mid-June); "Tb": irrigation during stone hardening stage (end of July); "Tc": irrigation after two weeks of stone hardening (September beginning) and all their combinations "Tab", "Tac", "Tbc" and "Tabc". In each water treatment, the trees were surface irrigated around the trunks by 2 m with a quantity equivalent to useful soil reserve on 70 cm of depth.

Results

Results show that shoot growth was very influenced by the first irrigation Ta which the effect was significantly higher than that obtained with the second and the third irrigation (Tb and Tc) even combined, increasing annual shoot length by an average of 35.8%. This, is explained by the fact that the first irrigation was applied during rapid growth of shoot, while the two other irrigations were applied during slowdown periods of shoot growth.

Yield level was influenced by variability of tree vigor in addition to water treatment doing what their multiple comparison was not highlighted the effect of water

Effect of different supplemental irrigations on yield, fruit weight and oil content of rainfed olive.

	2009				2010			
	Fruit yield (kg.tree ⁻¹)	Oil yield (kg. tree ⁻¹)	Fruit weight (g)	Oil content (%.DW)	Fruit yield (kg.tree ⁻¹)	Oil yield (kg. tree ⁻¹)	Fruit weight (g)	Oil content (%.DW)
T _a	42,2 ab	7,6 ab	4.41 c	37,8 d	35,1 ab	5,9 ab	3,96 c	33.6 cd
T _b	28,6 a	5,0 a	4.06 ab	36,5 c	26,3 a	4,2 a	3,61 ab	32.5 bcd
T _c	33,8 a	5,5 a	4.12 b	33,7 a	27,3 a	4,4 a	3,67 b	34.5 de
T _{ab}	51,9 ab	9,5 ab	4.79 d	37,5 d	39,1 ab	6,1 ab	4,34 d	30.2 a
T _{ac}	52,5 ab	9,2 ab	4.80 d	36,8 c	43,7 ab	5,9 ab	4,35 d	32.3 bc
T _{bc}	42,0 ab	6,7 ab	4.16 b	33,3 a	32,6 ab	5,7 ab	3,71 b	31.4 ab
T _{abc}	66,2 b	11,6 b	4.85 d	35,9 b	46,0 b	7,6 b	4,40 d	34.4 de
T _d	28,6 a	5,3 a	3.95 a	37,4 d	25,4 a	4,4 a	3,50 a	36.0 e
sig	*	**	**	**	*	*	**	**

Yield values are presented per average of trunk section

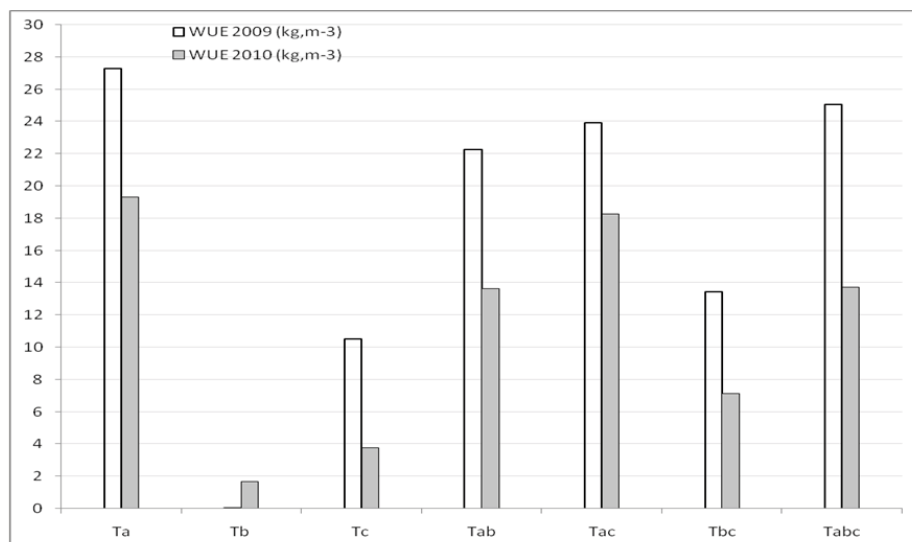

Water use efficiency of rainfed olive under different supplemental irrigations.

regimes. However, variance analysis of yield per unit trunk section shows that fruit and oil yields increased only by the first irrigation Ta ($p=0.022$). The two last irrigations "Tb" and "Tc" did not influence significantly yield level compared to rainfed regime "Td". It is only when these irrigations were combined (Tbc) that it ensure an effect statistically equal to that observed with the first irrigation Ta ($p=0.020$). However, their whole combination with the first irrigation "Tabc" gave the highest response comparatively to rainfed regime Td, with an increase of 106% for fruit yield where 43% returns to irrigation Ta and 96% for oil yield where 37% returns to irrigation Ta. These variations in yield levels were linked in large part to fruit weight variation because the water treatments started after fruit set. Indeed, linear regression between fruit weight and fruit yield is significant ($r^2=0.81$). Water

use efficiency value is highest under irrigation Ta with an average per tree of 23.2 kg m⁻³, equivalent to 10.5 € tree⁻¹ in case of Morocco.

Conclusions

At term of the experiment, we concluded that fruit weight and shoot growth were more affected by the first supplemental irrigation applied in mid-June, having thus increasing fruit and oil yields, allowing to generate a promising economical benefit for its adoption. Considerable effect was also found with addition of irrigation at beginning of the second rapid stage of fruit growth, in the beginning of September, although it slightly reduces fruit oil content.

Tolerance of selected potato cultivars to high temperature during the growing season

Rykaczewska, Krystyna

Plant Breeding & Acclimatization Institute, POLAND

Introduction

The potato is a crop plant typical of temperate climate. It is characterized by specific temperature requirements and develops best at a temperature of about 20°C. However, the limits and optimal values for the growth of the above-ground part of the potato plant and for the growth of the tubers are different. From experiments conducted in growth chambers it is known that haulm growth is fastest in the temperature range of 20-25°C whereas the optimal range for tuberization and tuber growth is 15-20°C. At a temperature higher than optimal a reduction or complete inhibition of tuberization takes place. Forecasts of global warming and the need to export seed potatoes to countries with high temperatures in the summer prompt us to study the tolerance of potato genotypes to heat during the growing season. The aim of this work was to single out potato genotypes most tolerant to high temperature during the growing season in moisture conditions favourable to plants and in drought conditions.

Materials and methods

In the years 2008-2011, two series of pot experiments were carried out in a greenhouse and air-conditioned chambers. The response of Polish potato cultivars to high temperature during the growing season was compared with the response of foreign cultivars designated in the European database as genotypes with very high adaptability to the environment. In the first series the cultivars: Adam, Cyprian, Irga, Zebra and Irys were compared with the American cultivar Kathadin, and in the second series the cultivars: Aruba, Etola, Finezja, Flaming and Tetyda were compared with the Dutch cultivar Desirée. The effect of heat stress (temperature day/night 32/25°C) on potato plants was tested in three periods: June 16-30, July 1-15 and July 16-30. In these periods half of the plants were watered to a level close to optimal, while the other half remained without irrigation under conditions of soil drought. The Control combination consisted of potato plants grown throughout the whole season under conditions close to optimal. The evaluation *in vivo* of the response of potato plants to heat stress was

based on the measurements of chlorophyll a fluorescence parameters (F_v/F_m – maximum quantum efficiency of photosystem II, and PI – vitality index of PS II) with a Pocket PEA Chlorophyll Fluorimeter.

Results

The most important factor for the development and yielding of the tested potato cultivars was the time of the occurrence of high temperature stress. The most damaging was this stress in the second half of June. The thermal stress in the next period, in the first half of July, caused much smaller decreases in yield, and the stress in the third period, in the second half of July, had no negative impact on yield. The response of the different cultivars varied. There was a significant decrease in the vitality index (PI) of the photosynthetic apparatus with the ageing of potato plants and the delay in the time of exposure to heat stress. In the case of plants growing in the soil with good moisture, this index was significantly higher than in the case of plants growing under the conditions of increasing soil drought. The final crop was found to have numerous physiological defects caused by high temperatures during the growing season. These were mainly deformed tubers and sprouting tubers.

Conclusions

1. The results allow us to confirm the hypothesis of quite a high tolerance of the tested cultivars to high temperature stress during the growing season. The most tolerant cultivar was 'Tetyda', which was characterized by the ability to maintain a high yield despite the exposure to high temperatures, with no tendency to deformity or early sprouting.
2. The vitality index (PI) of the photosynthetic apparatus appears to be a good indicator of the evaluation *in vivo* of the physiological state of potato plants, which may be useful for determining the response of plants to high temperature and drought under production conditions.

Yield response of tobacco (*Nicotiana tabacum* L.) grown for oil production in Mediterranean area

Sifola, Maria Isabella; Impagliazzo, Adriana; Fagnano, Massimo
University of Naples Federico II, ITALY

Introduction

Tobacco is traditionally cultivated for smoke products. Nevertheless, it also produces seeds with high content of non-food grade oil (33 to 40%) (Giannelos et al., 2002; Patel et al., 2008; Sifola and Di Giacomo, 2009). This oil is rich in linoleic acid (about 70%) (Giannelos et al., 2002; Patel et al., 2008; Sifola and Di Giacomo, 2009) and could be successfully used in both biodiesel and polymer industries (Patel et al., 2008). New cultivars were selected for this purpose, which produce more oils per hectare than other species traditionally cultivated for oil production (WO2008110876).

Materials and methods

Two field experiments were conducted during 2011 in Southern Italy (Acerra, Napoli). The first experiment was carried out to evaluate different low input cultural practices (irrigation and N fertilization) on biomass, seeds and oil yield of *Nicotiana tabacum* L. cv. Solaris (Sunchem Srl, www.Sunchem.it). The following 3 irrigation treatments: i) one watering at transplanting, ii) two waterings, at transplanting and at the beginning of stem elongation and iii) three waterings, at transplanting, at the beginning of stem elongation and flowering) were factorially combined with three N fertilization treatments: i) not-fertilized control, ii) 20 kg N ha⁻¹, iii) 40 kg N ha⁻¹.

In the second experiment, Solaris was compared with cvs PLT101 and PLT102 (Sunchem). Each cultivar received 20 kg N ha⁻¹ and 2 waterings (see first experiment). In both experiments, crops were furrow-irrigated. Seedlings were transplanted on June 13th (6 plants m⁻²) in plots of 9.6 and 11.2 m², in the first and in the second experiment, respectively. In the first experiment, plots were arranged in a split-plot design with three replications (blocks) with Irrigation treatments in main plots and N fertilization in sub-plots. The second experiment was completely randomized with three replications (blocks). In both experiments, plants were harvested on September 16th. After harvest, the following measurements were made: i) number of inflorescences and capsules per plant, seed weight (g capsule⁻¹), seeds and residual biomass yield (Mg ha⁻¹) at a standard moisture content of 7 and 70%, respectively.

Results and discussion

There was no significant effect of treatments (irrigation and N fertilization) on yield, yield components (number of inflorescence and capsules per plant and seed weight per capsule) and residual biomass of oil tobacco crop. The rainfall, well distributed during the phase of rapid growth-stem elongation (about 40 mm over July), should have determined these results. Regardless of treatments, it produced 4 Mg ha⁻¹ of seeds with an average of 3 inflorescences and 308 capsules per plant (data not shown). As for cultivars comparison, Solaris produced significantly less number of inflorescences and capsules per plant with respect to both PLT 101 and PLT 102 (Tab.1) but, due to a significantly greater seeds weight per capsule than other cultivars, there was no significant differences in seeds yield between the three cultivars as well as in residual biomass (Tab. 1).

Conclusions

In conclusion, on the average the seed (3.5-4.0 t ha⁻¹) and oil yield (1-2 t ha⁻¹) of the present experiments are comparable with those of other oil crops. In these experimental conditions, the tobacco cultivars, selected for oil production by Sunchem, resulted well adapted to low input cultivation conditions, thus allowing to gain good results in terms of economical and energetic balance. Of course, this result have to be confirmed in other environments or years with different pedo-climatic conditions.

References

- Giannelos, P.N., Zannikos, F., Stournas, S., Lois, E., Anastopoulos, G., 2002. Ind. Crops Prod 16, 1–9.
- Patel, K.I., Parmar, R.J., Parmar, J.S., 2008. J. Applied Polymer Sci. 107, 71–81.
- Sifola, M.I., Di Giacomo, M., 2009. XXXVIII SIA, Firenze 22-24 settembre 2009.
- WO2008110876. Mutagenized tobacco plant as seed culture for the production of oil for energetic, industrial and alimentary uses. Fogher C.

Table 1 . Yield, yield components and residual biomass of different cultivars of tobacco for oil production. Different letters indicate significant differences at $P \leq 0.05$ and $P \leq 0.01$ (capital letter) after subjecting data to analysis of variance (ANOVA).

Cultivars	Inflorescences (n. plant ⁻¹)	Capsules (n. plant ⁻¹)	Seeds (g capsule ⁻¹)	Seed Yield (Mg ha ⁻¹)	Residual Biomass (Mg ha ⁻¹)
SOLARIS	3.4 a	263.6 a	0.31 A	3.93	14.1
PLT 101	4.9 b	449.3 b	0.21 B	3.67	11.5
PLT 102	5.3 c	490.2 b	0.19 B	3.87	16.0

Effects of climate change on soil fertility of a typical cropping system of Southern Italy

Ventrella, Domenico; Giglio, Luisa; Charfeddine, Sonia; Castellini, Mirko
Agricultural Research Council CRA-SCA, Italy

Introduction

Particularly in the Mediterranean area, already considered a vulnerable zone, global warming, with its effects on temperature and precipitation pattern, could affect water availability and irrigation requirements due to significant variations of evapotranspiration rates, runoff, infiltration and soil moisture temporal dynamics.

Using sequences of various crops avoids the build-up of pathogen and pest problems, and also helps to conserve and improve soil structure and fertility, uses natural resources more efficiently and generally gives higher crop yields than these obtained in monoculture. Furthermore, the adoption of legumes into cereal rotations and incorporating of crop residues can reduce the usage of mineral N fertilizers.

This study focuses on Capitanata, a plain of 4000 km² in northern Apulia in southern Italy. The farms average 20 ha, with highly productive clay soils, and intensive and irrigated cropping. Winter durum wheat (*Triticum durum* L.) is the principal cereal, often grown in rotation with irrigated horticultural crops, particularly processing tomato (*Lycopersicon esculentum* Mill.) in 2-year (tomato-wheat) and 3-year (tomato-wheat-wheat) cycles.

The crop model DSSAT allows simulation of long-term crop sequences under different climate scenarios, permitting evaluation of the effects of rotation on crop yield, soil, water and nutrient balance. This study evaluated winter durum wheat and tomato responses under future climatic scenarios (Ventrella et al. 2012) and the effects on soil organic matter under the chosen crop sequences on a typical clay soil of Southern Italy.

Materials and methods

IPCC future climate scenarios B1 and A2 were used. The alternative climate projections used in this study were the output data of the Hadley Centre Coupled Model version 3 (HadCM3). The statistical downscaling procedure used the stochastic weather generator LARS WG that was calibrated including statistics and changes in mean climate, as derived from GCM, and integrated with the historical climatic data from the experimental farm of Agricultural Resource Council (CRA) at Foggia (Pizzigalli et al., 2012). The climate scenarios were compared to a generated baseline scenario (1951-2005).

The DSSAT cropping system model allows predicting and interpretation of the behaviour of the agronomic system for a given condition. The crop growth models CERES-wheat and CROPGRO-tomato, previously calibrated

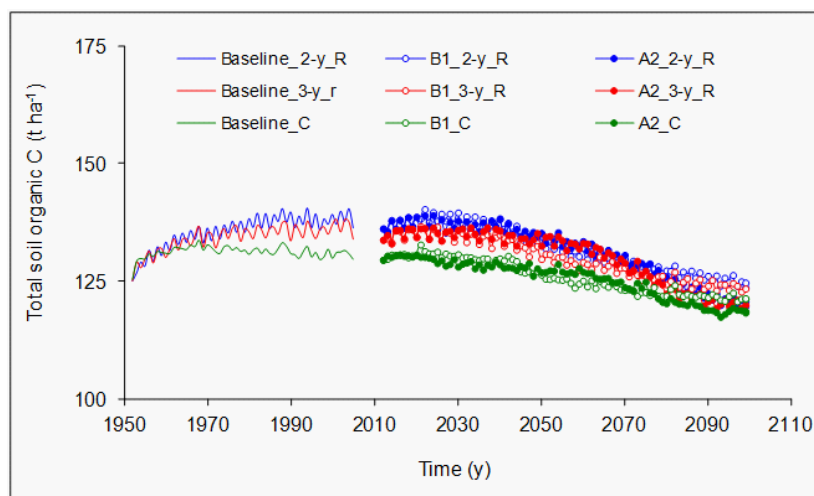

Fig. 1 – Total soil organic carbon trends considering for crop rotations (C = continuous wheat; 2-y_R = two-year rotation; 3-y_R = three-year rotation) under climate scenarios (Baseline, B1 and A2).

and validated in the area were embedded in DSSAT. The CENTURY module option was adopted to describe the dynamics of soil organic carbon under the 2-year and 3-year rotations, compared to continuous wheat.

Results and Conclusion

Higher values of soil organic C (Figure 1) and N (Figure 2) were found in 2- and 3-year crop rotations than in the durum monoculture, in both the Baseline and the future scenarios. The higher C and N soil content in the two-year rotation can be attributed to the higher production of tomato residues in this rotation.

In the Baseline scenario and during the first ten years, C and N contents increased in all crop rotations. Thereafter, the contents of C stabilized around 130 t ha^{-1} while those of the 2- and 3-year rotation continued to increase up to 140 t ha^{-1} . These values remained consistent for the next 40 years and then began to decrease reaching new

steady-state values at the end of the century ($120 - 130 \text{ t ha}^{-1}$ of C, Fig. 1). This decline of soil organic C content can be attributed to the higher temperature that increased its degradation and decreased the biomass production of tomato crop. Soil organic N showed the same trends with time but with larger differences between rotations.

References

- Pizzigalli C, Palatella L, Zampieri M, Lionello P, Miglietta MM, Paradisi P, 2012. Dynamical and statistical downscaling of precipitation and temperature in a Mediterranean area. *Ital. J. Agron.* 7:e2.
- Ventrella D, Giglio L, Charfeddine M, Lopez R, Castellini M, Sollitto D, Castrignanò A, Fornaro F, 2012. Climate change impact on crop rotations of winter durum wheat and tomato in Southern Italy: yield analysis and soil fertility. *Ital. J. Agron.* 7:e15.

Regeneration of cauliflower (*Brassica oleraceae* var. *botrytis*) via somatic embryogenesis

Al shamari, Magda; Rihan, Hail; Al Swedi, Fadil; Fuller, Michael;
Plymouth university, UNITED KINGDOM

Introduction

The addition of exogenous carbohydrate to the culture medium is essential for tissues in plant cell culture (George, 1993) and carbohydrates have an important effect in promoting somatic embryogenesis (Ricci et al., 2002). They can be considered not only the source of energy and a carbon skeleton in planta (Wan et al., 2011) but also can regulate many aspects of metabolism, assimilation, partitioning and transport. Also stress responses and growth and development can be influenced through promoting expression of relevant genes (Koch, 1996, Smeekens, 2000, Rolland et al., 2002). Among the carbohydrates, sucrose is preferred in most species that are propagated in tissue culture for induction, regeneration and the maturation of embryos (Finer et al., 1989, Ainsley and Aryan, 1998, Iraqi and Tremblay, 2001). This study aimed to establish a reliable system for in vitro proliferation of cauliflower somatic embryos.

Materials and methods

Root-derived embryogenic callus tissue was chopped and used in a constant volume (74 μ L/pot) to produce somatic embryos in agitated liquid MS (Murashige and Skoog, 1962) medium supplemented with Kinetin, IAA

(Indole -3-acetic acid) and four different concentrations of sucrose (1, 2, 3, 4 %).

Results

Sucrose at %20 was more inductive of normal somatic embryos whereas, abnormal somatic embryos (embryos with three or four cotyledons) were noticed at 1 % sucrose concentration. A high percentage of callogenesis on explants was observed on medium containing high concentrations of sucrose. The average value for callus diameter was 4 mm obtained on medium containing 4 % sucrose. Normal somatic embryos germinated on MS medium devoid of growth regulators and rooted plantlets were successfully transferred to soil with 80% survival.

Conclusions

Culture conditions for induction, development and conversion of cauliflower somatic embryos to plantlets were optimized. It was clear that sucrose concentration had an essential role to play in determining the number and quality of somatic embryos produced.

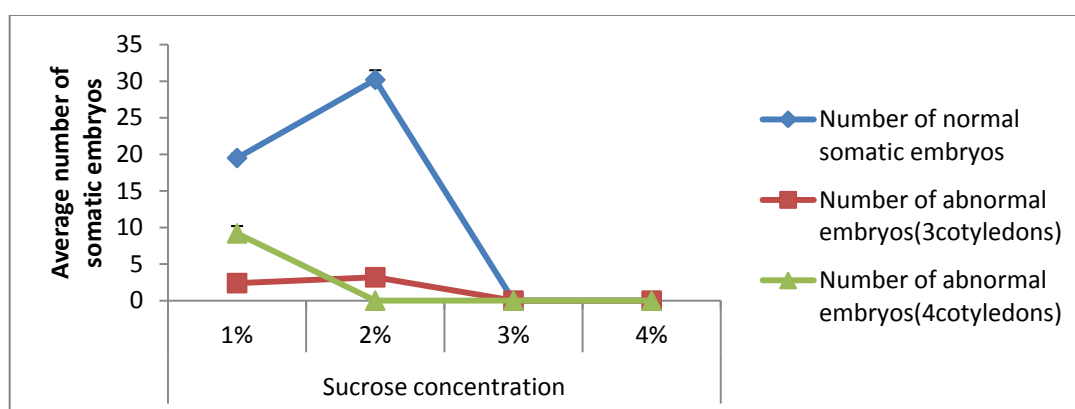

Figure 1. The effect of sucrose concentration on somatic embryos production after 40 days from culture (LSD=5.17 for normal somatic embryos, 3.54 for abnormal embryos (3 cotyledons) and 3.72 for abnormal embryos (4 cotyledons)).

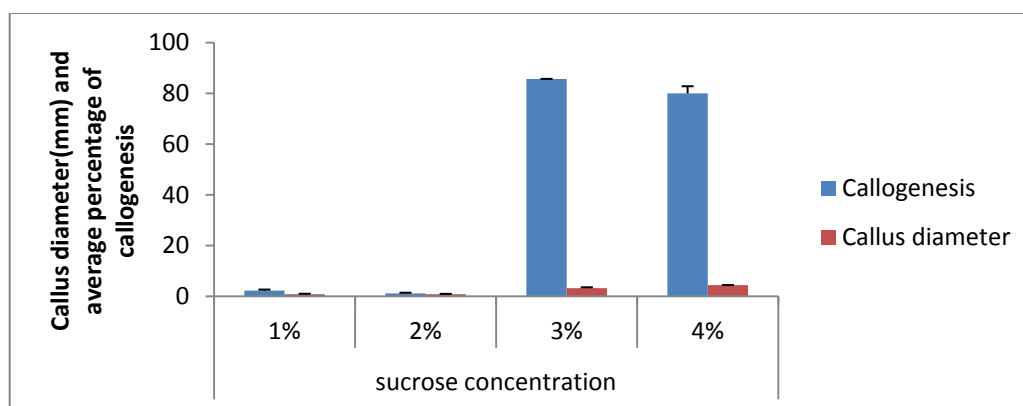

Figure 2. The effect of sucrose concentration on callogenesis percentage and callus diameter after 40 days from culture (LSD=9.73 for callogenesis and 0.86 for callus diameter).

References

- Ainsley, P. J. & Aryan, A. P. (1998) Efficient plant regeneration system for immature embryos of triticale (*x* Triticosecale Wittmack). *Plant Growth Regulation*, *24*, 23-30.
- Finer, J. J., Kriebel, H. B. & Becwar, M. R. (1989) Initiation of embryogenic callus and suspension cultures of eastern white pine (*Pinus strobus* L.). *Plant Cell Rep.*, *8*, 203-206.
- George, E. F. (Ed.) (1993) *Plant regeneration by tissue culture.*, Exegetics. England, Edington wilts.
- Iraqi, D. & Tremblay, F. M. (2001) The role of sucrose during maturation of black spruce [*Picea mariana* (Mill.) BSP] and white spruce [*Picea glauca* (Moench) Voss] somatic embryos. *Physiol. Plant*, *111*, 381-388.
- Koch, K. E. (1996) Carbohydrate-modulated gene expression in plants. *Rev. Plant. Physiol. Plant. Mol. Biol.*, *47*, 509-540.
- Murashige, T. & Skoog, F. (1962) A revised medium for rapid growth and bioassays with tobacco tissue cultures. *Physiol. Plant*, *15*, 473-497.
- Ricci, A. P., Mourao Filho, F. D. A. A., Mendes, B. M. J. & Piedade, S. M. D. S. (2002) Somatic embryogenesis in *Citrus sinensis*, *C. reticulata* and *C. nobilis* x *C. deliciosa*. *Sci Agric (Piracicaba, Braz)*, *59*, 41-46.
- Rolland, F., Moore, B. & Sheen, J. (2002) Sugar sensing and signalling in plants. *The Plant Cell*, *14*, 185-205.
- Smeekens, S. (2000) Sugar-induced signal transduction in plants. *Ann. Rev. Plant Physiol. Plant Mol. Bio*, *51*, 49-81.
- Wan, G. L., Naeem, M. S., Geng, X. X., Xu, L., Li, B., Jilani, G. & Zhou, W. J. (2011) Optimization of microspore embryogenesis and plant regeneration protocols for *Brassica napus*. *Int. J. Agric & Biol*, *13*.

Comparison of durum wheat varieties in relation to antioxidant activity of whole meal, semolina and pasta

Di Benedetto, Nilde Antonella; Giuzio, Luigia; Laus, Maura Nicoletta; Giuliani, Marcella Michela; Pastore, Donato; Flagella, Zina
University of Foggia, ITALY

Introduction

Epidemiological studies have associated consumption of whole-durum wheat products with reduced incidence of chronic diseases, diabetes and cancer. These health benefits have been mainly attributed to the unique phytochemical content in wheat. The most important groups of phytochemicals found in durum wheat can be classified as phenolic acids, flavonoids, carotenoids, vitamin E compounds, lignans, soluble and insoluble fibre [1]. Both genotype and environment influence the concentration of these compounds [2]. It is important to identify varieties that may yield the highest concentration of antioxidants and provide the most health benefit to consumers also improving the commercial value of wheat. The quality of durum wheat derived products, in terms of texture, colour, flavour, appearance and antioxidant capacity, is determined by raw material quality and processing methods [3]. Very few studies deal with the influence of durum wheat genotypes on the antioxidant activity (AA) of derived products. So the aim of this work was the comparison of five durum wheat varieties in relation to AA of whole grain, semolina and pasta to optimize the health value of derived products.

Materials and methods

During 2009-2010 crop season five varieties of durum wheat were cultivated in a field trial carried out in Foggia

(Southern Italy, 41°46' N, 15°54'E) on a sandy clay loam soil; N, P and S were applied at a rate of 102, 80 and 30 kg ha⁻¹. Semolina and pasta, extruded as spaghetti, were produced by CRA-CER Foggia. Hydrophilic and lipophilic compounds were extracted as reported in [4] and then analysed by TEAC (ABTS**assay) method, as described in [5]. The data were submitted to variance analysis (ANOVA) using MSTAT-C statistical program (version 2.1, 1991). The significant differences among the mean values were calculated following Duncan test.

Results

A significant varietal effect on whole grain, semolina and pasta samples was observed with hydrophilic and lipophilic extracts showing a different varietal classification (Table 1). Furthermore derived products showed a decrease in AA compared to whole flour. In particular for hydrophilic extracts the following decreasing order of AA was observed: whole flour>pasta>semolina; instead for lipophilic extracts, AA decrease followed the following order: whole flour>semolina>pasta. Finally only lipophilic extracts showed a positive significant correlation between whole meal and derived products: whole meal vs pasta ($P \leq 0.05$, $r = 0.577$); whole meal vs semolina ($P \leq 0.05$, $r = 0.477$); semolina vs pasta ($P \leq 0.05$, $r = 0.520$).

Table 1: Antioxidant activity (AA) of whole meal, semolina and pasta of durum wheat hydrophilic and lipophilic extracts (μmol equivalent trolox/g d.m.).

Genotypes	Hydrophilic extracts			Lipophilic extracts		
	whole meal	semolina	pasta	whole meal	semolina	pasta
Torrebianca	6.4 ^A	3.8 ^{ab}	4.5 ^{AB}	0.387 ^{AB}	0.130 ^C	0.109 ^B
Pietrafitta	6.1 ^A	3.8 ^{ab}	4.5 ^{AB}	0.347 ^B	0.126 ^D	0.099 ^E
Alemanno	5.9 ^{AB}	3.7 ^b	4.3 ^B	0.378 ^{AB}	0.121 ^E	0.101 ^D
Principe	5.4 ^B	3.8 ^{ab}	4.7 ^A	0.407 ^A	0.150 ^A	0.114 ^A
Cannavaro	6.2 ^A	4.0 ^a	4.6 ^A	0.345 ^B	0.136 ^B	0.107 ^C

Data are averages of three replicates.

Values in column followed by different letters are significantly different at $P \leq 0.05$ (small letters) and at $P \leq 0.01$ (capital letters) according to Duncan's test.

Discussion

In this paper a low varietal variability in AA of both hydrophilic (8%) and lipophilic extracts (12%) was observed. This result was in accordance with data reported in literature [4] by using TEAC (ABTS•+assay) method measuring mainly reducing power. Both for hydrophilic and lipophilic extracts, semolina compared to whole flour showed a decrease in AA, due to tegument/germ removal during grain milling. The observed increase of AA in all pasta samples with respect to semolina is mainly ascribable to melanoidins and Maillard reaction products. In fact, it is known that during extrusion and drying the Maillard reaction (MR) takes place, giving rise to the production of different antioxidant compounds [6]. Our results show that cultivar endowed with high AA of lipophilic extracts may generate healthier derivate

products. Further investigation will be necessary in different locations and growing seasons in order to evaluate the interactions between genotype and environment in relation to AA.

References

- [1] Hirawan et al., 2010, *Food Chem*, 119 258-264. [2]
- Menga et al., 2010, *Food Sci Technol Int*, 45 7-16. [3]
- Brennan et al., 2011, *Food Sci Technol Int*, 22 570-575. [4]
- Pastore et al., 2009, *J Agr Food Chem*, 57 9682-9692. [5]
- Re et al., 1999, *Free Radical Bio Med*, 26 1231-1237. [6]
- Fares et al., 2010, *Food Chem*, 119 1023-1029.

Antioxidant activity of free versus bound compounds in seeds of different cereal species

Laus, Maura Nicoletta; Soccio, Mario; Flagella, Zina; Pastore, Donato
University of Foggia, ITALY

Introduction

Antioxidant activity (AA) of cereal grains has been widely investigated, but, to date, not assessed in relation to the large expected variation in bioavailability among the different classes of phytochemicals. So, in this study, AA exerted by both free and bound antioxidant fractions from whole grains of six different wheat species and from seeds of the pseudocereal quinoa was evaluated. In particular, hydrophilic (H), lipophilic (L) and free-soluble phenolic (FSP) extracts, which are expected to contain antioxidants more readily available for small intestine absorption, were studied, as well as insoluble-bound phenolic (IBP) fraction, containing phenols bound to insoluble cell wall polymers, that are poorly digestible and thus available mostly at terminal intestine. AA was determined by the lipoxygenase/4-nitroso-*N,N*-dimethylaniline (LOX/RNO) method (Pastore et al., 2009). With respect to the majority of AA assays, this method is able to simultaneously detect different antioxidant mechanisms and to better highlight the synergistic effects among antioxidants, so it is expected to unearth properties of phytochemicals from wheat grains, potentially related to health benefits.

Materials and methods

Grain samples used in this study were obtained from six different wheat species [*Triticum monococcum* L. ssp. *monococcum*, accession ID3 (hulled einkorn), *T. turgidum* L. ssp. *dicoccum* Schübler, cv. Molise Colli (emmer), *T. aestivum* L. ssp. *spelta*, cv. Altgold Rotkorn (spelt), *T. monococcum* L. ssp. *sinskajae* (naked einkorn), *T. turgidum*

L. ssp. *durum* Desf. cv. Adamello (durum wheat), *T. aestivum* L. ssp. *vulgare* Host, cv. Bolero (bread wheat)], cultivated in a naturally lit glasshouse at the CRA-Cereal Research Centre (Foggia, Italy). Quinoa (*Chenopodium quinoa* Willd. cv. real) seeds were provided from "Ctm-Altromercato" Consortium (Bolzano, Italy). Extraction of H, L, FSP and IBP compounds was carried out as described in Pastore et al. (2009). Determination of AA by the LOX/RNO method was performed as reported in Pastore et al. (2009).

Results

In Table 1 AA values of H, L, FSP and IBP extracts, as well as the total AA, are reported for all the species under study. The highest AA values were found for the IBP extracts. These values were also much higher than the AA sum of the largely available components (H+L+FSP), with the only exception of bread wheat. The different species showed total AA values ranging from about 600 to 2500 $\mu\text{mol Trolox/g}$ dry whole flour, largely depending on the IBP contribution. In Figure 1 the ratios between AA values obtained for the widely available antioxidant components and those relative to the poorly digestible insoluble-bound phenolic fraction are reported. These ratios were distributed according to an inverse ranking with respect to that observed for total AA. Interestingly, the highest ratio obtained for bread wheat was about 5-fold higher than the ones obtained for durum wheat and hulled einkorn.

Table 1. Antioxidant activity (AA), evaluated by means of the LOX/RNO method, of hydrophilic (H), lipophilic (L), free-soluble (FSP) and insoluble-bound (IBP) phenolic extracts from whole grains of different wheat species and from seeds of quinoa. Compounds were extracted from whole flour of the different species under study and AA was determined by the LOX/RNO method. Data are reported as mean value \pm SD (n=3).

Species	AA ($\mu\text{mol Trolox eq./g}$ dry whole flour)				
	H	L	FSP	IBP	Total AA (H+L+FSP+IBP)
Hulled einkorn	72 \pm 4	148 \pm 11	263 \pm 6	2008 \pm 38	2491 \pm 59
Spelt	256 \pm 11	104 \pm 12	186 \pm 4	1764 \pm 25	2310 \pm 52
Emmer	360 \pm 65	141 \pm 11	14 \pm 1	1239 \pm 21	1754 \pm 98
Naked einkorn	115 \pm 12	210 \pm 8	74 \pm 2	1081 \pm 22	1480 \pm 44
Durum wheat	106 \pm 8	73 \pm 12	47 \pm 1	800 \pm 12	1026 \pm 33
Quinoa	138 \pm 11	130 \pm 6	81 \pm 4	428 \pm 4	777 \pm 25
Bread wheat	128 \pm 10	146 \pm 14	54 \pm 2	256 \pm 8	584 \pm 34

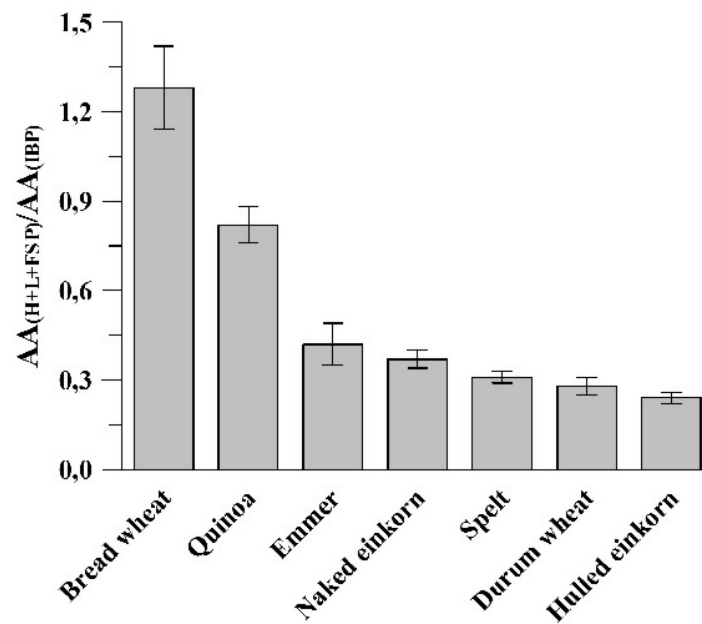

Figure 1. Ratios between AA of free compounds contained in H, L and FSP fractions and AA of IBP fractions from whole grains of different wheat species and from seeds of quinoa. Data are reported as mean value \pm SD (n=3).

Conclusions

Health-beneficial properties due to regular consumption of cereal whole grains have been widely demonstrated and appear to be strongly related to antioxidant properties of peculiar grain phytochemicals (Liu, 2007). Here, we show that the examined cereal species may vary remarkably in relation to the balance between free and bound antioxidants from grains. So, they may deeply differ in terms of presumable action on the health of consumers, with free compounds having a better systemic healthy activity and bound antioxidants showing a possible useful activity at the level of the terminal intestine.

References

- Pastore D, Laus MN, Tozzi D, Fogliano V, Soccio M, Flagella Z. 2009. New tool to evaluate a comprehensive antioxidant activity in food extracts: bleaching of 4-nitroso-N,N-dimethylaniline catalyzed by the soybean lipoxygenase-1. *J Agric Food Chem* 57: 9682-92.
- Liu RH. 2007. Whole grain phytochemicals and health. *J Cereal Sci* 46: 207-19.

Effect of water stress on storage protein composition of two durum wheat varieties evaluated by a proteomic approach

Giuliani, Marcella Michela; Pompa, Marianna; Palermo, Carmen; Giuzio, Luigia; Centonze, Diego; Flagella, Zina
University of Foggia, ITALY

Introduction

Both total amount and functional composition of storage proteins are of major importance in determining durum wheat (*Triticum durum* Desf.) technological quality. A proteomic approach has the potential to elucidate the gene expression pathway under different environmental conditions. In Mediterranean environments water deficit, often associated with high temperature, is one of the main factors influencing durum wheat quality [1, 2]. The aim of this study was to evaluate the effect of water stress on the composition of gluten proteins in two durum wheat varieties by using a proteomic approach.

Materials and methods

Two varieties (Ciccio, and Svevo) were grown in pots in a growth chamber during 2009. From flowering stage

two water treatments were applied: a control with irrigation bringing the soil moisture to field capacity whenever the threshold of 50% available water was reached and a stressed treatment with the restoration of the 70% of the available water. At physiological stage the storage proteins were extracted [3] and separated by two-dimensional electrophoresis [4] (four replicates). The image analysis was performed using the software ImageMaster 2D Platinum 6.0 (Amersham). The specific and/or differentially expressed spots were analyzed by nano-LC-ESI-IT-MS/MS. The acquired MS and MS/MS datasets were submitted to database searches by using Biotoools™ 3.2 (Bruker Daltonics) and MASCOT search engine (Matrix Science, London, UK).

Table 1. List of the main protein spots identified by nano-HPLC-MS/MS analysis and using the MASCOT server (www.matrixscience.com)

CICCIO	spot	MSDB	Proteins	Score	Coverage	Peptides Matched	Theor. Mw (kDa) / pI	
CONTROL	Up-regulated	38,44,48	Hmw glutenin subunit 1 By8	315	29%	11	76.69 kDa; 8.76 pI	
		108	Glutenin low molecular weight-wheat (fragment)	1085	32%	6	30.67 kDa; 8.57pI	
	Specific	156	Q84M19_TRITU	Gamma gliadin precursor (Fragment).	148	15%	5	32.7 kDa; 6.34pI
162		JA0153	Gamma-gliadin precursor- wheat	36	12%	3	34.7 kDa; 7.60pI	
166		Q5TLY8_WHEAT	Low-molecular-weight glutenin subunit (Fragment) .-	118	12%	1	24.85 kDa; 8.33 pI	
STRESSED	Up-regulated	126	Q9XGF0_TRITU	Low molecular weight glutenin subunit (Fragment)	1195	14%	3	42.67 kDa; 8.373 pI
		133	Q5TLY8_WHEAT	Low-molecular-weight glutenin subunit (Fragment)	118	12%	1	42.67 kDa; 8.373 pI
SVEVO								
CONTROL	Up-regulated	131	Q84TG6_TRITU	HMW glutenin subunit 1By8.-	190	13%	5	76.69 kDa ; 8.66pI
		108	S57655	Glutenin low molecular weight-wheat (fragment)	1085	32%	6	30.67 kDa; 8.57pI
STRESSED	Specific	150	gj215398470	globulin 3	296	14%	5	66.65 kDa ; 7.78 pI
		206	Q9M4L7_WHEAT	Alpha-gliadin	817	40%	8	31.61 kDa ; 7.66 pI
		Up-regulated	170	Q3YFI0_TRITU	Alpha-type gliadin (Fragment)	836	18%	3
212	Q3YFI0_TRITU		Alpha-type gliadin (Fragment)	453	31%	8	31.81 kDa ; 6.99 pI	

Results

The image analysis has allowed the detection of 103 spots in Ciccio, both for the control and stressed treatment, 108 and 111 in Svevo for the control and stressed treatments, respectively. Some of these protein spots of particular interest (see Table 1) were identified by mass spectrometry. Spot 38, 44, 48 and 131 were identified as HMW 1By8 and were up-regulated in the control treatment of Ciccio and Svevo. Spot 108 was identified as a LMW fragment and was down-regulated in both the varieties under water stress condition; for this protein a positive effect of on dough quality was reported [5]. Spot 156 and 162 were specific of Ciccio grown under drought condition and were identified both as γ -gliadin precursors. Spot 150 was detected only in Svevo grown in drought condition and identified as a globulin III protein. Also, spot 206, 170, and 212 were detected only in Svevo and all were identified as α -gliadins; in particular spot 206 was specific for this cultivar, while spots 170 and 212 were up-regulated under drought condition.

Conclusions

Both the HMW 1By8 and the LMW fragment (spot 108), associated with high elastic recovery, gluten firmness, and good quality semolina [6, 5], were up-regulated

in the control treatment in both cultivars. In Svevo a globulin III protein was identified in response to water deficit [7]. Moreover, in Svevo different α -gliadins showed an increased expression in drought condition. Finally, the presence of two γ -gliadin precursors, found in Ciccio under water stress condition, probably indicate that the stress conditions stopped the protein pathway with a consequent accumulation of its precursors. Water stress effects appear to be mainly related to changes in α - and γ -gliadins expressions. Further studies will be carried out in order to investigate the influence of both cultivars and environment on the composition of gluten proteins.

References

- [1] Flagella et al., 2010. *Eur. J. Agron.* 33:197–207.
- [2] Giuliani et al., 2011. *Agr. J.* 103: 1567-1880.
- [3] Hurkman & Tanaka, 2004. *J. Cer. Sci* 40: 295-299.
- [4] Ferrante P. et al., 2006. *Proteomics* 6: 1908-1914.
- [5] Masci S. et al., 2000. *Theor. Appl. Genet* 100: 396-400.
- [6] Yan et al., 2009. *J Cer.Sci* 50: 398-406.
- [7] Yang et al. 2011. *Proteomics* 11: 1684-1695.

Biodiversity in Legume-supported Cropping: a study across European field sites in the Legume Futures network.

Cass, Susannah¹; Stout, Jane¹; Schmidt, Olaf²; Williams, Michael¹

¹Trinity College, University of Dublin, IRELAND; ²University College Dublin, IRELAND

Introduction

Through changes in physical and biological elements of the agricultural N-cycle, legumes have the potential for numerous interconnected environmental impacts when used in European cropping systems. Legumes are known to significantly effect vegetation communities through modifications of N status and interactions with other vegetative functional groups (Tilman et al., 1997) and have been shown to have significant interactions with both plant and earthworm species in agricultural systems (Schmidt & Curry, 1999, 2001). It has been demonstrated that earthworms can significantly increase the biomass and N uptake of wheat in legume (clover) intercropping systems and alter the balance of N allocation between crop and intercrop (Schmidt & Curry, 1999). Vegetation composition can affect arthropod assemblages and Koricheva et al. (2000) found the presence of legumes in grassland systems resulted in higher invertebrate abundance. Birkhofer et al. (2011) have shown the impact of legume species richness on soil fauna feeding activity in agricultural grasslands through interactions between earthworms and other soil microfauna such as Collembolans. This study encompasses above and below-ground measures of biodiversity in legume cropping.

Materials and methods

Study sites: Experimental sites span a broad geographic and climatic range from boreal sites in Finland and Sweden, through Atlantic and continental regions of Ireland, Scotland, Germany, Poland and Romania, to Mediterranean Greece and Italy. Experimental sites encompass a diverse range of legume-supported cropping applications both typical and novel to each region.

Surveys: Non-crop vegetation richness and diversity is assessed through standard surveys with 'conventional', non-legume-supported crops, assessed for comparison.

Biodiversity surveys of earthworm populations under legume-supported crops are conducted through

time limited hand-sorting of soil samples and allyl isothiocyanate extraction (Schmidt, 2001).

At field-scale experimental sites in Finland, Poland and Germany the ground invertebrate communities of legume-supported crops have been assessed using pitfall traps (50% ethylene glycol solution) emptied every 2-3 weeks through the active season (Finnamore et al., 1998).

The bait-lamina method (Von Törne, 1990) is used to assess the feeding activity of soil fauna under legume-supported crops in early growth stages and pre-harvest.

Results

Preliminary results indicate some benefits of legume crops to earthworm biomass, as well as impacts on vegetation communities, all mediated by additional farm management.

References

- Birkhofer, K., Diekötter, T., Boch, S., Fischer, M., Müller, J., Socher, S. & Wolters, V. 2011 Soil fauna feeding activity in temperate grassland soils increases with legume and grass species richness. *Soil Biol. & Bioch.* 43, 2200-2207
- Finnamore, A. T., V. M. Behan-Pelletier and N. N. Winchester. 1998 *Protocols for measuring biodiversity: arthropod monitoring in terrestrial ecosystems*. EMAN and Partners Pubs, Canada
- Koricheva, J., Mulder, C., Schmid, B., Joshi, J. & Huss-Danell, K. 2000 Numerical responses of different trophic groups of invertebrates to manipulation of plant diversity in grasslands. *Oecol.* 125, 271-282
- Schmidt, O. 2001 Time-limited soil sorting for long-term monitoring of earthworm populations. *Pedobio.* 45, 69-83

Schmidt, O. & Curry, J. 1999 Effects of earthworms on biomass production, nitrogen allocation and nitrogen transfer in wheat–clover intercropping model systems. *Plant & Soil* 214 pp197-198

Schmidt, O. & Curry, J. 2001 Population dynamics of earthworms (Lumbriciae) and their role in nitrogen turnover in wheat and wheat–clover cropping systems. *Pedobio.* 45, 174-187

Tilman, D., Knops, J., Wedin, D., Reich, P., Ritchie, M. & Siemann, E. 1997 The influence of functional diversity and composition on ecosystem processes. *Science* 277, 1300-1302

Törne, E. Von 1990 Assessing feeding activities of soil-living animals. I. Bait-lamina-tests. *Pedobio.* 34, 89–101

Productivity effects of increased plant diversity in fertility building leys depend on soil organic matter levels

Döring, Thomas¹; Baddeley, John²; Collins, Rosemary³; Crowley, Oliver⁴; Cuttle, Steve³; Howlett, Sally⁴; Jones, Hannah⁵; McCalman, Heather³; Pearce, Helen⁴; Roderick, Steven⁶; Storkey, Jonathan⁷; Wolfe, Martin⁴

¹The Organic Research Centre, UNITED KINGDOM; ²Scottish Agricultural College, UNITED KINGDOM; ³IBERS, UNITED KINGDOM;

⁴Organic Research Centre, UNITED KINGDOM; ⁵Reading University, UNITED KINGDOM; ⁶Duchy College, UNITED KINGDOM;

⁷Rothamsted Research, UNITED KINGDOM

Introduction

One of the key properties that determine soil fertility is the content of soil organic matter (SOM). Among many other functions, SOM is essential for maintenance of soil structure, the protection against soil erosion, and water retention. Depleting soils of SOM, e.g. through imbalanced rotations or excessive tillage, is therefore detrimental to several functions delivered by the soil ecosystem. In addition, SOM cannot be re-built quickly once levels have been depleted. Therefore, it is essential to devise strategies for coping with generally low organic matter levels, while simultaneously building and re-building SOM in agroecosystems. In a three year study investigating the effects of plant diversity on the productivity of agroecosystems we found that productivity was increased when using higher levels of diversity. This effect was stronger under conditions of low SOM levels, i.e. when soil fertility was relatively poor.

The experiments were carried out on fertility building leys which make use of the nitrogen fixing ability of leguminous plants to provide nitrogen for the subsequent crop. Frequently, such leys are composed of relatively few species, with red and white clover being among the most frequently chosen species for the legume component in temperate agroecosystems.

Materials and methods

In the project, 34 farmers across the UK grew a diverse mixture of ten legume species and four grass species. These were Alsike clover (*Trifolium hybridum*), Birdsfoot trefoil (*Lotus corniculatus*), Black medic (*Medicago lupulina*), Crimson clover (*Trifolium incarnatum*), Large birdsfoot trefoil (*Lotus pedunculatus*), Lucerne (*Medicago sativa*), Meadow Pea (*Lathyrus pratensis*), Red clover (*Trifolium pratense*), Sainfoin (*Onobrychis viciifolia*), White clover (*Trifolium repens*); and Italian ryegrass

(*Lolium multiflorum*), Meadow fescue (*Festuca pratensis*), Perennial ryegrass (*Lolium perenne*) and Timothy (*Phleum pratense*). This complex mixture, termed the All Species Mix or ASM was sown alongside a farmer-chosen ley mix.

Results

With an average of 3.5 species (max=1; min=16; median=3), the diversity of the sown crops in the control ley was considerably lower than in the control ley in the ASM (14 species). SOM content was determined on 20 farms in 2009, directly before the ley was sown. SOM ranged from 2.4% to 9.2% (average 5.3%). Above ground biomass dry weight was determined in 2011, both in the complex mixture and in the adjacent, less diverse control mix. Four biomass samples (each 0.25 m²) were taken from the ASM and four from the control ley on each farm. Farm sites ranged from Cornwall to Scotland, and from West Wales to East Anglia.

Regression analysis in mixed effects model revealed that the advantage of the diverse All Species Mix over the control ley significantly depended on SOM levels ($p = 0.0018$, $df = 14$). The lower the SOM, the higher was the

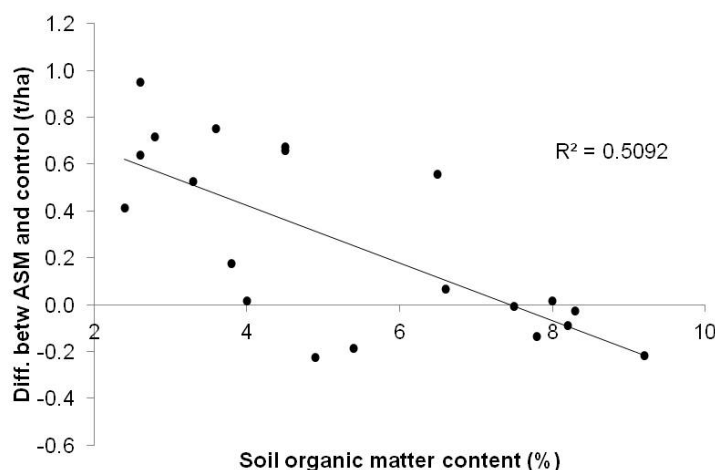

biomass of the diverse species mixture compared to the simpler mixes (Fig. 1).

Conclusions

On the soils poorest in organic matter, added plant diversity had the greatest benefit. From the experiment it cannot be deduced what caused this relationship; however, the finding has implications when planning a rotation: Turned around, this result means that not using highly diverse species mixes showed the biggest decrease

in productivity when SOM levels were low, thereby highlighting the importance of high organic matter levels for ley productivity. Thus, organic matter as an essential resource in the soil needs to be managed well, and should be monitored regularly. Although the trials were mainly carried out on organically managed farms, the findings have implications for conventional agriculture as well. In particular, in light of the increasing interest by conventional farmers in legumes used as cover crops, our results highlight the potential to optimize cover crop choices, especially on soils poor in organic matter.

Modelling the utility of legumes: increasing the sustainability of arable yield and reducing the dependence on inorganic nitrogenous fertilisers

Iannetta, Pietro; Young, Mark; Hawes, Cathy; Karley, Alison; Squire, Geoff

The James Hutton Institute, UNITED KINGDOM

Introduction

To maximise yield arable farming use chemical nitrogen (N) fertilisers that are expensive to manufacture and transport in terms of energy and greenhouse gas emissions. The increasing cost of N fertiliser is risking the maintenance of current crop yields. At the Centre for Sustainable Cropping (CSC; <http://www.hutton.ac.uk/about/facilities/centre-sustainable-cropping>), the relative ability of sustainable and conventional farming practices to improve arable ecological resilience and maintain crop production is being tested and the data used in a 'compartment and flow' model of plant growth and N-use.

Materials and methods

The model is encoded using Simile (v5.6, Simulistics, Edinburgh, UK), and simulates the flow and cycling of N and carbon (C) and thus energy within arable fields and represents an accounting tool to predict treatment effects. The foundation of the model, canopy development and energy capture of crop plants, is an implementation of the relation between thermal time and fractional interception of solar energy (Marshall et al., 1991). Dry matter (DM) accumulation is estimated using intercepted solar radiation and photosynthetic efficiency. Total N uptake is calculated from DM and the critical N concentration (Greenwood et al., 1985). Nitrogen and DM content of leaf, stem, root and harvestable fractions in crop plants are estimated using partitioning coefficients derived from extant experimental data. Estimates of N fixation by legume crops are targeted to give ca. 100 kg ha⁻¹ N in the harvested partition. Losses of N by volatilisation and leaching, and deposition of atmospheric N are not estimated by the model.

Results and discussion

Spring and winter crop dominated crop sequences (SD and WD, respectively), were simulated with a varying numbers of crops substituted for legumes (L); the sequences were: **SD** (B,B,B,B,B,B); **SD+L** (L,B,B,B,B,B); **SD+2L** (L,B,B,L,B,B); **WD** (W,W,W,O,W,W); **WD+L** (L,W,W,O,W,W), and; **WD+2L** (L,W,L,O,W,W); where B = Spring barley, W = Winter wheat, O = Winter oilseed rape and L = Legume. The model was run iteratively on sequences containing legumes; fertiliser N was reduced in response to high residual soil N. Also, nitrogen is not applied to legume crops, spring crops receive two N applications and winter crops receive three N applications. In simulations mean DM yield in both SD and WD sequences were similar to anticipated values. The yields of **SD+L** and **SD+2L** sequences were higher than the **SD** sequence. The yields of **WD+L** and **WD+2L** sequences were lower than for **WD** as a consequence of legumes having lower yields than winter cereals. Model runs show the scope to reduce N inputs using legumes in both spring and winter crop dominated rotations. Substituting non-legume crops with legume crops reduced N fertiliser through the lower N requirement of the legume itself and the N-rich plant residues legumes left behind as fertiliser. Only 2.5% of croppable land in Scotland is planted with legumes (Scottish Government, 2010), so there is opportunity to increase legume supported crop systems, especially in spring cereal dominated rotations. Increasing legumes within rotations will be dependent on developing new and existing markets for harvestable yields and highlighting the positive benefits of legumes in reducing the dependence on fossil-fuel derived N fertiliser input.

Acknowledgements

This work is supported by the Scottish Government.

References

- Greenwood D J, Neeteson J J, Draycott A. 1985. Response of potatoes to N fertiliser: quantitative relations for components of growth. *Plant and Soil* **85**, 163-183.
- Marshall B, Squire G R, Terry A C. 1991. Effect of temperature on interception and conversion of solar radiation by stands of froundnut. *Journal of Experimental Botany* **43**, 246 95-101.
- Results of June Agricultural Census - 2010 Provisionals and Finals Comparison (2010). The Scottish Government. <http://www.scotland.gov.uk/Topics/Statistics/Browse/Agriculture-Fisheries/ProvFin10>

Impact of farming practices (organic vs. conventional system) and salinity on a common bean crop (*Phaseolus vulgaris* L.) grown in Mediterranean

Kontopoulou, Charis-Konstantina¹; Savvas, Dimitrios¹; Bilalis, Dimitrios¹; Pappa, Valentini²; Karapanos, Ioannis¹; Rees, Robert M²

¹Agricultural University of Athens, GREECE; ²SAC, UNITED KINGDOM

Introduction

The inclusion of cultivated legumes in rotations is essential in maintaining soil fertility, especially in organic agriculture, which is a low input system of agricultural production. In Greece, common bean is a profitable legume that might be included in crop rotations, especially by farmers focusing on organic vegetable production. Little is known of the effect of the farming system (organic or conventional) on the contribution of bean to greenhouse gas emissions. A major problem in Mediterranean is the salinity of the irrigation water, which is frequently higher than the threshold levels for maximal production.

Materials and methods

An experiment was established on 30 April 2011 at Agrinio, West Greece. Common bean (*Phaseolus vulgaris* cv. contender) was cultivated. Organic and conventional systems were established as main plots with four randomly allocated plots per system. Each plot was divided into two subplots irrigated either with good-quality or with salt-enriched water. Furthermore, in two different sub-subplots of each subplot, bean and sweet corn, respectively, had been grown in the previous year. Soil was sampled to determine the soil C, total-N, NO₃-N and NH₄⁻-N. Gas samples for N₂O, CO₂ and CH₄ determinations were collected. Plant biomass samples were collected during the experiment. Root samples were also collected to examine nodulation and colonization by mycorrhiza. Yield was determined by manually harvesting each plot. Additionally, quality characteristics were estimated in pods.

Results

Conventional farming resulted in higher total plant biomass than organic but the difference was significant only 45 days after sowing. The yield of pods was significantly lower in the organic treatment compared to the conventional one. Organically produced bean pods

showed higher DM content than those originating from conventional. A high salinity level in the irrigation water restricted significantly the total plant biomass, yield and number of pods. Concerning the quality characteristics, three sugars were traced in the pods: glucose, fructose and sucrose. The concentration of sugars in pods was higher in the organic than in the conventional treatment. High salinity increased the levels of glucose and fructose in pods but not that of sucrose. The combination of conventional cropping, high salinity and sweet corn as preceding crop showed the highest N₂O emission, while the organic, low salinity and sweet corn as preceding crop showed the lowest N₂O emission. The combination of organic cropping of bean with low salinity showed the highest CO₂ emission, whereas the conventional resulted in the lowest values. The rate of CH₄ emission was decreasing with time without significant differences between treatments but still presenting a high value.

Discussion

Conventional farming showed higher fresh yield of pods compared to the organic. This result was due to the higher total plant biomass and concomitant increase in the total number of pods in the conventionally treated plots. The three sugars that were traced showed higher concentration in the organic treatment due to the higher dry matter content that was found in the organically produced beans. The highest N₂O emissions were observed from the combination of conventional cropping with high salinity and sweet corn as preceding crop. This can be attributed to the soil structure that deteriorates under soil salinity. Organic cropping of bean with low salinity showed the highest CO₂ emission, whereas the conventional treatments had lower values. This is in accordance with Kasimir-Klemetsson et al. (1997), which indicate that the net emission of CO₂ by the soil is higher in organically than in conventionally treated crops due to enhanced microbial activity.

References

Kasimir-Klemedtsson, A., Klemedtsson, A., Berglund, K., Martikainen, P., Silvola, J., and Oenema, O., 1997. Greenhouse gas emissions from farmed organic soils: a review. *Soil Use and Management* 13: 245-250.

Yield advantages and competition in intercropping of oil seed rape with pea and cereals in a pot experiment

Ebrahimi, Elnaz; Neugschwandtner, Reinhard; Kaul, Hans-Peter
BOKU University of Natural Resources and Life Sciences Vienna, AUSTRIA

Introduction

Intercropping (IC) is an old agricultural practice that can improve the use of environmental resources and result in yield advantages compared with sole cropping (SC). Several indices such as land equivalent ratio (LER), relative crowding coefficient (K) and aggressivity (A) have been developed to analyze the competition and eventual advantages in IC (Ghosh, 2004). In the present study we focused on the performance of oil seed rape (R) in IC with the legume pea (P) and cereals wheat (W), barley (B) and oat (O) with special regard on yield advantages and competition parameters.

Material and Methods

A pot experiment was conducted under glass house conditions (day: 20°C, 16 h; night: 16°C, 8 h). The soil was a Chernozem of silty loam. The experiment was designed as a completely randomized factorial with four replications. Treatments included five crop-stands, i. e. SC of rape (6 plants per pot), substitutive IC of rape-pea (3+3 plants per pot) and of rape-cereals (wheat, barley, oats; for all 3+9 plants per pot). All plants were harvested in the end of flowering and dry matter yield of shoots for individual species was measured. The advantage of intercropping and the effect of competition between two crops were calculated using different competition indices (Lithourgidis et al., 2011), namely land equivalent ratios LER for individual components and LER_{Total} relative

crowding coefficient K for individual species and K_{Total} and aggressivity A. All data were subject to analysis of variance. For significant effects, means were compared by least significant difference (LSD) test at the 0.05 probability level.

Results

Intercropping of rape with different crops significantly ($P < 0.01$) affected rape dry matter per pot, total dry matter yield per pot and competition indices.

Intercropping of rape with legume pea gave the highest dry matter of rape plants in intercropping and more total dry matter than with cereals (Table 1). Obviously, rape-pea intercrops were more productive than rape in SC and all rape-cereal mixtures. Among rape-cereal intercrops, rape-oat produced more total dry matter than rape combined with other cereals.

The total land equivalent ratio (LER) and the relative crowding coefficient (K) in intercropping of rape with pea were >1 (Table 2). At the same time a partial LER >0.5 and a partial K value >1 for both components were observed (data partly not shown). In particular, the LER of rape-pea intercrops was 1.18, which means that 18% more land area would be required by sole cropping to obtain a yield equal to intercropping. Despite LER_{Total}

Table 1: Dry matter of individual crops and total dry matter in intercropping rape with pea, wheat, barley and oat

Crop	Dry matter (g/pot)					Total
	Rape	Pea	Wheat	Barley	Oat	
R	3.41	-	-	-	-	3.41
R-P	1.92	3.25	-	-	-	5.17
R-W	0.91	-	2.68	-	-	3.59
R-B	0.81	-	-	2.71	-	3.52
R-O	0.73	-	-	-	4.07	4.81
LSD _{0.05}	0.74					1.12

Table 2: Land equivalent ratio LER of rape and total, relative crowding coefficient K of rape and total, and rape aggressivity A for intercrops of rape with pea, wheat, barley and oat

Crop	LER _R	LER _{Total}	K _R	K _{Total}	A _R
R-P	0.58	1.18	1.46	2.94	-0.04
R-W	0.26	0.87	0.36	0.59	-0.71
R-B	0.24	0.96	0.32	1.11	-0.97
R-O	0.24	0.84	0.33	0.53	-0.74
LSD _{0.05}	0.14	0.21	-	2.80	n.s.

lower than 1 in intercropping of rape with cereals, the partial LER and K values for cereals were higher than 0.5 and 1, respectively (data not shown). Obviously cereals profited in intercropping with rape. However, the rape-barley intercrop obtained a total K value of 1.11, indicating a slight, though non-significant advantage of intercropping. The results of aggressivity A show that in all cases rape was the dominated species ($A < 0$), which is in line with the lower partial LER and K values of rape.

Conclusions

Our experiment showed that in intercropping of rape with pea, the total dry matter was highest. Consequently the land equivalent ratio (LER) and the relative crowding coefficient (K) in intercropping of rape with pea were

higher than one, which shows yield advantages of intercropping with a legume. Despite of that, rape was the dominated crop in all intercropping systems.

References

- Lithourgidis, A.S., Vlachostergios, D.N., Dordas, C.A. and Damalas, C.A. (2011). Dry matter yield, nitrogen content and competition in pea–cereal intercropping systems. *European Journal of Agronomy* 34(4): 287-294.
- Ghosh, P. (2004). Growth, yield, competition and economics of groundnut-cereal fodder intercropping systems in the semi-arid tropics of India. *Field Crops Research* 88: 227-237.

Phosphorus efficiency in faba bean and narrow-leaved lupin

Lizarazo Torres, Clara Isabel; Stoddard, Frederick
University of Helsinki, FINLAND

Introduction

Phosphorus (P) is the second most important element for plant growth. P fertilizers are applied to agricultural soils in order to make P available to crops, but, crops take up only 20-30% of the applied P and the rest is bound into less labile forms (Mat Hassan et al., 2012). Phosphorus use efficiency (PUE) is an indicator of the P required to produce a certain amount of biomass. The root phosphorus absorption efficiency (RPAE) indicates the capacity of roots to acquire P from the soil. PUE and RPAE are calculated according to the following formulas (Pan et al., 2008): $RPAE = \frac{P \text{ content of the whole plant}}{\text{Root dry weight}}$ $PUE = \frac{\text{Dry weight of whole plant}}{P \text{ content of the whole plant}}$ Legumes are well known for their biological nitrogen fixation, and they can mobilize P from less labile P pools (Mat Hassan et al., 2012), thus improving the nutrition of subsequent crops. Here, we compare the P efficiency of faba bean (*Vicia faba*) and narrow-leaved lupin (*Lupinus angustifolius*).

Materials and methods

Faba bean (cv. Kontu) and narrow-leaved lupin (cv. Haags Blaue) were grown in a crop rotation trial at the University Experimental Farm at Viiikki, Helsinki, Finland. The experiment was a randomized complete block design with 4 replicates, plot size was 8 x 25 m, and sowing date was 13 May 2011. Seeds were inoculated with appropriate rhizobium (Elomestari) and plots were fertilized with 125 kg/ha of Cemagro (16-7-13). At maturity, 10 sites were randomly selected, and from each site 5 plants were collected, for a total of 50 plants per plot. Plants were separated into shoots and roots, roots were properly washed and then all components were oven dried at 80°C. Dried samples were milled to pass a 0.5 mm sieve using a Centrifugal Mill ZM200 (Retsch). P content of the samples was determined by inductively coupled plasma-optical emission spectrometry (ICP). After harvest, soil samples were collected from topsoil (0-10 cm) from across each of the plots in a "W" pattern, and then the four replicates were bulked and sent for chemical analysis to Suomen Ympäristöpalvelu Oy (Oulu, Finland). Data were analyzed by one- and two-way analysis of variance with PSAW Statistics 18 (SPSS inc. Chicago, USA).

Results and discussion

As expected from the interspecific differences in plant architecture, there were significant differences in most of the growth parameters, except for the ratio of root to shoot dry weight (Table 1). The tap root of narrow-leaved lupin is more dominant than that of faba bean, and depending on the growth conditions, lupins can develop proteoid roots that enhance nutrient uptake and may lead to a higher root P absorption efficiency (RPAE). Nevertheless, RPAE was significantly higher ($P < 0.05$) in faba bean as was total P uptake ($P < 0.001$). This may be partly attributable to competition for P from the greater abundance of weeds on narrow-leaved lupin plots, and the fact that faba bean translocates more P to its shoots.

In contrast, P utilization efficiency (PUE) was 50% higher in narrow-leaved lupin than in faba bean, indicating that lupins are able to grow in the presence of less P than faba beans. After harvest, the total P content of soil samples from faba bean plots was 10.9 mg/l while in those from narrow-leaved lupin plots it was 14.5 mg/l, confirming the higher P uptake of faba bean and indicating that these crops would have different effects on soil P pools.

Conclusions

Further studies are needed to evaluate how much plant-available P is left by these two crops, as this is an important aspect of their pre-crop effect for the nutrition of the following cereal crop.

References

- Mat Hassan, H., Marschner, P., McNeill, A. & Tang, C. 2012. Growth, P uptake in grain legumes and changes in rhizosphere soil P pools. *Biol Fertil Soils* 48: 151-159.
- Pan, X., Li, W., Zhang, Q., Li, Y., and Liu, M. 2008. Assessment on phosphorus efficiency characteristics of soybean genotypes in phosphorus deficient soils. *Agric. Sci. China*. 7: 958-969.

Table 1. Growth parameters, P content, Root phosphorus absorption efficiency (RPAE) and phosphorus utilization efficiency (PUE) of faba bean and blue lupin.

	Faba bean	Blue lupin	Significance level of species effect
Grain yield (t/ha)	2.45±0.10	1.45±0.22	***
Shoot weight (g/plant)	21.9±2.8	10.2±0.83	***
Root weight (g/plant)	0.99±0.07	0.43±0.04	***
Ratio of root to shoot dry weight	0.05±0.00	0.04±0.00	n.s.
Shoot P content (mg/plant)	93±17	27±1	***
Root P content (mg/plant)	4.23±0.64	1.16±0.09	***
Total P uptake (mg/plant)	97±17	29±1	***
Total P uptake (g/m ²)	5.34±0.94	3.57±0.16	*
Root phosphorus absorption efficiency RPAE (mg/g)	98±17	67±9	*
Phosphorus utilization efficiency PUE (g/g)	240±39	372±33	**

n.s., *, **, ***, represent no significant difference, difference at P=0.05, 0.01, and 0.001 respectively.

Chickpea yield and biological nitrogen fixation in a Mediterranean agroforestry system as influenced by tree row orientation

Metay, Aurélie¹; Dufour, Lydie²; Mahieu, Stéphanie¹; Wéry, Jacques¹

¹Montpellier Supagro, FRANCE; ²INRA, FRANCE

Introduction

Biological Nitrogen Fixation (BNF) by trees and crops in agroforestry has often been studied in the tropics. Despite its biological importance, such reports are rare in the temperate agroforestry literature (Nair et al., 2004). In particular, how a legume crop can grow and fix nitrogen in the microenvironment created by trees is unknown. Here we study the impact of agroforestry conditions on chickpea growth and BNF in a Mediterranean environment.

Material and Methods

The experiment was conducted in southeastern France, near Montpellier. Chickpea was intercropped with hybrid walnuts (*Juglans nigra* × *Juglans regia* NG23) planted in 1995 (density=100 trees ha⁻¹). The experiment was conducted in 2010, (annual rainfall: 853 mm). The soil is a silty deep alluvial fluvisol with 25% clay. The chickpea variety 'Twist', partially resistant to anthracnose was sown on March 16, 2010 (density: about 60 seeds m⁻²). A herbicide (Challenge 600 active, 4l/ha) was used two days later; subsequently, the plots were regularly weeded by hand. Two contrasted agroforestry systems with 13 m apart-tree rows were compared with a pure stand chickpea control (PS): in AF-EW, the tree rows are East-West orientated while they are North South orientated in AF-NS. In all the treatments (Fig 1) environmental variables (radiation, humidity, soil nitrogen) and chickpea growth were measured throughout the cycle from 1 m² plots. The proportion of nitrogen derived from N₂ fixation (%Ndfa) was deduced from the measurement of ¹⁵N natural abundance in the aboveground parts of chickpea and of a non fixing plant (fescue), with 4 replicates per treatment.

Results and discussion

The influence of walnut on the global radiation was low until tree budburst (from April to May depending on the trees). The average daily radiation cumulated during the chickpea growth period were 83 % and 76 % of PS (6754 W m⁻²) for AF EW and AF NS respectively.

Chickpea yields and BNF varied between AF treatments. Grain yields ranged from 1.36 to 2.34 t ha⁻¹, which is in

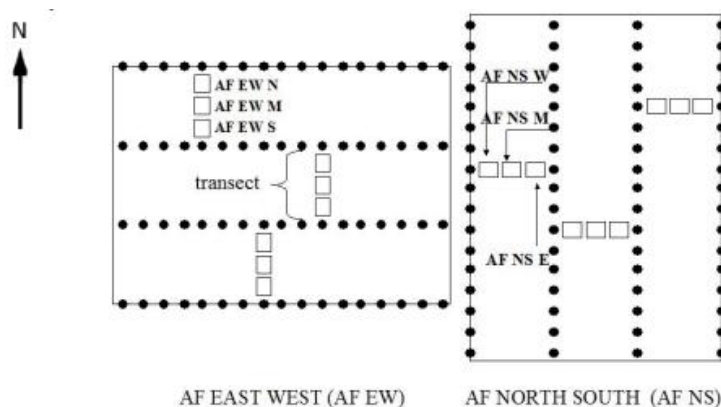

Figure 1: Part of the experimental design for the agroforestry treatments (only 3 transects are showed on the figure for each treatment). Dark disks schematically represent the trees. For each agroforestry plot AF, 3 zones are defined: AF EW N, AF EW M and AF EW S correspond to the zones respectively at the North, in the middle and at the South for each transect in AF EW treatment; AF NS W, AF NS M and AF NS E correspond to the zones respectively at the West, in the middle and at the East for each transect in AF NS treatment.

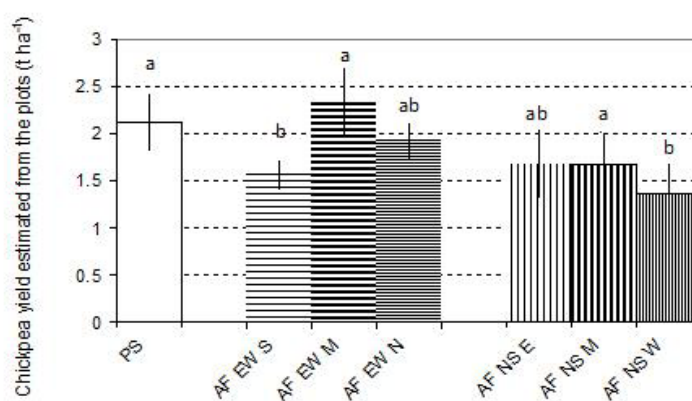

Figure 2: Chickpea yields in the different zones of the treatments, estimated from the plots (t ha⁻¹). Bars indicate standard errors. Different letters indicate significant differences (Kruskal Wallis, p<0.05).

the range of yields in rainfed Mediterranean conditions (Fig. 2). When considering the mean values for each treatment, PS yield was significantly higher than AF EW yield, itself higher than AF NS one. To estimate chickpea yield at the field scale in agroforestry plots, the area occupied by different zones was defined by the radiation patterns transmitted through the alleys, obtained from the hemispherical photographs and considering a 1.50 m wide grass strip on both sides of the tree line. Thus, we calculated the global yields: 2.11 t ha⁻¹; 1.79 t ha⁻¹ and 1.40 t ha⁻¹ for PS, AF EW and AF NS respectively, showing yield reductions of 15 % and 34 % for AF EW and AF NS respectively, compared to PS. The number of grains per plant explained most of the yield differences suggesting that competition between trees and chickpea occurred mostly during the flowering period, which is consistent with the walnuts budburst. Harvest index was higher in PS than in AF EW and AF NS (0.45, 0.41 and 0.35 respectively).

Estimates of %Ndfa were 48 %, 37% and 51 % for PS, AF EW and AF NS and low in comparison with %Ndfa range of 55–80 % for winter-sown chickpea in Syria and France (Aslam et al., 2003). Consequently, the estimated total nitrogen fixed at harvest, taking into account the roots N content (Mahieu et al., submitted) were 67 kg N ha⁻¹, 47 kg N ha⁻¹ and 74 kg N ha⁻¹ for PS, AF EW and AF NS respectively.

Conclusions

This exploratory study shows (i) the potential for chickpea cultivation in agroforestry systems as this system is

able to fix nitrogen, produce chickpea and wood in the long-term and (ii) the interest to better characterize the heterogeneous environment created by the introduction of trees in an annual crop field. Modeling solutions are under development to test different agroforestry field structures and their consequences on both crops and trees productions (Talbot 2011, Soltani & Sinclair, 2011).

References

- Aslam M, Mahmood IA, Peoples MB, Schwenke GD & Herridge DF. 2003. Contribution of chickpea nitrogen fixation to increased wheat production and soil organic fertility in rain-fed cropping. *Biol Fertil Soils* 38: 59–64
- Mahieu S, Metay A, Brunel B, Laguerre G & Dufour L. Nitrogen benefits of chickpea as influenced by trees in Mediterranean agroforestry systems, submitted.
- Nair PKR, Rao MR & Buck LE (eds.). 2004. *New Vistas in Agroforestry: A Compendium for the 1st World Congress of Agroforestry*. Kluwer Academic Publishers, Dordrecht, Netherlands. 480 p. ISBN 1-4020-2501-7.
- Soltani A & Sinclair TR. 2011. An improved model of chickpea growth and yield. *Field Crops Res.* 124: 252-260.
- Talbot G. 2011. *L'intégration spatiale et temporelle du partage des ressources dans un système agroforestier noyers-céréales : une clef pour en comprendre la productivité*. Thèse pour l'obtention du grade de Docteur de l'Université Montpellier II, 297 p.

Intercropping grain legume/cereal for ecologically intensifying the winter cereal cropping system

Priesteri, Aurelio; Preiti, Giovanni; Gresta, Fabio; Gelsomino, Antonio; Monti, Michele
Università Mediterranea di Reggio Calabria, ITALY

Introduction

Introducing legumes in a crop rotation or in intercropped systems with cereals can be regarded as an innovative strategy to preserve the farmers' income and reduce the abandoning of agricultural lands. Even though in the Mediterranean area, legume/cereal intercrop (IC) represents a common practice for forage production, only few studies have been addressed to evaluate grain production for feed or food destination. The present study was carried out within the European Research Programme "Legume Futures" (www.legumefutures.eu) and was aimed to assess the productive performance of barley intercropped with grain legumes, and to evaluate the role of these legume-supported cropping systems as providers of agro-ecological services.

Materials and methods

The field experiment was carried out in San Marco Argentano (I) (39°38'N, 16°13'E, 100 m a.s.l.) during the 2010-2011 growing season. Mean annual rainfall and air temperature are, respectively, 709 mm and 16.1°C (averages over the 1995-2009 period). The experimental set-up was established on a coarse silty, mixed, thermic soil (Fluventic Xerochrept) by using experimental plots arranged in a randomized block design with 4 replicates. Medium early six-row barley (*Hordeum vulgare* L. cv. Aldebaran) was intercropped with two legumes: faba bean (*Vicia faba* L. sub minor cv. Sikelia) and a leaf-less medium early, field pea (*Pisum sativum* L. cv. Hardy). Sole crops (SC) were winter sown at the recommended seed density of 40, 90 and 300 plants m⁻². Four different row by row intercropping patterns were designed: barley and legume were sown at the half density of corresponding SC in replacement designs (P50/B50 and F50/B50); in additive designs for pea and faba the same sowing density of SC was used (P100/B50 and F100/B50). Immediately before sowing, the soil was fertilized with 36 kg N ha⁻¹ and 92 kg P₂O₅ ha⁻¹ as diammonium phosphate. No other fertilisers, herbicides and pesticides were used. Grain yield and crop and weed biomass, nitrogen content on grain and N-fixation (Ndfa%) were evaluated. To estimate the IC

advantage the Land Equivalent Ratio was calculated according to the relationship $LER = Y_{cl}/Y_{cc} + Y_{cl}/Y_{ll}$ where Y_{cc} and Y_{ll} is the yield of the cereal and legumes SC and Y_{cl} and Y_{cl} are the yields for IC cereal and IC legumes respectively.

Results

Grain yield of barley and grain legumes sole crop observed in the experimental conditions can be considered representative for a Mediterranean environment justifying the use of this data for LER calculation. Pea/barley IC showed a better response than faba bean/barley IC particularly for P50/B50 where the reduction in grain yield of both partners compared to the respective SC was less than 20%. The higher response in pea/barley IC could be explained by a more efficient weed control. Facilitations in pea/barley IC were also confirmed by the higher harvest index obtained for barley in P100/B50. Probably it has been due to an increased resources utilisation efficiency that determined a higher 1000 seed weight in barley intercropped with pea (data not shown). On the contrary, faba bean reduced the total biomass and grain yield of IC barley, and this could be especially due to a low control of spring weeds (Fig. 1).

Conclusions

A greater efficiency in N fixation and more effective weed control allowed intercropped pea to achieve a level of facilitation higher than that of intercropped faba bean. The global advantage in the complementary use of resources was also confirmed by LER based on grain yield that was larger than 1 in all IC treatments, thus demonstrating a profitable land use of 62% and 18% for pea/barley and faba bean/barley IC respectively, compared to SC (Tab.1).

This could be considered an example of the ecological intensification of cereal systems in the Mediterranean area that can also help improve the net farmers' income.

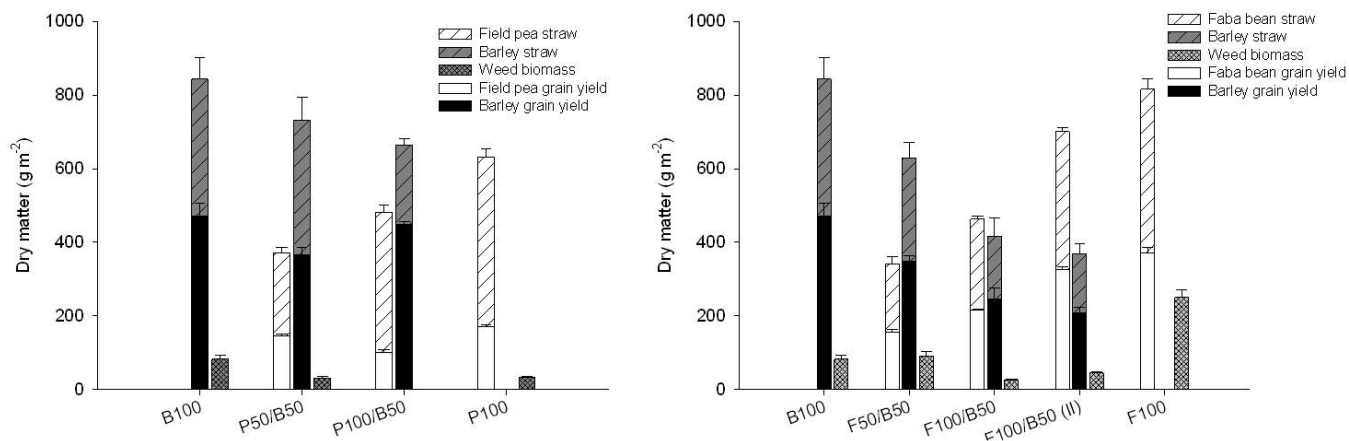

Fig.1 Total biomass of barley, legumes (separated for grain and straw) and weed at harvest. Values are mean (n = 4±se)

Tab.1 N₂-fixation of legumes (Ndfa%) and Land Equivalent Ratio (LER) for different IC treatments calculated for grain yield at harvest. F100 and P100 are faba bean and pea SC respectively; F50B50 and P50B50 are IC treatments in replacement designs; F100B50 and P100B50 are IC treatments in additive designs. Values are mean (n= 4±se)

	Ndfa (%)	Partial LER		LER
		Legume	Barley	
F100/B50	76.8 ± 0.29	0.60 ± 0.13	0.53 ± 0.19	1.13 ± 0.09
F100/B50 (II)		0.87 ± 0.11	0.49 ± 0.25	1.36 ± 0.29
F50/B50	79.1 ± 0.31	0.44 ± 0.13	0.80 ± 0.31	1.23 ± 0.25
F100	76.0 ± 0.30			
P100/B50	83.3 ± 0.32	0.59 ± 0.11	0.97 ± 0.16	1.57 ± 0.15
P50/B50	85.9 ± 0.11	0.87 ± 0.20	0.81 ± 0.16	1.68 ± 0.18
P100	81.3 ± 0.64			

The chemical quality of some legumes, peas, faba beans, blue and white lupins and soybeans cultivated in Finland

Saastamoinen, Marketta¹; Eurola, Merja²; Hietaniemi, Veli²

¹Satafood Development Association, FINLAND; ²MTT Agrifood Research Finland, FINLAND

Introduction

Legumes are nutritive protein crops. Soybean (*Glycine max*) is largely cultivated in North and South America and imported to Europe. In Europe legumes are not so popular. Pea (*Pisum sativum*) is the most cultivated legume in EU with the cultivation of 741 271 ha in 2010 (FAO, 2012). The cultivation area of dry pea is 3,000–5,000 ha and faba bean (*Vicia faba*) 9,000 ha in Finland. Legumes have good chemical quality, but they contain some anti-nutritional components. Many legumes are rich in phytic acid, which chelates with minerals causing mineral deficiencies in the diet of monogastric animals and human beings (Mohamed and Ryas-Dijarte, 2000).

Materials and methods

Seed samples and cultivation documents of legumes were collected from farms in South-Western Finland in 2010 and 2011. Soybean, blue (*Lupinus angustifolius*) and white lupin (*Lupinus albus*) (Fig. 1) were cultivated at some test fields. Cultivation was normal. Sowing was in May, harvesting in August except for faba bean and white lupin in September and for soybean in October. Nitrogen fertilization varied 20–47 kg ha⁻¹. The varieties are seen in Table 1. The mean temperature in May–September was in 2010 and 2011 14.6 °C in Jokioinen. Mean precipitation was in 2010 291 mm and in 2011 414 mm. Protein, oil,

fibre, and ash contents were analysed at Viljavuuspalvelu Ltd. Phytic acid contents of the legumes were analysed using the method of Plaami and Kumpulainen (1991) at the laboratories of MTT.

Results

Pea, faba bean and blue lupin gave yield from every field and year (Table 1). They are adapted to cultivation in Finland. The soya variety Elena and the Dieta white lupin ripened in 2010, but not in 2011. The difference between the years is not caused by temperature but maybe by heavy precipitation in 2011, which hindered ripening of white lupin and soybean. Fiskeby, an old Swedish soya variety, ripened in 2011.

The highest protein contents were found in soybeans Elena and Fiskeby, and in white lupin Dieta (Table 1). The protein content of the Haags Blaue blue lupin variety varied greatly in these two years being high in 2011, but low in 2010. The reason may be the first cultivation year of blue lupin in 2010 and poor nitrogen fixation. The protein contents of pea varieties were quite normal. The protein content of Kontu faba bean was higher than that of Fuego in both years. There was rather high fat content in soybean varieties Elena and Fiskeby and in white lupin Dieta (Table 1). Higher phytic acid contents were in soybean varieties Elena and Fiskeby, than in other legumes (Table 1). Faba bean variety Kontu had a higher phytic acid content than the Fuego variety. Pea and lupin varieties had lower levels of phytic acid. The lowest phytic acid content was in the Dieta white lupin variety.



Figure 1. Growing white lupin

Table 1. Seed yield and chemical composition of dry pea, fava bean, blue and white lupin and soya bean varieties cultivated in Finland in 2010 and 2011

Crop	Variety	Year	Fields/ samples n	Mean yield kg ha ⁻¹	Crude protein content g kg ⁻¹	Crude fat content g kg ⁻¹	Crude fibre content g kg ⁻¹	Ash content g kg ⁻¹	Nitrogen- free extract g kg ⁻¹	Phytic acid content mg g ⁻¹
Pea	Hulda	2010	1	1200	223					11.1
		2011	1		239					10.8
	Karita	2010	6	1980	234					9.6
		2011	1	3500	223					14.6
	Rokka Stok	2011	2	2000	215					13.6
		2011	2	3160	214					13.0
Faba bean	Fuego	2010	1	2610	298					11.7
		2011	1		305					12.6
	Kontu	2010	5	1560	300					16.5
		2011	5	2642	324					17.3
Blue lupin	Haags Blaue	2010	4	920	229	49	178	47	498	13.6
		2011	1	200	317	30	239	48	366	12.2
	Sonet	2010	1		308	41	157	43	451	
White lupin	Dieta	2010	1		382	101	141	31	345	6.2
		2011	not ripend							
Soybean	Elena	2010	1	2000	379	100	149	44	328	22.6
		2011	not ripend							
	Fiskeby	2011	1	800	369	91	155	60	422	18.9

Conclusions

Soybean and white lupin are ripening in Finland only in warm, dry years. The old soybean variety Fiskeby is more suitable for cultivation in north than Elena. Protein and fat contents are best in these legumes. White lupin has the lowest phytic acid content, which make it suitable for food and feed. Soybean has the highest phytic acid content from these legumes. Pea, faba bean and blue lupin are suitable for normal practical cultivation in Finland. Chemical quality of the studied legumes was in accordance with the results of earlier results (Mohamed and Rayas-Duarte, 1995; Martinez-Villaluenga et al., 2006).

Acknowledges

The present work was financed by the Rural Development Programme for Mainland Finland of EU.

References

- Plaami, S., Kumpulainen, J. 1991. Determination of phytic acid in cereals using ICP-AES to determine phosphorus. *J. Ass. Off. Anal. Chem.* 74, 32-36.
- Martinez-Villaluenga, C., Frias, J., Vidal-Valverde, C. 2006. Functional lupin seeds (*Lupinus albus* L. and *Lupinus luteus* L.) after extraction of α -galactosides. *Food Chem.* 98, 291-299.
- Mohamed, A.A., Ryas-Dijarte, P. 1995. Composition of *Lupinus albus*. *Cereal Chem.* 72, 643-647.

Nitrogen management in different crop production system evaluated by NDICEA model

Stalenga, Jaroslaw; Jonczyk, Krzysztof; Staniak, Mariola
IUNG-PIB, POLAND

Evaluation of nitrogen management in different crop production systems done by NDICEA model was aim of the research. Data from a special field experiment established in 1994 at the Experimental Station in Osiny in which different crop production systems are compared were used in this research. The input data covered period between 2009 and 2011. Nitrogen leaching, denitrification, N balance, changes of mineral nitrogen content in a soil profile and relationship between available

and uptaken nitrogen were evaluated by NDICEA model. Real measurements that were compared with the results of model simulation included mineral nitrogen content in a soil profile (0-90 cm). Nitrogen balance in the organic system calculated by NDICEA model amounted about 35 kg ha⁻¹ year⁻¹, and was the lowest in comparison to other systems. The highest values of leaching was observed for the conventional, intensive crop production systems where no legumes were present in the crop rotation.

Using the nitrogen fixation microorganism and phosphate mobilizing fungus for the preparation of the compost for the fertilizer of agricultural plants

Umarov, Bakhtiyor

Institute of Microbiology, UZBEKISTAN

Introduction

The Interactions of the plant with soil fungus and their close-fitting mutually beneficial symbiosis (the cortex and fungus), play the key role in mineral nutrition of higher plants. At the symbiosis of plant with soil fungus get additional feeding in the manner of easy element, which are residing in the difficult form (the phosphates) in the soil. Fungus penetrate inside fabric root system of the high plants, and actuate the influx mineral material in root. The plant, in turn, delivers the fungus ready organic nutrients. Phosphorus dissolved microorganism pertain the bacteria of *Bacillus* and *Pseudomonas* as well as fungus of *Aspergillus* and *Penicillium* which provide the plants with phosphoric feeding.

Materials and methods

Coming from much literary data in our experiment we have chosen seeds of the legume plants, soybean and common bean (*Glycine max*, *Phaseolus vulgaris* L). Phosphorus dissolving microorganisms *Aspergillus niger* 36 and *Penicillium canescens* 48 and nitrogen fixation bacteria *Bradyrhizobium japonicum*, (from the collection of the laboratory) and the their base these partners (the plants and microorganisms), the show, interactions of the plants with soil microorganisms in the vegetation period of the plants, the observe of assimilation of the plant with phosphate and nitrogen on the part of microorganism. We used plastic containers, filled with soil, to which was added nitrogen - 530 mg, phosphorus -610 mg, potassium- 480 mg, from calculation on 1 kg ground and added of the cells suspension with *Aspergillus niger* - 36 and *Penicillium canescens* 48, diluted in 100 once water and strains *Bradyrhizobium japonicum*. Moisture of ground were to 60% moisture. Seeds legume plants soybean and bean soaked with water cells of suspension *Aspergillus niger* - 36 and *Penicillium canescens* 48, during 5-10 hours, then seeds were inoculated with nodule bacteria and grown on the open ground in containers. Moisture supported during of vegetation period (60%

moisture). The experiments were conducted in the green house condition, and on natural base.

Results and discussion

In the period of the observation for the 60-day of vegetation period the plants growing after inoculation with phosphorus dissolved fungus of *Aspergillus niger* -36 and *Penicillium canescens* -48, and with *Bradyrhizobium japonicum* were in contrast with the control variant, the plants nearly in 1,5 times exceed with control variants. For 80-day of the vegetation period is checked accumulation of the biomass of plants. Accumulation of the biomass of the plants possible see that plant inoculated with microorganisms accumulate from 1,5 - 2 times more biomass, than in control. The similar results we are observed and on the plants of the beans. Seeds of the beans, soaked with water suspension by the fungus *Penicillium canescens* -48 nearly in two times exceed on growing to comparison with control plants, such differences existed before and the end of the vegetation of period, accumulations of the biomass (shoot and root of the plants), in two times above by comparison with control variants. All these data observations prove that phosphorus dissolved by fungus *Aspergillus niger* - 36 and *Penicillium canescens* -48, well enters in symbiosis, with legume plants.

Conclusions

From the results that legume plants (soybean and bean) entering in the symbiosis with the *Rhizobium japonicum* and phosphorus mobilizing microorganism with *Penicillium canescens*, and *Aspergillus niger*, will get phosphoric feeding from soil, (NPK) as phosphor flour, ammonium nitrate, potassium chloride in the compost with bio fertilizer, and productivity herewith increases on 1.3-1.5 times.

Crop growth and nitrogen utilisation of a Mixture of Winter oilseed rape (*Brassica napus*-WOSR) and legume in multi-local trials

Valantin-Morison, Muriel¹; Butier, Arnaud¹; Berder, Julie¹; Pinochet, Xavier²

¹INRA, FRANCE; ²CETIOM, FRANCE

Introduction

In order to reduce fertilisers applied on WOSR, mixing species with legumes could be argued as an interesting innovation. Several studies have shown that this diversification provides important services, such as capturing soil nutrients and preventing their loss, nitrogen fixation by legumes (Malezieux et al., 2008). Nevertheless, the effect of mixing species are not so obvious, since we can find studies that show that the cover crop decreases resource availability (competition with the main crop for light, nutrients and water). Winter oilseed rape (WOSR) is a break-crop widely used in French farming systems since it is of potential value in terms of market requirements and agronomic potential. However, mixing WOSR with legumes has received few attention and the objectives of this study are to assess the agronomic consequences on crop growth especially on nitrogen utilisation for WOSR.

Materials and methods

In the experiments investigated here, WOSR was mixed with spring legumes, sown with WOSR in summer and capable to freeze during winter in order to restore nitrogen in spring. In four regions of France, we have carried out 13 experiments in 2010 and 2011, on farmers' fields. Large plots of "sole WOSR" and six mixture of spring legumes-WOSR (faba bean, lentil, pea, 3 species of clover) or other species (buckwheat and *Camelina sativa*) were sown on the same day. Each mixture plot was divided in two subplots, one where the full balance dose minus 60 kg/ha was applied (X60) and one where no fertiliser was applied (No). Thanks to these on-farms experiments, we investigated the agronomic behaviour of each mixture with a focus on competition between legume and WOSR and on the capability of the legumes to restore nitrogen to crop in spring. Therefore, measurements of crop biomass, nitrogen uptake in plants, and mineral nitrogen in soil

have been performed either in autumn before winter and at the end of flowering during spring. We calculated two variables: partial Land Equivalent ratio for WOSR for crop biomass (LERBM) and for nitrogen uptake (LERQN) and the benefit in spring for WOSR in mineralized nitrogen from the legume $\{(N_{\text{abs-wosr-spring}} + N_{\text{soil-spring}}) - (N_{\text{abs-wosr-autumn}} + N_{\text{soil-autumn}})\}$, with N_{abs} for Nitrogen uptake by the crop in kg/ha, and N_{soil} for nitrogen in soil in kg/ha). The 13 farmers' fields were divided in 2 groups regarding to the type of soil and the amount of nitrogen in soil at sowing: low N soils with less than 90 kg/ha in soil and the high N soils with an amount higher than 90 kg/ha.

Results and discussion

For the low N soils, biomass of WOSR in autumn is often lower when it was mixed with legume (fig. 1A), except for mixture with buckwheat and two clover species. However, above ground biomass was always higher for the two components of the mixture than for sole WOSR, suggesting that mixing crops explored the soil nutrients better than the sole crop. For the high N soils, the biomass of WOSR and of the mixture was often much lower than the sole crop, suggesting an important competition for light and nitrogen between crop and legume in early winter. However, despite this competition effect of the legume in autumn, it is noticeable that in spring, LERBM is often higher than 1, especially for lentil, bean-lentil and pea, which argue for a possible benefit for the crop of this legume during spring (fig. 1B). In autumn, the legumes absorbed a very variable amount of nitrogen in soils: from 2,2 for clover to 53,8 kg/ha for pea (fig. 2). When no fertilizer applied, the benefit for the WOSR ranged from 11 kg/ha to 40 kg/ha. It resulted in LERQN, calculated on nitrogen accumulation, often higher than 1 in spring.

Figure 1: Biomass distribution between crop and mixing legume in autumn (A) and relationships between LER_{BM} in autumn and in spring for the different legume (B).

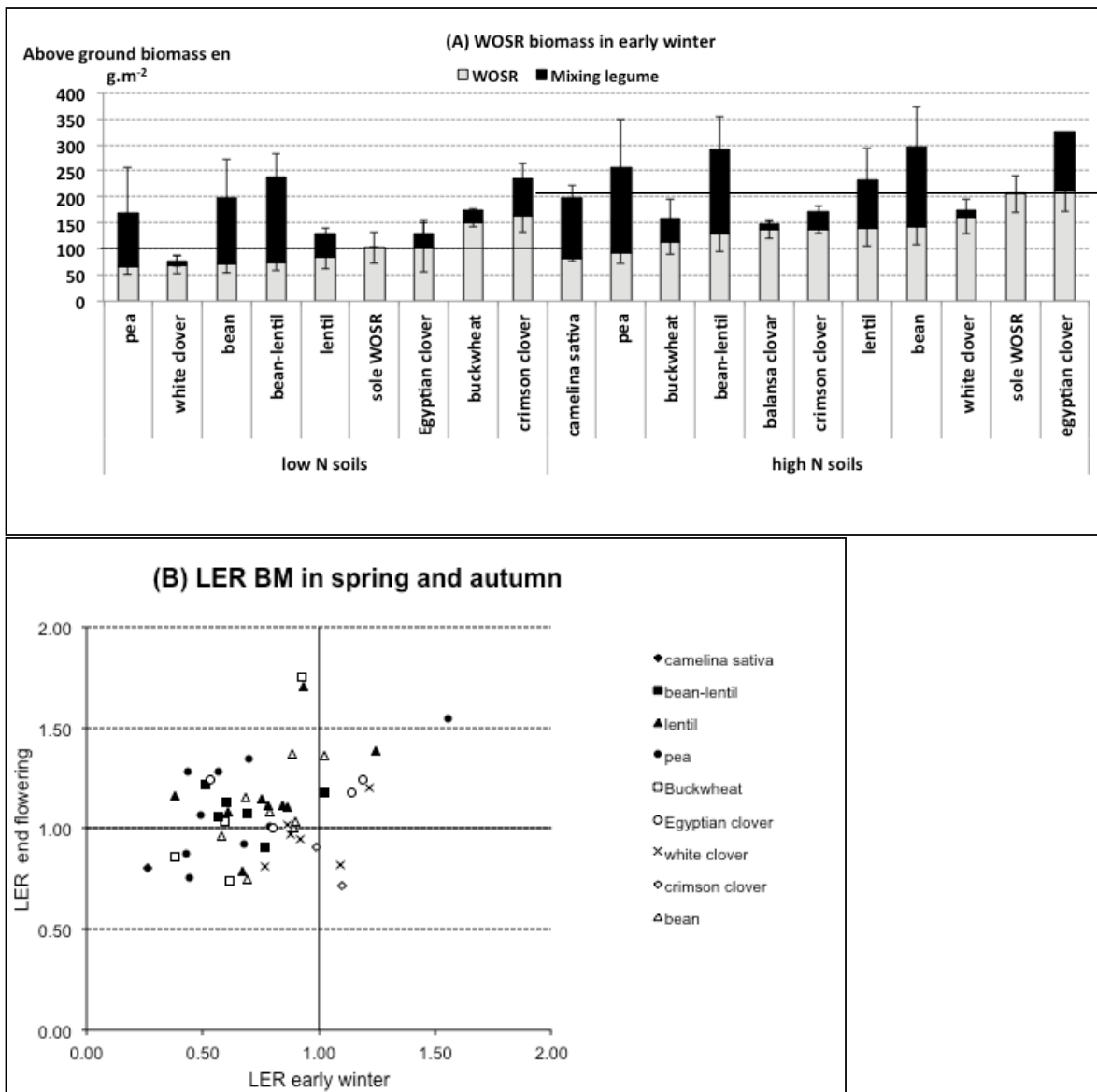

References

Malézieux E., Crozat Y., Dupraz C., Laurans M., Makowski D., Ozier-Lafontaine H., Rapidel B., de Tourdonnet S., Valantin-Morison M., 2008, Mixing plant species in cropping systems : concepts, tools and models. A review, ASD, 28, e-first : DOI: 10.1051/agro2007057

Indices of Photosynthesis of x Festulolium and Lolium x Boucheanum Sward

Adamovics, Aleksandrs; Gutmane, Iveta
Latvia University of Agriculture, LATVIA

Introduction

Leaf surface area and net photosynthesis productivity are the most significant indices of photosynthesis. Leaf surface area is usually expressed as leaf area index (LAI) which represents leaf area per unit ground surface area and shows how many times leaf surface is greater than soil area occupied by plants. The aim of the present research was to study the most important indices of photosynthesis (leaf area index and net photosynthesis productivity-NPP) and crop yield of festulolium (x *Festulolium* Asch. & Graebn.) and hybrid ryegrass (*Lolium x boucheanum* Kunth.) foreign varieties under agro-ecological conditions of Latvia.

Materials and methods

Field trials were conducted at LLU Research and study farm "Vecauce", Latvia. Soil: sod-gleyic, fine sandy loam, medium cultivated, medium drained. Swards were composed of: perennial ryegrass 'Spidola' (control); festulolium – 'Perun', 'Punia', 'Saikava', 'Lofa', and 'Hvkor', hybrid ryegrass – 'Tapirus'. The total seeding rate was 1000 germinating seeds per m². Dynamics of plant leaf area index and net photosynthesis productivity, expressed in g m⁻² day⁻¹, were determined for first cut following the method described by Kidd, West and Briggs. Sampling of each variety was carried out in 2 replications at 7–10-day intervals after spring regrowth till first cut. Dry weight and leaf area were determined at the beginning and end of each week. Data were statistically

analyzed employing analysis of variance, and correlation and regression analyses.

Results and discussion

In the Latvian climatic conditions, most of the dry matter yields are produced by the first cut grass. According to our results, NPP and LAI for festulolium, hybrid ryegrass and perennial ryegrass individual grass species were different during regrowth period till the first cut.

On the average between four years of trial, the highest NPP was observed for festulolium cv. 'Saikava' – 8.29 g m⁻² day⁻¹. Perennial ryegrass demonstrated not only the lowest average value of NPP but also the lowest DM yield. Though there were differences between NPP values of the investigated varieties, they were not statistically significant ($p > 0.05$). In the four years of trials, festulolium cv. 'Hvkor' and 'Punia' gave the highest average values of LAI – 2.91 and 2.66 respectively. Differences between LAI values of investigated varieties were statistically significant ($p < 0.05$). With the ageing of leaves, their photosynthetic capacity declines. The increase in leaf area resulted in the decrease of NPP indices because of mutual shading of leaves. Relationships between NPP and DM yields were characterised by weak negative linear correlation in all trial years. On the one hand, it leads to increase in biomass production close to maximum, but, on the other hand, it decreases the photosynthesis

Table 1
The net photosynthesis productivity and leaf area index (on average for four years)

Parameters	Varieties						
	Spidola	Lofa	Saikava	Hvkor	Perun	Tapirus	Punia
Net photosynthesis productivity, g m ⁻² day ⁻¹	5.63	7.48	8.29	6.99	7.30	7.94	7.85
S \bar{x}	0.88	0.53	0.79	0.31	0.23	0.17	0.45
Leaf area index	2.01	2.28	1.94	2.91	2.53	1.98	2.66
S \bar{x}	0.35	0.38	0.38	0.37	0.45	0.25	0.37
LSD _{0.05} for NPP=3.02, for LAI=0.63							

productivity. It is necessary to achieve the best balance between photosynthesis and plant tissue production, and the amount of leaf removed by grazing or cutting. In Latvia, the highest NPP values ($10.2-12.7 \text{ g m}^{-2} \text{ day}^{-1}$) were achieved in 24-32 days after the beginning of spring regrowth, which was influenced by meteorological conditions in the particular regrowth period.

Conclusions

Increase in grass dry matter yield was closely related to leaf area increase. A significant ($p < 0.01$) positive correlation was established between the dry matter yield

and leaf area index during regrowth period in spring till the first cut. The highest NPP ($10.2-12.7 \text{ g m}^{-2} \text{ day}^{-1}$) for festulolium, hybrid ryegrass and perennial ryegrass varieties was achieved 24-32 days after renewal of vegetation, which was greatly influenced by the weather conditions during leaf formation.

Acknowledgements

Project „Attraction of human resources to the research of the renewable energy sources”, Agreement No.2009/0225/1DP/1.1.1.2.0/09/APIA/VIAA/129.

Stevia rebaudiana Bertoni as a novel crop: optimization of nitrogen fertilisation

Angelini, Luciana; Tavarini, Silvia
University of Pisa, ITALY

Introduction

Stevia rebaudiana Bertoni, a perennial shrub of the *Asteraceae* is known for its leaf steviol glycosides (SG), non-cariogenic and non-caloric sweeteners with potential beneficial effects on human health (Chatsudthipong & Muanprasat, 2009). In Europe, there is an increasing interest for stevia extracts since they were approved as food additive within the EU. Stevia is a relatively new crop for Italy and the agronomic requirements are yet to be determined. In particular, the requirement for nitrogen (N) is poorly investigated. Although adequate N availability ensures high yield and maximum profits, N fertilization has increasing environmental implications (Ladha et al., 2005). Therefore, the aim of this work was to define the N fertilisation management in order to improve the sustainability of stevia cultivation in terms of productivity and leaf SG content.

Materials and methods

A 2-year field trial was set up in 2009 and 2010 at the Experimental Centre of the University of Pisa (Central Italy; 43°40'N; 10°19'E). The plants were grown in 20-L pots filled with sandy and low fertility soil and subjected to different N doses: no N application (Do); 50 kg N ha⁻¹ (D1, N deficiency); 150 kg N ha⁻¹ (D2, optimal N); 300 kg N ha⁻¹ (D3, N surplus). The N was applied as ammonium nitrate and split in 4 applications every 30 days. The organic fertilisation (Org) was also evaluated (1200 kg ha⁻¹ organic manure by Nutex gold 14% org N). In pre-planting and pre-sprouting, each pot, except those with Org, received 100 kg P₂O₅ ha⁻¹ and 100 kg K₂O ha⁻¹ and microelements (0.1 g L⁻¹). Water was supplied to all pots by a drip irrigation system to maintain soil moisture to 80% of field capacity. In each year, 2 leaf samplings were carried out to evaluate the dynamic of SG accumulation in the different treatments, one at the beginning of July (H1) during the vegetative growth and the other when the plants started flowering at the beginning of September (H2). After the last sampling, the plants were harvested and oven-dried at 40°C to measure stem, leaf and total above-ground dry yields. SG content was evaluated according to Hearn & Subedi (2009).

Results and discussions

In both years, the higher dry yields (g plant⁻¹) were observed with the maximum N rate (D3), while the lowest productions were recorded without N (Table 1). No significant differences were found in the dry yield between plants grown with Org and without mineral N. The SG content was statistically analysed pooling data from the two growing seasons (Fig. 1). From the 1st to the 2nd sampling, the total SG content significantly decreased, except the SG level recorded in plants grown without N. Our data showed that the SG content was highest during the vegetative growth and gradually decreased when the plant started flowering according to Bondarev et al. (2003/2004). In the 2nd sampling, the highest value was recorded in Do probably due to the stress to which the plants were subjected.

Conclusions

The productive characteristics were strongly influenced by the N fertilisation rate. The fertilisation treatments interacted with seasonal variations inducing significant effects on the dynamic of leaf SG accumulation. The evaluation of variation sources is extremely interesting in order to improve the quantitative and qualitative characteristics of stevia.

References

- Bondarev NI et al. 2003/2004. Steviol glycoside content in different organs of *Stevia rebaudiana* and its dynamics during ontogeny. *Biol. Plantarum* 47: 261-264.
- Chatsudthipong V & Muanprasat M. 2009. Stevioside and related compounds: therapeutic benefits beyond sweetness. *Pharmacol. Therapeut.* 121: 41-54.
- Hearn LK & Subedi PP. 2009. Determining levels of steviol glycosides in the leaves of *Stevia rebaudiana* by near infrared reflectance spectroscopy. *J. Food Compos. Anal.* 22: 165-168.
- Ladha JK et al. 2005. Efficiency of fertilizer nitrogen: retrospects and prospects. *Adv. Agron.* 87: 85-156.

Table 1. Effect of fertilisation on total, leaf and stem dry yield (g plant⁻¹) in plants of *Stevia rebaudiana* in the first (2009) and in the second year (2010) of growth. Data (mean ± SD) were subjected to one way ANOVA analysis with different fertilisation treatments as variability factor.

	Total dry yield	Leaf dry yield	Stem dry yield	Total dry yield	Leaf dry yield	Stem dry yield
	(g plant ⁻¹)	(g plant ⁻¹)	(g plant ⁻¹)	(g plant ⁻¹)	(g plant ⁻¹)	(g plant ⁻¹)
	2009			2010		
D0	15.5 ± 2.43 d	10.0 ± 1.6 d	5.5 ± 1.1 d	25.0 ± 4.3 d	14.9 ± 2.5 d	10.0 ± 2.0 d
D1	49.6 ± 15.7 c	26.2 ± 10.3 c	23.4 ± 7.3 c	57.8 ± 15.9 c	32.3 ± 8.8 c	25.6 ± 6.2 c
D2	100.0 ± 25.4 b	59.2 ± 12.3 b	40.7 ± 13.7 b	117.5 ± 25.7 b	65.1 ± 13.1 b	52.4 ± 11.3 b
D3	137.6 ± 20.3 a	80.2 ± 6.1 a	57.6 ± 14.8 a	176.2 ± 30.7 a	100.6 ± 15.1 a	75.7 ± 15.8 a
Org	31.5 ± 10.8 cd	19.3 ± 5.0 cd	12.2 ± 4.3 cd	31.8 ± 9.6 d	19.4 ± 4.8 cd	12.4 ± 5.0 d

For each column mean values followed by same letters are not significantly different 0.05 probability level according to the Least Significant Difference (LSD) test

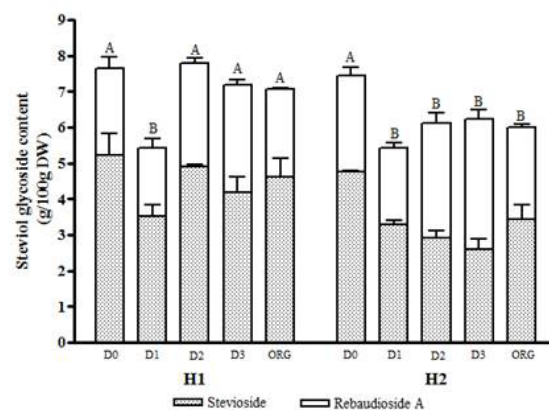

Figure 1. Effect of fertilisation management (T) and sampling time (S) on SG content (sum of stevioside and rebaudioside A).

Management of a novel crop: effects of nitrogen on indigo precursors and leaf yield in *Isatis tinctoria*

Tozzi, Sabrina; Cestone, Benedetta; Angelini, Luciana G.
University of Pisa, ITALY

Introduction

Woad (*Isatis tinctoria* L., *Brassicaceae*) is a novel crop, that is re-gaining increasing attention in temperate zones as one of the earliest known sources of indigo (Cardon 2007). As a blue dye, natural indigo is obtained by leaf-produced indossilic precursors, Indican and Isatans (John 2009), which could be positively affected by nitrogen (N) fertilisation (John & Angelini 2009). Efficient fertilisation is a central topic in sustainable agriculture since fertilisation strongly influences both crop performances and environmental impact. Aiming to ensure high and stable crop yield and indigo production in a sustainable way, the present field experiment was performed to compare the effect of two opposite N doses on indigo precursors and leaf yield in woad.

Materials and methods

A field trial was carried out in Pisa (Central Italy) during the 2003 and 2004 on a deep silt-loam *Typic Xerofluvent* soil. Two extreme fertilisation treatments were applied at rates of 0/100/100 (N_0) and 140/100/100 kg ha^{-1} of N/P/K (N_{140}). The N_{140} fertilisation was split in three applications of 40% (pre-planting), 30% and 30% each (30 and 50 days after transplanting, respectively). The experiment was laid out in a randomised block design with four replicates

(plot size: 4 x 3 m) and a plant density of about 33 plants m^{-2} . Water supply conditions were maintained at optimal level. From the beginning of May till the end of August ten plants were randomly selected from the central part of each plot, in order to measure indigo precursors and leaf yield. Concentration of indigo precursors (Indican and Isatan B, g kg^{-1} FW) was determined according to Gilbert et al. (2004) using a HPLC-ELSD system.

Results and discussion

During the spring-summer period the plant vegetative growth rate increased with increasing air temperature, which at 20-25°C was optimal for leaf development and expansion, till the reaching of a rosette stage. Once the temperature rose around 30°C, the vegetative development slowed to a stop. Leaf concentration of indigo precursors enhanced from mid-May to beginning of July, when plants reached the maximum leaf expansion (Figure 1).

As the main indigo source in *Isatis* species, Isatan B showed its higher content on 10th July at both N supplies. Furthermore, N_0 and N_{140} treatments did not significantly affect the two leaf precursors. The leaf yield was positively

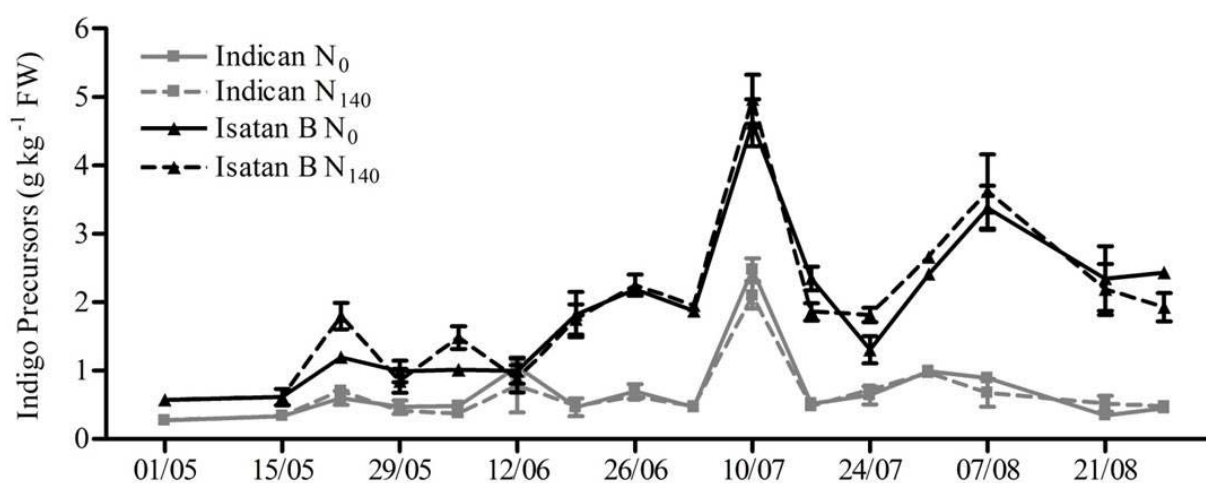

Figure 1: Seasonal indigo precursors (Indican and Isatan B, g kg^{-1} FW, \pm SD, $n = 10$) in *I. tinctoria* grown without (N_0) or with (N_{140}) N fertilisation (as 2003-2004 mean values).

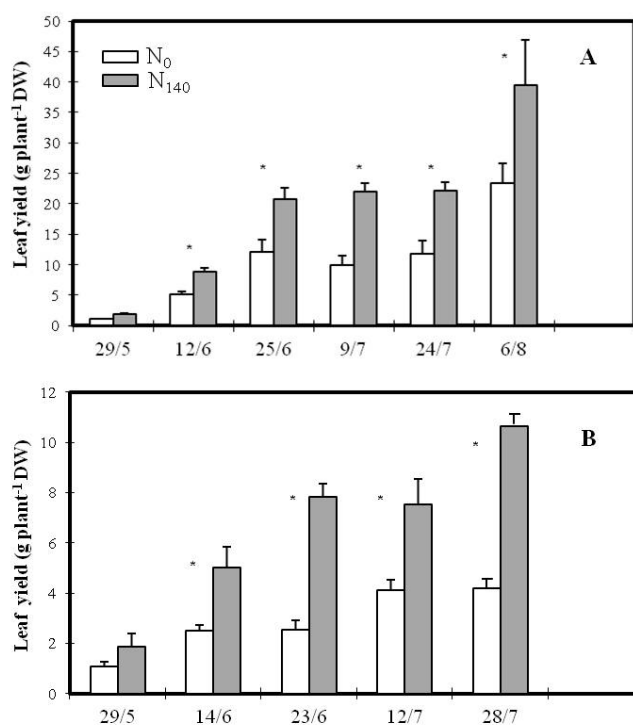

Figure 2: Leaf yield (g plant⁻¹ DW) (\pm SD, $n = 10$) in *I. tinctoria* grown without (N₀) or with (N₁₄₀) N fertilisation in 2003 (A) and 2004 (B) growing seasons. * significant at the 0.05 probability level according to *F*-test by ANOVA.

affected by fertilisation, increasing significantly with N₁₄₀ treatment in all the sampling dates, except for the first one at the end of May in both years (Figures 2A-B).

Along the two growing seasons, the highest N dose affected positively the leaf yield, when the plants reached the maximum leaf rosette expansion.

Conclusions

Results showed that N₀ and N₁₄₀ treatments had similar outcomes on indigo precursors, indicating that dry leaf yield is the most important factor in final indigo production. The knowledge of N requirement by woad, as a novel crop, could help to rationalize the N fertilisation, thus, contributing to the environmental and agronomic sustainable of cropping systems.

References

- Cardon D. 2007. Natural Dyes: Sources, Tradition, Technology and Science. Archetype Publications, London.
- John P. 2009. Indigo – Extraction. In Bechtold T, Mussak R: Handbook of Natural Colorants. Leopold-Franzens University, Austria, Wiley, pp. 105-133.
- John P & Angelini LG. 2009. Indigo - Agricultural Aspects. In Bechtold T, Mussak R: Handbook of Natural Colorants. Leopold-Franzens University, Austria, Wiley, pp. 75-104.
- Gilbert KG et al. 2004. Quantitative analysis of indigo and indigo-precursors in leaves of *Isatis* spp. and *Polygonum tinctorium*. Biotechnol. Prog. 20: 1289-1292.

Water consumption, biomass production and N uptake of species for phytoremediation and second generation ethanol.

Florio, Giulia; Borin, Maurizio

University of Padova, ITALY

Introduction

Many studies underline the potential of second-generation ethanol as sustainable bioenergy and its constraints to full commercial development (Tan et al., 2008; Sims et al., 2010). Unlike the first-generation biofuels, the second-generation ones might be obtained in marginal areas, avoiding the land competition for food and fiber. In addition some plants might be cultivated with reduced input and irrigated with poor quality water.

This paper reports the preliminary results of a research in progress, aiming to find out new macrophyte wetland plants able to give high biomass productivity suitable for second-generation ethanol and to grow under irrigation with wastewater.

Materials and methods

The research is carried out at the experimental farm of Padova University, Legnaro (PD). In this part of the Veneto Region, the mean annual rainfall is 810 mm and is moderately uniformly distributed throughout the year, with a higher variability from September to November. Mean annual average temperature is about 12.5°C. The reference evapotranspiration (ET_o), calculated with the Penman–Monteith formula, is 945 mm in the median year and increases during the summer.

The following species have been studied: *Arctium lappa* L., *Arundo donax* L., *Carex riparia* Curtis, *Carex*

acutiformis Ehrh., *Helianthus tuberosus* L., *Iris pseudacorus* L., *Miscanthus x Giganteus* Greef et Deu., *Scirpus sylvaticus* L., *Symphytum officinale asperimum* L.. Some of these species were selected from preliminary tests and other have been chosen on the basis of their potential productivity and adaptability to environmental conditions.

The plants were cultivated from June 2010 in growth boxes (2x2 m sided) installed with the top at 1.3 m above the field level and with an open bottom. The soil, according to FAO-UNESCO classification, is fulvi-calcaric Cambisol, with loamy texture in the upper 80 cm and silt percentage gradually increasing with the depth. The plants are fertilised in spring of every year with simulated slurry being equivalent to 400 kg N/ha. Controlled irrigations are applied (corresponding to 40 mm of water, supplied twice a week) and the soil moisture content is regularly measured with the Diviner 2000 device along the growing season. At time of harvest, samples of each species were collected and dried in order to obtain respectively the total biomass production, the N content (Kjeldhal) and the different constituents of fibers (hemicellulose, cellulose, lignin and ashes) according to the Van Soest's scheme analysis (Fan et al., 1987).

Results and discussion

All the species received the same quantity of water but their evapotranspiration was different in the analyzed months (Table 1) and higher than ET_o (corresponding to

Table 1: Mean evapotranspiration, biomass productivity and nitrogen uptake of the nine analyzed species.

Species	ET (mm)					Total	Dry matter production (t/ha)	N Uptake (kg/ha)
	May	June	July	August	September			
<i>A. lappa</i>	252	230	342	322	271	1416	3.9	81
<i>A. donax</i>	335	263	322	339	284	1544	87.9	439
<i>C. acutiformis</i>	245	237	347	309	285	1423	12.7	155
<i>C. riparia</i>	270	227	337	303	290	1427	14.0	191
<i>H. tuberosus</i>	310	266	337	322	273	1508	28.6	140
<i>I. pseudacorus</i>	264	235	344	305	284	1432	10.8	123
<i>M. x Giganteus</i>	295	266	291	382	274	1508	49.9	152
<i>S. sylvaticus</i>	255	249	349	314	290	1457	3.6	39
<i>S. officinale</i>	250	273	336	318	273	1450	15.3	301

173, 171, 192, 184 and 137 mm, respectively from May to September).

The highest dry biomass productivity was obtained with *A. donax* (87.9 t/ha), followed by *M. x Giganteus* (49.9 t/ha). All the other species gave lower and similar productions around 13 t/ha, apart from *S. sylvaticus* and *A. lappa* with only 3.9 and 3.6 t/ha. With regard to nitrogen uptake, *A. donax* had the best removal efficiency with 439 kg/ha, followed by *Symphitum officinale* (301 kg/ha) and *Carex riparia* (191 kg/ha) while the other species had values below 150 Kg/ha.

Conclusions

In the analyzed period all the species had ET higher than ET₀. *A. donax* showed the best productivity and removal

efficiency. High dry matter production is found also in *M. x Giganteus* while *S. officinale asperimum*, despite its low biomass results, has good potential for phytoremediation.

References

- Fan L.T., Gharpuray M.M, Lee Y.H., 1987. Cellulose Hydrolysis, Springer Publisher.
- Sims R.E.H, Mabee W., Saddler J.N., Taylor M., 2010. An overview of second generation biofuel technologies, *Bioresources Technology* 101, pp.1570-1580.
- Tan K.T., Lee K.T., Mohamed A. R., 2008. Role of energy policy in renewable energy accomplishment: The case of second-generation bioethanol. *Energy Policy* 36, pp.3360-3365.

Agroecological assessment of the cup plant (*Silphium perfoliatum* L.) as a biomass crop of the future

Müller, Anna-Lena¹; Schorpp, Quentin¹; Schoo, Burkart²; Schittenhelm, Siegfried²; Schrader, Stefan¹; Schroetter, Susanne²; Dauber, Jens¹; Weigel, Hans-Joachim¹

¹Johann Heinrich von Thuenen-Institut - vTI, GERMANY; ²Julius Kühn-Institute - JKI, GERMANY

Introduction

To counteract short maize crop rotations and monotonous agricultural landscapes the cup plant *Silphium perfoliatum* with its high yielding ability is a promising candidate for biomass production. The perennial lifecycle, long-lasting flowering period and low tillage imply positive effects on biodiversity and ecosystem services. Experience from agricultural practice also indicates a comparatively high drought tolerance.

The Research Project

We investigate the impact of *S. perfoliatum* on agroecosystems with a focus on functional aspects of biodiversity and water use. The project will provide scientific guidance for a sustainable establishment of the cup plant cropping system. The project is divided into two work packages:

WP1 analyses above- and below-ground biodiversity and ecosystem functions:

Above-ground - Qualitative and quantitative assessment of the flower-visiting insect community in a landscape context / Analysis of plant-pollinator networks of the cup

plant and surrounding crops / Examination of quality and quantity of the cup plant's floral resources (nectar and pollen) / Assessment of the seasonal habitat quality for pest and beneficial organisms as well as arable weed. Below-ground - Assessment of soil fauna communities / Nematode (micro-), collembolan (meso-) and earthworm (macrofauna) diversity in crop stands of different age during the vegetation period / Evaluation of the functional role of soil biodiversity / Analysis of decomposition dynamics of crop residues / Assessment of earthworm soil surface castings / Analysis of C- and N- dynamics in soil.

WP2 assesses water balance and ecophysiology of *S. perfoliatum*:

Analysis of water consumption in permanent culture / Assessment of water use efficiency on single leaf and field plot level / Characterisation of the root system depending on the soil moisture / Significance of the "cups" for the water balance / Monitoring of soil water content over the course of the year / Studying the temporal development of soil cover and leaf area index.

Agronomic performance of *Humulus lupulus* L. tetraploid plants

Trojak-Goluch, Anna; Skomra, Urszula; Agacka, Monika

Institute of Soil Science and Plant Cultivation, State Research Institute, POLAND

Introduction

Humulus lupulus is a dioecious perennial plant. Its secondary metabolites are used in brewing as well as in pharmaceutical industry (Roy et al. 2001). The Polish hop breeding programme focuses on generating polyploids as they are higher yielding, produce more soft resins and essential oils. This study reports on morphological evaluation of tetraploids of *H. lupulus* in order to assess how the ploidy level affects basic morphological traits of Polish cultivar Sybilla.

Materials and methods

Plant material were six tetraploids ($2n=4x=40$) of *H. lupulus* cv. Sybilla previously obtained after colchicine treatment (Trojak-Goluch et al. 2009). Diploids ($2n=2x=20$) were used as a standard. Vegetative characteristics of tetraploids were compared with those of diploid ones. The following traits were recorded: length and width of female flowers. Further characterization included the evaluation of the main stem diameter, length of lateral shoots, length, width and area of 50 leaves that were collected from central and upper part of main and lateral shoots. The analysis of hop cones concerned the weight of 100 hop cones as well as 100 spindles, size and number of lupuline glands on the 1 cm². The studies included the analysis of alfa acids content using toluene method. The data were analysed using F-test least significant difference.

Results

The morphological characteristics of tetraploids differ much from these of diploid counterparts. Tetraploids had significantly thinner shoots. The average stem diameter ranged from 4,7 to 7,4 mm for tetraploids and 8,2 mm for diploids (Tab. 1). Moreover, tetraploids produced lateral shoots much shorter than diploids, and in five cases the difference could be proved statistically. The influence of DNA content on vegetative traits was also reflected by significant differences in the length, width and area of leaves. All tetraploids tended to possess shorter and narrower leaves in the upper part of the main and lateral shoot than the diploid (Tab. 2). As a result, leaf area was smaller than that of diploids and in some cases the differences were statistically significant. The tetraploids were found to have significantly smaller leaves originating from the middle part of the main and lateral shoots. The analysis of flower traits, including length and width of flowers showed highly significant differences both between individual tetraploids, as well as between the tetraploids and diploids. It can be assumed that these traits are not affected by DNA content. The average weight of cones was variable depending on the tested plant and it ranged from 73,3 to 48,1 g. Tetraploids were superior to diploids for the mass of hop cones but the differences were below the significance level. The average weight of spindles was significantly higher than those of diploids. Tetraploids had significantly smaller number of lupulin glands than that in diploid counterparts. The

Table 1. Characteristics of stem, dimensions of leaves of diploid plants as well as they tetraploid counterparts of cv. Sybilla

No. plants tested	Stem diameter (mm)	Lateral shoot length (m)	Length of leaves (cm)				Width of leaves (cm)				Area of leaves (cm ²)			
			main shoot		lateral shoot		main shoot		lateral shoot		main shoot		lateral shoot	
			top	middle	top	middle	top	middle	top	middle	top	middle	top	middle
1	6,0*	0,2*	12,8*	13,3*	6,3	4,7*	12,0	13,4*	4,8	3,8*	103,6	147,3	23,0	15,1*
2	4,7*	0,4*	11,4*	11,5*	5,9*	5,5*	9,4*	10,6*	4,6	4,2*	72,9*	80,8*	20,4	16,4*
3	5,5*	0,7	13,8	11,9*	6,3	6,2*	10,8*	12,3*	5,1	4,7*	98,3	96,3*	22,6	20,8*
4	7,4	0,5*	12,5*	13,8*	5,3*	5,8*	11,2	13,3*	4,8	4,6*	82,5*	110,4*	22,9	20,3*
5	5,6*	0,2*	11,4*	13,2*	6,3	4,8*	9,0*	13,6*	4,0	3,7*	68,0*	101,5*	15,6*	13,7*
6	6,1*	0,5*	12,9	10,8*	6,8	5,4*	12,1	10,2*	5,1	4,3*	103,8	68,1*	25,3	15,8*
Sybilla	8,2	0,7	14,0	16,9	7,0	8,0	12,0	16,7	5,1	5,9	110,3	186,8	26,9	27,8
LSD	2,0	0,2	1,1	1,1	0,9	0,8	1,2	1,1	1,2	0,7	16,3	46,8	7,47	5,6

*Mean values within a column differ significantly from cv. Sybilla based on F-test at 0,05 1-6 tetraploid plants

Table 2. Morphological chemical characteristics of flowers and hop cones of diploid and tetraploid plants of cv. Sybilla

No. plants tested	Flower		Number of lupuline glands	Length of lupuline glands (μm)	Weight of 100 hop cones (g)	Weight of 100 spindles (g)	L-acid (%)
	length (mm)	width (mm)					
1	22,0*	7,1*	98,6*	252,9*	60,3*	14,2*	6,3
2	23,4*	9,1	85,1*	273,3*	55,6*	15,2*	8,2
3	22,6*	8,3	126,6	235,8*	48,1	12,1*	8,4
4	23,7	9,3	71,3*	257,0*	55,8*	11,9*	7,0
5	21,5*	7,5*	77,1*	236,3*	73,3*	17,1*	6,3
6	22,0*	7,9*	103,4*	240,1*	54,7*	12,8*	7,2
Sybilla	23,9	8,7	134,6	176,4	43,1	7,9	6,6
LSD	0,3	0,6	19,5	9,6	5,7	1,3	-

*Mean values within a column differ significantly from cv. Sybilla based on F-test at 0,05 1-6 tetraploid plants

average length of lupulin glands was almost twice longer, however it was not reflected in the quality of hops. L-acids content from tetraploids was only slightly higher than that of the diploids.

Conclusions

1. An increase in ploidy level of hop affected selected morphological traits, including stem diameter, length of lateral shoots, length, width and area of leaves located in the middle part of the main and lateral shoots
2. There was no influence of polyploidisation on the quality of hop cones. Despite the significant increase in

the length of lupulin glands in tetraploids, the content of L-acids was only slightly higher to that in diploid.

References

- Roy A. T., Leggett G. and Koutoulis A. 2001. In vitro tetraploid induction and tetraploids from mixoploids in hop (*Humulus lupulus* L.). Plant Cell Rep. 20:489-495
- Trojak-Goluch A., Depta A. and Agacka M. 2009. Induction of tetraploids in hop (*Humulus lupulus* L.) using in vitro cultures. Acta Biologica Cracoviensia vol. 51 suppl. 1:25
- Supported by Ministry of Science and Higher Education NN 310 437538

Effects of olive tree shading and nearness on faba bean (*Vicia faba* L.) productivity

Daoui, Khalid¹; Fatemi, Zain El Abidine¹; Raada, Sarah²; Lazraq, Abderahim²; Bendidi, Abderazak¹; Razouk, Rachid¹

¹Institut National de la Recherche Agronomique, MOROCCO; ²Faculté des Sciences et Techniques de Fes-Saïs, MOROCCO

Introduction

Agroforestry is a common practice in mountainous and oasis regions of Morocco. Small farmers may exploit small lands with different annual and perennial crops on the same place. In olive orchards rows left between trees are cultivated with cereal or legume crops. In a previous study, we found that cereals cultivated in olive tree inter rows may reduce olive production by about 30% while, legume crops like faba bean does not affect olive production. Shading may enhance grain yield of some crops by enhancing their reproductive cycle (Stirling and al. (1990) cited by Black and Ong, 2000). Nasrullahzadeh and al. (2006) found genotypic variation among faba bean genotypes for shading adaptation.

In the objective to assess olive tree impact on faba bean crop cultivated in inter rows, a field trial was conducted under rainfed conditions in experimental station.

Materials and methods

Two faba bean varieties (*Vicia faba* L major and minor) were cultivated on the olive tree rows. Olive trees are planted as 10 m * 10 m. Effects of olive tree on faba bean productivity were measured, at maturity stage of the annual crop, according to distance from olive tree and according to tree shading. The arrangement of the samples considering the shade which is not fixed during the day and during the cycle of the crop (Photo 1). So, the various positions of the sampling are: South (S). South East (SE). South West (SW). Center (C). North (N).



Photo 1. Faba bean cultivated in inter row of olive tree

North East (NE). And North West (NW). Five plants were randomly chosen for different measures : The height of the plant; thickness of the main stem, the number of total stems; number of total nodes by main and secondary stems; number of reproductive nodes on the main and on the secondary stems; the number of pods on the main and on the secondary stems; the number of seeds per pod on the main and on the secondary stems.

Results

Results showed that plant height was reduced according to plant positions: plant located in C, SW and WS were higher than others. While, plant located in positions: C, NW ; NE ; SE and SW were thinner than others. Plant tillering was not affected by olive tree nearness. Also total nodes of main tiller was not affected. Secondary tillers show a great number of vegetative nodes in the positions S, SE and C from olive tree. Reproductive nodes on main and on secondary stems were not affected by position. Also pod numbers did not show any differences according to plant position from olive tree. However, the number of grains per pod on the main stem was greater in positions NW and NE. On the secondary stems, number of grains per pod was more important for plants located in positions: NE ; SE ; SW ; WN ; WS and center from olive tree.

Conclusions

This study indicated first results on olive tree impact on faba bean productivity in an agroforestry system under rainfed conditions. An adequate arrangement between tree and inter crops may be determined according to soil and weather conditions and also according to tree age and density.

References

Black C. and C. Ong. 2000. Utilisation of light and water in tropical agriculture. *Agricultural and Forest Meteorology* 104:25–47.

Nasrullahzadeh S., K. Ghassemi–Golezani, A. Javanshir, M.Valizade and M.R. Shakiba. 2006. Effects of shade stress on ground cover and grain yield of faba bean (*Vicia faba* L.). *Journal: Food, Agriculture & Environment (JFAE)* 5, 337-340.

Relationships between crop height, yield and lodging in organic oats

Döring, Thomas; Pearce, Helen

The Organic Research Centre, UNITED KINGDOM

Introduction

Oats (*Avena sativa*) are an important crop species in terms of resource-use efficiency because they typically require lower inputs than other cereals such as wheat. In addition, oats are known for their comparatively high competitiveness against weeds, partly because of their relatively tall stature. For these reasons, oats are particularly well-suited to organic and low-input systems. However, as crop tallness may have the disadvantage to increase the risk of lodging crop height carries potential trade-offs.

To understand the relationship between yield and lodging in oats under organic conditions, the performance of eight winter oat varieties was compared under two different fertility regimes on an organically managed site in the UK over two years as part of the QUOATS project. Fertility level was found to have a greater effect on lodging than on yield.

Materials and methods

Five husked and three naked winter oat varieties were each trialled under two fertility levels (untreated; and treated with organic chicken manure pellets (equivalent to 80 N/ha N). Trials were conducted at Wakelyns Agroforestry, Suffolk, UK, in two years (2009-10 and 2010-11). The field experiments were set up as two-factorial randomised complete block designs with three replicates. Lodging and yield assessments were carried out. Data were analysed using ANOVA.

Results and discussion

In the first year of trials (2009-10), the increased fertility had a significant effect on lodging in both the husked ($p < 0.01$) and the naked oats ($p < 0.05$), but did not significantly increase yield in either the husked or naked oat varieties. Lodging only occurred in plots where the average plant height was 95 cm or higher.

In the second year of trials (2010-11) no lodging was observed in any of the trial plots. This was a result of very short straw caused by a spring drought, and favourable weather at harvest. The added fertility did not significantly affect the yield of the husked oats, but it did significantly increase the yield of the naked oats ($p < 0.01$). In both years, there was a significant positive correlation between plant height and yield within the husked varieties, both in the low and in the high fertility treatment. Variety x fertility interactions on yield were non-significant in both years and for both husked and naked varieties. It should be noted that in each year, the trials followed a two-year clover ley, and therefore the baseline untreated fertility level is likely to be higher than that found in untreated non-organic soil.

Conclusions

Our results suggest that added fertility may increase lodging risk, and that this might out-weigh any benefit to yield conferred by the added fertility. Also, very short heights such as in cv. Balado (<70 cm high), conferring robust lodging resistance seems to carry a yield disadvantage. We conclude that oat breeding programmes for organic systems do not need to aim for short straw, because this would decrease the competitive strength of the crop against weeds. More research is needed to understand the interaction between lodging, crop height and yield under organic crop management.

Acknowledgements

The QUOATS project, led by Aberystwyth University (IBERS), is jointly sponsored by BBSRC, by Defra through the Sustainable Arable LINK Programme, by European Regional Development Funding through the Welsh Assembly Government's Academic Expertise for Business (A4B) Programme and through the Scottish Government Contract Research Fund with funding from AHDB and industry partners.

Level and causes of weed control in organic pea cultivation via intercropping under varying ploughing depths

Gronle, Annkathrin; Böhm, Herwart

Johann Heinrich von Thünen-Institute, GERMANY

Introduction

Semi-leafless peas have a weak weed suppressive ability and a reduction of soil tillage depth is often related to an increase in weed infestation in organic farming. The high weed suppressive ability is one important aspect of growing peas in an intercrop with oat. Therefore a pea-oat intercropping is a feasible weed management strategy for pea cultivation in reduced tillage systems. We determined the interaction of pea sole or intercropping and of shallow or deep ploughing on annual weed infestation. Of additional concern were the causes of weed suppression in pea-oat intercrops.

Materials and methods

A field and a divided pot experiment were conducted in Northern Germany (8.8°C, 760 mm, sandy loam). The field experiment was carried out as a split-plot design of four replications with two tillage systems as the whole plot and three cropping systems as the subplot in 2009 and 2010. Deep ploughing (DP) consisted of stubble tillage with a precision cultivator (9 cm depth) followed by mouldboard ploughing (25-27 cm depth), whereas shallow ploughing (SP) was carried out using a skim plough (twice, 4-6 and 10-12 cm depth). The factor cropping system comprised pea sole cropping, oat sole cropping and pea-oat intercropping. Annual weed biomass was determined at the beginning of pea flowering, pod development and at maturity.

The divided pot experiment was carried out under growth chamber conditions to examine the effect of a pea sole crop, an oat sole crop or a pea-oat intercrop on the growth of *S. media*, the most dominant weed species in the field experiments. The crop and the weed were separated by shoot or/and root barriers. The crop-weed interference treatments were root barrier, shoot barrier, root and shoot barrier or no barrier. The experiment was carried out as a complete randomized block design and was repeated three times. The weed shoot biomass was determined at the end of the experiment.

Data were analysed using Proc GLIMMIX and GLM in SAS 9.2.

Results

Pea sole cropping under SP resulted in a significantly higher annual weed infestation compared to DP (Fig. 1). The weed infestation was significantly lower in oat than in pea sole crops in both tillage systems. In addition, we found lower weed infestation in pea-oat intercrops than in pea sole crops under DP. Shallow ploughing caused a greater weed biomass accumulation in the intercrop than in the pea sole crop under DP at the first and second harvest date in both years, whereas intercropping under SP tended to result in lower values at crop maturity. We detected significant differences between tillage systems in pea-oat intercrops in both years and oat sole crops in 2010. The divided pot experiment showed no significant influence of the cropping system on the weed growth in both treatments with root barrier. The weed shoot dry weight was significantly greater in the pea sole crop than in the intercrop and the oat sole crop in both treatments without root barrier.

Discussion

We have observed significantly higher weed biomass values in SP than in DP except for the oat sole crop in 2009. This can be due to an accumulation of weed seeds in the upper soil levels under shallow ploughing (Colbach et al. 2000). Pea sole cropping resulted in higher weed growth than pea-oat intercropping and oat sole cropping in the field and the divided pot experiment treatments without root barrier. Field experiment data indicate that the weed suppressive ability of pea-oat intercrops enhances towards crop maturity. For this reason the intercrop only compensated for the higher weed growth under SP in comparison to pea sole cropping under DP at crop maturity. Cropping system effects on weed growth were detected in treatments without root separation in the pot experiment. Therefore weed suppression in intercrops is attributable to a below-ground interaction.

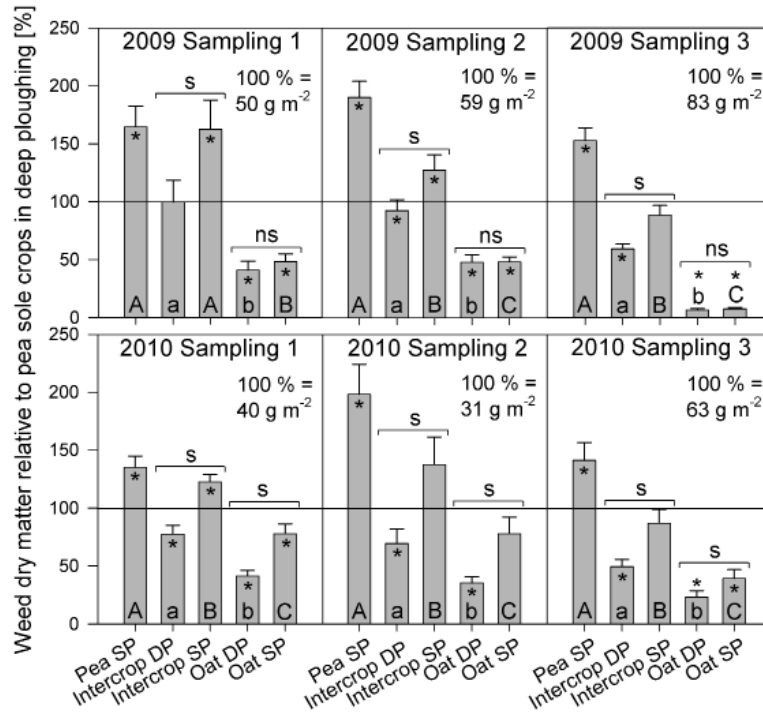

Figure 1: Relative weed biomass in pea and oat sole or intercrops under deep (DP) or shallow (SP) ploughing compared to the reference value pea sole cropping under DP at three sampling dates in 2009 and 2010. Different capital (SP) or lowercase (DP) letters indicate significant differences ($P < 0.05$) between cropping systems within the same tillage system. s/ns = significant/non-significant difference between DP and SP within the same cropping system, * = significantly different from the reference value pea sole cropping under DP.

References

Colbach et al. 2000: Eur. J. Agron. 13, 111-124.

Acknowledgements

Supported by the German Federal Program for Organic and Sustainable Farming

Interaction of pre-crop effects and nitrogen fertilization in sugar beet production

Jacobs, Anna; Koch, Heinz-Josef

Institute of sugar beet research, GERMANY

Introduction

In sustainable agricultural production, food security needs to come together with a reduction of environmental impacts. As a key factor, nitrogen (N)-fertilization requires a level of “as little as possible - as much as necessary” in all crop production systems. Hereby, positive pre-crop effects may optimize the N-efficiency through increased yields and/or a reduced need of fertilization (e.g. Rahimzadeh et al. 2010). For sugar beet production, interactions of pre-crop effects and N-supply were not quantified so far.

Materials and methods

Since 2007, a crop rotation trial was conducted near Göttingen, Germany (Stagnic Luvisol; 8.9°C; 620 mm). In three field replicates, pre-crops in sugar beet production were silage maize, winter wheat (+ catch crop), and grain pea (+ catch crop). The catch crop received 50 kg mineral N ha⁻¹. In 2011, a N-fertilization trial was additionally implemented with levels of 0, 40, 80, and 120 kg mineral N ha⁻¹, as calcium-ammonium-nitrate at sowing of sugar beet. Hereby, one of the N-levels corresponded to the mineral N-target value (target value - soil mineral N at 0-90 cm = amount of fertilizer) which was defined as dependent on the pre-crop: silage maize = 160 kg N ha⁻¹; winter wheat = 140 kg N ha⁻¹; grain pea = 140 kg N ha⁻¹ (see Fig. 1). Every four weeks, starting at canopy closure, the

N-status of the sugar beet was determined as the canopy greenness using a N-Tester (YARA, Dülmen, Germany; not shown). The yield of roots and leaves as well as the respective N-concentration (Fisons Instruments, Rodano, Italy) were analyzed at final harvest. The contents of sucrose, α-amino N compounds, and of further molassigenic substances in roots were analyzed by standard methods (Venema, Groningen, Netherlands; Mahn et al. 2002). The white sugar yield was calculated from beet yield, sucrose content, and losses through standard molasses and processing (Buchholz et al. 1995).

Results and discussion

In general, the white sugar yield was affected by pre-crop and by N-level (Fig. 1a). Highest yields were reached when grain pea had been the pre-crop (Fig. 1a) which had also been observed in the preceding years of the crop rotation experiment (not shown). The strongest differentiation by N-fertilization was found when silage maize had been cultivated before sugar beet (Fig. 1a). When grain pea and winter wheat had been pre-crops, a N-fertilization above the mineral N-target level did not significantly increase the white sugar yield. This was mainly induced by higher concentrations of α-amino N compounds up to 8-10 mmol kg⁻¹ which raised the standard molasses loss (Fig. 1b). At these high N-levels, the N-uptake by sugar beet

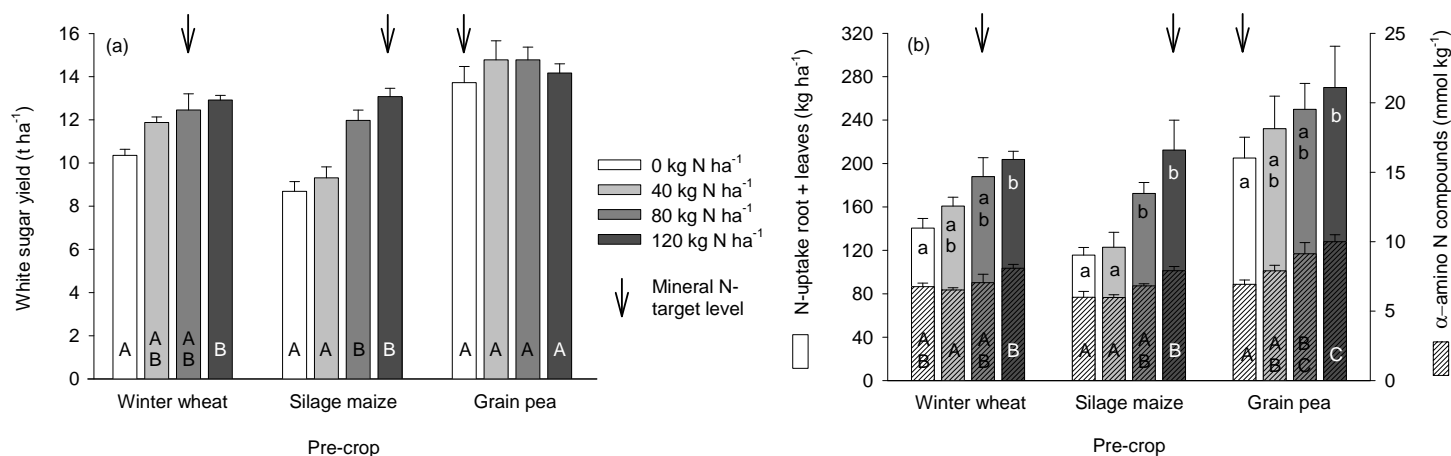

Fig. 1: White sugar yield (a), total N-uptake (b), and content of α-amino N compounds of sugar beet with different pre-crops and N-fertilization levels. Means and standard deviation (n = 3).

Different letters indicate significant differences (Tukey; p ≤ 0.05) between N-levels within the same pre-crop treatment.

reached ≥ 200 kg N ha⁻¹ (Fig. 1b) and the YARA N-Tester showed values ≥ 570 (not shown). Fertilization of 40 kg N ha⁻¹ lower than the mineral N-target level resulted in a slight but non-significant decrease in white sugar yield when silage maize and winter wheat had been cultivated as pre-crops.

We concluded that the demand of mineral N-fertilizer in sugar beet production depends on the pre-crop. A respective adjustment of the mineral N-target value would further optimize sugar beet production. Moreover, it did not seem to be necessary to raise the mineral N-target value for fertile sites.

References

- Buchholz, K., Märländer, B., Puke, H., Glattkowski, H., Thielke, K., 1995. Neubewertung des technischen Wertes von Zuckerrüben. Zuckerind. 120, 113-121.
- Mahn, K., Hoffmann, C., Märländer, B., 2002. Distribution of quality components in different morphological sections of sugar beet (*Beta vulgaris* L.). Europ. J. Agronomy 17, 29-39.
- Rahimizadeh, M., Kashani, A., Zare-Feizabadi, A., Koocheki, A.r., Nassiri-Mahallati, M., 2010. Nitrogen use efficiency of wheat as affected by preceding crop, application rate of nitrogen and crop residues. Australian Journal of Crop Science 4, 363-368.

Effects of No-till on Weed Control in Organic Corn Production

Lee, Byung-mo¹; Kwang-Lai, Park²; Lee, Sang-min²; Lee, Youn²; Cho, Jung-Lai²; An, Nan-Hee²; Jee, Hyeong-Jin²

¹Rural Development Administration, KOREA (REP); ²National Academy of Agricultural Science, Rural Development Administration, KOREA (REP)

Introduction

No-till cropping system controls soil erosion, builds soil quality, moderates soil temperature, reduces moisture loss and reduces machinery wear and fuel consumption compared to tillage-based system (Juergens et al., 2004). In addition, weed seeds tend to accumulate on the soil surface in no-till system, some proper weed management can reduce weed density very effectively (Young and Throne, 2004). In Korea, no-till researches on paddy-field were started in early '90s. But there is no research on upland crop system because of physical limitation of soil and climate. In 2011, we started research on no-till cropping system at organic corn field located in Kangwon province in Korea. This was the first attempt to no-till system on organic corn in Korea. The aim of this project was to identify the effects of no-till on soil and weed management.

Materials and methods

A field experiment was established in 2011 as a split-plot design includes two tillage systems [a conventional system (CS) and no tillage with cover crop mulch (NTS)] in the main plots, five fertilization rates for organic corn in the sub-plots. Five fertilization rates were oil cake (OC), 2X

oil cake (OC₂), liquid swine manure (LM), 2X liquid swine manure (LM₂), and no-fertilization (WF). The amount of oil cake was 20 kg/ha (which contains 8 kg N), and liquid manure was applied as same N equivalent. Soil chemical properties (such as soil pH, organic matter contents, total nitrogen contents, available phosphorous contents, and exchangeable cation contents) were examined during whole cropping period. Weeds were sampled three times by 50 cm x 50 cm quadrat, and examined weed species, population number and biomass. The differences between treatments were determined by the Duncan multiple Range Tests for a probability level of 5 % using SAS program (v. 9.0).

Results

Adequate supply of nutrient for no-till cropping is important. We applied green manure such as rye and hairy-vetch, and additional nitrogen source such as oil cake and swine manure. But those applications did not meet the nitrogen requirement of corn. Total nitrogen contents were low in no-till plots, compare to tillage plots. (Table 1) Corn yield was very low especially in no-till plots, because short of nitrogen supply in no-till plots.

Table 1. Soil chemical properties of experimental fields after harvest.

Treatments	pH (1:5)	OM (%)	T-N	Av. P ₂ O ₅ (mg/kg)	Ex. cation (cmol ⁺ /kg)				
					K	Ca	Mg	Na	
CS	WF	6.17	2.26	1.17	27.81	0.72	1.47	0.05	3.57
	LM	5.83	2.16	1.17	27.85	0.78	1.23	0.04	3.20
	LM ₂	5.78	2.03	1.02	37.81	0.74	1.05	0.05	2.57
	OC	5.39	2.02	1.00	41.99	0.52	1.36	0.06	3.77
	OC ₂	5.38	1.78	0.92	20.79	0.61	0.80	0.05	2.04
NTS	WF	5.49	1.47	0.68	45.68	0.64	0.83	0.04	2.06
	LM	5.61	1.57	0.79	74.12	0.70	0.72	0.05	1.70
	LM ₂	5.27	1.72	0.77	90.18	0.83	0.81	0.04	1.68
	OC	4.99	2.05	0.99	83.03	0.75	0.82	0.03	1.67
	OC ₂	5.13	1.67	0.81	84.98	0.77	0.86	0.04	1.90

CS: Conventional System, NTS: No-till System, WF: Without Fertilizer, LM: Liquid manure, LM₂: 2X Liquid manure, OC: Oil Cake, OC₂: 2X Oil Cake

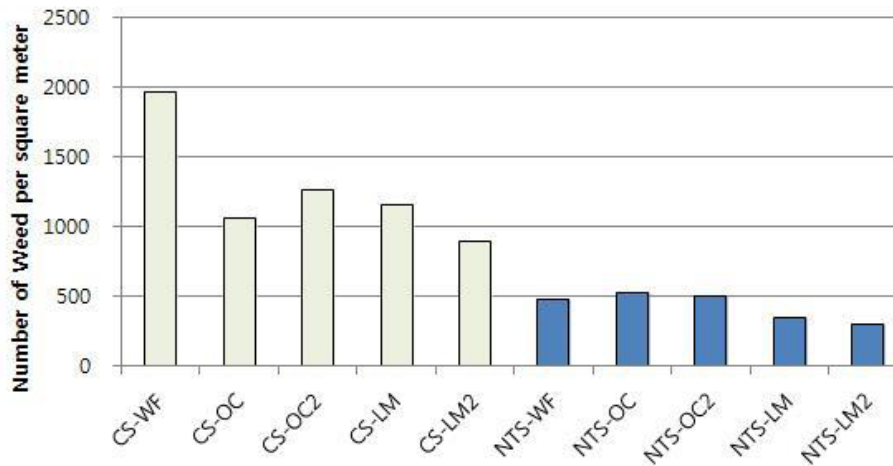

Fig 1. Number of weed population per 1m² in experimental fields.

CS: Conventional System, NTS: No-till System, WF: Without Fertilizer, LM: Liquid manure, LM2: 2X Liquid manure, OC: Oil Cake, OC2: 2X Oil Cake

As a matter of weed management, no-till was effective in number of weed per square meter. Number of weed per square meter in no-till plots was reduced about 66 % compare to tillage plots (Fig 1). In no-till plot, most of weed seeds were distributed in top soil layer, and quite a few seeds were distributed under 15 cm depth. But in tillage plot, weed seeds were distributed evenly in whole soil layer.

Conclusions

Number of weed per square meter in no-till system was significantly lower compared to conventional tillage. After soil tillage, weed seed germinated easily and rapidly grow compared to no-till system. In no-till system, proper

weed control such as mowing could make weed control efficiently. But, nutrition management is still needed to improve in organic no-till corn production.

References

- Juergens, L. A. 2004. Economics of alternative no-till spring crop rotations in Washington's wheat-fallow region. *Agronomy J.* 96:154-158.
- Young, F.L., M.E. Thorne. 2004. Weed-sepcies dynamics and management in no-till and reduced-till fallow cropping systems for the semi-arid agricultural region of the Pacific Northwest, USA. *Crop protection.* 23:1097-1110.

Long term effect of tillage practices and crop rotation on soil carbon storage under semiarid conditions

Martín-Lammerding, Diana¹; Tenorio, José Luis¹; Albarran, M^a del Mar¹; Navas, Mariela²; Walter, Ingrid¹

¹INIA, SPAIN; ²Centro de Biotecnología y Genómica de Plantas - UPM, SPAIN

Introduction

Conservation agriculture has been widely recognized as a way to maintain soil quality in agricultural systems without decreasing crop yields. Organic matter quantity and quality is a critical parameter for soil productivity. Specific fractions of soil C have demonstrated to be more useful than total C in detecting changes when different management practices are compared. Microbial biomass and enzyme activity play important roles in nutrient cycling and in organic matter transformations. Therefore they are specially sensitive to management effects such as tillage, fertilization and crop rotation (Ndiaye et al. 2000). Our objective was to study the effects of long term tillage systems (16 ys) on soil organic carbon content (SOC), dissolved organic carbon (DOC), basal soil respiration (C-CO₂), microbial biomass carbon (CMB) and on β-glucosidase activity in a Mediterranean Alfisol.

Materials and methods

Experimental design was a split plot with four randomized blocks. The main factor was tillage where Conventional Tillage (CT), Minimum Tillage (MT) and No Tillage (NT) practices were compared. Winter wheat monoculture was compared to a four year crop rotation (fallow–winter wheat–vetch–barley). Soil samples were taken at two depths in autumn and spring. SOC was analyzed following the wet oxidation method. DOC was extracted with distilled water (1:5). Basal soil respiration was assessed by determining the CO₂ emission after soil incubation at 28°C during 3 days. The CMB was estimated with the fumigation-extraction method. The activity of β-glucosidase was assessed using the method described in Strobl and Traunmüller (1993). Analysis of variance was performed using PROC MIXED (SAS Institute). All the soil properties (excluding C-CO₂/SOC and qCO₂) varied significantly with the date of sampling.

Table 1 Influence of the main treatments and their interactions on Soil Organic Carbon (SOC), Dissolved Organic Carbon (DOC), Basal soil respiration (C-CO₂), Microbial Biomass Carbon (CMB), metabolic quotient (qCO₂) and β-glucosidase activity. PROC MIXED variance analysis, significance level p<0.05.

Variable	SOC	DOC	DOC/SOC	C-CO ₂	C-CO ₂ /SOC	CMB	CMB/SOC	qCO ₂	β-Glucosidase
Effect	Pr>F								
Date	<0.0001	0.0015	0.0002	0.0006	0.1828	<0.0001	0.0005	0.1031	<0.0001
Depth (D)	<0.0001	<0.0001	<0.0001	<0.0001	0.1357	<0.0001	0.1321	0.4559	<0.0001
Date* D	<0.0001	0.0002	0.0047	0.0003	0.2287	0.0088	0.5536	0.8459	0.0448
Tillage (T)	0.9976	0.2815	0.3754	0.0928	0.5073	0.1604	0.6599	0.8681	0.1679
Date*T	0.007	0.9946	0.0039	0.8748	0.4342	0.2073	0.516	0.4008	0.5165
T*D	<0.0001	<0.0001	0.1835	<0.0001	0.833	<0.0001	0.2819	0.5258	<0.0001
Date*T*D	0.2594	0.9400	0.0906	0.2149	0.9663	0.5948	0.8372	0.3247	0.9511
Rotation (R)	0.0065	<0.0001	0.2705	0.2772	0.7684	0.4793	0.484	0.9775	<0.0001
Date*R	0.4908	0.5977	0.7793	0.5442	0.1357	0.6769	0.3675	0.712	0.5239
R* D	0.0757	0.5852	0.5197	0.476	0.1627	0.6214	0.1441	0.2896	0.3247
Date*R*D	0.6824	0.6209	0.8388	0.7755	0.8959	0.9686	0.5789	0.6462	0.0617
T*R	0.0028	<0.0001	0.5505	0.0391	0.6845	0.2579	0.7037	0.9025	0.0009
Date*T*R	0.7045	0.2563	0.6917	0.4205	0.9869	0.3247	0.8899	0.7345	0.5018
T*R*D	0.9369	0.6877	0.5071	0.5049	0.833	0.6923	0.6416	0.448	0.3716
Date*T*R*D	0.5081	0.4846	0.2716	0.316	0.02	0.5636	0.5488	0.4265	0.4301

Table 2 Mean values of Soil Organic Carbon (SOC), Dissolved Organic Carbon (DOC), Basal Soil Respiration (C-CO₂), Microbial Biomass Carbon (CMB) and β -glucosidase activity corresponding to both sampling dates and two depths for the different tillage systems. Means followed by different lowercase letter indicate significant differences among tillage systems for the same depth and date combination. Means followed by different uppercase letters indicate significant differences between depths for the same tillage and date combination (stratification). Significance level was set at $p < 0.05$.

Date	Depth	Tillage	SOC (g kg ⁻¹)		DOC (mg kg ⁻¹)		C-CO ₂ (mg kg ⁻¹ d ⁻¹)		CMB (mg kg ⁻¹)	β -glucosidase (μ g g ⁻¹ 3h ⁻¹)		
OCTOBER 2010	0-7.5 cm	CT	6.12	b	45.21	b	24.94	c	269.63	C	78.00	C
		MT	7.32	abA	50.74	bA	30.20	bA	336.27	bA	112.03	bA
		NT	9.21	aA	64.16	aA	40.12	aA	426.69	aA	145.60	aA
	7.5-15 cm	CT	5.98	a	42.00		22.56	a	262.23	A	79.72	
		MT	5.16	bB	39.56	B	19.25	abB	185.57	bB	58.35	B
		NT	4.93	bB	42.37	B	17.00	bB	195.92	bB	49.10	B
APRIL 2011	0-7.5 cm	CT	6.17	c	41.25	bB	25.87	b	282.71	B	54.49	cA
		MT	7.55	b	48.34	b	30.43	ab	386.55	Ab	85.17	bA
		NT	8.94	aA	63.95	aA	37.73	aA	519.38	aA	120.94	aA
	7.5-15 cm	CT	6.31		50.73	A	27.36		338.81		48.53	aB
		MT	6.61		44.40		25.78		315.65		38.79	abB
		NT	6.36	B	48.55	B	25.86	B	303.15	B	32.73	bB

Results and discussion

Biological properties showed a high seasonality effect mainly due to differences in soil conditions and crop stage of growth. Depth was also significant for most of the variables, with lower values usually found in deeper layers. Tillage effect was not significant for any property but the interaction D*T was highly significant. Crop rotation effect as well as the interaction T*R were only significant in the case of SOC, DOC and β -glucosidase activity. DOC varied significantly between dates in the 7.5-15 cm layer in the case of CT, where a 21% higher value was found in April 2011 compared to Oct 2010. The same trend occurred with the SOC and CMB contents. The β -glucosidase activity was the only test showing differences between sampling dates at both studied depths, where higher values were found in Oct 2010 than in April 2011. This might be due to the fact that this enzyme is sensitive to inputs of cellulose; consequently, its activity was higher 3 months after the crop residues were left on the soil surface. The interaction D*T was significant for all the analyzed variables. This effect is shown in Table 2, which the differences among tillage practices occurred mainly in the surface.

Conclusions

Differences between depths mainly occurred under NT and MT where a pronounced stratification of the variables was found. The distribution of CMB, and thus the C-CO₂ and the activity of β -glucosidase may be closely related to the placement of crop residues, being therefore greatly influenced by tillage. The sensitivity of CMB, C-CO₂ and β -glucosidase activity to soil management indicate that they may be good indicators of changes in soil, although seasonality should be taken into account in order to assess soil quality. Reducing tillage intensity and avoiding long fallow periods may be a more sustainable management practice under semiarid conditions than intensive tillage.

References

- Ndiaye, EL, JM Sandeno, D McGrath, RP Dick. 2000. Integrative biological indicators for detecting change in soil quality. *Am.J.Altern.Agric.*15:26-36.
- Strobl, W, M Traunmuller. 1993. Bestimmung der β -glucosidase Aktivitat. *Bodenbiologische Arbeitsmethoden*. Schinner et al. (eds). Springer, Berlin, Germany, pp.128-130.

Wheat-pea intercrops – Effects of mixing ratio and sowing date

Neugschwandtner, Reinhard; Herz, Patrick; Kaul, Hans-Peter
BOKU University of Natural Resources and Life Sciences Vienna, AUSTRIA

Introduction

In temperate agricultural systems, there is an increasing interest in intercropping cereal-legume mixtures both for forage production (Anil et al., 1998) and for grain production (Bulson et al., 1997). Reasons for growing intercrops are the better utilization of limiting growth factors (water, nutrients, light) and the minimization of detrimental effects on the crop stand, e.g. due to diseases, pests and weeds (Aufhammer, 1999).

Materials and methods

A field experiment was conducted in 2010/2011 at the Experimental Farm of BOKU University in Raasdorf which is located in the east of Vienna (Austria). The soil is a silty loam classified as Chernozem. Average long-term precipitation and temperature are 546 mm and 9.8°C, respectively.

Pure stands of wheat (*Triticum aestivum* L. cv. Xenos) and pea (*Pisum sativum* L. cv. Cherokee) were established with 300 (wheat) and 80 (pea) viable seeds m². Four wheat-pea

intercropping mixtures were sown in replacement series consisting of following ratios (%): 75:25, 50:50, 25:75 and 12.5:87.5. Sowing was performed in autumn (October 10th, 2010) and in spring (March 14th, 2011).

Results

Grain yield, kernels ear⁻¹ or pod⁻¹, respectively, and thousand kernel weight (TKW) of wheat and pea as affected by mixing ratio and sowing date are summarized in Table 1. Decreasing ratios generally impaired the grain yields of each crop. Anyhow, the grain yield of wheat just slightly decreased with decreasing ratio in the intercrops whereas the pea grain yield was strongly affected, e.g. with a share of 25% in the mixture the grain yield of wheat decrease from 417 to 353 g m⁻² whereas the pea yield decreased from 446 to 15 g m⁻². Sowing in autumn resulted in significantly higher wheat grain yields compared to spring sowing whereas pea grain yields were not affected by sowing date.

Table 1. Grain yield, number of kernels ear⁻¹ or pod⁻¹, respectively, and thousand kernel weight (TKW) of wheat and pea as affected by mixing ratio and sowing date. Different letters indicate significant differences between means (SNK test).

	Wheat			Pea		
	Grain yield (g m ⁻²)	Kernels ear ⁻¹ (n)	TKW (g)	Grain yield (g m ⁻²)	Kernels pod ⁻¹ (n)	TKW (g)
Mixing ratio						
100% wheat	417 ^{ab}	31.5 ^c	39.6 ^b			
75:25	468 ^a	33.0 ^c	40.6 ^b	15 ^d	3.2 ^b	144 ^c
50:50	410 ^{ab}	34.8 ^{bc}	40.1 ^a	56 ^d	3.4 ^b	152 ^{bc}
25:75	353 ^b	38.6 ^b	43.1 ^a	129 ^c	3.6 ^a	158 ^{ab}
12.5:87.5	264 ^c	42.8 ^a	43.5 ^a	268 ^b	4.0 ^a	163 ^a
100% pea				446 ^a	4.1 ^a	167 ^a
Sowing date						
Autumn	438 ^a	36.1 ^a	42.3 ^a	185 ^a	3.6 ^a	167 ^a
Spring	327 ^b	36.2 ^a	40.5 ^b	181 ^a	3.7 ^a	146 ^b
ANOVA GLM						
Mixing ratio (M)	***	***	***	***	***	***
Sowing Date (S)	***	n.s.	**	n.s.	n.s.	***
M×S	n.s.	n.s.	n.s.	n.s.	n.s.	***

Levels of statistical significance are p<0.05 (*), p<0.01 (**), and p<0.001 (***).

Number of kernels per ear⁻¹ or kernels per pod¹, respectively, were not affected by the sowing date but by the mixing ratios. A decreasing share of wheat in the mixtures increased the number of kernels per ear⁻¹ whereas the number of kernels per pea pod⁻¹ decreased. The thousand kernel weight (TKW) of wheat was higher when wheat was sown in autumn than in spring and it increased with decreasing shares of wheat in the mixtures. The significant mixing ratio x sowing date interaction for the TKW of peas was due to a steep decrease of the pea TKW with decreasing pea shares in the spring sown treatments whereas just a slight decrease was observed in the autumn sown treatments (data not shown).

Conclusions

Wheat was clearly the dominant partner outcompeting pea in the mixtures with both sowing dates (autumn and spring). The number of kernels per ear⁻¹ or kernels

per pod⁻¹, respectively, were affected by mixing ratio. Additionally, the sowing date influenced the TKW.

References

- Anil, L., Park, J., Phipps, R.H., Miller, F.A., 1998. Temperate intercropping of cereals for forage: A review of the potential for growth and utilization with particular reference to the UK. *Grass and Forage Science* 53, 301–317.
- Aufhammer, W., 1999. *Mischanbau von Getreide- und anderen Koernerfruchtarten. Ein Beitrag zur Nutzung von Biodiversitaet im Pflanzenbau*. Ulmer Verlag, Stuttgart.
- Bulson, H.A.J., Snaydon, R.W., Stopes, C.E., 1997. Effects of plant density on intercropped wheat and field beans in an organic farming system. *Journal of Agricultural Science* 128: 59–71.

Oats-pea intercrops – Effects of mixing ratio and N fertilization

Neuschwandtner, Reinhard; Kaul, Hans-Peter

BOKU University of Natural Resources and Life Sciences Vienna, AUSTRIA

Introduction

Field crop mixtures are still extensively grown in traditional agricultural systems of developing countries (Biabini et al., 2009). There is also in increasing scientific interest in intercropping systems in temperate regions for developing sustainable farming systems (Anil et al., 1998). Advantages of intercropping have been attributed to greater long-term yield stability, a more efficient utilization of the finite resources light, nutrients and water, and reduced weed and disease pressure (Musa et al., 2010).

Material and Methods

A field experiment was conducted in 2010 and 2011 at the Experimental Farm of BOKU University in Raasdorf which is located in the east of Vienna (Austria). The soil is a silty loam classified as Chernozem. Average long-term precipitation and temperature are 546 mm and 9.8°C, respectively.

Pure stands of oats (*Avena sativa* L. cv. Effektiv) and pea (*Pisum sativum* L. cv. Lessna) were established with 350 (oats) and 80 (pea) viable seeds m⁻². Three oats-pea intercropping mixtures were sown in replacement series consisting of following ratios (%): 75:25, 50:50 and 25:75. Pure stands and mixtures were fertilized with different amounts of N fertilizer (calcium ammonium nitrate, 27% N, Nitramoncal): 0, 60 and 120 kg N ha⁻¹, respectively, which were applied in two equal splits.

Land equivalent ratio (LER) indicating possible yield advantages of intercrops was calculated according to Mead and Willey (1980).

Results

Dry matter and grain yield and LER are summarized in Table 1. The oats pure stands produced the highest dry matter yields and the pea pure stands produced the lowest

Table 1. Dry matter and grain yields (g ha⁻¹) of oats-pea intercrops as affected by intercropping ratio, N fertilization and year. Different letters indicate significant differences between means (SNK test).

	Dry matter		Grain yield				LER
	Oats+Pea (g m ⁻²)	Oats+Pea (g m ⁻²)	Oats (g m ⁻²)	Oats (%)	Pea (g m ⁻²)	Pea (%)	
Mixing ratio							
100% oats	1204 ^a	508 ^b	508 ^a	100 ^a			
75:25	1206 ^{ab}	466 ^{ab}	441 ^b	94.3 ^a	25 ^d	5.6 ^d	0.93 ^a
50:50	1151 ^{ab}	454 ^{ab}	383 ^c	84.6 ^b	71 ^c	15.4 ^c	0.91 ^a
25:75	1105 ^b	443 ^c	268 ^d	59.9 ^c	175 ^b	40.1 ^b	0.85 ^a
100% pea	1083 ^b	557 ^a			557 ^a	100 ^a	
Fertilization							
0 kg N	1045 ^b	449 ^b	353 ^b	81.0 ^a	208 ^a	44 ^a	0.98 ^a
60 kg N	1201 ^a	508 ^a	427 ^a	86.7 ^a	209 ^a	38.3 ^a	0.92 ^a
120 kg N	1203 ^a	499 ^a	420 ^a	86.4 ^a	204 ^a	38.6 ^a	0.79 ^b
Year							
2010	1181 ^a	484 ^a	410 ^a	88.0 ^a	194 ^a	37.0 ^b	0.94 ^a
2011	1119 ^b	488 ^a	390 ^a	81.4 ^b	220 ^a	43.6 ^a	0.85 ^b
ANOVA GLM							
Mixing ratio (M)	*	***	***	***	***	***	n.s.
Fertilization (F)	***	**	**	n.s.	n.s.	n.s.	***
Year (Y)	*	n.s.	n.s.	*	n.s.	**	*
M×F	n.s.	n.s.	n.s.	n.s.	n.s.	n.s.	n.s.
M×Y	n.s.	n.s.	n.s.	***	*	*	n.s.
F×Y	n.s.	n.s.	n.s.	n.s.	n.s.	n.s.	n.s.
M×F×Y	n.s.	n.s.	n.s.	n.s.	n.s.	n.s.	n.s.

Levels of statistical significance are p<0.05 (*), p<0.01 (**) and p<0.001 (***).

ones. Fertilization increased dry matter. The highest grain yields were achieved by pea in pure stands (due to the high harvest index of pea), the lowest ones in the oats pure stands. The intercrops ranged in between (except for the 25% oats / 75% pea intercrop). Oats was the dominant partner in the intercrops producing a considerably higher share of the total grain yield compared to the sowing ratios. N fertilization generally increased the oats yields whereas it did not affect the pea yields.

The Land Equivalent Ratios (LER) of oats-pea intercrops were below unity indicating a lower grain productivity of these systems compared to the pure stands. The lowest LER was achieved in the highest N treatment supporting the observation by Hellou and Crozat (2006) that cereal-legume intercrops might be especially of interest in low input systems.

Conclusions

Oats was the dominant partner in the mixtures strongly outcompeting pea in oats-pea intercrops grown in Eastern Austria. The dominance of oats was generally enhanced with N fertilization. The Land Equivalent Ratios (LER) of intercrops were <1 regarding the grain yields, thus no quantitative yield advantage could be achieved by intercropping.

References

- Anil, L., Park, J., Phipps, R.H., Miller, F.A., 1998. Temperate intercropping of cereals for forage: A review of the potential for growth and utilization with particular reference to the UK. *Grass and Forage Science* 53, 301–317.
- Biabani, A., 2009. Agronomic Performance of Intercropped Wheat Cultivars. *Asian Journal of Plant Sciences* 8, 78–81.
- Corre-Hellou, G., Fustec, J., Crozat, Y., 2006. Interspecific competition for soil N and its interaction with N₂ fixation, leaf expansion and crop growth in pea-barley intercrops. *Plant and Soil* 282, 195–208.
- Mead, R., Wiley, W.R., 1980. The concept of land equivalent ratio and advantages in yields from intercropping. *Experimental Agriculture* 16, 217–228.
- Musa, M., Leitch, M.H., Iqbal, M., Sahi, F.U.H., 2010. Spatial arrangement affects growth characteristics of barley-pea intercrops. *International Journal of Agriculture and Biology* 12, 685–690.

Development and Validation of Practical Methods for the Determination of Dry Matter Yield in Grass Silage Swards

Pakarinen, Kirsi; Hyrkäs, Maarit; Juutinen, Elina

MTT Agrifood Research Finland, FINLAND

Introduction

Information of dry matter yield (DMY) would give the farmer a concept of yield potential of the whole farm and of each plot. In the long run, it could aid the farmer to find sites with weak performance, so that the use of input goods (e.g. fertilizers, seed) and more pronounced improvements may be allocated optimally. Weighing the harvested material is an accurate method to determine DMY, but does not allow for information on DMY of standing swards and is seldom site-specific.

Tools like disk meter, capacitance meter and sward stick are available for on-field determination of DMY. Primarily they are designed and satisfactorily validated for pastures. None of these tools can measure DMY of lodged, low-density or highly stem containing swards accurately. In aftermath vegetation they can give reliable results. (Virkajärvi, 1999.)

The aim of this study in KARPE-project was to prepare an easy-to-apply and practical methodology which can produce a satisfactory result about DMY in timothy-meadow fescue swards at silage stage.

Materials and methods

The study comprised of four phases: A) testing of several methods under field and experimental plot conditions; B) evaluation of the practicability and the accuracy of these methods in determining DMY; C) preparation of a methodology based on the best methods; D) validation of the new methodology.

During phase A, the methods tested in timothy-meadow fescue swards were: photography of the sward; measurement of the average stretched total height (cm); visual observation of density and lodging; determination of the volume of herbage per defined area ($\text{dm}^3 \text{m}^{-2}$); sampling with a cutting frame, weighing and drying of the herbage. In phase B, the most practicable and rapid

methods were chosen based on experiences of the workers and, evaluated for accuracy in determining DMY by (e.g. analysis of regression).

In phase C, a data set ($n = 202$) of average stretched total height and DMY from nine different plot-scale experiments was used to create a regression model (regression of random coefficients, Proc MIXED in SAS 9.2). For the farm-scale model, the level of DMY was slightly decreased and the effect of sward density was incorporated into the model. For phase D, the preliminary methodology was tested for accuracy under field conditions.

Results and discussion

From the methods tested in phase A, sampling with a cutting frame, weighing and determining of DM content was found to be an accurate but laborious method. The average stretched total height explained well the DMY (Figure 1a), especially in the first harvest, and the measurement was easy enough to perform on farm conditions. Other methods were not accurate for DMY determination.

The farm-scale model with the integrated effect of density and the lower DMY level (Figure 1b) proved to be sufficiently accurate under real on-farm conditions. A guideline based on this methodology was published in the Internet to be available for farmers.

It is assumed that in the future, attributable to new environmental legislation, farmers will be obligated to calculate the nutrient cycles and nutrient use efficiencies of swards for each field plot in detail. The information of DMY is a key factor to do this accurately. We are developing the model for better accuracy and the guideline produced in KARPE-project may act as one tool to determine DMY of standing swards.

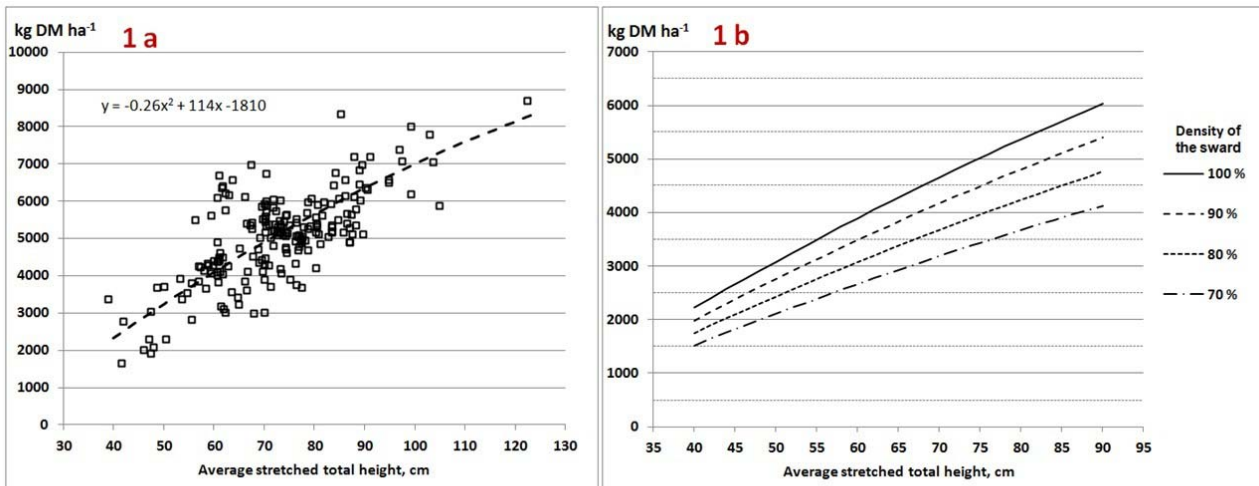

Figure 1a. Relations of average stretched total height (cm) and dry matter (DM) yield (kg DM ha⁻¹) in timothy-meadow fescue swards in experimental plots. **1b.** The modified model for practical farm-scale use.

Conclusions

Combining the measurement of average stretched total height and the density of the sward had a good correlation with dry matter yield, especially during the first harvest of timothy-meadow fescue silage swards. In addition, these measurements were easy to perform under farm conditions. A guideline based on this methodology was created, validated and published for practical use.

References

Virkajärvi, P. 1999. Comparison of three indirect methods for prediction of herbage mass on timothy-meadow fescue pastures. *Acta Agriculturae Scandinavica, Section B Soil and Plant Science* 49:75–81.

Response of some root crops to one operation strip tillage and in row liquid swine manure soil injection

Piechota, Tomasz; Majchrzak, Leszek; Idziak, Robert; Sawinska, Zuzanna; Dach, Jacek; Pilarski, Krzysztof
Poznań University of Life Sciences, POLAND

Introduction

Liquid swine manure (LSM) is good resource of plant nutrients but poor management can result in high air and water pollution, the poor response of crop or even plant injury (Chambers et al. 2000, Chopart et. al. 2007). High ammonia and odor emissions occurs when LSM is surface broadcast. Incorporation or injection reduces volatilization but requires additional tools, increased horsepower and application time.

Conservation tillage adds a new challenge to proper manure incorporation. Aggressive tools do a good job covering manure but reduce residue cover below an acceptable level.

Strip tillage is a new technology well established in USA but not so popular in Europe. Strip till unit cultivates strips for future row of plants but row middles are left uncultivated. This system works well for wide row crops like corn, sugar beet, cotton, sunflower. It combines benefits of intensive cultivation in crop row and no-till between rows (Hendrix et. al. 2004).

Combining strip tillage with injection of LSM may give many advantages. Reduced ammonia volatilization, less odor, nutrients applied close to plants, undisturbed soil cover between rows but good seedbed in crop row, savings in time, labor and fuel and all of this achieved in one operation. But there are also some concerns about crop injuries from LSM concentrated just under plants. High concentration of ammonia and salts combined with high oxygen demand may injure seedlings or inhibit root development, it is especially dangerous for root crop, when not only quantity but also quality of yield is affected.

Materials and methods

Field experiments were conducted in 2010 and 2011 at Wielkopolska Region in Poland to determine effect of tillage and LSM application on plant establishment and early growth of carrot, sugar beet, turnips and white radish. Studies were established as a cover crops after winter triticale. Conventional tillage were compared to strip till. Four row strip tillage machine consisted of four units attached to frame. Every unit included coulter, shank, covering disks and rolling basket. Cultivated

strips were 25 cm wide and 20 cm deep, with row spacing 45 cm. The applicator consisted of a 1000 l plastic tank mounted on the top of frame, valve, four delivery hoses and injection tubes installed just after strip tiller shanks. Average injection depth was 10 cm. On plots with conventional tillage machine was mounted over ground and additional splash plates were added for uniform broadcast application. LSM was compared with broadcasted mineral fertilizer and untreated control.

Results

Generally there was no negative effect of in row injection of LSM made in one operation with strip tillage. Index of root injury (1-100) had very low values, below 7, at all species and all treatments and in no one crop after LSM injection extended that observed after mineral fertilization.

Growing conditions in the first season were very unfavourable and plant biomass very low, but in the second year yields of turnip and radish roots reached 30 t/ha at combinations with LSM, again no negative effect of in row LSM injection occurred in yield of roots or leaves in all tested crops.

Conclusions

General conclusion from this study is that one operation strip tillage with in row injection of LSM was safe for seedlings of sugar beet, carrot, turnips and root radish and had no negative effect for its further growth. It makes opportunity for injection of LSM on low cost and in conservation tillage programs.

References

- Chambers B., Smith K., Pain B. 2000: Strategies to encourage better use of nitrogen in animal manures. *Soil Use and Management*, 16:157-161.
- Chopart J., Payet N., Saint Macary H., Vauclin M. 2007. Is maize root growth affected by pig slurry application on a tropical acid soil. *Plant Root*, 1:75-84.
- Hendrix B., Young B., Chong S., 2004. Weed management in strip tillage corn. *Agron. J.*96:229-235.

Evaluation of nitrogen efficiency indexes in cereals crop production in Mediterranean agro-ecosystems

Fiore, Maria Carola; Bono, Giuseppe; Poma, Ignazio

University of Palermo, Dipartimento dei Sistemi Agro Ambientali, ITALY

Introduction

Crop rotations are considered important factor to maintain adequate soil matter content and to reduce chemical nutritional intake (1). Thus, nitrogen fertility management represent an important aspect to realize sustainable cereal systems in the Mediterranean environment. To date, several studies have been carried out to evaluate the influence of crop management to nitrogen fertilization uptake and nitrogen efficiency (2,3). The aim of the present study was to study the effects of preceding crop on nitrogen use efficiency parameters of three cereal crops in a Mediterranean environment in order to ensure adequate nitrogen uptake and utilization and maximum crop yield.

Materials and methods

A field experiment was carried out at the Agricultural Research Stations of University of Palermo in Cammarata (AG-Italy) for two growing seasons (2008 -'10). The experimental design was a split-split plot with three replications. The main plot treatments were three nitrogen rates of 0, 60, and 120 kg N ha⁻¹, dispensed before seeding and at five leaves stage in equal doses; the sub plot treatments were durum wheat and pea as preceding crop; the sub-sub treatments were durum and common wheat, and barley. Sowing was carried out in the middle of November. The following N efficiency parameters were calculated: N use efficiency (NUE) as the ratio of grain yield and N supply, nitrogen utilization efficiency (NUE) as ratio of grain yield to total plant N uptake, nitrogen physiological efficiency (NPE) as ratio of (yield at N_x–yield at N₀) to (N uptake at N_x–N uptake at N₀), nitrogen agronomic efficiency (NAE) as the ratio of (yield at N_x–yield at N₀) to applied N at N_x and nitrogen apparent recovery fraction (NFR) as the ratio of (N uptake at N_x–N uptake at N₀) to applied N at N_x (3,5,6,7).

Results and discussion

The results are showed in tab. 1. On average, NUE and NUE values were significantly higher in the preceding pea crop treatment than in monoculture, according to that previously reported (4,6). The increase of N fertilizer rate caused a significantly decrement of NUE as well as NUE values. This result suggests that the advantage of pea

crop is a combination between increased N availability and other effects of crop rotation. Moreover, the NUE value was different depending on the cereal species; indeed the NUE in barley was higher compared with the NUE of other wheat species, probably due to its better ability to convert N uptake and translocation in grain fill, as also confirmed for NUE. On the other hand, not significant variation among treatments was recorded for other N efficiency indexes except for NFR affected only by preceding crops. It was observed an increment of values in cereal/pea rotation. This result could be due to a better development of cereal root system in favorable edaphic conditions as found in maize in succession to soybean crop compared to monoculture (8). This results cold be attributed to an increase of the N losses by leaching, volatilization and immobilization in monoculture.

Conclusions

The results of the present research furnish useful information regarding the role of soil N availability and legumes in crop rotations in a Mediterranean cereal crop system. Our data, together with further studies, could suggest technical solutions useful in specific agro-environmental contexts to rationalize the efficiency of nitrogen utilization in cereals crop production in southern Italy.

References

- 1) Bremer E et al. (2008) Soil Sci. Soc. Am. J. 72: 970–974.
- 2) Lopez-Bellido RJ and Lopez-Bellido L (2001)Field Crops Reserch, 71, 31-46.
- 3) Delogu G et al. (1998). Eur. J. Agron. 9: 11-20.
- 4) Badaruddin M and Meyer DW (1994). Crop. Sci. 34: 1304-1309.
- 5) Moll RH et al. (1982). Agronomy Journal 74, 562-574.
- 6) Pierce, FJ and Rice CW (1988). ASA Special Publication 51 :21-42.
- 7) Huggins DR and Pan (2003). Agronomy Journal, 85: 898-905.
- 8) Varvel, GE and Peteron, TA (1990). Agronomy Journal, 82: 935-938

Tab. 1: Effect of main factors on N efficiency parameters and their interactions

main factor		NUE	NUtE	NPE	NAE	NRF
genotype	durum wheat	16.36 c	18.00 c	21.06 ns	12.03 ns	62.96 ns
	barley	25.75 a	29.20 a	24.85 ns	11.5 ns	65.00 ns
	common wheat	20.00 b	22.54 b	20.33 ns	9.73 ns	60.97 ns
N application	N0	23.88 a	23.88 a	--	--	--
	N60	20.93 b	22.68 ab	26.02 ns	10.26 ns	62.79 ns
	N120	18.07 c	21.00 b	14.49 ns	9.09 ns	58.99 ns
Preceding crop	durum wheat	17.72 b	21.40 b	26.09 ns	11.65 ns	46.99 b
	pea	22.25 a	23.64 a	14.42 ns	7.69 ns	74.77 a
year	2008/2009	23.18 a	25.90 a	16.39	9.07	44.48
	2009/2010	20.01 b	22.55 b	20.20	9.66	40.62
Interaction						
year*N		*	*	ns	ns	ns
prec*N		ns	**	ns	ns	ns
year*species		**	*	**	ns	ns
prec*species		ns	*	***	***	ns
N*species		*	ns	ns	ns	ns
prec*N*species		**	***	ns	ns	ns
year*prec*species		ns	ns	ns	ns	ns
year*N*species		ns	*	ns	ns	ns
year*prec*N*species		ns	ns	ns	ns	ns

a, b, c: values within columns followed by the same letter are not significantly different.

*, **, ***: values significantly different at $P \leq 0.05$, $P \leq 0.01$ and $P \leq 0.001$, respectively; ns: not significant

Impact of soil tillage and catch crops on maize yields

Prochazka, Jaromir¹; Prochazkova, Blanka²

¹Agricultural Research, Ltd., CZECH REPUBLIC; ²Mendel University, CZECH REPUBLIC

Introduction

For farmers, growing of catch crops is both advantageous and disadvantageous. One of the most positive aspects of this method is the supply of top quality organic matter into the soil. The biomass of catch crops shows positive effects on soil structure, water stability of soil aggregates, content of oxidable carbon in soil, soil respiration etc. These properties are manifested not only in the year of catch crops sowing but also in the years to follow and can be manifested even in increased yields of the subsequent crops. Kramberger et al. (2009) tested some selected catch crops when growing maize and observed positive effects of this method on grain yields. Rüegg et al. (1998) recommended to grow winter catch crops in systems of minimum tillage as a method of elimination of some unfavourable factors. After overwintering catch crops the soil tillage can begin later and with some difficulties (higher soil moisture, lower soil temperature, plant residues).

Materials and methods

Within the period of 2004 – 2008, small plot field experiments were established to test some selected species of stubble catch crops grown as a source of green manure: 1. White mustard (*Sinapis alba*) 2. Phacelia (*Phacelia tanacetifolia*) 3. Italian annual ryegrass (*Lolium multiflorum* var. *westerwoldicum*) 4. Midsummer rye (*Secale cereale*, var. *multicaule*) 5. Safflower (*Carthamus tinctorius*) 6. Canarygrass (*Phalaris canariensis*) 7. Fodder

mallow (*Malva verticillata*) 8. White clover (*Trifolium repens*). All catch crop stands were established after the harvest of winter wheat. Two methods of tillage were used viz. either ploughing in the autumn or shallow tillage in early spring.

Results and discussion

Obtained yields indicate a positive response of maize crops to the soil tillage performed in the autumn. As compared with the shallow tillage performed in the spring, similar and/or even higher yields of maize grain were recorded in all time replications after the autumn ploughing of catch crops. However, these differences were relatively low and statistically nonsignificant. It seems that one of factors that caused a reduction of maize grain yield could be the overwintering of catch crops and, thus, a slower warming-through of no-tilled soil that inhibited the growth and development of young maize seedlings. Similar results were mentioned also by e.g. Hula and Prochazkova et al. (2008) who mentioned that under conditions of agricultural practice this negative effect is usually compensated by nitrogen fertilisation. As far as the exploitation of catch crops was concerned, the lowest yields were always recorded in variants without catch crops (Aister et al., 2006). The highest yields of maize grain were obtained after white mustard and phacelia, i.e. after catch crops producing the highest amounts of biomass.

Average grain maize yields (t.ha⁻¹) after different catch crops (2005 – 2008)

Variant	Autumn ploughing		Spring shallow tillage	
	t.ha ⁻¹	%	t.ha ⁻¹	%
No catch crop	4.52	100.0	4.23	100.0
White mustard	6.20	137.2	5.26	124.3
Phacelia	5.82	128.8	4.83	114.2
Italian annual ryegrass	5.26	116.4	4.58	108.3
Midsummer rye	5.40	119.5	4.78	113.0
Safflower	5.37	118.8	4.67	110.4
Canarygrass	4.98	110.2	4.35	102.8
Fodder mallow	4.93	109.1	4.49	106.1
White clover	4.81	106.4	4.40	104.0
Mean	5.25	-	4.62	-
D _{T0.05}	1.83	-	1.42	-

Conclusions

Basing on results of four-year experiments it can be concluded that the stubble catch crops showed a positive effect on maize grain yields. Although the differences recorded in individual years were statistically insignificant due to a high variability of yields, a positive trend could be observed in all experimental years. The highest yields of maize grain were obtained after white mustard and phacelia.

Acknowledgement

This study was financially supported by NAZV agency research project QJ 1210008.

References

- Astier, M. – Maass, J.M. et al., 2006. Short term green manure and tillage management effects on maize yields and soil duality in an Andisol. *Soil a. Till. Res.*, 88, 1-2:153-159
- Hůla, J – Procházková, B. et al., 2008. *Minimum Soil Tillage*, Profi Press Praha 248 pp. (In Czech)
- Kramberger, B. – Gselman, A. et al., 2009. Effect of cover crops on soil mineral nitrogen and on the yields and nitrogen content of maize. *Europ. J. of Agron.*, 31, 2:103-109
- Rüegg, W.T. – et al., 1998. Accumulation of dry matter and nitrogen by minimum-tillage silage maize planted into winter cover crop residues. *Europ. J. of Agron.*, 8, 1-2:59 – 69

Effect of different intensity of soil tillage on winter wheat yields

Prochazkova, Blanka¹; Prochazka, Jaromir²; Houst, Martin¹; Hledik, Pavel³

¹Mendel univerzity in Brno, CZECH REPUBLIC; ²Agricultural Research, Ltd., Troubsko, CZECH REPUBLIC;

³Research Institute of Plant Production, Prague, CZECH REPUBLIC

Introduction

At present there is a wide selection of soil tillage technologies and methods of winter wheat stands establishment. To select the suitable technology it is necessary to consider concrete growing conditions, i.e. site conditions and placement of winter wheat in the crop rotation system. The yield response of winter wheat to the reduction of the depth and intensity of soil tillage depends on growing conditions. More favourable conditions that enable the application of minimum tillage technologies generally exist in drier and warmer regions (Hemmat, Eskandari, 2006, Hùla, Procházková et al., 2008, Šíp et al., 2009 and others).

Materials and methods

Evaluations were done in a long-term field experiment conducted in years 1989-2010 on loamy chernozem soil in the sugar-beet region. The average annual temperature and sum of precipitation were 9.19 °C and 547 mm, respectively. Winter wheat was grown after three preceding crops, viz. after alfalfa, maize for silage and peas. Experimental results were obtained within the periods of 1989–2002 and 2004–2010. Four variants of tillage were always compared: Variant 1 – ploughing to the depth of 0.22 m; Variant 2 – shallow ploughing to the depth of 0.15 m; Variant 3 – direct sowing into non-tilled soil; and Variant 4 – soil discing to the depth of 0.10 m.

Results

Effect of the preceding crops on winter wheat yields was significant. The highest average yield was obtained after peas and the lowest one after alfalfa. The effect of different tillage technologies on winter wheat yields was statistically significant after all three preceding crops. After alfalfa, the highest average yield was obtained in Variant 2 (shallow ploughing to 0.15 m) followed by Variant 1 (ploughing to 0.22 m). Lower yields were recorded after no tillage (Variant 3) and discing to 0.10 m (Variant 4). Statistically significant difference was found out between variants 2 and 3 and between variant 1 and 3. Lower winter wheat yields after alfalfa, particularly in case of missing ploughing, are related to lower soil moisture at the time of the winter wheat stands establishment (greater water consumption of alfalfa and greater amount of crop residues in the seedbed layer). In case of winter wheat grown after the maize, the highest yield was achieved after ploughing to 0.22 m (Variant 1). Lower yields were recorded after no tillage, discing and ploughing to 0.15 m (Variants 3,4,2). Significant difference was observed between Variants 1 and 3. After peas, the highest and the lowest yields were recorded after no tillage (Variant 3) and discing to 0.10 m (Variant 4). The difference between these two variants was statistically significant.

Table 1. Yields of winter wheat ($t \cdot ha^{-1}$) grown after three preceding crops (mean values for the periods of 1989-2002 and 2004-2010)

Variant of tillage	Alfalfa	Maize	Peas
1 (ploughing, 0.22 m)	7,08	7,56	7,58
2 (ploughing, 0.15 m)	7,16	7,47	7,54
3 (no tillage)	6,86	7,33	7,69
4 (discing, 0.10 m)	6,99	7,41	7,43
Mean	7,02	7,44	7,56
Dt (tillage) p= 0,05	0.182	0.164	0.167
p= 0,01	0.222	0.201	0.204

Conclusions

Results of a long-term study on effects of various tillage technologies on yields of winter wheat grown in chernozems soil in the sugar-beet region indicated the possibility of using shallow tillage when growing winter wheat after alfalfa and maize for silage and of direct sowing of winter wheat after peas. The obtained results indicate that, under these conditions, it is possible to apply also technologies with a lower intensity of tillage, which are characterized by lower energy and labor consumption.

References

Hemmat A., Eskandari I. 2006: Dryland winter wheat response to conservation tillage in a continuous cropping system in northwestern Iran. *Soil and Tillage Research* 86:99-109.

Hůla J., Procházková B. et al. 2008. Minimalization of soil tillage. Praha, Profi Press, 248 pp. (In Czech).

Šíp V., Růžek P., Chrpová J., Vavera R., Kusá H. 2009: The effect of tillage practice, input level and environment on the grain yield of winter wheat in Czech Republic. *Soil and Tillage Research* 113:131-137.

Acknowledgements

The project No. MSM6215648905 and project of NAZV No. QJ 12 10008.

Rice suitability to drip irrigation in Northern Italy

Ragagnoli, Giorgio¹; Triana, Federico¹; Roncucci, Neri¹; Tozzini, Cristiano¹; Eli, Vered²; Enrico, Bonari¹; Alberto, Puggioni³

¹Scuola Superiore Sant'Anna, ITALY; ²Netafim, ISRAEL; ³Netafim Italia Srl, ITALY

Introduction

With a rapidly growing world population, the pressure on limited fresh water resources increases. Irrigated agriculture is the largest water-consuming sector and faces the challenge to produce more food with less water by increasing Crop Water Productivity [1].

Rice is usually cultivated under submerged conditions, which demands high water volumes. Thus, there is the need to develop water-saving technologies that depart from continuous submergence [2] as drip irrigation. The objective of this study was to evaluate the performance of rice under drip irrigation in Italy.

Materials & Methods

The experiment was carried out during 2011 in north Italy. Carnaroli (CAR), Vialone Nano (VN) and Selenio (SEL) varieties, were grown under drip irrigation, and compared to the farm flooding system (FS).

Three drip irrigation levels were compared: low (LWS), medium (MWS) and high water supply (HWS), restoring 85, 100 and 115% of ETo (Penman-Monteith) respectively. Drip lines were spaced 80 cm. A fourth treatment (MWS60) had the same supply level as MWS with drip lines spaced 60 cm.

A split-block design with four blocks, irrigation treatments (DI) as main plot and variety (VAR) as subplot (6 x 30 m), was adopted. The irrigation plant was provided by Netafim Ltd. 170 kg N ha⁻¹ was applied by fertigation, as in FS. Sowing occurred on May 5th.

Yield was assessed by cutting 2 m² per subplot after physiological maturity. Mean farm values under FS were collected and used as term of comparison.

Crop water consumption (WCDI) was estimated considering irrigation (WSDI) and rainfall. The water saving index was estimated considering water consumption per yield unit (CWU) in DI and FS as follows:

$$W_{\text{saving}} = (CWU_{\text{DI}} - CWU_{\text{FS}}) / CWU_{\text{FS}} \cdot 100$$

Crop water productivity (CWP) is equal to the inverse of CWU.

Results

Significant differences in yield were observed among irrigation treatments, varieties and interaction (Fig.1). In general, yield was higher in MWS₆₀ and HWS, 439 and 424 g m⁻² of DM respectively. In MWS it reached 396 g m⁻². The lowest value was measured in LWS, 354 g m⁻². FS registered nearly 540 g m⁻².

Differences within the three varieties were highly significant. VN was the most productive, 443 g m⁻², but it showed the highest yield gap respect to FS (-31%). CAR was the less productive (364 g m⁻²), except in MWS60, where results were comparable to FS.

Water use in flooding system was estimated at 3.1 l s⁻¹ ha⁻¹. Based on this estimation CWP in FS amounted to 0.13 for CAR, 0.15 for SEL and 0.19 kg m⁻³ for VN.

Under the experimental conditions VN showed the highest water saving potential and water productivity, reaching values of 82% and 0.84 kg m⁻³ respectively (Tab. 1).

Discussion

Even if observed yield in DI treatments was nearly 25% lower than farm average, a water saving of nearly 81% respect to FS was observed, resulting in a CWP of 0.76 kg m⁻³. The latter is within the range of CWP calculated on the basis of ETc [1, 3]. This confirmed the high efficiency of the adopted system and its suitability to Mediterranean climate conditions. In conclusion, these preliminary results point out that is possible to use less water intensive systems allowing the cultivation of rice in new areas, previously considered not suitable, and its introduction into rotation cropping systems.

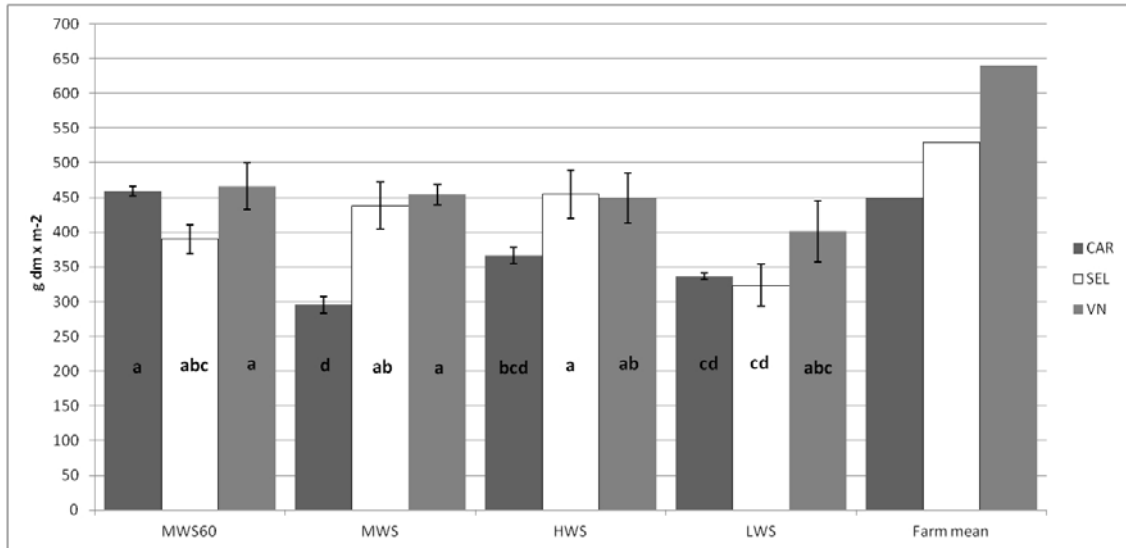

Figure 1. yield values for each IT x VAR treatment. Farm average values are included for comparison.

Table 1. yield, water supply (WS), water consumption (WC), water saving index (Wsaving) and crop water productivity (CWP) under DI.

	Grain [kg/ha]	WS [m3/ha]	WC [m3/ha]	Wsaving [%]	CWP [kg m3]
<i>CAR mean</i>	3,644	3,009	5,304	-80.7	0.69
MWS ₆₀	4,592	3,009	5,304	-85.0	0.87
MWS	2,954	3,009	5,304	-76.7	0.56
HWS	3,662	3,704	5,999	-78.7	0.61
LWS	3,367	2,315	4,610	-82.2	0.73
<i>SEL mean</i>	4,016	3,009	5,304	-79.6	0.76
MWS ₆₀	3,898	3,009	5,304	-79.1	0.73
MWS	4,383	3,009	5,304	-81.4	0.83
HWS	4,549	3,704	5,999	-79.7	0.76
LWS	3,234	2,315	4,610	-78.1	0.70
<i>VN mean</i>	4,428	3,009	5,304	-81.6	0.84
MWS ₆₀	4,664	3,009	5,304	-82.5	0.88
MWS	4,541	3,009	5,304	-82.0	0.86
HWS	4,493	3,704	5,999	-79.5	0.75
LWS	4,014	2,315	4,610	-82.3	0.87

References

1. Zwart SJ & Bastiaanssen WGM, 2004. Review of measured crop water productivity values for irrigated wheat, rice, cotton and maize. *Agr Water Manage*, 69:115–133.
2. Belder P et al., 2007. Exploring options for water savings in lowland rice using a modelling approach. *Agr Syst*, 92:91–114.
3. Doorenbos J & Kassam AH, 1979. *Yield Response to Water*. FAO Irrigation and Drainage Paper N.33 FAO, Rome, Italy.

Are winter hardiness and water distribution in crown tissue of sugar beet (*Beta vulgaris* L.) dependent on maximum beet diameter?

Reinsdorf, Eric; Jacobs, Anna; Koch, Heinz-Josef
Institute of Sugar Beet Research, GERMANY

Introduction

The cultivation of so called 'winter beets' differs from common spring beet cultivation by sowing the crop in spring or summer, overwintering in the field, and harvesting in spring or early summer. In temperate climate winter beets offer the potential to increase the total biomass yield (Kluge-Severin & Hoffmann, 2009) due to improved utilization of the site specific growth factors radiation and water in spring. This could allow to extend the sugar processing campaign or a more efficient use as substrate for bioenergy production (bioethanol, biogas).

Since 'non-bolting' hybrids are not yet available, a cropping system 'bolting winter beet' with the whole plant harvested after winter as substrate for biogas plants was tested in a project funded by the German Federal Ministry of Education and Research. A basic prerequisite of winter beet cropping is high winter hardiness of *Beta vulgaris* L. under German climatic conditions. Experiences with directly sown sugar beet for seed production in Mediterranean countries have shown that the survival rate over winter is closely related to the plant size with an optimum of 1 - 2 cm of top diameter for highest frost tolerance (Kockelmann & Meyer, 2006).

Materials and methods

Field trials at two different sites in Germany (Kiel, Schleswig-Holstein, maritime climate and Göttingen, Lower Saxony, continental climate) were conducted in 2010 / 2011 and 2011 / 2012. By varying sowing date (April, June, August) and plant density (148, 246, 370 thousand plants ha⁻²) a high phenotypic variability of sugar beet plants was created and the influence of single beet size on winter hardiness (% survival rate) was investigated. Furthermore, whole beet plants differing in sowing date / max. beet diameter (MBD) were collected in December 2011 before exposure to frost temperatures and tested for distribution of water within the top 1.5 cm of the

taproot (crown) by centrifugal extraction of apoplastic sap (Yu et al., 1999) from root pieces (1.5 x 0.5 x 0.5 cm) and gravimetric determination of the extracellular (apoplastic) and intracellular (symplastic) water amount. Three root diameter classes were investigated (Ø 1.3; 4.1; 7.6 cm). For each class, twelve samples each consisting of 24 crown pieces were analysed.

Results and discussion

Local weather conditions (temperature, snow depth) and, moreover the phenotype revealed a clear effect on frost tolerance. Increasing survival rates of sugar beet with decreasing MBD were observed. Up to MBDs of ~2.5 cm frost tolerance was highest (survival rates ~80 - 100 %) and rapidly decreased at MBDs >3 cm (Fig. 1). The smaller sugar beets were not protected against cooling of plant tissue below 0 °C due to very low crown heights but were able to tolerate the cooling and warming events of plant tissue without damage.

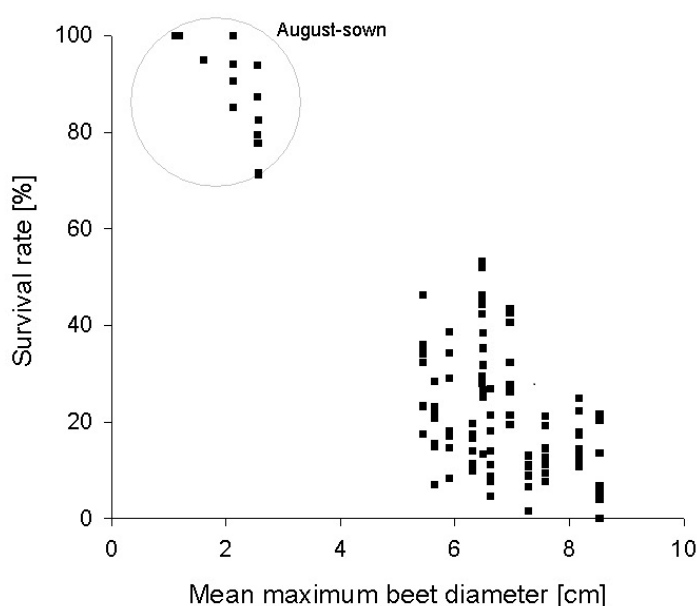

Figure 1: Relationship between max. beet diameter before winter 2010 / 2011 and survival rate.

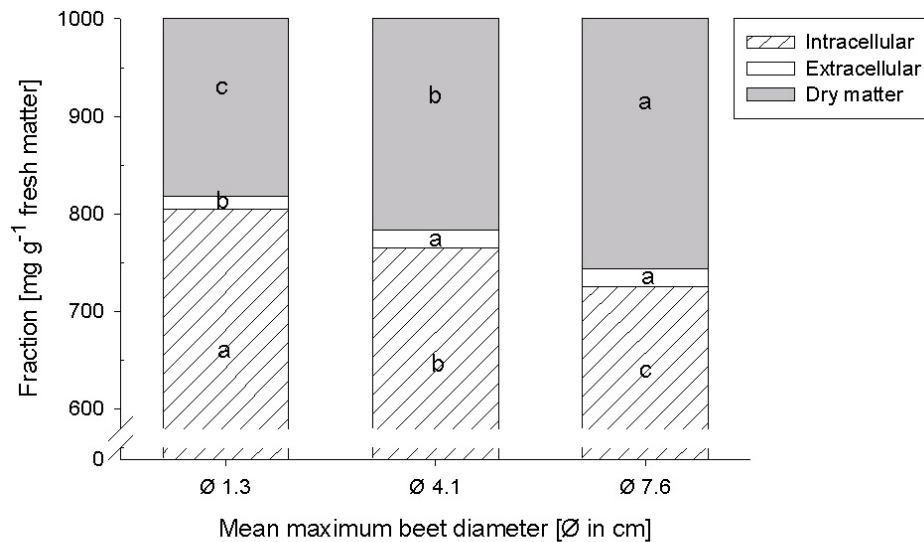

Figure 2: Distribution of water within the top 1.5 cm of sugar beet taproots as affected by the maximum beet diameter. For each fraction different letters indicate significant differences at $p < 0.05$ between different max. beet diameters (Tukey t-Test).

Sugar beets with MBDs of 1.4 cm (frost tolerant) significantly differed in distribution of water compared to sugar beets of bigger MBDs (Fig. 2). The total and intracellular water content of sugar beets decreased with increasing MBD but the content of extracellular water was significantly lower in small taproots. If freezing injury in sugar beet was directly resulting from rupture of cell membranes by expanding ice crystals, a very low extracellular water content would probably contribute to prevent the cell from freezing injury. This is because the formation of ice crystals is thought to start in the apoplast while intracellular ice formation sets in at much lower temperatures. More research is necessary to confirm these hypotheses.

References

- Kluge-Severin, S. and C. Hoffmann, 2009. Bessere Lichtnutzung durch Winterrüben! Zuckerrübe, 58 (2/2009), 79-81.
- Kockelmann, A. and U. Meyer. Draycott, A.P. (Ed.), Sugar beet: Seed production and quality. Oxford, UK: Blackwell Publishing, 2006. 89-113.
- Yu Q., C. Tang, Z. Chen and J. Kuo, 1999. Extraction of apoplastic sap from plant roots by centrifugation. *New Phytologist*, 143, 299-304.

Winter Turnip Rape as a Nitrogen Catch Crop in High-leaching Environment

Tuulos, Antti; Stoddard, Frederick; Yli-Halla, Markku; Mäkelä, Pirjo
University of Helsinki, FINLAND

Introduction

Species belonging to genus *Brassica* are widely reported to be efficient catch crops with the ability to decrease the leaching of nitrogen during winter months (Eichler et al. 2004, Kristensen and Thorup-Kristensen 2004). Most studies with Brassica catch crops are conducted in environments of low autumn rainfall. A study was conducted to find out if winter turnip rape (*Brassica rapa* L. ssp. *oleifera* (DC.) Metzg.) could scavenge soil mineral nitrogen after growing period under high rainfall conditions. Different sowing times and plant stand types were applied for comparison of different establishing methods of winter turnip rape and early sowing of winter turnip rape in May with a cereal has been used as an alternative to normal sowing at the end of July (Valle 1951).

Materials and methods

Field experiments were conducted at Viikki Experimental Farm of University of Helsinki, Finland during 2009 – 2011. All plots were fertilized with 80 kg N/ha, of which 42 kg was NO_3^- -N and 38 kg was NH_4^+ -N. Plant stand types were: 1) winter turnip rape undersown with six-rowed barley in May, 2) winter turnip rape sown in July after barley, 3) barley monocrop, left to stubble after harvest and 4) barley monocrop, ploughed after harvest. Topsoil (0-20cm) and subsoil (30-50cm) samples were collected after barley harvest, before the freezing of soil in autumn and after the thawing of soil in the following spring. Mineral nitrogen (NH_4^+ -N and NO_3^- -N) were extracted with 2M KCl and their amounts were determined with automated flow injection analyzer. In October 2009 winter turnip rape samples were collected and dried for C and N analysis with an automated element analyzer. Bird damage prevented yield estimation in 2010. Winter turnip rape plant stand densities were also measured. Barley yield from different treatments was harvested, dried and weighed.

Results and discussion

In the late autumn of 2009, there was significantly more NO_3^- -N in both soil layers of barley plots that were ploughed in autumn, than in other treatments (Figure 1.). Similar results were obtained in 2010, with the exception of early sown winter turnip rape distinguishing also from the barley left to stubble. In 2009, NH_4^+ -N was found to be less abundant in the topsoil of ploughed barley plots, than in early sown winter turnip rape plots. No differences were observed in soil N content after barley harvest or after overwintering in either of the years. Accumulated biomass and its nitrogen content indicated that by late autumn 2009, springsown winter turnip rape had gathered approximately 100% more dry matter and nitrogen than winter turnip rape sown in July (Table 1.). Barley yield was not affected by undersown winter turnip rape in either of the years.

Conclusions

It is suggested, that winter turnip rape can act as a N catch crop under conditions of high rainfall. The differences in soil NO_3^- -N content are of practical importance as reduction of excess NO_3^- -N by over 50% in topsoil and by 60 - 80% in subsoil can be expected, when soil is covered

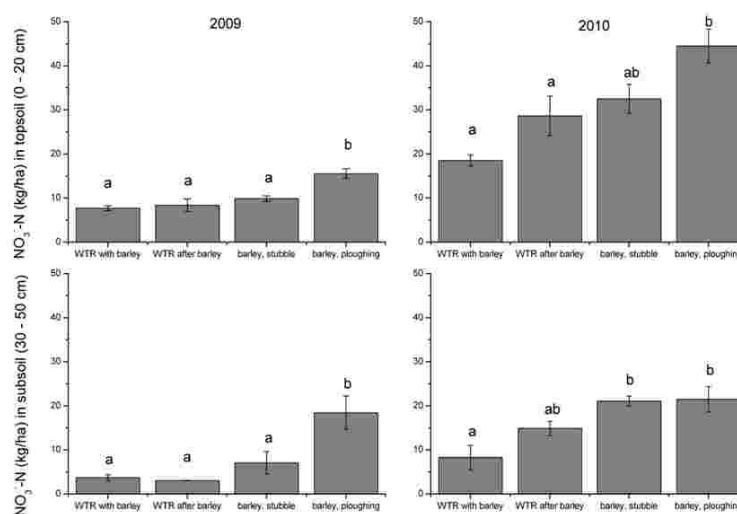

Figure 1. Soil NO_3^- -N content (kg/ha) in late autumn of two subsequent years in two soil layers after crop stands with winter turnip rape and/or barley. WTR = winter turnip rape. Columns with same letter do not differ significantly ($p = 0,05$). Values = means \pm S.E., $n = 4$.

Table 1. Dry biomasses and nitrogen content (kg/ha) in plant parts of winter turnip rape established in two different ways. Data derived from winter turnip rape density, weight of plant parts and nitrogen content. WTR = winter turnip rape. Values = means \pm S.E., n = 4.

WTR, sown with barley in May	Leaves	Hypocotyls	Roots	Total
Dry biomass, kg/ha	991 \pm 207	259 \pm 49	558 \pm 148	1808 \pm 389
N in WTR, kg/ha	25,5 \pm 5,6	5,9 \pm 1,0	10,6 \pm 2,5	42,0 \pm 8,7
WTR sown after barley in July	Leaves	Hypocotyls	Roots	Total
Dry biomass, kg/ha	373 \pm 112	203 \pm 156	302 \pm 99	879 \pm 296
N in WTR, kg/ha	9,6 \pm 3,1	5,3 \pm 4,1	5,9 \pm 2,0	20,9 \pm 8,0

with winter turnip rape instead of ploughed soil left bare after barley. Even though no adverse effects to barley yield were observed in this experiment, there is a risk that an undersown catch crop can affect the yield formation of a cereal. However, early undersown winter turnip rape is a more effective catch crop than late sown winter turnip rape.

References

Eichler, B., Zachow, B., Bartsch, S., Köppen, D., Schnug, E. 2004. Influence of catch cropping on nitrate contents

in soil and soil solution. *Landbauforschung Völkenrode* 54: 7-12.

Kristensen, H.L., Thorup-Kristensen, K. 2004. Root growth and nitrate uptake of three different catch crops in deep soil layers. *Soil Science Society of America Journal* 68: 529-537.

Valle, O. 1951. Über die Anbaumöglichkeiten von Winterrübsen in Finnland. *Forskning og Forsøk i Landbruket*: 38-51.

Intercanopy variability of soil parameters and grain yield of winter triticale on production plantations

Michalska-Klimczak, Beata; Wyszyński, Zdzisław; Kamińska, Sonia; Pagowski, Krzysztof
Warsaw University of Life Sciences - SGGW, POLAND

Introduction

A fundamental activity in precision agriculture is adjustment of mineral fertilizer ratios at each spot of the production field to intrinsic variability of nutrients availability in soil (Cambardella and Karlen 1999; Hanquet *et al.* 2004). The aim of this work was evaluation of intercanopy variability of such parameters of soil as pH or content of P, K and Mg, as well as triticale yielding at production plantations in Poland, and determination of variability dependence on studied soil characteristics.

Material and Methods

In the years 2008-2009 research was conducted on the 4 production plantations of winter triticale in central Poland. Area of analyzed plantations varied from 3,0 to 5,0 ha. To assess the analyzed variability on plantations of grain yield per 1 m² and its components (number of ears per square meter, number of grains in the ear, weight of one thousand grains), as well as on variation of soil parameters (pH, P, K and Mg contents), each production plantation was divided into smaller segments (50 and 60 plots). Just before harvesting (in the stage of full ripening of plants) samples of both plants and soil, were taken at random from an area of 1 m². The content of pH and P, K and Mg in soil samples (mg 100 g⁻¹ soil), the grain yield and its components in plant samples, were determined. The minimum, maximum and mean values for grain yield, as well as soil parameters were found and determination coefficients (CV) were calculated. Average yield on each plantation and the share of plots having given yielding interval, were assessed. Five class intervals of average yield on the plantation were distinguished: 91-110, 111-130, >130 and 71-90, <70%. For each plantation, determination coefficient (R²) and simple correlation coefficients between grain yield and soil parameters were calculated.

Results

The largest variability was determined in case of P and K soil content, while variability of Mg soil content was found

to be smaller, and pH content variability was found to be the smallest. It has to be noted that P, K and Mg content availability in soil on plots with minimum of observed range of values was several times smaller than the content on plots with maximum range values. Similarly, grain yield on plots of minimum yields were 200-300% below results obtained from plots with maximum values. Significant distribution of yielding variability is also reflected in large share of plots with grain yields 30% smaller or 30% larger than the average yield. Typical area of plots with yields 30% below average and 30% above average, was respectively 13,2 and 10,7% of total area of fields considered in this study.

Conclusions

Low values of determination coefficient (R²) found in the range of 9,23 – 33,2% depending on investigated plantation and reflecting dependence of grain yield on variability of soil parameters such as pH or P, K and Mg content, indicate other reasons for such significant yield variability on a single field, other than impact of investigated parameters of soil. Results obtained for triticale on production plantations, necessitate use of variable, point fertilization, adjusted to nutritional requirements of plants and local availability of soil nutrients. This method of fertilization ensures more efficient supply of plants in nutrients, and can enable reduction of fertilizer amounts and production costs.

References

1. Cambardella C.A., Karlen D.L. 1999. Spatial analysis of soil fertility parameters. *Precision Agriculture*, 1:5–14.
2. Hanquet B., Sirjacobs D., Destain M.F., Frankinet M., Verbrugge J.C. 2004. Analysis of soil variability measured with a soil strength sensor. *Precision Agriculture*, 5:227–246.

Table 1. Soil and grain yield ($g\ m^{-2}$) parameters and share (%) of plots in classes of grain yield on production plantations

Parameters and their values		Production plantations				
		I	II	III	IV	
pH	mean	5,0	5,0	6,3	4,6	
	min	4,5	3,9	4,2	4,1	
	max	7,0	6,1	7,6	5,8	
	CV (%)	10,4	11,3	14,4	8,4	
P	Content ($mg \cdot 100\ g\ soil^{-1}$)	mean	4,4	5,5	6,0	4,6
		min	2,1	2,1	1,8	3,7
		max	15,0	15,6	11,7	6,0
		CV (%)	55,3	62,1	47,7	11,1
K		mean	6,5	5,9	3,0	8,4
		min	3,0	1,7	1,8	4,2
		max	17,8	16,0	7,1	17,8
		CV (%)	52,8	62,1	33,7	34,2
Mg		mean	5,7	5,2	5,3	2,8
		min	3,6	3,0	1,6	1,2
		max	9,8	7,5	8,3	5,4
		CV (%)	24,7	24,3	28,5	32,9
Grain yield ($g \cdot m^{-2}$)		mean	692,0	656,0	337,5	478,0
		min	368,0	302,0	182,4	209,2
		max	953,0	799,0	617,2	764,9
		CV (%)	22,7	16,4	32,6	32,8
Grain yield classes (in % of average yield)		<70	10,0	3,3	20,0	19,6
		71-90	20,0	20,0	24,0	15,7
		91-110	33,4	43,4	24,0	25,5
		111-130	23,3	33,3	18,0	23,5
		>130	13,3	0,0	14,0	15,7

Table 2. Determination coefficient (R^2) and partial regression coefficients for relationship of grain yield on soil parameters on production plantations

Soil parameters	Production plantations			
	I	II	III	IV
pH	0,430	0,400	0,390	-0,774
P	0,030	0,130	-0,090	-0,210
K	-0,030	0,060	-0,080	0,241
Mg	-0,230	-0,100	-0,060	0,301
Determination coefficient R^2 (%)	33,20	21,30	9,23	30,65

Multi-functionality of the biodiverse Mediterranean agroecosystems. Can we model ecosystem services of agro-ecology?

Bondeau, Alberte¹; Müller, Christoph²; Saatkamp, Arne¹; Schaphoff, Sibyll²; Thonicke, Kirsten²

¹IMBE Institut Méditerranéen de Biodiversité et d'Ecologie marine et continentale, FRANCE;

²PIK Potsdam Institute for Climate Impact research, GERMANY

Similar to other Mediterranean regions, South-Eastern France has particularly diverse agroecosystems, many of them under low-intensity use. This provides a high level of biodiversity both at the species and the landscape level, which could play an important role for the provisioning of ecosystem services contributing to agricultural sustainability.

We investigate how a generic process-based ecosystem model can be used for the estimation of several diversity-related functions provided by a typical multi-functional agricultural landscape of the region. We focus on 3 ecosystem services: food production, carbon sequestration, and conservation of emblematic species. The aim of the modelling exercise is the assessment of trade-offs between production and other ecosystems services that are related to agro-ecological systems integrating various levels of biodiversity. The model is tested for a small region where the agricultural landscape is of high natural and cultural value, and which is a hot-spot of biodiversity for several threatened arable weeds.

LPJmL (Bondeau et al., 2007) simulates in a single framework the dynamics and biogeochemical fluxes between soil, vegetation and atmosphere for various crop and natural plant functional types that are present within each grid cell, depending on soil, climate and land use. Production, crop yields, carbon balance and water cycle are simulated through the representation of phenology, growth processes, and farming practices (more or less intensive, with positive, neutral or negative carbon balance). LPJmL is regularly improved, evaluated, and used for global change and integrated assessment studies. In such applications, the land use inputs and the parametrizations are representative for "conventional" agriculture, which does not consider any biodiversity level to interact with the agrosystem. We here account for a new land use data set that describes the diversity of a typical Mediterranean agricultural landscape and different intensity levels (High Natural Values farmlands, Pointereau et al., 2007), with additional information on

chemical use or sorting of seeds. Such characteristics determine the conservation potential for threatened wild-grass species (Saatkamp, 2009), and impact the simulated crop yield and carbon sequestration (Fig.1), once the model is supplied with the appropriate functions.

We use yield data to parametrize LPJmL in order to reproduce the production levels of the region and depending on the system (organic / low-input / conventional). By closing the carbon cycle, LPJmL can represent many features / practices of agro-ecology that impact carbon sequestration. We develop an indicator that represents the role of functional biodiversity for reducing the pressure from pests (Letourneau & Bothwell, 2008). We simulate 3 cases: 1) actual distribution of the various agrosystems, 2) all farms under "conventional" management, 3) all farms under "agroecological" management.

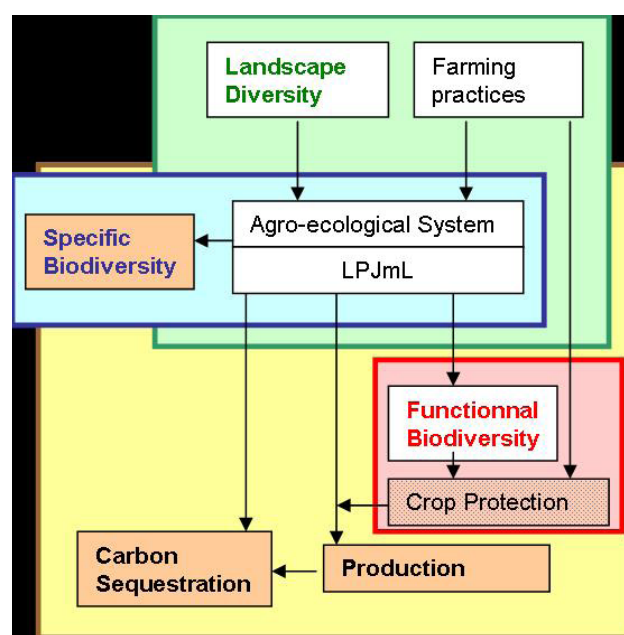

Figure 1. Interactions between agro-ecology and biodiversity

The model provides a consistent way of comparing the trade-offs between production, biodiversity conservation, and carbon sequestration of different agrosystems. Despite the still limited knowledge for developing functional biodiversity indicators, the assessment of conservation potential for endangered species and soils with agro-ecology is a necessary step supporting the design of more sustainable agriculture. In our simulations, such conservation services are associated with lower yields. As a next step we will account for additional environmental and socio-economic variables that impact other important trade-offs in the estimation of the vulnerability/resilience of agroecosystems.

References

- Bondeau et al., 2007. *Globl Change Biology*, 13(3): 679–706.
- Letourneau & Bothwell, 2008. *Frontiers in Ecology and the Environ*, 6(8): 430–438.
- Pointereau et al., 2007. Report EUR 22786 EN
- Saatkamp A. 2009. Dissertation Thesis. Aix-Marseille III, Regensburg.

Soil quality parameters in vegetated buffer strips and their association with herbicide losses

Cardinali, Alessandra; Gasparini, Valentina; Carletti, Paolo; Zanin, Giuseppe
University of Padua, ITALY

Introduction

Buffer strips (BS) are effective in removing pollutants from runoff. The presence of a permanent vegetation (grass and tree-grass species) also provides indirect environmental benefits such as increasing the biodiversity and improving soil quality parameters (Udawatta et al., 2002). Various buffer strips have been designed to remove sediment, chemical, and organic material transported in surface runoff (Arora et al., 1996). However, little is known about the soil quality characteristics of BS and their association with the fate of the herbicides after deposition in buffer strip soil. The present work aims 1) to delineate differences in soil quality parameters related to BS structure and composition; and 2) to highlight possible interactions between these parameters and herbicide losses from cultivated field.

Materials and methods

The experimental site is a rectangular field of 200 × 40 m, with a 0.8% slope down towards a ditch. Between cropland and ditch, a plot without buffer (NoBS) and four different BS were established: 3G, 3 m wide with grass cover; 3G1R, 3 m wide with one tree row (*Platanus hybrida* + *Viburnum opulus*); 6G1R, 6 m wide with one tree row;

6G2R, 6 m wide with two tree rows. Each BS had two biological replicates (Figure 1) and each plot was sampled in triplicate (n=6).

Soil chemical properties (organic carbon and nitrogen), humic substances (molecular weight distribution), enzyme activities (urease, protease, FDA hydrolase and dehydrogenase) and microbial biomass content were analysed in April and October 2010 in each BS and in NoBS. In April the field was sown with maize and two herbicides were applied: S-metolachlor (METO) and terbuthylazine (TERB) at 750 and 1250 g ha⁻¹ respectively. Runoff from the BS and from NoBS was collected to analyze herbicide concentration. Water samples were extracted using HLB sorbent cartridges and the extracts analyzed with LC-MS. These data were used to compute the total herbicide losses in terms of amount per hectare.

Results

Soil quality parameter data were pooled and Canonical Discriminant Analysis (CDA) was performed on selected variables. The resulting model significantly distinguished NoBS and 3G from the other BS while 6G1R resulted

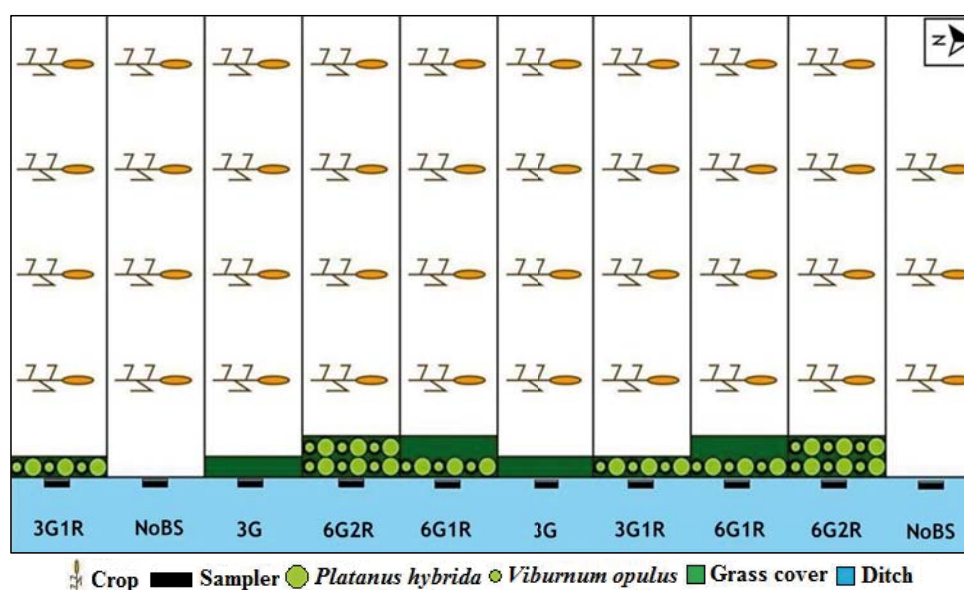

Figure 1: Layout of the experimental field with the four types of BS and NoBS.

Table 1: a) Amount of METO and TERB total losses; b) Pearson correlation matrix ($P < 0.05$).

a) BUFFER STRIP		METO	TERB
		Total loss mg/ha	Total loss mg/ha
NoBS		3.06	4.36
3G		0.03	0.03
3G1R		0.01	0.02
6G1R		0.03	0.04
6G2R		0.13	0.22

b) SOIL PARAMETER		METO	TERB
		Total loss mg/ha	Total loss mg/ha
Organic Carbon	r	-.801	-.855
	P	.056	.030
Microbial Biomass Content	r	-.940	-.842
	P	.005	.035
DOM pH	r	.883	.817
	P	.020	.047
Fulvic Acid	r	-.965	-.910
	P	.002	.012
Humic fraction 2	r	.852	.887
	P	.031	.018

not significantly different from 3G1R and 6G2R. Most important variables in CDA model were FDA enzyme activity, low molecular weight humic fraction, both humic and fulvic carbon contents. Table 1a showed total losses of the two herbicides in different BS. The data set (Table 1b) was normalized using the reciprocal and some

significant linear correlations were evidenced by Pearson correlation procedure.

Some parameters (such as organic carbon and microbial biomass content) were correlated with both METO and TERB total losses, indicating their involvement in mitigation effect of BS.

Conclusions

Present results suggest that buffers may have a positive impact on the ecological health of rural landscapes, resulting in improvement on soil quality and surface water. These positive effects should be considered in the decision making process of installing conservation buffers. Despite our data indicate a relation between soil parameters and herbicide loss, cause-effect connections are yet to be comprehended.

References

- Udawatta, R.P., Krstansky, J.J., Henderson, G.S., Garrett, H.E., 2002. Agroforestry practices, runoff, and nutrient loss: a paired watershed comparison. *J. Environ. Qual.* 31, 1214-1225.
- Arora, K., Mickelson S.K., Baker J.L., Tierney D.P., Peters C.J., 1996. Herbicide retention by vegetative buffer strips from runoff under natural rainfall. *Tran. of the ASAE* 39, 2155-2162.

How far should two ammonia sources be in order to neglect their interference?

Carozzi, Marco¹; Ferrara, Rossana Monica²; Lammirato, Carlo¹; Rana, Gianfranco²; Acutis, Marco¹

¹University of Milan, ITALY; ²CRA, ITALY

Introduction

Agriculture is known as the major source of atmospheric ammonia (NH_3) and it contributes to over 90% of the emissions at European scale (EEA, 2011). Intensive animal production, housing, manure storage and their field application (Asman et al., 2004) result the main NH_3 emitting activities, which represents a serious environmental concern and the low nitrogen (N) efficiency in cropping systems. However, reliable NH_3 losses quantification is still a challenge due to the reactive and sticky properties of NH_3 and the multiple possible point NH_3 sources present in a farm. The aim of this work is to determine the distance at which the effect of a source, identified by livestock facilities and storage tanks, loses its effect on measures of NH_3 concentration at the centre of a field.

Materials and methods

The trial was performed in a farm located in the Po Valley (Northern Italy) on a 4.3 ha field. Dairy slurry was broadcast applied on the field and subsequently incorporated after 30 hours. NH_3 concentrations were measured for 6 days using the passive samplers ALPHA (Adapted Low-cost Passive High Absorption) developed by Tang et al. (2001). Three sampling points were located along a 150 m horizontal transect (Fig.1, point A, B, C) from the centre of the field (first source, S1) to its edge, near two slurry storage tanks (\varnothing of 16 m, height 4 m) and livestock facilities of 200 heads (second source, S2).

For each sampling point, a series of three replicates ALPHA were employed, exposed continuously at 1.25 m above ground for a time from 3 to 12 hours. A three-dimensional ultrasonic anemometer (Gill-R2, Gill Instruments Ltd, UK) was placed in the centre of the field at the same height of the samplers in order to collect data relative to atmospheric turbulence and wind direction. For each exposure interval, using the NH_3 concentrations measured along the horizontal gradient, a non-linear logarithmic regression was performed in order to evaluate the evolution of NH_3 concentration as a function of the spatial separation between the two sources (i.e. the distance between the centre of the field and its edge). By means of this empirical law, the NH_3 concentrations on 5 m distance steps have been estimated. Therefore, the effect of S2 on S1 has been defined negligible when the difference between the estimated concentrations of two consecutive steps fell below 1/10 of the standard error (se). For each exposure interval, the standard error was calculated using the standard deviation of the three replicates samplers of each sampling point.

Results

During the trial the main wind direction was O, the averaged wind speed and temperature were 1.2 m s^{-1} and $18.5 \text{ }^\circ\text{C}$, respectively. In Fig. 2 are presented the results of the influence of the source S2 on S1, in respect both of the distance from the edge to centre of the field

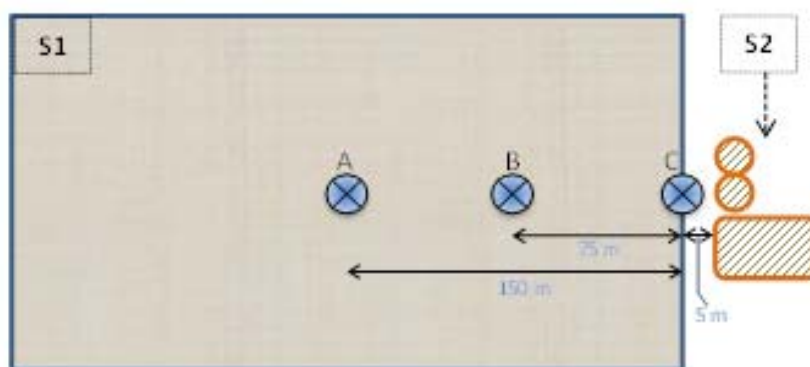

Fig. 1. Schematic representation of the experimental field. S1 and S2 are the two investigated NH_3 sources; A, B, C are the NH_3 concentration sampling points.

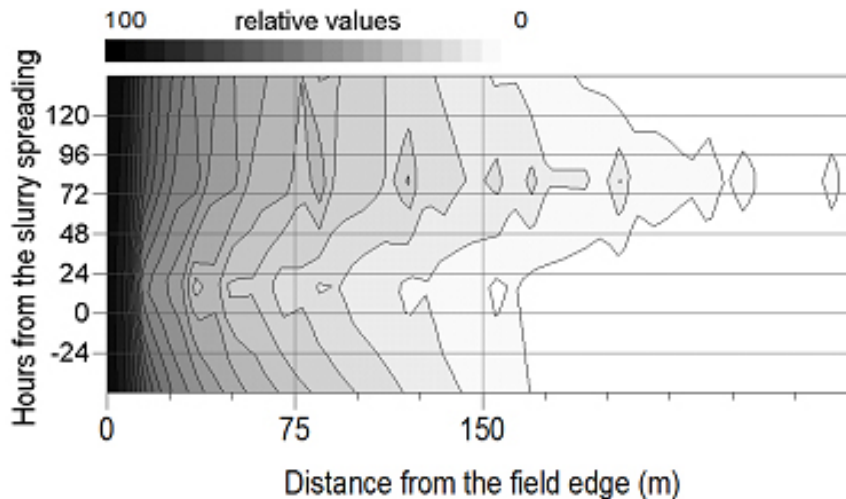

Fig. 2: The influence of the source S2 on S1 as function of their distance and the time of measurements (expressed in hours from the slurry spreading). In the relative scale 100 and 0 represent “maximum influence” and “no influence”, respectively (see text).

and as function of time. The scale bar was obtained by setting the value of concentration at the distance of “no influence” equal to 0, and the distance of “maximum influence” equal to the value of 100.

The mean distance at which the effect of S2 on S1 has no significance resulted of 203 m. Furthermore, taking into account the component of the wind vector blowing from S2 to S1 along the transect, the correlation with the distance of “no influence” for each sampling interval is $R^2=0.4$.

Conclusions

The distance at which the effect of one NH_3 source on the other is vanished has been estimated by using an

horizontal transect of concentration. In the case study the concentration estimated at the distance of “no influence” resulted a mean of 23% lower than the concentration measured in the centre of the field.

References

- Asman et al., 2004. In: Emissions of Air Pollutants (eds R. Friedrich & S. Reis), pp. 111–143.
- EEA, 2011. Technical report No 3/2011.
- Tang Y.S. et al., 2001. In: Proceedings of the International Symposium on Passive Sampling of Gaseous Pollutants in Ecological Research. The Scientific World, 1, 513-529.

Agronomic techniques to reduce NH₃ emissions from slurry spreading

Ferrara, Rossana Monica¹; Carozzi, Marco²; Brenna, Stefano³; Rana, Gianfranco¹; Acutis, Marco²

¹CRA, ITALY; ²University of Milan, ITALY; ³ERSAF, ITALY

Introduction

Ammonia (NH₃) volatilization is one of the major pathways of nitrogen (N) losses following N-fertiliser applications. According to the emission Italian inventory, agriculture accounts for over 95% of the NH₃ emissions (ISPRA, 2011), concentrated in the Po Valley (northern Italy), where most of the livestock productions are located, representing a serious environmental concern. Nevertheless, measurements of NH₃ emissions at field-scale are still scarce in this area (Valli et al., 2003) and, have been obtained using enclosure methods that cannot be representative of the entire field and perturb the environmental conditions (Loubet et al., 1999). Nowadays, several non-intrusive micrometeorological methods are available for measuring NH₃ fluxes, covering large areas (Denmead, 1983, Ferrara et al., 2012). Moreover, inverse dispersion methods are also been used for estimating fluxes using NH₃ concentrations measured downwind from the source (Flesch et al., 2004). This study reports preliminary results relative to the percentage of NH₃ losses from slurry applied using 3 different management practices, evaluating the best practices in reducing NH₃ losses.

Materials and methods

The experiments were performed on bare soil in 2 farms located in Po Valley, using 3 different application techniques of cattle slurry: (i) surface spreading (SS); (ii) surface spreading followed by incorporation after 24 hours (SI-24h); (iii) direct injection at 25 cm depth

(INJ) followed by incorporation after 24 hours. The eddy covariance method (Denmead, 1983) was used during the trial SI-24h: NH₃ fluxes were directly measured using a sonic anemometer coupled with a fast NH₃ concentration analyser developed by Aerodyne (USA), both located in the centre of the field at 1.45 m above ground. During the other two trials, NH₃ fluxes were estimated using the inverse dispersion model WindTrax (Flesch et al. 2004), whose inputs are the atmospheric parameters of turbulence, measured by a sonic anemometer, and NH₃ concentrations, measured by passive diffusion samplers (Tang et al., 2001), both measured in the centre of the field at 1.25 m above ground.

For each trial the cumulated NH₃ losses were calculated. Using the N supplied (Table 1), the emission factors were estimated in order to define the percentage reduction in NH₃ losses due to different agronomical practices with respect to surface spreading.

Results

The differences among soil, weather and slurry parameters of the 3 trials could partially explain the different percentage of NH₃ losses detected (Table 1), even if the application technique is surely the most important factor dominating the NH₃ volatilization rate. In fact, the direct injection into the soil (trial INJ) has reduced up to 94% the NH₃ losses by volatilization with respect to surface spreading.

Table 1. Main characteristics of the 3 case studies: 1) soil type, initial pH and soil water content (SWC); 2) average temperature (T_{med}) and wind speed (U) during each trial; 3) pH, dry matter (d.m.) and N supply of each slurry; 4) relative reduction of NH₃ losses with respect to surface spreading. SS is surface spreading, SI-24h is surface spreading followed by incorporation after 24 hours, INJ is direct injection followed by incorporation after 24 hours.

Dataset	Date (dd/mm/yy)	Field area (ha)	Soil			Weather		Slurry			Relative reduction
			Texture -	pH -	SWC m ³ m ⁻³	T _{med} °C	U m s ⁻¹	pH -	d.m. g kg ⁻¹	N supply kg N-NH ₄ ⁺ ha ⁻¹	
SS	9 - 17/10/11	4.3	silty-clay	8.2	0.22	12.3	1.2	7.5	30	68	*
SI-24h	26/3 - 3/4/09	3.9	loam	7.1	0.17	11.2	1.5	8.0	44	95	37% (±13)
INJ	24/9 - 1/10/09	2.9	silty-clay	7.5	0.36	19.5	0.9	8.0	34	139	94% (±1.5)

* set to 100% in order to compare the other two case studies.

Conclusions

Even if the trials are not directly comparable due to different boundary conditions, this preliminary results confirm that the injection of the slurry or at least the fast incorporation into the soil reduce significantly NH_3 losses in accordance with Huijsmans, et al. (2003). Then, it has to be recommended to stakeholders even if the most widely technique employed for the land application of slurries in Po Valley area is still the broad spreading.

References

- Denmead, 1983. In: Gaseous loss of nitrogen from plant-soil systems (Eds J.R. Freney & J.R. Simpson), pp 133-157.
- Ferrara et al., 2012. *Agric. For. Meteorol.*, 158, 30-42.
- Flesch, et al., 2004. *J. Appl. Meteorol.*, 43(3), 487-502.
- Huijsmans, et al., 2003. *Atmos. Environ.* 37, 3669–3680.
- ISPRA, 2011. Italian emission inventory 1990-2009. Information inventory report 2011. *Rapporti* 138/2011.
- Loubet et al., 1999. *J. Agric. Engng. Res.*, 72, 71-81.
- Tang et al., 2001. In: *Proceedings of the International Symposium on Passive Sampling of Gaseous Pollutants in Ecological Research*. The Scientific World, 1, 513-529.
- Valli et al., 2003. *Settima conferenza nazionale delle agenzie ambientali*, Milano.

Sowing environmental fallows: challenges and opportunities

Herzon, Iryna¹; Toivonen, Marjaana¹; Le Barh, Catherine²

¹University of Helsinki, FINLAND; ²ENITA de Bordeaux, FRANCE

Introduction

In 2009, Finland introduced a novel agri-environment scheme for Environmental Fallow (EF) (Herzon et al., submitted). It is arguably the single most important subsidy scheme targeted at natural values of ordinary agricultural landscapes and the one currently most preferred by farmers. There are two types: long-term grassland sown with a conventional grassland seed mixture, and biodiversity field, with meadow, game and landscape types. The ability of the current scheme for enhancing water protection and biodiversity was studied nationally in 2009–2011. The objective here was to evaluate importance of sown establishment success on biodiversity fallows on biodiversity.

Materials and methods

Data were collected from three regions from a total of 215 parcels (90 grassland, 77 meadow, 24 landscape and 24 game fields). We conducted vegetation surveys and interviewed the owners. We evaluated the covers of the species that were sown or are on the recommended list in the biodiversity fields ($n = 125$). We related the cover of the sown plants to the species diversity and three functional indices that indicate value of vegetation as a foraging resource for pollinators, butterflies and wild bees (ecosystem service in the agro-landscape) and source of weeds (dis-service). The pollination indices were calculated based on pollinator species' usage of plants in fallows. Index of agrotolerance reflects prevalence of weed species based on frequency and biomass of weeds in spring cereal and oilseed crops (Salonen et al., 2011a; b). The biodiversity metrics were modeled in generalized linear models that included the cover of the sown species, field type, their interaction, and the field area.

Results

In over 30% of fields, the cover of the sown plants was below 20% in the first year of establishment. There were considerable differences in establishment success among species. In meadows, the best results were achieved with *Leucanthemum vulgare*, *Festuca* sp., *Agrostis* sp., *Anthemis tinctoria*, and *Vicia villosa*. All other species were either

infrequent or present in low numbers. On game fields, the greatest cover was that of cereals, *Brassica* sp., *Raphanus sativus*, while the success of *Pisum sativum* was low. On landscape fields, *Trifolium resupinatum*, *Phacelia tanacetifolia*, *Melilotus officinalis*, and *Helianthus annuus* were fairly successful.

Correlation between the total cover of sown plants and species richness was positive and approached significance ($p < 0,81$). There were positive correlations with the combined index of pollinators ($p < 0,001$) and index for butterflies ($p < 0,003$). The relationship was the strongest in sown meadows. There was no significant correlation with the agrotolerance index.

Discussion

Close to 7% was fallowed in 2011, and 22 500 ha were biodiversity fields. These special seed mixtures, have never been tested previously on a scale of the scheme. The results confirmed that in order to improve value of EFs for biodiversity and related ecosystem services, it is critical to ensure the establishment success of the specially design seed mixtures. Especially the value for pollinating insects depends on species of meadow plants added to the seed mixtures, their germination in the first year and survival to the next (Kuussaari et al. 2011). The current challenges with novel "crops", especially meadow fields, should be addressed through targeted research on optimised placement, seed mixtures for different soils and level of sun exposure, and agrotechnical practices for achieving maximum environmental output with minimal agronomic problems for the surrounding and subsequent crops.

References

- Kuussaari M, Hyvönen, T, Härmä O (2011). Agric. Ecosyst. Environ. 143: 28–36.
- Salonen J, Hyvönen T, Jalli H (2011a). AFS, 10, 347-364.
- Salonen J, Laitinen P, Saastamoinen M, Salopelto J (2011b). AFS, 20, 262-268

Nitrogen leaching losses from organic and conventional crop rotations

Lemola, Riitta; Esala, Martti; Turtola, Eila
MTT Agrifood Research Finland, FINLAND

Introduction

Cultivated area under organic farming in Finland increased rapidly after Finland joined EU in 1995 due to higher subsidies that were based on expected potentially favourable impacts on the environment. However, there was no national research data on nutrient losses from organic farming, compared to conventional, to support that view. To fill in the knowledge gap, we established in 1997 four-year crop rotations on an experimental field on sandy soil at Toholampi, to compare nitrogen (N) leaching from organic and conventional crop rotations. After some changes of the experimental design in 2001, the crop rotations have continued until now. To focus on the differences between N input intensities and sources that are typical for organic and conventional rotations, the cultivated crop species and the tillage frequency have been kept as similar as possible between the rotations. The main differences are thus in fertilization, herbicide use and utilization of biological nitrogen fixation. Some results of the years 2001-2008 are presented here.

Material and Methods

Since 2001, the experimental design has been as follows: A) organic cereal rotation receiving cattle manure (0.5 cows ha⁻¹ a⁻¹), B) organic milk production self-sufficient with manure and fodder (0.9 cows ha⁻¹ a⁻¹), C) conventional cereal rotation with mineral fertilizers, D) conventional milk production with manure (1.1 cows ha⁻¹ a⁻¹) and mineral fertilizers. C and D were fertilized according to the Finnish Agri Environment Program. The 4-year rotations, with four replicates are: A) spring barley, ley, winter rye, spring oats, B) spring barley, ley, spring oats+common vetch, C) spring barley, spring barley, winter rye, spring oats, D) spring barley, ley, ley, spring barley for whole-crop silage. In A and B the ley was a mixture of timothy and red clover, while in D clover was replaced by meadow fescue.

The experiment is carried out in a field (2.56 ha) situated on a fine sandy soil in western Finland (Toholampi, 63° 49'N, 24° 09'E). The field is divided into 16 plots (100 m * 16 m) that, which are isolated hydrologically from each other and the surroundings and allowing the collection of drainage and surface runoff from each plot. The slope

of the field varies between 0.30–0.74%. The humus rich (5% org. C) soil is classified (FAO classification) as Haplic Podzol. A more detailed description of the field properties is given by Turtola and Kemppainen (1998).

Surface runoff and drainage flow were quantified from each plot and flow-proportional water samples were analysed for total N (TN), nitrate N (NO₃-N) and ammonium N (NH₄-N). Crop yields and N uptake were measured. Soil inorganic N (NH₄-N and NO₃-N) was sampled annually to the depths of 0–25 cm and 25–60 cm in early spring before farming operations and in late autumn before soil freezing.

Results

The leaching losses of total N in 2001-2008 were 63, 53, 87 and 60 kg ha⁻¹ in A, B, C and D rotations, respectively. Main part of TN losses occurred outside the growing seasons and 80% came through drainage flow. NO₃-N was the main form TN lost (75%), only 5% being NH₄-N. The inorganic N content in late autumn in 0-60 cm soil layer varied between 13-108 kg ha⁻¹ and there was a correlation between it and TN losses through drainage flow in the forthcoming autumn and spring. Total N losses per yield (feed units, fu) were: 2.4 g fu⁻¹, 1.3 g fu⁻¹, 2.9 g fu⁻¹ and 1.3 g fu⁻¹ in A, B, C and D, respectively.

Conclusions

The results imply that organic farming reduces leaching losses of TN per cultivated area. If the yield decrease in organic farming is less than the saving in the leaching, even the losses per produced yield can be smaller, as was the case in our cereal rotations.

References

Turtola, E., & Kemppainen, E. 1998. Nitrogen and phosphorus losses in surface runoff and drainage water after application of slurry and mineral fertilizer to perennial grass ley. *Agricultural and Food Science in Finland* 7: 569–581.

Long term effect of two maize cropping systems on soil carbon immobilization in Po valley environment

Motta, Silvia Renata; Cabassi, Giovanni; Borrelli, Lamberto; Degano, Luigi
 CRA, ITALY

Introduction

The importance of organic matter for sustainable soil functions has been acknowledged worldwide for several decades. The positive effects of soil organic matter (SOM) cover a wide range of well-documented physical, hydrological, chemical, biochemical and productive properties. Soil organic carbon (SOC) is an important index of soil fertility because of its relationship to crop productivity (Vinther et al., 2004; Pan et al., 2009). For instance, declining SOC levels often leads to decreased crop productivity (Lal, 2006). Thus, maintaining SOC level is essential for agricultural sustainability. The concept of sustainable agricultural production emphasizes the importance of SOC management for food security and environment protection.

Materials and methods

The experiment was carried out at Lodi, northern Italy, which is a location representative of the alluvial Po Valley, on a sandy-loam soil of the mollic Hapludalf family, with subacid pH (6.2), low in nitrogen, organic matter, and exchangeable potassium. The trial has run since 1985 and it is articulated in 2 cropping systems M1 = 1-yr continuous monoculture of Italian ryegrass + silage maize and MM = grain maize grown in continuous monoculture.

Each rotation was subjected to two treatments for input level, corresponding to an optimal (treatment A) and sub-optimal (treatment B) condition for the region, respectively. Treatment B received ca. 70% of the amount of organic and chemical fertilization and 75% of herbicide amount relative to A. A further difference between A and B treatments concerned soil tillage before autumn-sown crops. The treatments were arranged in a strip-split-plot design with three replication with a plot size of 60 m² each. Every three years the soil samples were collected and analyzed. One composite soil sample for each plot was made of 3 sub-samples taken from 0-30 cm soil layer. It was investigated the spatial variability within the blocks and between the replicates using a bootstrap statistical model and the soil organic carbon SOC and nitrogen content was investigated every three years since the 1985.

Results

The figure 1 shows how SOC changed through time for the different cropping systems and inputs from 1985 to 2009 in the experimental field. In figure 2 were represented the values of carbon/nitrogen (C/N) content in soils sampled every 3 years since 1985, for cropping systems and inputs.

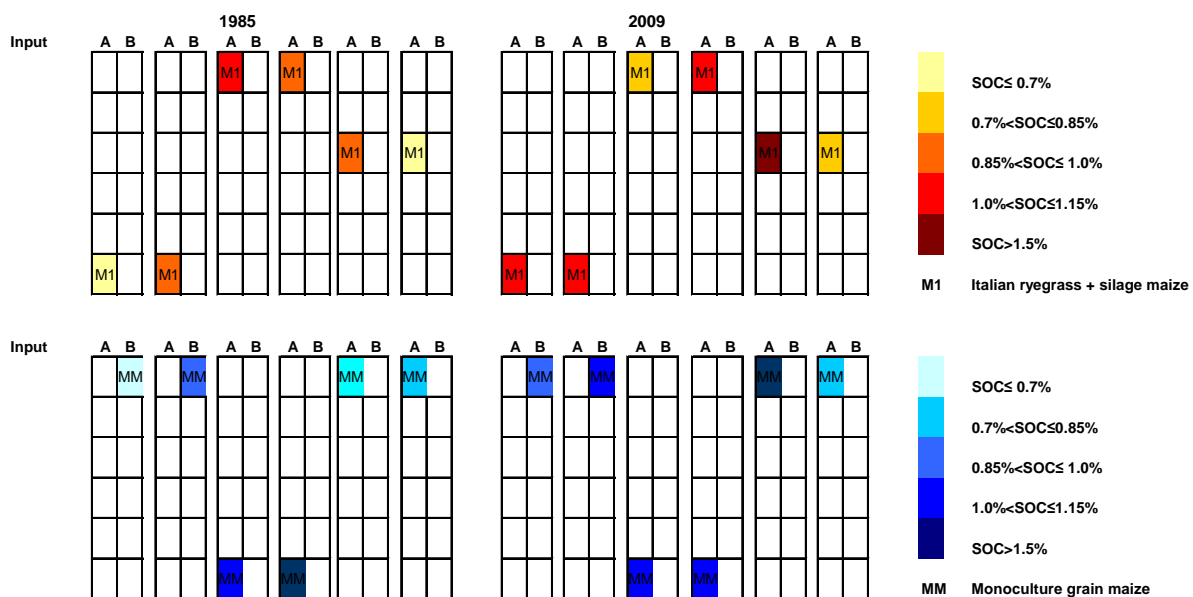

Figure 1 - Map of levels of SOC in the experimental field in 1985 and 2009 for the different cropping system.

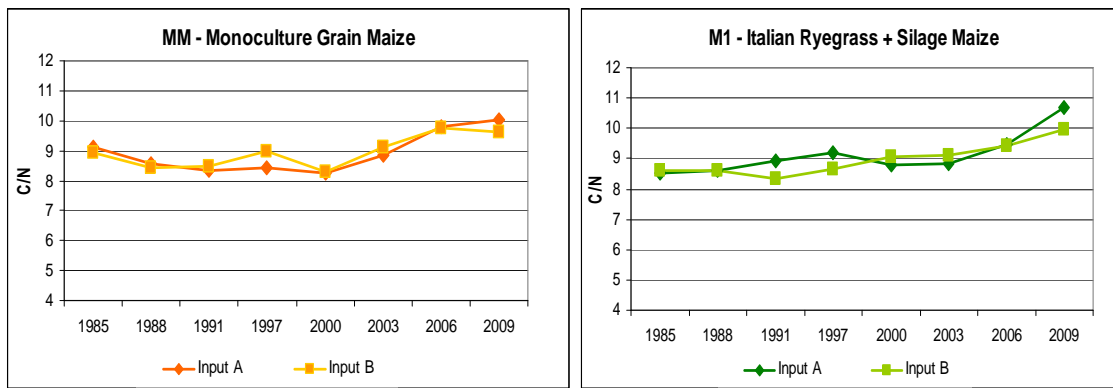

Figure 2. Soil C/N content from 1985 to 2009 in MM – monoculture grain maize and M1 – Italian ryegrass + silage maize

The increasing trend in M1 is clear for both the inputs, reaching values of 10.11 (input A) and 9.73 (input B), while in MM the curve progress is more stable.

Conclusions

The results showed that an increase of the rotation complexity, corresponded to an increase in the stock of C in soil. Summarizing, results showed that crop rotation could guarantee the maintenance of SOM level. These results indicate that soil C levels can be maintained or even increased in these types of cropping systems when optimal inputs is used.

References

- Lal, R., 2006. Enhancing crop yields in the developing countries through restoration of the soil organic carbon pool in agricultural lands, *Land Degrad. Dev.*, 17, 197-209.
- Pan, G., Smith, P., and Pan, W., 2009. The role of soil organic matter in maintaining the productivity and yield stability of cereals in China, *Agr. Ecosyst. Environ.*, 129, 344-348.
- Vinther, F. P., Hansen, E. M., and Olesen, J. E., 2004. Effects of plant residues on crop performance, N mineralisation and microbial activity including field CO₂ and N₂O fluxes in unfertilised crop rotations, *Nutr. Cycl. Agroecosys.*, 70, 189-199.

Crop specific ammonia emissions: model based scenario analysis of ammonia losses after application of biogas residues

Pacholski, Andreas; Ni, Kang; Gericke, Dirk; Kage, Henning
Christian-Albrechts-University at Kiel, GERMANY

Introduction

There is a strong trend of increasing biogas production on agricultural farms throughout Europe with currently ca. 7000 plants in Germany, mostly operated by co-fermentation. Silage maize is the dominant biogas crop in Germany, but whole crop cereals, grasses and sugar beet are also used. The biogas residues (BR) are applied as N-fertilizers. Due to high pH values and NH_4^+ -N concentrations of field applied BR are characterized by higher specific NH_3 losses than those from animal slurries (Ni et al., 2012). Different energy crops require varying application dates and N doses, resulting in crop specific NH_3 losses. However, ammonia emissions mainly depend on weather and canopy conditions, so that it is difficult to derive mean/median NH_3 losses from field measurements of 1-2 years. Therefore, a model based scenario analysis of NH_3 losses was carried out for different energy crops based on 12 years of weather data in the North of Germany.

Materials and methods

Ammonia emissions were simulated for the years 1997-2008 with a validated dynamic NH_3 loss model (Gericke et al. 2012). The model includes the effects of slurry pH and environmental factors on NH_3 losses and also covers the effects of canopy characteristics and application method.

Calculations were done for a time span of 5 days after application. Energy crops and weather data from three agricultural regions in the Federal State of Schleswig-Holstein, Northern Germany, were used: 1) eastern moraines (loam); 2) central sandy outwash plain (sand); 3) coastal marsh (clay). Crop rotations as well as N levels and application dates are summarized in Table 1. Oil seed rape is not a biogas crop but was included as an alternative culture for application of BR. Simulations were done for a typical BR with a pH of 7.8, a content of 5.9% and 56% of NH_4^+ -N of total N. BR were applied according to total N content by trail hoses and subsequent incorporation.

Results and discussion

Simulated NH_3 losses varied strongly and were not normally distributed between years (Fig. 1). Median losses ranged between 4% and 20% of NH_4^+ -N applied. Emissions increased with higher temperatures in summer. After analysis by Kruskal-Wallis test on ranks on the rotation level, maize with incorporated BR showed the lowest relative NH_3 losses, followed by sugar beet with incorporation while no differences were determined between the other rotations with application by trail hoses. Significant differences were detected between absolute losses of all rotations, with highest losses in grass. In the

Table 1. Crops, N doses and application dates for BR applied by trail hoses covered in the scenario analysis

Crop rotation	Crop	kg N _{tot} ha ⁻¹	Application Date
A	Maize	160 (incorp. after 4 h)	Mid April
B	Rye grass (4 cuts)	120, 80, 60, 60	Mid March, Mid May, Begin July, Begin August
C	Winter Wheat + Rye Grass	80, 80, 80 (rye grass)	Mid March, Mid April, Begin August
D	Sugar beet	70 (incorpor. after 4 h), 70	Mid April, Mid May
E	Rape seed	120, 80	Mid March, Mid April

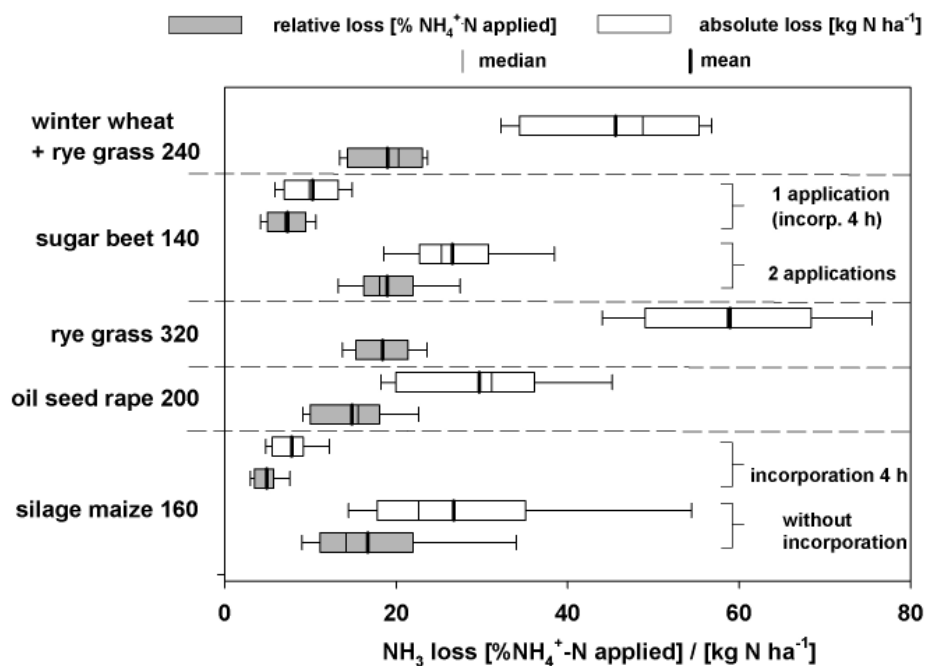

Figure 1. Simulated cumulated relative and absolute NH_3 losses 5 days after application of biogas residues, 1997-2008 ($n = 12$), Hohenschulen, Germany; values = fertilizer N_{tot} [$kg\ ha^{-1}$], error bars = 5% - 95% quintile

marsh emissions were 5% higher. As application dates were not adapted to crop growth, highest values indicate maximum losses. High relative absolute and relative NH_3 losses result in higher indirect N_2O emissions.

Conclusions

Simulation of NH_3 losses after application of BR using weather data from 1997-2008 showed a high variability of NH_3 losses which questions static emission factors for NH_3 losses. Field applied BR showed high emissions which may strongly decrease the environmental benefit of energy production by biogas. With respect to NH_3 emissions silage maize and sugar beet are favourable as

compared to winter cereals or grass. High BR application rates with incorporation resulted in the lowest simulated relative NH_3 emissions.

References

- Gericke D., Bornemann L., Kage H., Pacholski A. 2012. Modelling ammonia losses after field application of biogas slurry in energy crop rotations, *Water, Air & Soil Pollution* 223, 29-47.
- Ni K., Pacholski A., Gericke D., Kage H. 2011. Analysis of ammonia losses after field application of biogas slurries by an empirical model. *JPNSS* 175(2): 253-264

Ammonia emissions after application of biogas digestates: effects of soil, crop and weather conditions in 5 different regions of Germany

Seidel, Achim¹; Pacholski, Andreas¹; Augustin, Jürgen²; Kage, Henning¹

¹Institute of Crop Science and Plant Breeding, University of Kiel, GERMANY;

²Leibniz-Centre for Agricultural Landscape Research, Müncheberg, GERMANY

Introduction

With the political aim of supporting the renewable energy production there has been a rapid increase of agricultural biogas plants over the last 10 years in Germany with about 800,000 ha planted with crops for biogas production in 2011 (FNR 2011). Mostly animal slurries are co-fermented with maize-, but also grass- and whole crop cereal silages. There are large amounts of biogas digestates (BD) to be used as fertilizers, but with a higher potential of ammonia losses due to the typical higher pH-value compared to original animal slurries (Ni et al. 2011).

Materials and methods

To increase the knowledge on the climate protection potential of biogas production, a project has been established. Five sites in Germany were chosen regarding their soils and climatic conditions for the determination of trace gas fluxes (NH_3 , CH_4 , N_2O) and C-balances for the determination of biogas production greenhouse gas balances. Those sites are located in North Western, Northern, North Eastern, Central and Southern Germany. The project's main advantage is the uniformity of the field trial design at each site and of the measurements methods applied.

As one component of the trace gas monitoring, at each of the sites measurements of ammonia emissions directly after BD fertilization are carried out for about 4 days after application. Emissions are determined in maize, sorghum, triticale, winter wheat, rye and grass (*Lolium multiflorum*). Ammonia measurements are done without replication by a calibrated chamber method (Pacholski et al. 2006). In addition passive samplers will be applied to obtain replicated measurements in the multi-plot field trials. BD to Sorghum or Maize is applied by trail hoses and incorporated by harrow. The amount of BD is determined relative to the optimal N-fertilization rate (100 %) according to an assumed efficiency of N_{tot} of 70% mineral fertilizer equivalents. For maize, several N-levels (0, 50%, 100%, 200% of N_{opt}) are compared with respect to the height of gaseous N-losses and yields.

Results and discussion

As an example for first results obtained 2011, NH_3 losses from maize (100% = 160 kg N ha^{-1}) at sites in Central (Dornburg) and Southern Germany (Ascha) differed strongly under similar weather conditions and same

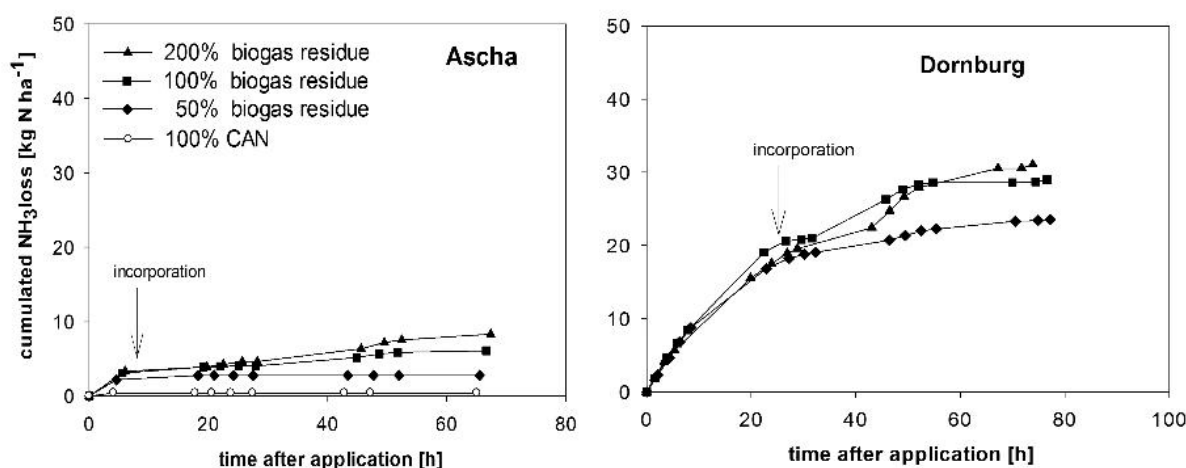

Figure 1. Ammonia emissions 2011 at two selected sites in Germany (Dornburg and Ascha) after BD fertilization, BD incorporated by harrow

N-application rate (Fig. 1). The lowest $\text{NH}_3\text{-N}$ losses were at the site in Ascha, with 2.7, 6.1 and 8.3 $\text{kg NH}_3\text{-N ha}^{-1}$ for the 50%, 100% and 200% BD-treatment, respectively. Considerably higher losses were measured in Dornburg, with 23.5, 29 and 31.1 $\text{kg NH}_3\text{-N ha}^{-1}$. Highest NH_3 losses, though not linearly higher as compared to the 100% treatment, were measured at all sites in the 200% BD treatment. This difference between NH_3 losses at the two sites was probably due to delayed incorporation, lower incorporation efficiency and higher pH values at the Dornburg site.

In the future the dataset of all NH_3 measurements shall primarily be used as a part of regionally based eco balances of biogas production systems for the whole of Germany. Further on it shall be used for a regionally expanded recalibration of a dynamic ammonia loss model (Gericke et al. 2012).

References

- FNR 2011. <http://mediathek.fnr.de/grafiken/daten-und-fakten.html> (25.03.2012)
- Gericke, D., Bornemann, L., Kage, H., Pacholski, A., 2012. Modelling ammonia losses after field application of biogas slurry in energy crop rotations. *Water Air Soil Pollut* 223:29–47
- Ni K., Pacholski A., Gericke D., Kage H. 2011. Analysis of ammonia losses after field application of biogas slurries by an empirical model. *JPNSS*. online: 22 Nov 2011, DOI: 10.1002/jpln.201000358
- Pacholski, A., Cai, G., Nieder, R., Richter, J., Fan, X., Zhu, Z., Roelcke, M., 2006. Calibration of a simple method for determining ammonia volatilization in the field – comparative measurements in Henan Province, China. *NUTR CYCL AGROECOSYS* 74: 259–273

Ecological footprint of different production systems

Straus, Sasa; Bavec, Franc; Turinek, Matjaz; Rozman, Crtomir; Bavec, Martina
University of Maribor, Faculty of Agriculture and Life Sciences, SLOVENIA

Introduction

In recent years, numerous tools and methods have emerged to determine environmental impacts. One of these tools is the ecological footprint, which aims to estimate the biologically productive area needed to generate the materials and energy required by the population of a certain region (Narodoslawsky and Krotscheck, 1995). The aim of our study was to measure the environmental impact of a particular production system through its ecological footprint at field level. We used experimental data from a production system's comparison field trial over three years and interpreted the data using the SPInExcel tool (SPI) (Narodoslawsky and Krotscheck, 1995).

Materials and methods

Three production systems (i.e., conventional (CON), integrated (INT), and organic (ORG)) and control plots were arranged in a randomized complete block split-plot design with four replications. The production systems differed mostly in plant protection and fertilization strategies. In CON, the preventive use of pesticides was allowed, in INT, only curative pesticides, and, in ORG, only natural pesticides. In INT and ORG, fertilizing was based on soil analysis, and ORG fertilizers were organic. No fertilization/plant protection was used in the control plots. A detailed description of the SPI is provided by Sandholzer and Narodoslawsky (2007). We calculated the total ecological footprint (A_{tot}), that is, the area necessary to embed the whole lifecycle generating a product (e.g., cabbage or red beets). The A_{tot} is calculated from partial footprints: direct land use, fertilizers and pesticides,

machinery use, and seed use. The partial footprints were calculated directly from the experimental field trial data.

Results and discussion

The highest A_{tot} was observed in CON, where for every hectare of CON cabbage production, an additional 70 ha of surface area was impacted, and 73 ha for CON red beet production. The difference between CON and INT was significant, although the A_{tot} for INT was only 1-2% lower. The A_{tot} was significantly lower for ORG, where it was 3.3 times lower for cabbage and red beet. The differences between ORG and the control plot are significant because, for cabbage, the results of ORG were 41% lower and, for red beet, they were 27% lower. Our results were eight times lower which correlates with the results of CON production in Italy (Niccolucci et al., 2008). The relatively large area utilized by CON and INT was mostly attributed to the mineral fertilizers and pesticides used. The smaller area appropriated by ORG was mostly due to machinery use, mainly because of manure spreading and additional harrowing. The surprising fact is that, even basic soil tillage and vegetable cultivation, without pesticides and fertilizers, leave a great environmental impact, and use between 11 and 17 times more land than is needed to plant the crops. The greatest improvements could be achieved by abandoning the mineral fertilizers and pesticides that were used in CON and INT. Also, the machinery presented a high environmental burden, since it is not energy efficient and represents between 65 and 75% of the total environmental footprint in ORG.

Table 1: Yield (Y) and ecological footprint (A_{tot}) for white cabbage and red beet from different production systems

Production system	White cabbage		Red beet	
	Y	A_{tot}	Y	A_{tot}
CON	68,475 ^a	702,754.70 ^a	27,879 ^a	732,234.40 ^a
INT	53,550 ^b	688,732.80 ^b	26,547 ^b	716,236.00 ^b
ORG	42,150 ^c	211,626.80 ^c	17,955 ^c	217,837.70 ^c
Control	18,825 ^d	125,594.10 ^d	8,250 ^d	159,398.20 ^d

Different letters (a-d) in rows mean significant differences between the production system at $p < 0.01$.

References

Narodoslawsky M & Krotscheck C. 1995. The Sustainable Process Index (SPI): evaluating processes according to environmental compatibility. *J. Hazard. Material.* 41: 383-397.

Narodoslawsky M & Krotscheck C. 2000. Integrated ecological optimization of processes with the Sustainable Process Index. *Waste Manag.* 20: 599-603.

Sandholzer D & Narodoslawsky M. 2007. SPionExcel – Fast and easy calculation of the Sustainable Process Index via computer. *Resour. Conserv. Recycl.* 50: 130-142.

The role of environmental factors and sowing date in the yield and quality of maize hybrids

Ványiné Széles, Adrienn; Ragán, Péter; Nagy, János
University of Debrecen, HUNGARY

Introduction

Climate change poses challenges to the world's agricultural production. Drier and rainy periods and extreme weather are increasingly typical and these negative effects are also stronger even within a year or a growing season. This situation is further increased by the fact that the World's population will increase from 7 to 8 billion in 15 years. From the aspect of world nourishment, increasing agricultural production is important and inevitable, resulting in an increasing quantity of irrigation water and increasing amount of mineral fertilisation taken up by crops.

Material and Methods

The examinations were carried out at the Experimental Site of the Centre for Agricultural and Applied Economic Sciences of the University of Debrecen in Eastern Hungary (N: 47°33', E: 21°26', 111 metres above sea level) in a moderately warm and dry production area on loess-based chernozem soil with deep humus layer in a small plot field experiment with a strip plot experimental design and four replications. In the two experimental years (2010, 2011) we evaluated the effect of the sowing date which was determined based on soil temperature (early sowing: 18 days before the optimal sowing date: 23rd April; late sowing: 17 days after the optimal date) and the environmental factors (temperature, precipitation) on the yield and grain quality factors (starch, protein and oil content) of four FAO maize hybrids (FAO 290, FAO 370, FAO 420 and FAO 500).

Results

Sowing date has the most significant effect, as it affects the yield quantity ($P < 0.01$), as well as the grain protein ($P < 0.001$), starch ($P < 0.001$) and oil content ($P < 0.001$). The yields of the examined genotypes were different ($P < 0.001$) in the average of sowing date and the experimental years. Since the effect of crop year was not significant and the genotype \times crop year was significant only at a 5% confidence level, it was concluded that yield

is determined by the differences between genotypes. The effect of the interaction sowing date \times crop year was the most significant ($P < 0.001$), but that of sowing date \times genotype could also be shown statistically ($P < 0.05$). As regards the quality parameters, there were significant differences between hybrids (Table 1).

There were significant differences between all three sowing dates based on the Duncan's test. The maize hybrids had the highest yield (in the average of the examined parameters) in the late sowing date (11.3 t ha⁻¹). In the early sowing date, the average hybrid yield was 8.3 t ha⁻¹ which is 22.5% lower than that of the optimal sowing date and 36.3% lower than the result obtained in the late sowing date. The optimal sowing date resulted in 1.2 t ha⁻¹ in comparison with the late sowing (11.1%).

As regards starch content, the early sowing date (6th April, Figure 1) was proved to be the best option, while starch and oil contents were more favourable in the late sowing date (10th May) in both years. The FAO 420 maize hybrid had higher starch content, while the FAO 290 hybrid had higher protein and oil content.

The average yield of the four hybrids was 9.5 t ha⁻¹ in 2010 and 10.3 t ha⁻¹ in 2011 which shows 0.8 t ha⁻¹ yield fluctuation. In the rainy year (2010), the sowing date did not cause significant difference in the average of genotypes, while there were significant differences between all three sowing dates ($P < 0.05$) in the average crop year (2011).

The protein and oil contents of the grain yield were lower in 2010, while the starch content was higher than 2011, when there was favourable weather, but the environmental parameters had a favourable impact on the oil content ($P < 0.05$) and they did not affect the protein and starch content.

Table 1. Variance analysis results of grain moisture content, grain starch content, grain oil content, grain protein content and yield of maize hybrids

Factor	Source of variation	Sig
grain starch content	sowing date (A)	***
	hybrids (B)	**
	years (C)	NS
	sowing date × hybrids (A×B)	NS
	sowing date × years (A×C)	NS
	hybrids × years (B×C)	NS
grain oil content	sowing date (A)	***
	hybrids (B)	***
	years (C)	*
	sowing date × hybrids (A×B)	NS
	sowing date × years (A×C)	***
	hybrids × years (B×C)	NS
grain protein content	sowing date (A)	***
	hybrids (B)	***
	years (C)	NS
	sowing date × hybrids (A×B)	NS
	sowing date × years (A×C)	***
	hybrids × years (B×C)	*
yield of maize hybrids	sowing date (A)	**
	hybrids (B)	***
	years (C)	NS
	sowing date × hybrids (A×B)	*
	sowing date × years (A×C)	***
	hybrids × years (B×C)	*

NS=not significant, * significant at P=0.05, **significant at P=0.01, ***significant at P=0.001,

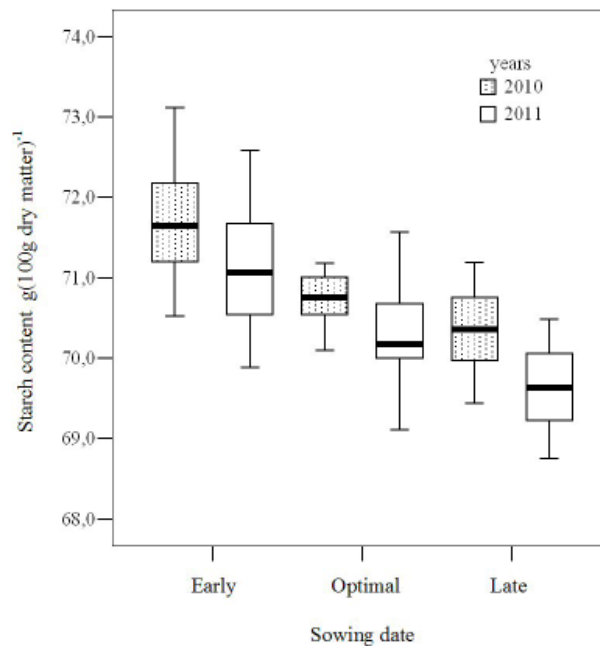

Figure 1. The effect of sowing date on the starch content of maize grains (Debrecen, 2010–2011)

Identification of main crop rotations in different Italian environments from RICA farm database

Albertazzi, Sergio¹; Baldoni, Guido¹; Della Chiara, Marco²; Cardillo, Concetta²; Trisorio, Antonella²; Vitali, Giuliano¹; Canavari, Maurizio¹

¹University of Bologna, ITALY; ²INEA, ITALY

Introduction

Agriculture plays an important role in carbon sequestration or emission (Smith et al., 2008). Tillage and manure management have a strong impact on soil organic matter. On arable land crop rotations are commonly used both to conserve fertility (Berzsenyi et al., 2000) and for pest control. To estimate GHG mitigation of Italian agriculture, rotations currently practised in a given region should be analysed, so as to be used in any model designed to optimize land use. Such a target has been pursued in the BIOSUS project that aims to estimate differences in carbon sequestration comparing conventional to organic farming.

Materials and methods

RICA database (Italian section of the EU-FADN database developed, maintained by INEA) is a collection of data from a sample of about 1% of Italian farms. Within BIOSUS it has been used to derive representative farms (Vitali et al., 2011) and, in parallel to obtain those rotations which better characterize the different Italian regions, under the assumption that crop rotations depend more on environmental conditions than on the other farming structural elements as tree crops or as

natural zones. Rotations has been obtained selecting from the RICA database (year 2007) 7682 farms with arable land and uniform slope. The 5 phyto-climatic zones (PCZ) of Italy has been combined with the 3 slope categories (plain, gently sloping, mountain) so as to obtain farm clusters by homogeneous environment. Then 29 arable crop categories classified in RICA have been grouped in 5 macro-activities (MA: set aside, forage crops, cereals crops, rice and intensive crops) on the basis of the likelihood of technical coefficients, environmental impacts and nutritional needs. Afterwards, ratios between MAs were calculated and discretized so as to obtain rotation ratios (see examples in figure 1). In a first instance ratio values have been bounded to 5 to consider a maximum of six-year course rotations, so as to preserve more relevant practices.

Results and discussion

Table 1 reports the most relevant rotations, selecting those that are used on more than 5% of farms in each environment. The 3 most important Italian rotation are continuous crops, respectively given by intensive, cereals and forage crops. The 5 remaining rotations have the same MAs. Rice and set aside do not emerge as relevant activities at this level of analysis. Continuous intensive crop can be observed in plain areas of warm PCZs (1,2,3) whereas in cold PCZs (4,5) it is present at every slope. It is also the main rotation in PCZ 5. Continuous cereal cropping appears only in warm PCZs (1,2,3) in each kind of slope without regular trend. Continuous forage crop is present in all PCZs, even though it is more important in gently sloping and mountain, with the exception of PCZ 5. Found rotations have only 2 MAs with biennial or three-year course. Rotations composed by intensive and cereal crops appear on PCZ 3 and 5. These types are more often observed

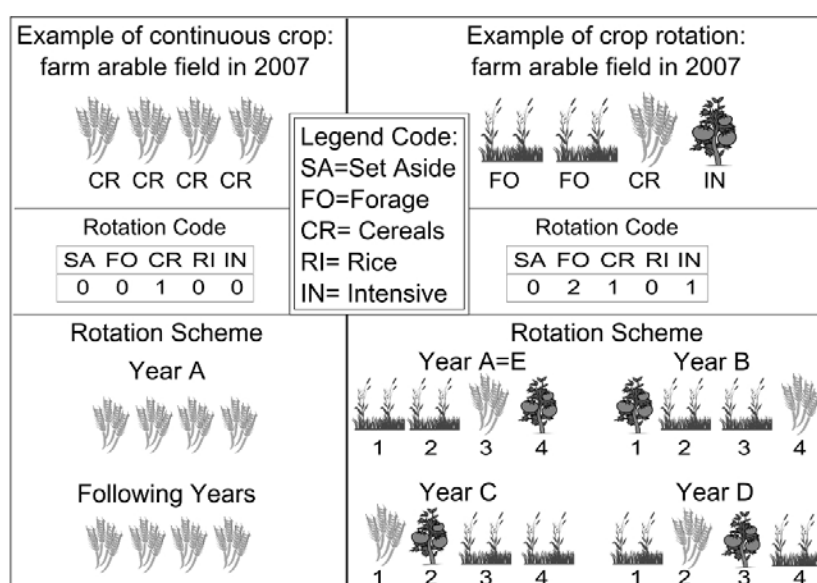

Figure 1. Examples of rotation schemes

in plain. Biennial rotation composed by intensive and forage crops is present in plain of some PCZs. Rotations composed by cereals and forage emerge with a good relevance especially in gently sloping and mountain areas.

References

Berzsenyi et al., 2000; Effect of crop rotation and fertilisation on maize and wheat yields and yield stability in a long-term experiment; Eur J Agron 13 225-244

Smith et al., 2008; Greenhouse gas mitigation in agriculture; Philos Trans R Soc Lond B Biol Sci 363 789-813

Vitali et al., 2011; Individuazione delle tipologie aziendali italiane su base agronomica per la valutazione degli agro-ecosistemi Biologici; in: "L'agricoltura biologica in risposta alle sfide del futuro: sostegno della ricerca e dell'innovazione"; ENEA, Rome p159

Table 1. Main cropping schemes with reported percentage of farms adopting it; Con: continuous crop; Rot: rotation; Int: intensive crop; Cer: cereals; For: forage crop.

Zone	Slope	Con. Intensive	Con. Cereals	Con. Forage	Rot. 1 Int + 1 Cer	Rot. 2 Int + 1 Cer	Rot. 1 Int + 1 For	Rot. 1 Cer + 2 For	Rot. 1 Cer + 1 For
1	1	21	18	21	5	5	9	5	5
1	2	22	14	30	5	5	5	5	8
1	3	5	7	61	5	5	5	5	10
2	1	34	24	13	5	5	9	5	5
2	2	7	18	35	5	5	5	6	11
2	3	5	17	38	5	5	5	5	18
3	1	25	8	8	7	5	5	5	5
3	2	5	14	26	5	5	5	7	10
3	3	6	12	33	5	5	8	5	10
4	1	35	5	8	5	5	5	5	5
4	2	53	5	13	5	5	5	5	5
4	3	30	5	35	5	5	5	5	5
5	1	86	5	7	7	5	5	5	5
5	2	52	5	30	5	5	5	5	5
5	3	67	5	5	5	33	5	5	5

Effect of Crop Rotation on Yield and Nutrient Balance in Organic Pepper and Green Onions

Lee, Sang-Min; Choi, Hyun-Sug; Lee, Youn; Sung, Jwa-Kyung; Yun, Hong-Bae; Jee, Hyeong-Jin
National Academy of Agricultural Science, Rural Development Administration, KOREA (REP)

Introduction

Codex and IFOAM prescribe firmly that organic agriculture should practice crop rotation by cultivating legume or deep-rooting crops. However, organic farmers in Korea mainly have used plastic film mulch to control weed occurrence during a growing season. This study was carried out to evaluate the effects of crop rotation on the yield of red pepper and green onion as well as nutrient balance.

Materials and methods

The study was conducted at the experimental farm in National Academy of Agricultural Science in Suwon, South Korea from 2003 to 2005. The conventional system was converted into organically managed systems from 2000 to 2002. Certified organic materials were used for pest management. Treatments were applied annually as follows: CF I; conventional farming system grown in green onion in summer in 2003, 2004, and 2005, OF I; organic farming system grown in hairy vetch in winter in 2002 and 2004, grown in green onion in summer in 2003, 2004, and 2005, and grown in rye in winter in 2003, CF II; conventional farming system grown in red pepper in summer in 2003, 2004, and 2005, OF II; organic farming system grown in hairy vetch in winter in 2002, 2003, and 2004 and grown in red pepper in summer in 2003, 2004, and 2005, OF III; organic farming system grown in rye in winter in 2002 and 2004, grown in red pepper in summer in 2003, 2004, and 2005, and grown in hairy vetch in winter in 2003. A chemical fertilizer and oilcake were annually applied for conventional

and organic farming systems, respectively, and livestock compost was supplied for the both systems (Table 1), depending on the soil nutrient analysis.

Results

Organic systems increased 13% of average yield of green onion compared to conventional systems but decreased from 23 to 36% of red pepper yield (Fig. 1). Application of rye without hairy vetch in organic system resulted in negative value for N balance (Table 1). Hairy vetch is a leguminous crop and supplied N of 10 to 20 kg/ha/year (Mitchell et al., 1977). The P_2O_5 balance was closed to 0 kg/ha/year in the organic systems, which indicated that crop rotation with green manures would be one of the effective ways to manage the adequate levels of phosphate in soil. The output value of K_2O in red pepper field was much higher than the input in the organic systems, which contributed to high level of K_2O surplus.

Table 1. Nutrient balance under different cropping systems

Treatment	Input (kg/ha)			Output (kg/ha)	Balance Balance (A+B-C)
	Fertilizer+ compost (A)	Green manure (B)	Total (A) + (B)	Crop uptake (C)	
N					
CF I	219	-	219	22	197
OF I	104	72	175	24	151
CF II	211	-	211	237	-25
OF II	75	111	186	208	-22
OF III	144	70	214	174	40
OF IV	47	151	198	213	-14
P_2O_5					
CF I	168	-	168	7	161
OF I	16	50	66	8	58
CF II	96	-	96	53	44
OF II	12	32	44	47	-3
OF III	23	49	71	43	28
OF IV	7	44	51	49	2
K_2O					
CF I	254	-	254	46	208
OF I	25	122	148	48	99
CF II	267	-	267	384	-117
OF II	18	72	90	371	-281
OF III	35	119	154	310	-155
OF IV	11	97	109	366	-257

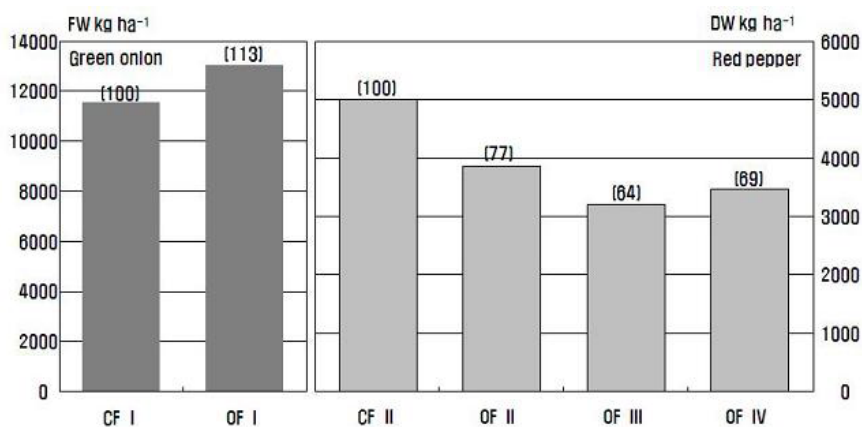

Figure 1. Average yield (2003-2005) of green onion and red pepper under different cropping systems

Conclusions

Application of leguminous green manure increased yield of the cash crops and minimized N and P₂O₅ surplus. However, the K₂O application in the red pepper field should be considered to avoid insufficient amount of nutrient available in maintaining vegetative growth of pepper crops during a growing season.

References

Mitchell, W.W. and M.R. Tell. 1977. Winter-annual clover crops for no-tillage corn production. *Agron. J.* 69:569-573.

Olive tree and annual crops association's productivities under Moroccan conditions

Daoui, Khalid; Fatemi, Zain El Abidine; Razouk, Rachid; Bendidi, Abderazak; Chergaoui, Abdelaziz; Ramdani, Abdelhamid

Institut National de la Recherche Agronomique, MOROCCO

Introduction

Agro forestry, the association on the same land of trees and crops, is a traditional practice. In recent years, because of negative impacts of monoculture intensification; agro forestry interested scientists at international level. This TRADITIONAL and also NATURAL innovation has many advantages (Kang and Wilson, 1987) (preservation of bio diversity, diversification of productions, C sequestration, alternative solution for climatic change, soil erosion control).

In Morocco such practice is used in mountainous and oasis regions where water and/or land resources are limited. In these locations many crops are mixed and their monitoring is complicated. Unfortunately, few scientific studies were dedicated to such system and someone might describe it as primitive, non-productive and in need of change.

The aims of this work, are a) determination of the importance of olive tree and annual crops association b) estimation with farmers of the productivity of the association and c) evaluation of advantages and disadvantages of such practice according to farmers and scientists point of views.

Materials and methods

This study is based on rapid rural appraisal approach. In different regions where olive tree are implemented, farmers (70 groups) gave qualitative indications of olive tree field: density and age of plantation, estimated olive yield, annual crops cultivated in inter rows of olive trees and their productivities in such situation. Also, interviews were made with farmers, researchers, development agents to determine the importance, advantage and disadvantages

of alley cropping based on olive tree. In parallel to this study, in different fields where olive tree are associated with other crops, we determine: density of trees, distance from tree to cultivated crops in inter rows and general observations on crops and olive tree performances.

Results and discussions

In the investigated zone, results shows that 75% of farmers growing olive tree are also producing annual crops between tree rows.

Those crops are: cereals (durum and soft wheat or barley), legumes (faba bean, lentils, pea, chickpea) and vegetables when irrigation is possible (potato, tomato, onion). Olive tree and cereals association are dominant (50% of cases).

We estimated that for an average density of 100 tree/ha, annual crops may occupy 75% of the land while olive tree may occupy the remaining part. Farmers indicated that technical interventions (ploughing, fertilizing) concerns mainly annual crops and then can profit to olive tree.

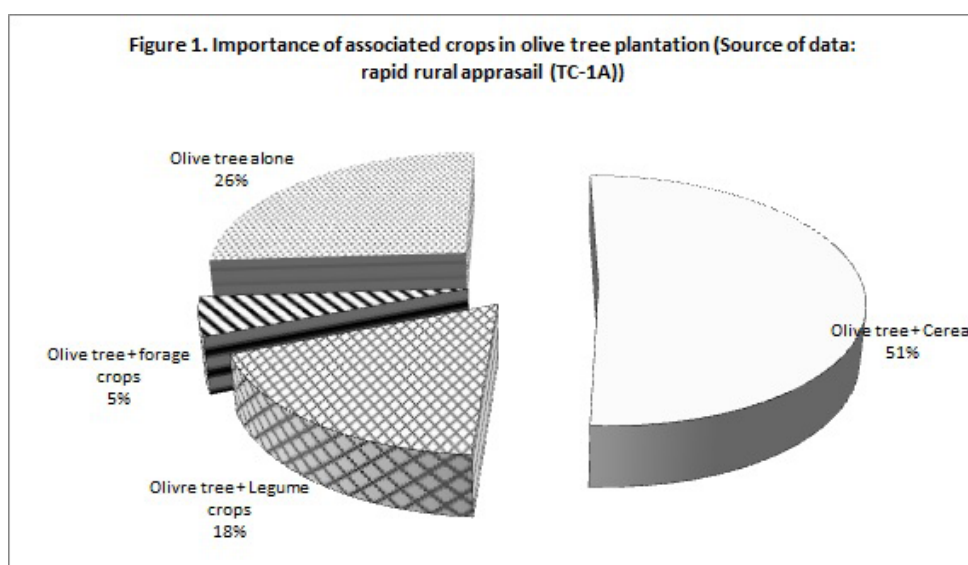

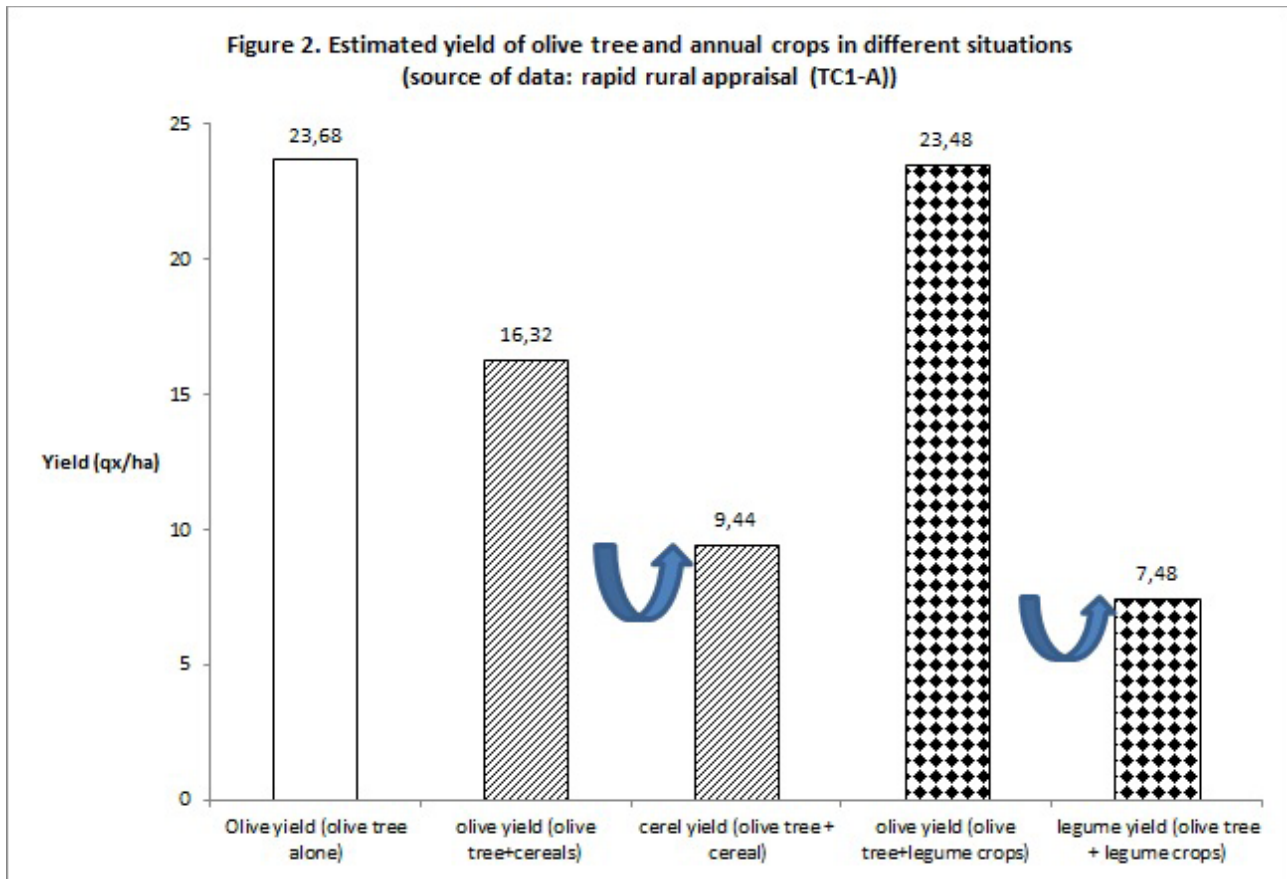

Olive tree monoculture is explained by: age of the plantation; when tree are old their shadow does not allow intercrop implementation also, when, tree density is high or when olive tree are implemented in accident land.

According to farmer's estimations: legume crops like faba bean do not affect olive production comparatively to cereals (durum or soft wheat or barley). In this second case, olive production is reduced by about 39% when cereals are intercropped between the rows. However, farmer produces an added value of cereals or legume of respectively 9 and 7 qx/ha.

We hypothesis that legume do not affect negatively olive production since those crops have short cycle comparatively to cereals and may give more nitrogen to plantation as result of biologically fixed nitrogen.

Conclusions

Association of perennial crops and annual ones is a common practice by farmers and might be more important in future due to land scarcity. Scientific involvement to analyses such system is necessary. Positive and negative interactions should be elucidating to choose more profitable combinations in more adaptable conditions.

References

Kang BT and Wilson GF (1987) The development of alley cropping as a promising agroforestry technology. In: Stepler HA and Nair PKR (eds) *Agroforestry: A Decade of Development*, pp 227-243. ICRAF, Nairobi, Kenya.

OSCAR – a new European project on cover crops

Baresel, Peter¹; Döring, Thomas²; Finckh, Maria³

¹*Technical University of Munich, GERMANY;*

²*The Organic Research Centre, UNITED KINGDOM;*

³*University of Kassel, GERMANY*

There is widespread concern over the damage caused by modern agriculture to soil structure and the ecosystem services provided. One approach to overcome this problem is conservation agriculture (CA) which aims to maintain soil structure by minimising soil disturbance, maximising soil cover and using crop rotation. However, despite recent legislation supporting minimum tillage and direct seeding, together with the efforts of pioneer farmers, CA is still practised on less than 4% of the agricultural land in Europe. This underlines the need for major improvements in the approach together with consolidation of, and access to, information about alternative cropping methods and their biological and economic value and performance.

A new European FP7-funded research project has started in April 2012 to address these issues. The project, called OSCAR is conducted by 20 partners and is led by University of Kassel, Germany. OSCAR aims to Optimise Subsidiary Crop Application in Rotations. It extends existing knowledge and improves and develops novel cropping systems based on cover crops, catch crops, living mulches and other subsidiary crops (SC). OSCAR aims to enhance the implementation and increase the duration of soil coverage by plants, introduce diversity to the crop rotation and reduce the need for and the intensity of soil tillage. Optimization will counteract the sometimes reduced yields associated with minimum or non-tillage systems whilst providing durable ecological benefits. Particular attention is given to conservation tillage systems. To maximise the potential of ecological benefits, both conventional and conservation agricultural systems are considered in OSCAR, encouraging a high level of innovation as well as offering a more immediate transfer into practical agriculture.

An overarching issue is the need to consider a broad range of environments and to make high quality tailored information widely accessible in Europe. The project also encompasses the identification and selection of new

SC and the development of adapted farm machinery for the various CC and LM species. These issues are addressed with two instruments in OSCAR, based on experimentation and knowledge management and transfer.

A series of coordinated field trials, i.e. a Multi-Environment Experiment, (MEE) is conducted in OSCAR as an experimental platform to generate the necessary knowledge for progressive improvements in the use of SCs in conventional, low-input, organic, and conservation agriculture systems. It is complemented by three long-term agricultural experiments (LTE) on CA and SC based farming systems. Established and novel plant species, agronomic measures and machinery will be assessed for their effect on productivity, need for fertilizers and pesticides, soil ecological impacts, and basic economical aspects. Research on the identification of new species and genotypes of interest in SC based systems and the development of adapted farm machinery accompany the MEE. The soil ecological impacts, basic mechanisms of competition in LM systems, problems concerning perennial weeds, as well as potential phytopathological risks and their solutions are also covered in OSCAR.

The knowledge generated through the research is made widely available to all relevant target groups in a Cover Crop Toolbox. The Toolbox makes project information available but also aims to reduce the fragmentation of existing knowledge by drawing together information in a central place. The Toolbox aims to help farmers to identify SC species most suited to their specific production systems, including economic aspects and technology requirements. In addition, the Toolbox encourages feedback from users and thus can evolve dynamically during and beyond the present project. Thus OSCAR will enable and motivate a substantial number of growers in different regions to adopt conservation agriculture methods and make a significant and durable contribution to soil conservation.

Why and how farmers delineate their plots on farming territories? A modelling approach

Schaller, Noémie¹; Boussard, Hugues¹; Castellazzi, Marie²; Joannon, Alexandre¹; Aubry, Christine¹; Martin, Philippe³; Benoit, Marc¹

¹INRA, FRANCE; ²The James Hutton Institute, UNITED KINGDOM; ³AgroParisTech, FRANCE

Introduction

Crop spatial organization at landscape scale strongly impacts many environmental issues. Not only do the crop proportions matter, but also their spatial arrangement, which determines the connectivity between plots and the associated environmental fluxes (e.g. water fluxes, gene fluxes). Thus the spatial characterization and modelling of crops in agricultural landscapes is required to design sustainable landscapes. While agronomic factors determining crop allocation to fields are well-understood, we today lack of knowledge about the determining factors of the subdivision of fields into plots (each with its own crop) inside farming territories. The aim of this paper is twofold: model how farmers define plot boundaries over time inside their farming territories, in relation with their cropping plan choices, and identify the factors determining their decisions.

Materials and methods

To gain theoretical insights about farmers' decisions of plot delineating, we used a case study approach and carried out successive surveys on 12 farms (Poitou-Charentes region, France). For each farm, we identified (1) the reasons of the presence and the localization of plot boundaries and (2) whether plot boundaries were permanent or not overtime. Once we had defined different types of plot boundaries, we evaluated their conceptual validity. We in particular tested the underlying hypothesis that the duration of plot boundaries depended on two criteria considered at the farm scale: (1) the yearly crop proportions and (2) the plot areas. To do so, we designed a virtual experimentation for simulating different cropping plans scenarios by varying the two above-cited criteria. The virtual experimentation was carried out by coupling two computer tools: APILand and LandSFACTS.

Results and discussion

We identified 84 plot boundaries inside the 256 fields of the 12 surveyed farms. We defined four types of plot

boundaries, depending on their duration over time and their determining factors, and showed that: (1) plot boundaries can be either permanent or temporary. By "permanent", we mean that the plot boundary remains every year at the same place. By "temporary", we on the contrary mean that the plot boundary can appear and disappear depending on years, but still at the same place inside the field. (2) There were two classes of factors determining plot boundaries: biophysical factors for 42% of plot boundaries (e.g. soil type) and agronomic ones for 58% of plot boundaries (e.g. crop proportions at farm scale). While biophysical-boundaries were mostly permanent (94%), we found that the duration of agronomic-boundaries (29% of permanent agronomic-boundaries and 71% of temporary agronomic-boundaries) depended on two criteria considered at the farm scale: the plot areas and the yearly crop proportions constraints. To evaluate this conceptual modelling of plot delineation, we simulated different cropping plans scenarios thanks to the coupled tool APILandSFACTS. The simulation results on a mixed crop-livestock farm confirmed that permanent agronomic-boundaries were mandatory every year to avoid strong interannual crop proportion variations and have yearly crop proportion constraints respected every year at farm scale. In contrast, temporary agronomic-boundaries were only sometimes necessary to punctually adjust or smooth interannual crop proportion variations. These temporary agronomic-boundaries aimed at increasing farmers' flexibility in the choice of cropping plans at farm scale. It now would be interesting to test the wider relevance of our results in other contexts, in particular in contexts where farmers do not aim at avoiding strong interannual crop proportion variations and in contexts with different biophysical constraints (e.g. soil salinity, flooded soils). To conclude, our insights about different types of plot boundaries should contribute to improving the representation of plot spatial arrangements in landscape models.

Evaluating impact of organic agriculture in GHG emissions at a national level: analysis framework

Vitali, Giuliano¹; Baldoni, Guido²; Albertazzi, Sergio²; Signorotti, Claudio²; Cardillo, Concetta³; Della Chiara, Marco³; Bazzani, Guido⁴; Canavari, Maurizio²

¹University of Bologna, ITALY; ²Univ.Bologna, ITALY; ³INEA, ITALY; ⁴CNR, ITALY

Estimating expected contributions of organic agriculture to GHG mitigation can be mostly considered a yet unsolved problem. At a national level, Italian project BIOSUS has the main aim to estimate the capability of such a new course of agricultural management to increase agriculture C storage by means of a farm-scale bio-economical model (MAD) oriented to relate this capability to farm net income. The model development started with most complete and reliable Italian data-base, RICA (compliant to EU-FADN, year 2007, maintained from INEA), reflecting about 1% of Italian agriculture holdings. On the base model objectives farm structure has been described at three different granularities. The lowest level of detail is represented by super-structure identifying 4 main farm activities: husbandry (ZOO), natural surfaces (NAT), tree-crops (ARB) and arable land (SEM), which are related to different farm management processes (and model components). At an intermediate level of detail farm is described by 14 macro-activities (10 land uses: BO-woodland, PR-meadows, SA-set-aside, FO-forage-crop, CR-cereals, RI-rice, IN-intensive, AR-fruit-trees, VT-wineyards, AB-low-input tree crops; 4 husbandry types: EC: meat cattle, EL: dairy cattle, SU:pigs, OC:ovines) that

has been used to specify technical parameters as resource requirements (average fuel, labour, fertilizers, pesticides) and C flux parameters (on the base of phyto-climatic zone). The lower level of detail refers to crop classes from RICA data-base (EC, 2008) and it has been used to specify those parameters more related to the crops that are actually cultivated in a given area as market prices. Former results of present investigation are a classification of farms (about 9.000) present in 2007 census as shown in figure 1 and of practiced rotations (Arbertazzi et al., 2012).

Farm-set analysis has been used to build up a model (MAD) and the relative parameter data-base. The former has been written in GAMS, and its main components are described in figure 1: it aims to optimize (economically) a farm structure (without changing its main composition in terms of super-structure, likely FSSIM, Van Ittersum and Wery, 2007) and compute environmental indicators.

Different sets of crop rotations can be used for a conventional and organic management scenarios, to estimate which is the expected differences of C stored

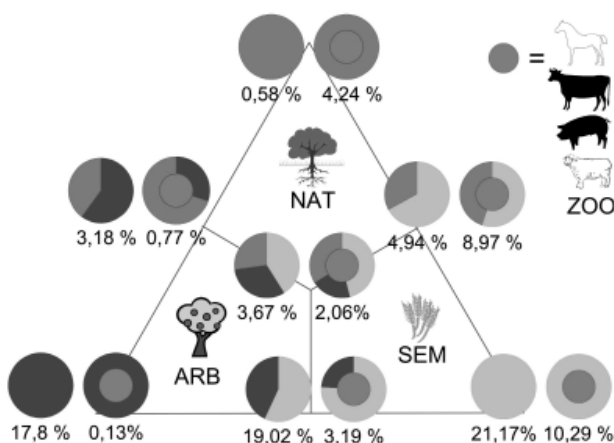

Figure 1. Main Italian farm types emerging from RICA data-base. Pie sector angles reflects composition in terms of the 3 super-activities (SEM-light grey, ARB-dark grey, NAT-gray) whereas the inner dot informs on the presence of husbandry; figures tells the percentage of each type on RICA db.

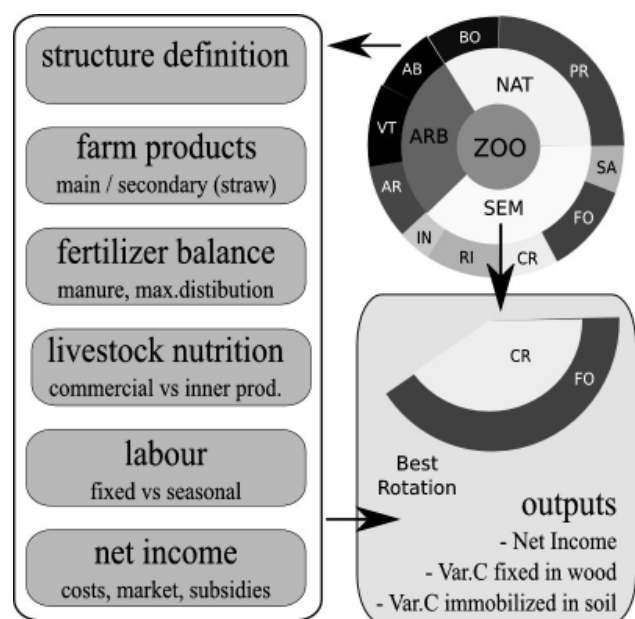

Figure 2. Model and farm structure

in soil and wood together with farmer's net income one. Such estimates are useful in subsidy-driven agriculture to estimate subsidies farmers need to consider to turn to organic. Furthermore results can be used at a national level to estimate differences of GHG emission from different agricultural land management, understand the impact of organic agriculture policies and for a more correct distribution of subsidies.

References

- Albertazzi S., Baldoni G., Della Chiara M., Cardillo C., Trisorio A., Vitali G., Canavari M., 2012, Identification of main crop rotations in different Italian environments from RICA farm database. ESA 2012.
- Van Ittersum M.K., Wery J., 2007, Integrated assessment of agricultural systems at multiple scales. In J.H.J. Spiertz, P.C. Struik and H.H. van Laar (eds.), *Scale and Complexity in Plant Systems* pp303-317,
- Springer. EC, 2008, establishing a Community typology for agricultural holdings - EC- 1242/2008, Official Journal of the European Union, 335/3.

Alphabetical list of authors

Acutis, Marco	P2-75, P2-76
<u>Adamovics, Aleksandrs</u>	<u>P1-80, P1-81, P1-82, P2-47</u>
Afif, Elias	P1-13, P2-10
Agacka, Monika	P2-53
Ahmadi, N.	P2-07
Ahmed, Lina	411-2
Al-Shamari, Magda	521-5, P2-26
<u>Al-swedi, Fadi</u>	<u>521-5, P2-26</u>
Alaru, Maarika	P1-32
<u>Albajes, Ramon</u>	<u>221-1K</u>
Albarran, M ^a del Mar	P2-60
Albergo, Roberto	442-4
Albertazzi, Sergio	P2-87, P2-92
Alberto, Puggioni	P2-68
Aliau, C.	P2-06
Allard, V	242-1K
Amein, Tahsein	P1-50
Amiaud, Bernard	241-2
An, Nan-Hee	P2-59
<u>Angelini, Luciana G.</u>	<u>P1-88, P2-48, P2-49</u>
<u>Angelopoulos, Nickolas</u>	<u>P1-04</u>
Angevin, Frédérique	231-3, P1-08, P1-46
<u>Angulo, Carlos</u>	<u>232-5</u>
Antanasovic, Svetlana	422-5, 422-6
Anten, Niels	211-1
<u>Antonio Ordoñez, Raziël</u>	<u>P2-01</u>
Arndorfer, Michaela	241-1, 241-5
Asari, Shashidar	P1-50
Asplund, Linnéa	P1-01
<u>Asseng, Senthold</u>	<u>141-4</u>
Aubry, Christine	P2-91
Augustin, Jürgen	P2-83
Avice, Jean Christophe	131-2
Baab, G.	132-4
Bachinger, Johann	412-4
<u>Baddeley, John</u>	<u>412-2, P2-32</u>
Bailey, Debra	241-1
Balács, Katalin	241-1
Balazs, K.	241-5
Baldoni, Guido	P2-87, P2-92
Balodis, Oskars	231-5
Bana, Anil	142-4
<u>Bandiera, Marianna</u>	<u>431-1</u>
<u>Bankina, Biruta</u>	<u>221-5, 231-5, P1-52</u>
Barba, Nuno W.G.	441-1
Barbanti, Lorenzo	P1-83
Barbet-Massin, Claire	P1-30
Barbi, F.	P2-06
Baresel, Peter	P2-90
Barkaoui, Karim	411-2
Barkusky, Dietmar	443-4
Baron, Christian	141-1
Barra, Vincent	441-5
Barre, Philippe	411-2
Barros, Flávio	441-1
Bartusevics, Janis	212-5
Baruth, Bettina	P1-11
Basçi, F.	P2-06
Basset-Mens, Claudine	423-6
Basso, Bruno	141-1
<u>Bassu, Simona</u>	<u>141-1</u>
Bataillé, Marie Paule	242-2
<u>Battaglia, Donatella</u>	<u>P1-39</u>
Baudry, Jacques	522-2
<u>Baux, Alice</u>	<u>P2-03</u>
<u>Bavec, Franc</u>	<u>P1-63, P2-85</u>
Bavec, Martina	P1-63, P2-85
Bazot, Mathieu	412-5, P1-90
Bazzani, Guido	P2-92
Beauclair, Patrick	242-2
Beaudoin, Nicolas	222-6
Bebeli, Penelope	P1-34
Bechini, Luca	P1-12
Bedoussac, Laurent	432-1
Begas, S.	P2-06
Begg, Graham	422-4
Bejai, Sarosh	P1-50
<u>Bellocchi, Gianni</u>	<u>441-5</u>
Ben Touhami, Haythem	441-5
Bendidi, Abderazak	P2-55, P2-89
<u>Benoit, Marc</u>	<u>411-1, 423-2, P2-91</u>
Berder, Julie	231-1, P1-46, P2-46
<u>Bergez, Jacques-Eric</u>	<u>211-5, 441-4, P1-08</u>
Bergkvist, Göran	P1-01
Bernhardt, K. G.	241-5
<u>Bertholdsson, Niils-Ove</u>	<u>431-2</u>
Bertrand, Michel	132-3
<u>Biau, Anna</u>	<u>432-6</u>
<u>Bienkowski, Jerzy</u>	<u>443-5</u>
Franciszek	
<u>Biernath, Christian</u>	<u>141-1, P1-02</u>
Bilalis, Dimitrios	P2-34
Bimsteine, Gunita	221-5, P1-52
<u>Birman, Delphine</u>	<u>522-2</u>
Bissett, Andrew	132-1K
Bittner, Sebastian	P1-02
Bobinas, Ceslovas	231-6
<u>Bockstaller, Christian</u>	<u>241-2, P1-08</u>
Boelt, Birte	242-5
Bogard, M	242-1K
Bogers, M.	241-5
Böhm, Herwart	443-2, P2-57
Bonari, Enrico	522-5, P1-85, P1-88, P1-92
<u>Bondeau, Alberte</u>	<u>P2-72</u>
<u>Bongcam-Rudloff, Erik</u>	<u>P1-50</u>
Bono, Giuseppe	P2-19, P2-65
Boogaard, Hendrik	141-1
Boote, Ken J.	141-1
Borin, Maurizio	442-4, P2-50
Borrelli, Lamberto	P1-26, P1-71, P2-81
Bosco, Simona	P1-92
<u>Böttcher, Ulf</u>	<u>131-1, 131-3, P1-25, P2-11</u>
Boussard, Hugues	P2-91
Bouwman, Alexander	433-4
<u>Bregaglio, Simone</u>	<u>131-6, 141-2, 441-2, P1-05</u>
Brenna, Stefano	P2-76
Brun, François	211-5
<u>Brunel-Muguet, Sophie</u>	<u>131-2, 242-2</u>
Brunotte, Joachim	P1-76
Buchmann, Nina	441-5
Bunce, R. G. H.	241-5
Bunzel, Katja	212-1K
<u>Buono, Vito</u>	<u>P1-06</u>
<u>Burchill, William</u>	<u>433-5</u>
Butier, Arnaud	P2-46
Büttner, Mirko	222-1
<u>Cabassi, Giovanni</u>	<u>P1-12, P1-26, P1-71, P2-81</u>
Cadoux, Stéphane	P1-84
Campi, Pasquale	222-4
Canavari, Maurizio	P2-87, P2-92
Canet, R.	132-4
Cannavacciolo, Mario	P1-67
Cano, M.	P2-06
<u>Capecchi, Lorenzo</u>	<u>P1-83</u>
<u>Cappelli, Giovanni</u>	<u>441-2</u>
Caputo, F.	P1-70
Cardillo, Concetta	P2-87, P2-92
<u>Cardinali, Alessandra</u>	<u>P2-74</u>
Cardoso, Rita M	441-1
Carletti, Paolo	P2-74
<u>Carney, John</u>	<u>P2-04</u>
<u>Carozzi, Marco</u>	<u>P2-75, P2-76</u>
Caruso, Giovanni	P1-68, P1-69
Casadebaig, Pierre	P1-09
Casebow, Richard	521-4
<u>Cass, Susannah</u>	<u>P2-31</u>
Cassagne, Nathalie	P1-67
Cassman, Kenneth	141-5, 142-2
Castellazzi, Marie	P2-91
Castellini, Mirko	P2-25
Catterou, Manuella	222-6
Cavalli, Daniele	P1-12, P1-26
Centonze, Diego	P2-29
Cestone, Benedetta	P2-49
Chabbi, Abad	411-2
Champclou, David	432-1
Champolivier, Luc	P1-09
Charfeddine, Monia	P2-25
Charrier, Xavier	221-2, P1-49
<u>Chatskikh, Dmitri</u>	<u>P1-07</u>
<u>Chatzivassiliou, Elisavet</u>	<u>P1-57</u>
Chauvel, Bruno	241-2
Chergaoui, Abdelaziz	P2-89
Chirinda, Ngonidzashe	P1-04
Chirurgwi, Tinashe	P1-19
Cho, Jung-Lai	P2-59

Choi, Hyun-Sug	P2-88	Egilmez, Petra	P1-66
Chois, J.-P.	241-5	Eiter, S.	241-5
<u>Christen, Olaf</u>	222-1	<u>Ekbom, Barbara</u>	241-3K
Chynoweth, Richard	242-5	Eli, Vered	P2-68
Cirelli, Giuseppe Luigi	442-4	Engan, G.	241-5
Claessens, Lieven	141-5	Enrico, Bonari	P2-68
Clouvel, Pascal	522-2	Erbs, Martin	442-5
<u>Colbach, Nathalie</u>	221-3, 413-5	Erdei, Éva	P1-86
Coll, Patrice	432-3	<u>Eremeev, Viacheslav</u>	P1-32
Collins, Rosemary	P2-32	Eric, Pero	422-6
<u>Colnenne-David, Caroline</u>	432-5, 443-3	Esala, Martti	P2-79
Colomb, Bruno	P1-08	Escobar-Gutierrez, Abraham	411-2
Combes, Didier	411-2	Etienne, Philippe	131-2, 242-2
Confalonieri, Roberto	131-6, 441-2, P1-05	Eurola, Merja	P2-40
Conijn, Sjaak	141-1	Evers, Jochem B.	131-4
<u>Constantin, Julie</u>	442-2	Ewert, Frank	211-3, 232-5, 421-5, P1-21
Corbeels, Marc	141-1	Fangmeier, Andreas	P1-02
Cordeiro, António M	441-1	Fanti, Paolo	P1-39
Corre-Hellou, Guénaëlle	211-4	Fasoula, Vasilisa	P1-34
Coste, Françoise	211-4	Fatemi, Zain El Abidine	P2-55, P2-89
Courtois, B.	P2-07	<u>Fauquet-Alekhine-</u>	442-1
Craheix, Damien	P1-08	<u>Pavlovskaya, Elena</u>	
Crowley, Oliver	P2-32	Fayaud, Benoit	211-4
Cruz, Pablo	411-2	<u>Feledyn-Szewczyk, Beata</u>	P1-44, P1-60
<u>Cupina, Branko</u>	422-5, 422-6	Félix, Irène	P1-45
Cuttle, Steve	P2-32	<u>Ferchaud, Fabien</u>	222-2, P1-84, P1-95
Dabkevicius, Zenonas	P1-87, P1-94	Fermaud, Marc	432-3, P1-42
Dabrowicz, Radoslaw	443-5	Fernández-Martínez, José	P2-09
Dach, Jacek	P2-64	María	
Daoui, Khalid	P2-20, P2-55, P2-89	Ferrante, Ariel	P1-33
Dauber, Jens	P2-52	Ferrara, Rossana Monica	P2-75, P2-76
David, Christophe	413-4	Filipe, João A.N.	221-4
De Marco, Alexandra	522-6	Finckh, Maria	P2-90
De Maria, Susanna	P1-39	Finell, Michael	212-2
<u>de Melo e Abreu, José Paulo</u>	441-1	Fiore, Maria Carola	P2-18, P2-19, P2-65
De Oliveira, Tatiana	132-3	Fischer, Jenny	443-2
De Sanctis, Giacomo	141-1	Fjellstad, W.	241-5
<u>Debaeke, Philippe</u>	P1-09, P1-30	Fjellstad, Wendy	241-1
<u>Debolini, Marta</u>	522-5	<u>Flagella, Zina</u>	P2-27, P2-28, P2-29
Decau, Marie-Laure	411-2	Flenet, Francis	131-1
Decock, Simon	P1-49	<u>Florio, Giulia</u>	442-4, P2-50
Degano, Luigi	P1-12, P1-26, P1-71, P2-81	Fogelberg, Fredrik	232-3
<u>Deihimfard, Reza</u>	P1-41, P2-23	<u>Fortino, Gabriele</u>	231-3, P1-46
Delbac, Lionel	432-3, P1-42	Foulkes, MJ	242-1K
Della Chiara, Marco	P2-87, P2-92	Fountaine, James	P1-73
<u>Delmotte, Sylvestre</u>	441-3	Fournier, Thomas	411-1
<u>Demay, Charlotte</u>	P1-84	<u>Fowler, D. Brian</u>	421-1K
Dennis, Peter	241-1, 241-5	Frak, Ela	411-2
<u>Denoroy, Pascal</u>	132-5	Frank, T.	241-5
Deryng, Delphine	141-1	Frasso, Nicolò	131-6
DeSilva, J	242-1K	Friedel, J. K.	241-5
Deumlich, Detlef	443-4	Friedel, Jürgen	241-1
Deveikyte, Irena	P1-54, P1-55	Fuccella, Roberto	P1-12, P1-26
Di Bene, Claudia	522-5	Fuller, Michael Paul	521-5, P2-26
Di Benedetto, Nilde	P2-27	Fülöp, Mihály	212-4
Antonella		Fumagalli, Davide	P1-11
Diaz, Mario	P1-61	<u>Fustec, Joëlle</u>	P1-67
Djordjevic, Vuk	422-5	Gaba, Sabrina	241-2
Dogliotti, Santiago	522-1, 522-3	Gabrielle, Benoît	222-5, 423-6, 443-3
<u>Doisy, Diana</u>	221-2, 221-3	Gaile, Zinta	212-5, 231-5
Doltra, Jordi	P1-10	Gaiser, Thomas	232-5
<u>Donatelli, Marcello</u>	141-2, 141-3K, P1-05, P1-11, P1-15, P1-16, P1-17	Gaju, O	242-1K
Dong, Yan	432-4	Garchi, Salah	241-1
Donn, Suzanne	132-1K	<u>García-Tejera, Omar</u>	P2-09
Doré, Thierry	221-4, 432-5, 443-3, P1-08	Garcia, Frédéric	441-4
<u>Döring, Thomas</u>	P2-32, P2-56, P2-90	Gardarin, Antoine	211-4
<u>Dragoni, Federico</u>	P1-85	Gary, Christian	231-2, 423-5
<u>Dramalis, C.</u>	P2-06	<u>Gasparini, Valentina</u>	P1-48, P2-74
<u>Dramalis, Christos</u>	P2-05, P2-07	Gastal, François	411-2
Dramstad, W.	241-5	Gayler, Sebastian	141-1, P1-02
Dratkiewicz, Piotr	P1-27	Geijzendorffer, Ilse	241-1, 241-5
Drewer, Julia	222-5	<u>Gelsomino, Antonio</u>	P1-75, P2-39
Drouet, Jean-Louis	222-5	Gennai, Clizia	P1-69
<u>Duchovskiene, Laisvune</u>	231-6	Gericke, Dirk	P2-82
<u>Dufossé, Karine</u>	222-5	Ghesquière, Marc	411-2
Dufour, Lydie	222-3, P2-37	Giglio, Luisa	P2-25
Dulos, Léa	432-2	Gilgen, Anna Katarina	441-5
Dupraz, Christian	222-3	Gill, Kulvinder	431-3
<u>Durand, Jean-Louis</u>	141-1, 411-2	Giller, Ken	433-4
Dürr, Carolyne	211-4	Gilligan, Christopher A.	221-4
Duveiller, Gregory	141-3K, P1-11	Gillingham, P.	241-5
Dyman, Tetyana	241-1	Gislum, Rene	242-5
<u>Ebrahimi, Elnaz</u>	P2-35	Giuliani, Marcella Michela	P2-27, P2-29
<u>Ebrahimi, Nashmin</u>	P1-65	Giuzio, Luigia	P2-27, P2-29
Eckersten, Henrik	232-2	<u>Goglio, Pietro</u>	443-3
		Gonzalez-Bornay, Guillermo	P1-61

Gooding, Mike	521-4, P1-51, P2-04	Jouany, Claire	411-2
Gorgoso, J. Javier	P1-13, P2-10	Journet, Etienne-Pascal	432-1
Goudier, Damien	131-2	Juarez, Enrique	P1-61
Goulevant, Gael	423-3	Julier, Bernadette	411-2
Gozdowski, Dariusz	P1-27	Justes, Eric	412-1, 432-1, 442-2
Grandeau, Gilles	432-5	Juutinen, Elina	P2-63
Granger, Sylvie	413-5	Kadziulienė, Zydre	P1-54, P1-87, P1-94
Graß, Rikard	P2-11	Kage, Henning	131-1, 131-3, P1-25, P2-11, P2-82, P2-83
Grassini, Patricio	141-1, 141-5, 142-2	Kainz, Maximilian	241-1, 241-4, 241-5
Gresta, Fabio	P2-39	Kajji, Abdellah	P2-20
Greveniotis, Vasileios	P1-34, P1-38	Kakitis, Aivars	P1-82
Griffiths, S	242-1K	Kalaji, Mohamed Hazem	P1-27
Grigatti, Marco	P1-83	Kambouzia, Jafar	P1-41, P2-15
Gristina, Luciano	P2-17	Kamińska, Sonia	P2-71
Gronle, Annkathrin	P2-57	Kanellopoulos, Argyris	522-4
Groot, Jeroen C.J.	522-3, 522-4	Kangor, Tiia	P1-03, P1-56
Grove, Ivan	421-3	Känkänen, Hannu	423-1
Gucci, Riccardo	P1-68, P1-69	Karapanos, Ioannis	P2-34
Guichard, Laurence	P1-08	Kargiotidou, Anastasia	P1-57
Guilpart, Nicolas	432-3	Karkleliene, Rasa	231-6
Gupta, Naveen	142-4	Karley, Alison	P2-33
Gutmene, Iveta	P2-47	Kartaatmadja, Sunendar	142-4
Guyot, Sébastien H.M.	413-5	Katajajuuri, Juha-Matti	443-1
Haigh, Ian	421-3	Katamadze, Merabs	231-5
Hajiboland, Roghieh	P1-65	Katsantonis, Dimitrios	P2-05, P2-06, P2-07
Hakala, Kaija	423-1	Kaul, Hans-Peter	P2-35, P2-61, P2-62
Hakojärvi, Mikko	P1-14	Kaur, Ravneet	521-2
Halling, Magnus	232-2	Kaymak, S.	132-4
Hare, Martin	421-3	Keatinge, F.J.D.	531-1K
Harsányi, Endre	P1-86	Keatinge, J.D.H (Dyno)	531-1K
Hartikainen, Helinä	P1-65, P1-66	Kelderer, M.	132-4, P1-70
Hatfield, Jerry L.	141-1	Kemanian, Armen	141-1
Hautala, Mikko	P1-14	Kenedy Etone, Epie	212-3
Hawes, Cathy	P2-33	Kersebaum, Kurt Christian	141-1, 211-2, 443-4
Hazard, Laurent	411-2	Keskitalo, Marjo	423-1
Heath, William	421-3	Kettlewell, Peter	421-3
Hecker, Jens-Martin	412-4	Keussayan, Nathalie	211-5
Hentschel, Rainer	P1-02	Khazaei, Hamid	411-5
Herz, Patrick	P2-61	Kihara, Job	142-5
Herzog, Felix	241-1, 241-4, 241-5	Kirkby, Clive	132-1K
Herzon, Iryna	P2-78	Kirkegaard, John	132-1K
Hietaniemi, Veli	P2-40	Klein, Christian	P1-02
Hledik, Pavel	P2-67	Knox, Oliver	P1-73
Hochman, Zvi	142-3	Koch, Heinz-Josef	P2-58, P2-69
Hoek, Steven B.	141-1	Kontopoulou, Charis-	422-1, P2-34
Hoffmann, Peter	P1-02	Konstantina	
Högy, Petra	P1-02	Koppel, Mati	P1-03
Holka, Malgorzata	443-5	Koppel, Reine	P1-03, P1-56
Holmes, Helen	P1-19	Kornher, Alois	232-2
Horaczek, Tomasz	P1-27	Koutroubas, Spiridon	P2-05, P2-07
Houst, Martin	P2-67	Koutsika-Sotiriou, Metaxia	P1-38
Howlett, Sally	P2-32	Kreita, Dzintra	231-5
Huat, Joël	423-6	Kreuger, Emma	212-2
Hubert, Bernard	522-2	Krstic, Djordje	422-5, 422-6
Hughes, J. d'A.	531-1K	Kryzeviciene, Aldona	P1-87
Huising, Jeroen	142-5	Kupisch, Moritz	211-3, P1-21
Hülsbergen, Kurt-Jürgen	241-4, 241-5	Kuzmin, Igor	P1-07
Humphreys, James	433-5	Kwang-Lai, Park	P2-59
Hunt, James	132-1K	Kymäläinen, Maritta	P1-89
Huusela-Veistola, Erja	423-1	Lääniste, Peeter	P1-32
Hyrkäs, Maarit	P2-16, P2-63	Lacroix, Bernard	211-5
Iannetta, Pietro	412-3K, 422-4, P2-33	Lafond, David	231-2
Ibijbijen, Jamal	P2-20	Lagerberg-	232-3
Idziak, Robert	P2-64	Fogelberg, Charlotte	
Ingver, Anne	P1-56	Lamb, William	433-2
Insam, H.	132-4	Lammirato, Carlo	P2-75
Izaurralde, Cesar	141-1	Landé, Nathalie	432-1, 432-2
Jacobs, Anna	P2-58, P2-69	Lane, Stuart	521-5
Jalli, Heikki	423-1	Langensiepen, Matthias	211-3, P1-21
Jalli, Marja	423-1	Lanigan, Gary	433-5
Jankowiak, Janusz	443-5	Lapina, Liga	221-5
Jat, M. L.	142-4	Lardy, Romain	441-5
Jauhiainen, Lauri	423-1	Last, Luisa	241-1
Jeanneret, Philippe	241-1, 241-4, 241-5	Lauk, Ruth	P1-32
Jee, Hyeong-Jin	P2-59, P2-88	Laus, Maura Nicoletta	P2-27, P2-28
Jerkovich, G.	241-5	Lazraq, Abderahim	P2-55
Jeuffroy, Marie-Hélène	412-5, P1-90	Le Barh, Catherine	P2-78
Joannon, Alexandre	P2-91	Lebas, Guillaume	222-6
Johansson, Anna	P1-50	Leclerc, Melen	221-4
Jokela, Venla	232-4	Ledesma, D.	531-1K
Joly, François-Xavier	P1-67	Lee, Byung-mo	P2-59
Jonczyk, Krzysztof	P2-41	Lee, Sang-min	P2-59, P2-88
Jones, Hannah	P1-51, P2-32	Lee, Youn	P2-59, P2-88
Jones, James W.	141-1	Leelarasamee, Natthanon	P1-50
Jongman, Rob	241-1, 241-5	Leffelaar, Peter	P1-18
Jongschaap, Raymond	141-1	LeGouis, J	242-1K

Leip, Adrian	522-6	Mosca, Giuliano	431-1
Lemola, Riitta	P1-89, P2-79	Motta, Silvia Renata	P1-71, P2-81
Leterme, Philippe	432-2	Mouret, Jean-Claude	441-3
Levy, Lilia	P2-03	Mugny, Corinne	P2-03
Li, Dejun	433-5	Müller, Anna-Lena	P2-52
Licker, Rachel	142-2	Müller, Christoph	141-1, P2-72
Lindahl, Lennart	232-3	Murphy-Bokern, Donal	412-3K, 522-6
Lindström, K	P1-79	Mutasa-Gottgens, Effie	P1-19
Litrico, Isabelle	411-2	Nábrádi, András	212-4
Lizarazo Torres, Clara Isabel	P2-36	Naef, A.	132-4
Lizaso, Jon	141-1, P1-20	Nagy, János	P2-86
Llao, R.	P2-06	Nassi o Di Nasso, Nicoletta	P1-85, P1-88, P1-92
Lloveras, Jaume	432-6	Navarro, Alejandra	222-4
Loddo, Donato	P1-47, P1-48	Navas, Mariela	P2-60
López-Bernal, Álvaro	P2-13	Negrini, Giorgio	131-6
Lopez-Diaz, María Lourdes	P1-61	Nelson, Roger	P1-11
Lopez-Ridaura, Santiago	423-3, 441-3, 522-2	Nendel, Claas	141-1, 211-2
Lopez, J. Enrique	P2-10	Nesme, Thomas	413-3, 413-4
Lopez, O.	P2-06	Nesterova, Irina	442-1
Louarn, Gaëtan	411-2	Neuschwandtner, _	P2-35, P2-61, P2-62
Loyce, Chantal	P1-45	Reinhard	
Lucas, Philippe	221-4	Neukam, Dorothee	131-3
Lucchini, Paola	431-1	Neves, Alcinda	441-1
Luhtanen, Juha	232-4	Ni, Kang	P2-82
Luna, Fernando	P1-97	Niazi, Adnan	P1-50
Lupotto, E.	P2-07	Niemeyer, Stefan	141-3K
Lüscher, Gisela	241-1, 241-4, 241-5	Niollet, Sylvie	132-5
Mahieu, Stéphanie	P2-37	Nkurunziza, Libère	232-2
Maia, Frederico B	441-1	Nkwiine, Charles	241-1
Maiorano, Andrea	141-2, P1-15, P1-16, P1-17	Nolot, Jean-Marie	412-1
Majchrzak, Leszek	P2-64	Novara, Agata	P2-17
Majumdar, Kaushik	142-4	Nowak, Benjamin	413-4
Mäkelä, Pirjo	212-3, P1-66, P1-79, P1-93, P2-70	Nunes, Luis F	441-1
Makowski, David	141-1, 412-5	Nykänen, Arja	P1-89
Malézieux, Eric	423-6	Ocampo, Apolonio	142-4
Manderscheid, Remy	442-5	Okereke, Victor	P1-51
Mandryk, Maryia	522-4	Okoth, Peter	142-5
Manici, Luisa M.	132-4, P1-70	Oldenburg, Elisabeth	P1-77
Manzoor, Shahid	P1-50	Oleksiak, Tadeusz	P1-35
Mari, Jean-François	423-2	Olesen, Jørgen Eivind	P1-10, P1-24
Marino Gallina, Pietro	P1-12, P1-26	Oliveira, J. Alberto	P1-13, P2-10
Marraccini, Elisa	522-5	Omon, Bertrand	P1-45
Marrou, Helene	222-3	Oosterhuis, Derrick	411-4
Martin-Lammerding, Diana	P1-20, P2-60	Orford, S	242-1K
Martin, Philippe	P2-91	Orgaz, Francisco	431-5K
Martin, Pierre	522-2	Oschatz, M. L.	241-5
Martre, P	242-1K	Ourry, Alain	131-2, 242-2
Mary, Bruno	222-2, 222-6, P1-95	Pacholski, Andreas	P2-82, P2-83
Masin, Roberta	P1-47, P1-48	Pagliai, Marcello	P1-68
Mastrorilli, Marcello	222-4	Pagowski, Krzysztof	P2-71
Máté, Ferenc	P1-74	Pakarinen, Kirsi	P2-16, P2-63
Mateos, Luciano	431-5K	Palencia, Pedro	P1-13, P2-10
Mattsson, Jan Erik	212-2	Palermo, Carmen	P2-29
Matyka, Mariusz	P1-60	Pallas-Areny, R.	P2-06
Mazel, B.	P2-06	Palumbo, A. Domenico	222-4
McCalman, Heather	P2-32	Pampolino, Mirasol	142-4
Médiène, Safia	221-2, 221-3, P1-49	Paoletti, Maurizio G.	241-1
Meijer, Johan	P1-50	Papadopoulos, Ioannis	P1-34
Mérot, Anne	231-2, 432-3, 423-5, P1-42	Papaja-	241-4, 241-5
Messéan, Antoine	231-3, P1-46	Hülsbergen, Susanne	
Mestries, Emmanuelle	P1-09	Pappa, Valentini A.	412-2, 422-1, P1-04, P1-73, P2-34
Metay, Aurélie	231-2, 432-3, P2-37	Pask, A	242-1K
Métral, Raphaël	231-2	Passot, Sixtine	412-1
Meuriot, Frédéric	411-2	Pastore, Donato	P2-27, P2-28
Mézière, Delphine	413-5	Pasuquin, Julie Mae	142-4
Michalska-Klimczak, Beata	P2-71	Paura, Liga	221-5
Mignolet, Catherine	423-2	Pearce, Helen	P2-32, P2-56
Mihailovic, Vojislav	422-5	Pecio, Alicja	421-2
Mikic, Aleksandar	422-5, 422-6	Pejic, Borivoje	422-6
Mikkonen, A	P1-79	Pellegrini, Sergio	P1-68
Milani, Mirco	442-4	Pellerin, Sylvain	413-3, 413-4
Mirschel, Wilfried	211-2	Pellet, Didier	P2-03
Modugno, A. Francesca	222-4	Pelosi, Céline	132-3
Mohan, Amita	431-3	Peltonen-Sainio, Pirjo	232-1K
Mollier, Alain	131-2, 132-5, 413-3	Pelzer, Elise	412-5, P1-46, P1-90
Monti, Andrea	P1-96, P1-97	Peoples, Mark	132-1K
Monti, Michele	P1-75, P2-39	Perez, Sarah	423-3
Morales, Alejandro	P1-18	Perrin, Aurélie	423-6
Moreau-	132-3	Petrovičová, Beatrix	P1-75
Valancogne, Pascaline		Piaud, Sébastien	P1-45
Moreau, D	242-1K	Picon-Cochard, Catherine	411-2
Morel, Christian	132-5	Piechota, Tomasz	P2-64
Moreno, Gerardo	241-1, P1-61	Pietkiewicz, Stefan	P1-27
Morris, N L	413-2	Piffanelli, P.	P2-07
Morvan-Bertrand, Annette	411-2	Pilarski, Krzysztof	P2-64
		Pinar, H.	132-4

Pinochet, Xavier	P2-46	Scalise, Antonella	P1-75
Plantureux, Sylvain	241-2	Schaller, Noémie	P2-91
<u>Platace, Rasma</u>	P1-80	Schaphoff, Sibyll	P2-72
Pointereau, Philippe	241-1, 241-5, 433-1K	Schillinger, William	431-3
Poisa, Liena	P1-81	Schittenhelm, Siegfried	P2-52
Poma, Ignazio	P2-17, P2-18, P2-19, P2-65	Schläfke, Nicole	412-4
Pompa, Marianna	P2-29	Schmidt, Olaf	P2-31
Popp, József	212-4	Schneider, M. K.	241-5
Pottier, Julien	411-2	Schneller, Chloé	241-2
Prade, Thomas	212-2	Schoo, Burkart	P2-52
Preiti, Giovanni	P2-39	Schorpp, Quentin	P2-52
Priekule, Ilze	221-5, P1-52	Schrader, Stefan	P1-76, P1-77, P2-52
Priesack, Eckart	141-1, P1-02	Schroetter, Susanne	P2-52
Pristeri, Aurelio	422-1, P2-39	Seidel, Achim	P2-83
Prochazka, Jaromir	P2-66, P2-67	Seleiman, Mahmoud F.	P1-93
Prochazkova, Blanka	P2-66, P2-67	Semaskiene, Roma	P1-55
Prudhomme, Marie-Pascale	411-2	Senthikumar, Kalimuthu	413-3
Pulido, Fernando	P1-61	Seppänen, Mervi	232-4, P1-65, P1-66
<u>Pulkkinen, Hannele</u>	443-1	Serrano, E.	P2-06
Qi, Aiming	P1-19	Shapkina, Yulia	P1-62
Quemada, M	P1-20	Shcherbak, Iurii	141-1
Raada, Sarah	P2-55	Siebert, Stefan	421-5
<u>Ragolini, Giorgio</u>	P1-85, P1-92, P2-68	Siebrecht, Norman	241-4, 241-5
Ragán, Péter	P2-86	Sieling, Klaus	P1-25
Ramdani, Abdelhamid	P2-89	Signorotti, Claudio	P2-92
Rampin, Enrico	131-1	Sinapidou, Evangelia	P1-38, P1-57
Rana, Gianfranco	P2-75, P2-76	<u>Singh, Jaswinder</u>	521-2
Randazzo, Biagio	P2-17, P2-18, P2-19	Singh, Manjit	521-2
Rasiukeviciute, Neringa	231-6	Singh, Surinder	521-2
<u>Rátonyi, Tamás</u>	P1-86	Skomra, Urszula	P2-53
Raynal, Helène	441-4	Slafer, Gustavo A.	142-1K, P1-33, P2-01
<u>Razouk, Rachid</u>	P2-20, P2-55, P2-89	Slepetys, Jonas	P1-87
Reau, Raymond	P1-08	Smits, Nathalie	432-3, P1-42
Rebetzke, Greg	132-1K	Snape, J	242-1K
<u>Reckling, Moritz</u>	412-4	Snider, John	411-4
Rees, Robert M.	412-2, 412-3K, 422-1, 422-4, P1-04, P1-73, P2-34	Soccio, Mario	P2-28
Regina, Kristiina	443-1	Sola, E.	P2-06
Reidsma, Pytrik	522-4	<u>Soldevilla-Martinez, M</u>	P1-20
Reinsdorf, Eric	P2-69	<u>Sooväli, Pille</u>	P1-03, P1-56
Reutter, Michaela	443-4	Specka, Xenia	211-2
Ribeiro, António C	441-1	Squire, Geoff	422-4, P2-33
Richardson, Alan	132-1K	Srivastava, Amit	141-3K
Ricou, Charles	241-2	<u>Stadler, Anja</u>	211-3, P1-21
Rihan, Hail	521-5, P2-26	<u>Stalenga, Jaroslaw</u>	P2-41
Rivelli, Anna Rita	P1-39	Stanca, M.	P1-70
Roche, Romain	443-3	Staniak, Mariola	P1-60, P2-41
Roderick, Steven	P2-32	Steidl, Jörg	443-4
Roger-Estrade, Jean	132-3, 221-3	Stella, Tommaso	131-6
Rolland, Bernard	P1-45	Stêpień, Wojciech	P1-27
<u>Roncucci, Neri</u>	P1-88, P1-92, P2-68	<u>Stobart, R M</u>	413-2
Rood, Trudy	522-6	Stoddard, Frederick L.	212-3, 411-5, 412-3K, 422-5, P1-66, P1-79, P1-93, P2-36, P2-70
Rosenzweig, Cynthia	141-1	Stomph, TjeerdJan	442-3
<u>Rossing, Walter</u>	522-1, 522-3	Storkey, Jonathan	P2-32
Rötter, Reimund	232-5	Stout, Jane	P2-31
Roudet, Jean	P1-42	Stoyanova, Siyka	241-1
Rousse, Nathalie	P1-09	Straus, Sasa	P1-63, P2-85
Rozman, Crtomir	P1-63, P2-85	Street, Kenneth	411-5
Ruane, Alex C.	141-1	Strullu, Loïc	222-6
Rühmer, T.	132-4	Stukonis, Vaclovas	P1-87
Ruza, Antons	221-5, P1-52	Sun, Yiyi	P1-23
<u>Ryaczewska, Krystyna</u>	P2-21	Sung, Jwa-Kyung	P2-88
<u>Saastamoinen, Marketta</u>	P2-40	Surviliene, Elena	231-6
Saatkamp, Arne	P2-72	Svensson, Sven-Erik	212-2
Salcedo, Gregorio	P1-10	Sylvester-Bradley, R	242-1K
Salvi, Frédéric	P1-30	Tamm, Ilmar	P1-56
Sampoux, Jean-Paul	411-2	Tamosiunas, Rimantas	231-6
Santanen, Arja	212-3, P1-66, P1-93	Tan, Han Qi	521-2
Santín-Montanyá, M. I.	P1-53	Tang, Li	432-4
Santiveri, Francisca	432-6	Tao, Fulu	141-1
<u>Sardi, Katalin</u>	P1-74	<u>Tardieu, Francois</u>	521-1K
Sarno, Mauro	P2-17	Targetti, Stefano	241-1, 241-4
Sarrazin, François	423-4	<u>Tarsitano, Davide</u>	P1-22
Sarthou, J.-P.	241-5	Tavarini, Silvia	P2-48
Sarthou, Jean-Pierre	241-1	Tein, Berit	P1-32
<u>Sarunaite, Lina</u>	P1-54, P1-87	Teixeira, Edmar	141-1
Sattari, Sheida	433-4	Tenorio-Pasamón, J.L.	P1-53
Satyanarayana, T.	142-4	<u>Tenorio, José Luis</u>	P1-20, P2-60
Sau, Federico	141-1	Terzi, V.	P1-70
<u>Sausserde, Rudite</u>	P1-81, P1-82	Testi, Luca	431-5K, P1-18, P2-13
Sauzet, Gilles	432-2	Thiard, Jérôme	P1-09
Savin, Igor	433-3	Thiéry, Denis	432-3, P1-42
Savin, Roxana	P1-33, P2-01	<u>Thiollet-Scholtus, Marie</u>	423-4
Savvas, Dimitrios	422-1, P2-34	Thonicke, Kirsten	P2-72
Sawinska, Zuzanna	P2-64	<u>Thrän, Daniela</u>	212-1K

<u>Tilvikiene, Vita</u>	P1-87, P1-94	<u>Virkajärvi, Perttu</u>	232-4, P2-16
Timlin, Dennis	141-1	<u>Vitali, Giuliano</u>	P2-87, P2-92
<u>Tittonell, Pablo</u>	413-1K, 522-2, 522-3	<u>Vitte, Guillaume</u>	222-2, P1-95
Todorovic, Mladen	P1-06	Voltaire, Florence	411-2
Toivonen, Marjaana	P2-78	<u>Vos, Jan</u>	131-4, 442-3
<u>Tokatlidis, Ioannis</u>	411-3, P1-34, P1-38, P1-57	Wach, Damian	421-2
Toma, Irene	P1-39	Wagner, Susanne	522-6
Toncea, Ion	422-1	Waha, Katharina	141-1
Topp, C.F.E.	412-3K, 412-4, 422-4, 433-2, P1-04, P1-22, P1-23	Walker, Robin	412-2
Tortorella, Demetrio	P1-75	Wallach, Daniel	211-5
Tozzi, Sabrina	P2-49	Walter, Ingrid	P1-20, P2-60
Tozzini, Cristiano	P1-85, P2-68	Wasson, Anton	132-1K
Triana, Federico	P2-68	<u>Watson, Christine</u>	412-2, 412-3K, 412-4, 422-4, 433-2
Tribouillois, Héléne	432-1	Watt, Michelle	132-1K
Trisorio, Antonella	P2-87	Weerasinghe, Minuka	421-3
Trnka, Miroslav	232-5	<u>Weigel, Hans-Joachim</u>	442-5, P1-76, P1-77, P2-52
<u>Trojak-Goluch, Anna</u>	P2-53	Weih, Martin	232-2, P1-01
Trotta, Vincenzo	P1-39	<u>Wery, Jacques</u>	222-3, 231-2, 423-5, 432-3
Trouverie, Jacques	131-2	<u>Wéry, Jacques</u>	P1-42, P2-37
Tsaftaris, Athanasios	P1-38	Westerbergh, Anna	P1-01
<u>Tsygutkin, Alexander</u>	P1-62, P2-42, P2-44	Westhoek, Henk	522-6
Turinek, Matjaz	P2-85	<u>Weymann, Wiebke</u>	P1-25
Turtola, Eila	P2-79	Whittle, I.	132-4
Tuulos, Antti	P1-79, P2-70	Wieland, Ralf	211-2
Tzantarmas, Constantinos	P1-38, P1-57	Williams, Adrian	522-6
Umarov, Bakhtiyor	P2-45	Williams, Michael	P2-31, 433-5
<u>Uppal, Rajneet</u>	521-4	Williams, Mike	412-3K
Uyttewaal, Valérie	P1-30	Winkler, Jan	P1-59
Valagussa, Massimo	P1-71	Witing, Felix	212-1K
<u>Valantin-Morison, Muriel</u>	231-1, P1-46, P2-46	Wolf, Joost	141-5, 142-2
Valduga, Matéus	423-4	Wolfarth, Friederike	P1-77
Valentini, Riccardo	433-3	Wolfe, Martin	P2-32
Valiuskaite, Alma	231-6	<u>Wolfrum, Sebastian</u>	241-4, 241-5
Vamerali, Teofilo	431-1	Wollenweber, Bernd	P1-24
<u>van Bussel, Lenny</u>	141-5, 142-2	<u>Wyszynski, Zdzislaw</u>	P1-27, P2-71
van Capelle, Christine	P1-76	<u>Xiao, Ying</u>	423-2
van Delden, Sander H.	442-3	Yehouessi, Wilfried	423-6
van der Werf, Wopke	131-4, 432-4	Yli-Halla, Markku	P1-66, P2-70
<u>van Ittersum, Martin K.</u>	141-5, 142-2, 433-4, 522-4	Young, Mark	422-4, P2-33
van Wart, Justin	141-5, 142-2	Yun, Hong-Bae	P2-88
<u>Vanaga, Ineta</u>	P1-58	Zaini, Zulkifli	142-4
<u>Ványiné Széles, Adrienn</u>	P2-86	Zakrevskis, Sergejs	P1-82
<u>Vasenev, Ivan</u>	433-3, P1-62	Zambrana-Quesada, E.	P1-53
Vasileiadis, Vasileios P.	231-3	Zand, Eskandar	P1-41
Vasiljevic, Sanja	422-6	Zander, Peter	412-3K, 412-4, 443-4
Vecchi, Angela	P1-83, P1-96, P1-97	Zanin, Giuseppe	P1-47, P1-48, P2-74
Velasco, Leonardo	P2-09	<u>Zatta, Alessandro</u>	P1-96, P1-97
Venezia, Giacomo	P2-18	<u>Zegada-Lizarazu, Walter</u>	P1-96, P1-97
<u>Ventrella, Domenico</u>	P2-25	Zhang, Chaochun	432-4
Véricel, Grégory	432-1	Zhang, Fusuo	432-4
Viaggi, Davide	241-1, 241-4	Zhang, Wenxuan	221-2
<u>Vignjevic, Marija</u>	P1-24	Zhu, Junqi	131-4
Vignozzi, Nadia	P1-68	<u>Zingore, Shamie</u>	142-5
<u>Villalobos, Francisco J.</u>	431-5K, 441-1, P1-18, P2-09, P2-13	Zoidou, Anastasia	P1-73
		<u>Zou, Ling</u>	212-3, P1-79
		Zucchini, Antonio	P1-11



ESA12

**12th Congress of the
European Society for Agronomy**
Helsinki, Finland, 20-24 August 2012