



**HAL**  
open science

# Environmental damages versus economic performance, sustainability of guadeloupean banana cropping systems in question: an emergetic approach

Jean-Marc Blazy, Inacio de Barros, Geraldo S. Rodrigues, Harry Ozier  
Lafontaine

## ► To cite this version:

Jean-Marc Blazy, Inacio de Barros, Geraldo S. Rodrigues, Harry Ozier Lafontaine. Environmental damages versus economic performance, sustainability of guadeloupean banana cropping systems in question: an emergetic approach. 44. Annual Meeting of the Caribbean Food Crops Society (CFCS), Jul 2008, Miami, Floride, United States. 178 p. (vol. 1); 355 p. (vol. 2). hal-02752790

**HAL Id: hal-02752790**

**<https://hal.inrae.fr/hal-02752790>**

Submitted on 3 Jun 2020

**HAL** is a multi-disciplinary open access archive for the deposit and dissemination of scientific research documents, whether they are published or not. The documents may come from teaching and research institutions in France or abroad, or from public or private research centers.

L'archive ouverte pluridisciplinaire **HAL**, est destinée au dépôt et à la diffusion de documents scientifiques de niveau recherche, publiés ou non, émanant des établissements d'enseignement et de recherche français ou étrangers, des laboratoires publics ou privés.



**CARIBBEAN  
FOOD  
CROPS SOCIETY  
44**

**Forty Fourth  
Annual Meeting 2008**

**Miami, Florida, USA**

**Vol. XLIV – Number 2 Continued  
Poster Session Abstracts  
With Some Posters Expanded as Full Papers**

**MEETING HOST:**





**PROCEEDINGS  
OF THE  
44<sup>th</sup> ANNUAL MEETING**

Caribbean Food Crops Society  
44<sup>th</sup> Annual Meeting  
July 13-17, 2008

Hosted by the  
University of Florida's  
Institute of Food and Agricultural Sciences  
(UF/IFAS)

Miami Beach Resort and Spa  
Miami Beach, Florida, USA

**Repositioning Caribbean Agriculture:  
Challenges and Opportunities for Sustainability**

**Reposicionando la Agricultura Caribeña:  
Retos y Oportunidades para la Sostenibilidad**

**Repositionner l'agriculture de la Caraïbe :  
Défis et opportunités pour la durabilité**

**Caribbean Food Crops Society  
POSTER SESSION**

**Poster Session Abstracts with Some Posters  
Expanded into Full Papers**

**Poster Session Edition  
Vol. XLIV – Number 2 Continued  
Edited by  
Bala Rathinasabapathi, James P. Cuda,  
Adegbola T. Adesogan, Wilfredo Colón-Guasp,  
and Linda Evans**

**Published by the Caribbean Food Crops Society**

© Caribbean Food Crops Society, 2008

ISSN 95-07-0410

Copies of this publication may be obtained from:

Secretariat, CFCS  
P.O. Box 40108  
San Juan, Puerto Rico, 00940

or from:

CFCS Treasurer  
Agricultural Experiment Station  
Botanical Garden South  
1193 Guayacán Street  
San Juan, Puerto Rico 00926-1118

Mention of company and trade names does not imply endorsement by the Caribbean Food Crops Society.

The Caribbean Food Crops Society is not responsible for statements and opinions advanced in its meeting or printed in its proceedings; they represent the views of the individuals to whom they are credited and are not binding on the Society as a whole.

**EDITOR'S NOTE ON "NUMBER 2" AND "NUMBER 2 CONTINUED" FOR READERS AND AUTHORS:** It was discovered at press-time that Volume XLIV "Number 2" of the Proceedings was too thick for conventional binding in the printed-book format. To solve this production problem, the volume was broken in half. The second "half" (Number 2 Continued) is a direct continuation of the first "half" (Number 2), with the page numbering of the second half picking up directly where the page numbering ended in the first half. Number 2's Roman numeral section ("i, ii, iii") of introductory information ends at "page xi" and the Roman numeral section of Number 2 Continued begins at "page xii."

Number 2's "Arabic numeral" section (i.e. 1, 2, 3 rather than i, ii, iii) ends at page 355, while the Arabic numeral section for Number 2 Continued begins at page 356, after the introductory Roman numeral section. The Roman numeral section of Number 2 Continued includes introductory information such as this page and the Table of Contents. The Table of Contents in Number 2 Continued picks up precisely where the Number 2 Table of Contents ends. The two volumes are thus a paired set. Both "Number 2" and "Number 2 Continued" are listed as "Number 2" on the covers and in the citations for each abstract and paper, to reduce confusion when authors list their citations in CVs and other documents. "Number 2 Continued" consists of "Poster Session Abstracts and Expanded Papers," as some poster authors expanded their poster abstracts into full papers for these Proceedings.

## **2007-2008 CFCS BOARD OF DIRECTORS AND OFFICERS**

### **BOARD OF DIRECTORS**

<b>Chair:</b>	Dr. Héctor Santiago, University of Puerto Rico
<b>Vice Chair:</b>	Dr. Kwame Garcia, University of the Virgin Island
<b>Secretary:</b>	Mr. Wilfredo Colón, Universidad del Este, Puerto Rico
<b>Treasurer:</b>	Dr. Alberto Beale, University of Puerto Rico
<b>President 2007- 2008:</b>	Dr. Jimmy Cheek, University of Florida

### **REGIONAL REPRESENTATIVES**

#### **English:**

Mr. Kwame Garcia, UVI, University of the U.S. Virgin Islands  
Dr. William F. Brown, University of Florida  
Mr. Bruce Lauckner, CARDI, Trinidad and Tobago

#### **Spanish:**

Dr. Wilfredo Colón, Universidad del Este, PR  
Mr. Jerry Dupuy, Private Sector, Dominican Republic  
Dr. Héctor Santiago, University of Puerto Rico

#### **French:**

Mr. Marceau Farant, INRA, Guadeloupe  
Dr. Jean Louis Diman, INRA, Guadeloupe  
Dr. Isabelle Jean-Baptiste, AMADEPA, Association Martiniquaise por le Developpement des Plantes Alimentaires, Martinique

#### **Dutch:**

Prof. Robert Tjien Foooh, ADEKUS, Suriname

### **ADVISORY BOARD**

Dr. Altigracia Rivera de Castillo, Dominican Republic, President  
Dr. Claude Vuillaume, CIRAD, Guadeloupe  
Dr. Harry Ozier Lafontaine, INRA, Guadeloupe  
Dr. Arlington Chesney, CARDI, Caribbean Region  
Dr. Rafael Perez Duverge, IDIAF, Dominican Republic  
Prof. Vivian Carro, UPR, Puerto Rico  
Dr. Chelston W. D. Brathwaite, IICA, Costa Rica  
Dr. Errol Rhoden, HBCU, USA  
Dr. Guy Anais, INRA (retired), St. Martin  
Dr. Louis Petersen, DOA, U.S. Virgin Islands  
Dr. Cassel Gardner, FAMU, Florida  
Dr. Wendel Parham, CARDI, Trinidad and Tobago



**Caribbean Food Crops Society  
44th Annual Meeting  
July 13-17, 2008**

**Miami Beach Resort and Spa  
Miami Beach, Florida, USA**

**Repositioning Caribbean Agriculture:  
Challenges and Opportunities for Sustainability**

**Reposicionando la Agricultura Caribeña:  
Retos y Oportunidades para la Sostenibilidad**

**Repositionner l'agriculture de la Caraïbe :  
Défis et opportunités pour la durabilité**

**Caribbean Food Crops Society**

**POSTER SESSION**

**Poster Session Abstracts with Some Posters Expanded into Full Papers**

**Poster Session Edition**

## **TABLE OF CONTENTS**

<b>PROCEEDINGS OF THE 44th ANNUAL MEETING OF THE CARIBBEAN FOOD CROPS SOCIETY .....</b>	<b>xii</b>
<b>Published by the Caribbean Food Crops Society .....</b>	<b>xiii</b>
<b>2007-2008 CFCS BOARD OF DIRECTORS AND OFFICERS .....</b>	<b>xiv</b>
<b>BOARD OF DIRECTORS.....</b>	<b>xiv</b>
<b>REGIONAL REPRESENTATIVES.....</b>	<b>xiv</b>
<b>English.....</b>	<b>xiv</b>
<b>Spanish.....</b>	<b>xiv</b>
<b>French .....</b>	<b>xiv</b>
<b>Dutch .....</b>	<b>xiv</b>
<b>ADVISORY BOARD.....</b>	<b>xiv</b>

TABLE OF CONTENTS Number 2 Continued .....	xv-xxiii
POSTER PRESENTATIONS.....	356
NATURAL RESOURCES .....	356
<b>Impact of Coffee Management Practices on the Soil Ecosystem: Earthworm Community Function, J. A. Amador, K. Winiarski, and D. Sotomayor-Ramirez</b>	356
<b>Factores de Transferencia Suelo-Hojas de Metales Pesados (Co, Cu, Ni, Zn) en Prunus Persica L., Orihuela, DL., Hernández, J.C., Colón, W., and Bastida, F. .</b>	365
<b>Caracterización del Transporte de Nutrientes y Sedimentos en Suelos Enmendados con Residuos Orgánicos ve Vaquería, G. Ardila, D. Sotomayor Ramírez, G. Martínez, y L. Perez Alegría.....</b>	379
<b>Tillage Effects on a Crop Rotation of Yam, Eggplant, Bean and Corn in Oxisol, Ultisol and Vertisol Soils in Puerto Rico, Wanda I. Lugo, Agenol González, Elvin Román, Nydia Rafols and Héctor Lugo .....</b>	380
<b>Relationship between Vegetative Covers and Soil Physical Properties of one Mollisol on <i>Phytophthora cinnamomi</i> Occurrence in Avocado <i>Persea americana</i> Mill. in Puerto Rico, Beatriz E. Torres Ordóñez, C. Estévez de Jensen, V. Snyder, y M. Vazquez.....</b>	387
FRUITS, VEGETABLES, AND SPECIALTY CROPS.....	388
<b>Respuesta de Líneas de Habichuela (<i>Phaseolus vulgaris L.</i>) a Diferentes Niveles de Fertilidad en un Oxisol, R. Dorcinvil, D. Sotomayor Ramirez, and J. Beaver</b>	388
<b>Response of Taro var. Lila or Bun Long to Levels of Supplemental Irrigation, Luis E. Rivera, Carlos E. Ortiz, and John J. Cho.....</b>	389
<b>Production of Table Cucumber (<i>Cucumis sativa</i>) on Two Trellis Systems in North Florida, C. S. Gardner, G.L. Queeley, K. T. Grant, B. G. Brown and T. Hylton.....</b>	393
<b>Effects of Bulbils Weight Used as Seed on Tuber Yield of Greater Yam Belep (<i>dioscorea alata l.</i>), David Hammouya, Marceau Farant, J. Lator, and J. L. Irep</b>	398
<b>Performance of a Quality Protein Maize Variety Grown in a Vertisol, Elvin Román-Paoli, and James Beaver.....</b>	399
<b>Effects of Plastic Mulch on Development and Nodulation of Cowpeas, Steven H. Wysinger, E. G. Rhoden, V. Khan, C. Stevens, and J. R. Bartlett.....</b>	400

<b>The Effect of Lime Application on Emergence and Growth of Castor Oil Plants</b> , <i>Ronald J. Smith, Errol G. Rhoden, Janette R. Bartlett, Victor A. Khan, Crystal Drakes and Prosanto K. Biswas</i> .....	401
<b>Mandarina Híbrida Fallglo: Primeros Cuatro Años de Crecimiento en Dos Localidades de Puerto Rico</b> , <i>Félix M. Román Pérez, Agenol González Vélez, y Raúl Macchiavelli</i> .....	408
<b>Yield and Fruit Quality of Rambutan Cultivars Grown at Two Locations in Puerto Rico</b> , <i>R. Goenaga and A. Marrero</i> .....	413
<b>Calibration of SPAD-Meter Readings to Chlorophyll Content in Strawberry</b> , <i>D.L. Orihuela, W. Colón, J.C. Hernández, and C. Weiland</i> .....	414
<b>Growth Rate and Yield of Coffee (<i>Coffea arabica</i> L.) Grown Under Partial Shade and Full Sunlight after Severe Renovation Pruning</b> , <i>Carlos A Flores Ortega and Miguel A. Muñoz</i> .....	415
<b>Using a Commercial Mixture of Amino Acids and a Commercial Extract of <i>Ascophyllum</i> Kelp To Reduce the Time in Nursery of ‘Duncan’ and ‘Marsh’ Grapefruits (<i>Citrus Paradisi</i> Macf.) in Puerto Rico</b> , <i>J. Pablo Morales-Payan</i> ..	416
<b>Evaluation of Alternative Pesticides and Mulching for Organically-Grown Watermelons in Puerto Rico</b> , <i>Mabel Vega-Almodovar, J. Pablo Morales-Payan, Sonia Martinez-Garrastazu, &amp; Bryan Brunner</i> .....	420
<b>Crecimientos Vegetativo y Reproductivo del Aguacate ‘Hass’ en Varios Climas de Michoacán, México</b> , <i>J.L. Rocha-Arroyo, S. Salazar-García, I.J.L. González-Durán, y J. Anguiano-Contreras</i> .....	425
<b>Corrección de la Deficiencia Crónica de Zinc en Aguacate ‘Hass’</b> , <i>S. Salazar-García, L.E. Cossio-Vargas y I.J.L. González-Durán</i> .....	426
<b>Papaya Growth in Double-Row Systems Established During the Dry Season</b> , <i>Thomas W. Zimmerman</i> .....	427
<b>SOCIOECONOMICS AND POLICY</b> .....	437
<b>Agricultural Labor Issues and Immigration in Southwest Florida</b> , <i>Robert D. Halman</i> .....	437
<b>PROCINORTE’S Tropical and Subtropical Fruits Task Force: a Tri-National Effort to Improve Fruit Quality and Trade</b> , <i>R. Goenaga, S. Salazar-García, G. Doyon, J.A. Osuna-García, I.J.L. González-Durán, and J.A. Landry</i> .....	438



<b>Le Programme Régional de Développement Agricole : un outil méthodologique pour la modernisation et l'adaptation de l'agriculture Guadeloupéenne,</b> <i>Edmond Rubrice</i> .....	439
<b>Incubator Farms as a Sustainable Approach for 'Neo Farmers',</b> <i>Puran Bridgemohan</i> .....	440
<b>Policy Implications of the Composite CARICOM Business Environment,</b> <i>Ronald M. Gordon and John J. VanSickle</i> .....	447
<b>An Evaluation of Dairy Farming in Suriname,</b> <i>Samantha Engeldal</i> .....	448
<b>Exploring the Internationalizing of Extension Opportunities: A Partnership with the Antigua 4-H Youth Program,</b> <i>Norma Samuel and Nicole Walker</i> .....	449
<b>Environmental Damages Versus Economic Performance, Sustainability of Guadeloupean Banana Cropping Systems in Question: an Emergetic Approach,</b> <i>Jean-Marc Blazy; Inacio de Barros; Geraldo S Rodrigues; Harry Ozier-Lafontaine</i> .....	450
<b>Banana Sector in the French West Indies (FWI) in the 21<sup>st</sup> Century: Typology of Farmers' Room for Manoeuvre in Adapting their Cropping Systems to Crisis,</b> <i>Jean-Marc Blazy; Jean-Louis Diman; François Causeret; and Danny Peregrin</i> .....	461
<b>Village du Millénaire : Expérience d'Haïti,</b> <i>Ronald Bien-aimé</i> .....	462
<b>FORAGE AND LIVESTOCK</b> .....	463
<b>Effects of Palm Kernel Cake on Daily Gain and Carcass Yield of Broiler Chicks; Efecto de la Sustitución de Palmiste por Maíz en la Dieta de Pollo Engorde Sobre la Ganancia Diaria y el Rendimiento de Canal,</b> <i>Neirin Matos, Rosina Polanco, Carlos M. De Jesús, and Rafael A. Vásquez</i> .....	463
<b>Evaluacion de Nitrogeno Líquido (ULB-35®) para la Produccion de Forraje en Puerto Rico,</b> <i>Alexander Recamán-Serna, David Sotomayor Ramírez, Yamil Quijano, y Gilberto Lozada</i> .....	473
<b>Tecnicas de Aplicación de Nitrogeno Líquido (ULB-35®) en la Produccion de Forraje en Puerto Rico,</b> <i>Alexander Recamán-Serna, David Sotomayor-Ramírez, y Gilberto Lozada</i> .....	474
<b>Plant Density and Dry Matter Yield of 'Ubon Stylo' (<i>Stylosanthes guianensis</i>) in an Oxisol of Puerto Rico,</b> <i>Jorge Luis Olivares-Lopez, Elide Valencia, and Abner Rodríguez-Carías</i> .....	475

<b>Effects of Planting Density and Cut Frequency on Dry Matter Yield of Mulberry (<i>Morus Alba</i>) and Guacima (<i>Guázuma ulmifolia</i>; Influencia de Diferentes Densidades de Siembra y Frecuencias de Corte sobre el Rendimiento en Biomasa de <i>Morus alba</i> y <i>Guázuma ulmifolia</i>), Ramón A. Marte Estévez, Carlos M. de J. Arias, Rafael A. Vásquez Martínez .....</b>	<b>481</b>
<b>The Mineral Status of Sheep and Goats with Reference to Swayback in Central Trinidad, Aphzal Mohammed and Fayez G. Youssef.....</b>	<b>489</b>
<b>Lamb's Voluntary Intake and Digestibility of Forage Soybean 'Hinson Long-Juvenile (<i>Glycine max</i>) and Lablab 'Rongai' [<i>Lablab purpureus</i> (L.) Sweet], Rivera-Melendez, F., A. Rodríguez-Carias, and E. Valencia .....</b>	<b>495</b>
<b>Composición Química de <i>Stylosanthes guianensis</i> Fresco o Fermentado en Pacas Cilíndricas durante dos Periodos de Fermentación, Vázquez, M.S., A.A. Rodríguez, E. Valencia, y P. Randel.....</b>	<b>500</b>
<b>Liquid Urea Rate Effects on Nutritive Value of 8-Week Regrowth of Guineagrass (<i>Panicum maximum</i> Jacq.) Hay, Almodóvar L. E., E. Valencia, y A. Rodríguez .....</b>	<b>501</b>
<b>Fermentation Characteristics and Consumption of Forage Sorghum and Sudax Ensiled in Round Bales, W. Rodríguez, A.A. Rodríguez, and E. Valencia .....</b>	<b>505</b>
<b>Composición Química y Consumo Voluntario de <i>Calliandra calothyrsus</i> Deshidratada o Fresca por Ovinos y Caprinos, Lisa Dillon, Melanie Román Zayas, Abner A. Rodríguez Carias y Elide Valencia .....</b>	<b>506</b>
<b>The Evaluation of Three Feeding Regimens and Three Anthelmintics in a Meat Goat Production System: a Florida A&amp;M University Research/ Extension Project, T. E. Peterson, R. Mobley, G. Nurse, F. Okpebholo, C. J. Lyttle-N'guessan, G. Queeley, and T. Kahan.....</b>	<b>507</b>
<b>Stocking Rate Trial with Boer X Spanish Goats under Thinned Loblolly Pines, Nadine Gordon-Bradley and O. U. Onokpise.....</b>	<b>516</b>
<b>Effects of Palm Kernel Cake in the Diet of Dairy Goats on Milk Production and Kid Daily Gain; Efecto del Palmiste (<i>Elaeis guineensis</i>) Sobre el Comportamiento Productivo de Cabras Lecheras, Juan C. Ureña, Marco E. Fernández, Carlos M. De Jesús, Rafael A. Vásquez.....</b>	<b>522</b>
<b>Development of Small Scale Aquaculture Farms in North Florida, Uford A. Madden, G. Nurse, J. Beaudouin, A. Bolques, L. Muralles, S. Harris-Thompson, A. Wallamsley, M. May, and F. Chapman .....</b>	<b>530</b>

<b>Comparison of Oral Administration of Various Doses of Moxidectin and Ivermectin Pour-On Formulations Against Intestinal Parasites in Meat Goats,</b> <i>Uford A. Madden, N. Wilson, G. Nurse, and J. Beaudouin</i> .....	535
<b>A Comparison of Grass vs. Legume Free Range Small Ruminant Finishing Systems for the Tropics,</b> <i>S.A. Weiss, R. Ben-Avraham, R.C. Ketring, and R.W. Godfrey</i> .....	542
<b>Development and Evaluation of a Ready to Cook Vacuum Packaged Goat Meat Product,</b> <i>N. Djeri, S. K. Williams, R. Mobley, A. McKenzie-Jakes, K. Sarjeant, and A. Ruiz</i> .....	543
<b>Development and Evaluation of Pre-Cooked Vacuum Packaged Goat Meat Products,</b> <i>N. Djeri, S.K. Williams, R. Mobley, A. McKenzie-Jakes, K. Sarjeant, and A. Ruiz</i> .....	544
<b>The Effects of Synchronization Treatments on Estrous Response in Seasonal Does,</b> <i>Angela McKenzie-Jakes, G. Nurse, and G. Byrant</i> .....	545
<b>An Integrated Approach to Increasing Food Safety Awareness at the Farm Level among Small and Limited Resource Goat Producers in Florida,</b> <i>A. McKenzie-Jakes, R. Mobley, T.E. Peterson, P. Hunter, G. Nurse, J. Beaudouin, G. Bryant, G. Queeley, S. Thompson, N. Tillman, and L. Anderson</i> .....	546
<b>CROP PROTECTION AND PEST MANAGEMENT</b> .....	547
<b>First Report of <i>Cladosporium tenuissimum</i> Cooke on Taro in Puerto Rico,</b> <i>Evelyn Rosa-Márquez and Carlos E. Ortíz</i> .....	547
<b>Relación entre las Propiedades Físicas de un Oxisol y Coberturas Vegetales en la Incidencia de <i>Phytophthora cinnamomi</i> en Aguacate <i>Persea americana</i> Mill.,</b> <i>Torres Ordóñez B., C. Estévez de Jensen, V. Snyder, y M. Vazquez</i> .....	548
<b>Weed Management During and After Rhizoma Perennial Peanut Establishment,</b> <i>María de L. Lugo-Torres and Teodoro Ruiz</i> .....	550
<b>Black Sigatoka IPM in Puerto Rico,</b> <i>W. Almodóvar and M. Díaz</i> .....	553
<b>Crianza Masiva de <i>Mirax insularis</i> Muesebeck, el Parasitoide Exótico del Minador del Café <i>Leucoptera coffeella</i> Guérin-Ménéville (Lepidoptera: Lyonetiidae) en Puerto Rico,</b> <i>Fernando Gallardo, Evelio Hernández, Marcela Daza, &amp; Jennifer González</i> .....	554
<b>Extracts of Native and Non-Native Plant Species for the Control of Cogongrass (<i>Imperata cylindrica</i> L),</b> <i>Lissa D. Reid, Bravo G. Brown, and Oghenekome U. Onokpise</i> .....	563

<b>Evaluation of Acibenzolar-S-Methyl, PGPR and Silicon for Their Effects on Growth and TYLCV of Tomato, Shouan Zhang, Thomas L. White and Waldemar Klassen.....</b>	<b>571</b>
<b>Evaluation of Triazole and Strobilurin Fungicides, Alone and in Combination, for Control of <i>Exserohilum turcicum</i> on Sweet Corn, Richard N. Raid .....</b>	<b>576</b>
<b>Educational Efforts Enhance Diagnostic Capabilities in the United States and the Caribbean Region, Amanda Hodges, Greg Hodges, and Russell Duncan.....</b>	<b>577</b>
<b>Response of the Melon Thrips, <i>Thrips palmi</i> Karny, and the Chilli Thrips, <i>Scirtothrips dorsalis</i>, to some Selective Insecticides, Dakshina R. Seal, Vivek Kumar Jha, Waldemar Klassen, and Catherine M. Sabines.....</b>	<b>578</b>
<b>Development of IPM Field Guides for Coffee, Citrus, Plantain and Banana, Ada N. Alvarado Ortíz.....</b>	<b>579</b>
<b>Erythrina Gall Wasp, <i>Quadrastichus erythrinae</i> (Hymenoptera: Eulophidae), a Pest of Coral Trees (<i>Erythrina</i> spp.) Recently Found in the Western Hemisphere, Forrest W. Bill Howard.....</b>	<b>580</b>
<b>Climate Factor Comparison Analysis for Red Palm Mite, <i>Raoiella Indica</i>, D. Borchert and D. Fieselmann.....</b>	<b>581</b>
<b>Tropical Race 4 of Panama Disease: A Dangerous Threat to Sustainable Production of Banana and Plantain, Randy C. Ploetz .....</b>	<b>582</b>
<b>Distribution and Host Associations of <i>Proba distanti</i> (Atkinson) (Hemiptera: Miridae), a Plant Bug Recently Established in Florida, Thomas T. Dobbs, Thomas J. Henry, and Alfred G. Wheeler, Jr.....</b>	<b>583</b>
<b>The Caribbean Pathway Analysis - Evaluation of Pathways for Exotic Plant Pest Movement into and within the Greater Caribbean Region, Heike E. Meissner, Christie A. Bertone, Lisa M. Ferguson, Andrea V. Lemay, and Kimberly A. Schwartzburg.....</b>	<b>584</b>
<b>Population Dynamics of the Red Palm Mite (<i>Raoiella indica</i> Hirst) and the Search for Sustainable Management Options in Jamaica, J. V. Goldsmith, and L. R. Myers .....</b>	<b>586</b>
<b>Management of Pink Hibiscus Mealybug (<i>Maconellicoccus hirsutus</i> Green) in Jamaica, Michelle A. Sherwood, L. R. Myers, M. Young, D. Robinson and J. Lawrence.....</b>	<b>587</b>

<b>Impact of Organic Mulches on Watermelon Fruit Yield and Purple Nutsedge Tuber Productivity in an Ecological Production System, J. Pablo Morales- Payan, Pedro Marquez-Mendez, Erin Rosskopf, Yasser Shabana, Raghavan Charudattan &amp; Waldemar Klassen.....</b>	<b>588</b>
<b>Effects of Altitude and Harvest Period on Broca (<i>Hypothenemus hampei</i> <i>Ferrari</i>) infestations in Coffee (<i>Coffea arabica L.</i>) Beans in the Dominican Republic, Yluminada O. López, Miguel M. Campo, and José B. Nuñez.....</b>	<b>593</b>
<b>Disease Management Programs for Basil Downy Mildew, R. N. Raid, P. Roberts, and P. Harmon.....</b>	<b>601</b>
<b>A New Lethal Disease of <i>Syagrus romanzoffiana</i> and <i>Washingtonia robusta</i> in Florida is Caused by <i>Fusarium oxysporum</i>, Monica L. Elliott<sup>1</sup> and Elizabeth A. Des Jardin.....</b>	<b>602</b>
<b><i>In Vivo</i> Study of Cogongrass (<i>Imperata Cylindrica L.</i>) Rhizome Production, Oghenekome U. Onokpise, James J. Muchovej, and Susan K. Bambo.....</b>	<b>608</b>
<b>Natural Spread of Pests within and into the Greater Caribbean Region, Christie A. Bertone, Heike E. Meissner, and Andrea V. Lemay .....</b>	<b>617</b>
<b>Wood Packaging Material as a Pathway for the Movement of Exotic Insect Pests into and within the Greater Caribbean Region, Heike E. Meissner, Thomas W. Culliney, Andrea V. Lemay, Leslie P. Newton, and Christie A. Bertone.....</b>	<b>621</b>
<b>Airline Passenger Baggage as a Pathway for Exotic Plant Pest Movement through the Greater Caribbean Region, Heike E. Meissner, Andrea V. Lemay, and Kimberly A. Schwartzburg .....</b>	<b>628</b>
<b>Likelihood of Hitchhiker Pests Being Moved into and within the Greater Caribbean Region, Andrea V. Lemay and Heike E. Meissner .....</b>	<b>634</b>
<b>Control of Broad Mite, <i>Polyphagotarsonemus Latus</i> and the Whitefly, <i>Bemisia tabaci</i>, in Open Field Pepper and Eggplant with Predaceous Mites, José Castillo and Philip A. Stansly.....</b>	<b>638</b>
<b>Demonstrating Integrated Pest Management of Hot Peppers, Jesusa Crisostomo Legaspi, Cassel Gardner, Gilbert Queeley, Norman Leppla, and James Cuda.....</b>	<b>639</b>
<b>CIRAD Invasive Species Initiatives in the Caribbean Basin, Emmanuel Wicker, Catherine Abadie, Jean Heinrich Daugrois, Luc Baudouin, Michel Dollet, Claude Vuillaume and Pierre-Yves Teycheney .....</b>	<b>640</b>

<b>FOOD SCIENCE AND POSTHARVEST TECHNOLOGY .....</b>	<b>641</b>
<b>Biogas Production from Rice Hulls and Straw Treated with Urea, Amarely Santana, Jerry Gabriel, Pascal Fenelus, Eliezer Louis, Juguette Badette, Carlos Miguel De Jesús Arias .....</b>	<b>641</b>
<b>Optimization of a Clarification Process for Guava Puree using Bioguavase Enzyme, María L. Plaza and Murat Balaban .....</b>	<b>651</b>
<b>Relationship between Chlorophyll Fluorescence and Dry Matter Content of ‘Hass’ Avocado Fruit, J.A. Osuna-García, G. Doyon, I.J.L González-Durán, S. Salazar-García, and R. Goenaga.....</b>	<b>652</b>
<b>Effect of Harvest Time and Ripening Degree on Quality and Shelf Life of ‘Hass’ Avocado, J.A. Osuna-García, G. Doyon, I.J.L González-Durán, S. Salazar-García, and R. Goenaga .....</b>	<b>653</b>
<b>Influencia del Clima, Riego y Época de Floración Sobre la Composición Nutritional del Fruto de Aguacate ‘Hass’ en Michoacán, S. Salazar-García, M. Gallardo-Valdez, y L.M. Tapia-Vargas .....</b>	<b>654</b>

# POSTER PRESENTATIONS

Tuesday, July 15, 2008

## NATURAL RESOURCES

2008 Proceedings of the Caribbean Food Crops Society. 44(2):356-364. 2008

### Poster #1

#### Impact of Coffee Management Practices on the Soil Ecosystem: Earthworm Community Function

J. A. Amador<sup>1</sup>, K. Winiarski<sup>2</sup>, and D. Sotomayor-Ramirez<sup>3</sup>. <sup>1</sup>Laboratory of Soil Ecology and Microbiology and <sup>2</sup>Physiological Ecology Laboratory, University of Rhode Island; <sup>3</sup>Dept. of Agronomy and Soils, University of Puerto Rico – Mayagüez. jamador@uri.edu

#### ABSTRACT.

Coffee (*Coffea arabica* L.) is the most economically important crop in the central mountainous region of Puerto Rico, where it is grown under shade or in full sunlight. The conditions under which coffee is grown may affect the long-term sustainability of this land use through effects on soil physical, chemical and biological properties. As ecosystem engineers, earthworms are known to have a profound effect on abiotic and biotic properties and processes in terrestrial ecosystems. We examined differences in earthworm communities as a function of ecosystem type (sun and shade coffee, forest) and soil order (Oxisols, Ultisols, Inceptisols) as part of a study of the effects of coffee production practices on the structure and function of coffee agroecosystems led by scientists in the Dept. of Agronomy and Soils of the University of Puerto Rico – Mayagüez. Ecosystem type significantly affected earthworm population density (Sun, 281/m<sup>2</sup> > Shade, 125/m<sup>2</sup> > Forest, 37/m<sup>2</sup>) and earthworm biomass (Sun, 71 g f.w./m<sup>2</sup> > Shade, 34 g f.w./m<sup>2</sup> > Forest, 12 g f.w./m<sup>2</sup>). In contrast, the specific biomass of earthworms was significantly affected only by soil order. In general, earthworm population density and biomass appeared to be a function of soil moisture, leaf litter biomass, and the mineral content of leaf litter. Analyses of <sup>15</sup>N and <sup>13</sup>C enrichment of earthworm tissues suggest that management practices affect the trophic level they occupy within an ecosystem. Examination of isotopic enrichment of soil and leaf litter is underway to help elucidate the role of earthworms in carbon and nitrogen cycling in these ecosystems.

**KEYWORDS:** *Coffea arabica*, cultivation practices, stable isotope enrichment

#### INTRODUCTION

Coffee (*Coffea arabica*) is an economically important crop in Puerto Rico, where its production accounts for nearly 15% of the annual gross revenue from all crop production (Estado Libre Asociado de Puerto Rico - Departamento de Agricultura, 2004). Although cultivation practices vary considerably, whether to grow coffee under shade

trees – often leguminous, N<sub>2</sub>-fixing species (Aranguren et al., 1982) – or in full sunlight is one of the most basic decisions made by coffee growers. This choice has consequences for the structure and function of these ecosystems that may affect their long-term sustainability. Shade coffee is generally regarded as more environmentally benign, supporting greater plant and animal diversity (Perfecto et al., 1996), resulting in lower soil erosion (Smith and Abruña., 1955), and requiring lower inputs of synthetic fertilizers. In contrast, coffee cultivation under full sunlight produces higher yields, but also higher rates of soil and water runoff (Smith and Abruña., 1955) and lower biodiversity (Perfecto et al., 1996).

The long-term sustainability of agricultural production systems is tied to maintenance of soil physical and chemical attributes and elemental cycling that are favorable to crop production and soil quality. Earthworms are widely recognized as ecosystem engineers in a wide range of natural and agricultural ecosystems, where they play important roles in the physical, chemical and biogeochemical properties and processes (Jones et al., 1994). They are important in the translocation of organic forms of C and nutrients across the litter-soil interface and within the soil profile, accelerating their decomposition and increasing the availability of these resources with the soil foodweb (Edwards and Bohlen, 1996). The limited number of field and greenhouse studies on effects of earthworms in tropical agroecosystems suggest that they generally have a positive effect on plant growth and yields (Brown et al., 1999).

We compared the abundance, biomass and specific biomass of earthworms in sites with coffee under partial shade, coffee under full sunlight, and secondary forest in western-central Puerto Rico. We also examined relationships to resource quality and quantity, as well as the role of earthworms in C and N cycling.

## **MATERIALS AND METHODS**

*Study area.* The experiment was conducted in coffee farms and adjacent forested areas at three different sites in western-central Puerto Rico (Table 1). Within each site three replicate square plots (20 m × 20 m) were established in each of three ecosystem types: (i) coffee grown under partial shade (SHD), (ii) coffee grown under full-sunlight (SUN), and (iii) secondary forest (FOR).



Table 1. Altitude, soil order, and latitude and longitude of study sites for shade (SHD) and sun (SUN) coffee and secondary forest (FOR) ecosystems in Puerto Rico.

Site	Altitude range (m)	Soil order	Ecosys.	Latitude (West)	Longitude (North)
Jayuya	670 – 870	Oxisol	FOR	66°38' 52.21"	18°09' 35.96"
			SHD	66°38' 52.21"	18°09' 35.96"
			SUN	66°37' 47.77"	18°09' 58.35"
Lares	470 – 670	Inceptisol	FOR	66°50' 47.42"	18°11' 54.41"
			SHD	66°50' 47.42"	18°11' 54.41"
			SUN	66°50' 47.42"	18°11' 54.41"
Las Marias	270 – 670	Ultisol	FOR	67°00' 7.42"	18°14' 30.22"
			SHD	67°00' 22.11"	18°14' 32.97"
			SUN	67°00' 22.11"	18°14' 32.97"

*Sampling.* Sites were sampled between November and December 2007. Within each replicate 20 m × 20 m plot a 30 cm × 30 cm subplot was established for sampling of leaf litter, earthworms and soil. The leaf litter was removed from the subplot and stored in plastic bags. To sample earthworms, soil in the subplot was excavated to a depth of 10 cm, placed on a plastic bag, and earthworms picked out by hand. A subsample of the excavated soil was stored in a sealable plastic bag.

*Sample processing and analyses.* Leaf litter dry weight was determined after drying at 65°C for 24 h. Dried litter was ground in a Wiley mill and mineral content determined by ashing at 550°C for 4 h. Soil moisture was determined gravimetrically. Soil pH was determined using a 1:5 (wt/vol) mixture of soil and water and a pH meter. Earthworms were weighed after rinsing and drying. They were frozen at -4°C, shipped in dry ice to Kingston, RI by overnight courier, where they were dried using a lyophilizer.

*<sup>13</sup>C and <sup>15</sup>N, and total C and N content.* Stable isotope content of C and N, and the total C and N content of earthworms, leaf litter and soil were determined using a Carlo-Erba NA 1500 series II elemental analyzer (Thermo Fisher, Waltham, MA) attached to a continuous flow isotope ratio Micromass Optima mass spectrometer (Micromass, Manchester, UK).

*Statistical analyses.* A two-way analysis of variance (with interaction) with ecosystem and site as the two factors was used to examine differences in earthworm parameters. Tukey's test was used to identify treatment differences. Correlations between earthworm parameters and environmental variables were evaluated using a Pearson correlation analysis. All statistical analyses were evaluated at the P < 0.05 level.

## RESULTS AND DISCUSSION

*Biomass and abundance.* There were no significant differences in biomass when data were grouped by site. When data were grouped by ecosystem, mean biomass values for SUN were significantly higher than for FOR and SHD ecosystems (Fig. 1). The earthworm community in the FOR had significantly higher specific biomass than either SHD or SUN ecosystems (Fig. 1). Earthworms abundance was not significantly different when grouped by site. Grouping the data by ecosystem revealed that earthworm abundance in the SUN ecosystem was significantly higher than in the FOR and SHD ecosystems (Fig. 1).

Similarities in SHD and FOR ecosystems may stem from similar plant community structure. According to Marcano-Vega et al. (2002), *Coffea arabica* and shade tree species tend to persist in secondary forests that develop after abandonment of coffee plantations. These forests tend to have species composition similar to those of shade coffee plantations even 20-40 years after abandonment. Similarities in plant community structure between SHD and FOR ecosystems likely result in similarities in earthworm habitat.

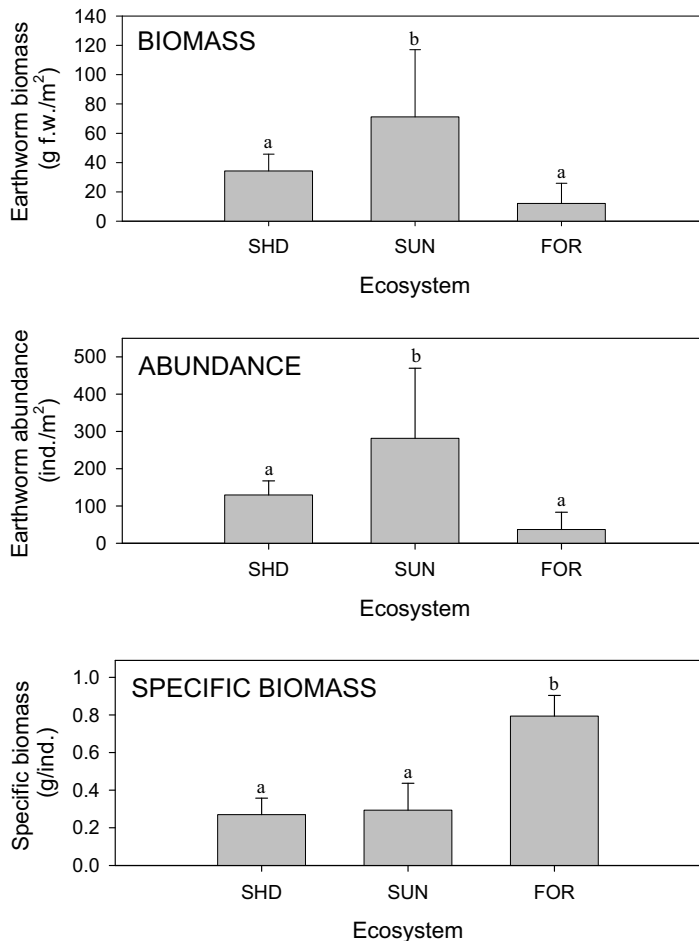

Figure 1. Biomass, abundance, and specific biomass of earthworms from shade (SHD) and sun (SUN) coffee and secondary forest (FOR) ecosystems in Puerto Rico. Treatments with the same letter were not significantly different.

Higher abundance and biomass of earthworms in SUN relative to SHD and FOR ecosystems may be associated with differences in the physical (e.g. open canopy) and biotic structure of these ecosystems. Lower moisture content and higher temperatures in the soil in SUN coffee plantations may result in greater rates of earthworm survival and reproduction than in SHD or FOR ecosystems. In general, the number of cocoons produced by earthworms is higher, the time to hatch is shorter, and the time to sexual maturity is shorter as temperature increases, given adequate soil moisture (Edwards and Bohlen, 1996).

*Relationship to resource quality and quantity.* Within the FOR ecosystem, a strong, positive correlation was observed only between the specific biomass of earthworms and soil pH (Table 2). In the SUN ecosystem, earthworm biomass was negatively correlated with the C content and C/N ratio of leaf litter. Earthworm specific biomass was positively correlated with litter biomass and soil moisture. In the SHD ecosystem, earthworm biomass was negatively correlated with litter biomass. Specific biomass was negatively correlated with litter biomass and soil N content.

Table 2. Pearson correlation coefficients for earthworm and resource quality and quantity parameters in secondary forest (FOR), partial shade coffee (SHD) and sunlight coffee (SUN) ecosystems in Puerto Rico. Statistically significant correlations are indicated in bold.

Ecosystem	Parameter	Litter			Soil				
		Mass	Min. cont.	C/N ratio	C cont.	N cont.	C/N ratio	Water cont.	pH
FOR	Biomass	-0.322	0.062	0.157	0.057	0.146	-0.419	0.227	-0.193
	Abundance	-0.353	-0.203	0.005	0.096	0.097	-0.020	0.184	-0.461
	Spec. biomass	-0.090	0.407	-0.404	-0.494	-0.453	-0.558	-0.406	0.861
SHD	Biomass	-0.688	0.103	0.339	-0.476	-0.485	-0.148	-0.348	0.432
	Abundance	0.008	0.447	0.285	0.182	0.211	-0.065	0.030	0.316
	Spec. biomass	-0.780	-0.188	0.028	-0.641	-0.711	0.051	-0.455	0.213
SUN	Biomass	0.329	0.262	-0.866	0.051	0.027	0.331	0.143	0.349
	Abundance	-0.230	0.115	-0.421	-0.254	-0.295	0.343	-0.296	0.167
	Spec. biomass	0.830	0.059	-0.539	0.598	0.605	0.203	0.762	0.444

Ramos et al. (unpublished) found that earthworm species richness at our sampling sites was highest in SUN and SHD (3 species each), with 2 species found in FOR. *Ponstoscolex corethrurus*, an exotic endogeic (soil-dwelling) was the most prevalent species in all three ecosystems. Anecic (surface litter-feeding, vertical burrowing) species constituted 3.2% and 1.4% of the earthworms population found in SUN and SHD ecosystems, respectively, whereas no anecic species were found in FOR ecosystems. Our results suggest that the feeding ecology of earthworms may be an important determinant of effects of litter quality and/or quantity. Significant correlations of biomass or specific

biomass with litter quality and/or quantity were observed only in the SHD and SUN treatments, the two ecosystems where anecic earthworms were present, lending support to this view. By contrast, only soil pH was correlated with earthworms in the FOR ecosystem, where only soil-dwelling earthworms were found.

*Role in carbon and nitrogen cycling.* Carbon and nitrogen isotope values of soil, leaf litter and earthworms were used to examine the role of litter and soil as sources of C and N for earthworms in SUN, SHD and FOR ecosystems. Differences in  $\delta^{13}\text{C}$  and  $\delta^{15}\text{N}$  between consumers (earthworms) and food sources (soil and leaf litter) allow for determination of the relative importance of these sources to the earthworms. In general, trophic transfer between an organism and its food is expected to result in a  $<1\text{‰}$  increase in  $\delta^{13}\text{C}$  values and a  $\sim 3\text{‰}$  increase in  $\delta^{15}\text{N}$  (Wada et al., 1991). Carbon isotope values of earthworm tissues suggest that soil was the main source of C for earthworms in SHD ecosystems (Fig. 2). The  $\delta^{13}\text{C}$  values of earthworm tissues were slightly enriched compared to soil (0.3 to 0.7 ‰), while leaf litter was enriched 3-5‰, suggesting that leaf litter is not a likely source of carbon for earthworms in SHD ecosystems. Soil also appears to be the main source of N for earthworms. Nitrogen isotope values of earthworm tissue were enriched  $\sim 3\text{‰}$  relative to soil (Fig. 2). Similar to carbon,  $\delta^{15}\text{N}$  values of litter were depleted 4-5‰ in comparison to earthworm tissue, making it an unlikely nitrogen source for earthworms in SHD ecosystems. These results are consistent with an ecosystem dominated by endogeic earthworms that feed primarily on surface soil. The Lares site appears to be an exception, with larger than expected differences between soil and earthworms in  $\delta^{13}\text{C}$  ( $\sim 2.5\text{‰}$ ) and  $\delta^{15}\text{N}$  ( $\sim 5\text{‰}$ ), and even larger differences between litter and earthworms. These results suggest a food source with higher  $\delta^{13}\text{C}$  and  $\delta^{15}\text{N}$  values, possibly soil from deeper areas within the profile, which generally is more enriched in  $^{13}\text{C}$  and  $^{15}\text{N}$  than surface soil (Hendrix et al., 1999).

The extent of differences in  $^{13}\text{C}$  enrichment between earthworms and soil and earthworms and litter (Fig. 2) in the SUN ecosystems suggests that both litter and soil are sources of earthworm carbon. Differences in  $\delta^{15}\text{N}$  values between soil and earthworms are less than the expected 3‰, which may indicate a greater contribution of N from the more isotope-depleted litter. These results are consistent with an earthworm community in which both anecic and endogeic earthworms are present.

Earthworm tissue in FOR ecosystems in Jayuya and Lares (Fig. 2) had higher values of  $\delta^{13}\text{C}$  and  $\delta^{15}\text{N}$  relative to soil (3 to 6‰) and litter (5 to 9‰), making them unlikely sources of C. Earthworms at these sites may consume soil from deeper in the soil profile, which has a higher  $\delta^{13}\text{C}$  (Hendrix et al., 1999). Nitrogen isotope values of earthworm tissue were enriched  $\sim 3\text{‰}$  relative to soil, suggesting that surface soil is the main source of N. Earthworm tissue sampled from Jayuya was depleted in  $^{15}\text{N}$  relative to surface soil, suggesting that earthworms are foraging deeper in the soil profile (Hendrix et al., 1999). These results are consistent with an earthworm community in which endogeic earthworms are dominant.

## **ACKNOWLEDGEMENTS**

We are grateful to Jacqueline Vega, Emmanuel Feliciano, Glenny López and Melissa Matos for technical assistance, to Sonia Borges and Cynthia Ramos for fruitful discussions, and to Eduardo Schroeder for access to field sites, all at the University of Puerto Rico-Mayagüez Campus. We thank the EPA Atlantic Ecology Laboratory, Narragansett, RI for use of the C/N analyzer. J. A. is grateful to the Barreto, Otero and Quiñones families, and to C. Añeses for their support and hospitality. This research was funded by a grant to D. S.-R. from the UPR–Mayagüez Campus Atlantea Program and by the authors' personal funds. The study was conducted while J. A. was on sabbatical leave at UPR-Mayagüez.

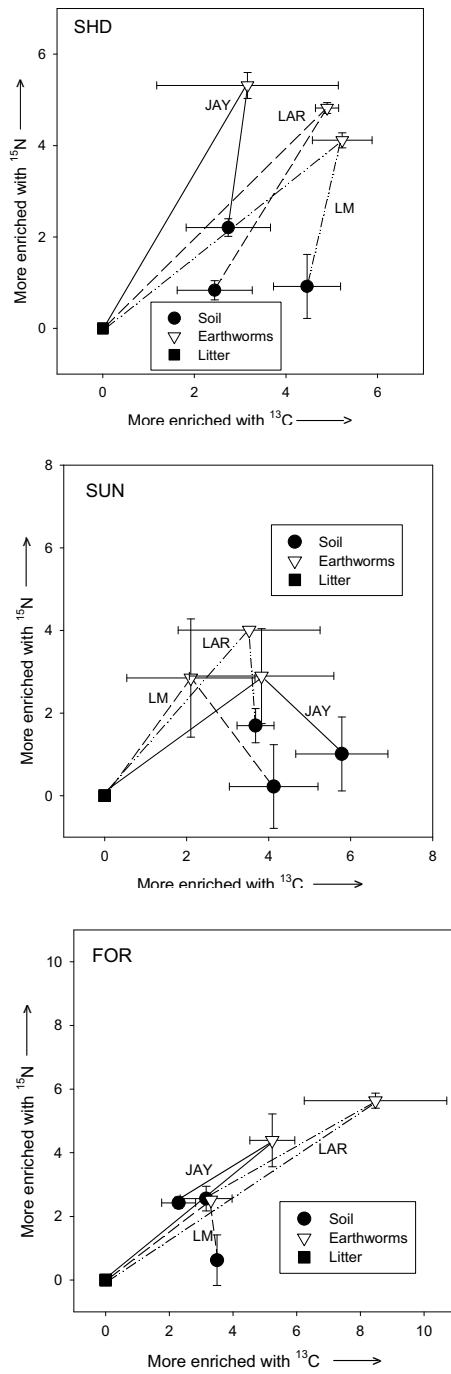

Figure 2. Mean ( $n = 3$ ) values of  $\delta^{13}\text{C}$  and  $\delta^{15}\text{N}$  of leaf litter, soil and earthworms in shade (SHD) and sun (SUN) coffee and forest (FOR) ecosystems in Jayuya (JAY), Lares (LAR) and Las Marias (LM) sites. Units for both axis are ‰. Bars represent standard error. In order to facilitate comparisons among sites, isotopic enrichment data were adjusted for differences in enrichment of litter at a particular site by subtracting the enrichment value for litter from all values.

## REFERENCES

- Aranguren, J., Escalante, G., and Herrera, R. (1982). Nitrogen cycle of tropical perennial crops under shade trees. *Plant and Soil* 67, 247-258.
- Brown, G. G., Pashanasi, B., Villenave, C., Patron, J. C., Senapati, B. K., Giri, S., Barois, I., Lavelle, P., Blanchart, E., Blakemore, R. J., Spain, A. V., and Boyer, J. (1999). Effects of earthworms on plant production in the tropics. In "Earthworm Management in Tropical Agroecosystems" (P. Lavelle, Brussaard, L., and Hendrix, P.F., ed.), pp. 87-147. CAB International, Wallingford, UK.
- Edwards, C. A., and Bohlen, P. J. (1996). "Biology and Ecology of Earthworms," 3rd/Ed. Chapman & Hall, New York.
- Estado Libre Asociado de Puerto Rico - Departamento de Agricultura (2004). "Anuario Estadístico, 2003. Oficina de Estadísticas Agrícolas. Estado Libre Asociado de Puerto Rico, Departamento de Agricultura."
- Hendrix, P. F., Lachnicht, S. L., Callaham, M. A., and Zou, X. (1999). Stable isotopic studies of earthworm feeding ecology in tropical ecosystems of Puerto Rico. *Rapid Communications in Mass Spectrometry* 13, 1295-1299.
- Jones, C. G., Lawton, J. H., and Shachak, M. (1994). Organisms as ecosystem engineers. *Oikos* 69, 373-386.
- Marcano-Vega, H., Aide, T. M., and Báez, D. (2002). Forest regeneration in abandoned coffee plantations and pastures in the Cordillera Central of Puerto Rico *Plant Ecology* 161, 75-87.
- Perfecto, I., Rice, R. A., Greenberg, R., and Van derVoort, M. E. (1996). Shade coffee: A disappearing refuge for biodiversity. *BioScience* 46, 598-608.
- Smith, R. M., and Abruña, F. (1955). "Soil and water conservation research in Puerto Rico. 1938 to 1949. Bulletin 124. University of Puerto Rico. Agricultural Experiment Station. Rio Piedras, PR.
- Wada, E., Mizutani, H., and Minagawa, M. (1991). The use of stable isotopes for food web analysis. *Critical Reviews in Food Science and Nutrition* 30, 361-371.

**Poster #2**

**Factores de Transferencia Suelo-Hojas de Metales Pesados (Co, Cu, Ni, Zn) en *Prunus Persica L.***

<sup>b</sup>Orihuela, DL. <sup>a</sup>Hernández, J.C.; <sup>b</sup>Colón, W.; and Bastida, F.

<sup>a</sup>Escuela Politécnica Superior La Rábida; <sup>b</sup>Universidad del Este. Carolina. Puerto Rico.  
[orihuela@uhu.es](mailto:orihuela@uhu.es) Tlf: 959-017524

**RESUMEN**

La cantidad de un elemento que la planta es capaz de absorber de un suelo ha sido objeto de numerosos estudios científicos. El Factor de Transferencia (FT) se define, conceptualmente, en la literatura científica, como la relación entre la concentración en la planta, o en un órgano de ella, de un elemento determinado y la concentración de ese elemento en el suelo. Esta definición desde una óptica matemática sería un modelo lineal muy simplista. Los modelos matemáticos que expresan los datos experimentales del Factor Transferencia (FT) serán, por lo general, más complicados, pero siempre tienen la notable ventaja de ayudar a entender parte del proceso de traslocación de los elementos nutritivos desde los suelos a las plantas cuantitativa y temporalmente.

El objeto de este trabajo es estudiar en un cultivo de melocotones, *Prunus persica L.* los FT de los metales pesados más importantes cuando la solubilidad del suelo se altera por un proceso de corrección de pH. Concluimos que los modelos de transferencia de metales pesados (Co, Cu, Ni y Zn) expresados por el valor de FT desde suelos calizos hacia las hojas en cultivos de melocotón (*Prunus persica L.*) son por lo general modelos lineales. La mayoría de ellos salvo casos singulares como el Zn, además, son modelos casi horizontales expresando el hecho de que las concentraciones de estos elementos en hojas son independientes de las concentraciones en el suelo, y que las alteraciones del pH modifica escasamente los valores de FT.

**PALABRAS CLAVES:** Factor Transferencia, Metales pesados, Melocotones, *Prunus persica L.*

**ABSTRACT.**

The quantity of an element that the plant is able to absorb of a soil has been object of numerous scientific studies. Transfer Factor (FT) is defined, conceptually, in the scientific literature, as the relation between the concentration either in the plant, or in an organ of it a certain element and the concentration of that element in the soil. From a mathematical point of view, this definition would be a deceivingly simple lineal model. The mathematical models that express the experimental data of the Transfer Factor (FT) are, in general, more complicated, but they always have the remarkable advantage of quantitatively and temporally helping to understand part of the process of soil-to-plant traslocación of the nutritious elements.

The aim of this work is to study the FT of the most important heavy metals in peaches (*Prunus persica L.*) when the solubility of the soil change with a process of pH correction. We conclude that the models of transfer of heavy metals (Co, Cu, Ni and Zn)



in calcareous soil toward the leaves in peach tree expressed by the value of FT are in general lineal models. Most of these models of transfer of heavy metals with exceptions such as the Zn, also, they are model almost horizontal model showing the fact that the concentrations of these elements in leaves are independent of the concentrations in the soil, and that the alterations of the pH of the soil scarcely modify the values of FT.

**KEYWORDS:** Transfers Factor, Heavy Metals, Peach, *Prunus persica* L.

## INTRODUCCIÓN

Las plantas están involucradas en sofisticadas estrategias para la absorción de micronutrientes relativamente escasos (Zn, Mn, Fe) del suelo y estos micronutrientes esenciales suelen ser altamente reactivos y algunos potencialmente tóxicos, por lo que su absorción, transporte y acumulación es un proceso bien coordinado y regulado (León, 2002).

Las carencias, que son en definitiva un proceso de descoordinación o de imposibilidad de absorber determinados micronutrientes en las plantas, y sus síntomas, están relativamente bien descritos en la literatura científica. Carencia de hierro (clorosis férrica) de zinc (foliocolosis) etc., no solo están bien descritas sino que su corrección, además, entra dentro de la practicas comunes que los agricultores incorporan a su actividad.

Por otra parte, y tratándose de metales pesados hay que añadir la preocupación de que la ruta suelo-planta es la ruta mas común por la que entran estos metales en la cadena alimentaría, por lo que este asunto ha sido de notable preocupación por el mundo científico. No enjuiciaremos aquí ni el proceso celular que asegura una distribución correcta de estos elementos ni los mecanismos hoy conocidos que emplea la planta para defenderse de un exceso de determinados metales en su absorción. El objeto de este trabajo es cuantificar la relación entre las concentraciones de determinados elementos en el suelo y su correspondiente concentración en las hojas. Esta transferencia es un proceso de enorme complejidad afectado por procesos naturales y antropogénicos (Kabata, 2004).

La absorción de un determinado elemento por la planta desde las raíces hacia la parte aérea depende de numerosos factores que de forma resumida son los siguientes (Carini, 2001).

- Las características físico químicas de suelo (humedad, pH, Capacidad de Intercambio Catiónico, potencial redox, aplicación de fertilizantes, textura y estructura, materia orgánica)
- La interceptación y absorción radicular (superficie radicular, velocidad de crecimiento radicular, genotipo, etc.)
- El transporte iónico a través de las membranas radiculares (tipo de membrana, tipo de ión)
- La traslocación iónica (transporte unidireccional en el xilema y bi-direccional en el floema)
- La remobilización iónica de las zonas de acumulación (transporte desde hojas o maderas a las zonas sumidero, como frutos o yemas)
- Exudación radicular (modificación del pH, exudados para micorrizas)
- Micorrizas, (asociaciones plantas-micorrizas, actividad total de la rizosfera)

Así, para Kabata (2004) la biodisponibilidad de un elemento para una planta esta gobernada por una serie de factores, que en orden de importancia serían: pH y potencial rédox, textura, materia orgánica, composición mineral del suelo y régimen de humedad.

Así, la clorosis férrica (imposibilidad de absorber hierro) está asociada a pH alto, en suelos calizos y plantas sensibles (vid, cítricos, melocotones, etc.). La corrección con quelatos de esta deficiencia es práctica agrícola común cuyas únicas limitaciones son, generalmente, las de carácter económico. La corrección del pH de los suelos, que es la causa primaria de la clorosis, con productos de costo más razonable, es una de las posibles soluciones a este problema.

La bajada del pH de los suelos básicos implica por lo general importantes beneficios en todos los sentidos para las plantas y para el medio microbiano, pero también presenta aspectos colaterales, no deseables, que son importantes conocer. Uno de ellos es el aumento de la solubilidad de algunos elementos antes citados, que en un medio básico estaban insolubles. El aumento de solubilidad pudiera llevar, por una parte a la corrección de la deficiencia, objeto de la mejora, pero por otro, a un proceso de aparición de toxicidad de algunos elementos antes insolubles.

Hay especies de árboles incapaces de adaptarse a un proceso brusco de aumento de concentración en la solución del suelo de estos metales, y solo algunos ecotipos, o la propia intervención de mejora del hombre (portainjertos resistentes) hace posible su utilidad (Kahle,1993).

La valoración de todos estos procesos individualmente es de notable complejidad por lo que se procede a sistematizarlos y resumirlos, a veces, por conceptos más sencillos. Uno de esos conceptos es el Factor de Transferencia (FT).

El FT relaciona la cantidad de un elemento que hay en el suelo con la que hay en la planta, total o parcialmente, es decir con la planta completa o con una parte de ella (hoja, fruto, etc), y puede ser expresado como la cantidad de producto que hay en una relación de peso seco suelo a peso seco planta (IAEA, 1994); o como área de suelo (a una profundidad de 20 cm para cultivos o 10 cm para pastos) a peso seco de planta (Frissel, 1997); o como también peso seco de suelo a peso fresco, lo que es más normal en el caso de frutos. La forma más sencilla de definir el FT, en la literatura científica, es el cociente entre la concentración en la planta, o en un órgano de ella, de un elemento determinado y la concentración de ese elemento en el suelo.

$$C_{\text{planta}} = FT * C_{\text{suelo}} \quad (1)$$

También se encuentra la definición de... *cantidad esperada de un elemento que entra en una planta de un suelo en condiciones de equilibrio* (Chojnacka, 2004). En este caso, las condiciones de equilibrio, no obstante, son difíciles de definir.

Ese concepto básico de traslocación o absorción, se ha aplicado a metales pesados (Chamberlain, 1983; Gast, 1998) a pesticidas (Trapp, 1990), a radionucleidos (Ehlken, 2002; Blanco, 2002), etc.

La anterior definición asume dos hechos de dudosa certeza; que la relación entre ambas concentraciones es lineal y, además, que es constante. Una larga lista de citas en la literatura científica demuestra que, en muchos casos, ni es lineal ni es constante y que en una misma planta y suelo puede llegar a tener una notable variabilidad, indicando así que esa relación lineal exacta no tiene porque existir, es puntual en el tiempo y en el espacio.

Esa variabilidad es obvia, dada el gran número de factores (climáticos, biológicos, genéticos, etc.) y parámetros (pH, CIC del suelo, humedad, competencia entre iones, etc.), que gobiernan las relaciones suelo-planta.

La formulación simplista de un modelo lineal para explicar como se gobierna el proceso de absorción por la planta de un elemento, con relación al sistema agua-suelo procede tomarla, pues, con suma precaución. Los casos encontrados en la literatura asumen modelos lineales principalmente para elementos que se encuentran en el suelo en muy baja concentración, y con valores de un amplio rango de variación (Blanco, 2002). Lo anterior significaría que la transferencia de un elemento del suelo a la planta, en el caso de rectas muy horizontales, no dependería, para estos elementos, de la concentración del suelo. Si además existiera una gran dispersión de los valores de FT con respecto a su propia media, se expresaría el hecho que el elemento considerado estaría en forma de sales muy insolubles y es difícilmente absorbible por la planta, o por el contrario en forma de sales muy solubles que facilita la absorción por la planta.

Modelos de transferencia lineales algo más elaborados formulan la relación de concentraciones como la ecuación de una recta que corta al eje de la Y en un punto:

$$C_{\text{planta}} = a \cdot C_{\text{suelo}} + b \quad (2)$$

Si b es cero, que es el caso de la ecuación (1) se asume que el elemento considerado solo entra en la planta por las raíces. La discusión en cuanto al coeficiente angular de la recta ( $a = FT$ ) sería el mismo que anteriormente.

Relaciones más complejas encontradas en la literatura científica expresan la relación de absorción con una ecuación hiperbólica de tipo:

$$C_{\text{planta}} = m \cdot C_{\text{suelo}}^n \quad (3)$$

Si  $n=1$  la curva se transforma en una recta con coeficiente angular igual a m. Si  $n=0$  la recta es horizontal y la concentración en la planta es constante e igual a m. Si  $n<1$  los valores de la concentración en la planta disminuirían cuando se incrementan los valores de concentración en el suelo.

Existen modelos para la determinación de FT que tienen en cuenta la transpiración de la planta y la humedad del suelo como el modelo usado por Ambe (1999).

$$FT = ST_c / (\theta + K_d) \quad (4)$$

S es el Coeficiente de Absorción selectiva del elemento;  $T_c$  el coeficiente de transpiración (cc/g), que es el agua requerida para la producción de un gramo de planta;  $\theta$  es el contenido de agua del suelo (cc/g) y  $K_d$  el coeficiente de distribución (cc/g).

El uso de modelos algo más complejos, se ha utilizado en diversos campos de la investigación. Se han planteado modelos como los aquí expresados pasando por modelos conceptuales teóricos como el de Mitscherlich (Tudoreanu, 2004), modelos dinámicos

(TERMOD, NRPB, RADFOOD, PATHWAY, RADAL o DYNAMON) o modelos estáticos (HERMES, UNSCEAR, USNRC, ECOSYS) cuya revisión se ha realizado por Kabai, 2004 e incluso el modelo dinámico del autor citado ETM-2002, mucho más complejos, etc., que incorporan un número notable de variables tales como deposición aérea, superficie de la planta, agua intersticial, superficie de suelo considerado, concentración del elemento en la zona radicular, etc.

El uso de FT ó modelos de transferencia es casi una constante, especialmente en aquellos autores que investigan transmisión de radionucleidos, metales pesados y fitorestauración. Su traslado a cultivos que sean comestibles, como es nuestro caso, por sus hojas, frutos, etc. puede ayudar a entender el movimiento de los metales pesados, con escasas concentraciones, en los sistemas suelo-hojas. Estos modelos, posiblemente, no serían trasladables a macroelementos nutritivos ni cuantitativa y/o temporalmente.

La International Union of Radioecologist está planteándose actualmente la posibilidad de calcular modelos de transferencia para cereales que sirvan de unidades, que mediante un factor de conversión, puedan ser aplicados a otros cultivos (Frissel, 2002; Nisbet, 2000).

## **METODOLOGÍA**

### ▪ **Parcela experimental**

Se eligió un cultivo melocotones y se determinó un área experimental sita en Cartaya (Huelva-España). El área de experiencia tenía una superficie cuadrada de 36x36 m. Los árboles están situados a un marco de plantación de 6x3 m. Las muestras se toman en la línea de árboles alternativamente, árbol si árbol no, de tal manera que la malla de muestro es cuadrada a 6x6 m. El suelo es una arcilla pliocénica clasificada como Aquic Palexeralfs .

### ▪ **Técnica de muestreo en campo**

Primera toma datos de suelos se realiza en Septiembre del primer año, llamándose a éstas muestras Suelos1, referentes a la 1ª toma de muestras. La segunda toma de suelos se realiza en Septiembre del segundo año, llamándose a éstas Suelos3. Todas las muestras son introducidas en bolsas y son etiquetadas debidamente para su correcta identificación, mostrando en ella el árbol de la cual es cogida y la fecha, para su envío al laboratorio.

Las correcciones para bajar el pH de los suelos se han realizado con Sulfato Ferroso Monohidratado (SFM), procedente de la industria del titanio obtenido por tratamiento de la ilmenita. Se realiza una mejora equivalente a 600kg/ha, aplicada en la proximidad de los goteros de cada árbol. Se muestrean en total 36 árboles. Se toman muestras de hojas en Septiembre del primer año y en Septiembre del segundo año.

### ▪ **Análisis químico**

Método: Basado en Standard Methods

- Aparatos: ICP-MS (espectrómetro de masas con fuente de ionización de plasma acoplado inductivamente). Serie 4500 de Hewlett Packard.
- Espectrofotómetro Lambda-2 de Perkin-Elmer.
- pH-metro WTW con electrodo combinado de calomelano.

- Las muestras de hojas se trocearon y se lavaron con agua de 18,2 MW producida en un equipo Milli-Q Ro siendo en esta solución donde se procedió a las determinaciones mediante ICP-MS.

Para la disgregación ácida se empleó 10 ml de agua regia inversa sobre 1 gr de muestra en el caso de las hojas. Las medidas de pH se fueron tomando cada 10 min.

#### Condiciones instrumentales

- Para ICP-MS: La sintonía y comprobación de la calibración del ICP-MS se efectuó con una solución de 10 ppb de <sup>7</sup>Li, <sup>89</sup>Sr y <sup>205</sup>Tl, consiguiéndose una RSD inferior al 5\%.
- Para la calibración externa se emplearon estándares multielementales, con una concentración inicial en cada elemento de 10 ppm de Spex Cheminal y a partir de estos, se prepararon por disolución los estándares para la estandarización del sistema, de 1 ppb, 10 ppb, 50 ppb y 100 ppb.
- Para el espectrofotómetro: El sistema se calibró usando patrones de 5, 10, 20, 25, y 30 ppm de sulfatos preparados por dilución a partir de un patrón de 1000 ppm.
- Para el pH-metro: El sistema se calibró a dos puntos pH 4 y pH 7,02 empleando soluciones amortiguadoras para tal fin de la casa Merck.

- Características del Sulfato de Hierro Monohidratado (SFM)

Se trata de un Sulfato de Hierro Monohidratado con otros microelementos y con ácido sulfúrico que se presenta en forma cristalina. Es un producto preventivo de clorosis férrica para todo tipo de cultivos, actúa como acidificante del suelo y aporta microelementos previniendo su carencia.

Las características técnicas (Información facilitada por la empresa Huntsman-TOXIDE S.L.) son las siguientes: Fe soluble en agua 20,5 %; SO<sub>3</sub> soluble en agua 40,0 %; Ti soluble en agua 1,5 %; Mn soluble en agua 1,0 % y Zn soluble en agua 0,5 %.

- Tratamiento estadístico

Para la obtención de los modelos se utiliza el programa Informático SPSS 12.0.

#### Resultados y discusión

Una vez obtenidos los datos analíticos de suelos y hojas se tratan estadísticamente y se realizan los estudios correspondientes. Se estudian las concentraciones en hojas frente a la concentración en suelos mediante cuatro modelos (lineal, logarítmico, cuadrático y cúbico). Los datos expresados en la Tabla nº 1, son los dos modelos mejor ajustados (Lineal y Logarítmico).

Tabla nº 1: Valores de las rectas de regresión lineal y logarítmica de los metales pesados a estudio

Variable Dependiente	Variable Independiente	Modelo	Rsq	g.l.	F	Sig.	b0	b1
CoIf	CoIs	Lineal	,027	34	,93	,342	,2020	-,0057

Co1f	Co1s	Logarítmico	,018	34	,62	,437	,2300	-,0358
Co3f	Co3s	Lineal	,000	34	2,3 (-0,5)	,996	,1994	-4 (-0,5)
Co3f	Co3s	Logarítmico	,000	34	,01	,912	,1884	,0056
Cu1f	Cu1s	Lineal	,193	34	8,15	,007	3,9982	,4118
Cu1f	Cu1s	Logarítmico	,188	34	7,85	,008	-4,6540	5,4934
Cu3f	Cu3s	Lineal	,091	34	3,42	,073	7,5564	-,1006
Cu3f	Cu3s	Logarítmico	,078	34	2,87	,100	8,7337	-,9783
Ni1f	Ni1s	Lineal	,030	34	1,05	,313	5,0010	-,0348
Ni1f	Ni1s	Logarítmico	,030	34	1,05	,312	6,6112	-,7724
Ni3f	Ni3s	Lineal	,003	34	,11	,747	1,8053	-,0060
Ni3f	Ni3s	Logarítmico	,000	34	1,3E-03	,971	1,6263	,0154
Zn1f	Zn1s	Lineal	0,004	34	0,13	0,724	11,1663	-,0306
Zn1f	Zn1s	Logarítmico	0,011	34	0,36	0,550	6,4091	1,6535
Zn3f	Zn3s	Lineal	0,187	34	7,84	0,008	6,0301	,0622
Zn3f	Zn3s	Logarítmico	0,194	34	8,29	0,007	-1,6336	2,7952

Nota: g.l.: Grados de libertad; Sig: Significación; b0 = FT; b1 = Coordenada en el origen;

Tabla nº 2: Valores de Factor Transferencia para los elementos a estudio

Elemento	N	Mínimo	Máximo	Media	Desviación Std.
pH1	36	7,27	8,39	8,0761	0,2618
pH3	36	3,27	7,77	6,1694	1,3797
Co1	36	0,01	0,04	0,0197	0,00810
Co3	36	0,01	0,07	0,0292	0,01131
Cu1	36	0,43	1,17	0,7042	0,15230
Cu3	36	0,18	1,43	0,6956	0,31920
Ni1	36	0,10	0,39	0,1914	0,05885
Ni3	36	0,03	0,12	0,0767	0,02318
Zn1	36	0,23	0,58	0,3742	0,08473
Zn3	36	0,16	0,38	0,2481	0,05280

Nota: pH1: pH en primera toma de suelo ; pH3: pH en segunda toma de suelo Co1: Cobalto en primera toma; Co3: Cobalto en segunda toma; Cu1: Cobre en primera toma; Cu3: Cobre en segunda toma; Ni1: Níquel en primera toma; Ni3: Níquel en segunda toma; Zn1: Zinc en primera toma; Zn3: Zinc en segunda toma;

Gráfico nº 1: Representación de las regresiones lineales (línea continua) de los distintos elementos, las líneas discontinuas representan la concentración en las hojas frente a la concentración en el suelo



Gráfico 1.1: Variación de la Concentración de Co en hojas frente a la concentración en suelos (ppm) en primera toma



Gráfico 1.2: Variación de la Concentración de Co en hojas frente a la concentración en suelos (ppm) en segunda toma

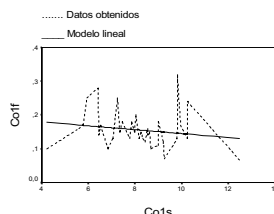

Gráfico 1.3: Variación de la Concentración de Cu en hojas frente a la concentración en suelos (ppm) en primera toma

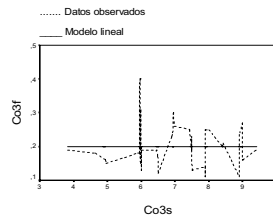

Grafico 1.4: Variación de la Concentración de Cu en hojas frente a la concentración en suelos (ppm) en segunda toma

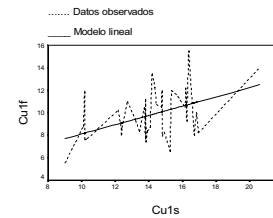

Grafico 1.7: Variación de la Concentración de Zn en hojas frente a la concentración en suelos (ppm) en primera toma

Grafico 1.5: Variación de la Concentración de Ni en hojas frente a la concentración en suelos (ppm) en primera toma

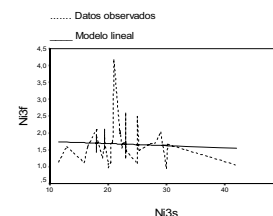
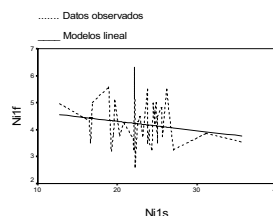
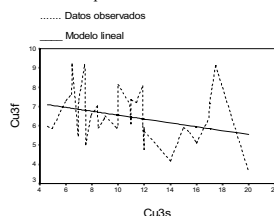

Grafico 1.8: Variación de la Concentración de Zn en hojas frente a la concentración en suelos (ppm) en segunda toma

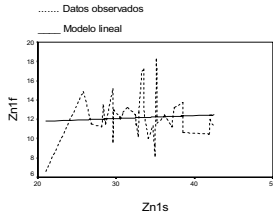
Grafico 1.6: Variación de la Concentración de Ni en hojas frente a la concentración en suelos (ppm) en segunda toma

Gráfico nº 2: Variación de los valores de FT sobre la concentración de los diferentes elementos a estudio. La línea representa el valor medio.



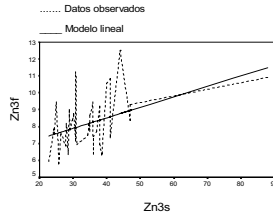
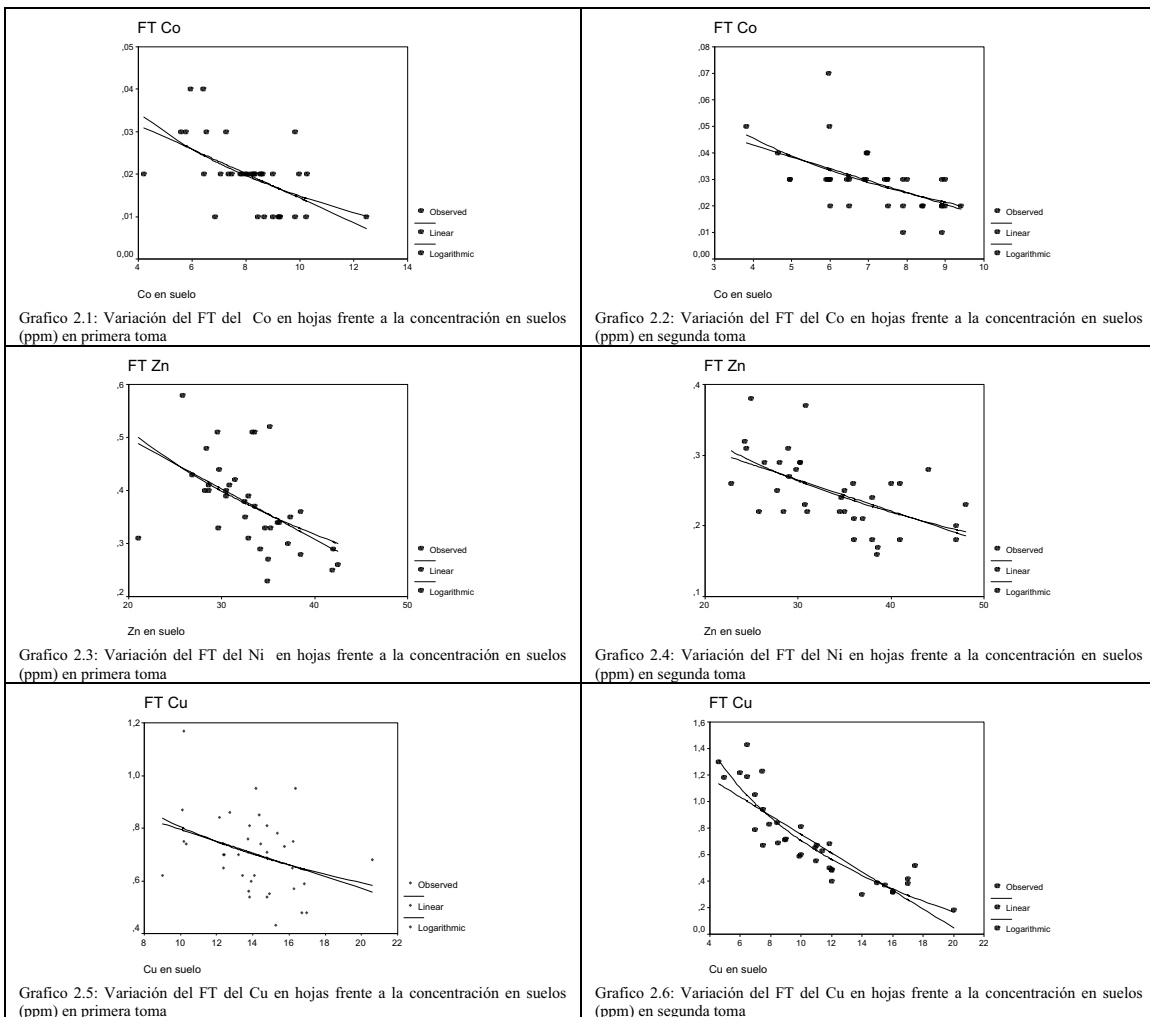
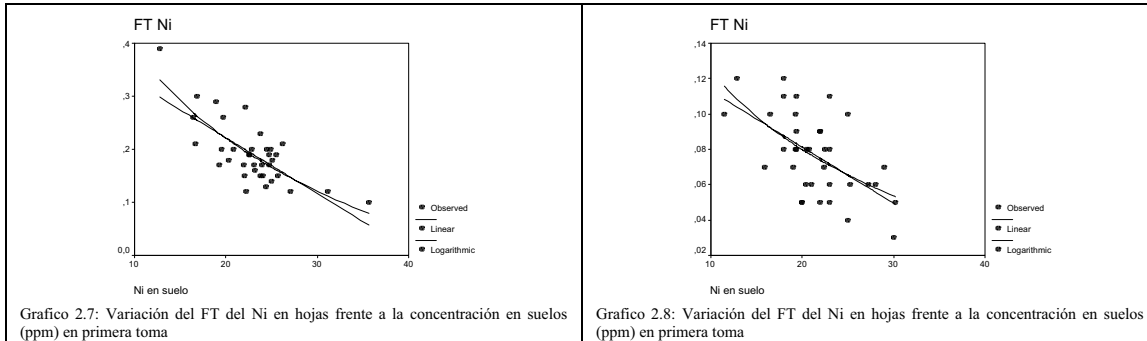

## Cobalto

Al comienzo de la experiencia las relaciones de concentración hojas/suelos están correlacionadas por una recta de regresión (modelo lineal de regresión) cuya ecuación es  $C_{\text{hoja}} = -0,0057C_{\text{suelo}} + 0,2020$ , y al final de la experiencia esa recta tiene la ecuación  $C_{\text{hoja}} = -0,5000C_{\text{suelo}} + 0,1994$ . Lo anterior nos indica que el modelo de regresión sigue siendo lineal y que el aumento de la concentración de Co en los suelos hace la recta más horizontal, es decir **la concentración en hojas se hace prácticamente independiente de la concentración en suelo**. (Gráficos 1.1 y Gráficos 1.2).

El FT medido por el cociente  $FT = C_{\text{hoja}}/C_{\text{suelo}}$ , con respecto a la concentración del suelo, comienza con un modelo prácticamente lineal plano de ecuación  $FT = -0,0029C_{\text{suelo}} + 0,0431$  y termina con un modelo  $FT = -0,0045C_{\text{suelo}} + 0,0609$  igualmente plano. Esto significa que, a los niveles que se ha conseguido mover el pH de este suelo, el FT no se ha modificado para este elemento, es decir **las modificaciones del pH no alteran los modelos de FT**.

Este elemento presenta situaciones de muy **poca estabilidad** en sus estados de solubilidad con una dispersión notable respecto a su media (Media de FT inicial =  $0.0197 \pm 0.00810$ ). Al final sigue manteniendo su dispersión de valores (Media de FT final =  $0.0292 \pm 0.01131$ ). (Gráficos 2.1 y Gráficos 2.2). Los procesos de solubilidad/insolubilidad son notables en pequeños rangos de concentración en el suelo.

## Cobre

Al comienzo de la experiencia las relaciones de concentración hojas/suelos estaban correlacionadas por una recta de regresión (modelo lineal de regresión) cuya ecuación era  $C_{\text{hoja}} = 0,4118C_{\text{suelo}} + 3.9982$ , y al final de la experiencia esa recta tiene la ecuación  $C_{\text{hoja}} = -0.1006C_{\text{suelo}} + 7.5564$ . Lo anterior nos indica que el modelo de regresión sigue siendo lineal pero no horizontal y que **el aumento de la concentración de Cu<sub>suelos</sub> si influye débilmente en el valor del Cu<sub>hoja</sub>**. Esto está en concordancia con Hooda (1997) cuando afirma que la absorción de Cu por las plantas no aumenta demasiado cuando se aumenta la concentración del suelo.

Cuando se hace la corrección de pH se observan dos hechos. El primero es que la recta se vuelve horizontal con lo que, ahora la concentración de Cu<sub>hoja</sub> deja de ser independiente de la Cu<sub>suelo</sub>, y que esa recta corta al eje de la Y en un valor casi doble que el inicial. La elevación del punto de corte de la recta puede hacer sospechar que las hojas, en este caso, pudieran estar afectadas por **tratamientos con productos cúpricos**, los cuales han sido aplicados para evitar enfermedades fúngicas (Gráficos 1.3 y Gráficos 1.4).



El FT medido por el cociente  $FT=C_{\text{hoja}}/C_{\text{suelo}}$ , con respecto a la concentración del suelo, comienza con un modelo prácticamente lineal plano de ecuación  $FT = -0,0224C_{\text{suelo}} + 1.0190$  y termina con un modelo  $FT = -0,0704C_{\text{suelo}} + 1.4568$  igualmente plano. Esto significa que, a los niveles que se ha conseguido mover el pH de este suelo, el FT no se ha modificado para este elemento, es decir **las modificaciones del pH no alteran los modelos de FT.**

Este elemento presenta, **al principio**, situaciones de **mayor estabilidad** en sus estados de solubilidad con una dispersión pequeña respecto a su media (Media de FT inicial =  $0.7042 \pm 0.1523$ ). Es posible que al principio la forma iónica más probable sea  $\text{CO}_3\text{Cu}$  cuyo proceso de solubilidad no depende del pH.

En el rango de disminución de pH como el aquí conseguido los valores, finalmente, se hacen más dispersos (Media de FT final =  $0.6956 \pm 0.3192$ ), (Gráficos 2.5 y Gráficos 2.6) y los procesos de solubilidad/insolubilidad se hacen más aleatorios debido a la presencia de otros tipos de compuestos tales como  $\text{Cu}(\text{OH})_3^-$  o  $\text{Cu}(\text{OH})_4^-$ , cuya dependencia del pH es manifiesta.

## Niquel

El Ni es un micronutriente básico para la vida de las plantas superiores siendo esencial como componente de la ureasa enzima que influye en los procesos de nitrificación. El transporte de Ni dentro de ella depende de las especies, de la edad y del estatus nutricional.

Al comienzo de la experiencia las relaciones de concentración hojas/suelos estaban correlacionadas por una recta de regresión (modelo lineal de regresión) cuya ecuación era  $C_{\text{hoja}} = -0.0348C_{\text{suelo}} + 5.0010$ , y al final de la experiencia esa recta tiene la ecuación  $C_{\text{hoja}} = -0.0060C_{\text{suelo}} + 1.8053$ . Lo anterior nos indica que el modelo de regresión es lineal y horizontal y que el aumento de la concentración de  $\text{Ni}_{\text{suelos}}$  no influye en el valor del  $\text{Ni}_{\text{hoja}}$  (Gráficos 1.5 y Gráficos 1.6). Las concentraciones de  $\text{Ni}_{\text{hojas}}$ , **en el rango de valores de pH que nos movemos, son pues independientes de las  $C_{\text{suelo}}$ .** Esto está en concordancia con (Kashem, 2002). Se observa, además que la recta del modelo de regresión corta al eje de la Y en un valor bastante más bajo que inicialmente, es decir se ha desplazado hacia abajo. Es posible que la mejora de las condiciones de desarrollo de la planta produzcan un efecto **dilución** (igual cantidad de elemento en más desarrollo foliar).

El FT medido por el cociente  $FT=C_{\text{hoja}}/C_{\text{suelo}}$ , con respecto a la concentración del suelo, comienza con un modelo prácticamente lineal plano de ecuación  $FT = -0,0105C_{\text{suelo}} + 0.4322$  y termina con un modelo  $FT = -0.0032C_{\text{suelo}} + 0.1448$  igualmente plano. Esto significa que, a los niveles que se ha conseguido mover el pH de este suelo, el FT no se ha modificado para este elemento, es decir **las modificaciones del pH no alteran los modelos de FT.** Lo anterior concuerda con las investigaciones de Kashem cuando asegura que los cambios leves de pH afectarían poco a la dinámica del Ni en suelos (Kashem, 2002) y consecuentemente a la absorción y traslocación a las partes aéreas de las plantas. Por otra parte es posible que muchas plantas sean capaces de regular el flujo de Ni hacia sus órganos aéreos independientemente de las concentraciones en el suelo.

Este elemento presenta, al principio por su probable unión a formas carbonato, situaciones estables en sus estados de solubilidad (Media FT inicial =  $0.1914 \pm 0.05885$ ).

En el rango de **disminución de pH** como el aquí conseguido, los valores, finalmente, no se modifican sustancialmente (Media de FT final =0.0767±0.02318), (Gráficos 2.7 y Gráficos 2.8) y los **procesos de solubilidad/ insolubilidad no se alteran**. Lo anterior esta en consonancia con la revisión de las formas de Ni presentes en los suelos realizada por Uren (1992), que pone de manifiesto que el Ni es un elemento relativamente inerte cuya dinámica depende esencialmente de la capacidad de cambio, de las condiciones redox y de la materia orgánica de los suelos. En nuestro caso, es posible que, la adicción al suelo de iones sulfato reduzca la adsorción de Ni en los componentes orgánicos.

## Zinc

Al comienzo de la experiencia la concentración hojas dividido por la concentración en suelos estaban relacionadas mediante una recta de regresión (modelo lineal de regresión) cuya ecuación era  $C_{\text{hoja}} = -0.0306C_{\text{suelo}} + 11.1663$ , y al final de la experiencia esa recta tiene la ecuación  $C_{\text{hoja}} = -0,0622C_{\text{suelo}} + 6,0301$ . Lo anterior nos indica que el modelo de regresión en ambos casos lineal, pero ocurren dos hechos. El primero es que la recta de coeficiente angular negativo se hace de coeficiente positivo y valor casi doble del inicial lo que supone un giro considerable. El segundo es que la recta cortaba inicialmente al eje de las Y en el punto 11.1663 y termina cortándolo solo en 6,0301, es decir prácticamente al mitad. Así pues es probable que la concentración de Zn **en hojas dependa de la concentración en suelo, en los niveles de esta experiencia**. (Gráficos 1.7 y Gráficos 1.8). La bajada del pH disminuye el punto de corte de la recta lo que hace pensar en un efecto “dilución” por aumento del desarrollo foliar del árbol al mejorar las condiciones de cultivo. Es decir la disminución del pH hace al elemento más soluble y la traslocación hacia las hojas depende ahora de la concentración en suelo.

Podría pensarse con Hedal (1999) que el proceso de fertirrigación, y el incremento de conductividad que ello conlleva a nivel de los sistemas radiculares afecta sustantivamente al comportamiento del Zn en melocotones. Así, Helal (1999) opina que, el aumento de concentración salina a nivel radicular puede alterar notablemente el proceso de absorción del Zn en *Leucaena Leucocephala*. Según ello, el aumento de la Conductividad Eléctrica que implica el propio proceso de fertirrigación al que están sometidos estos árboles, además de la aplicación del SFM, podría elevar la cantidad de este metal que se transfiere hacia las hojas.

Si lo anterior fuese cierto, entonces, todo ello podría ser debido fundamentalmente a que los factores que más influirían en este caso estarían relacionados, (como en el caso de *Leucaena*) no tanto con las características estructurales y físico-químicas del suelo, sino con las características del sistema radicular del melocotonero.

La opinión de Helal (1999) no concuerda con la expresada por Ambe (1999) para *Brassica rapa* var. *perviridis*, donde el coeficiente de absorción del Zn disminuye cuando la Conductividad Eléctrica aumenta. Estos dos hechos serían solo aparentemente contradictorios ya que como expresa Mollah (1998) los valores de transferencia pueden variar no solo entre especies distintas para situaciones aparentemente iguales, sino entre distintas variedades de una misma especie. En nuestro caso nos inclinamos a pensar que es la disminución del pH producida por el SFM la que ha alterado las condiciones de solubilidad de este elemento.

El FT medido por el cociente  $FT=C_{\text{hoja}}/C_{\text{suelo}}$ , con respecto a la concentración del suelo, comienza con un modelo prácticamente lineal plano de ecuación  $FT = -0,00951C_{\text{suelo}} + 0,6880$  y termina con un modelo  $FT = -0,0044C_{\text{suelo}} + 0,3969$  igualmente plano. Esto significa que, a los niveles que se ha conseguido mover el pH de este suelo, el FT no ha cambiado para este elemento, es decir **las modificaciones del pH no alteran los modelos de FT.**

Este elemento presenta situaciones de estabilidad en sus estados de solubilidad con los mismos porcentajes de dispersión al principio (Media de FT inicial =  $0.3742 \pm 0.08473$ ) y al final (Media de FT final =  $0.2481 \pm 0.05280$ ). (Gráficos 2.3 y Gráficos 2.4) Por ello los **procesos de solubilidad/ insolubilidad que puedan darse en el rango de pH** considerado son estables.

## CONCLUSIONES

No se ha encontrado en la literatura científica valores de transferencia suelos-hojas en melocotones en suelos calizos para su posible comparación. Los estudios mas parecidos son las revisiones de Carini (2001) en frutos de melocotón.

Las concentraciones de los metales considerados en las hojas, por lo general, son independientes de las concentraciones en el suelo, salvo casos como el Zn. Por lo que respecta a las cantidades absorbidas se puede citar como singularidad el caso del Cu, que puede verse afectado por los tratamientos antifúngicos que a lo largo del periodo de crecimiento de la hoja modifique elevándolos, o así mismo el caso del Zn por un posible efecto “**dilución**” por mejor desarrollo foliar del árbol

Los modelos de transferencia de metales pesados (Co, Cu, Ni y Zn) desde suelos calizos hacia las hojas en cultivos de melocotón (*Prunus persica L.*) son **por lo general modelos lineales**. La mayoría de ellos salvo casos singulares como el Zn, además, son modelos casi horizontales, expresando el hecho de que las concentraciones relativas transferidas de estos elementos hacia las hojas son independientes de las concentraciones en el suelo. La bajada del pH de los suelos calizos con mejoradores edáficos tales como el Sulfato de Hierro Monohidratado (SFM) modifican escasamente los niveles de traslocación de estos elementos en las cantidades que esta experiencia ha aplicado.

## REFERENCES

- Ambe S, Shinonaga T, Ozaki T, Enomoto S, Yasuda H and Uchioda S 1999 Ion competition effects on the selective absorption of radionuclides by komatsuna (*Brassica rapa var. perviridis*). *Environmental and Experimental Botany*. 41, 185-194.
- Blanco P, Vera F and Lozano J C 2002 About the assumption of linearity in soil-to-plant transfer factor for uranium and thorium isotopes and  $^{226}\text{Ra}$ . *The Science of the Total Environment*. 284, 167-175.
- Carini F 2001 Radionuclide transfer from soil to fruit. *Journal Environment Radioactivity*. 52, 237-279.
- Chamberlain A C 1983 Fallout of lead and uptake by crops. *Atmospheric Environment*. 17, 693-706.
- Chojnacka K, Chojnacki A, Górecka H and Górecki H 2004 Bioavailability of heavy metals from polluted soils to plants. *Science of the Total Environment*. In Press.

- Ehlkem S and Kirchner G 2002 Environmental processes affecting plant root uptake of radioactive trace elements and variability of transfer factor data: a review. *Journal of Environmental Radioactivity*. 58, 97-112.
- Frissel M J 1997 Protocol for experimental determination of soil to plant transfer factors (concentration ratios) to be used in radiological assessment models. *UIR Newsletter*. 25, 5-8.
- Frissel M J, Deb D L, Fathony [http://www.sciencedirect.com/science?\\_ob=ArticleURL&\\_udi=B6VB2-44C8691-3&\\_user=705994&\\_coverDate=12%2F31%2F2002&\\_alid=268529846&\\_rdoc=1&\\_fmt=full&\\_orig=search&\\_cdi=5914&\\_sort=d&\\_st=4&\\_docanchor=&\\_acct=C000039438&\\_version=1&\\_urlVersion=0&\\_userid=705994&md5=dbce54abf31be644d31e2b6ba5a22986](http://www.sciencedirect.com/science?_ob=ArticleURL&_udi=B6VB2-44C8691-3&_user=705994&_coverDate=12%2F31%2F2002&_alid=268529846&_rdoc=1&_fmt=full&_orig=search&_cdi=5914&_sort=d&_st=4&_docanchor=&_acct=C000039438&_version=1&_urlVersion=0&_userid=705994&md5=dbce54abf31be644d31e2b6ba5a22986) - affc M, Lin Y M, Mollah [http://www.sciencedirect.com/science?\\_ob=ArticleURL&\\_udi=B6VB2-44C8691-3&\\_user=705994&\\_coverDate=12%2F31%2F2002&\\_alid=268529846&\\_rdoc=1&\\_fmt=full&\\_orig=search&\\_cdi=5914&\\_sort=d&\\_st=4&\\_docanchor=&\\_acct=C000039438&\\_version=1&\\_urlVersion=0&\\_userid=705994&md5=dbce54abf31be644d31e2b6ba5a22986](http://www.sciencedirect.com/science?_ob=ArticleURL&_udi=B6VB2-44C8691-3&_user=705994&_coverDate=12%2F31%2F2002&_alid=268529846&_rdoc=1&_fmt=full&_orig=search&_cdi=5914&_sort=d&_st=4&_docanchor=&_acct=C000039438&_version=1&_urlVersion=0&_userid=705994&md5=dbce54abf31be644d31e2b6ba5a22986) - affe A S, Ngo [http://www.sciencedirect.com/science?\\_ob=ArticleURL&\\_udi=B6VB2-44C8691-3&\\_user=705994&\\_coverDate=12%2F31%2F2002&\\_alid=268529846&\\_rdoc=1&\\_fmt=full&\\_orig=search&\\_cdi=5914&\\_sort=d&\\_st=4&\\_docanchor=&\\_acct=C000039438&\\_version=1&\\_urlVersion=0&\\_userid=705994&md5=dbce54abf31be644d31e2b6ba5a22986](http://www.sciencedirect.com/science?_ob=ArticleURL&_udi=B6VB2-44C8691-3&_user=705994&_coverDate=12%2F31%2F2002&_alid=268529846&_rdoc=1&_fmt=full&_orig=search&_cdi=5914&_sort=d&_st=4&_docanchor=&_acct=C000039438&_version=1&_urlVersion=0&_userid=705994&md5=dbce54abf31be644d31e2b6ba5a22986) - aff N T, Othman I, Robison W L, Skarlou-Alexiou V, Topcuoglu [http://www.sciencedirect.com/science?\\_ob=ArticleURL&\\_udi=B6VB2-44C8691-3&\\_user=705994&\\_coverDate=12%2F31%2F2002&\\_alid=268529846&\\_rdoc=1&\\_fmt=full&\\_orig=search&\\_cdi=5914&\\_sort=d&\\_st=4&\\_docanchor=&\\_acct=C000039438&\\_version=1&\\_urlVersion=0&\\_userid=705994&md5=dbce54abf31be644d31e2b6ba5a22986](http://www.sciencedirect.com/science?_ob=ArticleURL&_udi=B6VB2-44C8691-3&_user=705994&_coverDate=12%2F31%2F2002&_alid=268529846&_rdoc=1&_fmt=full&_orig=search&_cdi=5914&_sort=d&_st=4&_docanchor=&_acct=C000039438&_version=1&_urlVersion=0&_userid=705994&md5=dbce54abf31be644d31e2b6ba5a22986) - affj S, Twining J R, Uchida S and Wasserman M A 2002 Generic values for soil-to-plant transfer factor of radiocesium. *Journal Environment Radioact*. 58, 113-118.
- Gast C H, Jansen E, Bierling J and Haanstra L 1988 Heavy metals in mushrooms and their relationship with soil characteristics. *Chemosphere*. 17, 789-799.
- Helal H M, Upenov A and Issa G J 1999 Growth and uptake of Cd and Zn by *Leucaena leucocephala* in reclaimed soils as affected by NaCl salinity. *Journal Plant Nutrition*. 162, 589-592.
- IAEA 1994 Handbook of parameter values for the prediction of radionuclide transfer in temperate environments. Technical Report Series 364. Vienna.
- Kabai E, Zagybai P, Láng-Lázi M and Oncsik M B 2004 Radionuclide migration modeling through the soil-plant system as adapted for Hungarian environment. *Science of the total Environment*. 330, 199-216.
- Kabata A 2004 Soil-plant transfer of trace elements, an environmental issue. *Geoderma*. In Press.
- Kahle H 1993 Response of roots of trees to heavy metals. *Environ. Exp. Bot*. 33, 99-119.

- Leon V, Pence N S, Letham D, Pineros M and Magalhaes J 2002 Mechanisms of metal resistance in plants: aluminium and heavy metals. *Plant and Soil*. 247, 109-119.
- Nisbet A F and Woodman R F 2000 Soil-to-plant transfer factor for radiocesium and radiostroncium in agricultural systems. *Health Phys*. 78(3), 279-288.
- Trapp S, Matthies M, Scheunert I and Topp E M 1990 Modeling the bioconcentration of organic chemicals in plants. *Environmental Science and Technology*. 24, 1246-1252.
- Tudoreanu L and Phillips C J C 2004 Modeling cadmium uptake and accumulation in plants. *Advances in Agronomy*. 84, 121-157.
- Uren, NC 1992 . Forms, reactions and availability of nickel in soils. *Adv, Agronomy.*, 48; 141-203.

**Poster #3**

**Caracterización del Transporte de Nutrientes y Sedimentos en Suelos Enmendados con Residuos Orgánicos ve Vaquería**

G. Ardila<sup>1</sup>, D. Sotomayor Ramírez<sup>1\*</sup>, G. Martínez<sup>1</sup> y L. Perez Alegria<sup>2</sup>

Universidad de Puerto Rico - Recinto de Mayagüez (UPRM), Colegio de Ciencias Agrícolas, Departamento de Agronomía y Suelos, Mayagüez, Puerto Rico;

<sup>2</sup>Departamento de Ingeniería Agrícola y Biosistemas, UPRM.

\* Autor de contacto: dsotomayor@uprm.edu

**RESUMEN.**

La escorrentía con concentraciones elevadas de nitrógeno (N) y de fósforo (P) proveniente de suelos agrícolas contribuye a la reducción en la calidad de las aguas superficiales. La disponibilidad ambiental y agronómica de P en suelos puede ser evaluada por medio de un análisis de suelos que sirve de predictor de las concentraciones de P en escorrentía. Se estudiaron las relaciones entre niveles de P extraíble en suelo, niveles de aplicación de estiércol bovino, y tiempo transcurrido entre la aplicación de la enmienda y la precipitación sobre las concentraciones de N, P y sedimentos en la escorrentía de un suelo de la serie Humatas arcilloso (*Typic Haplohumults*) bajo la producción de forraje (*Brachiaria Decumbens*). Suelos con niveles (Bray1) “bajos” (30 a 90 mg P kg<sup>-1</sup>) y “altos” (120 a 200 mg P kg<sup>-1</sup>) fueron enmendados con una aplicación baja (15.5 kg N ha<sup>-1</sup> y 5.6 kg P ha<sup>-1</sup>) y alta (31 kg N ha<sup>-1</sup> y 11.2 kg P ha<sup>-1</sup>) de estiércol bovino y se sometieron a simulaciones de lluvia con intensidad de 70 mm h<sup>-1</sup> para producir 30 minutos de escorrentía. Las concentraciones de P disuelto, P total, y N total en la escorrentía fueron mayores en los suelos con mayor contenido de P extraíble y con la aplicación alta de estiércol ( $P < 0.05$ ). No hubieron diferencias significativas en las concentraciones de nutrientes en suelos con “bajo” contenido de P extraíble con la aplicación baja de estiércol y el suelo sin enmienda. Es de importancia caracterizar el P extraíble que corresponde al grado de saturación de P umbral para predecir adecuadamente el punto cuando las concentraciones de P en escorrentía se incrementarán.

**PALABRAS CLAVE:** escorrentía, fósforo, enmienda orgánica.

**Poster #4**

**Tillage Effects on a Crop Rotation of Yam, Eggplant, Bean and Corn in Oxisol, Ultisol and Vertisol Soils in Puerto Rico**

*Wanda I. Lugo, Agenol González, Elvin Román, Nydia Rafols and Héctor Lugo. Agricultural Experiment Station, University of Puerto Rico-Mayagüez. wandalugo2001@yahoo.com*

**ABSTRACT.**

Three tillage methods, conventional till, minimum till and deep till versus no till and their respective interaction with three fertilizer levels (0, 1x and 2x the recommended amount) were evaluated in a crop rotation that included yam (*Dioscorea alata* L.), eggplant (*Solanum melongena* L.), bean (*Phaseolus vulgaris* L.) and corn (*Zea mays* L.). The experiment was established at three ecologically different locations with three different soil orders: Ultisol, Oxisol and Vertisol. Yam, the first crop in the rotation, was planted after soil preparation according to the treatments. The crops that followed in the rotation were planted no till in the same plots. A fifth treatment, in which all crops in the rotation were planted under conventional tillage, was used as a check. Yield response of the rotation crops varied with location. Yam yields in the no till plots were significantly lower than in the conventional till plots in the Ultisol and Vertisol soils, but not in the Oxisol soil. Response to fertilizer was observed only in the Oxisol. Yield response of eggplant with respect to the tillage treatments was similar to that observed for yams, thus suggesting that there was a residual effect of tillage. For the bean and corn crops, the third and fourth crops of the rotation, the residual effect of the tillage practices performed at the beginning of the rotation cycle was little if any.

**KEYWORDS:** Tillage, crop rotation, tropical soils

**INTRODUCTION**

Soil management techniques that result in efficient use and conservation of land resources have been adopted because they are less erosive, less costly and in many cases more profitable for crop production. In Puerto Rico the use of these cultural practices has been limited to crops such as fruit trees, coffee, plantains and bananas. In experiments conducted in Puerto Rico with root crops, legumes and vegetables, the response to conservation tillage varied considerably, depending on soil type and climate. Experiments conducted in a Mollisol suggested that watermelon, tomato and pigeon pea could be grown with minimum or even no tillage (Lugo-Mercado et al., 1987). Limited research has been conducted in Puerto Rico concerning tillage methods for yam production. Vicente-Chandler et al. (1966) obtained yam yields that were as high in undisturbed as in thoroughly tilled, highly weathered soils of the mountain region. Lugo et al. (1978), however, reported a 75% yield reduction in taniers (*Xanthosoma* spp.) grown in an undisturbed Oxisol.

Since under no tillage conditions soil nutrients may not be as readily available to the plant as when under conventional tillage, increased rates of fertilizer might

compensate for reductions in yield. However, if this assumption is proven correct, the high cost of fertilizer constitutes a limiting factor. The research herein reported was conducted to evaluate the effect of tillage treatments and fertilizer rates on a crop rotation of yam, eggplant, bean and corn.

## **MATERIALS AND METHODS**

A tillage-rotation experiment was established at the Isabela, Corozal and Lajas substations in Oxisol, Ultisol and Vertisol soils, respectively. Crops in the rotation were yam, eggplant, bean and corn. Tillage treatments were 1) no till (undisturbed); 2) conventional tillage (disc-plowed at a depth of 20 to 30 cm, and harrowed, raised beds); 3) deep tillage (plowed to a depth of over 30 cm); 4) minimum tillage (either chiseled to a depth of 20 cm or tilled to a depth of 10 cm with a cultivator). Tillage treatments were applied before planting the first crop of the rotation. For studying tillage residual effects, all other crops of the rotation were planted no till in the same plots. The order of the crops in the rotation was according to their tillage requirements (in decreasing order). A fifth treatment (continuous conventional), in which plots were conventionally tilled for all the crops in the rotation, was used as a check. For all the crops in the rotation the plots were split into three subplots, and fertilizer was applied at rates of 0, 1 and 2 times the recommended levels.

Tuber sections of yam were direct planted, spaced at 46 cm within the row and at 122 cm between rows. Plants were staked when vines were 0.45 m long. The fertilizer was applied in two equal amounts, two and five months after planting. Eggplant cv. Rosita plantlets were transplanted to the undisturbed soil. Half of the fertilizer was applied one week after transplanting, the other half at flowering. Beans (LW-227) were planted after the harvesting of the eggplant, and then harvested when completely dry (approximately 90 days after planting). Fertilizer was split into two applications. Corn, the last crop of the rotation, was planted in double rows. Part of the fertilizer was applied at planting, and the rest was applied as ammonium sulfate one month after planting. For all crops, irrigation was applied as necessary. All the other practices were as recommended. No tillage operations were performed after planting the yams, except in the control plots.

## **RESULTS AND DISCUSSION**

Differences in yam plant growth were observed from early in the season. Plants in the minimum and no till plots developed more slowly than the plants in the other plots. Differences in the amount of foliage were also observed among the fertilizer treatments. Yams were harvested about seven to eight months after planting. Table 1 shows yields from the three locations. Yields were very low at Lajas and Isabela because of anthracnose. Significant yield differences were observed among tillage treatments at Lajas and Corozal. At Isabela (Oxisol) there were no significant differences among the tillage treatments. At Corozal, in a heavier soil (Ultisol), the higher yam yields were obtained in the deep till and conventionally tilled plots, whereas at Lajas (Vertisol), the significantly lower yields were obtained in the no tilled plots. Increasing the fertilizer level over the recommended amount (1X) did not significantly increase yields at any of the locations.



Table 2 presents yield data from eggplant, the second crop of the rotation. At Isabela no differences in yield were observed among the previous tillage methods. There were, however, significant differences between the fertilizer levels, as if the high level of fertilizer offset the detrimental effect of the reduced tillage. A similar trend was observed at Lajas. At Corozal, the highest eggplant yields were observed in the continuous conventional treatment, where eggplant was planted after conventional tillage as compared to yields of the other treatments where no tillage operations were performed.

At Isabela and Corozal bean yields were significantly higher under the continuous conventional tillage (Table 3). The residual effect of the tillage treatments had been diminished to the point that no further benefit was obtained. However, at Lajas yields in the continuous conventional tillage treatment were significantly different from only those in the no till plots, thus suggesting that there was some residual effect. The effect of the fertilizer level varied among locations.

At Corozal corn yields in the continuous conventional tillage treatment were significantly higher than yields with any other treatment thus indicating that there was no residual effect (Table 4). A similar pattern was observed at Lajas. At Isabela there were no yield differences among treatments; however, yields were very low at this location in all treatments, possibly because of some other factor. The response of corn to the fertilizer levels was the same at all locations. The 2X and 1X levels produced significantly higher yields than the 0 level.

## REFERENCES

- Lugo, W.I., A. González, F. Román and E. Román, 2007. Tillage residual effect on a crop rotation of taro, cabbage and eggplant in Oxisol, Ultisol and Vertisol soils of Puerto Rico. *Proc. Caribbean Food Crops Society* 43: 204-208.
- Lugo-Mercado, H. M., J. Badillo-Feliciano and J. López-García, 1978. Effects of soil compaction on tanager yields. *J. Agric. Univ. P.R.* 62: 52-56.
- Lugo-Mercado, H. M., J. Badillo-Feliciano and F. H. Ortiz-Alvarado, 1987. Yield response of watermelon, tomato and pigeon pea to land preparation techniques in southern Puerto Rico. *J. Agric. Univ. P.R.* 71:203-208.
- Vicente-Chandler, J., R. Caro-Costas and E. Boneta, 1966. High crop yields produced with or without tillage on three typical soils of the humid mountain region of Puerto Rico. *J. Agric. Univ. P.R.* 50: 146-50.

Table 1. Yam yields under variable tillage and fertilization regimes.

Tillage Treatment	Fertilizer Level			Mean <sup>1</sup>
	0	1	2	
	kg/ha			
	Corozal			
Conventional	39630	53440	42600	9270c
Deep-till	46440	37640	40690	45230a
Minimum	22770	27230	25740	41590ab
No-till	3870	10720	13220	25250bc
Continuous				
Conventional	43500	45380	56100	48330a
Mean	31240	34880	35670	
	Isabela			
Conventional	12800	17530	18350	6780b
Deep-till	11910	16600	17840	16230ab
Minimum	11790	16450	12680	15450ab
No-till	3760	9630	6960	13640ab
Continuous				
Conventional	15180	20940	18350	18160a
Mean	11090b	16230a	14830a	
	Lajas			
Conventional	18760	19460	22340	8140c
Deep-till	17080	14180	23100	20190a
Minimum	9780	9730	12240	18120ab
No-till	5960	9310	9140	10580bc
Continuous				
Conventional	15120	16990	11880	14660abc
Mean	13340	13940	15740	

<sup>1</sup> Means followed by different letters are significantly different  $P \leq 0.05$ .

Table 2. Eggplant yields under variable tillage and fertilization regimes.

Tillage Treatment	Fertilizer Level			Mean <sup>1</sup>
	0	1	2	
	kg/ha			
	Corozal			
Conventional	14190	21060	25680	7100c
Deep-till	8760	13020	19630	20310b
Minimum	4920	10750	14370	13800bc
No-till	2850	9740	8720	10010c
Continuous Conventional	20280	32590	41820	31560a
Mean	10200c	17430b	22050a	
	Isabela			
Conventional	6490	36070	50400	27160
Deep-till	7190	38430	42880	30990
Minimum	5050	39170	46410	29500
No-till	3920	34360	43200	30210
Continuous Conventional	13460	47490	55780	38910
Mean	7220c	39100b	47730a	
	Lajas			
Conventional	4190	11430	13000	9630
Deep-till	4400	10270	13400	9540
Minimum	3190	9190	13210	9360
No-till	3550	11970	13370	8530
Continuous Conventional	6090	11720	11800	9870
Mean	4280c	10920b	12960a	

<sup>1</sup> Means followed by different letters are significantly different  $P \leq 0.05$ .

Table 3. Bean yields under variable tillage and fertilization regimes.

Tillage Treatment	Fertilizer Level			Mean <sup>1</sup>
	0	1	2	
	kg/ha			
	Corozal			
Conventional	460	610	880	490b
Deep-till	310	580	760	650b
Minimum	390	440	660	550b
No-till	320	560	580	490b
Continuous Conventional	890	1300	1310	1170a
Mean	470c	700b	840a	
	Isabela			
Conventional	310	400	360	450b
Deep-till	290	560	610	360b
Minimum	320	640	390	490b
No-till	330	480	530	450b
Continuous Conventional	470	890	870	740a
Mean	350b	590a	550a	
	Lajas			
Conventional	1000	1210	1430	1100b
Deep-till	1010	1160	1470	1210ab
Minimum	1310	1000	1340	1210ab
No-till	960	1130	1200	1220ab
Continuous Conventional	1460	1310	1500	1420a
Mean	1150b	1160b	1390a	

<sup>1</sup> Means followed by different letters are significantly different  $P \leq 0.05$ .

Table 4. Corn yields under variable tillage and fertilization regimes.

Tillage Treatment	Fertilizer Level			Mean <sup>1</sup>
	0	1	2	
	kg/ha			
	Corozal			
Conventional	1860	2740	2880	2520b
Deep-till	2400	3480	3420	2490b
Minimum	2240	2940	3000	3100b
No-till	1780	3300	2480	2730b
Continuous Conventional	3900	4340	3120	4540a
Mean	2440b	3360a	3430a	
	Isabela			
Conventional	2860	4180	4510	4310
Deep-till	3030	5210	6360	3850
Minimum	3240	3940	4910	4870
No-till	3000	4460	5470	4030
Continuous Conventional	2960	5610	4200	4260
Mean	3020b	4680a	5090a	
	Lajas			
Conventional	6115	12430	10910	5740c
Deep-till	5240	6590	10190	9820a
Minimum	8690	10000	8860	7340bc
No-till	4360	5520	7340	9180a
Continuous Conventional	7210	9630	9440	8760ab
Mean	6320b	8830a	9370a	

<sup>1</sup> Means followed by different letters are significantly different  $P \leq 0.05$ .

**Poster #88**

(Appears out of sequence after Poster #4)

**Relationship between Vegetative Covers and Soil Physical Properties of one Mollisol on *Phytophthora cinnamomi* Occurrence in Avocado *Persea americana* Mill. in Puerto Rico.**

Beatriz E. Torres Ordóñez<sup>1</sup>, C. Estévez de Jensen<sup>2</sup>, V. Snyder<sup>1</sup> y M. Vazquez<sup>1</sup>.  
<sup>1</sup>Department of Agronomy and Soils, <sup>2</sup>Department of Crop Protection.  
College of Agricultural Sciences, University of Puerto Rico-Mayagüez Campus. P.O.Box 9032 Mayagüez, P.R. 00680. bettorres25@yahoo.com

**ABSTRACT.**

Puerto Rico imports 80 percent of the avocado that is consumed, which indicates economic potential of increasing its local production. However, the production of this crop have been affected with the high incidence and severity of the root rot associated with *Phytophthora cinnamomi*. This condition is exacerbated soil saturation conditions during the rainy season (July – December), high air temperatures and soil cracks during the dry season causing mechanical damage to the rooting system. During May 2006 an avocado plantation was established with the Semil 34/Semil 34 variety (pattern/graft) in order to evaluate the *Arachis pintoii* and *Arachis glabrata* influence in San Antón soil series, a fine-loamy Cumulic Haplustoll. The vegetative covers were established at the avocado trees surroundings during June 2006. The vegetative covers were compared with a control (no coverage legume) in a completely randomized design with four repetitions for treatment. The analyzed soil physical properties were: aggregates stability percentage, which after 21 months of coverage provided significant differences ( $p < 0.05$ ) between the *Arachis glabrata* (46.24%) versus the control (22.36%); also provided significant differences in field infiltration and bulk density. The moisture retention curves highlighted a better performance in *A. glabrata* versus the control after 12 months. The analyzed soil chemical properties were: total nitrogen percentage and available phosphorous (ppm) which provided significant differences; no significant differences were found in organic matter and pH. This investigation will continue to evaluate the soil properties until the end of a two year period.

**KEYWORDS:** *Arachis pintoii*, *Arachis glabrata*, avocado, soil physical properties.

## FRUITS, VEGETABLES, AND SPECIALTY CROPS

2008 Proceedings of the Caribbean Food Crops Society. 44(2):388. 2008

### Poster #5

#### Respuesta de Líneas de Habichuela (*Phaseolus vulgaris* L.) a Diferentes Niveles de Fertilidad en un Oxisol

R. Dorcinvil<sup>1</sup>, D. Sotomayor Ramírez<sup>1\*</sup>, and J. Beaver<sup>1</sup>, Universidad de Puerto Rico - Recinto de Mayagüez, Colegio de Ciencias Agrícolas, Departamento de Agronomía y Suelos, Mayagüez, Puerto Rico

\* Autor de contacto: dsotomayor@uprm.edu

#### RESUMEN.

La baja disponibilidad de fósforo (P) y de nitrógeno (N), seguido por factores de acidez del suelo como exceso de aluminio (Al) y de manganeso (Mn) constituyen las limitaciones más importantes para la producción de habichuela (*Phaseolus vulgaris* L.) en el trópico. El desarrollo de genotipos adaptados a estas condiciones es una estrategia económica y ecológicamente viable para enfrentar el problema. Se realizaron dos experimentos para identificar líneas de habichuela adaptadas a condiciones de baja fertilidad en un Oxisol de Puerto Rico. En el primer experimento, 6 líneas hermanas de habichuela (3 con sistema radicular superficial y 3 con sistema radicular profundo) y 9 combinaciones de mezclas de semillas fueron sembradas bajo dos niveles de fertilidad (sin fertilizante y aplicación de 50 kg/ha de N, P<sub>2</sub>O<sub>5</sub>, K<sub>2</sub>O respectivamente). En el segundo experimento, 38 líneas mayoritariamente de grano rojo y negro provenientes de una selección previa de 228 líneas del programa de mejoramiento de la Escuela Agrícola Panamericana de Honduras denominado Vivero de Adaptación Centroamericano (VIDAC) fueron evaluadas bajo 3 regímenes de fertilización: (i) 50 kg N/ha, 57 kg P<sub>2</sub>O<sub>5</sub>/ha (+N+P); (ii) 0 kg N/ha, 57 kg P<sub>2</sub>O<sub>5</sub>/ha (-N+P); y (iii) 50 kg N/ha, 0 kg P<sub>2</sub>O<sub>5</sub>/ha (+N-P); todas las parcelas recibieron 54 kg K<sub>2</sub>O/ha. Las líneas con sistema radicular superficial y mixto obtuvieron mayores rendimientos y mayores concentraciones de N y de P que las líneas con sistema radicular profundo en las parcelas de baja fertilidad. Las líneas con un sistema radicular superficial y extenso como VAX 3 y las líneas RBF tuvieron rendimientos similares independiente del régimen de fertilidad. Los rendimientos en las líneas con un sistema radicular profundo como SER 16 y las XRAV tuvieron rendimientos en el orden de +N+P > +N-P > -N+P. La arquitectura de la raíz es una adaptación genotípica de la habichuela para la adquisición de N y de P.

**PALABRAS CLAVE:** Fertilidad de suelos, Habichuelas, Adaptación genotípica

**Poster #6**

**Response of Taro var. Lila or Bun Long to Levels of Supplemental Irrigation**

Luis E. Rivera<sup>1</sup>, Carlos E. Ortiz<sup>1</sup> and John J. Cho<sup>2</sup>, <sup>1</sup>Department of Agronomy & Soils, University of Puerto Rico, Mayaguez Campus; <sup>2</sup>Department of Plant Pathology, University of Hawaii. cortiz@uprm.edu

**ABSTRACT.**

Production of taro (*Colocasia esculenta*) throughout the Caribbean Basin has been drastically reduced as a consequence of the taro leaf blight. Traditional variety Lila (known as Bun Long in Hawaii) is very susceptible to the blight. In the short term there is interest in the production of Lila under drip irrigation, a system under which blight incidence tends to be lower. The objective was to provide practical information in regard to growth, yield, corm quality and the minimum irrigation requirement for taro Lila grown under upland conditions and under the presence of the blight. Three irrigation treatments were evaluated: rainfed and supplemental irrigation based upon Class A pan factors of 1.0 and 1.3. Providing Lila with supplemental irrigation of at least 1.0 ET resulted in increased growth. Irrigation was non significant for stand. There were no differences for corm fresh weight, nor in plant dry weight or harvest index between plants subjected to 1.0 and 1.3 Class A pan factors. This study suggests that to obtain a Lila crop under upland conditions and under the presence of the leaf blight water to be applied by irrigation should replace at least that lost through evapotranspiration.

**KEYWORDS.** *Colocasia esculenta*, upland taro, irrigation

**INTRODUCTION**

Production of taro (*Colocasia esculenta*) throughout the Caribbean Basin has been drastically reduced as a consequence of the taro leaf blight (*Phytophthora colocasiae*) (Mendez et al., 2005; Ortiz et al., 2007). Before the blight, over 95% of taro production in Puerto Rico was under wetland conditions. Traditional variety Lila –highly regarded for its table quality- is very susceptible to the blight (Rosa-Márquez et al., 2006). Lila is identical to the Hawaiian variety Bun Long (Schnell et al., 1999). Blight-tolerant varieties from Hawaii, currently under evaluation in Puerto Rico, appear not to have the culinary characteristics preferred by consumers in the Caribbean.

Work done before the blight shows Lila is adapted to cultivation under upland conditions (Goenaga, 1995). Thus, in the short term there is interest in the production of Lila under drip irrigation, a system under which blight incidence tends to be lower. The objective was to provide practical information to farmers in regard to growth, yield, corm quality and the minimum irrigation requirement for taro Lila grown under upland conditions and under the presence of the leaf blight.

**MATERIALS AND METHODS**



The experiment was conducted from May 2007 to January 2008 at Gurabo, Puerto Rico. Plots consisted of a 9.2-m-long x 0.61-m-wide bed. Suckers were planted 0.46 m apart in a double row within the bed. There were 40 plants per plot. A drip irrigation line was placed on the surface along the center of each bed. Three irrigation treatments were arranged in a randomized complete block design with eight replications. Treatments were rainfed and supplemental irrigation based upon Class A pan factors of 1.0 and 1.3. The plants were subjected to treatments from 67 to 237 days after planting. Treatments were applied Monday, Wednesday and Friday. Except for irrigation, management practices followed standard procedures. Samples were taken 123 and 231 days after planting. Harvest was performed at 243 days after planting. Corm fresh weight was recorded at harvest. Harvest index was calculated from plants sampled at harvest.

## RESULTS AND DISCUSSION

*Early and mid season:* Mild infection of the taro leaf blight was present throughout the crop cycle. Rainfall received by the plants totaled 1493 mm. Goenaga (1995) reported maximum leaf area index for Lila at 117 days after planting. With this information, we chose to sample 123 days after planting. At 123 days, irrigation was significant for leaf area, plant dry weight and plant height (a visual indicator of growth) (Table 1). As expected for a variety adapted to wetland conditions, providing Lila with supplemental irrigation of at least 1.0 evapotranspiration (ET) resulted in increased growth (Table 1). Up to 123 days into the cropping cycle, irrigating with 1.0 ET or 1.3 ET made no difference in growth (Table 1).

*Late in the season:* Irrigation was non significant for stand (average 78%) thus indicating that no effect was observed in the number of plants completing the crop cycle. As for 123 days, at 231 days into the cropping cycle, irrigation was significant for plant dry weight. Rainfed plants had significantly less dry weight than those irrigated (Table 2). Under leaf blight pressure, irrigation increased Lila's corm fresh weight (Table 2). Corm fresh weight is an indicator of yield. However, there were no differences for corm fresh weight, nor in plant dry weight or harvest index between plants subjected to 1.0 and 1.3 ET treatments (Table 2). Average fresh corm weight of 479 and 542 g obtained with 1.0 and 1.3 ET treatments, respectively (Table 2), tend to be lower than those preferred by consumers of Lila (900-1,000 g). This study does not provide evidence that irrigation based upon 1.3 ET resulted in better performance than irrigation based upon 1.0 ET (Table 2). A pan factor of 1.0 means that the water applied to the plants replaces that lost through calculated evapotranspiration; this amount is considered the theoretical optimum (Goenaga et al., 2004).

Having a limited access to drip irrigation infrastructure and water, tuber farmers in the Caribbean have to make decisions on whether to produce taro or another aroid crop such as cocoyam (*Xanthosoma* spp.). This study suggests that to obtain a Lila crop under upland conditions and under the presence of the leaf blight, water to be applied by irrigation should replace at least that lost through evapotranspiration. Taro production under upland conditions is commercially efficient when corms are adequate for the market. Corm quality characteristics are of paramount importance because in the Caribbean taro is primarily grown for table use. We made an informal assessment of quality with corms harvested from this study, an assessment which includes taste, texture and acidity. Corms evaluated tend to be similar in eating attributes to those grown under

wetland conditions. However, fine tuning for field management is needed for increased corm size.

#### REFERENCES

- Goenaga, R., E. Rivera and C. Almodovar. 2004. Yield of papaya irrigated with fractions of Class A pan evaporation in a semiarid environment. *J. Agric. Univ. P.R.* 88:1-10.
- Goenaga, R. 1995. Accumulation and partitioning of dry matter in taro [*Colocasia esculenta* (L.) Schott]. *Ann. Bot.* 76:337-341.
- Mendez, R.M., R. Angeles, M. Reyes y R. Hernandez. 2005. Tizon foliar: enfermedad de la yautia coco (*Colocasia esculenta* L. Schott) causado por (*Phytophthora colocasiae*) en la Republica Dominicana. *Proc. Caribbean Food Crop Soc.* 41 (2):515-519.
- Ortiz C.E., J.J. Cho, E. Rosa-Márquez y L.E. Rivera. 2007. El tizon foliar de *Colocasia esculenta* en Puerto Rico. *Proc. Caribbean Food Crop Soc* 43: 134-138.
- Rosa-Márquez, E., W.I. Almodovar, C.E. Ortiz and M. Díaz. 2006. Taro leaf blight (*Phytophthora colocasiae*): A new disease in Puerto Rico. *J. Agric. Univ. P.R.* 90:137-138.
- Schnell R.J., R. Goenaga and C.T. Olano. 1999. Genetic similarities among cocoyam cultivars based on randomly amplified polymorphic DNA (RAPD) analysis. *Scientia horticultrae.* 80 (3-4): 267-276.

**Table 1.** Leaf area, dry weight and height of taro plants at 123 days after planting as affected by irrigation.

Irrigation	123 Days After Planting		
	Leaf Area - sq.cm/plant -	Plant Dry Weight - g/plant -	Plant Height - cm -
Rainfed	1751 b <sup>1</sup>	70 b	22 b
Rain+1.0 ET <sup>2</sup>	4729 a	152 a	39 a
Rain+1.3 ET	3870 a	137 a	42 a

<sup>1</sup> Means within columns separated by LSD ( $P \leq 0.05$ ).

<sup>2</sup> ET stands for evapotranspiration.

**Table 2.** Plant dry weight and harvest index and corm fresh weight of taro plants affected by irrigation.

Irrigation	Plant	At harvest		Theoretical Yield for 23,900 plants/ha - t/ha -
	Dry Weight at 231 days - g/plant -	Harvest Index	Corm Fresh Weight - g/corm -	
Rainfed	94 b <sup>1</sup>	0.39 b	215 b	5.1
Rain+1.0 ET <sup>2</sup>	305 a	0.44 ab	479 a	11.4
Rain+1.3 ET	288 a	0.53 a	542 a	12.9

<sup>1</sup> Means within columns separated by LSD ( $P \leq 0.05$ ).

<sup>2</sup> ET stands for evapotranspiration.

**ACKNOWLEDGMENT.** This study was supported by the USDA-CSREES Special Grant Tropical & Subtropical Agricultural Research (T-STAR); Project Award: 2006-34135-17654.

**Poster #7**

**Production of Table Cucumber (*Cucumis sativa*) on Two Trellis Systems in North Florida**

*C. S. Gardner, G.L. Queeley, K. T. Grant, B. G. Brown and T. Hylton*

*Cooperative Extension Program Florida Agricultural and Mechanical University (FAMU) College Of Engineering Sciences Technology and Agriculture 202 Perry – Paige Building South, Tallahassee, FL 32307. E-mail: [cassel.gardner@famu.edu](mailto:cassel.gardner@famu.edu). Fax: (850) 561-2151*

**ABSTRACT.**

The use of trellises to support vine crops such as tomato, squash and cucumber may result in increased fruit quality compared to the conventional practice of allowing the vines to run freely on the ground. Other stated advantages of the trellis system include better canopy light interception, better control of pest and ease of harvesting. However, there is still much debate over whether the use of trellises results in increased yield. The objective of this study was to determine the performance of trellis grown cucumber vs. conventional practice. A two year study was done at the FAMU research and extension center, Quincy Florida. The experimental design was a randomized complete block with three treatments: A-frame trellis, wire trellis and conventional practice as a control. Parameters measured included fruit size (length and circumference), fruit quality and total yield. Treatment effects were evaluated by Analysis of Variance and Fisher's exact test. Despite numerically higher numbers of spoiled fruits from the conventional practice, the results showed no significant treatment effect. The study concluded that the use of trellises provided no advantage over the conventional system with respect to the parameters measured.

**KEYWORDS:** *Cucumis sativa*, trellis, light interception, conventional practice, quality measures.

**INTRODUCTION**

It is widely believed that growing cucumbers on trellises will lead to superior performance as opposed to growing these crops using conventional methods where the plants are allowed to run freely over the ground. Proponents of the trellis system have claimed certain advantages over conventional methods, including less fruit spoilage and better canopy interception resulting in higher total fruit production. However, opponents of the trellis system have argued that trellises expose more fruit to predators such as birds and insects and the amount of light intercepted by the crop is not sufficient to offset any losses realized from conventional methods.

**MATERIAL AND METHODS**

The experiment was laid out as a Randomized Complete block Design (RCBD) with three treatments. Treatment one involved an A-frame wooden trellis using wooden strips spaced approximately 12 inches apart for vine support. Treatment two was a wire trellis with parallel lines spread approximately 12 inches apart for vine support. In treatment three (the control) the plants were allowed to run at will over bare ground covered with plastic mulch; a practice traditionally used by cucumber growers. All plots were drip irrigated periodically on an 'as needed basis'. Data were collected weekly on fruit yield, fruit circumference, fruit length and the number of spoiled fruits. A total of six harvests were conducted, three in each year of the study. All mature fruits were harvested from within a 400 square feet (4306 sq meter) area. After taking the total weight of the harvested fruits from each treatment, thirty fruits were selected at random, examined for blemishes and deformities then their circumference were taken. Quantitative data were analyzed by analysis of variance to determine significant treatment (trellis) effects. Quality measures which included counts of deformed, discolored and rotted fruits were subjected to Fisher's exact test. The 0.05 level of significance was used for all of the statistical analyses.

## **RESULT AND DISCUSSION**

The highest numerical yield, 5332 lb/acre (5972 kg/ha) was obtained from the control treatment. This was followed by the A-Frame, 5059 lb/acre (5666 kg/ha) and the wire trellis, 4351 lb/acre (4873 (kg/ha). Fruits from all three treatments were similar in size (circumference and length). The overall results indicated no treatment effects on yield parameters (Figures 1, 2 and 3). With respect to fruit quality, the control resulted in a slightly higher percentage of spoiled fruits. This was anticipated since the fruits in this treatment experienced some ground contact as well as exposure to moist damp conditions and other related factors could potentially cause fruit spoilage. However, since harvesting was done on a weekly basis, this period of exposure was not sufficient to result in any significant fruit spoilage (Fig.4).

## **CONCLUSION**

With the exception of a slightly lower percentage of spoiled fruits, the use of trellises did not provide any significant benefits over the conventional method of growing cucumbers. In fact, despite being statistically insignificant, the yield parameters (fruit weight and size) were numerically higher under the conventional system. Although production costs were not assessed during this study, it is evident that the conventional method may be more suited for commercial production due to its low requirements for equipment and labor. However, trellises may be better suited for small scale production and elderly home gardeners since they facilitate easy harvesting of mature fruits.

## **REFERENCES**

- Hochmuth, C. 2001. Greenhouse Cucumber production: Florida Greenhouse Vegetable production Handbook, Vol. III. University of Florida IFAS Extension.
- Hochmuth, J. and C. Hochmuth. 2003. Key to Successful Tomato and Cucumber Production in Perlite Media. University of Florida IFAS Extension.
- Nischit, V.,S. Wehner and C. Wehner. 2002. Screening the Cucumber Germplasm Collection for Fruit Yield and Quality. *Crop Sci. Soc. of Am.*42:2174-2183.

Swiader, J.M., G.W. Ware and J.P. MacCollum.1996. Commercial Cucumber  
Production: Producing Vegetable Crops. Interstate Publishers Inc., Danville,  
Illinois.

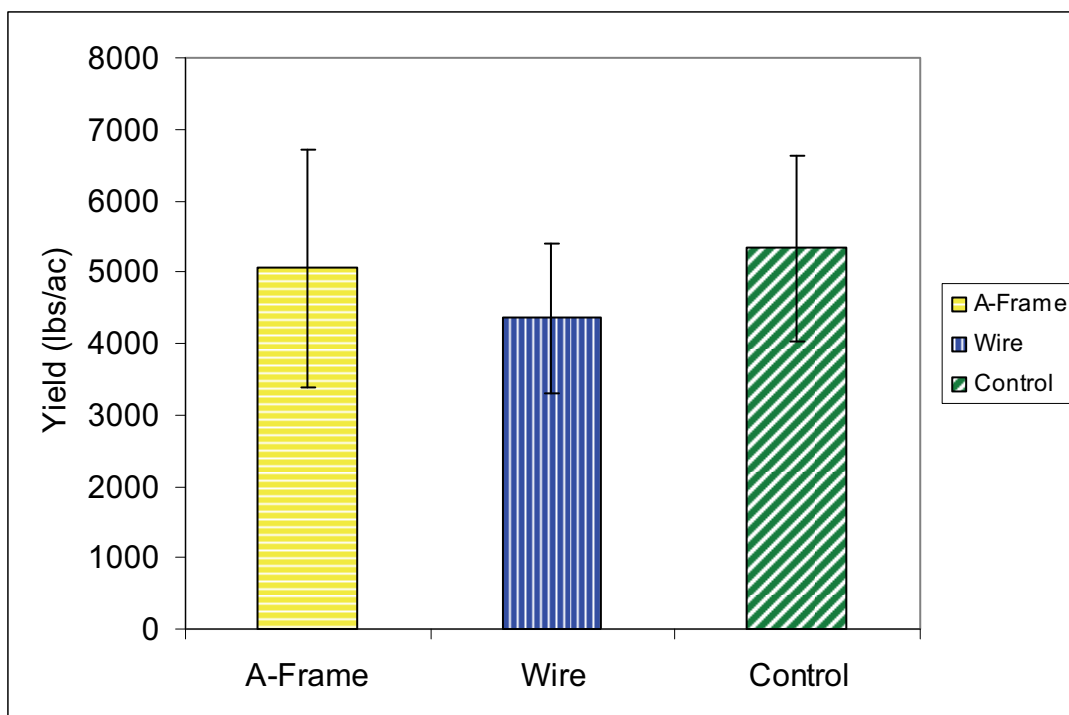

Figure. 1. Fresh fruit yield. (Data represent an average of two years)

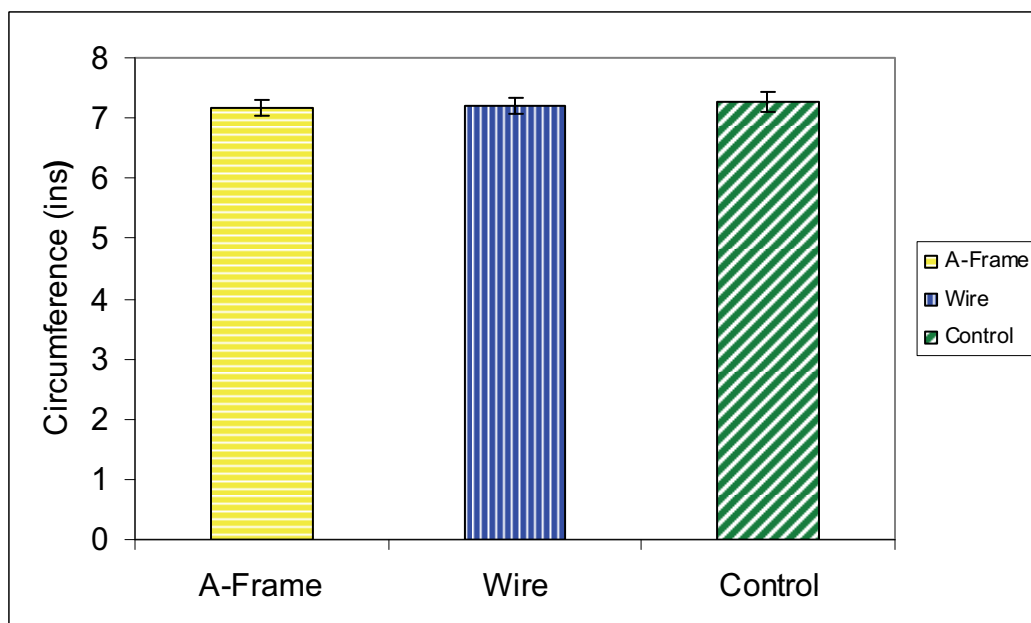

Figure. 2. Mean circumference of cucumber fruits (Data are an average of two years)

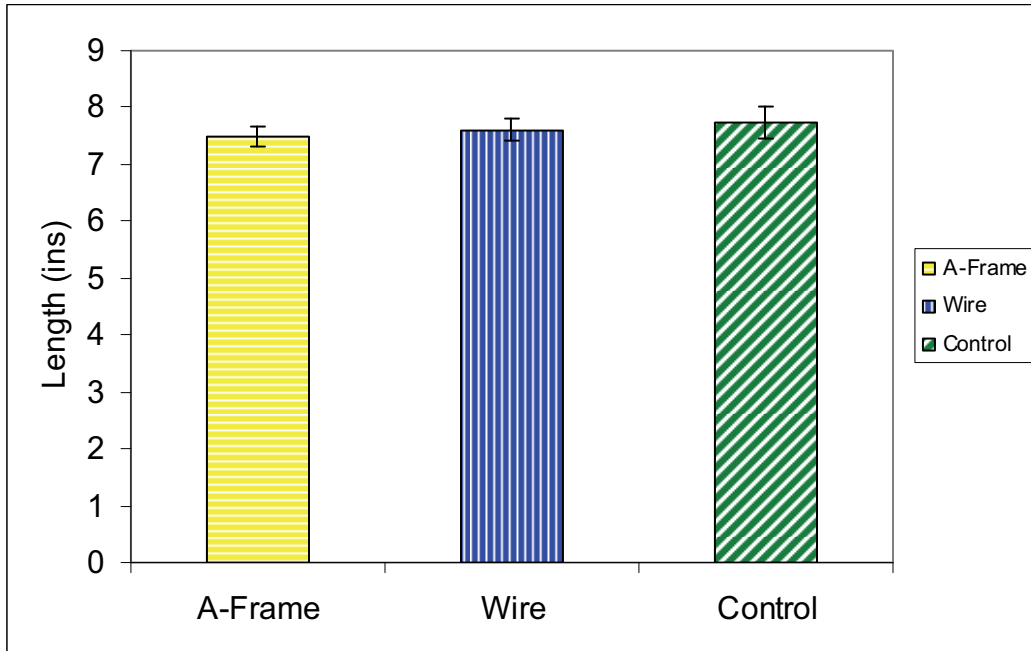

Figure. 3. Mean fruit length of table cucumbers. (Data are an average of two years)

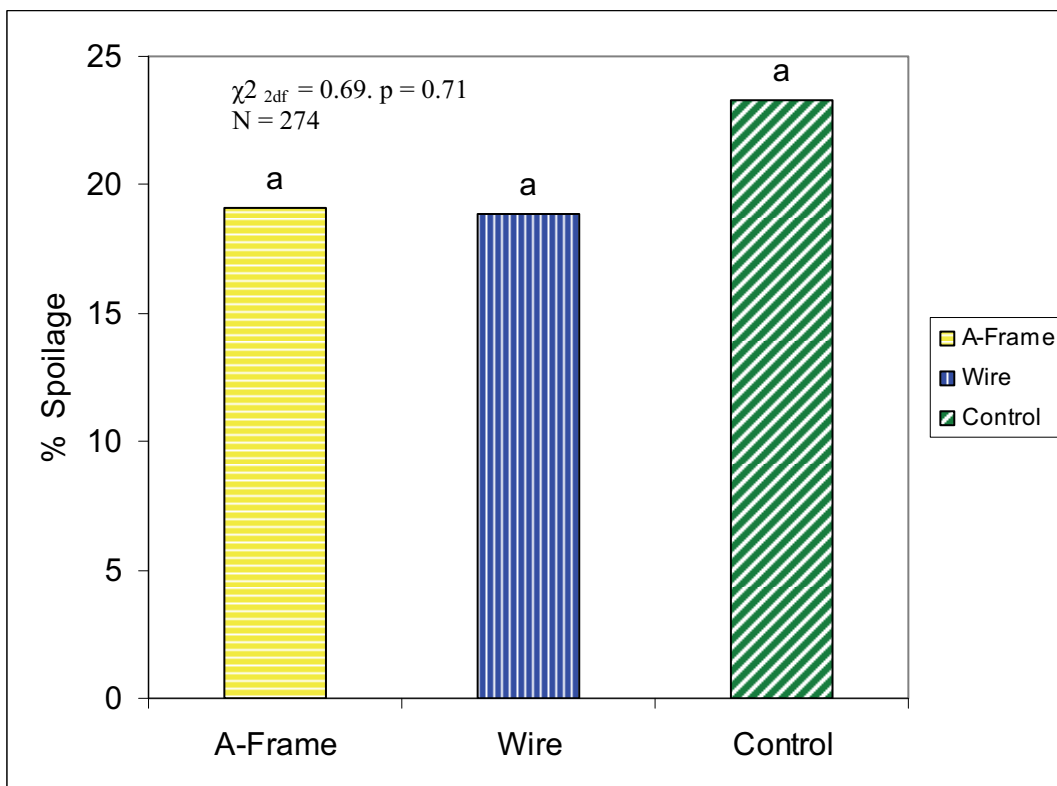

Figure. 4. Percentage of spoiled cucumber fruits (Data are an average of two harvests)



**Poster #8**

**Effects of Bulbils Weight Used as Seed on Tuber Yield of Greater Yam Belep (*dioscorea alata l.*)**

*David Hammouya, Marceau Farant, J. Lator, and J. L. Irep. INRA, Unité expérimentale de Duclos Godet, Cluny, 97131, Petit-Canal, Guadeloupe.  
david.hammouya@antilles.inra.fr*

**ABSTRACT.**

Traditionally, yams are grown from tuber cuttings, termed setts. Aerial tubers named bulbils could constitute, for some species, an alternative way to produce yam seeds in order to benefit safe seed and more earnings of harvested tubers.

Work reported in this paper comes from experimentation conducted during two years on effects of bulbil weight on tuber yield. An experiment was carried out on vertisols at Godet experimental station in Guadeloupe. Four bulbil classes of weight were combined and some of the results obtained are presented in this paper.

Bulbil weight strongly affected the yield, whereas the effect on tuber number was not significant for the commercial tuber yield and the number of non commercial tubers. Commercial tuber yield tended to increase asymptotically with increasing bulbil weight.

**KEYWORDS:** yam, bulbils, seed, setts

**Poster #9**

**Performance of a Quality Protein Maize Variety Grown in a Vertisol**

*Elvin Román-Paoli<sup>1</sup>, and James Beaver<sup>2</sup>, <sup>1</sup>Professor, Department of Agronomy y Soils, College of Agricultural Science, University of Puerto Rico. HC-O2 BZ 11656, Lajas, PR 00667-9714. Tel.(787) 899-1530, Fax (787) 899-1265, eroman@uprm.edu. <sup>2</sup>Professor, Department of Agronomy y Soils, College of Agricultural Science, University of Puerto Rico. Mayagüez, PR*

**ABSTRACT.**

Almost all of the maize consumed in Puerto Rico (PR) is imported. The artificial scarcity of maize due to its destination for ethanol production has contributed to a worldwide price increase. Quality protein maize (QPM) are hard-endosperm maize developed by the "Centro Internacional de Mejoramiento de Maíz y Trigo" (CIMMYT). QPM has the recessive *opaque-2* gene that contains higher lysine and tryptophan content than common maize. The objective of this research is to develop appropriate management practices for the production of QPM in PR. Field trials were conducted at the Lajas Substations to evaluate the performance of a QPM variety. During 2007, a QPM variety was submitted to three nitrogen fertilization rates (120, 160, 200 kg/ha) split in two applications. Plants were also fertilized with 50 and 100 kg/ha of P<sub>2</sub>O<sub>5</sub> and K<sub>2</sub>O, respectively. Final plant density was 36,580 plants/ha. No significant differences were found among N rates with an average yield of 2,770 kg/ha. A split-plot arrangement of a Randomized Complete Block Design was used in an experiment established during 2008 where levels of microirrigation treatments were the whole-plots and plant density the sub-plots. Whole plot treatments consisted of 100, 75 and 50% ET<sub>0</sub> applied through drip irrigation. The sub-plot treatment consisted of 50,000, 62,000 and 71,400 plants/ha. The results obtained in this research will be shared with swine producers and farmers who may be interested in producing QPM to partially substitute maize imports in PR.

**KEYWORDS:** Maize, yield, Quality Protein Maize

**Poster #10**

**Effects of Plastic Mulch on Development and Nodulation of Cowpeas**

*Steven H. Wysinger, E. G. Rhoden, V. Khan, C. Stevens, and J. R. Bartlett. George Washington Carver Agricultural Experiment Station, Tuskegee University, Tuskegee, AL 36088. rhoden@tuskegee.edu*

**ABSTRACT.**

Cowpeas or Southern peas (*Vigna unguiculata L. Walp*) are a warm season crop and its growth and development are impacted by various soil and environmental conditions. Cowpea is an important crop in the southeastern United States for both animal and human consumption. It contains approximately 24.8% protein, 63.6% carbohydrate and many trace minerals. When cowpeas are intercropped it provides nitrogen to its companion crops thereby reducing the need for mineral nitrogen. Due to advances in plasticulture many warm season crops are able to be planted earlier without significant yield losses. Despite these advances very little is known about the effects of plastic mulch in cowpea production. This study was conducted to compare the effects of white and black plastic mulches as opposed to bare soil in terms of cowpea development and nodulation. The experiment was conducted as a complete randomized design consisted of three treatments (white and black plastic with bare soil as the control) planted on a 150' rows. Plant height was monitored throughout the study while nodule number and weights were taken at the 10% bloom stage. Cowpeas yield comprised of three harvests (once per week for 3 weeks) There were no significant difference in the yield between white (WP) and black plastic (BP) but these were significantly higher than bare soil (BS). In terms of nodulation, WP treatment had the highest nodule weight followed by BS; on the other hand, BP had numerous small nodules. Further evaluations are being conducted to quantify the differences in soil temperature, solar reflectance and microbial activities in the soil that might explain some of the differences observed in the various treatments.

**KEYWORDS:** plastic mulch, cowpea, nodulation, legume development

**Poster #11**

**The Effect of Lime Application on Emergence and Growth of Castor Oil Plants**

Ronald J. Smith, Errol G. Rhoden, Janette R. Bartlett, Victor A. Khan, Crystal Drakes and Prosanto K. Biswas. George Washington Carver Agricultural Experiment Station, Tuskegee University, Tuskegee, AL. Corresponding author: 308 Milbank Hall, Tuskegee Univ., Tuskegee, AL, 36088; (334) 727-8435; rhoden@tuskegee.edu

**ABSTRACT.**

Castor oil (*Ricinus communis*) has been cultivated for centuries and its production is currently being scrutinized because of the ricin content of the plant and its possible use in terrorist activities. The objective of this study was to measure the effects of lime application on the emergence, growth and development of castor accessions under greenhouse conditions. Lime was applied to a Norfolk Sandy loam soil and incubated for three months. Castor oil seeds were planted into a soil with a pH of either 5.3 or 5.9. The five accessions used in the study were obtained from: Tanzania (TZ1, TZ2), Guyana (GY-PAR), and Jamaica (JA2, JA4). The study was conducted in the greenhouse facilities at the G. W. Carver Agricultural Experiment Station at Tuskegee University. Data were collected on plant emergence, height, and vigor, as well as dry matter yield. Four weeks after emergence, TZ2 and GY-PAR had the highest percent germination (96%), while JA2 exhibited the lowest (80%) when limed. One week later, the highest percent germination remained the same, and JA2 had the lowest percent germination (88%). When soil was left unlimed (pH 5.3) TZ1 had the highest percent germination (88%), while only 76 % of JA4 seeds had germinated. One week later, TZ1 remained the same, and all other accessions exhibited 80% germination. At 4 weeks only JA2 plants showed increased foliage production when limed. However, 8 weeks after emergence, JA2 and JA4 produced more foliage when limed. After 8 weeks, the results also indicated that plants that were limed had higher dry weights (66.1 g/pot) than unlimed plants (63.3 g/pot). At 12 weeks only JA2 had increased foliage production under limed conditions. It is possible that both the Tanzania and the Guyana accessions produced more dry matter at 4 and 8 weeks, when no lime was applied, because the soil types in both locations were predominantly acid. On the other hand, the Jamaican accessions give higher dry weights under limed conditions because they were taken from soils that were calcareous. Further studies are needed to identify accessions that are suitable for the southern US.

**KEYWORDS:** castor, germination, accession

**INTRODUCTION**

The castor bean (*Ricinus communis* L.) is an herbaceous perennial that has been cultivated for centuries to obtain the oil produced by its seeds (Weiss, 1971). According to Moshkin (1986b), ancient interest in castor was not only for the medicinal use of its parts (seeds, roots, and leaves), but also for its oil that was used in making perfumes and

fuel. Furthermore, the author pointed out that the Ancient Egyptians burned castor oil in lamps more than 4000 years ago, and seeds have been found in their tombs.

Castor is commonly referred to as a “bean,” however it is not a legume. It is a native of tropical Africa and the plant is considered a member of the spurge family (Brigham, 1993). Castor is grown widely throughout many regions of the world and the principal producing countries are India, Brazil and China. Other areas of cultivation include Latin America, the West Indies, Africa, Asia, and the United States. In the tropics, the castor plant is a perennial, but it is cultivated as an annual in temperate regions, requiring a frost-free period of 140 to 180 days (Shroyer and Erickson, 1987; Glaser et al., 1992). Generally, germination of the seed is slow, which usually occurs within 21 days after planting (Labalette et al., 1996). Based on the oil requirements, production characteristics of commercial varieties vary and they grow to a height of 3 to 10 feet.

*Castor plant seeds contain varying levels of oil. Moshkin (1986a) noted that castor plant seeds contained between 50-55% oil. Labalette et al. (1996) also documented seeds containing up to 55% of natural oil rich in ricinoleic acid. Among all the vegetable oils, castor oil is distinctive because of its high level of ricinoleic acid (over 85%), a fatty acid consisting of 18 carbons, a double bond between the ninth and tenth position, and a hydroxyl group attached to C12. As a result, castor oil has one of the highest and most stable viscosity indexes among vegetable oils combined with high lubricity, especially under low temperature conditions.*

The seeds of the castor plant contain the toxic protein ricin and the alkaloid ricinine, which are poisonous to humans and animals. Gale et al., (1981) described ricin as a cytotoxic protein that inhibits protein synthesis by inactivating ribosomes. Consumption of a seed causes nausea and eating several seeds may result in death. According to the Centers for Disease Control and Prevention (2005), initial symptoms of ricin poisoning by inhalation may occur within 8 hours of exposure. Within a few hours of inhaling significant amounts of ricin, likely symptoms include: difficulty breathing, fever, coughing, nausea, and tightness in the chest. Heavy sweating may follow as well as fluid build-up in the lungs. This would make the situation worse by making breathing more difficult, and eventually the skin turns blue. Finally, low blood pressure and respiratory failure may occur, leading to death.

Anyone that has been exposed to ricin should seek medical care if they have respiratory symptoms that started within 12 hours of inhaling ricin. If someone swallows a significant amount of ricin, vomiting is the first symptom followed by diarrhea and in extreme cases the excreta becomes bloody. As a result, severe dehydration will result, followed by low blood pressure. Other symptoms include hallucinations, seizures, and blood in the urine. Within several days, the person's liver, spleen, and kidneys will stop functioning leading to death. Ricin in powder or mist form can cause skin and eye irritation. The major symptoms of ricin poisoning depend on the route of exposure and the dose received, though several organs may be affected in severe cases. Death from ricin poisoning could take place within 36 to 72 hours of exposure, depending on the route of exposure (inhalation, ingestion, or injection) and the dose received. If death has not occurred in 3 to 5 days, the victim usually recovers. As a result, there is fear of use of ricin as a biological agent.

Historically, castor oil was used in the manufacture of hydraulic fluids, greases, and lubricants for military equipment (Brigham, 1993). It is also used in the synthesis of cosmetics, toiletries, and as a purgative. Castor oil is used extensively in the manufacture of artificial leather used in upholstery. It furnishes a coloring for butter, and 'Turkey-red' oil that is used in the dyeing of cotton textiles. Castor oil is an essential component in some artificial rubbers, celluloid, the making of certain waterproof products, and is used extensively in the manufacture of transparent soaps. It also furnishes sebacic acid that is employed in the manufacture of candles, and caprylic acid, which is mixed into varnishes (Bhardwaj et. al, 1996; Ogunniyi, 2005). In the mid 1990s, world annual production of castor oil was about 460,000 tons (1.1 million metric tons of seeds); the main producers are India, Brazil, and China. The United States is the largest importer and consumer of castor oil in the world. Castor oil was classed as a strategic material critical to U.S. national defense by the Agricultural Materials Act P.L. 98-284 passed by Congress in 1984 (Brigham, 1993). According to Roetheli et al. (1991), Public Law 81-774 requires that sufficient supplies of such materials be acquired and stored in the United States to meet national defense needs in case of war. Due to new outlets for castor oil (such as anticorrosive products or odorant captivators), demand is expected to increase over the next ten years.

Castor oil has various applications in different industrial sectors: paintings and coatings, polyurethane coating, plastics, transport, cosmetics, textiles, and leathers (Labalette et. al, 1996). One of the major products derived from castor oil is Rilsan B, developed by Atochem (France). This 100% castor-based product has numerous applications such as rotating glass car-wipers, ski boots fixatives, and for use in air-brake systems on trucks. Many new uses, based on biodegradability of castor oil derived products, are expected in the future. Therefore, the objective of this research was to determine the growth characteristics of five accessions of castor and to ascertain the possibility of the crop being included in the cropping system of small-scale limited resource farmers in Alabama.

## **MATERIALS AND METHODS.**

This study was conducted in the greenhouse facilities of the George Washington Carver Agricultural Experiment Station, Tuskegee University, Tuskegee, Alabama during the 2005 and 2006 growing seasons. Five accessions of castor oil plants were germinated, established and selected for uniformity. The seeds of five accessions were obtained from the different locations:

- 1) Tanzania 1 (TZ1) - Fulwe, Tanzania
- 2) Tanzania 2 (TZ2) - Morogoro, Tanzania
- 3) Guyana (GY-PAR)- Parika, Guyana
- 4) Jamaica 2 (JA2) - St. Ann's Bay, Jamaica
- 5) Jamaica 4 (JA4) - Top Road, St. Ann, Jamaica

Twenty-six centimeter diameter polyethylene pots were placed on greenhouse benches in two strips, one limed and the other un-limed. The accessions in each strip were arranged as a complete randomized design (CRD) with ten replications. The growth media was a Norfolk sandy loam (fine, siliceous, thermic, Typic, Palendult) from Tuskegee, Alabama. To obtain the desired soil pH levels, dolomitic lime was applied to

raise the soil pH. Prior to lime application the soil pH was 5.3. After liming, pots were placed on greenhouse benches for an incubation period of three months. During this period changes in pH were monitored. The final pH obtained was 5.9. Seeds of the five accessions were planted into the pots receiving the two lime treatments (pH 5.3 vs. 5.9). Preliminary germination tests were conducted (Table.1), and emergence and growth were monitored and recorded. A day/night temperature of  $30/25^{\circ}\text{C} \pm 2.5^{\circ}\text{C}$  was maintained in the greenhouse for the length of the study. A nutrient solution of 20-20-20 (NPK) was given once weekly at a rate of 1.5 g/pot (approximately, 25 kg - N;  $\text{P}_2\text{O}_5$ ;  $\text{K}_2\text{O}$ /ha). Data on plant height and vigor was recorded weekly for all plants. Harvest weights were then recorded for total dry matter yield, as well as leaf, petiole and stem yields. Data was subjected to analysis of variance, and where effects were significant ( $P < 0.05$ ) the least significant difference (LSD) test was used to separate the means.

## RESULTS AND DISCUSSION

Based on germination and growth parameters the accessions showed varied response to lime. Twenty-eight days after planting (DAP), germination rate was highest for TZ2 and GY-PAR (96%) with JA2 having the lowest (80%), when limed. At 35 DAP, the two highest germinating accessions remained in the same order, and although it increased, JA2 exhibited the lowest percent germination (88%). When soil was unlimed, the rate of germination decreased. Twenty-eight DAP, TZ1 had the highest percent germination (84%), and JA4 the lowest germination rate (76%) when no lime was applied. The germination rates at 35 DAP for TZ1 was highest (84%), with all other accessions exhibiting approximately 80%. When limed, average plant heights at 28 DAP ranged from 3cm (JA4) to 4.75cm (TZ2). Fifty-six DAP average plant height ranged from 11.8cm (JA2) to 16.25cm (GY-PAR), and at 84 DAP average plant height ranged from 19.7cm (JA2) to 26.25cm (GY-PAR; JA4). Average plant heights at 28 DAP ranged from 2.80 cm (JA4) to 4.03 cm (TZ2) for unlimed plants.

At 56 DAP, average plant height ranged from 12.45 cm (TZ1) to 17 cm (JA4), and at 84 DAP, average plant height ranged from 22.45 cm (JA2) to 29.95 cm (JA4). At 28 DAP; plants that were limed had dry weights ranging from 24.07 g/pot to 30.58 g/pot. However, when no lime was applied, there was an increase in plant dry weight ranging from 25.01 g/pot to 33.57 g/pot. At 56 DAP, the results indicated that the plants that were limed had higher dry weights (62.86 to 69.18 g/pot) than the unlimed plants (60.80 to 65.82 g/pot). This is a reverse of the observations made at 28 DAP where the unlimed plants had higher dry weights. At 28 DAP; JA4 produced more biomass when no lime was applied. This result was unexpected because both Jamaican accessions produced more dry matter after 56 days when limed. This followed expected results, as the native soil was predominantly alkaline. When no lime was applied, both Tanzania accessions, as well as the Guyana accession produced more dry matter at 28 and 56 DAP. These were results were expected since the native soil types in both locations were predominantly acid. These results indicate that further study of these different accessions is needed.

## REFERENCES

- Bhardwaj, H.L., A.I. Mohamed, C.L. Webber, III, and G.R. Lovell. 1996. Evaluation of castor germplasm for agronomic and oil characteristics. p. 342-346. In: J. Janick (ed.), *Progress in new crops*. ASHS Press, Alexandria, VA.
- Brigham, R.D. 1993. Castor: Return of an old crop. p. 380-383. In: J. Janick and J.E. Simon (eds.), *New crops*. Wiley, New York.
- Centers for Disease Control and Prevention. Questions and Answers about Ricin. (2005). <http://www.bt.cdc.gov/agent/ricin/qa.asp> [Retrieved November 20, 2006].
- Gale, E.F., E. Cundliffe, P.E. Reynolds, M.H. Richmond, and M.J. Waring. 1981. *The Molecular Basis of Antibiotic Action*. John Wiley and Sons, New York.
- Glaser, L.K., J.C. Roetheli, A.E. Thompson, R.D. Brigham and Carlson. 1992. Castor and lesquerella: sources of hydroxy fatty acids. *Yearbook United States Department Agriculture*, 1992: 111-117.
- Labalette, F., A. Estragnat, and A. Messéan. 1996. Development of castor bean production in France. p. 340-342. In: J. Janick (ed.), *Progress in new crops*. ASHS Press, Alexandria, VA.
- Moshkin, V.A. 1986a. Economic importance and regions of cultivation of castor, p. 1-5. In: V.A. Moskin (ed.), *Castor*, Oxonian Press Ltd. New Dehli.
- Moshkin, V.A. 1986b. History and origin of castor, p. 6-10. In: V.A. Moskin In V.A. Moskin (ed.), *Castor*, Oxonian Press Ltd. New Dehli.
- Ogunniyi, D.S. 2005. Castor oil: a vital industrial raw material. *Bioresource Tech.* 97(9): 1086-1091
- Roetheli, J.C., L.K. Glaser, and R.D. Brigham. 1991. Castor: Assessing the feasibility of U.S. production. Workshop summary, Plainview, TX, Sept. 18-19, 1990. USDA/CSRS Office of Agr. Materials. *Growing Ind. Material Ser.*
- Shroyer, J.P., and D.B. Erickson. 1987. Specialty and non-traditional crops. *Cooperative Extension Service Bulletin MF-844*. Kansas State University. Manhattan, KS.
- Weiss, E.A. 1971. *Castor, sesame, and safflower*. Leonard Hill, London.



**Table 1.** The effect of lime application on the emergence of castor seeds 28 and 35 days after Planting (DAP)

Accession	Limed	Limed	Unlimed	Unlimed
	28 DAP	35 DAP	28 DAP	35 DAP
----- (%) -----				
TZ2	96	96	80	80
TZ1	88	92	84	84
JA4	92	92	76	80
JA2	80	88	80	80
GY-PAR	96	96	80	80
Average	90.40	92.80	80.00	80.80

**Table 2.** Height of 5 castor oil plants 28, 56, and 84 days after planting (DAP) - limed

Accession	28 DAP	56 DAP	84 DAP
		(cm)	
TZ2	4.75	13.80	22.80
TZ1	3.35	12.45	23.45
JA4	3.00	15.00	26.25
JA2	3.55	11.80	19.70
GY-PAR	4.15	16.25	26.25

**Table 3.** Height of 5 castor oil plants 28, 56, and 84 days after planting (DAP) - unlimed

Accession	28 DAP	56 DAP	84 DAP
		(cm)	
TZ2	4.30	15.80	26.20
TZ1	3.05	12.45	22.60
JA4	2.80	17.00	29.95
JA2	3.15	13.65	22.45
GY-PAR	3.25	16.10	27.40

**Table 4.** Dry Matter Production of castor oil plants at 28 days after planting

Accession	Limed (grams)	Unlimed
TZ2	27.48	31.05
TZ1	24.07	30.66
JA4	28.08	32.26
JA2	29.11	25.01
GY-PAR	30.58	33.57

**Table 5.** Dry Matter Production of castor oil plants at 56 days after planting

Accession	Limed (grams)	Unlimed
TZ2	64.13	64.39
TZ1	62.86	65.82
JA4	65.24	63.19
JA2	69.18	60.80
GY-PAR	63.14	65.70

**Poster #12**

**Mandarina Híbrida Fallglo: Primeros Cuatro Años de Crecimiento en Dos Localidades de Puerto Rico**

*Félix M. Román Pérez, Agenol González Vélez, y Raúl Macchiavelli, Catedráticos, Colegio de Ciencias Agrícolas, Estación Experimental Agrícola, Universidad de Puerto Rico, Recinto Universitario de Mayagüez, fmroman@uprm.edu*

**RESUMEN.**

La mandarina híbrida Fallglo, Bower (*C. reticulata* x tangelo Orlando) x Temple (*C. reticulata* híbrida) liberada por el USDA en el 1987 está siendo evaluada en las localidades de Isabela y Corozal en la isla de Puerto Rico. La primera localidad es representativa de la zona costera (124 msnm) y la segunda de la zona intermedia central (200 msnm), con temperatura promedio anual de 77 y 76 °F, respectivamente. Los primeros cuatro años se observó el desarrollo y comportamiento hortícola de los árboles en las dos zonas. El primer año de producción comercial, correspondiente al cuarto año de crecimiento, las primeras frutas comenzaron a madurar en el mes de septiembre en Isabela, mientras que en Corozal comenzaron a madurar en octubre. La variedad fue injertada en los patrones Swingle citrumelo (*Citrus paradisi* x *Poncirus trifoliata*), el híbrido HRS 812 [mandarina Sunki (*C. reticulata*) x naranja trifoliada Benecke (*P. trifoliata*)], Carrizo (*Citrus sinensis* x *P. trifoliata*), y las mandarinas Cleopatra (*Citrus reticulata* Blanco) y Sun Chu Sha. Durante la primera cosecha se tomaron los siguientes datos: promedio de número de frutas por árbol, peso total y peso promedio por fruta, diámetro, altura y diámetro de copa de los árboles y volumen de copa. Los resultados de la primera cosecha muestran que los patrones produjeron significativamente mayor cantidad de frutas por árbol en la localidad de Corozal (235.2) que en la localidad de Isabela (92.8). Para la variable peso promedio de frutas por árbol los valores obtenidos para la comparación entre localidades se acercaron a la significancia ( $p=0.0678$ ), indicando una tendencia a ser mayor en la localidad de Corozal que en Isabela, 48.6 kg y 29.1 kg, respectivamente. En ambas localidades no se detectaron diferencias significativas entre los distintos patrones para ninguno de los parámetros medidos. En ambas localidades, algunos árboles fueron afectados por una muerte descendente en algunas ramas, siendo la misma de origen desconocido. Síntomas muy similares a estos han sido reportados en la literatura.

**PALABRAS CLAVE:** cítricos, patrones, crecimiento, variedad

**INTRODUCCIÓN**

La mandarina híbrida Fallglo, Bower (*C. reticulata* x tangelo Orlando) x Temple (*C. reticulata* híbrida) fue liberada por el USDA en el 1987 (Hearn, 1987). La fruta es de producción temprana, grande y con bastante semilla (20 a 40 semillas por fruta), con color de cascara y jugo intenso (Hearn, 1987; Davis y Albrigo, 1993; Jackson y Futch, 2003). Una limitación de los árboles jóvenes es la muerte fisiológica de ramitas terminales y exudación de goma. Aunque la mayoría de los arbolitos no mueren, esta

condición puede afectar el área de volumen de copa. En el estado de la Florida esta condición también afecta los árboles de la mandarina 'Robinson' (Hearn, 1987).

Esta mandarina está siendo evaluada en dos localidades de Puerto Rico en cinco patrones de cítricas. Se presentan los datos de los primeros cuatro años de crecimiento y desarrollo observados en estas localidades.

## **MATERIALES Y MÉTODOS**

Se establecieron dos experimentos en las localidades de Corozal e Isabela, Puerto Rico. La primera localidad es representativa de la zona costera (124 msnm) y la segunda de la zona intermedia central (200 msnm), con temperatura promedio anual de 77 y 76 °F, respectivamente. Los primeros cuatro años se observó el desarrollo y comportamiento hortícola de los árboles en las dos zonas. La variedad Fallglo se injertó en los patrones Swingle citrumelo (*Citrus paradisi* x *Poncirus trifoliata*), el híbrido HRS 812 [mandarina Sunki (*C. reticulata*) x naranja trifoliada Benecke (*P. trifoliata*)], Carrizo (*Citrus sinensis* x *P. trifoliata*), y las mandarinas Cleopatra (*Citrus reticulata* Blanco) y Sun Chu Sha. Los árboles se sembraron a una distancia de 4.4 m x 5.9 m. Se utilizó un diseño de bloques completos aleatorizados con cuatro repeticiones. Durante la primera cosecha se tomaron datos de: número de frutas por árbol, peso total y peso promedio por fruta, diámetro, altura y diámetro de copa de los árboles y volumen de copa. Los árboles se manejaron siguiendo las recomendaciones de la Estación Experimental Agrícola para la producción de cítricas. Se estableció un sistema de riego suplementario para ambos experimentos.

## **RESULTADOS Y DISCUSIÓN**

En el primer año de producción comercial, correspondiente al cuarto año de crecimiento, en Isabela las primeras frutas comenzaron a madurar en el mes de septiembre, mientras que en Corozal comenzaron a madurar en octubre. En ambas localidades los árboles produjeron frutas de una buena apariencia y color (Figura 1). Sin embargo, algunos árboles fueron afectados por la condición de muerte descendente de algunas ramas (Figura 2), siendo la misma de origen desconocido. Esta condición en pruebas realizadas en Florida no fue un problema serio (Hearn, 1987). Síntomas muy similares a estos han sido reportados en la literatura (Tucker y colaboradores, 1995 y 1998).



Figura 1 Cosecha de la mandarina Fallglo en noviembre de 2007.



Figura 2 Muerte de ramas en mandarina Fallglo

Los resultados de la primera cosecha muestran que los patrones produjeron significativamente mayor cantidad de frutas por árbol en la localidad de Corozal (235.2) que en la localidad de Isabela (92.8). Siendo este el primer año de producción comercial y por ser demasiado jóvenes los árboles, eran de esperarse las bajas producciones. A medida que los árboles se desarrollen los rendimientos deberán aumentar. Para la variable peso promedio de frutas por árbol, los valores obtenidos para la comparación entre localidades se acercaron a la significancia ( $p=0.0678$ ), mostrando una tendencia a ser mayor en la localidad de Corozal que en la de Isabela, 48.6 kg y 29.1 kg, respectivamente. En ambas localidades (Figura 3) no se detectaron diferencias significativas entre los distintos patrones para ninguno de los parámetros medidos. Es necesario podar anualmente para evitar que los árboles se agobien y se quiebren las ramas por el peso de la carga de fruta, sobre todo en aquellos de crecimiento vigoroso como lo es el HRS 812 (Figura 4). Los datos de volumen de copa presentados fueron tomados en el cuarto de año de crecimiento lo cual irán cambiando en la medida que los árboles lleguen a la etapa de adultez.



Figura 3. Promedio de número de frutas por patrones por localidad



Figura 4. Volumen de copa en las localidades de Isabela y Corozal

## CONCLUSIONES

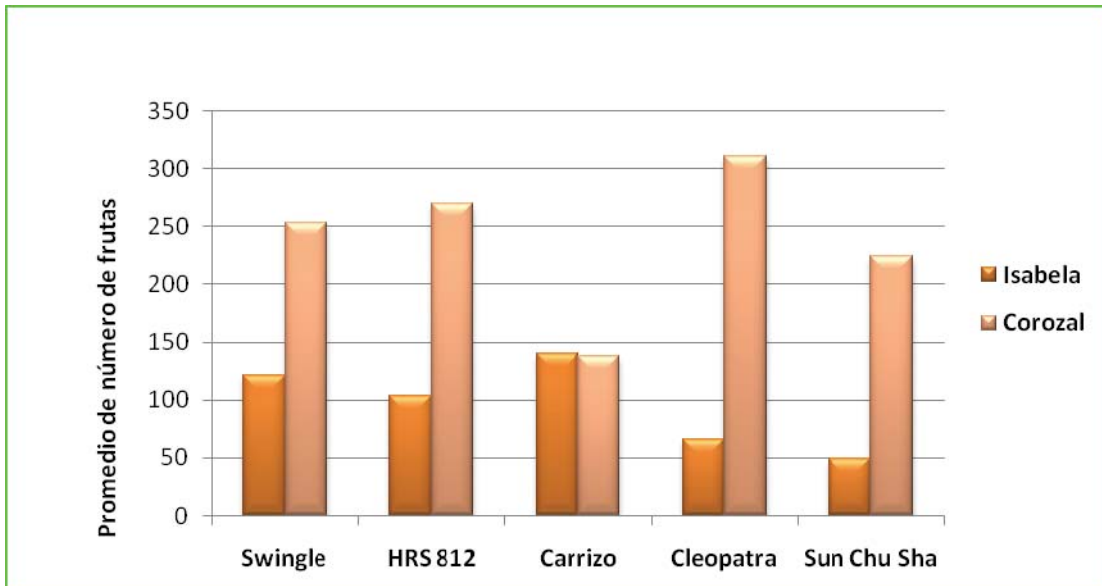
Aunque los resultados de la primera cosecha muestran que los patrones produjeron significativamente mayor cantidad de frutas por árbol en la localidad de Corozal (235.2) que en la localidad de Isabela (92.8), es muy prematuro predecir el comportamiento de los mismos toda vez que no han llegado al punto óptimo de producción. Se tomarán datos de por lo menos cuatro cosechas más. En la localidad de Isabela (zona costera) se observa una tendencia de los árboles a producir frutas que

maduran ligeramente más temprano; este comportamiento se podría deber a la temperatura y humedad prevaleciente en la localidad. Los árboles en ambas localidades fueron susceptibles a la condición de muerte ascendente de ramitas y exudación de goma, condición que ha sido reportada en la literatura. Aunque la investigación no ha concluido, esta variedad promete ser una alternativa para los citricultores de la isla siempre y cuando la manejen adecuadamente y utilicen el patrón que resulte con las mejores características.

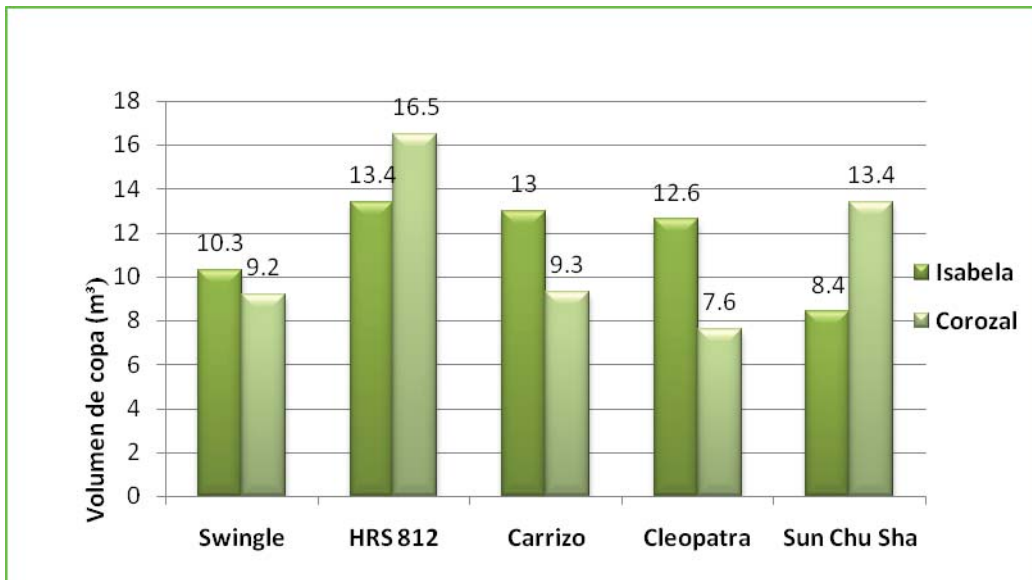
#### **REFERENCIAS**

- Davis, F.S. y L. G. Albrigo. 1994. Major Taxonomic Groups within Citrus. Citrus CAB International p 35-36
- Hearn, C.J. 1987 The 'Fallglo' Citrus Hybrid in Florida Proc Fla State Hort. Soc. 100:119-121
- Jackson, L. and F.H. S. H. Futch. 2003. Fallglo tangerine. Fact Sheet HS-173 Florida Extension Service University of Florida Institute of Food and Agricultural Services, Cooperative Extension Service
- Tucker, D.P.H., C.J. Hearn and C.O. Youtsey. 1995. Florida Citrus Varieties SP-102 University of Florida, IFAS 57 p
- Tucker, D.P.H., S.H. Futch, F.G. Gmitter, and M.C. Kesinger. 1998. *Florida Citrus Varieties*. SP-102. University of Florida Institute of Food and Agricultural Services, Cooperative Extension Service. p. 40.

**Poster #13**

**Yield and Fruit Quality of Rambutan Cultivars Grown at Two Locations in Puerto Rico**

*R. Goenaga<sup>1</sup> and A. Marrero<sup>1</sup>. <sup>1</sup>USDA-ARS, Tropical Agriculture Research Station, 2200 P. A. Campos Ave., Suite 201, Mayagüez, Puerto Rico 00680-5470.  
Ricardo.Goenaga@ars.usda.gov*

**ABSTRACT.**

Eight rambutan (*Nephelium lappaceum*) cultivars grown on an Oxisol and Ultisol were evaluated for three years under intensive management at Isabela and Corozal, Puerto Rico, respectively. There were significant differences in number and weight of fruits per hectare between locations and years. Significantly more fruits were produced at Corozal (357,004 fruits/ha) than at Isabela (168,083 fruits/ha). Fruit yield at Corozal and Isabela was 11,357 and 5,111 kg/ha, respectively. At Corozal, varieties were not significantly different for number of fruit and yield per hectare. At Isabela, cultivar Gula Batus and R-162 produced significantly more fruits and higher fruit weight than other cultivars averaging 234,153 fruits/ha and 6,979 kg/ha, respectively. Cultivar R-156Y had the lowest yield at both locations. Cultivars R-156Y and Rongrien had fruit with significantly more pulp (58%) than other cultivars (47%). At both locations, significantly lower fruit soluble solids (Brix) values (19.1) were obtained from fruits of cultivars R-156Y and Gula Batus; there were no significant differences in Brix among the rest of the cultivars (20.2).

**KEYWORDS:** tropical fruits, rambutan, adaptability, soluble solids



**Poster #14**

**Calibration of SPAD-Meter Readings to Chlorophyll Content in Strawberry**

*D.L. Orihuela<sup>1</sup>, W. Colón<sup>2</sup>, J.C. Hernández<sup>1</sup>, and C. Weiland<sup>1</sup>,*

*<sup>1</sup>Escuela Politécnica Superior de La Rábida, Universidad de Huelva, Huelva, España,*

*<sup>2</sup>Universidad del Este, Carolina, Puerto Rico, orihuela@uhu.es*

**ABSTRACT.**

The relationship between SPAD-meter readings to Chlorophyll content vary according to the crop sampled, crop vegetative stage, fertilization regimes, water stress, and other environmental factors. The objective of this research was to calibrate the Minolta SPAD 502 readings to chlorophyll content in strawberry (*Fragaria x ananasa* Duch.). Once the meter was calibrated, the model was compared to other crops and with other models. Leaf chlorophyll content was determined by the acetone extraction and spectrophotometer method. Greenhouse grown plants were exposed to 27 fertilization treatments of different levels of N-P-K with 5 replications. To obtain the best fit, linear, logarithmic, cubic, and exponential models were tested between SPAD readings and leaf chlorophyll content. The linear model equation resulted in the best fit and the relationship was  $\mu\text{g chlorophyll/g leaf} = 0.0116 \text{ SPAD reading} - 0.1457$ .

**KEYWORDS:** SPAD-meter, chlorophyll, strawberry

**Poster #15**

**Growth Rate and Yield of Coffee (*Coffea arabica* L.) Grown Under Partial Shade and Full Sunlight after Severe Renovation Pruning**

*Carlos A Flores Ortega<sup>1</sup> and Miguel A. Muñoz<sup>2</sup>. <sup>1</sup>Horticulture Department, <sup>2</sup>Agronomy and Soils Department, Agricultural Experiment Station, University of Puerto Rico, Mayagüez Campus. agro\_flores@yahoo.com*

**ABSTRACT.**

Severe renovation pruning of old coffee trees is an alternative to renovate old plantations. The success of success after implementing severe pruning may vary depending if coffee is grown under partial shade or full sunlight. It has been suggested that permanent partial shade creates a better environment for coffee renovation after severe pruning and that the crop can withstand better drought periods; it will benefit from reduced evapotranspiration; reduced wind and sun damage on new leaves and the fruit size is improved. This paper presents the results of a series of experiments on agroforestry planting systems on coffee plantations, comparing the recuperation of a severe pruned plantation under full sunlight and under shade conditions. The study was conducted for five years in the Agricultural Experimental Station at Adjuntas, located in the central region of the island. Two coffee plots of Puerto Rico 401 variety planted under partial shade of *Pithecellobium carbonarium* were used for the study. The shade was eliminated in one plot and both plots were submitted to severe renovation pruning. A factorial design was used for the study where the main plot was the treatment (partial shade and Full sun), years as subplot and 12 repetitions (trees). Data was collected on foliage development, canopy volume, harvesting, mortality and coffee quality. Climatic data on sunlight intensity, and air and soil temperature was also collected. Three methods to estimate canopy volume were evaluated. Significant differences ( $p \leq 0.05$ ) on tree height was found. Average tree's height under partial shade was 1.68 m during 2004, 3.09 m during 2006 and 4.12 m during 2008 while full sun trees reached 1.34 m during 2004, 2.59 m during 2006 and 3.42 m during 2008. Canopy volume (CV) estimated by the CVF3 was the more precise among the three formulas tested. CV for full sun trees was estimated on 17.64 m while the shaded trees CV was estimated in 28.49 m, with a DMS=7.92125. Also mortality observed was three times higher at full sun treatment than at partial shade.

**KEYWORDS:** coffee, pruning, agroforestry.

**Poster #16**

**Using a Commercial Mixture of Amino Acids and a Commercial Extract of *Ascophyllum* Kelp to Reduce the Time in Nursery of ‘Duncan’ and ‘Marsh’ Grapefruits (*Citrus Paradisi* Macf.) in Puerto Rico**

Note: This paper was presented as poster #16: Reducing the time in nursery for ‘Marsh’ and ‘Duncan’ Grapefruits with a Commercial Amino Acid Mixture and a Commercial *Ascophyllum* Kelp Extract”

*J. Pablo Morales-Payan, Department of Horticulture, College of Agricultural Sciences, University of Puerto Rico, Mayagüez Campus. P.O. Box 9030, P.R. 00681-9030. [morales.payan@upr.edu](mailto:morales.payan@upr.edu), [josepablomoraless@yahoo.com](mailto:josepablomoraless@yahoo.com)*

**ABSTRACT.**

Experiments were conducted in Mayagüez, Puerto Rico, to determine the effect of two biostimulants on the in-nursery growth of grapefruit budded on ‘Cleopatra’ rootstock. A kelp (*Ascophyllum nodosum*) extract (Stimplex®) and a commercial mixture of amino acids (Macro-Sorb Radicular®) were drenched at several rates, starting one month after budding and repeating the applications every 10 days until the plants reached the adequate transplanting stage. Biostimulant-treated plants attained the adequate transplanting stage earlier than untreated plants. ‘Duncan’ and ‘Marsh’ responded equally to the biostimulants, and the extent of growth response was greater as the biostimulant rates increased. These results indicate that both biostimulants may be useful to accelerate the production of ‘Duncan’ and ‘Marsh’ grapefruits budded on ‘Cleopatra’ rootstock.

**KEYWORDS:** Biostimulants; growth regulators; physiological regulators.

**INTRODUCTION**

In Puerto Rico, tropical fruits are among the most economically important crop groups. In fiscal year 2006-2007, in Puerto Rico tropical fruit crops (excluding bananas) had a farm gate worth of approximately \$38.2 million, of which approximately \$8.6 million were from citrus crops (Puerto Rico Department of Agriculture, 2008).

Budded transplants are commonly used to establish commercial grapefruit orchards (Román Pérez et al., 2002), and it generally takes at least 100 days to grow citrus transplants from budding to adequate size for planting in their permanent sites in the orchards (Morales-Payan and Santiago, 2008; Santana et al., 2006). Budded grapefruit plants are deemed ready to be transplanted to their definite sites (adequate transplanting stage = ATS) when the scion (grapefruit) stem is at least 0.7 cm in diameter at its union with the rootstock, and the scion shoot is >50 cm in length.

Transplant growers are interested in reducing the time necessary to grow citrus transplants to adequate transplanting size, as a shorter time in nursery would reduce the risk of losing transplants to hurricanes, the time of exposure to pests and diseases (and the need to manage them), and as a result may help reduce production costs. In a literature search, documentation on the effect of biostimulants on grapefruit (*Citrus paradisi* Macf.) transplant growth was not found. Because biostimulants have been utilized to

reduce time in nursery for other fruit and tree crops such as coffee (*Coffea arabica*) (Villacres Vallejo, 1992), tangelo (*Citrus reticulata* x *C. paradisi*) (Morales-Payan and Santiago, 2008), orange (*Citrus sinensis*) (Santana et al., 2006), and papaya (*Carica papaya*) (Morales-Payan and Stall, 2005), it seemed feasible that biostimulants could be useful in reducing time to ATS in grapefruit as well. The objective of this research was to determine the effect of two biostimulants on the in-nursery growth of grapefruit budded on 'Cleopatra' mandarin (*Citrus reticulata*) rootstock.

## **MATERIALS AND METHODS**

Experiments were conducted at the fruit crops nursery of the Alzamora Teaching and Research Farm in Mayagüez, Puerto Rico, in 2007 and 2008. Two biostimulants [a commercial extract of kelp (*Ascophyllum nodosum*) (Stimplex®), and a commercial blend of amino acids and peptides (Macro-Sorb Radicular®) were individually applied as drenches to 'Marsh' and 'Duncan' grapefruits previously budded onto the rootstock 'Cleopatra' mandarin. The biostimulant rates were 0, 0.25, 0.5, 0.75, and 1.0 ml per L of water. Each budded plant received 150 ml of the aqueous solutions per plant, starting 30 days after budding and repeating the application every 10 days, and ending 90 days after budding or when plants reached the adequate transplanting stage (ATS), whichever happened first. Treatments were arranged in a randomized complete block design with 10 replications. Shoot height, stem diameter, and number of fully expanded leaves were determined every 10 days after the first biostimulant application, until plants reached ATS (when the scion was at least 0.7 cm in diameter at its union with the rootstock, and the scion length was >50 cm). Regression analysis (5% level) was conducted on the data.

## **RESULTS AND DISCUSSION**

Biostimulant rates had significant effects on grapefruit transplant growth. Rates of both biostimulants had comparable effects on grapefruit transplant growth, and thus regression data for only one biostimulant is presented here (Figure 1).

The response tendency was that of increasing growth as biostimulant rates increased. As a result, control (untreated) plants attained ATS 100 days after budding, whereas biostimulant-treated plants reached ATS earlier (Figure 1). Time from budding to ATS decreased linearly as biostimulant rate increased, from 100 days (untreated plants) to 20 days (plants treated with the rate of 1.0 ml/L of either the kelp extract or the amino acid and peptide blend), which corresponds to a reduction of 20% of time in nursery. Similar effects have been reported from research when transplants of tangelo, orange, papaya, and coffee were treated with biostimulants such as kelp extracts, amino acid + peptide mixtures, and folcysteine (Morales-Payan 2007; Morales-Payan and Stall, 2005; Morales-Payan and Santiago, 2008; Santana et al., 2006; Villacres Vallejo, 1992)

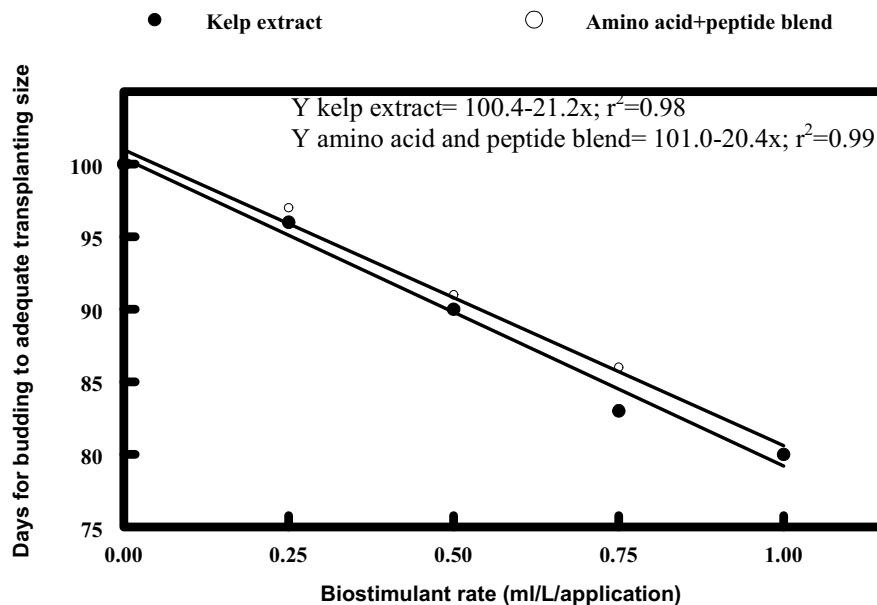

Figure 1. Effect of an *Ascophyllum nodosum* kelp extract (Stimplex®) and a blend of amino acids and peptides (Macro-Sorb Radicular®) on the time from budding to adequate transplanting stage in ‘Marsh’ and ‘Duncan’ grapefruits in Mayagüez, Puerto Rico, in 2007 and 2008. The data represents the average of both grapefruit varieties in two experiments.

The results of this research indicate the kelp extract and the blend of amino acids + peptides are promising to accelerate in-nursery growth of grapefruit transplants, reducing the time for production of adequate transplants by as much as 20%. Future research will include other citrus and other biostimulants and rates, in attempts to further reduce the time necessary to produce adequate citrus transplants in the conditions of Puerto Rico.

#### ACKNOWLEDGEMENTS

The author thanks Acadian Seaplants Ltd. (Nova Scotia, Canada) and BioIberica, S.A. (Barcelona, Spain) for supplying biostimulant application information and samples for this research.

#### REFERENCES

Morales-Payan, J. P. 2007. Growth acceleration of 'Cara Cara' and 'Valencia' oranges in nursery with an *Ascophyllum* seaweed extract and an amino acid mixture. Caribbean Food Crops Society Abstracts 43:104.

- Morales-Payan, J. P. & W, M, Stall. 2005. Papaya (*Carica papaya*) transplant growth and quality as affected by nitrogen and a soil-applied seaweed extract. *HortScience* 40:1107-1108.
- Morales-Payan, J. P., & S. Santiago. 2008. Accelerating the growth of 'Orlando' tangelo (*Citrus reticulata* x *C. paradisi*) in nursery with a commercial amino acid formulation, a commercial extract of kelp (*Ascophyllum nodosum*), and a fertilizer. *Plant Growth Regulation Society of America 35<sup>th</sup> Annual Meeting*. San Francisco, California (August 2-6, 2008) 35:1.
- Puerto Rico Department of Agriculture. 2008. Ingreso Bruto de la Agricultura en Puerto Rico. [http://www.gobierno.pr/NR/rdonlyres/CF939105-E2DA-44EC-A0DF-41622555F06A/0/IngresoBrutoAgricola2006\\_07.pdf](http://www.gobierno.pr/NR/rdonlyres/CF939105-E2DA-44EC-A0DF-41622555F06A/0/IngresoBrutoAgricola2006_07.pdf). Accessed on August 30, 2008.
- Román Pérez, F. M., R. Rodríguez, O. Santana, & R. Macchiavelli. 2002. Comportamiento hortícola de la toronja 'Redblush' en tres patrones en la zona de Isabela. *Abstracts Caribbean Food Crops Society* 38:6.
- Santana, L. M., R. Gabriel, J. P. Morales-Payan, C. H. Puello, J. Mancebo, & F. Rondon. 2006. Effects of biostimulants on nursery growth of orange budded on volkamer lemon (*Citrus volkameriana*) and 'Swingle' citrumelo (*C. paradisi* x *Poncirus trifoliata*). *Abstr. Plant Growth Regulation Society of America 33<sup>rd</sup> Annual Meeting*. Quebec City, July 9-13, 2006. Abstr. 65.
- Villacres Vallejo, J. Y. 1992. Efecto del bioestimulante Ergostim (thiazolidín-4-carboxílico) en la germinación y edades de trasplante en el crecimiento de plántulas de café (*Coffea arabica* L.) cv. Caturra Roja. B. S. Thesis, La Molina National Agricultural University, Peru.

**Poster #17**

**Evaluation of Alternative Pesticides and Mulching for Organically-Grown Watermelons in Puerto Rico**

Note: This paper was presented as Poster #17 "Organic Watermelon Yield is Affected by Alternative Pesticides and Mulching".

*Mabel Vega-Almodovar, J. Pablo Morales-Payan, Sonia Martinez-Garrastazu, & Bryan Brunner. Department of Horticulture, College of Agricultural Sciences. University of Puerto Rico, Mayagüez Campus. P.O. Box 9030, PR. 00681-9030. morales.payan@upr.edu, josepablomorales@yahoo.com*

**ABSTRACT.**

There is an increasing interest in organic horticulture in Puerto Rico. One of the main limitations for organic production is the scarcity of local research for production recommendations. Research was conducted to evaluate mulching for weed suppression and alternative pesticides for disease management in an organic watermelon system in Lajas, Puerto Rico. Plots were either not mulched or mulched with freshly-cut grass straw. The alternative pesticides were (1) a blend of oils of rosemary, clove, thyme and wintergreen, mixed with lecithin and buthyl lactate (Sporan®), (2) hydrogen dioxide (OxiDate®), (3) an oil extract from the tea tree *Melaleuca alternifolia* (Timorex®), (4) a clarified Hydrophobic Extract of neem (*Azadirachta indica*) oil (Trilogy®), (5) mint and rosemary oils mixed with wintergreen oil, vanillin, lecithin and buthyl lactate (Ecotrol®), (6) potassium bicarbonate (Milstop®), (7) *Bacillus pumilis* strain QST 2808 (Sonata®), (8) *B. subtilis* strain QST 713 (Serenade®), (9) whole milk (10% solution in water), (10) a garlic (*Allium sativum*) extract (Garlic Barrier®), (11) (Javelin®) mixed with a copper fungicide (NuCop®) alternated with *B. thuringiensis* (Agree®) mixed with a copper fungicide (NuCop®), and (12) a check treated with water. The organic pesticides were applied weekly at recommended rates. Downy mildew was the prevalent disease throughout the season. Watermelon yield was significantly higher in mulched plots than in non-mulched plots, due to weed suppression by the mulch. Among the organic pesticide treatments resulting in the highest crop yields were hydrogen dioxide, *Bacillus pumilis* strain QST 2808, the garlic extract, and the *Melaleuca alternifolia* oil extract. These results provide valuable information for weed and disease management in organic and ecological watermelon systems in tropical regions.

**KEYWORDS:** Biopesticides; *Cyperus rotundus*; downy mildew; ecological pesticides.

**INTRODUCTION**

Interest in produce grown organically or ecologically has been increasing in Puerto Rico (Morales-Cotto and Morales-Payan, 2007a and 2007b), but scarcity of research-founded recommendations for organic and ecological production in Puerto Rico hinders the productivity and expansion of crops grown in non-traditional systems.

Organic and ecological watermelons are among the fruits that Puerto Rican consumers are interested in purchasing, more so if they are grown in the island (unpublished survey data by Morales-Payan and collaborators).

In Puerto Rico, watermelon (*Citrullus lanatus*) had a farm gate worth of approximately \$2 million in the fiscal year 2006-2007 (Puerto Rico Department of Agriculture, 2008), and most of it is still grown in conventional systems. Management of weeds, diseases, and pests are among the main concerns of watermelon growers in Puerto Rico.

Weeds, particularly purple nutsedge (*Cyperus rotundus*) may be devastating to watermelon if allowed to grow unchecked or poorly managed (Roque et al., 2006; Wszelaki and Brunner, 2006). Diseases are commonly a threat to watermelons in Puerto Rico, especially fungal diseases in the southwestern region of the island (Wszelaki and Brunner, 2006). Little is known regarding the effect of crop protection inputs and practices on organic/ecological watermelon production systems in Puerto Rico.

The objective of this research was to determine the effect of mulching for weed management and application of alternative pesticides allowed in certified organic production on the yield and quality of watermelons grown as a transitioning crop in Puerto Rico. The objective of this research was to evaluate mulching and alternative pesticides for weed and disease management in watermelons grown following organic regulations in the conditions of southwestern Puerto Rico.

## **MATERIALS AND METHODS**

Field research was conducted with transplanted 'Crimson Sweet' watermelon at the Experiment Substation of the University of Puerto Rico-Mayaguez in Lajas during June-August 2007. The treatments (mulching x alternative pesticide combinations) were established in a split-plot randomized complete block design with four replications. The large plots were either not mulched or mulched with freshly cut grass. The subplots were pesticides allowed in certified organic systems, applied according to the US National Organic Program regulations.

The alternative pesticides evaluated were (1) a blend of oils of rosemary, clove, thyme and wintergreen, mixed with lecithin and buthyl lactate (Sporan®), (2) hydrogen dioxide (OxiDate®), (3) an oil extract from the tea tree *Melaleuca alternifolia* (Timorex®), (4) a clarified hydrophobic extract of neem (*Azadirachta indica*) oil (Trilogy®), (5) mint and rosemary oils mixed with wintergreen oil, vanillin, lecithin and buthyl lactate (Ecotrol®), (6) potassium bicarbonate (Milstop®), (7) *Bacillus pumilis* strain QST 2808 (Sonata®), (8) *B. subtilis* strain QST 713 (Serenade®), (9) whole milk (10% solution in water), (10) a garlic (*Allium sativum*) extract (Garlic Barrier®), (11) (Javelin®) tank-mixed with a copper fungicide (NuCop®) alternated with *B. thuringiensis* (Agree®) tank-mixed with a copper fungicide (NuCop®), and (12) a check treated with water. The alternative pesticides were applied weekly at label recommendation rates.

The experimental units were raised soil beds 6 m long containing 10 watermelon plants each. The crop was transplanted onto the experimental units the same day the mulching was laid on the plots, and the watermelon was managed following practices allowed under the US National Organic Program standards. Weed density, disease



incidence and severity, and pest density and damage were evaluated weekly one or two days prior to treatment reapplication. Fruit yield (fruit number and weight) were determined at harvest. Fruit grade (size, internal and external color, flesh firmness and soluble sugar concentration) were determined in post-harvest. Analysis of variance and separation of means were conducted on the resulting data.

## RESULTS AND DISCUSSION

The prevalent weed during the first month was after crop transplanting was purple nutsedge (*Cyperus rotundus*). Mulching significantly affected purple nutsedge density by one month after crop transplanting, which reached approximately 500 shoots per m<sup>2</sup> in non-mulched plots, and approximately 100 shoots in mulched plots (data not-shown).

Downy mildew (caused by *Pseudoperonospora cubensis*) was the prevalent disease throughout the season. Alternative pesticides had significant effects on the extent of damage caused by downy mildew on watermelon. The leaf area damaged by downy mildew by the fruit enlargement stage was as low as 22% and as high as 95% (data not shown). Insect and mite presence during the watermelon season was insignificant.

Watermelon yield was significantly higher in mulched plots than in non-mulched plots, due to weed suppression by the mulch. On average, in non-mulched plots, yield was approximately 55% lower than in mulched plots, regardless of the pesticide applied (data not shown).

Most pesticide treatments had no measurable impact on disease severity and on watermelon yield. However, the copper/Bt treatment resulted in lower yields than the check (which may be partially attributable to copper toxicity)(Figure 1). In contrast, the hydrogen dioxide treatment resulted in the highest yields among all the treatments. Aside from the hydrogen dioxide treatment, among the organic pesticide treatments resulting in the highest crop yields were *Bacillus pumilis* strain QST 2808, the garlic extract, and the *Melaleuca alternifolia* oil extract (Figure 1).

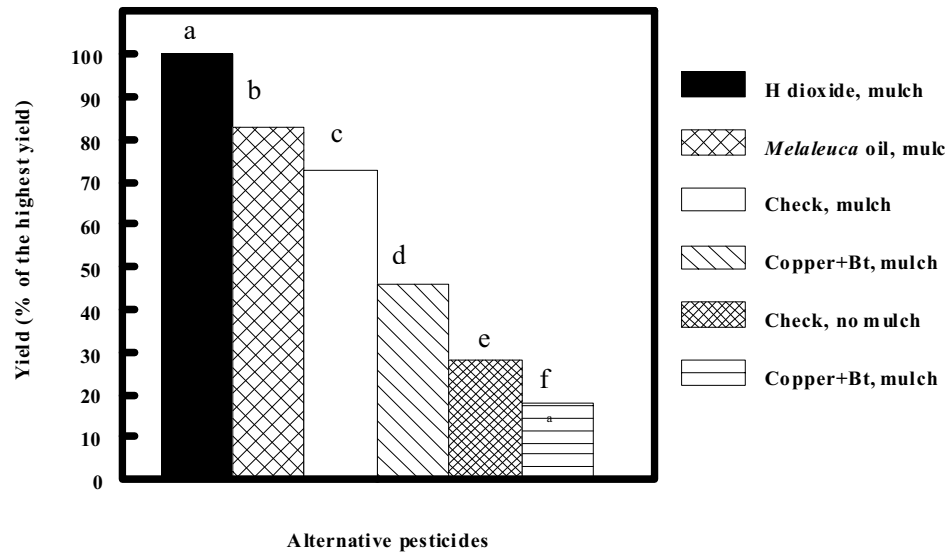

Figure 1. Effect of selected alternative pesticides and mulching on the yield of organically-grown watermelon in Lajas, Puerto Rico, in 2007.

In summary, in this research we found that (1) mulching significantly reduced purple nutsedge density and interference with organically-grown watermelon, and that (2) several alternative pesticides (mainly hydrogen dioxide) were efficacious reducing downy mildew severity and helped increase watermelon yield. In future studies, the best treatments from this research will be compared to other weed management practices and other alternative pesticides, to generate more information useful to organic and ecological watermelon growers in Puerto Rico and similar locations.

#### ACKNOWLEDGEMENTS

Research funded by the USDA-HATCH Program (UPR-Mayaguez Project H-405).

#### REFERENCES

- Morales Cotto, S. & J. P. Morales-Payan. 2007a. A survey of ecological (organic) growers in Puerto Rico: Situation, challenges, and obstacles. *Abstr. Society for Agricultural Sciences of Puerto Rico (SOPCA)* 33:25.
- Morales Cotto, S. & J. P. Morales-Payan. 2007b. Organic food production in Puerto Rico: progress, challenges, demand and quality (original in Spanish: Alimentos orgánicos en Puerto Rico: retos y avances de producción, demanda y calidad alimenticia). *Abstr. Jornada del Colegio de Ciencias Agrícolas de la Universidad de Puerto Rico* 2:18-19.
- Puerto Rico Department of Agriculture. 2008. Ingreso Bruto de la Agricultura en Puerto Rico. <http://www.gobierno.pr/NR/ronlyres/CF939105-E2DA-44EC-A0DF->

- [41622555F06A/0/IngresoBrutoAgricola2006\\_07.pdf](#). Accessed on August 30, 2008.
- Roque, S.M., B. Brunner and A. Wszelaki. 2006. Alternativas para el manejo de malezas en la producción de sandía orgánica tropical (Alternatives for weed management in tropical organic watermelon production). Abstracts of the Inter-American Society for Tropical Horticulture 52:70.
- Wszelaki, A., and B. Brunner. 2006. Creating a more sustainable watermelon production system in Puerto Rico. Abstracts of the Inter-American Society for Tropical Horticulture 52:17.

**Poster #18**

**Crecimientos Vegetativo y Reproductivo del Aguacate ‘Hass’ en Varios Climas de Michoacán, México**

*J.L. Rocha-Arroyo, S. Salazar-García, I.J.L. González-Durán, y J. Anguiano-Contreras. INIFAP-Campo Experimental Uruapan, Uruapan, Michoacán. México. E-mail: samuelsalazar@prodigy.net.mx*

**RESUMEN.**

En Michoacán se cultivan más de 96 mil ha de aguacate ‘Hass’ pero existe poca información para entender su comportamiento fenológico en los diferentes climas. El objetivo del estudio fue cuantificar la influencia del clima sobre la ocurrencia e intensidad de los flujos vegetativos (FV) y su importancia para la floración. Se seleccionaron 14 huertos adultos de ‘Hass’ distribuidos en siete climas. En cada huerto se eligieron 10 árboles y en cada uno de ellos se marcaron cinco ramas de 1-1.5 m de longitud; en cada rama se etiquetaron 15-20 brotes del FV de invierno para darle seguimiento a cada brote. Los brotes vegetativos producidos por cada FV fueron etiquetados para determinar el tipo de crecimiento producido (vegetativo, floral o inactivo) durante 2006-2008. En todos los climas hubo tres FV (invierno, primavera y verano) y cuatro flujos de floración: “Loca” (Ago-Sep), “Aventajada” (Oct-Dic), “Normal” (Dic-Feb), y “Marceña” (Feb-Mar). El clima influyó ( $P = 0.05$ ) la intensidad de floración producida por los brotes originados en los tres FV’s. La floración Normal fue la más abundante en los tres FV’s y en la mayoría de los climas. El FV de invierno fue el más importante para la producción de cualquier flujo de floración. Para el FV invierno, la mayor intensidad de las floraciones Loca y Aventajada ocurrió en climas Semicálido subhúmedo (SS) y Templado húmedo (TH). En brotes de los FV’s primavera y verano estas floraciones fueron más intensas en los climas SS, Semicálido húmedo (SH), Templado subhúmedo (TS) y TH. La mayor intensidad de floración Normal ocurrió en los climas SH y TH (brotes de invierno), Cálido subhúmedo (CS) (brotes de primavera), y en climas SS, SH y TH (brotes de verano). Para los tres FV’s, la floración Marceña fue más intensa en los climas CS y SS. En cualquier FV la floración Normal tendió a ser más intensa en los climas fríos (SH, TS y TH), mientras que la Marceña se incrementó en los climas cálidos (CS y SS).

**PALABRAS CLAVE:** *Persea americana*, floración, fenología.

**Poster #19**

**Corrección de la Deficiencia Crónica de Zinc en Aguacate ‘Hass’**

S. Salazar-García<sup>1</sup>, L.E. Cossio-Vargas<sup>2</sup> y I.J.L. González-Durán<sup>1</sup>, <sup>1</sup>INIFAP-Campo Experimental Santiago Ixcuintla, Nayarit, México. <sup>2</sup>Universidad Autónoma de Nayarit, Posgrado en Ciencias Biológico Agropecuarias. Xalisco, Nayarit, México. E-mail: samuelsalazar@prodigy.net.mx

**RESUMEN.**

En los huertos de aguacate ‘Hass’ de los municipios de Tepic y Xalisco, Nayarit, son frecuentes los niveles foliares debajo de lo normal de zinc (Zn) y la presencia de síntomas visuales de deficiencia de Zn en hojas, brotes y frutos. Esta investigación se desarrolló del 2001 al 2005 en dos huertos comerciales de aguacate ‘Hass’ cultivados sin riego en el Mpio. de Tepic con el objetivo de evaluar el efecto de las aplicaciones de sulfato de zinc (ZnSO<sub>4</sub>), al follaje o al suelo, sobre la producción, tamaño y forma del fruto. El suelo de los huertos era de textura ligera, pH 5.8 y bajo contenido de Zn (1.4 a 3.13 mg·kg<sup>-1</sup>). Los tratamientos al follaje fueron aplicados en 8 L agua/árbol y consistieron en: **a**) una aspersión con 4.056 g ZnSO<sub>4</sub>/L agua (1.46 g Zn), y **b**) dos aspersiones con 2.028 g ZnSO<sub>4</sub>/L agua (0.73 g Zn); ambos tratamientos proporcionaron 11.68 g Zn/árbol. Los tratamientos al suelo consistieron en: **a**) una aplicación (1.5 kg), y **b**) dos aplicaciones (0.75 kg c/u) anuales de ZnSO<sub>4</sub> (35.5% Zn) al suelo. El tratamiento Control no recibió Zn. Las aspersiones foliares con ZnSO<sub>4</sub> no afectaron la producción y tamaño del fruto. El promedio de las cosechas 2003, 2004 y 2005 mostró que dos aplicaciones al suelo con 0.75 kg ZnSO<sub>4</sub>/árbol/año resultaron en la mayor producción total de fruto (173 kg/árbol), producción de fruto grande (170 a >266 g/fruto; 109 kg/árbol), y la relación largo-ancho del fruto (1.9), comparado con los árboles Control, que tuvieron menor producción total (136.7 kg/árbol), menor producción de fruto grande (59.2 kg/árbol), y forma más redonda del fruto (rel. largo-ancho = 1.36). La aplicación anual de 1.5 kg ZnSO<sub>4</sub>/árbol mostró valores significativamente inferiores a dos aplicaciones anuales de 0.75 kg c/u, pero significativamente superiores al Control. Se encontró una pobre relación entre los niveles de ZnSO<sub>4</sub> aplicados al suelo y el contenido foliar de Zn.

**PALABRAS CLAVE:** *Persea americana*, producción, deficiencias nutrimentales

**Poster #20**

**Papaya Growth in Double-Row Systems Established During the Dry Season**

*Thomas W. Zimmerman, University of the Virgin Islands Agricultural Experiment Station, RR 1 Box 10,000, Kingshill, VI 00850. Email: tzimmer@uvi.edu*

**ABSTRACT.**

Papaya is an important fruit in the tropics due to its nutritional level and year round production. Papaya production in the Virgin Islands is hindered by the lengthy dry season in this semi arid environment where fresh water is lacking. Three selected papaya varieties, 'Maradol', 'Tainung 5' and 'Yuen Nong 1' were grown in 1 x 1 m, 1 x 2 m or 1 x 3 m double-row spacing regime randomized block design incorporating drip irrigation with 4L/hr emitters at 1 m intervals and grass-hay mulch. The objective was to determine water usage, plant growth and fruit set during the first six months establishment in the dry season of the U.S. Virgin Islands. Tensiometers set at 30 cm depth were used to determine when water was applied and indicated that the 1 x 1 m double row depleted the water quicker than the other two spacing regimes. Data was collected included: rainfall, irrigation water applied, plant height, height to first flower, height to first fruit, stem diameter at 1 m and number of fruit set after six months. Plants grown in the 1 x 1 m double row were taller, had thinner stems and significantly fewer fruit set for all varieties during the six months of plant establishment and growth. The 1 x 2 m double row grown papaya were similar to the 1 x 3 m double row plants for height, stem diameter and fruit set. The 1 x 2 m double row growing system is recommended to increase production where space and water are limiting factors. A grass/hay mulch is very effective in controlling weeds, conserving soil moisture and protecting the soil from erosion during sudden short heavy tropical rains.

**INTRODUCTION**

The crop farms in the U.S. Virgin Islands are mainly comprised of small farmers. The average amount of land for a crop farmer is 4.7 acres (National Agricultural Statistics, 2000). Though this average includes livestock farmers, the crop farmers are less than 2 acres. The small size limits the investment the farmer can make to produce a crop. They have to see a strong benefit to a technology before they invest in it and adapt it to their farming practices. New technologies are being developed for papaya production. Papaya requires nine months from seed, in the early varieties, to have a marketable crop. To have fruits available during the holiday season and peak tourist season, papayas need to be planted in late February through March. However, February through August are normally the driest months of the year in the US Virgin Islands.

Plant spacing from the past project indicated that growth and production were not influenced by plant spacing (Kowalski and Zimmerman, 2006). The plant spacing was 3 m x 3 m, 2 m x 3 m and a double-row 1 m x 3 m. The double-row provided a higher planting density and a more efficient use of space and irrigation water.

Drip irrigation technology permits the resourceful use of water and can help maximize the use of semiarid lands for agricultural use. This technology is particularly

suited to widely spaced crops as papaya. Though multiple field trials have shown the economic beneficial use of drip irrigation on vegetable and herb production in the Virgin Islands (Palada et al, 1995; Crossman et al, 1997; Palada and O'Keefe, 2001) limited information is available on the use of drip irrigation for papaya production (Kowalski and Zimmerman, 2001; 2006). It has been suggested that the water needs for papaya in Hawaii are ideally supplied with 100 mm of rainfall each month (Nakasone and Paull, 1998). This amount is seldom encountered in the semiarid climate of the Virgin Islands where erratic rainfall patterns and extended dry periods are the norm. Also, the local preference is for large, greater than two pounds, red papayas while most papaya research from Hawaii has focused on small, yellow one pound or smaller fruit. Not only are the varieties different between the Virgin Islands and Hawaii but also the soil. The soils of the Virgin Islands are calcareous, having a high pH around 8 versus volcanic base in Hawaii. Breeding and selection of papayas at the University of the Virgin Islands has resulted in early bearing varieties that meet the fruit preferences of the Virgin Islanders (Zimmerman and Kowalski, 2004).

Water is most often the limiting factor to crop production in the U.S. Virgin Islands. The municipal source of water is from desalination of ocean water. Due to the cost of the desalinated municipal water, farmers use the water sparingly. The most efficient use of water can result in economical gains for the local farmers. This research expanded on the double-row concept to include closer double-row spacing to determine the best intensive plant spacing for the most efficient use of water for fruit set.

## **MATERIALS & METHODS**

The objectives of this research were to develop a commercial papaya producing field plot that incorporates drip irrigation and mulch for growing selected papaya varieties at multiple double-row spacing regimes and determine water usage during the dry season in the U.S. Virgin Islands. Specifically to integrate water conservation through drip irrigation and mulching into papaya production, determine water requirements of papaya grown under multiple double-row plant spacing regimes and determine the growth and production potential of papaya as influenced by spacing under drip irrigation and biodegradable mulch.

Papaya plants were established in double-row spacings during February from greenhouse grown seedlings. Water usage was recorded over a six month period which corresponds to the annual dry season from March through August with the assistance of a prebaccalaureate student. Tensiometers were used to record soil moisture levels and determine when irrigation water needed to be applied.

To study the integrate water conservation through drip irrigation and mulching into papaya production, papaya were established from seed in a greenhouse one and a half months prior to transplantation to the field at the University of the Virgin Islands Agricultural Experiment Station on St. Croix. The three varieties used were 'Maradol', 'Tainung 5' and 'Yuen Nong 1'. 'Maradol' is a compact variety producing red 4-5 lb fruit. 'Tainung 5' and 'Yuen Nong 1' are standard sized trees that produce large red and yellow fruit respectively.

A double-row plant spacing regime was followed. A nine foot distance was between double-rows to allow for tractor cultivation until the plants attain three feet. Each double-row was three feet apart. The distance between each plant within a row of

the double-row varied from three feet, six feet or nine feet which corresponds to 2,400, 1,200, or 800 plants per acre respectively. Each plant spacing was replicated three times and had ten plants of each variety per replication. Guard rows were planted on both sides of the field and between replications. Guard plants were also planted at the end of each row.

One drip line of irrigation was installed at the time of transplanting six-eight inch tall seedlings into the field. The spacing of the orifices in the linear irrigation tubing was three feet and exude one gallon per hour. The drip lines were placed near the plant base and moved outward to a distance of 1.5 feet from the base of the plant. A final drip line was added between the double rows when the plants were at three feet in height. The double rows then had a drip line outside of each row and one between the double-rows for a total of three lines per double-row. Hay mulch was applied to the whole field after the third drip line was installed. The drip lines were under the mulch and in contact with the soil. The hay mulch was spread to a depth of the three inches between plants and rows. The straw/hay was obtained from the VI Department of Agriculture as large round bales.

To determine water requirements of papaya grown under double-row plant spacing regimes soil moisture tensiometers were placed throughout the plots at a depth of 15 cm and 30 cm. The tensiometers were used to determine soil moisture content. Water meters were installed for each plant spacing plots and the amount of water applied recorded over time. Rainfall information was obtained from the IVI-AES weather station.

During the initial six month growth of the papaya plot corresponding to the dry season, data was collected on plant height, height to first flower, height to first set fruit, stem diameter at three feet from the soil surface and number of fruit set when the first fruit was ripening. This growth and production data was obtained to determine the influence of spacing and drip irrigation on papaya yield.

## **RESULTS AND DISCUSSION**

Papaya were established under field plot conditions in early 2007 from seeds germinated in a greenhouse. The first six months of 2007, during the establishment of the papaya plot, a typical dry season was experienced on St Croix (Figure 1). Low rainfall started in January and when plant establishment occurred in early February, the soil was dry. There was a spike in rainfall during April. Heavy rains were received that lasted a week and provided seven inches of rainfall. The soil moisture content was at field capacity during these heavy rains causing the tensiometer to read zero for ten days (Figure 2). The soil tensiometers' readings increase in value as the soil dries. When the soil is saturated the readings decrease to zero. Figure 2 also indicates that plant spacing did have an influence on soil moisture available to the plants. The same dripline, with three foot emitters, was used for all spacing treatments and the 1 m x 1 m double row spacing configuration had drier soil before and after the heavy April rains. The closer the plant spacing results in more competition from the plants roots for the water available in the soil. The papaya plants in the 1 m x 1 m spacing competed more for the available water, reducing the soil moisture quicker, then was observed for either the 1 m x 2 m or 1 m x 3 m double row spacing.



During the initial six months of papaya establishment and growth, water was applied as indicated in Figure 3. The wet soils from the heavy April rains resulted in less water being applied to the papayas in April. The mulch was very effective in controlling weeds, conserving soil moisture and protecting the soil from erosion during sudden short heavy tropical rains. However, the straw mulch absorbs the light showers preventing the water from reaching the soil. Most light showers have minimal effect on the soil and availability to plants due to the high evaporation rate (Goenaga et al., 2004). The total amount of water given to each plant was 62 gallons over seven and one half months for the 1 m x 2 m plant spacing during which plant establishment, floral induction and fruit set occurred.

Plant spacing did have an influence on the height of 'Maradol' plants over time. After two months of growth, the 1 m x 1 m spacing caused the plants to be taller than the more distant spacings (Figure 4). 'Maradol' is a compact papaya variety that has a slower rate of growth but the close plant spacing caused it to stretch to have a difference of 50 cm by the fourth month. 'Maradol' grew at the same rate for the 1 m x 2 m and 1 m x 3 m plant spacing.

Both 'Tainung 5' and 'Yuen Nong 1' are standard sized papaya trees. However, the close 1 m x 1 m spacing had taller plants after one month (Figures 4 and 5). The leaves start interacting with each other after a month's growth at the close plant spacing. As the plants became taller with age, the close spacing caused the plants to grow outwards resulting in a 'V' shaped double row. This leaning outward was not observed in the 1 m x 2 m or 1 m x 3 m spacing which grew perpendicular to the soil.

The stem diameter can have an influence on the plants ability to support a column of fruit as well as have tolerance to wind. Thinner stemmed plants tend to snap in wind when carrying a heavy fruit set. These varieties are grown because they are able to set 30-50 fruits (Kowalski and Zimmerman, 2001). For all three varieties the close plant spacing had the thinnest stems (Table 1). The 1 m x 3 m plant spacing resulted in significantly thicker stems than the 1 m x 1 m spacing. With 'Tainung 5' both the 1 m x 3 m and 1 m x 2 m spacing had significantly thicker stems than the 1 m x 1 m spaced plants.

The height to first flower and height of the first set fruit indicate how low the fruit is set on the stem. These three varieties were chosen because they set fruit early. Flowers are present between the first and second of field establishment. Papaya trees that set fruit early have a lower center of gravity and less prone to high winds (Zimmerman and Kowalski, 2004). Both the 1 m x 2 m and the 1 m x 3 m spaced plants had earlier flowering and fruit set lower to the soil surface for all varieties than the 1 m x 1 m plants (Figure 7). Lower fruit set also allows more fruit to be within reach for a longer period of time.

The main reason for growing papaya is for production. The number of fruit set on a papaya stem column was recorded when the first fruit ripened and indicates expected production for the tree. For all three varieties, the 1 m x 1 m double row spacing set significantly less fruit than either the 1 m x 2 m or 1 m x 3 m double row spacing (Figure 7). This indicates that the close plant spacing can't hold as many fruit and may be influenced by the water availability to the plant previously discussed. The 1 m x 2 m and 1 m x 3 m double spaced plants were not significantly different for fruit set. The 1 m x 2

m double row spacing was the most efficient for water usage and land area to produce the most fruit.

## CONCLUSIONS

The papaya plants for 'Maradol', 'Tainung 5' and 'Yuen Nong 1', grown in a 1 m x 1 m double row system were taller, had thinner stems and significantly fewer fruit set than the 1 m x 2 m or 1 m x 3 m double row spacing regime during a normal dry season of six months for plant establishment and growth. The 1 m x 2 m double row grown papaya were similar to the 1 m x 3 m double row plants for height, stem diameter and fruit set. The 1 m x 2 m double row growing system is recommended to increase production where space and water are limiting factors. A grass/hay mulch is very effective in controlling weeds, conserving soil moisture and protecting the soil from erosion during sudden short heavy tropical rains.

## REFERENCES

- Crossman, S.M.A., M.C. Palada and J.A Kowalski. 1997. Comparison of mulch type effect on yield of parsley in the Virgin Islands. *Caribbean Food Crops Society*. 33:216-220.
- Goenaga, R., E. Rivera and C. Almodovar. 2004. Yield of papaya irrigated with fractions of class A pan evaporation in a semiarid environment. *Journal of Agriculture University of Puerto Rico* 88:1-10.
- Kowalski, J.A. and T.W. Zimmerman. 2001. Evaluation of papaya germplasm in the U.S. Virgin Islands. *Caribbean Food Crops Society*. 37:24-28.
- Kowalski, J.A. and T.W. Zimmerman. 2006. Papaya production under different spacing regimes. *Caribbean Food Crops Society*. 42: 399-402.
- Nakasone H.Y. and R.E. Paull. 1998. *Tropical Fruits*. CAB International, New York, NY
- National Agricultural Statistics. 2000. *Virgin Islands of the United States 1998 Census of Agriculture*. <http://www.nass.usda.gov/census/census97/vi/vi.htm>
- Palada M.C. and D.A. O'Keefe. 2001. Response of hot pepper cultivars to levels of drip irrigation. *Caribbean Food Crops Society*. 37:190-196.
- Palada M.C., S.M.A. Crossman and J.A Kowalski. 1995. Water use and yield of basil as influenced by drip irrigation levels and mulching. *Caribbean Food Crops Society*. 31:143-149.
- Zimmerman, T.W. and J.A. Kowalski. 2004. Breeding and selection for early bearing papayas. *Acta Horticulturae* 632:53-55.

**Table 1.** Diameter of papaya stems taken at a one meter height for three varieties as influenced by plant spacing in a double row system.

<b>Variety</b>	<b>Spacing (ft)*</b>		
	<b>3x3</b>	<b>3x6</b>	<b>3x9</b>
<b>Maradol</b>	<b>6.70 a</b>	<b>7.80 ab</b>	<b>9.01 b</b>
<b>Tainung 5</b>	<b>6.49 a</b>	<b>8.67 b</b>	<b>9.36 b</b>
<b>Yuen Nong 1</b>	<b>7.01 a</b>	<b>8.35 ab</b>	<b>9.86 b</b>

\*Mean separation within rows conducted using LSD P=0.05

**Table 2.** Number of fruit set at the time of the first ripe fruit for three papaya varieties as influenced by plant spacing in a double row system.

<b>Variety</b>	<b>Spacing (ft)*</b>		
	<b>3x3</b>	<b>3x6</b>	<b>3x9</b>
<b>Maradol</b>	<b>23.3 a</b>	<b>35.9 b</b>	<b>38.8 b</b>
<b>Tainung 5</b>	<b>27.9 a</b>	<b>46.1 b</b>	<b>49.0 b</b>
<b>Yuen Nong 1</b>	<b>23.1 a</b>	<b>36.5 b</b>	<b>39.1 b</b>

\*Mean separation within rows conducted using LSD P=0.05

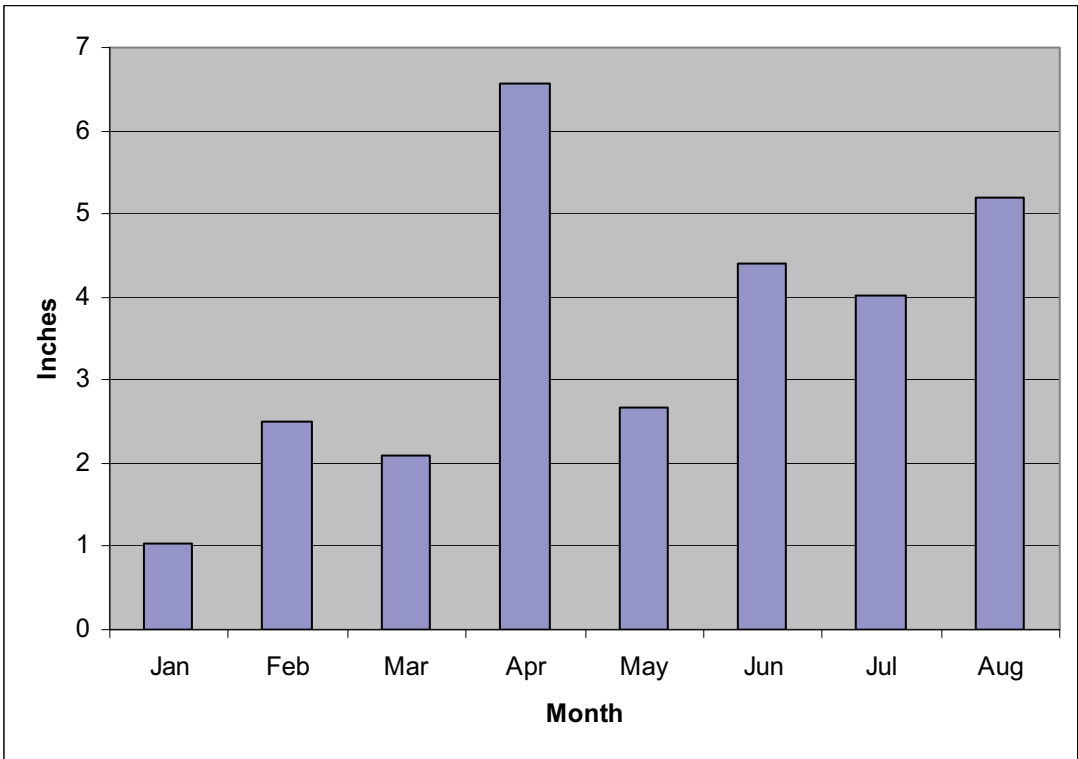

Fig. 1. Average monthly rainfall during 2007.

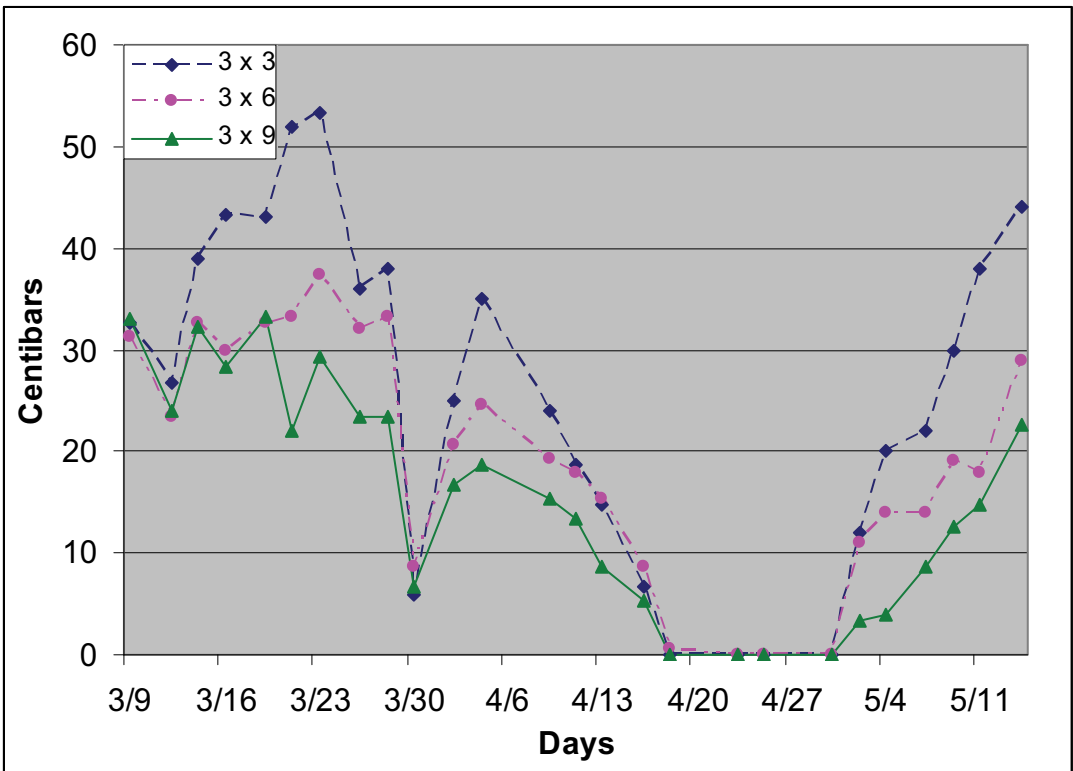

Fig. 2 Soil tensiometer readings, in centibars, over time for each papaya spacing.

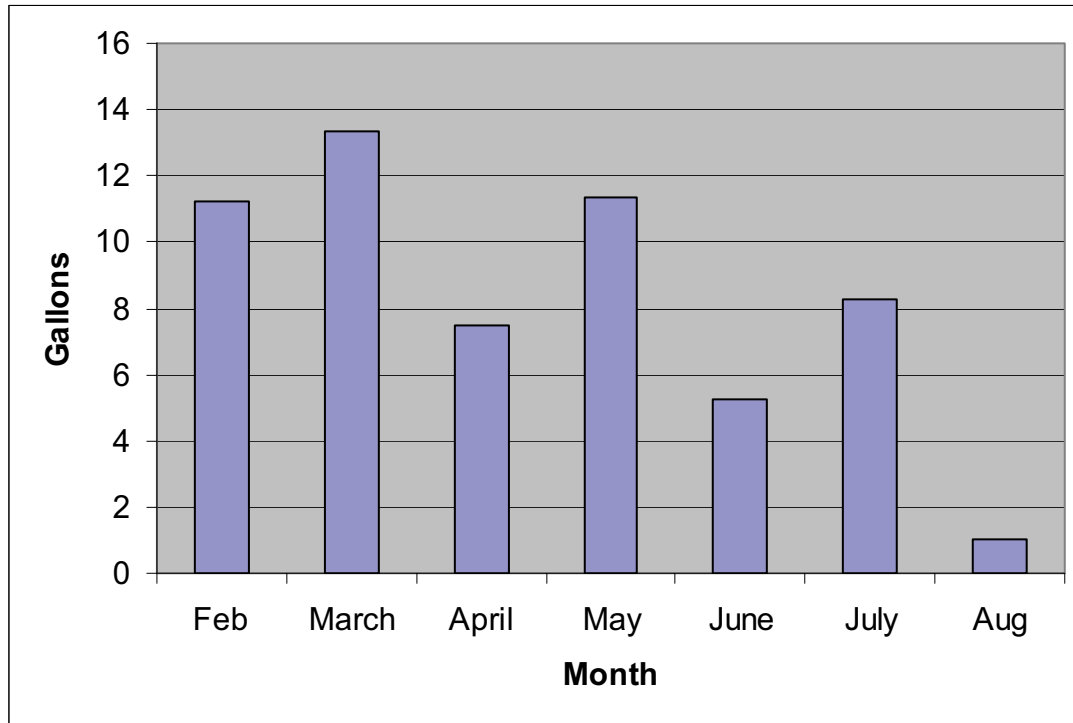

Fig. 3. Average gallons of water applied to each papaya plant.

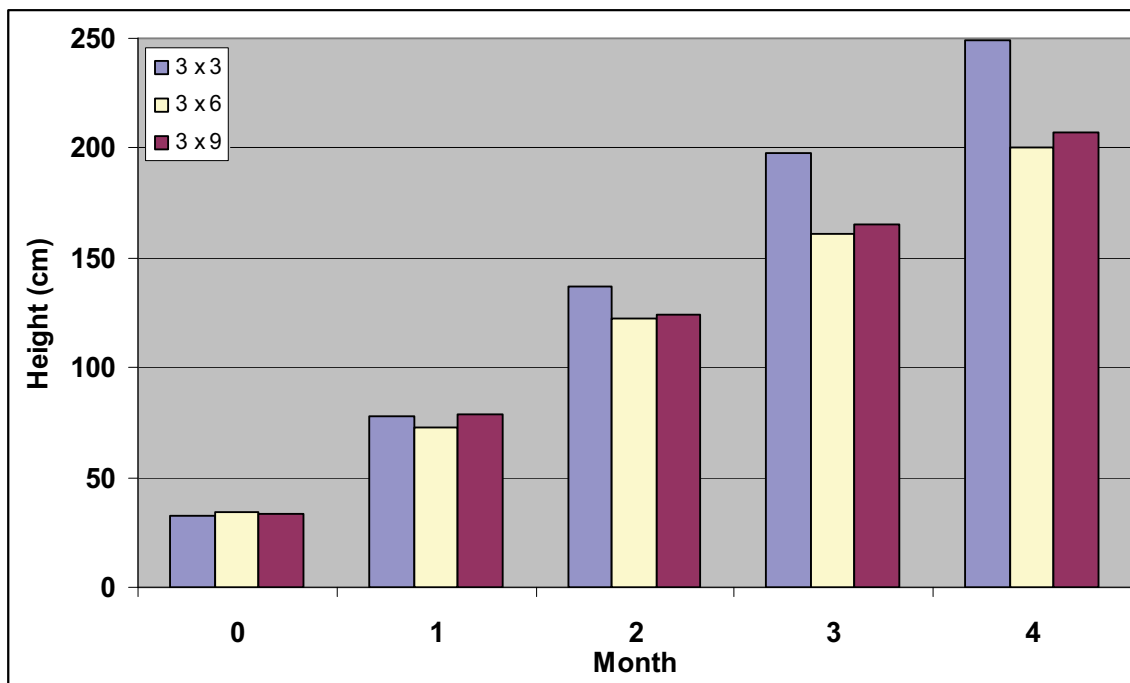

Fig. 4. Plant height of the 'Maradol' papaya plants during the first four months.

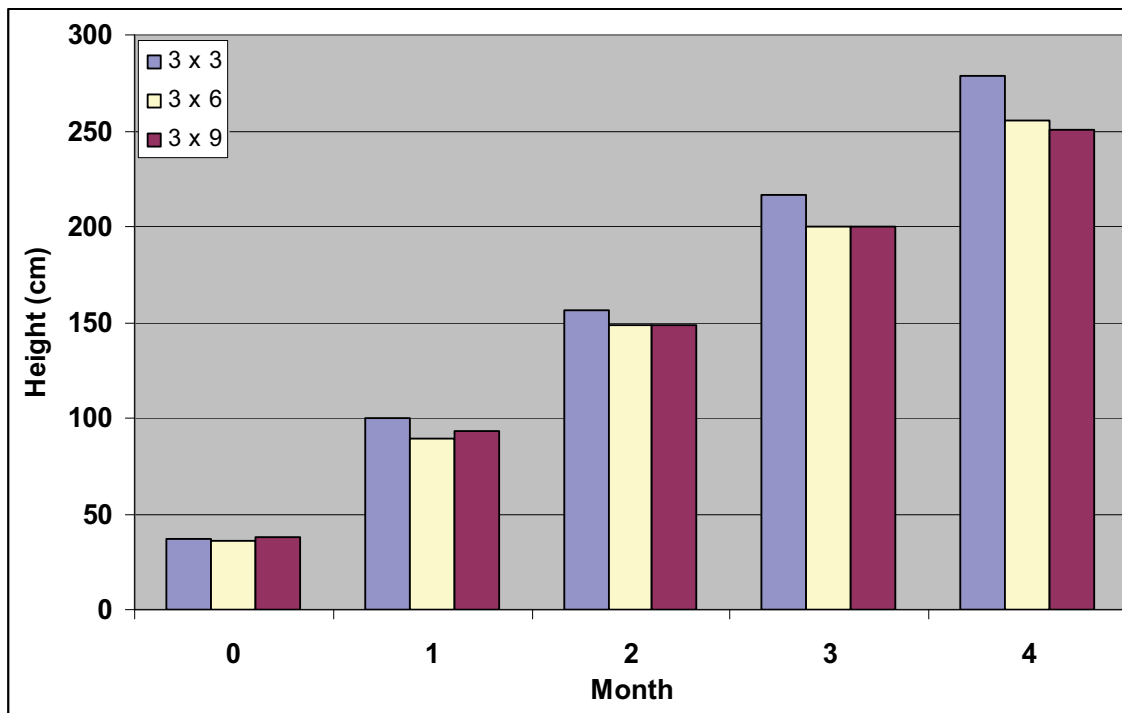

Fig. 5. Plant height of the ‘Tainung 5’ papaya plants during the first four months.

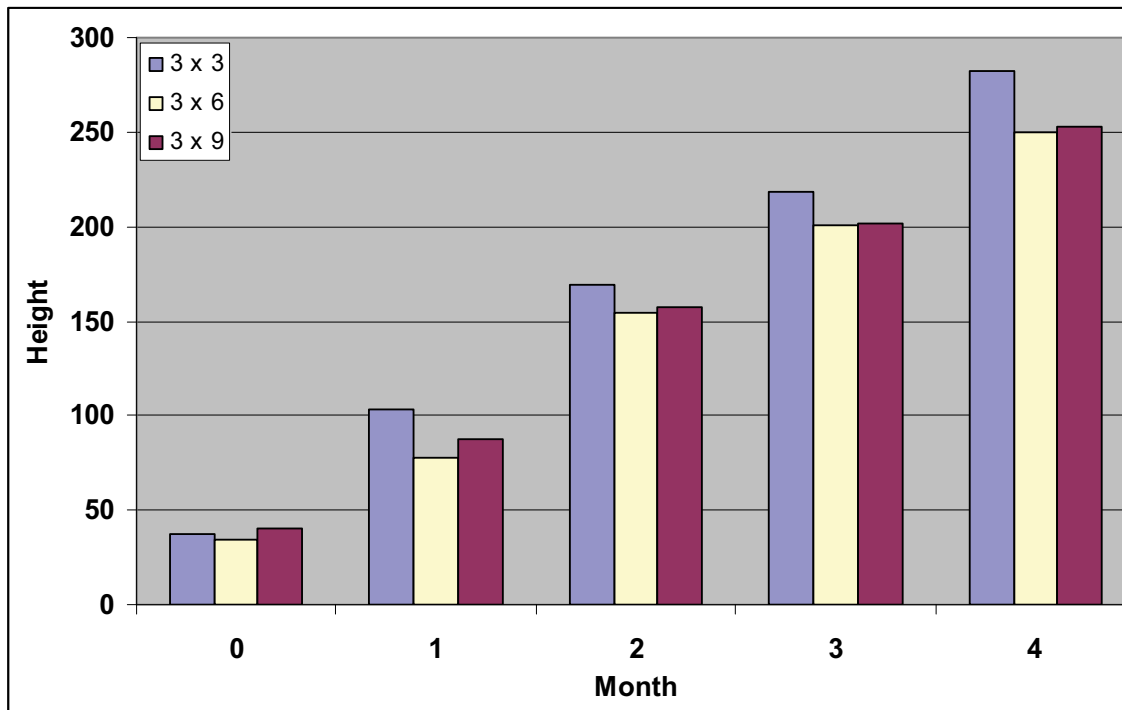

Fig. 6. Plant height of the ‘Yuen Nong 1’ papaya plants during the first four months.

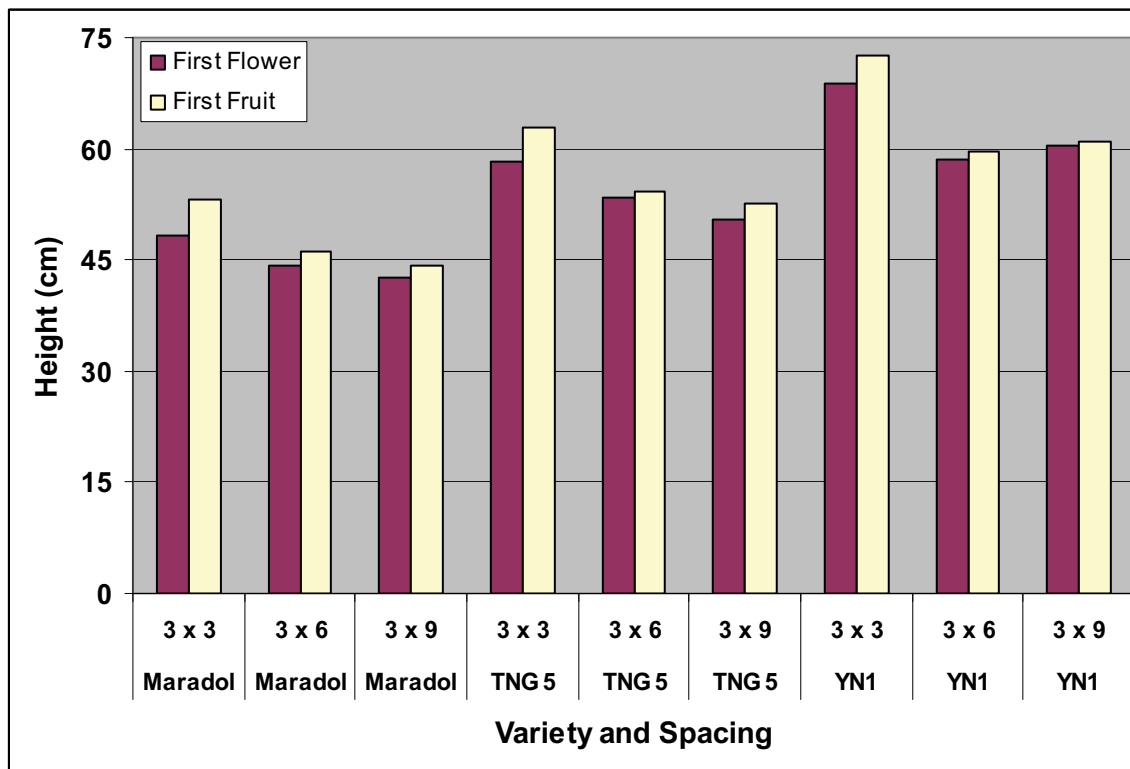

Fig. 7. Effect of plant spacing on the initiation of the first flower and setting of the first fruit for three papaya varieties.

## **SOCIOECONOMICS AND POLICY**

**2008 Proceedings of the Caribbean Food Crops Society. 44(2):437. 2008**

### **Poster #21**

#### **Agricultural Labor Issues and Immigration in Southwest Florida:**

*Robert D. Halman, University of Florida IFAS Extension – Collier County, 14700 Immokalee Road, Naples FL 34120. rdhalman@ufl.edu*

#### **ABSTRACT.**

Southwest Florida is a major agricultural area on the Florida Gulf Coast. The sub-tropical climate of many of the counties makes the region ideal for the production of diversified agricultural crops. A large migrant labor force is responsible for land preparation, planting, harvesting and processing of the fruits and vegetables grown in the region. The recent stepped up activities of the U.S. Immigration and Customs Enforcement (ICE) responsible for investigating a wide range of domestic and international activities arising from the illegal movement of people and goods into, within, and out of the United States has been critical in labor availability. The region, as an excellent recreational, tourist and residential destination, has caused another labor dynamic in the landscape industry. These transitional labor issues as well as local law enforcement involvement will be presented.

**KEYWORDS:** Migrant, Immigration and Customs Enforcement (ICE), Labor



**Poster #22**

**PROCINORTE'S Tropical and Subtropical Fruits Task Force: a Tri-National Effort to Improve Fruit Quality and Trade**

*R. Goenaga<sup>1</sup>, S. Salazar-García<sup>2</sup>, G. Doyon<sup>3</sup>, J.A. Osuna-García<sup>2</sup>, I.J.L. González-Durán<sup>2</sup> and J.A. Landry<sup>4</sup>. <sup>1</sup>USDA-ARS, Tropical Agriculture Research Station, 2200 P. A. Campos Ave., Suite 201, Mayagüez, Puerto Rico 00680-5470 (Ricardo.Goenaga@ars.usda.gov); <sup>2</sup>INIFAP-Campo Experimental Santiago Ixcuintla, Apdo. Postal 100, Santiago Ixcuintla, Nayarit, Mexico 63300; <sup>3</sup>Food Research and Development Centre, Agriculture and Agri-Food Canada, 3600 Casavant Blvd. West, St. Hyacinthe, Québec, Canada J2S 8E3; <sup>4</sup>University of Québec, 1100 Notre Dame W. St., Québec, Canada H3C 1K3*

**ABSTRACT.**

Canada, Mexico and United States are countries that share many interests in agricultural affairs. The three countries have been commercial partners for many years, and most recently they have been working under the North American Free Trade Agreement (NAFTA) umbrella. The three countries are natural commercial partners sharing several common problems in agriculture. Some of these problems are related to food safety and quality, control of pests and diseases, and other issues concerning food exports and imports. One very important mechanism to facilitate the institutional and technical integration of Canada, United States and Mexico is PROCINORTE under the umbrella of the Inter American Institute for Cooperation on Agriculture's (IICA), Northern Regional Center. PROCINORTE is a cooperative Program in Research and Technology for the Northern Region, with an Umbrella Task Force that determines common research priorities. Within PROCINORTE, several initiatives or task forces have been formed. The Tropical and Subtropical Fruits Task Force was established in 2002. The main goal of this task force is to improve production, consumption and trade of tropical and subtropical fruits in the entire PROCINORTE region. Specific objectives are to: 1) encourage the communications and collaboration among scientists working in quality, safety, and production of tropical and subtropical fruits; and 2) identification of common problems and opportunities associated with tropical fruit production and quality and work jointly in research projects to solve these. A summary of activities carried out by the Tropical and Subtropical Fruits Task Force is presented here.

**KEYWORDS:** commerce, exportation, food safety.

**Poster #23**

**Le Programme Régional de Développement Agricole : un outil méthodologique pour la modernisation et l'adaptation de l'agriculture Guadeloupéenne.**

*Edmond Rubrice, Chambre d'agriculture de Guadeloupe, Guadeloupe.  
rubrice.cda@wanadoo.fr*

**RÉSUMÉ**

Après la réforme du financement du développement agricole et rural en France, le Ministère de l'agriculture et de la Pêche signait avec l'APCA en 2004 un premier contrat d'objectifs pour les programmes de développement agricole des chambres d'agriculture. Ce contrat commun à toutes les chambres régionales d'agriculture de France a représenté un changement méthodologique important et a amélioré la lisibilité des actions à partir de six objectifs : Accompagner les mutations des exploitations agricoles ; adapter les productions et les activités aux attentes des marchés ; gérer et préserver les ressources en eau ; participer au développement territorial ; piloter les actions en cohérence avec les autres politiques publiques.

En Guadeloupe, en complément du conseil technique individualisé, le Programme Régional de Développement Agricole a favorisé la réalisation des actions d'intérêt général et l'accompagnement des agriculteurs au changement des politiques agricoles et rurales : Organisation des filières de diversification ; nouvelles méthodes de collecte des données pour le réseau de suivi, les références systèmes et technico-économiques ; observatoire économique et social ; agro transformation ; agritourisme et animation du réseau « bienvenue à la ferme » ; sensibilisation sur les enjeux de l'agri-environnement ; partenariat avec les acteurs du système recherche développement formation ; amélioration de la gouvernance du projet.

La valorisation des acquis méthodologiques se poursuivra dans le cadre d'un second contrat d'objectifs 2009-2013. Il permettra de préparer l'avenir de l'agriculture guadeloupéenne sur les bases de quatre nouvelles priorités et en fonction des attentes de la société : satisfaire les marchés par des productions adaptées ; relever les défis environnementaux par des modes de production innovants et durables ; contribuer au développement durable des territoires par des activités et des systèmes d'exploitations adaptés ; innover dans l'exercice des métiers par des entreprises agricoles performantes avec des actifs professionnels responsables et organisés.

**MOTS CLÉS** : contrat d'objectifs, agriculture durable, Guadeloupe.

**Poster #24**

**Incubator Farms as a Sustainable Approach for ‘Neo Farmers’**

*Puran Bridgemohan, Centre Biosciences, Agriculture, and Food Technology, University of Trinidad and Tobago, Point Lisas Campus. puran.bridgemohan@utt.edu.tta*

**ABSTRACT.**

Trinidad and Tobago is facing a challenge of urban migration and a reduction in an already ageing farming population. There is an urgent need to attract new and emerging farmers to this vocation and guide them to be economically viable and educated farmers of the future. Incubator Farm is a unique and successfully proven approach which will be appropriate for Small Island States Economies, and will assist to educate aspiring farmers and establish their business as incubators. This paper discusses the creation of a more closed-loop food system through the establishment of several farms for the production of dwarf pommecythere, cassava, and hot peppers linked to a post-harvest facilities and multi-purpose pilot processing plant.

**KEYWORDS:** Incubator Farm, dwarf pommecythere, cassava, and hot peppers

**INTRODUCTION:**

Trinidad and Tobago food production and agro-processing industry is facing a challenge of urban migration and a reduction in an already ageing farming population. This is further complicated with consumers having to face shortages in cereals, particularly rice and wheat products. There is an urgent need to attract new and emerging farmers to this vocation and guide them to be economically viable and educated farmers. Incubator Farm is a unique and successfully proven approach which will assist to educate aspiring farmers to establish their own business and focuses on agricultural transformation (Handy, 2001).

A strategy for sustainable growth and economic development in the agro-production and processing sector can be achieved through farm incubators (Hirschman, 1958). This is used to host and train farmers and small processors as they produce, share equipment and facilities, establish their market (Eaton, 2001) and learn from each other.

There is currently a growing farming population of over 5,000 small part-time farmers or ‘2 acre farmers’ or ‘neo-farmers’ in Trinidad which arose from the closure of the sugar industry<sup>1</sup>. Most of these ‘neo-farmers’ would prefer perennial crops with low input and establishment cost, minimal labour requirements and maintenance cost, early revenue generation spread evenly throughout over a 3 to 4 year period, and that can be intercropped (Anon, 1998). These new farmers, although they may have worked in an agro-processing [sugar] industry, really are not culturally farmers and lack the husbandry and skills. However, they would be exposed to low input sustainable agriculture [LISA]

---

<sup>1</sup> Sugar Adaptation Strategy for the sugarcane Industry of Trinidad and Tobago

and good agricultural practices [GAP] which will assist in production catering for fresh market and processing plants (Anon, 2002).

When pooled due to their close proximity, the farmers will benefit from irrigation facilities, and participate in a rotational cropping system to ensure a continuous supply of raw material to the processing plant (Anon, 2008). This concept mirrors the “mega-farms’ now touted about by the Agricultural Planners. The most suitable crop for both production and processing on the heavy clay soils of central and south Trinidad are dwarf pommecythere, green coconuts, cassava and hot peppers/chillies. The agronomy<sup>2</sup> and processing protocols<sup>3</sup> for these crops have already been established.

This paper presents the strategy for the creation of a more closed-loop<sup>4</sup> food system through the establishment of several farms for the production of crops linked to a post-harvest facility and multi-purpose pilot processing plant

### **STRATEGIC DIRECTION:**

The Rutland Area Farm and Food Link (Hubbard , 2006 ) had identified a need for a program to nurture beginning farmers, that will in turn start agriculturally based business in the region. The incubator farms were an ideal place where new farmers got their enterprises started and built their markets before making significant capital investments. The vision for incubator farms was for it to operate as a regional agricultural centre supporting a community based food system by providing resources that encourage farm enterprises and expand local agriculture in the community (Sayre, L. 2005).

This background was used in developing a strategic direction for the establishment of an incubator farm for the production of dwarf pommecythere, cassava and hot peppers/chillies in the Waterloo area, which is in close proximity with the Centre Biosciences, Agriculture, and Food Technology, University of Trinidad and Tobago, Point Lisas Campus. Further, it is proposed that together with CARIRI, an agro-post harvest / production and processing facility will be established along side the training facility. This is to be used for hosting and training farmers and small processors as they produce.

### **GOALS & OBJECTIVES:**

The strategic goals and objectives of incubator farms are summarized as follows:

- To connect all people in the local area to develop a viable farms community.
- To provide an economical and diverse agro-processing industry that is market led and technology driven.
- To cultivate land, and optimize production, processing and market opportunities.
- Educate and empower aspiring and potential partners/entrepreneurs to establish their own business.
- To partner with institutions specializing in financial, marketing, R&D, and processing etc services.

---

<sup>2</sup> Pers. Com. (2008). Dr. Wayne Ganpat, Deputy Director, ICT, Ministry of Agriculture, Land and Marine Resources.

<sup>3</sup> Caribbean Industrial Research Institute.

<sup>4</sup> Pers. Com., (2008). Dr. Kimberly Fitch, Finance and Program Coordinator, New Entry Sustainable Farming Project.

**APPROACH:**

The Intervale Incubator Farms [Anon, 2008] has developed a program which has proved congenial to a wide range of different types of farms, from crops to marketing strategies to management structures. Intervale Farmers sell to farmers' markets, restaurants, local supermarkets, and co-ops. To achieve the above, the it is intended that an effective approach is to study, interact and network with personnel already in the business and conduct a feasibility on integrating production, processing and marketing "on-site", and thus encourage entrepreneurial activity.

The strategic approach<sup>5</sup> in the creation of this closed-loop food system is through the coalition of multiple small farm holders [ 2 acres ] for the production of crops. These farms will be clustered in groups of 10 farms to provide 20 acre blocks so as to facilitate sequential field and harvesting operations, and expand the rotational cycle. This grouping ensures the optimum use of field equipment, irrigation facilities, and extends the supply of material and produces to th4e pilot processing plant. When this is programmed into the intercropping and crop succession cycle, a wider variety of crop will become available.

**ACTIVITIES:**

The following are critical activities which are essential in the establishment of a one hundred acre farm incubator, together with a multi-purpose pilot processing plant and post-harvest facility. The latter will be flexible so that it can expand operations to accommodate several similar size incubators.

---

<sup>5</sup> Pers . Com., (2008). Mike Lanier, Agricultural Economic Development Centre N.C. Cooperative Extension, Orange County Centre, N.C.

Activity	Details
Farm Incubator [ fifty 2ac farms]	<ul style="list-style-type: none"> <li>• germplasm management</li> <li>• Nursery Crop production</li> <li>• Access roads, drainage and irrigation facilities</li> <li>• Procurement of field equipment and tractors</li> <li>• Preparation of rotation cycles, intercropping plans, crop production schedules, pest and disease management programs.</li> </ul>
Post Harvest Facility [ multi-purpose pack-house]	<ul style="list-style-type: none"> <li>• Preparation of design physical structure</li> <li>• Renovation / modification of existing building</li> <li>• Procurement of equipment and instruments</li> </ul>
Pilot Plant/Processing Incubator	<ul style="list-style-type: none"> <li>• Establishment of Pilot Plant and Post Harvest facilities</li> <li>• Procurement of equipment and instruments</li> <li>• Testing/dry run</li> <li>• Training and education</li> </ul>
Evaluation of System	<ul style="list-style-type: none"> <li>• Gap Analysis of system</li> <li>• Develop appropriate R &amp; D studies</li> <li>• Marketing system</li> <li>• Recruit relevant R &amp; D personnel</li> <li>• Implement quality assurance system</li> </ul>

**FUNDING:**

The initial cost for the development and execution of this project should be borne by the state as ‘seed funding’. The capital expenditure and project cost is estimated at \$9.5 MTTD. This grant funding can be sourced from the Public Sector invest Program [PSIP] funds in the Ministry of Agriculture, Lands and Marine Resources as part of the

European Union Funding for the displacement of sugar farmers / workers and the diversification of the sector This will contribute to social and economic development by empowering the residents in the community to take responsibility of an entrepreneurial activity.

Expenditure	Cost Detail	[\$M.TT]
Capital: [\$M.TT]	Pilot processing plant	<b>3.5</b>
	Post harvest facility	<b>1.5</b>
	Training Room	<b>0.25</b>
	Greenhouse & screen-house	<b>1.25</b>
Project:	Field station	<b>0.25</b>
	training	<b>0.5</b>
	management	<b>0.75</b>
	Fields trials and experiments	<b>0.05</b>
	Inputs	<b>0.75</b>
	Lab. upgrades	<b>0.75</b>
	<b>TOTAL</b>	<b>9.55</b>

The institutional stakeholders in this Project are definitely the Ministry of Agriculture, Lands and Marine Resources, The Universities of the West Indies and Trinidad and Tobago, National Agricultural Marketing and Development Company, Caribbean Agricultural Research and Development Institute, Caribbean Industrial Research Institute, Agricultural Development Bank, Trinidad and Tobago Agri-Business Association, and National Enterprises Development Company amongst others. These institutions can facilitate research and development work, training and provide back-stopping support for the activity.

**BENEFITS:**

The expected benefits of this project can be summarized in the following:

- Expansion in number of viable farms [incubators]
- Preservation of productive agriculture lands
- Increased accessibility to small scale local food production and processing
- Improved management of the natural resources and protection of water quality.
- A better informed and developed food security plan with opportunities for new and emerging small scale farmers.

- An appropriate program designed with respect to creating a culture , market, educational opportunities, with identifiable mechanism and institutions
- A developed and enhanced farm and land-based enterprise that can generate economic and social opportunity while protecting the natural resources and bio-diversity of a fragile tropical island.
- A reconnection of former retrenched sugar workers, displaced sugar-cane farmers, potential new farmers, and financially struggling farmers with minimal resources,, but capable of producing fresh food to a urban people with an active lifestyle based on processed foods.

Year	Expected Output
1	A program designed to nurture beginning farmers, processors and entrepreneurs that will in time start agri-based business and build markets before making significant capital requirement
2 -3	Increased acreages under cultivation with selected crops minimum of 50 farmers with 2 acres [100ac]
2	Establish multiprocessing pilot plant and post harvest facilities .
2	Training sessions for farmers and producers, with significant publications and multi-media presentations [6]
2	Minimum of 4 M.Phil and 2 Ph.D graduate
2	A strong research and development program that will be funded by grants, University, and government

#### **SELECTED AREAS OF RESEARCH AND DEVELOPMENT:**

1. Agro-economic studies of integrated farming for specific commodities with processing potential.
2. Non-traditional crop production, processing, and marketing.
3. Value-added agro-processing of crops as natural food colours, additives, preservatives, essential oils, specialized food, and food processing waste technology.
4. Certified seed production and propagating studies.
5. Application of bio-technology advances to production and processing viz tissue culture and genetic engineering



## REFERENCES:

- Anon. (1998). A Rural non-farm income in developing countries. *The state of Food and Agriculture*. Rome
- Anon. (2002). Balance between Food Security and the Sustainable management of natural resources in Latin America and the Caribbean. Twenty –seventh FAO Regional Conference for Latin America and the Caribbean , Havana, Cuba, 22 to 26 April, 2002
- Anon. (2008). New England Workers on organic Farms. <http://www.smallfarms.org/newwoof/.html>
- Anon. (2008). Intervale Farms Program, Vermont. <http://www.intervale.org/FarmsProgam.html>
- Anon. (2008).New Entry Sustainable Farming Project.Tufts University.  
<http://nutrition.tufts.edu/research/nesfp>
- Eaton, M. J. (2001). Contract Farming. Partnership for Growth. FAO Agricultural Services, Bulletin145. Rome
- Handy, S. (2001). Focus for Agricultural Transformation. Agric. Review. Vol. 8, No. 3, July –Aug, 2001, pp14 -38
- Hirschman, A. (1958). The Strategy of Economic Development. New Haven: Yale University Press
- Hubbard, P. (2006). Incubator Farm Summary. Community Food and Agriculture Coalition of Missoula County. <http://intervale.org/>.
- Pers. Com. (2008). Dr. Wayne Ganpat, Deputy Director, Information Communication and Training, , Ministry of Agriculture, Land and Marine Resources, Trinidad and Tobago.
- Pers.Com. (2008). Mike Lanier, Agricultural Economic Development Centre, N.C. Cooperative Extension, Orange County Centre, P.O. Box , 181, Hillsborough, N.C. 27278, [919-215-2063]
- Pers.Com. (2008). Dr. Kimberly Fitch, Finance and Program Coordinator, New Entry Sustainable Farming Project, 9 Central St. Suite 402, Lowell, M.A. 01852, [978-654-6745]
- Sayre, L. (2005). From the ground up. Framers Perspective. New Farm. Rodale Institute, May 12<sup>th</sup>.

**Poster #25**

**Policy Implications of the Composite CARICOM Business Environment**

*Ronald M. Gordon and John J. VanSickle. Food and Resource Economics Department, University of Florida, 1197 McCarty Hal, PO Box 110240, Gainesville, FL 32611-0240. rmg251@yahoo.com.*

**ABSTRACT.**

Comprehensive data and information on the characteristics of the business environment of CARICOM countries are limited, likely constraining informed policy formulation. This research project sought to characterize the CARICOM business environment by interviewing and surveying representatives of firms from the countries of Dominica, Guyana, Jamaica, St. Lucia and Trinidad and Tobago.

The business environment was revealed to be heterogeneous and multi-faceted with important differences pertaining to firm size, area of operation and geographical scope. The proportion of micro firms with an annual sales volume (ASV) of less than US dollars 1.0 million exceeded twice that of large firms with an ASV in excess of US dollars 6.5 million. The proportion of small firms with an ASV between US dollars 1.0 million and US dollars 2.5 million is similar to that of medium firms with an ASV between US dollars 2.5 million and US dollars 6.5 million. Some firms operated only in one sector. Others, across the firm-size groups, reported multi-sectoral operations with combinations such as agriculture and manufacturing; agriculture, manufacturing and services; manufacturing with trade and commerce; and agriculture and professional services. Some firms' geographical scope of operations also transcended the firm-size groups, with micro and large firms among those indicating global operations. Respondents viewed CARICOM positively but entrepreneurs thought CARICOM did not strengthen their business environment.

These findings suggest that CARICOM policy formulation should be more cognizant of the distinctiveness of the business environment, exhibited by the major sub-groups of firms across the countries. The policy strategy should also actively and deliberately embrace the economic and related characteristics exhibited by countries, firms and sub-sectors within the business environment.

**KEYWORDS:** CARICOM countries; Caribbean business environment; policy formulation.

**Poster #26**

**An Evaluation of Dairy Farming in Suriname**

*Samantha Engeldal, Dept. of Agriculture, Anton de Kom University of Suriname.  
r.tjienfooh@uvs.edu*

**ABSTRACT.**

The dairy industry in Suriname consists of approximately 600 registered farmers who supply milk to the largest of four processing plants, the Melk Centrale Paramaribo. Recent analysis of milk samples have proven that the quality of produced raw milk does not meet the standards. The implementation of good farming practices is important to assure quality and safety of milk. A survey was conducted amongst local dairy farmers to investigate current farming practices and evaluate management on dairy farms. Results proved that in general the management strategies are below standards. It is clear that many farmers lack understanding of effective dairy farming practices. Recommendations were given to dairy farmers on how to improve the quality of milk.

**KEYWORDS:** standards, raw milk quality, good dairy farming practices

**Poster #27**

**Exploring the Internationalizing of Extension Opportunities: A Partnership with the Antigua 4-H Youth Program**

*Norma Samuel<sup>1</sup> and Nicole Walker<sup>2</sup>. University of Florida/Institute of Food and Agricultural Science Marion County Extension Service<sup>1</sup>, and University of Florida/Institute of Food and Agricultural Sciences Polk County Extension Service<sup>2</sup>. P.O. Box 9005, Drawer HS03, Bartow, FL 33831-9005; naw@ufl.edu*

**ABSTRACT.**

The Youth Department within the Ministry of Education, Sports and Youth Affairs for the Government of Antigua and Barbuda is charged with reviving an almost dormant 4-H program in Antigua. The need for a structured youth development program is particularly significant in light of recent outbreaks in youth violence. Staff had minimal 4-H knowledge and needed training on use of the Experiential Learning Model (ELM) and understanding the Essential Elements of 4-H. A needs assessment was conducted to determine how UF/IFAS could assist. Norma Samuel, Marion County and Nicole Walker, Polk County, designed a program to address the needs identified. The objectives were to meet with local and regional officials to develop a 4-H support system; teach the 4-H 101 curriculum to effectively manage 4-H clubs and country-wide programming; design, implement, and evaluate a horticulture judging event; conduct a teen leadership workshop; and gather local information to enhance our own county programs. Each of the objectives was met. A meeting was held with Youth Department staff and various stakeholders to gather information on program history, technical and financial support, and program direction. The major outcome of the 4-H 101 session was an action plan developed by the group outlining the role of the Youth Department staff, partnering organizations in Antigua, and UF/IFAS. The plan is currently being implemented and followed up once per quarter. An annual evaluation of progress is planned starting January 2009. One-hundred percent of the final evaluations for the training session indicated knowledge gained in many areas, including: recognition of competencies critical for healthy youth development; understanding the history and culture of 4-H; targeting specific life skills in 4-H programs; applying the ELM; and starting 4-H clubs. Partnerships between government agricultural agencies and the growing 4-H program may contribute to a renewed emphasis on agriculture among young people.

**KEYWORDS:** 4-H, experiential learning, youth development

**Poster #29**

**Environmental Damages Versus Economic Performance, Sustainability of Guadeloupean Banana Cropping Systems in Question: an Emergetic Approach**

*Jean-Marc Blazy<sup>1</sup>.; Inacio de Barros<sup>1</sup>.; Geraldo S Rodrigues<sup>2</sup>.; Harry Ozier-Lafontaine<sup>1</sup>.*

*(1) INRA UR agropédologique, Domaine Duclos, 97170 Petit-Bourg, Guadeloupe (FWI)*

*(2) EMBRAPA Labex Europe. Unité Propre de Recherche Performance des systèmes de culture de plantes pérennes - CIRAD-PerSyst, Avenue Agropolis, 34398 Montpellier, France.*

*Corresponding authors: Jean-Marc Blazy [jean-marc.blazy@antilles.inra.fr](mailto:jean-marc.blazy@antilles.inra.fr) & Harry Ozier Lafontaine [ozier@antilles.inra.fr](mailto:ozier@antilles.inra.fr)*

**ABSTRACT.**

Banana is an important agricultural commodity in Guadeloupe (French West Indies) and, to increase their competitiveness in the international market, banana growers have intensified their production systems during the last fifteen years by increasing the use of man-made technological inputs. Such intensification strategies, that require investment increases, are economically and environmentally risky. In order to assess the environmental performance of banana production in Guadeloupe, emergy synthesis methods were applied to six different types of banana cropping systems previously identified in the island. Additionally, aiming at improving farmers decision making, environmental performance results were compared with economic analysis for each cropping system. These analyses showed that the better the environmental benefit of any cropping system, the worse its economic performance. This main result was corroborated by an increased contrast among cropping systems as related to their dependence on purchased inputs, although all of them are based on the same intensive and arguably wasteful agricultural model. Therefore, the analysis point out that sustainable banana production in Guadeloupe depends on a shift from the high fossil imported input model to a local renewable resources intensive one. In this sense, emergy flow analysis shows that innovation towards environmentally sound practices that would enhance nutrient cycling; integrate weeds, pests and diseases control; and improve the banana packing process might result most positive impacts on overall sustainability. Economic analysis showed that the high labour costs contribute largely to the dependency of banana production on public subsidies. Nevertheless, reorienting the current European agricultural income policy to an environmental performance-based subvention might represent an opportunity to achieve the present social goals while promoting sustainability in banana production.

**KEYWORDS:** Banana; Guadeloupe; Cropping Systems; Environmental impact; Agricultural Economics.

## **INTRODUCTION**

Banana production is a major crop for local economy and contributes to the typical landscape of Guadeloupe. It represents 24% of local agricultural production, 12% of the total cultivated area, and generates about 5,000 direct jobs (Insee, 2001) in this caribbean french island. This sector is facing severe environmental and economic crises (Dulcire and Cattan, 2002), mostly due to a market liberalization that has prevailed during the last fifteen years, causing the price of banana to decline by an average rate of 1.4% per year (Arias et al. 2003; FAO, 2003a) and compelling farmers to intensify their production systems in order to maintain their income (Heuze, 2005; Perret and Dorel, 1999). Looking for higher productivity, farmers increment the use of technological inputs such as intensive use of machinery, fertilizers, pesticides, and irrigation, that push energy flows through the agroecosystem to unsustainable levels (Giampietro et al., 1992a,b). In Guadeloupe the systematic use of ploughing and pesticides has lead to chronic contamination of soils and waters by organochlorine compounds (Bonan and Prim, 2001). The reported contamination problem has in turn contributed to a decrease in soil biological diversity and consequent reduction in fertility (Clermont Dauphin et al., 2004), while contaminating drinking water sources (Bonan and Prim, 2001).

In order to align banana cropping systems in Guadeloupe with societal requirements for environment friendly production, and to develop actions towards sustainable cropping systems, new assessment tools are necessary to highlight innovations that would effect most significant and positive impacts. Agriculture operates at the interface between nature and the human economy, and relies on a combination of natural and economic inputs to produce goods. Therefore, both economic and environmental contributions need to be accounted in equivalent terms when comparing resource uses in agricultural systems (Campbell, 1998).

The goals of the present study are: i) to compare the different banana cropping systems observed in Guadeloupe (FWI), with regard to resource use, productivity, environmental impact, and overall sustainability; ii) to evaluate the emergy signature of the banana production as a whole in the region; iii) to contrast an ecocentric analysis (emergy) with an anthropocentric analysis (economic) of the banana cropping systems and observe their respective tradeoffs; and iv) to highlight points where innovations might result in greater improvements towards overall sustainability of banana cropping systems in Guadeloupe.

## **MATERIAL AND METHODS**

In order to organize the diversity of existing banana cropping systems at the regional scale for emergy and economic analysis, a typology was applied according to three different dimensions: 1) Environmental: expressed by rainfall regime, solar radiation, soil category, and topography; 2) Technical: expressed by broad agronomic management aspects, and 3) Economic: expressed by financial input and output balances. Each cropping system type consolidated according to this typology regroups all individual farmers with high degree of similarity for all three dimensions. For the purposes of this study each type has been translated into an hypothetical farm that represents the average for all farms included in it. The cropping systems typology was based on farmers' interviews comprising 45 description variables for the three

aforementioned dimensions. The statistical process for the typology comprised two consecutive steps. A Principal Component Analysis (PCA) then an Agglomerative Hierarchical Clustering treatment (AHC). The validity of the system of types obtained has been thereafter assessed by applying analysis of variance to the initial quantitative variables and a Discriminant Analysis (DA) to the qualitative ones (Blazy et al. 2008). Financial performances of the different cropping systems have been assessed by a set of economic indicators calculated from the average results for each type. These economic indicators were net income as the financial surplus over costs, profitability rate and the productivity of work measured as the surplus-value obtained from labour.

Emergy analysis is based on the works of Odum (1996), Ulgiati and Brown (1998) and Brown and Ulgiati (2004a, b). The procedure begins by drawing system diagrams to identify all inputs, outputs and internal components for the studied system. The studied banana cropping systems have been subdivided in two subsystems: subsystem I refers to the banana field and includes operations of fertilization; weed, disease and pest control; plant anchorage and bunch covering, and labelling; while subsystem II reports on the operations related to harvesting, sorting, packing and transporting bananas to market or port for export. This division corresponds to the usual rationale of banana production in Guadeloupe.

After quantifying annual flows for each component and cropping system in physical units (i.e., joules, grams, US\$), these values were translated into emergy units (seJ) through previously calculated transformities for each item. For some components and products, different transformities had been derived in different contexts, so the transformity calculated under the most similar conditions to those observed in the studied situation has been selected (Lefroy and Rydberg, 2003). Furthermore, each component or production item was classified whether it is an endogenous resource (L) or a resource purchased from outside (P), whether it is a renewable (R) or non-renewable resource (N) or an exported product (Y). The percentage of renewable and non-renewable emergy supporting labour was determined based on previous studies (Ulgiati et al., 1994). In Sweden and Italy, 87 and 90%, respectively, of the emergy supporting labour was provided by non-renewable sources (Panzieri et al., 2002; Rydberg and Jansen, 2002). As the living standards in Guadeloupe are similar to those observed in European countries, 87% of the emergy supporting labour was assumed to be nonrenewable. In order to make the flows easily comparable among cropping systems and facilitate calculations, the amounts of the different components and items have been normalized both for area (1 ha) and time (1 year), for the various cropping systems studied. On the other hand, when the emergy synthesis of the overall banana production system was analyzed, the flows were expressed for the total area cropped with banana in Guadeloupe (2,350 ha), according to FAO (2008) and weighed by the respective area fraction for each cropping system type. Several performance and sustainability indices have been calculated for the different cropping systems. These indices were derived in Ulgiati et al. (1994), Odum (1996), and Ulgiati and Brown (1998) and summarize systems resource use intensity, process efficiency, economic-environment interactions and quantify sustainability.

## **RESULTS**

Renewable flows (sunlight, wind, rainfall geopotential energy and rainfall chemical energy) were expressed for the emergy accounting of banana cropping systems

mostly as evapotranspiration, which is the largest flow and integrates sunlight-derived flows. Little variation was observed in the inputs of renewable resources between the different banana cropping systems, mainly because of the high rainfall regime in all regions cultivated with banana in Guadeloupe (between 2.6 and 4.6 m, evenly distributed yearly rainfall average). As a consequence, crop evapotranspiration is near maximum and no water stress is generally experienced. Hence, as evapotranspiration (the main item of renewable flows) is similar among cropping systems, overall renewable flows are also similar. Differences were observed mainly in the fraction of human labour and organic matter amendment from discarded bananas attributed as a renewable source. Actually, only the type III cropping system farmers return the non-commercialized bananas as organic matter amendment to their fields, which means an additional emergy input of about  $13.08E^{+13}$  seJ.ha<sup>-1</sup>.year<sup>-1</sup>. Non-renewable resources used included important flows referred to soil erosion, which varied from 0.98 up to  $6.19E^{+13}$  seJ.ha<sup>-1</sup>.year<sup>-1</sup>. The low levels of non-renewable emergy flow caused by soil erosion in the studied cropping systems are explained by the fact that banana crops provide good soil coverage (high leaf area index), and are cultivated mainly in the Andisols and at a lesser extent in Ferralsols areas of Guadeloupe.

The main differences between the cropping systems studied were observed in the use of purchased resources that varied 3 folds from the lowest value ( $1.86E^{+16}$  seJ.ha<sup>-1</sup>.year<sup>-1</sup> for type V) to the largest flow observed ( $6.25E^{+16}$  seJ.ha<sup>-1</sup>.year<sup>-1</sup> for type III) reflecting the cropping intensity levels observed in the typology. In spite of these differences, all banana production systems in Guadeloupe may be considered as highly dependent of purchased resources, since these represent between 89 and 96% of the total emergy use. When the overall banana production sector is considered, the emergy flow due to purchased resources nears the maximum value of 95%, because cropping systems types III and IV alone respond for 74% of the banana cropped surface. Of the purchased emergy inputs, between 37 and 46% is invested in the process of harvesting, sorting, packing and transporting the harvested products (Subsystem II) which represented an overall average of 39% of emergy flows among cropping systems. From this share, the largest amount is invested as emergy flow in financial resources for buying card boxes for packing. Actually, the card boxes represent the largest single item of emergy inputs for all systems studied except for the type V. Regarding the field operations (Subsystem I), the largest purchased resources are the fertilizers.

The emergy allocated to banana yield in the banana cropping systems in Guadeloupe varied 3.11 times from the lowest value observed of  $2.10E^{+16}$  seJ.ha<sup>-1</sup>.year<sup>-1</sup> (type V) to  $6.52E^{+16}$  seJ.ha<sup>-1</sup>.year<sup>-1</sup> for type III, resulting in transformities that showed little variation from  $2.36E^{+05}$  to  $3.15E^{+05}$  seJ.J<sup>-1</sup>. As a whole, a total of  $1.09E^{+20}$  seJ are assigned to the production of the  $8.36E^{+04}$  tons of bananas, of which  $7.85E^{+04}$  tons are placed in the market resulting in an overall transformity of  $2.89E^{+05}$  seJ.J<sup>-1</sup>. These transformity values for banana production in Guadeloupe are comparable to the  $2.87E^{+05}$  obtained for fruit production (as an average) in Italy (Ulgiati et al., 1993); and the  $5.97E^{+05}$  value obtained for tomatoes in Florida (Brandt-Williams, 2002), both representing intensive fruit production systems for which similar processing steps for market insertion can be assumed. By contrast, fruit production systems with much smaller ( $7.03E^{+04}$  for oranges in Florida, Brandt-Williams, 2002) or much larger



(5.40E<sup>+06</sup>, tomatoes in Sweden, Lagerberg, 2000) transformities are related, respectively, to lesser or greater levels of purchased input flow and productive intensity.

The results obtained for the different economic performance indicators of banana production in Guadeloupe indicate that the sector is able to survive as an economic activity only due to important governmental subsidies. Subsidies account for the totality of net income, while covering all net financial losses, for all cropping system types and farmer classes, and correspond to about 50% of farmers' gross income. Although all cropping system types would show net financial losses without subsidies, losses decrease with increasing investment in technological inputs. Profit rates increase from 4% for type V up to 41% for type III when subsidies are included as gross income. In the same trend, labour productivity increases with increasing input use. Although subjected to a 49% higher labour cost – US\$ 83.62 and US\$ 56.20 per man day for types III and V, respectively the most intensive farm type III produces about US\$ 1.00 of net income for each dollar invested in labour while type V (the less intensive one) produces only US\$ 0.08. The large differences observed in the costs per unit of labour (from US\$ 50.91 to US\$ 86.93) are basically explained by differences in the family workforce engagement, representing the percentage of labour provided by family members, considered costless in the farm budget analysis. Production costs of banana in Guadeloupe is high, varying from US\$ 0.60 for type V to US\$ 0.71 per kilogram for type I and labour represents the most important single factor in production costs. On average, 48% (varying from 40% for type III to 55% for type V) of the costs to produce each kilogram of banana is expended in labour. This represents an average of US\$ 0.31 (from US\$ 0.25 for type III to US\$ 0.35 for type I) labour expenditure per kilogram of banana exported. The high labour costs may explain the dependency of the banana sector on public subsidy. On average, the market price obtained by the farmers is US\$ 0.37 per kilogram of commercialised banana. This value is very close to the US\$ 0.31 expended in labour costs alone.

## DISCUSSION

Banana production in Guadeloupe is heavily dependent on purchased inputs. The fraction of renewable energy flow varies from 4.05 to 10.9% according to cropping system type, and an overall average of 5.19% was estimated. Considering only the subsystem I (field operations), the renewable fraction increases to 9%, varying from 6 to 20% depending of the cropping system type. As most input-intensive agricultural systems, banana production in Guadeloupe depends heavily on fossil energy in the form of fertilizers and pesticides. Together, these two kinds of inputs respond to 31 and 43%, respectively, of all emergy flows in subsystem I. In fact, together with water, nutrients are key limiting factors for crop production (Pimentel & Pimentel, 1996) and the application of chemical fertilizers generally results in yield gains. This trend has been clearly observed in this study since a linear relationship between banana yield and emergy inflow through chemical fertilizers has been estimated. However, emergy investment in chemical fertilizers reflects negatively on sustainability, as expressed by the ESI. A similar trend is observed in relation to pesticide inputs. A clear trade-off exists between producers' interest on increased yields and income and the sustainability of their fields. Therefore, innovations in cropping techniques that would enhance nutrient cycling and the control of weeds, pests and diseases through management options such as cover-crops, buffer vegetation zones in the landscape, among others might represent promising

practices to promote an adequate compromise between farmers' economic interests and systems sustainability, in a future scenario of limited access to fossil-origin resources. Farmers of cropping system types V and VI are the less dependent on purchased inputs. The renewable fraction in the subsystem I of these farmers reaches 17 and 20%, respectively. In fact, type V cropping system returns 26% of the invested flow of purchased energy in the form of renewable resources energy flow in the field (subsystem I). This rate decreases to 13% when the subsystem II is included, as this subsystem uses only purchased resources. As cropping systems types III and IV are at the same time the most dependent on purchased inputs, and respond to the largest share of banana production in Guadeloupe, the EYR of the overall banana production is as low as only 9 and 6% for subsystem I only, and subsystem II included, respectively.

Large differences were observed in the emergy invested in fuels and lubricants across all types of cropping systems varying from 0.77 to  $5.83E^{+15}$  seJ.ha<sup>-1</sup>.year<sup>-1</sup> for types V (and VI) and IV respectively. The use machinery (and fuels) in agricultural production is intended to replace human labour and therefore to increase labour efficiency measured as the amount of harvested product per man day invested. Considering energy invested in work as the sum of energetic flows of human labour plus the energetic flows of fuels, the available energy of the harvested product per unit of energy invested in work increases as the contribution of the human labour in the energy invested in work increases. However, each joule expended on fuels costs US\$  $4.31E^{-08}$ , while each joule of human labour costs US\$  $1.82E^{-05}$  (calculated by the average prices of diesel and labour in Guadeloupe). Hence, for the same quantity of energy used, human labour costs 422 times more than fuels. This result demonstrates that although human labour is more efficient in converting energy into work than machinery, it is financially more interesting for farmers to invest in mechanization because fuel is an energy source much less expensive than labour.

The largest environmental loading ratio (ELR) among all cropping system types was observed in type III. Taking ELR is a measure of the ecosystem stress due to production (Ulgiati and Brown, 1998) - because most purchased resources cause environmental degradation during their production, use and environmental assimilation (Martin et al, 2006) - the global environmental impact caused by cropping system type III is 4 times higher than that observed for type V. As the larger ELR are observed among the cropping system types that correspond to the larger surfaces of production in Guadeloupe, the ELR of banana production in this island is 18.28, which is higher than the ELR observed for the French economy, estimated as 5.19 (SAHEL, 2008). This clear unbalance between the amount of non-renewable (including purchased) and renewable resources for banana production, with strong dependence on purchased resources, reflects an important degree of potential environmental stress. In general, the processes of harvesting, sorting, packing and transporting contribute to nearly 40% of the total emergy of banana production, varying from 38 to 45% according to cropping system type. Of this share, the highest contribution comes from the card boxes used to pack the product which, alone, respond to about half of emergy used in the subsystem II. As these boxes are a one-way use material, substantial improvements in the sustainability of the banana production in Guadeloupe could be achieved by replacing them by more durable ones that could be used several times. All banana exports from Guadeloupe have the European Community as destination. There, quality standards for bananas are normalized. This

regulation impacts strongly on the sustainability of banana production. For instance, established quality standards for bananas rely basically on aesthetic aspects of the product, and most of the discarded bananas have the same organoleptic and nutritive characteristics as the marketed ones. Comparing the energy-net income ratio (ENR) and the rate of discarded bananas, it is possible to realize that the economic sustainability of farmers would be improved in direct proportion with the marketed production. Therefore, an acceptance for a product with the same nutritional and taste qualities but with aesthetic characteristics slightly out of the standards would represent a step towards sustainability of the sector. Furthermore, substantial non-renewable and purchased energy inflows in banana production aim at increasing the compliance with aesthetic quality regulations and not necessarily improve productive efficiency.

Banana production in Guadeloupe depends on EU subsidies to remain in business (Frémeaux, 2003). Alone, the activity consumes 70% of all public subsidies paid to agricultural production in Guadeloupe, which is disproportional with spatial and economic weight in the region (Chia and Dulcire, 2005). On average, production costs are 81% (varying from 34% for cropping system type III to 145% for type V) higher than returns paid by the market, and this difference is been covered by public subsidies. This dependency on the EU agricultural income policy may be explained by the high costs of production. While the average banana production costs amount to around US\$ 0.17 per kg in Costa Rica, US\$ 0.16 in Equator, and US\$ 0.20 in Colombia (Paggi and Spreen, 2003), the cost in Guadeloupe was estimated as US\$ 0.65 per kg in the present study (average of all cropping system types), close to the US\$ 0.67 per kg reported by Paggi and Spreen (2003) for Martinique, another French overseas department. The key factor explaining this much higher production costs in Guadeloupe seems to be the high cost of labour. Actually, labour costs in Guadeloupe represent 48% of the total costs of banana production on the average of all cropping system types (varying from 40% for type III to 55% for type V) while in Costa Rica it represents 28%, in Equator 31% and in Colombia 39% (calculated from Little, 2000). Additionally, while each kg of banana produced in Guadeloupe needs an average investment of US\$ 0.31 in labour, only US\$ 0.05 is necessary in Costa Rica and Equator, and US\$ 0.08 in Colombia (calculated from Little, 2000). Therefore, to increase profits (including subsidies), farmers should increase the productivity of labour. The higher the investment in external inputs, the higher the profit and the productivity of labour. Hence, following the current agricultural model adopted by Guadeloupean banana growers, improvements in economic performances depend on the rate of investment in external inputs. However, Pimentel and Giampietro (1994) stated that though human-made technological capital such as fertilizers, pesticides, and irrigation may be used to substitute for natural capital to increase yields, as well as to substitute for human labour to increase labour productivity; the heavier use of technological inputs causes environmental damage and push energy flows through the agroecosystems to unsustainable levels (Giampietro et al., 1992a,b). Increasing the investment in external inputs increases yields, profits and labour productivity but, at the same time, it reduces FR (fraction renewable) and ESI while increasing ELR. As a general rule, the better the economic performance of banana production in Guadeloupe, the worse is the environmental performance. This result is most probably due to the fact that though differing in the amount of purchased inputs, all cropping system types follow the same intensive and arguably wasteful agricultural model. This approach is being

presently strongly criticized due to its reliance on non-renewable resources. Therefore, the improvement of sustainability of banana production in Guadeloupe will depend on a change of the agricultural model used, shifting from a high fossil input model to a natural resources intensive one that enhances the contribution of local renewable resources.

Several initiatives are on-going elsewhere to endorse the adoption of environmentally friend cropping systems for banana and other crops. However, such efforts are still not in the banana production agenda in Guadeloupe. In order to promote such change in the agricultural model, innovative cropping systems with environmentally sound practices have to be developed and the innovations adopted by the farmers. Innovation adoption, however, will depend on their financial attractiveness. This represents an opportunity to reorient current European agricultural income support policies and may lead to a system of subsidies based on environmental performance, and hence decoupled from agricultural commodity production levels, albeit likely to reward most of the same farm political constituency (Zinn, 2005; Swinton et al., 2006).

## CONCLUSION

As emergy analysis quantify natural and man-made, as well as renewable and non-renewable inputs to agricultural systems on a common basis, it helps comparison across different cropping systems and allows the identification of the critical elements to be improved in order to achieve greater sustainability. In the present case, emergy indices show that banana production in Guadeloupe has very low environmental performance and that, as a general rule, increases in environmental performances would imply decreases in yields, profits and labour productivity. The most probable reason is that the six different types of banana cropping systems identified in Guadeloupe, represent simply a gradient in the use of purchased inputs following the same intensive model. This model prizes the augmentation of land and work productivity by the use man-made technologies in the form of fertilizers, pesticides, machinery, and other purchased resources associated to financial investment and potential environmental damage, due to reliance on non-renewable resources. Therefore, innovative production systems based on ecologically intensive cropping techniques are necessary to improve the sustainability of banana production in Guadeloupe. The emergy analysis of the different banana cropping system types highlighted several points where environmentally sound innovations would effect most positive and significant impacts. First, fertilizers and pesticides alone are responsible for 74% of all emergy flows in the field operations and therefore, cropping techniques aiming to enhance nutrient cycling; and weeds, pests and diseases integrated management should be regarded as priorities. Second, although field practices are more frequently emphasized and criticised, the processes of sorting, packing and transporting represent 40% of the total emergy in the banana production system. The one-way card boxes used to pack the product correspond to near half the emergy used and, hence, improvements in the material used for packing bananas may have significant positive impacts on overall sustainability. And last, the EC regulation on quality standard for commercial bananas, by imposing strict aesthetic benchmarks, have a negative effect on the sustainability of banana production because substantial non-renewable and purchased emergy inflows into banana production systems aim to improve aesthetic standards over sound ecological management. Besides, an acceptance for a product with the same nutritional and taste qualities but with aesthetic characteristics slightly out of the

established standards would increase the ENR and therefore the financial profit of farmers. The economic analysis shows that, under the current agricultural model, increasing investment in external inputs would lead to increased profit and labour productivity. Nevertheless, the sector depends heavily on EU subsidies. This dependency stems from higher production costs, mostly related to high labour costs. Agricultural subsidies aim to promote equity in income levels between agriculture and other sectors of the French society and are therefore a political instrument for the country's and for Europe's social cohesion. However, as subsidy is coupled with banana production levels, it encourages farmers to intensify their cropping systems in order to increase yields. This intensification, however, brings potential environmental damage. Therefore, a reorientation of the European agricultural income support policies towards a system of subsidies based on environmental performance would be an opportunity to enhance the adoption of ecologically intensive agricultural innovations, while warranting and reinforcing their economic and social goals.

## REFERENCES

- Arias, P.; Dankers, C.; Liu, P.; Pilkauskas, P., 2003. *The World Banana Economy, 1985-2002*. FAO Commodity Studies 1. FAO, Rome, 97 pp.
- Blazy, J.M.; Peregrine, D.; Diman, J.-L.; Causeret, F., 2008. *Ex ante* assessment of banana farmers' room for manoeuvre for adopting agro-ecological innovations in Guadeloupe: a functional and typological approach. In: *Proceedings of the 8th European IFSA Symposium, Workshop 3 "Adaptive farming systems"*. (In press)
- Bonan, H.; Prim, J.L., 2001. *Rapport sur la presence des pesticides dans les eaux de consommation humaine en Guadeloupe*. Rapport N° 2001-070. Ministère de l'Aménagement du Territoire et de l'Environnement, Ministère de l'Emploi et de la Solidarité. Paris.
- Brandt-Williams, S.L., 2002. Folio #4. *Emergy of Florida Agriculture*. Handbook of Emergy Evaluation. A Compendium of Data for Emergy Computation Issued in a Series of Folios. Center for Environmental Policy. University of Florida. Gainesville, FL.
- Brown, L., 1993. A new era unfolds. In: L. Brown et al. (Eds.), *State of the World 1993*, pp. 3-21. W.W. Norton & Company, New York.
- Brown, M.T.; Ulgiati, S., 2004a. Emergy quality, emergy, and transformity: H.T. Odum's contributions to quantifying and understanding systems. *Ecol. Model.* 178:201-213.
- Brown, M.T.; Ulgiati, S., 2004b. Emergy analysis and environmental accounting. *Encyclopedia energy* 2:329-354.
- Campbell, D., 1998. Emergy analysis of human carrying capacity and regional sustainability: an example using the state of Maine. *Environ. Monit. Assess.* 51:631-659.
- Clermont-Dauphin C., Cabidoche Y.M., Meynard J.M., 2004. Effects of intensive monocropping of bananas on properties of volcanic soils in the uplands of the French West Indies. *Soil Use and Management* 20:105-113
- Dulcire M., Cattani P., 2002. Monoculture d'exportation et développement agricole durable : cas de la banane en Guadeloupe. *Cahiers Agricultures*, 11, 313-321

- FAO, 2003a. Banana projections to 2010. Committee on Commodity Problems. Intergovernmental Group on Bananas and on Tropical Fruits. Third Section, Puerto de la Cruz, Spain. 11-15 December. FAO. Rome.
- FAO. 2008. FAOSTAT database (PRODSTAT/Crops). <http://faostat.fao.org/>. (Accessed on 14/03/2008).
- Frémeaux P., 2003. Guadeloupe en progrès, mais peut mieux faire. *Alternatives économiques*, 215, 33-35.
- Giampietro, M., Cerretelli, G. and Pimentel, D., 1992a. Energy analysis of agricultural ecosystem management: human return and sustainability. *Agriculture, Ecosystems and Environment* 38: 219-244.
- Giampietro, M., Cerretelli, G. and Pimentel, D., 1992b. Assessment of different agricultural production practices. *Ambio* 21(7): 451-459.
- Heuze, S. 2005. Hydrological behaviour of banana crops on a tropical: estimation of the properties of an andosol and identification of the water processes at local scale. M.Sc. Dissertation. Cranfield University, Silsoe (GBR), 72 pp. Available at: <http://hdl.handle.net/1826/1294> (Accessed on 14/03/2008)
- INSEE, 2001. Tableaux Economiques de la Guadeloupe. Pointe à Pitre
- Lefroy, E.; Rydberg, T., 2003. Emergy evaluation of three cropping systems in southwestern Australia. *Ecol. Model.* 161:195-211.
- Little, V., 2000. Towards a Competitive Banana Industry in the Caribbean. *Comuniica on-line*. Year 4 Nr. 14. Available at: [http://webiica.iica.ac.cr/comuniica/n\\_14/english/art.asp?art=5](http://webiica.iica.ac.cr/comuniica/n_14/english/art.asp?art=5) (Accessed on 12/03/2008)
- Martin, J.F.; Diemont, S.A.W.; Powell, E.; Stanton, M.; Levy-Tacher, S., 2006. Emergy evaluation of the performance and sustainability of three agricultural systems with different scales and management. *Agri., Ecos. Environ.* 115:128-140.
- Odum, H.T., 1996. *Environmental Accounting: Energy and Environmental Decision Making*. John Wiley and Sons Inc., New York.
- Odum, H.T., 1998. Suggestion for a project for the International Society for Ecological Modelling: Representing simulation models with energy systems (pp. 1–11). In: *Ecomod, Newsletter of International Society for Ecological Modelling*, December 1998.
- Paggi, M.; Spreen, T., 2003. Overview of the world banana market. In: Josling, T. E.; Taylor, T.G. (Eds). *Banana Wars: The Anatomy of a Trade Dispute*. CABI Publishing. 240 p.
- Panzieri, M.; Marchettini, N., Bastianoni, S., 2002. A thermodynamic methodology to assess how different cultivation methods affect sustainability of agricultural systems. *Int. J. Sustain. Dev. World Ecol.* 9:1-8.
- Perret, S.; Dorel, M., 1999. Relationship between land use, fertility and Andisol behaviour: examples from volcanic islands. *Soil Use and Management* 15: 144-149.
- Pimentel, D.; Giampietro, M., 1994. Food, land, population and the U.S. economy. Carrying Capacity Network. Available at <http://dieoff.org/page40.htm> (Accessed on 12/03/2008)
- Rydberg, T.; Jansen, J., 2002. Comparison of horse and tractor traction using emergy analysis. *Ecol. Eng.* 19:13-28.

- SAHEL., 2008. Environmental Accounting and Systems Synthesis of Land Management Interventions at Multiple Scales in the Sahel Region of West Africa/ Database Resource./ France, 2000/ Table 2. At: <http://sahel.ees.ufl.edu/> (Accessed on 28/01/2008).
- Ulgiati, S.; Brown, M.T., 1998. Monitoring patterns of sustainability in natural and man-made ecosystems. *Ecol. Model.* 108:23-36.
- Ulgiati, S.; Odum, H. T.; Bastianoni, S. 1993. Emergy analysis of Italian agricultural system. The role of energy quality and environmental inputs. *In*: Bonati, L.; Consentino, U.; Lasagni, M.; Moro, G.; Pitea, D.; Schiraldi, A., (eds). Second International Workshop on Ecological Physical Chemistry, Milan. p. 187-215.
- Ulgiati, S.; Odum, H.T.; Bastianoni, S., 1994. Emergy use, environmental loading and sustainability. An emergy analysis of Italy. *Ecol. Model.* 73:215-268.

**Poster #30**

**Banana Sector in the French West Indies (FWI) in the 21<sup>st</sup> Century: Typology of Farmers' Room for Manoeuvre in Adapting their Cropping Systems to Crisis**

*Jean-Marc Blazy, M.Sc.; Jean-Louis Diman, M.Sc.; François Causeret; Danny Peregrine, M.Sc. INRA UR agropédoclimatique, Domaine Duclos, 97170 Petit-Bourg, Guadeloupe (FWI). diman@antilles.inra.fr*

**ABSTRACT.**

Production of bananas for export in the French West Indies is passing through a severe economic and environmental crisis. To help farmers in adapting their cropping systems to cope with these new constraints, local agronomic research is focusing on different innovative agro-management techniques. To improve the adoption of innovations, room for manoeuvre of farmers in adapting their cropping system had to be taken into account early in the innovation conception process. The objective of this paper is to present the construction of a farm typology which models the diversity of banana cropping systems management on a regional scale. Indicators were chosen with the help of a conceptual generic model of farmers' decision making. Data for typology elaboration was collected through interviews with a significant sample of farmers. The typology has been built by combining principal component analysis (PCA) and Agglomerative Hierarchical Clustering (AHC). Correspondence analysis (CA) and analysis of variance analysis (ANOVA) treatments were used to validate the pertinence of the final typology. Six different types of farm were found with a wide range in room for manoeuvre. While some types present high flexibility in terms of work resources reallocation due to the familial and non declared nature of workers, they are highly constrained by low financial margins, cash flow and land availability. The latter could include, for example, a strong limitation for the adoption of improved fallow. On the other hand, some types present high rooms for financial manoeuvre in terms of land use reallocation and financial resources mobilization. However, the latter type has no capacity for managing a temporary decrease in work demand because their manpower is abundant, mainly full-time established and contracted due to the importance of the scope of farm production. Finally, this paper discusses how such kind of study can improve the adoption of innovations through the early integration of farmer's room for manoeuvre as a framework of constraints into the innovation conception process.

**KEYWORDS:** banana sector; farmer's decision; typology; cropping systems; innovation



**Poster #31**

**Village du Millénaire : Expérience d'Haïti**

*Ronald Bien-aimé. Project Medishare, University of Miami  
bronald75@yahoo.es*

**RÉSUMÉ**

L'Université de Miami de concert avec l'Université de Floride met en œuvre le premier Village du Millénaire dans le Nouveau Monde. Ce projet assiste la Section communale de Marmont dans le Plateau Central pour qu'Haïti atteigne sûrement les objectifs 2015 des Nations Unies en lui fournissant des services de base (santé, agriculture et développement communautaire). L'UF a conçu un stimulant programme d'agriculture et d'environnement (janvier 2008), prenant en compte la réalité du pays, pour accroître la production, transformer les surplus, fournir des services de vulgarisation et nourrir 16,000 âmes. Engager la nouvelle génération a prouvé être une puissante stratégie de communication et est pensé comme étant plus durable dans le moyen et long terme en ce qui concerne la production agro-écologique.

Le Village est aussi un modèle de développement local qui présente les principales caractéristiques suivantes:

- a- L'approche est centrée sur les gens. Elle les place au cœur du développement, les fait participer de façon active et effective, considérant qu'elle les aide et les accompagne à atteindre leurs propres objectifs de développement.
- b- L'approche est holistique. Elle reconnaît l'effet d'influences multiples sur les gens, la présence ou l'apport d'acteurs divers (Gouvernement, ONG, entreprises privées et publiques, organisations de base), l'adoption de stratégies variées par les individus pour s'assurer des moyens d'existence durables.
- c- L'approche est dynamique. Elle met à profit les leçons apprises de manière à renforcer les tendances évolutives positives et à contribuer à réduire les négatives.
- d- L'approche renforce les qualités. Elle priorise les qualités aux besoins. Elle se propose d'aider les gens à devenir plus résistants, plus forts, mieux préparés et mieux capables d'atteindre leurs propres objectifs.
- e- Le modèle prône une approche multidisciplinaire, interinstitutionnelle et intersectorielle.
- f- Le développement du modèle s'appuie sur l'utilisation et l'exploitation des ressources humaines et environnementales disponibles localement.

En somme, le Village du Millénaire repose sur la base stratégique de la réduction de la pauvreté pour l'amélioration des conditions de vie de la population de Marmont.

**MOTS CLÉ:** développement holistique, Village du Millénaire, Haïti

## FORAGE AND LIVESTOCK

2008 Proceedings of the Caribbean Food Crops Society. 44(2):463-472. 2008

### Poster #32

#### Effects of Palm Kernel Cake on Daily Gain and Carcass Yield of Broiler Chicks; Efecto de la Sustitución de Palmiste por Maíz en la Dieta de Pollo Engorde Sobre la Ganancia Diaria y el Rendimiento de Canal

*Neirin Matos, Rosina Polanco, Carlos M. De Jesús<sup>1\*</sup>, and Rafael A. Vásquez<sup>2</sup>*  
*Department of Animal Science<sup>1</sup>; Facultad de Ciencias Agroalimentarias y del Ambiente<sup>2</sup>;*  
*Universidad ISA; Ave. Antonio Guzmán Fernández, Km 51/2, La Herradura, Santiago,*  
*Dominican Republic. cdejesus@isa.edu.do*

#### ABSTRACT.

Corn and soybean meal, used in the diet of broiler chickens are expensive and they are imported commodities in the Dominican Republic. Therefore, feeding alternatives to these ingredients are needed in this country. Palm kernel cake (PKC) has shown to improved body weight and feed conversion of chickens, pig and cattle. However, it has not been evaluated in the Dominican Republic conditions. The objective of this study was to evaluate the effect of PKC on broiler performance and carcass yield at 43 days of age. Two separate trials were conducted using a total of 200 chicks per trial and the results were combined for the statistic analysis. These chicks were randomly distributed in five treatment groups (40 chicks/treatment group/trial). The treatment groups include a normal corn-soybean meal diet, which met or exceeded the nutritional requirements of NRC, 1994 or the same diet with 6%, 12%, 24% and 30% of PKC. Chickens were weighted weekly and the feed intake was registered daily. The feed intake for the whole period of the experiment (43 days) was significant higher at 6%, ( $3.04 \pm 0.18$  kg) 12% ( $3.38 \pm 0.18$  kg), 24% ( $3.63 \pm 0.18$  kg) and 30% ( $3.60 \pm 0.18$  kg) compared to PKC control diet ( $2.42 \pm 0.18$  kg). The PKC treatments increased the daily weight gain ( $56.40 \pm 1.06$  g/d (from day 0 to 43) at 12 % compared to 0% ( $44.75 \pm 1.06$  g/d). The feed efficiency was improved at 6% PKC ( $79.34 \pm 1.40$ ) compared to 30% ( $62.14 \pm 1.39$ ). Carcass yield was not affected by the PKC levels. The data of the present study suggest that the addition of PKC in the diet of chicken may substitute the corn without affecting chicken performance; moreover, PKC may represent an alternative to reduce the cost in the poultry industry

**KEYWORDS:** Chicken, palm kernel cake, daily gain

#### INTRODUCCION

La producción de pollos en la República Dominicana, ha mostrado un crecimiento importante en los últimos años y es fácil entender el motivo, la cría de pollos no tiene restricciones u objeciones religiosas en cuanto a su consumo, cuenta con bajos niveles de colesterol y es rápida su producción, cualidades importantes para satisfacer al consumidor moderno. Así mismo, este auge se evidencia en las siguientes cifras: para el año 2005 se

produjeron 296,642 TM de carne de pollo, (Cabrera, 2006), representando un consumo per cápita entre 29.5 a 34 kg /año, lo que explica la importancia de este rubro en la economía del país y como fuente de proteína en la dieta del dominicano, (Oficina de la Presidencia, 2005).

La alimentación de los pollos de engorde juega un papel muy significativo en la sustentabilidad del sector avícola, ya que la contribución de la alimentación en el costo total de producción se ubica entre 70 y 80% (León *et al*, 1991). Tomando esto en consideración podría ser el momento oportuno para dinamizar el sector agropecuario mediante cambios profundos de las prácticas tradicionales, ya que la explotación avícola está relacionada con la utilización de alta tecnología y el uso de cereales y soya, teniendo una influencia directa en el factor económico, debido a que la adquisición de estas materias se encuentran sujeta al constante cambio monetario de la tasa del dólar y a las políticas de importación que rigen para cada país.

El uso de materiales regionales de bajo costo se convierte en una de las opciones más recomendadas, una alternativa de subproducto agroindustrial lo constituye el palmiste, material obtenido de la extracción mecánica de aceite de la nuez de la palma africana (*Elaeis guineensis*) con niveles de energía metabolizable de 2,198 Kcal. Kg.; 15.6% de proteína cruda, 0.27% de calcio y 0.61% de fósforo, lo que permite definirlo como un producto de alto potencial nutricional (Vargas y Zumbado, 2003), para sustituir los ingredientes principales en la dieta de pollos.

En ese sentido se han llevado a cabo varias investigaciones en el país utilizando este subproducto agroindustrial en monogástricos y rumiantes, sin embargo, aun no existen publicaciones nacionales en donde se haya estudiado el uso del palmiste en la alimentación aviar. Aunque, en el caso de cerdos en etapa de desarrollo y engorde, específicamente estudios realizados en la universidad de Costa Rica en 1992 no recomiendan incluir más de 10% en la dieta y en la alimentación de cerdas gestante se permite un máximo de un 20% (Campabadal y Navarro, 2002), mientras, en pollos de engorde y pollas ponedoras la incorporación de un 15% no afectó los parámetros zootécnicos de los animales (Vilariño *et al*, 1996).

Consecuentemente otros ensayos realizados por Zumbado *et al*, 1992, indican que la inclusión entre 10 y 12 % de palmiste en dietas de pollos de engorde mejoró significativamente la ganancia de peso y la conversión alimenticia de los animales, demostrando ser una excelente alternativa como fuente de energía. De igual forma, Marín (1987) y Chavarria (1987) citados por (Zumbado y Jackson, 1996) encontraron que era factible utilizar hasta 20% de palmiste sin afectar el rendimiento de pollos de engorde durante los primeros 28 días de edad, siendo evidente la importancia que tiene este subproducto como ingrediente alternativo en la alimentación avícola. Por lo tanto se plantea un estudio para evaluar la inclusión de cinco niveles de palmiste en dietas de pollo de engorde.

## **MATERIALES Y METODOS**

### **Animales y corrales**

400 pollos de ambos sexos de la Línea Cobb 500 de un día de edad fueron distribuidos en los distintos tratamientos. Se recibieron dos repeticiones de 200 pollos bebe, los cuales se provinieron de un mismo lote de gallinas reproductoras. Los períodos

de las repeticiones fueron 13 Julio al 24 Agosto y 11 Septiembre al 24 de Octubre del 2007. Las aves fueron alojadas en una nave experimental con dirección Este-Oeste, se construyeron 10 corrales de 1.0 Pie<sup>2</sup>/animal con una capacidad para 20 pollos. Cada pollo se identifico con una cinta en la pata acorde con el tratamiento y la repetición.

### **Diseño experimental**

Se utilizó un diseño completamente al azar (DCA) con cinco tratamientos y cuatros repeticiones, cada tratamiento tuvo 20 pollos por repetición. Se realizaron dos repeticiones en tiempo con el objetivo de incrementar el número de animales por tratamiento y debido a las limitaciones de las facilidades del área experimental que sólo permitía tener dos repeticiones por tratamiento.

El modelo estadístico que se utilizó para analizar la variación entre los tratamientos y el error fue el siguiente:

$$Y_{ij} = \mu + P_i + E_{ij}$$

Donde:

$Y_{ij}$  = Valor observado de la variable A.

$\mu$  = Media general.

$P_i$  = Efecto de los niveles de palmiste (0, 6,12, 24 y 30%)

$E_{ij}$  = Efecto del error experimental

Las variables estimadas y calculadas en los distintos tratamientos fueron: Consumo del alimento diario (g), Ganancia diaria de peso de los pollos (g), Conversión alimenticia (%), Rendimiento de la canal (%) y la Relación Beneficio \ Costo .

### **Tratamientos**

Los tratamientos consistieron en la inclusión de cinco (0, 6, 12, 24 y 30%) niveles de palmiste en dietas de pollo de engorde. La dieta estuvo constituida por mezcla de maíz, soya, premezcla de vitaminas y minerales, aditivos y el nivel de inclusión de palmiste. Todos los tratamientos estuvieron en iguales condiciones ambientales y de manejo.

Los tratamientos consistieron en la inclusión de los siguiente niveles de palmiste:  $T_0$ =Testigo, 0% de palmiste;  $T_6$ = 6% de palmiste;  $T_{12}$ =12% de palmiste;  $T_{24}$ =24% de palmiste;  $T_{30}$ =30% de palmiste.

### **Manejo del Experimento**

Se utilizó un programa de alimentación basado en tres etapas fisiológicas de acuerdo a los días de vida: 0 - 3 semanas, etapa inicial, 3 - 6 semanas etapa de crecimiento, 6 - 7 semana etapa de engorde o finalización. El agua y el alimento fue suministrado a voluntad, con el objetivo de que los pollos siempre tuvieran alimento y agua disponible. La composición de las dietas en las fases de inicio, crecimiento y finalización se formularon según a los requerimientos de la NRC, 1994 de energía metabolizable, proteína, macro y microminerales y vitaminas en las distintas etapas de desarrollo y la guía de manejo Coob-Vantress Inc.,1994.

Una semana antes de la llegada de los pollitos la nave fue lavada y desinfectada con la aplicación de creolina, yodo y cal viva, luego se cubrió el piso con cascarilla de arroz hasta formar una capa de aproximadamente 5 cm de espesor. El galpón fue protegido con cortinas para contrarrestar las corrientes de aire e impedir la entrada de la lluvia y con esto proteger a los pollitos a cambios de temperatura. A partir de los 8 días se subieron las cortinas en el día y se bajaron en la noche hasta los 15 días, luego se dejaron subida todo el tiempo y sólo se bajaron en caso de lluvia o vientos fuertes.

Se utilizaron calentadores a base de gas, los cuales se encendieron una hora antes de la llegada de los pollitos y se utilizaron para mantener la temperatura constante dentro de la nave, hasta los 8 días de instalado el experimento. Además se instalaron comederos de tolvas a razón de uno por cada 20 pollos hasta el día 10 donde fueron sustituidos por comederos de tubo. Se utilizaron bebederos de galón uno por cada 20 pollos, hasta los 8 días siendo reemplazados por bebederos de campana.

A la llegada de los pollitos se preparó una solución anti estrés disolviendo un sobre de vitaminas con electrolitos (227 g/ 700 gl de agua), durante el día 1 para hidratar y suministrar energía a los pollitos y disminuir el estrés causado durante el transporte desde la incubadora hasta la granja. En los primeros tres días de iniciado el experimento se inspeccionaba constantemente el funcionamiento de las calentadoras, la temperatura debajo de estas y el efecto de la misma en el comportamiento de los animales.

Desde el inicio del estudio se aplicó un programa de vacuna oral preventiva contra las enfermedades de Newcastle, Gumboro y Bronquitis según las instrucciones de los laboratorios fabricantes. Frecuentemente fue lavado y desinfectado el tinaco destinado para el abastecimiento del agua, una vez higienizado y llenado de nuevo se le aplicaba cloro (0.01%) al agua de bebida.

Durante toda la fase experimental, los comederos se movieron constantemente para estimular el consumo de los animales, se suministró alimento a tiempo y en cantidad suficiente. Los bebederos se higienizaban dos veces al día con yodo, se mantuvo buena ventilación e higiene tanto dentro como fuera de la granja.

### **Análisis de Datos**

Los datos recolectados en las variables evaluadas fueron sometidos a un análisis de varianza usando el cuadrado mínimo del modelo lineal general (GLM) con el programa estadístico SAS<sup>TM</sup> 8.1 Inc. Si hubo diferencias significativas las medias fueron sometidas al análisis de separación de medias de Tukey a un nivel de confiabilidad de 95%.(Cody y Smith ,1997).

## **RESULTADOS Y DISCUSION**

### **Consumo**

El consumo de alimento durante el periodo de iniciación 0-21 días (grafica1) fue significativamente ( $P>0.05$ ) mayor en los niveles 24 y 30% del palmiste, con un consumo de  $1.01 \pm 0.06$  kg y  $1.13 \pm 0.06$  kg comparado con el tratamiento sin palmiste, en el cual el consumo de alimento fue de  $0.76 \pm 0.06$  kg . El consumo obtenido en este estudio en la etapa de iniciación de (0-21 d) es superior a los reportados por Peña y Guerrero (1996) al evaluar el efecto de la inclusión de harina de semillas de palma real de

0, 5, 10, 15 y 20% como fuente energética en la alimentación de pollos de engorde (0.520, 0.720, 0.583, 0.764 y 0.809 kg).

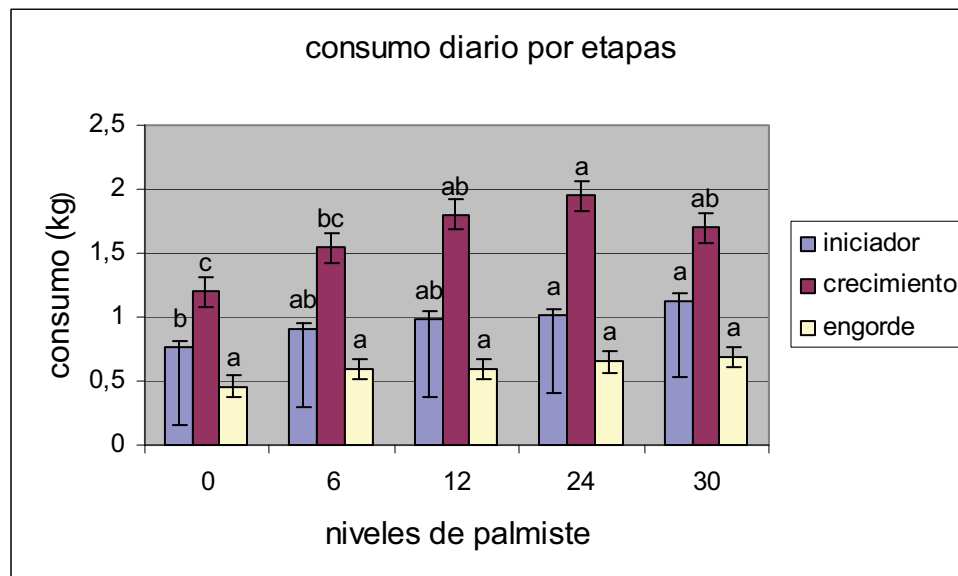

**Figura 1** Efecto de los niveles de palmiste en el consumo de pollo de engorde

En cuanto al consumo total durante la etapa de crecimiento 22-35 días (grafica 1) existen diferencias significativas ( $P>0.05$ ) entre los niveles 12, 24 y 30% que obtuvieron consumos de  $1.80 \pm 0.12$ ,  $1.95 \pm 0.12$  y  $1.77 \pm 0.12$  kg con relación al nivel 0% que obtuvo un consumo de  $1.20 \pm 0.12$  kg de alimento. Estos resultados coinciden con los reportados por Zumbado (1992) quien evaluaba el efecto de la composición de palmiste en pollos de engorde (0, 5, 10,15 y 20%) hasta los 28 días.

En la etapa de engorde (grafica 1) se puede observar que los animales no mostraron diferencias significativas( $P>0.05$ ) en cuanto al consumo de alimentos, sin embargo, en el consumo promedio total del experimento (0-43 días) se encontraron diferencias ( $P>0.05$ ) estadísticamente superiores entre los niveles con palmiste, los cuales presentan consumos de  $3.04 \pm 0.18$ ,  $3.34 \pm 0.18$ ,  $3.63 \pm 0.18$  y  $3.6 \pm 0.18$  kg, respectivamente, con relación al nivel 0% de palmiste, el cual mostró un consumo total de  $2.43 \pm 0.18$  kg. Al comparar estos resultados son superiores con los obtenidos por Belliar y Ropceau (1996) quienes evaluaron la inclusión de diferentes niveles de harina de guineo de rechazo como fuente de energía en la alimentación de pollos de engorde.

### Ganancia Diaria

En lo referente a la ganancia diaria total durante la etapa de iniciador (0-21 días) (tabla 1) existen diferencias significativas ( $P>0.05$ ) entre los niveles 0 y 6% los cuales presentan ganancia de 72.95 y 73.83 g en comparación con los niveles 24 y 30% que obtuvieron ganancia de 77.23 y 78.27 g con relación al nivel 12% que muestra 83.91 g de ganancia.

**Tabla 1.** Efectos del palmiste sobre la ganancia diaria en pollo de Engorde

Ganancia (g)	iveles de inclusión de Palmiste %				
	0	6	12	24	30
<b>Sem 1</b>	14.04 ± 0.39c	15.76 ± 0.39b	18.84 ± 0.39a	16.26 ± 0.39b	17.92 ± 0.39a
<b>Sem 2</b>	25.23 ± 0.94c	32.01 ± 0.94b	37.03 ± 0.94a	34.31 ± 0.94b	33.44 ± 0.94b
<b>Sem 3</b>	41.03 ± 1.74c	54.54 ± 1.74b	66.71 ± 1.74a	57.21 ± 1.74b	54.23 ± 1.74b
<b>Total iniciador</b>	72.95±1.166c	73.83±1.166c	83.91 ±1.16a	77.23 ±1.15b	78.27± 1.15b
<b>Sem 4</b>	54.13±2.43c	73.59± 2.43 a	64.30± 2.43 b	72.48± 2.43 a	65.17±2.43b
<b>Sem 5</b>	65.97±2.58b	74.35± 2.58 a	76.29± 2.58 a	73.16± 2.58 a	79.24±2.58a
<b>Total crecimiento</b>	129.79±1.75ab	125.95±1.75b	134.76±1.78a	129.56±1.75ab	130.03±1.75ab
<b>Sem 6</b>	67.04±2.53c	75.08±2.53ab	73.67± 2.53bc	81.36± 2.53a	70.92±2.53bc
<b>Total engorde</b>	60.07±2.022c	70.26±1.99b	73.91±2.021ab	78.44±1.99a	73.15±1.99ab
<b>G/D Total</b>	44.75 ± 1.06b	54.04 ± 1.06 a	56.40 ± 1.06a	55.99 ± 1.06 a	53.49 ± 1.06a

Nota: Letras diferentes en filas presentan diferencias significativas ( $P \leq 0.05$ ), entre las medias ( $\pm$  error estándar)

En cuanto a la ganancia diaria total durante la etapa de crecimiento ( 22-35 días) (tabla 1) existen diferencias significativas ( $P > 0.05$ ) entre el nivel 6% que presenta una ganancia de 125.95 g con relación al 12% que muestra 134.76 g de ganancia de peso, por lo que al comparar estos resultados con los reportado por Zumbado (1992) quien evaluaba el efecto de la composición de palmiste en pollos de engorde ( 0, 5,10,15 y 20%) hasta los 28 días muestran mayores ganancia de peso a medida que se aumentaron los niveles de palmiste (864 g/d).

En la ganancia diaria total durante la etapa de engorde (35-43 días) (tabla 1) muestran diferencias significativas ( $P > 0.05$ ) el nivel 6% que presenta una ganancia 70.26 g con relación al 24% que obtuvo 78.44g de ganancia de peso respectivamente, asimismo, se observan diferencias significativas entre los niveles 6, 12,24 y 30 % con relación al nivel 0 % de palmiste que muestra una ganancia de 60.07g de peso.

Como se puede observar en la ganancia diaria total del experimento ( 0 – 43 días) (tabla 1) muestran diferencia estadísticamente superiores en los niveles 6, 12, 24, 30%, los cuales presentan ganancia de 54.04g, 56.40g, 55.99g y 53.49g con relación al nivel

0% de Palmiste, el cual mostró una ganancia de  $44.75 \pm 1.06$  g. y semejanza a un estudio hecho por Sundu y Dingle (2004) sobre el uso de una enzima para mejorar el valor nutritivo de la dieta con palma y copra en pollos quienes reportaron diferencias significativas en la ganancia de peso diaria y obtuvieron por ende un peso de  $621.9 \pm 22$  g mayor que en este experimento.

### **Eficiencia Alimenticia**

En la eficiencia alimenticia (tabla 2) Los niveles 6 y 12% no difieren del control, sin embargo, se presenta diferencias estadísticas en los tratamientos 24 y 30% comparado con el tratamiento control 0% y el 6%.

**Tabla 2.** Efecto del palmiste sobre la eficiencia alimenticia en pollo de engorde

Niveles de inclusión de palmiste	Eficiencia Alimenticia
0%	75.92 $\pm$ 1.40a
6%	79.34 $\pm$ 1.40a
12%	70.55 $\pm$ 1.41ab
24%	65.13 $\pm$ 1.39b
30%	62.14 $\pm$ 1.39b

Nota: Letras diferentes en filas presentan diferencias significativas ( $P \leq 0.05$ ), entre las medias ( $\pm$  error estándar)

### **Rendimiento de canal**

Los pesos vivos (tabla 3) fueron estadísticamente superiores en los niveles 6,12,24 y 30% los cuales obtuvieron pesos de 2566.6, 2629.5, 2652.2 y 2652.5 g en comparación al nivel 0% de palmiste que alcanzó 2250.0 g de peso. De igual forma para la canal caliente (tabla4) presentan diferencias significativas ( $P > 0.05$ ) los tratamientos con palmiste quienes consiguieron 1920.8g, 1970g, 1922.08g, 1957.5g de peso con relación al nivel 0% que obtuvo 1662.5g de peso. Mientras que para el rendimiento de la canal (tabla 4), no se aprecian diferencias significativas ( $P > 0.05$ ) entre los tratamientos. Con relación a la grasa abdominal se presentan diferencias significativas ( $P > 0.05$ ) el nivel 0% que presenta un peso de 20.03 g con relación a los niveles 12 y 24% los cuales muestran 31.63 y 30.53 g de peso.



**Tabla 3.** Características de la canal de cabritos mestizos estabulados.

Descripción	Niveles de inclusión de palmiste %				
	0	6	12	24	30
<b>Peso vivo(g)</b>	2250.0±81.1 b	2566.6±81.1 a	2629.5±81.1a	2652.5 ±81.1a	2652.5±81.1a
<b>Canal cal.(g)</b>	1662.5±70.9 b	1920.8±70.9 a	1970.0±70.9a	1922.08±70.9a	1957.5±70.9a
<b>Rend. canal(%)</b> en	73.575±1.61 a	75.073±1.61a	75.221±1.6a	72.415±1.61 a	73.809±1.61 a
<b>Grasa abd.(g)</b>	20.033±2.9 b	26.766±2.9ab	31.633±2.9a	30.525±2.9a	24.191±2.9ab
<b>Pechuga(g)</b>	512.5±29.8 b	620.8±29.8 a	615.0±29.8 a	620.0 ±29.8 a	638.7±29.8a
<b>Muslo Corto(g)</b>	255.1±12.79 b	276.4±12.7ab	305.5±12.7 a	284.1 ±12.7ab	295.5±12.7a

Nota: Letras diferentes en filas presentan diferencias significativas ( $P \leq 0.05$ ), entre las medias entre las medias ( $\pm$  error estándar)

Al evaluar los pesos de la pechuga (tabla 3) se puede observar diferencias significativas ( $P > 0.05$ ) entre el nivel 0% que obtuvo un peso de 512.5g con relación a los niveles 6, 12, 24 y 30% los cuales obtuvieron peso de 620.8, 615.0, 620.0 y 638.7g, respectivamente al confrontarlos con un estudio de (Okeudo et al., 2005) sobre el crecimiento, características de la canal y calidad organoléptica de niveles de palma en pollos (0, 10, 20, 30%), resultan ser mejores y significantes. De igual forma para el muslo corto (tabla 3) se presentan diferencias significativas ( $P > 0.05$ ) el nivel 0% que muestra 255.1g de peso con respecto a los niveles 12 y 30% los cuales presentan peso de 305.5 y 295.5g.

### Analisis Economico

En el análisis económico (tabla 4), se determinó que el mayor beneficio neto por animal (RD\$ 9.69) fue obtenido con una ración de 24% de palmiste en la dieta de pollos de engorde seguido por el tratamiento 12% y 6% presentando una mayor relación beneficio-costos los niveles de inclusión de 24% 12 y 6% respectivamente Sin embargo, el costo de producción mayor por animal fue (RD\$80.69) registrado en el nivel 12% y el menor (RD\$ 74.38) se registro en el nivel 0%.

**Tabla 4** Relación Beneficio-Costo del engorde de pollo de engorde con la inclusión de cuatro niveles de palmiste

<b>Ingreso y costo por animal vivo</b>	<b>0</b>	<b>6</b>	<b>12</b>	<b>24</b>	<b>30</b>
Ingreso, RD\$/animal	71.22	86.12	90.23	89.04	85.08
Costos, RD\$/animal	74.38	76.83	80.69	78.66	78.64
Beneficio Brutos, RD\$/animal	-3.16	9.30	9.53	10.38	6.44
Interés, 20 % anual del total costos	-0.21	0.62	0.64	0.69	0.43
Beneficio Neto	<b>-2.95</b>	<b>8.68</b>	<b>8.90</b>	<b>9.69</b>	<b>6.01</b>
<b>Relación B/C</b>	<b>0.96</b>	<b>1.12</b>	<b>1.12</b>	<b>1.13</b>	<b>1.08</b>

### CONCLUSIONES Y RECOMENDACIONES

En base a los resultados obtenidos en la evaluación del Efecto de la sustitución de maíz (*Zea mays*) por palmiste (*Elaeis guineensis*) en dietas de pollos de engorde se puede concluir que el palmiste afecta positivamente el consumo de alimento, ganancia diaria y rendimiento en canal caliente de los pollos de engorde comparado con el control y que el nivel de 6% presenta una mejor relación beneficio- costo. Sin embargo, un nivel palmiste mayor de 24% en pollos de engorde afecta negativamente la eficiencia alimenticia comparada con el control.

### REFERENCIAS

- Belliard, C. Ropceau, M. A . 1996. Evaluación de la inclusión de diferentes niveles de la Harina de guineo de rechazo como fuente de energía en la alimentación de pollo de engorde. Tesis Ing.Zootecnista, Programa ISA, Santiago, Rep. Dom.
- Campabadal, C. M., Navarro, H. 2002. Alimentación de los cerdos en condiciones tropicales. Colonia Los Morales Polanco, México D.F, 3era ed. Editora Segrain, S.A. Pág. 207-208.
- Cabrera, C. 2006. Banco Central. Obstáculo no impiden lograr metas productivas.
- Cobb – Vantress, Inc. 1994. Guía de manejo para el parrillero Cobb 500. Arkansas. USA.
- Cody, R. P. y Smith J. K. 1997. Applied Statistic and the SAS Programming Language. Fourth Ed. Prentice Hall, New Jersey. U.S.A.
- Dingle, J. G. 2005. Palm kernel meal in broiler diets: effect on chicken performance and health. School of Animal Studies. The University of Queensland. Australia.
- Oficina de la Presidencia. 2005. Presidencia de la República Dominicana, Septiembre 2005. Autoridades agropecuarias planifican con avicultores producción de pollo. <http://www.presidencia.gov.do>.
- Okeudo N.J., Eboh K.V., Ndidi, Izugboekwe V., Akanno E.C. 2005. Growth rate, carcass, characteristics and organoleptic quality of broiler fed graded levels of palm kernel cake.
- National Research Council. Nutrient Requirements of Poultry. 1994. National Academy Press Washington, D. C. Pag. 27.

- Sundu, B y Dingle, J.G. 2004. Use of enzymes to improve the nutritional value of palm kernel meal and copra meal. Queensland Poultry. Sci. Symp. Australia.
- Vargas, E., Zumbado, M. E. 2003. Composición de los subproductos de la industrialización de la palma africana utilizados en la alimentación animal en Costa Rica. *Agronomía Costarricense*: 07-16.
- Vilariño, M., León, M., Picard, M. 1996. Efecto de la composición y presentación del alimento sobre el comportamiento de las aves en clima tropical. Centro Nacional de Investigaciones Agropecuaria de Venezuela (Ceniap).
- Zumbado, M.; Jackson, F. 1996. Efecto de la presencia de endocarpo en el palmiste integral (*Elaeis guinensis*) sobre su valor nutritivo. II. Rendimientos de pollos de engorde en iniciación. *Agronomía Costarricense*: 145-149.
- Zumbado, M.; Madrigal, S.; Marin, M. 1992. Composición y valor nutricional del palmiste o coquito integral de palma africana (*Elaeis guinensis*) en pollos de engorde. *Agronomía Costarricense*: 83-89.

**Poster #33**

**Evaluación de Nitrogeno Líquido (ULB-35®) para la Producción de Forraje en Puerto Rico**

*Alexander Recamán-Serna<sup>1</sup>, David Sotomayor Ramírez<sup>1</sup>, Yamil Quijano<sup>1</sup>, y Gilberto Lozada<sup>2</sup>. <sup>1</sup> Universidad de Puerto Rico, Colegio de Ciencias Agrícolas, Departamento de Agronomía y Suelos, Mayagüez, Puerto Rico, <sup>3</sup>Pan American Fertilizer, Guánica, PR. \* Autor de contacto: dsotomayor@uprm.edu*

**RESUMEN.**

La fertilización con nitrógeno (N) representa el costo más alto en la producción de forrajes debido a que se requieren altos niveles de N para lograr altos rendimientos y contenido protéico. En Puerto Rico, gran parte de la producción de forraje, está destinada para satisfacer la demanda de la industria lechera, por lo que es importante mantener su estabilidad a largo plazo. La utilización de N en forma de urea líquida (ULB-35®) puede mantener los niveles de producción, mejorar la eficiencia de utilización de N, y reducir los costos de producción. Se realizaron tres experimentos en tres fincas comerciales (Lajas, Sábana Grande y Arecibo) para evaluar la eficacia de ULB-35® sobre la producción y rendimiento del forraje. En Lajas, se evaluaron tres niveles de ULB-35® (112, 224 y 336 kg N/ha\*año) y se compararon con 336 kg N/ha\*año de 15-5-10 (N-P<sub>2</sub>O<sub>5</sub>-K<sub>2</sub>O) granulado. En Sábana Grande, se evaluaron tres fuentes de N: ULB-35®, sulfato de amonio (SA) y mezcla completa de 15-5-10, a una dosis de 336 kg N/ha\*año. En ambos casos, se complementó con fósforo (P) y potasio (K), proporcional a los niveles aplicados con 15-5-10. En Arecibo, se evaluó la aplicación de ULB-35® en tres concentraciones de N diferentes (1.5% N, 3% N y 7.5% N) y un control con sulfato de amonio. Los resultados indican que en Lajas, la producción de materia seca de forraje fue mayor para el tratamiento con 15-5-10, seguido de los niveles medio, alto y bajo de ULB-35®. En Sábana Grande, la producción de materia seca de forraje fue mayor para ULB-35®, seguido por 15-5-10 y SA. En Arecibo, la producción de materia seca fue mayor para SA, seguido por las concentraciones baja, media y alta de ULB-35®. Es necesario evaluar formas alternas de aplicación de ULB-35®, para mejorar la eficiencia de utilización en la producción de forraje.

**PALABRAS CLAVE:** urea líquida, forraje, fertilización

**Poster #34**

**Técnicas de Aplicación de Nitrogeno Líquido (ULB-35®) en la Producción de Forraje en Puerto Rico**

*Alexander Recamán-Serna<sup>1</sup>, David Sotomayor-Ramírez<sup>1\*</sup> y Gilberto Lozada<sup>2</sup>*

*<sup>1</sup>Universidad de Puerto Rico, Colegio de Ciencias Agrícolas, Departamento de Agronomía y Suelos, Mayagüez, Puerto Rico, <sup>2</sup>Pan American Fertilizar, Guánica, PR. \* Autor de contacto: dsotomayor@uprm.edu*

**RESUMEN.**

La fertilización con nitrógeno (N) en la producción de forrajes de corte y pastoreo, se realiza en forma granulada al voleo mediante equipos especiales. Sin embargo, muchas de las vaquerías y fincas productoras de forraje, cuentan con sistemas de riego por aspersión que son utilizados normalmente durante la época seca. La inyección de un fertilizante líquido, al sistema de riego podría mejorar la eficiencia de aplicación y reducir los costos de producción de forraje. El material ULB-35® es una fuente de urea-N líquido con 15% de N que no contiene metales pesados, patógenos y con bajo biuret disponible en el mercado de Puerto Rico. El costo del material es 68 y 200% más barato que la misma cantidad de N en forma de urea y sulfato de amonio, respectivamente. El uso de ULB-35®, como fuente de N, es una opción que debe ser evaluada y cobra mayor importancia cuando se mezcla con los residuos orgánicos de vaquerías aplicados a pasturas ya que puede mejorar la eficiencia en la utilización del N y aumentar el valor nutritivo del forraje. Se demostrarán las técnicas de inyección de N líquido a pasturas, en la tubería de succión de la bomba del sistema de aspersión de residuos orgánicos, en el sistema de riego aéreo por cañones, sistema de riego con pivote central y por aspersor móvil.

**PALABRAS CLAVE:** sistema de riego, urea líquida, forraje, fertilización.

**Poster #35**

**Plant Density and Dry Matter Yield of 'Ubon Stylo' (*Stylosanthes guianensis*) in an Oxisol of Puerto Rico**

Jorge Luis Olivares-Lopez<sup>1</sup>, Elide Valencia<sup>2</sup>, and Abner Rodríguez-Carías<sup>3</sup>. <sup>1</sup>Graduate Student, Agronomy and Soils Department; <sup>2</sup>Professor, Department of Agronomy and Soils, Univ. of Puerto Rico, Mayagüez, and <sup>3</sup>Professor, Department of Animal Industry, Univ. of Puerto Rico, Mayagüez. [jolivares67@hotmail.com](mailto:jolivares67@hotmail.com)

**ABSTRACT.** The focus of this research was to evaluate plant density and dry matter yield of 'Ubon Stylo' (*Stylosanthes guianensis*) (95% germination) at seeding rates of 5, 10, 15, and 20 kg/ha. 'Ubon Stylo' was planted in August 2007 at the Isabela Substation of the Agricultural Experimental Station, University of Puerto Rico. The aftermath (first harvest) was 100 days after establishment. The experimental design was a complete randomized block with four replicates for the seeding rates. Variables assessed were: 1) Ubon Stylo and weed density (number of emerged plants in 1 m<sup>2</sup>) and dry matter yield (DMY; kg/ha). There were significant differences (p<0.05) between plant density of Ubon Stylo and weed species. Ubon Stylo plant density averaged 82 plants/m<sup>2</sup> determined at the highest seeding rate (20 kg/ha). There was significant difference in DMY among seeding rates. Lowest DMY yield was observed at low seeding rate of 5 kg/ha (2758 kg/ha), but no difference was observed between the 10 (5,200 kg/ha) and 15 kg/ha (4752). Planting at a high rate 20 kg/ha (6100 kg/ha), although statistically significant from other rates, does not justify seed costs. It is concluded that seeding rates of Ubon Stylo between 10 and 15 kg/ha provides adequate plant densities and excellent DMY.

**KEYWORDS:** Ubon Stylo, plant density, Dry matter yield.

**Densidad de Siembra y Rendimiento de Materia Seca de ubon stylo (*Stylosanthes guianensis*) en un Oxisol de Puerto Rico**

Olivares-López, J. L.<sup>1</sup>, E. Valencia<sup>2</sup>, y A. Rodríguez-Carías<sup>3</sup>. <sup>1</sup>Estudiante Graduado, Departamento de Agronomía y Suelos, Universidad de Puerto Rico, Mayagüez., <sup>2</sup>Catedrático, Departamento de Agronomía y Suelos, Universidad de Puerto Rico, Mayagüez y <sup>3</sup>Catedrático, Departamento de Industria Pecuarias. Box 9030, Mayagüez, PR 00681

[Jolivares67@hotmail.com](mailto:Jolivares67@hotmail.com)

**RESUMEN:**

El enfoque de esta investigación fue evaluar el efecto de cuatro tasas (5, 10, 15, y 20 kg/ha) de siembra de 'Ubon Stylo' (*Stylosanthes guianensis*; 95% de germinación) en densidad de plantas y rendimiento de materia seca (MS). Ubon Stylo fue sembrado en agosto 2007 en la Subestación de Isabela de la Estación Experimental Agrícola,

Universidad de Puerto Rico. La cosecha fue a 100 días después de establecido. El diseño utilizado fue en bloques completos aleatorizados con cuatro repeticiones para las densidades de siembra. Las variables evaluadas fueron: 1) densidad de Ubon Stylo y malezas (numero de plantas emergidas en 1 m<sup>2</sup>) y 2) rendimiento de materia seca (RMS). Se encontró diferencia significativa ( $p < 0.05$ ) entre las densidades y especies de plantas, basados en el número de plantas de Ubon Stylo y malezas. El mayor número de plantas de Ubon Stylo (82 plantas/m<sup>2</sup>) se observó en tasas de siembra de 20 kg/ha. Hubo diferencia significativa para el RMS entre la tasas de siembra de 5 kg/ha (2758 kg/ha) y las otras tasas, pero no se encontro diferencias entre tasas de 10 (5200 kg/ha) y 15 kg/ha (4752 kg/ha). EL RMS en la tasa de siembra de 20 kg/ha (6100 kg/ha) aunque estadísticamente significativa, no justifica la inversión en costo de semilla. En conclusión, tasas de siembra entre 10 a 15 kg/ha de Ubon Stylo provee una alta densidad y excelente RMS.

**PALABRAS CLAVES:** Ubon Stylo, densidad de plantas, rendimiento de materia seca.

**ABSTRACT.** The focus of this research was to evaluate plant density and dry matter yield of 'Ubon Stylo' (*Stylosanthes guianensis*) (95% germination) at seeding rates of 5, 10, 15, and 20 kg/ha. 'Ubon Stylo' was planted in August 2007 at the Isabela Substation of the Agricultural Experimental Station, University of Puerto Rico. The aftermath (first harvest) was 100 days after establishment. The experimental design was a complete randomized block with four replicates for the seeding rates. Variables assessed were: 1) Ubon Stylo and weed density (number of emerged plants in 1 m<sup>2</sup>) and dry matter yield (DMY; kg/ha). There were significant differences ( $p < 0.05$ ) between plant density of Ubon Stylo and weed species. Ubon Stylo plant density averaged 82 plants/m<sup>2</sup> determined at the highest seeding rate (20 kg/ha). There was significant difference in DMY among seeding rates. Lowest DMY yield was observed at low seeding rate of 5 kg/ha (2758 kg/ha), but no difference was observed between the 10 (5,200 kg/ha) and 15 kg/ha (4752). Planting at a high rate 20 kg/ha (6100 kg/ha), although statistically significant from other rates, does not justify seed costs. It is concluded that seeding rates of Ubon Stylo between 10 and 15 kg/ha provides adequate plant densities and excellent DMY.

**KEYWORDS:** Ubon Stylo, plant density, Dry matter yield.

## INTRODUCCIÓN

La producción de leche en Puerto Rico se basa en forrajes de bajo valor nutritivo, y alta suplementación de concentrados sintéticos para llenar los requerimientos nutricionales de vacas lecheras. En los últimos años la industria lechera ha experimentando incrementos en los costos de alimentación de concentrados, por lo cual forrajes de alto valor nutritivo son necesarios (Ej. Leguminosas forrajeras; Argel, 2006).

En los trópicos, el uso de las leguminosas en la dieta de los rumiantes no ha tenido mucho éxito debido a falta de información sobre un buen establecimiento, carencia de persistencia y manejo adecuado. Ubon Stylo (*Stylosanthes guianensis*) es una leguminosa tropical con amplio rango de adaptación, buen rendimiento y alto contenido

de proteína (18 a 20%). Estudios previos en Puerto Rico indican que Ubon Stylo se adapta a suelos ácidos (Barbara 1988). Su producción de biomasa en Argentina ha alcanzado 10 t MS en suelos pobres y 18 t de MS en suelos fértiles (Ciotti et al., 2003). Existe poca información en tasas de semillas necesarias para un buen establecimiento y tener una buena densidad de plantas. Estudios en Argentina recomiendan 3 kg/ha (Ciotti et al., 2003, Camero et al., 1997).

Ubon Stylo se considera material promisorio para conservación de forraje por la cual es importante desarrollar sistemas de establecimientos y evaluar su persistencia y rendimiento de materia seca bajo corte. Información sobre prácticas de manejo agronómico como densidad necesaria para mejor su persistencia no existe. El objetivo de este estudio fue evaluar cuatro tasas (5, 10, 15, 20 kg/ha) de semilla de Ubon Stylo en una siembra convencional para medir su efecto sobre densidad de plantas y rendimiento de materia seca.

## **MATERIALES Y METODOS**

Esta investigación se realizó en las facilidades de la Estación Experimental de Isabela, de la Universidad de Puerto Rico, Recinto Universitario de Mayagüez, ubicado a 18° 30' N latitud y 67°00' Longitud oeste, a una altura de 128 msnm, con precipitación promedio anual de 1675 mm y temperatura media de 25° C, con fluctuaciones de 19° a 29° C. Ubon Stylo se estableció en un suelo Oxisol coto clay, Tropetic haplothox, caolinitico hisohipertermico. El análisis químico del suelo indica un pH de 5.42 con 2.64% de materia orgánica y 9, 85, 1107 ppm de P, K, CA respectivamente.

El ensayo se estableció el 28 de agosto del 2007 en un arreglo factorial de parcelas en bloques completos aleatorizados con cuatro repeticiones. El área de siembra se preparo 30 días antes de siembra con un pase de arado a 45-cm de profundidad y dos de rastra (grada) a 25 cm de profundidad (labranza convencional) con 8 días de intervalo entre grada y un pase de rototiller antes de siembra. Para el control de malezas se aplicó post-emergente Fusilade, a razón de 4 litros por ha.

Se utilizó el cultivar Ubon Stylo (95% de germinación) y la siembra se realizó a chorrillo con una sembradora de tracción mecánica (Brillion). Las semillas fueron distribuidas en líneas continuas de 3 m a lo ancho de cada parcela por 78 m de largo, para un área de 234 m<sup>2</sup> con separación de 0.5 m entre parcelas y 1 m entre bloques. La parcela útil estaba conformada por 1 m<sup>2</sup> en tres sitios de muestreo aleatorizados en cada unidad experimental, y cada área de muestreo se cosecho, se tomo el peso total fresco.

Las tasas de siembra fueron 5, 10, 15 y 20 kg/ha de semilla de Ubon Stylo. Se evaluaron las densidad de plantas (numero de plantas en un 1m<sup>2</sup>) y el rendimiento de materia Seca (MS; kg/ha). Las plantas fueron cortadas a 15-cm de altura en cada área de 1 m<sup>2</sup> seleccionado aleatoriamente en tres sitios de la parcela y luego submuestras representativas (500 g) se tomaron. Las submuestras se pesaron y se secaron en un horno de aire forzado a 60° C por 48 hrs para determinar su MS. Los datos fueron analizados usando el modelo general lineal de SAS [Statistical Advances System SAS (V.9)], y para la separación de medias tukey (P=0.05).

## **RESULTADOS Y DISCUSSION**

Se observo una interacción (p<0.05) entre densidad y especies de plantas basado en el número de plantas de Ubon Stylo y malezas germinadas en 1 m<sup>2</sup> de área. Se observa



que al incrementar las tasas de siembra de 5 a 20 kg/ha la densidad población de plantas germinadas de Ubon Stylo supera la población de plantas germinadas de malezas de hoja ancha y se observa una reducción en densidad de gramíneas (Figura 1).

Se observó diferencia significativa ( $P < 0.05$ ) en rendimiento de MS entre las tasas de siembra de 5 kg/ha y 20 kg/ha de semilla, presentando un rendimiento promedio de 2758 kg/ha y 6100 kg/ha), respectivamente. Se observa un incremento de MS ( $> 2000$  kg/ha) al incrementarse las tasas de siembra entre 5 a 10 kg/ha, pero no hay diferencia en rendimiento de MS entre las tasas de 10 y 15 kg/ha (Figura 2). Estos resultados coinciden con lo sustentado por Barbara (1988), quien reporta una respuesta similar en la alta densidad de siembra en la cual los rendimientos fueron superior al de la baja densidad.

Estos resultados preliminares de rendimiento de MS con tasas de siembra de 10 kg/ha de semilla, son superiores a los rendimientos manifestados por Quintero et al., (1997), quien asegura que leguminosas con menos de 80 plantas por metro cuadrado no supera los 3000 a 4000 kg/ha por año. En esta investigación esos rendimientos son superiores utilizando una tasa de siembra de 10 kg/ha, en un corte 100 días después de siembra (Figura 2).

## CONCLUSIONES

Tasas de siembra de 10 kg/ha de semilla de Ubon Stylo proporciona un rango de densidad entre 33 a 55 plantas  $m^2$ . A partir de esta tasa inicia la mayor cantidad de plantas respecto a la cantidad de malezas de hoja ancha por  $m^2$ . De igual manera, al incrementar las tasas de siembra de 15 a 20 kg/ha, la densidad poblacional de Ubon Stylo es superior a la población de malezas de hoja ancha por  $m^2$ , mientras la densidad de gramíneas se ve afectada por la cantidad de plantas de Stylo.

También estos resultados dejan clara evidencia que en un suelo Oxisol, con una densidad de 60 plantas de leguminosa de Ubon Stylo por  $m^2$ , supera los 4500 kg/ha de MS en un corte a 15-cm de altura a 100 días de establecido. Por lo que se considera que una tasa de siembra 10 kg/ha provee una densidad adecuada de plantas para ejercer efecto competitivo en población de malezas de hoja ancha o gramíneas y proporciona rendimientos altos de MS ( $\approx 5000$  kg/ha).

## AGRADECIMIENTO

Esta investigación obtuvo apoyo financiero de TSTAR “Improving the productivity of warm season legumes”

## LITERATURA CITADA

- Argel, P. J. 2006. Contribution of improved pastures to animal productivity in dual purpose systems. Arch. Latinoam. Prod. Anim. 14 (2): 65-72.
- Barbara, B. 1988. Response of *Stylosanthes guianensis* varieties to two population densities and three cutting dates in Western Puerto Rico. MSc. thesis. University of Puerto Rico, Mayagüez, pp. 63.
- Camero, A.; J.C. Camargo, M. Ibrahim, y A. Schlönvoigt. 2000. Agroforestería y Sistemas de Producción Animal en América Central. En: Intensificación de la Ganadería en Centroamérica – Beneficios Económicos y Ambientales.

Editores: Carlos Pomareda y Henning Steinfeld. CATIE, FAO, SIDE. San José, Costa Rica, pp. 177-198.

Ciotti, E. M.; M. E. Castelan, C. E. Tomei, I. P. Monaco y J. F. Benítez. 2003. Answer of *Stylosanthes guianensis* CIAT 184 to fertilization with low doses of phosphorus. Comunicaciones Científicas y Tecnológicas RIA, 32(2), 137-148. ISSN 0325-9718. INTA, Corrientes Argentina.

Quintero C.E.; N.G. Boschetti y R.A. Benavides. 1997. Efecto Residual y fertilización fosfatada de pasturas implantadas en Entre Ríos (Argentina). Ciencias de Suelo 15:1-5.

**Figura 1. Efecto de cuatro tasas de siembra en densidad de Ubon stylo, gramíneas, y malezas de hoja ancha.**

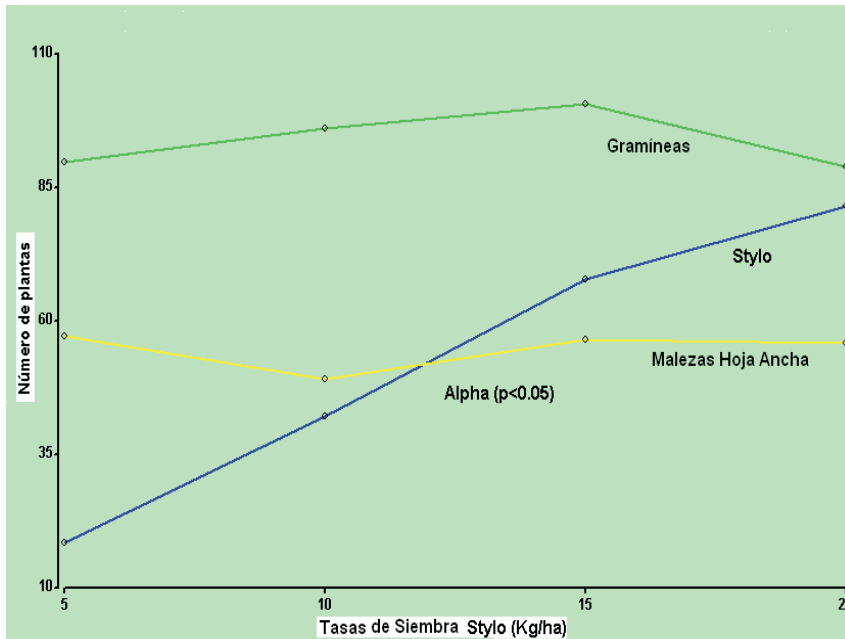

**Figura 2. Efecto de cuatro tasas de siembra Ubon Stylo en rendimiento de materia seca (kg/ha).**

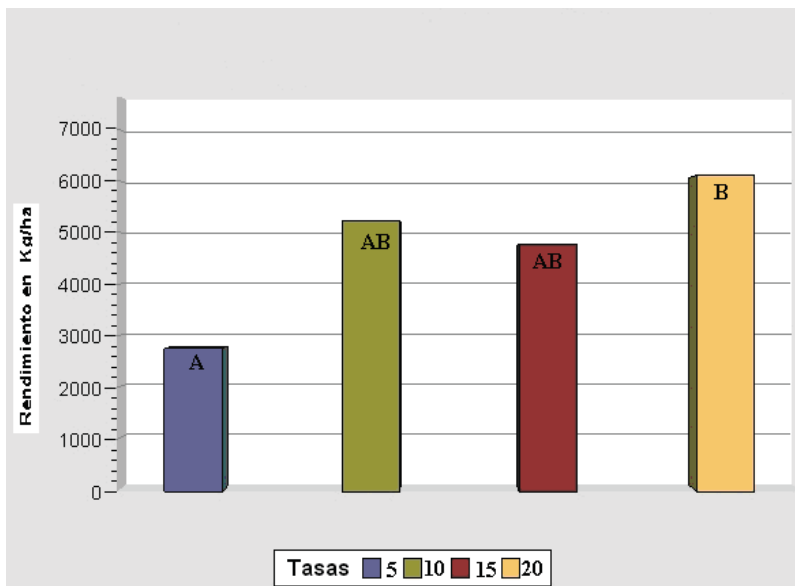

Medias con letras distintas son significativamente diferentes ( $p < 0.05$ ).

### Poster #36

#### Effects of Planting Density and Cut Frequency on Dry Matter Yield of Mulberry (*Morus Alba*) and Guácima (*Guázuma ulmifolia*);

#### Influencia de Diferentes Densidades de Siembra y Frecuencias de Corte sobre el Rendimiento en Biomasa de *Morus alba* y *Guázuma ulmifolia*

Ramón A. Marte Estévez<sup>1</sup>, Carlos M. de J. Arias<sup>2\*</sup>, Rafael A. Vásquez Martínez<sup>3</sup>.

<sup>1</sup>Veterinary Medicine and Animal Science Department, <sup>2</sup>Animal Science Department.

<sup>3</sup>Facultad de Ciencias Agroalimentarias y del Ambiente, Universidad ISA, La Herradura, Santiago, Republica Dominicana. ramonmarte@yahoo.com; rmarte@isa.edu.do; cdejesus@isa.edu.do; car1070@yahoo.com

#### ABSTRACT.

A study was set to evaluate the dry matter (DM) yield and nutritional composition of the species *Morus alba* and *Guázuma ulmifolia* under 3 plantation densities and 3 cut frequencies. Every treatment combination of 2 x 3 x 3=18 was replicated four times in a randomized complete block design. Four plants per plot were randomly selected to test the DM and crude protein contents. The higher total DM yield of *Morus alba* ( $P \leq 0.05$ ) was registered on 25,000 plants/ha and 60 d at cut treatment combination, whereas the planting density and cut frequency of larger DM was at 75 d and 25000 plants/ha in *Morus alba*. The average plant height was 280.3±43.4 cm on *Morus alba* and 260.9±43.4 cm on *Guázuma ulmifolia*. The leave crude protein content was 28% in *Guázuma ulmifolia* with a planting density (25,000 plants/ha) of 75 d, however, leave crude protein contents were 21.9% on 45 days of age and 25,000 plants/ha in *Morus alba*. We conclude that the best planting density is 25,000 plants/ha and the cut frequency is 60 and 75 d in Mulberry and *Guázuma ulmifolia*, respectively.

**KEYWORDS:** guácima, mulberry, density plantation, cut frequency

#### INTRODUCCIÓN

Las especies morera (*Morus alba* L.) y guácima (*Guázuma ulmifolia* Lam.), especialmente la primera, están siendo usadas como fuentes de proteínas en la alimentación de ganado bovino, ovino y caprino en la República Dominicana. Los conocimientos sobre ambas especies, respecto a la densidad de plantación óptima para mayor rendimiento en biomasa y los períodos apropiados de corte de cada una en condiciones intensivas de cultivo son escasos.

#### MATERIALES Y MÉTODOS

Se realizó un estudio para determinar el rendimiento en biomasa de las especies *Morus alba* (Foto 1) y *Guázuma ulmifolia* (Foto 2) sometidas a tres densidades de siembra y tres frecuencias de corte. Se estableció un diseño por bloques completos al azar con arreglo factorial 2 x 2 x 3 con tratamientos con densidades de siembra de 25,000, 16,666 y 12,500 plantas por hectárea y marco de plantación de 1.0 x 0.80, 1.0 x 0.60 y

1.0 x 0.40 metros respectivamente. Las frecuencias de corte usadas son 45, 60 y 75 días (Foto 3). Este estudio se realizó en condiciones de altitud 169 m, humedad relativa de 73%, temperatura media anual de 25.3 °C, precipitación media anual de 824 mm y pH de 7.9 a 8.3. Se utilizó un sistema de riego por aspersión. El experimento se realizó del 09 de noviembre del 2006 al 18 de julio 2007. Se realizaron 3 cortes según las frecuencias de corte y se midieron los rendimientos y el % de proteínas de las hojas. Para analizar los datos se utilizó el software Statistical Analysis System (SAS) v8.1. Se realizó un análisis de varianza (ANOVA) y para la separación de medias se aplicó la prueba de Tukey a un nivel de significación de 5%.



Foto 1. *Morus alba*.



Foto 2. *Guázuma ulmifolia*.



Foto 3. Plantación experimental.

**RESULTADOS  
DISCUSIONES**

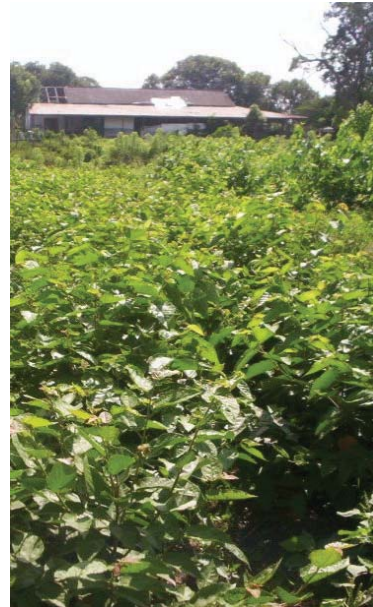
**Y**

Se observaron diferencias significativas ( $P \leq 0.05$ ) en la producción de materia seca para las especies, las frecuencias de corte y las densidades de siembra utilizadas. Según los Cuadros 1, 2 y 3 la mayor producción ocurre en la morera a una frecuencia de corte de 75 días y una densidad de siembra de 25,000 plantas por hectárea.

Cuadro 1. Comportamiento del Rendimiento en las Especies *Morus alba* y *Guázuma ulmifolia* Influenciado por Tres Frecuencias de Corte y Tres Densidades de Siembra.

Corte	Variable	Especie		C.V. <sup>3</sup>	s <sup>4</sup>
		M <sup>1</sup>	G <sup>2</sup>		
1	Materia seca total en kgMS/ha.d	62.6 a	33.0 b	50.5	24.1
2	Materia seca total en kgMS/ha.d	66.1 a	42.9 b	44.2	24.1
3	Materia seca total en kgMS/ha.d	65.5 a	52.9 b	46.2	27.4

Letras diferentes tienen diferencias significativas a  $P \leq 0.05$ ; 1: *Morus Alba*; 2: *Guázuma ulmifolia*; 3: Coeficiente de variación; 4: Desviación estándar.

Cuadro 2. Comportamiento de los Rendimientos Agrupados en las Especies *Morus alba* y *Guázuma ulmifolia* Influenciado por Tres Frecuencias de Corte.

Corte	Variable	Frecuencia de corte, d		
		45	60	75
1	Materia seca total en kgMS/ha.d	39.6 b	48.6 a	55.3 a
2	Materia seca total en kgMS/ha.d	28.7 c	53.8 b	81.0 a
3	Materia seca total en kgMS/ha.d	31.3 b	70.4 a	75.8 a

Letras diferentes tienen diferencias significativas a  $P \leq 0.05$ .

Cuadro 3. Comportamiento de los Rendimientos Agrupados en las Especies *Morus alba* y *Guázuma ulmifolia* Influenciado por Tres Densidades de Siembra.

Corte	Variable	Densidad, plantas*1000		
		25	16.6	12.5
1	Materia seca total en kgMS/ha.d	58.1 a	45.7 b	39.6 b
	Relación hojas/tallos	1.8 a	1.8 a	1.7 a
2	Materia seca total en kgMS/ha.d	66.1 a	54.6 b	42.9 c
	Relación hojas/tallos	1.6 a	1.6 a	1.5 a
3	Materia seca total en kgMS/ha.d	70.4 a	62.3 a	44.9 b
	Relación hojas/tallos	1.3 b	1.6 a	1.4 ab

Letras diferentes tienen diferencias significativas.  $P \leq 0.05$ .

En la interacción especie\*densidad de siembra\*frecuencia de corte resultó que en cada densidad de siembra, la producción de MS mantiene la misma tendencia para las tres frecuencias de corte utilizadas en las dos especie (Figura 1 y 2).



Figura 1. Comparación de las Medias de Producción Total de la Morera (kgMStotal/ha.d) en el corte 1 (C1), corte 2 (C2) y corte 3 (C3) influenciada por las densidades de siembra y frecuencias de corte.



Figura 2. Comparación de las Medias de Producción Total de la Guácima (kgMStotal/ha/d) en el corte 1 (C1), corte 2 (C2) y corte 3 (C3) influenciada por las densidades de siembra y frecuencias de corte.

Se observó que la guácima alcanza valores en % de proteínas crudas (%PC) por encima de la morera (Cuadro 4).

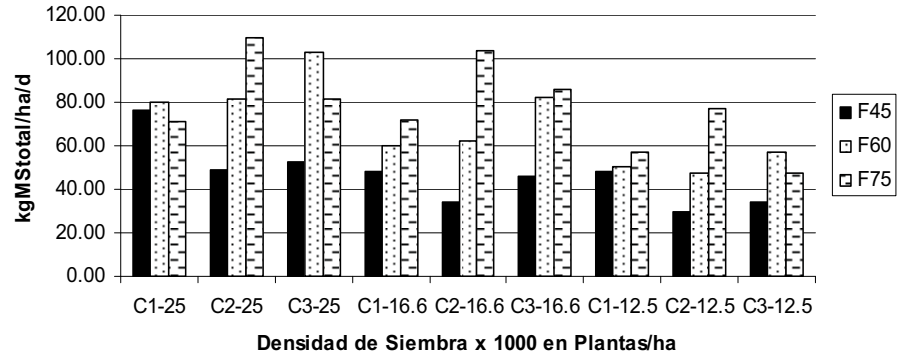
Cuadro 4. Comparación Entre las Medias del % de Proteínas Crudas en las Hojas de las Especies Morera y Guácima Según la Influencia de Tres Densidades de Siembra y Tres Frecuencias de Corte.

Densidad siembra*1000 (plantas/ha)	Frecuencia de corte (días)	n	% PC	
			M <sup>1</sup>	G <sup>2</sup>
25	45	8	21.9	26.8
25	60	8	19.3	22.9
25	75	8	19.1	22.6
16.6	45	8	21.7	25.7
16.6	60	8	18.0	24.3
16.6	75	8	20.9	23.0
12.5	45	8	21.2	25.5
12.5	60	8	19.6	23.3
12.5	75	8	20.2	28.0

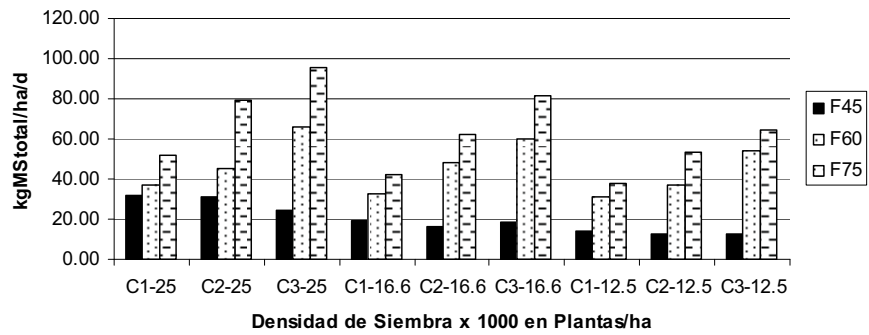
1: Morera; 2: Guácima.

## REFERENCIAS

- Almeida, JE de; y Canto, F. 2000. A Contribution to the introduction of the high-trunk mulberry system in tropical climates. Estación Experimental de Zootecnia e Instituto de Zootecnia, BR. Electronic Conference on "Mulberry for animal production" 1st Mayo – 31 June 2000. FAO. Consultado 17 mar 2002. Disponible en <http://www.fao.org/ag/AGA/AGAP/FRG/Mulberry/Posters/HTML/Almeida2.htm>
- Benavides. J. 1995. Arboles y arbustos forrajeros para las montañas americanas. En: Sistemas pecuarios sostenibles para las montañas tropicales. Pp103-123 CIPAV, Cali, Colombia. Citado en Uribe, F.. 2000. Mulberry for rearing dairy heifers. Electronic Conference on "Mulberry for animal production" 1st Mayo – 31 June 2000. FAO. Consultado 15 mar 2002. Disponible en <http://www.fao.org/WAICENT/FAOINFO/AGRICULT/AGA/AGAP/FRG/MULBERRY/Posters/Html/Uribe.htm>.
- Benavides, J.E. 1998. Utilización de la morera en sistemas de producción animal. En: Agroforestería para la producción animal en Latinoamérica. Memorias de la conferencia electrónica. FAO, Roma (in press). Consultado 24 feb. 2002. Disponible en <http://www.fao.org/ag/aga/agap/frg/agrofor1/bnvdes12.htm>.
- Botero, J; David, P; y Saldarriaga, J. 1995. Efecto de tres densidades de árboles en el potencial forrajero de un sistema silvopastoril situado en bosque seco tropical. Tesis Zootecnia. Universidad Nacional de Colombia. CO. 105 p. Citado en Giraldo A. 1999. Potencial de la arborea Guácimo (*Guázuma ulmifolia*) como componente forrajero en sistemas silvopastoriles. Universidad Nacional de Colombia. CO. Conferencia electrónica de la FAO sobre “Agroforestería para la producción animal en Latinoamérica”. Consultado 24 feb 2002. Disponible en <http://www.fao.org/ag/aga/agap/frg/agrofor1/Giral13.htm>.
- Centro Agronómico Tropical de Investigación y Enseñanza (CATIE). 1986. Silvicultura de especies promisorias para la producción de leña en América Central. Silvoenergía. Serie Técnica. Informe Técnico No. 86. Turrialba. CR. Citado en



- Giraldo A. 1999. Potencial de la arborea Guácimo (*Guázuma ulmifolia*) como componente forrajero en sistemas silvopastoriles. Universidad Nacional de Colombia. CO. Conferencia electrónica de la FAO sobre “Agroforestería para la producción animal en Latinoamérica”. Consultado 24 feb 2002. Disponible en <http://www.fao.org/ag/aga/agap/frg/agrofor1/Girall3.htm>.
- CATIE. 1991. Guácimo (*Guázuma ulmifolia*) especie de árbol de uso múltiple en América Central. Proyecto Cultivo de Arboles de Uso Múltiple (MADELEÑA). Turrialba, CR. Serie Técnica. Informe Técnico No. 165. ISBN 9977-57-091-4. 72 p.
- Cifuentes, CA; y Han, KM. 1992. Manual de sericultura. Plan Nacional de Rehabilitación Ed. Imprimiendo Ltda., Pereira, Colombia. Citado en Uribe, F.. 2000. Mulberry for rearing dairy heifers. Electronic Conference on "Mulberry for animal production" 1st Mayo – 31 June 2000. FAO. Consultado 15 mar 2002. Disponible en <http://www.fao.org/WAICENT/FAOINFO/AGRICULT/AGA/AGAP/FRG/MULBERRY/Posters/Html/Uribe.htm>.
- Duke, JA. 1978. The quest for tolerant germplasm. p. 1–61. In: ASA Special Symposium 32, Crop tolerance to suboptimal land conditions. Am. Soc. Agron. Madison, WI. *Compendiado en:* Purdue University, West Lafayette. Center for New Crops & Plant Products. Consultado 3 mar. 2002. Disponible en [http://www.hort.purdue.edu/newcrop/duke\\_energy/Morus\\_alba.html](http://www.hort.purdue.edu/newcrop/duke_energy/Morus_alba.html).
- Duke, JA. 1983. Handbook of energy crops. Unpublished. *Compendiado en:* Purdue University, West Lafayette. Center for New Crops & Plant Products. Consultado 3 mar. 2002. Disponible en [http://www.hort.purdue.edu/newcrop/duke\\_energy/Morus\\_alba.html](http://www.hort.purdue.edu/newcrop/duke_energy/Morus_alba.html).
- Esquivel, J., Benavides, J.E., Hernández, I., Vasconcelos, J., González, J., & Espinoza, E. 1996. Efecto de la sustitución de concentrado con Morera (*Morus alba*) sobre la producción de leche de vacas en pastoreo. En: Resúmenes. Taller Internacional "Los árboles en la producción ganadera". EEPF "Indio Hatuey", Matanzas, Cuba. p25.
- Geilfus, F. 1989. El árbol al servicio del agricultor. Principios y técnicas. Guía de especies. Manual de Agroforestería para el desarrollo rural. Enda-Caribe. Centro Agronómico y Tropical de Investigación y Enseñanza (CATIE). Editorial Santo Domingo, República Dominicana. 2 v.
- García F. et al, 2002. Altura de corte de Morera (*Morus alba*) <http://www.fao.org/WAICENT/FAOINFO/AGRICULT/AGA/AGAP/FRG/AFRIS/espanol/Document/Morera/morera12.htm> Abril 2002, 3552 bytes. Consultado 2 oct. 2007. Disponible en [http://www.unet.utafoundation.org/articulos/xiv\\_jortecgan.pdf](http://www.unet.utafoundation.org/articulos/xiv_jortecgan.pdf).
- Instituto Nacional de Recursos Hidráulicos (INDRHI). 1970. Estudio del área de influencia de la presa Tavera. Río Yaque del Norte. Santiago, DO. (RD-YN-310). Estudio Agrológico. Ingenieros Consultores y Proyectistas (C.I.E.P.S.s.c). Planos de series de suelos. v 3.
- Martín, G; García, F; Reyes, F; Hernández, I; González, T; y Milera, M. 2000. Agronomic studies with mulberry in Cuba. Estación Experimental de Pastos y Forrajes "Indio Hatuey". Matanzas, Centro Politécnico "Villena Revolución", La

- Habana, CU. Electronic Conference on "Mulberry for Animal Production" 1st Mayo – 31 June 2000. FAO. Consultado 17 mar 2002. Disponible en <http://www.fao.org/ag/AGA/AGAP/FRG/Mulberry/Papers/HTML/Martin.htm>.
- Pezo, D; Kass, M; Benavides, J; Romero, F; y Chaves, C. 1990. Potential of legume tree fodders as animal feed in Central America. In: Shrubs and tree fodders for farm animals. (1989, Denpasar, Indonesia). Proceeding of Workshop. Ed. Po C. Devendra. Ottawa, Canada. IDRC. p 163 –175.
- Reynald, JJ; Mevs, RA. 1998. Evaluación de las especies forrajeras morera (*Morus alba*) y margarita haitiana (*Tithonia diversifolia*) y su utilización en la alimentación de ovinos de engorde. Tesis Ing. Zootecnista, República Dominicana, ISA. 73 p.
- Roger, JP. 2002. Description of mulberry tree. Conservatoire Botanique National Méditerranéen de Porquerolles – France. Consultado 3 mar. 2002. Disponible en <http://www.unifi.it/project/ueresgen29/ds15.htm>.
- Sánchez, MD. 1998. Mulberry: an exceptional forage available almost worldwide. IT FAO. Electronic Conference on "Mulberry for animal production" 1st Mayo – 31 June 2000. FAO. Consultado 24 feb 2002. Disponible en <http://www.fao.org/WAICENT/FAOINFO/AGRICULT/AGA/AGAP/FRG/MULBERRY/Papers/text/Sanchez2.txt>.
- Sanginés G., Lara L., Rivera L., Pinzon L., Ramos P., Murillo J., Itra, M., Fuentes C. y G Azcorra. 2001. Avances en los programas de investigación en morera (*Morus alba*) en Yucatán. <http://www.fao.org/WAICENT/FAOINFO/AGRICULT/AGA/AGAP/FRG/AFRIS/espanol/Document/Morera/MORERA20.HTM>. 71753 bytes. Consultado 2 oct. 2007. Disponible en [http://www.unet.utafoundation.org/articulos/xiv\\_jortecgan.pdf](http://www.unet.utafoundation.org/articulos/xiv_jortecgan.pdf).
- Santander F, CI; y Campos A, JJ. 1983. El Guácimo (*Guázuma ulmifolia* Lam.,) especie forestal de uso múltiple para los trópicos. San José, CR. CATIE. 15 p. Simposio Internacional sobre Plantaciones Forestales plantadas en los Neotrópicos como Fuente de Energía, 1983; Viscosa, Minas Gerais, BR. Citado en CATIE (Centro Agronómico Tropical de Investigación y Enseñanza). 1991. Guácimo (*Guázuma ulmifolia*) especie de árbol de uso múltiple en América Central. Proyecto Cultivo de Arboles de Uso Múltiple (MADELEÑA). Turrialba, CR. Serie Técnica. Informe Técnico No. 165. ISBN 9977-57-091-4. 72 p.
- Santander F, CI; y Campos A., JJ. 1988. El Guácimo (*Guázuma ulmifolia* Lam.,) especie forestal de uso múltiple para los trópicos húmedos. San José, CR. Consultoría y Asesoría Agroforestal. 36 p. Citado en CATIE (Centro Agronómico Tropical de Investigación y Enseñanza). 1991. Guácimo (*Guázuma ulmifolia*) especie de árbol de uso múltiple en América Central. Proyecto Cultivo de Arboles de Uso Múltiple (MADELEÑA). Turrialba, CR. Serie Técnica. Informe Técnico No. 165. ISBN 9977-57-091-4. 72 p.
- Secretaría de Estado de Agricultura (SEA). 1979. Requerimiento de agua para la agricultura según el clima de la República Dominicana. Sub-secretaría de Recursos Naturales. Departamento de Tierras y Aguas. Cooperación del OEA (Instituto Interamericano de Ciencias Agrícolas). Documento Técnico N°. 02. Preparado por Ernesto Reyna y Manuel Paulet. DTA-DT N°. 4. IICA-AID-27/79. Santo Domingo, DO. p A-13. 132 p.

- SEA. 1998. Registro Nacional de Productores Agropecuarios. Consultado el 24 febrero del 2002. Disponible en <http://www.agricultura.gov.do/mcenso.htm>.
- Singh, B.; Goel, G.C. and Negi, S.S. 1984. Effect of supplementing muberry (*Morus alba*) leaves ad libitum to concentrate diets of Angora rabbits on wool production. *Journal of Applied Rabbit Research* 7(4):156-160.
- Solano, R. 1986. El caulote (*Guázuma ulmifolia* Lam.) para la producción de forraje y leña en Nueva Concepción, Guatemala. *In* Investigación en componentes de apoyo al desarrollo de la alternativa mejorada para el sistema mixto en Nueva Concepción, Guatemala. CATIE. Serie Técnica. Informe Técnico No. 96 p. 80-86. Citado en CATIE (Centro Agronómico Tropical de Investigación y Enseñanza). 1991. Guácimo (*Guázuma ulmifolia*) especie de árbol de uso múltiple en América Central. Proyecto Cultivo de Arboles de Uso Múltiple (MADELEÑA). Turrialba, CR. Serie Técnica. Informe Técnico No. 165. ISBN 9977-57-091-4. 72 p.
- Soto S., R. 1980. Curso de ecología de plantaciones. San José, DR. Universidad de Costa Rica – Organization for Tropical Studies. 6 p. Citado en CATIE (Centro Agronómico Tropical de Investigación y Enseñanza). 1991. Guácimo (*Guázuma ulmifolia*) especie de árbol de uso múltiple en América Central. Proyecto Cultivo de Arboles de Uso Múltiple (MADELEÑA). Turrialba, CR. Serie Técnica. Informe Técnico No. 165. ISBN 9977-57-091-4. 72 p.
- Ting-Zing, Z; Yun-Fang, T; Guang-Xian, H; Huaizhong, F; y Ben, M. 1998. FAO Agricultural services bulletin. No. 73/1. FAO, IT. 127 p. Citado en Benavides, J. 2000. Utilización de la Morera en sistemas de producción animal (en línea). CR. FAO. Consultado 24 feb. 2002. Disponible en <http://www.fao.org/ag/aga/agap/frg/agrofor1/bnvdes12.htm>.
- Trigueros, R.O. y Villalta, P. 1997. Evaluación del uso de follaje deshidratado de morera (*Morus alba*) en alimentación de cerdos de la raza Landrace en etapa de engorde. En: Resultados de Investigación, CENTA, El Salvador p150-155.
- Uribe, F. 2000. Mulberry for rearing dairy heifers. Electronic Conference on "Mulberry for animal production" 1st Mayo – 31 June 2000. FAO. Consultado 15 mar 2002. Disponible en <http://www.fao.org/WAICENT/FAOINFO/AGRICULT/AGA/AGAP/FRG/MULBERRY/Posters/Html/Uribe.htm>.
- Wagner J, B; Vargas G, M. y Almanzar R, E. 2006. Caribbean Food Crops Society 42th Annual Meeting July 9 – 15, 2006. Food Safety and Value Added Production and Marketing in Tropical Crops. Puerto Rico. Vol. XLII-Number 2. ISSN 95-07-0410.
- Ye, Z. 2000. Factors influencing mulberry leaf yield. College of Animal Sciences, Zhejiang University, Hangzhou, Zhejiang, CN. Electronic Conference on "Mulberry for animal production" 1st Mayo – 31 June 2000. FAO. Consultado 17 mar 2002. Disponible en <http://www.fao.org/ag/AGA/AGAP/FRG/Mulberry/Posters/Html/ZHIYI.htm>

**Poster #37**

**The Mineral Status of Sheep and Goats with Reference to Swayback in Central Trinidad**

*Aphzal Mohammed<sup>1</sup> and Fayez G. Youssef<sup>2</sup>. <sup>1</sup>The University of Trinidad and Tobago, lot 74-98 O'Meara Industrial Park, Arima Trinidad; <sup>2</sup>Department of Food Production, The University of the West Indies, St. Augustine, Trinidad, West Indies. aphzal.mohammed@utt.edu.tt*

**ABSTRACT.**

There have been many occurrences in Trinidad of lambs and kids that have died within 6 months of birth of suspected Cu deficiency resulting in clinical signs resembling swayback. Animals displayed an inability to stand at birth or hind limb ataxia progressing to an inability to stand in the delayed forms. The condition continues to be of economic importance because of poor growth rates and high mortality of lambs and kids of affected farms.

**OBJECTIVES.**

This study investigates the mineral status of

- 1) Swayback (n=50) and apparently normal lambs (n=39) and adult sheep (n=42) and
- 2) Swayback (n=24) and apparently normal kids (n=21) and adult goats (n=41) of affected farms of Central Trinidad

**MATERIALS AND METHODS.**

Calcium, Mg, Na, K, Cu and Zn concentrations were evaluated by atomic Absorption spectroscopy and colorimetrically for P, on blood serum of swayback and apparently normal sheep and goats. The identical minerals including Fe and Mn were evaluated on grasses of swayback affected farms or locations (Table I).

**RESULTS.**

Significantly lower ( $p < 0.001$ ) serum Ca, Cu, and Zn levels were found in swayback than in apparently normal lambs and adult sheep. Serum Cu was also lower ( $p < 0.001$ ) in swayback than in apparently normal kids and adult goats. Several swayback lambs had low concentrations of Ca ( $< 2.0$  mmol/L), P ( $< 1.3$  mmol/L) and Zn ( $< 9.2$   $\mu$ mol/L), while most swayback lambs and kids had critically low Cu ( $< 7.9$   $\mu$ mol/L). Several adult sheep and goats were also deficient in Cu and P, while about half of the grasses analysed had low Cu ( $< 5$  ppm) (Tables II, III, & IV).

**CONCLUSIONS.**

Critically low serum Cu in swayback lambs and kids was probably caused by the low Cu concentrations found in the grasses. Twenty four, 47 and 16% of grasses also had levels of Ca, Mg, and P below minimum requirements ( $< 0.20\%$  DM). The study provides

a basis for the inclusion of Cu and P supplementation to enhance productivity of sheep and goats of Central Trinidad.

**REFERENCES.**

- NRC, 1985. Nutrient Requirements of Sheep. 6th edn. (National Academic Press, Washington, D C)
- Smith, M.C. and Sherman, D.M., 1994. Musculoepithelium System In Goat Medicine,( Lea and Febiger, Philadelphia, U.S.A.)
- Underwood, E.J.and Suttle N.F., 1999. The Mineral Nutrition of Livestock. 3rd edn., (Commonwealth Agricultural Bureaux, London.)

**TABLE 1**  
**Blood samples collected from Swayback and Apparently normal sheep and goats**

Sheep farm/location	swayback			apparently normal			total
	Newborn	1 - 6 mth	Newborn	1 - 6 mth	1 - 4 yr		
	Petrotrin Sheep Farm	0	6	0	9	3	
Chaguanas Location	1	10	2	12	12	37	
Mon Jaloux Livestock Farm	24	2	2	9	19	56	
Sugarcane Feeds Centre	0	7	1	4	8	20	
<b>Total Sheep</b>	<b>25</b>	<b>25</b>	<b>5</b>	<b>34</b>	<b>42</b>	<b>131</b>	

Goats farm/location	swayback		apparently normal		total
	1 - 6 mth	1 - 6 mth	1 - 4 yr		
	Couva Location	13	8	22	
Chaguanas Location	11	5	15	31	
Sugarcane Feeds Centre	0	8	4	12	
<b>Total Goats</b>	<b>24</b>	<b>21</b>	<b>41</b>	<b>86</b>	

TABLE II  
Serum macro (mmol/l) and micro ( $\mu\text{mol/l}$ ) mineral levels in swayback and apparently normal sheep of Central Trinidad

Mineral	Swayback			Apparently Normal			Sig. <sup>1</sup>			
	I 25 <sup>a</sup>	II 25 <sup>a</sup>	III 5 <sup>b</sup>	IV 34 <sup>b</sup>	V 42 <sup>c</sup>	$\pm$ SE				
Ca	2.60	0.10	2.39	0.07	2.91	0.16	0.06	2.53	0.06	***
Mg	1.03	0.06	0.99	0.04	1.07	0.09	0.04	1.09	0.04	NS
P	1.32	0.12	1.42	0.09	1.91	0.19	0.07	1.59	0.07	*
Na	138.17	2.52	137.70	1.90	139.70	4.11	1.59	141.83	1.59	*
k	5.26	0.16	5.46	0.12	5.77	0.26	0.10	5.86	0.10	***
Cu	4.41	0.47	4.88	0.38	9.44	0.83	0.31	8.50	0.31	***
Zn	10.25	0.69	10.55	0.55	16.98	1.22	0.47	14.68	0.47	***

Serum mineral concentrations found in sheep and goats are compared with the following critical levels: Ca 2.0, Mg 0.6 and P 1.3 mmol/L; Cu 7.9  $\mu\text{mol/L}$  and Zn 9.2  $\mu\text{mol/L}$  (Underwood and Suttle, 1999)

a,b,c I, Newborn lambs affected with congenital swayback; II, 1 to 6 month old lambs affected with delayed ataxia; III, newborn lambs, apparently normal; IV, 1 to 6 month old lambs, apparently normal; V, 1 to 4 year old adult sheep, apparently normal.

<sup>1</sup> \*  $P < 0.05$ ; \*\*\*  $P < 0.001$ ; NS Not Significant

TABLE III  
Serum macro (mmol/l) and micro ( $\mu\text{mol/l}$ ) mineral levels of swayback and apparently normal goats of Central Trinidad

Mineral <sup>1</sup>	Swayback			Apparently Normal			Sig. <sup>2</sup>
	II	$\pm$ SE	24 <sup>a</sup>	IV	$\pm$ SE	V	
n				21 <sup>b</sup>		41 <sup>b</sup>	
Ca	2.47	0.07		2.56	0.07	2.47	NS
Mg	1.11	0.04		1.14	0.04	1.19	NS
P	1.63	0.07		1.56	0.06	1.48	NS
Na	132.70	2.39		137.96	2.25	136.39	NS
K	5.51	0.11		5.69	0.10	5.54	NS
Cu	6.14	0.55		8.97	0.52	7.87	***
Zn	13.31	0.92		15.75	0.86	13.77	NS

<sup>a,b</sup>

II, 1 to 6 month old kids affected with delayed ataxia; IV and V, 1 to 6 month old kids and 1 to 4 year old adult goats, apparently normal

<sup>1</sup> Normal expected Levels : Ca 2.3-2.9, Mg 1.1-1.5 and P, 1.5-5.3 mmol/L; Cu 9.4-23.6 and Zn 12.7-16.8  $\mu\text{mol/L}$  (Smith and Sherman, 1994)

<sup>2</sup> \* P < 0.05; \*\*\* P < 0.001; NS Not Significant



TABLE IV  
Forage macro (% dm) and micro (ppm) mineral levels of swayback affected farms

Mineral	Mean <sup>1</sup> and range	± SD	Minimum requirement <sup>2</sup>	% Below requirements
Ca	0.36 (0.07 - 0.86)	0.20	0.20	24
Mg	0.26 (0.10 - 0.86)	0.13	0.12(0.20)	0(47)
P	0.26 (0.07 - 0.79)	0.09	0.16(0.20)	0(16)
Na	0.16 (0.03 - 0.18)	0.14	0.09	40
K	1.80 (1.03 - 3.66)	0.72	0.50	0
SO <sub>4</sub>	0.14 (0.12 - 0.16)	0.01	---	0
Cu	5.3 (1.2 - 10.7)	2.18	7(5) <sup>3</sup>	85(49)
Zn	58 (26 - 175)	28.8	20	0
Fe	133 (74 - 356)	56.9	20	0
Mn	186 (16 - 797)	150.2	20	0

<sup>1</sup> Based on 45 grass samples

<sup>2</sup> Lower Limit or Minimum Requirements for Sheep (NRC, 1985)

<sup>3</sup> Deficient level associated with swayback in lambs (Underwood and Suttle, 1999))

**Poster #38**

**Lamb's Voluntary Intake and Digestibility of Forage Soybean 'Hinson Long-Juvenile' (*Glycine max*) and Lablab 'Rongai' [*Lablab purpureus* (L.) Sweet]**

Rivera-Melendez, F.<sup>1</sup>, A. Rodriguez-Carias<sup>1</sup> and E. Valencia<sup>1</sup>, <sup>1</sup>Department of Animal Industry and <sup>2</sup>Agronomy and Soils Department, University of Puerto Rico, Mayagüez, Box 9030, Mayagüez, PR 00681. [frm9612@uprm.edu](mailto:frm9612@uprm.edu)

**ABSTRACT.**

In Puerto Rico, tropical grasses do not adequately meet the nutritional requirements of dairy cows. For this reason, imports alfalfa hay and costly concentrate based diets are used in the dairy industry. It has been widely documented that legumes are generally higher in nutritive value than grasses, but information on forage intake and nutritive value of the annual legumes forage soybean Hinson Long-Juvenile (HLJ) (*Glycine max*) and lablab cv. Rongai [*Lablab purpureus* (L.) Sweet] is limited. The research objective was to compare daily intake, and dry matter, crude protein (CP), and neutral detergent fiber (NDF) digestibility of 'HLJ' and 'Rongai' hay when fed to mature lambs. The experiment was conducted at the University of Puerto Rico, Finca Alzamora using rams (28.4±4 kg BW) in a completely randomized design with three replicates. Rams were housed in individual cages and fed treatment diets for a 7d adaptation period and 5d of data collection. Higher voluntary feed intake (P<0.05) was observed by rams fed 'HLJ' than Rongai (0.944 vs. 0.852 kg/d). Crude protein and NDF concentration were 15.7 and 15.5% and 42.8, and 41.7% for HLJ and Rongai, respectively. CP and NDF digestibility of HLJ and Rongai did not differ (P>0.05). But DM Digestibility (56.2 vs. 49.6%) was higher (P<0.05) in HLJ than Rongai. Both HLJ and Rongai exhibit potential for use in hay conservation systems to improve the feeding value of diet basal on grass hay and minimize concentrate use in dairy cows.

**KEYWORDS:** Voluntary intake, forage soybean, lablab

**RESUMEN.**

En Puerto Rico, las gramíneas tropicales no cumplen adecuadamente los requerimientos nutricionales de las vacas lecheras. Por consiguiente, se utilizan heno de alfalfa y dietas basadas en alimentos concentrados de altos costos en la industria lechera. Se ha documentado extensamente que las leguminosas generalmente tienen mayor valor nutritivo que las gramíneas, pero información en el consumo y valor nutritivo forrajero de las leguminosas anuales soya forrajera Hinson Long-Juvenile (HLJ) (*Glycine max*) y Lablab cv. Rongai [*Lablab purpureus* (L.) Sweet] es limitada. El objetivo de esta investigación fue comparar el consume diario de materia seca, proteína bruta (CP), y fibra detergente neutro (NDF) y digestibilidad de heno de HLJ y Rongai en la alimentación de ovinos adultos. El experimento fue conducido en la Universidad de Puerto Rico, Finca Alzamora utilizando ovejos (28.4±4 kg peso vivo) en cajas individuales y alimentados por un periodo de 7 días de adaptación y 5 de recolección de

datos. Se observó mayor consumo voluntario ( $P < 0.05$ ) por los ovejos alimentados por HLJ en comparación con Rongai (0.944 vs. 0.852 kg/d), no se encontró diferencia significativa ( $P > 0.05$ ) en el contenido de proteína bruta y de FDN, los cuales se obtuvieron 15.7%, 15.5% y 42.8, 41.7 para HLJ y Rongai respectivamente. Aunque la digestibilidad (56.2 vs. 49.6%) fue mayor ( $P < 0.05$ ) en HLJ en comparación con Rongai. Ambas leguminosas forrajeras HLJ y Rongai presentan gran potencial en sistemas de conservación utilizando henos para mejorar el valor alimenticio de dietas básicas de gramíneas y reducir la utilización de concentrados en las industrias lecheras.

**PALABRAS CLAVES:** Consumo voluntario, soya forrajera, lablab

## INTRODUCTION

Forage intake, especially the fibrous part, is vitally important in ruminant feeding. Ruminants require a high level of quality fiber in their diets for good rumen function, feed efficiency and production (milk, meat, hair). In Puerto Rico, native or naturalized grasses do not meet the nutritional requirements of high producing ruminants. For this reason, alfalfa hay and concentrate based diets are used in the dairy industry.

Tropical forage legumes represent an alternative to increase animal performance in the tropics (Skerman et al., 1992) and are an option to minimize the use of concentrates and alfalfa in milk production systems in Puerto Rico. The addition of legumes in tropical pastures can improve CP concentration, rate of passage and feed intake (Kretschmer and Pitman, 2001).

Forage soybean (*Glycine max*) and Lablab (*Lablab purpureus*) are legumes with potential for use in dairy production systems in Puerto Rico. Soybean has been considered one of the best annual proteinaceous seed and hay producing plant (Sheaffer et al., 2001). It provides high protein and energy feed supplement that complements ruminant nutritional requirements (Rotz et al., 2001). Lablab can be grazed or used for hay or silage; its foliage has high protein and digestibility (Murphy et al., 1999) and lablab is among the most palatable legume for livestock (Valenzuela et al., 2002).

In Puerto Rico, information on forage intake and nutritive value of the annual legumes forage soybean Hinson Long-Juvenile ('HLJ') (*Glycine max*) and lablab cv. Rongai [*Lablab purpureus* (L.) Sweet] are limited. Research objectives were to compare daily intake, and dry matter, crude protein (CP), and neutral detergent fiber (NDF) digestibility of HLJ and Rongai hay when fed to mature lambs.

## MATERIAL AND METHODS

The experiment was conducted at the University of Puerto Rico, Finca Alzamora using rams (28.4±4 kg BW) in a completely randomized design with three replicates. Rams were housed in individual cages and feed treatment diets for a 7d adaptation period and 5d of data collection. Treatments used were Soybean cv. Hinson Long-Juvenile (HLJ) and Rongai sun cured hay (66-d re-growth) at 4% of body weight and fed *ad libitum*. Hay offered, rejected and digestibility [(intake-feces/intake) \*100] were determined. At the end of the period rams were weighed and representative samples were taken of feed offered, rejected and feces for crude protein and NDF determination.

Chemical analyses were conducted at the Animal Nutrition Laboratory of the University of Puerto Rico, Mayagüez. Crude protein was determined by micro-Kjeldhal

method using a nitrogen analyzer *Kjeltec system 1002* (CP = N\*6.25). Neutral detergent fiber (NDF) was determined with the Fiber Analyzer Ankom 200, following the methodology of Van Soest et al. (1991) (CC = 100-NDF). Data were analyzed according to a completely randomized design with a SAS program (2006) with  $\alpha = .05$ .

## RESULTS AND DISCUSSION

There was treatment difference ( $P < 0.05$ ). Higher voluntary feed intake ( $P < 0.05$ ) was observed by rams fed HLJ than Rongai (0.944 vs. 0.852 kg/d). Higher intake (100 g) of HLJ hay (80% of forage on offer consumed) can be attributed to a higher leaf:stem ratio as compared to Rongai (75% of forage on offer consumed). Crude protein and NDF concentration were 15.7 and 15.5% and 42.8, and 41.7% for 'HLJ' and Rongai, respectively. Both CP and NDF digestibility of HLJ and Rongai did not differ ( $P > 0.05$ ), but DM digestibility (56.2 vs. 49.6%) was higher ( $P < 0.05$ ) in HLJ than Rongai (Table 1 and Figure 1).

Voluntary intake is the most important factor in production systems and is associated with quality and palatability. In this study we observed that both hays were readily consumed. Valenzuela and Smith (2002) described lablab as highly palatable with 55% digestibility and similar to the digestibility of Rongai observed in this study. Dry matter digestibility of HLJ was in the range reported previously (56.2%).

Crude protein (>15%) and NDF (42%) values for both HLJ and Rongai reflect a high quality forage. Tobias and Villalobos (2004) reported that soybean harvested at R6 stage (full seed 90-d) had 20% CP and 42% of NDF. It is well documented that season of the year has an effect in plant development and disposition of nutrient content. Many studies also found an increase in the fiber fraction of the plant with its maturity (Murphy and Colucci, 1999). Additional studies should assess date of maturity of both HJL and Rongai.

## CONCLUSIONS

Both HLJ and Rongai exhibited high voluntary intake, as well as excellent CP and NDF supporting their potential for use in hay conservation systems to improve the feeding value of grass hay based diets and minimize concentrate use in dairy cows in Puerto Rico. Lambs fed with HLJ showed more voluntary intake and higher digestibility in comparison with Rongai hay. It was observed that leaves were preferred by lambs rather than stem fractions. Other nutritional and non-nutritional factors have to be considered to determine which one of these legume hays have better forage quality.

## ACKNOWLEDGMENTS

Research was financially supported by the TSTAR grant "Improving the productivity of warm season legumes"

## REFERENCES

Murphy, A.M., P.E. Colucci, and M.R. Padilla. 1999. Analysis of the growth and nutritional characteristics of *Lablab purpureus*. Livestock Research for Rural Development. (11)3:1999. <http://www.cipav.org.co/lrrd/lrrd11/2/colu112.htm>

- Murphy, A.M. and Colucci, P. E. 1999. A tropical forage solution to poor quality ruminant diets: A review of *Lablab purpureus*. Livestock Research for Rural Development. (11)2:1999. <http://www.cipav.org.co/lrrd/lrrd11/2/colu112.htm>
- Pirela, M. F. 2005. Valor nutritivo de los pastos tropicales. Manual de Ganadería de doble Propósito.
- Sheaffer C. C., J.H Orf, T.E. Devine and J.G. Jewett. 2001. Yield and Quality of forage soybean. Agron. J. 93:99-106.
- Skerman, P. J., D. G. Cameron y F. Riveros 1992. Leguminosas forrajeras tropicales. Colección FAO: Producción y Protección Vegetal 2:1-635 (1992).
- Tobias, C. y E. Villalobos. 2004. Producción y valor nutritivo del forraje de soya en condiciones tropicales adversas. Revista Agonomía Costaricense. 28 (1): 17-25.
- Valenzuela, H. and J. Smith. 2002. Lablab. Cooperative Extension Service College of Tropical Agriculture and Human Resources. University of Hawaii, Manoa.

**Table 1.** Voluntary daily intake and digestibility of forage soybean Hinson long-juvenile and lablab cv. Rongai hay.

Treatments	Voluntary Intake (Kg)	Intake of total offered (%)	Digestibility (%)
Soybean (HLJ)	0.94a	80.05a	56.22a
Rongai	0.85b	75.01b	49.59b

Values followed by the same letter are not significantly different.

**Figure 1.** Crude Protein and NDF concentration of forage soybean Hinson long-juvenile (HLJ) and Lablab cv. Rongai hay

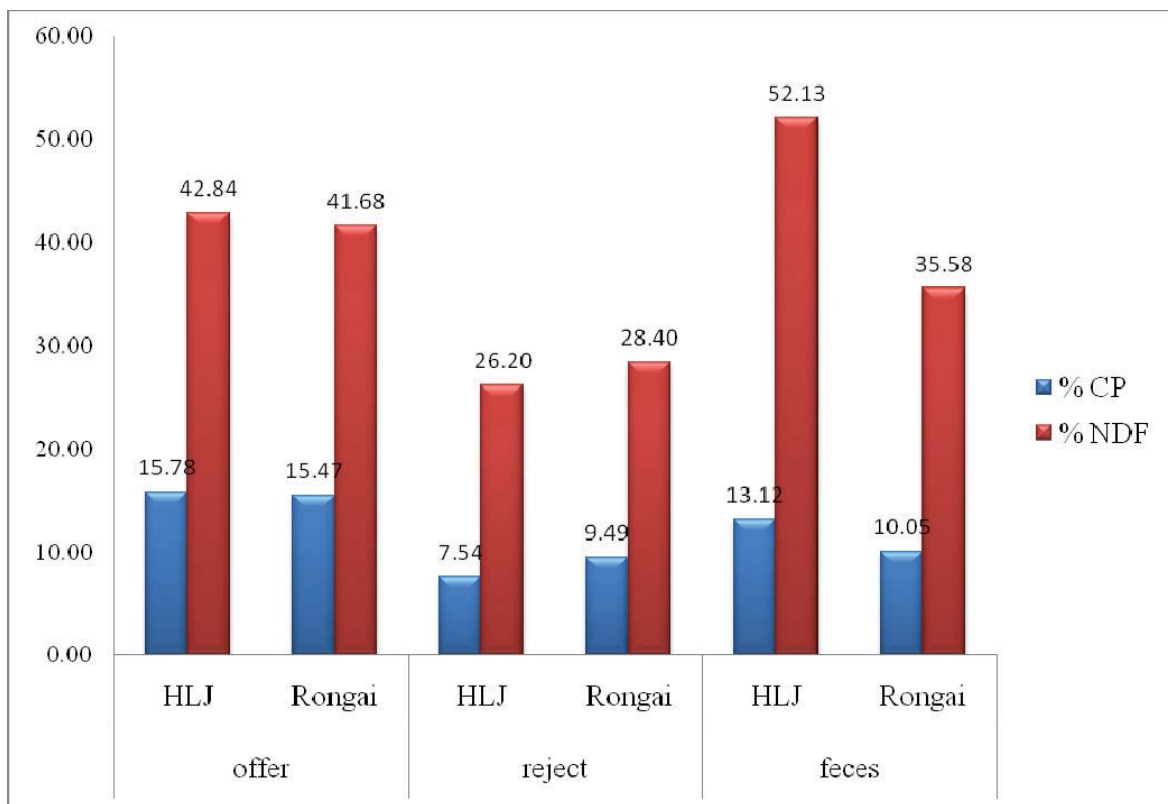

**Poster #39**

**Composición Química de *Stylosanthes guianensis* Fresco o Fermentado en Pacas Cilíndricas durante dos Periodos de Fermentación**

Vázquez, M.S.<sup>1</sup>, A.A. Rodríguez<sup>1</sup>, E. Valencia<sup>2</sup>, y P. Randel<sup>1</sup>. <sup>1</sup>Departamento de Industria Pecuaría y <sup>2</sup> Departamento de Agronomía y Suelos, Universidad de Puerto Rico, Recinto Universitario de Mayagüez. marie\_socky@hotmail.com

**RESUMEN.**

Las leguminosas tropicales ofrecidas como forraje fresco o heno son una alternativa para utilizarlas en dietas para rumiantes, sin embargo, su uso potencial como henilaje fermentado en pacas cilíndricas todavía no está bien documentado. El objetivo de este estudio fue comparar la composición química de heno de gramíneas tropicales (HGT) y *Stylosanthes guianensis* fresco (SGF) o henilado en pacas cilíndricas durante 30 (SGF1) o 72 días (SGF2). Muestras de HGT y de SGF se analizaron para determinar su contenido de MS, PB, FDA, FDN, hemicelulosa (FDN-FDA), carbohidratos no fibrosos (CNF) y NDT. Además, tres pacas de *Stylosanthes* a cada largo de fermentación (SGF1 y SGF2) se analizaron para las mismas variables de composición química y para la relación N-NH<sub>3</sub>/N-total. La data se analizó mediante un diseño completamente aleatorizado utilizando el paquete estadístico de SAS. La separación de medias se realizó mediante la prueba de Tukey. La composición química del SGF fue de 14.1% PB, 59.80% FDN, 47.00% FDA, 20.50% CNF, 57.00% NDT y 12.80% hemicelulosa, mientras que la de HGT fue de 7.01% PB, 70.70% FDN, 41.8% FDA, 15.90% CNF, 54.00% NDT y 28.90% hemicelulosa. Henilar SG en pacas cilíndricas durante 30 o 72 días disminuyó el contenido de CNF 7.7% y 2.77% respectivamente, pero aumentó el contenido de FDN 9.60% después de 30 d de fermentación y 3.60% después 72 d. La relación N-NH<sub>3</sub>/N-total fue mayor en SGF2 (7.38%) que en SGF1 (4.16%). En resumen, SGF contiene un mejor perfil de nutrientes que HGT. Henilar SG en pacas cilíndricas degrada proteínas a N-NH<sub>3</sub>, disminuye el contenido de CNF y aumenta el % de FDN, sin embargo estos cambios son menos apreciables en henilaje fermentado durante períodos de fermentación más cortos (30 vs 72d).

**PALABRAS CLAVES:** *Stylosanthes*, Henilaje, pacas cilíndricas

**Poster #40**

**Liquid Urea Rate Effects on Nutritive Value of 8-Week Regrowth of Guinea Grass (*Panicum maximum* Jacq.) Hay**

Almodóvar L. E.<sup>1</sup>, E. Valencia<sup>1</sup>, y A. Rodríguez<sup>2</sup>. <sup>1</sup>Department of Agronomy and Soils University of Puerto Rico Mayagüez and <sup>2</sup>Department of Animal Industry University of Puerto Rico Mayagüez, Box 9030, Mayagüez, PR 00681.

**ABSTRACT.**

Guineagrass (*Panicum maximum* Jacq.) is a valuable grass in grazing systems in Puerto Rico, but when conserved as hay, its low protein (<6.0%) concentration limits both meat and milk production. This study assessed the effect of applying liquid urea (LU) on hay harvested at 8-weeks regrowth of guineagrass cvs. 'Mombasa' and 'Tanzania' hay. Liquid urea were applied in a fine mist at baling at low (L; 0 lt/ha), medium (M; 204 lt/ha) and high rate (H; 807 lt/ha). Hays were stored for 8 week and core samples (250 g) were taken for determination of chemical composition of crude protein (CP), neutral detergent fiber (NDF) and acid detergent fiber (ADF) using a completely randomized design. There were cultivar effects and LU rate effects ( $P<0.05$ ) for CP, but there was no interaction. Crude protein averaged 13 and 17.7% for cv. Mombasa and Tanzania, respectively. There was a linear increase ( $P<0.05$ ) in CP with an increasing rate of LU. Mean CP was 12, 15 and 20% for the L, M, and H rate, respectively. Additive LU did not affect ( $P<0.05$ ) either NDF or ADF concentration in Mombasa and Tanzania. This study shows that adding LU at baling increases CP, but has no effect on NDF or ADF. Liquid urea at either concentration can be used to increase the nutritive value of low quality hay in Puerto Rico. Forage intake and digestibility and nitrogen balance studies, however, are needed to determine potential losses of N.

**KEYWORDS:** Grazing systems, crude protein, NDF, ADF

**INTRODUCTION.**

Guineagrass (*Panicum maximum* Jacq.) is naturalized in the Caribbean Island and Puerto Rico and used mainly for grazing and green chop. It is seldom conserved as hay because of its low protein (<6.0%) concentration and low digestibility. In hay conservation systems in Puerto Rico hay producers generally give greater importance to yield (quantity per acre) than the quality of the same. Rodríguez et al. (2004) noted that hay conserved in tropical conditions is usually of poor nutritive value because the pastures are not harvested at the appropriate vegetative stage, and it is very common to see hay from pastures after the flowering period.

Hay nutritive value can be improved by N fertilization and harvesting at early regrowth stages (60d). Chemical treatment (e.g., ammonization) has been used to improve the nutritional value of fodder preserved in the form of hay (Brown, 1993). The N concentration is usually increased by ammonization to levels considered to meet animal requirements. Amonification allows conserving starches and sugars of high energy value



in the original form, avoiding its loss by fermentation, which is then translated in forage of a high nutritive value. Ammonia hydrolysis of linkages between lignin and structural polysaccharides has been shown to increase digestibility (Conrad et al., 1990).

New guineagrass cv. Mombasa and Tanzania exhibit potential for forage conservation (hay or haylage) in Puerto Rico (E. Valencia; personal communication) but its nutritive value needs to be improved if it is to be fed to dairy cows. Liquid urea (LU) nitrogen (ULB-35; 15% of the active ingredient is Urea Low Biuret) is being promoted as N fertilizer in pastures, but limited plant response is observed. The objective of this study was to assess the effect of applying LU in a fine mist at baling at a low (L; 0 lt/ha), medium (M; 204 lt/ha) and high rate (H; 408 lt/ha) to 8-wk regrowths of Mombasa and Tanzania on its nutritive value after an 8-wk storage.

## **MATERIALS AND METHODS.**

The experiment was conducted at the Lajas Agricultural Experimental substation of the University of Puerto Rico. Soil type was of the Fraternidad series (fine, smectitic Isohyperthermic Typic Haplusterts).

Guineagrass cvs. were planted in 8 plots of 0.22 ha each; four plots of Mombasa and four plots of Tanzania. At 120d, established plots were clipped to 15-cm height, and subdivided in three subplots. Plots at clipping were maintained with a base N fertilizer (56 kg/ha ammonium sulfate).

Experimental treatments were randomly assigned and included a low (L; 0 kg/ha), medium (M; 30kg/ha) and high (H; 60 kg/ha) LU (15% N). At 8-wks regrowth guineagrass plots were clipped at 15-cm, and air dried for 3-d. When baled, LU was applied in a fine mist using a boom sprayer. Bales were stored in a dry place for 8-wks prior to sampling. Core samples, three randomly selected bales from each LU treatment and cv. (24 bales) were taken using a master forage probe. Representative samples of each bale (500 g) were ground in a Willey mill and analyzed for crude protein (CP), acid detergent fiber (ADF) and neutral detergent fiber (NDF) using standardized laboratory procedures.

Data was analyzed using Proc. Mixed of SAS (2008). Linear and quadratic treatment effects determined.

## **RESULTS.**

There were cultivar effects and LU rate effects ( $P<0.05$ ) for CP, but there was no interaction. Crude protein averaged 13 and 17.7% for cv. Mombasa and Tanzania, respectively. There was a linear increase ( $P<0.05$ ) in CP with an increasing rate of LU. Mean CP was 12, 15 and 20% for the L, M, and H rate, respectively. The fertilization only with the ammonium sulfate gave from 10 to 13% of CP for cv. Mombasa and Tanzania, respectively. Additive LU did not affect ( $P>0.05$ ) either NDF or ADF concentration in Mombasa and Tanzania (Table 1). Merrill et al. (1961) and Rodriguez-Carrasquel et al. (1983) reported similar increases in CP with N or urea applications to mature hays.

## **CONCLUSION.**

This study shows that adding LU at baling increases CP, but has no effect on NDF or ADF. Liquid urea at either concentration can be used to increase the nutritive value of

low quality hay in Puerto Rico. Forage intake and digestibility and nitrogen balance studies, however, are needed to determine potential losses of N.

#### **ACKNOWLEDGMENTS.**

Research was financially supported by HATCH formula funds (H-401) of the Agriculture Experiment Station, Univ. of Puerto Rico.

#### **REFERENCES.**

- Brown, W., 1993. Cane molasses and cottonseed meal supplementation of ammoniated tropical grass hay for yearling cattle. *J. Anim. Sci.* 71:3451.
- Conrad J., R. Pastrana. 1990 Amonificación usando urea para mejorar el valor nutritivo de materiales fibrosos. *Revista ICA-Infoma, Bogotá-Colombia.* v. 24(2) p. 5-11.
- Knapp, W. R., D. A. Holt and V. L. Lechtenberg. 1975. Hay preservation and Quality improvement by anhydrous ammonia treatment. *Agron. J.* 67:766-769.
- Merrill, W. G., J. K. Loosli, R. L. Mitchell and W. K. Kennedy. 1961. Effects of foliar application of urea on the yield and nutritive value of some grass hays. *J. Anim. Sci.* 20:785-791.
- Rodríguez-Carrasquel, S., C. F. Chicco, y E. Chacón. 1983. Efecto de la aspersion de urea sobre el rendimiento, composición química y digestibilidad del pasto pangola y A-24. *Agronomía Tropical* 24(3):183-192.
- Rodríguez-Romero, N., O., Araujo-Febres, y B., González., 2004. Efecto de la adición de urea sobre la composición química y digestibilidad *In vitro* de la materia seca de heno de *Brachiaria humidicola* (Rendle) Shweick cosechado a diferentes edades. *Arch. Latinoam. Prod. Anim.* Vol.12 (2): 52-58.
- Ventura, M., A. Barrios., I. Morales, C. Toro, K. Barreto, F. Noguera. 2002. Efecto de la Amonificación seca sobre el valor nutricional de la soca de sorgo (*Sorghum bicolor* L. Moench). *Revista Científica* Vol.XII-Suplemento 2, Octubre, 513-516.

**Table 1.** Effect of liquid urea rates (kg/ha) on crude protein (CP), acid detergent fiber (ADF) and neutral detergent fiber (NDF) % of guineagrass cv. Mombasa and Tanzania.

Liquid Urea	CP	cv. Mombasa			cv. Tanzania		
		ADF	NDF	CP	ADF	NDF	
Kg/ha	%			%			
0	10.5±1.67	42.8	67.6	13.7±1.67	42.0	66.7	
30	14.4±1.67	41.8	65.6	15.5±1.67	39.6	67.2	
60	17.0±1.67	41.4	66.3	24.1±1.67	43.0	67.0	
†L	*	NS	NS	*	NS	NS	
††Q	NS	NS	NS	NS	NS	NS	

†Linear

††Quadratic

**Poster #41**

**Fermentation Characteristics and Consumption of Forage Sorghum and Sudax Ensiled in Round Bales**

*W. Rodríguez<sup>1</sup>, A.A. Rodríguez<sup>1</sup> and E. Valencia<sup>2</sup>. <sup>1</sup>Departament of Animal Industry<sup>1</sup> and <sup>2</sup>Department of Agronomy and Soils, University of Puerto Rico, Mayagüez Campus. Wandaliz\_rodriguez@yahoo.com; abner@uprm.edu*

**ABSTRACT.**

Forage sorghum (*Sorghum bicolor* (L.) Moench.) is an important forage crop in the tropics because of its high productivity and ability to utilize water efficiently. However, information about its potential use in ruminant diets as haylage fermented in round bales (RB) is limited. The objective of this experiment was to compare the fermentation characteristics of forage sorghum and sorghum x Sudangrass hybrid (Sudax) and to determine daily intake by sheep. Forage sorghum (FS; DM 34%) and Sudax (DM 35%) were harvested at 90 days of growth and preserved as haylage in round bales (RB; 400 kg). Eight RB per variety were prepared and two were opened and sampled after 3, 7, 14 and 30 d of fermentation and pH and fermentation products determined. Data was analyzed as a completely randomized design with a 2 (sorghum varieties) by 5 (days of fermentation) factorial arrangement of treatments. To assess forage intake, 8 lambs were assigned to either forage (N=4) in individual pens. Forages were offered andorts were collected during 12 d with a 7 d adaptation and 5 d data collection period. Daily forage on offer was 3% of lamb BW on dry matter basis. Final pH was lower (P<.05) in FS (6.10) than in Sudax (6.14), however, sorghum variety did not affect final lactic acid, acetic acid and butyric acid content. There were no differences in forage intake between varieties by lambs (624 and 676 g/d for FS and Sudax, respectively). In summary, fermentation characteristics of SF were greater than Sudax as evidenced by lower pH, however, sorghum variety did not affect lamb haylage intake.

**KEYWORDS:** Sorghum, haylage, round bales, lambs intake

**Poster #42**

**Composición Química y Consumo Voluntario de *Calliandra calothyrsus* Deshidratada o Fresca por Ovinos y Caprinos**

*Lisa Dillon*<sup>1</sup>, *Melanie Román Zayas*<sup>1</sup>, *Abner A. Rodríguez Carías*<sup>1</sup> y *Elide Valencia*<sup>2</sup>. <sup>1</sup> Departamento de Industria Pecuaria <sup>2</sup> Departamento de Agronomía y Suelos, Universidad de Puerto Rico, Recinto de Mayagüez. *abner@uprm.edu*, *ldf23932@uprm.edu*

**RESUMEN.**

Se realizaron dos experimentos con el objetivo de evaluar la composición química y la inclusión de hojas de *Calliandra calothyrsus* deshidratada (CCD) o ramas frescas de la misma leguminosa (CCF) a razón de 25% de la materia seca (MS) dietética sobre el consumo voluntario (CV) de heno de gramíneas tropicales (HGT) utilizando ovinos y caprinos. Se utilizaron cuatro caprinos en el experimento uno con CCD y cuatro ovinos con CCF en el experimento dos. En cada estudio los animales fueron confinados en jaulas individuales y alimentados con 100% HGT ó 75% HGT y 25% CCD o CCF. El ofrecimiento del forraje fue basado en un CV de MS total estimado en 4% PV/d. Los forrajes se analizaron para determinar su contenido de PB, FND y FAD. Ambos experimentos se llevaron a cabo durante dos periodos de diez días con cinco días de adaptación a la dieta y cinco días de recolección de data. En cada estudio, se registró la cantidad de forraje ofrecido y rechazado para calcular el CV. La data de ambos experimentos se analizó según un diseño cuadrado latino 2 \* 2. Los valores de PB, FND y FAD de CCD fueron de 14.2, 40.9 y 33.9 %, respectivamente. Las ramas frescas de la leguminosa presentaron contenidos de PB, FDN y FDA de 10.6, 58.6 y 55.3%, respectivamente. En Ambos experimentos el consumo total de forraje fue mayor en cabros y ovinos alimentados con 75% HGT y 25% CCD o CCF que los alimentados con 100% HGT. En resumen, la composición bromatológica y la forma física (hojas vs. ramas y deshidratada o fresca) afecta la composición química de *Calliandra calothyrsus*. Sin embargo, en ambos experimentos los animales demostraron un mayor CV cuando se les ofreció 25% CCD o CCF en la dieta. La CC henificada o fresca representa una excelente fuente de nutrientes para pequeños rumiantes. Estudios futuros deben realizarse incluyendo CCD o CCF en la dieta en porcentajes mayores de 25.

**PALABRAS CLAVES:**

**Poster #43**

**The Evaluation of Three Feeding Regimens and Three Anthelmintics in a Meat Goat Production System: a Florida A&M University Research/ Extension Project**

*T. E. Peterson, R. Mobley, G. Nurse, F. Okpebholo, C. J. Lyttle-N'guessan, G. Queeley, T. Kahan; Cooperative Extension Program, College of Engineering Sciences, Technology and Agriculture, Florida A&M University, Tallahassee, Florida. Thomas.peterson@fam.u.edu*

**ABSTRACT.**

Food safety starts at the farm gate. Proper management and feeding are important to the productivity and survivability of the farm as well as to the health and safety of the food supply. Nutrition and internal parasites are two factors that affect the growth of the meat goat industry in Florida. The project evaluated three common feeding strategies [(i) a cracked corn feed, (ii) a 12% crude protein commercial feed, and (iii) a 16% crude protein commercial feed)] and three anthelmintics for their effects on weight gain and economic efficiency, and any resistance among the herd, respectively. The results indicated that the 12% crude protein commercial feed-feeding regimen was the most economical / sustainable, and had the lowest weight gain. In addition, the results indicated that Florida A&M University, Research Extension Center herd might be resistant to the Levamisole type anthelmintic. One of the objectives, also, was to apply the most efficient resources to maintain food safety. The aim is to attain healthier animals through proper nutrition, weight gain and carcass quality, thereby maximizing safe food supply.

**KEYWORDS:** food safety, anthelmintic, resistance

**INTRODUCTION**

Feed management and internal parasites are two of the biggest constraints to the growth of the meat goat industry in Florida. Proper management of these issues is a necessity to the survival of a small ruminant enterprise in terms of profitability and productivity. Producers must think of efficiency and effectiveness when developing a management system for their herd.

In most livestock production systems, cost of feed amounts to 60-75% of the total cost of production. Feed efficiency is, therefore, key to the profitability of a livestock project. The basic goal of feed efficiency is to maximize profits while assuring that the animals receive the necessary amount of nutrients to perform for growth and development. For small farmers in particularly, sustainability is important.

Internal parasite infection is one of the biggest problems in the small ruminant industry. Internal parasite infestations of herds cause great losses to the producer by decreasing the performance ability of the herd. Since anthelmintic resistance among goat herds is increasing, the proper management of internal parasites is extremely important to the success of the goat producer. The misuse (or overuse) of anthelmintics is one of the main cause of the build up of resistance. Misuse and overuse of anthelmintics also impact

the farmer economically, as anthelmintics can be very expensive (Waller, 2004). Goat producers must be knowledgeable about proper internal parasite management techniques, especially in tropical and subtropical areas like Florida, where internal parasites are a major problem.

The purpose of this project was to evaluate the effectiveness of three common feeding strategies on weight gain and economic efficiency. The project also evaluated three anthelmintics to detect if there was a resistance at the Florida A&M University Research and Extension Center (FAMU REC).

## **MATERIALS AND METHODS**

### **Weight Gain Analysis:**

Thirty-six kids with an average live weight of 36.1 pounds and an average age of five months were used to conduct this study at the Florida Agricultural and Mechanical University Research and Extension Center (FAMU REC) in Quincy, FL. The eight week study was conducted on bahia grass pastures between September and November 2006.

For the feeding regimen evaluation, the animals were randomly placed into three groups of 12 animals with similar average weights. The first group was fed cracked corn (corn) at the rate of 1.0 lb per animal daily and was allowed to graze freely on pasture. The second group was fed a 12% crude protein commercial feed (12%CP) at the rate of 1.0 lb per animal daily and was also allowed to graze freely on pasture. The third group was fed a 16% crude protein commercial feed (16%CP) ad-libitum but was limited in their ability to graze. The conditions of the third treatment simulated a feedlot situation. The animals of the 16%CP group were placed on a smaller amount of pasture land (approximately half the area of the other two groups) in order to increase the stocking density. The pasture of the 16%CP group was also cut to the ground weekly to allow only minimal access to grass. All the animals were weighed every two weeks (Days 0, 14, 28, and 54) for the duration of the study.

The animals in each feed regimen were then randomly divided into three groups of four animals and were treated with either avermectin (Cydectin<sup>®</sup> at 1 milliliter per 25 pounds), albendazole (Valbazen<sup>®</sup> at 0.75 milliliter per 20 pounds), or levamisole (Levasol<sup>®</sup> at 1 milliliter per 50 pounds). The dosages were based on the suggested rates on the label. The selection of animals for the evaluation of the anthelmintics was done so that there would be an even number of animals among each feed regimen. Fecal samples with an average weight of 1.6 grams were collected from each animal every two weeks (Days 0, 14, 28, and 54) in order to conduct a fecal analysis. Fecal egg counts (FEC) were determined with a simple flotation procedure using a salt flotation solution. The Fecal Egg Count Reduction Test (FECRT) was used to test for resistance among the anthelmintics. The FECRT is the percent reduction of the FECs from Day 0 to Day 54. Resistance in a herd is suspected if the reduction is less than 90 percent (Luginbuhl, 1998).

### **Economic Analysis:**

Economic efficiency was evaluated by measuring the cost of production and weight gain per pound of feed used. Marginal productivity (MP) was calculated as the gain in live weight that resulted from consuming one additional pound of feed. The

marginal factor cost (MFC) and the marginal value product (MVP) were computed to determine and compare the optimum least cost production. The MFC is basically the average price per pound of feed. The MVP is the change in the total value of the product (change in live weight multiply by the price received per pound of weight) as a result of feeding one additional unit of feed. The difference between the MVP and the MFC was used to determine if the feeding regimen would earn more revenue than it would cost to follow the regimen. If the MVP is greater than the MFC, the regimen results in a product that could possibly earn a profit when considering only the cost of feed. Also, note that the comparison between the regimens was based only on the purchased inputs of feed and not the other costs related to the management of the animals such as the economic value of the pasture, the cost of medications, etc. The comparison relates the relative efficiency in live weight gain and profit potential between the feeding regimens with respect to the use of purchased inputs (McGowan & Leong, nd). The feed conversion rate and the feed per pound of weight gain were also calculated.

#### **Fecal Analysis:**

The fecal egg count (FEC) was used to identify the level of internal parasite infestation. The level of infestation was evaluated based on the following chart, which is the protocol for the FAMU REC.

- 100-250 EPG = Not a significant amount
- 250-500 EPG = Low infection level
- 500-1000 EPG = Moderate infection level
- >1,000 EPG = High infection level

Statistical analysis was done using the general linear model procedure (PROC GLM) of SAS<sup>®</sup> software (SAS Institute, Inc., 1998). Significant differences were analyzed using the Least-squared Denominator test, using a level of significance of  $\alpha=0.05$ . The percent reduction of the fecal egg counts from Day 0 to Day 14 was calculated and used to determine if there was resistance to the particular anthelmintic based on the limit of 90%.

## **RESULTS AND DISCUSSION**

#### **Weight Gain:**

Animals under the 16%CP feeding regimen had the highest average weight, while animals in the 12%CP feeding regimen had the lowest average weight (Figure 1). Overall, animals under the 16%CP feeding regimen had the highest mean weight gain compared to the other treatments. The reason could be linked to the higher plane of nutrition because of the high protein level of the 16% feed and to the fact that the animals in this group were fed *ad libitum*. For the corn group, the weight gain was higher than that of the group fed with the 12%CP feed. This could relate to the fact that the corn feed contained more energy than the 12%CP feed. For the 12%CP group and the corn group, weight loss began to occur during the 55-70 day period, whereas the animals in the 16%CP treatment continued to gain weight. One possible explanation for this is that the quality of the pasture normally begins to decrease as winter approaches. The 12%CP



group and the corn group relied on pasture more than the 16%CP group, which was limited in its ability to graze and was given supplement *ad libitum*.

### **Economic Analysis**

While the aim is to attain healthier animals through proper feeding and management techniques and strategies, economic efficiency and sustainability is also important. The group fed 16%CP resulted in the highest cost of feed per pound gain at \$1.80 per pound of gain (Table 1). Although this is expected because protein is normally the most expensive component of a feed, the cost per pound of gain for this regimen is more than the average price that producers receive per pound of live weight, which is \$1.25 per pound (Cosenza et al., 2003). Basically, this regimen would result in a producer spending more on feed than the revenue they would receive per pound of gain when the animal is sold, which would result in a negative profit. Although the average weight gain of goats in the 12%CP group was the lowest, it cost \$0.79 for enough feed to produce a pound of gain. Additionally, the difference between the MVP and the MFC was the greatest for the 12%CP, which means that this feeding regimen has the possibility to produce the greatest amount of profit out of the three regimens evaluated when comparing the cost of feed to the potential revenue. Thus, the 12%CP feeding regimen is the most economically efficient.

### **Fecal Analysis:**

The average FEC of the entire herd remain in and around the “not a significant amount” to the “low infection level” throughout the study. Although some individuals had large fecal egg counts at times, the average remained low. This also points to the need to treat individual animals instead of the entire herd because it is usually a minority of animals that shed the majority of the parasites.

Overall, the total worm FECs were similar for each feeding regimen. The difference in FECs over time did not change significantly, but a decreasing trend can be observed (Figure 2). The FECs decreased on Day 14 because of the effects of treatment with anthelmintics and increased after Day 14 because of re-infestation of the herd by parasites on the respective contaminated pastures. On Days 42 and 54, the animals in the 16%CP group had significantly higher FECs than the other two groups. The higher FEC could be attributed to the higher stocking density of the group in the 16%CP group and the lower grass levels of the paddock of this group, which could have led to a faster rate of re-infestation. In addition, the 16%CP group had the highest FEC's of *Eimeria* and *Strongyloides* (Figure 3). The FECs of *Haemonchus*, *Nematodirus*, and *Monezia* were similar for each feeding regimen.

The average FEC over all days for each anthelmintic were similar (Figure 4). Generally, the efficacy of the different common anthelmintics when used properly is trivial and should not be used to decide which anthelmintic to use. Although the three anthelmintics had similar FECs on Day 0, animals treated with levamisole had the highest mean FEC on Days 14 and 28. The percent reduction in FEC according to the FECRT described previously was found for each anthelmintic (Table 2), and it is suspected that the herd at the FAMU REC might be resistant to levamisole. Scarfe (1993) suggests that a less than acceptable FEC reduction could also indicate an improper dosage or an improper administration of the anthelmintic evaluated. After the completion of this study,

the dosage of levamisole was increased and another FECRT was performed. The reduction in the fecal egg counts of the animals treated with levamisole increased but more research needs to be done in order to make a conclusion. If under-dosing or improper dosing is suspected on a farm, those issues should be addressed relatively quickly as they will accelerate the build up of resistance. In addition, it is important to note that resistance varies between herds and the fact that resistance is suspected in one herd does not mean that another herd will also have the same level of resistance. The FECs between all anthelmintics at Day 54 were similar, which suggest that all the drugs no longer had any residual effects and were excreted from the system by this time.

The effects of the anthelmintics on the FECs of the individual species of parasites were also similar (Figure 5). According to the product labels, avermectin and levamisole are not effective against *Monezia*; whereas, albendazole is effective against *Monezia*. The mean FECs of *Eimeria* (coccidia) were similar for each anthelmintic. None of these anthelmintics are effective against coccidia. Coccidiosis is normally treated with sulfa drugs (Albon<sup>®</sup>) and Amprolium (Corid<sup>®</sup>). The sulfa drugs do not directly cure the coccidiosis but instead prevent secondary bacteria diarrhea.

## CONCLUSION

Many of the methods of evaluation used in this study including the economic efficiency, weight gain, the FEC, and the FECRT can all be done on the farm of the average producer. It is important to evaluate feeding regimens for economic efficiency and their effect on animal performance. The most expensive feeds are often the least economically efficient. It is suggested that an extension agent be contacted to help develop a suitable feeding regimen for a particular production system.

For this study, the most economically efficient feeding regimen was the 12%CP feeding regimen although this feeding regimen had the lowest weight gain. With regards to the use of anthelmintics to control internal parasites, the most important consideration when using an anthelmintic is not what anthelmintic is used but proper dosage and administration techniques to impede the build up of resistance. It is important to consult a credible and knowledgeable source on proper management of internal parasites because many stress the importance of finding methods of parasite control that will allow producers to decrease their reliance on anthelmintics. The ability to properly manage and evaluate feeding regimens and internal parasite infestations will be beneficial to any goat producer.

## REFERENCES

- Cosenza, G. H., Williams, S. K., Johnson, D. D., Sims, C. and McGowan, C. H. (2003). *Development and evaluation of a fermented cabrito snack stick product*. Meat Science. 64: 51-57.
- McGowan, C. H. and Leong, S. S.. (n.d.) *Comparative analysis of two meat goat management systems in north Florida*. Retrieved May 15, 2007, from <http://www.famu.edu/oldsite/acad/colleges/cesta/comparative-analysis.html>
- Luginbuhl, J. (1998). *Gastrointestinal parasite management of meat goats*. Retrieved January 16, 2007, from [http://www.cals.ncsu.edu/an\\_sci/extension/animal/meatgoat/MGWormer.htm](http://www.cals.ncsu.edu/an_sci/extension/animal/meatgoat/MGWormer.htm)

Scarfe, A. D. (1993). *Approaches to managing gastrointestinal nematode parasites in small ruminants*. Retrieved March 19, 2007 from <http://www.clemson.edu/agronomy/goats/handbook/nematode.html>.

Waller, P. J. (2004). *Management and control of nematode parasites of small ruminants in the face of total anthelmintic failure*. *Tropical biomedicine*. 21:7-13.

Parameters Evaluated	Corn	12%CP	16%CP
Initial Avg. Weight (lbs)	32.2	31.3	32.0
Final Avg. Weight (lbs)	42.6	40.2	45.4
Avg. Weight Gain <sup>a</sup> (lbs)	10.4	8.9	13.4
Avg. Feed Consumed <sup>b</sup> (lbs)	69.9	70.5	136.0
Feed Conversion Rate <sup>c</sup> (lbs)	1 : 6.7	1 : 7.9	1 : 10.1
Feed Cost/Pound of Feed <sup>d</sup>	\$ 0.17	\$ 0.10	\$ 0.18
Feed Cost/ Pound of Weight Gain <sup>e</sup>	\$ 1.14	\$ 0.79	\$ 1.80
Marginal Productivity <sup>f</sup>	\$ 0.15	\$ 0.13	\$ 0.10
Value of Marginal Product <sup>g</sup>	\$ 12.99	\$ 11.16	\$16.80
Marginal Value Product <sup>h</sup>	\$ 0.19	\$ 0.16	\$ 0.10
Marginal Factor Cost <sup>i</sup>	\$ 0.17	\$ 0.10	\$ 0.18

**Table 1.** Analysis of the economic efficiency of three feeding regimens.

<sup>a</sup>Avg. Weight Gain (AWG) = (Final Avg. Weight – Initial Avg. Weight)

<sup>b</sup>Avg. Feed Consumed (AFC) = Amount Fed / Number of Days

<sup>c</sup>Feed Conversion Rate (FCR) = AFC / AWG

<sup>d</sup>Feed Cost/Pound of Feed (FC:F) = Cost of Feed / Total Amount of Feed

<sup>e</sup>Feed Cost / Pound of Weight Gain (FC:WG) = FC:F x AFC / AWG

<sup>f</sup>Marginal Productivity (MP) = AWG / AFC

<sup>g</sup>Value of Marginal Product (VMP) = (AWG x price per pound of weight) / AFC

<sup>h</sup>Marginal Value Product (MVP) = VMP / AFC

<sup>i</sup>Marginal Factor Cost = FC:F

**Table 2.** Fecal egg count reduction test (FECRT)

	Avermectin	Levamisole	Albendazole
FECRT <sup>a</sup>	0.95	-0.11	1.00

<sup>a</sup>FECRT equals the average fecal egg count of Day 0 minus the average fecal egg count of Day 14 divided by the average fecal egg count of Day 0.

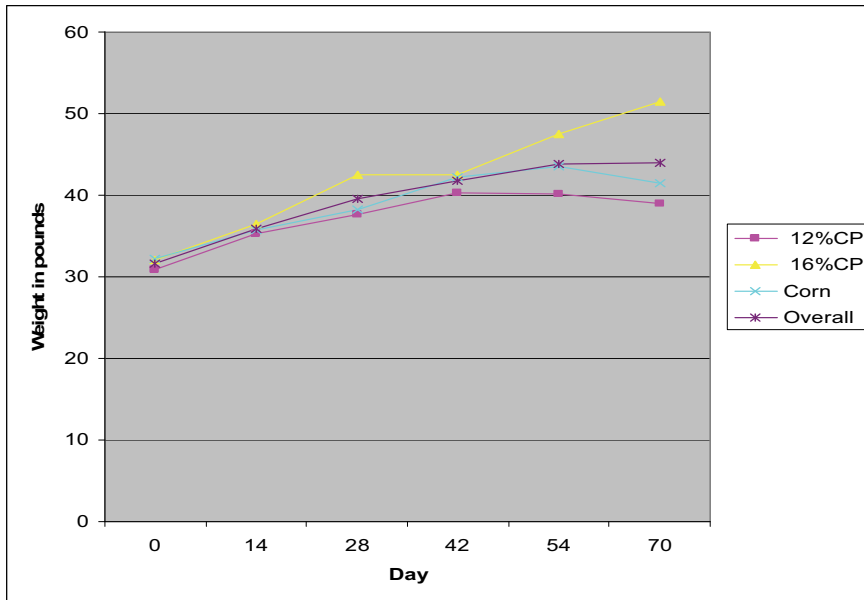

Figure 1. Average weight by feed regimen over time

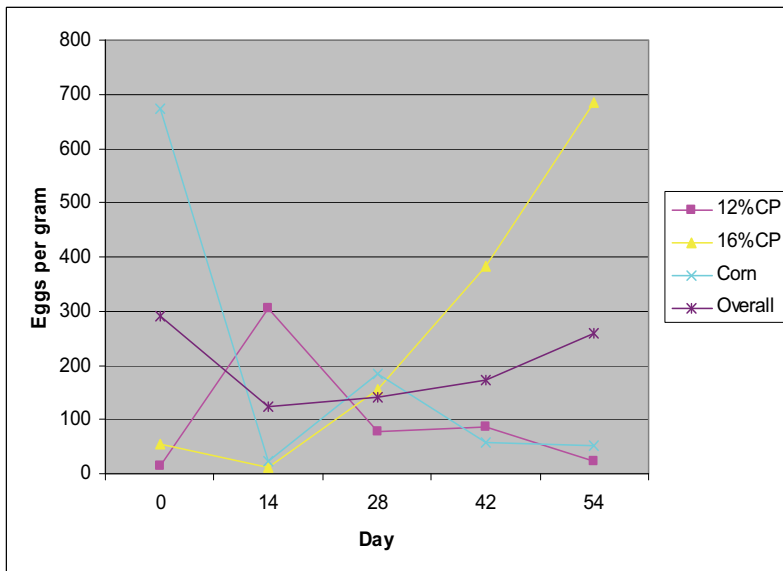

Figure 2. Fecal egg counts by feed regimen over time

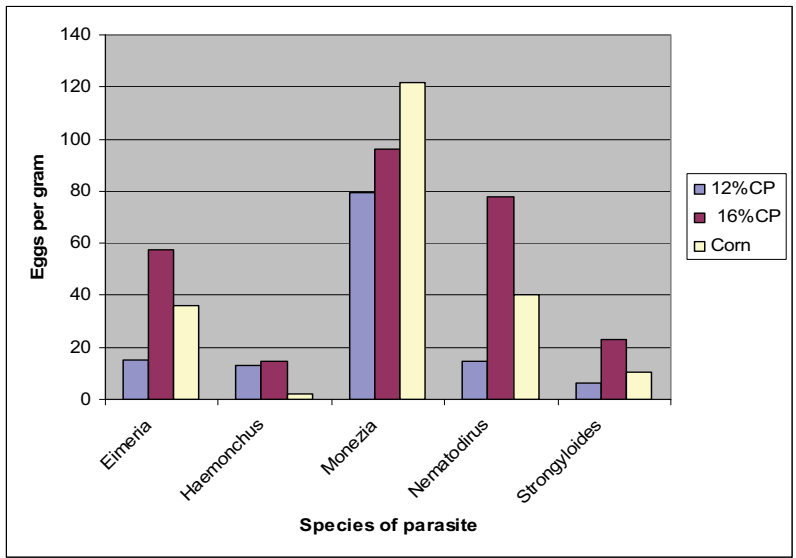

Figure 3. Fecal egg counts by species of parasite for each feed regimen

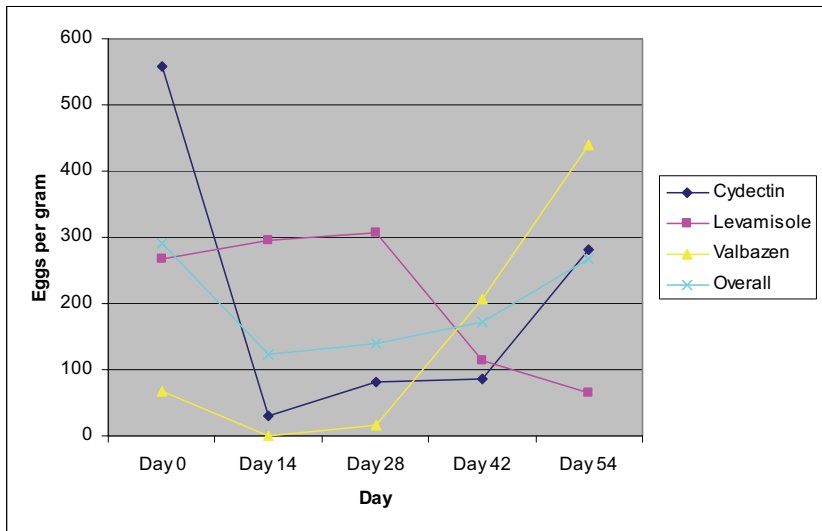

Figure 4. Fecal egg counts by anthelmenthic

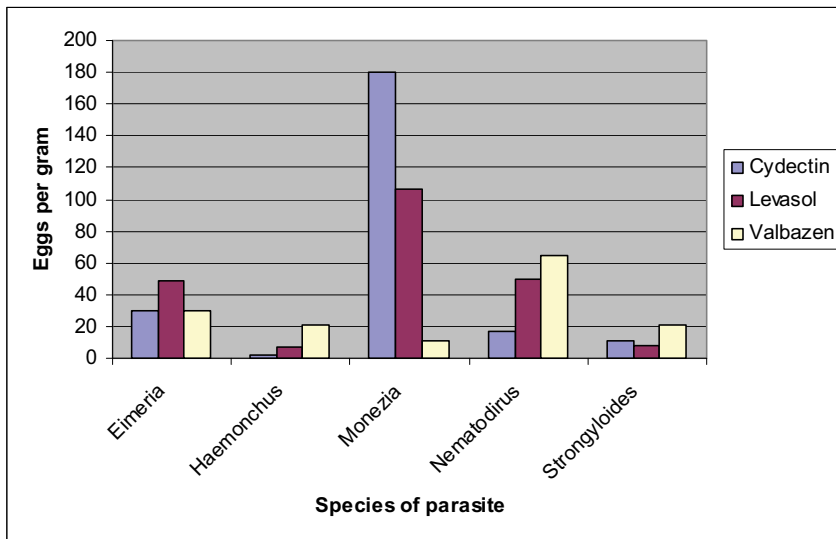

Figure 5. Fecal egg counts by species of parasite for anthelmintics

**Poster #44**

**Stocking Rate Trial with Boer X Spanish Goats under Thinned Loblolly Pines**

*Nadine Gordon-Bradley and O. U. Onokpise, Agronomy, Forestry and Natural Resources Conservation Program, College of Engineering Sciences, Technology and Agriculture, Florida A&M University, Tallahassee, Florida 32307. gordonnadine@hotmail.com*

**ABSTRACT.**

Goat meat is said to be one of the most highly consumed meat in the world. The perception of using goats for vegetation management other than as a grazing livestock remains very high. As the demand for goats increases due to healthy diet needs and ethnic population presence, the need to increase production using various grazing practices for small ruminants has begun to receive attention. The present study was conducted to determine stocking rates of Boer x Spanish goat crossbreeds in a silvopastoral system of loblolly pines and Tifton9 bahiagrass. The experimental area consisted of loblolly pine plantation that was planted in 1979 and thinned in November 2001 to 1.2- x 12-m spacing. Tifton-9 bahiagrass was planted between widely spaced loblolly pine trees. Treatments consisted of (1) shaded pastures and open pastures of Tifton-9 bahiagrass as the main plots, and (2) two stocking rates (10 and 17 goats per ha) crossbred goats as the subplots using a split-plot arrangement. Goats grazed paddocks using a rotational stocking method. Live weight data was used to calculate the average daily gain (ADG) and weight gain or loss of animals over the grazing period to determine recommended stocking. For Year 1, there was no significant difference in ADG of the animals for the shade treatment ( $P = 0.124$ ) or stocking rate treatment ( $P = 0.673$ ). For Year 2, the results showed a significant effect of stocking rate ( $P = 0.003$ ) on ADG. The result from this study indicated that the low stocking rate was best for the goats evaluated. High stocking rates for both years caused weight loss thus indicating that a low stocking rate will be best for the paddock sizes used for the study. A silvopastoral system with goats at a stocking rate of 10 goats ha<sup>-1</sup> averaging 34 -45 kg body weight on bahiagrass grown under trees can provide adequate forage.

**KEYWORDS:** silvopastoral system, Tifton-9 bahiagrass, stocking rate.

**INTRODUCTION.**

Meat goat production is increasing in the United States due to goats' economic value as efficient converters of low quality forages into quality meat, milk, and hides products for specialty markets (Engle et al., 2000). According to the National Agricultural Statistics Service, there are approximately 60,000 head of meat goats found in the state of Florida for 2007. The main reason for meat goat increase in the United States is the wide variety of ethnic groups that have settled in the United States who have a desire for goat meat, milk and other goat products (Engle et al., 2000). Another reason

is that with limited resources a small herd of goats may be the only livestock that a small farmer can raise in self-sustainable enterprises (Engle et al., 2000).

Farmers can use goats as brush control since goats tend to browse shrubs and trees more readily than grass (Mislevy et al., 2000). However, goats will graze well on improved grass pastures (Mislevy et al., 2000). Mature goats have a daily dry matter (DM) intake ranging from 30 to 50 g kg<sup>-1</sup> of their body weight (Pinkerton et al., 1991). The quantity of the forage eaten by the animals per day is influenced by availability, DM concentration, digestibility, and rate of passage (Pinkerton et al., 1991).

Research data on stocking rate of small ruminant for silvopastoral systems is not readily available. With the increased influx of goat farmers in Florida and other southern states, coupled with the need for tree maintenance for environmental benefits, this type of information is needed for the farmers to decide upon an actual stocking rate using goats as the livestock component. The objective of this study was to provide information for an optimal stocking rate for Boer x Spanish crossbred goats for a silvopastoral system with loblolly pine trees.

## **MATERIALS AND METHODS.**

### **Study Site**

The site for this study is located at Florida A&M University Research and Extension Center Farm, Quincy, Florida. The farm is located in the lower southeastern region of the United States Geological Survey (USGS), 7.5-minute Dog-town quadrangle topography map. The property lies west of state road 267 and south of state road 272 at 30° 36" N latitude and 84° 33" W longitude (Clarke, 1999). The major land cover includes pine, mixed hardwood/pines forests, agriculture and non-vegetative urban infrastructure (Darbyshire, 1993).

The area used for this research consisted of loblolly pine that was planted in 1979. This area was thinned in November 2001 from the original spacing of 1.2 x 2.4 m to a 1.2 x 12-m spacing (Whilby, 2004).

### **Experimental Design**

A split plot experimental design was used for these studies. Treatments consisted of 1) shaded pastures (existing under the established loblolly pines) and open pastures of Tifton 9 bahiagrass as main plots, and 2) two stocking rates (10 & 17 goats per hectare) of Boer x Spanish crossbred goats as subplots.

The total acreage used for this research was 1.62 hectares of land; 0.8 hectare shaded and 0.8 hectare unshaded. Both the shaded and unshaded areas were divided into four 0.2-ha experimental units. Each experimental unit was then further subdivided into two 0.1-ha paddocks. Each experimental unit consisted of two stocking rates of Boer x Spanish crossbreed of goats and there were two replications of each treatment. Goats grazed paddocks using a rotational stocking method. Goats were placed in each 0.1 ha paddock for 14 d then rotated to the second 0.1-ha paddock within that experimental unit for the next 14 d, that is, a 14-d grazing period followed by a 14-d rest period in each 0.1-ha paddock. Thus, there was a 28-d grazing cycle in all the experimental units.

### **Animal Management**



For Year 1, thirty-two 18-month old animals were dewormed with cydectin at a rate of 1 cc per 9 kg animal weight. Iron (Ferrodex 5 ml / 23 kg) was given to each animal one week before assignment to pastures. For Year 2 the same deworming program was used, however, these animals were 36 months old. The animals were bred at Florida A&M University Research and Extension Station in Quincy, Florida. Animals were assigned randomly to treatments but balanced for average weight of animals. For Year 1, the average initial weight of the animals was 23 kg (0.08 AU). Animals were assigned to pastures on September 27, 2005. For Year 2, 32 adult animals were selected averaging 45 kg initial body weight (0.17 AU) and assigned to pastures on August 22, 2006. Each paddock within each experimental unit was grazed by the assigned stocking rates for the Boer x Spanish goats.

### **Data Collection for the Goat Weights**

Live weight data was collected for goats during a two-year study. For Year 1, initial weights of animals were collected before they entered into the grazing trial and another weight was taken 6 wk later at the end of the grazing trial. For Year 2, goats were weighed at the beginning and every 28 d after being introduced into the paddocks.

### **Weight Analysis for Goats**

Live weight data was used to calculate the average daily gain (ADG) and weight gain or loss of animals over the grazing period. Average daily gain was calculated using the following formula:

$$\frac{F W - I W}{\# \text{ of grazing days}}$$

FW = final weight, IW = initial weight

### **Statistical Analysis**

Animal performance responses were analyzed using the Proc Mixed of SAS at the 0.05 probability level. The treatments were shade (shaded versus unshaded) and stocking rate (high (17 animals ha<sup>-1</sup>) and low (10 animals ha<sup>-1</sup>) animals) with two replications. Average weight for the animals over the entire grazing period was also analyzed using analysis of variance. Treatments were stocking rate, shade and dates.

### **RESULTS/DISCUSSION.**

For Year 1, there was no significant difference in average daily gain (ADG) of the animals for the shade treatment (P = 0.124) or stocking rate treatment (P = 0.673). Animals in the shaded area lost an average of 0.017 kg d<sup>-1</sup> while the goats in the unshaded area gained an average of 0.016 kg d<sup>-1</sup>. Goats in the low stocking rate gained an average of 0.004 kg d<sup>-1</sup> while the goats in the high stocking rate loss 0.005 kg d<sup>-1</sup>. Kallenbach et al., (2006) indicated that ADG of heifers was the same for animals in shaded and unshaded pastures. The average weight gain/loss for the animals during Year 1 showed that the animals maintained their body weight throughout the grazing period (Table 1). These results were expected since the grazing period was very short thus a significant weight gain would not be seen in the animals. Another reason for these results could be due to the age of the animals. These animals were older and so they are expected

to have a lower growth rate when compared to yearlings or six months old animals that are expected to have a faster growth rate.

For Year 2, the results showed a significant effect of stocking rate ( $P = 0.003$ ) on ADG. The animals in the low stocking rate were gaining an average of  $0.047 \text{ kg d}^{-1}$  while the animals in the high stocking rate were losing an average of  $0.011 \text{ kg d}^{-1}$ . The average weight gain/loss analysis for Year 2 showed that the animals in the low stocking rate gained weight while the high stocking rate lost weight (Table 2).

Similar results have been obtained by Goodwin et al., 2004, who reported that goats reared in a grass only pasture had an average daily gain of  $27 \text{ g d}^{-1}$ .

The results obtained showed the lower stocking rate performed better than the high stocking rate. This result could be due to increased availability of forage for the animals, which could provide for the weight gains.

## **SUMMARY.**

The results from this study indicated that the low stocking rate was best for the goats evaluated. High stocking rates for both years caused weight loss in the animals, thus indicating that the stocking was too high for the paddock sizes used. The shade did not significantly affect the stocking rate of the animals. The data obtained for Year 1 showed no significant differences among the treatments. It was expected that the animals in the low stocking rate in the shaded pastures would perform better due to the shade which would allow the animals to be grazing more frequently than the animals in full sunlight. These results however could have come from factors such as the management conditions of the animals before they were placed on pasture. The animals used were being supplemented and when they were used in the study, no supplementation was given to these animals. The removal of the supplementation could have resulted in loss of some vitamins or essential nutrients found in the supplementation feeds that were not available in adequate proportions in the grass.

## **REFERENCE.**

- Clarke, F.L.G. 1999. Investigating the spatial distribution of American beech and southern magnolia with remotely sensed data. M.S. Thesis, Florida A&M University, Tallahassee.
- Darbyshire, J. 1993. Forestry management plan. F&W Forestry Services, Quincy, Fl. pp 8.
- Engle, C., G. Greaser and J. Harper. 2000. Meat Goat Production (Agricultural Alternatives). Penn State University, University Park.  
(<http://www.das.psu.edu/user/publications/pdf/ua340.pdf>).
- Goodwin D.J., J.P. Muir, R.D. Wittie and T.F. Brown. 2004. Goat weight gains, forage selectivity and forage quality dynamics in three cultivated warm season pastures in north-central Texas. *Small Rumin. Res.* 52: 1-2, pp 53-62.
- Kallenbach, R.L., M.S. Kerley and G.J. Bishop-Hurley. 2006. Cumulative forage production, forage quality and livestock performance from an annual ryegrass and cereal rye mixture in a Pine-Walnut Silvopastoral. *Agrofor. Syst.* 66: 43-53.
- Mislevy, P., F.G. Martin, and J.T. Nelson. 2000. Selectivity of tropical grasses by Spanish x Boer Goats. *Soil Crop Sci. Soc., Florida Proc.* 59:77-81.

- Pinkerton, F., D. Scarfe, and B. Pinkerton. 1991. Meat goat production and marketing. Fact Sheet M-01 E. (Kika) de la Garza Institute for Goat Research. Field Day Proceedings No. M-01. Langston University, Langston, OK.
- Pratt, M. and G. A. Rasmussen. 2001. Determining your stocking rate, Range Management Fact Sheet, NR/RM/04. Utah State University Extension (<https://extension.usu.edu/files/natrpubs/range4.pdf>).
- Whilby, L.A. 2004. Evaluation of bahiagrass (*Paspalum notatum* Flugge) and bermudagrass (*Cynodon dactylon* (L.) Pers.) as pasturable pastures under newly thinned loblolly pine (*Pinus taeda* L.) plantation. Master's Thesis, Florida A & M University, Tallahassee.

**Table 1:** Mean Weight gain/ loss (kg) of Boer x Spanish Crossbreed goats by shade and stocking rate during Year 1 of a Two year Silvopastoral study.

<sup>a</sup> Converted from 3 goats and 5 goats per 0.1 ha paddocks respectively.

Effect	Weights				
	Weight Dates	Initial weight (8-22-06)	9-19-06	10-17-06	Final weight (11-14-06)
Shade	Shaded	48	48	49	50
	Unshaded	47	48	46	46
Stocking Rate	Low (10 goats/ha) <sup>a</sup>	47	48	49	49
	High (17 goats/ha) <sup>a</sup>	47	48	48	47

**Table 2:** Mean Weight gain/ loss (kg) of Boer x Spanish Crossbreed goats by shade and stocking rate during Year 2 of a Two year Silvopastoral study.

<sup>a</sup> Converted from 3 goats and 5 goats per 0.1 ha paddocks respectively.

Effect	Stocking Rate	Initial weight (9/27/2005)	Final weight (11/8/2005)
Shaded	10 goats/ha <sup>a</sup>	30	30
	17 goats/ha	30	30
Unshaded	10 goats/ha	30	30
	17 goats/ha	30	30

**Poster #45**

**Effects of Palm Kernel Cake in the Diet of Dairy Goats on Milk Production and Kid Daily Gain;**

**Efecto del Palmiste (*Elaeis guineensis*) Sobre el Comportamiento Productivo de Cabras Lecheras.**

*Juan C. Ureña, Marco E. Fernández, Carlos M. De Jesús, Rafael A. Vásquez.*

*Animal Science Department, Universidad ISA, Avenida Antonio Guzmán Fernández, Km 51/2, La Herradura, Santiago, República Dominicana. [cdejesus@isa.edu.do](mailto:cdejesus@isa.edu.do); Departamento de Ciencia Animal, Universidad ISA, Avenida Antonio Guzmán Fernández, Km 51/2, La Herradura, Santiago, República Dominicana. [cdejesus@isa.edu.do](mailto:cdejesus@isa.edu.do)*

**ABSTRACT.**

A field trial was carried out to evaluate the effects of the inclusion of palm kernel cake (PKC) in diets of dairy goats on goat performance, milk yield, kid daily gains and, milk composition. Forty-eight (48) last quarter gestating crossbreed dairy goats in the last quarter of gestation with 54 kg of BW were randomly distributed in eight PKC treatments arranged in 3 blocks in a randomized block design. The treatments were 0, 15, 30, 45% of PKC and two milking frequency (one and twice at day). The dairy ration was formulated (NRC, 1981) to contain 62.93 g of DP and 2.4 Mcal/kg NEL per dairy goat weighing 54 kg and producing milk containing 4.0 % milk fat. The ration consisted in hay grass (Transvala) and grains supplement. Body condition, feed intake, profit, milk production and composition, were measured with respect to the dairy goats and daily gain was registered with respect to the kids. The body condition was not affected by the PKC levels. The PKC treatments did not affect goat feed intake, which was 2.81kg /animal/d and 1.92 kg/animal/d when goats were milked once or twice per day, respectively. The average kid daily gain was 72.57 g/d in those lactated by goats that were milked once per day. Milk production was 18.62 kg per animal and 12.95 kg per animal in goats milked once and twice per day, respectively. The milk of dairy goats milked twice per day had higher milk fat content (4.45 %) than of those milked once per day (3.45 %). With goats milked once per day the highest profit was obtained with 15 % of PKC in the ration, and with goats milked twice per day the highest profit was obtained with 30 % of PKC in the ration.

**KEYWORDS:** dairy, goat, feed intake, milk, yield, ration

**INTRODUCCION**

En los países subtropicales como la República Dominicana, la tendencia es la intensificación del sector caprino lechero debido a la importancia que este reviste en la economía agropecuaria y en la salud humana. Otra de las razones es el aprovechamiento de la gran cantidad de fuentes de forrajes con que cuenta nuestro país, lo que representa un gran potencial para desarrollar dicha explotación pecuaria en las diferentes regiones.

Esto se puede observar en el intervalo 1999-2002 durante el cual ha habido un incremento en el volumen (TM) de productos de origen caprino-ovino de 29 % (Banco Central, 2003).

Para maximizar la rentabilidad de la explotación caprina, es necesaria la inclusión de subproductos de origen agroindustrial y de producción nacional. El empleo de dietas con inclusión de subproductos agroindustriales es una alternativa para cubrir el déficit de nutrientes originados en algunas ocasiones por la escasez de alimentos y pastos de baja calidad en la sequía y los altos costos de materia prima importada para la elaboración de alimentos (Sánchez et al., 2001)

Es necesario buscar alternativas que ayuden a aumentar la producción de leche caprina de calidad con el menor costo posible, ya que esto puede ser una solución a los problemas que enfrenta el sector pecuario de la República Dominicana, como es el alto costo productivo. En cierto punto, la producción de leche depende del número de ordeños que se efectuó puesto que esto estimula la producción láctea en la glándula mamaria (Bath et al., 1985). Se han realizado investigaciones en ordeño de cabras en la Universidad ISA empleando palmiste, Pasta de arroz y otros subproductos agroindustriales con una producción promedio de leche de 0.74 kg/día/animal, donde el factor frecuencia no fue evaluado (Alcántara, 2006). Sin embargo, es una necesidad determinar la sustentabilidad de una producción intensiva de leche en cabras con varias frecuencias de ordeño bajo nuestras condiciones climáticas. Por lo tanto se planteó un estudio con cabras mestizas bajo dos frecuencias de ordeño y la inclusión de subproductos agroindustriales

## **MATERIALES Y METODOS**

### **Animales y corrales**

Las 48 cabras multíparas utilizadas se obtuvieron del rebaño caprino de la Universidad ISA compuesto por las razas Nubia-Boer, Alpina-Nubia, Alpina-Criolla. Las cabras tenían un peso promedio de 54.6 Kg y estaban en el último tercio de gestación y fueron confinadas en grupo de dos cabras con una densidad de 3 m<sup>2</sup> /animal.

### **Diseño experimental**

Se utilizó un diseño completamente al azar con arreglo factorial (4x2) con 3 repeticiones con un total de 24 unidades experimentales. Los factores evaluados fueron 4 niveles de palmiste y 2 frecuencias de ordeño.

El modelo estadístico que se utilizó para analizar la variación entre los tratamientos y el error fue el siguiente:

$$Y_{ijk} = \mu + F_i + P_j + (FP)_{ij} + E_{ijk}$$

Donde:

$Y_{ijk}$  = Valor observado de la variable A.

$\mu$  = Media general.

$F_i$  = Efecto de la frecuencia de Ordeño ( $i = 12$  y  $24$  h/día)

$P_j$  = Efecto de los niveles de palmiste ( $J = 0, 15, 30$  y  $45\%$ )

$E_{ijk}$  = Efecto del error experimental

Las variables estimadas y calculadas en los distintos tratamientos fueron: Peso del cabrito al nacer (kg), Peso del cabrito al destete (kg), Consumo de MS diario en las cabras (kg), Ganancia diaria de peso de los cabritos (g), Condición corporal en cabra,

Producción láctea (kg), Índice de conversión alimenticia(%) y la Relación Beneficio \ Costo .

### **Tratamientos**

Los tratamientos consistieron en la inclusión de cuatro (0, 15, 30 y 45%) en dietas de cabra lecheras mestizas. Las raciones fueron formuladas de acuerdo a los requerimientos nutricionales de las cabras según al NCR, 1981 (ver tabla 1). La dieta base estuvo constituida por forraje y concentrado (60:40); el alimento balanceado consistió en un suplemento (40 %) de la dieta total. Este suplemento estuvo constituido por una mezcla de maíz, soya, premezcla de vitaminas y minerales, aditivos y el nivel de inclusión de palmiste. El forraje (60%) provino de heno de Pasto Transvala (*Digitaria decumbens*) que fue suministrado 700 y 1600 h, conjuntamente con el concentrado. Los animales dispusieron de agua y alimento a voluntad.

### **Manejo del Experimento**

Todos los tratamientos estuvieron en iguales condiciones ambientales y de manejo. Esto incluye la desinfección y encalado de los corrales previo al experimento y además las cabras recibieron un vermífugo y vitaminas.

El consumo de forraje y suplemento en cabras y cabritos se registro diariamente con relación al peso corporal, donde el consumo real fue la diferencia entre el monto ofrecido y el rechazado. Al momento del parto se registro el peso al nacer del cabrito y curado del ombligo y se identificaron los cabritos y se confirmo la ingestión de calostro por los recién nacidos y la expulsión de la placenta en las cabras. El ordeño se realizo en forma manual, donde se registraba diariamente la cantidad (kg) de leche producida. El grupo de cabras ordeñadas una vez (24 h) por día se apartaba los cabritos de sus madres a 1800 h para su ordeño a las 600 h y en caso de dos veces (cada 12 h) por día se realizaba el ordeño a 600 h y 1800h. Los cabritos del grupo de 12 h se destetaron un día posterior al nacimiento y fueron alimentados con leche de vacas y concentrado. Cada dos semanas, los cabritos fueron pesados y se registro al condición corporal de las cabras según la escala de Langston University.

### **Análisis de Datos**

Los datos recolectados en las variables evaluadas fueron sometidos a un análisis de varianza usando el cuadrado mínimo del modelo lineal general (GLM) con el programa estadístico SAS<sup>TM</sup> 8.1 Inc. Si hubo diferencias significativas las medias fueron sometidas al análisis de separación de medias de Tukey a un nivel de confiabilidad de 95%.(Cody y Smith ,1997).

## **RESULTADOS Y DISCUSION**

### **Consumo alimento**

No se registro diferencias significativas ( $P \leq 0.05$ ) en el consumo de las cabras lecheras alimentadas con diferentes niveles de palmiste ( ver tabla 1). El consumo vario de 1.92-2.86 kg/día/animal. Al comparar estos resultados son superiores con los reportados por Alcántara (2006), en la alimentación de cabras con palmiste. La frecuencia de ordeño tuvo un efecto significativo en incrementar el consumo en las cabras que se ordeñaron cada 24 h con relaciona 12h.

El consumo total de MS en las cabras lecheras fue significativos en las cabras alimentadas con 15% de palmiste con 3.95 kg/día/animal con relación a los demás niveles

de inclusión 0, 30 y 45 % (ver tabla 1). Asimismo, la frecuencia de ordeño cada 24h registro el mayor consumo MS en las cabras lecheras.

#### **Producción láctea y condición corporal**

Los niveles de inclusión de 0, 15, 30 y 45% no afectaron ( $P \leq 0.05$ ) la producción láctea (kg) en las cabras lecheras mestizas. Sin embargo, la frecuencia de ordeño tuvo un efecto positivo ( $P \geq 0.05$ ) al incrementar la producción total de leche (18.62 kg cada en 12 h vs 12.95 kg cada 24h) (ver tabla 1) Resultados inferiores fueron reportados por Alcántara, 2006 al alimentar cabras lecheras con 30 % de palmiste comparados con registrados por este estudio de 15.12, 18.06, 10.72 en los niveles de inclusión de 15, 45 y 30 %, respectivamente.

Los niveles de inclusión de palmiste y frecuencia de ordeño no afectaron ( $P \leq 0.05$ ) la condición corporal de las cabras lecheras mestizas ni al inicio ni al final de la lactación, lo que indica que las cabras satisficieron los requerimientos nutricionales con las dietas sin afectar sus reservas corporales.

#### **Ganancia Diaria de los cabritos**

La inclusión de palmiste 15% alcanzo la mayor ganancia diaria con 105.5 g/d/animal con relación a los demás niveles de inclusión 30 %(85.51 g/d ), 45% (74.38 g/d) y 0% (73.68 g/d). De igual forma, la frecuencia de ordeño cada 12 h registro la mayor ganancia diaria (95.56 g/d) con al ordeño de 24h (72.57 g/d) (ver tabla 1).

#### **Eficiencia Alimenticia**

Al comparar las medias de la eficiencia alimenticia entre los grupos de cabras alimentadas con los niveles de inclusión de palmiste no presentaron diferencias significativas ( $P \leq 0.05$ ) (ver tabla 1). Sin embargo, las cabras ordeñadas dos veces al día tuvieron una eficiencia mayor con valor de 47 % comparado con un ordeño por día con 27 %.

#### **Por ciento de sólidos no grasos y grasa en la Leche**

La composición de grasa y sólidos no grasos en la leche no fue afectada ( $P \leq 0.05$ ) por la inclusión de palmiste en la dieta de cabras lecheras (ver tabla 1). Aunque, al comparar el efecto de la inclusión de palmiste en las frecuencia de ordeño de dos veces y una vez por día se observo una diferencia ( $P \geq 0.05$ ) significativa entre estas. El contenido de grasa registrado en la leche fue de 4.45 % en el doble ordeño y 3.45 % en el ordeño una vez por día. En cambio, los sólidos no grasos en leche fue de 8.09 % y 7.75 % al ordeñar las cabras cada 12 y 24 h.

#### **Relación Beneficio Costo**

El análisis económico marginal (Perrin et al., 1988) determino que los mayores beneficios neto fueron en los niveles de 45 y 15 % de palmiste con RD\$ 3,357.32 y RD\$ 2635.03 con los mas bajos costos de RD\$ 1,688.62 y RD\$ 1,728.06 (ver tabla 1). Aunque, la tasa de retorno marginal fueron negativas para todos los niveles y más recomendable fue el nivel de 30% de Palmiste. Al evaluar la tasa de retorno marginal en las diferentes frecuencias de ordeño, el nivel de inclusión de 15 % de palmiste arrojó el mayor beneficio neto con RD\$ 2,225.87 (ver tabla 1).

## **CONCLUSIONES Y RECOMENDACIONES**

Al realizar la investigación sobre el comportamiento productivo de cabras mestizas bajo dos frecuencias de ordeño alimentadas con cuatro niveles de palmiste se concluye que los niveles de inclusión no ejercieron efectos negativos sobre el consumo y



la producción de leche. Sin embargo, el contenido de grasa y sólidos no grasos en la leche fue afectado por los niveles de palmiste. Con respecto a la relación beneficios/costo, la mejor opción económica es la el nivel de 15% de palmiste con un ordeño por día y 30% en doble ordeño.

## REFERENCIAS

- Alcántara, M.A. 2006. Evaluación de la Inclusión de Subproductos Agroindustriales (Palmiste, Pasta de Arroz y Afrecho de Trigo) en la dieta de Cabras Lechera Mestizas. Tesis para optar por el título de Ingeniero en Producción Animal. Universidad ISA. Santiago, República Dominicana.
- Banco Central de la República Dominicana. 2003. Volumen y Valor Producción Pecuaria, Silvicultura y pesca.
- Bath, D. L., Dickinson, F.N., Tucker, H.A., Appleman, R.D. 1985. Dairy Cattle: Principles, Practices, Problems, Profits. Third edition. Lea and Febiger. Philadelphia. USA. Pag. 301.
- Cody, R. P. y Smith J. K. 1997. Applied Statistic and the SAS Programming Language. Fourth Ed. Prentice Hall. New Jersey. U.S.A.
- National Research Council. Nutrient Requirements of Goat: Angora, Dairy, and meat Goats in temperate and tropical countries. 1981. National Academy Press Washington, D. C.
- Perrin, R.K., Winkelman, D.L., Moscardi, E., Anderson, J.R. 1988. La Formulación de Recomendaciones a partir de Datos Agronómicos. En: Un manual metodológico de Evaluación Económica. Centro Internacional para Mejoramiento de Maíz y Trigo (CIMMYT). El Batán. México.
- Sánchez Seiquer, P., Alemán Sabater, S., Dejodar Sánchez, I., Muelas Domingo, R., Rubert Alemán, J., Lizaso Azkarte, J., Fernández Martínez, C. 2001. Empleo de tres fuentes de proteína en la alimentación con raciones completas de las cabras Muricano-Granadino. XXVI Jornadas Científicas y V Internacionales de la Sociedad Española Ovinotecnia y Caprinotecnia. Pag. 617.

## TABLAS

**Tabla 1.** Parámetros productivos de Cabras lecheras alimentadas con 4 niveles de palmiste

<b>Ingredientes</b>	<b>Niveles de inclusión palmiste</b>			
	0	15	30	45
Palmiste (%)	0	15	30	45
Maíz molido (%)	54	42	32	21
Soya 48% (%)	38	35	31	27
Grasa (%)	2	2	2	2
Piedra Caliza (%)	3	3	3	3
Fosforo Dicalcico(%)	1.5	1.5	1.5	1.5
Sal (%)	0.05	0.05	0.05	0.05
Premezcla Vit. y Minerales	0.04	0.04	0.04	0.04
Total	100			
<b>Nutrientes</b>				
Proteína Cruda(%)	21	21	21	21
E M (MJ/kg)	24.90	24.90	24.90	24.90
MS (%)	88	88	88	88
Calcio (%)	1.41	1.43	1.41	1.43
Fosforo(%)	0.88	0.87	0.88	0.87

**Tabla 2.** Parámetros productivos de Cabras lecheras alimentadas con 4 niveles de palmiste<sup>1</sup>

Variables	Niveles de Palmiste				Frecuencia		
	0	15	30	45	24 h	12 h	CV
Ganancia Cabrito (g/d)	73.68b	105.01a	85.51b	74.38b	72.57b	95.56a	6.63
Consumo de alimento (kg)	2.44a	2.86a	2.20a	1.97a	2.81b	1.92a	2.71
Consumo MS (kg)	3.09b	3.95a	2.94b	2.81b	6.00a	3.82b	1.77
Eficiencia Alimenticia (%)	0.32a	0.42a	0.34a	0.49a	0.27b	0.47a	0.05
Condición Corporal	3.85a	3.61a	3.96a	3.73a	3.71a	3.83a	0.12
Producción láctea (kg)	19.56a	18.06a	10.78	15.12a	12.95b	18.62a	3.37
Contenido de grasa (%)	3.65a	4.23a	4.17a	4.42a	3.45b	4.45a	0.12
Contenido de Sólidos no grasos (%)	8.01a	7.86a	7.86a	7.71a	8.09a	7.75b	0.05

<sup>1</sup>Letras diferentes en filas presentan diferencias significativas ( $P \leq 0.05$ ), entre las medias ( $\pm$  error estándar)

**Tabla 3** Análisis Marginal<sup>1</sup> para el ordeño una vez por día en cabras mestizas alimentadas con cuatro niveles de palmiste.

Tratamientos	Beneficio Neto Parcial (BNP)	Costos Variables	Incremento Marginal BNP	Incremento Marginal Costo Variable	Tasa Retorno Marginal	Costo Capital (Interés 20%)	BNP después de pagar interés
<b>0</b>	1,390.48	2,402.92	*	*			
<b>15</b>	2,378.80	2,294.04	988.32	-108.89	-9.08%	152.94	2,225.87
<b>30</b>	925.78	1,981.32	-1,453.03	-312.72	4.65%	132.09	793.69
<b>45</b>	1,234.41	2,126.86	308.63	145.54	2.12%	141.79	1,092.62

<sup>1</sup>El análisis marginal se realizó según la metodología de Perrin et al., 1988.

**Tabla 4** Análisis Marginal<sup>1</sup> para la frecuencia de doble ordeño en cabras mestizas alimentadas con cuatro niveles de palmiste.

<b>Tratamientos</b>	<b>Beneficio Neto Parcial (BNP)</b>	<b>Costos Variable</b>	<b>Incremento Marginal al BNP</b>	<b>Incremento Marginal Costo Variable</b>	<b>Tasa Retorno Marginal</b>	<b>Costo Capital (Interés 20%)</b>	<b>BNP después de pagar interés</b>
<b>0</b>	2,446.58	2,857.76	*	*			
<b>15</b>	2,750.23	1,728.06	303.66	-1,129.70	-0.27%	115.20	2,635.03
<b>30</b>	2,388.73	1,741.26	-361.51	13.19	-27.40%	116.08	2,272.64
<b>45</b>	3,469.90	1,688.62	1081.17	-52.64	-20.54%	112.57	3,357.32

<sup>1</sup>El análisis marginal se realizó según la metodología de Perrin et al., 1988.

**Poster #46**

**Development of Small Scale Aquaculture Farms in North Florida**

*Uford A. Madden<sup>1</sup>, G. Nurse<sup>1</sup>, J. Beaudouin<sup>1</sup>, A. Bolques<sup>1</sup>, L. Muralles<sup>1</sup>, S. Harris-Thompson<sup>1</sup>, A. Wallamsley<sup>2</sup>, M. May<sup>3</sup>, and F. Chapman<sup>4</sup>, <sup>1</sup>Extension and Outreach Program, College of Engineering Sciences, Florida A & M University, Tallahassee, Florida <sup>2</sup>Florida Farm Bureau Federation, Gainesville, Florida, <sup>3</sup>Florida Department of Agriculture and Consumer Services, Tallahassee, Florida, and <sup>4</sup>University of Florida, Gainesville, Florida .*

**ABSTRACT.**

This program provides teaching, research and extension assistance to small farmers operating small-scale aquaculture farms, which utilize natural water bodies to contribute to food production. Thus the program supports the development of the aquaculture industry and the economy of Florida. A specific objective was to bring together production, economic and marketing specialists in integrated demonstration of projects to optimize production systems (ponds, tanks, raceways cages and hybrid systems), spawning and hatchery techniques, microencapsulated feeds, batch plankton culture procedures, preventive aquatic animal health practices and product value. The program addresses problems/needs of small, limited resource and economically disadvantaged farmers and facilitates cooperation of specialists and county agents in finding solutions to various challenges encountered in the industry. Initially the project involved ten (10) existing and new farmers in counties within a one hundred (100) mile radius. Farmers currently growing fish and those interested in growing fish, with or without ownership of existing water bodies, were identified. The project began in July 2006 at FAMU Research and Extension Center, Quincy, Florida, where there are ponds; and it provided classroom and hands-on training and a farm visit was made with each farmer. A training curriculum was developed with modules and information used for the instruction. Fourteen farmers were trained on the best management practices and alternative methods for improvement of production systems for fish (e.g. Bait fish and Sturgeon). Marketing strategies were addressed to sustain the increased production of fish and profitability. Four ponds were revitalized and once per week pH, temperature, depth and dissolved oxygen data were collected as the ponds stabilized. Brochures were developed to support development of small scale enterprises, production of fingerlings and utilization of existing natural resources and reduction of specialized inputs.

**KEYWORDS:** Aquaculture, small scale farms, fish production

**INTRODUCTION.**

Aquaculture can contribute to increase in food production and the agricultural economy of the State of Florida by development of small scale aquaculture farms. It has been hypothesized that fresh water aquaculture is one of the fastest growing sectors in the United States agricultural economy. In 2003, Florida had 34 catfish operations with a

total of 660 acres of water surface area which indicated a 25% decrease (220 acres) from 2002. Foodsize fish (590 acres) and fingerlings (45 acres) accounted for the majority of the acreage. In 2002, majority of the sales were to processors and total sales were \$756,000. In 2003, a survey conducted for the Division of Aquaculture, Florida Department of Agriculture and Consumer Services, showed that reported sales by aquaculture producers were \$95.5 million. These were comparable to sales reported in 2001 of \$99.5 million that were reported for 2001 which is the third highest volume of sales recorded by survey since it was started in 1988. In 1997, 102 million of sales was recorded and is the largest volume of sales realized from aquaculture products.

Increased sales for Tropical Fish, Tilapia, Catfish, Live Rock, and Other Aquatics were reported in 2003 whereas Aquatic Plants, Clams and Oysters, Alligators, Shrimp, and Other Fish sales decreased. A total of 544 operations utilized 6,450 acres in 2003, whereas in 2001 684 operations used 7,010 acres. In the 2003 survey, 80 active operations had no sales, which may as be as result of new operations that had no product for sale or operations in business that did have sell any product for sale. Thirty (30) operations sales to foreign markets totaled \$5.3 million. Most aquaculture operations in Florida are small farm enterprises. In 2003, 43.9 percent of the 544 operations were less than 3 acres and represent many of the clam producers, with lease of 2 acres of water in the Gulf of Mexico or the Indian River Lagoon, and included some of the small tropical fish farmers. Approximately 20.6% of the operations utilized 3 to 6 acres of land and/or water and operations that used 50 acres or more accounted for 3 percent.

Florida A & M University (FAMU) has eight fish ponds that can be used to make significant contribution to increase fish production. In North Florida, there are several farmers with existing ponds, lakes, and other water bodies that are producing fish but there are other water bodies that are not been utilized for fish production. There is a need to develop programs that will allow farmers to utilize existing water bodies and integrated with tank production systems to produce fish to increase their productivity and profitability and development of small scale farming enterprises.

## **OBJECTIVES.**

The specific objectives of this project was to address food production by utilization of integrated demonstration projects that bring production, economic and marketing specialists together are needed to improve or develop production systems (ponds, tanks, raceways cages and hybrid systems), spawning and hatchery techniques, microencapsulated feeds, batch plankton culture procedures, preventive aquatic animal health practices and product value. The program objectives were: 1).To provide services in teaching, research and extension to small farmers in the development of small-scale aquaculture farms utilizing natural water bodies to contribute to food production, the development of the Aquaculture industry and to the economy of the State of Florida; 2) To address the objective: Integrated demonstration projects that bring production, economic and marketing specialists together are needed to improve or develop production systems (ponds, tanks, raceways cages and hybrid systems), spawning and hatchery techniques, microencapsulated feeds, batch plankton culture procedures, preventive aquatic animal health practices and product value

## **MATERIALS AND METHODS.**

Four ponds were available for conducting research, hands-on training and demonstrations for small, limited resource farmers and economically disadvantaged farmers. Farmers who are currently growing fish and farmers who are interested in growing fish with or without ownership of existing water bodies were identified. The farmers were trained on the best management practices and on alternative methods for improvement of production systems for fish (Bait fish and Sturgeon). Marketing strategies were addressed at the beginning of the program in order to provide information to assist farmers on how to develop plans that will help them to sustain market for the increased production of fish and profitability of these farms. Farmers were assisted in the development of plans for small scale enterprises and producing fingerlings for their own production. The project was designed to work initially with ten (10) existing and new farmers in counties within a one hundred (100) mile radius. The project utilized the Florida A & M University Community Development Center (CDC), formerly Research and Extension Center in Quincy, Florida, where there are existing ponds. County agents and the Florida Farm Bureau Federation personnel assisted in the identification and recruitment of these farmers. The project provided classroom and hands-on training at the FAMU CDC on the various aspects of fish production. Hands-on training was conducted at the FAMU CDC and farm site visits were with each farmer to provide the technical support for the type of production system. A curriculum was developed and a training package with the modules was provided to each farmer with information used for the instruction. The information gathered from this project will be disseminated in lectures, at workshops, conferences, seminars and field demonstrations. The information will be incorporated into teaching and extension education activities to students and limited resources producers. Research findings will be presented at conferences and seminars locally and nationally. Workshops and field demonstrations will be conducted for small and limited resource producers to increase their awareness of the importance of good production practices, appropriate preventative aquatic animal health practices and their potential impact on product value, production, efficiency, and profitability of their farms.

## **RESULTS AND DISCUSSION.**

A training curriculum was developed with modules and information used for the instruction. Fourteen farmers were trained on the best management practices and alternative methods for improvement of production systems for fish (e.g. Bait fish and Sturgeon). Marketing strategies were addressed to sustain the increased production of fish and profitability. Four ponds were revitalized and once per week pH, temperature, depth and dissolved oxygen data were collected as the ponds stabilized. Brochures were developed to support development of small scale enterprises, production of fingerlings and utilization of existing natural resources and reduction of specialized inputs. Further consideration is for the development of a website or for posting the information on various websites that can be accessed and links can be made to other websites. Presently, there are websites that may be considered: [smallfarms.ifas.ufl.edu](http://smallfarms.ifas.ufl.edu); [www.fl-aquaculture.com](http://www.fl-aquaculture.com); FAMU.CESTA; Small Business and Florida Farm Bureau. Farmers,



A pond at the start of the project



A revitalized pond ready for fish production

Teachers, students and the public will be able to access the information posted on these websites. The information gathered from this project will be disseminated in lectures, at workshops, conferences, seminars and field demonstrations. The information will be incorporated into teaching and extension education activities for students and limited resources producers. Research findings will be presented at conferences and seminars locally and nationally. Workshops and field demonstrations will be conducted for small and limited resource producers to increase their awareness of the importance of good production practices, appropriate preventative aquatic animal health practices and their potential impact on product value, production, efficiency, and profitability of their farms.

#### **ACKNOWLEDGEMENTS.**

The authors would like to thank the collaborators and professionals in the various areas who assisted with the classroom lectures, hands-on training and provided invaluable technical information that was used in the development of the project and the undergraduate students who participated in this project with sample collection and data analysis.. This project provided a source of experiential learning for two undergraduate students involved in the work study program in Cooperative Extension Service, College of Engineering Sciences, Technology and Agriculture at Florida A&M University. Also, this project served as a resource for one student in the Summer Rattler Phase III Internship Program in 2007. The student prepared a research paper on “Two Species of Fish That Are Commonly Raised by Farmers in Florida” and prepared and presented the information by Power Point as part of the requirement for the program. This project was funded in part by the State of Florida Department of Agriculture and Consumer Services, Division of Aquaculture Programs, Honorable Charles Bronson, Commissioner.

#### **REFERENCES.**

1. Core, J. and Spillman, A. 2003. Keeping Catfish on Consumers' Menus. ARS National Program (# 106). [www.nps.ars.gov](http://www.nps.ars.gov). (1/28/05).
2. Elstein, D. 2004. Training Dogs to Smell Off-flavor in Catfish. ARS National Program (# 106). [www.nps.ars.gov](http://www.nps.ars.gov). (1/28/05).



3. Florida Agricultural Statistics Service. Aquaculture(2/2003).  
<http://www.nass.usda.gov/fl> (5/11/05).
4. Florida Agricultural Statistics Service. Aquaculture. <http://www.nass.usda.gov/fl>  
(5/11/05).
5. Seafood and Aquaculture Marketing: Marketing Florida Agriculture.  
<http://www.florida-agriculture.com/seafood.htm> (5/11/05).

**Poster #47**

**Comparison of Oral Administration of Various Doses of Moxidectin and Ivermectin Pour-On Formulations Against Intestinal Parasites in Meat Goats**

*Uford A. Madden<sup>1</sup>, N. Wilson<sup>2</sup>, G. Nurse<sup>1</sup>, and J. Beaudouin<sup>1</sup>, <sup>1</sup>Extension and Outreach Program, College of Engineering Sciences, Technology and Agriculture, Florida A& M University, Tallahassee, Florida, and <sup>2</sup>Marion County Extension, University of Florida, Gainesville, Florida.*

**ABSTRACT.**

A total of 64 meat goats (6 months old) were used to investigate the effects of various doses of two anthelmintics on naturally occurring intestinal parasites in two feeding systems (32 animals each). Animals in the extensive system received grazing only and those in the semi-intensive system received grazing plus 1.1 kg of a 12% protein pellet per head per day. Animals in both systems received treatments of Moxidectin (MOX) and Ivermectin (IVM) at 0.275 mg/kg; 0.550 mg/kg and 0.825 mg/kg bodyweight and 0 mg/kg (CONT). Two males and 2 females were randomly assigned to each treatment. A single dose of MOX or IVM was administered orally to each treated animal at Day 0. A fecal sample was taken from each animal on Days 0, 7, 28, 56, and 84 for evaluation of parasite eggs. Body weights were taken on Days 0, 28, 56, and 84. Sampling began on March 8, 2005 and ended on June 15, 2005. In the extensive system, IVM-treated animals (19.95 kg) had a higher average bodyweight gain than those treated with MOX (17.14 kg). MOX-treated animals, 0.550 mg/kg had slightly higher bodyweight gain (5.77 kg) than CONT animals (5.14 kg). In IVM-treated animals, 0.825 mg/kg had the highest bodyweight gain (6 kg). In the semi-intensive system, MOX-treated animals (25.23 kg) had slightly higher average bodyweight gain than IVM-treated (24.64 kg). MOX-treated, 0.825 mg/kg and CONT animals had similar bodyweight gain (6.59 and 6.54 kg). IVM-treated animals, 0.825 mg/kg had the highest bodyweight gain (7.59 kg). Fecal samples showed marked reductions in parasite egg counts in MOX-, IVM-treated and CONT animals for both systems. In the extensive system, MOX-treated animals, had parasite eggs only in animals treated with 0.550 mg/kg whereas IVM-treated animals had no eggs in animals treated with 0.825 mg/kg, and CONT animals at the end of the study. In the semi-intensive system, no parasite eggs were detected in any sample in MOX- treated but were in CONT animals at the end of the study. In IVM-treated animals, 0.550 mg/kg, and CONT animals, no parasite eggs were detected at the end of the study.

**KEYWORDS:** Moxidectin, ivermectin, meat goats

**INTRODUCTION.**

Small, mid-size and economically disadvantaged family farms are important as they continue to be significant to national agricultural productivity. Sustaining agriculture in rural communities is not only critically important for the livelihood and self-sufficiency of farm families, but will strengthen families and maintain stability and

quality of life in these long-standing communities. Information on investigation of the efficacy of various doses Moxidectin and Ivermectin can be used to enhance implementation of strategies in areas of production systems to reduce the potential impact of nematodes on small, mid-size and economically disadvantaged family farms and coupled with the appropriate education can influence national economic health and well-being manifested in these communities. Improvement of on-farm technologies and management systems coupled with the appropriate research and extension education activities will allow for enhanced production, efficiency, profitability and long-term survival of small, mid-size farms and economically disadvantaged farms operated by farm families as we make strides in animal health care and incorporate food safety and animal health measures to improve the socio-economic condition, performance and profitability of small, mid-size and economically disadvantaged farmers

Small, mid-sized and economically disadvantaged family farms are defined as: (1) farm comprise of 200 acres and/or (2) farms with annual sales totaling less than \$50,000 and/or (3) farms that are in operation but the farm operators' chief source of income is from activities other than farm activities. In 1997, 78% of Florida's farm sales came from farms with total annual sales of less than \$50,000. According to the 1997 Agricultural Census, Florida had 28,645 farms with 200 acres or less. Total sales of 27,077 farms were less than \$50,000 and the principal source of income of 19,017 farms was not from far-related activities. These farms were 82% of the 78% of farms with total annual sales of less than \$50,000 and 55% of all farms in the state. The types of small farms described above accounted for 6.4% of the agricultural product sales in Florida in 1997, but represent most of the farm population in the state.

According to 1997 Agricultural Census, Florida had 18,000 beef cattle farms, 636, sheep farms, and 2,556 goat farms. Of the 18,000 beef farms in the state, 16,000 had less than 100 animals, 14,500 had less than 50 animals [1999 Florida Livestock, Dairy, Poultry Summary (Florida Agricultural Statistics Service, July 2000)] and 40 to 50 animals and 25 to 30 animals respectively for goat and sheep farms of 50 acres or less. There are numerous challenges encountered by these small, mid-size and economically disadvantaged livestock producers during on-farm activities that need to be addressed. The persistence of anthelmintic efficacy is important in the control of naturally occurring nematodes in affected animals. In a comparative study of the efficacy of topical formulations of doramectin, ivermectin, eprinomectin, and moxidectin in beef calves against naturally acquired nematode infections, anthelmintic activity of moxidectin was greater than that for ivermectin based on fecal egg counts (Williams et al., 1999) In weaned calves, moxidectin pour-on treated animals gained 19.4 pounds more than untreated controls and 11.7 pounds more than ivermectin pour-on treated animals (Fort Dodge Animal Health, 2000). Determination of the efficacy of moxidectin and ivermectin in meat goats will provide information on a treatment that is effective in reducing the potential impact of nematodes on these farms animals and the potential long-term effect on meat goat production in the state of Florida.

Small farm agriculture continue to make important contributions to Florida and national aggregate agricultural production, therefore information on moxidectin or ivermectin should be considered when making determinations for improvement of on-farm animal health and management systems. These producers will be able to implement better management practices and technologies that incorporate appropriate strategies

(protocols) for treatment, prevention and control of parasites in meat goats that will impact their ability to continue to make contributions to the economies of the state and the nation and to the viability, sustainability and the quality of life of rural communities.

### **OBJECTIVES:**

The overall objective of this project was to compare the efficacy of various doses of Moxidectin and Ivermectin in meat goats to determine the most effective dose that would reduce the potential impact of intestinal parasites (e.g. nematodes) on these farms animals and the potential long-term effect on production systems, harvesting, processing, handling, distribution and marketing of food products on small, mid-size economically disadvantaged livestock family farms.

### **MATERIALS AND METHODS.**

A total of 64 meat goats (6 months old) were used to investigate the effects of various doses of two anthelmintics on naturally occurring intestinal parasites in two feeding systems (32 animals each). Animals in the extensive system received grazing only and those in the semi-intensive system received grazing plus 1.1 kg of a 12% protein pellet per head per day. Animals in both systems received treatments of Moxidectin (MOX) and Ivermectin (IVM) at 0.275 mg/kg; 0.550 mg/kg and 0.825 mg/kg bodyweight and 0 mg/kg (CONT). Two males and 2 females were randomly assigned to each treatment. A single dose of MOX or IVM was administered orally to each treated animal at Day 0. A fecal sample was taken from each animal on Days 0, 7, 28, 56, and 84 for evaluation of parasite eggs. Body weights were taken on Days 0, 28, 56, and 84. Sampling began on March 8, 2005 and ended on June 15, 2005. Fecal samples were subjected to fecal flotation and intestinal parasite egg counts were expressed as egg per gram (EPG) of feces. Evaluation of fecal data was done to determine the effectiveness of MOX and IVM to control intestinal parasites in meat goats. Evaluation of body weights was done to determine the effect of MOX and IVM on performance and production efficiency of meat goats and potential economic gain for goat farmers Data collected on body weight and fecal EPG count were analyzed for system, treatment, day effects using the SAS System software package and utilizing General Linear Model Procedures for Analysis of Variance Procedure (SAS, 2005). Variable means showing significance were indicated using Duncan's Multiple Range Test. All statements of significance were based on a probability value at 0.05

### **RESULTS AND DISCUSSION.**

In the extensive system, differences observed in average body weights for treatments were not significant ( $p < 0.4020$ ) but the differences for days were significant ( $p < 0.0001$ ) (Table1). IVM-treated animals (19.95 kg) had a higher average bodyweight gain than those treated with MOX (17.14 kg). MOX-treated animals, 0.550 mg/kg had slightly higher bodyweight gain (5.77 kg) than CONT animals (5.14 kg). In IVM-treated animals, 0.825 mg/kg had the highest bodyweight gain (6.03 kg). Average body weight was significantly higher on Day 84 than Days 0 and 28 but was not different from Day 56. At Day 56, average body weight was significantly higher than at Day 0 but was not different from Day 28. Average body weight for Day 28 was not different from Day 0. Average body weights observed in the semi-intensive system for treatments were not

significantly different ( $p < 0.7622$ ) but the differences for days were significant ( $p < 0.0001$ ) (Table 1). MOX-treated animals (25.23 kg) had slightly higher average body weight gain than IVM-treated (24.64 kg). MOX-treated, 0.825 mg/kg and CONT animals had similar bodyweight gain (6.59 and 6.54 kg). IVM-treated animals, 0.825 mg/kg had the highest bodyweight gain (7.59 kg). Average body weight was significantly higher on Days 84 and 56 than Days 0 and 28 which were not different from each other. At Day 28, average body weight was significantly higher than at Day 0. In the extensive system, no significant differences ( $p < 0.2821$ ) were observed in EPG counts for treatments but the differences for days were significant ( $p < 0.0001$ ) (Table 2). EPG counts for Day 7 were significantly higher than for Days 0, 28, 56 and 84 which were not different from each other. MOX-treated animals had parasite eggs only in animals treated with 0.550 mg/kg whereas IVM-treated animals had no eggs in animals treated with 0.825 mg/kg and CONT animals at the end of the study. In the semi-intensive system, no significant differences ( $p < 0.4200$ ) were observed in EPG counts for treatments but the differences for days were significant ( $p < 0.0121$ ) (Table 2). EPG counts for Day 7 were significantly higher than for Days 0 and 56 but were not different from Days 28 and 84. EPG counts for Days 0, 28, 56 and 84 were not different from each other. No parasite eggs were detected in any sample in MOX- treated animals but were in CONT animals at the end of the study. In IVM-treated animals, 0.550 mg/kg and CONT animals, no parasite eggs were detected at the end of the study. Fecal samples in MOX-, IVM-treated and CONT animals showed marked reductions in parasite egg counts for both systems.

#### **ACKNOWLEDGEMENTS.**

The authors would like to thank Mr. Gilbert Queeley for his assistance with statistical analysis and the undergraduate students who participated in this project with sample collection and data analysis. This project was funded in part by the Center for Cooperative Agricultural Programs and provided a source of experiential learning for students attending the Animal Sanitation and Disease Control course and for students involved in the work study program in Cooperative Extension Service, College of Engineering Sciences, Technology and Agriculture at Florida A&M University.

**Table 1.**

Average bodyweight (kg) of control and treated meat goats with various doses of pour-on formulations of moxidectin (cydectin) or ivermectin (ivomec) orally at Day 0<sup>a</sup>

Extensive	(n = 4)	Experimental days				Mean Gain
		Day 0	Day 28	Day 56	Day 91	
Moxidectin						
0.825 mg/kg		22.39a	22.50a	23.52a	26.14a	3.75
0.550 mg/kg		21.25a	24.09a	25.80a	27.05a	5.77
0.275 mg/kg		21.48a	22.84a	24.66a	23.98a	2.50
0.0 mg/kg		22.73a	24.66a	25.45a	27.84a	5.14
Total						17.16 <sup>d</sup>
Ivermectin						
0.825 mg/kg		22.61a	25.57a	24.20a	28.64a	6.03
0.550 mg/kg		21.82a	23.86a	25.00a	27.79a	5.97
0.275 mg/kg		21.48a	23.75a	24.09a	25.23a	3.75
0.0 mg/kg		22.27b	23.52ab	25.11ab	27.05a	4.78
Mean						22.00c
23.85bc						24.73ab
26.36a						19.95 <sup>d</sup>
Semi-intensive	(n = 4)	Experimental days				Mean Gain
		Day 0	Day 28	Day 56	Day 84	
Moxidectin						
0.825 mg/kg		22.39a	25.80a	27.95a	27.84a	5.45
0.550 mg/kg		21.36a	26.02a	27.50a	27.50a	6.14
0.275 mg/kg		21.59b	26.70a	28.18a	27.61a	6.02
0.0 mg/kg		22.39b	26.14ab	27.95a	28.98a	6.59
Total						24.20 <sup>d</sup>
Ivermectin						
0.825 mg/kg		22.27a	26.36a	29.43a	29.32a	7.05
0.550 mg/kg		21.59b	24.43ab	27.61a	27.95a	6.36
0.275 mg/kg		21.59c	24.77b	27.05ab	27.50a	5.91
0.0 mg/kg		22.05b	26.48ab	28.64a	28.52a	6.48
Mean						21.90c
25.84b						28.04a
28.15a						25.80 <sup>d</sup>

<sup>a</sup>Different letters in the same row indicate significant differences at  $p < 0.05$ .

<sup>d</sup>Total mean body weight gain

**Table 2.**

Mean parasite egg counts (egg per gram) in control and treated meat goats with various doses of pour-on formulations of moxidectin (cydectin) or ivermectin (ivomec) orally at Day 0<sup>a</sup>

Extensive Treatment	(n = 4) Day 0	Experimental days			
		Day 7	Day 28	Day 56	Day 84
Moxidectin					
0.825 mg/kg	34.21a	90.60a	31.05a	0.00a	0.00a
0.550 mg/kg	95.25a	31.45a	35.15a	0.00a	30.75a
0.275 mg/kg	1.94b	158.50a	6.40b	0.00b	0.00b
0.0 mg/kg	15.80b	442.50a	0.00b	0.00b	0.00b
Ivermectin					
0.825 mg/kg	9.70b	1121.50a	201.50b	0.00b	0.00b
0.550 mg/kg	6.40a	1210.30a	6.00a	0.00a	17.80a
0.275 mg/kg	0.00a	33.25a	15.60a	0.00a	83.25a
0.0 mg/kg	4.50a	634.00a	23.10a	0.00a	0.00a
Semi-intensive					
Treatment	(n = 4) Day 0	Experimental days			
		Day 7	Day 28	Day 56	Day 84
Moxidectin					
0.825 mg/kg	33.25ab	127.40a	0.0b	5.55b	0.00b
0.550 mg/kg	0.00a	20.48a	16.65a	0.00a	0.00a
0.275 mg/kg	2.00a	20.50a	283.00a	2.40a	0.00a
0.0 mg/kg	23.50a	739.30a	64.10a	0.00a	277.50a
Ivermectin					
0.825 mg/kg	6.65b	294.53a	13.88b	0.00b	9.50b
0.550 mg/kg	22.28a	151.50a	5.75a	0.00a	0.00a
0.275 mg/kg	0.00a	155.20a	421.80a	0.00a	37.20a
0.0 mg/kg	13.30a	365.60a	79.40a	0.00a	0.00a

<sup>a</sup>Different letters in the same row indicate significant differences at  $p < 0.05$ .

## REFERENCES.

1. 1997 Agricultural Census, National Statistics Service. United States Department of Agriculture. 1998.
2. 1999 Florida Livestock, Dairy, and Poultry Summary. Florida Agricultural Statistics and Service. 2000.
3. Williams, J. C., Loyacano, A. F., DeRosa, Gurie, J., Clymer, B. C., and Guerino, F. 1999. A Comparison of Persistent Anthelmintic Efficacy of Topical Formulations of Doramectin, Ivermectin, Eprinomectin, and Moxidectin Against Naturally Acquired Nematode Infections. *Veterinary Parasitology*. 85: 277-288.
4. Fort Dodge Animal Health. 2000. A Comparison of the Persistent Efficacy of Pour-On Formulations of Moxidectin (Cydectin) and Ivermectin (Ivomec) Against Naturally Acquired Nematode Infections of Beef Cattle (Cows and Calves) Following a Single Treatment. Technigram. FDP802 5M.
5. Diagnostic Services, AVC, 2003. Parasitology. Atlantic Veterinary College, University of Prince Edward Island. <http://www.upei.ca/~diagserv/paras.htm>.
6. SAS, 2005. SAS for Windows Version 9.1. SAS Institute, Cary NC.



**Poster #79**

**A Comparison of Grass vs. Legume Free Range Small Ruminant Finishing Systems for the Tropics**

*S.A. Weiss, R. Ben-Avraham, R.C. Ketring, and R.W. Godfrey, Agricultural Experiment Station, Agronomy Program, University of the Virgin Islands, St. Croix. stuweiss@yahoo.com*

*Small Ruminant Special Session during evening Poster Session*

*Tuesday July 15, 2008, Mediterranean West and Center*

**ABSTRACT.**

The objective of the present study was to evaluate live animal performance and carcass characteristics of Dorper X St. Croix White lambs managed in two types of post-weaning alternative pasture finishing systems in the tropics. After weaning and background grazing on native pasture for eight months, lambs (n = 37) were stratified by weight and sex into two treatments consisting of native pasture (NP) and improved pasture (IP), with energy supplement. Native pasture consisted of a mix of guinea grass (*Panicum maximum*) and hurricane grass (*Boithrocloa pertusa*), while IP consisted of a mix of seeded tropical legumes (*Vigna unguiculata*, *Clitoria ternetea*, and *Lablab purpureus*) and volunteer guinea grass in 0.45 ha paddocks where forage availability was not a limiting factor. All lambs were supplemented with crushed corn daily at a rate of 1 % of their body weight for 100 days and slaughtered at approximately 365d of age. During the finishing trial IP lambs had greater total weight gain ( $P < 0.0001$ ) than NP lambs ( $10.7 \pm 0.4$  vs.  $7.5 \pm 0.4$  kg, respectively). In addition, IP lambs had higher ADG ( $P < 0.0002$ ) than NP lambs ( $104.3 \pm 4.5$  vs.  $77.9 \pm 4.5$  g/d, respectively). Compared to NP lambs, IP lambs were heavier at slaughter ( $P < 0.05$ ;  $40.6 \pm 1.1$  vs.  $36.9 \pm 1.1$  kg, respectively) had heavier carcasses ( $P < 0.05$ ;  $20.5 \pm 0.6$  vs.  $18.1 \pm 0.6$  kg, respectively) and greater dressing percent ( $P < 0.05$ ;  $50.4 \pm 0.4$  vs.  $48.9 \pm 0.4$  %, respectively). Further, IP lambs had greater body wall thickness ( $P < 0.05$ ;  $14.1 \pm 0.6$  vs.  $11.9 \pm 0.6$  mm, respectively) and rib eye area ( $P=0.08$ ;  $10.1 \pm 0.3$  vs.  $9.2 \pm 0.3$  cm<sup>2</sup>, respectively) than NP lambs. Back fat thickness, KPH fat, and leg circumference for IP and NP lambs was not significantly different. Results of this study indicate that the adoption of alternative pasture finishing practices utilizing mixed legume improved pasture with corn supplementation can lead to improvements in animal performance and carcass muscularity of crossbred hair sheep lambs under tropical conditions.

**KEYWORDS:** sheep, legumes, pasture finishing, carcass characteristics

**Poster #80**

**Development and Evaluation of a Ready to Cook Vacuum Packaged Goat Meat Product**

*N. Djeri<sup>1</sup>, S. K. Williams<sup>1</sup>, R. Mobley<sup>2</sup>, A. McKenzie-Jakes<sup>2</sup>, K. Sarjeant<sup>1</sup>, and A. Ruiz<sup>1</sup>,  
<sup>1</sup>Department of Animal Sciences, University of Florida, Gainesville, FL and <sup>2</sup>Florida Agricultural & Mechanical University, Tallahassee, FL. noufoh@ufl.edu*

**ABSTRACT.**

The objective of this study was to develop a goat meat rib product. Four product prototypes were developed containing either all goat meat ribs, no additives and marinated in water (control) (Treatment 1); goat meat ribs marinated in water and apple cider vinegar (Treatment 2); goat meat ribs marinated in water only and manually rubbed with a spice blend (Treatment 3); and goat meat ribs marinated in apple cider vinegar and water and manually rubbed with a spice blend (Treatment 4). The products were vacuum-packaged and stored at  $4 \pm 1^\circ\text{C}$  for 21 days. Sensory evaluation using a trained sensory panel, microbiological analyses, pH and processing yields were determined from 0 to 21 days storage. The panelists detected no significant differences ( $P > 0.05$ ) in overall tenderness between the four treatments. The goat meat ribs formulated with apple cider vinegar only were rated significantly higher ( $P < 0.05$ ) for goat flavor intensity and off-flavor, when compared to all other treatments. *Staphylococcus aureus*, *Salmonella* spp., *Escherichia coli* O157:H7, generic *Escherichia coli* and fecal coliforms were not detected in any of the treatments. Total aerobic plate counts, total coliforms and anaerobic bacteria were significantly lower ( $P < 0.05$ ) for goat meat ribs marinated with apple cider vinegar and ribs marinated with both apple cider vinegar and manually rubbed with the spice blend, when compared to ribs marinated with water only, and ribs marinated with water only and manually rubbed with the spice blend. Psychrotrophic counts were significantly lower ( $P < 0.05$ ) for ribs marinated with apple cider vinegar and manually rubbed with the spice blend when compared to all other treatments. Results from this study suggested that marinating and applying a spice rub to goat ribs could produce an acceptable value added product.

**KEYWORDS:** goat meat ribs, sensory analysis, psychrotrophs, coliforms

**Poster #84**

**Development and Evaluation of Pre-Cooked Vacuum Packaged Goat Meat Products**

N. Djeri<sup>1</sup>, S.K. Williams<sup>1</sup>, R. Mobley<sup>2</sup>, A. McKenzie-Jakes<sup>2</sup>, K. Sarjeant<sup>1</sup>, A. Ruiz<sup>1</sup>.  
<sup>1</sup>Department of Animal Sciences, University of Florida, Gainesville, FL and <sup>2</sup>Florida Agricultural & Mechanical University, Tallahassee, FL. noufoh@ufl.edu

**ABSTRACT.**

Production of value added pre-cooked goat meat products could increase demand, consumption, acceptability, and marketability of goat meat. The objectives of this study were to develop and evaluate proximate composition, pH, sensory and microbiological characteristics (fecal coliforms, aerobic plate counts, psychrotroph counts, anaerobic plate counts) of refrigerated pre-cooked vacuum-packaged goat rib products. Racks from ten Boer Crossbred Spanish meat goats were cut into three longitudinally proportional rib units, and randomly assigned to four groups and formulated with either 1) no treatment, control, 2) apple cider vinegar only, 3) Spice rub only or 4) spice rub plus apple cider vinegar. After formulation, all goat ribs were baked to an internal temperature of 74°C in a conventional gas oven, vacuum packaged, and stored at 4 ± 1°C for 42 days.

The trained panelists rated all samples slightly bland (4.00) to slightly intense (5.68). Overall, there was no significant difference (P > 0.05) between treatments through the 42 days shelf life for overall tenderness. Overall flavor of marinated goat rib with spice rub applied. The texture of both samples was similar (P > 0.05). The consumer panelists were also more likely to purchase the goat meat that had been marinated and a spice rub applied, over goat meat with a spice rub applied only. Psychrotrophic organisms counts varied from 0 to 5.95 log CFU/g: except for the spice rub, the data demonstrated a decrease in psychrotrophic organisms through 42 days for all treatments. No organisms of public health safety (*Staphylococcus aureus*, *Salmonella*, *Escherichia coli* 0157:H7, and *Listeria monocytogenes*) were found. The trained and consumer panelists found the products acceptable, regarding goat flavor intensity, overall tenderness, and texture (consumer panel only). Manufacturing a pre-cooked marinated vacuum packaged goat rib product could be a successful venture.

**KEYWORDS:** pre-cooked, goat ribs, vinegar

**Poster #86**

**The Effects of Synchronization Treatments on Estrous Response in Seasonal Does**

*Angela McKenzie-Jakes, G. Nurse, and G. Byrant. Research and Cooperative Extension Programs, Florida A&M University. angusboer34@hotmail.com*

**ABSTRACT.**

Reproduction efficiency is one of the most important economic traits in terms of livestock production. Maintaining good reproductive functions in the herd is pivotal to the success of any livestock production system. Productivity and profitability in the goat herd is measured by ovulation rate, conception rate, the number of kids born, the number of kids weaned and the frequency in which they are produced. Theoretically, a gestational period (pregnancy) of five months should support more than one kidding interval per doe per year. However, the seasonal breeding behavior of goats in the U.S. has seriously limited the ability of the producer to increase herd productivity and to access markets that bring about the highest economic returns. In recent years, estrus synchronization has become a valuable reproductive tool for controlling and manipulating the breeding period in goats. Studies have shown that differences exist in the onset and duration of estrus between various breeds of goats and even among individuals within the same breed. The objective of this study was to determine efficacy of different treatment regimens on inducing cyclic heat in breeding does. Sixty does were randomly assigned among three treatment groups. Goats in group A (n=20) were the control group (no treatment). Goats in group B were synchronized using CIDR, (Controlled Internal Releasing Device) in combination with lutalyse (1ml) and goats in group C were exposed to a vasectomized buck for 21 days. Blood samples were collected after the does were observed in standing heat. Immunoassays test were used to determine serum progesterone concentrations in the experimental does. Cyclic heat was observed in 85% of the does within 24 hours after the implants were removed (treatment B), 24 hours after the vasectomized buck was removed from the pen (treatment C) and 40% of the does were in heat in the control group 24 hours after being exposed to an intact buck.

**KEYWORDS:** goats, reproduction, synchronization, CIDR

**Poster #87**

**An Integrated Approach to Increasing Food Safety Awareness at the Farm Level among Small and Limited Resource Goat Producers in Florida**

<sup>1</sup>A. McKenzie-Jakes, <sup>1</sup>R. Mobley, DVM, <sup>1</sup>T.E. Peterson, DVM, <sup>2</sup>P. Hunter, DVM, <sup>1</sup>G. Nurse, J. Beaudouin, <sup>1</sup>G. Bryant, <sup>1</sup>G. Queeley, <sup>1</sup>S. Thompson, <sup>3</sup>N. Tillman, and <sup>1</sup>L. Anderson. <sup>1</sup>Florida A&M University, Research and Cooperative Extension Program, <sup>2</sup>Florida Department of Agriculture (DOACS) and <sup>3</sup>Southeaster Small Farmer's Network. [angusboer34@hotmail.com](mailto:angusboer34@hotmail.com)

**ABSTRACT.**

Many researchers today agree that most food borne illnesses start on the farm. The Center for Disease Control and Prevention (2007) estimated that 76 million food borne illnesses occur each year in the United States. In 2007, the Master Goat Producers Program was initiated through Florida A&M University's Research and Cooperative Extension program to address increasing incidents of food borne illness and herd health issues linked to goat production. The goal of this program was to educate producers about the real threat of food borne illnesses. Furthermore the program was established to ensure that producers took strides in protecting their animals and consumers from microbial food borne contaminations and other infectious diseases.

In view of this a 5 day comprehensive training program was developed for small and limited resource goat producers followed by on-farm inspections. The program emphasized training on food safety and associated herd health problems with small ruminants.

A survey conducted revealed that prior to attending the program most of the participants were unfamiliar with HACCP (77.78%), biosecurity (66.67%), quality assurance (68.00%) and bioterrorism (57.69%). These results may explain why only 3% of the participants passed the pre-examination. Contrastingly, 89% of the producers passed the post-examination with a score of 70% or greater. From the pool of producers that applied for certification status, 64.3% passed their initial farm inspection and adopted 5 or more sustainable goat production practices on their farm. These results provide convincing evidence that extension programs of this nature are highly warranted.

**KEYWORDS:** food borne illness, food safety, Master Goat Program

## CROP PROTECTION AND PEST MANAGEMENT

2008 Proceedings of the Caribbean Food Crops Society. 44(2):547. 2008

### Poster #48

#### First Report of *Cladosporium tenuissimum* Cooke on Taro in Puerto Rico

*Evelyn Rosa-Márquez*<sup>1</sup> and *Carlos E. Ortíz*<sup>2</sup>

*Crop Protection Department, Agricultural Experiment Station, Agronomy and Soils Department, University of Puerto Rico, Mayagüez. eve\_rosa@hotmail.com*

#### ABSTRACT.

*Cladosporium tenuissimum* Cooke has been identified in Puerto Rico on taro [*Colocasia esculenta* (L.) Schott.]. At the onset of the symptoms, the fungus causes reddish-brown leaf spots that become tan to brown with age. Spots are circular or irregular. In the upper leaf surface pale greenish- yellow spots were observed that belongs to the corresponded spot at the lower. Spots often coalesce to form large necrotic areas. Pathogen city test were performed with pure culture of the fungus, isolated in potato-dextrose agar by misting conidial suspensions in sterile distilled water on healthy plants in pods. Typical lesions developed six days after inoculation. The causal agent was reisolated. This fungus was having been previously reported in both Cuba and Puerto Rico. It is reported here for the first time in Puerto Rico affecting both cultivated and non-cultivated taro.

**KEYWORDS:** disease symptoms, Koch's postulates

**Poster #49**

**Relación entre las Propiedades Físicas de un Oxisol y Coberturas Vegetales en la Incidencia de *Phytophthora cinnamomi* en Aguacate *Persea americana* Mill.**

Beatriz E. Torres Ordóñez<sup>1</sup>, C. Estévez de Jensen<sup>2</sup>, V. Snyder<sup>1</sup> y M. Vazquez<sup>1</sup>.  
<sup>1</sup>Department of Agronomy and Soils, <sup>2</sup>Department of Crop Protection, College of Agricultural Sciences, University of Puerto Rico-Mayagüez Campus. P.O. Box 9032 Mayagüez, P.R. 00680. bettorres25@yahoo.com

**RESUMEN.**

En Puerto Rico se importa el 80 por ciento del aguacate que se consume, lo cual indica el potencial económico de aumentar la producción local del cultivo. Sin embargo, las áreas de producción se han visto afectadas con la alta incidencia y severidad de pudrición de la raíz asociada a *Phytophthora cinnamomi*. Dicha condición se ve acentuada por condiciones de saturación del suelo durante la época lluviosa (julio – diciembre), altas temperaturas, y agrietamiento del suelo en épocas de sequía que causan daño mecánico al sistema radicular. En mayo de 2006 se estableció un huerto con la variedad Semil 34/Semil 34 (patrón/injerto) para evaluar la influencia de *Arachis pintoii* y *Arachis glabrata* en un Cumulic Haplustoll, serie San Antón, franco arcilloso. Las coberturas fueron establecidas alrededor de los árboles en junio de 2006, las cuales se comparan con un control (no cobertura leguminosa) en un diseño completamente aleatorizado con 4 repeticiones por tratamiento. Las propiedades físicas del suelo consideradas en este estudio son: estabilidad de agregados donde después de 20 meses de establecidas las coberturas se encontró diferencias significativas ( $p < 0.05$ ) entre el tratamiento con *Arachis glabrata*, 46.24%, versus el control, 22.36% de estabilidad, también se encontraron diferencias significativas en infiltración en campo, potencial mátrico inicial. Hasta el momento no se han encontrado diferencias significativas para Densidad aparente, permeabilidad en laboratorio, y curvas de retención de humedad, pero cabe destacar un mejor comportamiento de estas propiedades con las coberturas versus el control. Algunas propiedades químicas evaluadas fueron Nitrógeno total y Fósforo, en donde se encontraron diferencias significativas; no se han encontrado diferencias en materia orgánica, ni en pH. Se continuará evaluando las propiedades del suelo hasta completar un período de dos años.

**PALABRAS CLAVE:** *Arachis pintoii*, *Arachis glabrata*, aguacate, propiedades físicas de suelos.

**Relationship between Vegetative Covers and Soil Physical Properties of one Mollisol on *Phytophthora cinnamomi* Occurrence in Avocado *Persea americana* Mill. in Puerto Rico.**

**ABSTRACT.**

Puerto Rico imports 80 percent of the avocado that is consumed, which indicates economic potential of increasing its local production. However, the production of this crop have been affected with the high incidence and severity of the root rot associated with *Phytophthora cinnamomi*. This condition is exacerbated soil saturation conditions during the rainy season (July – December), high air temperatures and soil cracks during the dry season causing mechanical damage to the rooting system. During May 2006 an avocado plantation was established with the Semil 34/Semil 34 variety (pattern/graft) in order to evaluate the *Arachis pintoii* and *Arachis glabrata* influence in San Antón soil series, a fine-loamy Cumulic Haplustoll. The vegetative covers were established at the avocado trees surroundings during June 2006. The vegetative covers were compared with a control (no coverage legume) in a completely randomized design with four repetitions for treatment. The analyzed soil physical properties were: aggregates stability percentage, which after 21 months of coverage provided significant differences ( $p < 0.05$ ) between the *Arachis glabrata* (46.24%) versus the control (22.36%); also provided significant differences in field infiltration and bulk density. The moisture retention curves highlighted a better performance in *A. glabrata* versus the control after 12 months. The analyzed soil chemical properties were: total nitrogen percentage and available phosphorous (ppm) which provided significant differences; no significant differences were found in organic matter and pH. This investigation will continue to evaluate the soil properties until the end of a two year period.

**KEYWORDS:** *Arachis pintoii*, *Arachis glabrata*, avocado, soil physical properties.



**Poster #50**

**Weed Management During and After Rhizoma Perennial Peanut Establishment**

*María de L. Lugo-Torres<sup>1</sup> and Teodoro Ruiz<sup>2</sup>. <sup>1</sup>Weed Scientist, Dept. of Crop Protection, <sup>2</sup>Professor, Dept. of Animal Science, University of Puerto Rico, Mayaguez Campus. mlugo@uprm.edu*

**ABSTRACT.**

Beef and dairy enterprises are among the most economically important agricultural activities through the Caribbean Islands of the US. Rhizoma perennial peanut is currently being considered in the Caribbean as an alternative forage because of its low requirements for nitrogen fertilization, relatively high protein content, adaptability to contrasting ecological areas and low susceptibility to pests. The objective was to evaluate strategies to control weeds during and after rhizoma perennial peanut establishment. Four herbicide treatments of imazethapyr and dimethenamid were evaluated. Predominant weeds were junglerice, purple nutsedge, horse purslane, wild poinsettia and common purslane. Differences were detected for dry weight of the peanut and weeds among herbicides treatments at establishment. After establishment, evaluations indicated the best weed control was obtained on the early application dates.

**KEYWORDS:** rhizome perennial peanut, weeds

**INTRODUCTION**

Beef and dairy enterprises are among the most economically important agricultural activities through the Caribbean Islands of the US. There is considerable interest in this area to improve production and quality of forages. Rhizoma perennial peanut (RPP) (*Arachis glabrata*) is currently being considered in the Caribbean as an alternative forage because of its low requirements for nitrogen fertilization, relatively high protein content, adaptability to contrasting ecological areas and low susceptibility to pests. The response of weeds and rhizoma perennial peanut to imazethapyr and dimethenamid in tropical and sub tropical conditions are unknown. Thus, the objective of this study was to evaluate strategies to control weeds during and after RPP establishment.

**MATERIALS AND METHODS**

A field experiment was established at Juana Díaz, Puerto Rico. The soil was a Mollisols with a pH of 7.7. Two RPP accessions, USDA 17033 and USDA 17095, were used. Plot size was 4.57m x 6.0 m and consisted of five rows 0.76 m apart. Planting material was freshly dug rhizomes that were planted continuously in the row at 10-cm depth.

Herbicide treatments were: 1)-imazethapyr at 0.070 kg ai/ha, preemergence (PRE); 2)-dimethenamid at 1.68 kg ai/ha – PRE; 3)-dimethenamid at 3.36 kg ai/ha – PRE; and 4)-imazethapyr at 0.070 kg ai/ha early postemergence (early POE, applied 16 days after planting). Preemergence herbicide treatments were applied the day after planting with a

portable CO<sub>2</sub> pressured backpack sprayer delivering 187 L/ha. Treatments were arranged in a RCBD with four reps. To ensure plant survival, plots were uniformly irrigated with sprinklers the day after the PRE herbicides treatments were applied.

After herbicides treatments, and to complete weed management until RPP establishment, plots received uniformly bromoxynil at 0.28 kg ai/ha 4, 8, 11 weeks after planting and clethodim at 0.28 kg ai/ha at: 4, 11, 24, 31 WAP. By week 42 after planting, glyphosate at rate mix of 20:1 water:herbicide was applied with a weed wiper adjusted 40 cm above the ground.

*Data and Analyses:* Data for analyses included: 1)-Weed dry weight and RPP were evaluated, 6 six and 12 months after planting. 2)-Relative yield among plots at 7 and 13 weeks after the leveling cut (2 years after planting). All data were subjected to analysis of variance, and means were separated using the Tukey's test at the  $P \leq 0.05$  level.

## RESULTS AND DISCUSSION

Predominant weeds were junglerice (*Echinochloa colona*), purple nutsedge (*Cyperus rotundus*), horse purslane (*Thrianthema portulacastrum*), wild poinsettia (*Euphorbia heterophylla*) and common purslane (*Portulaca oleracea*).

*Dry weight of weeds and RPP yield during establishment* (Table 1): Differences were detected for dry weight of RPP and weeds among herbicides treatments at establishment (Table 1). Those plots receiving imazethapyr as an early postemergence had 44 g/m<sup>2</sup> more dry weight of weeds than dimethenamid at the lowest rate, but not significant differences were found among the other treatments. The lowest weight of RPP as compared with the other three herbicide treatments, was that with imazethapyr early POE (Table 1). No difference was observed when comparing dimethenamid at the two rates. No differences were detected for dry weight of RPP and weeds among herbicide treatments at six months nor at 12 months after harvest.

*Dry weight of weeds and RPP yield after establishment* (Table 2): Imazethapyr early POE was not as effective as the rest of the treatments in controlling weeds. As a response to imazethapyr early POE, RPP yield was significantly lower (Table 2). Overall, taking into account all rates and dates of herbicide applications, the best weed control was obtained on the early application dates. A prior study by Ruiz et al. (2000), indicated high yield of the RPP when high doses of imazethapyr were combined with appropriate irrigation.

**Table 1.** Dry weight of rhizoma perennial peanut and weeds during the establishment at Juana Díaz, Puerto Rico <sup>1</sup>

Herbicide Treatment	Rate kg ai/ha	Dry weight of peanut		Dry weight of weeds	
		----- g/m <sup>2</sup> -----		----- g/m <sup>2</sup> -----	
Imazethapyr PRE <sup>2</sup>	0.07	203.6	a	54.7	ab
Imazethapyr – early POE	0.07	92.6	b	77.1	a
Dimethenamid PRE	1.68	286.2	a	32.9	b
Dimethenamid PRE	3.36	203.2	a	64.2	ab

<sup>1</sup> Means within a column followed by the same letter are not significantly different according to Tukey's at the P < 0.05 probability level.

<sup>2</sup> PRE = preemergence; early POE = early postemergence.

**Table 2.** Dry weight of weeds and yield of rhizoma perennial peanut after two years of establishment at Juana Díaz, Puerto Rico on 2005 <sup>1</sup>.

Herbicide Treatment	Rate kg ai/ha	----- Dry matter -----					
		Weeds		Perennial peanut			
		----- g/m <sup>2</sup> -----		----- g/m <sup>2</sup> -----			
				7 WAL	13 WAL		
Imazethapyr PRE	0.07	90.3	a	509.9	a	826.3	a
Imazethapyr- early POE	0.07	210.8	b	307.9	b	290.1	b
Dimethenamid PRE	1.68	56.5	a	719.7	a	1001.7	a
Dimethenamid PRE	3.36	91.8	a	538.7	b	997.8	a

<sup>1</sup> Means within a column followed by the same letter are not significantly different according to Tukey's at the P < 0.05 probability level

## REFERENCES

Ruiz, T.M., R. Ramos–Santana and A. Sotomayor-Rios. 2000. Establishment of rhizoma perennial peanut (*Arachis glabrata*) under irrigation at two semiarid sites in the Caribbean. J. Agric. Univ. of PR. 84:105-114.

## ACKNOWLEDGMENT:

This study was supported in part by the USDA-CSREES special grant Tropical/Subtropical Agricultural Research (T-STAR).

**Poster #51**

**Black Sigatoka IPM in Puerto Rico**

*W. Almodóvar<sup>1</sup> and M. Díaz<sup>2</sup>, <sup>1</sup>Crop Protection Department, and <sup>2</sup>Horticulture Department, University of Puerto Rico, Mayagüez Campus. walmodovar@uprm.edu*

**ABSTRACT.**

The Black Sigatoka Management (BSM) Program of the University of Puerto Rico Extension was funded in part by the Southern Region IPM Center and the USDA/ES/IPM program. There were two field day workshops for Extension Agents held at the Gurabo Research Station. Each workshop introduced the concepts and practice of BSM. Seventy-five Extension Agents were trained to identify the stages of Black Sigatoka, determine the incidence of this disease using the Stover scale, and calculate the percentage infection. An experimental plot of plantain infected with the disease was used for this purpose. A field guide with an electronic presentation in Spanish about BSM was created. Each attendee received a copy of these educational materials, and agreed to conduct field day and training meetings for growers on the topics discussed in the BSM program. All attendees increased their knowledge and attitudes toward non-chemical management of Black Sigatoka, and pesticide safety. They considered the field guide and the set of electronic presentations appropriate to train growers to implement effective and environmentally responsible management strategies for the protection of plantain and banana from Black Sigatoka. The outcomes of this project will lead to reduce the potential for Black Sigatoka problems on plantain and banana and to decrease pesticide use in the environment. This project expands the existing pesticide safety, and IPM programs in Puerto Rico. The field guide and electronic presentations about the BSM can be reached at:

<http://academic.uprm.edu/walmodovar>

**KEYWORDS:** Stover scale, plantain, banana, strategies

**Poster #52**

**Crianza Masiva de *Mirax Insularis* Muesebeck, el Parasitoide Exótico del Minador del Café *Leucoptera coffeella* Guérin-Ménéville (Lepidoptera: Lyonetiidae) en Puerto Rico<sup>5</sup>**

Fernando Gallardo<sup>1</sup>, Evelio Hernández<sup>2</sup>, Marcela Daza<sup>3</sup> y Jennifer Pagán<sup>4</sup>  
<sup>1</sup>Catedrático, <sup>2</sup>Ayudante de Investigaciones, <sup>3</sup>Estudiante Graduada, <sup>4</sup>Auxiliar de Investigaciones. Universidad de Puerto Rico, Recinto Universitario de Mayagüez, Departamento de Protección de Cultivos, Apartado 9000, Mayagüez. PR 00920. fgallardo@uprm.edu <sup>5</sup>Este trabajo de investigación es financiado en parte por “USDA-Special Grants in Tropical Agriculture, Project TSART-110 “Augmentation of *Mirax insularis* Muesebeck for the population suppression of the coffee leafminer *Leucoptera coffeella* in Puerto Rico”.

**RESUMEN.**

El minador del café, *Leucoptera coffeella* (Guerin Ménéville) es una de las plagas principales del cultivo del café mundialmente. Cuando las prácticas de control no son apropiadas ocasionan defoliación a los arboles de café afectando su producción. Desde hace algunos años se han estado buscando alternativas de control que sean viables tanto económicamente como ambientalmente. Una de las técnicas sugeridas es la incrementación de uno de sus más abundantes parasitoides en el Caribe, el bracónido, *Mirax insularis* Muesebeck. Para la crianza masiva del huésped del bracónido utilizamos plántulas de café (*Coffea arabica* L. cultivar Catuaí) de tres meses. Expusimos 65 plántulas de café, cultivadas libres de insectos, a 60-80 adultos del minador del café dentro de una cajuela de infestación durante tres días. Removimos las plántulas al cuarto día después de la infestación y a los tres días siguientes introducimos los adultos del parasitoide para que parasitaran las minas presentes en las hojas por espacio de 48 horas. Al cabo de 13 días podamos las hojas de cada plántula y las mantuvimos *in Vitro* para la recuperación de adultos. La introducción de los parasitoides se hizo de acuerdo al momento más adecuado de su huésped que es cuando las larvas del minador están en el primer o segundo instar, evento que ocurre entre los tres y siete días post-oviposición. En promedio se recuperaron  $4 \pm 0.25$  ( $\mu \pm SEM$ ) adultos del parasitoide por cada hembra introducida. La recuperación de los adultos del parasitoide estuvo muy por debajo de lo esperado. La capacidad reproductiva del parasitoide bajo las condiciones de este estudio nos obliga a repensar la viabilidad de un programa de control biológico por incrementación utilizando a *Mirax insularis* como agente de biocontrol.

**ABSTRACT.**

The coffee leafminer, *Leucoptera coffeella* (Guerin-Ménéville), is one of the key pests of coffee worldwide. When the control practices are not appropriate they cause defoliation to the coffee trees affecting its production. For many years, we have been looking for alternative controls that are viable as much economically as environmentally. One of the control method suggested is the augmentation of one of his more abundant parasitoids in

the Caribbean, the braconid, *Mirax insularis* Muesebeck. For the massive rearing of its host, we used three months old coffee seedlings (*Coffea arabica* L. cultivar Catuaí). Sixty-five seedlings, cultivated free of insects, were exposed to 60-80 adults of the coffee leafminer inside a rearing cage during three days. Three days post-infestation, the seedlings were removed to a parasitoid-infestation cage and during the next three days we introduce adults of *M. insularis* so that the present mines in the leaves would be parasitize. After 13 days we pruned the leaves of each seedling and maintained *in Vitro* for the recovery of the parasitoids adults. This procedure was replicated four times. The introduction of the parasitoid were done according to the most suitable moment of its host that is when the coffee leafminer larva is in the first or second instar, event that happens between the three and seven days post-oviposition. In average we recovered  $4 \pm 0,25$  ( $\mu \pm$  SEM) adults of the parasitoid by each female introduced. The parasitization rate that we observed during this study was very below to what can be expected. Thus, the low reproductive capacity of *Mirax insularis* under the conditions of this study forces us to rethink the viability of a biological control program by augmentation of the braconid to suppress the coffee leafminer in Puerto Rico.

**PALABRAS CLAVE:** Café, *Coffea arabica*, Biocontrol, Minador del Café, *Mirax insularis*, Crianza Masiva.

## INTRODUCCIÓN

El minador de la hoja del cafeto, *Leucoptera coffeella* Guérin-Ménéville, es una de las plagas principales de *Coffea arabica* L. en Puerto Rico. Su oruga penetra en el mesófilo de la hoja alimentándose y causando una mancha marrón irregular que afecta la capacidad fotosintética del cafeto disminuyendo su producción hasta un 50% (Figura 1) (Cibes & Pérez 1958). Aunque su control es obtenido con la aplicación de insecticidas sistémicos granulares es necesario buscar otras alternativas de control, tales como el uso de enemigos naturales. La incrementación de parasitoides para control de las poblaciones del minador ha sido propuesto como una de las alternativas viables a este problema (Gallardo 1992).

En Puerto Rico el minador tiene una amplia gama de parasitoides siendo el braconido *Mirax insularis* Muesebeck el más abundante (Figura 2). Este parasitoide fue introducido desde la isla caribeña de Guadalupe a Puerto Rico a principios de la década del cuarenta (Gallardo 1988). En la actualidad se encuentra distribuido en todas las zonas cafetaleras de Puerto Rico y su nivel de parasitación llega alcanzar el 32.4 % (Gallardo 2006). Este parasitoide es un koinobionte con tres estadios larvales y su ciclo de vida se completa en 15 días emergiendo su adulto de la pupa del minador del café (León 1997). Estudios realizados de la dinámica poblacional de su huésped nos indican que en Puerto Rico tenemos dos picos de abundancia del minador definidos por un periodo de lluvia seguido por tres o más semanas de sequía. Con el objetivo de criarlo masivamente y liberarlo en los momentos estratégicos antes que comiencen a aumentar las poblaciones del minador se estableció una crianza artificial del minador y posteriormente se estudio la capacidad de reproducción masiva de *M. insularis*.

## MÉTODOS Y MATERIALES

El procedimiento de crianza de *M. insularis* se divide en los siguientes pasos: 1) en el invernadero de producción (libre de insectos) sembramos en tiestos las plántulas de café, las cuales serán utilizadas al cabo de los tres meses 2) recolectamos en el campo hojas infestadas de minador y con el parasitoide, 3) en el laboratorio recolectamos los adultos del parasitoide según van emergiendo de las muestras de hojas traídas del campo, 4) exponemos las plántulas de café previamente infestadas con el minador a los adultos del parasitoide recolectados en el paso anterior, 5) mantenemos las plántulas tratadas anteriormente en el invernadero de infestación hasta los 13 días post-infestación con el parasitoide, 6) cortamos las hojas infestadas por el minador, 6) llevamos las hojas podadas al laboratorio y las mantenemos in Vitro, y 7) recolectamos los adultos del parasitoide en el laboratorio (Figura 3). Los costos de producción se dividen en recurrentes (plántulas, fertilizantes, mano de obra, medio de crecimiento y citokinina) y no recurrentes (tiestos, cajuelas de recolección, infestación y crianza, aspirador de vacío, tubos plásticos, y aspiradores). El costo de espacio y utilidades es provisto por la Estación Experimental Agrícola de Adjuntas (EEAA), de la Universidad de Puerto Rico y no es considerado en los análisis de costo.

**Condiciones Ambientales:** Todos los procedimientos de crianza en el invernadero se realizan en la EEAA a unas temperaturas de 18 a 25 °C, 65 ± 5% HR. Toda la crianza in Vitro del minador es realizada en el laboratorio en un cuarto de crianza (25 ± 1 °C y 45 ± 5% HR) en la EEAA. La fuente de luz utilizada son tubos fluorescentes “cool-white”, 40 voltios, con un ciclo de 12 hr L:O.

**Producción de Plántulas:** Plántulas del cultivar Catuaí, seleccionado como el más apropiado (data no publicada) para la crianza del minador, fueron sembradas en tiestos plásticos (19.6 cm. dia.) y depositadas en un invernadero preparado para mantenerlas libres de insecto, (15.23 x 15.23 x 2.43 m altura); cubierto con tela Lumite<sup>(R)</sup> (50 x 24 mesh), dentro de un invernadero en la EEAA. El invernadero de crecimiento tiene cuatro bancos con capacidad de 250 tiestos cada uno, lo cual nos permite una producción de 1,000 plántulas cada tres meses. Sembramos una plántula por tiesto en medio estéril (Pro-Mix<sup>(R)</sup> sphagnum peat moss) las cuales se irrigan a mano dos veces por semana y se fertilizan mensualmente (20-20-20 Nutrileaf<sup>(R)</sup>).

**Infestación con minador:** Transferimos las plántulas de café (3 meses), cultivadas libre de insectos, a las cajuelas de infestación (183 X 183 X 183 cm.) cubiertas con Lumite<sup>(R)</sup> (32 X 32 mesh) (Figura 5) dentro de un invernadero en la EEAA. Cada cajuela de infestación tiene cabida para 65 tiestos o plántulas. Miel y agua se proveen como fuente de alimento. Inoculamos cada cajuela con 60 hasta 80 adultos del minador por cada ciclo de crianza.

**Recolección de adultos del parasitoide.** Recolectamos hojas de cafeto atacadas por el minador semanalmente en diversas fincas de la Zona Cafetalera de Puerto Rico y las transportamos a la EEAA. Depositamos aproximadamente 50 hojas en cada cajuela de recolección (Figura 4). Miel y agua se proveen como fuente de alimento. Cada mañana se recogen los parasitoides que emergen en las cajuelas de recolección y se transfieren inmediatamente a las cajuelas de infestación. En el Cuadro 1 se presentan los totales de parasitoides recolectados del campo e introducidos a las cajuelas de infestación.

**Infestación con el parasitoide y crianza del minador:** Removimos las plántulas de café luego de tres días post-infestación y las mantenemos dentro de una cajuela de crianza similar a la cajuela de infestación. Esto nos permite sincronizar su crianza ya que

casi todos los huevos depositados por la hembra del minador tendrán una misma edad y por lo tanto el desarrollo de larva es controlado. De tres a siete días post-infestación se encuentran la mayor cantidad de larvas del minador en los estadios primero y segundo los cuales son los preferidos por el parasitoide para ser parasitados ( Navarro 2007).

**Recolección *In Vitro* de minador:** Tres semanas después de la exposición a los adultos de *M. insularis* separamos las hojas de las plántulas y las llevamos al laboratorio. Cada pecíolo de la hoja es insertado y fijado en un “foam” de polietileno (densidad 28, y 3-cm. espesor) conteniendo agua destilada para el mantenimiento de las hojas separadas de la plántula *in Vitro* y depositados dentro de una caja acrílica de emergencia (Figura 6). La hojas se mantienen bajo condiciones de laboratorio hasta que emergen los adultos del minador o del parasitoide.

## RESULTADOS Y DISCUSIÓN

Para la crianza del parasitoide y el minador en 65 plántulas nos tardamos 25:38 horas en completar todas las tareas (sembrar y mantener las plántulas, recolectar hojas minadas en el campo, infestar las plántulas, transferir y mantener las plántulas infestadas en las cajuelas de crianza, inocular con los parasitoides, podar las plántulas, transferir y mantener las hojas podadas *in Vitro*, y recolectar adultos del parasitoide. El costo de labor es estimado en \$ 187.81 (25:38 horas x \$ 7.40). El costo inicial para producir 7,020 minas es estimado en \$ 5,653.91 (Cuadro 2). Este estimado incluye los costos no-recurrentes como los recurrentes. Sin embargo, después que la crianza esta en producción solo los costos recurrentes deben ser considerados. Por la tanto, los costos recurrentes de producir 7,020 minas es de \$ 361.21 (aproximadamente \$ 0.05 por mina). Una crianza mensual utilizando solamente 250 plántulas nos produce aproximadamente 27,000 minas. Utilizando las facilidades actuales podemos producir 324,000 minas por año, si aumentáramos nuestra capacidad de crianza podríamos criar masivamente al minador y a sus enemigos naturales.

Realizamos la introducción de los parasitoides de acuerdo al momento más adecuado de su huésped que es cuando las larvas del minador están en el primer o segundo instar, evento que ocurre entre los tres y siete días post-oviposición. En total introducimos un promedio de 300 adultos por cada cajuela comenzando en el mes de julio de 2007 hasta marzo de 2008 (Cuadro 1) . En promedio recuperamos  $12 \pm 0.25$  ( $\mu \pm$  SEM) adultos por cada cajuela durante el periodo del experimento. Además, estimamos que en promedio se recuperaron  $4 \pm 0.25$  ( $\mu \pm$  SEM) adultos del parasitoide por cada hembra introducida.

## CONCLUSIÓN

Hemos demostrado que podemos criar masivamente al minador de la hoja del café, *L. coffeella*. Desarrollamos un método para producir masivamente al minador, desde huevo hasta adulto, bajo condiciones entoaxénicas utilizando plántulas de café de tres meses y hojas mantenidas *in Vitro*. Esta metodología maximiza los recursos disponibles para criar al minador evitando la contaminación por residuos de insecticidas sistémicos. Aunque la recuperación de adultos del minador utilizando esta metodología sobrepasa las expectativas y sin lugar a dudas podemos criarlo masivamente libre de toxicidad por insecticidas sistémicos o de parasitoides no es así para su parasitoide principal el braconido *M. insularis*. La recuperación de los adultos del parasitoide estuvo



muy por debajo de lo esperado en comparación con su tasa de parasitización observado en el campo. La capacidad reproductiva del parasitoide bajo las condiciones de este estudio nos obliga a repensar la viabilidad de un programa de control biológico por incrementación utilizando a *M. insularis* como agente de biocontrol.

## REFERENCIAS

- Cibes H. R. & M. Pérez. 1958. Minador de la hoja disminuye en grado considerable el vigor de los cafetos. *El café de El Salvador* 28: 325-326.
- Gallardo F. 1988. Faunal Survey of the coffee leaf miner, *Leucoptera coffeella*, parasitoids in Puerto Rico. *Journal of Agriculture of the University of Puerto Rico* 72 (2): 255-263.
- Gallardo F. 1992. Augmentation of *Mirax insularis* Muesebeck: An alternative for the population control of the coffee leafminer, *Leucoptera coffeella* Guérin-Ménéville in Puerto Rico. *Journal of Agriculture of the University of Puerto Rico* 76(2): 43-54.
- Gallardo F. 2006. Population dynamics of the exotic coffee leaf miner *Leucoptera: coffeella* Guerin-Meneville (Lepidoptera: Lyonettidae) larvae parasitoid, *Mirax insularis* Muesebeck, in a sunlight coffee plantation of Puerto Rico. In: Caribbean Food Crops Society. Forty Second Annual Meeting. Carolina, Puerto Rico. Vol. 42 (2):87-92.
- Navarro, P., 2007. Larval stages (instars) of the coffee leafminer *Leucoptera coffeella* (Guerin-Ménéville)(Lepidoptera: Lyonetiidae) and its synchronization with the parasitoid *Mirax insularis* Muesebeck (Hymenoptera: Braconidae) in Puerto Rico.

Tesis

Cuadro 1. Numero de adultos de <i>Mirax insularis</i> Muesebeck introducidos en las cajuelas de infestación y adultos del parasitoide criados artificialmente in vitro. Julio 2007 hasta Marzo 2008.
--

M.S.

Universidad de Puerto Rico, Mayagüez, P.R. 75 pp.

- León, A. 1997. Descripción de las etapas inmaduras del ciclo de vida de *Mirax insularis* (Hymenoptera: Braconidae) in vitro y el efecto de su relación parasítica con el minador de hoja de café, *Leucoptera coffeella* (Lepidoptera: Lyonetidae). Tesis M.S. Universidad de Puerto Rico, Mayagüez, P.R. 55 pp.

Cajuela de Crianza	Introducidos	Criados
1	400	1
2	261	4
3	364	7
4	197	37
<b>TOTAL</b>	<b>1222</b>	<b>49</b>



**Figura 1.** Hojas de cafeto atacadas por el minador de la hoja del café, *Leucoptera coffeella*, Guerin-Ménéville..



**Figura 2.** *Mirax insularis* Muesebeck. A) Hembra, B) Macho

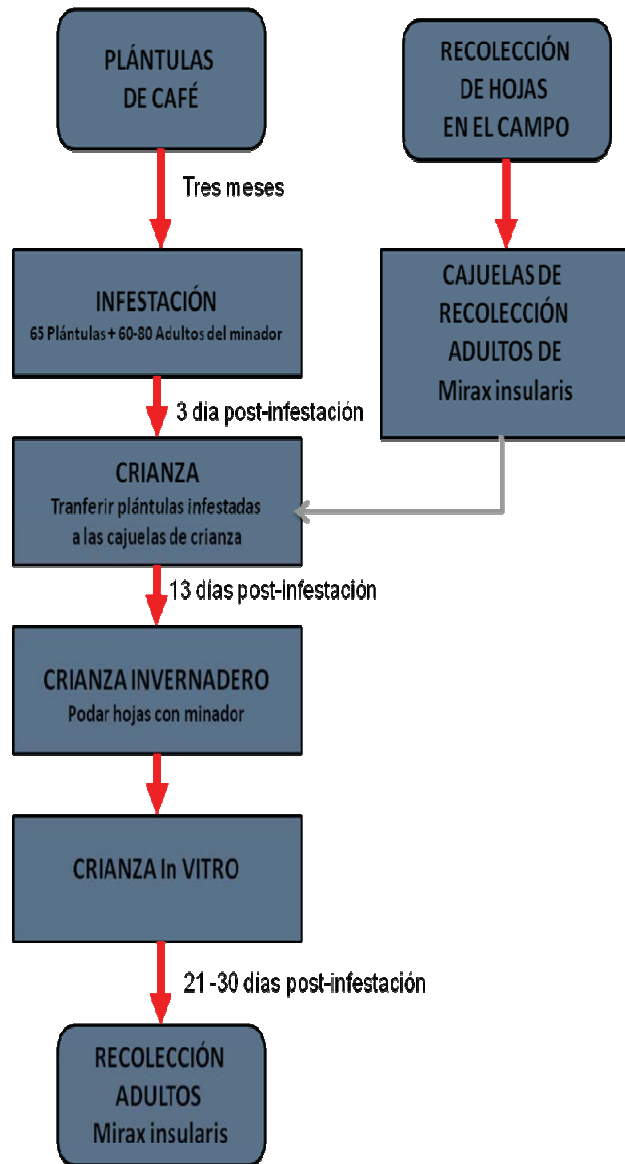

**Figura 3.** Diagrama de flujo de los pasos y tiempos necesarios para la crianza del braconido *Mirax insularis* en su huésped el minador de la hoja del cafeto, *Leucoptera coffeella*.



**Figura 4.** Cajuelas transparente para la recolección de adultos del minador del café, *Leucoptera coffeella* y de *Mirax insularis*



**Figura 5.** Cajuela para la infestación del minador del café, *Leucoptera coffeella* y posteriormente con el parasitoide.

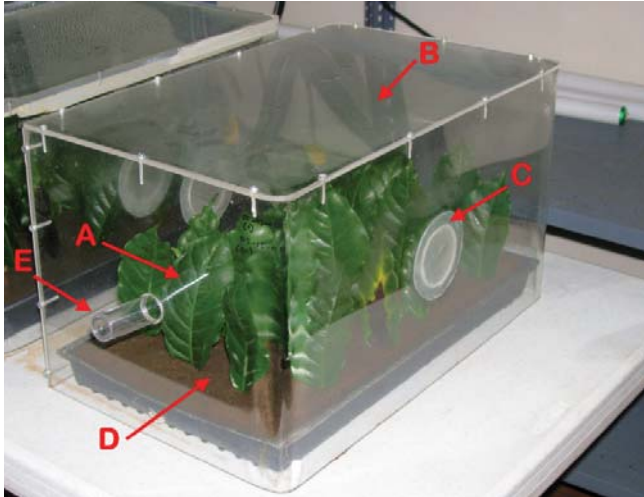

**Figura 6.** Cajuela de emergencia para la recolección in Vitro del minador del café, *Leucoptera coffeella*. A) hojas del cafeto; B) Caja Acrílica; C) Aperturas de ventilación cubiertos con Lumite; D) "foam" E) Tubos de recolección (9 drams).

Cuadro 2. Costos estimados para la crianza del minador del café, *Leucoptera coffeella*, en 65 plántulas de café, *Coffea arabica*, cult. Catuaí.

	Cantidad	Precio Unidad (\$)	Total (\$)
<b>Costos No-Recurrentes</b>			
Tiestos (3.78 L)	65	0.40	26.00
Cajuela Axenica <sup>1</sup>	1	2,960.90	2,960.60
Cajuela Recolección <sup>1</sup>	10	18.75	187.50
Aspirador Vacío	2	264.25	528.50
Aspiradores	4	6.70	26.80
Tubos Plásticos, 9 Drams	200	1.85	370.00
Cajuela Infestación <sup>1</sup>	1	315.40	315.40
Cajuela Crianza <sup>1</sup>	1	315.40	315.40
Cajas Acrílico In vitro <sup>1</sup>	25	22.50	562.50
		<b>Total</b>	<b>\$ 5,292.70</b>
<b>Costos Recurrentes</b>			
Plántulas de café	65	0.35	22.75
Bolsas Plásticas	100	0.04	4.00
Medio de Crecimiento <sup>2</sup>	1	25.00	25.00
Fertilizante (Triple 20 Nutrileaf)	1 Kg	5.95	5.95
Oasis	1 box	95.00	95.00
Benzyladenin	1 gram	20.70	20.70
Labor	25:38 hours	7.40	187.81
		<b>Total</b>	<b>361.21</b>
		<b>Gran Total</b>	<b>\$ 5,653.91</b>

<sup>1</sup> Construido en la Estación Experimental de Adjuntas; costo incluye labor.

<sup>2</sup> Pro-Mix(R) sphagnum peat moss (0.107) metros cúbicos

**Poster #53**

**Extracts of Native and Non-Native Plant Species for the Control of Cogongrass (*Imperata cylindrica* L)**

*Lissa D. Reid, Bravo G. Brown, and Oghenekome U. Onokpise, Florida A&M University, Tallahassee, Florida. Lissa1.reid@famu.edu*

One of the most invasive species in Florida and other Gulf Coast States is Cogongrass. Cogongrass poses a major problem in natural habitats, on forested lands, rights-of-way and interstate highways. The present study was undertaken to evaluate the performance of cogongrass when grown in extracts of muhly grass (*Muhlenbergia capillaries* Lam) and chenopodium (*Chenopodium ambrosioides* L). Genets and ramets of cogongrass were transplanted into magenta vessels containing 50% solution of root and shoot extracts of muhly grass and chenopodium, and placing magenta vessels in a growth chamber maintained at 28°C, 16/8 hour photoperiod and a relative humidity of 55 %. The genets and ramets of cogongrass were evaluated once per week for shoot and root growth, as well as rhizome extension after transplanting. Preliminary results show that the extracts of muhly grass and chenopodium reduced shoot growth and rhizome extension of cogongrass. Shoot extracts of muhly grass and chenopodium were more effective in reducing the performance of cogongrass compared to muhly grass and chenopodium root extracts. Root: shoot ratios of cogongrass also decreased by 50-70%. Thus, muhly grass and chenopodium extracts may contain some allelochemicals that could impact the invasiveness of cogongrass.

**KEYWORDS:** culms, *in vivo*, *in vitro*, Chenopodium, Muhly grass, genets, ramets, extracts, magenta vessels, allelochemical.

**INTRODUCTION**

Cogongrass (*Imperata cylindrica* L.) sometimes called japgrass, blady grass, spear grass and alang-alang, is a C<sub>4</sub> rhizomatous perennial weed with culms that grow erect typically reaching a height of 1.2 m but may sometimes grow as tall as 3m. The fibrous roots are extensive and extend from a scaly rhizome (Brown, 1944). Cogongrass is one of the most difficult weed to control. It can grow almost any where in the world and under any temperature. Cogongrass is not found in the Antarctica (Willard et al, 1990). Cogongrass was introduced to the United States in the late nineteenth century and early twentieth centuries. Today, cogongrass is an invasive weed in the Gulf Coast States of southeastern United States. Cogongrass is considered a serious invasive species in parts of Florida, southern Alabama, southern Mississippi, and Georgia where it invades pastures, nurseries, pecan plantation, highway right-of-way, lawns, phosphate mined areas, pine plantation, parks and recreational areas (Onokpise, 2000; Patterson et al., 1980). It constitutes an impediment to efforts aimed at reclamation and restoration of these sites to their natural conditions or productive lands. Cogongrass is mainly spread by rhizomes and seed. Once cogongrass is established it competes with neighboring crops

and plants and reduces their yields (Bolfrey-Arku et al.; 2002, 2004). The persistent and aggressive rhizome of cogongrass remains the main mechanisms for survival and spread, while its resilience makes it difficult to control. Besides the rhizomes, wind blown seeds have aided in the establishment of vast areas of cogongrass.

Based on studies conducted on the species (Shilling et al., 1997) a combination of herbicides (glyphosphate and imazapyr), and mechanical treatments provide excellent control. However a single herbicide application is costly. Reinvasion by cogongrass rapidly occurs if ecological niche is not replaced by another plant species. Imazapyr is the recommended herbicide because it is effective and has a long lasting residual effect on soil and prevent revegetation of the controlled areas while glyphosphate and others are relatively biodegradable. The impact on non target species from the use of herbicide often has severe implications causing reinvasion of cogongrass or invasion by other weed species (Gaffney and Shilling, 1996). For economic and environmental reasons the current control strategies are often not acceptable and necessary considerations need to be given other control methods. Studies conducted in other parts of the world with leguminous plant species, have revealed that these species provide effective control of cogongrass in their natural habitat (Bolfrey-Arku et al., 2002; Chikoye et al., 1999)

Biological control is the action of one organism (plant or animal) in the control or maintenance of another organism. The aim is to maintain the organism at economic level. There are many advantages of using biological control for the management of weeds. There are no environmental residues, self reputation with human assistance, non toxic to animals and human, and more sustainable to the environment (Zimdahl, 1993). The use of native plant species, as biological control agents (Onokpise et al.; 2007), maybe an expensive and efficient way of controlling cogongrass which will prove beneficial to the forestry, agricultural, and other communities in the southern region of United States. Species with potential for use in the biological control of cogongrass are *Chenopodium* (*Chenopodium ambrosioides*) and Muhly grass (*Muhlenburgia capillaries* Lam.). These species may possess natural chemicals that may inhibit the growth and extension of cogongrass rhizomes. The objective of this study was to evaluate extracts from two plant species for effectively controlling cogongrass *in vitro*.

## **MATERIALS AND METHODS**

### **1. Preparation of planting materials**

The cogongrass plant materials were collected from an infested area on Tram Road Tallahassee, Florida. They were harvested by digging the cogongrass from the soil with a Hisco garden spade blade hollow back size 67/8 inches x 105/8 inches. Ramets were separated from genets, cleaned, washed and then cut into three inches pieces and placed in 36 cell plastic flat trays measuring 30 cm x 14 cm. The trays were then filled with commercial ready made potting medium (“Pro-Mix” Premier Horticulture, Quebec, Canada). Approximately one, two-node ramet was planted in each cell. Ramets were grown in the George Connolly Greenhouse on Florida A&M campus until they were at two-leaves stage and ready to be transplanted.

### **2. Extract Preparation**

The *Chenopodium* plants were obtained from the FAMU Research and Extension Farm, Quincy, Florida and Muhly grass plant materials were obtained from the St. Marks

National Wildlife Refuge, Florida. The study was conducted in the growth chambers, in the Forestry and Agronomy Laboratory located in Room 303 South Perry-Paige Building at Florida Agricultural and Mechanical University, Tallahassee, Florida.

The chenopodium and muhly grass plants were collected by using heavy duty garden fork with four angular back tines so the soil could plunge through. The hands were used to remove unwanted leaves and soil. The chenopodium and muhly grass were then washed under a steady stream of water from the top. Then the plants were separated into different plant parts (root, stem and leaf). They were then cut into ¼ inch pieces washed and weighed into 140 gram and placed 140 gram into storage bags. Materials from each 140 gram bags were retrieved and blended with 400 ml of distilled water using Hamilton Beach blender at high speed until the parts became liquefied. The liquid was then poured from the blender into a four gallon mixing bowl the extract was thoroughly mixed for about five minutes. Cheese cloth (grade #10 with 20 v x12 h threads per inch) was cut and was used to filter the extract to remove remaining pieces of plant parts. The extract was then strained a second time with the cheese cloth folded into four layers so as to remove the very small particles. The resulting solution (plant extract) was then measured into aliquots of 100 ml and poured into magenta vessels. Cogongrass at the two leaves-stages were then retrieved and removed from trays. They were washed in a laboratory tray to remove soil particles from roots of plants and one plant each was inserted into each magenta vessel containing plant extracts. The magenta vessels were then placed into a growth chamber set at 28°C and 16/8 hour photoperiod. The plants were observed for new roots and new leaf at seven days intervals. The data collected was the number of new cogongrass root and new shoot produce after planting. Data was analyzed using SAS 9.0 (SAS 2003).

## **RESULTS AND DISCUSSION**

A pair wise comparison was done following analysis of data. When muhly grass leaf extract and control when compared there was no significant difference in the survival rate (figure 1). Also muhly grass root extract when compared with control showed no significant difference between the two treatments. However, when the muhly grass root with muhly grass shoot extract were compared cogongrass survival rate was a significantly difference between these two treatments (Figure 1). The muhly grass root however, was more effective in controlling cogongrass growth (Figure 1). However, there was no significant difference for survival percentages for cogongrass treated with chenopodium root and stem extracts (Figure 2). The root and stem extracts of chenopodium were equally effective in controlling cogongrass growth (Figure 2). However the chenopodium leaf was the least effective in controlling the growth of cogongrass. When the control was compared against chenopodium treatments, chenopodium stem and root did better in controlling the growth of cogongrass (Figure 3). There is very limited information in literature in the use of plant extracts form muhly grass and chenopodium for controlling cogongrass. While some information exist for the possible allelochemical of cogongrass it is possible that muhly grass and chenopodium may possess such allelochemicals that will significantly impact cogongrass development and growth. The results from our study may allow for utilization



**FIGURES (Following 3 pages)**

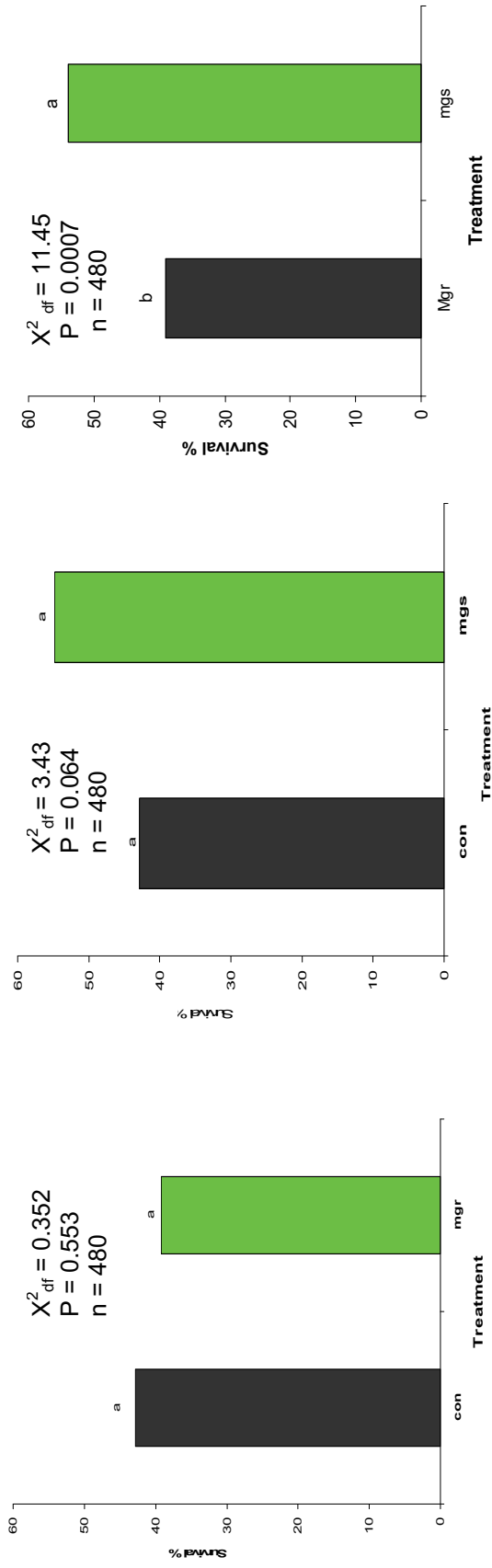

Figure 1. Proportion of Cogongrass Survival in Muhly grass root (mgr) extract, Muhly grass shoot (mgrs) extracts and control (con) after six weeks

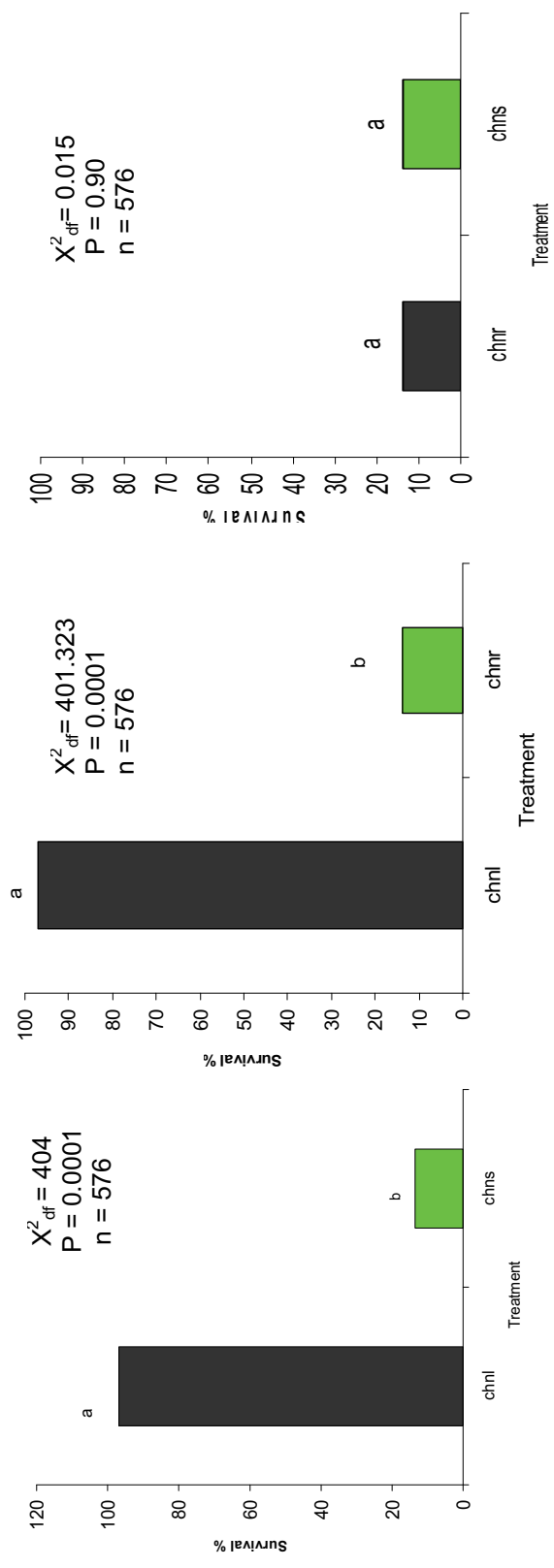

Figure 2. Proportion of cogongrass survival from Chenopodium root (chnr) Chenopodium leaf (chnl) and chenopodium stem (chns) extracts after six weeks

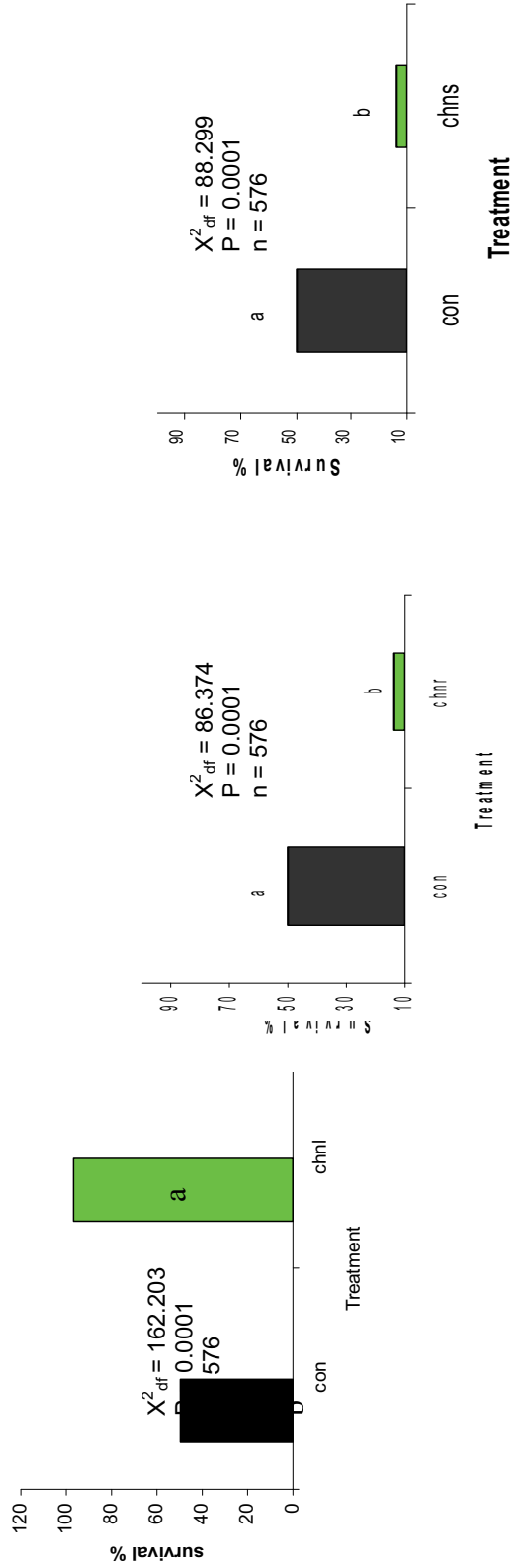

Figure 3. Proportion of cogon grass survival from Chenopodium root (chnr), Chenopodium leaf (chl), chenopodium shoots (chns) extract and control (con) after six weeks

## ACKNOWLEDGEMENT

This study was made possible in part, by a grant #2005-38814-16377 from USDA-CSREES 1890 Capacity Building Grant Program. Thanks are extended Dr. S. Bambo, Dr. J. Muchovej and Mr. G. Queeysl for assistance in the course of this study.

## REFERENCES

- Bolfrey\_Arku, G. 2004. Management of Noxious weed speargrass (*Imperata cylindrica* (L) Beauv.) in the forest and forest-savanna transition agro-ecological zones of Ghana. Ph.D Thesis , Department of Crop Science, University Cape Coast, Takoradi, Ghana.
- Bolfrey-Arku, G., O. U. Onokpise, D. Shilling and C. Coultas. 2002. Land preparation and legume cover crop for biological control of cogongrass. Soil Crop Science Society. Pro. 61: 4-9.
- Brown, D. 1944. Cogongrass is now considered a serious invasive species in parts of Florida, southern Alabama, southern Mississippi, and where it invades pastures, nurseries, pecan plantation, highway right-of-way, lawns, and natural habitats Anatomy and Reproduction in *Imperata cylindrica*. Joint Publication NO.7:15-18.
- Chikoye, D., F. Ekeleme and J.T. Ambe. 1999. Survey of distribution and farmer's perception of speargrass [*Imperata cylindrica* (L)Raeuschel] in cassava based systems in West Africa. Int. Journal Pest Management 45: 305-311.
- Gaffney, J.F. and Shilling. 1996 The presence of *Imperata cylindrical* to chemical control followed by revegetation with desirable species, pp. 981-986. In Brown, H. (ed.) Proceedings of Second International Weed Control Congress. Copenhagen, Denmark, June 25-28, 1996. Department of Weed Control and Pesticide Ecology, Slagelse, Denmark.
- Onokpise, U. O., J. Moody, H. Dueberry, L. Reid, J.L. Norcini, J. J. Muchovej, and S. Bambo. 2007. Comparative Studies on the Control of Cogongrass (*Imperata cylindrical* L.). Journal of Environmental Monitoring and Restoration. 3: 323-330
- Onokpise, O.U. 2000. Population of cogongrass (*Impeata cylindrical* L) in Leon County, Florida. Association of Research Directors, Inc., Symposium. April 19-21, 2000, Washington D.C., pp 97
- Patterson, D. T., E. P. Flint, and R. Dickens. 1980. Effect of temperature, photoperiod, and population source on the growth of cogongrass (*Imperata cylindrical*”). Weed Science. Vol.28, Issue 5:505-509.
- SAS 2003
- Shilling, D. G., T.A. Bewick, J. F. Gaffrey, S.K. McDonald, C.A Chase and E.R.R.L. Johnson. 1997. Ecology, physiology and management of cogongras (*Imperata cylindrical* L) Final Report: FPIR Project No93-03-107.128 pp
- Willard, T. R., D. W. Hall, D.G.Shilling, J.A. Lewis, and W. L. Currey. 1990. Cogongrass (*Imperata cylindrical*) distribution on Florida highway right-of-way. Weed Technology 4:658-660
- Zimdahl, R. 1993. Fundamentals of Weed Science. Academic Press, Inc. New York, N.Y. 48-54.

**Poster #54**

**Evaluation of Acibenzolar-S-Methyl, PGPR and Silicon for Their Effects on Growth and TYLCV of Tomato**

*Shouan Zhang, Thomas L. White, and Waldemar Klassen. Tropical Research and Education Center, University of Florida, IFAS, Homestead, Florida 33031, USA*

**ABSTRACT.**

TYLCV is a major limiting factor for tomato production in south Florida. There is no single method which provides adequate control of TYLCV on tomato. In the greenhouse assays, Actigard® at 3 mg/l, plant growth-promoting rhizobacteria (PGPR) strains SE34 and IN937b at  $1 \times 10^7$  CFU/ml, and silicic acid at 1.5 mM and 0.15 mM applied as soil drench significantly increased plant height when compared with the nontreated control. SE34, IN937b and silicic acid significantly increased stem caliper, and IN937b increased the chlorophyll content in the leaves of tomato seedlings. All treatments with disease resistance inducers significantly reduced disease severity of TYLCV compared to the nontreated control. In the field trial, tomato plants treated with Actigard® at 3 mg/l had significantly less disease than the nontreated control plants 4 weeks after transplanting.

**KEYWORDS:** Tomato yellow leaf curl virus, TYLCV, growth promotion, induced disease resistance, tomato

**INTRODUCTION**

Tomato yellow leaf curl disease, caused by Tomato yellow leaf curl virus (TYLCV), has become one of major disease problems of tomato in south Florida (Polston et al., 1999). TYLCV is only transmitted by the sweet potato whitefly (*Bemisia tabaci* Biotype B = *Bemisia argentifolii*) which has a broad host range including vegetable, ornamental crops and weed species (Cohen and Antignus, 1994; Mansour and Al-Musa, 1992). Tomato plants can be severely stunted if infected at an early stage, and consequently this can result in substantial yield losses. Chemical control is relied on heavily to reduce the impact of TYLCV. However, chemical control methods have become progressively less effective due to high whitefly population densities and their mounting resistance to insecticides (Schuster, 2007). Although the development of resistant cultivars holds promise in reducing the impact of TYLCV (Lapidot et al., 2001) and the highly resistant cultivars are now available for use, they are lacking in the ideal horticultural traits appropriate for Florida. Production practices are only partially effective in ameliorating TYLCV disease because reservoirs of whiteflies exist year-round, and population levels of whiteflies are very high in south Florida. Development of alternatives including induced disease resistance is imperative for management of TYLCV on tomato in south Florida. The specific objective of this research was to evaluate acibenzolar-S-methyl (ASM), plant growth-promoting rhizobacteria (PGPR) and silicic acid for their potential (i) to enhance plant growth and (ii) to ameliorate the impact of TYLCV on tomato production in south Florida.

## MATERIALS AND METHODS

Greenhouse experiments were conducted with tomato cv. 'FL47'. Seeds of tomato were planted in Styrofoam flats (Speedling, Inc., Sun City, FL) containing potting mix. Four applications at weekly intervals of the disease resistance inducers were each applied as a soil drench (5 ml/plant) beginning at 1 week after planting (WAP). The treatments were ASM (Actigard® 50 WG, Syngenta, Inc.) at 30 and 3 mg/l, PGPR strains SE 34 and IN937b each at  $1 \times 10^7$  CFU/ml, and silicic acid at 1.5 and 0.5 mM. Tomato plants treated with imidacloprid (Merit®) served as the standard chemical control and nontreated plants served as the blank control. Plants were transplanted at 5 WAP following the last treatment into 4-inch diameter pots containing potting mix. Treatments were arranged as randomized complete blocks with twelve replications for each treatment and one plant per replication. Plant height, stem caliper and chlorophyll content in leaves of tomato plants were measured at 6 WAP using SPAD-502 (MINOLTA Co., LTD, Japan).

For TYLCV infection, one plant from each treatment (a total of eight plants) was placed in a cage for 1 week containing viruliferous whiteflies (kindly provided by Dr. D. J. Schuster). Tomato plants were then transferred onto greenhouse benches for 2.5 weeks when the disease severity of TYLCV was rated based on a 0-4 scale described by Lapidot et al.(2001): 0 = no visible symptoms, inoculated plants grow similarly as noninoculated plants; 1 = very slight yellowing of leaflet margins on apical leaves; 2 = some yellowing and minor curling of leaf ends; 3 = a wide range of leaf yellowing, curling and cupping with reduction in size, yet plants continue to develop; and 4 = very severe plant growth stunting and yellowing, pronounced leaf curling and cupping, and plants stop growing.

A field trial was carried out at the Tropical Research and Education Center, University of Florida, Homestead, FL in the spring of 2008. Tomato (cv. 'FL47') seedlings in Speedling trays treated with the same compounds or PGPR at 2, 3 and 4 WAP were transplanted into the field beds 5 WAP on March 3, 2008. Two more applications by soil drench of the inducers were made at 1.5 and 2.5 weeks after transplanting (WAT). A randomized complete design was employed with four replications for each treatment and fifteen plants for each replication. Tomato plants were naturally infected with TYLCV by whiteflies. Severity of TYLCV disease was rated at 4 WAT based on a rating scale as described above.

Data from greenhouse and field experiments were analyzed by analysis of variance using JMP software (SAS Institute Inc., Cary, NC). The significance of effects of treatments was determined by the magnitude of the F value ( $P = 0.05$ ). When a significant F test was obtained for treatments, the separation of means was accomplished by Fisher's protected Least Significant Difference (LSD).

## RESULTS AND DISCUSSION

In the greenhouse experiment, all treatments except Actigard® at 30 mg/l significantly increased plant height by 6 WAP compared to the nontreated control ( $P < 0.05$ ) (Table 1). Stem caliper was significantly increased by treatment with PGPR strains SE34 and IN937b and by silicic acid at both test concentrations; the chlorophyll content in the leaves of tomato plants treated with IN937b was significantly greater than that of the nontreated control plants.

For TYLCV disease, all treatments in the greenhouse assay except for imidacloprid (Merit®) significantly reduced disease severity of TYLCV compared to the nontreated control (Figures 1, 2). In the field trial, tomato plants treated with Actigard® at 3 mg/l had significantly less disease than the nontreated control plants (Figure 3). The whitefly populations had become very high at the time when the field trial was performed, the occurrence of TYLCV disease was found in the tomato field as early as 2 WAT. The disease severity of TYCV by 6 WAT was high, and most plants were severely stunted by TYLCV. The incidence of TYLCV disease was nearly 100%, and the disease severity rating was 3 or 4. Therefore, this field trial should be repeated in the winter and early spring seasons in south Florida when the whitefly population densities are low or moderate. We plan to retest the disease resistance inducers for their effects on TYLCV in the 2008-2009 winter tomato production seasons.

## REFERENCES

- Cohen, S., and Antignus, Y. 1994. Tomato yellow leaf curl virus, a whitefly-borne geminivirus of tomatoes. Pages 259-288 in: *Advances in Disease Vector Research*. Vol. 10. Springer-Verlag, New York.
- Mansour, A., and Al-Musa, A. 1992. Tomato yellow leaf curl virus: Host range and virus-vector relationships. *Plant Pathol.* 41:122- 125.
- Lapidot, M., Friedmann, M., Pilowsky, M., Ben-Joseph, R., and Cohen, S. 2001. Effect of host plant resistance to tomato yellow leaf curl virus (TYLCV) on virus acquisition and transmission by its whitefly vector. *Phytopathology* 91: 1209-1213.
- Polston, J.E., McGovern, R. J., and Brown, L.G. 1999. Introduction of tomato yellow leaf curl virus in Florida and implications for the spread of this and other geminiviruses of tomato. *Plant Dis.* 83:984-988.
- Schuster, D. J. 2007. Whitefly resistance update. Pp. 23-27, In A. Whidden, P. Gilreath and E. Simonne (eds.). *Florida Tomato Institute Proceedings*, University of Florida, PRO 524.

Table 1. Effects of ASM, PGPR and silicic acid on plant growth of tomato in greenhouse assays

Treatment	Plant height (cm)	Stem caliper (mm)	Chlorophyll content
Actigard® 30 mg/L	13.7 d <sup>z</sup>	5.8 f	31.0 b
Actigard® 3 mg/L	16.1 c	6.5 de	30.5 b
silicic acid 1.5 mM	16.7 bc	7.3 ab	29.4 b
silicic acid 0.15 mM	17.7 a	7.8 a	29.5 b
SE34	17.3 ab	7.1 b	30.0 b
IN937b	16.0 c	6.7 cd	33.3 a
CK	13.4 d	6.0 ef	30.7 b

<sup>z</sup> Means within each column with a letter in common are not significantly different (P=0.05, LSD).





Figure 1. Effect of ASM and PGPR treatments on TYLCV disease of tomato in the greenhouse. Treatments (left to right): nontreated control, ASM, PGPR strains IN937b and SE34

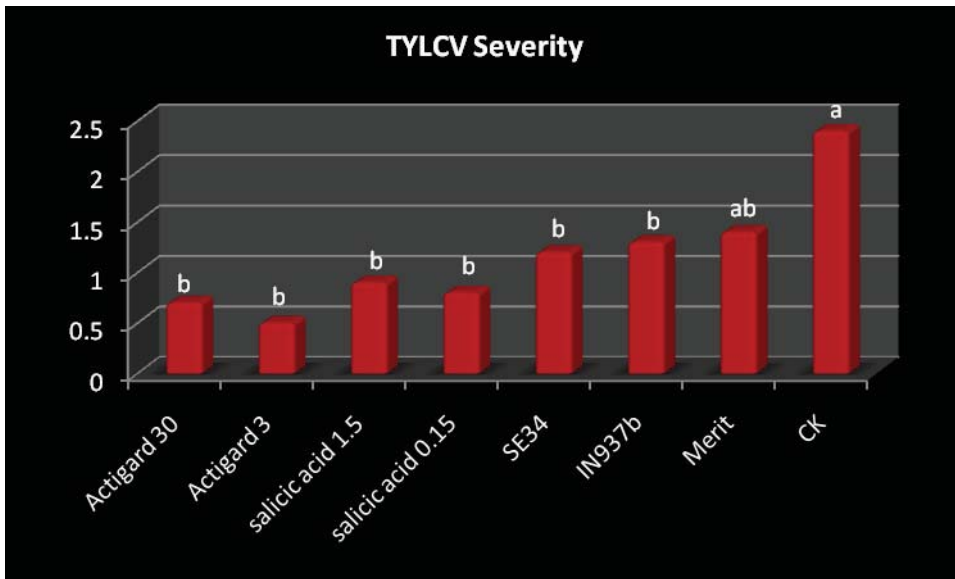

Figure 2. Suppression of TYLCV on tomato by ASM, PGPR and silicic acid in the greenhouse. values with a letter in common are not significantly different ( $P=0.05$ , LSD).

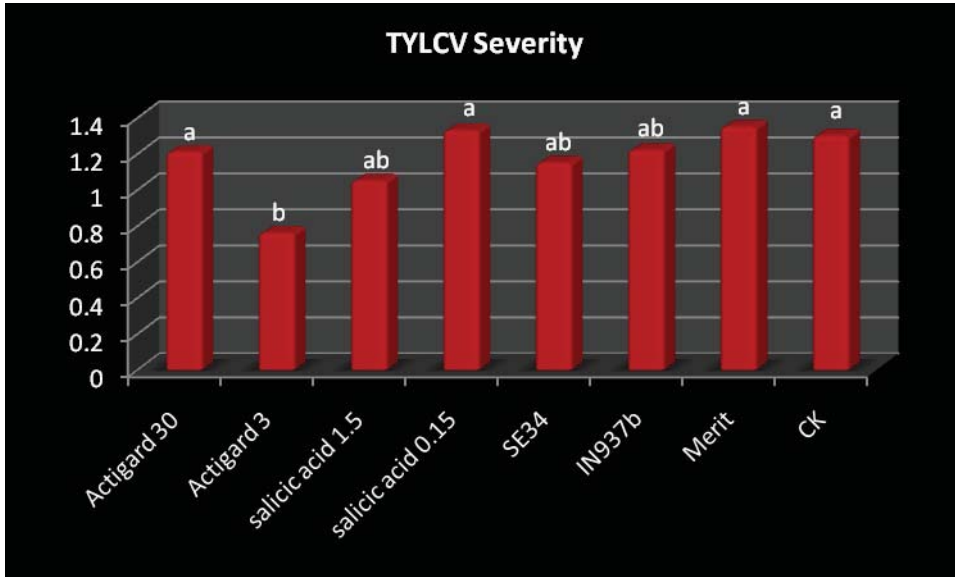

Figure 3. Effect of ASM, PGPR and silicic acid on TYLCV of tomato in the field trial. Values with a letter in common are not significantly different ( $P=0.05$ , LSD).

**Poster #55**

**Evaluation of Triazole and Strobilurin Fungicides, Alone and in Combination, for Control of *Exserohilum turcicum* on Sweet Corn**

*Richard N. Raid, Everglades Research and Education Center, University of Florida, IFAS, Belle Glade, FL 33430. rnr@ifas.ufl.edu*

**ABSTRACT.**

Northern corn leaf blight, incited by *Exserohilum turcicum*, is one of the most important foliar diseases of sweet corn (*Zea mays*). Causing large elliptical lesions that may coalesce and result in significant levels of leaf necrosis, fungicides are frequently relied upon for control. Two field experiments were conducted in south Florida during Spring 2008 to evaluate the efficacy of several triazole and strobilurin fungicides, alone and in pre-mixtures, for control of this fungal pathogen. The experimental design consisted of four replications of ten fungicide treatments arranged in randomized complete blocks. Experimental units were composed of two rows, 9 meters in length, separated by three non-sprayed guard rows. Fungicides were applied using a CO<sub>2</sub> backpack sprayer equipped with a 3-nozzle handheld boom. Fungicides investigated included the strobilurin compounds azoxystrobin, pyraclostrobin, and trifloxystrobin, as well as the triazole compounds metconazole, propiconazole, prothioconazole, and tebuconazole, either alone or in combination. The broad spectrum protectant maneb was also included. Northern corn leaf blight was severe in both experiments, along with southern corn leaf blight in one of the trials. Both trials were considered definitive. All fungicide treatments provided for significant levels of disease control, with triazole and strobilurin fungicides proving significantly better than maneb. In both trials, fungicides containing a triazole, either alone or in combination, were more efficacious than fungicides containing only a strobilurin compound. These results emphasize the benefits of including triazole chemistries in a foliar disease management program on sweet corn, particularly if northern corn leaf blight is the featured disease. Triazole/strobilurin pre-mixtures, or rotations of triazoles with strobilurin fungicides, would likely be the best candidates for controlling the prevalent sweet corn disease complex that includes the foliar blights and rust, since the strobilurins are excellent rust control fungicides.

**KEYWORDS:** Sweet corn diseases, fungicidal control, northern corn leaf blight

**Poster #56**

**Educational Efforts Enhance Diagnostic Capabilities in the United States and the Caribbean Region**

*Amanda Hodges<sup>1</sup>, Greg Hodges<sup>2</sup>, and Russell Duncan<sup>3</sup>, <sup>1</sup>Entomology and Nematology Department, University of Florida/IFAS, <sup>2</sup>Florida Department of Agriculture and Consumer Services, Division of Plant Industry, and <sup>3</sup>USDA, APHIS, International Services. [achodges@ufl.edu](mailto:achodges@ufl.edu)*

**ABSTRACT.**

The introduction of invasive, exotic arthropod species continually threatens US and Caribbean agriculture, forests, and other natural areas. Undetected pest species have the potential to cause major economic damage to a local economy or result in trade implications for producers. The warm, tropical climate of the Caribbean Region and the southern US are particularly vulnerable to new pest establishment. Proper pest identification is critical to the early detection of threatening invasive, exotic arthropod pests. The Southern Plant Diagnostic Network (SPDN), coordinated through the University of Florida/IFAS has coordinated and/or partnered with other organizations in order to provide advanced taxonomic training to US and Caribbean scientists from 2004-08. Topics for SPDN education program have include Hemiptera (Auchenorrhyncha, Sternorrhyncha), the pink hibiscus mealybug (*Maconellicoccus hirsutus*), Coleoptera (Chrysomelidae, Scolytinae, and Cerambycidae), and invasive species of relevance to the southern US. USDA-APHIS, International Services provided lead coordination for Caribbean workshops in partnership with the Inter-American Institute for Cooperative Agriculture (IICA), Barbados Ministry of Agriculture, and Ministry of Agriculture in Jamaica. Scale insects and mealybugs (Hemiptera: Coccoidea), a particularly problematic taxon in terms of identification and potential status as an invasive or actionable pest, were the focus of the Caribbean training workshops (2007-08). Workshop outcomes for both US and Caribbean training sessions generally included 1) an increase in technical skill and confidence for genus, and in some cases species-level, determinations of fairly complex taxa groups 2) follow-up communications with specialist instructors and 3) early pest detections and/or new pest detection reports.

**KEYWORDS:** Invasive species, SPDN, diagnostics, USDA, APHIS, entomology identification, Coccoidea, scale insects, mealybugs

**Poster #57**

**Response of the Melon Thrips, *Thrips palmi* Karny, and the Chilli Thrips, *Scirtothrips dorsalis*, to some Selective Insecticides**

*Dakshina R. Seal, Vivek Kumar Jha, Waldemar Klassen, and Catherine M. Sabines, University of Florida-IFAS, Tropical Research and Education Center, Homestead, FL 33031. vivekiari@ufl.edu*

**ABSTRACT.**

The melon thrips and the chilli thrips are important pests of fruit, ornamental and vegetable crops. The melon thrips is very difficult to control. None of the currently registered insecticides provide satisfactory control of this pest. On the other hand, insecticides of various classes provide satisfactory control of chilli thrips. Neonicotinoid insecticides are effective in controlling chilli thrips; but provide insignificant reduction of melon thrips. Pyrethroid insecticides are not effective against the melon thrips nor the chilli thrips. Spinetoram and Spintor have provided significant reduction of populations of both thrips species. However, these insecticides showed reduced levels of control of the melon thrips in our recent studies conducted in 2008. Spinetoram (8.0 oz/acre) in combination with Dyne-Amic (0.25% v/v; nonionic organosilicone surfactant) provided better reduction of both thrips than when Spinetoram was used alone. We also investigated two new Insecticide chemistries, Rynaxypyr™ and Cyazypyr™ for the control of melon thrips and chilli thrips. In our preliminary study, we did not record any significant reduction of thrips populations when these products were applied as a soil drench. Voliam flexi™, a premix product containing Coragen® and Actara® provided significant reduction of chilli thrips. Our main focus of this study was to use Spinetoram in rotation with other effective products to develop a lasting management program against melon thrips and chilli thrips.

**KEYWORDS:** melon thrips, chilli thrips, chemical insecticides, reduced control of melon thrips

**Poster #58**

**Development of IPM Field Guides for Coffee, Citrus, Plantain and Banana**

*Ada N. Alvarado Ortíz, Crop Protection Department, University of Puerto Rico, Mayagüez Campus, aalvarado@uprm.edu*

**ABSTRACT.**

The nature of tropical agriculture in Puerto Rico is one of a multiplicity of crops, most of these grown in small farms, threatening by a diversity of pests and diseases that impact crop production, causing economic loss to their producers. Coffee, Plantain, Banana and Citrus are commodities of great economic importance in Puerto Rico Agriculture. During year 2004 - 2005 altogether contributed with 130 millions to the agricultural income, in approximately 105,746 acre devotes to them. The great variety of pests and diseases that our tropical environment sustains and the agronomic intensive practices carried out by growers in their farms makes necessary a new vision in keeping them informed and updated in the identification and pest management strategies.

In an effort to assist growers, Extension personnel and other agricultural educators, IPM Field Guides for Coffee, Citrus, Plantain and Banana were developed to help in the fast and accurate identification of pests and diseases. The main goal is to promote the adoption and implementation of effective strategies responding to specific needs of growers working with management of pests in crops of major importance in the Island. The guides are available at no cost online at <http://academic.uprm.edu/aalvarado>. The guides are for field use by a wide range of people, they carry descriptions and color photographs of fungal, bacterial and viral diseases as well as arthropods. Also, include a narrative section with the description and development of symptoms and information about how to identify key pests and diseases.

The educational materials created under this project complement the ongoing pesticide safety and IPM programs in Puerto Rico. The outcomes of this project will lead to minimize the impacts and reduce the potential of pests in plantain and banana, citrus and coffee.

**KEYWORDS:** field guides, pest, diseases

**Poster #59**

**Erythrina Gall Wasp, *Quadrastichus erythrinae* (Hymenoptera: Eulophidae), a Pest of Coral Trees (*Erythrina* spp.) Recently Found in the Western Hemisphere**

Forrest W. "Bill" Howard, University of Florida, IFAS, Fort Lauderdale Research & Education Center, 3205 College Avenue, Fort Lauderdale, Florida, 33301 USA. FWHOWARD@UFL.EDU

**ABSTRACT.**

Various species of the coral tree genus, *Erythrina* (Fabaceae), are grown as shade trees and for soil improvement in coffee and cacao crops in the American Tropics. The Erythrina gall wasp, *Quadrastichus erythrinae* Kim (Hymenoptera: Eulophidae), believed to be native to Africa, was recently spread to localities in Asia and Oceania where its galls have seriously damaged coral trees of various species. The insect was first found in the Continental US in Miami-Dade County, Florida, in October, 2006. Five months later, we observed galls on foliage of *E. variegata* growing 65 km north of the former site and reared *Q. erythrinae* from the galls. We began field observations of *Q. erythrinae* to determine characteristics of its damage, its host preferences among *Erythrina* spp., and characteristics of its population dynamics and dispersal behavior. The gall wasps showed a marked tendency to remain close to their natal host tree and attack it repeatedly, rather than disperse from it, yet they nevertheless found and infested isolated *Erythrina* plants. *Erythrina* spp. appeared to have pronounced differences in susceptibility, with *E. herbacea* (native to Florida) highly resistant compared to several Eastern Hemisphere species upon which the wasps caused extensive galling. Massive galling of some *Erythrina* trees caused extensive defoliation and branch die-back, in some cases resulting in the death of the tree. The numbers of Erythrina gall wasps caught in traps in *Erythrina* trees and the incidence of galling on hosts fluctuated considerably during the one-year period of observation. Some trees of exotic *Erythrina* spp. survived almost total defoliation caused by galling, but recovered and currently have a low incidence of galling. The potential for *Q. erythrinae* to spread in the Caribbean Region, and preliminary research on management methods for this pest will be discussed.

**KEYWORDS:** insect pests, invasive pests, crop shade trees.

**Poster #60**

**Climate Factor Comparison Analysis for Red Palm Mite, *Raoiella Indica***

*D. Borchert and D. Fieselmann, USDA, Plant Protection and Quarantine, Center for Plant Health Science and Technology, Raleigh, North Carolina, USA. Daniel.A.Fieselmann@aphis.usda.gov*

**ABSTRACT.**

The red palm mite, *Raoiella indica* was first detected in the Western Hemisphere in Martinique in 2004. It has rapidly spread through the Caribbean Basin causing extensive foliar damage, especially on young coconuts, other palms and bananas. Red palm mite has been reported in Israel and Egypt for over 25 years without causing significant damage. The aim of this study is to investigate the climatic factors that might explain the difference in pest status between the Mediterranean Region as opposed to the Caribbean Basin. The web based NAPPFAST (North Carolina State University- Animal and Plant Health Inspection Service Plant Pest Forecasting) system was used to compare various climatic factors that may determine red palm mite populations. Three climatic factors utilized in the analysis are present in the countries where *R. indica* is reported to be a pest. This NAPPFAST model may be useful for predicting areas at high risk for red palm mite. This model may also be useful to assess the risk from other pest species based upon climatic factors.

**KEYWORDS:** *Raoiella indica*, Climate matching, NAPPFAST



**Poster #61**

**Tropical Race 4 of Panama Disease: A Dangerous Threat to Sustainable Production of Banana and Plantain**

*Randy C. Ploetz, University of Florida, IFAS, Tropical Research & Education Center, 18905 SW 280<sup>th</sup> Street, Homestead, FL 33031-3314 USA. RCPloetz@ifas.ufl.edu*

**ABSTRACT.**

Panama disease, aka fusarium wilt of banana, is caused by *Fusarium oxysporum* f. sp. *cubense*. A dangerous new variant of this pathogen, tropical race 4 (TR4), was reported in Southeast Asia in the early 1990s. TR4 has since spread widely in that region, and represents a serious threat to banana production in the Americas. Over 80% of the bananas that are produced worldwide are susceptible to this new race, including all commercial cultivars of the Cavendish subgroup, the plantain subgroup, important AAA and ABB cooking bananas, and diverse AA, AB, AAA and AAB dessert bananas. TR4 could easily be moved to the Americas in infected plants and suckers, and would devastate dessert, plantain and cooking banana production wherever it established. This poster outlines the nature and magnitude of the threat, measures that should be taken to exclude TR4 from the region, and strategies for containing the pathogen should it spread to the hemisphere.

**KEYWORDS:** Cavendish subgroup, plantain subgroup, prevention of spread

**Poster #62**

**Distribution and Host Associations of *Proba distanti* (Atkinson) (Hemiptera: Miridae), a Plant Bug Recently Established in Florida**

Thomas T. Dobbs<sup>1</sup>, Thomas J. Henry<sup>2</sup> and Alfred G. Wheeler, Jr.<sup>3</sup>.

<sup>1</sup>Miami Plant Inspection Station, United States Department of Agriculture, Animal and Plant Health Inspection Service, Plant Protection and Quarantine; <sup>2</sup>Systematic Entomology Laboratory, United States Department of Agriculture, Agricultural Research Service c/o National Museum of Natural History, Smithsonian Institution; <sup>3</sup> Dept. of Entomology, Soils and Plant Sciences, Clemson University. [thomas.dobbs@aphis.usda.gov](mailto:thomas.dobbs@aphis.usda.gov)

**ABSTRACT.**

The Neotropical plant bug, *Proba distanti* (Atkinson) (Hemiptera: Miridae), was first detected in Florida in 1990 in Palm Beach County. Extensive surveys have revealed that it is now widely established throughout much of the Florida peninsula. The majority of specimens were collected from two common herbaceous weeds that we consider primary hosts: ragweed (*Ambrosia artemesiifolia* L.) and dogfennel (*Eupatorium capillifolium* (Lam.) Small). These weeds are common in open fields, disturbed sites, and along roadsides. In Florida, their vegetative growing seasons do not generally overlap. Ragweed is typically a spring and summer plant whereas dogfennel appears in the fall and persists through the winter. Colonization of ragweed by *P. distanti* normally begins in February and extends until host die-back, usually around September. The bug then migrates to dogfennel, feeding on that host from late September through the winter months. Ragweed and dogfennel support a rich diversity of heteropteran herbivores, but *P. distanti* can frequently be observed on each as the dominant mirid species. *Proba distanti* is distributed in Florida from the southernmost county of Monroe throughout the peninsula as far north as Clay County, just northeast of Gainesville. As a diagnostic aid, we provide redescriptions of the genus *Proba* and the species *P. distanti*, along with a checklist of the North American species and their distributions.

**KEYWORDS:** *Proba*, Florida, exotic species

**Poster #63**

**The Caribbean Pathway Analysis - Evaluation of Pathways for Exotic Plant Pest Movement into and within the Greater Caribbean Region**

*Heike E. Meissner, Christie A. Bertone, Lisa M. Ferguson, Andrea V. Lemay, and Kimberly A. Schwartzburg, United States Department of Agriculture (USDA), Raleigh, North Carolina 27606, USA. Contact: Heike.E.Meissner@aphis.usda.gov*

**ABSTRACT.**

The analysis “Evaluation of pathways for exotic plant pest movement into, within, and out of the Greater Caribbean Region”, is a collaborative effort between the Caribbean Invasive Species Working Group (CISWG) and the United States Department of Agriculture (USDA). The objective of this analysis is to contribute to an improved understanding of pathways of exotic pest movement as they pertain to the Greater Caribbean Region, thereby helping CISWG to enhance or refine the Caribbean Regional Invasive Species Intervention Strategy (CRISIS) for preventing the introduction or spread of exotic pests. The scope of the pathway analysis includes nearly all countries bordering the Caribbean Sea and all terrestrial, non-vertebrate, plant pests. Among the pathways evaluated in the context of this analysis are: airline passenger baggage, international mail, people movement, maritime cargo, and wood packaging material. Some of these topics are discussed in other papers published in these proceedings.

**KEYWORDS:** Caribbean Region, pathway analysis

**What is the Caribbean Pathway Analysis?**

The project “Evaluation of pathways for exotic plant pest movement into and within the Greater Caribbean Region” is a collaborative effort between the Caribbean Invasive Species Working Group (CISWG) and the United States Department of Agriculture (USDA). This project is also referred to as the “Caribbean Pathway Analysis.”

**What is the objective of the Caribbean Pathway Analysis?**

The objective of the Caribbean Pathway Analysis is to contribute to an improved understanding of pathways of exotic pest movement as they pertain to the Greater Caribbean Region and to develop recommendations for improved safeguarding, thereby helping CISWG to enhance or refine the Caribbean Regional Invasive Species Intervention Strategy (CRISIS) for preventing the introduction or spread of exotic pests. Among the pathways evaluated in the context of this project are:

- Airline passenger baggage
- International mail
- Movement of people
- Hitchhiker pests
- Wood packaging material

- Natural spread

The results of some of these evaluations were also presented at this meeting.

### **Who is carrying out the Caribbean Pathway Analysis?**

This project is being conducted under the leadership of CISWG. A team of five risk analysts from the USDA-Animal and Plant Health Inspection Service (APHIS) is responsible for: Collecting relevant information through literature research, expert consultation, site visits, and mining of databases; evaluating, analyzing, organizing, and summarizing this information; and producing a comprehensive report. The project process allows for the participation of all nations of the Greater Caribbean Region, as well as major organizations or working groups (*e.g.*, CABI, CIRAD, *etc.*) operating in the Region.

### **What is the timeline for the Caribbean Pathway Analysis?**

- September 2006: USDA-APHIS makes offer to assist CISWG in conducting analysis
- October 2006: CISWG acceptance of offer
- November 2006: Establish partnering responsibilities; planning and coordination
- December 2006: Begin data gathering and contacting experts
- August 2007: Risk Assessors officially start work on the project
- August 2008: Distribution of draft report for review
- October 2008: End of comment period
- December 2008: Revisions completed; delivery of final report to CISWG for distribution to stakeholders

**Poster #64**

**Population Dynamics of the Red Palm Mite (*Raoiella indica* Hirst) and the Search for Sustainable Management Options in Jamaica**

*J. V. Goldsmith, and L. R. Myers*, Research and Development Division, Ministry of Agriculture, Jamaica. *julietgoldsmith@gmail.com*

**ABSTRACT.**

The red palm mite (*Raoiella indica* Hirst), first detected in Jamaica in April 2007, has spread to several parishes, affecting coconut and ornamental palms, some severely. The search for sustainable management practices for the pest involved two initial studies: population dynamics including a hunt for natural enemies and the determination of an environmentally friendly treatment for coconut palm seedlings under nursery conditions. The seasonal dynamics of *Raoiella indica* were studied between July 2007 and May 2008. The study was conducted in a commercial orchard, to which bi-weekly visits were made. *Raoiella indica* populations increased during dry periods, and declined during periods of persistent rainfall. Two predators; a phytoseiid mite (*Amblyseius largoensis*), and a thrips (*Leptothrips* sp) were found feeding on the red palm mite. *Amblyseius largoensis* was the most abundant predator. This predator and *R. indica* exhibited similar population fluctuations throughout the sampling period.

Twelve plots, each measuring 1m x 2m and containing 55 coconut palm seedlings (at the 6-leaf stage) were established in Spring Gardens, Portland and treated with six chemicals: abamectin, diafenthiuron, soybean oil, sulphur, insecticidal soap and spiromesifen. The treatments were replicated two times in a randomized complete block design and included two unsprayed (control) plots. All the treatments were effective in reducing red palm mite populations. Insecticidal soap had the least impact on the predators (efficacy 53%). Thus low populations of *Raoiella indica* are favoured by high rainfall conditions and can be achieved by the application of select chemical treatments.

**KEYWORDS:** *Raoiella indica*, population dynamics, Jamaica

**Poster #65**

**Management of Pink Hibiscus Mealybug (*Maconellicoccus hirsutus* Green) in Jamaica**

Michelle A. Sherwood<sup>1</sup>, L. R. Myers<sup>1</sup>, M. Young<sup>2</sup>, D. Robinson<sup>3</sup> and J. Lawrence<sup>4</sup>.

<sup>1</sup>Ministry of Agriculture, Research and Development Division, Plant Protection Unit; <sup>2</sup>Rural Agricultural and Development Authority (RADA); <sup>3</sup>University of the West Indies, (Mona), Life Sciences Department, Entomology; <sup>4</sup>Caribbean Agricultural Research and Development Institute (CARDI). *mishanton@yahoo.com*

**ABSTRACT.**

Pink Hibiscus Mealy Bug (PHMB), *Maconellicoccus hirsutus* Green, a polyphagous pest (>300 host plants) of economic and quarantine importance was first reported in Jamaica in June 2007. As of May 2008 the PHMB infestation is limited to the parishes of Portland and Kingston. Containment and management of the pest is based on an integrated pest management programme involving primarily surveillance, biological control and cultural control components, underpinned by public education and awareness efforts. Locally ornamentals, fruit trees, vegetables and weeds have been attacked by this pest. The parasitoid wasp *Anagyrus kamali* Moursi was sourced through the United States Department of Agriculture (USDA) and released at all infested sites. A total of 168,200 adult *A. kamali* were received between August 15, 2007 and May 13, 2008. Pre-release monitoring was conducted at 12 sites in Portland and two in Kingston. Monthly post-release monitoring continues by sampling Hibiscus plants to determine PHMB populations and parasitism levels.

Initial parasite recovery was observed within three months of the programme in Portland. After eight months the mean PHMB population at all monitoring sites in Portland had decreased by 75 - 100% of pre-release levels and 97-100% parasitism levels recorded at 50% of the sites in Portland and Kingston. In January 2008 resurgence in PHMB populations was observed at several sites however not up to pre-release levels. Local natural enemies observed include species of ladybird beetles, a predatory reduvid bug and a parasitoid wasp. The programme has proven effective to date by containing and reducing the PHMB population in the affected parishes with the PHMB remaining only an urban pest with little or no impact on agriculture and natural areas.

**KEYWORDS:** *Maconellicoccus hirsutus*, biological control, *Anagyrus kamali*, Jamaica

## Poster #66

### Impact of Organic Mulches on Watermelon Fruit Yield and Purple Nutsedge Tuber Productivity in an Ecological Production System

Note: This paper was presented as Poster #66 “Purple Nutsedge Tuber Productivity as Affected by Organic Mulches in a Watermelon Production System”

J. Pablo Morales-Payan<sup>1</sup>, Pedro Marquez-Mendez<sup>1</sup>, Erin Rosskopf<sup>2</sup>, Yasser Shabana<sup>3</sup>, Raghavan Charudattan<sup>3</sup> & Waldemar Klassen<sup>4</sup>

<sup>1</sup>Department of Horticulture, University of Puerto Rico-Mayagüez Campus, PO Box 9030, Mayagüez, PR 00681; <sup>2</sup>USDA, ARS, USHRL, 2001 South Rock Road, Fort Pierce, FL 34945; <sup>3</sup>Department of Plant Pathology, University of Florida, 1453 Fifield Hall, PO Box 110680, Gainesville, FL 32611, and <sup>4</sup>Tropical REC, 18905 SW 280 St., PO Box 111569, Homestead, FL 33031. [jpmorales@uprm.edu](mailto:jpmorales@uprm.edu)

#### ABSTRACT.

Research was conducted in Isabela, Puerto Rico, to determine the tuber productivity of the weed purple nutsedge (PN) and the yield of ‘Crimson Sweet’ watermelon when grown with or without organic soil bed mulches [hays of millet (*Pennisetum glaucum*), nutsedge (*Cyperus rotundus*), sunn hemp (*Crotalaria juncea*), sorghum (*Sorghum bicolor*), cowpea (*Vigna unguiculata*), cogongrass (*Imperata cylindrica*), Bahiagrass (*Paspalum notatum*), and rye (*Secale cereale*)]. The mulches covered the top of the soil beds, and were set the same day the watermelon was established. Natural populations of PN on the site were approximately 100 viable tubers/m<sup>2</sup>. PN shoots able to grow through the mulches were left unchecked until the final harvest of the crop. For non-mulched checks, we had a bare soil weed-free treatment and a bare soil season-long-PN-infested treatment. There were significant effects on watermelon yield and PN tuber productivity by mulch material. The tuber productivity of PN production was significantly reduced when watermelon was mulched with Bahiagrass (68% lower), nutsedge (45% lower), cogongrass (36% lower), millet (36% lower), and sorghum (34% lower), as compared to PN-infested checks. When mulching with cogongrass and nutsedge, watermelon yield was significantly higher than with other mulches.

**KEYWORDS:** Organic horticulture; vegetable crops; weeds

#### INTRODUCTION

In Puerto Rico, watermelon (*Citrullus lanatus*) is a popular horticultural crop grown all year long. In fiscal year 2006-2007, watermelon’s farm gate worth in Puerto Rico was approximately \$2 million (Puerto Rico Department of Agriculture, 2008). Among the main limiting factors for watermelon production in Puerto Rico are weed, pest, and disease management.

Crop protection is a major concern for the increasing number of ecologically-oriented growers in Puerto Rico that decide not to use synthetic pesticides. Weeds in general and PN (*Cyperus rotundus*) in particular are in the top priority list of production

obstacles pointed out by those growers. Unchecked interference from PN is known to significantly reduce the yield of watermelon (Webster et al., 2008). Mulching with straw or with green (recently cut) plant shoots is one of the non-pesticide alternatives for management of PN and other weeds in watermelon, and has been shown to reduce PN interference in other horticultural crops such as tomato (*Lycopersicon esculentum*)(Shabana et al., 2008). Straw or hay mulching has the additional advantage that it does not have to be removed from the field when the crop season ends, and can be used to amend the soil (Johnson et al., 2004). Because of the scarcity of recommendations based on local research, there is an urgent need to generate information about alternative means of weed suppression, such as mulches. The objective of this research was to determine the tuber productivity of the weed purple nutsedge and the yield of 'Crimson Sweet' watermelon when grown with or without selected organic soil bed mulches.

## **MATERIALS AND METHODS**

Field research was conducted at the Experiment Substation of the University of Puerto Rico-Mayagüez in Isabela, Puerto Rico. The site of the experiment had a natural population of approximately 100 viable PN tubers per m<sup>2</sup>. Plots were 3 m long with 6 watermelon plants each. The organic mulches were set covering the top of the soil beds the same day the crop was established. The organic mulches were hays of millet (*Pennisetum glaucum*), nutsedge (*Cyperus rotundus*), sunn hemp (*Crotalaria juncea*), sorghum (*Sorghum bicolor*), cowpea (*Vigna unguiculata*), cogongrass (*Imperata cylindrica*), Bahiagrass (*Paspalum notatum*), and rye (*Secale cereale*). The weedy checks were plots infested season-long with PN, and non-mulched weed-free checks were kept by weekly removal of emerging weeds. The treatments were established in a randomized complete block design with three replications.

The 'Crimson Sweet' watermelon crop was grown without synthetic pesticides and fertilizers. PN plants able to grow through the mulches were left unchecked until the end of the crop, and no further PN management was implemented. Watermelon fruits were harvested at commercial maturity, their number and weight being recorded. Four days after the final watermelon harvest, PN tuber number and weight were determined from soil samples 20 cm long x 20 wide x 20 cm deep collected from each plot of the experiment. Analysis of variance and separation of means (Duncan's Test) at the 5% level were conducted on the data.

## **RESULTS AND DISCUSSION**

Organic mulches had significant effects on PN tuber productivity and on watermelon yield. PN tuber productivity was the lowest when the watermelon plots were covered with Bahiagrass mulch, with a 68% reduction in PN tuber productivity as compared to the watermelon plots infested with PN season-long (Figure 1). Mulching with nutsedge, cogongrass, millet, and sorghum resulted in PN tuber productivity being reduced by 34 to 45%. The least efficacious mulches for suppression of PN tuber propagation were cowpea (10% reduction of PN tuber productivity), sunn hemp (20% reduction of PN tuber productivity), and rye (22% reduction of PN tuber productivity)(Figure 1). The differential effect of these mulches on PN tuber productivity



may be partially due to the speed of their decomposition on the soil surface (legumes such as cowpea and sunn hemp decomposing more rapidly than the non-legume mulches; data not shown) and/or natural chemicals being released from the mulches and their decomposing parts. No attempt was made to determine potential allelopathic compounds released from the mulches.

**Figure 1.** Effect of selected organic mulches on the tuber productivity of purple nutsedge (*Cyperus rotundus*) in ecologically-managed watermelon in Isabela, Puerto Rico. Bars with the same letters are not significantly different.

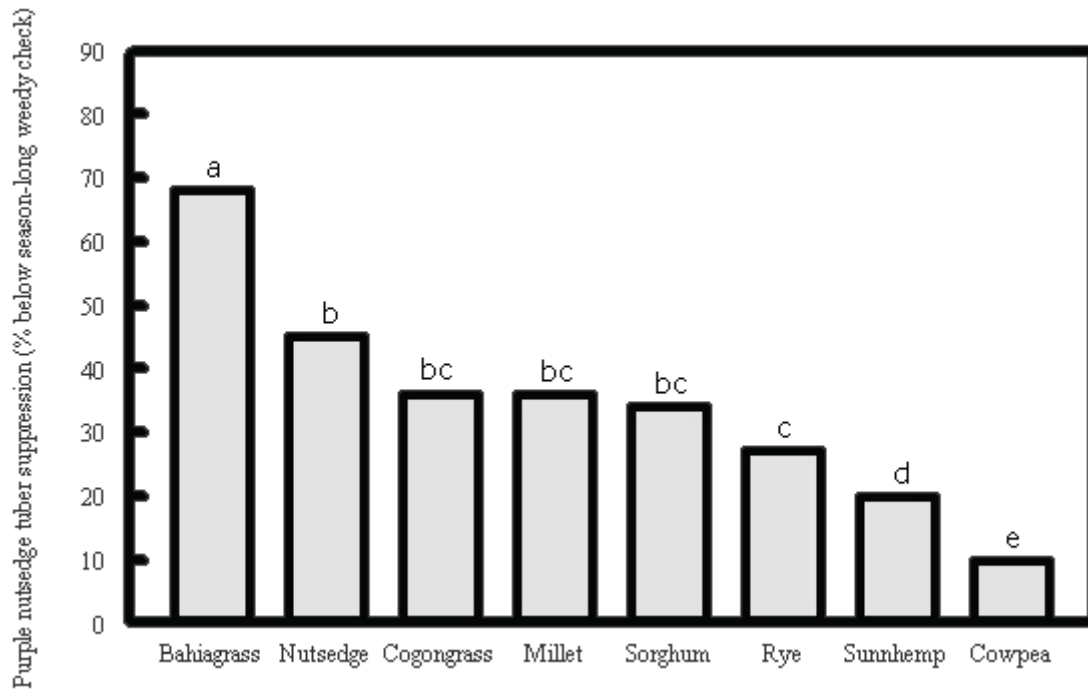

**Figure 2.** Effect of selected organic mulches on the yield of ecologically-managed watermelon in Isabela, Puerto Rico. Bars with the same letters are not significantly different.

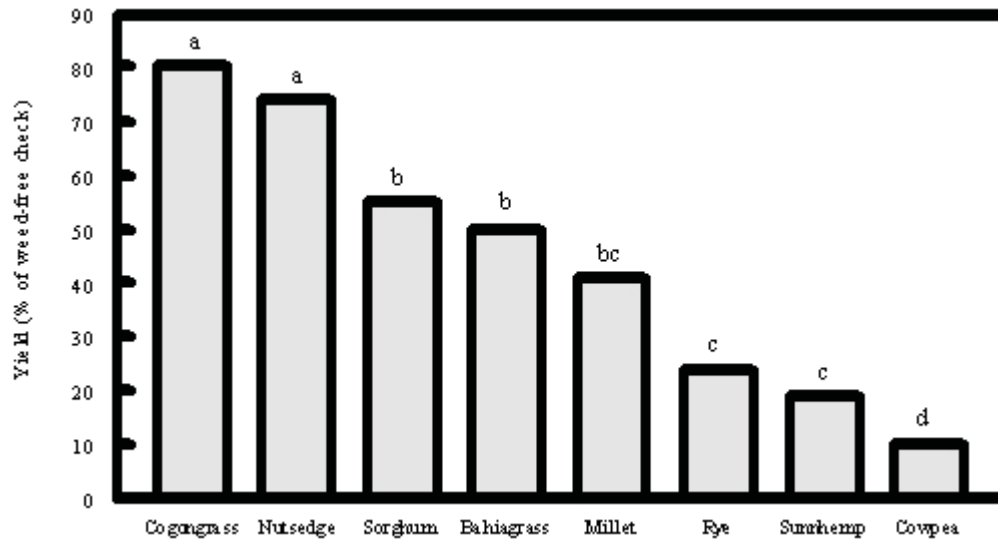

There were also differential effects of organic mulches on watermelon yield. The highest watermelon yields were found in plots mulched with cogongrass and nutsedge hays. In those two treatments, watermelon yield averaged 75-80% that of the yield found in the permanently weed-free checks (Figure 2), which may be acceptable for ecological growers. It is likely that those yields may be improved if in addition to mulching other means of weed control were implemented.

Mulching with hays of sorghum, Bahiagrass, and millet (all of them grasses) resulted in watermelon yields 45-55% those of the weed-free checks (Figure 2), which for most growers would be unacceptable. Watermelon yields were the lowest when mulching with rye, sunn hemp, and cowpea.

Rye, sunn hemp, and cowpea had the lowest performance for both watermelon yield and reduction of PN tuber productivity. The other mulches were more efficacious in terms of watermelon yield and suppression of PN propagation. These results show that some of the organic mulches tested in this research may be useful components of integrated weed management systems for organic and ecological watermelon production in Puerto Rico and similar locations.

#### ACKNOWLEDGEMENTS

Research funded by the T-STAR Program (UPR-Mayagüez Project ZTS-36).

#### REFERENCES

- Johnson, J. M., J. A. Hough-Goldstein, & M. J. Vangessel. 2004. Effects of straw mulch on pest insects, predators, and weeds in watermelons and potatoes. *Environmental Entomology* 33:1632-1643.
- Puerto Rico Department of Agriculture. 2008. Ingreso Bruto de la Agricultura en Puerto Rico. <http://www.gobierno.pr/NR/ronlyres/CF939105-E2DA-44EC-A0DF->

- [41622555F06A/0/IngresoBrutoAgricola2006\\_07.pdf](#). Accessed on August 30, 2008.
- Shabana, Y., E. Rosskopf, J. P. Morales-Payan, A. H. Abou Tabl, W. Klassen, & R. Charudattan. 2008. Use of hay, green, and plastic mulches to suppress nutsedge in horticultural crops. Abstr. Caribbean Food Crops Society 44<sup>th</sup> Meeting, Miami, Florida, July 13-17, 2008.  
[http://cfcs.eea.uprm.edu/44th\\_Meeting/OralPresentations.htm](http://cfcs.eea.uprm.edu/44th_Meeting/OralPresentations.htm). Accessed August 30, 2008.
- Webster, T. M., T. L. Grey, J. W. Davis, & A. S. Culpepper. 2008. Glyphosate hinders purple nutsedge (*Cyperus rotundus*) and yellow nutsedge (*Cyperus esculentus*) tuber Production. *Weed Science* 56:735-742.

**Poster #67**

**Effects of Altitude and Harvest Period on Broca (*Hypothenemus hampei* Ferrari) infestations in Coffee (*Coffea arabica* L.) Beans in the Dominican Republic; Efecto de la Altitud y Períodos de Cosecha en la Infestación por la Broca (*Hypothenemus hampei* Ferrari), en Granos del Cultivo de Café (*Coffea arabica* L.), Barahona, República Dominicana**

*Yluminada O. López, Miguel M. Campo, and José B. Nuñez. Departamento de Agronomía, Universidad ISA, Avenida Antonio Guzmán Fernández, Km 51/2, La Herradura, Santiago, Dominican Republic. jnunez@isa.edu.do; cdejesus@isa.edu.do*

**ABSTRACT.**

In the Dominican Republic, the area planted with coffee is 132,500 ha which produces an annual harvest of 36,636,364 kg through the efforts of more than 50,000 coffee farmers. Since 1997, the broca (*Hypothenemus hampei*) pest has infested the coffee fields in the country and has reduced crop yield and quality. The objectives of this study were to evaluate the influence of altitude and harvest period on the incidence of the broca incidence and on coffee bean grain quality. The experimental design was a completely randomized design with a factorial arrangement with 4 replicates. The twelve treatment combinations were formed from four altitudes (400-500, 600-700, 850-950 and 1000-1100 meters) and three harvest periods (November, December and January). The variables were crop management, percentage of infected grains, and commercial quality of the beans. The results showed that from 78.4% to 100% of the farmers controlled the shade at 850-950 meters of altitude while 74.75% did so at 400-500 meters of altitude. The higher incidences (22.33 % and 20.00 %) of infected beans were at 400-500 and 600-700 meters of altitude, respectively. The lineal regression analysis showed an inverse relationship between altitude and percentage of infected grains. Moreover, this analysis showed a direct relationship between altitude and bean quality AAA, but an inverse relationship with quality AA and A. The highest percentage of beans with quality AAA (69.44 %) and AA (52.61 %) were at 1000 -1100, and 400-500 meters of altitude, respectively. The data suggest that altitude affects the yield and quality of coffee beans.

**KEYWORDS:** altitude, harvest periods, broca, coffee berry borer, bean,

**RESUMEN**

En la República Dominicana, aproximadamente (2002, 2003 y 2004), el área sembrada es de 132,500 ha, de estas, a 28,220 ha se les da manejo tecnificado. La cosecha promedio es de 36,636,364 kg por año e involucra a 50,000 caficultores. A partir del 1997, la broca (*Hypothenemus hampei*) afecta la producción cafetalera, reduciendo la conversión de café uva en café pergamino. Esta investigación, tiene el objetivo de evaluar la influencia de la altitud y los períodos de cosecha, sobre la prevalencia de granos infestados por broca y la calidad del grano cosechado. Se realizó en la Provincia de Barahona, República Dominicana en el período noviembre 2004 y enero 2005. Utilizamos un diseño completamente al azar con arreglo factorial con 4 repeticiones. El factor A, la altitud con

los niveles 400-500, 600-700, 850-950 y 1000-1100 msnm y el factor B, períodos de cosechas, con los niveles noviembre, diciembre y enero. Variables evaluadas: prevalencia de granos infestados por broca y calidad comercial de los granos. Resultados obtenidos. La mayor prevalencia de granos infestados por broca, fueron la altitud 400-500 msnm con 22.33 % y 600-700 msnm con 20.00 %. Los resultados de la ecuación de regresión lineal simple, indicaron, que por cada aumento de 1 msnm de altitud, el porcentaje de infestación baja en uno por ciento. El mayor porcentaje de granos calidad grado AAA se obtuvo en la altitud 1000 -1100 msnm con 69.44 %, el mayor porcentaje de granos calidad grado AA, se cosechó en la altitud 400-500 msnm con 52.61 % y la altitud con mayor porcentaje de granos calidad grado A fue 400-500 msnm. Las ecuaciones de regresión lineal para el grado de calidad de los granos, significaron que, por el aumento en 1 msnm de altitud, el porcentaje de granos calidad grado AAA aumenta en siete por ciento, el grano calidad grado AA baja en cinco por ciento y el grano calidad grado A baja en dos por ciento.

## **INTRODUCCIÓN**

En la República Dominicana el cultivo de café es un renglón importante para la exportación. Se siembra, aproximadamente 132,500 ha y de esta, a 28,220 ha se les da manejo tecnificado, involucrando a 50,000 caficultores. En el manejo de este cultivo se emplean alrededor de 500,000 personas anualmente. La producción promedio de las cosechas de los años 2002, 2003 y 2004 fue de 36, 636,364 kg. A partir del año 1997 la rentabilidad del cultivo se ha visto afectada por la broca (*Hypothenemus hampei* Ferrari), al afecta la calidad de grano y la bebida y disminuir los rendimientos hasta en un 50 %, al reducir la conversión de café uva en café pergamino. La broca prospera en zonas bajas, y puede hacer daños en plantaciones con altura de 800 hasta 1200 msnm, dependiendo de las condiciones del ambiente.

### **Objetivo**

Evaluar la influencia de las altitudes, entre 400 - 500, 600 - 700, 850 - 950 y 1,000 - 1,100 metros sobre el nivel del mar, y los períodos de cosecha, (noviembre, diciembre y enero), sobre la prevalencia de la broca (*Hypothenemus hampei* Ferrari) y la calidad del grano de café cosechado.

## **MATERIALES Y MÉTODOS**

### **Ubicación**

Se realizó en el período octubre de 2004 a febrero de 2005. En la provincia de Barahona, República Dominicana. Las temperaturas registradas oscilan entre 17 a 22 °C con pluviometría media anual de 2,296 mm. La altitud de cada localidad evaluada, fue determinada mediante un altímetro.

### **Diseño Experimental**

Diseño completamente al azar con arreglo factorial y cuatro repeticiones. Factor A la altitud, con cuatro niveles: 400-500, 600-700, 850-950 y 1000-1100 msnm respectivamente y el factor B períodos de cosechas con tres niveles, correspondientes a los meses de noviembre, diciembre y enero (3X4=12 tratamientos).

## **Muestreo**

Conjuntamente con técnicos del Consejo Dominicano del Café (CODOCAFE), se determinó evaluar cuatro fincas por cada altitud, con áreas variadas de 3.9 a 32.1 ha y seleccionada al azar. Estas fueron divididas en 9 áreas y escogidas al azar 20 plantas por área. Cosechamos cinco granos por planta, para un total de 100 granos por muestra y 900 granos por finca. Se realizaron tres muestreos por período por finca, con un intervalo de 10 días, aproximadamente.

## **Manejo de la Cosecha**

Los frutos cosechados, fueron observados y separados los granos sanos de los brocados (presencia de agujero en el ápice). Para el beneficiado, los frutos sanos fueron despulpados manualmente el mismo día de la selección. Los granos fueron fermentados de forma natural durante 15 horas. Luego se procedió a la remoción del mucílago mediante el lavado o fricción manual de los granos. Los granos fueron secados en piso de cemento, al sol y removido cada dos horas, durante un periodo de 39 horas. Los granos se dejaron 48 horas en reposo y en la sombra, para que se estabilizaran sus características organolépticas. La humedad fue llevada a 12 %. Se procedió al descascarado del pergamino, manualmente. Estos fueron llevados al laboratorio para el análisis de clasificación de calidad de los granos.

## **Variables Evaluadas**

Prevalencia de Granos Infestados por Broca: los granos infectados por brocas fueron abiertos con una pinza y observados con una lupa, reportamos la cantidad de especímenes cada estadio.

Calidad Comercial de los Granos Cosechados: las muestras fueron pesadas individualmente, en una balanza. Pasados por un vibrador con mallas de orificios de diámetros diferentes (números entre 14 y 20). Los granos retenidos en las mallas números 20, 19 y 18 fueron clasificados de grado AAA, grande, forma redondeada y duro. Los granos retenidos en las mallas números 17 y 16 fueron clasificados como grado AA, mediano y forma alargada, y los granos retenidos en las mallas número 15 y 14 fueron granos de grado A. Estos fueron pesados y se obtuvo su respectivo porcentaje.

## **Análisis Estadístico**

Los datos obtenidos fueron analizados mediante el programa estadístico SAS, a un nivel de significancia de 5 %. Para las medias que presentaron diferencias estadísticas, se aplicó a prueba de rangos múltiples de Duncan. Además se realizaron análisis de regresión lineal.

## **RESULTADOS Y DISCUSIÓN**

### **Prevalencia de Granos Infestados por Broca**

El análisis de varianza (Cuadro 1), indicó diferencias estadísticas significativas para el factor altitud. Para el factor período de cosecha y las interacciones entre los factores evaluados, no hubo diferencias estadísticas significativas.

Cuadro 1. Análisis de Varianza de la Prevalencia de Granos Infestados por Broca, en la Investigación Efecto de la Altitud y Período de Cosecha en la Infestación por Broca de los Granos de Café, Barahona, República Dominicana. 2004-2005

FV	GL	SC	CM	Fc	Pr>f
Altitud	3	939,63	313,21	6,71	0,0003
Período	2	59,041	24,52	0,63	0,5331
Altitud x periodo	6	291,9	48,65	1,04	0,4014
Error	132	6165,1666	46,7		
Corrección Total	143	7455,75			

#### Factor Altitud

La Figura 1, muestra los niveles 400-500, y 600-700 msnm, con los mayores porcentajes de granos infectados por brocados con 22.33 y 20.00 %, respectivamente, resultando con igual significancia estadística. Los niveles 850-950 y 1000-1100 msnm, resultaron con los menores porcentajes de granos brocados, con 15.78 y 17.05 %, respectivamente.



Figura 1. Comparación de Media para la prevalencia de Granos Infestados por Broca según la Altitud.

La ecuación obtenida del análisis de regresión lineal (Figura 2) fue,  $y = -0.0112x + 27.229$ , con un  $R^2$  de 0.2439. Esta significó que, por cada aumento en 1 msnm de altitud, la prevalencia de granos infestados por broca se reduce uno por ciento.

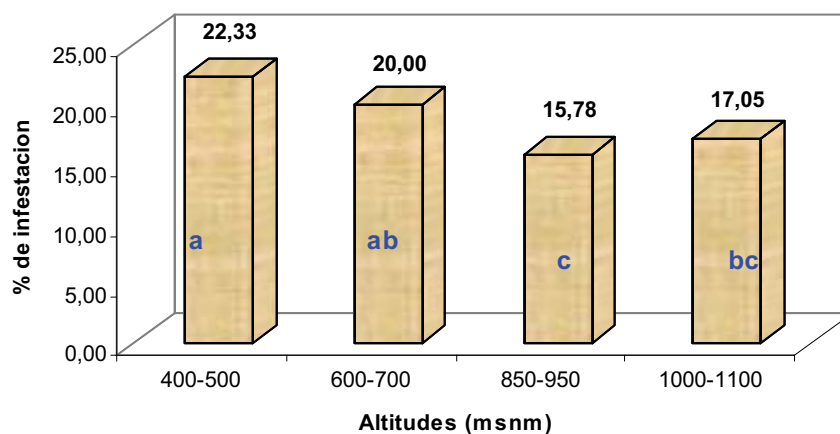

Figura 2. Regresión Lineal para la Prevalencia de Granos Infestados por Broca según la Altitud

#### Calidad Comercial de los Granos Cosechados

Los análisis de varianza (Cuadro 2) indican que hay diferencia estadísticas significativas para los factores altitud y periodo de cosecha, también para su interrelación.

Cuadro 2 Análisis de Varianza para la Variable Calidad del Grano de Café para Exportación (AAA), en el efecto de la Altitud y Período de Cosecha

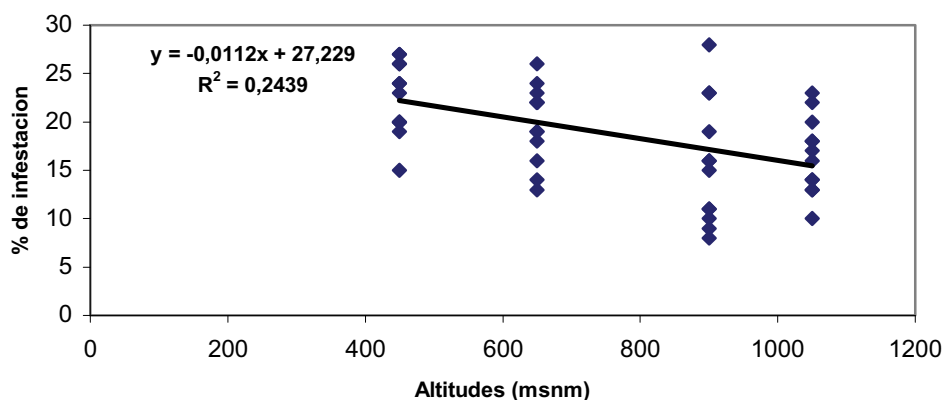
FV	GL	SC	CM	Fc	Pr>f
Altitud	3	24811,8888	8270,62963	37,41	
Periodo	2	2466,7222	1233,3611	5,58	0,0047
Altitud x Periodo	6	5370,61111	895,10185	4,05	0,0009
Error	132	29185,333	221,10101		
Corrección total	143	61834,555			

#### Factor Altitud

El Cuadro 3, muestra el nivel 1000-1100 msnm con el mayor porcentaje de granos calidad grado AAA con 69.44 %, resultando estadísticamente diferentes a los demás niveles del factor altitud. La altitud que presentó menor porcentaje de granos calidad grado AAA fue la de 400-500 msnm, con 32.77 %; también este nivel resulto con mayor porcentaje de granos grados AA y A con 52.61 y 14.44 % respectivamente.



Cuadro 3. Comparación de Medias para la Calidad Comercial de los Granos Cosechados según la Altitud.

Altitud (msnm)	Grado (AAA) %	Grado (AA) %	Grado(A) %
400-500	32.77 C	52.61 a	14.44 a
600-700	51.80 b	38.02 b	9.63 b
850-950	46.66 b	48.97 a	4.25 c
1000-1100	69.44 a	26.75 c	3.77 c

Para el grano calidad grado AAA, la ecuación de regresión obtenida fue,  $y = -0.0112x + 27.229$ , la cual tuvo un  $R^2$  de 0.2439 (Figura 3). Esta nos significó que, por cada aumento de 1 msnm de altitud el grado de calidad aumenta en siete por ciento.



Figura 3. Regresión Lineal Para la calidad del Grano Grado (AAA) por Altitud.

Para los granos calidad grado AA, la ecuación de regresión lineal obtenida fue,  $y = -0.0523x + 76.857$  y  $R^2 = 0.5545$ . Esta significó, que por cada aumento de 1 msnm de altitud el grano de calidad grado AA baja cinco por ciento (Figura 4).

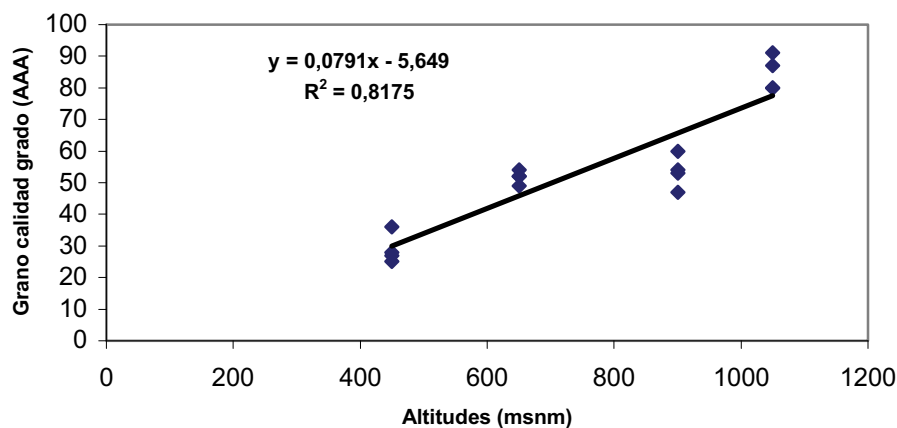

Figura 4. Regresión Lineal Para la Calidad del Grano para la Exportación (AA) por Altitud.

Para el grano calidad grado A, la ecuación regresión lineal fue,  $y = -0.0295x + 31.169$  la cual tuvo un  $R^2 = 0.675$ . La misma significó que por cada aumento de 1 msnm de altitud el grado de calidad A baja dos por ciento (Figura 5)

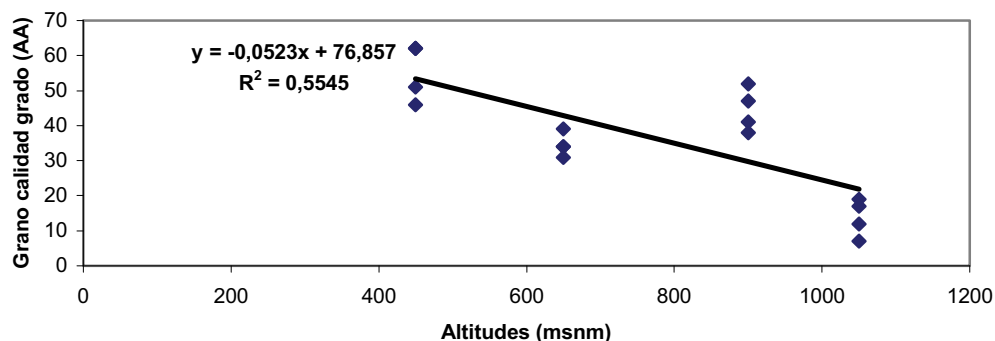

Figura 5. Regresión Lineal Para la Calidad del Grano para la Exportación (A) por Altitud

#### Factor Periodo

La comparación de medias (Cuadro 4), muestra los mayores porcentajes de granos de calidad grado AAA los niveles de diciembre y enero, con 54.62 y 51.29 % de granos, resultando con igual significancia estadística. Las medias de granos grado A, resultaron con igual significancia estadística, para los niveles.

Cuadro 4 Comparación de Medias para la Calidad Comercial de los Granos Cosechados según Período de Cosecha

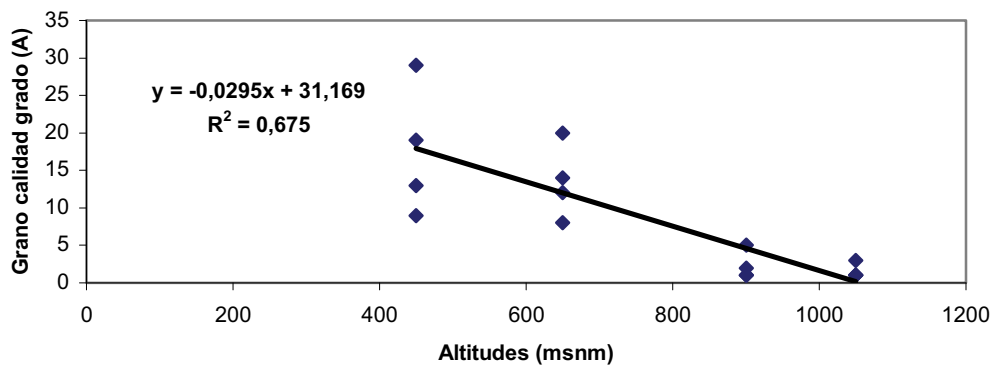
Periodo	Grado (AAA) %	Grado (AA) %	Grado(A) %
Noviembre	44.66 b	45.31 a	9.91 a
Diciembre	54.62 a	37.54 b	7.75 a
Enero	51.29 a	41.91 ab	6.41 a

### CONCLUSIONES

La prevalencia de granos infectados por broca, es influenciada por la altitud, disminuyendo uno por ciento por cada metro de altitud. El periodo de cosecha no afecta la prevalencia de granos Infestados por broca.

Al aumentar 1 msnm de altitud, el porcentaje de granos de calidad grado AAA aumenta en siete por ciento, el grano calidad grado AA baja en cinco por ciento y el grano calidad grado A baja en dos por ciento

## REFERENCIAS

- Abud, A. 1995. La Broca del Café (*Hypothenemus hampei* Ferrari Coleóptero: Scolitidae) en Republica Dominicana, Santo Domingo, Republica Dominicana.
- Borbón, o. 1991. La Broca del Cafeto (*H. hampei*) Programa Cooperativo de Café, San José Costa Rica.
- Camilo G., D. A. 1987. Manual de la Caficultora Dominicana. Subsecretaria de Producción y Mercadeo. Departamento de Café. Republica Dominicana. Pág. 110.
- Cantor et. al. 2001. Biología de *Phymastichus Caffea* Lasalle Himenóptera: Eulophidae endoparacitoide de la Broca del Café, en Tres Altitudes Diferentes de la Zona Cafetalera Colombiana. Congreso de la Sociedad Colombiana de Entomología. Colombia.
- Consejo Dominicano del Café (CODOCAFE). 2002. Boletín estadístico No. V. Santo Domingo, Republica Dominicana.
- Castillo, A. et. al. 2001. Investigaciones Sobre la Broca del Café Realizadas por ECOSUR, Soconusco, Chiapas, México.
- Federación de Desarrollo Agropecuario Inc. (FDA). 1997. La Broca del Café (*Hypothenemus hampei*, Ferrari) su Biología y Control, Santo Domingo, Republica Dominicana.
- Fundación Salvadoreña para Investigaciones del Café (PROCAFE). 1997. Manual del Caficultor Salvadoreño. El Salvador.
- Garcías, A. y Campos, O. 2001. Orientación de la Investigación para el Manejo de la Broca del Café (*Hypothenemus hampei* Ferr.) Guatemala
- García, A. Medina, R. Roca R., 1996. Observaciones Sobre Patogenicidad de Cepas de *B. bassiana* Hacia la Broca del Café. Nata técnica ANACAFE, Guatemala.
- Instituto Interamericano de Cooperación para la Agricultura (IICA). 1998. La Broca del Fruto del Cafeto. Biología y Control. Primera Edición. San José, Costa Rica.
- Junta Agroempresarial Dominicana (JAD), 1997. Estrategia para el Manejo Integrado de la Broca del Café (*Hypothenemus hampei* Ferrari) en la Republica Dominicana, Santo Domingo Republica Dominicana.
- Perez, A. 2002. Validación de la Efectividad y Eficiencia de la Repela, Pepena y Graniteo en el Control de la Broca (*Hypothenemus hampei* Ferrari). Instituto Dominicano de Investigaciones Agropecuarias y Forestales (IDIAF), Barahona, Republica Dominicana.
- Quijano, J. 2003. Manual del Caficultor. Fundación Salvadoreña para Investigaciones del Café PROCAFE, Nueva San Salvador, El Salvador.
- Sánchez, A. 1984. Manual de las Enfermedades y Plagas del Café. Daños y técnicas de Control. Guatemala, C. A.
- Secretaría de Estado de Agricultura (SEA). 2004. Manual del Caficultor Dominicano. Consejo Dominicano del Café (CODOCAFE). Instituto dominicano de Investigaciones Agropecuarias y Forestales (IDAF), Republica Dominicana.

**Poster #68**

**Disease Management Programs for Basil Downy Mildew**

*R. N. Raid<sup>1</sup>, P. Roberts<sup>2</sup>, and P. Harmon<sup>3</sup>, Department of Plant Pathology, University of Florida, IFAS, <sup>1</sup>Everglades Research and Education Center, Belle Glade, <sup>2</sup>Southwest FL Research and Education Center, and <sup>3</sup>Dept. of Plant Pathology, Gainesville, FL [rnrr@ifas.ufl.edu](mailto:rnrr@ifas.ufl.edu)*

**ABSTRACT.**

During the summer of 2007, a severe foliar disease was noted on basil grown in south Florida. The disease was characterized by foliar chlorosis, frequently delineated by leaf veination, with a light grey fungal growth evident on lower leaf surfaces. Initially observed in the lower canopy, the disease subsequently developed in the mid to upper canopy. Severely infected leaves frequently dehisced. The disorder displayed fungal signs associated with downy mildew. Crop losses in individual fields ran as high as 100%, with a number of basil shipments being rejected at delivery due symptom development in transit. The performance of Koch's postulates has verified the disease as being caused by a fungal species, most likely within the genus *Peronospora*. To identify prospects for chemical control of this disease, a number of field experiments were conducted during fall 2007 through spring 2008. Trials were conducted in commercial fields where basil was grown on 20-cm raised beds. The crop was direct-seeded in four rows set on 25-cm centers, with an in-row plant spacing of approximately 2.5-cm. The experimental design consisted of 3-4 replications of fungicide treatments arranged in randomized complete blocks. Experimental units were composed of 4 basil rows, 4 meters in length, separated by 2-m non-sprayed buffer plots. Fungicides were applied using a CO<sub>2</sub> backpack sprayer equipped with a handheld boom calibrated to deliver 580 l/ha at 2.1 x 10<sup>5</sup> Pa. High levels of natural inocula in the area and long dew periods created ideal conditions for downy mildew development. Disease conditions were severe and all tests were judged definitive. A number of different chemistries showed promise, among them various phosphonic compounds, mandipropamid, fenamidone, dimethomorph, propamocarb, and azoxystrobin. Tank-mixtures, and/or alternations of phosphonic fungicides, with the aforementioned other chemistries, provided for excellent control when applications were initiated before disease onset and applied on a weekly basis.

**KEYWORDS:** basil, downy mildew, fungicidal control

**Poster #69**

**A New Lethal Disease of *Syagrus romanzoffiana* and *Washingtonia robusta* in Florida is Caused by *Fusarium oxysporum***

Monica L. Elliott<sup>1</sup> and Elizabeth A. Des Jardin<sup>1</sup>

<sup>1</sup>Fort Lauderdale Research and Education Center, University of Florida – IFAS, Fort Lauderdale, Florida 33314, USA Corresponding author: [melliott@ufl.edu](mailto:melliott@ufl.edu)

**ABSTRACT**

*Syagrus romanzoffiana* and *Washingtonia robusta* are popular landscape ornamental palms grown throughout most of Florida. Since late 2004, we have noted mature specimens in the landscape and juvenile material in nurseries of *S. romanzoffiana* with symptoms not observed previously for this species. Symptoms are first observed on the oldest leaves, with individual leaves exhibiting chlorosis and necrosis initially only on one side. A distinct reddish-brown stripe is visible on the petiole and rachis, and there is a corresponding discoloration internally. Within 2-3 months after onset of initial symptoms, the entire canopy desiccates and turns brown as if freeze-dried *in situ*. Similar symptoms were observed on *W. robusta* beginning in the spring of 2007 in landscapes and a nursery. *Fusarium oxysporum* was consistently isolated from symptomatic petiole tissue from both palm species. DNA was extracted from single-spore isolates, and a portion of the translation elongation factor 1-alpha (TEF) was amplified using the polymerase chain reaction and the *ef1* and *ef2* primers. The resulting amplicons were sequenced. Comparison of the sequences obtained with TEF sequences in the FUSARIUM-ID database (<http://fusarium.cbio.psu.edu>) demonstrated that this *F. oxysporum* is likely to be a new forma specialis. Koch's postulates were completed using *S. romanzoffiana* and *W. robusta* and *F. oxysporum* isolates obtained from both palm species. *F. oxysporum* isolates from *S. romanzoffiana* were pathogenic on *W. robusta*, and, likewise, isolates from *W. robusta* were pathogenic on *S. romanzoffiana*.

**KEYWORDS:** *Fusarium oxysporum*, palm diseases, *Syagrus romanzoffiana*, *Washingtonia robusta*

**INTRODUCTION**

*Syagrus romanzoffiana* (queen palm) and *Washingtonia robusta* (Mexican fan palm) are landscape ornamental palms grown throughout most of Florida. Quickly dying (within 2-3 months), mature queen palms in landscapes across the southern half of Florida were brought to our attention beginning in late 2004. In spring 2007, Mexican fan palms were observed with similar symptoms and disease progression, also throughout southern Florida. The symptoms are similar to those associated with Fusarium wilt of other palm species, such as *Phoenix canariensis* (Simone, 2004). Symptoms are first observed on the oldest leaves, and the disease progresses up through the canopy. Early, individual leaf symptoms include one side of the leaf blade exhibiting chlorosis and

necrosis (one-sided wilt or death), and a distinct reddish-brown stripe is visible on the petiole or rachis. There is a corresponding internal discoloration. Within 2-3 months after onset of initial symptoms in the oldest leaves, the entire canopy is desiccated and necrotic as if freeze-dried *in situ*. There is no indication of trunk or root infection. Studies were initiated to determine the etiological agent of this lethal decline.

## MATERIALS AND METHODS

Internal petiole or rachis tissue of symptomatic leaves was obtained by carefully cutting away the petiole or rachis epidermis. Small internal tissue pieces were placed directly on 1/5 strength potato dextrose agar. *Fusarium*-like colonies were consistently isolated from symptomatic tissue. Therefore, such colonies were selected, purified, single-spored and stored for future use. Isolates were identified morphologically by placement on 1.5% water agar with irradiated carnation leaves embedded in the agar surface (CLA). After 2-4 weeks growth at 26°C with 12 hours light, cultures were examined for presence and characteristics of microconidia, mesoconidia, macroconidia and chlamydospores (Leslie and Summerell, 2006).

*Fusarium* isolates were identified molecularly by obtaining fungal DNA and subjecting to a standard polymerase chain reaction (PCR) protocol using the *ef1* and *ef2* primers to amplify a portion of the translation elongation factor 1-alpha gene (TEF), a highly informative region for differentiating *Fusarium* species and formae speciales of *F. oxysporum* (Geiser et al., 2004). The approximately 690 bp amplicon was viewed using agarose gel electrophoresis, purified, and then used as a template for DNA sequencing by the DNA Sequencing Core Laboratory, ICBR, UF, Gainesville. Sequences were edited and then queried against the FUSARIUM-ID database using the BLAST search tool (<http://fusarium.cbio.psu.edu>; Geiser et al., 2004).

*F. oxysporum* isolates PLM-140B and PLM-153B were selected for the first pathogenicity experiment, which was conducted with juvenile queen palms (3-4 true leaves) and initiated in April 2006. Both isolates were obtained from symptomatic mature queen palms growing in landscapes. Isolates were grown on potato dextrose agar (PDA) at 26°C with 12 hours light. Spore suspensions ( $10^7$  per ml) were made with sterile water. Each palm was inoculated with two methods. First, a 4-mm hole was drilled into the palm 8-10 cm above the soil line (and above the apical meristem), and then a 2 ml spore suspension was slowly injected internally. Second, a 5-cm shallow slit was made on the adaxial surface of the petiole of the second, youngest fully-expanded leaf, and a 1 ml spore suspension was dribbled on this slit. Palms designated as controls were handled in the same manner but with sterile water. Palms were immediately placed in clear, polyethylene bags and placed in an area with no direct sun for 3 days. Bags were removed, and the palms placed in a sun nursery with daily overhead irrigation. There were four replicate palms per treatment.

*Fusarium oxysporum* isolates PLM-140B (queen palm, Broward Co. landscape), PLM-246B (queen palm, Lee Co. field nursery) and PLM-249A (Mexican fan palm, Lee Co. field nursery) were selected for the second pathogenicity experiment, which was conducted with seedling queen and Mexican fan palms (3-4 seedling leaves) and initiated in May 2007. Isolates and spore suspensions were prepared as described previously. Palms in containers were inoculated by pipeting 40 ml spore suspension between the leaf bases, with excess suspension percolating through the potting mix. Palms designated

as controls were handled in the same manner but with sterile water. Palms were immediately placed in clear, polyethylene bags and placed in an area with no direct sun for 3 days. Bags were removed, and the palms transplanted into 450-ml pots using a peat moss/sand/perlite (1:1:1) potting mix. Palms were placed in a covered shadehouse and irrigated daily. There were five replicate palms per treatment, and each palm species was inoculated with each fungal isolate.

This experiment was repeated in October 2007 using these same three *F. oxysporum* isolates plus *F. proliferatum* PLM-137B and *F. semitectum* PLM-138B. These latter two isolates and *F. oxysporum* PLM-140B had been isolated from the same symptomatic queen palm. All experimental preparations and conditions were the same as described above.

## RESULTS AND DISCUSSION

The vast majority of the isolates were tentatively identified as *Fusarium oxysporum* based on morphological characteristics. Macroconidia were formed on CLA in orange sporodochia, and were 3-4 septate with a foot-shaped basal cell and curved apical cell. Microconidia were produced in false heads on short phialides, were unicellular and were primarily oval, elliptical or reniform in shape. Chlamydospores were readily produced by most isolates in less than 4 weeks. The only other *Fusarium* species isolated were identified as *F. proliferatum* and *F. semitectum*. *F. proliferatum* had macroconidia that were longer and more slender than the *F. oxysporum* isolates, and microconidia (distinctively club-shaped with flattened base) were present in long chains on polyphialides. *F. semitectum* was identified based on lack of microconidia production, but production of fusoid-shaped mesoconidia were readily observed in characteristic pairs on polyphialides. Macroconidia were shorter than the *F. oxysporum* isolates. These two species were not consistently isolated from symptomatic tissue as was *F. oxysporum*.

The vast majority of the *Fusarium* isolates most closely matched *Fusarium oxysporum*, but did not match any of the formae speciales TEF sequences currently available in the database, including those for *F. o. canariensis*, the etiological agent of Fusarium wilt of *Phoenix canariensis* which is already present in Florida. A phylogenetic tree was developed using representative *F. oxysporum* isolates from queen and Mexican fan palms and *F. o. canariensis* (isolates from diseased *Phoenix* spp. in Florida), with a *F. semitectum* isolate from a queen palm used as the root (Figure 1).

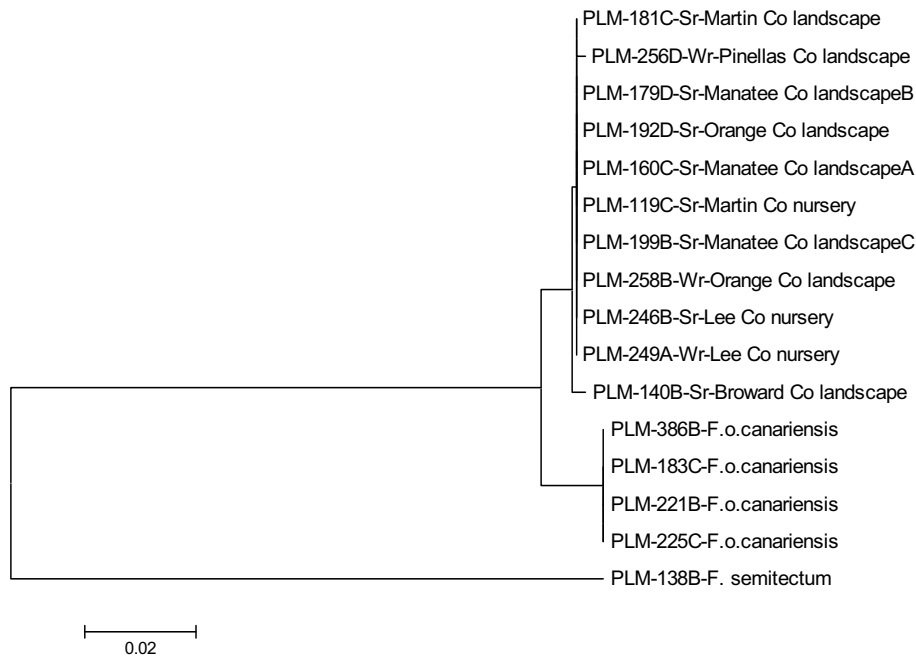

Figure 1. Phylogenetic tree of *Fusarium oxysporum* isolates causing a new, lethal disease of *Syagrus romanzoffiana* (Sr) and *Washingtonia robusta* (Wr), compared with *Fusarium oxysporum* f. sp. *canariensis*.

In the pathogenicity experiment using juvenile queen palms, all control palms were healthy after 9 months, but 2 of 4 inoculated palms of each *F. oxysporum* isolate treatment had died after exhibiting leaf symptoms typically observed in the landscape. *F. oxysporum* was isolated from symptomatic tissue. The remaining 2 replicate palms of each pathogen-inoculation treatment were healthy and never exhibited symptoms during the 9-month period.

In the pathogenicity experiment using seedling queen and Mexican fan palms, symptoms were observed on Mexican fan palms within 3 weeks of inoculation, and all five replicate palms of all three *F. oxysporum* treatments were dead after 5 weeks. Controls were healthy. For queen palms, no symptoms were observed until 8-9 weeks after inoculation. By November 2007, all five replicate palms infested with PLM-249A were dead, 3 of 5 replicate palms infested with PLM-246B were dead, and 2 of 5 replicate palms infested with PLM-140B were dead. By January 2008, the remaining inoculated palms had not died, but were severely stunted, had ceased to produce new leaves, and only the youngest leaf or leaves were still green. Controls remained healthy. *F. oxysporum* was isolated from symptomatic tissue.

The repetition of this pathogenicity experiment yielded similar results with the *F. oxysporum* isolates. All 5 replicate Mexican fan palms of all three isolate treatments were dead after 6 weeks. By 12 weeks, 4 of 5 replicate queen palms of all three isolate treatments were dead and the 5th replicate was declining. All control palms for both species remained healthy, as did the palms inoculated with *F. proliferatum* and *F. semitectum* (Figure 2).



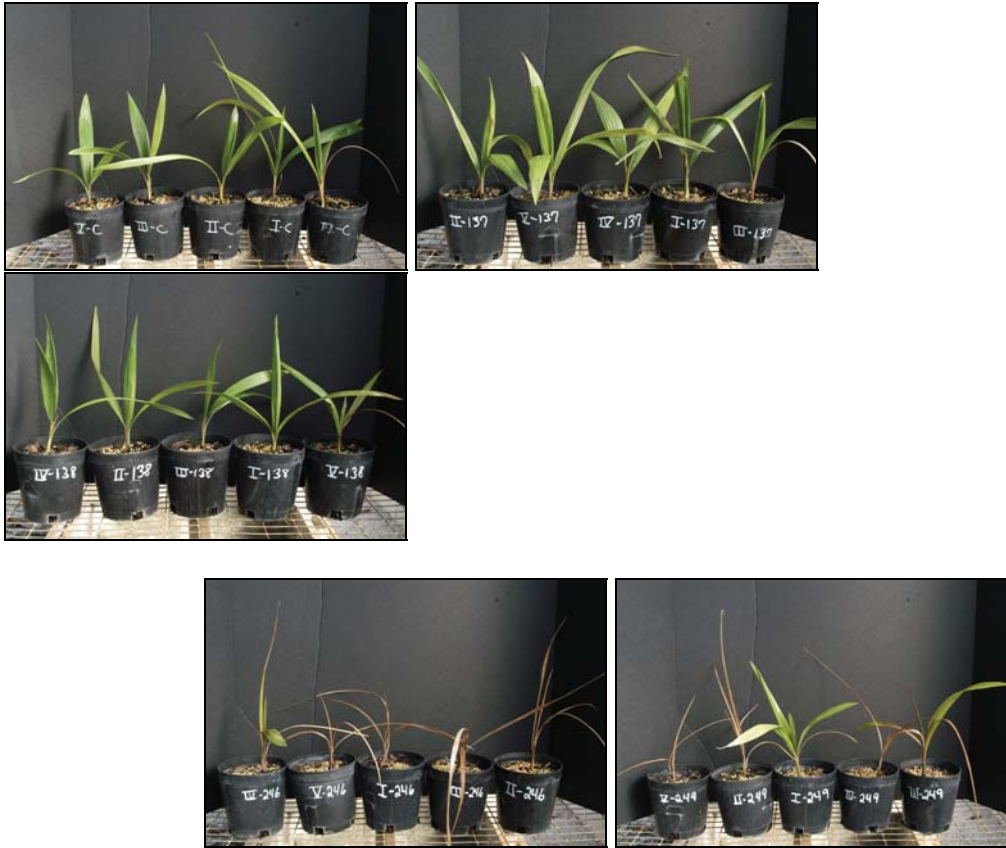

Figure 2. Appearance of *Syagrus romanzoffiana* at 10 weeks after inoculation with *Fusarium* isolates. Top row: Control, *Fusarium proliferatum* PLM-137B, *Fusarium semitectum* PLM-138B. Bottom row: *Fusarium oxysporum* PLM-246A, *Fusarium oxysporum* PLM-249A.

Based on the results obtained to date, we believe a new forma specialis of *Fusarium oxysporum* is the etiological agent of a new lethal disease of queen and Mexican fan palms occurring in Florida. While the disease is primarily observed in mature landscapes, where palms have been established for 5 or more years, it has been observed in three nurseries, one was a container nursery and two were field nurseries with juvenile palms. Because of the wide geographic range of the disease in Florida, wind movement of the pathogen is implicated.

## REFERENCES

- Geiser, D. M., Jimenez-Gasco, M. M., Kang, S., Makalowska, I., Veeraraghavan, N., Ward, T. J., Zhang, N., Kuldau, G. A., and O'Donnell, K. 2004. FUSARIUM-ID v. 1.0: A DNA sequence database for identifying *Fusarium*. *European Journal of Plant Pathology* 110:473-479.
- Leslie, J. F. and Summerell, B. A.. 2006. *The Fusarium Laboratory Manual*. Blackwell Publishing, Ames, IA.

Simone, G. W. 2004. Fusarium wilt, pp. 17-22, Compendium of ornamental palm diseases and disorders, M. L. Elliott, T. K. Broschat, J. Y. Uchida, and G. W. Simone (eds.). The American Phytopathological Society, St. Paul, MN.

**Poster #70**

***In Vivo* Study of Cogongrass (*Imperata Cylindrica* L.) Rhizome Production**

Oghenekome U. Onokpise, James J. Muchovej, and Susan K. Bambo. College of Engineering Sciences, Technology and Agriculture, Florida A&M University, Tallahassee, Florida 32307. susan.bambo@famuedu

**ABSTRACT.**

Cogongrass is an aggressive, rhizomatous, invasive perennial grass that is scattered throughout the tropical and subtropical regions of the world, and has become a serious problem in Florida and other Gulf Coast States. A greenhouse study was conducted to evaluate the growth and spread of rhizomes of grass species grown in combination with other native grass species. Native grass species used included: switchgrass (*Panicum virgatum* L), maidencane (*Panicum hemitomon* Schult.), and muhlygrass (*Muhlenbergia capillaries* (Lam) Trin.). All plants were raised in tubbets and then transplanted to 7.6 L greenhouse pots in different combinations with cogongrass. Data on rhizomes of cogongrass and maidencane (rhizomatous species) were recorded during the harvest periods (6, 12, 18 or 24 weeks). The mean number and mean total length of cogongrass rhizomes ranged from 3 to 8 and 0.06 to 0.14 m at 6 weeks to 40 to 94 and 8.37 to 20.39 m at 24 weeks, respectively. Similarly, the mean number and mean total length of maidencane rhizomes ranged from 0.01 to 3 and 0.05 to 0.27 m at 6 weeks to 11 to 26 and 1.57 to 3.31 m at 24 weeks, respectively. There were 51 to 74% and 47 to 74% reductions in the mean total length of cogongrass rhizomes grown in combination than those grown individually at 12 and 18 weeks, respectively. The mean number of cogongrass rhizomes had 54 to 71% reductions when in combination than individually at 12 weeks. Likewise, at 18 weeks the mean number and mean total length of rhizomes of maidencane were reduced by 51 to 65% and 20 to 75%, respectively, when grown in combination with others grasses than alone. The number and spread of rhizomes explain cogongrass' invasiveness and competitiveness. The reduction of cogongrass in combination with native species shows a prospect that some Florida native grasses could reduce the invasiveness of cogongrass in the Gulf Coast States.

**KEYWORDS:** Cogongrass, rhizomes, native grasses

**INTRODUCTION**

Cogongrass is considered "the seventh worst weed in the world" (Dozier et al. 1998; Holm et al. 1997). It is an aggressive, rhizomatous, perennial grass that is distributed widely in the tropical and subtropical zones of the world. It occurs in 73 countries and has infested more than 500 million hectares of plantation and agricultural land worldwide (Holm et al. 1977). It was first introduced into the USA both accidentally (into Mobile Alabama through a packaging material in a shipment from Japan) in 1911 and intentionally (into Alabama, Mississippi and Florida as a forage plant and soil stabilizer) from the 1920s to 1940s (Patterson et al. 1980; Dickens 1974; Tabor 1952;

Tabor 1949). Unfortunately, the purpose of its introduction was not achieved, as its evaluation in these states in the 1920 to the 1940s was only acceptable as a short-term forage crop and soil stabilizer. From 1940s to date, it has developed into a major invasive noxious species and serious weed problem in Florida, Georgia, Alabama, Louisiana, Mississippi, and some recent reports include S. Carolina and Eastern Texas (Bolfrey-Arku et al. 2006; Miller 2000). The spread of cogongrass in these areas was by illegal plantings and inadvertent transport in forage and in soil contaminated with cogongrass rhizomes during roadway constructions (Holm et al., 1977; Dickens, 1974). It has become established in the southeastern United States within the last fifty years, with Alabama, Mississippi and Florida having extensive acreage of roadway and pasture infested with cogongrass (Gaffney 1996). It is commonly found along roadways, in forests, parks, residential areas, grasslands, less cultivated agronomic lands, mined areas, and natural areas, and has been reported to be a serious problem in these areas (Dozier et al. 1998; Bryson and Carter 1993; Coile and Shillings 1993; Holm et al. 1977 ).

Cogongrass has numerous attributes that contribute to its extremely invasive nature. Cogongrass produces new rhizomes readily, even with rhizome fragments. The persistent and aggressive rhizome of *I. cylindrica* is the main mechanism of survival and spread, while its resilience makes it difficult to control. Established stands may produce over 7 tons of rhizomes per hectare (Soerjani 1970). These rhizomes can also spread up to 3 to 4 m forming a mat of internodes with potential to produce hundreds of new plants. Cogongrass has received extensive research attention due to its agriculture, economic and social implications in various regions of the world. It has little advantages including short-term poor forage production, erosion control, thatch and to a limited extent it has been used in paper making (Coil and Shilling 1993). On the other hand, it has caused injury to tuber crops, inhibited desirable perennial grass species to establish, produced poor habitats for wildlife animals, and increased fire hazards that destroy most fire intolerant species (Lippincott 2000; Shilling et al. 1995; Boonitee and Ritdhit 1984).

In the Western Hemisphere, cogongrass weedy habit outweighed its usefulness and over fifty years ago, Pendleton (1948) stated that steps should be taken at once to completely eradicate this noxious weed. After several years, many considerable research efforts have been underway to understanding the spread of cogongrass, throughout many habitats, and management for its control and possible eradication as a noxious weed and an invasive species (Chikoye et al. 1999; Shilling et al. 1997; Holm et al. 1997). Control measures included mechanical, chemical, biological control, and some combination of mechanical, chemical, or biological treatments (Onokpise et al. 2007; Dozier et al. 1998; Shilling and Gaffney 1995). Different methods of integrated approaches have been used to control cogongrass, and different levels of successes have been achieved (Chikoye et al. 2005). However, cogongrass finally begins to re-infest, regardless of the control measure. It is essential to introduce desirable vegetation as quickly as possible to avoid cogongrass from re-infesting the area, once a stage of good management is achieved. Some of these desirable species are native species to the Gulf Coast States. To eliminate cogongrass, control strategies should include limiting or destroying the rhizome production. It is important to study which native species can grow in association or reduce the spread of cogongrass rhizomes. Therefore the objectives of this study were to evaluate the performance of rhizomes of cogongrass grown in combination with Florida's

native grass species, and also evaluate the growth of maidencane (a native grass species) rhizomes in such combinations.

## **MATERIALS AND METHODS**

The experiment was conducted in the George Connolly greenhouse on Florida A&M University campus, Tallahassee, Florida in the USA. The grass species used for this study were cogongrass and three native species, which included switchgrass (*Panicum virgatum* L), maidencane (*Panicum hemitomon* Schult.), and muhlygrass (*Muhlenbergia capillaries* (Lam) Trin.). Cogongrass materials used were obtained from a naturally infested site on Tram Road in Tallahassee, Florida. Muhlygrass was harvested from its natural habitat at St. Marks National Wildlife Refuge, St Marks, Florida. A shovel was used to dig up the cogongrass and muhlygrass plants. ‘Citrus’ maidencane (*Panicum hemitomon* Schult.) and switchgrass (*Panicum virgatum* L.) were obtained from the United States Department of Agriculture - Natural Resources Conservation Service, Plant Materials Center (USDA-NRCS PMC) Brooksville, Florida.

Rhizomes of cogongrass and maidencane were cut into pieces of about 4 cm segments. These pieces of rhizomes were planted in plastic trays (pro-tray) that were filled up with Jungle Grow® potting mix. Muhlygrass and switchgrass were divided into smaller clumps that were potted into 5.5 cm diameter tubetts using the same potting mix. Both cogongrass and the native species were placed on greenhouse benches where they were watered daily for about 6 weeks before transplanting into larger pots.

The pots used for the study were the Accelerator® Model AP-3 (7.6 L) that had a series of slots on the sides to allow for aeration. Pots were filled up with a potting mix purchased from Graco Fertilizer Company, Cairo, Georgia. Potting mix was composed of 80 % bark, 10 % sand and 10 % peat (Graco Fertilizer Co, Cairo, GA). Plants were planted into the mix either alone or in all possible combinations with cogongrass. This study was laid out in a randomized complete blocked design with nine treatments and four replications. Each pot received one table spoon of Osmocote® (19-6-12) every 4 weeks. Destructive sampling was conducted at 6, 12, 18, and 24 weeks after planting (WAP) in 7.6 L greenhouse pots. During harvest or sampling, the content of each pot was removed and the plant material was separated from the peat. Data on rhizomes of cogongrass and maidencane (rhizomatous species) were recorded. Data collected included the number of rhizomes and length of rhizomes produced by each plant species. Data was analyzed using SAS 9.1 (SAS 2002). Means were separated using LSMEANS statement.

## **RESULTS AND DISCUSSION**

The mean number of rhizomes of cogongrass varied from one harvest period to another, although, at 6 and 24 WAP, there were no significant differences among cogongrass mean number of rhizomes growing alone or in combination with native species (Figures 1). The number of rhizomes range from 3 to 8 and 40 to 94 at 6 and 24 WAP, respectively. The mean number of rhizomes were not significantly different, except at 12 ( $P = 0.005$ ) WAP, where all cogongrass grown in combination with native species was reduced by 53 to 71 % (Figure 1). At this harvest period the reduction in the number of rhizomes occurred in all combinations compared cogongrass alone. At the first harvest, there was an indication that cogongrass rhizomes did not encounter the

competition from the native species. However, at the 24 WAP, despite the greater number of rhizomes produced by cogongrass growing individually, there was an overlap in the range between the treatment combinations.

The mean total length of cogongrass rhizomes did not vary at the first and last harvest periods and the range was from 0.32 to 0.88 m and 8.37 to 20.40 m at 6 and 24 WAP, respectively. On the other hand, the mean total length of rhizomes of cogongrass varied among treatment combinations at 12 ( $P = 0.003$ ) and 18 ( $P = 0.01$ ) WAP (Figure 2). There was 51 to 74% and 47 to 74% reduction in the mean total length of cogongrass rhizomes grown in combination than those grown individually at 12 and 18 WAP, respectively. Cogongrass rhizomes growing in combination with any native species were similar throughout the sampling periods. Native grasses were selected on the basis of their growth habit, resistance to adverse environmental conditions, and their ability to grow with the invasive cogongrass (Evans 1991). The mean number and total length of cogongrass rhizome indicated that muhlygrass alone may not compete effectively with cogongrass. The presence of switchgrass in the planting combination generally reduced cogongrass rhizome production. Employing biological control strategies to manage cogongrass is especially pertinent in natural ecosystems and low maintenance areas where the cost of chemical and mechanical control methods would be prohibitive and/or impracticable. The ability of these native species to compete and grow with cogongrass in a short term was viewed possible. Field experiments are needed to validate these native species as a valuable biological control mechanism to control cogongrass.

Considering treatments with maidencane and their rhizome performance, variability occurred from one harvest period to the next. The mean number of maidencane rhizomes ranged from 1 to 3 and 11 to 26 at 6 and 24 WAP, respectively (Figure 3). Likewise, the mean total length of maidencane rhizomes ranged from 0.01 to 0.03 m and 1.57 to 3.31 m at 6 and 24 WAP, respectively (Figure 4). It was observed that maidencane had similar mean total length of rhizomes and the mean number of rhizomes throughout the sampling periods, except at 18 WAP (Figures 3 and 4). At this sampling period, the mean number and mean total length of rhizomes of maidencane were reduced by 51 to 65% and 20 to 75%, respectively, when grown in combination with others grasses than alone. Maidencane generally had a stable performance in the treatment combinations. The presence of switchgrass in the planting combination occasionally reduced maidencane rhizome production.

It is remarkable to note that the 4 cm segmented pieces of rhizomes from each species were able to produce the number and length of rhizomes reported. This study confirmed the earlier studies on cogongrass which suggested that shoots may form from the smallest of rhizome segments (Hubbard et al. 1944). During this study, rhizomes of cogongrass grew both from apical buds and along the length of the rhizomes from axillary buds (Figure 5). Other researchers, for instance, Ayeni (1985) and Wilcut et al (1988) report that rhizomes are apically dormant; while English (1998) investigation reported that cogongrass does produce axillary buds. The rhizome system of cogongrass is undoubtedly a competitive strength of the species as reported by Ayeni and Duke (1985).

It can be concluded that the number and spread of rhizomes explain cogongrass' invasiveness and competitiveness. The performance of maidencane in maintaining its rhizome growth with other species in most of the sampling periods indicated its potential

to grow in association with cogongrass. The presence of switchgrass had large impact on cogongrass rhizomes than on maidencane rhizomes. The reduction of cogongrass in combination with native grass species showed a prospect that some of these native grasses could grow in association with cogongrass or reduce the invasiveness of cogongrass in the Gulf Coast States. Controlling cogongrass requires persistence and diligence by the land manager but will be well worth the effort for protecting our natural resources from this very serious exotic invader.

## ACKNOWLEDGEMENTS

Funding for this project is principally from USDA-CSREES 1890 capacity Building Grant # 2005 38814 – 16377. These funds are gratefully acknowledged. Special thanks are extended to Dr. Mimi Williams, Ms. Anne-Marie Gunter and all the staff at the USDA-NRCS PMC Brooksville, Florida for their tremendous assistance in these studies.

## REFERENCES

- Ayeni, A. O. 1985. Observations on the vegetative growth pattern of speargrass (*Imperata cylindrica* (L.) Beauv.). *Agriculture, Ecosystems and Environment* 13: 301-307.
- Ayeni, A. O. and W. B. Duke. 1985. The influence of rhizome features on subsequent regenerative capacity in Speargrass (*Imperata cylindrica* [L.] Beauv.). *Agriculture, Ecosystems and Environment* 35: 309-317.
- Bolfrey-ArKu, G. E-K., O. U. Onokpise, D. G. Shilling, C. C. Coultas, and A. G. K. Carson. 2006. The speargrass (*Imperata cylindrica* (L.) Beauv) menace in Ghana; Perception, practices and incidence in the forest, and forest-savanna transition zones. *West African Journal of Applied Ecology* 10:177-188.
- Bryson, C. T., and R. Carter. 1993. Cogongrass, *Imperata cylindrica*, in the United States. *Weed technology* 7:1004-1009.
- Chikoye, D., F. Ekeleme, and J. T. Ambe. 1999. Survey of distribution and farmers' perceptions of speargrass [*Imperata cylindrica* (L.) Raeusche] in cassava-based systems in West Africa. *Journal of International Pest Management*. 45:305-311.
- Chikoye, D., U. E. Udensi, and S. Ogunyemi. 2005. Integrated management of cogongrass (*Imperata cylindrica* (L.) Rauesch. *In* corn using tillage, glyphosate, row spacing, cultivar and cover cropping. *Agronomy Journal* 97:1164-1171.
- Coil, N. C., and D. G. Shilling. 1993. Cogongrass, *Imperata cylindrica* (L.) Beauv.: a good grass gone bad! *Botanical circulation* No. 28. Gainesville, Florida: Florida Department of Agriculture and Consumer Services, Division of Plant Industry, 3 pp.
- Dickens, R. 1974. Cogongrass in Alabama after sixty years. *Weed Science* 22:177-179.
- Dozier, H., J. F. Gaffney, S. K. McDonald, E. R. R. L. Johnson, and D. G. Shilling. 1998. Cogongrass in the United States: history, ecology, impacts, and management. *Weed Technology* 12:737-743.
- Evans, H. C. 1991. Biological control of tropical grassy weeds, pp. 52-72. *In* Baker, F. W. G. and P. J. Terry (eds.). *Tropical Grassy Weeds*. CAB International, Wallingford, United Kingdom.
- Gaffney, J. F. 1996. Ecophysiological and technical factors influencing the management of cogongrass (*Imperata cylindrica*). Ph.D. dissertation, University of Florida, Gainesville, FL, USA. 111 pp.

- Holm, L. G., D. L. Pucknett, J. B. Pancho, and J. P. Herberger. 1977. *The World's Worst Weeds. Distribution and Biology*. Univ. Press of Hawaii, Honolulu, HI. 609 pp.
- Hubbard, C. E. 1944. *Imperata cylindrica*. Taxonomy, Distribution, Economic Significance, and Control. Imperial Agriculture Bureau Joint Publication No. 7, Imperial Bureau Pastures and Forage Crops, Aberystwyth, Wales, UK. 63 pp.
- Lippincott, C. L. 2000. Effects of *Imperata cylindrica* (L.) Beauv. (cogongrass) invasion on fire regime in Florida sandhill. *Natural Areas Journal* 20:140-149. *Natural Areas Journal*. 20:140-149.
- Miller, J. H. 2000. Refining rates and treatment sequences for cogongrass (*Imperata cylindrica*) control with imazapyr and glyphosate. *Proceedings of the Southern Weed Science Society of America* 53:131-132.
- Onokpise, O. U., H. Dueberry, L. Reid, J. L. Norcini, J. J. Muchovej, and S. K. Bambo. 2007. Comparative studies on the control of cogongrass (*Imperata cylindrica* L.). *Journal of Environmental Monitoring and Restoration (JEMREST)*: 3:325-331.
- Pendleton, R. L. 1948. Cogongrass, *Imperata cylindrica*, in the western hemisphere. *Journal of the American Society of Agronomy*. 40: 1047-1049
- Patterson, D. T., E. P. Flint, and R. Dickens. 1980. Effects of temperature, photoperiod, and population source on the growth of cogongrass (*Imperata cylindrica*). *Weed Science*. 28: 505-509.
- SAS Institute. 2002. SAS/STAT user's guide. Version 9.1. SAS Inst., Cary, NC, USA.
- Shilling, DG, and J. F. Gaffney. 1995. Cogongrass control requires integrated approach (Florida). *Restoration and Management Notes* 13: 227.
- Shilling, D. G., T. A. Bewick, J. F. Gaffney, S. K. McDonald, C. A. Chase, E. R. R. L. Johnson. 1997. Ecology, physiology, and management of cogongrass (*Imperata cylindrica*). Publication No. 03-107-140. Gainesville, FL: University of Florida. 128 p.
- Soerjani, M. 1970. Alang-alang *Imperata cylindrica* (L.) Beauv., pattern of growth as related to its problem of control. *BIOTROP Bulletin in Tropical Biology* 1:88-96.
- Tabor, P. 1949. Cogongrass, *Imperata cylindrica* (L.) Beauv., in the southeastern United States. *Agronomy Journal* 41:270.
- Tabor, P. 1952. Comments on cogon and torpedo grasses: A challenge to weed workers. *Weeds* 1:374-375.
- Wilcut, J. W., R. R. Dute, B. Truelove, D. E. Davis. 1988. Factors limiting distribution of cogongrass, *Imperata cylindrica*, and torpedograss, *Panicum repens*. *Weed Science* 36:577-582.



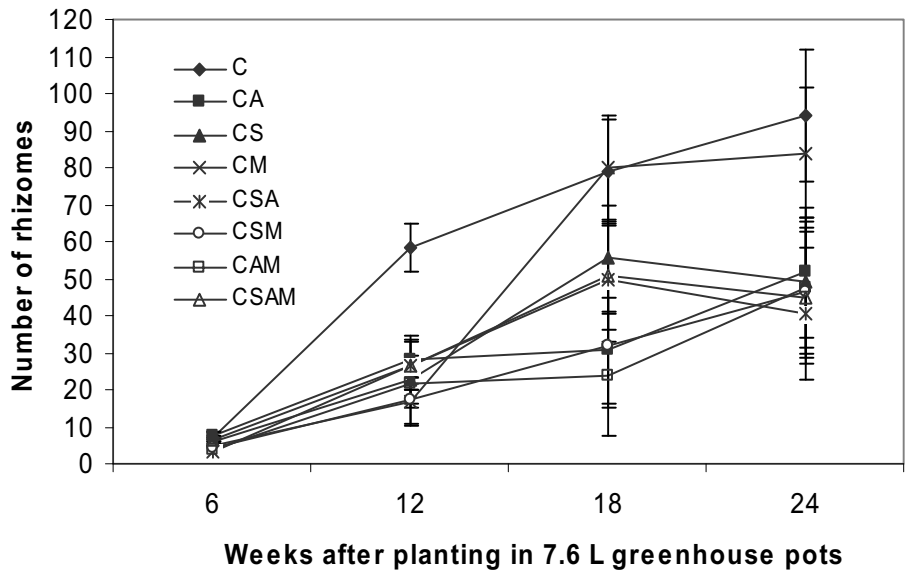

Figure 1. Mean number of rhizomes of cogongrass in response to competition from different native grass species combinations. C, cogongrass; CS, cogongrass and switchgrass; CA, cogongrass and Maidencane; CM, cogongrass and muhlygrass; CSA, cogongrass, switchgrass and maidencane; CSM, cogongrass, switchgrass and muhlygrass; CAM, cogongrass, maidencane and muhlygrass; CSAM, cogongrass, switchgrass, maidencane and muhlygrass. Vertical bars are the standard error of the mean.

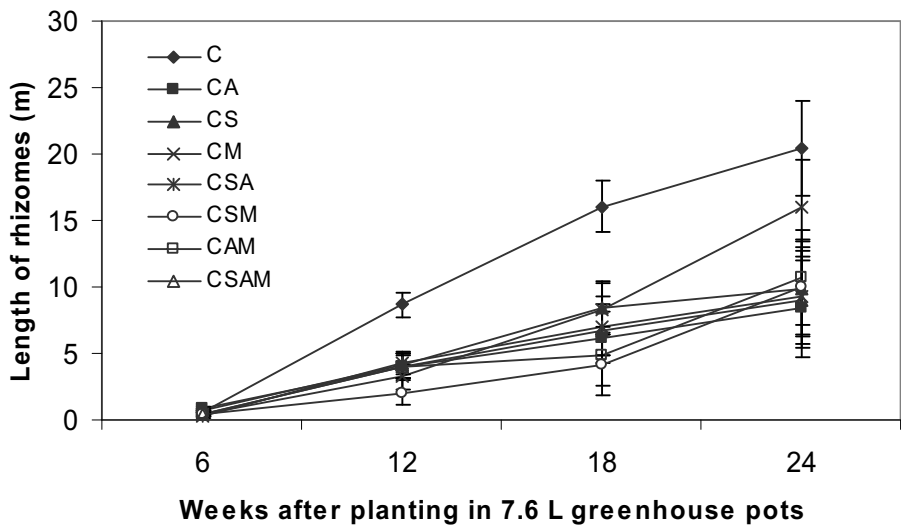

Figure 2. Mean total length of rhizomes of cogongrass in response to competition from different native grass species combinations. C, cogongrass; CS, cogongrass and switchgrass; CA, cogongrass and Maidencane; CM, cogongrass and muhlygrass; CSA, cogongrass, switchgrass and maidencane; CSM, cogongrass, switchgrass and muhlygrass; CAM, cogongrass, maidencane and muhlygrass; CSAM, cogongrass,

switchgrass, maidencane and muhlygrass. Vertical bars are the standard error of the mean.

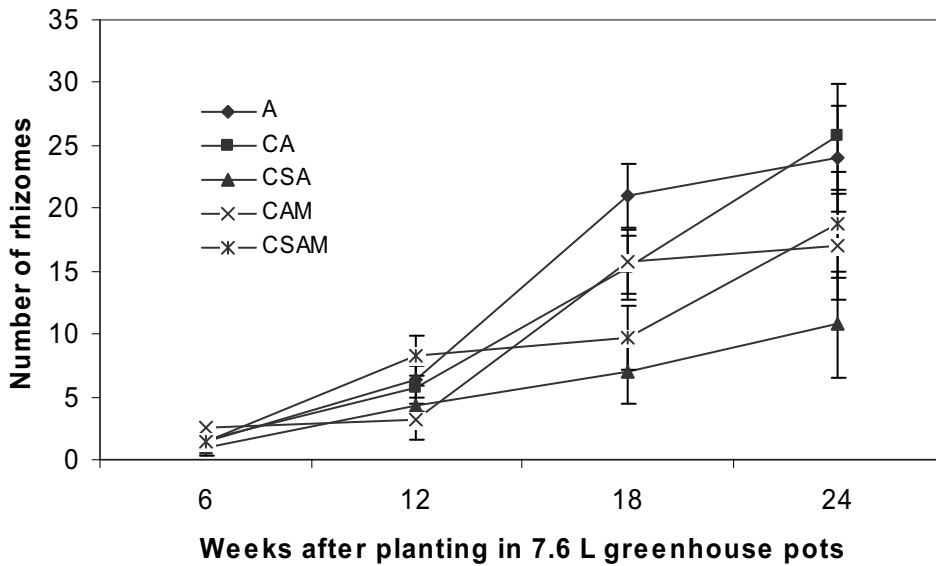

Figure 3. Mean number of rhizomes of maidencane in response to competition from cogongrass and different native grass species combinations. A, Maidencane; CA, cogongrass and maidencane; CSA, cogongrass, switchgrass and maidencane; CAM, cogongrass, maidencane and muhlygrass; CSAM, cogongrass, switchgrass, maidencane and muhlygrass. Vertical bars are the standard error of the mean.

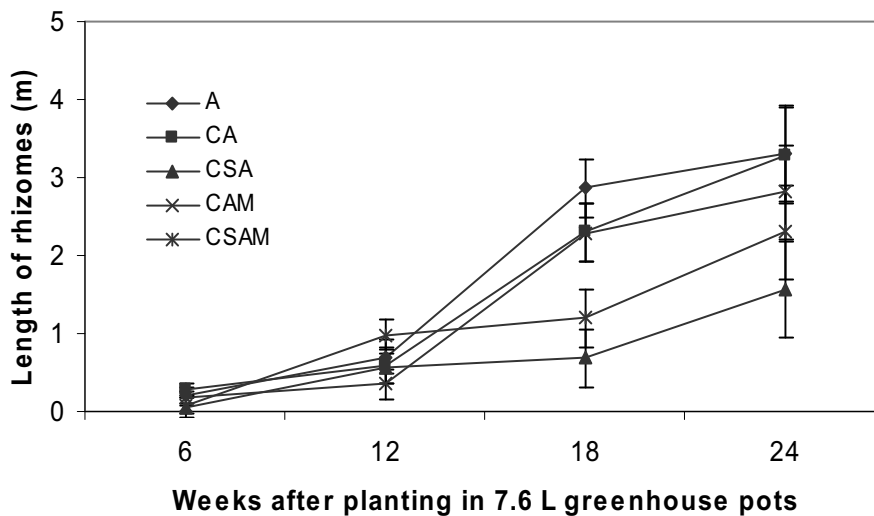

Figure 4. Mean total length of rhizomes of maidencane in response to competition from cogongrass and different native grass species: A, Maidencane; CA, cogongrass and maidencane; CSA, cogongrass, switchgrass and maidencane; CAM, cogongrass, maidencane and muhlygrass; CSAM, cogongrass, switchgrass, maidencane and muhlygrass. Vertical bars are the standard error of the mean.

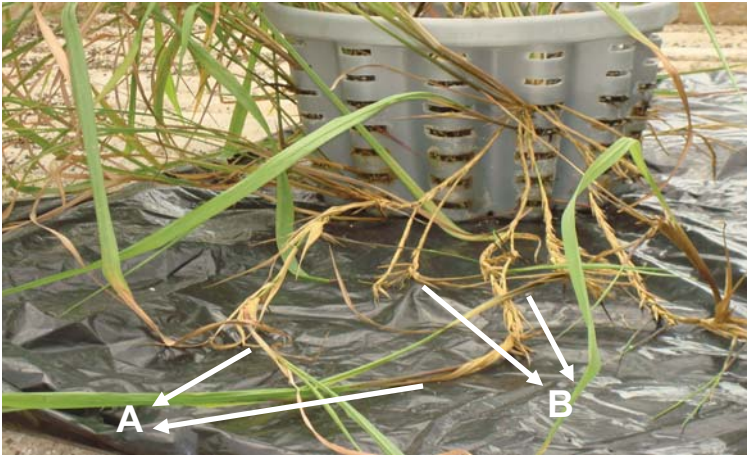

Figure 5. Cogongrass rhizome development at both apical (A) and auxiliary (B) buds

**Poster #71**

**Natural Spread of Pests within and into the Greater Caribbean Region**

*Christie A. Bertone, Heike E. Meissner, and Andrea V. Lemay, United States Department of Agriculture (USDA), Raleigh, North Carolina 27606, USA. Contact: Heike.E.Meissner@aphis.usda.gov*

**ABSTRACT.**

Natural spread of exotic pest organisms mediated by wind may play a significant role in the movement of pests throughout the Greater Caribbean Region. Biological and atmospheric events and processes interact to facilitate aerial dispersal of organisms over long distances. Our objective was to review the scientific literature to answer questions about natural spread of exotic plant pests into and within the Greater Caribbean Region, *e.g.*, whether it occurs, patterns of movement, types of pests prone to natural spread, and possible methods for reducing the likelihood of establishment. Certain plant pathogens seem to have wind-dispersed from Africa into the Caribbean, and wind-assisted dispersal within the Greater Caribbean Region occurs on an ongoing basis. The effects of natural dispersal may be mitigated through stringent surveys supported by predictive modeling. Knowing which pests are capable of becoming established and causing economic damage within a given area and intervention as soon as a pest is introduced may reduce the likelihood of establishment.

**KEYWORDS:** wind dispersal, natural movement, pest spread

**INTRODUCTION**

Natural spread of pests throughout the Greater Caribbean Region seems likely, given the close proximity of islands and land masses. Biological and atmospheric events and processes often facilitate aerial dispersal of plant pathogens, insects, and mites, which can be transported over long distances and cause widespread infections or infestations.

Once a pest is established in a new area, it is difficult to determine the pathway of introduction. The route of natural movement between close land masses most likely follows prevailing winds, which move from the Windward Islands (the most southeasterly islands), toward the northwest to the Leeward Islands, and on to the Greater Antilles and the southeastern United States. Hurricanes and tropical storms are also potential conduits for pest movement. In the Greater Caribbean Region, tropical storms and hurricanes can occur at any time from June through November, but most develop during August, September, and October (**Figure 1**). An average of 15 tropical cyclones occur each year, including seven or eight hurricanes, but many do not reach land (Quantick, 2001).

## EXAMPLES OF EXOTIC PEST MOVEMENT

***Pest Movement from within the Greater Caribbean Region.*** *Spodoptera frugiperda*, the fall armyworm, follows “rainy” seasons and migrates from the Caribbean islands to the United States each year (Luginbill, 1928). The moth survives year-round in Puerto Rico, the U.S. Virgin Islands, Guadeloupe, and French Guiana, but it cannot survive the winter in the United States, except in southern Florida and southern Texas (Luginbill, 1928).

*Raoiella indica*, the red palm mite, was detected in Martinique in 2004. Less than a year later, the mite appeared on coconut palms on nearby islands. Finding *R. indica* populations on tall and established coconut palms in St. Lucia strongly supports the premise that wind currents dispersed the mite (Hoy *et al.*, 2006). Soon after, *R. indica* became established in Dominica, Guadeloupe, St. Martin, St. Lucia, and Trinidad and Tobago. It was found in Puerto Rico in November of 2006 and in West Palm Beach, Florida, in December of 2007. The pest is spreading rapidly, aided by winds as well as commerce, and it is expected to become established throughout the subtropical and tropical regions of the Western Hemisphere.

***Pest Movement from outside of the Greater Caribbean Region.*** Some exotic plant pests are capable of long-distance migration from Africa to the Greater Caribbean Region (Figure 2). A few significant plant pathogens, including sugarcane smut (*Ustilago scitaminae*), sugarcane rust (*Puccinia melanocephala*), and possibly blue mold of tobacco (*Peronospora tabacina*), were carried by wind from Africa into the Greater Caribbean Region (Purdy *et al.*, 1985; Nagarajan and Singh, 1990).

*Schistocerca gregaria*, the migratory locust, has probably been carried repeatedly from Africa to the Caribbean by tropical cyclones, though it never became established (Richardson and Nemeth, 1991).

Thomas (2000) showed that only a small percentage of the exotic arthropods in Florida originated in Africa and that the major sources are Asia, the Pacific Islands, and the Neotropics. Thus, although there are some examples of pests that have exhibited long-distance migration, other pathways (*i.e.*, trade, commerce, and tourism) appear to be of greater importance for the introduction of plant and animal pests and diseases into the Greater Caribbean Region.

## COUNTERING NATURAL DISPERSAL

When plant pests and pathogens move naturally without human assistance, little can be done to stop them without investing considerable resources. National Plant Protection Organizations (NPPOs) should emphasize alternative strategies to reduce the risk of establishment of these pests.

- **A surveillance and diagnostic network is necessary** to monitor the arrival of any new pests. Predictive modeling works well for some plant pathogens and arthropods. Risk mitigation must be handled on a case-by-case basis, with foresight given to the likelihood of new pest establishment.
- **Sterile insect technique** has successfully been used to prevent pests from invading and spreading further into the United States.

- **Host-free zones** work well for pests and pathogens with only a few hosts, but they may not be feasible for highly polyphagous pests.
- **Classical biological control** has proven to be an important means to mitigate the impacts of some exotic pests.

## REFERENCES

- Hoy, M. A., J. E. Pena, and R. Nguyen. 2006. The red palm mite, *Raoiella indica* Hirst. Featured Creatures. [http://creatures.ifas.ufl.edu/orn/palms/red\\_palm\\_mite.htm](http://creatures.ifas.ufl.edu/orn/palms/red_palm_mite.htm).
- Luginbill, P. 1928. The Fall Army Worm. USDA Tech. Bull. No. 34. 91 pp.
- Lutgens, F. K. and E. J. Tarbuck. 2007. The Atmosphere: An Introduction to Meteorology. 10th ed. Pearson Prentice Hall, Uppersaddle River, NJ. 520pp.
- Nagarajan, S., and D. V. Singh. 1990. Long-distance dispersion of rust pathogens. Annual Review of Phytopathology 28:139-153.
- Purdy, L. H., S. V. Krupa, and J. L. Dean. 1985. Introduction of sugarcane rust into the Americas and its spread to Florida. Plant Disease 69(8): 689-693.
- Quantick, H. R. 2001. Climatology for Airline Pilots. Blackwell Science, Malden, MA. 284 pp.
- Richardson, C. H. and D. J. Nemeth. 1991. Hurricane-borne African Locusts (*Schistocerca gregaria*) on the Windward Islands. GeoJournal 23(4):349-357.
- Thomas, M. C. 2000. The Exotic Invasion of Florida. A Report on Arthropod Immigration into the Sunshine State. Florida Department of Agriculture and Consumer Services.

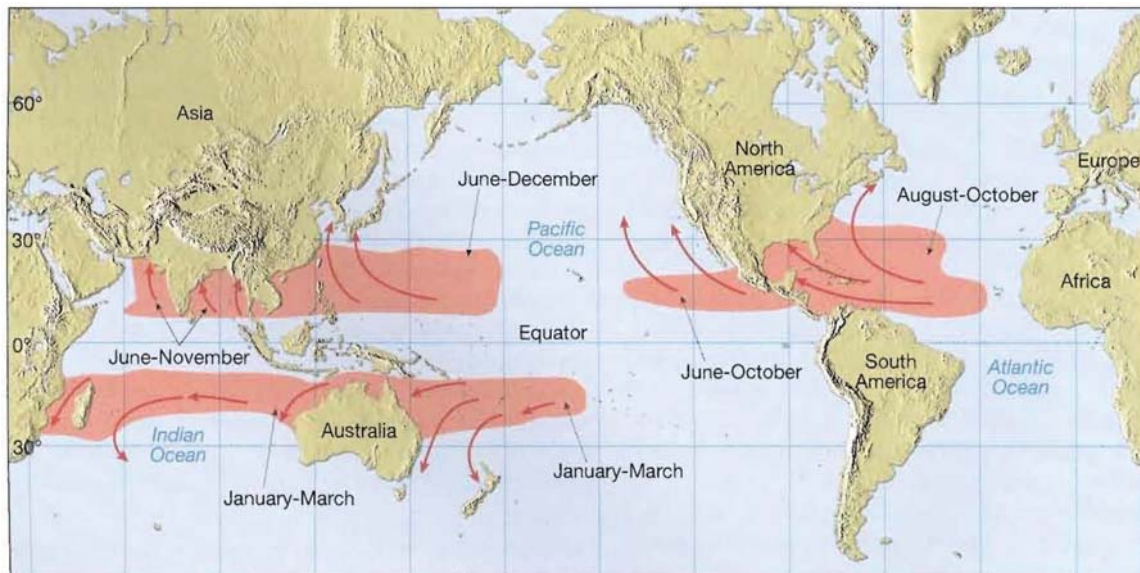

Figure 1. Areas and times of hurricane formation and directions of prevailing winds (or likely track for hurricane movement?) (Lutgens and Tarbuck, 2007)

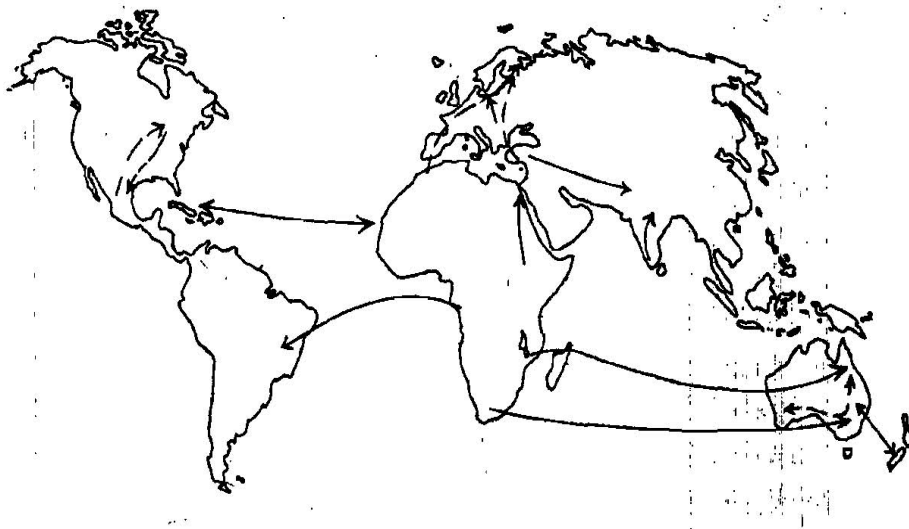

Figure 2. Pathways for long-distance dispersal (Nagarajan and Singh, 1990)

**Poster #72**

**Wood Packaging Material as a Pathway for the Movement of Exotic Insect Pests into and within the Greater Caribbean Region**

*Heike E. Meissner, Thomas W. Culliney, Andrea V. Lemay, Leslie P. Newton, and Christie A. Bertone, United States Department of Agriculture (USDA), Raleigh, North Carolina 27606, USA. Contact: Heike.E.Meissner@aphis.usda.gov*

**ABSTRACT.**

Pallets, crates, and dunnage made of wood are commonly used packaging materials in international trade. Our objective was to use data collected by the United States Department of Agriculture (USDA) to discuss the current role of wood packaging material (WPM) in the movement of pest species into and within the Greater Caribbean Region. For both maritime and air cargo, significant differences were found between countries of origin in terms of the percentage of shipments that contain WPM. A list of species intercepted on WPM at U.S. ports-of-entry after full enforcement of the international standard ISPM 15, as well as a list of species associated with WPM that have the potential to establish in the Greater Caribbean Region, are presented.

**KEYWORDS:** Wood packaging material, pest interception, pallets

**INTRODUCTION**

Wood packing material (WPM), such as pallets, crates, and dunnage, is used worldwide in agricultural and non-agricultural shipments. WPM has been recognized as a pathway for the spread of exotic pests, including arthropods, nematodes, mollusks, weeds, and plant pathogens (Pasek, 2000; Allen and Humble, 2002). WPM is often produced from low-grade wood of multiple species (Clark *et al.*, 2001), often with bark still attached. WPM is routinely re-used and re-conditioned (Clarke *et al.*, 2001; Bush *et al.*, 2002), making it difficult to determine its origin. Countries that have adopted the standard ISPM 15 of the International Plant Protection Convention (IPPC, 2006) now require WPM to be either fumigated or heat-treated prior to import. The United States began full enforcement of its requirements based on ISPM 15 on July 5, 2006.

**MATERIALS AND METHODS**

Agricultural Quarantine Inspection Monitoring (AQIM) data on maritime and air cargo, collected between Sept. 16, 2005 and Aug. 15, 2007, were used to estimate the proportion of maritime and air cargo shipments that contain WPM. The data were collected at several ports throughout the United States according to the USDA AQIM Handbook (USDA, 2006). Maritime shipments were selected randomly, and the presence or absence of WPM was recorded.

The samples were divided into two categories: 1) perishable, agricultural cargo and 2) non-agricultural cargo (excluding Italian tiles). On air shipments, samples were randomly collected from perishable agricultural cargo, including cut flowers. The



following commodities were specifically excluded from both air and maritime cargo: a) commodities which were pre-cleared at foreign sites; b) commodities admissible under the National Agricultural Release Program; c) frozen commodities; d) commodities which undergo mandatory treatment other than cold treatment (*e.g.*, fumigation, irradiation, hot water treatment) at work locations; and e) oil, salt, iron ore, coal, and similar bulk materials. The USDA PestID database was consulted for pest interception records at U.S. ports-of-entry.

## RESULTS AND DISCUSSION

The percentage of cargo that contained WPM differed among countries of origin. (Only countries of origin with sample sizes of 30 or higher are discussed here.) In terms of maritime cargo (Figure 1), several Caribbean countries (Costa Rica, Guatemala, and the Dominican Republic) had high percentages of export cargo with WPM. Other countries with a high incidence of WPM in export cargo were New Zealand and several European countries. Cargo from Honduras, Nicaragua, Venezuela, and Panama had comparatively lower incidences of WPM. Shipments from China had the lowest incidence of WPM, significantly lower than that from most other countries. This was true for both agricultural and non-agricultural maritime cargo, confirming results reported by MAF (2003) (Figures 2, 3). In the air cargo samples, far fewer countries were represented. Notably, imports from The Netherlands had by far the highest incidence of WPM in air cargo (Figure 4). In contrast to maritime cargo, air cargo shipments from Costa Rica and the Dominican Republic had a low incidence of WPM.

Obviously, the phytosanitary hazard is not presented by the WPM itself, but by pest organisms that may be associated with it. Unfortunately, there is little published data available on the incidence of pests associated with WPM. The New Zealand Ministry of Agriculture and Forestry found that, of 1,517 maritime containers with WPM inspected, about 16% had contaminations that resulted in phytosanitary action, such as fumigation or incineration (MAF 2003). Among the organisms detected on the WPM were a large number of fungi and insects, as well as isopods, millipedes, mites, plant materials, spiders, mollusks, and reptiles. A 2006 study carried out at several U.S. ports-of-entry resulted in an estimate of 0.1% of all marked WPM being infested with live wood-boring beetles (Haack *et al.*, 2006).

**Table 1** lists organisms associated with wood intercepted at U.S. ports-of-entry between July 5, 2006 (date of full enforcement of ISPM #15) and January 1, 2008. The large majority of the interceptions were wood-boring beetles of the families Scolytidae, Cerambycidae, and Curculionidae. A variety of other insect orders were also found, in addition to weeds and mollusks. These data suggest that live pests are entering with WPM in spite of ISPM #15. It is unknown whether the presence of pests is due to ineffectiveness of the required treatments, incorrectly applied treatments, re-infestation of the wood after effective treatment, or fraudulent use of the stamp/seal.

**Table 2** lists some examples of insect species commonly associated with WPM that have the potential to become established in the Greater Caribbean Region or to spread within the region if they already are established in some Caribbean countries.

## REFERENCES

- Allen, E. A. and L. M. Humble. 2002. Non-indigenous species introductions: A threat to Canada's forests and forest economy. *Canadian Journal of Plant Pathology* 24:103-110.
- Bush, R. J., J. J. Bejune, B. G. Hansen, and P. A. Araman. 2002. Trends in the use of materials for pallets and other factors affecting the demand for hardwood products. 30<sup>th</sup> Hardwood Symposium.
- Clarke, J. W., M. S. White, and P. A. Araman. 2001. Performance of pallet parts recovered from used wood pallets. *Forest Products Journal* 51:1-8.
- Haack R. A., T. R. Petrice, P. Nzoku, and D.P. Kamden. 2006. Do insects infest wood packing material with bark following heat-treatment? IUFRO UNIT 7.03.12 Alien Invasive Species and International Trade Inaugural Meeting, Jedlnia, Poland.
- IPPC. 2006. Guidelines for regulating wood packaging material in international trade (2002) with modifications to Annex I (2006). *In*: FAO (ed) International Standards for Phytosanitary Measures, Secretariat of the International Plant Protection Convention, United Nations Food and Agriculture Organization, Rome.
- MAF. 2003. Sea container review (MAF Discussion Paper No: 35). Ministry of Agriculture and Forestry (MAF), Border Management Group, Auckland, New Zealand.
- Pasek, J. E. 2000. Pest Risk Assessment for Importation of Solid Wood Packing Materials into the United States. USDA-APHIS/USDA Forest Service.
- USDA. 2007a. Agricultural Quarantine Activity Systems - PestID. USDA-APHIS-PPQ. Available at: <https://mokcs14.aphis.usda.gov/aqas/login.jsp>.
- USDA. 2007b. Agricultural Quarantine Activity Systems - WADS. USDA-APHIS-PPQ. Available at: <https://mokcs14.aphis.usda.gov/aqas/login.jsp>.

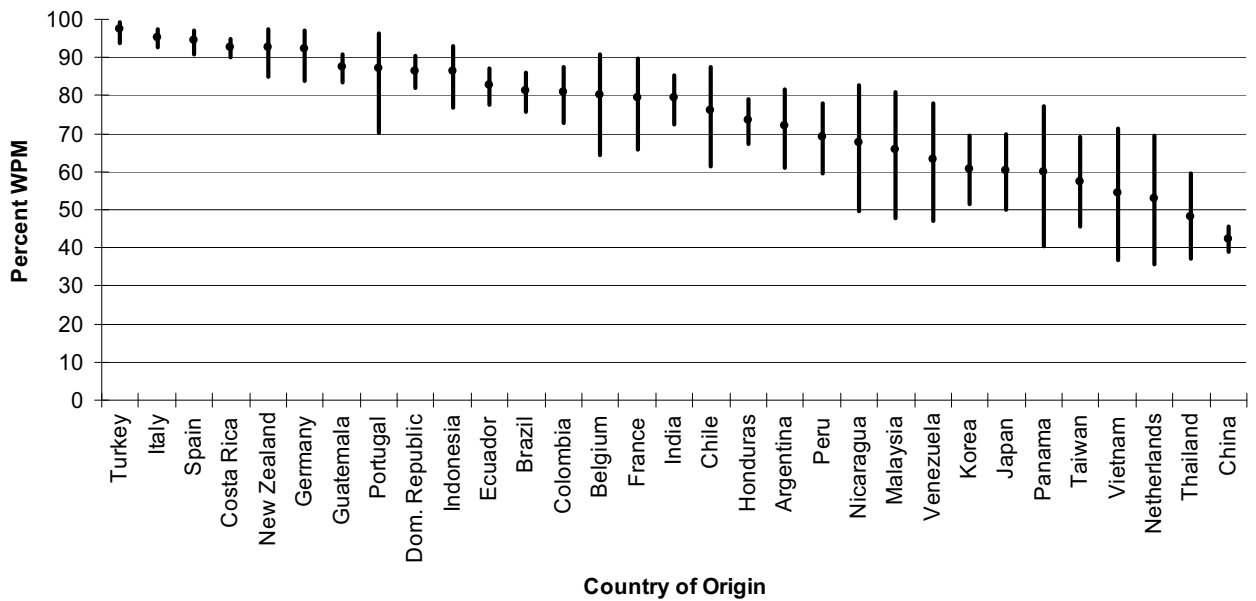

**Figure 1.** Percentage (and 95% binomial confidence interval) of maritime cargo (both agricultural and non-agricultural) imported into the United States that contained WPM (Data source: AQIM data, Sep 16, 2005 - Aug 15, 2007).

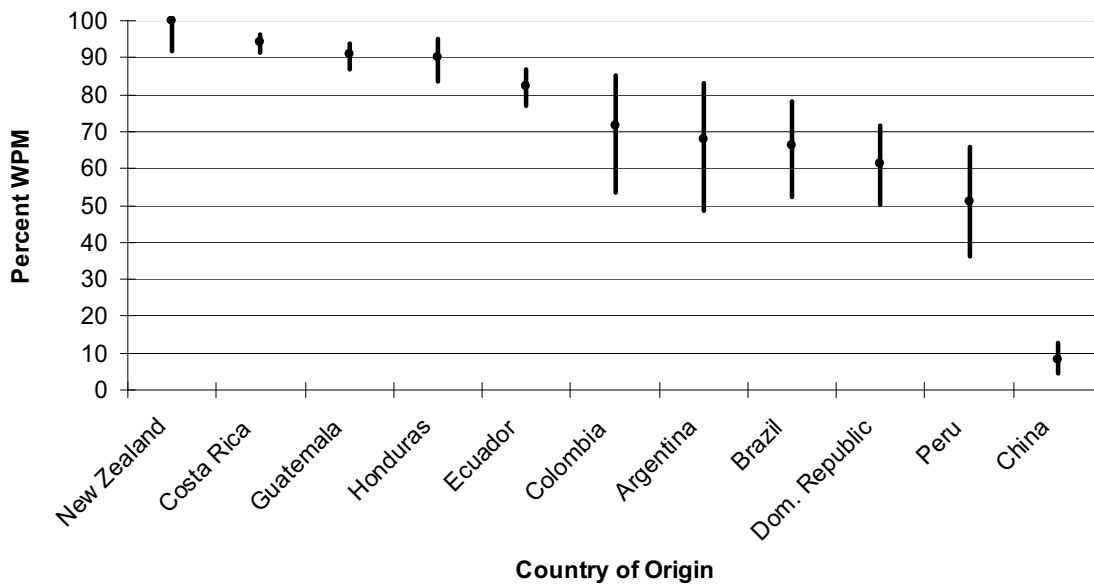

**Figure 2.** Percentage (and 95% binomial confidence interval) of maritime agricultural cargo imported into the United States that contained WPM (Data source: AQIM data, Sep 16, 2005 - Aug 15, 2007).

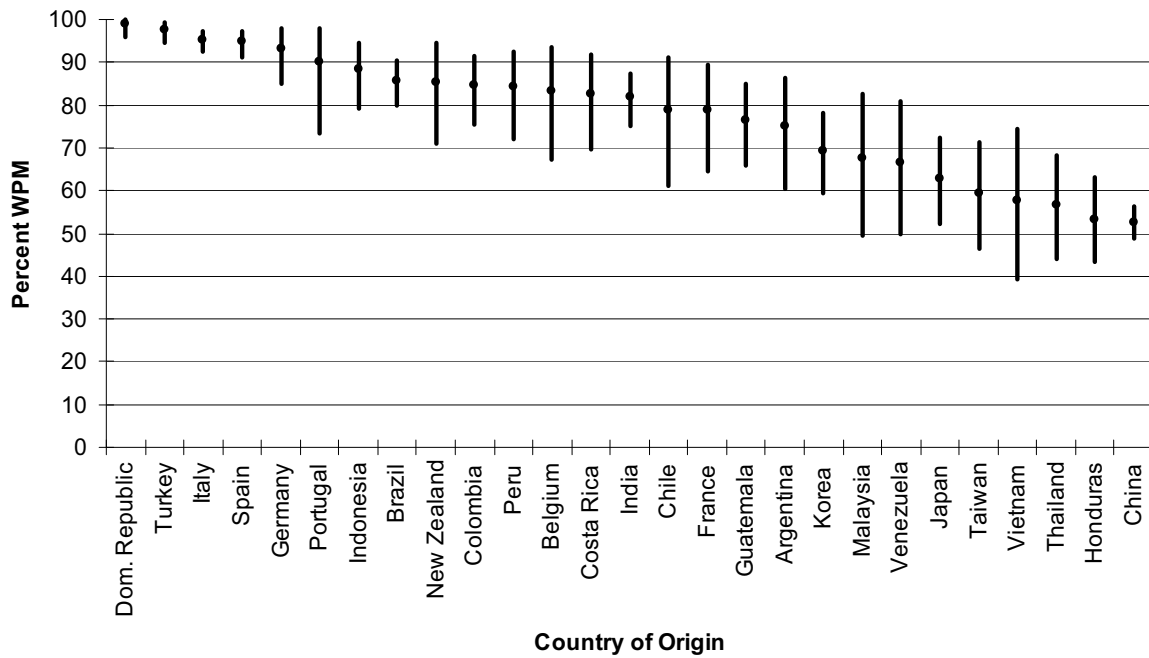

**Figure 3.** Percentage (and 95% binomial confidence interval) of maritime non-agricultural cargo imported into the United States that contained WPM (Data source: AQIM data, Sep 16, 2005 - Aug 15, 2007).

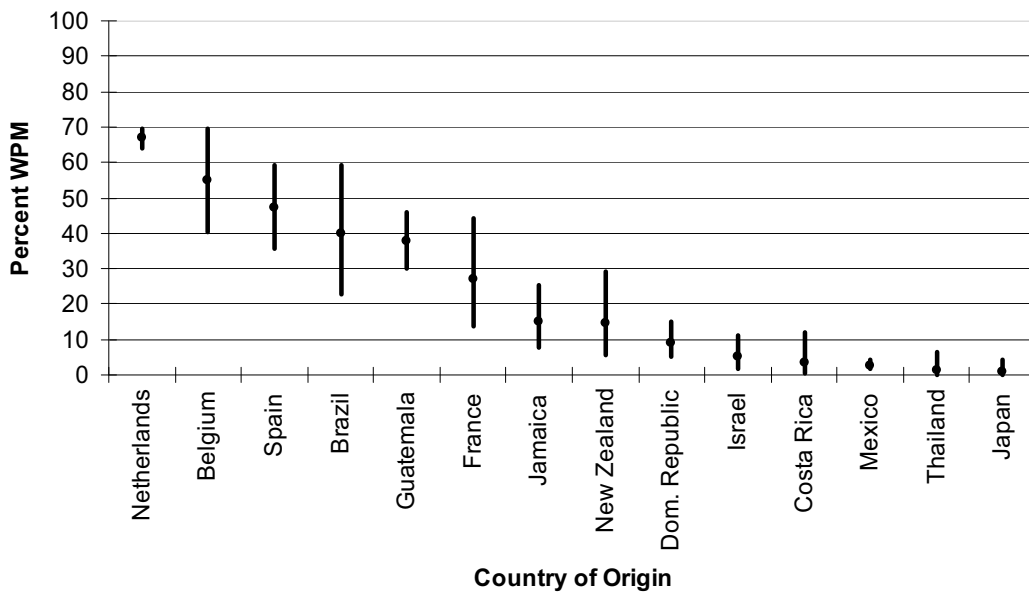

**Figure 4.** Percentage (and 95% binomial confidence interval) of agricultural air cargo imported into the United States that contained WPM (Data source: AQIM data, Sep 16, 2005 - Aug 15, 2007).

**Table 1.** Pest taxa intercepted on or in wood materials at U.S. ports-of-entry between July 5, 2006 and January 1, 2008. (Data source: PestID database).

<b>Order</b>	<b>Family</b>	<b>Interceptions</b>	<b>Specimens</b>
Coleoptera	Anobiidae	2	2
	Bostrichidae	9	32
	Buprestidae	15	16
	Cerambycidae	38	49
	Chrysomelidae	1	3
	Cleridae	3	17
	Corticariidae	1	5
	Cryptophagidae	3	3
	Curculionidae	40	131
	Histeridae	1	1
	Laemophloeidae	1	1
	Mycetophagidae	1	1
	Nitidulidae	2	8
	Platypodidae	8	13
	Scarabaeidae	2	2
	Scolytidae	247	788
	Silvanidae	5	13
	Staphylinidae	1	1
	Tenebrionidae	2	3
	Diptera	Scatopsidae	1
Hemiptera	Aradidae	1	1
	Cixiidae	1	1
	Coreidae	1	1
	Miridae	1	1
	Reduviidae	1	1
	Rhyparochromidae	1	1
	Hymenoptera	Apidae	1
	Formicidae	8	78
Isopoda	unknown	1	3
Isoptera	Rhinotermitidae	4	135
	Termitidae	1	4
Lepidoptera	Geometridae	2	2
	Pyralidae	3	4
	Tineidae	1	1
Mollusks	Cochlicellidae	1	3
	Helicidae	2	12
Orthoptera	Gryllidae	2	2
	Tettigoniidae	1	2
<b>TOTAL</b>		<b>424</b>	<b>1,346</b>

**Table 2.** Examples of insects that have been intercepted on WPM and have the potential to be introduced into one or more countries of the Greater Caribbean Region.

<b>Coleoptera: Bostrichidae</b>
<i>Heterobostrychus brunneus, Sinoxylon anale, Sinoxylon crassum, Xylothrips flavipes</i>
<b>Coleoptera: Buprestidae</b>
<i>Buprestis haemorrhoidalis, Melanophila cuspidata</i>
<b>Coleoptera: Cerambycidae</b>
<i>Callidiellum rufipenne, Monochamus alternatus, Plagionotus christophi, Pyrrhidium sanguineum, Stromatium barbatum, Xylotrechus grayi, Xylotrechus magnicollis</i>
<b>Coleoptera: Curculionidae</b>
<i>Pissodes pini</i>
<b>Coleoptera: Scolytidae</b>
<i>Carphoborus minimus, Carphoborus pini, Cryphalus asperatus, Cryphalus piceae, Crypturgus cinereus, Crypturgus mediterraneus, Crypturgus numidicus, Dryocoetes autographus, Dryocoetes villosus, Euwallacea validus, Gnathotrichus materiarius, Hylastes angustatus, Hylastes ater, Hylastes attenuatus, Hylastes cunicularius, Hylastes linearis, Hylastes opacus, Hylesinus varius, Hylurgops glabratus, Hylurgops palliates, Hylurgus ligniperda, Ips acuminatus, Ips amitinus, Ips cembrae, Ips mannsfeldi, Ips sexdentatus, Ips typographus, Orthotomicus erosus, Orthotomicus laricis, Orthotomicus proximus, Orthotomicus suturalis, Phloeosinus rudis, Phloeotribus scarabaeoides, Pityogenes bidentatus, Pityogenes bistridentatus, Pityogenes calcaratus, Pityogenes chalcographus, Pityogenes quadridens, Pityogenes trepanatus, Pityokteines curvidens, Pityokteines spinidens, Pityophthorus pityographus, Polygraphus poligraphus, Polygraphus subopacus, Pteleobius vittatus, Scolytus intricatus, Scolytus ratzeburgi, Scolytus scolytus, Taphrorychus bicolor, Taphrorychus villifrons, Tomicus minor, Tomicus piniperda, Trypodendron domesticum, Trypodendron signatum, Xyleborinus alni, Xyleborus californicus, Xyleborus eurygraphus, Xyleborus glabratus, Xyleborus pfeili, Xyleborus similis, Xylechinus pilosus, Xyloterinus politus</i>
<b>Hymenoptera: Siricidae</b>
<i>Sirex noctilio</i>
<b>Hymenoptera: Xiphydriidae</b>
<i>Xiphydria prolongata</i>
<b>Isoptera: Rhinotermitidae</b>
<i>Coptotermes crassus</i>

**Poster #73**

**Airline Passenger Baggage as a Pathway for Exotic Plant Pest Movement through the Greater Caribbean Region**

*Heike E. Meissner, Andrea V. Lemay, and Kimberly A. Schwartzburg, United States Department of Agriculture (USDA), Raleigh, North Carolina 27606, USA. Contact: Heike.E.Meissner@aphis.usda.gov*

**ABSTRACT.**

International air travel has long been considered a significant means of moving pest organisms. Passengers may carry pests (*e.g.*, snails, weed seeds), or items that are infested with pests (*e.g.*, fruits or vegetables). Our objective was to use data collected by the U.S. federal government to estimate plant quarantine material (QM) approach rates (the percentage of sampling units containing QMs) and the annual number of plant QMs entering the United States in airline passenger baggage. We concluded that the pest risk associated with passenger baggage may be considerable. In the United States, the risk from international airline passenger baggage can be mainly attributed to travelers who are visiting family or friends (about one third of the travelers). Several Caribbean countries were among the 25 countries of passenger origin with the highest plant QM approach rates.

**KEYWORDS:** luggage, human-mediated pest movement, plane travel

**INTRODUCTION**

International air travel has served as a conduit for the movement of pest species (Liebhold *et al.*, 2006; NRC, 2002). For example, Laird (1951) pointed out that aircraft are a pathway for insect introductions. Evans *et al.* (1963) found significant numbers of arthropods in both baggage compartments and passenger cabins of international aircraft. Takahashi (1984) reported finds of insect vectors of human diseases in airplane cabins, and Takeishi (1992) found 5% of the fresh fruits carried illegally by airplane passengers from Thailand to Japan to be infested with fruit flies. Our objective was to estimate the pest risk associated with the airline passenger baggage, based on United States Department of Agriculture (USDA) and Department of Homeland Security (DHS) data.

**MATERIALS AND METHODS**

We used U.S. Agricultural Quarantine Inspection Monitoring (AQIM) (USDA, 2006) data to estimate approach rates of plant quarantine materials (QMs) associated with international airline passenger baggage arriving in the United States. Plant QMs are any plants or plant parts that are prohibited from entering the United States. AQIM data are collected through a detailed inspection of randomly selected sampling units, *i.e.*, they are unbiased and thus suitable for risk quantification. AQIM data do not include useable information on pest interceptions.

The AQIM data used in this study were collected at 30 U.S. airports between Jan. 1, 2005 and Aug. 22, 2007. The plant QM approach rate is the percentage of sampling units in which plant QMs are found. The sampling unit is the group of airline passengers traveling together under one U.S. customs declaration. Estimates are presented as 95% binomial confidence intervals, *i.e.*, the limits within which the actual approach rates lie with 95% certainty (Steel *et al.*, 1997). Treatment groups with sample sizes under 30 were not considered for this analysis.

## RESULTS AND DISCUSSION

An estimated 1.4 million QMs enter the United States annually in airline passenger baggage (Table 1). Only a fraction of these QMs will be infested with pests, and for most countries, the pest risk associated with airline passengers is probably not comparable to the commodity import pathway; however, the risks associated with this pathway may nevertheless be considerable. Since the worldwide air transportation network can quickly connect geographically distant but climatically similar regions (Tatem and Hay, 2007), the plant QMs that do move may carry exotic plant pests that can easily adapt to the new environment. In the United States, the risk from international airline passenger baggage can be mainly attributed to travelers who are visiting family or friends (Figure 1) (about one third of the travelers). In contrast, tourists or business travelers represent a smaller risk to the United States. For most other countries in the Greater Caribbean Region, the majority of visitors are tourists.

A total of 237 different countries of origin were represented in the AQIM data set. Of these, 164 had sample sizes of 30 or higher and were therefore included in the following analysis. Twenty-nine countries of origin with sample sizes of 30 or higher are located in the Greater Caribbean Region. Plant QM approach rate estimates for the countries of origin ranged between zero (lowest lower CL) and 62% (highest upper CL). Figure 2 shows the 25 countries with the highest plant QM approach rates. In some cases, the 95% binomial confidence intervals were large, due to relatively small sample sizes. For Angola, Botswana, French Guyana, Georgia, Luxembourg, Mongolia, Oman, Samoa, and Sudan, binomial confidence intervals included zero, *i.e.*, the plant QM approach rates were not significantly different from zero. Out of the 25 countries with the highest approach rates, ten were Caribbean countries: Haiti (21%), Bonaire (18%), St. Vincent (13%), Grenada (13%), Guadeloupe (12%), St. Lucia (11%), Antigua (9%), Bahamas (9%), Jamaica (8%), and Dominica (8%). The plant QM approach rates for all available Caribbean countries of origin are depicted in Figure 3.

Port inspections can discover only a fraction of what is entering. Thus, it is unlikely that the existing pest risk associated with airline passenger pathways can be mitigated effectively by inspection alone. It may be possible to improve inspection efficiency by increasing the number of inspectors and by providing them with more adequate inspection equipment and facilities. However, additional ways of preventing exotic species introduction will have to be pursued. Many travelers are unaware of existing laws concerning plant QMs and the potential consequences of introducing plant pests. Public awareness programs may help to keep travelers from unknowingly introducing exotic species, and larger fines may help to deter intentional smuggling.



Airline passenger baggage may present an important pathway for the movement of exotic pests into and within the Greater Caribbean Region. The following measures for improved safeguarding may be considered:

- **Show educational videos** in airplanes and in airports to ensure that travelers understand what materials are prohibited and what the biological and economic consequences of unintentional pest introduction may be. Articles in airline magazines, as well as posters at airports, may serve the same educational purpose.
- **Remind plane passengers to consume or discard prohibited materials** during the flight. The flight crew could make repeated announcements reminding travelers that they are not allowed to take certain materials into the destination countries. When collecting trash before landing, the flight crew could also specifically ask for fruits, vegetables, seeds, plants, meats, *etc.*
- **Print statement on international flight tickets** making travelers aware of the regulations and giving them a contact phone number or website address where they can find details.
- **Assess severe fines** for introducing prohibited materials. These fines should be widely advertised to serve as a deterrent to intentional smuggling.

## REFERENCES

- Evans, B. R., C. R. Joyce, and J. E. Porter. 1963. Mosquitoes and other arthropods found in baggage compartments of international aircraft. *Mosquito News* 23:9-12.
- Laird, M. 1951. The accidental carriage of insects on board aircraft. *Journal of the Royal Aeronautical Society* 55:735-743.
- Liebhold, A. M., T. T. Work, D. G. McCullough, and J. F. Cavey. 2006. Airline baggage as a pathway for alien insect species invading the United States. *American Entomologist* 52:48-54.
- NRC. 2002. *Predicting Invasions of Nonindigenous Plants and Plant Pests*. National Academies Press, Washington, D.C.
- Steel, R. G. D., J. H. Torrie, and D. A. Dickey. 1997. *Principles and Procedures of Statistics: A Biometrical Approach*. McGraw-Hill, New York.
- Takahashi, S. 1984. Survey on accidental introductions of insects entering Japan via aircraft. In: Laird, M. (ed) *Commerce and the Spread of Pests and Disease Vectors*, pp 65-79, Praeger Publishers, New York.
- Takeishi, H. 1992. A study on the fruit flies (Diptera: Tephritidae) found in the fresh fruits carried by passengers from Thailand to Narita Airport, Japan. *Research Bulletin of the Plant Protection Service, Japan*:75-78.
- Tatem, A. and S. Hay. 2007. Climatic similarity and biological exchange in the worldwide airline transportation network. *Proceedings of the Royal Society (Biological Sciences)* 274:1489-1496.
- USDA. 2006. *Agricultural Quarantine Inspection Monitoring (AQIM) Handbook*. USDA-APHIS-PPQ.

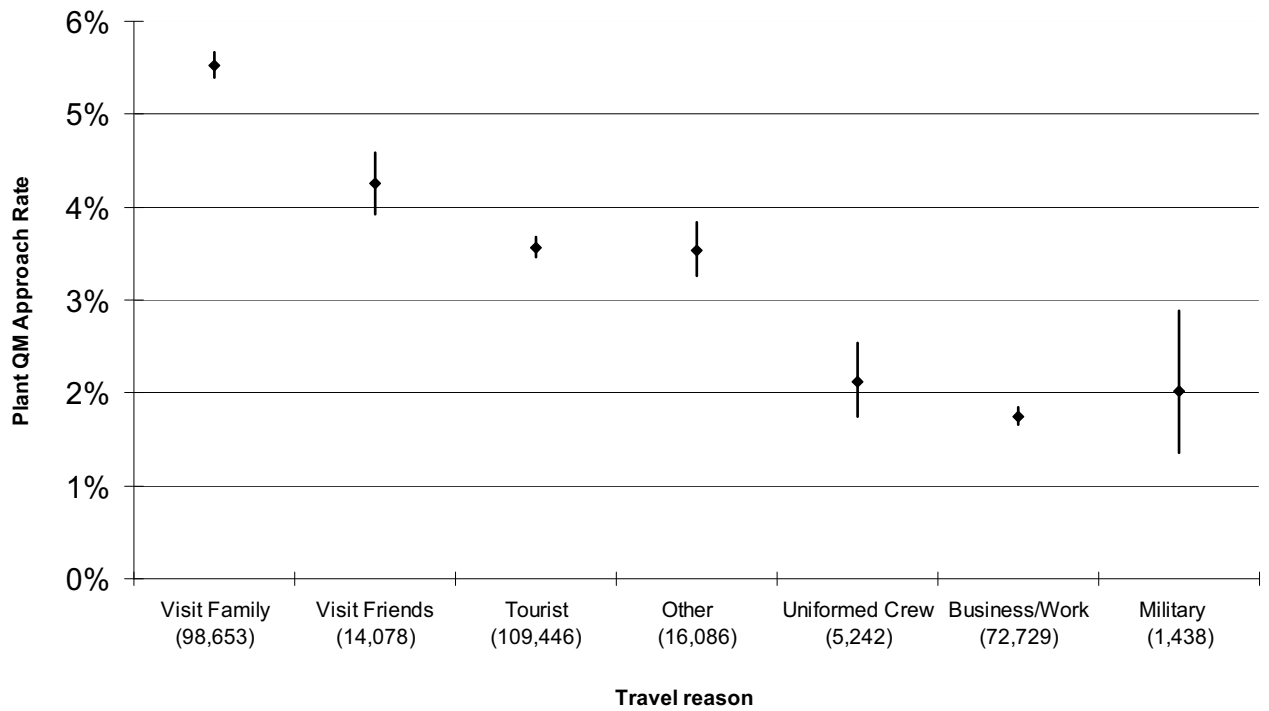

**Figure 1.** 95% binomial confidence intervals for plant QM approach rates in international airline passenger baggage at U.S. ports-of-entry. Sample sizes in parentheses. Sample sizes < 30 were excluded from the analysis. Data source: Agricultural Quarantine Inspection Monitoring (AQIM) data of the USDA collected between Jan. 1, 2005 and Aug. 22, 2007.

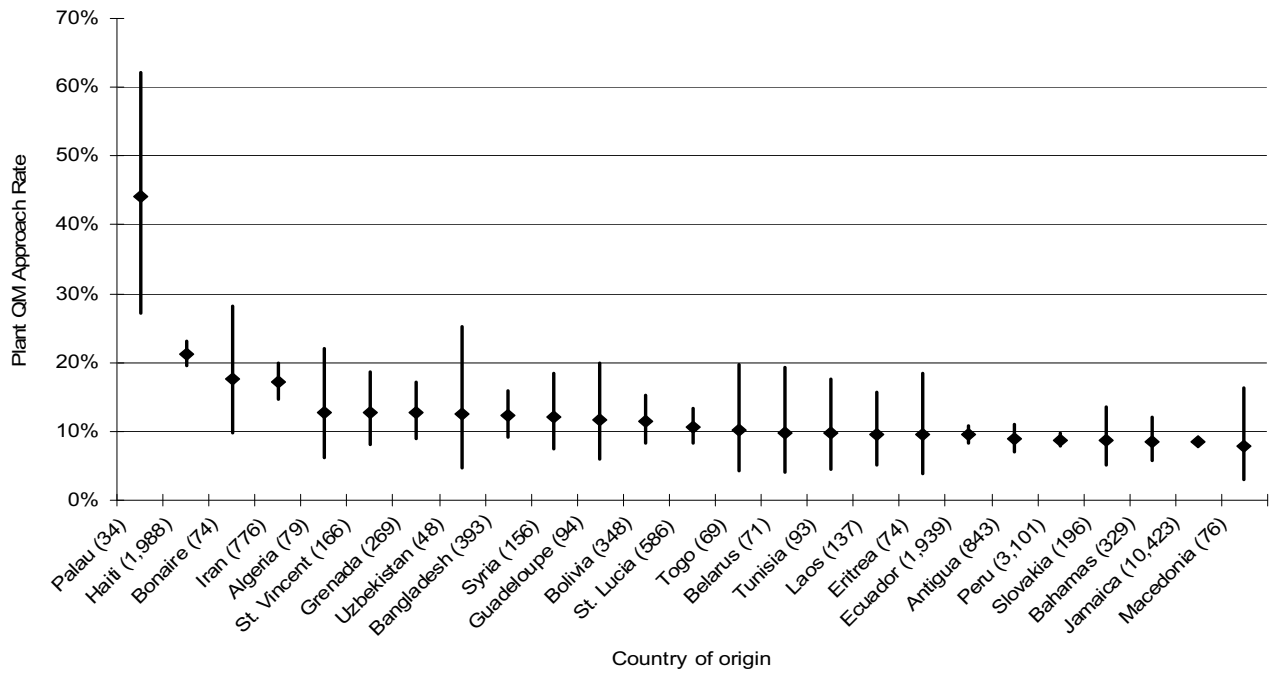

**Figure 2.** 95% binomial confidence intervals for plant QM approach rates in international airline passenger baggage at U.S. ports of entry. By country of passenger origin (sample sizes in parenthesis). Shows the 25 countries of origin with the highest approach rates. Countries with samples sizes < 30 were omitted. Data source: Agricultural Quarantine Inspection Monitoring (AQIM) data of the U.S. Department of Agriculture collected between January 1, 2005 and August 22, 2007.

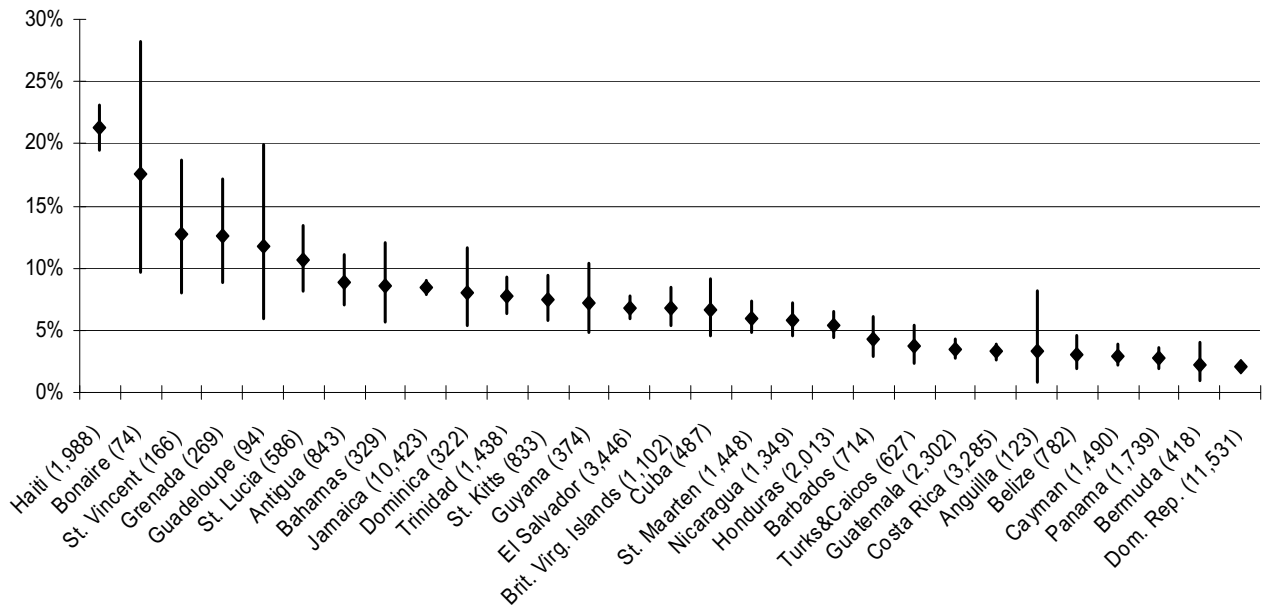

**Figure 3.** 95% binomial confidence intervals for plant QM approach rates in international airline passenger baggage across U.S. ports of entry. Caribbean countries of passenger origin (sample sizes in parenthesis). Countries with sample sizes < 30 were omitted. Data source: Agricultural Quarantine Inspection Monitoring (AQIM) of the U.S. Department of Agriculture collected between January 1, 2005 and August 22, 2007.

**Table 1.** AQIM results of international air passengers arriving at U.S. airports between January 1, 2005 and August 22, 2007.

Passenger groups with QMs <sup>1</sup>	Passengers Inspected <sup>2</sup>	Approach Rate <sup>3</sup>	Passenger groups Entering <sup>4</sup>	QMs Entering <sup>5</sup>
11,977	319,599	3.75%	37 million	1.4 million

<sup>1</sup> Number of passenger groups where QMs were found.  
<sup>2</sup> Number of passenger groups inspected.  
<sup>3</sup> Percentage of passenger groups inspected where QMs were found.  
<sup>4</sup> Number of passenger groups entering the United States annually.  
<sup>5</sup> Predicted number of QMs entering the United States annually.

**Poster #74**

**Likelihood of Hitchhiker Pests Being Moved into and within the Greater Caribbean Region**

*Andrea V. Lemay and Heike E. Meissner, United States Department of Agriculture (USDA), Raleigh, North Carolina 27606, USA.*

*Contact: Heike.E.Meissner@aphis.usda.gov*

**ABSTRACT.**

A “hitchhiker” pest is defined as an agricultural pest organism moving in or on a commodity which is not one of its hosts or moving in or on a conveyance (airplane, ship) or shipping container. Our objective was to examine the movement of plant pests as hitchhikers in trade. We examined USDA data and the scientific literature to address the frequency of hitchhiking pests arriving at airports and maritime ports in the Greater Caribbean Region. We concluded that most insects, mollusks, weed seeds, and plant pathogens are likely to survive shipping conditions. Of the 6.2 million cargo containers entering maritime ports within the Greater Caribbean Region, more than 1.4 million were estimated to have arrived with contaminants. The immense number of conveyances and containers circulated in international trade make this a pathway that presents a high risk, but is difficult to control.

**KEYWORDS:** contaminating pest, trade-mediated pest movement, hitchhiker

**INTRODUCTION**

Hitchhiker pests may get into or onto a commodity, conveyance, or container either by pure chance (*e.g.*, nematodes in soil on truck tires) or because they are attracted by certain conditions or characteristics. For example, flying insects may be attracted by airplane lights during nighttime loading (Caton, 2003), or insects or mollusks may find shelter on or in cargo containers. Furthermore, pests originally associated with a shipment of a host commodity (fruit, seed, whole plant, *etc.*) may be left behind in a container or conveyance after unloading of the commodity, thus becoming hitchhiker pests. The scientific literature mentions numerous cases of hitchhiker pests arriving at ports in cargo holds, aircraft cabins, or shipping containers (Dale and Maddison, 1984; Gadgil *et al.*, 2000; Gadgil *et al.*, 2002; Smith and Carter, 1984; Takahashi, 1984).

**Aircraft holds.** In the United States, live pests have been intercepted in aircraft holds, stores, and quarters. Between 1997 and 2007, over 1,900 live pest interceptions, including insects, weeds, a mollusk, and a mite, were recorded from aircraft holds (Table 1) (USDA, 2007a). The majority (87%) of the pest interceptions in aircraft holds were made at Miami International Airport (MIA) in Miami, FL. Between 2005 and 2007, 677 records of live pests requiring mitigation in Florida were intercepted at MIA in aircraft holds (USDA, 2007a). Although 89,270 of the foreign aircraft arriving at MIA were inspected between 2005 and 2007 (USDA, 2007b), we were unable to calculate pest approach rates because aircraft inspections are not uniform (*i.e.*, an inspection does not

necessarily include an inspection of the holds). Due to limitations in the dataset, we also were unable to calculate contamination rates of aircraft arriving from a particular origin.

**Sea cargo containers.** Gadgil *et al.* (2000) estimated an approach rate of 23% for sea cargo containers arriving at New Zealand ports with external contamination with plant pests, pathogens, or soil containing plant pests or pathogens. Using this approach rate, we calculated the number of contaminated sea cargo containers entering countries within the Greater Caribbean Region (Table 2). The majority of ports in the Greater Caribbean Region report container traffic in twenty-foot equivalent units (TEU), not by actual number of container boxes. To convert TEUs to containers, we first estimated the ratio of twenty-foot and forty-foot containers arriving at a port (other container sizes exist, but twenty-foot and forty-foot containers are most common). Based on those ports in the region that reported the number of each type of container, an estimated 80% of the containers were forty-foot containers and the remaining 20% were twenty-foot containers. Based on this, we estimated that of the 6.2 million containers arriving annually at ports within the Greater Caribbean Region, ca. 1.4 million arrive with contaminants.

**Maritime vessels.** Maritime vessels, including ship decks, holds, and stores, may be contaminated with live pests, soil, or other debris. Inspections of maritime vessels, including ship holds and stores, at U.S. ports-of-entry have resulted in interceptions of live pests, including pests of agricultural importance (Table 1) (USDA, 2007a).

## REFERENCES

- Caton, B. 2003. Quantitative analysis of insect pest risks from the international cargo aircraft pathway to Miami. USDA-APHIS-PPQ, Center for Plant Health Science and Technology, Plant Epidemiology and Risk Analysis Laboratory, Raleigh, NC.
- Dale, P. S. and P. A. Maddison. 1984. Transport services as an aid to insect dispersal in the South Pacific, pp. 225-256. In: M. Laird [ed.], *Commerce and the Spread of Pests and Disease Vectors*. Praeger Publishers, New York.
- Gadgil, P. D., L. S. Bulman, R. Crabtree, K. L. Glassey, J. C. O'Neil, and R. N. Watson. 2000. Significance to New Zealand forestry of contaminants on the external surfaces of shipping containers. *New Zealand Journal of Forestry Science* 30:341-358.
- Gadgil, P. D., L. S. Bulman, and K. L. Glassey. 2002. Quarantine risk associated with air cargo containers. *New Zealand Journal of Forestry Science* 32:28-42.
- Smith, A. and I. D. Carter. 1984. International transportation of mosquitoes of public health importance, pp. 1-21. In: M. Laird [ed.], *Commerce and the Spread of Pests and Disease Vectors*. Praeger Publishers, New York.
- Takahashi, S. 1984. Survey on accidental introductions of insects entering Japan via aircraft, pp. 65-79. In: M. Laird [ed.], *Commerce and the Spread of Pests and Disease Vectors*. Praeger Publishers, New York.
- USDA. 2007a. Agricultural Quarantine Activity Systems - PestID. USDA-APHIS-PPQ. Available at: <https://mokcs14.aphis.usda.gov/aqas/login.jsp>.
- USDA. 2007b. Agricultural Quarantine Activity Systems - WADS. USDA-APHIS-PPQ. Available at: <https://mokcs14.aphis.usda.gov/aqas/login.jsp>.

Table 1. Important <sup>1</sup> pest families intercepted at U.S. ports-of-entry on maritime vessels (including holds and stores), aircraft cargo holds, or containers (USDA, 2007a).	
<b>Arthropods</b>	
Coleoptera	Bostrichidae, Buprestidae, Cerambycidae, Chrysomelidae, Curculionidae, Dryophthoridae, Elateridae, Meloidae, Platypodidae, Scarabaeidae, Scolytidae, Tenebrionidae
Diptera	Agromyzidae, Chloropidae, Tephritidae
Hemiptera	Achilidae, Aleyrodidae, Alydidae, Aphididae, Aphrophoridae, Aradidae, Cercopidae, Cicadellidae, Cicadidae, Cixiidae, Cydnidae, Delphacidae, Diaspididae, Lygaeidae, Membracidae, Miridae, Oxycarenidae, Pachygronthidae, Pentatomidae, Psyllidae, Pyrrhocoridae, Rhopalidae, Rhyparochromidae, Scutelleridae, Tingidae
Hymenoptera	Apidae, Formicidae, Siricidae
Isoptera	Termitidae
Lepidoptera	Acrolophidae, Agryresthiidae, Arctiidae, Crambidae, Ctenuchidae, Elachistidae, Gelechiidae, Geometridae, Gracillariidae, Hesperidae, Limacodidae, Megalopygidae, Noctuidae, Notodontidae, Nymphalidae, Oecophoridae, Psychidae, Pyralidae, Saturniidae, Sesiidae, Sphingidae, Tineidae, Tortricidae
Orthoptera	Acrididae, Gryllidae, Gryllotalpidae, Pyrgomorphidae, Romaleidae, Tetrigidae, Tettigoniidae
<b>Weeds</b>	
	Asteraceae, Solanaceae
<b>Mollusks</b>	
Pulmonata	Achatinidae, Agriolimacidae, Arionidae, Bradybaenidae, Cochlicellidae, Helicidae, Limacidae, Pleurodontidae, Succineidae
Stylommatophora	Hygromiidae

<sup>1</sup> All of these families contain many species that are pests of agricultural importance and are capable of active dispersal.

Table 2. Number of containers and estimated number of contaminated containers arriving at ports-of-entry in the Greater Caribbean Region.  
(Data obtained from port authority websites, trade websites, and publications.)

<b>Country</b>	<b>Containers arriving<sup>1</sup></b>	<b>Containers contaminated</b>
Aruba <sup>2</sup>	8,830	2,066
Bahamas <sup>2</sup>	415,758	97,287
Barbados <sup>2</sup>	27,752	6,494
Belize <sup>2</sup>	12,258	2,868
Cayman Islands <sup>2</sup>	18,002	4,212
Costa Rica <sup>2</sup>	418,835	98,007
Cuba <sup>3</sup>	95,132	22,261
Curaçao <sup>2</sup>	27,638	6,467
Dominica <sup>2</sup>	3,329	779
Dominican Republic <sup>3</sup>	107,109	25,063
El Salvador <sup>2</sup>	39,433	9,227
Guatemala <sup>2</sup>	227,409	53,214
Guadeloupe <sup>3</sup>	46,961	10,989
Haiti <sup>4</sup>	166,647	38,995
Honduras <sup>3</sup>	176,498	41,300
Jamaica <sup>3,5</sup>	543,633	127,210
Netherland Antilles <sup>5</sup>	481,522	112,676
Nicaragua <sup>2</sup>	15,073	3,527
Panama <sup>2</sup>	1,190,592	278,512
Puerto Rico <sup>3</sup>	518,217	121,263
St. Lucia <sup>2</sup>	12,368	2,894
St. Martin <sup>5</sup>	132,111	30,914
Trinidad and Tobago <sup>3,4</sup>	126,440	29,587
United States (Alabama, Florida, Louisiana, Mississippi, Texas) <sup>2,3</sup>	1,461,171	341,915
<b>Regional total<sup>6</sup></b>	<b>6,272,718</b>	<b>1,467,727</b>

<sup>1</sup> Containers entering include only those arriving at the port. The number may be the actual number reported or may be estimated from the number of TEUs reported.

<sup>2</sup> Based on 2006 data.

<sup>3</sup> Based on 2005 data.

<sup>4</sup> Based on 2004 data.

<sup>5</sup> Based on 2003 data.

<sup>6</sup> Data for some ports and countries or territories were not available.



**Poster #75**

**Control of Broad Mite, *Polyphagotarsonemus Latus* and the Whitefly, *Bemisia tabaci*, in Open Field Pepper and Eggplant with Predaceous Mites**

*José Castillo and Philip A. Stansly. University of Florida/IFAS  
Southwest Florida Research and Education Center, Immokalee, Florida 34142.  
[jacastil@ufl.edu](mailto:jacastil@ufl.edu); [pstansly@ufl.edu](mailto:pstansly@ufl.edu)*

The broad mite, *Polyphagotarsonemus latus* (Banks), and the sweetpotato whitefly, *Bemisia tabaci* (Gennadius), are serious pests of pepper and eggplant in Florida and elsewhere. In greenhouse-grown pepper, both pests have been controlled by *Amblyseius swirskii* and broad mite has been controlled by *A. cucumeris*; however, there have been no reports regarding the effectiveness of these Phytoseiid mites in open field pepper or eggplant. We evaluated both predaceous mite species in eggplant and ‘Serrano’ pepper in experimental plots in southwest Florida, and also assessed control of broad mite in ‘bell’ pepper on a commercial farm in the same region. Both mites controlled broad mite on both crops, although fewer releases were necessary and better control was achieved with *A. swirskii* than with *A. cucumeris*. In addition, *A. swirskii* controlled *B. tabaci* which is an especially important pest of eggplant in this region. Both pepper and eggplant receiving *A. swirskii* yielded significantly more fruit than untreated plants or even eggplants receiving two acaricide sprays in 2007. However, the cost of releasing *A. swirskii* in eggplant exceeded average insecticide costs by a factor of 2 or more. Furthermore, *A. swirskii* did not provide adequate control of the spider mite, *Tetranychus urticae* Koch, another important pest of this crop in south Florida. Therefore, further research is warranted to define lower effective rates of *A. swirskii* and combinations with spider mite specific predators.

**KEYWORDS:** Phytoseiid mites, cost *Tetranychus urticae*, release rates

**Poster #76**

**Demonstrating Integrated Pest Management of Hot Peppers**

*Jesusa Crisostomo Legaspi<sup>1</sup>, Cassel Gardner<sup>1</sup>, Gilbert Queeley<sup>2</sup>, Norman Leppla<sup>1</sup>, and James Cuda<sup>3</sup>. <sup>1</sup> USDA-ARS-CMAVE, Florida A&M University-Center for Biological Control, 6383 Mahan Drive, Tallahassee, FL 32308; <sup>2</sup> Florida Cooperative Extension Service, CESTA, Florida A&M University, Tallahassee, FL 32307; <sup>3</sup> Entomology and Nematology Department, University of Florida, IFAS, Gainesville, FL 32611. slegaspi@gmail.com*

**ABSTRACT.**

We studied the effects of organic and synthetic chemical fertilizers on crop growth, yield and associated insect pests for two varieties of hot pepper, *Capsicum chinense* Jacquin (Solanaceae): “Scotch Bonnet” and “Caribbean Red” in north Florida. Hot peppers were grown under three treatments: poultry manure; mushroom compost; or “Growers’ Practice”, (conventional pesticides and chemical fertilizers), with equivalent amounts of soil nutrients applied to all treatments. The Growers’ Practice treatment permitted use of conventional insecticides if insect pests exceeded economic thresholds. Plant height and canopy diameter were significantly greater in the mushroom compost treatment for Scotch Bonnet; however, yields were not significantly affected by treatment or variety. The Growers’ practice treatment resulted in lowest plant height in Caribbean Red. The dominant insect pests found were the silverleaf whitefly, *Bemisia argentifolii* Bellows and Perring (Hemiptera: Aleyrodidae); green peach aphid, *Myzus persicae* (Sulzer) (Hemiptera: Aphidae); bandedwinged whitefly, *Trialeurodes abutilonea* (Haldeman) (Hemiptera: Aleyrodidae); and western flower thrips, *Frankliniella occidentalis* (Pergande) (Thysanoptera: Thripidae). Significantly more insect pests were found on Caribbean Red than on Scotch Bonnet, but in none of the treatments did pests reach economic injury levels. Results indicate that hot peppers may be grown without using insecticides in north Florida because insect pests did not reach levels high enough to affect yield. Furthermore, the crops may be grown using relatively inexpensive organic fertilizers because the use of synthetic chemical fertilizers does not result in higher yields. We found that organic methods can be profitable for growers in Florida provided pests remain below economic threshold levels.

**KEYWORDS:** poultry manure; mushroom compost, organic fertilizers, economic thresholds

**Poster #85**

**CIRAD Invasive Species Initiatives in the Caribbean Basin**

*Emmanuel Wicker<sup>1</sup>, Catherine Abadie<sup>2</sup>, Jean Heinrich Daugrois<sup>3</sup>, Luc Baudouin<sup>4</sup>, Michel Dollet<sup>4</sup>, Claude Vuillaume<sup>2</sup> and Pierre-Yves Teycheney<sup>2,1</sup>.<sup>1</sup>CIRAD-UR 27, PRAM, 97285 Le Lamentin Cedex 2, Martinique, FWI; <sup>2</sup>CIRAD-UPR75 & CIRAD-DG, Station de Neufchateau, 97130 Capesterre Belle-Eau, Guadeloupe, FWI; <sup>3</sup>CIRAD-UPR75, Station de Roujol, 97170 Petit-Bourg, Guadeloupe, FWI; <sup>4</sup>CIRAD-UPR29, Campus international de Baillarguet - TA A-29 / F - 34398 Montpellier Cedex 5. Author for correspondence : teycheney@cirad.fr*

**ABSTRACT.**

CIRAD has developed several initiatives on invasive plant pathogens that are present in the Caribbean. These initiatives are primarily focused on *Ralstonia solanacearum*, Black Sigatoka, coconut lethal yellowing and viral diseases of sugarcane and banana. They include research activities, transfer of diagnosis techniques to plant protection and quarantine services, and participation to surveillance networks, either existing or under construction.

Epidemiological studies are the key component of many of our research activities, which are often carried out in the frame of collaborative projects. This is best illustrated by the surveys that were recently carried out in Grenada and that are in progress in St. Vincent on banana Moko disease (*Ralstonia solanacearum* race 2). Epidemiological studies were also carried out in Guadeloupe and Martinique on several pathogens affecting sugarcane, such as sugarcane yellow leaf virus and leaf scald disease, and on banana streak viruses. Likewise, surveys were carried out in St. Lucia, St. Vincent, Dominica and Suriname in order to confirm the presence/absence of Black Sigatoka, and in most Caribbean islands for characterising recent disease foci of coconut lethal yellowing.

Diagnosis and monitoring tools and techniques are one of the major outputs of our research activities. Transfers of these tools and techniques towards plant protection and quarantine services of Caribbean countries are achieved through collaborative projects and courses.

CIRAD also plays an active role in several projects and global surveillance networks such as PANDOeR and the current initiatives for promoting plant health in the Region. Its current projects involve the development of a regional Black Sigatoka surveillance and control network and a participatory database on major diseases of banana, coconut, horticultural crops, sugarcane and yam.

**KEYWORDS:** epidemiological surveys, surveillance and control network, participatory database, *Ralstonia solanacearum*, Black Sigatoka, coconut lethal yellowing, viral diseases of sugarcane and banana

## FOOD SCIENCE AND POSTHARVEST TECHNOLOGY

2008 Proceedings of the Caribbean Food Crops Society. 44(2):641-650. 2008

### Poster #77

#### Biogas Production from Rice Hulls and Straw Treated with Urea

*Amarely Santana<sup>1</sup>, Jerry Gabriel, Pascal Fenelus, Eliezer Louis, Juguette Badette, Carlos Miguel De Jesús Arias<sup>2\*</sup>. Animal Science Department<sup>1,2</sup>; Universidad ISA, La Herradura, Santiago, República Dominicana*

#### ABSTRACT.

The rice production of Dominican Republic is around half million of TM per year, from which 50% is crops residues (hull and straw). This high production of fiber is used as feed, poultry bedding and organic fertilizer. Taking in account this amount of fiber as a very good source to produce biogas, ISA University setup two trial of 60 day to evaluate the biogas yields using two substrate of rice crops residues (hulls and straw). The trials consisted of rice hulls and straws treated with urea and rabbit urine or fresh bovine manure under environmental conditions. The Trials had a randomized design, however, the rice hull trials had two treatments and three repetitions and the straws trial had four treatments with three repetition. The evaluated variable was the biogas production ( $\text{dm}^3$ ) per kg of DM in 10 d periods. The rice hulls treated with rabbit urine yields about 57.38  $\text{dm}^3$  /kg de DM in 60 d and the rice straws treated with rabbit urine and bovine manure yields 98.28  $\text{dm}^3$  /kg DM. From these trials we conclude that it is possible to produce a good yield per kg of DM of biogas from rice crops residues with artisanal biodigester

**KEYWORDS:** Crops residues, rice, biogas, yield.

#### INTRODUCCION

Con el término biogás se designa la mezcla de gases resultantes de la descomposición de la materia orgánica realizada por acción bacteriana en condiciones anaeróbicas. El biogás es un gas combustible usado para secar, cocinar, hacer marchar un motor generador y producir electricidad. La tecnología del biogás se constituye una valiosa alternativa para el aprovechamiento de los desechos agropecuarios, pues permite disminuir la carga contaminante al ambiente, mejorar la capacidad fertilizante del material, eliminar los malos olores y generar combustible. Además, el efluente obtenido después de la digestión anaeróbica sustituye los abonos químicos mediante la producción de un abono biológico vegetal de gran valor compatible con las plantas (Cavidad, 1997).

Los países pobres invierten muchísimo dinero para adquirir el petróleo, como es el caso de la República Dominicana y de la República de Haití. Esta situación hace que los campesinos de estos países utilicen otros sustitutos de combustible tales como la leña y el carbón para satisfacer sus necesidades y sea necesario investigar sobre fuentes alternativas de combustible no dañinas para el medio ambiente (OMS, 2006).

Para la producción de biogás se necesita de un sustrato, el cual debe ser fermentado por una colonia de bacterias en condiciones anaeróbicas. La disponibilidad y la calidad del sustrato pueden influir en la producción del biogás (Caneta *et al.*, 2001).

Se considera que la cáscara y el rastrojo de arroz pueden ser buenos sustratos para la producción de biogás. La cáscara de arroz está disponible en la República Dominicana con una producción de más de 2.44 millones de quintales por año (IICA, 2003). En cuanto a la calidad, la degradación microbiológica de la celulosa contenida en la cáscara y rastrojo de arroz no se puede conseguir en forma directa, tal como se hace en los residuos domésticos, pues hay junto a ella un componente, la lignina que representa un 16% de la cáscara de arroz, que no es atacable por los microorganismos. Se necesita articular mecanismos que permitan utilizarlo de forma más eficiente. Una alternativa es la producción de biogás, utilizando aditivos que estimulen el proceso de fermentación. Este tratamiento puede ser a base de urea o hidróxido de sodio (Souza *et al.*, 1999). Según estudios realizados se afirmó que la amonificación de heno por medio de tratamiento con urea provocó una disminución en las fracciones FDN (Fibra Detergente Neutro), FDA (Fibra Detergente Acido), celulosa y lignina (Rodríguez, 1998; Peña, et al., 2001).

La urea es una de las mejores fuentes de nitrógeno (46%) y la misma se puede utilizar para tratar pajas y otros residuos fibrosos en la alimentación animal y en la producción de biogás. Sin embargo la orina de conejos (1 litro=20 gramos de nitrógeno) representa una fuente sostenible y valiosa de nitrógeno que puede sustituir a la urea industrial (Preston, 1999).

Producir biogás y evaluar diferentes biomásas vuelven a ser temas de estudio importantes. Tanto para República Dominicana como para Haití, las diferentes razones, antes expuestas hacen que, evaluar diferentes tipos de sustratos para producir biogás, es contribuir a la solución de disminuir el gasto en combustibles fósiles y a la preservación del ambiente (COPDES, 2006; BME, 2000). Con el propósito de comparar la producción de biogás a partir de la cáscara y rastrojo de arroz tratadas con una fuente de nitrógeno industrial, la urea y otra natural, la orina de conejos se ha hecho esta investigación.

## **MATERIALES Y METODOS**

### **Localización del estudio**

Los experimentos se llevaron a cabo en el campo experimental de la Universidad ISA, en La Herradura, Santiago, República Dominicana, durante el período de 10 de noviembre de 2006 hasta el 10 de enero de 2007. Esta zona presentan las siguientes condiciones geoclimáticas: latitud 19°21' norte, longitud 71°44' oeste, altitud 160 msnm, temperatura media anual 26°C, precipitación media anual 970 mm y humedad relativa 84.28 %.

### **Diseño experimental y Tratamientos**

En el experimento 1 y 2, se utilizó un diseño completamente al azar. Sin embargo en el experimento 1 consto de 2 tratamientos y 3 repeticiones para un total de 6 unidades experimentales y en el experimento 2 se evaluó con 4 tratamientos y 3 repeticiones para un total de 12 unidades experimentales. Los tratamientos fueron nitrógeno industrial (urea) y nitrógeno natural (orina de conejos) para tratar la cáscara de arroz en el

experimento 1 y paja de arroz sola, paja de arroz con estiércol de vaca, paja de arroz con urea y paja de arroz con orina de conejos en el experimento 2.

El modelo estadístico que se utilizó en los dos experimentos para analizar la variación entre los tratamientos y el error fue el siguiente:

$$Y_{ij} = \mu + T_i + \varepsilon_{ij}$$

donde:

$\mu$  = media de la población

$T_i$  = efecto del i-ésimo tratamiento ( $i = 1, 2, \dots$ )

$\varepsilon_{ij}$  = desviación al azar de la j-ésima repetición del i-ésimo tratamiento (error experimental)

Las variables calculadas en los distintos tratamientos fue: **producción de biogás en  $\text{dm}^3$  por kg de materia seca**. La producción de biogás se evaluó en períodos de 10 días (PBPMS) cuyos valores se sumaron para tener una producción de biogás total (PBTMS) en  $\text{dm}^3$  por kg de materia seca, donde  $\text{PBTMS} (\text{dm}^3/\text{kg}) = \sum \text{PBPMS} (\text{dm}^3/\text{kg})$ . La producción de biogás del período por kg de materia seca (PBPMS) ( $\text{dm}^3/\text{kg}$ ) =  $\text{PBP} (\text{dm}^3) / \text{peso de materia seca (kg)}$  se calculó dividiendo la producción de biogás del período en  $\text{dm}^3$  (PBP) por el peso seco del sustrato en kg. La producción de biogás del período PBP ( $\text{dm}^3$ ) =  $\sum V (\text{dm}^3)$  para cada tratamiento se obtuvo a partir de la sumatoria de los volúmenes diarios (V) del período en  $\text{dm}^3$ . El volumen diario (V) se calculó mediante lectura tomada 2 a 4 veces al día según la cantidad de biogás producida. Para tomar la lectura se anotó la elevación (cm) de la parte superior de la campana con la ayuda de la cinta métrica. Después de tomar la lectura se dejó escapar el biogás abriendo las válvulas. Luego se aseguró mantener cerrada la salida del biogás nuevamente.

#### **Calculo de Volumen de biogás generado por los biodigestores**

El cálculo del volumen fue mediante el siguiente procedimiento: se cálculo del volumen de un tronco de cono conociendo el radio más pequeño, y la generatriz que representa la lectura, o sea el volumen del cono va a variar según la distancia del punto E al punto A donde se va a colocar el cero (ver figura 1). Por ejemplo: determinar el volumen del tronco de generatriz AE, AE', AE'' conociendo el valor de AB, EC, AE, donde AB: Radio pequeño; EC: Radio grande; AD y BC: la Altura; AE: la generatriz y la Lectura máxima.



Figura 1. Campana utilizada para determinar la producción de biogás diaria de cáscara y rastrojo de arroz con urea o orina de conejos

Por lo tanto, el Volumen del tronco de cono se determino mediante la formula  $V = \pi * h (r^2 + R^2 + R * r) / 3$ , donde  $\pi = 3.1416$ ;  $h$  = Altura del tronco del cono;  $r$  = Radio menor;  $R$  = Radio mayor;  $AE'$ : Lectura 1;  $AE''$ : Lectura 2;  $AB = 13$  cm;  $EC = 14.1$  cm;  $AE = 34.1$  cm.

Para determinar el volumen de biogás producido en cada lectura fue necesario conocer: 1)  $r = AB$ ; 2)  $R = E'C'$ ; 3)  $h = BC'$ ; 4)  $L = AE'$ .

El calculo de  $R (E'C')$  se determino por: 5)  $E'C' = E'D' + D'C'$ ; 6)  $D'C' = DC = AB$ ; 7)  $E'C' = E'D' + AB$  (5 y 6); 8) El ángulo  $e = \angle AED = \angle AE'D'$ ; 9) El triangulo  $AED$  rectangular en  $d$ ,  $\triangle AE'D'$  rectangular  $D'$  así; 10)  $\cos \hat{e} = ED / AE = E'D' / AE'$  (8 y 9); 11)  $\cos \hat{e} = E'D' / AE'$  (10); 12)  $E'D' = \cos \hat{e} * AE'$  (10 y 11); 13)  $E'C' = \cos \hat{e} * AE' + AB$ ; 14)  $R = \cos \hat{e} * L + r$  (1, 2, 4 y 10).

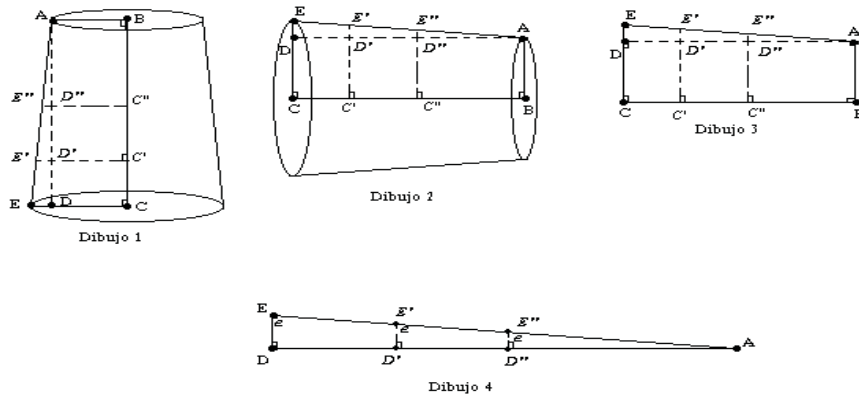
El Cálculo de la altura ( $h$ ) ( $BC'$ ): 15)  $BC' = AD'$ ; 16)  $\text{Seno } \hat{e} = AD / AE = AD' / AE'$  (8 y 9); 17)  $\text{Seno } \hat{e} = BC' / AE'$  (15); 18)  $BC' = AE' * \text{Seno } \hat{e}$ ; 19)  $h = L * \text{Seno } \hat{e}$  (1, 3, 4 y 18); 20)  $AB = 13$  cm; 21)  $EC = 14.1$  cm; 22)  $EC = ED + AB$ ; 23)  $ED = EC - AB$ ; 24)  $ED = 14.1 - 13 = 1.1$  (20 y 21); 25)  $AE = 34.1$  cm; 26)  $\cos \hat{e} = ED / AE = 1.1 / 34.1 = 0.035$ ;  $\cos \hat{e} = 0.035$  (10, 24 y 25); 27)  $\hat{e} = \cos^{-1}(0.035)$ ; 29)  $\hat{e} = 87.99$  o 30)  $\text{Seno } \hat{e} = \text{Seno}(87.99)$  = 0.999;  $\text{Seno } \hat{e} = 0.999$ .

Volumen del tronco =  $\pi * h (r^2 + R^2 + R * r) / 3$

Volumen del tronco =  $\pi * L * \sin e [r^2 + (r + L * \cos e)^2 + r * (r + L * \cos e)] / 3$

$V = 0.999 * 3.1416 * L * (13^2 + (13 + 0.035 L)^2 + 13 * (13 + 0.035 L)) / 3$

$V = 3.138 * L * (169 + 169 + 2 * 13 * 0.035 * L + 0.001 * L^2 + 169 + 0.455 * L) / 3$

$V = 3.138 * L * (169 + 169 + 169 + 0.91 L + 0.455 L + 0.001 * L^2) / 3$

$V = 3.138 * L * (507 + 1.365 L + 0.001 * L^2) / 3$

$V = 1.046 * L * (507 + 1.365 L + 0.001 * L^2)$ .

## Manejo del Experimento

### Preparación de los digestores

Se usaron 6 tanques en polietileno de 200 litros como digestores de carga discontinua o de “Batch”, los cuales fueron cargados una vez y vaciados por completo después del tiempo de retención. Los tanques poseían dos tapas, una de ellas, se perforó un hueco en el cual se conectó una manguera de gas (1/2”) que permitió el paso del biogás hacia el depósito de campana flotante. Para mantener pegada la manguera, se utilizó un pegamento para PVC rígido. La otra tapa se mantuvo cerrada durante el experimento (Ver foto 1).

### **Preparación de las Campanas Flotantes.**

**Las campanas para medir la producción de biogás estaban compuesta por dos secciones: la base y la parte superior.**

Base de la campana. La base de la campana, para el experimento 1, correspondió a una caja en madera de 120 cm de largo, 40 cm de ancho y 45 cm de profundidad dividida en tres compartimientos iguales de 40 cm x 40 cm x 45 cm. Dos bases de campana fueron construidas en el taller de la Universidad ISA. Se pegó dentro de cada compartimiento dos fundas plásticas negras para evitar la filtración del agua a través de la madera (Ver figura 2). Para el experimento 2, se utilizaron tanques de cartón de 36” x 54”, 55 galones los cuales fueron cortados en dos, luego se les colocó una funda de plástico, para ayudar a retener el agua (ver foto 2).



Figura 2. Diseño de la Base de Campana en la producción de Biogás a partir de la cáscara y rastrojos de Arroz tratada con Urea y con Orina de Conejos.

Parte superior de la campana. En ambos experimento, para preparar la parte superior de la campana se utilizaron cubos plásticos con capacidad para 5 galones. En el centro de cada cubo invertido se perforó un hueco en el cual se adaptó un tubo de ¼ pulgada de diámetro. A este tubo se colocó, respectivamente la T, otro tubo ¼ pulgada, la válvula. Las partes del sistema fueron mantenidas unidas por el PVC. Se aplicó silicón en las zonas donde hay uniones para sellar las posibles fugas de biogás. A la parte externa del cubo se colocó una cinta métrica que va del borde inferior al borde superior por medio de una cinta adhesiva transparente. La cinta métrica permitió tomar la lectura diariamente al subir la parte superior de la campana sobre el nivel del agua (Ver figura 3).

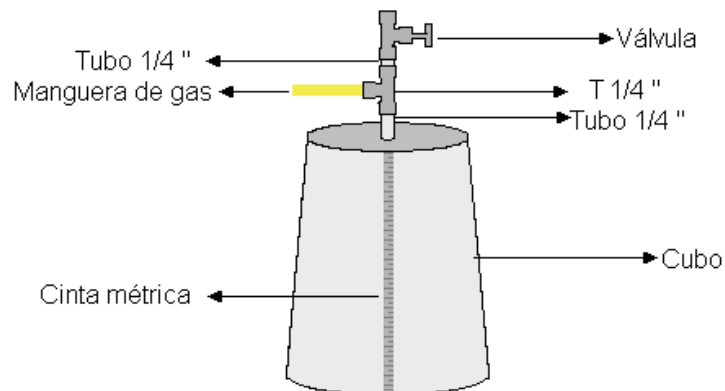

**Montaje del Sistema Completo:** Se llenó de agua los compartimientos de las bases de campana. Se introdujo la parte superior de la campana en cada compartimiento. Se aseguró que el agua contenida en los compartimientos está al nivel del punto cero de la cinta métrica colocada a la parte superior de la campana. Posterior, se cargó los tanques con el sustrato a evaluar, dejando un 20% del volumen total del tanque (40 litros) para el almacenaje del biogás. Se alimentó a los tres digestores con agua, urea pre-disuelta en agua, cáscara de arroz y los demás con agua, orina de conejos y cáscara de arroz o rastrojo según las proporciones indicadas anteriormente. Se añadió en cada digestor 1.5 kg de material inoculante a base de estiércol fresco de ganado bovino. Se tapó el digestor y selló las juntas con silicón. Terminado esto se conectó cada digestor a su sistema de depósito de gas introduciendo la manguera de gas en la salida libre de la T. Se aseguró de cerrar la salida de gas por medio de las válvulas. Para mantener recta la parte superior de la campana se sostuvo la manguera con una botella de 2 litros llena de agua (Ver foto 3.)

### **Análisis de Datos**

Los datos recolectados en la producción de biogás en  $\text{dm}^3$  por kg de materia seca en período de 10 días y en total fueron sometidos a un análisis de varianza usando el cuadrado mínimo del modelo lineal general (GLM) con el programa estadístico SAS<sup>TM</sup> 8.1 Inc. Si hubo diferencias significativas las medias fueron sometidas al análisis de separación de medias de Tukey a un nivel de confiabilidad de 95%. (Cody y Smith, 1997).

## **RESULTADOS Y DISCUSION**

### **Producción de Biogás**

En el Experimento 1, la producción de biogás durante los períodos primero, segundo y tercero, el tratamiento CAOC produjo más volumen de biogás que el tratamiento CAU. La producción de biogás para el tratamiento CAU resultó mayor durante los períodos 4 y 5. Durante el sexto período, la producción fue igual para los 2 tratamientos. Para el tiempo de retención de 60 días. El CAOC obtuvo mayor producción total ( $57.38 \text{ dm}^3/\text{kg}$ ) que el CAU ( $42.70 \text{ dm}^3/\text{kg}$ ) (ver tabla 1). El tratamiento CAOC obtuvo su pico de producción en el período 2 mientras que la CAU en el período 4. Lo que significa que el CAU obtuvo su pico 2 períodos (20 días) después el CAOC.

Tabla 1 Producción de Biogás  $\text{dm}^3/\text{kg}$  de MS a partir de Cáscara y Rastrojo de Arroz Tratada con Urea u Orina de Conejos

Periodos (días)	Sustratos					
	Experimento 1		Experimento 2			
	CAU*	CAOC*	RAS*	RA*	RAU*	RAOC*
1-10	4.00 b	7.15 a	4.81 a	6.70 a	14.00 a	11.58 a
11-20	4.10 b	17.97 a	4.24 b	9.47 ab	22.49 a	13.12ab
21-30	5.38 b	11.28 a	3.68 b	7.46 ab	29.64 a	31.71 a
31-40	14.69 a	9.57 b	4.32 a	6.07 a	18.24 a	14.41 a
41-50	8.93 a	6.46 b	3.51 b	7.44 ab	4.79 b	15.66 a
51-60	5.60 a	5.00 b	2.86 a	9.23 a	9.09 a	9.75 a
Total	42.70 b	57.43 a	23.45 b	46.39ab	98.28a	96.25 a

NOTA: Letras diferentes en una fila dentro de los experimentos indican diferencias significativas ( $P < 0.05$ ).

\*CAU: Cáscara de Arroz con Urea; CAOC: Cáscara de Arroz con Orina de Conejo; RAS: Rastrojo de Arroz con agua; RA: Rastrojo de Arroz con inoculante; RAU: Rastrojo de Arroz con Urea; RAOC: Rastrojo de Arroz con orina de Conejo.

Este comportamiento de la producción de biogás con el CAU parece ser consecuencia de que el nitrógeno suministrado en la forma de urea a la población bacteriana no es asimilable sin la intervención de las bacterias productoras de ureasa especialmente los *Proteus* (Cortes, 2002). Por lo tanto, la acción de los demás grupos de bacterias era mínima en los periodos 1, 2,3. Sin embargo, la disponibilidad del nitrógeno en forma de amonio ha permitido un aumento de la población bacteriana lo que puede ocasionar el brusco crecimiento de la producción en el período 4 y la caída lenta en los periodos 5 y 6.

En cuanto al CAOC se puede relacionar este comportamiento a la disponibilidad de la ureasa en la orina, la cual interviene en el proceso producción de amonio a partir de la urea y de los compuestos nitrogenitos (Dinatec, 2000) y a la presencia de los actinomicetes, los cuales son microorganismos presentes en la orina de conejos y especialmente hábiles para degradar materiales con alto niveles de lignina (Arroyo, 2004).

Normalmente, la producción de biogás varía de 200-400  $\text{dm}^3$  por Kg de materia seca en condiciones ambientales (ISF, 2005). Respecto a este parámetro de producción de biogás este experimento no ha alcanzado este rango debido a la posible razón: por ser un material lignificado y por su alto contenido de silicio, la cáscara de arroz presentaba una degradación lenta y baja a nivel del digestor.

El experimento 2 mostró que, durante los periodos primero y segundo, el tratamiento PAU produjo más volumen de biogás que los demás. El tratamiento PAOC produjo más que los demás en el periodo 3, 5 y 6. En el período 4 el PAU produjo más que los demás. Y finalmente para el tiempo de retención de 60 días, el PAU (98.28  $\text{dm}^3/\text{Kg}$  de materia seca) y PAOC (96.25  $\text{dm}^3/\text{kg}$  de materia seca) obtuvieron la mayor producción total que PA (46.39  $\text{dm}^3/\text{kg}$  de materia seca) y PAS (23.45  $\text{dm}^3/\text{kg}$  de materia seca), la razón podría obedecer a que si se compara con la cascara de arroz es más lignificada que la paja de arroz, mayor lignina más tiempo de retención menos producción (Yongfu *et al.* 1989).



Figura 2 Comportamiento de la Producción Total de Biogás en  $\text{dm}^3/\text{kg}$  a Partir de Paja o Rastrojo de Arroz Tratada con Urea u Orina de Conejos por

Con relación a los picos de mayor producción los tratamientos PAU y PAOC tuvieron un comportamiento de pico y caída similar en el período 3. Mientras que el tratamiento PA obtuvo su pico de producción en el período 2 y el tratamiento PAS en el período 1. Esto resulta que los tratamientos PAS y PA no tuvieron la disponibilidad del nitrógeno que es la principal fuente de nutriente para las bacterias formadoras de metano (metanogénicas), mientras que los tratamientos PAU y PAOC tuvieron nitrógeno lo que permite a ellos obtener sus picos 10 días después (GTZ, 1999)

## CONCLUSIONES Y RECOMENDACIONES

Bajo las condiciones de clima y las variaciones de temperatura durante el período de los ensayos, resulta más apropiado y sostenible tratar la cáscara de arroz con orina de conejos para la producción de biogás y que el rastrojo de arroz puede ser una fuente para biogás tratada con urea o con orina de conejo con una producción de 98.28 o 96.25  $\text{dm}^3/\text{kg}$  de materia seca, respectivamente. Además es factible el tratamiento por digestión anaerobia de la cáscara y rastrojos de arroz obteniéndose así, una fuente de energía renovable. Con dicha utilización se logra una manera para deponer estos residuos de cosecha tan abundante en República Dominicana.

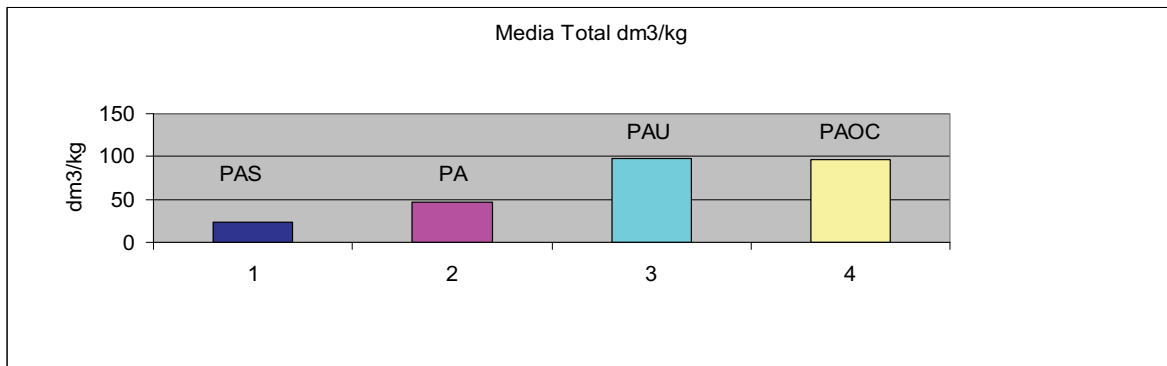
## REFERENCIAS

- Arroyo, F. J. 2004. El uso de la orina humana en los procesos de compostage. revista PGU # 10
- Banco Central, 2004. Boletín Trimestral del Banco Central de la República Dominicana. Abril-Mayo
- Bureau des mines et de l'énergie (BME), 2000. L'énergie en Haiti Diagnostic du Secteur de L'énergie.
- Caneta, L., Álvarez, J. M. Y Moyano, C. 2001. Biomasa y Biogás. Cátedra: Máquinas Térmicas II Facultad de Ingeniería. Universidad Nacional Del Nordeste de Argentina.
- Cavidad, Z. A. 1997. Utilización del Biogás para Generación de Electricidad. Fundación CIPAV.

- Cody, R. P. y Smith J. K. 1997. Applied Statistic and the SAS Programming Language. Fourth Ed. Prentice Hall, New Jersey. U.S.A.
- Comisión Presidencial sobre los objetivos del Milenio y el desarrollo Sostenible (COPDES), 2006. <http://www.copdes.gov.do/noticias.html>
- Cortés, J. A. 2002. Prueba de la Ureasa.
- Ingeniería Sin Fronteras (ISF). 2005. Biomasa como fuente energética en países en desarrollo. Módulo 7. Lectura 7.1. 2.
- Instituto Interamericano de Cooperación para la Agricultura (IICA). 2003. Estudio sobre el Mercado de Arroz en la República Dominicana. Santo Domingo, D.N.
- La Deutsche Gesellschaft für Technische Zusammenarbeit (GTZ), Information And Advisory Service On Appropriate Technology (ISAT).1999. Biogas Basics. Volume I. Biogas Digest.
- Organización Mundial de la Salud OMS, 2006. Las Inversiones para promover el Combustibles.
- Preston T.R.,1999 Tropical animal feeding .University of Agriculture and Forestry Ho Chi Minh City Viet Nam. FAO, Roma, Italia
- Rodríguez, N y Araujo-Febres, O y Gonzales, b y Vergara, J. 1998 Efecto de la Amonificación con Urea sobre los Componentes Estructurales de la Pared celular de Heno de Brachiaria Humidicola
- Souza, O. y Izabele, E. 1999. Aprovechamiento De Los Residuos Agropecuarios Tratados Con Urea En La Alimentación Animal. Facultad de Agronomía y Veterinaria, Universidad Nacional de Río Cuarto, Río Cuarto, provincia de Córdoba, República Argentina.
- .Youngfu, Y., Yibo, Q., Yunxuan, G., Hui, Z., Yuansheng, X., Chenyong, X., Guoyuan, F., Jienquan, X., Taiming, Z. y Gan, L. 1989. The biogas technology in China. Agricultural Publishing House. Beijing, Pag.20-54



Foto 1. Tanque de polietileno utilizado como Digestor en la producción de Biogás a partir de la cáscara y rastrojos de Arroz tratada con Urea y con Orina de Conejos.



Foto 2 Instalación del Sistema, para la Producción de Biogás a partir de la cáscara y rastrojos de Arroz tratada con Urea y con Orina de Conejos.

**Poster #78**

**Optimization of a Clarification Process for Guava Puree using Bioguavase Enzyme**

*María L. Plaza<sup>1</sup> and Murat Balaban<sup>1</sup>, <sup>1</sup>University of Florida, Gainesville, FL  
mplaza@ufl.edu*

**ABSTRACT.**

Fruit juices are an important part of our diet. Guava (*Psidium guajava* L.) is a delicious, healthful tropical fruit that has not been used as processed juice. One of the challenges in processing guava juice is cloudiness due to suspended complex carbohydrates in the end product. Clarification of the juice is desirable in order to enhance consumer acceptability. Enzyme treatment is one method of enhancing the removal of suspended solids. Bioguavase is a commercially available pectinolytic enzyme system containing a variety of carbohydrase enzymes derived from *Aspergillus niger*. Our objective was to determine the optimal treatment time and concentration of Bioguavase for treatment of guava juice to obtain a clarified product. Four treatment times (3, 6, 9 and 12 hours) and three enzyme concentrations (400, 600 and 800 ppm) were tested in a repeated measures design at 30° C. Following treatment, juice was clarified by centrifugation and analyzed for vitamin C content (2,6-dichloroindophenol titration method), antioxidant capacity (ORAC), total soluble phenolics, turbidity and color. After 3h reaction time, the 800 ppm treatment produced the clearest juice. Juice yield did not show significant differences ( $\alpha = 0.05$ ) at 600 and 800 ppm of enzyme concentration when the reaction time was extended beyond 13h. All enzyme treatments reduced the antioxidant capacity (between 17 and 21%) and decreased the total soluble phenolic content (between 3 and 7%) of the juice. We conclude that treatment of guava juice with 600 ppm Bioguavase for 3h is suitable for obtaining clarified juice.

Additional studies should further characterize phytochemical modifications caused by the treatment. The yield of clarified juice is significantly affected by the temperature and time used for the enzyme treatment. Increasing the temperature may produce a good clarified juice but may also reduce the phytochemical composition and ascorbic acid content due to oxidation. Using 30°C with the appropriate enzyme concentration and reaction time will help minimize the reduction of the phytochemical component.

**KEYWORDS:** guava, clarified juice, enzyme treatment

**Poster #81**

**Relationship between Chlorophyll Fluorescence and Dry Matter Content of 'Hass' Avocado Fruit**

*J.A. Osuna-García<sup>1</sup>, G. Doyon<sup>2</sup>, I.J.L González-Durán<sup>1</sup>, S. Salazar-García<sup>1</sup> and R. Goenaga<sup>3</sup>, <sup>1</sup>INIFAP-Santiago Ixcuintla Experimental Station. Santiago Ixcuintla, Nayarit, Mexico. <sup>2</sup>Food Research and Development Centre, Agriculture and Agri-Food Canada, St. Hyacinthe, Quebec, Canada. <sup>3</sup>USDA-ARS, Tropical Agriculture Research Station, Mayagüez, Puerto Rico.  
josunaga@tepic.megared.net.mx; osuna.jorgealberto@inifap.gob.mx*

**ABSTRACT.**

Mexico is the main 'Hass' avocado exporter in the world with more than 100,000 ton exported every year. Canada is an important importer country accounting for 12-15% of total exports from Mexico. Normally, from December to May exported fruit to Canada have very high dry matter content which is determined with a destructive and time consuming method. The objective of this experiment was to correlate skin chlorophyll fluorescence, as a non-destructive method, with dry matter content of 'Hass' avocado fruit. From December 2007 to April 2008, 10 fruit of five different skin color categories were collected monthly from a packinghouse in Michoacan, Mexico and rated using the following scale: 1 = fully green, 2 = <25% skin blackening, 3 = 26- 50% skin blackening, 4 = 51-75% skin blackening, and 5 >76% skin blackening. Two days after harvest, individual fruit were assessed for chlorophyll fluorescence using a modulated fluorometer, Model OS1-FL reporting fluorescence under steady state conditions (Fs), maximal fluorescence under steady state conditions (Fms), and quantum efficiency yield (Y). Immediately after reading fluorescence, fruit mesocarp dry matter content (DM) was determined using a microwave oven and values were correlated with fluorescence. Fs values varied from 147 to 292; FMS from 357 to 989 and Y from 0.504 to 0.818, while DM did so from 19 to 42%. The only fluorescence parameter that correlated significantly (P<0.001) with DM was Fs; however, correlation was low (r = - 0.31). This could be due to the relative high DM content of fruit (avg. 32.9%), which was much higher than the maturity standard (DM ≥ 21.5%). The results showed that chlorophyll fluorescence did not correlate with DM content of over-ripe avocado fruit. Efforts are underway to find out if fluorescence may be useful to predict legal maturity on unharvested 'Hass' avocado fruit.

**KEYWORDS:** non-destructive, fluorescence, fruit maturity

**Poster #82**

**Effect of Harvest Time and Ripening Degree on Quality and Shelf Life of 'Hass' Avocado**

*J.A. Osuna-García<sup>1</sup>, G. Doyon<sup>2</sup>, I.J.L González-Durán<sup>1</sup>, S. Salazar-García<sup>1</sup> and R. Goenaga<sup>3</sup>, <sup>1</sup>INIFAP-Santiago Ixcuintla Experimental Station. Santiago Ixcuintla, Nayarit, Mexico. <sup>2</sup>Food Research and Development Centre, Agriculture and Agri-Food Canada, St. Hyacinthe, Quebec, Canada. <sup>3</sup>USDA-ARS, Tropical Agriculture Research Station, Mayagüez, Puerto Rico.*

*josunaga@tepic.megared.net.mx; osuna.jorgealberto@inifap.gob.mx*

**ABSTRACT.**

Canada is an important avocado importer country accounting for 12-15% of total avocado exports from Mexico. 'Hass' avocado is harvested year round in the state of Michoacan. For most part of the season, fruit reach adequate mesocarp dry matter content (DM), ripen properly and consequently, quality and shelf life are excellent. However, after early January fruit DM content increases and skin blackening occurs. Shipments to Canada containing fruit with blackening skin have been rejected since this characteristic is sometimes associated with low pulp firmness and short shelf life. The objective of this experiment was to study the effect of harvest time and ripening degree on initial quality and shelf life of 'Hass' avocado. Fruit were harvested in October and December, 2007 and from January to April, 2008 and rated according to the following scale: 1 = fully green, 2 = <25% skin blackening, 3 = 26-50% skin blackening, 4 = 51-75% skin blackening and 5 > 76% skin blackening. At harvest, DM, skin color, pulp firmness, and pulp color were evaluated. Fruit were then refrigerated ( $6.0 \pm 1.0$  °C;  $90 \pm 5\%$  RH) for seven days to simulate terrestrial shipment to Canada. After this period, fruit were stored under market conditions ( $22 \pm 2$  °C;  $75 \pm 10\%$  RH) until they reached the edible ripening stage. Weight loss (WL), fruit with skin blackening, pulp firmness, and pulp color were determined every three days. Pulp DM, skin color and pulp color significantly increased with harvest time and degree of skin blackening. However, there were no significant differences for WL and firmness. Our results showed that there is no reason for Canadian retailers to reject fruit with blackened skin since fruit quality and shelf life were not affected by harvest time and degree of skin color.

**KEYWORDS:** skin color, maturity index, firmness



**Poster #83**

**Influencia del Clima, Riego y Época de Floración Sobre la Composición Nutricional del Fruto de Aguacate ‘Hass’ en Michoacán**

*S. Salazar-García, M. Gallardo-Valdez, y L.M. Tapia-Vargas, INIFAP-Campo Experimental Uruapan, Michoacán, México. E-mail: samuelsalazar@prodigy.net.mx*

**RESUMEN.**

El objetivo de esta investigación fue evaluar el efecto del clima [semicálido subhúmedo (SS), semicálido húmedo (SH), y templado subhúmedo (TS)], la condición de humedad (con y sin riego) y época de floración que originó al fruto [“loca” (septiembre) y “normal” (enero)] sobre la composición nutricional del fruto de aguacate ‘Hass’ en Michoacán. Se seleccionaron dos huertos de ‘Hass’ por cada clima y condición de humedad del suelo. En cada huerto se seleccionaron 10 árboles y cuando su fruto alcanzó la madurez legal ( $\geq 21.5\%$  de materia seca de la pulpa), de cada árbol y tipo de fruto (floración Loca o Normal) se cortaron cinco frutos de la misma edad para diseccionarlos en sus componentes (epidermis, pulpa, tegumento y cotiledones). El clima afectó la composición nutricional de las partes del fruto. En la epidermis, los nutrientes afectados fueron: N, P, Ca, Cl, Fe, Mn y B; en la pulpa: N, P, K, Ca y Mn; en el tegumento: S y Mn; en cotiledones: P, S, Cu, Mn y B. La condición de humedad del suelo tuvo poco efecto sobre la concentración de macronutrientes en el fruto. En huertos sin riego, el fruto presentó mayores concentraciones de K, Ca, y S en la epidermis, de K y Ca en la pulpa y de Mg en el tegumento. El N y P no fueron afectados. En frutos de la floración Loca (cosechados en agosto) fue mayor la concentración de N (epidermis y pulpa), Ca (cotiledones), Mg (cotiledones) y Zn (pulpa y cotiledones). En frutos de la floración normal (cosechados en octubre), solamente el N presentó mayor concentración en el tegumento.

**PALABRAS CLAVE:** *Persea americana*, nutrición.

NOTES:



**T-STAR** A Special Grant of the USDA, CSREES  
Tropical & Subtropical Agriculture Research

**UF** UNIVERSITY of  
**FLORIDA**  
IFAS



Caribbean Food Crops Society  
Sociedad Caribeña De Cultivos  
Alimenticos  
Societ  Carajibe Des Plantes Alimentaires

**44** TH ANNUAL MEETING  
REUNION ANUAL  
CONGRÈS ANNUEL

HOSTING ORGANIZATION  
University of Florida  
Institute of Food and Agricultural Sciences

CO-SPONSORS  
Florida A&M University  
Florida Cattlemen's Association  
IICA  
UF/IFAS International Programs  
UF/IFAS T-STAR  
(Tropical-Subtropical Agricultural Research)  
USDA  
USDA/APHIS  
USDA/CSREES

Miami, Florida  
July 13-17, 2008