



HAL
open science

Establishment of quinoa (*Chenopodium quinoa* Willd.) and simulation of its cultivation with the STICS crop model

Sophie Lebonvallet, Nadine N. Brisson, Jean-Pierre Raffillac, Marie Launay

► **To cite this version:**

Sophie Lebonvallet, Nadine N. Brisson, Jean-Pierre Raffillac, Marie Launay. Establishment of quinoa (*Chenopodium quinoa* Willd.) and simulation of its cultivation with the STICS crop model. AgSAP 2009, Mar 2009, Egmond aan Zee, Netherlands. hal-02753348

HAL Id: hal-02753348

<https://hal.inrae.fr/hal-02753348v1>

Submitted on 3 Jun 2020

HAL is a multi-disciplinary open access archive for the deposit and dissemination of scientific research documents, whether they are published or not. The documents may come from teaching and research institutions in France or abroad, or from public or private research centers.

L'archive ouverte pluridisciplinaire **HAL**, est destinée au dépôt et à la diffusion de documents scientifiques de niveau recherche, publiés ou non, émanant des établissements d'enseignement et de recherche français ou étrangers, des laboratoires publics ou privés.



**Integrated Assessment of Agriculture and
Sustainable Development;
Setting the Agenda for Science and Policy
(AgSAP 2009)**

**10 – 12 March 2009
Hotel Zuiderduin, Egmond aan Zee
The Netherlands**

PROCEEDINGS

AgSAP Conference 2009
Egmond aan Zee
The Netherlands

Editorial Committee of these Proceedings:

Martin van Ittersum Coordinator SEAMLESS, Wageningen University, Plant
Production Systems (NL)

Joost Wolf Wageningen University, Plant Production Systems (NL)

Gon van Laar Wageningen University, Centre for Crop Systems Analysis
(NL)

Local Organizing Committee

Martin van Ittersum Coordinator SEAMLESS, Wageningen University, Plant
Production Systems (NL)

Floor Brouwer LEI, Wageningen UR (NL)

Joost Wolf Wageningen University, Plant Production Systems (NL)

Theo Jetten Wageningen University, C.T. de Wit Graduate School
PE&RC (NL)

Marcel Lubbers Wageningen University, Plant Production Systems (NL)

Charlotte Schilt Wageningen University, Plant Production Systems (NL)

Corresponding address:

AgSAP Office

Plant Production Systems

Wageningen University

P.O. Box 430, 6700 AK Wageningen

The Netherlands

Website: www.conference-AgSAP.org

E-mail: office.PP@wur.nl

Suggested citation:

Van Ittersum, M.K., J. Wolf & H.H. Van Laar (Eds), 2009. Proceedings of the Conference on
Integrated Assessment of Agriculture and Sustainable Development: Setting the Agenda
for Science and Policy (AgSAP 2009). Egmond aan Zee, The Netherlands, 10-12 March
2009. Wageningen University and Research Centre, Wageningen, 560 pp.

Printing: GVO, Ede, The Netherlands

Publisher: Wageningen University and Research Centre, The Netherlands

ISBN: 978-90-8585-401-2

Contents

Preface	xvii
Plenary Sessions	1
Von Braun, J.: Agriculture and sustainable development in developing countries	2
Legg, W.J.: Agriculture and sustainable development in OECD countries: A policy perspective.....	4
Van Ittersum, M.K., F. Ewert, E. Andersen, F. Brouwer, T. Heckelei, J. Alkan Olsson, J. Wery, J.J.F. Wien: Integrated assessment of agricultural systems: On integrated science and science integration	6
Rotmans, J.: Two decades of Integrated Assessment tools: A promising way forward	8
Pingali, P.: Enhancing developing world agricultural performance: Getting beyond the current plateau.....	11
 Theme A: Methodology for integrated assessment	
 Session A1: Methods for integrated assessment of agricultural systems and land use 13	
Helming, K., I. De la Flor Tejero, M.K. Van Ittersum, P. Nowicki, W. Rienks, A. Volkery: Scenario studies for agriculture, land use and landscape in Europe: A comparison.....	14
Arriaza, M., O. Nekhay: Integrating social preferences and spatial analysis to optimize the use of marginal agricultural lands.....	16
Berkhoff, K., S. Herrmann: Understanding land use change with the aid of an integrated modelling framework: A case study on rural south-west China	18
Christen, O.: Concept and application of a DLG sustainability standard on the farm level	20
Herrero, M., P.K. Thornton, A. Notenbaert, S. Msangi, S. Wood, R. Kruska, J. Dixon, D. Bossio, J. Van de Steeg, H.A. Freeman, B. Gerard: An integrated assessment of global changes in crop-livestock systems to 2030: Implications for policy development.....	22
Jansson, T., M. Adenauer, M. Kuiper: The CAPRI and GTAP link: Linking a partial and a global equilibrium model	24
Lippe, M., T. Thai Minh, A. Neef, V. Hoffmann, G. Cadisch, T. Hilger: Integration of interdisciplinary participative research tools: New vistas for land use modelling?	26
Marohn, C., U. Schuler, M. Lippe, Y.Z. Ayanu, C. Hugenschmidt, T. Hilger, G. Cadisch: Modelling resource distribution in mountainous watersheds in Thailand: An integrated approach	28
McRoberts, N., C.F.E. Topp: Construction of a multi-attribute model of arable system sustainability by elicitation of expert opinion	30
McRoberts, N., C.F.E. Topp, C. Hawes, R.L. Walker, C.A. Watson, P. Hallett, T. Daniell, M. Young, G.R. Squire: Gathering baseline data for studying arable system resilience in Scotland by integrated farm surveys	32
Meyer, B., R. Grabaum, D. Watson, D. Adams, A. Hood, A. Phillips: Integrating multiple functions to optimize rural land health.....	34

Santos, R., P. Antunes, P. Beça: Framework for the socio-economic performance assessment of irrigation schemes	36
Spoelstra, S.F., B. Elzen: Sustainable livestock production: Assessment of farmers initiatives	38
Tittonell, P., M.C. Rufino, M.T. Van Wijk, M. Herrero, M. Corbeels, C. Pacini, J. Smith, S. Karanja, C. Quiroz, P. Mapfumo, J. K'ungu, F. Baijukya, C. Kaizzi, M. Mwale, O.M. Sanogo, E. Yeboah, D. Nwage, B. Vanlauwe, A. Albrecht, N. De Ridder, K.E. Giller: Integrated assessment of nutrient management options in smallholder farming systems: The NUANCES framework	40
Van Delden, H., M.L. Paracchini, T. Stuczynski, P. Ciaian, R. Vanhout: The LUMOCAP PSS, impact assessment of agricultural policies in an integrative context.....	42
Wustenberghs, H., E. Wauters, S. Van Passel: Measuring sustainability at a supra-farm level: Evaluation of methods	44

Session A2: Methods for up- and downscaling in integrated assessments **47**

Antle, J.M.: Strategies for addressing spatial and temporal scale in Integrated Assessment of agricultural systems	48
Britz, W.: EU-wide spatial down-scaling of results of a regionalized agricultural economic model to analyse environmental impacts	50
Britz, W., M. Adenäuer: Calibration of regional programming models to exogenous supply elasticities by a variable cost function: The CAPRI-EXPAMOD example	52
Elbersen, B.S., R. Jongeneel, M. Kempen, M. Mikk, A. Peepson: Compliance and costs of compliance: A procedure to obtain estimates at a disaggregated level	54
Ewert, F., M.K. Van Ittersum, O. Therond, I. Bezlepkina, E. Andersen, T. Heckeley, G. Flichman, N. Turpin: Complex scaling issues in integrated assessment modelling: Approaches used and their integration into SEAMLESS-IF	56
Pérez Dominguez, I., I. Bezlepkina, A. Kanellopoulos, T. Heckeley, A. Oude Lansink, E. Romstad: EXPAMOD – connecting the farm and market levels.....	58
Righi, E., G.C. Pacini, S. Dogliotti, V. Aguerre, W.A.H. Rossing: Farm typology identification by multi-variate analysis as a method to scale-up results of integrated impact assessment	60
Rufino, M.C., J. Dury, P. Tittonell, M.T. Van Wijk, S. Zingore, K.E. Giller: Competing use of organic resources, climate variability and interactions at village scale in a communal area of NE Zimbabwe.....	62
Turpin, N., R. Laplana, D. Kopeva, L. Stapleton, K. Happe, G. Deffuant, F. Brouwer, M. Burghard: PRIMA, Prototypical Policy Impacts on Multi-functional Activities in rural municipalities	64
Turpin, N., O. Therond, F. Ewert, I. Bezlepkina, J. Alkan Olsson, C. Bockstaller, S. Janssen: Spatial upscaling of on-farm indicators: Concepts to use a scientific knowledge base to match policymakers' requirements.....	66
Valdivia, R.O., J.M. Antle, J.J. Stoorvogel: Coupling integrated assessment models to market equilibrium models to analyse economic and agricultural-environment interactions across different scales.....	68
Van Bussel, L.G.J., F. Ewert, P.A. Leffelaar, H. Van Keulen: Assessing the effects of data aggregation using a crop simulation model.....	70
Van de Giesen, N., T.J. Stomph: Scale effects in Hortonian surface runoff with management implications	72
Van Os, J., B.S. Elbersen, J. Kros, W. De Vries, J.P. Lesschen, M. Kempen: Effect of spatial resolution within the Cross Compliance Assessment Tool: The case of Nitrate Directive. 74	

Zakayo, S.: Risk assessment methodology for pesticide control in the Nil River Basin, Belgium	76
Zasada, I., A. Piorr, R. Berges: A generic downscaling approach for scenario driven modelling outputs from European to regional scale.....	78

Session A3: Integrated assessment of ecosystem services from agriculture 81

Buckwell, A.: Environmental services delivered and deliverable by land managers	82
Arriaza, M., O. Nekhay, M.J. López-Baldovín: Restoration of abandoned agricultural lands toward umbrella species habitats.....	84
Blandford, D., I. Gaasland, E. Vårdal: Examining the degree of jointness between food and cultural landscape production.....	86
De Blaeij, A., V. Linderhof, N. Polman: The monetary value of combining ecosystem-services in private artificial wetlands	88
Dhillion, S.S.: Reconfiguration of ecosystem services in agricultural landscapes: Mitigation and policy concerns for renewable energy development.....	90
Dirkx, G.H.P.: ‘Green services’: Bridging the gap between consumers and producers of landscape in The Netherlands?.....	92
Elbersen, B.S., R.G.H. Bunce, A. Van Doorn: Quantification of the relationship between changes in farming and changes in biological diversity: The Atlantic case	94
Giannoccaro, G., M. Prosperi, J. Berbel: Integrated assessment of multi-functionality of irrigated agriculture: An application for the Mediterranean regions.....	96
Pérez-Soba, M., M.L.M. Jones, C. Pacini, M.L. Paracchini: Land Use Functions: An approach for integrated assessment of the goods and services provided by agriculture in a multi-functional and sustainable context.....	98
Pinto-Correia, T., S. Truchet, C. Machado, F. Barroso, P. Picchi, Y. Michelin, N. Turpin, J.P. Bousset: How do policy options modify landscape amenities? An assessment approach based on public expressed preferences	100
Rodrigues-Filho, S., V.M. De Castro, F. Bakker, D. Lindoso, N. Debortoli, M. Bursztyjn: Regional sustainability contrasts in Brazil as indicated by the CompasSus: Compass of Sustainability	102
Romstad, E., K. Louhichi, P. Zander: Economic modelling of multi-functionality at the farm level	104
Rowe, E.C., S. Smart, C.D. Evans, B.A. Emmett: Predicting combined impacts of land management and pollution on biodiversity: A dynamic niche occupancy approach	106
Rudrum, D.P., R.A.M. Schrijver, A. Corporaal, T.J. De Koeijer: Cost effectiveness of biodiversity in agricultural production systems	108
Stoorvogel, J.J., A. Temme, J.M. Antle, L. Claessens, J.M. Schoorl: A novel site-specific methodology to assess the supply curve of environmental services	110
Tagliafierro, C., M. Antrop, V. Van Eetvelde, W.G. Hutchinson, A. Longo: Redefining landscape economics: A proposal to integrate economics approaches and landscape disciplines.....	112
Turpin, N., L. Stapleton, G. Garrod, E. Perret, F. Brouwer: Towards indicators of multi-functionality: Assessing jointness between commodity and non-commodity outputs.....	114
Van der Heide, C.M., F.J. Sijtsma, P. Van Egmond, S. Kruitwagen, A. Van Hinsberg, F.J. Dietz: Valuation of ecosystem services and decision making: Combining a CBA with MCA.....	116
Van der Werf, W., D.A. Landis, M.M. Gardiner, A.C. Costamagna, J.M. Baveco, F.J.J.A. Bianchi, N.C. Schellhorn, W. Zhang: Analysing, forecasting and valuating the effects of landscape change on the ecosystem service of biological pest control.....	118

Villa, F., M. Ceroni, K. Bagstad, G.W. Johnson Jr., S. Krivov: Understanding agricultural ecosystem services with ARIES (ARTificial Intelligence for Ecosystem Services): Perspectives for assisted policy making	120
Westhoek, H., A.G. Prins, H. Van Zeijts: Policy options for safeguarding the provision of public goods and services in intensive and extensive farming systems	122
Willemen, L., L. Hein, P.H. Verburg: Translating spatial policy into future landscape functions	124

Session A4: The organization of tools for impact assessment: Standards or diversity? 127

De Smedt, P.: Impact Assessment practice to support sustainable policy measures in Europe	128
Ewert, F., M.K. Van Ittersum, I. Bezlepina, O. Therond, E. Andersen, H. Belhouchette, C. Bockstaller, F. Brouwer, T. Heckeley, S. Janssen, B. Jonsson, M.J.R. Knapen, M. Kuiper, K. Louhichi, J. Alkan Olsson, L. Ruinelli, A.E. Rizzoli, N. Turpin, J. Wery, J.J.F. Wien, J. Wolf: A methodology for enhanced flexibility of integrated assessment of policy impacts in agriculture.....	130
Fricke, K., K. Helming, S. Sieber: Choose complexity: How to bundle knowledge in Integrated Assessment Tools? Comparing implicit knowledge integration in SENSOR and PLUREL	132
Gaillard, G., T. Nemecek: Swiss Agricultural Life Cycle Assessment (SALCA): An integrated environmental assessment concept for agriculture.....	134
Khanh Hoang, L., S. Van Griensven, J. Cools, L. Benedetti, A. Mynett: Linking agricultural pollution to receiving waters using OpenMI	136
Reidsma, P., H. König, S. Feng, I. Bezlepina, H. Van Keulen, M.K. Van Ittersum, F. Brouwer: A methodological framework for sustainability impact assessment of land use policies in developing countries: Re-using and complementing approaches.....	138
Therond, O., N. Turpin, S. Janssen, I.N. Athanasiadis, M.J.R. Knapen, C. Bockstaller, J. Alkan Olsson, F. Ewert, I. Bezlepina: From models to indicators: Ontology as a knowledge representation system.....	140

Theme B: State-of-the-art of components for integrated systems

Session B1: Large scale integrated policy assessment: Tools and applications 143

Britz, W., T. Hertel: Impacts of EU biofuels directives on global markets and EU environmental quality: An integrated PE, global CGE analysis	144
Bouwman, A.F., A.H.W. Beusen, G. Billen: Modelling global N and P surface balances: Implementation of the millennium ecosystem assessment scenarios.....	146
Herrero, M., P.K. Thornton, M. Rosegrant, P. Havlik, S. Msangi, S. Fritz, H. Lotze-Campen, A. Notenbaert, A. Popp, B. Eickhout, C. Muller, J. Van de Steeg, D. Gerten, T. Sulser, C. Ringler, S. Wood, H.A. Freeman: Incorporating livestock in global integrated assessments of land use and agro-ecosystems services	148
Kuiper, M.: What if not all land is created equal? The role of heterogeneous land when assessing the impact of trade liberalization on developing countries.....	150
Morand, H., G. Achuo, R.J. MacGregor, A. Lefebvre: Integrated economic-environmental modelling for domestic policy development and assessment: The Canadian experience. 152	
Müller, M., I. Pérez Dominguez, W. Britz, T. Heckeley: Comparison of econometric techniques for deriving consolidated databases: The AGROSAM case	154

Sauer, T., P. Havlík, U.A. Schneider, G. Kindermann, M. Obersteiner: Agriculture and natural resources in a changing world: The role of irrigation	156
Smaling, E.M.A., R. Roscoe, J.P. Lesschen, A.F. Bouwman, E. Comunello: The fate of nitrogen in the Brazilian soybean chain	158
Van der Straeten, B., J. Buysse, S. Nolte, F.L. Marchand, L. Lauwers, D. Claeys, G. Van Huylenbroeck: Spatial planning of livestock production and manure abatement.....	160
Van Meijl, H., T. Jansson, M. Banse, G.B. Woltjer: The impact of modulation: Modelling first and second pillar CAP policies	162
Westhoek, H., B. Eickhout, N. Hoogervorst, T. Rood, E. Stehfest, G.B. Woltjer: Environmental impacts of the European livestock sector on different scales, and prospects for reduction	164
Woltjer, G.B.: Agricultural policy and land use	166
Zimmermann, A., T. Heckelei: Farm structural change in European regions	168

Session B2: Indicators for integrated assessment

171

Binder, C.R., A. Schmid, J.K. Steinberger: Sustainability Solution Space: An indicator based tool for assessing the sustainability of agricultural systems	172
Adamowicz, M., A. Smarzewska: Model and indicators of sustainable development in rural areas from the local perspective	174
Bockstaller, C., N. Turpin, L. Stapleton, M. Van der Heide, O. Therond, T. Pinto-Correia, V. Voltr, M. Raley, I. Bezlepkina, J.P. Bousset, J. Alkan Olsson, F. Ewert: A structured set of indicators for integrated assessment of future agri-environmental policies.....	176
Bockstaller, C., L. Stapleton, M. Van der Heide, G. Geniaux, S. Bellon, E. Josien, M. Raley, J. Alkan Olsson: From a disaggregated set of indicators to a synthetic, composite assessment of sustainability: Paths and pitfalls	178
Delmotte, S., C. Gary, A. Ripoche, J.M. Barbier, J. Wery: Contextualization of on farm <i>ex-ante</i> evaluation of the sustainability of innovative cropping systems in viticulture, using a multiple criteria assessment tool (DEXi)	180
Giannoccaro, G., J.M. Pistón, J. Berbel: Assessing the environmental sustainability of the CAP: A DPSIR framework approach.....	182
Leip, A., F. Weiss, W. Britz: Agri-environmental nitrogen indicators for EU27	184
Meul, M., S. Van Passel: Sustainability of Flemish farms: Advising farmers and policymakers.....	186
Scholz, J., S. Herrmann: Rural regions in Europe: A new typology based on a multi-sectoral point of view	188

Session B3: Cropping systems modelling

191

Keating, B.A., M.J. Robertson, P.S. Carberry, D.P. Holzworth, N.I. Huth: Cropping systems modelling: Past performance and future prospects	192
Adam, M., H. Belhouchette, E. Casellas, O. Therond, J. Wery: APES, an agricultural production and externalities simulator evaluated for two main crops in Midi-Pyrenees ..	194
Belhouchette, H., M. Adam, E. Casellas, F. Celette, M. Corbeels, J. Wery: Performances of two crop models in various conditions: The importance of underlying assumptions	196
Casellas, E., J.E. Bergez, H. Belhouchette, O. Therond, M. Adam, A. Metay, J. Wery: A methodology for the evaluation and improvement of a generic biophysical Soil-Plant-Atmosphere crop model based on ‘Mini-Application’	198

Casellas, E., O. Therond, H. Belhouchette, D. Wallach, R.J. Oomen, G. Russell, F. Ewert, H. Hengsdijk, M.K. Van Ittersum, M. Adam, J. Wery: Using a cropping system model for large scale impact assessment in Europe.....	200
Clavel, L., M.-H. Charron, D. Baudet, J. Soudais, D. Leenhardt: Spatializing a bio-decisional crop-model to assess the sensitivity of a region to modifications in agricultural practices	202
Corbeels, M., E. Casellas, F. Celette, A. Mérot: The SoilC&N module of APES: Simulating the immobilization-mineralization turnover for predicting short- and long-term C and N dynamics in the soil.....	204
Donatelli, M., G. Russell, A.E. Rizzoli: APES: The Agricultural Production and Externalities Simulator	206
Erdélyi, É.: The effects of climate change on the phenology of cereal crops in Hungary	208
Fantke, P., A. Kuhn, S. Wagner, R. Friedrich: Estimating external costs from the application of plant protection products in Europe	210
Guillaume, S., J.E. Bergez, E. Justes: Modelling water and nitrogen interactions in durum wheat: A first step towards the conception of joint management strategies for irrigation and nitrogen fertilization	212
Heinemann, A.B.: Optimization of upland rice breeding programme based on a crop modelling approach	214
Ines, A.V.M., J.W. Hansen: Extracting useful information from daily GCM rainfall for cropping system modelling.....	216
Jones, J.W., J. Naab, D. Fatondji, K. Dzotsi, S. Adiku, J. He: Uncertainties in simulating crop performance in degraded soils and low input production systems	218
Koo, J., S. Wood, Z. Guo: Crop systems evaluation for strategic investment decisions	220
Launay, M., N. Brisson, S. Satger, H. Hauggaard-Nielsen, G. Corre-Hellou, E. Kasynova, E.S. Jensen, M.J. Gooding, C. Dahlmann, P. Von Fragstein, A. Pristeri, M. Romeo, M. Monti: A modelling approach to optimize the management of pea-barley intercropping in Europe.....	222
Lebonvallet, S., N. Brisson, J.-P. Raffailac, M. Launay: Establishment of quinoa (<i>Chenopodium quinoa</i> Willd.) and simulation of its cultivation with the STICS crop model	224
Mérot, A., J.E. Bergez, J.C. Mailhol, J. Wery: An integrative modelling approach to simulate the agricultural system through a combination of a decisional, technical and biophysical sub-system	226
Metay, A., C. Gary, E. Casellas, A. Ripoche, K. Kansou, J. Wery: Modelling cover-cropped vineyards with APES: A modular simulation platform.....	228
Mirsky, S.B., J.R. Teasdale, R.A. Mangum, M.A. Cavigelli, J. Maul, J.T. Spargo: A systems approach to optimizing agronomic and economic performance of legume-based organic maize production	230
Oomen, R.J., H. Hengsdijk, O. Therond, J.E. Bergez, G. Russell, E. Casellas, S. Janssen, M.K. Van Ittersum: Development of generic management rules for crop growth simulation models.....	232
Schönhart, M., E. Schmid, U.A. Schneider, P. Liebhard: Crop rotation modelling for integrated environmental assessment: Case study results and empirical evidence	234
Snow, V.O., M. Lieffering, B.R. Cullen, I.R. Johnson: Implications of heterogeneous urinary-N return for modelling pasture production and N losses from grazed pastures under climate change.....	236
Tittonell, P., M. Corbeels, K.E. Giller: The interaction between sub-optimally available resources for crop production as implemented in the simplified model FIELD	238
Van der Velde, M., F. Bouraoui, P. Prospero, J.M. Terres, B.S. Elbersen: The effect of conservation agriculture practices in Europe	240

Welch, S.M., A. Wilczek, J.L. Roe, B. Moyer, M. Cooper, J. Schmitt, S. Das, P. Koduru, X. Cai: Toward gene-based crop simulation models for use in climate change studies ... 242

Session B4: Bio-economic farm modelling **245**

Flichman, G., K. Louhichi: Some conceptual issues for modelling the interaction between agriculture and environment through the bio-economic mathematical programming models	246
Akkas Ali, M., M. Robiul Alam, M.S.H. Molla, M.A. Momin: Integrated home garden model for food security, nutrition and poverty alleviation.....	248
Ben El Ghali, M., A. Ridier, C. Kephaliacos, G. Nguyen: Economic impact of voluntary agri-environmental measures: The case study of a ‘Test-Action’ in a basin of south-western France	250
Bocquého, G., F. Jacquet, L. Bamière: An appraisal of risk on perennial energy crops in France	252
Goulevant, G., S. De Cara, F. Jacquet, A. Reynaud, M.H. Jeuffroy, P. Lucas, F. Montfort: Economic analysis of cover crop (white mustard) adoption to reduce take-all disease and N-leaching	254
Janssen, S., K. Louhichi, A. Kanellopoulos, P. Zander, G. Flichman, H. Hengsdijk, Hongtao Li, T. Heckelei, G. Stokstad, N. Borkowski, M. Hecker, A. Oude Lansink, M. Blanco, E. Meuter, M.K. Van Ittersum: Farming Systems SIMulator: First generic bio-economic farm model.....	256
Lauwers, L., P. Everaert, J. Van Meensel, K. Bryon: Using time driven activity-based costing data for modelling complex innovations: The case of batch farrowing	258
Leneman, H., R.A.M. Schrijver: Higher prices, less nature management? Modelling farmers’ decisions on dairy farms	260
Louhichi, K., H. Hengsdijk, S. Janssen, G. Bigot, E. Perret, M.K. Van Ittersum: EU dairy farming in the face of change: An exploration using a bio-economic farm model.....	262
Mosnier, C., A. Reynaud, J. Agabriel, M. Lherm: Dynamics of suckler cow farms under stochastic crop yields: A recursive discrete stochastic programming approach	264
Mosnier, C., J. Agabriel, M. Lherm, A. Reynaud: A dynamic bio-economic model to simulate optimal adjustments of suckler cow farm management to production and markets shocks	266
Nidumolu, U.D., M. Lubbers, V. Alary, P. Lecomte, H. Van Keulen: Modelling Nitrogen balance for a regional scale livestock-pasture system as a discussion support tool.....	268
Robertson, M.J., A. Moore, A. Bathgate: Linking cropping systems models with farm bio-economic models to examine the relationship between profit and natural resource condition	270
Salgado, P., M. Lubbers, R. Schipper, H. Van Keulen, V. Alary, P. Lecomte: Adoption of new forage technology: Impact on the socio-economic sustainability of milk production in Moc Chau, Vietnam (DAIVIE model)	272
Schönhart, M., T. Schauppenlehner, E. Schmid: Integration of biophysical and economic models for spatially explicit land use and landscape analysis on farm level	274
Traoré, B., K. Louhichi, B. Rapidel: A bio-economic model to analyse the performance of the cotton sector in Mali.....	276
Van Meensel, J., L. Lauwers, G. Van Huylenbroeck, S. Van Passel: Exploring production-theoretical insights for economic-environmental trade-off analysis	278
Vayssières, J., M. Vigne, V. Slegten, P. Lecomte: A whole farm simulation model to improve multi-criteria system efficiency.....	280

Session B5: Integrated assessment methods for regional and landscape levels 283

Stoorvogel, J.J.: Integrated assessment modelling: How to assess regional impacts?..... 284

Bobojonov, I., E. Berg, C. Martius, J.P.A. Lamers, J. Franz: Integrated Assessment of crop and water allocation under conditions of uncertain water supply in the Khorezm Region of Uzbekistan, Central Asia 286

Brady, M., K. Kellermann: An agent-based model for assessing the impacts of decoupled agricultural support on landscape values..... 288

Breukers, A., W. Van der Werf, M. Mourits, A. Oude Lansink: Generic bio-economic modelling of plant diseases: An exploration 290

Bulatewicz, T., X. Yang, J.M. Peterson, S. Staggenborg, D.R. Steward, S.M. Welch: Integration of agriculture, groundwater and economic models using the Open Modeling Interface (OpenMI): Application to the Ogallala Aquifer..... 292

Gary, C., J.M. Barbier, P. Rio, P. Andrieux, J.M. Blazy, X. Louchart, M. Bonin, J.L. Diman, F. Causeret, H. Ozier-Lafontaine: How to design technical and organizational innovations to promote sustainable development in catchments with intensive use of pesticides 294

Griffon, S., D. Auclair: Visualizing changes in agricultural landscapes 296

Kros, J., T.J.A. Gies, J.C. Voogd, R. Smidt, W. De Vries: Integrated analysis of the effects of agricultural management and spatial planning on environmental quality at landscape scale 298

Osterburg, B., T.G. Schmidt: Assessment of nitrogen balances at farm and regional level .. 300

Schleyer, C., I. Theesfeld, O. Aznar: Assessing the institutional compatibility of new policies 302

Shahbazi, F., A.A. Jafarzadeh, M.R. Shahbazi: Assessing sustainable agriculture development using the MicroLEIS DSS in Souma area, Iran..... 304

Streifeneder, T., C. Hoffmann, F.V. Ruffini: Assessing and predicting agro-structural change in the Alpine Region..... 306

Uthes, S., C. Sattler, A. Osuch, K. Happe, A. Piorr, P. Zander: Sustainability impact assessment of EU policies at regional level: An analysis of land use dynamics and environmental effects with the MEA-Scope tool 308

Wagner, S., O. Beletskaya, U. Kummer, J. Theloke, E. Angenendt, R. Friedrich, J. Zeddies: Assessment of mitigation measures for air pollutants and greenhouse gases from agricultural systems in Germany at high spatial resolution..... 310

Warnecke, S., M. Biberacher, G. Broll: Regionally optimized animal farm manure transports in an area with high intensity animal farming systems 312

Session B6: Software infrastructures and tools for integrated assessment 315

Moore, R.V., J.J.F. Wien: Integrated modelling tools, mass collaboration and the opportunities ahead..... 316

Antle, J.M., J.J. Stoorvogel, R.O. Valdivia: The Trade-off Analysis software: Modelling tools to support informed policy decision making 318

Athanasiadis, I.N., S. Janssen, E. Andersen, A.E. Rizzoli, J.J.F. Wien: Granular ontologies for integrated assessment of agricultural systems 320

Botreau, R., I. Veissier, P. Champciaux, J.-P. Brun, A. Lamadon, P. Perny: A software tool to support multi-criteria-based assessment of animal welfare..... 322

Carlson, J., O. David, J. Ascough, F. Geter, L. Ahuja: The role of the Object Modelling System (OMS) for integrated assessments of conservation on agricultural land in the United States..... 324

Justes, E., P. Lecharpentier, S. Buis, M. Launay, J. Bourges, J. Soudais, P. Clastre, J.E. Bergez, P. Debaeke, D. Wallach, M. Guérif: OptimISTICS, a software for STICS crop model parameter estimation and evaluation which was build up to function with other dynamical models.....	326
Kassahun, A.: ProST: A process support tool for supporting water stress mitigation through a participatory approach.....	328
Knapen, M.J.R., I.N. Athanasiadis, B. Jonsson, D. Huber, J.J.F. Wien, A.E. Rizzoli, S. Janssen: Use of OpenMI in SEAMLESS.....	330
Meuter, E., S. Janssen, M.K. Van Ittersum: A graphical user interface for a generic bio-economic farm model (FSSIM).....	332
Nemecek, T., S. Blaser, D. Dux, G. Gaillard: What are the key factors for successful integration of life cycle assessment into FADN?	334
Salazar, O., A. Joel, I. Wesström: An integrated framework for management of spatial and temporal data on a drained watershed	336
Steward, D.R., X. Yang, W.J. De Lange: Groundwater concepts and agriculture: A GIScience data model study.....	338
Verweij, P.J.F.M., M. Van Eupen, J. Roos-Klein Lankorst, W. Nieuwenhuizen: Tools for transparent spatial integrated assessments.....	340
Wallach, D., F. Van Evert, M. Adam: Parameter estimation software for crop models.....	342
Wien, J.J.F., A.E. Rizzoli, M.J.R. Knapen, I.N. Athanasiadis, S. Janssen, L. Ruinelli, F. Villa, M. Svensson, P. Wallman, B. Jonsson: Architecture of SEAMLESS-IF as framework application for integrated modelling	344

Session B7: Databases for integrated assessment of agriculture and rural development

347

Kasnakoglu, H.: Usefulness, feasibility, limitations and sustainability of an integrated international database on agricultural statistics	348
Andersen, E., B. Baruth, B.S. Elbersen, G.W. Hazeu, S. Janssen, I. Staritsky, I.J. Terluin, C.A. Van Diepen, D. Verhoog: Integrating farming system, environmental and socio-economic data: The SEAMLESS database	350
Hazeu, G.W., E. Andersen, B. Baruth, M.J. Metzger, C.A. Múcher, M. Pérez-Soba, Ch. Renetzeder, C.A. Van Diepen: European environmental stratifications: an overview	352
Kempen, M., B.S. Elbersen, I. Staritsky, E. Andersen: Detailed spatial distribution of farming systems in Europe: A basic starting point for the further environmental assessment of changes in farming and CAP reform.....	354
Lavelle, P., X. Arnauld de Sartre, S. Dolédec, B. Hubert, I. Veiga: Need for a theoretical framework in building an integrated database.....	356
Terluin, I.J., D. Verhoog, F.E. Godeschalk: Some reflections on the design and use of typologies of EU regions in socio-economic analyses	358

Theme C: Case studies and application of tools and empirical methods

Session C1: Integrated assessment of biomass for biofuel or renewables - trade-offs with feed and food

361

Petersen, J.-E.: Challenges in modelling environmental bio-energy potential(s)	362
Bocardo, P.J., K. Kondoh, J.C.S. Cruz, D.S. Kimura: Life cycle assessment of the sugarcane production system in Brasil.....	364

Coletto, L., A. Brigi, A. Calgaro, S.G. Sandrini, S. Bona: Application of Life Cycle Assessment methodology to compare sunflower oil and diesel for fulfilling farm energy needs.....	366
Dos Santos Rocha, A., M. Mendes da Silva: Family production systems with <i>dende (Elaeis guineensis)</i> and the alternative of biodiesel: Analysis in the Cajaíba community, municipality of Valença (Bahia-Brasil).....	368
Guille, T., A. Fallot, F. Jacquet, P. Havlík: The availability of crop residues for energy, assessing global potentials.....	370
Kukk, L., E. Suuster, A. Astover, M. Noormets, H. Roostalu: Soil optimized suitability analysis for allocation of energy grasses.....	372
Lankoski, J., M. Ollikainen: Environmental impacts of agricultural land allocation between bio-energy crops and food/feed crops	374
Leip, A., R.W. Howarth, S. Bringezu: Biofuels: The way forward.....	376
Msangi, S., R. Schaldach, C. Kölling, J. Koch, J. Alcamo: Exploring the land, water and energy linkages in agriculture: An expanded partial-equilibrium approach to modelling environmental impacts.....	378
Nonhebel, S.: Energy from agricultural residues and the trade-off to the food system	380
Schuler, J., G. Uckert, P. Zander: Assessing the environmental effects of an increasing biogas production on agricultural farms	382
Stehfest, E., G.B. Woltjer, A.G. Prins, B. Eickhout, M. Banse: First and second generation biofuels up to 2030: Possible scenarios and their environmental impacts	384
Suuster, E., L. Kukk, A. Astover, M. Noormets: Spatial assessment of abandoned agricultural land for bio-energy production.....	386
Thorburn, P.J., D. O'Connell, T. Grant: Enhancing the assessment of biofuels feedstock production through more realistic representation of farming systems	388
Topp, C.F.E., R.M. Rees: Greenhouse gas emissions from grassland swards: A Scottish perspective.....	390
Van der Velde, M., G. Wriedt, F. Bouraoui: Water implications of biofuel crop cultivation and set-aside suspension in the European Union	392
Van de Ven, G.W.J., C.L.M. De Visser, H. Langeveld, S.C. De Vries, L. Van den Brink: Bio-ethanol from sugar beet in The Netherlands: Sustainability assessment.....	394
Van Slycken, V., N. Witters, E. Meers, K. Adriaensen, T. Thewys, J. Vangronsveld, F.M.G. Tack: Energy maize for phytoremediation of metal-enriched soils and production of energy: The Campine region, Belgium	396

Session C2: Modelling adaptation strategies to cope with climate change 399

Meinke, H., R. Nelson: Will global mitigation policy enhance or undermine local adaptation?	400
Baethgen, W.E., J.W. Hansen, A.V.M. Ines, A.M. Greene, L. Goddard: Exploring options to improve adaptation to climate change in crop production of south-eastern South America	402
Bezabij, Y.G., R. Sintanyeho, A. Van Griensven: Assessment and predictions of agricultural drought for the Upper Blue Nile Basin, Ethiopia.....	404
Boote, K.J., J.W. Jones, G. Hoogenboom, C. Rosenzweig: Pre-requisites for crop models used to test strategies for adapting to, or mitigating effects of climate change.....	406
Claessens, L., J.J. Stoorvogel, J.M. Antle, R.O. Valdivia, M. Herrero: A minimum-data approach to <i>ex-ante</i> assessment of climate change adaptation strategies in resource-poor countries	408

Crespo, O., S. Hachigonta, M. Tadross: Sensitivity of southern African maize yields to the definition of onset under conditions of climate change.....	410
De Vries, W., J. Kros, G.J. Reinds, H.J.J. Wieggers, G.L. Velthof, D.A. Oudendag, G.J. Nabuurs, M.J. Schelhaas, M. Pérez-Soba, W.P. De Winter, J. Van den Akker, M.M. Bakker, P.H. Verburg, J. Liski, B. Eickhout, A.F. Bouwman: Assessment of nitrogen and green house gas fluxes at the European scale in response to land use and livestock change	412
Dray, A., S. Asseng, P. Perez, S.P. Charles, B. Bates: SimKat: A virtual laboratory to explore the impact of climate change scenarios on the Western Australian wheat-belt	414
Havlik, P., U.A. Schneider, E. Schmid, H. Böttcher, G. Kindermann, S. Leduc, M. Obersteiner: GHG mitigation through bio-energy production <i>versus</i> avoided deforestation and afforestation: A quantitative analysis	416
Kan, I., A. Kimhi, K. Shraberman: Impact assessment of climate change on agriculture: Econometric-process analysis under partial equilibrium	418
Kim, Chang-Gil: Counter measures of agricultural sector for post-Kyoto Protocol	420
Kimura, S.D., Y. Toma, Z. Mu, R. Hatano: Analysis of land use combination to minimize global warming potential from farmland and farmland surplus Nitrogen and to maximize income using eco-balance analysis.....	422
Lieffering, M., P. Newton: Modelling the costs of climate change on grazing systems	424
Moriondo, M., R. Ferrise, M. Bindi: Testing adaptation options in a +2 °C warmer climate	426
Strauss, F., E. Schmid, E. Moltchanova: Simulation of climate scenarios and the bio-economic assessment of different agricultural management systems in the Marchfeld region.....	428
Vigne, M., J. Vayssières, J.L. Bochu, P. Lecomte: Energy use efficiency and greenhouse gases emissions of dairy farms of an isolated territory: Reunion Island from 2000 to 2007	430
Walker, S., D. Nanja, P. Gondwe, J. Dimes, <i>et al.</i> : Mujika community climate: Cropping systems modelling exercise	432

Session C3: Application of integrated assessment tools 435

Adenäuer, M., M. Kuiper, K. Louhichi: Effects of trade liberalization on EU agriculture: A typical macro level application of SEAMLESS-IF	436
Amblard, L., C. Mann, C. Schleyer: <i>Ex-ante</i> institutional compatibility assessment of policy options: Insights from empirical applications and interactions with policy experts	438
Antunes, P., R. Santos, V. Karadzic: Challenges in the application of multi-criteria assessment (MCA) tool for the evaluation of irrigation management alternatives: PLEIADeS project	440
Belhouchette, H., K. Louhichi, O. Therond, J. Wery, G. Flichman: A crop-farm-indicators modelling chain to assess farmer's decision in response to socio-economic scenarios	442
Cacovean, H., T. Man, T. Rusu, D.C. Weindorf, I. Fodorean, C. Moldovan, V. Puiu, A. Pop: Land-Use Management using a soil survey geographic database for the Viisoara-Aiton hills (Transylvanian Plain-Romania).....	444
Coletto, L., S. Bona, S.G. Sandrini, A. Brigi, G. Florio, P. Sambo: Organic crop rotations evaluated using LCA (Life Cycle Assessment).....	446
Colomb, B., F. Angevin, J.E. Bergez, M. Blouin, F. Carpy-Goulard, A. Glandières, L. Prieur: Using MASC to evaluate the sustainability of cropping systems: Application to multi-criteria assessment of organic cropping systems in Southern France	448

Hochman, Z., J. Hunt, B. Long, D.P. Holzworth, A. Whitbread, S. Van Rees, P. DeVoi: Building crop producers' capacity to adapt to climate change and climate variability with Yield Prophet.....	450
Lescot, J.M., P. Bordenave: A decision support to choose between changes of agricultural practices: A spatially distributed Costs/Effectiveness assessment framework	452
Lesschen, J.P., J. Kros, G.L. Velthof, D.A. Oudendag, M. Kempen, W. De Vries: Quantification of the impacts of Cross Compliance measures on European air, soil and water quality	454
Neuwirth, J., K. Wagner, H. Janetschek: Assessment of flood prevention contribution of multi-functional agricultural land: Results of a case study in Lower Austria.....	456
Palma, J., A.R. Graves, P.J. Burgess, W. Van der Werf, F. Herzog: Silvo-arable agro-forestry in Europe: Systems for meeting food and industry crop requirements with improved resource-use efficiency	458
Perugini, M., M. Toderi, G. Seddaiu, R. Orsini, G. De Sanctis, P.P. Roggero: Integrated impact assessment of agro-environmental schemes on soil erosion and water quality.....	460
Oñate, J.J., B.S. Elbersen, P. Martinez Alonso, B. Peco, J. Roos-Klein Lankhorst: Assessing the effects of Cross Compliance obligations on European biodiversity and landscapes ..	462
Sasaki, H.: Integrated model of paddy rice production and related environmental effects ...	464
Turpin, N., J.P. Bousset, G. Bigot, E. Josien, E. Perret: Can regional policies mitigate the environmental effects of price raise? A typical application of SEAMLESS framework at meso level in Auvergne	466

**Session C4: Systems analysis informing policy: Case studies from agricultural systems
and rural regions in the face of change** **469**

Pannell, D.: Systems analysis informing policy.....	470
Antle, J.M., J.J. Stoorvogel, R.O. Valdivia: Assessing poverty-sustainability trade-offs in semi-subsistence agricultural systems: A case study of policy options in Machakos, Kenya	472
Chen, Z., F. Qu, X. Huang: Performance analysis on the changes of farmland property right system: An explanation of the diversification of Chinese farmland system in transition.	474
Dillon, E.J., T. Hennessy, S. Hynes: Assessing the sustainability of Irish agriculture.....	476
Kanellopoulos, A., H. Hengsdijk, S. Janssen, M.K. Van Ittersum: <i>Ex-ante</i> assessment of the abolishment of the EU set aside policy: Results from a bio-economic farm analysis	478
Lange, A., A. Piorr, R. Siebert, D. Viaggi: Direct and indirect impacts of CAP changes on the economy of rural areas: Integrated assessment of farm households' adaptation strategies in Eastern and Western Germany	480
Mack, G., C. Flury, T. Walter: Alpine grazing trends in Switzerland: Economic importance and impact on biotic communities.....	482
Majewski, E., A. Was, H. Belhouchette, K. Louhichi, I. Mouratiadou: Impact Assessment of policy changes on the arable sector using the FSSIM model: Case study of the Zachodniopomorskie NUTS2 region	484
Marchand, F.L., D. Claeys, L. Lauwers, J. Buysse, B. Van der Straeten, G. Van Huylenbroeck: Introducing flat rate direct payments taking into account social concerns and ecological non-commodities.....	486
Mouratiadou, I., C.F.E. Topp, G. Russell: Investigating the economic and water quality effects of the 2003 CAP reform on arable cropping systems: A Scottish case study	488
Thorburn, P.J., J. Brodie, R. Milla, E. Shannon, S. Attard, T. Anderson, A. Davis: Systems analysis underpinning development of management action targets to meet water quality objectives in sugarcane production systems.....	490

Havlikova, M., C. Kroeze: Efficiency of environmental policies in agriculture in the Czech Republic: The case of dairy cattle	492
---	-----

Theme D: Integrated assessment: Science and impact

Session D1: Stakeholder involvement in designing, use and evaluation of integrated assessment models 495

Pahl-Wostl, C.: The role of models in supporting processes of change towards sustainable resource governance	497
De Kraker, J., C. Kroeze, P. Kirschner: Models as social learning tools in participatory integrated assessment	498
De Mey, K., K. D’Haene, M. Meul: Application of an integrated monitoring tool for sustainable dairy farming in Flanders.....	500
Duru, M., G. Martin: Analysis of stakeholder-researcher interactions for designing a generic grassland model suited for a diversity of farmers’ practices	502
Gabbert, S., M.K. Van Ittersum, F. Ewert, C. Kroeze, S. Stalpers, J. Alkan Olsson: Accounting for user’s uncertainty information needs in Integrated Assessment models: The case of the SEAMLESS Integrated Framework	504
Jonsson, A., J. Alkan Olsson, L. Andersson: Modellers, model results and local stakeholders – dynamics in combining expert and lay knowledge in locally grounded policy formulation	506
Karadzic, V., P. Antunes, R. Santos, A. Osann: Transition towards more adaptive irrigation management: The impact of innovative technologies. A case study in Caia, Guadiana River Basin	508
Lusiana, B., D. Suyanto, R. Mulia, M. Van Noordwijk, G. Cadisch: Prospecting the behaviour of agro-ecosystems: Experiences in using FALLOW model with natural resource managers	510
Nicetic, O., E. Van de Fliert, Ho Van Chien, R. Spooner-Hart, Z. O’Leary, D. Rae: Learning by doing: Designing and conducting impact assessment studies for citrus Farmer Field Schools in Vietnam.....	512
Reidsma, P., J. Alkan Olsson, I. Bezlepkina, S. Brogaard, J. Queste, R. Fischer, M.K. Van Ittersum: SEAMLESS training material on concepts and models for Integrated Assessment of agriculture and sustainable development	514
Speelman, E.N., L.E. García-Barrios: Serious Gaming as a tool to create sustainability awareness, discussion and negotiation among stakeholders in cattle systems, the case of Los Angelitos.....	516
Speelman, E.N., J.C.J. Groot, H. Van Keulen, K. Kok, W.A.H. Rossing: Understanding and modelling socio-ecological networks to support multi-scale governance of sustainable dairy farming systems.....	518
Taverne, M., O. Therond, J.P. Bousset, J. Alkan Olsson, F. Ewert, M.K. Van Ittersum, J. Wery: Specifying impact assessment simulations in interaction with end-users: The example of SEAMLESS-IF	520
Thorburn, P.J., E. Jakku: Agricultural decision support systems: Tools to facilitate co-learning for stakeholders and scientists	522
Van Paassen, A., C. Barnaud, G. Trébuil: Participatory modelling for Renewable Resource Management: A critical assessment	524
Van Paassen, A., N. De Ridder, L. Stroosnijder: Using explorative models to enhance expert learning about farm context and farmer rationalities in Burkina Faso	526

Session D2: Role of integrated assessment for policy making and evaluation 529

Alkan Olsson, J., M.K. Van Ittersum, A.-K. Bäcklund, S. Brogaard, F. Brouwer: Participatory IA tool development: Lessons learnt in the SEAMLESS project 530

Bäcklund, A.-K., J. Alkan Olsson, S. Brogaard, M. Taverner, J.P. Bousset, J. Wery, M.K. Van Ittersum: Multiple agendas and cultures in a participatory development of computerized IA tools: The experience of SEAMLESS 532

Dahal, B.M.: Integrated assessment for the development of Progressive Coordinative Action (PCA) plan: An approach for sustainable agriculture 534

Fischer, R., I. Theesfeld: Better regulation by the use of Integrated Assessment? SEAMLESS integrated framework and European policy making 536

Hasnain, N., H. ApSimon, T. Oxley: A multi-criteria approach to environmental policy 538

Hernández Jiménez, V.: Exploring receptivity through innovative actions..... 540

König, B., K. Helming, K. Tscherning, H. König, K. Diehl: Determinants of policy-oriented research design 542

Padmanabhan, M.: Integrated impact assessment as a new institution: The political dimensions of modelling-tool use 544

Van Delden, H., R. Vanhout: Contribution of the development process to the actual implementation and use of Integrated Spatial Decision Support Systems 546

Sieber, S., P.J.F.M. Verweij, K. Müller, K. Tscherning, K. Helming: Design and institutional embedment of the meta-model Sustainability Impact Assessment Tools (SIAT) 548

König, H., K. Helming, P. Reidsma, L. Zhen, S. Feng, S. Sieber, F. Brouwer: Bridging the gap between science and decision makers for sustainable development of multi-functional land use in developing countries 550

Authors Index 553

Preface

The theme of the AgSAP conference reflects the increased need for integrated research approaches that assist in assessing agricultural systems at multiple levels and in terms of economic, environmental and social aspects. The conference presents the state-of-the-art of scientific approaches to assess agricultural systems in the context of sustainable development, and aims to propose an agenda for future research and for improved science-policy interaction in this domain.

The ca. 250 contributions present, evaluate and compare alternative methods and modelling approaches, applications and policy support options. They focus on the integration and use of models for linking science and policy, as a method for improving natural resource use, policy making and policy implementation in agriculture. The conference is structured along four major themes, each with several sessions:

- A. Methodology for integrated assessment – Alternative methods for integrated assessment of agricultural systems and contributions to rural development are presented. Methods for up- and downscaling are discussed.
- B. State-of-the-art components for integrated systems – Progress in modelling tools and their use for supporting policy assessment on agriculture, rural development and sustainable development. Focus in these sessions is on components rather than on entire systems: assessment at field, farm, regional, continental or market level; indicators; databases and software engineering.
- C. Case studies and application of tools and empirical methods – The sessions present empirical applications, using modelling tools, to specific problems, policy areas and public concerns.
- D. Integrated assessment science and impact – Explore the broader societal use and impact of integrated assessment tools, including the contribution to science-policy interactions.

The conference was initiated by the SEAMLESS integrated project (System for Environmental and Agricultural Modelling; Linking European Science and Society), funded by the European Commission under Framework Programme 6. This project (2005–2009; www.seamless-ip.org) developed an operational modelling framework for integrated assessment of agricultural systems. The conference was endorsed by the European Society for Agronomy (ESA), European Federation for Information Technology in Agriculture (EFITA), International Consortium for Agricultural Systems Applications (ICASA) and the International Environmental Modelling and Software Society (iEMSs).

The conference is greatly indebted to the session chairs for organizing the 17 parallel sessions and evaluating the abstracts:

- Johanna Alkan Olsson, Lund University, Sweden
- Erling Andersen, University of Copenhagen, Denmark
- John Antle, Montana State University, USA
- Robert Argent, Bureau of Meteorology, Canberra, Australia
- Daniel Auclair, INRA, Montpellier, France
- Martin Banse, LEI, Wageningen UR, The Netherlands
- Irina Bezlepkina, LEI, Wageningen UR, The Netherlands
- Floor Brouwer, LEI, Wageningen UR, The Netherlands
- Frank Ewert, University of Bonn, Germany
- Guillermo Flichman, IAMM, Montpellier, France

- Hayo Haanstra, Ministry of Agriculture, Nature and Food Quality, The Netherlands
- Jim Hansen, International Research Institute for Climate Prediction, New York, USA
- Thomas Heckelei, University of Bonn, Germany
- Katharina Helming, ZALF, Müncheberg, Germany
- Sylvia Herrmann, Leibniz University, Hannover, Germany
- George Hutchinson, Queen's University Belfast, Northern Ireland
- Jim Jones, University of Florida, Gainesville, USA
- Haluk Kasnakoglu, Middle East Technical University, Ankara, Turkey
- Brian Keating, CSIRO, Sustainable Ecosystems, Brisbane, Australia
- Marijke Kuiper, LEI, Wageningen UR, The Netherlands
- Ken Moore, Iowa State University, USA
- Roger Moore, CEH, Wallingford, UK
- Lennart Olsson, Lund University, Sweden
- Maria Luisa Paracchini, Joint Research Centre, Ispra, Italy
- Pytrik Reidsma, Wageningen University, The Netherlands
- Andrea Rizzoli, IDSIA, Lugano, Switzerland
- Mike Robertson, CSIRO, Sustainable Ecosystems, Australia
- Graham Russell, University of Edinburgh, UK
- Stefan Sieber, IPTS, Joint Research Centre, Seville, Spain and ZALF, Germany
- Insa Theesfeld, Leibniz Inst. of Agric. Development in CE Europe, Halle, Germany
- Pablo Tittonell, CIRAD, Montpellier, France
- Nadine Turpin, CEMAGREF, Clermont Ferrand, France
- Elske Van de Fliert, The University of Queensland, Brisbane, Australia
- Martin Volk, Helmholtz Centre for Environmental Research - UFZ, Leipzig, Germany
- Jacques Wery, UMR System (Agro.M-CIRAD-INRA), Montpellier, France
- Jan Erik Wien, Alterra, Wageningen UR, The Netherlands

Finally, these Proceedings are available, in time, thanks to the enormous dedication of Joost Wolf and Gon van Laar. Joost organized the evaluation and made sure that no abstract is missing and Gon edited the Book of Proceedings. Thank you Joost and thank you Gon for your professional and kind contributions!

On behalf of the Organization,

Martin K. Van Ittersum

Plenary Sessions

Agriculture and sustainable development in developing countries

Joachim Von Braun

International Food Policy Research Institute,
2033 K Street, NW, Washington, DC 20006, USA

Contact: j.vonbraun@cgiar.org

Introduction

The sustainability and advancement of agriculture in low-income countries is hampered by the complex interaction of new challenges, including the global food and financial crises that occurred in 2007–08, demand for biofuel production, and climate change. Agricultural productivity growth supported by significant investments in research and development (R&D) is crucial for addressing these risk factors and building resiliency. Such investments, however, have been stagnating since the mid-1990s, and the recent financial crunch has further constrained the availability of capital for agriculture. A strategic initiative for technological and institutional innovations at global scale and related investment action is urgently needed to respond to the challenges.

New and ongoing pressures

The global food crisis in 2007–08 and financial crisis in 2008 have serious implications for agriculture and poor people in developing countries (Von Braun, 2008). The surge in prices of food commodities resulted in a major food crisis that stemmed from rising demand for agricultural products (due to income and population growth), rising energy prices, and expansion of biofuel production. However, the much needed and fast supply response was limited to industrialized countries and not forthcoming in the developing regions because of underinvestment in agriculture, farmers' limited access to inputs, natural resource constraints, and weather disruptions (Von Braun *et al.*, 2008). In fact, cereal production in developing countries excluding Brazil, China, and India fell by 1.6% between 2007 and 2008 (FAO, 2008). Although high food prices provided incentives for policymakers, farmers, and investors to boost agricultural productivity, the variability of prices was an obstacle to long-term planning. As the financial crisis and economic slowdown unfolded, decreasing demand for agricultural commodities pushed food prices to lower level. Further, with limited and more expensive capital, broader plans for agricultural investments in low-income economies are cut short.

Increasing competition for land and water resources for agriculture as a result of the food crisis and declining capital for long-term investments caused a revaluation of natural resources in some countries. In Brazil, for example, farmland prices rose by 16% in 2007 alone as reported by the media and probably dropped back in 2008. In addition, constraints on capital availability may again lead to overexploitation and degradation of scarce natural resources, i.e. land and water. Developed water sources are almost fully utilized in many countries, while agricultural demand for water is expected to increase significantly in the future (GES, 2008).

The productivity and sustainability of agriculture remains at risk as yields and overall productivity growth are stagnating. Even before the food crisis hit, average annual cereal yield growth in developing countries was declining (World Bank, 2007). Total factor productivity – derived from the ratio of total output growth to total input growth – in the developing world grew on average by 2.1% per annum from 1992 to 2003; in some regions, the rate of growth was even lower. Threats to productivity and output growth will also rise in the future as climate variability and change increases temperatures and the risk of droughts and floods (Cline, 2007) and yields in developing countries could further decrease (Fischer *et al.*, 2005).

Strategic action for technological and institutional change in food and agriculture

A significant increase in the level of current investments is crucial for agriculture to face challenges and respond to new opportunities. Investments should be made in research and development (R&D), rural infrastructure, rural institutions, and information monitoring and sharing.

A recent study by IFPRI shows that if investments in public agricultural research doubled from US\$5 to US\$10 billion from 2008 to 2013, agricultural output would increase significantly and millions of people would emerge from poverty. If these R&D investments are targeted at the poor regions of the world – Sub-Saharan Africa and South Asia – overall agricultural output growth would increase by 1.1 percentage points a year and lift about 282 million people out of poverty by 2020. International agricultural research projects with substantial payoffs for a large number of beneficiaries should be given priority. The centres of the Consultative Group on International Agricultural Research (CGIAR) have identified examples of ‘best bets’ in agricultural research (Von Braun *et al.*, 2008b). These ‘best bets’ include programmes to revitalize yield growth in intensive cereal systems in Asia, increase small-scale fish production, address threatening pests like virulent wheat rust, tackle cattle diseases such as East Coast Fever, breed maize that can be grown in drought-prone areas, and scale up bio-fortified food crops that are rich in micronutrients.

The technological change initiatives must be accompanied by institutional innovations for sustainable actions. These include a comprehensive re-vitalization of agricultural extension and service systems in small farm agriculture, sound cooperative and contract farming arrangements that address economy of scale constraints, incentives for sustainable land and water management, innovative arrangements that include agriculture into climate change adaptation and mitigation regimes, and market and trade arrangements that facilitate fair and open trade. The adequate governance of these institutional arrangements at national and global level poses a major challenge for reaching a sustainable food and agriculture system in the 21st century.

References

- Cline, W.R., 2007. Global warming and agriculture: Impact estimates by country. Center for Global Development and Peterson Institute for International Economics, Washington, DC.
- FAO, 2008. Food Outlook. November, Food and Agriculture Organization of the United Nations, Rome.
- Fischer, G., *et al.*, 2005. Philosophical Transactions of Royal Society B 360: 2067-2083.
- GES, 2008. The crisis of water management. Global Economic Symposium 2008 session handout. Available at [http://www.global-economic-symposium.org/ges-2008/downloads/GES%202008%20Session%](http://www.global-economic-symposium.org/ges-2008/downloads/GES%202008%20Session%20). Schleswig-Holstein, Germany.
- Von Braun, J., 2008. Food and Financial Crises: Implications for agriculture and the poor. Brief prepared for the CGIAR Annual General Meeting, Maputo, Mozambique. December 1.
- Von Braun, J., *et al.*, 2008a. High food prices: The what, who, and how of proposed policy actions. IFPRI Policy Brief. Washington, DC: International Food Policy Research Institute.
- Von Braun J., *et al.*, 2008b. International agricultural research for food security, poverty reduction, and the environment: What to expect from scaling up CGIAR investments and ‘best bet’ programs. International Food Policy Research Institute, Washington, DC.
- World Bank, 2007. World development report 2008: Agriculture for development. Washington, DC.

Agriculture and sustainable development in OECD countries: A policy perspective

W.J. Legg

Trade and Agriculture Directorate,
OECD-Organisation for Economic Co-operation and Development,
2 rue André-Pascal, 75016 Paris, France
Contact: wilfrid.legg@oecd.org

Introduction

In the 30 member countries of the OECD – as well as many non-OECD countries – concern with sustainable agricultural development has led to increasing attention to the role of policies in improving environmental performance. Countries are also interested in identifying possible future environmental problems associated with agricultural activities, and trying to better understand the effects of different agricultural policy measures on the environment. More recently there is heightened concern over the effect of external environmental events – in particular climate change and variability risks – on the agricultural sector.

Many factors influence environmental performance – agro-ecological conditions, farmer knowledge and behaviour, regulations, market forces, external events such as weather, climate change and industrial pollution – and many of the effects are site specific and take time to appear. Moreover, across countries there are very different histories and preferences with regard to the nature, extent and mix of policy interventions in the agricultural sector.

Agriculture is a sector in which policy plays a significant role. Agricultural policies provide monetary transfers that influence – directly or indirectly – on what and how much to produce, where and under what conditions, while environmental regulations require farmers – either at their own cost or with the aid of subsidies – to adopt certain practices or deliver particular outcomes determined by governments. Overall, this leads to a complex web of incentives and disincentives facing farmers, with an equally complex set of multiple environmental effects.

In most OECD countries, the dominant trend in recent years has been the gradual (and sometimes limited) decoupling of farm support from agricultural commodity production and a shift towards policy measures that do not require farmers to produce specific commodities in order to be eligible for support (or any commodities at all); are targeted at specific environmental objectives; or link environmental and income support measures (cross-compliance). Agricultural and associated trade policy reform in itself will have both positive and negative impacts on the environment as the production incentives facing farmers change.

The challenge is to determine and move towards the level and mix of agricultural production and practices that is both economically and environmentally efficient: production may be economically efficient but does not deliver the ‘right’ amount of environmental outputs (or *vice versa*). Finding the best balance between farming profitability, competitiveness and resource conservation is a complex issue. There is a need to identify the existing market or policy failures causing the problem, establish the extent to which markets could be created or policy intervention is need to address the problem, define the most cost-effective policy approaches and choice of instruments, and implement, monitor and evaluate policies.

Essentially, policymakers in most OECD countries have applied at least two broad sets of objectives and instruments in this area – one relates to agricultural production and farm incomes, the other relates to environmental performance. Given the integrated nature of the

relationship between agriculture and the environment (joint agriculture and environmental production, and dynamic interactions) such that targeting one set of objectives inevitably leads to consequences for the achievement of the other, the appropriate policy instruments cannot be evaluated in isolation. There are consequences for agricultural production where environmental regulations constrain production. Payments that only compensate for the extra costs involved in the provision of environmental services could be production-neutral.

Work in the OECD aims to help inform policy makers to design and implement effective policy measures (that achieve desired objectives), which are also efficient (giving best value for money with least distortion to production and trade), and which will thus contribute to sustainable agricultural development. The main conclusions from the work thus far – which is based on a mix of conceptual, empirical and modelling studies – are the following:

- An overall improvement in the environmental performance of agriculture, but masking a number of severe local and regional problems, while future global pressures on land and water resources, including climate change, will be significant.
- While environmental improvements have resulted from agri-environmental policy measures, in a number of OECD countries unconstrained commodity production-linked support policies are still pulling in the opposite direction.
- Environmental improvement in agriculture has involved costs that would be lower in the absence of commodity production-linked support measures, which provide incentives to adopt environmentally harmful practices and input use, and expand commodity production to environmentally sensitive land.
- Although environmental cross-compliance conditions associated with commodity production-linked payments to farmers are mitigating some environmental pressures, they are not necessarily the most effective or efficient ways of reducing environmental pressures,
- Research is underway to analyse the effectiveness and efficiency of different agri-environmental policy measures in order to identify the policies and market actions that would achieve the same or better environmental outcomes at lower cost.
- Establishing reference levels to distinguish the conditions under which farmers should be accountable for the environmental costs they impose on society (polluter-pays-principle) from those under which farmers should be rewarded for the provision of non-remunerated environmental benefits they provide to society (provider-gets-principle) is crucial.
- Agro-ecological conditions and public preferences vary across and within countries, and a variety of different policy measure, market creation and voluntary initiatives, and technological developments are appropriate to deal with environmental concerns.
- The current financial, economic and food price crises significantly increase the challenge to produce food sustainably, in particular given longer term demographic, income and climate change trends.

Reference

OECD, 2008. Environmental performance of agriculture in OECD countries since 1990. Paris, France.

Integrated assessment of agricultural systems: On integrated science and science integration

M.K. Van Ittersum, F. Ewert, E. Andersen, F. Brouwer, T. Heckelei, J. Alkan Olsson,
J. Wery, J.J.F. Wien
Plant Production Systems, Wageningen University,
P.O. Box 430, 6700AK Wageningen, The Netherlands
Contact: martin.vanittersum@wur.nl

Introduction

The recent fluctuations in prices of agricultural commodities have distinct impacts on agricultural systems at global, continental, regional, farm and field level. They not only affect the economy of agricultural systems, but can also have substantial environmental and social implications. These price fluctuations underpin two main requirements for ‘integrated assessment (IA) of agricultural systems’ in general: IA must provide integrated analysis at multiple scales and of economic, environmental and social factors. The dynamics in food prices and, for instance, the rise and decline in popularity of using biomass for biofuel also point at a third requirement: research tools must be flexible, as issues can change within short time periods, and research tools fit for only one purpose can become outdated rapidly.

These three requirements challenge research for integrated assessment of agriculture and point at the need for generic and flexible tools. This contribution will illustrate some of the advances achieved over the past four years in a large integrated and EU-funded research project (SEAMLESS), involving 30 institutes and a large group of scientists with an agronomic, environmental, economic, information technology or sociological background (Van Ittersum *et al.*, 2008). We present key methodological features of a computerized framework for integrated assessment of agricultural systems. The paper demonstrates an application, and reflects on some research challenges for interdisciplinary science. Finally, it discusses the positioning of science-based IA frameworks and derived information in the science-policy interface.

A component-based framework for integrated assessment

The SEAMLESS Integrated Framework (SEAMLESS-IF) allows integrated, *ex-ante* assessments of agricultural and agri-environmental policies and technologies across a range of scales, from field/farm to region and the European Union. SEAMLESS-IF integrates relationships and processes across disciplines and scales which are conceptualized following the paradigm of hierarchy theory (Ewert *et al.*, 2009). The relationships and processes at different levels of organization are modelled in so-called components. These components include a modular, biophysical simulation model calculating agricultural production and externalities at field level (APES); a bio-economic farm model quantifying the integrated agricultural, environmental and socio-economic aspects of farming systems (FSSIM); and an agricultural sector model (CAPRI) providing information on supply-demand relationships. Various scaling methods have been used to link information from one level to another or to simulate the feedbacks between levels of organization and processes. The framework uses a European data base with data on soils, weather, farming systems, agro-management, prices and sectoral accounts as well as a library containing indicators for economic, environmental, social aspects organized in an indicator framework. Institutional indicators are included and organized in a specific component for institutional compatibility assessment (PICA). The conceptual linkage of components is facilitated through the use of ontologies and the technical linkage through the use of the Open Modelling Interface (OpenMI). Two applications have been used to test and improve the framework. One simulates impacts of international trade liberalization proposals on the European Union and a second case study

analyses the consequences of environmental policies at a regional and farm level. Additional components, for instance focusing on landscape quality or on global market interactions have been developed in the project or are available and can be integrated into SEAMLESS-IF.

Reflections on integrated science

The developed integrated framework follows one of the possible methodological pathways for integrated assessment. The method focuses on integration of standalone components that are strong in simulating specific processes and relationships, including crop and livestock production and externalities, farm responses and supply-demand relationships. A benefit of this approach is that it allows to structure the development of integrated assessment tools in relatively independent components and to benefit from advances of science focusing on specific parts of the system. All details in each of the components may not be needed for a specific application but do provide a degree of flexibility needed for a broad range of applications (Ewert *et al.*, 2009).

A key question is whether this approach allows an adequate system representation for specific problems, and does capture the most relevant feedback mechanisms and interactions which may occur at the interface of subsystems, e.g. between crops and livestock, between different fields and landscapes, or between farms and markets. Here, further testing remains to be done with interesting science. A particular challenge of this research method is the high data demand. Three routes or combinations of them are available: (1) using statistical sampling procedures; (2) developing science-based rules to ‘generate’ certain crucial but missing data; (3) using available pan-European data.

Structuring research tools in components also allows structuring the workforce and European and international collaboration. The teams developing components can work relatively independent and may consist of specialists with sufficient so-called T-shaped, that is integrative, skills (Bouma, 1997). At the same time, a team of adequate size needs to have the necessary conceptual and technical skills for integration and linkage of components. The relatively flexible linkage of components puts high demand on state-of-the-art information technology (IT) which is not present in all teams. The experience of SEAMLESS showed the crucial importance of having a team with unprecedented interdisciplinary skills and which is motivated to invest in IT.

Reflections on integration of science and policy

Despite the advances in developing generic and flexible research tools in SEAMLESS and many other research projects, science cannot take for granted that its results will be heard and used in the policy domain. It remains very important to understand the aims and role of integrated analysis within decision-making processes for which science-based information is just one relevant ingredient. Classifications and ideotypes, of foresight studies (Van Ittersum *et al.*, 1998), of the role of science in policy and politics (Pielke Jr, 2007) and of the institutional interfaces of science and policy in so-called boundary arrangements (Sterk *et al.*, 2009) can assist in defining and contrasting the precise aims of integrated assessment and in further working on an effective science-policy interface.

References

- Bouma, J., 1997. *Geoderma* 78: 1-12.
- Ewert, F., *et al.*, 2009. *Environmental Science & Policy*. (in review)
- Pielke Jr, R.A., 2007. *The Honest Broker. Making Sense of Science in Policy and Politics*. Cambridge University Press, 188 pp.
- Sterk, B., *et al.*, 2009. *Land Use Policy* 26: 434-442.
- Van Ittersum, M.K., *et al.*, 1998. *Agricultural Systems* 58: 309-330.
- Van Ittersum, M.K., *et al.*, 2008. *Agricultural Systems* 96: 150-165.

Two decades of Integrated Assessment tools: A promising way forward

Jan Rotmans

DRIFT: Dutch Research Institute For Transitions,
Erasmus University Rotterdam, P.O. Box 1738,
3000 DR Rotterdam, The Netherlands
Contact: Rotmans@fsw.eur.nl

Integrated Assessment (IA) is the multi- or interdisciplinary process of structuring knowledge elements from various scientific disciplines in such a manner that all relevant aspects of a social problem are considered in their mutual coherence for the benefit of decision-making. IA has a heuristic character, being a quest in triplicate: for causalities, coherence and commonalities. IA is therefore an iterative, reciprocal process, where integrated insights from the scientific community are conveyed to the decision-making community, and experiences and insights from decision-makers are taken account of in the integrated analyses. Although active participation is no prerequisite, more and more people in the IA-community are convinced of the vital importance of involvement of stakeholders in the IA-process. It is generally acknowledged that involvement of non-scientific and practical knowledge and expertise, valuation and preferences in the form of direct involvement of actors will enrich the process of Integrated Assessment.

In general, two types of Integrated Assessment methods can be distinguished: analytical methods and participatory methods. While analytical methods are often rooted in natural sciences, participatory methods, also labelled as interactive or communicative methods, stem from social sciences. The group of analytical methods is reasonably well-defined and basically includes model analysis, scenario analysis and risk analysis. Their commonality is that they provide analytical frameworks for representing and structuring scientific knowledge in an integrated manner. The group of participatory methods, however, involves a plethora of methods, varying from expert panels, delphi methods, to gaming, policy exercises and focus groups. They have in common that they aim to involve non-scientists as stakeholders in the process, where the assessment effort is driven by stakeholder-scientist interactions.

Although it is hard to generalize, it is acknowledged that over the last two decades tools for IA have evolved significantly: from supply-driven to more demand-driven, from mono-disciplinary to multi-disciplinary, from technocratic to participatory, from objective to subjective, from certainty to uncertainty and from predictive to explorative. As Wynne & Shackley (1994) put it: we used to build truth machines, but now we build heuristic tools.

Within this changed IA-context we now face the ultimate challenge is to perform IA for sustainable development, this is what we call Integrated Sustainability Assessment (ISA), not to be confused with Sustainability Impact Assessment (SIA). Sustainable development is a complex, multi-dimensional phenomenon, with a breadth and depth that cannot be fully covered by the current portfolio of IA-tools. We, therefore, need a new generation of ISA-tools, that is rooted in a new paradigm and that can handle the complexity and multiplicity of sustainable development, in terms of multiple scales, multiple domains and multiple generations. To build-up a new generation of IA-tools requires time, resources and a clear investment strategy, it is proposed here to follow a two-track strategy: find new ways to use the current portfolio of IA-tools as efficiently and effectively as possible, while at the same time developing the next generation of IA-tools for sustainable development, called ISA-tools.

References

- Rotmans, J. & H. Dowlatabadi, 1998. Integrated assessment of climate change: Evaluation of models and other methods. In: Eds S. Rayner & E. Malone, Human choice and climate change: An international social science assessment. Batelle Press, USA.
- Rotmans, J., 2006. Integrated Assessment 6(4): 35-57.
- Weaver, P. & J. Rotmans, 2006. International Journal of Innovation and Sustainable Development 1(4): 284-303.
- Wynne, B. & S. Shackley, 1994. Environmental models: Truth machines or social heuristics. The Globe 21, 6-8.

**Enhancing developing world agricultural performance:
Getting beyond the current plateau**

Prabhu Pingali

Deputy Director, Agriculture Development,
Bill and Melinda Gates Foundation

Contact: Prabhu.Pingali@gatesfoundation.org

Developing world agriculture has witnessed unprecedented levels of growth over the past four decades yet serious problems remain. While food supply outpaced population growth rates, hunger and poverty persist in large parts of the developing world, with particular concentration in sub-Saharan Africa. Technology induced productivity growth has generally not reached beyond the ‘bread basket areas’, causing a widening welfare gap with the lagging regions, even in emerging economies. Moreover, ‘Green Revolution’ productivity gains have shown clear signs of stagnation and potential reversal due to intensification induced resource degradation, resource competition and the emerging consequences of climate change. Technology solutions for addressing the problems of lagging regions, especially drought tolerance, as well as, correcting for resource degradation are hampered by the changing locus of innovation from the public to the private sector. Incentives for enhancing productivity growth have been hampered by the general decline in public investments for the agricultural sector, as well as, a continuing policy bias towards urban areas. The problems of the developing country agriculture are as complex today as they were four decades ago, if not more so. However, we are better positioned to address these problems today than in the past due to a vastly expanded knowledge base and a set of viable solutions. What’s needed is better ground level information on the constraints to productivity growth and an enhanced ability to adapt solutions to these problems. Agriculture can be an effective pathway out of rural poverty, only if there is a long term and sustained commitment by the state to productivity enhancement, there are no quick wins.

Theme A
Methodology for integrated assessment

**Session A1: Methods for integrated assessment of
agricultural systems and land use**

Session organizers:

Irina Bezlepkina

LEI, Wageningen UR, The Netherlands

Stefan Sieber

IPTS, Joint Research Centre, Seville, Spain
ZALF, Germany

Scenario studies for agriculture, land use and landscape in Europe: A comparison¹

Katharina Helming, Ignacio De la Flor Tejero, Martin K. Van Ittersum, Peter Nowicki,
Willem Rienks, Axel Volkery
Leibniz-Centre for Agricultural Landscape Research (ZALF), Germany
Contact: khelming@zalf.de

Introduction

Land use and agriculture are key human activities, which, through the exploitation of natural resources, foster socio-economic development and alter structures and processes in the landscape. At the European level, the Sustainable Development Strategy stresses the need for real integration of economic, environmental and social issues across policy areas. In particular, land use policies aim to promote sustainability pathways of natural resources use and rural development through the decoupling of economic growth from environmental degradation while supporting social cohesion. In recent years, foresight and *ex-ante* assessment studies of land use and agriculture have emerged that place land use decisions into the logical chain of driving forces and impacts. The purpose of these studies was to provide decision support to land use and agricultural policy making through the anticipation of possible effects of land use and agricultural change scenarios on sustainable development targets. While similar in general purpose and approach, the studies differed in their approach to the spatio-temporal systems and in their use of driving forces, scenarios, modelling approaches, etc. The objective of this paper was to conduct a comparative analysis of selected forecasting studies for land use change in Europe, namely SEAMLESS (Van Ittersum *et al.*, 2008) SENSOR (Helming *et al.*, 2008), EURURALIS (Eickhout & Prins, 2008), SCENAR 2020 (Nowicki *et al.*, 2007), and PRELUDE (EEA, 2007).

Methods

The DPSIR (Drivers, Pressures, States, Impacts, Responses) was used as a general framework for comparison. Although originally focused on the environment and the effects of humans on it, the DPSIR framework is easily applicable to the cases of land use and agriculture and helps structuring complex analytical chains. Based on the DPSIR chain and integrating further structuring elements, seven parameters were selected to compare the analytical design of the assessment studies. These were: (1) purpose of the project, (2) spatial and temporal scale (grain and extend), (3) driving forces considered, (4) scenario design, (5) modelling approach, (6) impact analysis (indicator frameworks), (7) sustainability interpretation.

Results

Although considerably different in size, complexity and purpose, a comparison of the studies using the above described criteria proved possible and revealed a number of similarities. All projects aimed at providing *ex-ante* assessments of future development trends as affected by human decisions. They were based on scenario studies and used indicator systems to address environmental, social and economic impacts. Despite the similar purposes, each study revealed its particular strengths and unique features: SCENAR2020 and EURURALIS, two meta models, were particularly dedicated to the policy environment of agriculture and rural development in Europe. For the case of SCENAR, the high degree of policy relevancy was also manifested with the startling short time span of less than one year they required for the analyses. PRELUDE, an expert system, was based on a very sophisticated approach to stakeholder involvement in scenario design, which also allowed for visionary, antithetic

¹ Keynote presentation

Table 1. Foresight and assessment studies included in the comparative review.

Study	Time horizon	Spatial System	Issue	Purpose
SCENAR	2020	Europe at NUTS2/3 and regional clusters	Agriculture and rural areas	Future of EU agriculture and the rural economy
PRELUDE	2035	Europe at 10min grid	Landscape and environment	Visions on future landscape developments
EURURALIS	2030	Europe at NUTS2/3 and regional clusters	Agriculture and rural sustainability	Foresight rural areas
SEAMLESS	2015–2025	Nested system from farm level to regional, national, European and Global	Agricultural Systems	Integrated assessment of agricultural systems
SENSOR	2025	Europe at NUTS2/3 and regional clusters	Land use (agriculture, tourism, forestry, nat. conservation, transport, and energy infrastructure)	<i>Ex-ante</i> impact assessment of European policies

anticipations of possible future landscape developments. It was particularly useful to trigger societal debate on future development targets of the rural environment. SEAMLESS and SENSOR involved far more resources than the other projects allowing for differentiated and complex approaches to the assessments and to the development of fully dynamic modelling systems. SEAMLESS, involving the coupling of comprehensive standalone models, emphasised on sophisticated scaling approaches in integrated modelling leading from detailed simulations of single farming systems up to global interactions in agricultural decision making. SENSOR with its meta-model SIAT emphasised on a cross-sectoral approach integrating a variety of land use sectors. It also developed new approaches to sustainability interpretation of environmental, social and economic impacts. Both projects developed impact assessment tools for further use in policy making.

References

- Nowicki, P., *et al.*, 2006. SCENAR 2020. European Commission, Directorate-General Agriculture and Rural Development, Brussels.
- EEA, 2007. PRELUDE. Technical report No. 9. Copenhagen, Denmark.
- Eickhout, B. & A.G. Prins, 2008. EURURALIS 2.0, Wageningen UR and Netherlands Environmental Assessment Agency (MNP) Bilthoven, The Netherlands.
- Helming, K., *et al.*, 2008 Sustainability impact assessment of land use changes. Springer Berlin, Heidelberg.
- Van Ittersum, M.K., *et al.*, 2008. Agricultural Systems 96: 150-165.

Integrating social preferences and spatial analysis to optimize the use of marginal agricultural lands¹

M. Arriaza, O. Nekhay
Centro IFAPA 'Alameda del Obispo', Apartado 3092, Córdoba, Spain
Contact: manuel.arriaza@juntadeandalucia.es

Introduction

The land management of olive plantations in Southern Spain is analysed from a threefold point of view: economic, social and environmental sustainability. The economic approach addresses the viability of the farming activities, the social criterion aims to prevent population loss in rural areas, whereas the environmental analysis involves the consideration of the reduction of soil erosion, the improvement of biodiversity, the control of fire risk and the provision of quality agricultural landscapes. The study analyses how the type of management of the olive grove (conventional, integrated and organic) or its abandonment contributes to the achievement of these objectives.

First, we asked to the local and non-local population to weigh these three aspects of sustainability *via* a classical Analytic Hierarchy Process (AHP) questionnaire. Second, a group of experts weighed how the different land management contributes to these objectives. Finally, the Geographical Information Systems (GIS) provide the territorial integration of both weighing exercises. For each objective, the best management alternative is selected for each pixel, then the weight of the objective in the pixel determines which one dominates the rest.

The case study is the olive (*Olea europaea* L.) plantations of the mountain areas of Andalusia (Spain). These plantations are located in highly sensitive places from an environmental point of view and, after the decoupling of the subsidies, a large percentage of them face the risk of abandonment, therefore, the study aims to optimize the type of land management and to spot the most suitable places for restoration. The municipality of Montoro is located in the province of Cordoba in Southern Spain. The territory enjoys typical Mediterranean continental climate conditions with irregular precipitation distribution during the year (less than 600 mm yr⁻¹). Municipality of Montoro represents a variety of agricultural ecosystems (pasture, olive groves and annual crops) and forest/shrub natural vegetation near agricultural areas. Its 58,103 hectares are divided into olive plantations (27.5%), arable crops (6.6%), forest and natural vegetation (37.5%), natural park (20.9%), Mediterranean pasture (6.7%) and other crops (0.8%).

Methods

The AHP technique uses expert judgments as inputs for weighing alternatives (Saaty, 1980). In our study, expert knowledge determines the relative importance of each criterion of the optimizing function. Empirical studies that have used multi-criteria evaluation methods for the solution of spatial problems include that of Malczewski (1999), which brought together two approaches developed much earlier: Multi-Attribute Utility Theory (MAUT) and the use of Geographical Information Systems (GIS) as a platform for representing the spatial dimension of the problems. A large number of studies have since adopted Malczewski's approach, including Thirumalaivasan *et al.* (2003), Ayalew *et al.* (2005) and Neaupane & Piantanakulchai (2006), this last dealing with different fields of landscape assessment process.

The utility function to be optimized takes the form: $U_{n,g} = \sum_{i=1}^6 A_{gi} \cdot P_i \cdot F_{ni}$; where n represents each

¹ This research has been financed by INIA through the research project RTA04-086.

pixel of the territory (10×10 m), g is the type of management or abandonment, A_{gi} represents the importance of the type of management g for objective i , P_i is the weight that Society assigned to objective i and F_{ni} represents the potential suitability/risk (between 0 and 1) of pixel n for objective i . Then, the highest U determines the optimum alternative in the final map.

Results and discussion

The maps in Figures 1–3 show the sequence of the analysis:

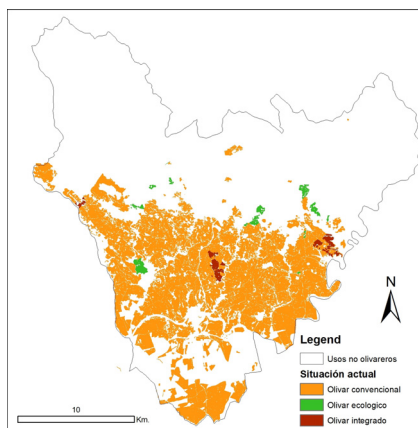

Figure 1. Initial agricultural land use.

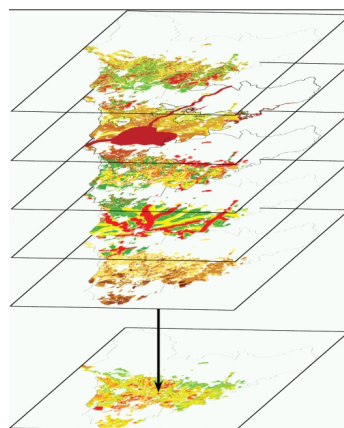

Figure 2. Aggregation of maps.

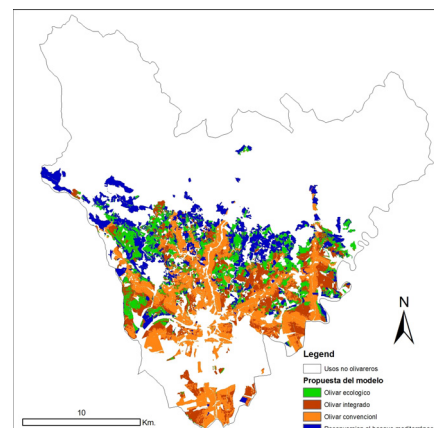

Figure 3. Optimized land use.

From a methodological point of view, the use of the ideal mode of AHP avoids the bias that arises from the weighting of elements in each layer when the number of elements differs in individual layers. Consideration of negative priorities instead of their transformation into small positive priorities also gives the model more internal consistency and produces more accurate results that are in accordance with the preferences revealed by the experts. Also, the data requirements of this approach are less rigorous than those of classical statistical models based on historical data. The sensitivity analysis indicates that the model is stable on the basis of the results of the four alternative scenarios considered. The simulation carried out in the study identifies the edges of major agricultural areas (mostly olive groves), areas of natural vegetation and areas adjacent to Natural Park with oaks as being most suitable for wildlife habitat restoration. These results have similarities to those obtained by other researchers on biodiversity, based on either individual or groups of species.

References

- Ayalew, L., *et al.*, 2005. *Engineering Geology* 81: 432-445.
- Malczewski, J., 1999. *GIS and Multicriteria Decision Analysis*. John Wiley & Sons, NY.
- Neaupane, K.M. & M. Piantanakulchai, 2006. *Engineering Geology* 85: 281-294.
- Saaty, T.L., 1980. *The analytic hierarchy process: Planning, priority setting, resource allocation*. McGraw-Hill, NY.
- Thirumalaivasan, D.M., *et al.*, 2003. *Environ. Model. Soft.* 18(4): 645-656.

Understanding land use change with the aid of an integrated modelling framework: A case study on rural south-west China

K. Berkhoff, S. Herrmann

Department of Environmental Planning, Leibniz University Hannover,
Herrenhaeuser Strasse 2, 30419 Hannover, Germany

Contact: berkhoff@umwelt.uni-hannover.de

Introduction

Cash crop production and rapid economic growth have generated huge impacts on the natural resources, ecosystems and livelihoods of ethnic minorities in the ecologically fragile upland areas of the Naban river catchment. The region is located in the south of Yunnan province in China and is part of the Indo-Birma hotspot of biodiversity. The production of natural rubber dominates the regional economy and increasingly replaces traditional, diversified and sustainable land use practices. This situation requires an integrated approach to land use planning. The Sino-German research project LILAC¹ supports this process by a modelling framework dealing with the multiple impacts of rubber cultivation: loss of biodiversity, increasing income, farmers' dependency on the market, etc. By 'integrated modelling approach', we mean the coordinated application of an agro-economic, ecological and social model which altogether interact with a land allocation model via defined interfaces (no dynamic coupling). We call this approach the NabanFrame modelling framework.

Due to the strong social implications of changes in land use the major focus is laid on the appropriate definition and integration of the social drivers initiating and underlying the current land use pattern. The presentation describes how the land allocation model (CLUE_{Naban}) is parameterized to model the status quo of land use in the study area. For model calibration, narrative interviews with individual stakeholders are used. They were conducted in the study area with regard to knowledge exchange and the adoption of innovations (Aenis *et al.*, 2008).

Modelling framework (NabanFrame)

The objective of the modelling approach is to provide policy support for land use planning; the addressees are decision makers of the nature reserve and regional planning authorities.

NabanFrame consists of three disciplinary models describing the issues of ecology, economy and sociology and further the land allocation model CLUE_{Naban} which has an integrating function. NabanFrame follows a three steps approach of data preprocessing and land use demand negotiation, then land allocation (ruled by CLUE_{Naban}) and finally the evaluation of the resulting land use maps (see Figure 1). In all three steps information of the disciplinary models is considered. E.g., in the pre-processing phase yearly demand for the land use types is adjusted between agro-economic and ecological demand. In the next step of NabanFrame, all models deliver location factors for the land allocation module. Finally, they are applied to conduct the impact analysis in the concluding post-processing step.

Incorporation of social information into CLUE_{Naban}

The land use allocation model CLUE_{Naban} is based on the CLUE-S model (Verburg *et al.*, 2002). CLUE-S has been designed to simulate land use change using empirically quantified relations (regression analysis) between land use and its driving factors combined with the modelling of competition between land use types (dependent on location suitability, neighbourhood setting, conversion elasticity and a demand-related iteration variable).

¹ 'Living Landscapes China', a project supported by the German Federal Ministry of Education and Research under promotional reference: 0330797A

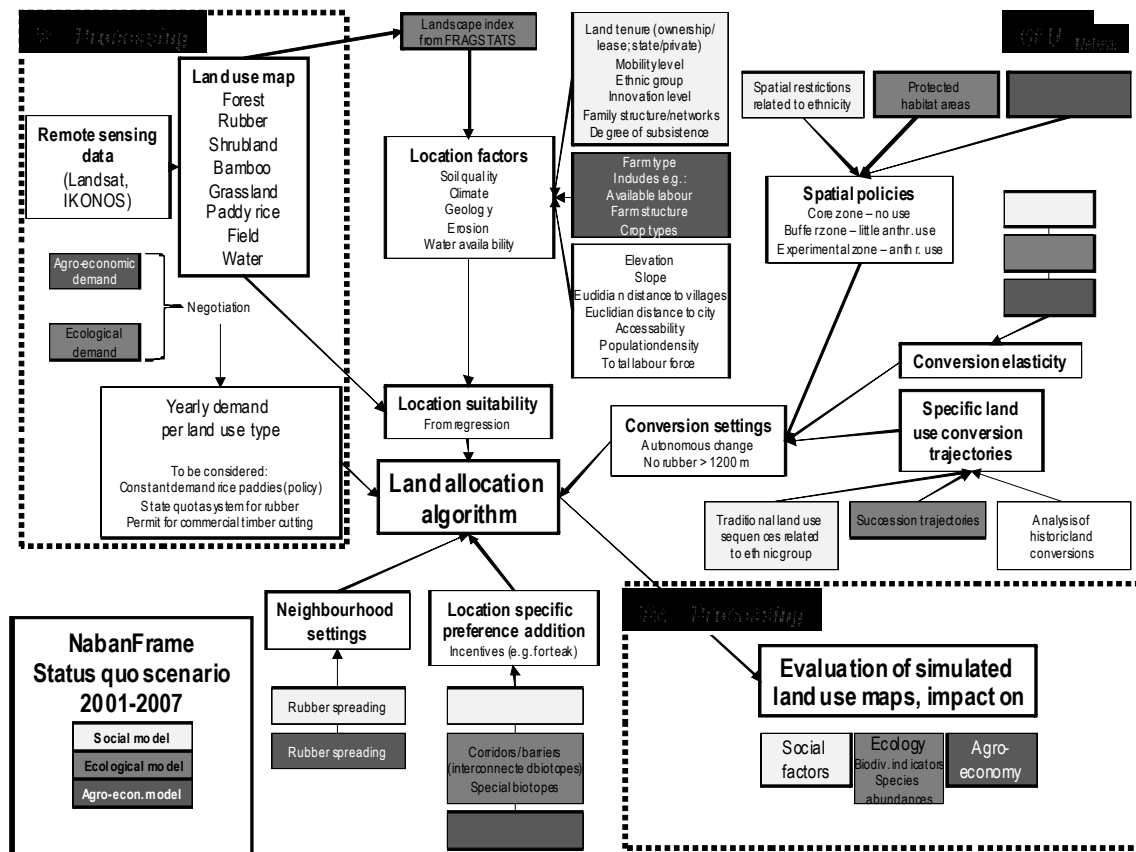

Figure 1. The NabanFrame modelling framework, operationalized for the status quo scenario. Colors refer to model inputs (light grey: social model, medium grey: ecological model, dark grey: agro-economic model). Empty boxes are not yet operationalized, white boxes are in the responsibility of the land allocation model.

It is assumed that locations are assigned to the land use type with the highest total probability. In the presentation, the setup of $CLUE_{Naban}$ will be illustrated as it was chosen for modelling the status quo of land use, focusing on the incorporation of social issues into the modules of $CLUE_{Naban}$. Data from questionnaires has been referenced to spatial entities in the study area before it is integrated in $CLUE_{Naban}$. The simulation runs from 2001 to 2007 (referred to as “status quo”) for which a detailed land use map has been generated from IKONOS 2 remote sensing data. In contrast to the questionnaire information, the narrative interviews serve the purpose of calibrating the parameterization of the status quo scenario: Can the processes and decisions reported in the interviews be recovered in the modelled land use map?

Modelling scenarios of land use change

The understanding of the relevant processes that drive land use change in the study area is an indispensable condition for the subsequent modelling of scenarios. Two scenarios for the study area will be modelled by the NabanFrame modelling framework: a scenario of sustainable development and a business as usual scenario; the time horizon of the scenarios will be the years 2007 until 2020. The land use maps resulting from the scenario modelling exercise as well as the results of the impact analysis conducted by the agro-economic, ecological and social model provide the basis for discussion with the regional decision makers.

References

Aenis, T., *et al.*, 2008. Land-use related innovations and knowledge flows (LILAC subproject SOSI-A). Unpublished document.
 Verburg, P.H., *et al.*, 2002. Environmental Management 30: 391-405.

Concept and application of a DLG sustainability standard on the farm level

O. Christen

Institute of Agricultural and Nutritional Sciences,
Chair of Agronomy and Organic Farming,
University of Halle-Wittenberg, 06099 Halle, Germany
Contact: olaf.christen@landw.uni-halle.de

Introduction

To assess practical farms according to the principles of sustainable farming requires a comprehensive approach taking into account environmental, economic and social aspects of production. In general such an assessment is possible on different levels, starting at the crop or crop rotation level, the farm level, or the regional level. In our approach we focus on the farm level, because the farm level is relevant for all major decisions regarding varieties, input, crop rotation.

In cooperation with University Freising-Weihenstephan and the German Agricultural Society (DLG) we have developed an assessment system on the farm level based on the computer model REPRO, which has been developed at the University of Halle-Wittenberg. With this model it is possible to quantify all major energy and material flows on the farm and on the field level as well as relevant information on economic effects of the different decisions taken on the farm. The aim of this project is to establish a standard for a certification scheme run by the DLG. In this paper we will focus on the ecological indicators and the results on a number of pilot farms (Deumelandt & Christen, 2008).

Materials and methods

The assessment of sustainability on the farm level is mainly based on the use of pressure indicators, which have been established in a number of previous projects (Heyer *et al.*, 2003; Rücknagel *et al.*, 2006). The following indicators are calculated: Nitrogen-balance, phosphorus-balance, SOM-balance, energy intensity, GHG-emissions, pesticide-index, soil compaction, soil erosion, biodiversity, proportion for conservation agriculture. All calculations for the ecological indicators are conducted with the software REPRO, which allows to normalize the different scales to figures between 0 and 1 (see Figure 1). The threshold for a sustainable system is 0.75 in this system. A farm is rated as sustainable if all three areas average above 0.75. The basis for all calculations is based on husbandry data as well as details on soil and climate conditions.

Results and discussion

The results for the five pilot farms are given in Table 1. On average all five farms fulfilled the criteria set in this project, however, single indicators on some farms were well below the standard of 0.75. Especially the pesticide index and the proportion of area for nature conservation projects were below 0.75 in a number of cases.

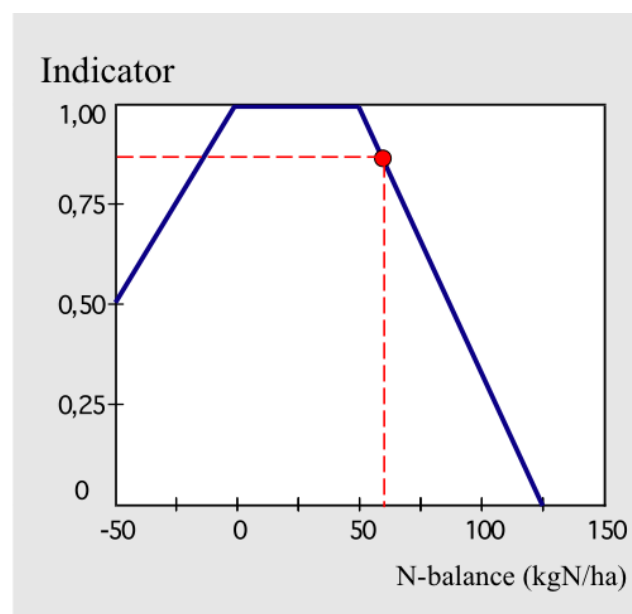

Figure 1. Function to normalize N-balance.

Table 1. Normalized indicators for the five pilot farms.

Indicator	Scale	Farm A	Farm B	Farm C	Farm D	Farm E
N-balance	kg ha ⁻¹	0.82	0.93	0.97	1.00	0.88
P-balance	kg ha ⁻¹	1.00	0.79	0.85	0.70	0.88
SOM-balance	kg C ha ⁻¹	0.70	1.00	0.93	1.00	1.00
GHG	CO ₂ equ GJ ⁻¹	0.71	0.66	0.66	0.49	0.85
Energy intensity	MJ GE ⁻¹	1.00	1.00	1.00	1.00	1.00
Pesticide index		0.47	0.14	0.59	1.00	0.00
Biodiversity		0.90	0.63	0.62	0.89	0.70
Conservation		0.35	0.55	0.29	0.36	0.42
Erosion	t ha ⁻¹ yr ⁻¹		0.89	1.00	0.85	
Soil compaction		0.98	0.88	0.88	0.75	0.98
Average		0.77	0.75	0.78	0.80	0.75

Further work is now required to include a greater number of farms in the assessment and to aggregate the different indicators in various ways based on their environmental relevance.

References

- Deumelandt, P. & O. Christen, 2008. Sugar Industry 133: 9-18.
 Heyer, W., *et al.*, 2003. Agriculture, Ecosystems and Environment 98: 453-461.
 Rücknagel J., *et al.*, 2006. Soil & Tillage Research 92(1-2): 213-220.

An integrated assessment of global changes in crop-livestock systems to 2030: Implications for policy development

M. Herrero, P.K. Thornton, A. Notenbaert, S. Mwangi, S. Wood, R. Kruska, J. Dixon, D. Bossio, J. Van de Steeg, H.A. Freeman, B. Gerard
International Livestock Research Institute, P.O. Box 30709-00100, Nairobi, Kenya
Contact: m.herrero@cgiar.org

Introduction

The world's population is predicted to increase by 50% over the next quarter of a century to reach 9 billion by 2030. During this period, and if the livestock revolution fully materializes, in developing countries there is likely to be a rapid increase in demand for livestock products, driven by increasing urbanization and rising incomes. On top of this, the impacts of a range of driving forces such as water availability, climate change, technological innovations on smallholder crop and livestock production may be substantial. The result of these drivers is that smallholder farms will inevitably change. The challenge is to ensure that the resource-poor, mixed crop-livestock, smallholder sector, which currently provides the majority of milk and meat in the tropics, is able to take advantage of the opportunity to meet the increased demand for these products. To do so the sector will need to intensify, but at the same time it is vital that this does not compromise household food security, sustainable natural resource management or rural livelihoods. This study attempts to find policy alternatives for the above by using a range of coupled integrated assessment models and spatial disaggregation methods.

Methods

The framework for the study was based on the framework for the Millennium Ecosystem Assessment (MA, 2005) and subsequently used for other major assessments like the IAASTD (2008). We used the IMPACT-Water model (Rosegrant *et al.*, 2005) and a spatially disaggregated crop-livestock systems classification (Kruska *et al.*, 2003) for looking at alternative scenarios of change in mixed crop-livestock systems. We built upon the results of the IAASTD (2008). The scenarios we used were the reference scenario, which tries to mimic business as usual conditions of growth in agriculture, incomes, population and others. Additionally we investigated what would be the consequences of increased demand for biofuels, increase expansion of irrigation to produce more food and feed and what would happen if the demand for livestock products increased.

Results and discussion

The results of this study have several policy implications and are present in full in (Herrero *et al.*, 2008). Some of the main findings are as follows:

- Mixed intensive systems in the developing World are under significant pressures. These pressures are larger in some systems than in others but are all caused by the rising demands of the human population and its income shifts and rates of urbanization. For example, mixed intensive systems in South Asia are reaching a point where production factors are seriously limiting production as land per capita decreases significantly. Significant trade-offs in the use of resources (land, water, nutrients) exist in mixed systems, especially as the demands for biomass for food, feed and energy increase.
- Important productivity gains could be made in the more extensive mixed rainfed areas. Resources constraints in some land-based mixed intensive system are reaching a point where livestock production and environmental degradation may have deleterious impacts on humans. In more extensive systems, with less pressure on the land yield gaps of crops and livestock are still large. Pro-poor policies and public investments in infrastructure will be required to create system of incentives, reduce transaction costs and improve risk

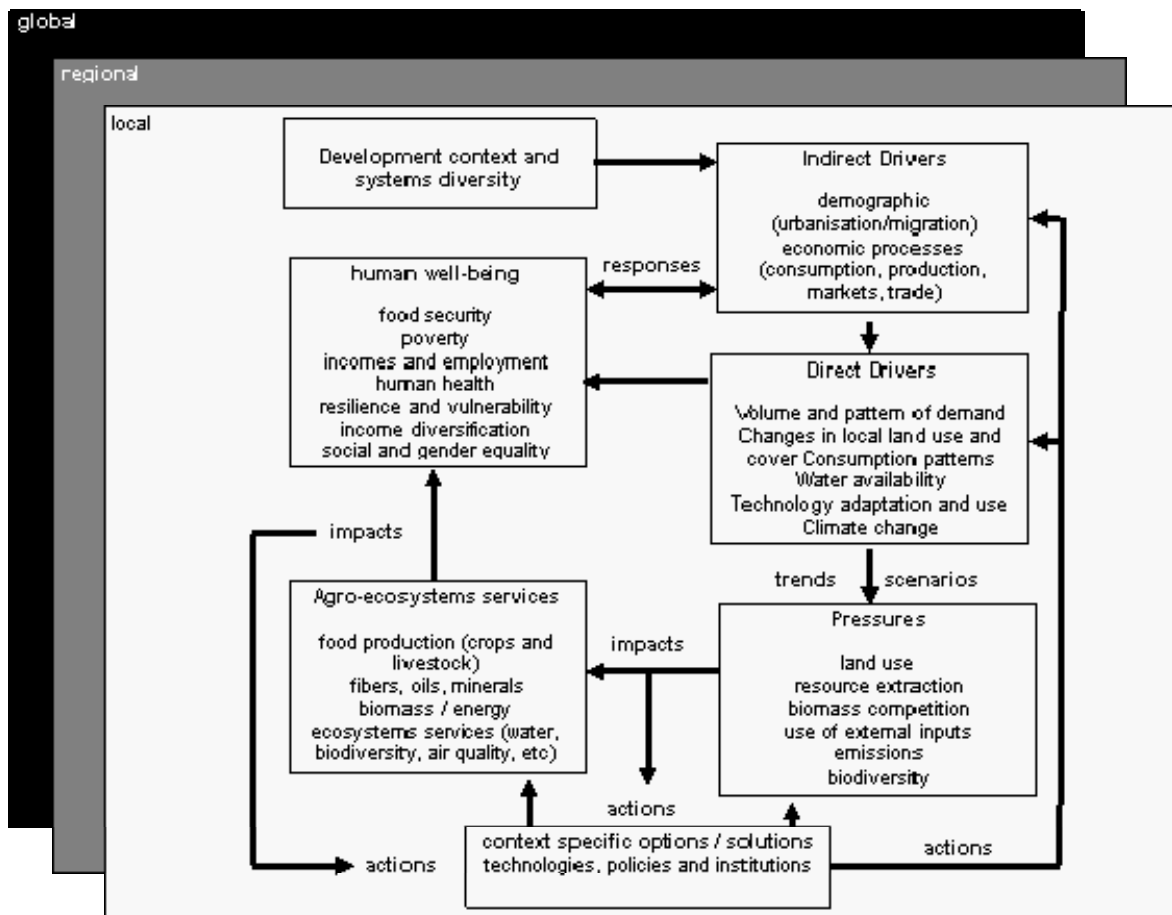

Figure 1. Conceptual framework for studying the impacts of drivers of crop-livestock systems change (Adapted from MA, 2005).

management in these systems. Integration of production in these systems to supply agro-ecosystems services (feeds, food, etc) to the more intensive systems should be promoted.

- The livestock revolution – at least from ruminants – could potentially exclude the poor in terms of the benefits of consumption of meat. If green fodders became scarce because of land and water shortages, and more grains were fed to ruminants to match production, this is likely to increase the prices of animal products further, thus bypassing the abilities of the poor to consume more milk and meat. This would present significant challenges in mixed systems, particularly in Asia.

References

- Herrero, M., *et al.*, 2008. Drivers of change in crop-livestock systems and their potential impacts on agro-ecosystems services and human well-being to 2030. International Livestock Research Institute, Nairobi, Kenya, 101 pp.
- IAASTD, 2008. The International Assessment of Agricultural Science and Technology for Development. Island Press, Washington DC.
- Kruska, R.L., *et al.*, 2003. *Agricultural Systems* 77: 39-63.
- MA, 2005. The Millennium Ecosystem Assessment. Ecosystems and Human Well-being: Scenarios, Volume 2. Island Press, US, 2005, 560 pp.
- Rosegrant, M.W., *et al.*, 2002. *World Water and Food to 2025: Dealing with Scarcity*. IFPRI, Washington DC. <http://www.ifpri.org/pubs/books/water2025book.htm>.

The CAPRI and GTAP link: Linking a partial and a global equilibrium model

T. Jansson, M. Adenäuer, M. Kuiper
Nussallee 21, D-53115 Bonn, Germany
Contact: marcel.adenaeuer@ilr.uni-bonn.de

Introduction

Many of the most interesting current research questions in economics span issues from the very small and detailed to the very large and abstract, or require the interdisciplinary study of relations between fields that are causally wide separated and generally not studied together: What are the implications of general trade liberalization on the physical environment in certain rural regions? Or what do regional differences in policy implementation imply at the global level? Such questions stress, in the absence of “The Great Model For Everything”, the trade-off between generality and depth, i.e. between covering many aspects of the system studied and details of certain interesting components. This dilemma may be resolved by linking specialized models to exploit their different strengths, as done within SEAMLESS (Van Ittersum *et al.*, 2008). This paper refines the link between the general equilibrium model GTAP (offering an economy-wide perspective; Hertel, 2004) and the partial agricultural model CAPRI (offering a detailed model of the agricultural production and policies, Britz *et al.*, 2007) which was developed in Jansson *et al.* (2008b). We aim to illustrate the potential of the linked system by analysing a multi-lateral trade reform, where results are computed for regional nitrate surpluses and agricultural incomes in the EU as well as welfare effects for the world. The results will indicate the interdependence between regional and global economies and regional physical impacts. This level of analysis is not possible with either model by itself. We firmly believe that this kind of analysis will be increasingly important to address future research questions.

Methods

The linking approach relies on using the variables and equations of the models as they are, introducing the link by shocking parameters already present in the models. This is similar to Jansson *et al.* (2008a) but contrasts with for example Grant *et al.* (2006), which replace the original GTAP equations by iso-elastic approximations in the form of supply functions. By maintaining the original model equations, maintenance of the core models is greatly facilitated, and the links can be adopted for other versions of CAPRI and GTAP with less effort. In addition, auxiliary facilities like data exploration tools and the welfare computations in GTAP will keep functioning as in the stand alone applications. The link works with an iterative exchange of input parameters to each model as visualized here:

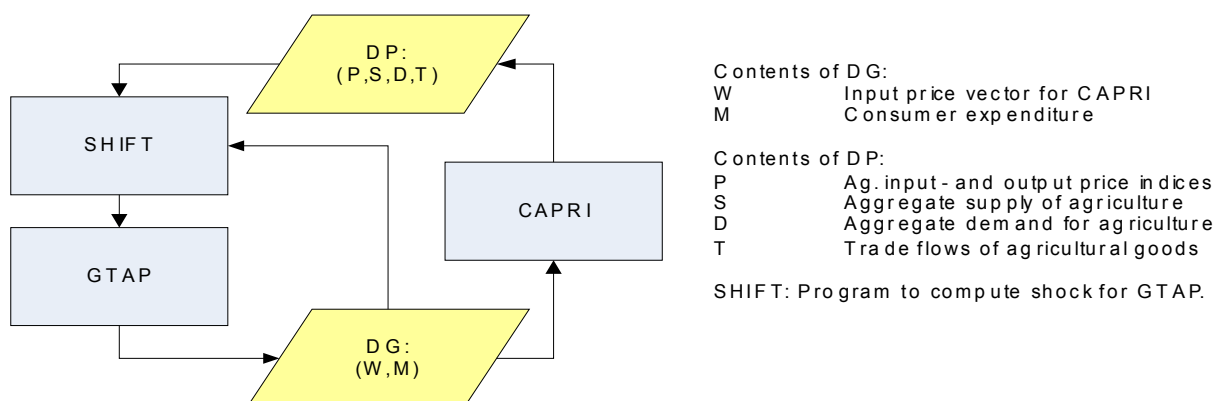

Starting by solving GTAP (bottom left), we particularly solve for the price vector W containing prices of agricultural intermediate inputs, capital and labour, and the vector M of consumer expenditures per country (aggregate). Those data are written to the dataset DG. Next, CAPRI is solved, using W and M as exogenous variables (parameters). CAPRI computes for the aggregate agricultural sector price indices of output P per region, total supply S , demand D disaggregated into human consumption, processing consumption and intermediate demand by agriculture itself, and trade flows T . This is written to the dataset DP. Finally, the program SHIFT computes shocks for GTAP by shocking the agricultural producers of GTAP so that they, in a partial setting, would replicate the outcome of CAPRI, and similar for consumption and trade of agricultural goods.

Results and discussion

To assess the value-added of the linked system of CAPRI and GTAP, we analyse a simplified trade liberalization scenario consisting of a reduction in tariffs according to a tiered formula described in the Doha draft modalities for agriculture released on February 8, 2008 by the WTO. Comparison with the results from stand-alone versions of the models provides a benchmark to assess the value-added of linking the models. We limit the scenario to agricultural liberalization only to gauge the effect of economy-wide results provided by GTAP. Since CAPRI is an agricultural sector model it will not account for the impact of liberalization of non-agricultural trade, which would be included in a more realistic Doha scenario. This would however obscure the effects of the just the economy-wide feedbacks to a change in the agricultural sector. Detailed results are not yet available.

References

- Britz, W., *et al.*, 2007. Description of the CAPRI Modeling System, Final report of the CAPRI-DYNASPAT project; Universität Bonn, available on http://www.ilr1.uni-bonn.de/agpo/rsrch/capri/Final_Report_Model_Description.pdf
- Grant, J.H., *et al.*, 2006. Extending general equilibrium to the tariff line. Paper prepared for the Ninth Annual Conference on Global Trade Analysis, June 15-17, Addis Ababa, Ethiopia.
- Hertel, T.W., 2004. Global trade analysis. Cambridge University Press, UK.
- Jansson, T., *et al.*, 2008a. Cross sector land use modelling framework. In: Eds K. Helming, *et al.*, Sustainability impact assessment of land use changes. Springer, Berlin.
- Jansson, T., *et al.*, 2008b. Getting the best of both worlds? Linking CAPRI and GTAP for an economywide assessment of agriculture. Paper presented at the Eleventh Annual Conference of the Global Trade Analysis Project (GTAP) "Future of Global Economy", Helsinki, June 12-14, 2008.
- Van Ittersum, M.K., *et al.*, 2008. *Agricultural Systems* 96: 150-165.

Integration of interdisciplinary participative research tools: New vistas for land use modelling?

M. Lippe, T. Thai Minh, A. Neef, V. Hoffmann, G. Cadisch, T. Hilger
Institute for Plant Production and Agroecology, Universität Hohenheim, 70599 Stuttgart
Contact: Melvin.Lippe@uni-hohenheim.de

Introduction

Land use has been generally considered a local environmental issue, but it is becoming a force of global importance (Foley *et al.*, 2005). The complexity of land-use systems calls for multi-disciplinary analyses (Mulder, 2001). Modelling is one of the methods in the portfolio of tools and techniques available to unravel the dynamics of land use systems. A prerequisite to the development of realistic models of land use change is the identification of the most important drivers of change (Verburg *et al.*, 2006). Factual knowledge and analytical techniques have to be combined with local knowledge and subjective perceptions of the various stakeholder groups (Pahl-Wostl, 2002).

Methods

An interdisciplinary team of socio-economic and ecological researchers was formed to integrate participative research tools to derive datasets for the FALLOW (Van Noordwijk, 2002) model. The uplands cropping area of Ban Put, Yen Chau District, Son La Province, Northwest Vietnam was chosen as study site, and a list of model input parameters was selected as prerequisite for the data collection process. Open and semi-structured interviews were conducted with local stakeholder groups, e.g., young (18–35) and old (36–65), male and female farmers, and village key persons. Information on land use history, plot soil fertility status, farmer management and current problems of the upland land use systems were collected. The interviews concept aimed to promote participation of local stakeholders by using different tools, such as a 3D topographic map, drawing and ranking cards, developing a resource flowchart and uplands seasonal calendar. The approach was designed based on an information feedback loop: 1st a data analysis is required after each data collection loop; 2nd results of previous loop are taken as basic knowledge and used as an entry point of the following loop; 3rd information is crosschecked with stakeholders such as local authorities, key farmers, farmers of young/old/male/female groups; and finally 4th data generated during these processes are validated by all local stakeholders during a synthesis discussion. It was assumed that by interviewing different stakeholder groups a validation of derived information and thus a consistency assessment could be achieved. The derived datasets were then used to calibrate the model accordingly. Three scenarios were defined in line with the study findings to test the FALLOW model *modus operandi*.

Results and discussion

In general, land use change on the village level revealed the following situation: 1st expansion of cropping area close to the village and lower elevation and inclination levels to mid-slope and hilltop positions, 2nd land tenure changed from cooperate to individual management systems, 3rd traditional swiddening systems changed to permanent annual cropping, 4th individual plot management continuously intensified by improved tillage methods, use of chemical fertilizers and cropping of hybrid varieties, and mayor problems of the upland cropping systems are soil erosion and declining soil fertility.

Following the stage of model calibration, each scenario was set for a time period of 25 and 50 years, respectively. Figure 1 presents the output maps of scenario “transition swiddening to permanent cropping systems”. The initial land use presents the major cropping area close to the village area, where only a small part of the area is used for cropping. Beside agroforestry

areas close to village, the remaining area is in a stage of fallow or old secondary forest. This image changes after 25 years, where more land has been opened for cropping or agroforestry purposes. The overall forest area declined, although a pioneer forest develops in the lower right corner. After 50 years, the agroforestry areas almost vanished and cropping is the dominating land form. Remaining old secondary and primary forest areas are due to an initial calibration setup to keep forested areas on the steeper slopes of the study area.

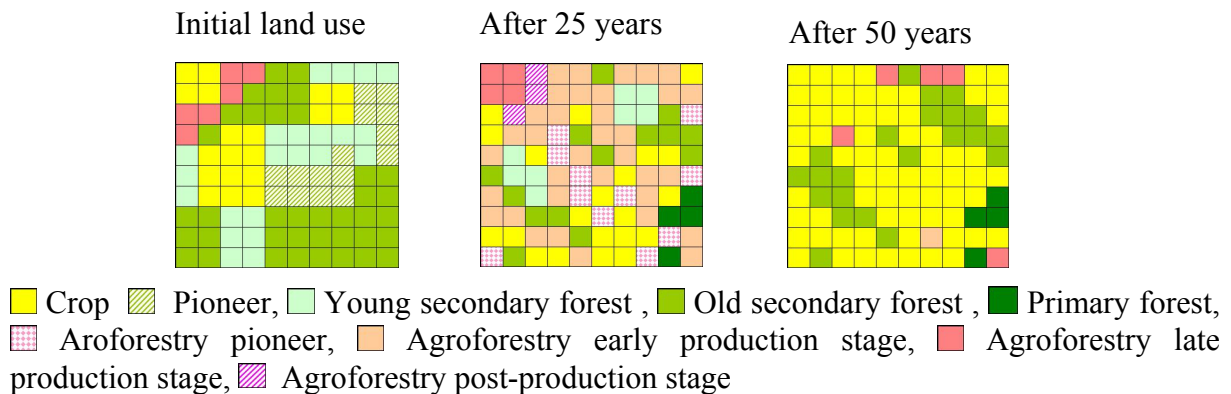

Figure 1. Outputs of model scenario ‘transition swiddening to permanent cropping systems’.

The application of an interdisciplinary participative research approach was useful to address different stakeholder perceptions of the upland ecological and socio-economical system. The combination of qualitative tools together with secondary datasets helped to close to gap of lacking information, as especially in the context of Northern Vietnam, data collection and land use analysis is particularly challenging (Castella & Verburg, 2007). By this means, different scenario input datasets could be derived to test the model *modus operandi*. The FALLOW model was able to generate similar land use trends as described by local stakeholders. Furthermore, results of an *in-situ* land use survey in summer 2008 (not presented here) indicate similar findings of cropping intensification. Rather the intensification timeframe between model scenario run and reality seem to differ, and in this sense, land use intensification even accelerated in a shorter time then modelled. As the FALLOW model is a conceptualized tool, specific land use intensity consequences, e.g., soil erosion could not be presented as indicated in farmer interviews. For this purpose, a rather more specific biophysical spatial model approach is appropriate, and may in combination with the basic FALLOW algorithms a useful integration of biophysical and socio-economic driving forces.

References

- Castella, J.C. & P.H. Verburg, 2007. *Ecol. Mod.* 202: 410-420.
- Foley, J.A., *et al.*, 2005. *Science* 309: 570-574.
- Mulder, M., 2001. *Integrated Assessment* 2: 73-78.
- Pahl-Wostl, C., 2002. *Integrated Assessment* 3(1): 3-14.
- Van Noordwijk, M., 2002. *Ecol. Mod.* 149: 113-126.
- Verburg, P.H., *et al.*, 2006. *Landscape Ecol.* 21: 1171-1183.

Modelling resource distribution in mountainous watersheds in Thailand: An integrated approach

C. Marohn, U. Schuler, M. Lippe, Y.Z. Ayanu, C. Hugenschmidt, T. Hilger, G. Cadisch
Inst. for Agroecology and Plant Production in the Tropics and Subtropics,
University of Hohenheim, Garbenstr. 13, 70593 Stuttgart, Germany
Contact: marohn@uni-hohenheim.de

Introduction

During the past 30 years, upland watersheds in the region of Chiang Mai, NW Thailand, have been subject to multiple changes in land use. Due to political interventions, ethnic preferences and market demand, some major trends were the replacement of poppy, a lychee boom and, recently, a surge of cut-flower cultivation in greenhouses.

To allow the *ex-ante* assessment of effects of such dynamics on upland – lowland resource competition, on nutrient flows (erosion but also deposition) or dispersal of contaminants, a Land Use Change Impact Assessment Tool, acronym LUCIA, has been developed.

LUCIA aims at a generic and process-based simulation of the most relevant processes of small watersheds at affordable run time.

Model development is part of the interdisciplinary special research programme *Sustainable Landuse and Rural Development in Mountainous Regions of Southeast Asia (Uplands Program)*; findings and scenarios of other subprojects are integrated.

Methods

Model concept

The spatially explicit dynamic LUCIA model runs on PCRaster (Van Deursen, 1995), using a 25 m grid and daily time step. LUCIA builds on existing validated models: Hydrological concepts have been adapted from GenRiver (Van Noordwijk *et al.*, 2003), plant growth is based on CGMS-WOFOST (Supit, 2003), while dynamic bulk density and succession of natural vegetation follow the FALLOW approach (Van Noordwijk, 2002). Soil fertility is oriented by a strongly simplified CENTURY approach (Parton *et al.*, 1988). The hydrologic and plant growth modules will be dynamically linked to an existing Multi-Agent System (Berger *et al.*, 2006), which simulates economic factors and decision-making (Figure 1). Land use decisions will then be made on the basis of yield and other biophysical outputs and lead to a land use map that is fed back into LUCIA.

Parameterization

The model has been parameterized for the small (7 km²) watershed of Mae Sa Noi. Soil and land use maps were generated from on-site measurements by Schuler (2008) and satellite imagery, while secondary data were taken for plant parameterization. Weather data were obtained from twinned subprojects in the Uplands Program. Parameters referring to soil and land use classes are entered into a spreadsheet, which allows basic calculations outside the model. Parameterization files, look-up tables and time series are then exported through a macro.

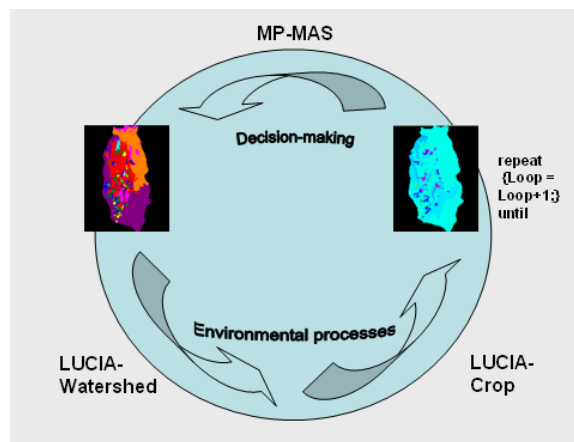

Figure 1. Schematic coupling of LUCIA components.

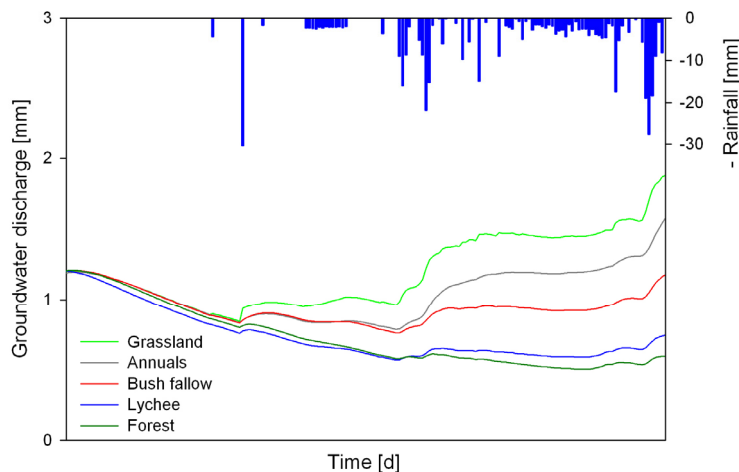

Figure 2. Groundwater discharge under different land uses.

proportional to groundwater stocks, rainfall is indirectly reflected by groundwater discharge.

Future work will conceptually concentrate on the implementation of an erosion module based on the GUEST approach (Yu *et al.*, 1997), out- and upscaling and the option to couple single modules in and out on demand. Technically, dynamic coupling to the MP-MAS model, transfer functions for soil hydraulic properties (based on WaNuLCAS; Van Noordwijk & Lusiana, 1999) and a user-friendly interface to determine outputs will be emphasized.

References

- Berger, T., *et al.*, 2006. Mathematical Programming-based multi-agent systems to simulate sustainable resource use in agriculture and forestry. Internal document, University of Hohenheim, Stuttgart, Germany.
- Parton, W.J., *et al.*, 1988. *Biogeochemistry* 5: 109-131.
- Schuler, U., 2008. Towards regionalisation of soils in Northern Thailand and consequences for mapping approaches and upscaling procedures. Doctoral dissertation, University of Hohenheim, Germany.
- Supit, I., 2003. Updated system description of the WOFOST crop growth simulation model as implemented in the crop growth monitoring system applied by the European Commission. Treemail Publishers, Heelsum, The Netherlands.
- Van Deursen, W.P.A., 1995. Geographical Information Systems and Dynamic Models: Development and application of a prototype spatial modelling language. PhD dissertation, Utrecht University, NGS 190.
- Van Noordwijk, M., 2002. *Ecological Modelling* 149: 113-126.
- Van Noordwijk, M. & B. Lusiana, 1999. *Agroforestry Systems* 45: 131-158.
- Van Noordwijk, M., *et al.*, 2003. Spatial variability of rainfall governs river flow and reduces effects on landuse change at landscape scale: GenRiver and SpatRain simulations. Paper presented at MODSIM Conference, Australia.
- Yu, B., *et al.*, 1997. *Aust. J. Soil Res.* 37: 13-31.

First scenarios and future work

Model development is still ongoing and plausibility is being tested prior to validation on measured data. As an example of interlinkage between land use and hydrology, Figure 2 shows groundwater discharge under different vegetation types: Deep-rooting plants consume larger quantities of soil water so that percolation into groundwater is less compared to flows under shallow-rooting vegetation. Groundwater recharge responds to rainfall events shown on the right axis. As groundwater discharge is by definition

Construction of a multi-attribute model of arable system sustainability by elicitation of expert opinion

N. McRoberts, C.F.E. Topp

Land Economy & Environment Research Group, SAC, Edinburgh,
Edinburgh, EH9 3JG, UK

Contact: neil.mcroberts@sac.ac.uk

Introduction

In 2006, the Scottish Government introduced a new procedure for funding research in agriculture, biological sciences and land use. A number of new 5-year research workpackages replaced the existing funding streams, with work more closely aligned to policy questions and additionally aimed specifically at developing inter-institute, interdisciplinary research. Several of the workpackages deal explicitly with issues of resilience and sustainability in agricultural systems, and one of these is concerned specifically with arable and mixed arable production systems which dominate the land use pattern on the eastern side of the Scottish mainland, between Inverness in the north and Berwick (on the English border) in the south. The aim of the workpackage is to identify the factors which confer resilience and sustainability on arable systems along the familiar set of environmental, economic and social dimensions and to propose management approaches for such systems so that resilience and sustainability can be maintained. Over the whole life of the project empirical studies and systems simulation modelling (see McRoberts *et al.* (2009); Topp & Rees (2009)) will be used to address these questions but it was recognized at the start of the project that there would be a lag time before the project was able use such methods to assess policy options and make projections for sustainable land use. However, since the workpackage is built on previous research and utilizes approximately 30 scientists, covering a range of disciplines, there was already considerable knowledge about many of the key issues before any new research was done. To help structure the research and to provide an interim mechanism for examining policy options, a multi-attribute model (MAM) of arable system sustainability was constructed by eliciting expert opinion from the research team. The resulting model is being used to establish a set of future scenarios which will be tested in more detail once the quantitative modelling framework is available.

Methods

The MAM was constructed using the DEXi modelling tool (Bohanec, 2008) available from the Joseph Stefan Institute, Slovenia. An iterative process knowledge elicitation process was used to gather information from the research team and construct the MAM for arable system sustainability from the information. An initial seminar session was used to explain to the whole research team what the aims of the exercise were. The team is composed of a number of natural sub-groups which specialize in discipline-oriented research; i.e. in ecology, economics, and social sciences. These sub-groups were asked to discuss among themselves (i.e. not in conjunction with the other groups) what they already knew about factors which would lead to either an increase or decrease in sustainability. The groups were allowed to represent this information in any way they chose, but had been introduced to the hierarchical structure of DEXi models as one possible approach. A round of discussions was held with each group to allow us to gain an understanding of their representations of knowledge and an initial MAM was constructed following these discussions. This MAM was then shown to the groups, in a second round of discussions and suggestions for changes, additions and improvements were incorporated to produce the final first operational version of the MAM. This version of the model is currently being evaluated by the research team as a whole, and joint decisions are being made about how the different branches of the model would be

weighted in the overall assessment of sustainability and the initial set of policy options that will be evaluated.

Results and discussion

Illustrative sections of hierarchical MAM in DEXi are shown in Figure 1. The model contains 89 attributes of which 43 are basic attributes (i.e. they are the end-points of branches in the hierarchical model) and 46 are aggregate attributes, composed from two or more underlying more basic attributes.

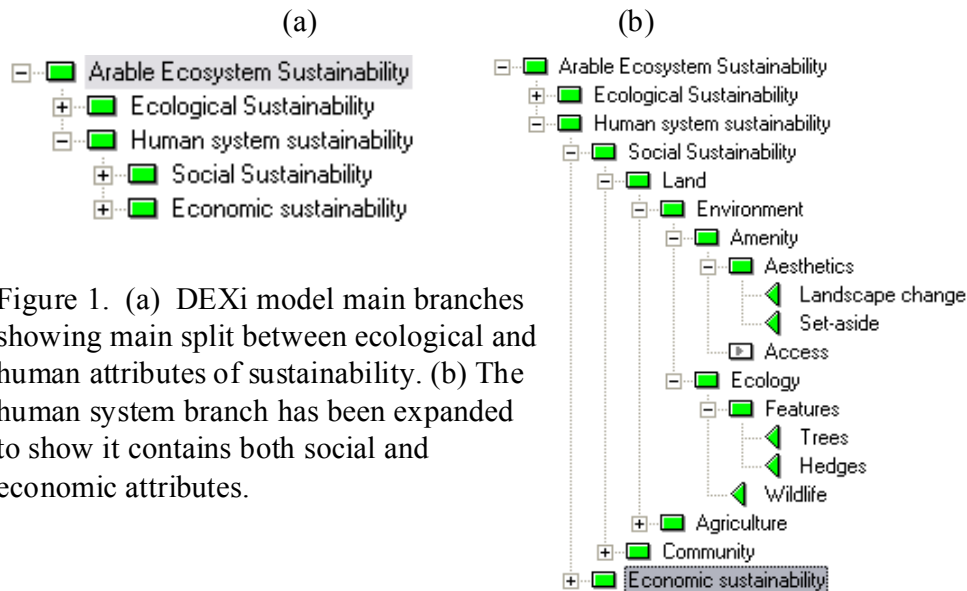

Figure 1. (a) DEXi model main branches showing main split between ecological and human attributes of sustainability. (b) The human system branch has been expanded to show it contains both social and economic attributes.

The MAM has proved useful in helping to bridge inter-disciplinary gaps in the research team by allowing different sub-groups to evaluate their own research objectives more clearly against the project as a whole, and by providing the opportunity for joint discussions about the relative importance of the different facets of sustainability. These discussions act as a useful precursor of the sorts of questions that we, the model developers, can expect policymakers and stakeholders to raise when the model is deployed in practice to evaluate potential policy options. In common with previous efforts to use MAMs in the analysis of cropping systems (Bohanec *et al.*, 2004) we have found that the relationships among real-world entities and processes in the knowledge base were highly cyclical, suggesting that an alternative model building approach based on a network structure might be more appropriate. A variety of well validated methods exist for developing such models and offer a further set of tools for integrated analysis of agricultural and social systems (e.g., Ozesmi & Ozesmi, 2004). A key issue in the use of MAMs and similar methods is the careful documentation of the mechanism by which the relationships represented in the knowledge base are translated into the rules or weights in the model. This is also true for the construction of formal simulation models, but since MAMs and other knowledge-based models are often viewed as being more subjective than their mathematical counterparts, it can be an important issue in user-acceptance to have a transparent process of model construction.

References

- Bohanec, M., 2008. DEXi: Program for Multi-Attribute Decision Making, User's Manual, Version 3.00. Joseph Stefan Institute, Ljubljana.
- Bohanec, M., *et al.*, 2004. *Informatica* 28: 387-392.
- McRoberts, N., *et al.*, 2009. AgSAP Conference 2009, these proceedings.
- Ozesmi, U. & S. Ozesmi, 2004. *Ecol. Mod.* 176: 43-64.
- Topp, C.F.E. & R.M. Rees, 2009. AgSAP Conference 2009, these proceedings.

Gathering baseline data for studying arable system resilience in Scotland by integrated farm surveys

N. McRoberts, C.F.E. Topp, C. Hawes, R.L. Walker, C.A. Watson, P. Hallett, T. Daniell,
M. Young, G.R. Squire
Land Economy & Environment Research Group, SAC, Edinburgh,
Edinburgh, EH9 3JG, UK
Contact: neil.mcroberts@sac.ac.uk

Introduction

In 2006, the Scottish Government introduced a new procedure for funding research in agriculture, biological sciences and land use. A number of new 5-year research workpackages replaced the existing funding streams, with work more closely aligned to policy questions and additionally aimed specifically at developing inter-institute, interdisciplinary research. Several of the workpackages deal explicitly with issues of resilience and sustainability in agricultural systems, and one of these is concerned specifically with arable and mixed arable production systems which dominate the land use pattern on the eastern side of the Scottish mainland, between Inverness in the north and Berwick (on the English border) in the south. The aim of the workpackage is to identify the factors which confer resilience and sustainability on arable systems along the familiar set of environmental, economic and social dimensions and to propose management approaches for such systems so that resilience and sustainability can be maintained. Over the whole life of the project empirical studies and systems simulation modelling (see McRoberts *et al.* (2009); Topp & Rees (2009)) will be used to address these questions. Modelling will allow possible future configurations for land use to be explored in support of questions being raised by policymakers. Empirical data, however, plays a key role in the research. First, it allows the models to be parameterized so that they correctly reflect the local conditions of Scottish arable production. Secondly, data collected now (together with previously collected data) provide a baseline against which to measure change in the future. Finally, the data allows an empirical analysis to be made of potential trade-offs which might exist between different policy objectives, providing a means of checking whether model predictions aimed at identifying satisfactory solutions for multiple goals are feasible. This paper describes on-farm survey work which has been undertaken to collect such data in Scotland and briefly reports on some of the findings.

Methods

The survey was constructed using a targeted sampling approach intended to produce a data set with a wide variation in crop inputs, production methods geophysical and climatic conditions. This range of conditions was met in the survey by including farms with certified organic status, farms which belong to a recognized body which promotes integrated production methods (LEAF), and farms, covering a wide range of sizes, that did not belong to either of the other categories. As far as possible, on each farm a cereal crop and a non-cereal, break crop were selected and a range of biophysical data were gathered following agreed standardized protocols. The main elements of these surveys were: an assessment of the within-field flora; the soil seed bank; the composition of the marginal flora of the field and data on the biological and physical properties of the soil. A two-part farm management survey was also conducted: participating farmers were asked to provide rotational history and general farm management information at the time of the initial ecological survey, and were subsequently asked for information specifically on crop inputs for the crops included in the survey, to allow gross margins to be calculated for each crop.

Results and discussion

A wide range of analyses have been carried out on the survey data for 2007/8. Figure 1 shows an illustrative output from the analyses in which different clusters of fields have been identified based on their rotational history.

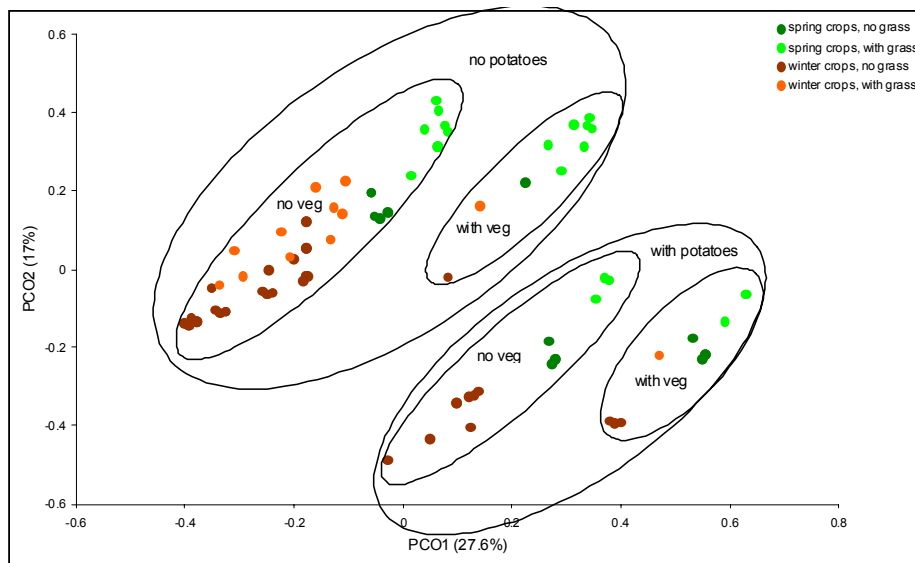

Figure 1. Classification of Scottish arable fields on the basis of presence or absence of different classes of crop in their rotational history.

As indicated in the introduction the aim in carrying out such analyses is to gain a perspective on where the Scottish arable system currently is so that we can make objective statements about its future trajectory and its resilience. The study of resilience requires us to address concepts which ecologists and economists can seem share in studying the behaviour of complex systems. A sustainable system or population can be defined as one in which there is no unchecked trend and for which deviations from the trend are bounded within limits. This leads to a requirement that resilient systems are those in which variables which ‘measure’ the system return to the above behaviour after being forced outside the bounds around the trend. So, for instance, an ideal or sustainable seed bank population (defined by the abundance of a range of species or functional types) is one which provides food resource for a wide variety of plant species but not to the detriment of crop yield. It is resilient if it can be returned to the ideal state if it temporarily moved above or below that state; e.g., through extremely intense or lax management, respectively. The empirical analyses are allowing us to gain an understanding of the ranges that such indicators as seed bank size take across a range of production situations. We are also using the data to examine the extent to which intensive cereal production is associated with declines in floral biodiversity and soil health. Generally, in a non-resilient system, measured variables are likely to display increasingly large departures from their reference values. Measuring such departures in a time series of data could be used as a method to test for resilience and (by extension) sustainability. Royama (1996) discusses this issue in an ecological context and Pearce (1998) suggests the applicability of the method both to ecological and economic variables.

References

- Pearce, D.W., 1998. In: Environmental indicators for agriculture. Vol. 2: Issues and Design, OECD, Paris, France, pp. 29-42.
- Royama, T., 1996. Analytical population dynamics (2nd ed.). Chapman & Hall, London.
- McRoberts, N. & K. Topp, 2009. AgSAP Conference 2009, these proceedings.
- Topp, C.F.E. & R.M. Rees, 2009. AgSAP Conference 2009, these proceedings.

Integrating multiple functions to optimize rural land health

B. Meyer, R. Grabaum, D. Watson, D. Adams, A. Hood, A. Phillips
School of Spatial Planning,
Dortmund University of Technology,
August-Schmidt-Straße 10, 44227 Dortmund, Germany
Contact: burghard.meyer@tu-dortmund.de

Introduction

As the results of the Millennium Ecosystems Assessment has shown, there is an obvious and urgent need for integrated land use planning to help provide optimal outcomes for the health of rural landscapes. Land use problems in rural landscapes involve complex trade-offs between multiple, and sometimes competing, objectives. These land use decision problems require new kinds of decision methodologies which can integrate these multiple objectives and provide optimal solutions.

Methods

The MULBO (Multi-criteria Landscape Assessment and Optimization) framework has been specifically developed to help guide these complex multiple objective decisions. In this current project MULBO has been trialled in the Lake Tyrrell Basin of Northern Victoria, Australia (Meyer & Grabaum, 2008). Lake Tyrrell is situated within the Mallee region and covers an area of around 400,000 hectares. The Mallee is a semi-arid region which supports broad-scale cropping on sandy low nutrient soils, where traditional agriculture has had a high impact on native fauna and flora, and where naturally saline groundwater and wind erosion present significant threats to both agricultural production and biodiversity.

The MULBO process includes the following steps (a) goal determination across multiple management criteria, (b) function analysis on the basis of GIS, (c) function assessment, (d) scenario formulation and (e) land use compromise optimization to calculate land use scenarios (Figure 1).

In this project, major land management goals within the Mallee were identified on the basis of regional and local management objectives and input from regional land managers, representatives from community environmental programs and farmers. Major landscape health problems in the region were identified, as were the major management objectives to be optimized. These objectives included indicators for (a) farm income, (b) salinity risks, (b) wind erosion and (d) habitat connectivity.

Inputs to the MULBO process include a range of data sets from a variety of sources. Based on an initial consultation, these data sets were processed to provide a new decision geography. The resulting data sets take the form of qualitative landscape value surfaces classified from low to high.

The land use optimization software LNOPT 2.0 was used to integrate the spatial data sets and provide suggested optimal land use patterns providing a range of compromise solutions for land use distribution in the Lake Tyrrell Basin Region. Different land use scenarios were calculated by adjusting weights for each indicator.

Results and discussion

The application of the MULBO framework in Victoria's Mallee region has shown the framework's ability to integrate a range of qualitative and quantitative information in support of complex land use decision making. The framework's ability to integrate spatial data from a range of sources and its open, flexible, structure make it a highly flexible decision tool to support sustainable solutions to rural land health. In particular, MULBO was able to support

the engagement of important stakeholders through a deliberate and clear decision methodology.

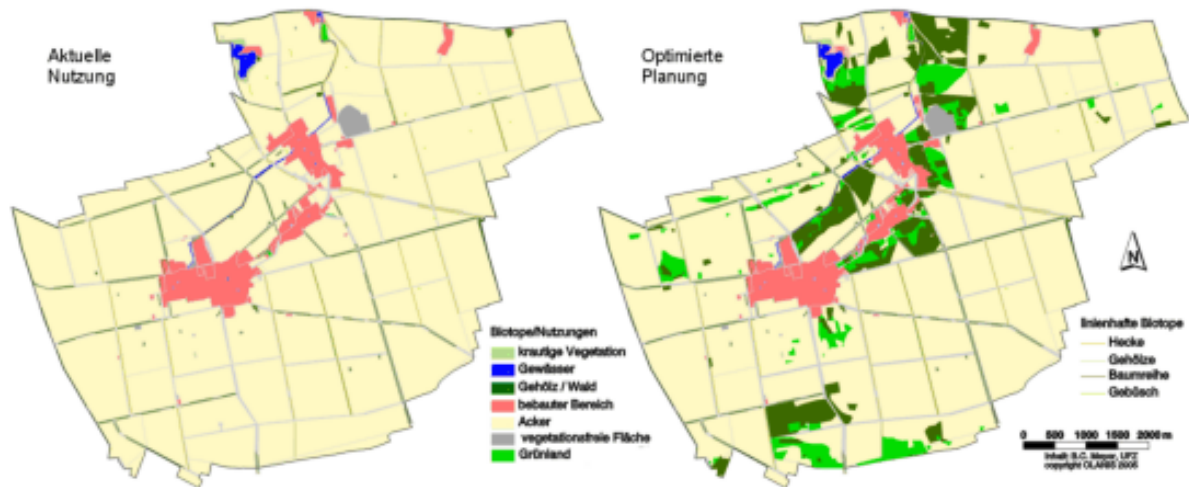

Figure 1. Optimized spatial outputs from the MULBO process.

Reference

Meyer, B.C. & R. Grabaum, 2008. Landscape Research 33(2): 155-179.

Framework for the socio-economic performance assessment of irrigation schemes

Rui Santos, Paula Antunes, Pedro Beça
CENSE/ECOMAN - Ecological Economics and Environmental Management Group,
Department of Environmental Sciences and Engineering,
Faculty of Sciences and Technology, New University of Lisbon,
Campus de Caparica, 2829-516 Caparica, Portugal
Contact: rfs@fct.unl.pt

Introduction

The sustainable use of water in agriculture is a global policy priority of vital importance, particularly considering an increasing demand for water and competition among uses resulting in growing scarcity. Irrigated agriculture deals with very complex issues, such as, resource preservation, environmental compatibility, economic feasibility, technological knowledge and social acceptance. Several potential economic, social and environmental impacts are generated and endured by diverse water users, which are more significant in regions where water is scarce (e.g., IEEP, 2000; Bouwer, 2002; Qadir *et al.*, 2003; Wichelns & Oster, 2006; Kassam *et al.*, 2007). Social impacts can be related with employment, public health, security (sometimes associated to conflicts), gender balance and livelihood, while some relevant environmental impacts can be related to water depletion, water quality degradation, impact on sensitive habitats and soil erosion. Economic impacts result, for instance, from changes in water prices, costs of irrigation technologies and infrastructures and water productivity, as well as other indirect effects on the productivity, competitiveness and attractiveness of agriculture and rural systems.

This paper proposes a framework for the socio-economic performance assessment of irrigation schemes, which can be applied in different contexts for irrigation schemes and farms, allowing for the characterization of existing systems and the comparison of alternative management options. The innovation is related with the selection of a set of economic and social indicators (e.g., Bos *et al.*, 2005; Molden *et al.*, 1998) and their combination using a 3-tiered flexible approach, designed in order to allow for application in different contexts. The three levels of assessment adopted, which range from a general level to an intermediate and advanced levels, are built considering differences in the assessment scope, information needs and stakeholders' involvement.

Methods

The proposed assessment framework considers a 3-tiered approach, which allows for the characterization of the irrigations schemes in different levels, requiring distinct levels of information detail and research resources. For example, the general level includes only basic descriptors of the irrigation scheme, whereas the advanced level includes also more social and economic indicators and is detailed per farm and per crop. In some cases, the development of a CBA study may be considered at this level. The main stages in the framework implementation include: (a) description of the irrigation scheme; (b) definition of the assessment objectives, scope and time horizon; (c) identification of information sources, main stakeholders, management issues and actors to be involved; (d) selection of the adequate level of assessment; (e) selection of relevant indicators as well as of needed complementary evaluation tools; (f) data collection, computation of indicators and application of complementary tools; (g) validation and comparison of the results with other irrigation schemes and regional and national information.

It is provided a set of indicators to be selected for each of the three levels of assessment, considering, simultaneously, the inputs, outputs and impacts of irrigation, which facilitates a

comparative analysis between diverse regions, different irrigation systems and management alternatives, as well as the analysis of trends in time and in space. The proposed indicators are focused not only in water use and agricultural production, but also in social, economical and environmental aspects associated with irrigated agriculture.

Results and discussion

This framework allows a quantitative and qualitative assessment that can be applied in different contexts for irrigation schemes and farms, allowing for the characterization of existing systems, the comparison of alternative management options, as well as an analysis of trends in time and in space. The proposed indicators are focused not only in water use and agricultural production, but also in social, economical and environmental aspects associated with irrigated agriculture. The quantitative results of the assessment process integrated with the qualitative inputs from stakeholders' involvement, contribute to the evaluation of global irrigation scheme performance as well as to the identification of the factors that are limiting performance such as structural, social or management issues.

The application of the framework to a Portuguese case study is in progress (Caia irrigation scheme, with an area of 9000 ha). Some difficulties in the process are related with data availability, but the involvement of the stakeholders in the evaluation process contributes to mitigate this problem. Results obtained so far confirm the contribution of the proposed framework to increase the capacity to evaluate irrigation schemes performance, for both water managers and farmers.

This work points the way towards further developments in the following aspects associated to this type of assessment:

- (1) evaluate the net effects that a change can have in the irrigation scheme;
- (2) the inclusion of objective performance standards for each indicator, and
- (3) the use of additional information such as key descriptors of the irrigation scheme characteristics that can help in the interpretation and comparison of results.

Selected References

- Bouwer, H., 2002. *Journal of Irrigation and Drainage Engineering* 128: 193-202.
- Bos, M.G., *et al.*, 2005. *Irrigation and drainage performance assessment: practical guidelines*. CABI Publishing, UK.
- Kassam, A., *et al.*, 2007. *Irrigation Science* 25: 185-188.
- IEEP, 2000. *The Environmental impacts of Irrigation in the European Union*. Institute for European Environmental Policy (IEEP), London.
- Molden, D.J., *et al.*, 1998. *Indicators for comparing performance of irrigated agricultural systems*. Research Report 20. Colombo, Sri Lanka: International Water Management Institute.
- Qadir, M., *et al.*, 2003. *Agricultural Water Management* 62: 165-185.
- Wichelns, D. & J.D. Oster, 2006. *Agricultural Water Management* 86(1): 114-127.

Sustainable livestock production: Assessment of farmers initiatives

S.F. Spoelstra, B. Elzen
Animal Sciences Group, Wageningen UR, P.O. Box 65,
8200 AB Lelystad, The Netherlands
Contact: sierk.spoelstra@wur.nl

Introduction

Dutch livestock production has become highly efficient in terms of output per unit input, but is also heavily criticized on sustainability issues including deprived animal welfare, environmental burdening and outbreaks of contagious diseases. As a response, in 2007 the Dutch government set policy targets of 5% and 100% sustainable livestock production at the farm level for 2011 and 2023, respectively. These goals represent major challenges in defining what sustainable farming is and in developing effective policy measures to support the required transition (Rotmans, 2003) towards sustainable livestock production. Setting a specific target of 5% for 2011 assumes that sustainability can be defined at the farm level and that by choosing proper criteria the number of farms that satisfy the definition can be assessed. A farm, however, is embedded in a wider socio-technical system and sustainable development requires changes on a variety of dimensions to lead to a transition. Various new approaches will have to be tested and learned about in practice to be able to assess what may work in practice. In this perspective change initiatives at the farm level (called ‘farmers initiatives’ in this paper) should not just be ‘counted’ to establish their contribution to the short-term policy goal but be assessed as part of a learning process towards a broader sustainable livestock production system (the long-term policy goal).

Methods

To monitor achievement of the short-term policy goal, criteria were developed to assess the number of sustainable farms. These criteria emphasized improved animal welfare while environmental issues should at least comply with present legislation. This was put into practice by using existing certification schemes for organic agriculture (EKO-label), environmental assurance scheme (*Milieukeur*-label) and compliance with rules for tax reduction, including green financing. These criteria should allow the ‘counting’ of the progress in the number of ‘sustainable’ livestock farms in the years up to 2011.

Such a method of counting, however, does not provide a proper assessment tool for a transition towards a sustainable system. Theories on system innovation and transition management emphasize development of innovation pathways in a multi-actor and multi-level learning process to result eventually in a shift to a socio-technical regime of the livestock production sector. To assess the progress of such developments we need interactive forms of assessment, which, as Van der Sluijs (2002) wrote, are at the core of integrated assessment. Such an assessment method should focus on the potential for learning about sustainability.

From this perspective farmers initiatives should be assessed for their potential to contribute to learning about the (in-)possibilities of such multi-dimensional change processes. In such an approach sustainability is also understood as a multi-dimensional and dynamic phenomenon. This adds a considerable complexity to the process which requires learning, on the one hand because of uncertainty on which of the present initiatives may contribute to sustainable development in the broader sense and on the other hand because unforeseen trade-offs may emerge.

To assess the potential of farmers initiatives to contribute to sustainable development we use four major criteria:

1. Presence of a strong vision. Visions, e.g., of an integral design of a sustainable farming system (Groot Koerkamp & Bos, 2008) can play an important role in systems innovation. They make sustainability operational, give direction to development and can mobilize stakeholders from various domains.
2. Institutional change. As Roep *et al.* (2003) argued, technical innovation in farming should be accompanied by institutional innovation to achieve 'effective reformism'.
3. Potential business model. Three earning models for an integral form of sustainable farming (1) The costs of livestock produce is cost effective and gives a competitive advantage in the market. (2) The costs of livestock produce are higher but the additional costs can be earned in the market, e.g., by sustainability-certified supply chains. (3) Costs of livestock produce are higher, but as part of sustainable farming additional functions providing new sources of income are added (e.g., energy and fertilizer production).
4. Possibility to mitigate excess entrepreneurial risks. Farmer's initiatives with a potential to contribute to sustainable development are accompanied by uncertainties and costs which could jeopardize continuity of the farm (Meijer, 2008).

Results and discussion

Our main argument is that, whereas the assessment of sustainable livestock farming systems is presently based on quality assurance schemes, it should be based on an assessment of the potential of farmer's initiatives to contribute to a sustainable development path. This implies seeing these initiatives as part of a learning and experimentation strategy to achieve sustainable development in the broader sense and should be based on insights from systems innovation analysis. The approach of 'Strategic Niche Management' offers a good starting point to carry out such an assessment. (e.g., Schot & Geels, 2008). Preliminary experiences based on ideas of strategic niche management with smart experimentation with dairy farmers initiatives (Roep *et al.*, 2007) were used to corroborate and refine our approach. As a next step will apply the method by selecting a number of dairy farmers initiatives to obtain a coherent portfolio allowing learning for sustainable dairy farming including aspects as welfare, green house gases, energy use, economy and labour conditions.

Thus, the approach not only looks at the potential of single initiatives to assess their potential to contribute to sustainable development but also analyses the cohesion between initiatives to obtain synergy in learning and also compares the learning achieved in these initiatives with future visions and explicit demands of various relevant actors.

References

- Groot Koerkamp, P.W.G. & A.P. Bos, 2008. *Neth. J. Agric. Sci.* 55: 113-138.
- Meijer, I., 2008. *Uncertainty and entrepreneurial action*. PhD thesis, University of Utrecht.
- Roep, D., *et al.*, 2003. *Neth. J. Agric. Sci.* 51: 95-217.
- Roep, D., *et al.*, 2007. *Slim experimenteren in de veehouderij*. Report 26, Animal Sciences Group, Wageningen UR.
- Rotmans, J., 2003, *Transitiemanagement, sleutel voor een duurzame samenleving*. Van Gorcum, Assen.
- Schot, J. & F.W. Geels, 2008. *Technology Analysis & Strategic Management* 20: 537-554.
- Van der Sluijs, J.P., 2002. In: Ed. T. Munn, *Encyclopedia of global environmental change*, Volume 4. John Wiley & Sons, Chichester, UK, pp. 250-253.

Integrated assessment of nutrient management options in smallholder farming systems: The NUANCES framework

P. Tittonell, M.C. Rufino, M.T. Van Wijk, M. Herrero, M. Corbeels, C. Pacini, J. Smith, S. Karanja, C. Quiroz, P. Mapfumo, J. K'ungu, F. Baijukya, C. Kaizzi, M. Mwale, O.M. Sanogo, E. Yeboah, D. Nwage, B. Vanlauwe, A. Albrecht, N. De Ridder, K.E. Giller
 Plant Production Systems, Wageningen University, P.O. Box 430, 6700AK Wageningen
 Contact: Pablo.Tittonell@cirad.fr

Introduction

Options for integrated management of nutrient resources and soil fertility by smallholder farmers in Sub-Saharan Africa (SSA) must be targeted (i) to the specific context in which farming takes place, (ii) to particular types of households pursuing different livelihood strategies, and (iii) to spatio-temporal 'niches' within the farming system. The NUANCES framework (Nutrient Use in Animal and Cropping systems – Efficiencies and Scales; www.africanuances.nl) is a methodological approach to *ex-ante* assessment of the feasibility, impact and trade-offs of implementing technologies for strategic nutrient management (SNM) in small-holder farming systems in the short and long terms, with a focus on processes taking place at the farm rather than the plot scale (Giller *et al.*, 2006). The framework consists of several methodological steps organized in two major 'loops' (Figure 1), and the various steps are articulated using the 'DEED' approach:

1. *Describe*, current production systems and their problems;
2. *Explain*, current farmers' decisions on resource allocation and their consequences;
3. *Explore*, options for agro-technological improvement in face of possible future scenarios;
4. *Design*, new management systems that contribute to a sustainable intensification.

Methodological steps

Field (surveys, experiments) and desktop (databases, models) tools are used in combination. The diversity of households within a community is analysed through socio-economic surveys and categorization of farm types (farm typology) according to main production objectives/ orientation/ resource constraints. Representative farms within each farm type are selected as case studies for quantitative characterization of production activities and key resource (cash, labour, nutrient) flows. This information is synthesized as simplified 'virtual' farms.

At this step key entry points for SNM may be already identified, thus, closing up the short loop. Virtual farms constitute the basis for the dynamic simulation of the farm system, coupling soil/crop, grassland, livestock, manure and household models (e.g., Tittonell *et al.*, 2007; Rufino *et al.*, 2007; Herrero *et al.*, 2007). Modelling is used to both 'Explain' current trade-offs and 'Design' alternative strategies for sustainable intensification. While the first phase of an EU funded project AfricaNUANCES was one of

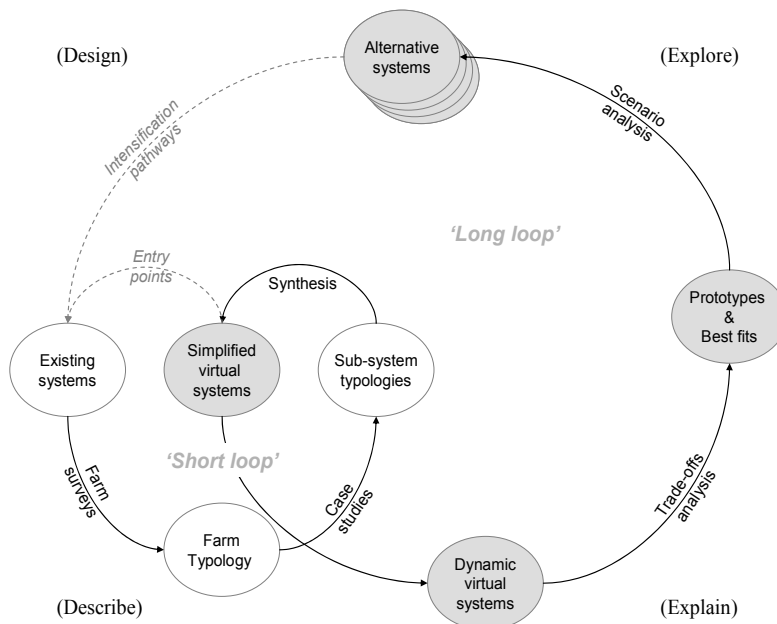

Figure 1. The NUANCES framework (see text for explanation)

Virtual farms constitute the basis for the dynamic simulation of the farm system, coupling soil/crop, grassland, livestock, manure and household models (e.g., Tittonell *et al.*, 2007; Rufino *et al.*, 2007; Herrero *et al.*, 2007). Modelling is used to both 'Explain' current trade-offs and 'Design' alternative strategies for sustainable intensification. While the first phase of an EU funded project AfricaNUANCES was one of

tool development and population of databases, a second phase is being designed (NUANCES-DEEDS) to out-scale best-fit SNM options, closing the long loop.

Targeting mineral fertilizers within smallholder farms – An example

The 2006 Fertilizer Summit in Abuja, Nigeria brought together scientists and policymakers from all over Africa who agreed that fertilizer use should be promoted; the goal of increasing the average application rates from 10 to 50 kg ha⁻¹ was set. Our explorations using the farm-scale model across representative farm types in the Kenya highlands indicate that such ‘blanket’ recommendations lead to dissimilar results across agroecologies, farm types and fields within individual farms. For example, farms located on sandy soils exhibit poorer fertilizer use efficiencies than on clayey soils, e.g., with maize responses of 5-10 vs. 30-40 kg grain per kg N with same rate of fertilizer applied. The home gardens that received continuous nutrient inputs produce good yields and respond poorly to applied fertilizers; they can be managed with small ‘maintenance fertilization’ rates. Degraded outfields do not respond to fertilizers and need long-term rehabilitation through organic matter addition. Model runs indicate that in such cases investments could be better directed towards improved livestock productivity and manure handling, to increase the quantity of manure with better quality for soil amendment.

Table 1. Fertilizer:maize price ratios (kg of maize necessary to pay for 1 kg N fertilizer) for different commercialization channels and at different times of the year and in western Kenya (source TSBF, 2007).

Price per kg N fertilizer	Maize sold in 90-kg bags		Maize retailed in 2-kg tins	
	Before harvest	After harvest	Before harvest	After harvest
78 KSh (agro dealer)	3.9	9.0	2.6	7.8
130 KSh (local retailer)	6.5	15.1	4.3	13.0

1 Euro = 99 KSh (Sep. 2008)

Our understanding of the diversity of households and their accessibility to markets (short loop in Figure 1) allows us to place these results in context. Poorer farmers in need of cash are forced to sell their maize immediately after harvest, when maize is abundant on the market (Table 1). These farmers often buy (locally retailed) maize during the rest of the year and when they buy fertilizers they do it in small amounts, experiencing the most unfavourable fertilizer:price ratios. The opposite is true for wealthier farmers, who can buy fertilizers in bags and stock their maize to wait for better prices before harvesting. Model explorations suggest that poorer households could benefit from producing fodder crops to sell to livestock owners instead of producing (poor yielding) maize in most of their farm.

Conclusion

The assessment of SNM options across case studies in 8 countries of SSA has taught us that production resources should be targeted strategically within diverse, heterogeneous and dynamic smallholder systems. *Ex-ante* impact assessment tools such as NUANCES can help in identifying the most promising options (at farm scale and in the short- and long-term) before they are promoted among farmers. This is of particular importance nowadays, in face of the major investments in soil fertility planned for SSA (e.g., www.agra-alliance.org).

References

- Giller, K.E., *et al.*, 2006. *Agric. Syst.* 88: 8-27.
- Herrero, M., *et al.*, 2007. *Agric. Syst.* 92: 240-265.
- Rufino, M.C., *et al.*, 2007. *Livest. Sci.* 112: 273-287.
- Tittonell, P., *et al.*, 2007. *Field Crops Res.* 100: 348-368.

The LUMOCAP PSS, impact assessment of agricultural policies in an integrative context

H. Van Delden, M.L. Paracchini, T. Stuczynski, P. Ciaian, R. Vanhout
RIKS, P.O. Box 463, 6200 AL Maastricht, The Netherlands
Contact: hvdelden@riks.nl

Introduction

As agriculture covers about half of the EU-territory, the Common Agricultural Policy (CAP) is a main driver determining land-use structure and landscape quality. It aims at ensuring adequate market prices, satisfactory income to farmers, food availability and rural development. The latter includes policy instruments such as agri-environmental schemes which are designed for achieving sustainability of agri-ecosystems and the preservation of landscapes.

The LUMOCAP Policy Support System (PSS) aims to assess how different policy scenarios will impact efficiency in meeting sustainability objectives. It focuses on the relations between the CAP and landscape changes and emphasizes the spatial and temporal dimension of this process.

Methods

For any land use model to work properly it is important that it includes the relevant drivers, processes and characteristics of the land use system. To move beyond the research phase and provide added value to decision and policy-making, a system needs to connect to the *policy context* as well as the *policy process* and moreover, provide *added value* to those working with it.

To capture processes occurring at different spatial levels, the LUMOCAP system includes sub-models at these different levels (EU-27, country, region, 1000×1000 m cells, 200×200 m cells). The system utilizes an existing spatially explicit dynamic land use modelling framework called METRONAMICA. Based on the knowledge of agricultural policies, driving forces of land use change and end-user requirements, the METRONAMICA model is adapted and improved to fulfil the requirements of policymakers at the EU, national and regional level. To capture the interaction between different disciplines and processes operating on various spatial resolutions emphasis has been put on the inclusion of dynamic feedback loops between the different model components.

Regarding the context, it is important that such a system incorporates the main drivers and processes of land use change and is able to simulate the change over time and in space. Very often, (research) models stop at this point and are unable to translate policy questions under consideration into model input and provide model results as policy-relevant information. For an ISDSS, however, it is crucial that the user can analyse the impact of various policy alternatives on a selected set of policy relevant indicators.

To be able to link to the policy process, it is crucial to have an overview of the stakeholders involved and the steps that are followed. Based on this information a decision can be made as to where and how in this process the system should provide support. The decision has a large impact on the overall development since it requires making trade-offs based on the desired functionality. If the system is to be used in an interactive workshop session to scope future developments and brainstorm about possible scenarios, running speed will be more important than the incorporation of very detailed models, while for a thorough analysis of possible alternatives further along the policy process, the requirement might be the opposite.

Since the ISDSS described in this presentation encompasses relatively complex (integrated) models, the GUI should be able to provide access to two different types of users:

the policymakers who use the system as part of their policy process and who carry out impact assessment studies with the model, and the modellers who can update the underlying data and parameters and possibly even the model equations. The first group mostly benefits from a GUI that follows the steps of a scenario or impact assessment process, the latter prefers to look at the system in a more systemic way and values easy access to individual disciplinary models.

The last crucial element for an ISDSS mentioned in the beginning of this abstract is the added value that such a system provides to its users. From our experience we have learned that users value the following benefits of an ISDSS (see also Van Delden & Engelen, 2006):

- An improved understanding of the interaction between the different functions and processes that shape the region. Analysing the dynamic cause-effect relations of alternatives enables learning which leads to awareness building;
- Because of the integrated nature, through feedback between models, effects are not only simulated for the discipline itself. Understanding those impacts can prevent the occurrence of unexpected and unwanted side-effects after the implementation of new policies;
- Although system development is a time-consuming and expensive task, once the system has been set-up it provides the possibility to quickly calculate the consequences of different alternatives;
- Although in every model subjective choices and assumptions will be made, ISDSS provide a means to objectively measure and evaluate of alternatives in a repeatable way;
- Improved communication between the different sectors and disciplines.

Results and discussion

The final LUMOCAP product is an open-ended, flexible, transparent, PC-based, analytical system enabling users to interactively enter policy options under a specific set of natural and socio-economic conditions as external driving forces, to formulate potential land use scenarios, and to assess the impact of both on the quality of rural landscapes through the analysis of selected landscape indicators.

Besides model development, special attention is given to the interaction with the end-users in order to incorporate their requirements into the final system – this is needed to ensure acceptability of the overall approach and to provide an added value to decision making at administrations. Therefore, the LUMOCAP system is developed in an iterative process in which frequent end-user consultations provide information for upgrading and adjusting the final product.

Training courses have been provided to (1) teach policymakers at the level of the European Commission and the Member states how to work with the system and (2) assess the usefulness and usability of the system. Although first reactions are very promising, more work on data collection, calibration and fine-tuning the system to the exact wishes of particular organizations is crucial for its actual implementation and use.

Reference

Van Delden, H. & G. Engelen, 2006. In: Eds A. Voinov, *et al.*, Proceedings of the iEMSs Third Biennial Meeting: ‘Summit on Environmental Modelling and Software’. International Environmental Modelling and Software Society, Burlington, USA, July 2006.

Measuring sustainability at a supra-farm level: Evaluation of methods

H. Wustenberghs, E. Wauters, S. Van Passel
Institute for Agricultural and Fisheries Research - Social Sciences Unit
Burg. Van Gansberghelaan 115, Box 2, 9820 Merelbeke, Belgium
Contact: hilde.wustenberghs@ilvo.vlaanderen.be

Introduction

Since the Brundtland report (WCED, 1987) put sustainable development on the policy agenda, many attempts have been made to put the theoretical concept into practice. This also entailed the need to monitor progress towards sustainability and hence to ‘measure’ it. So, over the last 20 years a wide range of sustainability monitoring tools have been developed. The majority of these efforts focussed on the national level. Well known examples are the ecological footprint (Wackernagel & Rees, 1995), integrated environmental and economic (‘green’) national accounts (UN, 2003) or the index of sustainable economic welfare (Daly & Cobb, 1989). Some efforts focussed on the firm level, such as some eco-efficiency measures or the sustainable value added (Figge & Hahn, 2004).

Maybe even more than in other sectors, sustainable production is of vital importance in agriculture, as farming, unlike most other economic activities, forms a part of the ecosystem rather than being external to it. Sustainability assessments for agriculture at national level have (partially) been made by drawing up economic and environmental accounts (Atkinson *et al.*, 2004, Wustenberghs *et al.*, 2004). At the farm level, sustainability can be assessed by a balanced set of indicators that might be visually integrated (Rigby *et al.*, 2001; Meul *et al.*, 2008) or by an adjusted sustainable value added (Van Passel *et al.*, 2007).

However, recently, the need has emerged for more regionalized policies that no longer focus on nationwide measures but on ‘tailor-made’ solutions for relatively small regions or for (sub)sectors. The Water Framework Directive is a good example of such a policy: while having common goals for the whole of Europe, catchment basin specific measurements are encouraged. Another example can be found in rural development policies, where regional identity has become an important issue. Thus the need for sustainability assessment at an intermediate level pushes forward.

The goal of this study is to evaluate existing methods for sustainability measurement for their possibilities of application at the supra-farm level and, if necessary, to formulate suggestions for the construction of a specifically adapted sustainability monitoring tool.

Methods

Criteria mainly used to assess sustainability monitoring methods are:

- Integration of the three dimensions of sustainability: existing monitoring tools often focus on only one or two aspects, in general economics and/or ecology. However, the integrated achievement of economic, environmental and social performance needs to be measured, while giving equal weight to all three dimensions.
- Possibilities to identify and evaluate both positive and negative externalities: too often assessment instruments only picture negative externalities (resource depletion or emissions). Typically though, agriculture also has a number of positive externalities, such as providing landscape amenities or specific ecosystems. Analogously agriculture can be very important to social structures in rural areas. A comprehensive assessment of agriculture’s sustainability can thus only be reached by a method that values both types of externalities on an equal footing.
- Trade-offs: the goal of integrated sustainability assessment is not in the final figure (e.g., a multi-dimensional value added, an ecological footprint, ...), but in the elements of this

figure, especially in their mutual dependency and in their evolution in time. A measuring tool needs to be able to answer questions such as ‘What is the effect of meeting Nitrate Directive goals on the other aspects of sustainability?’

- Transfers: can the methods adequately represent transfers between farms or regions or between the agricultural sector and the rest of society?
- Innovations: can the methods be used for *ex-ante* evaluation of the introduction of new technologies or policies?
- Data availability and feasibility of calculation: are appropriate data readily available or can reasonable proxies be derived from existing statistics? Is indicator calculation feasible within a reasonable time frame? E.g., monetary valuation of non-commodity goods often requires time-consuming revealed or stated preference techniques (Freeman, 1993).
- Unit of measurement: sustainability indicators can be expressed in monetary values, hectares, indices, etc. Monetizing environmental and social effects has the advantage of making them directly comparable to economic values, but the implementation is often cumbersome. ‘Hectarizing’ all effects seems an attractive path, especially for agriculture, where land is an important production factor (Hubacek & Giljum, 2003). In index methods selection of the indicators, their relative weights or over-aggregation might be drawbacks.

Results and discussion

To assess sustainability at supra-farm level, diverse methodologies fit with the definitional diversity of sustainability. In other words, a general framework can be developed, but the assessment methodology should be tailored to specific research questions and contexts. Based on our criteria and the evaluation of existing methods (on different levels), we will formulate suggestions for a general assessment framework that meets some specific needs.

References

- Atkinson, G., *et al.*, 2004. Framework for environmental accounts for agriculture. Economics for the Environment Consultancy (eftec), London.
- Freeman, A.M., 1993. The measurement of environmental and resource values. Theory and methods. Resources for the future, Washington DC, USA.
- Daly, H.E. & J.B. Cobb, 1989. For the common good: Redirecting the economy towards community, the environment, and a sustainable future. Boston Beacon Press, USA.
- Figge, F. & T. Hahn, 2004. *Ecol. Econ.* 48(2): 173-187.
- Hubacek, K. & S. Giljum, 2003. *Ecol. Econ.* 44(2-3): 137-151.
- Meul, M., *et al.*, 2008. *Agronomy for Sustainable Development* 28: 321-332.
- Rigby, D., *et al.*, 2001. *Ecol. Econ.* 39(3): 463-478.
- UN, 2003. Integrated Environmental and Economic Accounting. Studies in Methods, Series F, No.61, Rev.1 (ST/ESA/STAT/SER.F/61/Rev.1).
- Van Passel, S., *et al.*, 2007. *Ecol. Econ.* 62(1): 149-161.
- Wackernagel, M. & W. Rees, 1995. Our ecological footprint: Reducing human impact on the earth. New Society Publishers, Philadelphia.
- WCED, 1987. Our Common Future. World Commission on Environment and Development. Oxford University Press, UK.
- Wustenberghs, H., *et al.*, 2004. Monitoring agriculture’s multifunctionality by means of integrated nation-wide accounting. 90th EAAE Seminar, Rennes, October 27-29, 2004.

Theme A
Methodology for integrated assessment

**Session A2: Methods for up- and downscaling in
integrated assessments**

Session organizers:

Frank Ewert

University of Bonn, Germany

Martin Volk

Helmholtz Centre for Environmental Research - UFZ, Leipzig, Germany

Strategies for addressing spatial and temporal scale in Integrated Assessment of agricultural systems¹

J.M. Antle

Montana State University, Bozeman, MT 59717, USA

Contact: Jantle@montana.edu

Introduction

In this Keynote Address, I argue that integrated assessment models should be designed primarily to provide information needed to support informed policy decision making. To be useful, information must be timely and sufficiently accurate to improve the quality of decisions. These considerations imply that integrated assessment model design should be demand-driven in the sense that models need to be tailored to address the policy questions of interest, recognizing that there will always be trade-offs between data availability, model complexity, and ability to accurately represent processes and interactions between sub-systems. There is no one-size-fits-all approach that will work, given the time and other resource limitations that exist.

In choosing a modelling strategy, one of the major challenges faced by modellers is how to deal with the fact that data and processes operate at different spatial and temporal scales. In this Keynote presentation, my goal is to characterize the challenge and discuss one approach to resolving it.

Spatial and temporal scales in agricultural systems

For my presentation, I define an agricultural system as a complex, human-managed system intended to provide both market and non-market goods and services. The 'farm' is the basic economic unit which is comprised of a collection of land management units with associated flows of inputs and outputs (De Jager *et al.*, 1998). As Ewert *et al.* (2009) and other papers in this session observe, the farm interacts with markets, and more generally, within a hierarchy of biophysical and social systems (biological and physical soil and micro-climates, fields, farms, agro-ecological zones, regional climate, local, national and international markets and policy regimes). Various physical, biological and human processes and systems operate at each of these levels in the hierarchy, many on distinct spatial and temporal scales. As one example, crop growth and pest populations may operate at the level of the cell and crop plant levels on extremely high temporal resolution, but management processes may operate at the field scale on daily, weekly or seasonal time steps in conjunction with market and policy processes that operate at much larger spatial and temporal scales.

Research-driven versus policy-driven modelling strategies

Given these nested levels of complexity, how is the researcher to proceed? Given data and other resource limitations, it is not currently possible (nor likely to be in our lifetimes) to create the 'grand synthesis' of data and models at all levels covering the entire landscape in even a relatively small region, not to mention larger regions or the globe. So some compromises must be made. The question I pose here is how to define a strategy to making the inevitable trade-offs.

My observation is that, despite giving lip-service to policy, most models are research driven. By research driven I mean designed to be as true to scientific principles as possible, and outside of economics, this means process-based in most cases. Research-driven also tends to mean that the models are motivated by the goal of publication in peer-reviewed scientific journals. A consequence of the research orientation is that information produced by the

¹ Keynote presentation

models may or may not be relevant or useful to policy decision makers. For example, it may not be possible to ‘scale-up’ the results to the geographic regions of interest to policy design.

I shall argue in my Keynote Address that in order to meet the objective of supporting informed policy decision making, model design should be policy-driven, meaning that stakeholders should participate in the identification of the key quantifiable indicators that the models produce, and in the design of technology and policy scenarios to be investigated with the models. Not coincidentally, this is the approach advocated in Trade-off Analysis (Stoorvogel *et al.*, 2004). Once these issues have been addressed, the researchers can determine the appropriate disciplinary components to be incorporated into the agricultural system model, and the best spatial and temporal scales for each model component to operate, and how the disciplinary components can be integrated.

Discussion

One conclusion that can be drawn from research on the impact of spatial and temporal scales is that in some cases, a high-degree of resolution is required to obtain a reasonably accurate analysis of tillage erosion (e.g., Antle & Stoorvogel, 2006), whereas in the analysis of soil carbon sequestration, it appears possible to aggregate carbon rates to the regional level and obtain accurate predictions of carbon sequestration potential (Antle *et al.*, 2007). Likewise, it appears possible in some cases to significantly simplify data and models and obtain results sufficiently accurate to inform policy decisions (Antle & Valdivia, 2006). With further research, there appears to be a good possibility that these kinds of findings can be generalized so that researchers will know what kinds of models work well for different types of systems and policy questions.

These considerations suggest that there is no one ‘right’ scale of analysis in integrated assessment of agricultural systems. Rather, at each hierarchical level, it should be possible to develop modular frameworks with standard inputs and outputs that can be adapted to different systems and policy questions, and researchers can choose from this ‘toolbox’ when designing an analysis to meet the informational needs of stakeholders.

References

- Antle, J.M. & J.J. Stoorvogel, 2006. *Environment and Development Economics* 11(1): 39-58.
- Antle, J.M. & R. Valdivia, 2006. *Australian Journal of Agricultural and Resource Economics* 50(1): 1-15.
- Antle, J.M., *et al.*, 2007. *Climatic Change* 80(1-2): 145-171.
- De Jager, A., *et al.*, 1998. *Agric. Ecosys. Environ.* 71: 37-48.
- Ewert, F., *et al.*, 2009. *AgSAP Conference 2009, these proceedings.*
- Stoorvogel, J.J., *et al.*, 2004. *Agricultural Systems* 80(1): 43-66.

EU-wide spatial down-scaling of results of a regionalized agricultural economic model to analyse environmental impacts

Wolfgang Britz

Nussallee 21, D-53115 Bonn, Germany

Contact: wolfgang.britz@ilr.uni-bonn.de

Introduction

Robust simulation responses for economic modelling require observations for estimation or validation of how agents react to changes in market and policy signals. Most often, at least for large-scale analysis, solely time series data for larger administrative units provide the necessary variance in signals and responses. For Pan-EU economic analysis, already a sub-national regional resolution as in CAPRI (Common Agric. Policy Regional Impact model, Britz *et al.*, 2007) is, therefore, rather unique. With higher spatial variance inside administrative units, estimates of environmental impacts based on regional averages may be considerably biased under non-linear dependencies between these impacts and soil parameters, climate or farming practice. Certain impacts can only be assessed in their proper spatial setting such as the relation between nitrate leaching and drinking water resources or the effects of land use on specific habitats. Statistical down-scaling provides, therefore, a bridge between large-scale economic and environmental analysis in agriculture. The behavioral response regarding crop shares, yields or animal stocking densities is simulated for administrative units with the economic model. The downscaling tool then consistently distributes these changes to geo-referenced units below the administrative level. Environmental impacts are then analysed with indicator calculators or simulated with biophysical models at an appropriate spatial resolution. A work package of the project 'CAPRI-Dynaspat' contributed a spatial down-scaling tool to CAPRI. It established the necessary geo-referenced data bases and developed methodologies and software to consistently dis-aggregate for the whole EU27 all major results from the CAPRI modelling system to about 150.000 clusters of 1×1 km grid cells (Leip *et al.*, 2007).

Methods

Firstly, all available data as the soil map, climate data, digital elevation model, land cover map, or administrative boundaries have been rastered to a 1×1 km resolution for the EU27. Next, so-called Homogenous Soil Mapping Units (HSMUs) were defined consisting of clusters of 1×1 km pixel identical in soil, slope, administrative unit and dominant land cover, based on the assumption that these delineation features are decisive in determining differences in farming practice below the administrative unit level. Each HSMU covers between one and several ten thousands 1×1 km cells, capturing spatial variability where it matters. These about 150.000 units were deemed better suitable for the necessary crop share representation for the about 35 crops covered by CAPRI compared to pre-dominant land-cover presentation, and kept the amount of data cells manageable.

A statistical estimator assigns shares for individual crops and some broad non-agricultural land cover classes to the HSMUs maximizing the joint posterior density of the shares so that the area of each HSUM is exhausted and regional hectares for each crop and land use type are recovered. The necessary a-priori distributions for the shares were derived from locally widened logit-regressions on soil, climate and relief parameters, using the LUCAS sample as observations (Kempen *et al.*, 2005). The sub-regional distribution of yields is based on water and on-water limited potential yields for major crops provided by JRC's MARS project, taking into account regional data on irrigation shares and FAO's irrigation map. Assigning stocking densities for the about dozen animal activities in CAPRI follows as similar approach as for crop shares, the a priori distribution are here based on regression on Farm Structure Survey data at NUTS 2/3 regions.

The stocking densities allow estimated organic manure availability per HSMU, using spatial smoothing to wipe out peaks. Together with the yield estimates, a spatial distribution of fertilizer application rates is then derived recovering the average regional organic and mineral fertilizer application rates per crop as estimated by CAPRI. The yields and fertilizer application rates are a major input data into a spatial explicit link to the biophysical model DNDC (Li *et al.*, 1994), based on two approaches. The first, more standard one performs DNDC runs for major crops and representative sites. However, computing time and storage limitations render that approach only feasible for selected applications. Therefore, a statistical response surface was derived from DNDC runs with different levels of organic and mineral fertilizer doses, for a large sample of different soil and climate conditions for each crop and integrated in the downscaling tool (Britz & Leip, 2008).

Results and discussion

The whole down-scaling procedure is set-up in GAMS code and linked to the overall CAPRI modelling system. Results can be generated for the base year, for projection results or for simulation runs. A JAVA-based GUI allows to generate maps and tables from the result set.

The major problem with statistical down-scaling consists in the limited access to geo-referenced high-resolution data to estimate and/or validate the down-scaled results against real-world observations. Validation of the crop shares were performed at the level of sub-regional administrative units (Elbersen *et al.*, 2006). Especially the shares for important arable crops were estimated rather convincingly. Differences in grassland share were often significant, but are already present at the aggregate regional level between the different data source (land use maps, Farm Structure Survey FSS, land use statistics), and therefore probably to a large extent not due to the statistical procedure. The approach certainly would benefit from access to high-resolution data sets as FSS data at municipality level.

Despite the remaining uncertainty due to missing observations, e.g., regarding geo-referenced fertilizer application rates per crop, statistical down-scaling has some advantages over competing methods. Compared to bottom-up approaches which model economic behavior at a high spatial resolution, it can rely on existing data sources for the economic modelling part and does not require additional surveys. Due the high cost of the latter, a full-coverage bottom-up application to the EU level is not probable, asking for some kind extrapolation to map results for selected spots to all regions. It cannot be excluded that eventual gains from the fine-tuned and interlinked economic and biophysical modelling for selected spots are lost in the extrapolation step. Bio-economic bottom-up approaches are however potentially able to model changes in farming behaviour as switches in tillage techniques not covered in most top-down approaches. Compared to most existing LUCM approaches, the CAPRI downscaling tool distributes single crops, and covers further farm practice parameters as yields, animal stocking densities and fertilizer application rates. However, it is currently not able to account for neighbouring effects between land use categories as in classical LUCM, but could be easily linked to such an approach.

References

- Britz, W., *et al.* (Eds), 2007. Final report of the CAPRI-Dynaspat Project. Institute for Food and Resource Economics, University of Bonn, Germany.
- Britz, W. & A. Leip, 2008. NEU-annual meeting PSG2, Ghent 18.02.2008, Belgium.
- Elbersen B.S., *et al.*, 2006. Protocols for spatial allocation of farm types, SEAMLESS Report No. 19, www.SEAMLESS-IP.org, 107 pp.
- Kempen, M., *et al.*, 2005. In: Ed. F. Arfini, Modelling agricultural policies: State of the art and new challenges. Monte Universita, Parma, Italy, pp. 810-831.
- Leip, A., *et al.*, 2008. Biogeosciences 5: 73-94
- Li, C., *et al.*, 1994. Cycles 8(3): 237-254.

Calibration of regional programming models to exogenous supply elasticities by a variable cost function: The CAPRI-EXPAMOD example

Wolfgang Britz, Marcel Adenäuer
 Nussallee 21, D-53115 Bonn, Germany
 Contact: wolfgang.britz @ilr.uni-bonn.de

Introduction

The calibration of programming models to exogenous supply elasticities by setting parameters of a quadratic cost function is an established idea in the context of ‘Positive Mathematical Programming’ (Howitt, 1995). Existing approaches (e.g., Helming *et al.*, 2001) refer only to own price elasticities, and systematically overestimate the supply responsiveness of the calibrated model by neglecting the effect of changes in dual values. The paper builds on attempts to estimate variable cost functions of programming models (e.g., Britz & Heckeley, 2000, Heckeley & Wolff, 2003; Jansson, 2007) and proposes an estimator based on an analytical derivation of the supply response as proposed in Heckeley (2002), including cross-price terms. The calibration which defines a symmetric quadratic matrix of cost function parameters to recover a given own- and cross price elasticities. It may be seen as a special case of an estimation characterized by zero degrees of freedom and a specific data generating process. The approach is motivated by the integration of the large-scale agricultural sector model CAPRI (Common Agricultural Policy Regionalized Impact) into the SEAMLESS model chain (Van Ittersum *et al.*, 2008) where supply elasticities derived from simulations with farm type models and subsequently statistically extrapolated to cover all of Europe (Bezlepkina *et al.*, 2007) are used in the calibration process for CAPRI’s regional programming models.

Methods

The basic structure of each CAPRI regional model may be described as $\max_x Z = \mathbf{gm}'\mathbf{x} - \mathbf{d}'\mathbf{x} - \frac{1}{2}\mathbf{x}'\mathbf{Q}\mathbf{x}$ where \mathbf{gm} are per activity gross margins, and \mathbf{d} and \mathbf{Q} parameters of a variable cost function, all regional specific, subject to $\mathbf{A}\mathbf{x} \geq \mathbf{b} [\lambda], 0 \leq \mathbf{x}$. The vector \mathbf{x} comprises levels for about 50 crop and animal production activities in each of the about 250 regional models in CAPRI \mathbf{x} , \mathbf{b} is a vector of resource constraints and \mathbf{A} the related coefficient matrix, again region specific. The calibration estimates the matrix \mathbf{Q}^* which generates the Jacobian matrix of the activity level equations

$$H^* = \frac{\partial \mathbf{x}}{\partial \mathbf{gm}} = \mathbf{Q}^{-1} - \mathbf{Q}^{-1} \mathbf{A}^* (\mathbf{A}^* \mathbf{Q}^{-1} \mathbf{A}^*)^{-1} \mathbf{A}^* \mathbf{Q}^{-1}$$

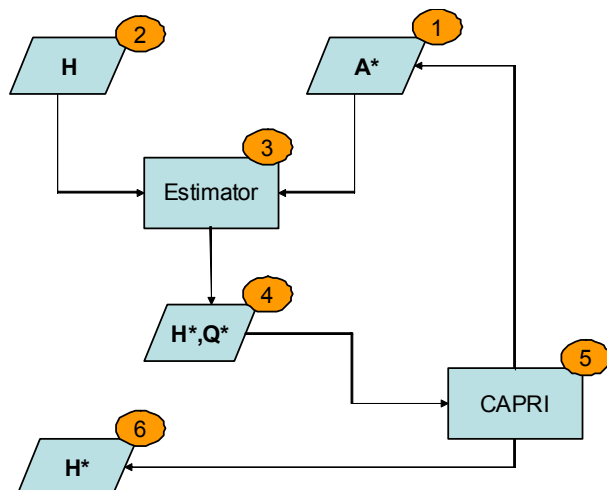

which comes close to a matrix \mathbf{H} derived from exogenous elasticities at a given simplified coefficient matrix \mathbf{A}^* . The following graphic gives an overview of the whole process. In(1), a simplified coefficient matrix \mathbf{A}^* is derived which comprises the major constraints such as land and fodder balances, set-aside or sales quotas from the CAPRI regional programming models and sets feed input coefficients to constant levels. At the same time, low and high yield variants for the crop activities in CAPRI are aggregated.

The gross margins for activity k are defined as

$gm_k = \sum_j o_{kj} p_j + prem_k - costs_k$ where \mathbf{o} are output coefficient, \mathbf{p} are prices, \mathbf{prem} are

subsidies and \mathbf{costs} variable costs per activity. From there, supply effects describing reaction to output price changes can be derived as

$$\frac{\partial x_k}{\partial p_j} = \frac{\partial x_k}{\partial gm_l} \frac{\partial gm_l}{\partial p_j} = \frac{\partial x_k}{\partial gm_l} \frac{\partial \left(\sum_j o_{lj} p_j + prem_l - costs_l \right)}{\partial p_j} = \frac{\partial x_k}{\partial gm_l} o_{lj} = H_{kl} o_{lj}$$

and elasticities defined as $\varepsilon_{ij} = \frac{\partial S_i}{\partial p_j} \frac{p_j^0}{S_i^0} = \frac{\partial \sum_k x_k o_{ki}}{\partial p_j} \frac{p_j^0}{S_i^0} = \sum_{kl} H_{kl} o_{ki} o_{lj} \frac{p_j^0}{S_i^0}$. The estimator then

derives in (3) a matrix \mathbf{Q}^* along with a matrix \mathbf{H}^* which deviates from the matrix \mathbf{H} as defined from the elasticities due to differences in structure and parameterization between CAPRI and FFSIM. In order to ensure regularity, \mathbf{Q}^* must be positive definite, guaranteed by a Cholesky decomposition. \mathbf{Q}^* and an appropriately set vector d calibrate the regional programming models in (4). The resulting models are then used in the (5) to perform sensitivity analysis while changing the revenues \mathbf{gm} , and the resulting supply effects are in the final step compared with \mathbf{H} .

Results and discussion

For a large-scale calibration exercise involving the 250 regional programming models of CAPRI and about 50 activities, numerical stability and an acceptable estimation error are crucial. The latter ensures mutual consistency between prices simulated in CAPRI based on the supply response of the regional programming models and the simulation behavior of FFSIM used to analyse environmental or farm type specific impacts at simulated prices. Compared to existing approaches, we allow for the integration of cross-price effects while considerably reducing the estimation error. Tests with randomly drawn matrices of supply elasticities were performed. The errors between the estimated supply effects and the one derived in sensitivity analysis are in an acceptable range. The major drawback compared to simplistic calibration approaches is the numerical complexity resulting from the need to integrate both matrix inversions and a Cholesky decomposition for large matrices in the estimation process. It leads to considerable computing time. Therefore, parallel estimation of several regions combined with algorithms to generate suitable starting values are used to speed up processing.

References

- Bezlepkina, I., *et al.*, 2007. EXPAMOD: Component to statistically extrapolate from FFSIM models to other farm types and regions including aggregation to NUTS2: motivation, description and prototype, PD3.6.11.2, www.SEAMLESS-IP.org, 28 pp.
- Britz, W. & T. Heckeley, 2000. Cahiers d'Economie et Sociologie Rurales 57: 28-50.
- Heckeley, T., 2002. Habilitation Thesis, University of Bonn, Germany.
- Heckeley T. & H. Wolff, 2003. European Review of Agricultural Economics 30: S. 27-50.
- Helming, J.F.M., *et al.*, 2001. In: Eds.T. Heckeley, *et al.*, Wissenschaftsverlag Vauk, Kiel.
- Howitt, R.E. 1995. American Journal of Agricultural Economics 77(2): 329-342.
- Jansson, T., 2007. Dissertation, Bonn University.
- Van Ittersum, M.K., *et al.*, 2008. Agricultural Systems 96: 150-165.

Compliance and costs of compliance: A procedure to obtain estimates at a disaggregated level

B.S. Elbersen, R. Jongeneel, M. Kempen, M. Mikk, A. Peepson
Alterra, Wageningen UR,
P.O. Box, 6700 AA Wageningen, The Netherlands
Contact: Berien.elbersen@wur.nl

Introduction

Cross compliance was introduced as part of the CAP Reform of 2003 with Regulation 1782/2003. It involves member states making receipt of the direct payment aid, called the Single Payment, conditional on farmers meeting two sets of standards. The first, called Statutory Management Requirements (SMRs), relate to 19 pieces of EU environmental, public, animal and plant health and animal welfare legislation. The second set, referred to as standards of Good Agricultural and Environmental Condition (GAEC), relate to the appropriate management of soils and the minimum maintenance of agricultural land and features found on that land. These SMRs and GAEC obligations apply to all farmers who claim the Single Payment, and apply to the entire farm holding.

In order to assess the impacts of cross compliance, insight into the compliance levels as well as the costs of compliance is needed. More in particular, one would also be able to detect changes in compliance rate over time in order to determine whether cross-compliance was successful in increasing the level of compliance with EU regulation. Unfortunately, only limited information about compliance and its costs is currently publically available. Examples of recent EU wide studies that provide compliance estimates are the Cross-compliance project and the study by the Alliance Environment (2007) prepared for DG-Agriculture. But even these studies, only provide estimates at national level. Since the impact of compliance to regulation is likely to vary between different locations (depending on type of farming, area designated as a Nitrate Vulnerable Zone or Natura 2000 area, etc.), still a further disaggregation of these estimates to regional levels (e.g., Nuts 2/3 regions, Nitrate Vulnerable Zones) is crucial. The aim of this document is to present a framework that allows for determining best estimates of compliance and costs of compliance at a disaggregated regional level (Nuts 2) in terms of farm, livestock and land use shares compliant and non-compliant. The method is applied to the Nitrate Directive being one of the SMRs in the Cross Compliance instrument.

Methods

Regulations aim to direct farmer's behaviour in such a way that certain (minimum) standards are respected. A farmer has the option to either comply or not comply. In the latter case (s)he faces the risk to be detected as a non-compliant, and risks that part of the direct payments might be withdrawn (depending on the significance of the violation). Figure 1 provides a

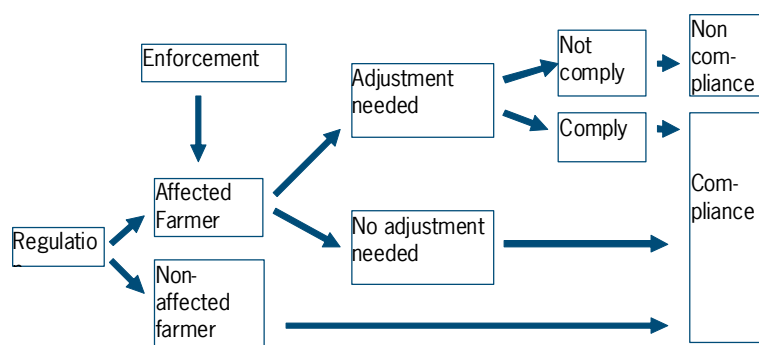

Figure 1. Farm affectedness, farmer adjustment and compliance (Based on Herzfeld & Jongeneel, 2008).

more refined scheme of the link between a regulatory requirement and compliance. Already by characterizing farms in being affected or non-affected by an obligation may help to get more insight into the compliance issue. If data are available at farm group level which could help to identify which part of the affected farms is likely to need to make adjustments, this further informs about which part of the farming population is most likely to have lower levels of compliance.

There are three categories of farms which have a large probability to be compliant: non-affected farms, affected farms but already exceeding EU standards, and affected farms which take action in such a way as to become compliant. Here the non-affected farms can be said to be compliant by definition. With respect to the affected farms the compliance rates are calculated in the following steps:

1. Identify groups of farms per region (Nuts 2 and NVZ) at no, medium and high risk of not complying with the Nitrate Directive.
2. Allocation of groups of farms at no, medium and high risk of not complying with Nitrate Directive to NVZ
3. Calculation of compliance rates per sectoral farm type group using nationally reported compliance and breaches levels
4. Calculation of the final total compliance rates for the Nitrate Directive obligations expressed as shares in total holding, livestock and utilized agricultural area shares per region (Nuts 2 and NVZ).

As for the estimation of the compliance costs specific estimates need to be made per obligation. According to information from the Cross Compliance project, the Nitrate Directive is one of the standards for which significant costs at farm level need to be made to become compliant. Estimation of these cost are based on operational costs (transportation, handling and spreading costs of surplus manure, labor cost associated with proper registration and record keeping of manure applications) and costs associated with investments that have to be made (sufficient manure storage capacity, manure transport and spreading equipment).

Results and discussion

The results show that the overall compliance levels with the Nitrate Directive in 2005 were already quite high in most EU regions. However, there are several regions where livestock systems dominate and which coincide with where the Nitrate Vulnerable zones are. In these regions we still see a very high compliance rate in terms of farm shares reaching above 90%, but in terms of animal shares the rate is between 70%–90%. These regions therefore have a significant higher risk for non compliance but also for higher costs of compliance.

References

- Alliance Environment, 2007. Evaluation of the application of Cross Compliance as foreseen under the Regulation 1782/2003. All national reports and synthesis reports prepared for DG Agriculture.
- De Roest, K., *et al.*, 2006. Framework for analysis of the cost of compliance. Deliverable 7, CROSSCOMPLIANCE project, EU 6th Framework Programme, Priority 8.1 (European Commission, DG RTD, contract no. SSPE-CT-2005-006489).
- Herzfeld, T. & R. Jongeneel, 2008. Economics of Compliance: A review of theories and application to agriculture. Paper presented at IAMO Forum conference 2008, IAMO, Halle an der Saale.
- Jongeneel, R., *et al.*, 2008. Final Report: Compliance and costs of compliance with standards and their impact on the EUs external competitiveness. CROSS-COMPLIANCE project, EU 6th Framework Programme, Priority 8.1 (European Commission, DG RTD, contract no. SSPECT-2005-006489), 120 pp.

Complex scaling issues in integrated assessment modelling: Approaches used and their integration into SEAMLESS-IF

F. Ewert, M.K. Van Ittersum, O. Therond, I. Bezlepkina, E. Andersen, T. Heckelei,
G. Flichman, N. Turpin

Institute of Crop Science and Resource Conservation, University of Bonn,
Katzenburgweg 5, D-53115 Bonn, Germany
Contact: Frank.ewert@uni-bonn.de

Introduction

Agricultural systems and associated problems of sustainability and sustainable development are typically complex. Several methods have been developed to effectively describe and analyse complexity. It is argued that hierarchy theory can provide a much needed conceptual framework for developing successful scaling theories and approaches to reach this objective. Hierarchy theory partitions complex systems into nested levels that share similar temporal and spatial scales.

In the recently developed integrated assessment (IA) modelling platform SEAMLESS-IF (Van Ittersum *et al.*, 2008) the concept of hierarchical system has been adopted. SEAMLESS-IF integrates relationships and processes across disciplines and scales which are conceptualized and modelled following the paradigm of hierarchy theory. Several scaling approaches are used in SEAMLESS-IF which are presented in this paper. Specific emphasis is on the integration of these different approaches. The progress achieved and the challenges experienced in modelling complexity within the paradigm of hierarchy theory are discussed.

Scaling methods in SEAMLESS-IF

Different methods have been employed in natural sciences to estimate systems responses across scales or levels of organization (see Ewert *et al.*, 2006). These include data extrapolation, data aggregation, model linking, development of summary models, scaling or aggregation of model parameters. The method chosen depends on the specific objective.

SEAMLESS attempts to capture the biophysical, economic and social, and to some extent the institutional dimensions of agricultural systems. Modelling efforts consider different levels of organization from the local field to the globe. Central to the SEAMLESS-IF approach is the linking of different models across scales and disciplines (Figure 1) to address (parts of) the complexity of the agricultural system. The core set of processes for which models were selected refers to the market level (CAPRI), the farming system level (FSSIM) and to the biophysical processes at the field level (APES) (Figure 1). Additional models can be considered if required.

The linking of models required a set of other approaches to scale information. These include:

- Generation of coefficients for (static) model linking;
- Development of typologies to define simulation units and to support data sampling;
- Scaling of model parameters;
- Extrapolation and aggregation to transfer data across scales (e.g., from farm to EU)

Due to the complexity of the developed model chain computational extensive dynamic model links were not considered, only one feedback loop (with a single iteration) is implemented from FSSIM to CAPRI and back to FSSIM. The link between APES and FSSIM is static in the form that APES generates coefficients for the FSSIM models.

The complex model structure(s) required simplification of data to consistently apply models across space. Different types of data are grouped into homogenous classes determined by the factors that explain most of the variability in the data with respect to specific variables of interest. The resulting typologies are the basis for up- and down-scaling procedures in

SEAMLESS-IF. The following three main typologies have been developed and used so far; the Agri-environmental Zonation (AEnZ), the farm typology and the administrative (NUTS2) regions (the latter has not been developed but is used in the project). These typologies are used to define simulation units to which data are scaled (e.g., aggregation of biophysical input data per AenZ for APES), to support data sampling (e.g., collection of management activity data per sample region for FSSIM), to transfer data between models that represent different scales (e.g., extrapolation of FSSIM outputs to feed CAPRI) and to scale up indicators (e.g., aggregation of FSSIM outputs to compute indicators at regional level). As there are spatial mismatches between typologies, approaches have also been developed to link simulation units of different typology (e.g., spatial allocation of farm types across AenZs).

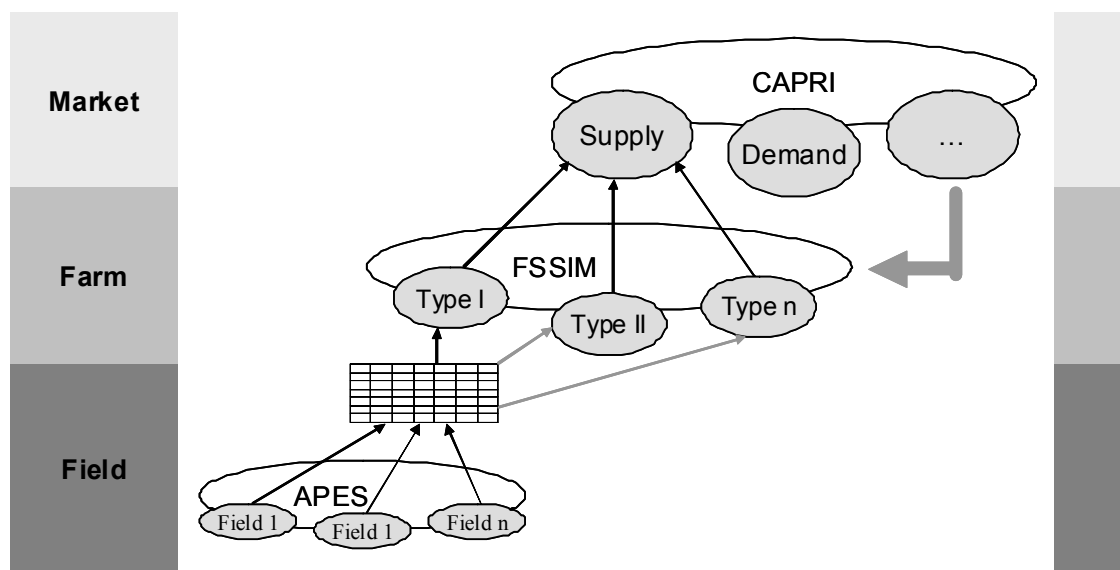

Figure 1. Schematic representation of nested linking of CAPRI-FSSIM and APES within a hierarchical system.

Discussion and conclusions

We have combined several scaling methods into a coherent modelling framework for IA of complex problems in agriculture. First experiences in working with SEAMLESS-IF show that the developed framework provides useful results and advances IA capabilities of earlier frameworks. Yet, the developed model chain is relatively complex and further simplifications may improve its usability and transparency. Further modelling work should therefore focus on developing simplified models for the different parts of the overall system. This can only be achieved if the most important drivers and processes are identified and understood for well specified problems. The developed chain (Figure 1) can be of assistance in the process.

References

- Ewert, F., *et al.*, 2006. Proceedings of the iEMSS. Burlington, USA, July 2006. <http://www.iemss.org/iemss2006/sessions/all.html>.
- Van Ittersum, M.K., *et al.*, 2008. *Agricultural Systems* 96: 150-165.

EXPAMOD – connecting the farm and market levels

I. Pérez Dominguez, I. Bezlepkina, A. Kanellopoulos, T. Heckeleei,
A. Oude Lansink, E. Romstad
Joint Research Center of the EC,
Institute for Prospective Technological Studies, Sevilla, Spain
Contact: Ignacio.perez-dominguez@ec.europa.eu

Introduction

Farm management models help quantifying changes in land use patterns and agronomic practices for a given set of prices and policies. These changes impact indicators of multi-functionality like the visual character of agricultural landscapes, biological diversity, and pollution levels. However, prices are unlikely to remain constant as policies change. Therefore, farm level optimization results based on exogenous prices may no longer be valid. Market level models, on the contrary, are able to capture the supply and price impacts derived by policy shocks at the farm and regional level, but are generally not sufficiently detailed for the calculation of environmental impacts, since they lack differentiated agronomic practices.

By linking farm level and market level models through a newly developed econometric model, EXPAMOD, we seek to mitigate this weakness and endogenize the price-quantity response in farm management models. This paper explains how EXPAMOD works, and applies it to a number of policy scenarios as used in SEAMLESS (Van Ittersum *et al.*, 2008).

The main modelling benefit of our approach is that it enables combining the strong points of farm management (the detailed linkages to agronomic and natural science models), and market level models (endogenous prices and closure of the economy). From a policy analysis perspective the resulting farm type and acreage responses provide a much improved base for various environmental and landscape modelling exercises.

Methods

Our modelling chain consists of three models. First, FSSIM, a normative mathematical programming model that is specifically fitted for model farm types and regions across Europe. Second, CAPRI, a comparative static partial equilibrium model of the European agricultural sector. Third, EXPAMOD, an econometric model that estimates changes in supply responses, and statistically propagates these responses to out of sample farm-region combinations.

The first step in our model chain is a collection of farm models, FSSIM, for several representative farm types with different exogenous price sets for a baseline and a policy scenario. Next, the econometric model, EXPAMOD, is used to estimate changes in supply responses for the exogenous price sets. Changes in relative farm level profits are then used to assign new weights to the farm types covered by the analysis. The supply changes at the micro level and the revised weights for the farm types are then used to adjust supply in the market model CAPRI, so that revised prices are obtained. Finally, these prices are fed back to FSSIM.

A major challenge for connecting the farm and market level is that the number of model runs at the farm level is limited due to the input data requirements of farm level model, FSSIM. Therefore, FSSIM is run for a stratified sample of model farms and regions to cover the main variation in the EU-27 of farm types and agro-climatic zones. Following Andersen *et al.* (2007), the selection of sample regions was made at the NUTS2 level, as this is the minimum disaggregation level for the market models in SEAMLESS. Nevertheless, the major source of farm type data is only available for FADN regions, i.e. regional classification used by Farm Accountancy Data Network, so that a mapping between both classifications is necessary (Janssen *et al.*, 2008). Due to laborious requirements on the data collection, 16 sample regions were targeted as this was judged to be feasible for data collection and modelling purposes.

In FSSIM regional supply at NUTS2 is recovered by aggregating farm type supply using farm weights from the FADN (see, Wieck & Heckeley (2007) for further details). How well the farm types selected represent the farm composition within a NUT2 region is an important issue for EXPAMOD. The weights derived from the observed data are only suitable for the calibration of the model in the base year, since they refer to FSSIM results. Since SEAMLESS targets the *ex-ante* impact assessment of agricultural policies, the projection of agricultural markets to a baseline period in the future, requires additional assumptions on technological development, changes in consumer demand, inflation, GDP growth, etc. These effects are explicitly handled by the CAPRI model and fed back into FSSIM.

The price impacts from supply changes in the farm optimization models generate information interpreted as 'pseudo-observations' for the econometric estimation of EXPAMOD. The current simulation design implements varying 'one-price-at-a-time'. The price vector, for each scenario, is kept at the 100% level of the initial price vector obtained from CAPRI and additional price-quantity vectors for four different price shocks in FSSIM are considered (-40%, -20%, +20%, and +40% from the initial price). These scenarios generate information on own and cross price-quantity effects that are reintroduced in the extrapolation routine of EXPAMOD. In most cases, price changes are likely to be far smaller. However, sufficient variation of prices is needed to stabilize the estimates of the price-related coefficients.

Results and discussion

The tests, performed with a flexible functional form, show plausible results and a high statistical explanatory power. Nevertheless, some poor predictions have been observed for estimations with a low number of observations and high number of parameters. This should be easily solved by generating a higher number of pseudo-observations. Additionally, a higher variance has been observed compared to the data (especially for products under a quota regime, such as sugar beet) and a closer link of results to the biophysical and farm management variables would be desirable. Out of sample tests are envisaged to provide relevant validation of strengths and weaknesses of the statistical extrapolation.

Our approach may also be applicable to scale up non-economic results, such as environmental impacts. However, further research is needed to refine the method employed for up-scaling such impacts, in particular where the spatial distribution of impacts matter.

References

- Andersen, E., *et al.*, 2007. The environmental component, the farming systems component and the socio-economic component of the SEAMLESS database for the Prototype 2, D4.3.5-D4.4-D4.5.4. SEAMLESS integrated project, 195 pp.
- Janssen, S., *et al.*, 2008. A European database for policy evaluation and assessment of agricultural systems. Environmental Science & Policy. (forthcoming)
- Van Ittersum, M.K., *et al.*, 2008. Agricultural Systems 96: 150-165.
- Wieck, C. & T. Heckeley, 2007. Agricultural Economics 36: 203-220.

Farm typology identification by multi-variate analysis as a method to scale-up results of integrated impact assessment

E. Righi, G.C. Pacini, S. Dogliotti, V. Aguerre, W.A.H. Rossing
Department of Agronomy and Land Management (DISAT), University of Florence,
Piazzale delle Cascine, 18 – 50144 Firenze, Italy
Contact: emilio.righi@unifi.it

Introduction

Farm typology identification within a specific case study area is a means to summarize the variability among farms in terms of agro-ecological and socio-economic livelihood aspects into farm groupings or 'typologies' and thus obtain insight in the major factors which distinguish farming systems.

The aim of this paper is to present a methodology to identify farm typologies and indicate how this method could be linked to model-based integrated impact assessment at regional level. The method will be presented as part of the description of a case study in South Uruguay, within the context of the EU project EULACIAS which aims to improve farm livelihoods in an action-research setting using systems approaches.

Methods

The method starts by defining a complete list of classification variables describing farm structure and functioning for three general categories of information: Land resources, Socio-economic aspects and Infrastructure and equipment. Principle Component Analysis (PCA) was used to compare different sets of key variables and to choose one of them which produced a meaningful differentiation of the farm samples. All data were standardized by total to avoid the influence of different units of measure. A Resemblance matrix was then calculated using the Bray-Curtis method. Farm typologies were generated by overlaying the results of two Multi-variate Analyses (MVA) techniques: Multi-Dimensional Scaling (MDS) and Cluster Analysis (CA). An analysis of similarities (ANOSIM) between the farm groupings was performed to calculate the level of dissimilarity between all pair-wise combinations. The last step of the methodology was a SIMPER analysis to determine the contribution to similarity within a group, which supplies information on the most representative indicators of each group.

The case study area is located in South Uruguay, in the region around Montevideo (Dogliotti, 2003). The analysis focused on 2373 specialized vegetable production farms. Farm typology identification was based on Census data of the year 2000 carried out by DIEA (Directorate of Agriculture and Livestock Economical Inquiries) of the Ministry of Agriculture of Uruguay. A random subset of 142 farm (5.98% of the total) was taken, due to calculation and visualization limits of the software PRIMER 6 (Clarke & Warwick, 2001), which were used for data elaboration.

Results and discussion

In Table 1, the selected key variables are listed and correspondent average abundances, for each farm grouping that was identified through the overlapping of MDS and CA, are reported. ANOSIM confirmed what was found by the combination of MDS and CA, since high levels of dissimilarity were found between all groups with an acceptable significance level. In Table 1, variables identified by the SIMPER analysis as contributing at least 70% to inside-group similarity are shown. The meaningfulness of the conclusions was verified with local researchers.

Within the EULACIAS project the farm typologies are used to select representative farms for the evaluation of consequences of alternative livelihood strategies on income generation

and resource use. SIMPER values that identify and describe typologies can be used for the selection of representative farms and to build average virtual farms aimed at impact assessment. Representative farms are used for empirical analyses and, in combination with virtual farms, to calibrate a modelling framework developed for EULACIAS case-studies, aimed at explorative and design analyses (Groot *et al.*, 2007). Data retrieved from MVA on farm group extension and composition are used to up-scale farm-level results, obtained through in-field surveys and simulation models, to study impact of different livelihood strategies at the regional level (Figure 1).

Table 1. Average abundances of the key variables calculated for the farm groupings identified for the specialized vegetable production system in South Uruguay. Most representative variables of each group are marked in bold.

Indicators	Group 1	Group 2	Group 3	Group 4
Area of vegetable crops (ha) / Total area (ha)	0.45	0.56	0.43	0.68
Protected cultivation area (ha) / area of vegetable crops (ha)	0.00	0.00	0.76	0.21
Family Labour (days \times yr $^{-1}$) / Total labour (days \times yr $^{-1}$)	0.95	0.94	0.70	0.49
Labour availability per ha (hours \times ha $^{-1}$)	836.97	931.00	2868.80	2308.53
Irrigated area of vegetable crops (ha) / Total area of vegetable crops (ha)	0.01	0.75	0.79	0.55
Mechanization Level (classes 1 to 5) *	1.69	2.36	2.22	2.60

* Mechanization Level is a qualitative variable: five classes were defined according to the farm mechanization level.

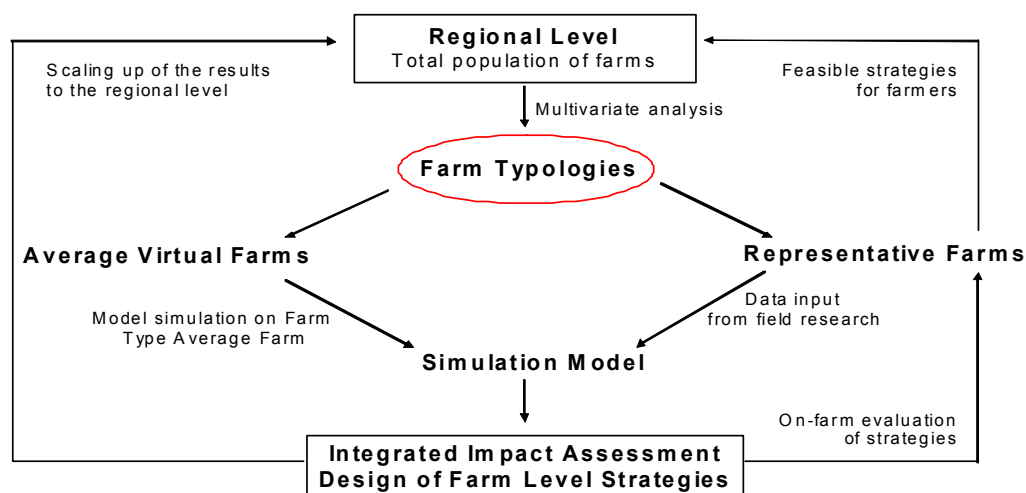

Figure 1. Diagram showing the framework to up-scale results of integrated impact assessment at farm to regional level using farm typology identification based on MVA.

References

- Clarke, K.R. & R.M. Warwick, 2001. Change in marine communities: an approach to statistical analysis and interpretation (2nd edition). PRIMER-E Ltd.
- Dogliotti, S., 2003. Exploring options for sustainable development of vegetable farms in South Uruguay. PhD thesis Wageningen University, Wageningen, The Netherlands.
- Groot, J.C.J., *et al.*, 2007. Agric. Ecosyst. Environ. 120: 58-69.

Competing use of organic resources, climate variability and interactions at village scale in a communal area of NE Zimbabwe

M.C. Rufino, J. Dury, P. Tittone, M.T. Van Wijk, S. Zingore, K.E. Giller
Plant Production Systems Group, Wageningen University,
P.O. Box 430, 6700 AK Wageningen, The Netherlands
Contact: mariana.rufino@wur.nl

Introduction

Mixed crop-livestock systems support the livelihood of the largest number of poor people in Sub-Saharan Africa. These rural people are exposed to a variety of risks such as recurrent droughts, political instability, failure of markets for inputs and products. Livestock provide food (milk and meat) and other services to the household, such as animal traction for cropping, but also fulfil a financial role. In places with low population density, livestock may feed on grasslands. As population pressure and competition for natural resources increases, some of the feed for livestock is produced in the cropland, and because of the continuous cultivation of the land, the removal of nutrients from the soils needs to be compensated by adding fertilizers, or making use of animal manure. As population pressure and competition for natural resources increase further, grasslands tend to disappear, more feeds need to be produced in cropland, and some feed is imported to the farm.

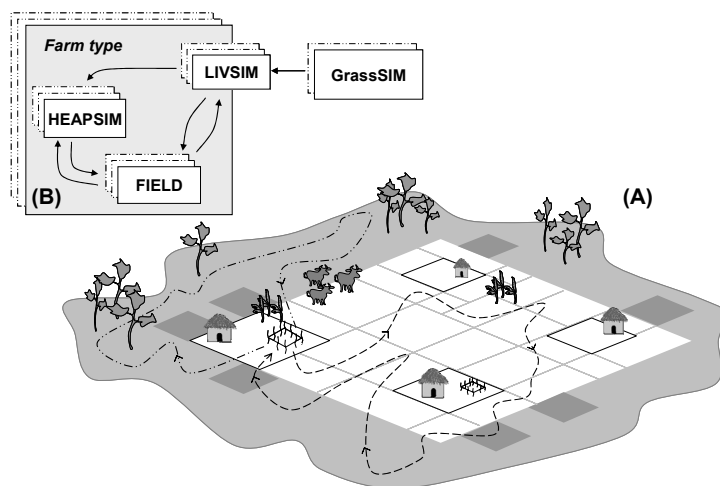

Figure 1. Schematic representation of the virtual village (A), and of the integrated tool FARMSIM (B), with the models FIELD (simulates crop production and nutrients dynamics in the soils), LIVSIM (simulates animal production and reproduction), HEAPSIM (describes decomposition of manure and other organic resources), GrassSIM (describes the availability of grass in the different grazing units).

The objectives of this study were (i) to understand the dynamics of crop-livestock interactions under climate variability and (ii) to identify opportunities for intensification. To achieve these objectives, we developed and tested an analytical tool to analyse crop-livestock interactions at the scale of the village using a communal area of NE Zimbabwe as example.

Methods

We combined information available for the area of study, collected through interviews, observations, experiments, and literature. We used the NUANCES-FARMSIM modelling framework (Giller *et al.*, 2006; Figure 1) adapted and tested for the conditions of smallholder farming in Majonjo, Murewa, NE Zimbabwe. We constructed a simplified 'virtual' village using the farm typology developed by Zingore *et al.* (2007) which distinguishes four farmer resource groups (RG) based on cattle ownership, farm size, production orientation, hiring labour, and food self-sufficiency. Feeding strategies, herding patterns, crop residues, and manure management were studied during the dry season of 2006 and the rainy season of 2007 (Dury, 2007). Additionally, the communal grasslands were characterized. The tool includes

different levels of detail: it simulates crop production at plot scale, grass production for different grazing units, animal production at individual level, while management decisions are considered at both farm and village scales by using rules. The most important transfers of nutrients: from grasslands to cropland, and between different farms within the village territory, are kept track of by integrating the different scales in which the different models operate. Climate variability is accounted for by simulating scenarios using data from the locality, which includes contrasting rainfall series.

Results and discussion

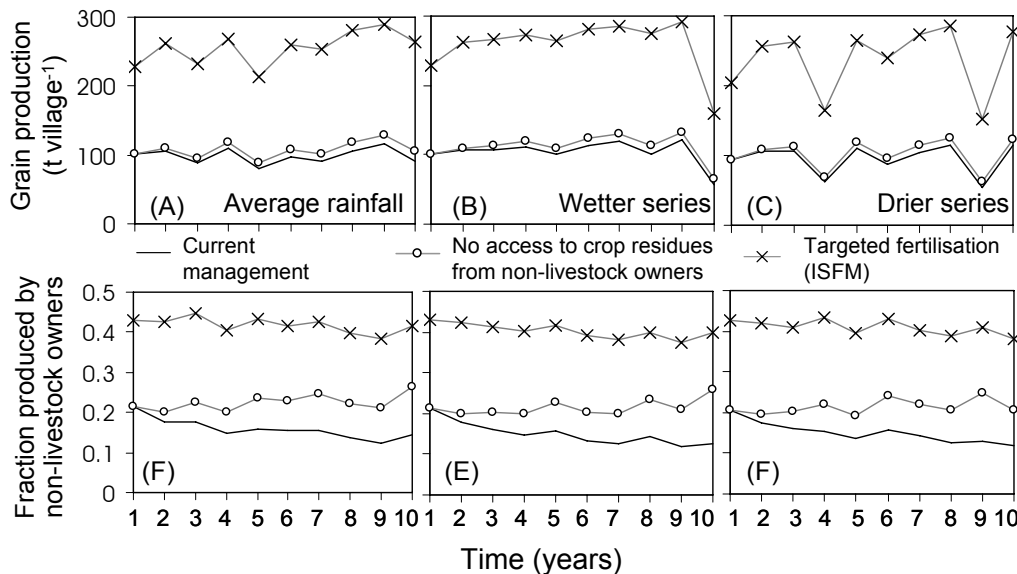

Figure 2. Simulated grain production for the whole ‘virtual’ village under three management scenarios (baseline, no access to cattle to crop residues of the non-cattle farmers (RG3 and RG4), and targeted fertilization), and using three different rainfall series: (A) average series, (B) a wetter series and (C) a drier series, and the share of the non-cattle farmers grain production to total production of the whole village for (D) average rainfall series, (E) a wetter rainfall series and (F) a drier rainfall series.

The interaction between farmers determines who benefits from integration of crop and livestock. The removal of C by cattle leads to lower crop yields in the poor fields of these farmers, and has relatively smaller effect on the fields of the cattle owners that receive animal manure and fertilizers (Figure 2). Rainfall variability intensifies the interactions, when the start of the rains is delayed, the low availability of crop residues during the dry season may lead to loss of animals from the herd. In years of good rainfall the removal is relatively unimportant. Crop-livestock integration at village scale results in concentration of nutrients in the farms with larger herds and increases dependency of the poorer smallholders on external inputs, and other types of exchanges within the village such as labour for food, cash or manures. In the targeted fertilization scenario, fertilizer compensated for the negative effect of the interactions, though it may be an unrealistic scenario for a smallholder community in Zimbabwe, certainly under the current economic and political circumstances.

References

- Dury, J., 2007. MSc thesis, Wageningen University, 133 pp.
 Giller, K.E., *et al.*, 2006. *Agric. Systems* 88: 8-27.
 Zingore, S., *et al.*, 2007. *Agric. Ecosyst. Environ.* 119: 112-126.

PRIMA, Prototypical Policy Impacts on Multi-functional Activities in rural municipalities¹

N. Turpin, R. Laplana, D. Kopeva, L. Stapleton, K. Happe, G. Deffuant,
F. Brouwer, M. Burghard
UMR 1273 Métafort, 24, avenue des Landais, BP 50085,
63172 Aubiere Cedex, France
Contact: nadine.turpin@cemagref.fr

Introduction

While the majority of Europe's population is congregated in cities, rural-designated areas have nonetheless recorded positive net migration over the past decade. Rural areas are becoming increasingly differentiated and gradually losing their agricultural specificity. They now need to support the coexistence of two logical approaches to occupation of their space: one based on the supply of agricultural and forestry products, the other on the various demands from local residents and seasonal tourists. Under these conditions, the role of farming, forestry and tourism industry is evolving; the focus is no longer simply on supplying market goods while limiting the impacts of this supply on negative external factors but now also on participating in land development and meeting the multiple expectations of society.

As these expectations regard public goods, public intervention is often needed to encourage economic actors to supply such public goods. Evaluation of such policies requires a targeted and systematic approach, and several research efforts currently develop tools that enable impact assessment for European land use policies and land management practices at the national and regional scales. The existing tools do not yet allow gaining information at lower levels on mechanisms that modify the economic structure of the firms (new entrants, disappearing of firms, new markets, re-organization in industry, local knowledge/expertise, local opportunities, local geographical constraints and local environmental values).

PRIMA framework aims to develop a method for scaling down the analysis of policy impacts on multi-functional land-use and on the economic activities from the EU level to the local scale. Special attention is paid to the structural effects of the policies and on their impact on the environment quality in the regions. PRIMA considers policies related to sustainable rural development such as Structural Funds, Cohesion Fund, Pre-accession funds and EAFRD.

Methods

The objective of PRIMA project is firstly to design and develop micro-simulation and agent-based models, of such dynamics and of the impact of European structural policies at municipality level, with the involvement of local stakeholders, and secondly to analyse how such an approach can improve *ex-ante* policy impact assessment.

To perform such analysis, we set out to design and implement micro-simulation and agent-based models that rely on behaviour rules drawn up at local level from stakeholders' consultations for the main actors in rural landscapes (e.g., farmers, forest industries, local consumers, tourism actors), in a set of municipality case studies, drawn from regional case studies. When facing new driving forces, these actors may adopt new activities, increase the size of their enterprise, associate themselves with other actors at the local level, re-organize their production systems in accordance with the accurate industry, or even disappear if the local context becomes not favourable. Of course, in the case of highly favourable context, new entrants are liable to appear.

¹ PRIMA is a collaborative project, 7th EU Research Framework, theme 6 Environment.

The models address the structural evolution of the populations (appearance, disappearing and change of agents) depending on the local conditions for applying the structural policies (sphere of influence for processing industries, possibility and tradition of actors' cooperation at local level, local development potential for the foreseen activities, specific local markets). Of course, local stakeholders will contribute to validate, in a post-modelling stage, the aggregated results of such local models, and if those results differ from the ones expected, the design rules will be modified. The models are designed to be compatible with more usual European Policy models (SEAMLESS-IF for the agricultural sector, SIAT tools resulting from the SENSOR project for the forest and tourism sector, GTAP-IMAGE for global changes and interactions between land use changes and land-related changes on emissions of greenhouse gases), when simplified to match the main assumptions of these aggregated models.

Results and discussion

PRIMA starts in November 2008. The paper presents the first insights of the project, with a focus on agriculture.

Spatial upscaling of on-farm indicators: Concepts to use a scientific knowledge base to match policymakers' requirements

N. Turpin, O. Therond, F. Ewert, I. Bezlepkina, J. Alkan Olsson, C. Bockstaller, S. Janssen
UMR 1273 Métafort, 24, avenue des Landais, 63172 Aubiere Cedex, France
Contact: nadine.turpin@cemagref.fr

Introduction

The SEAMLESS-Integrated Framework (S-IF) aims at assessing *ex-ante* impacts of policy options and agro-technical innovations on the sustainability of agricultural systems and on sustainable development at large (Van Ittersum *et al.*, 2008). This assessment is mainly performed through the use of modelling chains allowing the quantification of a set of sustainability indicators at multiple scales. SEAMLESS-IF models have been designed to simulate behaviour of the key hierarchical agricultural systems (field, farm, region, EU and world). However, despite the wide range of scales covered by these models there can be gaps between the scale at which model outputs are available (i.e. the model scale) and the scale at which policymakers' demand indicators for decision making (i.e. the decision scale). Accordingly, to meet expectations of policymakers there is a need for procedures changing the scale of this information from the model to the decision scale (Dalgaard *et al.*, 2004; Bierkens *et al.*, 2000). This paper presents aggregation concepts and methods that underpin the scaling capacities with respect to the indicator quantification in S-IF.

Methods

Temporal and spatial aggregation of models outputs to calculate indicators in SEAMLESS_IF is realized through the definition of appropriate indicator attributes which are capture in the indicator ontology (Therond *et al.*, 2009). These attributes specify for each indicator the spatial and temporal resolutions which refers to (the scale of) model outputs and the extents referring to the decision scales at which at which indicators are demanded. Once this information is defined the complementary information necessary to manage the aggregation from the indicator resolution to the indicator extent is associated (tagged) to the indicator (aggregation algorithms, aggregation weight...).

Results and discussion

The main characteristics of SEAMLESS-IF are its component structure which allows flexible linkages of independent model components depending on the problem to be addressed. In addition, components can be added that allow the scaling of data to compute indicators from model outputs to scales that are relevant for the decision makers. For the spatial up-scaling of data at the farming system level, information about the spatial allocation of farm types is important and considered in the proposed scaling approach (Figure 1). Of course, different scaling factor are used for different indicators (Figure 2), enabling scaling-up of information on the basis of farm type area for environmental processes, or on the number of farms per farm type for economic information, or even more complex information as indexes for income inequalities. For example, for some environmental issues linked to local impact (water quality, soil erosion, etc.) calculation of a weighted mean by farm size is not relevant, so that specific indicators like percentage of area with high nitrate leaching have to be developed. Approaches and results are presented and discussed for different indicators and conclusions for future work are derived.

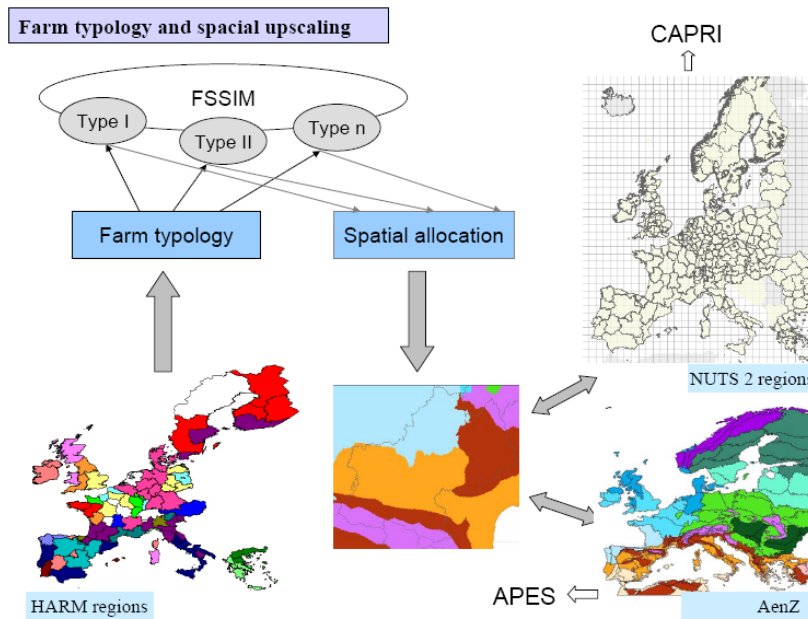

Figure 1. SEAMLESS farm typology and spatial upscaling issues.

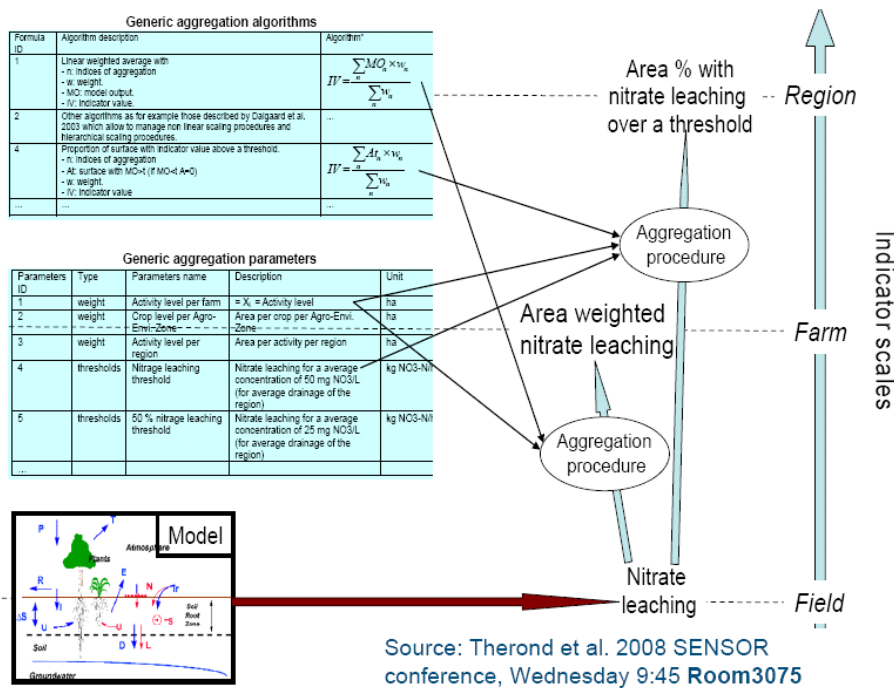

Figure 2. Procedures to scale information for project concerning detailed regions with a spatial extent of problem assessment corresponding to the region.

References

- Bierkens, M.F.P., *et al.*, 2000, Upscaling and downscaling methods for environmental research. Kluwer Academic Publishers.
- Dalgaard, T., *et al.*, 2003, Ecosystems & Environment 100: 39-51.
- Therond, O., *et al.*, 2009. AgSAP Conference 2009, these proceedings.
- Van Ittersum, M.K., *et al.*, 2008. Agricultural Systems 96: 150-165.

Coupling integrated assessment models to market equilibrium models to analyse economic and agricultural-environment interactions across different scales

Roberto O. Valdivia, John M. Antle, Jetse J. Stoorvogel
Dept. Agricultural Economics & Economics,
Montana State University, Bozeman, MT 59718, USA
Contact: valdivia@montana.edu

Introduction

One of the aims of agricultural research is to develop sustainable agricultural production systems that balance the often competing goals of profitability, human and environmental health, and equity. Researchers have been developing different methods to assess the sustainability of agricultural production systems. On the one hand, methods have been developed to integrate biophysical and economic models at a disaggregated level with the objective of capturing the heterogeneity of the physical environment and economic behavior of farmers (Just & Antle, 1990; Fleming & Adams, 1997; Stoorvogel *et al.*, 2004). On the other hand, aggregated models based on the construct of ‘representative agent’ have been widely used in policy decision making. Market equilibrium (ME) models are a good example of these models. They have been used to evaluate welfare implications of a particular change (policy, environmental, etc.) using representative data of producer and consumer behaviors. This implies that aggregated models do not capture the biophysical and economical heterogeneity that characterizes production systems. Conversely, results from integrated assessment models that capture this heterogeneity have not been linked to market equilibrium models. However, several studies have recognized the need to link these two types of models as an important step in the assessment of agriculture-environment interactions in order to understand the processes and relationships across different scales (Kayser, 1999). It is clear from the literature that here is an evident lack of methods that couple site-specific integrated assessment models with ME models. This study presents a method for coupling a site-specific integrated assessment model to a ME model.

Methods

The Trade-off Analysis (Stoorvogel *et al.*, 2004) model is an integrated assessment model that links site-specific biophysical process models and economic decision models and captures the spatial heterogeneity that characterizes the production system. Results can be statistically aggregated to a level that is relevant for policymakers and used for welfare and policy analysis. Resulting trade-off curves are a set of possible equilibrium points associated with different prices, therefore trade-off curves can be interpreted as generalized heterogeneity-based supply curves that include both market and non-market effects. The proposed linkage of heterogeneity-based supply curves to the market conditions and their effect on the underlying spatial distribution is described in Figure 1. The trade-offs among environmental outcomes, E (e.g., environment quality) and the economic output, Q (e.g. aggregate output) are represented by the curve T . That trade-off curve is generated by varying a price P^1 (e.g., price of Q or an input price). Each point along T is a possible equilibrium, and corresponds to a point on the supply curve S . Adding a demand curve such as D_θ , we obtain a market equilibrium point (a), which in turn, defines the point b on the trade-off curve as the equilibrium. This point is associated with a specific spatial distribution, then we can go from market equilibrium back to the implied spatial distribution of outcomes (Map₀). If demand conditions are changed and a new market equilibrium point, a' is attained, then this would imply that a different spatial

¹ More generally a vector of prices.

distribution of outcomes (Map_1) is associated with the corresponding equilibrium point (b') in the trade-off curve. The key point of this analysis is that we can use site-specific data to capture the heterogeneity of the population and generate trade-offs among economic and environmental indicators, estimate market equilibrium and link these results back to the underlying spatial distributions and measure their effects.

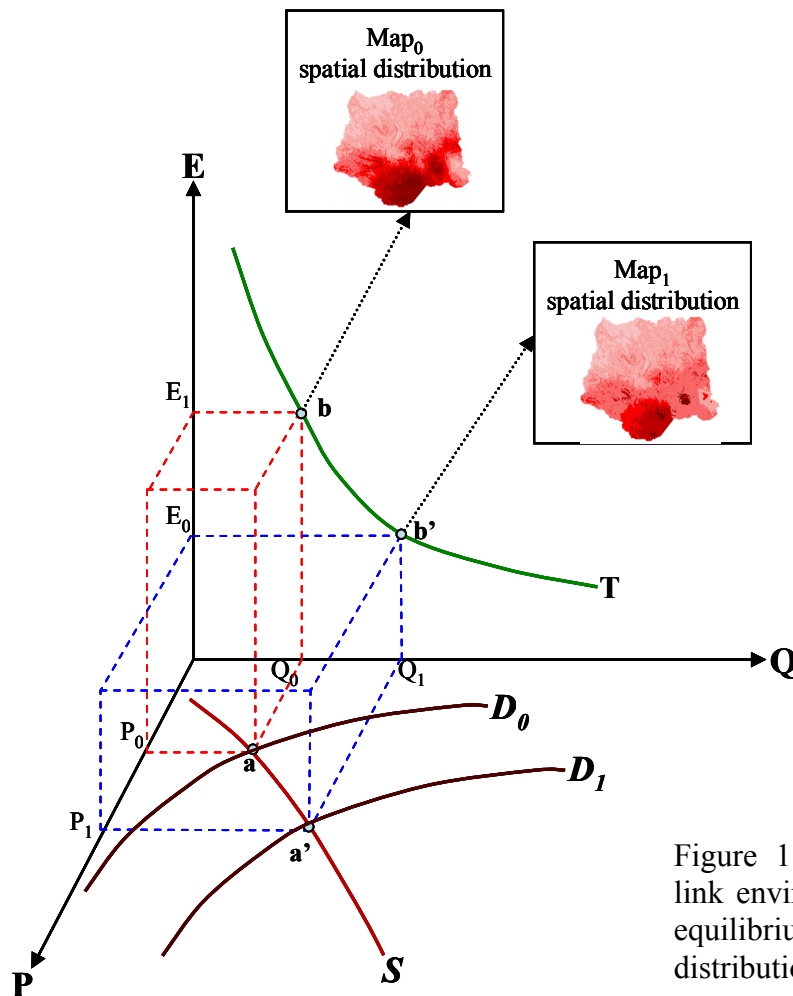

Figure 1. Theoretical framework to link environmental outcomes, market equilibrium and underlying spatial distributions.

Results and discussion

The goal of the empirical work will be to test the modelling methods and to assess the conditions under which market equilibrium analysis is important in assessment of agriculture-environment interactions. We will use the case study of a semi-subsistence agricultural system (Machakos, Kenya) to test policy intervention and technological change scenarios in the context of market equilibrium and their effects on the underlying spatial distributions.

References

- Just, R. & J. Antle, 1990. *Am. Econ. Rev.* 80: 197-202.
- Fleming, R.A. & R.M. Adams, 1997. *J. of Envir. Economics and Management* 33: 347-358.
- Kayser, H., 1999. *Assessing Research on the impacts of Climate Change on Agriculture*. In: *Global Environmental Change and Agriculture*. 1998. Chapter 7.
- Stoorvogel, J., *et al.*, 2004. *Agricultural Systems* 80(1): 43-66.

Assessing the effects of data aggregation using a crop simulation model

L.G.J. Van Bussel, F. Ewert, P.A. Leffelaar, H. Van Keulen
 Plant Production Systems Group, Wageningen University, P.O. Box 430,
 6700 AK Wageningen, The Netherlands
 Contact: Lenny.vanBussel@wur.nl

Introduction

Crop yields are determined to a large extent by the length and timing of their phenological phases, that are governed by the interactions of genetic properties and environmental conditions (ambient temperatures and day length), but also by management, especially sowing date. Future environmental conditions are anticipated to be characterized by higher temperatures, leading to modifications in crop phenological development patterns, influencing yields. Information on phenological development of crops under climate change, may be derived from phenological models such as AFRCWHEAT2, that simulates wheat development based on thermal time, photoperiod and vernalization (Harrison *et al.*, 2000).

Policy decisions to mitigate or adapt to climate change often refer to larger scales such as regions or countries. However, crop models like AFRCWHEAT2 are developed for the smaller field scale. To study climate change impacts, (results from) field-scale models have to be scaled-up (Rastetter *et al.*, 1992; Harrison *et al.*, 2000; Harvey, 2000; Ewert, 2004). In scaling-up model applications, heterogeneity in input data may be encountered, e.g. in temperature or sowing dates. Large-scale model applications often ignore this variability and use generalized data. To generate reliable model outcomes and/or estimate their confidence intervals, it is important to understand and consider the effect of such data generalization.

Approaches for data generalization usually refer to the aggregation of input or output data (Harvey, 2000; Ewert, 2004). It is expected that with increasing aggregation extreme values will be averaged out, with implications for the simulation results. Accordingly, the present paper investigates the impact of aggregating observed sowing dates and temperature on the simulation of phenological stages of winter wheat (*Triticum aestivum*) across Germany.

Methodology

Aggregation of input data

Germany has been divided into grid cells of varying size: starting from 10×10 km to 100×100 km with a 10 km interval. Observed sowing dates from the year 1995 for winter wheat were averaged for grid cells of each size.

Effects of data aggregation on model outcomes

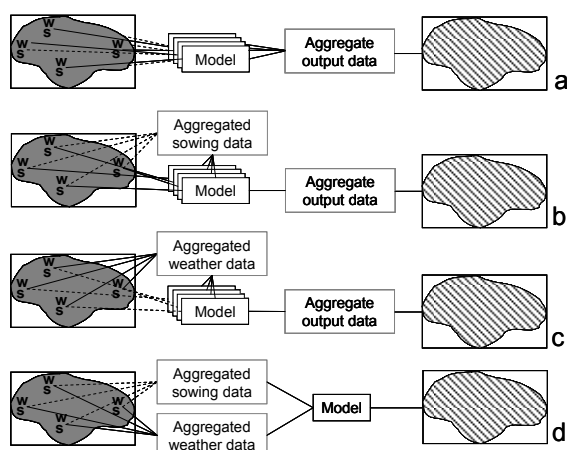

In one region, Niedersachsen, an area of 100×100 km has been identified with ten observation points for wheat phenology and weather. The observed range in sowing dates was on average 73 days for the considered years from 1984 until 1988 (including a relative warm and a relative cold year). AFRCWHEAT2 was run for four different combinations of aggregating input (sowing date or weather) and output data (Figure 1), for each year. The outputs of the runs according to Figure 1b-d have been compared with the output of run a.

Figure 1. Overview of model runs;
 w = weather observation (—), s = sowing date observation (---).

Results and discussion

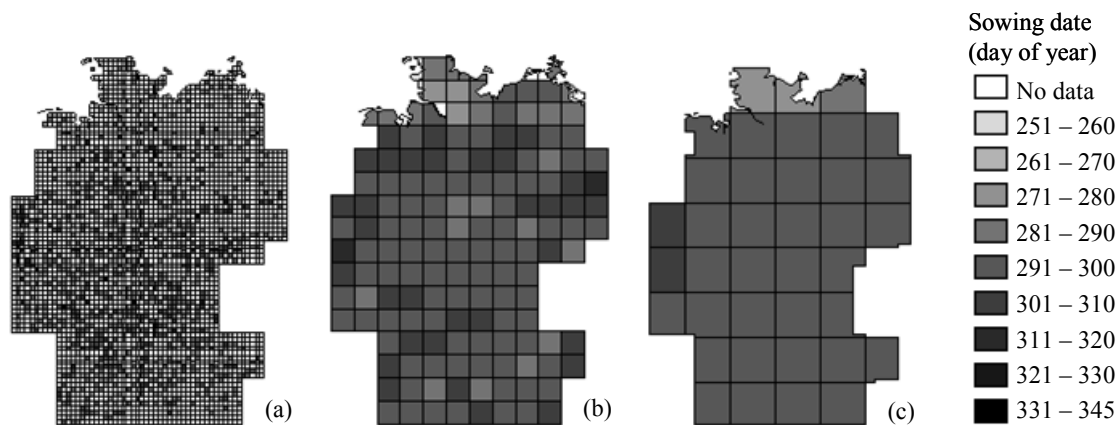

Figure 2. Effect of data aggregation on spatial distribution of sowing dates for grid cell sizes of: (a) 10×10 km, (b) 50×50 km, and (c) 100×100 km, for the year 1995.

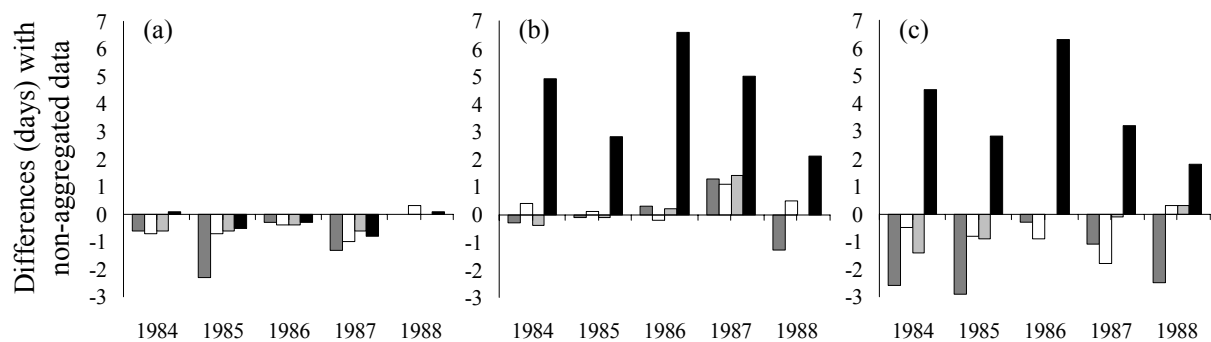

Figure 3. Differences (in days) between non-aggregated data and: (a) aggregated sowing dates, (b) aggregated weather data, and (c) aggregated sowing dates and weather data, for a 100×100 km grid, for the phases listed in the legend.

An increasing grid cell size results in loss of variability and a change in the spatial pattern of sowing dates (Figure 2). Moreover, data aggregation appears necessary for complete coverage of the area of interest: data for all grid cells are available only at grid cell sizes with a minimum area of 50×50 km, considering all the studied sizes.

Effects of input data aggregation on model outcomes are different for sowing date and weather data (Figure 3). Aggregation of weather data has the strongest effect, particularly on simulated harvest date that is 2 to 6 days earlier when aggregated weather data are used compared to point observations.

As aggregation of sowing dates results in only small deviations, the use of an average sowing date per region, with a maximum area of 100×100 km, seems justified.

References

- Ewert, F., 2004. Modelling changes in global regionalized food production systems under changing climate and consequences for food security and environment. Report, Plant Production Systems Group, Wageningen University, 55 pp.
- Harrison, P.A., *et al.*, 2000. *Agricultural and Forest Meteorology* 101: 167-186.
- Harvey, L.D.D., 2000. *Clim. Change* 44: 225-263.
- Rastetter, E.B., *et al.*, 1992. *Ecological Applications* 2: 55-70.

Scale effects in Hortonian surface runoff with management implications

Nick Van de Giesen, Tjeerd-Jan Stomph

Delft University of Technology, Stevinweg 1, 2628 CN Delft, The Netherlands

Contact: n.c.vandegiesen@tudelft.nl

Introduction

When rainfall intensity exceeds the infiltration capacity of a soil, Hortonian surface runoff will occur. This type of surface runoff can mainly be found in (sub-)tropical climates with heavy rainstorms. Although during such storms water can be observed on the surface throughout the landscape, not all water makes it to the bottom of the slope. Once the rain stops, much of the water on the surface will infiltrate before reaching the slope bottom. This causes a reduction in the fraction of rain that runs off. This fraction is called the runoff coefficient. The longer the slope, the smaller the runoff coefficient becomes. How strong this effect is depends on slope angle, rainfall intensity and duration, surface roughness, and infiltration capacity of the soil. In West Africa, on moderate slopes (2%–4%), strong reductions in runoff coefficients were found with increasing slope length (Van de Giesen *et al.*, 2000). Laboratory and simulation studies confirmed the field findings and helped explain the relevance of different factors (Stomph *et al.*, 2001, 2002). Three different runoff regimes can be distinguished, based on the specific combination of slope and rainfall properties. Through a simple analytical model and dimensional analysis, the dominant runoff regime can be determined for a region. In turn, each regime comes with its own runoff and erosion reducing management measures such as mulching, hedgerows, and riparian zones. Here, a review of the research is presented, whereby emphasis is placed on the scaling laws that govern different runoff regimes and the associated different management options.

Methods

The methods consist of three parts. The first part is field experimentation in Côte d'Ivoire where runoff was measured coming from plots with two different lengths. The short plots were 0.8 m wide and 1.25 m long. The long plots were 0.8 m wide and 12.0 m long. Runoff was collected at the bottom of each plots through gutters and oil drums. Runoff was measured after each of the 30 rainfall events. Figure 1 shows the experimental lay out. Due to different fallow treatments and slope positions, there was only one true repetition.

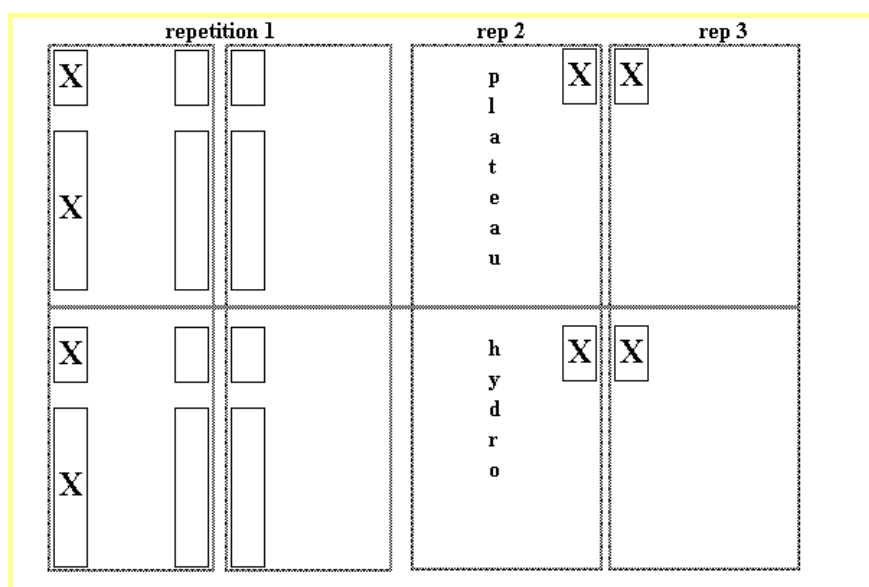

Figure 1. Experimental lay-out.

To have better control over the different factors that determine runoff, an artificial slope was built in the laboratory that allowed for runoff measurements under different slope angles and lengths. The complete set of results helped to develop a model based on the numerical integration of the kinematic wave equation, using the method of characteristics. This method also allowed for analytical solutions for simplified rainfall and infiltration patterns, which aided the dimensional analysis and regime identification.

Results and discussion

Table 1 summarizes experimental results found for the field experimentation in Côte d'Ivoire. Even a relatively short slope of twelve meters showed a reduction of over 40% in runoff when compared with the 'point' runoff from the short plots. Clearly, runoff from a slope can not be calculated by simply multiplying the runoff from a point with slope length. This effect has been observed in many settings. In the literature, this effect is often 'blamed' on the spatial variability in infiltration characteristics. What remains unclear is why this variability would always lead to a reduction in runoff. The analysis provided here shows that temporal dynamics alone can account for the observed scale effects. Only under certain circumstances does spatial variability play a (random) role.

Table 1. Experimental runoff results for short (1.25 m) and long (12.0 m) plots from the M'bé experimental farm, Bouaké, Côte d'Ivoire. Tot: total runoff (liters); C1: runoff coefficient short plot; C10: runoff coefficient long plot.

Repetition	Short		Long		C10/C1
	Tot (l)	C1	Tot (l)	C10	
Set 1, bare fallow/rice	397	0.37	2156	0.21	0.57
Set 2, bare fallow/rice	495	0.46	2801	0.27	0.59

By defining a set of dimensionless variables, the kinematic wave equation was solved for different rainfall durations and intensities (Van de Giesen *et al.*, 2004). This analysis showed when scale effects were significant and when not. When scale effects are extreme, only a small strip along the bottom of the slope will contribute to runoff. In such cases, it will suffice to manage this riparian zone. In other case, hedgerows and ridges can be used along the slope. The optimal spacing will depend on the characteristic lengths resulting from slope and rainfall properties.

References

- Stomph, T.J., *et al.*, 2001. *Earth Surface Processes and Landforms* 26(6): 647-655.
 Stomph, T.J., *et al.*, 2002. *Earth Surface Processes and Landforms* 27(8): 847-855.
 Van de Giesen, N., *et al.*, 2000. *Hydrological Processes* 14(1): 165-175.
 Van de Giesen, N., *et al.*, 2004. *Agricultural Water Management* 72(2): 109-130.

Effect of spatial resolution within the Cross Compliance Assessment Tool: The case of Nitrate Directive

J. Van Os, B.S. Elbersen, J. Kros, W. De Vries, J.P. Lesschen, M. Kempen
Alterra, Wageningen UR, Droevendaalsesteeg 3,
6708 PB Wageningen, The Netherlands
Contact: Jaap.vanOs@wur.nl

Introduction

The purpose of this paper is to make a description of the spatial scaling problems encountered in the CCAT project and explain how these were handled and what effects these may have on the final results. CCAT stands for Cross Compliance Assessment Tool. A Framework 6 research project (EC 44423-CCAT) aiming at the development of a tool to assess the effects of Cross Compliance on agricultural markets, environment, landscape, biodiversity animal welfare and public health.

Cross Compliance was introduced as part of the CAP Reform of 2003 with Regulation 1782/2003. It means that farmers in the EU who apply for the Single Payment Scheme, have to comply to two sets of standards. The first, called Statutory Management Requirements (SMRs), relate to 19 pieces of EU environmental, public, animal and plant health and animal welfare legislation, which is applicable to all farmers. The second set, referred to as standards of Good Agricultural and Environmental Condition (GAEC), relate to the appropriate management of soils and the minimum maintenance of agricultural land and features found on that land.

For the integrated assessment of the effects of Cross Compliance two existing core models are used: the MITERRA model and the CAPRI model. MITERRA is a steady state environmental model and CAPRI is a dynamic economic model. Both models are linked through input-output relations and they are joint under one user interface. CCAT is a steady state model and not affected by temporal resolution. Conversely, this is not the case for the spatial resolution. Spatial scale of available input data and model calculations are often different. This means that scale transitions are needed. In this paper the scale problems of CCAT models encountered during the implementation of the Nitrate Directive in CCAT are discussed.

Methods

Two steps are followed to explore the scale transitions encountered in the Nitrate Directive case study in CCAT. First, we will describe the scale of the different input data and the model calculations and explain which steps were followed to translate them to the appropriate scale in order to allow for integration. This is a descriptive approach. Secondly, we will focus on the results of the CCAT calculations concerning the Nitrate Directive and their sensitivity to up- and downscaling procedures applied in the post model phase.

We will give special attention to the linkage between the different models and the scale transitions which are necessary to couple the models. In this paper we will focus on prototype 1 of CCAT. Figure 1 gives an overview of the coupling of CAPRI and MITERRA within CCAT prototype 1.

The CAPRI model (Britz *et al.*, 2008) is a regionalized economic model for agriculture. It calculates nitrogen flow through the agricultural system in Europe too, embedded in a regionalized economic model calculating supply of agricultural commodities in Europe within a global market and a European policy situation. Within the CAPRI modelling system, a database has been established, which calculated production statistics (crop acreages, animal population numbers, etc.) at the regional (NUTS2) level.

MITERRA-Europe is a deterministic and static N cycling model which calculated N emissions on an annual basis, using N emission factors and N leaching fractions (Velthof *et al.*, 2007). The model can be used to assess the effects of measures and policies on the emissions of ammonia, nitrous oxide (N₂O), N oxides (NO_x), and methane (CH₄) to the atmosphere, leaching of N (including nitrate) to ground water and surface waters, and on the phosphorus (P) balance at EU-27 level, country level, and regional (NUTS-2) level.

Results and discussion

Agricultural data and models are often available for administrative regions, such as municipalities or provinces. In contrast, ecosystems and landscapes cross administrative boundaries; the scale of these processes is quite different from agricultural activities. Coupling of all processes in an integrated assessment means that a lot of scale transitions have to be performed. In these transitions the essential properties of the data have to be maintained. The results will show to what extent CCAT succeeds in this. The results can be useful for other integrated assessment projects where different models are coupled and for the implementation of prototype 2 of CCAT.

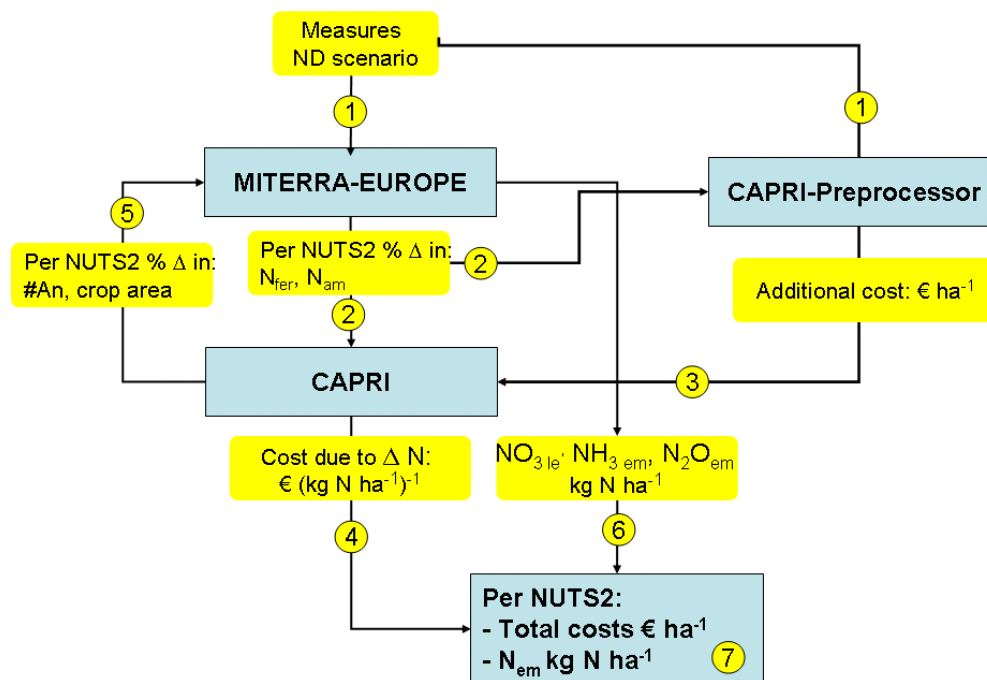

Figure 1. Coupling of MITERRA and CAPRI to assess the effects of the N-Directive.

References

- Britz, W., *et al.*, 2008. Description of the CAPRI Modeling System, Specific targeted research project, *Ex-ante* policy assessment of CAP. Contract nr 501981, University of Bonn, Germany.
- Velthof, G., *et al.*, 2007. Development and application of the Integrated model MITERRA-Europe. Service contract European Commission “Integrated measures in agriculture to reduce ammonia emissions” Contract number 070501/2005/422822/MAR/C1 Task 1.

Risk assessment methodology for pesticide control in the Nil River Basin, Belgium

S. Zakayo

Department of Hydroinformatics and Knowledge Management,
UNESCO-IHE, P.O. Box 3015,
2601 DA Delft, The Netherlands
Contact: Zakay1@unesco-ihe.org

Introduction

Van Leeuwen & Hermans (1995) defined risk assessment as the process of estimating the likelihood that a particular event will occur under a given set of circumstances. Hence, risk assessment for pesticides involves an analysis of information on the environmental fate and behaviour of chemicals in the environment (i.e. air, water and land) integrated with an analysis of information on their effects on human beings and ecological systems. Kannan *et al.* (2007) indicated that actual risk will vary temporarily and spatially with site-specific factors such as point-source loads, environmental conditions (e.g., river flows, soil drainage rates, soil properties) and loss processes. These issues seem to be heavily scale dependent, e.g., small areas may be very sensitive to direct losses while applying the pesticides, whereas larger catchments are more affected by the accumulated effect of pesticides in the runoff water (Holvoet, 2006). Since these factors appear to be difficult to include into generic risk assessment methodologies, Kannan *et al.* (2007) suggested that they can be considered in more sophisticated models like GREAT-ER (Geography-referenced Regional Exposure Assessment Tool for European Rivers) to predict point-source chemical exposure in rivers and large number of diffuse-source contaminant transport models.

Methods

In order to achieve the above, modelling of pesticides in question (i.e. atrazine and isoproturon) serves as a valuable tool in understanding surface water contaminant caused by pesticides used in agricultural watersheds. Kannan *et al.* (2006) referred to a few but increasing number of studies using the Soil and Water Assessment Tool (Arnold *et al.*, 2002) to model watershed-based pesticide processes. Holvoet (2006) mentioned that an inventory study on pesticides was conducted in Belgian catchments and the most 20 pesticides were reported in VMM (2005). Further, detailed information on pesticides application in the Nil catchment from 1998-2002 is available, which makes research on transport and fate of pesticides in the area attracting. Holvoet (2006) conducted a study in monitoring and modelling the dynamic fate and behaviour of pesticides in the Nil catchment.

Despite the complexity in pesticides models, knowledge on transport processes of pesticides is still incomplete. This study focuses on modelling transport of pesticides and formulates improved equations in SWAT for pesticides in question (i.e. atrazine and isoproturon) to represent the dynamic nature of these pesticides characterized by a fast transport by surface water. A Pareto optimization tool is used to optimize SWAT for better hydrology and pesticides results. In addition, time series of simulated pesticide concentrations provided by SWAT are linked with GREAT-ER for providing risk assessment in the Nil catchment.

Results and discussion

The model results review a diversity in causes of pesticide pollution that relate to the application practices (Figure 1).

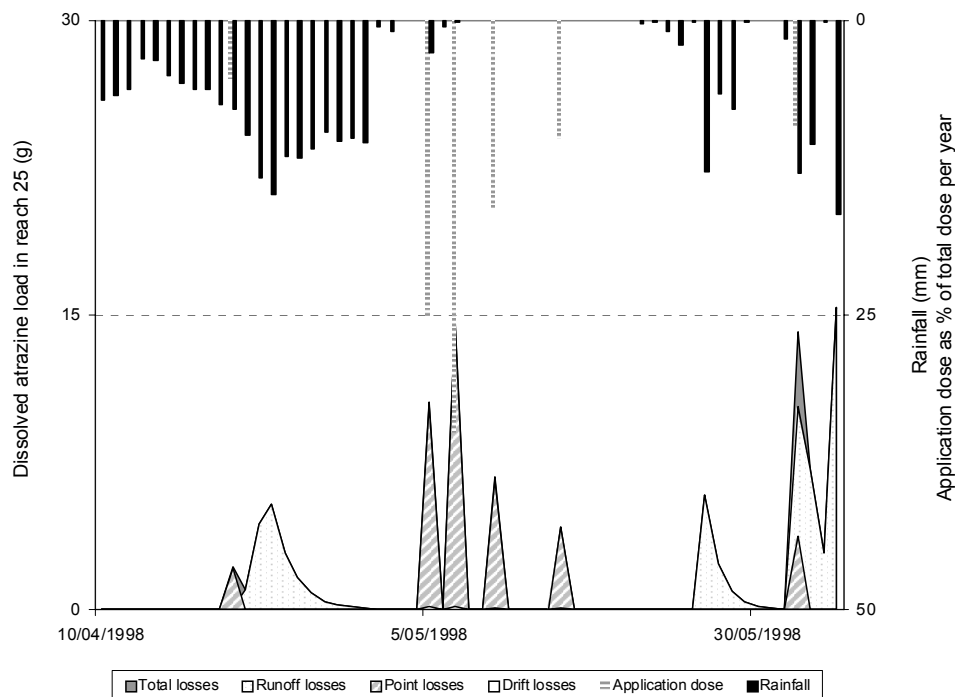

Figure 1. Predicted load of dissolved atrazine coming from sub-basin 25 during spring 1998, together with the measured rainfall and the initial pesticide dose (showed as hanging bars on the secondary axis).

A risk assessment for atrazine and isotroturon enables a more informed environmental impact assessment whereby information is provided to risk managers and decision makers in a manner that is understandable and relevant to the decisions being made.

References

- Arnold, J.G., *et al.*, 2002, Soil and water assessment tool, theoretical documentation, Grassland, soil and water research laboratory - Agricultural Research Service, Texas, US.
- Holvoet, K., 2006. Monitoring and modelling the dynamic fate behaviour of pesticides in river Systems at Catchment Scale. PhD thesis, Ghent University, Ghent, Belgium.
- Kannan, N., *et al.*, 2006. *Environmental Science and Health, Part B* 41: 1049-1070.
- Kannan, N., *et al.*, 2007. *Chemosphere* 66: 1336-1345.
- Van Leeuwen, C.J. & J. Hermans, 1995. *Risk Assessment of Chemicals: An introduction.* Kluwer Academic Publishers, Dordrecht.
- VMM, Flemish Environment Agency, 2005. *Water- en waterbodemkwaliteit; Lozingen in het water. Evaluatie saneringsinfrastructuur 2004*, 88 pp. (in dutch) <http://www.vmm.be>

A generic downscaling approach for scenario driven modelling outputs from European to regional scale

Ingo Zasada, Annette Piorr, Regine Berges
Institute of Land Use Systems and Landscape Ecology, ZALF,
Eberswalder Str. 84, 15374 Muencheberg, Germany
Contact: ingo.zasada@zalf.de

Introduction

Scenarios represent powerful tools and foundations for impact assessments and decision-making support at the European level. Rather than predicting and forecasting, the scenario framework of the FP6 Integrated Project PLUREL refers to possible futures, exploring development trajectories of driver-pressure-relationships in rural-urban-regions in Europe (RUR) (Ravetz *et al.*, 2008). In the four different scenarios analysed, the narrative storylines consider assumptions on drivers related to demography, economy, climate and technology. These storylines are translated into quantitative socio-economic variables of the econometric model NEMESIS to calculate (urban) land-use change at NUTS 0 level (member state). Following the operational approach of the project, focussing on the issue of regional urban-rural-relationships, the responses of different landscape functions on urban sprawl or decline are assessed. Regression modelling for the impact assessment of land-use changes requires the lower spatial scale of NUTS 2/3. In addition to the econometric model, locational characteristics distinguishing different regions within Europe, which are expressed in determinants influencing (urban) land-use change, need to be taken into consideration. A downscaling model has been developed which is based on generic and not spatially explicit approaches. It allows for the adaption of basic response functions to limit the number of different regression algorithms.

Regional determinants and tacit knowledge

A lot of theoretical and empirical research in the field of regional science is carried out on the role of regional characteristics as push and pull factors for land use and land use changes. Especially questions of accessibility (Krugman, 1993) innovative capacity (Acs, 2002), environmental quality as well as natural and technological hazards and vulnerability (UN/ISDR, 2004) and the planning and governance regime represent important determinants. Due to spatial observation and monitoring efforts, e.g., by ESPON, EIS or EUROSTAT, European-wide typologies and benchmarking assessments of these regional determinants are available. Even though strong relationships between locational qualities and urban development are observed, the actual urban growth response is hardly empirically ascertainable and predictable. Instead, there is broad and resilient knowledge distributed among researchers, practitioners and policymakers on various spatial levels and fields of expertise, which is fuzzy structured, non-codified, undirected and hardly quantifiable – so-called tacit knowledge (Polanyi, 1966). On the one hand knowledge on land-use dynamics evolves throughout the scientific community through research engagement. On the other hand regional representatives and stakeholder on the local level possess endogenous knowledge on the basis of regional experience.

Integration of participatory methods in land-use modelling

The newly developed generic regionalization and downscaling procedure consists of various single modules integrating (i) the high aggregated land-use information (NUTS 0), (ii) empiric information about regional determinants on NUTS 2 level, (iii) generic land-use relevance of the particular determinant as well as (iv) the scenario sensitivity of each determinant. For the estimation of the land-use impact relevance and scenario sensitivity of

regional determinants, participatory approaches (expert interview, Delphi process) (Linstone & Turoff, 2002; Flick, 2005) are applied.

Results and discussion

In a first step an expert judgement among researchers on the relative relevance from a list of regional determinants has been conducted, which is used for a regional validation. In parallel, a Delphi process with scenario modellers regarding the scenario sensitivity of the determinants is carried out and agreed. The results are implemented for the downscaling procedure to obtain regionally differentiated European maps on NUTS 2 level. Additionally, single disaggregated determinant values serve as explanatory factors in the regression modelling approach for the impact assessment (see Figure 1).

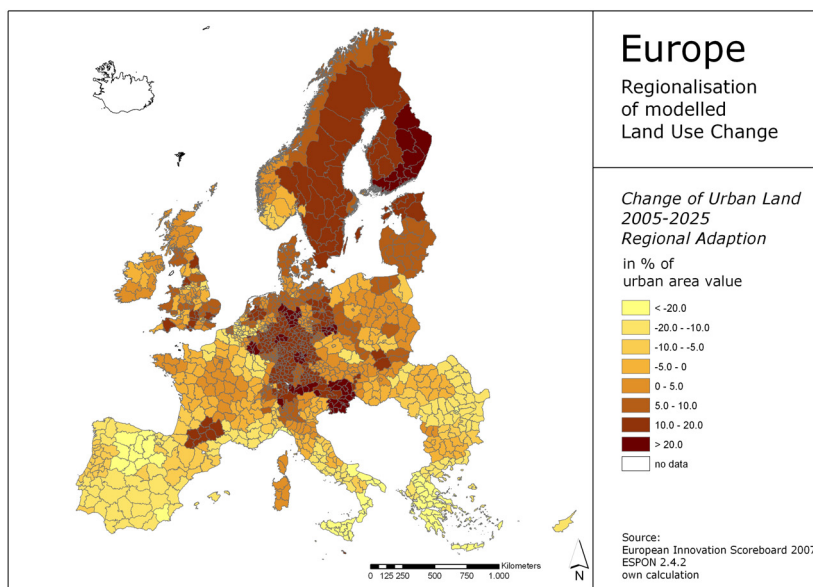

Figure 1. Regionalization of scenario-based urban land use change.

References

- Acs, Z.J., 2002. Innovation and the growth of cities. Edward Elgar Publishing, Northampton.
- Flick, U., 2005. Qualitative Sozialforschung. Eine Einführung. 4 ed. Rowolt Tb.
- Krugman, P.R., 1993. Review of International Economics 1: 110-122.
- Linstone, H.A. & M. Turoff, 2002. The Delphi Method: 1. Techniques and Applications.
- Polanyi, M., 1966. The Tacit Dimension. Doubleday & Co.
- Ravetz, J., *et al.*, 2008. Scenario Framework, Report D1.3.2 for Peri-urban land use relationships (PLUREL). EU 6th framework.
- UN/ISDR, 2004. Living with Risk. <http://www.unis.unvienna.org/unis/pressrels/2004/unisinf23.html>

Theme A
Methodology for integrated assessment

**Session A3: Integrated assessment of ecosystem services
from agriculture**

Session organizers:

Floor Brouwer

LEI, Wageningen UR, The Netherlands

George Hutchinson

Queen's University Belfast, Northern Ireland

Environmental services delivered and deliverable by land managers

Allan Buckwell
Country Land and Business Association,
16 Belgrave Square, London SW1X 8PQ, UK
Contact: allan.buckwell@cla.org.uk

Introduction

In the last decade there has been a widening appreciation of the breadth, components and scale of market failures surrounding the major land management activities of farming, forestry and certain recreational activities. This has been accompanied by an acknowledgement that these market failures open a space for public policy action (Braat & Ten Brink, 2008). However, there are at least four dimensions of difficulty in turning this appreciation and acknowledgement into operational policy frameworks in the EU. These are, the motives and objectives of land managers as well as the agricultural policy framework within which they operate; the different levels of economic development and attitudes to environment across the EU; the complexity caused by the interaction of positive and negative externalities; and the lack of agreed conceptual framework for dealing with these issues. The proposition underlying the paper is that there is a wide gulf between the rhetoric of EU agricultural policy reform, viz. to move from Pillar 1 to Pillar 2, and the reality.

Methods

This paper will proceed by observation and argumentation rather than following formal economic or other analytical methods. It will tease out and justify the four difficulties listed.

Private sector farmers, foresters and game managers see themselves predominantly concerned with a market-based economic activity. A minority, but growing proportion of them, have appreciated the non-market aspects of their primary activity and in varying ways have found ways to integrate this in what and how they produce. Meanwhile policy over many decades has overtly reinforced farmers' view in focusing single-mindedly on their primary role. This adds to the scale of the task of reversing policy from focusing on the market to the non-market outputs.

A critical element of the EU policy mix in finding a way through this policy maze is the very different historical, political and economic backgrounds of the Member States, and the scale of the environmental challenges they face. Some summary indicators of the development status and the environmental indicators of the Member States will be examined to see if there are predictable clusters of potential attitudes towards moving policy focus from market to non-market objectives.

In addition to these political-economy considerations, there are genuinely difficult technical and biological aspects of the environmental services and disservices rendered by land managers. Farmers and foresters as well as creating and maintaining semi-natural habitats, ecosystems and cultural landscapes which are now treasured, also degrade the environment, reducing biodiversity, pollution soil, water and atmosphere. The production functions of these environmental goods and bads are complex, interactive and dynamic. Drawing the line between good and bad and devising the most cost effective ways of incentivizing the good and disincentivizing the bads turns out to be extraordinarily difficult. It is not clear which is the greater problem conceptual or empirical?

What is the most fruitful framework for pulling these considerations together? The implicit conceptual model which underpins current EU agricultural/agri-environmental/rural policy is a (now largely discredited) market model to which some environmental bells and whistles has been bolted. What would be a better model? Two will be examined: the environmental accounts approach (Defra, 2008); and the ecosystem services approach (Constanza *et al.*,

1997; Defra, 2007; EC, 2008). The hope is that this presentation will stimulate suggestions of other or better approaches.

Discussion

This is not the kind of paper from which to expect concrete research results. The discussion will put these ideas into the context of the real political choices the EU faces in the coming two years. The Union is currently drifting. It has failed to agree a Constitution, its latest Treaty is in abeyance; and it has agreed to review in 2009 all its major policies and the size and purpose of its budget, yet this review seems not to have stimulated a genuine debate about the purpose and scope of EU policy. The to the extent that 'the protection and management of natural resources' is thought by academics, by environmental NGOs and by land managers to be an important part of EU activity, then producing research findings to reflect on the scale and nature of the policies to do this is a worthwhile activity.

References

- Braat, L. & P. Ten Brink, 2008. The cost of policy inaction: The case of not meeting the 2010 biodiversity target. European Commission DG Environment study OJ Ref 2007/S95 – 116033, Wageningen/Brussels.
- Constanza, R., *et al.*, 1997. *Nature* 387 (15 May 1997): 253-260.
- Defra, 2007. An Introductory guide to valuing ecosystem services. London.
- Defra, 2008. Environmental Accounts for Agriculture, Final Report, conducted by Jacobs, with Scottish Agricultural College and Cranfield University, SFS0601, London.
- EC, 2008. The economics of ecosystems and biodiversity. An interim report, compiled by Pavan Sukhdev *et al.*, European Communities, Brussels.

Restoration of abandoned agricultural lands toward umbrella species habitats¹

M. Arriaza, O. Nekhay, M.J. López-Baldovín
Centro IFAPA 'Alameda del Obispo', Apartado 3092, Córdoba, Spain
Contact: manuel.arriaza@juntadeandalucia.es

Introduction

The present study analyses the suitability of agricultural lands with risk of abandonment to be restored to suitable habitats for endangered species. As a case study, we focus on the olive plantations of mountain areas of Southern Spain and the Iberian lynx. The methodology weighs experts' judgements about the effects of the landscape elements on this habitat *via* the Analytic Hierarchy Process (AHP) and spots the most suitable areas for restoration through the Geographical Information Systems (GIS).

The main interest of the study relies on the potentiality of the methodology to combine complex territorial analysis with the biological requirements of endangered species to facilitate their dispersal.

Methods

The methodology involves three phases: First, an inventory of Iberian lynx habitat requirements is drawn up. Then, the AHP method is implemented based on the experts' knowledge. Finally, the Geographical Information Systems technology is used to assess the potential of the study area for Iberian lynx's habitat restoration.

Selection of landscape elements related to Iberian lynx habitat requirements

The main causes that have brought the Iberian lynx to the border of extinction are habitat alterations and removal, the fall in the number of rabbits (the main lynx's prey), human activity, such as illegal hunting and traps (Gaona *et al.*, 1998; Delibes *et al.*, 2000).

Analytic Hierarchy Process multi-criteria decision-making technique

There are two specific characteristics that distinguish this method (Saaty, 1980) from the other multi-criteria methods of this family: (a) the construction of the hierarchy structure of the problem to be solved, and (b) the pair-wise comparisons made between different criteria to weigh them with respect to the overall objective.

GIS-aided analysis

The GIS software used as a platform for the representation, management and analysis of the spatial information was ArcGIS 9.1 and ILWIS 3.4 (Integrated Land and Water Information System). The operations of spatial multi-criteria evaluation was carried out in ILWIS 3.4. SMCE module. The input data were: land use map (1999; 1:50,000); aerial monochrome orthophotos (2001–2002; 1:5000) and colour orthophotos (2005; 1:10,000); olive plantations productivity maps (2004; 1:25,000); road infrastructure map (1999; 1:25,000).

Results and discussion

According to the results, the most important landscape objects are the natural vegetation structures (32%), followed by the proximity to asphalted roads (28%), the proximity to the Natural Park (18%) and the proximity to watercourses (14%). Olive groves with vegetation cover obtained the lowest weight (8%).

¹ This research has been financed by INIA through the research project RTA04-086.

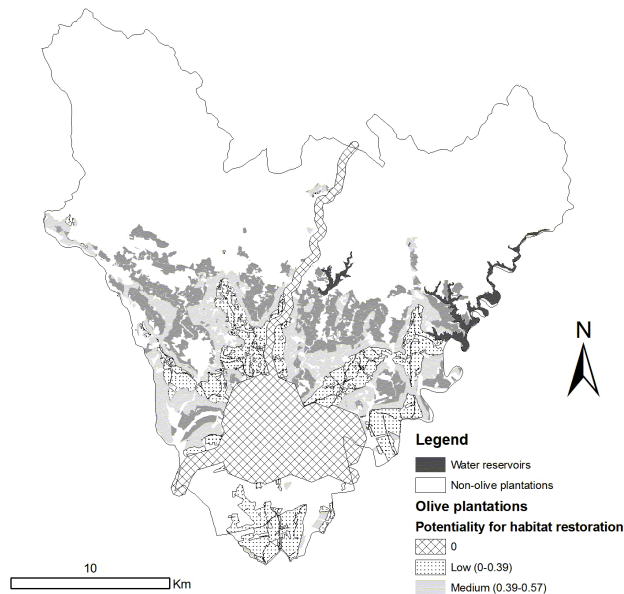

Figure 1. Evaluation of Iberian lynx habitat restoration potential.

The red spot in the centre represents the urban area and it is regarded as a constraint (non-compensatory criteria). The red lines that pass through the map represent two motorways that have high levels of traffic. The maximum suitability value recorded in the study area was 0.92, the minimum was 0 and mean value was 0.46 (in a 0–1 scale). The green colour represents the areas suitable to implement the restoration measures. All situated on the North of the motorway A-IV. Since the divergences in the opinions of the experts raise a good deal of uncertainty about the reliability of the result, we decided to perform a sensitivity analysis of the results.

It is interesting to report some similarities between the results obtained in this study and those provided by Van der Horst & Gimona (2005), which used multi-criteria spatial analysis to determine the most suitable territories in agricultural areas for the implementation of action plans to promote biodiversity. Unlike the present study, these authors combine the requirements of 15 species as map layers, weighted according to the importance of each species. However, the results of both studies emphasize the importance of the edge zones of major agricultural areas, the riparian zones (in our case the natural vegetation) and areas adjacent to nature pinewoods (in our case Mediterranean forest and shrub lands) as having the highest potential for biodiversity.

References

- Delibes, M., *et al.*, 2000. *Nature Environ.* 111: 1-45.
 Gaona P., *et al.*, 1998. *Ecol. Monog.* 68: 349-370.
 Saaty, T.L., 1980. *The analytic hierarchy process: Planning, priority setting, resource allocation.* McGraw-Hill, NY.
 Van der Horst, D. & A. Gimona, 2005. *Biol. Conserv.* 123: 421-432.

Examining the degree of jointness between food and cultural landscape production

David Blandford, Ivar Gaasland, Erling Vårdal
The Pennsylvania State University,
University Park, PA, USA
Contact: dblandford@psu.edu

Introduction

The main purpose of agriculture is to produce private goods. However, it is well recognized that agricultural activity renders public goods (cultural landscape) as a by-product, i.e. these goods are produced jointly (Boisvert, 2001). The degree of jointness is an open question. Some have assumed that jointness takes the form of a one to one relationship, e.g., Prestegaard (2004), others that supply can be completely decoupled. In between these extremes, different degrees of jointness seem probable, i.e., there should be some possibility for choosing production techniques that are more geared towards the supply of cultural landscape than others.

Methods

In this paper, the issue of jointness between food production and cultural landscape is examined. For the sake of clarity, we set up a model with two representative agricultural sectors, one for pure plant production (e.g., grain) and one based on animals (e.g., milk production). Each production sector has a corresponding function for the supply of cultural landscape. Both the private good and the corresponding cultural landscape is a function of value added to land, but factor shares in the value added aggregate differ substantially. For example, a high capital-labor share yields high production levels, but a low cultural landscape value.

On the demand side, we assume that cultural landscape is a multi-dimensional good, represented by a utility function where cultural landscape from the two agricultural sectors enters as arguments. Preferences for variety and the assumption of decreasing marginal willingness to pay for each landscape type are reflected in the substitution elasticity attached to this function. Two regions are also included in the model (rural and suburban), allowing for regional differences in the valuation of landscape. Also, the endowment of land and productivity for the two agricultural products varies between the two regions.

The model is of a partial equilibrium type, where economic surplus is maximized. On the supply (of private commodities) side, the two production processes in each region cover a substantial part of the activity in the Norwegian agriculture sector. The assumption of two regions is also realistic, since the current agricultural production is divided (appr.) evenly between suburban and urban areas.

The model is implemented using actual numbers from the Norwegian economy. Information on the various production processes are taken from official sources, see NILF (2008). The demand functions of the private goods are based on available demand studies. As for willingness to pay estimates, they will be based on estimates found in the literature, see Drake (1992) and Lopez (1994).

Results

The model is used to demonstrate the importance of technology when assessing a shift in agricultural policy from price support to targeted cultural landscape payments, taking into account the interplay between supply and demand for different attributes of the cultural landscape. The focus will be on the consequences of such a policy, i.e. the (expected) decline in agricultural production in the two regions. Furthermore we will focus on the expected shift

in the use of inputs, from capital intensive to land/labour intensive production. The focus will also be on where the cultural landscape is upheld, i.e. in the rural versus suburban areas.

References

- Boisvert, R., 2001. Joint production in four outputs: Two commodities and positive and negative externalities. In: Multifunctionality: Toward an analytical framework. Annex 2, OECD, Paris.
- Drake, L., 1992. European Review of Agricultural Economics 19(3): 351-364.
- Lopez, R.A., *et al.*, 1994. Land Economics 70(1): 53-62.
- NILF (Norwegian Agricultural Research Institute), 2008. Budsjettnemda for jordbruket: Jordbrukets totalregnskap, 1959-2007. Oslo.
- Prestegaard, S.S., 2004. Acta Agriculturae Scandinavica, Section C, Food Economics 1: 151-162.

The monetary value of combining ecosystem-services in private artificial wetlands¹

Arianne De Blaeij, Vincent Linderhof, Nico Polman
LEI-WUR, Public Issues Division, P.O. Box 29703,
2502 LS The Hague, The Netherlands
Contact: Arianne.deBlaeij@wur.nl

Introduction

Multi-functional land use and the creation of multiple values in rural areas are creating new challenges and posing new questions (see also Jongeneel *et al.*, 2008). An artificial wetland is an example of multi-functional land-use, as it combines at least five different ecosystem services. The main two reasons for investigating options for creating artificial wetlands in the Netherlands are the water treatment function of surface water in the form of a reed filter, and the accompanying biomass production. Additional functions are water storage, the improvement of biodiversity in the surrounding area by solving the dry-out problems and recreation².

Currently, most of the functions supplied by an artificial wetland are public goods without any market value. Therefore, managing privately owned wetland areas in a multi-functional way raises the questions whether the public see a role for farmers (landowners) to provide multi-functional wetland. More in detail, how society values the benefits of these wetlands. In this paper, we analyse how citizens of the Netherlands value private artificial wetlands. In particular, we estimate the monetary value of the complete concept of artificial wetlands with the Contingent Valuation Method (CVM). Additionally, we value the different functions separately with the Analytical Hierarchical Process method (AHP).

A private multi-functional artificial wetland

Multi-functionality in artificial wetland management is directly, although not exclusively, linked to the different functions wetlands can fulfil. Wetlands are optimally allocated if they fulfil the mixture of functions demanded by society. These demands are not constant, but are influenced by many factors, including changes in income level and population density, productivity-induced changes in relative price, etc (see also Jongeneel *et al.*, 2008).

According to the Water Frameworks Directive (WFD), the government is responsible for achieving a good quality status of surface water. Wetlands, whether or not privately owned, provide next to better water quality, extra water-services to society. The social demand for private wetlands depends on alternative options to reach objectives derived from national and international water policies.

Next to this, other policy domains can play a role as well, an example is the aim to realize lively rural areas. According to European law, it is only allowed to pay for non-statutory services. Whether a farmer or landowner invests in an artificial wetland depends on the possibilities of receiving payments for the services delivered. Paying for the non-market services is an extra source of income next to the future income earned with biomass production (reed is an agricultural crop).

¹ The valuation exercise presented here is part of a technical and economic research project called Waterpark 'het Lankheet'. The technical research is carried out in wetland 'het Lankheet' which is located in the eastern part of The Netherlands. (Meerburg *et al.*, 2008).

² As ecosystem services are defined as "the capacity of natural processes and components to provide goods and services that satisfy human needs" (De Groot *et al.*, 2002), recreation can be seen as an ecosystem function as well.

Valuation method

To determine the value of private artificial wetlands in The Netherlands, we use the Contingent Valuation Method. Separately valuing the wetland-functions through individual CV exercises could lead to seriously biased estimations, due to series of biases. With the Analytical Hierarchical Process (AHP) we are able to decompose the aggregated value of the artificial wetland into values of its different functions. The AHP method uses a series of pair wise comparisons between the different the artificial wetland functions to assess the relative importance of each criterion. We will elicit weights for each of the functions. The cognitive burden of respondents are reduced because AHP always uses two clear functions comparisons (Kallas *et al.*, 2007; Moran *et al.*, 2007).

Next to socio-demographic variables, there will be taken into account a number of aspects such as individuals' perceptions with respect to the natural environment, the fact that individuals recreate in agricultural areas, and the fact that individuals will recreate in private artificial wetlands.

Results and discussion

In The Netherlands, the administrative responsibility of the wetland functions is distributed over different governmental levels. As an example; the local and regional government (provinces and municipalities) are responsible for nature-conservation, the national government for biomass-energy objectives and water boards for water quality (Water Framework Directive¹) and water quantity issues. For policy design it is relevant to know how citizens value artificial wetlands and its different functions in order to be able to extend or stimulate the implementation of artificial wetlands in The Netherlands.

References

- De Groot, R.S., *et al.*, 2002. *Ecological Economics* 41: 393-408.
- Jongeneel, R.A., *et al.*, 2008. *Land Use Policy* 25: 81-94.
- Kallas, Z., *et al.*, 2007. *Journal of Agricultural Economics* 58(2): 218-241.
- Meerburg, B.G., *et al.*, 2008. Surface water sanitation and biomass production in a constructed wetland: Pilot Lankheet. Submitted to *Ecological Engineering*.
- Moran, D., *et al.*, 2007. *Ecological Economics* 63: 42-53.

¹ Water Framework Directive 2000/60/EC of the European Parliament and of the Council of 23 October 2000 establishing a framework for Community action in the field of water policy.

Reconfiguration of ecosystem services in agricultural landscapes: Mitigation and policy concerns for renewable energy development

S.S. Dhillion

ENVIRO-DEV, nordstu olsberg, 2510 Tyllidalen, Norway

Contact: dhillion@online.no

Introduction

The interactions of agriculture and the environment can be woven in the concept of agriculture as a sustaining, producing and consuming ecosystem services. Agricultural landscapes and agriculture provide ecosystem services in the form of food and non-food services and public goods. In developed nations the main non-food services include maintaining a healthy environment (air and water), a buffer for climate irregularities, food security and livelihoods. In developing nations the definition of an agricultural landscape has many dimensions ranging from large areas dominated by agriculture to those which have agriculture intimately defused with semi-forest like areas. The latter make up a common feature in many remote agricultural rural areas of the developing world. Ecosystem services from these agricultural and agro-forest landscapes bring additional services to light, e.g., health security, cultural refuges and cosmological arenas, and a continued supply of food propagules and land, and more recently encompass carbon sequestration. Development processes (through international or national projects/aid) continuously bring new dimensions to these rural areas – and some can be said to increase the number of facets in agricultural practices and thus even the multi-functionality of land aimed at poverty alleviation. Often the changes which occur with rural development are gradual and imbibed by rural communities for better or worse. However changes with development which make create large changes are those directly linked with the renewable energy project, e.g., the construction of hydropower dams. This paper is on understanding how agriculture landscapes and associated services can alter with hydropower projects and how mitigation proposals may be facilitated or hindered by national/international regulations and conventions. A central focus in on the reconfiguration of services and goods in the altered and new agricultural landscapes associated with hydropower projects. Both national and transboundary case studies will be presented.

Methods

Literature reviews, reports and interviews were used to study the issues mentioned. The author has been personally involved in environmental and social assessments of hydropower projects in Vietnam, Cambodia and Chile and, thus, draws on first hand knowledge (see references).

Results

In Vietnam and Cambodia the hydropower projects and planning spans over two large rivers (the Se San and Srepok) which are the lifeline of local communities. Land use is diverse and traditional practices prevail. Here the hydropower projects alter significantly the agricultural landscape and thus the ecosystem services. Hydropower operators, the governments of Vietnam and Cambodia have come up with various mitigation and development options in the past and at present. Legislation is not in place to link hydropower development with land use and thus changes in agricultural landscapes. The poorest of the downstream inhabitants loose traditional forms of river bank agriculture and divert to deforestation for agricultural activities.

In similar lines in the case of Chile where cascades of hydropower projects are being planned in low populated, grazing dominated agriculture and natural areas ecosystem services

in relations to agriculture take a different form, with extensive agriculture is the only form. The reconfiguration of services and goods render changes in livelihoods. In the case of the Philippines the mitigation and reorganization of agriculture has had positive response from a variety of sectors and a wide range of stakeholders. The responses are in part due to the increase in the multi-functionality of land use, and increase in services.

Conclusions

In all the above cases policy and the lack of regulations are a deciding factor for the final reconfiguration of the agriculture. Poverty alleviation or livelihood restoration may occur for the key affected population but at large the long term consequences are turbid at best. How ecosystems are maintained, altered and reconfigured in light of existing policy will be discussed.

References

- Integrated Impact Assessment of the Aysen Hydropower Project. Chile. Draft 2008. By SWECO Norway
- Rapid Environmental Impact Assessment on the Cambodian part of the Srepok River due to Hydropower Development in Vietnam. 2007. Submitted by SWECO Grøner, ENVIRO-DEV, NIVA.
- Rapid Environmental Impact Assessment on the Cambodian part of the Se San River due to Hydropower Development in Vietnam. 2007. Submitted by SWECO Grøner, ENVIRO-DEV, NIVA.
- Summary Environmental Impact Assessment (SEIA) – Main Report. July 2006. Song Bung 4 Hydropower Project, TA No. 4625-VIE, Vietnam. (Final GoV's Report). www.adb.org

**‘Green services’:
Bridging the gap between consumers and producers of landscape in
The Netherlands?**

G.H.P. Dirkx

Wageningen-UR, PO-Box 47, 6700 AA Wageningen, The Netherlands

Contact: joep.dirkx@wur.nl

Introduction

The Dutch landscape is in essence an agricultural landscape. It has developed as the result of agricultural land use systems that were in practice until the 19th century. These landscapes are nowadays highly valued by the general public. With that, the meaning of the landscape has undergone a shift from a mono-functional agricultural territory to a multi-functional environment that is considered to provide a wide scope of ‘products’, varying from food to attractive landscapes.

Agriculture has, however, changed. Attractive landscapes are not any longer the obvious non-commodity output of agriculture. Modern agriculture may even be threatening valued landscape features, such as field patterns or wooded banks, as they are impeding the modernization of agriculture. Farmers are nevertheless still the producers of landscape quality. The societal demand for attractive landscapes is not necessarily in their interest, as there is no market for attractive landscapes. Farmers that are investing in attractive landscapes, do not get a better price for milk or other farm products.

With the concept of *green services* the Dutch government aims to provide an alternative for a market for attractive landscapes. Green services are services provided by farmers that go beyond normal farm practice. Maintenance of landscape elements is an example. With the EU approval, in February 2007, of a *Catalogue* describing services to be delivered and the height of the allowances for these services, payment for green services has been brought in accordance to the EU State Aid regulations. With this catalogue being approved, the concept of green services can be brought into practice.

The paper analyses the first practical experiences with ‘green services’ in order to explore the possibilities for involving agriculture in providing ecosystem services. Some policy options will be given.

Methods

The first step in the analyses was to obtain an overview of the degree to which ‘green services’ are actually being supplied. Information was provided by the Dutch counties. The next step was to interview stakeholders involved in setting up green services. They have been asked about the pro and cons of working with the Catalogue, about the interest in supplying green services, the kind of green services being supplied and the height of the allowances. Stakeholders have also been asked about the willingness to reserve public or private funds to be able to pay farmers for the services provided.

Results and discussion

Although there is a lot of interest in the concept of green services, green services are hardly being brought in practice. Only two of the 12 Dutch counties have decided on policy instruments on green services. In one county policy instruments are being prepared. In these three counties funds have been reserved for greens services. In the other nine counties there is in general no readiness to reserve funds.

The counties that have made funds available, require 50% co-financing when contracts for green services are being agreed upon. In most cases municipalities are the parties that are providing the required co-financing. Therefore, within the counties with a green services

policy instrument, only in municipalities that are prepared to co-finance green services, green services can be supplied. In general there are no private parties willing to co-finance green services. The possibilities to have investments in landscape quality financed by private parties, turn out to be limited.

In the two counties where there are regulations, farmers are willing to supply green services. The allowances are considered to be reasonable. The supply of green services turns out to be exceeding the possibilities within the available funds. Making more funds available, might help to increase the amount of ecosystems services supplied by agriculture.

Green services are meant to provide a supplement to the environmental stewardship schemes that are only available in designated areas that are considered to be of national importance. Green services enable farmers to supply ecosystem services in the other parts of the country, the often called white areas. However, the reticence of counties and municipalities to fund green services, causes the largest part of the Netherlands to remain a 'white' area in terms of ecosystem services.

There are fundamental differences in the way demand and supply are being brought together. In one county, contracts are based on a landscape plan describing the kind of services that are required in an area. Contracts are being composed out of fixed packets of green services with fixed allowances. In the other county people in the area negotiate with farmers about the kind of services to be delivered by the farmer and the allowance he will receive for these services. In the latter county, demand and supply are indeed ruling the agreements on green services.

Quantification of the relationship between changes in farming and changes in biological diversity: The Atlantic case

B.S. Elbersen, R.G.H. Bunce, A. Van Doorn
Alterra, Wageningen-UR,
P.O. Box, 6700 AA Wageningen, The Netherlands
Contact: Berien.elbersen@wur.nl

Introduction

The first stage of the paper is allocated to a providing the historical background to changes in agricultural practices in Atlantic Europe and their links with biodiversity. It is widely recognized that the intensification of agriculture due to support for increased production has led to a decline in biodiversity and this trend has been quantified in the UK Countryside Survey (CS). Relevant results from this survey are then presented. Elsewhere in Europe disparate studies have shown the same pattern which is linked to globalization and technology transfer (Petit *et al.*, 2001). The driving forces and processes behind such changes are then summarized.

Data from a stratified random series of sites from southern Britain are then used to establish relationships between changes in agricultural practices and changes in biodiversity. Whilst the major losses of biodiversity have been on agricultural land there have been parallel losses because of declining management both on unfarmed features on farms but also in woodlands and roadsides.

Finally the review is used to develop a model of future likely trends in biodiversity linked to changes in farming based on the analyses of past patterns.

Methods

For this study we use the field survey data from a selection of agricultural CS plots (which are allocated within the selected 1 km squares) collected in three survey years (1978, 1984, 1990). With this information the relationship between changes in farming and biodiversity can then be further underpinned and it can be determined whether these relationships can be quantified and made specific for certain types of farming. The identified relationships derived from the CS results are then translated in general relationships which can be used for future predictions in biodiversity change in response to changes in farming, modelled in the bio-economic farm model FSSIM, part of SEAMLESS (Van Ittersum *et al.*, 2008). For this study these general relationships can only be applied to the Atlantic environmental zone as this is well covered with the CS data.

Results and discussion

As widely reported in CS, biodiversity in intensively farmed lowland landscapes is now largely restricted to linear features and small patches. The decline in biodiversity is greatest in the farmed fields but is also taking place in the unfarmed categories partly because of the indirect effect of eutrophication from agricultural practices but also because of independent ecological processes such as canopy closure in woodlands. This statistical exercise shows that there are real differences between the farmed/unfarmed classes and that they are changing in biodiversity at different rates.

As to the future it is expected that whilst the intensification scenarios are all deleterious the impact is much greater in infertile grassland because of the high initial capital (Robinson & Sutherland, 2002). Extensification has some benefits although they are likely to be limited because of the inherent resistance to change in highly fertile systems (Hopkins *et al.*, 2000). The most important influence is that the loss of species in infertile grassland may stabilize. By contrast abandonment will have major benefits to cropland and fertile grassland but will be

strongly negative in infertile grassland because in these systems the high resources of biodiversity are dependent on traditional farm management.

References

- Hopkins, A., *et al.*, 2000. *Journal of the Royal Agricultural Society of England* 161: 210-223.
Petit, S., *et al.*, 2001. *Ambio* 30: 81-88.
Robinson, R.A. & W. J. Sutherland, 2002. *Journal of Applied Ecology* 39: 157-176.
Van Ittersum, M.K., *et al.*, 2008. *Agricultural Systems* 96: 150-165.

Integrated assessment of multi-functionality of irrigated agriculture: An application for the Mediterranean regions

G. Giannoccaro, M. Prosperi, J. Berbel
ETSIAM – University of Córdoba,
Dpt. Agricultural Economics, Sociology and y Policy,
Universidad de Córdoba, Campus de Rabanales Edificio C5, 14014 - Spain
Contact: es2gigig@uco.es

Introduction

Multi-functionality refers to the numerous benefits that agricultural systems may provide for a region. Besides producing food and fiber, agriculture may also provide jobs for rural people and contribute to the viability of the area, create a more stable food supply, and provide other desired (and undesired) environmental and rural outputs. The multi-functionality refers to comprehensive agricultural systems where irrigated areas cannot be excluded.

The vast majority of studies regarding agricultural multi-functionality have focused on the supply (or producer) side (OECD, 2001a). They analyse issues such as the joint production of agricultural outputs, market failures or options for ensuring the provision of public goods and services from multi-functional agriculture. However, it is surprising to note that the multi-functionality debate has rarely stopped to consider the demand (or consumer) side by analysing individual preferences for private and public goods and services, as well as individuals' opinions on the performance of agriculture within this multi-functional framework.

Methods

Within this context, in the present research it is proposed an integrated assessment of multi-functionality of irrigated agriculture taking into account simultaneously the two points of view. On the supply side, the role in terms of multi-functionality of irrigated agriculture will be assessed. On the demand (or consumer) side, it will be considered the individual preferences, as well as individual opinions on the performance of irrigated agriculture.

For these purposes, firstly the indicator-based assessment will be used in order to estimate the functions provided by irrigated systems (see Table 1). Up to four different service classes will be identified, namely: Food production (concern on quantity); Contribution to economy; Employment generation; Environmental protection. Essentially, the definition and calculation of the indicators will be redacted from OECD book (see OECD, 2001b).

Moreover, by comparing the rainfall to irrigated systems it will assess the relative role that water in term of multi-functionality takes. It will implement the new course of the CAP based on the decoupled payments and cross-compliance constrains.

Secondly, we will try to establish social utility function that should be maximized using policy instruments. In this regards, it will be implemented the joint valuation of private and public goods and services from irrigated agriculture.

Results

The empirical application will be referred to Spanish (Guadalquivir basins), and Italian (Irrigated Board of Capitanata) regions where the irrigation is a very hard issue for the achievement of adequate farm income. The first results confirm on the supply side the important socio-economic role played by the irrigated systems in the Mediterranean areas. However, the major environmental challenge of irrigated agriculture is to achieve a trade-off between socioeconomic impacts and environmental sustainability. In this regards the new policy regulation, such as uncoupled payment subsidies and the environmental restrictions (e.g., pesticide's prohibition), may be improve the environmental impact. From demand side

the analysis points out the factors that affect individuals' opinions on different services of multi-functionality of irrigated systems. Basically the results reflect the role that the irrigated systems play at local level. Consequently aspects such as place of residence and demographic and socio-economic characteristics can significantly influence peoples' opinions.

This research aims to contribute on the assessment of agricultural multi-functionality through quantitative methods focusing on the irrigated systems. On the whole, the evaluation of multi-functionality of irrigated agriculture both on the supply and demand side can help policy-makers for the design and implementation of agricultural policies. In this sense, the results will enable in policy decision making so as to optimize the multi-functional services of irrigated systems according to the social preferences.

Table 1. Multi-functionality assessment of irrigated agriculture with respect to rain fed.

SERVICE CLASS	INDICATOR	increase	=	decrease
Food production	Food production (quantity)	x		
Contribution to economy	Gross Margin	x		
	Public support GDP	x		x
Employment generation	Employment	x		
Environmental protection	Soil cover	x	x	
	Biodiversity index		x	x
	Landscape maintenance		x	x
	Water use			x
	Nitrogen balance			x
	Pesticides risk			x
	Energy balance	x	x	

References

- OECD, 2001a. Multifunctionality: Towards an analytical framework. OECD, Paris.
 OECD, 2001b. Environmental Indicators for Agriculture, Volume 3 - Methods and Results. OECD, Paris.

**Land Use Functions:
An approach for integrated assessment of the goods and services provided
by agriculture in a multi-functional and sustainable context**

M. Pérez-Soba, M.L.M. Jones, C. Pacini, M.L. Paracchini
Alterra, WUR, P.O. Box 47, 6700 AA Wageningen, The Netherlands
Contact: Marta.perezsoba@wur.nl

Introduction

The traditional role that agriculture plays in the European rural areas has evolved from the traditional, mono-functional production of goods (food and fiber), to a multi-functional provision of goods and services (landscape identity, cultural heritage, provision of habitat, etc.). The impact that this new role of agriculture might have on sustainability of regions is largely unquantified. There is, therefore, a need for approaches that help to identify the multiple functions of agricultural systems and assess their interrelations with the other land uses co-existing in the rural areas. These approaches should integrate the goods and services provided by agriculture in a multi-functional context, through a true integration of the economic, environmental and societal issues (three dimensions of sustainability) at a meaningful spatial scale considering the territorial perspective.

The integration of economic, environmental and social issues demands complex systems of thinking based on multi-scale integrated analysis and not a collection of independent analyses, each based on a defined discipline. In addition, the assessment has to be performed at the appropriate spatial scale. For example, the environmental services provided by the agricultural activities may vary among countries and regions depending on their agricultural systems and social demand. Therefore, there is a need for flexible approaches that allow the assessment to be performed at the appropriate regional scale. Finally, it is deemed vital to consider stakeholder preferences when linking multi-functionality to the sustainability concept.

In conclusion there is a need for an approach that (i) defines and measures the economic, environmental and social goods and services – functions – provided by the multiple use of agricultural land at territorial level, and (ii) helps to identify the sustainability limits/thresholds/targets of these functions. An interdisciplinary team has addressed this need by developing an innovative approach, the Land Use Functions (LUFs), which (i) link directly the economic, environmental and social functions to the use of the land; (ii) provide a flexible method to assess at the appropriate spatial resolution; and (iii) transparently address the identification of the different functions that a specific land use (in this case agriculture) might have, facilitating the explicit analysis of their trade-offs. This paper describes the conceptual LUFs framework and highlights the advantages of its use.

Land Use Functions: the good and services attached to the land use

The LUF approach has its main roots in the concepts of multi-functionality in agriculture (OECD, 2001), ecosystems goods and services (Costanza *et al.*, 1997), and landscape functions (Kienast *et al.*, 2007). Land Use Functions are defined as the private and public goods and services provided by the different land uses, that summarize the most relevant economic, environmental and societal aspects of a region. For example, agricultural land use might have several functions, such as provision of employment or landscape identity (social), provision of food, timber or biofuels (economical), support for biodiversity and maintenance of ecosystem processes (environmental). The LUFs allow for a cross-sectoral assessment since they consider the main sectors involved in land use, i.e. agriculture, forestry, energy, tourism and nature conservation. The LUFs aggregation method is built to be applied on a Europe-wide indicator framework consisting of a large set of indicators, selected to represent

key impact issues of sustainability of land use, as listed in the EC Impact Assessment Guidelines (CEC, 2005). These impact indicators cover a wide variety of land uses across the three dimensions of sustainability. At a higher level, there are Land Use Functions (LUFs) (Pérez-Soba *et al.*, 2008) which aggregate indicator types loosely into a multi-dimensional space, which is linked to the three dimensions of sustainability. Each sustainability dimension is represented by three LUFs: Economic (Residential and Industrial Services, Land-based Production, Infrastructure), Environmental (Abiotic Resources, Provision of Habitat, Ecosystem Processes) and Social (Work, Health and Recreation, Culture), giving nine Land Use Functions in all. The LUF framework reduces the number of dimensions represented by the set of impact indicators to make sustainability impact assessment interpretable. The concept of sustainability is recognized at two principal scales – at the level of individual indicators for which specific sustainability limits are defined, and at the level of Land Use Functions where an optimum sustainability with respect to multi-functional land use is arrived at by an end-user through evaluation of competing LUFs within the ‘trade-off evaluation space’. The indicator sustainability limits are independent of the wider LUF evaluation process, but may be subject to change given future knowledge, or when investigated within the context of local-scale participatory approaches.

The advantages of using Land Use Functions

LUFs are a new tool for assessing the good and services provided by land use, such as agriculture, in a multi-functional and sustainable context. They simplify complex assessments based on a large set of indicators by grouping them into nine LUFs that cover the main functions of the land. It, therefore, makes possible for policymakers, stakeholders and scientists to identify at a glance those functions of the land that are hindered and those functions that are enhanced by a change in the land use, e.g., policy option (Figure 1).

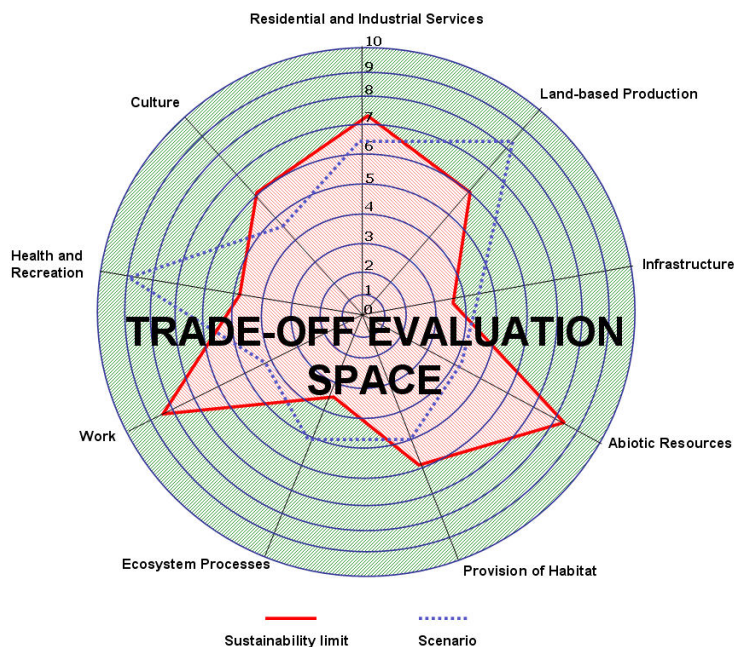

Figure 1. The impacts are summarized in changes in the nine LUFs, represented in the spider diagram.

References

- CEC, 2005. SEC 791.
 Costanza, R., *et al.*, 1997. Nature 387: 253-260.
 Kienast, F., *et al.*, 2007. Internal SENSOR deliverable. OECD, 2001. Paris.
 OECD, 2001. Multifunctionality: Towards an analytical framework. OECD, Paris.
 Pérez-Soba, M., *et al.*, 2008. In: Eds. K. Helming, *et al.*, Sustainability impact assessment of land use changes. Springer Verlag, pp. 375-404.

How do policy options modify landscape amenities? An assessment approach based on public expressed preferences

T. Pinto-Correia, S. Truchet, C. Machado, F. Barroso, P. Picchi, Y. Michelin,
N. Turpin, J.P. Bousset

ICAM-Group on Mediterranean Ecosystems and Landscapes, University of Évora,
Colégio da Mitra, 7000 Évora, Portugal

Contact: mtpc@uevora.pt

Introduction

‘Landscape’ means an area, as perceived by people, whose character is the result of the action and interaction of natural and/or human factors (European Landscape Convention, 2000). The definition is clear and nowadays well accepted. Trickier is to progress in the sense of identifying landscape quality objectives, which should depend on the public demand of these landscapes, i.e. their cultural and amenity values. New EU policies focusing on the development of Europe’s rural areas, including its broad variation of landscapes, and specially the New European Model of Agriculture, which stresses the territorial role of agriculture, increase the need to better understand how these different landscapes are valued by people, and how farming may contribute to so-called landscape quality. Indeed, people do value landscape patterns, elements, and their combinations (Dramstad *et al.*, 2006). They are also able to express their preferences for certain landscape patterns, but there are still challenges to assess these preferences taking care of the diversity and complexity of the landscape (Al-Kodmany, 1999), and to combine these preferences with the increasing number of models assessing how policy options can modify the chain “on-farm modifications → agricultural land use changes → landscape pattern → adequacy to people needs and expectations”. And reversely, how human expectations can be considered in the design of specific policy options can be coordinated with each other. This paper describes a landscape amenities evaluation tool that aims at filling this gap. This tool is based on the identification of an optimum range of landscape composition, defined through a survey assessment to user groups or expert panels, and its relation, through selected indicators, to the landscape composition resulting from different scenarios.

Methods

The approach focuses on human factors and follows the ‘subjective’ paradigm. Landscape visual aesthetic quality is considered to be a product of the visible features of the landscape interacting with personal cultural background of the observer. Landscape quality, for what concerns its cultural and amenity functions (De Groot & Hein, 2007), is consequently “in the eyes of the beholders”. Linking current preferences of various groups of people with future changes in the landscape lead by policy options can be made assessing the preferences for present land cover combination using photographs as visual stimuli (Fairweather & Swaffield, 2002; Lewis, 2008). We tested the index of function suitability (IFS) designed by Pinto-Correia & Picchi (2008) associated with SEAMLESS outputs (Van Ittersum *et al.*, 2008) for various policy options in two case studies, in Portugal and in France. The approach of this IFS is based on the identification of a range of optimum combinations in land cover, for the support of the various amenity functions. This optimum is then compared with the land cover combination that results from the scenarios of policy changes, in order to assess the function suitability of that combination for each specific function.

We start from a landscape taxonomy jointly built by scientist and expert panels in each region. This taxonomy is used to design landscape prototypes in each region. The prototypes are key elements to link model outputs to preferences, through the use of snapshots and photos.

Then we capture the preferences on the capability of prototypes to contribute to landscape functions (recreation, second housing, hunting, etc) from individual interviews, using snapshots and IFS. We specify changes in the landscape prototypes as policy impacts by using an interaction model between results of FSSIM simulations (pressure indicators) and landscape (environmental function & state indicators).

Results and discussion

The use of the photographs as visual stimuli has proved to demand a very well planned selection and manipulation. The photographs should show clearly what is aimed at being assessed. Similarly, the organization of the inquiries and the sampling method are important. Several tests have been developed. Results show it possible to identify the optimum range of combinations. The relation to scenarios through the indicators selected is still under progress but seems to lead to a possible assessment. Figure 1 show a test result of the IFS applied to four different case studies in Portugal. Other results will be presented in the paper.

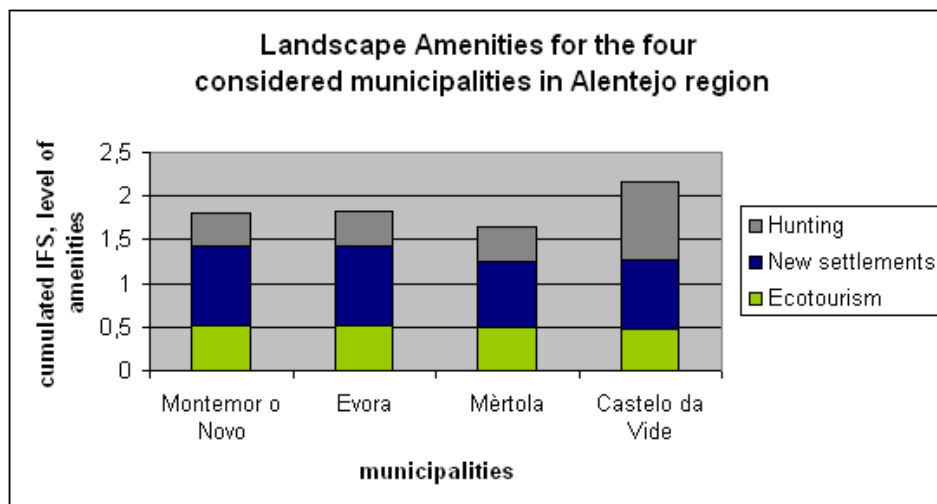

Figure 1. Landscape multi-functionality for four sample municipalities in the Alentejo region.

References

- Al-Kodmany, K., 1999. *Landscape and Urban Planning* 45: 37-45.
- De Groot, R. & L. Hein, 2007. In: Eds U. Mander, *et al.*, *Multifunctional Land Use, Meeting Future Demands for Landscapes Goods and Services*. Springer, pp. 15-36.
- Dramstad, W.E., *et al.*, 2006. *Landscape and Urban Planning* 78: 465-474.
- Fairweather, J.R. & S.R. Swaffield, 2002. *Intern. Journal of Tourism Research* 4: 283-297.
- Lewis, J.L., 2008. *Landscape and Urban Planning* 85: 45-59.
- Pinto-Correia T. & P. Picchi, 2008. *Landscape Amenities Handbook*. Appendix to SEAMLESS PD 224.
- Van Ittersum, M.K., *et al.*, 2008. *Agricultural Systems* 96: 150-165.

Regional sustainability contrasts in Brazil as indicated by the CompasSus: Compass of Sustainability

Saulo Rodrigues-Filho, Vanessa M. De Castro, Fabio Bakker, Diego Lindoso,
Nathan Debortoli, Marcel Bursztyn
University of Brasília, FUB Center for Sustainable Development - CDS,
Av. L3 Norte, Bloco. C, Campus UnB, 70904-970, Brasília-DF, Brazil
Contact: srodrigues@unb.br

Introduction

Aiming at the current need for assessing sustainable processes and states, the objective of this article is to present preliminary results obtained by applying the Compass of Sustainability (CompasSus) to administrative regions of Brazil. The methodological approach is based on both an original conceptual framework and existing assessment methodologies, such as the Barometer of Sustainability and the Ecological Footprint.

Methods

CompasSus is elaborated under the perspective of the different operational concepts of sustainable development, according to those methods. In spite of the advances on the perspective of sustainable development perceived in international agreements for conservation of nature, as well as in the implementation of national policies aiming at sustainability, there still exists an operational ambiguity of the concept of sustainability. Thus, its fuzzy theoretical consolidation for clear definition of objectives and lines of action still leads to different assumptions for diverse authors.

Results

Looking at the Brazilian case within the LUPIS EU-Project, conservation strategies are needed to protect the world's largest tropical rainforest against a predatory business-as-usual frontier expansion. On the other hand, socio-economic development is a legitimate demand of Amazonian residents (12% of Brazil's population) living in a region that occupies 58% of the Brazilian territory and produces just 7% of the country's GDP. The ecological-economic literature on weak and strong sustainability has explored some important values and

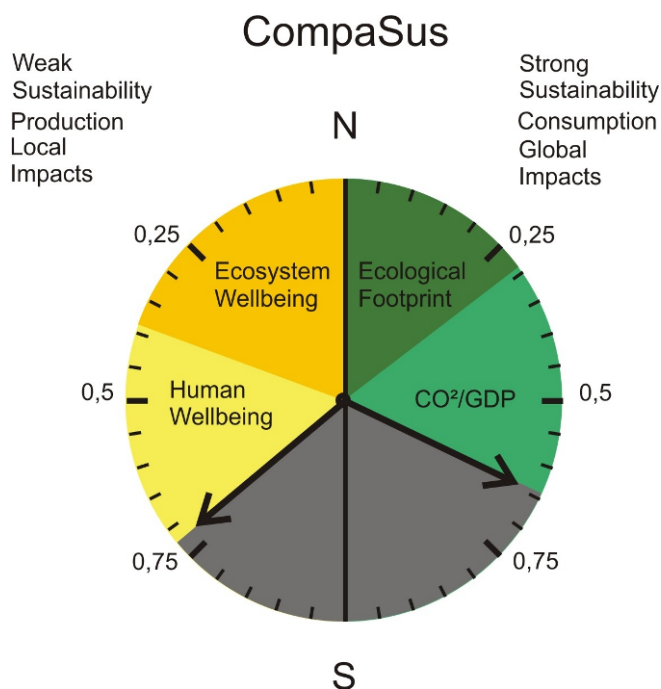

Figure 1. Illustration of the conceptual framework of CompasSus, a combination of both weak and strong sustainability approaches.

interpretations affecting a desired operational concept of sustainability. The concept of critical natural capital, for example, has a pivotal role for defining strong sustainability.

As for addressing trade-offs between environmental conservation and regional development demands the Compass of Sustainability (CompasSus) introduces a Combined Hemispheric Assessment of Sustainability (CHAS), as illustrated in Figure 1. Whereas the left hemisphere reflects a weak sustainability approach, with a focus on local/regional impacts caused by production systems, the right hemisphere mirrors a strong sustainability focused on global impacts caused by consumption patterns, considering critical natural capital an important component of sustainability. Preliminary results using the CompasSus approach indicate its potential to combine strengths of both weak and strong sustainability approaches so that a more comprehensive notion of sustainability for different Brazilian Regions is achieved. According to the sustainability assessment performed the state of Santa Catarina in the Southern Region of Brazil scored the best performance due to a combination of environmental and socioeconomic indicators: high efficiency in energy consumption in relation to wealth; low intensity of fertilizers and pesticides associated with high agricultural yields; and an above average performance in all social and economic indicators. On the other hand, the state of Maranhão in the Northeastern Region of Brazil scored the worst sustainability performance as a consequence of its least developed social and economic dimensions, including indicators of education, life expectancy and income.

Economic modelling of multi-functionality at the farm level

E. Romstad, K. Louhichi, P. Zander
 Dept. of Economics & Resource Management,
 Norwegian University of Life Sciences,
 P.O. Box 5033, 1432 Aas, Norway
 Contact: eirik.romstad@umb.no

Introduction

Market failures constitute the primary reason for justifying policy intervention. Goods not amicable for market exchange, also denoted non-market or public goods, are of particular relevance in the case of agri-environmental policies and has received substantial attention both in the academic literature and in real policy (see Lankoski & Ollikainen (2008) for an overview). Multi-functionality basically implies that some non-market goods are produced in conjunction with the ordinary production of market goods in agriculture.

This paper considers the jointness and policy implications of multi-functionality, and provides insights to how multi-functionality can be modelled under various settings for data availability.

Our starting point is that in an economically rational equilibrium there must be a negative relationship between the market commodity and the non-market good or service per hectare of land as long as the non-market attribute has a non-negative price. The reason for this is if this was not the case, the farmer could earn larger expected profits by increasing the per hectare supply of either of the goods. Figure 1 provides an illustration.

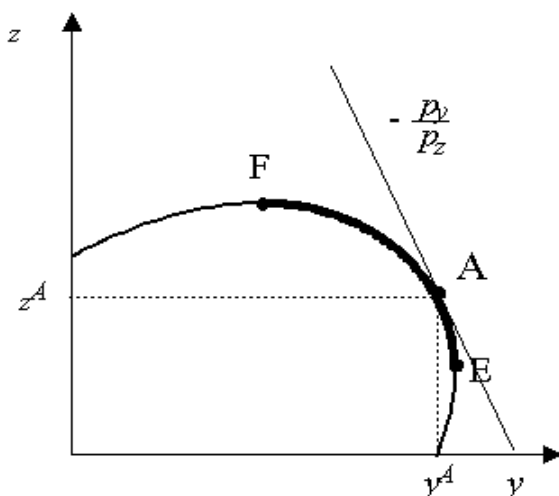

Figure1. The trade-off between the extent of market (y) and non-market (z) goods or services.

In Figure 1 only the thick segment on the production possibility frontier, that bounds the production possibility set, are technically efficient. To see this consider allocations on the frontier left to F or below E , where it is possible for the farmer to increase the production of both y and z without additional costs. For a given price ratio, $-p_y/p_z$, the optimal allocation is in A where the relative price line tangents the production possibility frontier.

Multiple authors claim that there is some strict technical jointness (again see Lankoski & Ollikainen (2008) for an overview) pointing to empirical data. We claim that this perceived jointness is due to two factors. First, if the price of the market commodity is increased, it becomes profitable to increase the expenditures spent on commodity production, leading to an expansion of the per hectare production possibility set. If this expansion more than offsets the substitution of producing more of the market commodity due to the relative price change, there will be an increase in the production of both the market and non-market good (Romstad, 2007).

Second, the increased per hectare profits due to a price increase of the market commodity entails that more acreage goes to this type of production. Consequently, also more of the non-market good may be produced on this acreage, even if the above substitution effect is larger than the effect of the expansion of the production possibility set (Romstad, *ibid.*). These analytical results have strong implications for how multi-functionality is to be modelled. Ideally, one seeks to embed non-market goods or services included in the farm model objective function so that one could fully study the impacts of relative price changes. Unfortunately, there has been little quantitative modelling done on this using real data. A notable exception is Groot *et al.* (2007) who find the negative relationship illustrated in Figure 1 for biological diversity and biomass production. Unfortunately, few of these multi-attribute relationships have been analysed to capture the corresponding production possibility frontier.

Methods

FSSIM is a bio-economic farm model simulating farm level behaviour given a set of bio-physical, socio-economic and region-specific policy constraints, allowing for technological innovations and policy changes (Van Ittersum *et al.*, 2008). It is a primal based approach (i.e., technology is explicitly represented) using nonlinear programming to account for selected positive and the negative jointness in outputs (i.e., joint production) associated with the production process. FSSIM is based on discrete production functions and a limited number of externalities functions. These specifications enable FSSIM to directly explore the impacts of some premium and policy changes not only on the relationship between market and non-market goods, but also on the production process (Louhichi *et al.*, 2007).

Whenever the production possibility frontier is not well specified due to the before mentioned lack of data, it is difficult to perform analyses using direct payments for the non-market goods or attributes. However, many multi-functionality attributes, like hedgerows or solitary trees, are not joint products in a strict sense. In these cases there is a discrete land use decision to be made by the land owner on adding such elements in the landscape if the payments for these elements is sufficiently high to offset the reduction of the most profitable land use in absence of targeted land use payments. Such elements represent a direct competing land use that appear of particular relevance given the work done on the visual characteristics of landscapes in Seamless, and enters the optimal solution if the corresponding acreage or attribute payments are sufficiently high.

Results and discussion

The linkages between commodity production and acreage use on one hand, and landscape attributes like scenic nature or biological diversity on the other hand, are not yet fully implemented. Such results are foreseen before the end of 2008.

References

- Groot, J.C.J., *et al.*, 2007. *Agriculture, Ecosystems and Environment* 120: 58-69.
- Lankoski, J. & M. Ollikainen (Eds.), 2008. *Multifunctionality in agriculture. Evaluating the degree of jointness. Policy implications.* OECD, Paris, 252 pp.
- Louhichi, K., *et al.*, 2007. *A generic template for FSSIM for all farming systems*, PD 3.3.11, Seamless Integrated project, IAMM, Montpellier, 82 pp.
- Romstad, E., 2007. *Multifunctionality in SEAMLESS-IF*. PD 3.3.10, Seamless Integrated project, Norwegian University of Life Sciences, Ås, 15 pp.
- Van Ittersum, M.K., *et al.*, 2008. *Agricultural Systems* 96: 150-165.

Predicting combined impacts of land management and pollution on biodiversity: A dynamic niche occupancy approach

E.C. Rowe, S. Smart, C.D. Evans, B.A. Emmett
Centre for Ecology and Hydrology,
Environment Centre Wales, Deiniol Road, Bangor, Gwynedd, LL57 2UW, UK
Contact: ecro@ceh.ac.uk

Introduction

Biodiversity has intrinsic value and may be essential to certain ecosystem functions. The maintenance of biodiversity is thus a key ecosystem service (Millennium Ecosystem Assessment Board, 2003), but the difficulty of predicting effects of changes in land use and management on biodiversity means that this service is not easily incorporated into integrated assessments of such changes. Niche envelope modelling has been widely applied to predict impacts of climate change on species' distributions. By incorporating other environmental factors into niche models, in particular soil and vegetation characteristics, responses of species to multiple drivers can be predicted (Coudun, 2006).

While sulphur pollution has declined greatly in Europe since the 1980s, pollution by reactive nitrogen continues. Nitrogen pollution is causing a global loss of biodiversity (Phoenix *et al.*, 2006), due largely to effects on interspecific competition among plants. The reduction of N limitation increases the growth of fast- and tall-growing plant species, thus shading out smaller-growing, light-demanding plant species (Clark *et al.*, 2007) and reducing the availability of niches for many animal species (Wallisdeevries *et al.*, 2006). Semi-natural European habitats such as grasslands and heathlands support large numbers of species principally because the regular removal of biomass through grazing or fire reduces ground-level shading.

We present a dynamic niche occupancy approach that can be used to assess the combined impacts of management change and nitrogen pollution on plant species occurrence.

Methods

In the dynamic niche occupancy approach, changes in the likely occurrence of a species are predicted by linking dynamic models of environmental change to regression models of the niche for the species. The 'realized niche' of a plant species can be defined as the hypervolume where the species occurs within a space defined by a set of environmental factors and restricted by biotic interactions (Hutchinson 1957). Empirical realized niche models have been derived for 822 higher plant and 315 bryophyte species in the UK, by multiple logistic regression of their occurrence in relation to soil pH, total soil carbon and nitrogen concentrations, soil moisture and canopy height. These factors are easily measured and hence have been recorded together with plant species occurrence in several large datasets. The set of species models is collectively called GBMOVE (Smart *et al.*, 2009).

Predictions of changes in the environmental factors that define plant species niches were obtained using the biogeochemical models MAGIC (Cosby *et al.*, 2001) and SUMO (Wamelink *et al.*, 2009). Using the outputs from these models to solve the regression models allows changes in the probability of occurrence of individual plant species to be predicted. Plant species are valued differentially by biodiversity specialists, and lists of positive and negative indicator species are available for particular habitats (JNCC, 2006). A habitat-specific index of biodiversity value was calculated by subtracting the mean probability of occurrence of negative indicator species from the mean probability of occurrence of positive indicator species.

Results and discussion

The model chain was tested by comparison of predictions against observed changes in species composition at a lightly grazed upland site in Cumbria, UK. Predicted rates of change in probability of occurrence of species present at the site were correlated with observed rates of changes in these species (Pearson correlation coefficient = 0.568, $p=0.002$). Historic and projected changes to soil pH and C/N ratio, probability of occurrence of positive indicator species and overall habitat quality are illustrated in Figure 1.

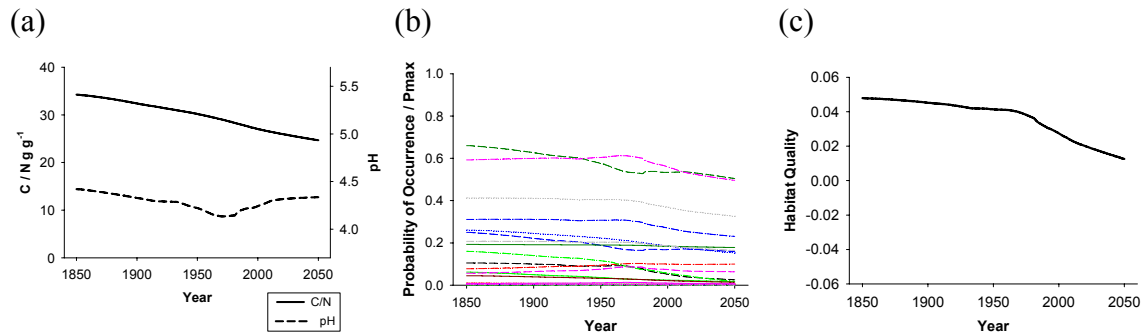

Figure 1. Simulated changes at Moor House long-term monitoring site, Cumbria, UK, under the Gothenberg scenario for projected nitrogen and sulphur emissions: (a) soil pH and C/N ratio simulated using the MAGIC soil chemistry model; (b) probabilities of occurrence of positive Common Standards Monitoring indicator species rescaled to maximum probability for the species; (c) overall habitat quality. Soil water content and canopy height were assumed to be constant.

The model chain is currently being refined by further testing against long-term floristic datasets, and by incorporation of a more sensitive indicator of soil N availability. The approach is being used to assess the effects of changes in pollutant load under different air pollution policy scenarios, and is being adapted as a tool to assist land managers in setting appropriate levels of grazing and fertilization to maintain plant diversity. Forecasts of biodiversity change will also be useful for broader assessments of ecosystem services.

References

- Clark, C.M., *et al.*, 2007. *Ecology Letters* 10: 596-607.
- Cosby, B.J., *et al.*, 2001. *Hydrol. Earth Syst. Sci.* 5: 499-517.
- Coudun, C., *et al.*, 2006. *J. Biogeog.* 33: 1760-1763.
- Hutchinson, G.E., 1957. *Cold Spring Harbor Symp. Quantitative Biol.* 22: 415-427.
- JNCC, 2006. <http://www.jncc.gov.uk/page-2237>
- Millenium Ecosystem Assessment Board, 2003. <http://www.millenniumassessment.org/en/Framework.aspx>
- Phoenix, G.K., *et al.*, 2006. *Global Change Biol.* 12: 470-476.
- Smart, S.M., *et al.*, 2009. *Ecol. Model.* (submitted)
- Wallisdevries, M.F. & C.A.M. Van Swaay, 2006. *Global Change Biol.* 12: 1620-1626.
- Wamelink, G.W.W., *et al.*, 2009. *For. Ecol. Mgmt.* (submitted)

Cost effectiveness of biodiversity in agricultural production systems

D.P. Rudrum, R.A.M. Schrijver, A. Corporaal, T.J. De Koeijer
LEI, Postbus 47, 6700 AA Wageningen, The Netherlands
Contact: dale.rudrum@wur.nl

Introduction

In The Netherlands, there is an ongoing discussion on how to reform the current Common Agricultural Policy from payments based on historical production levels towards payments based on delivered services according to societal demands. One of the demands being considered is the conservation of biodiversity. To explore this option further, the question that should be answered now is how biodiversity in the modern agricultural landscape could be stimulated and which measures are the most cost effective. As measures in the agricultural landscape should be taken by the farmer insight is needed in which measures could be incorporated in the management of the agricultural production system and how these measures affect the production system, biodiversity and income. The effect on income of the farmer is important as it may be assumed that if a measure is profitable a farmer will be more willing to adapt a measure than if the measure is not profitable. Assuming that farmers do not have a willingness to pay for biodiversity, the loss of income provides a minimum cost price for the concerning measure.

For the assessment of the cost effectiveness of biodiversity in the agricultural landscape an indicator for biodiversity and a method to calculate cost price are needed. Both have to be related to on farm measures aimed at influencing biodiversity. In this work the HEMO index, a measure for biodiversity is incorporated into FIONA, a farm optimization model. Our research is aimed at providing a first study to show the possibilities of the combination of FIONA with the HEMO index. For this two cases are chosen. One area characterized by dairy farms on sand soil situated in the east of The Netherlands, and one area characterized by arable farms on clay soil situated in the south-west of The Netherlands. Possible measures for the biodiversity in these areas are chosen with the help of local experts. Next based on data of the farm structure in the area for each area two representative farms are identified. These farms are modelled in FIONA to give both cost price and effects on biodiversity.

Each proposed measure is evaluated on its economic and ecological effects after which the effects of combinations of measures will be analysed.

Methods

The biodiversity indicator should give a continuous measure of biodiversity with which completely different options can be compared, and a tuning mechanism so that the order of a list of possibilities is in accordance with policy priorities. In this work first results with a new biodiversity indicator, the HEMO index, will be presented. In short, the index is calculated in the following steps: the geographical location of a plot of land provides a list of possible and or relevant species that may occur in the area. The specific environmental conditions are used as a proxy for the occurrence of the species on that plot. Finally, the index is calculated based on the sensitivities of the occurring species for environmental conditions. Habitats for sensitive species score better than habitats only supporting common species.

Corporaal *et al.* (in prep.) introduced the niche number, an indicator based on the environmental conditions like the fertility of the soil, the water table, the management of the vegetation in which a species can live. If the species is indifferent to a condition it scores 100%, if however it is sensitive to the condition it scores a percentage based on the range in habitat variation still acceptable for this species. The niche number of a species is the average over all indicators. Species scoring 100% can live anywhere, and a decreasing niche number is associated with an increase in sensitivity to habitat conditions. In our work the conditions

are all weighted one, but distinctions can easily be made if required.

The niche number is used to calculate the HEMO index. This is the ratio of habitat sensitive species to habitat indifferent species that occur (or in our case: are expected to occur) in a certain area. The species considered are chosen in the context of the geographical location. In this way, the populations of species supported by very different habitats can be compared, essentially based on the likelihood of the ecosystem occurring elsewhere.

The next step is to link the conditions used for the niche number to management practices on the farm. As the condition is used, and not the measure that provides the condition it is made easier to compare the effect of separate measures and to explore the possibility to mix measures. Obviously not all conditions can be influenced by farming practices. Soil type is a given. Also some measurements remain directly linked to conditions, like grazing pressure and fertilization. The possibility to mix measures is, therefore, considered the main advantage.

Finally the costs of the measures have to be assessed. This is done using FIONA. With this model the economic optimal in and output can be identified given the restrictions of the farm concerning the area and amount of labour. The model was developed by Berentsen for analysis of economic and ecological effects of technical and institutional changes concerning fertilization practices (Berentsen & Giessen, 1995). We adapted the model for the evaluation of the participation level of farmers into on farm nature conservation schemes (Schrijver *et al.*, 2006). By the incorporation of a biodiversity index the model is also suitable for cost effectiveness analyses.

Results and discussion

The results are not available yet but will be available by the end of the year 2008.

References

- Berentsen, P.B.M. & G.W.J. Giessen, 1995. *Agricultural Systems* 49: 153-175.
Schrijver, R.A.M., *et al.*, 2006. *Agarwirtschaft* 55(5/6): 280-289.

A novel site-specific methodology to assess the supply curve of environmental services

J.J. Stoorvogel, A. Temme, J.M. Antle, L. Claessens, J.M. Schoorl
Land Dynamics Group, Wageningen University, P.O. Box 47,
6700 AA Wageningen, The Netherlands
Contact: Jetse.Stoorvogel@wur.nl

Introduction

Water use and watershed management have a long history of conflicts which continue to take place as long as we deal with limited resources (Kashaigili *et al.*, 2003). Recently a new policy instrument has been introduced that is based on positive incentives through so-called payments for environmental services (PES, Zbinden & Lee, 2005). However, there is a structural lack of *ex-ante* screening tools that allow for a rapid assessment of the potential for payments for environmental services. The issue has multiple dimensions including the provision of environmental services, the economics of the adoption of alternative practices, but also the proper implementation of PES schemes. A joint analysis should provide key information to policy makers: What is the supply of environmental services at a particular price? In this study we will demonstrate a site-specific methodology to assess this supply curve of environmental services. The methodology will be illustrated with a case study to secure sustainable land use of the Tugela watershed and the Woodstock dam in South Africa. The 1150 km² basin is an important provider of food crops but at the same time the Tugela basin is an important provider of drinking water for Johannesburg and the hydro-electrical plant in the Woodstock dam is a key player in the South African electrical network. As a result water has a significant value and payments to the various land and water users in the watershed are feasible if they result in a more efficient water use and an increase of water availability.

Methods

Antle & Valdivia (2006) introduced a methodology to model the supply of ecosystem services from agriculture. The methodology provides an efficient way to calculate the supply of environmental services for a region. However, the methodology is not site-specific and therefore not very suitable for environmental problems like soil erosion and water supply that require the analysis of spatial interactions. We therefore linked the methodology to the LAPSUS model (Schoorl *et al.*, 2002) to be able to evaluate in a site-specific manner the effect of the adoption of alternative practices in terms of water use and soil redistribution. The methodology determines for each location in the area an expected opportunity cost to switch to an alternative management practice on the water holding capacity at that location, erosion/sedimentation, and expected net returns. The opportunity costs now allow us to determine for each location and for various scenarios of the payments (prices for water and sediment, or a fixed payment for adoption) whether farmers will accept the payments for environmental services. This can be presented in a map, but the results can also be aggregated for the region to calculate the supply curves for the environmental services.

Results for the Tugela river basin

Land use in the Tugela basin was mapped on the basis of a supervised classification of a satellite image and classified in five major categories (Table 1). For each of these classes possible changes in management were identified to conserve water use. Survey and literature data provided insight in the variation in opportunity cost to switch practices and the effect of the potential changes that were identified. The effects were evaluated with the LAPSUS model to assess erosion and runoff.

Table 1. Land use in the Tugela basin and proposed management changes to increase water use efficiency and reduce erosion.

Land use	Proposed change
Large scale irrigated farming	Improved irrigation efficiency through drip irrigation
Large scale rangelands	Reduction of stocking density/ controlled burning
Subsistence farming	Simple erosion control measures
Communal lands	Fencing and rotational grazing
Forest areas	Improved trail management

The results (Figure 1) show that even without payments (corresponding to the negative prices for ES) a certain percentage of the farmers may already adopt the conserving practices. With an increase in the price for the ES the area under conservation will quadruple together with the environmental services provided (right side of Figure 1). The key question that remains is the assessment of proper transaction and adoption costs. These costs will shift the supply curve leftward and may have a significant impact on the interpretation of the results.

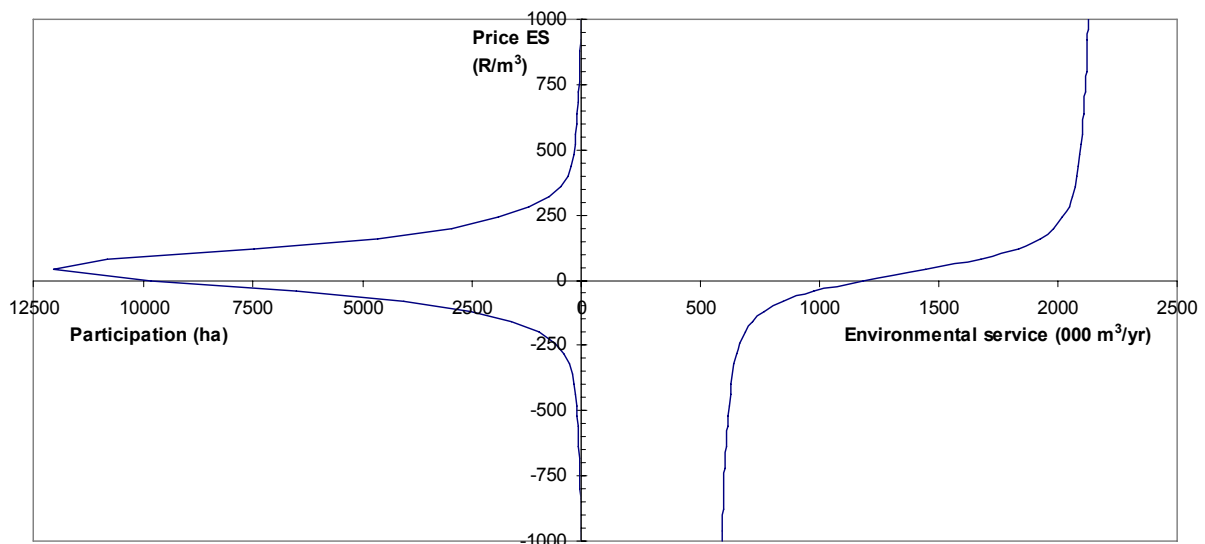

Figure 1. The supply curve of environmental services (expressed as water preserved) at the right side and the adoption of conserving practices in the watershed under different prices for the environmental services on the left side of the graph.

Discussion

The case study illustrates the applicability of the modelling framework with limited data availability. The linkage with site-specific models like the LAPSUS model provides new opportunities to analyse processes that have a clear spatial interaction and for which the local conditions play an important role in the effect of changes.

References

- Antle, J.M. & R.O. Valdivia, 2006. *Aust. J. Ag. & Res. Econ.* 50: 1-15.
- Kashaigili, J.J., *et al.*, 2003. *Phys. and Chem. of the Earth* 28: 839-851.
- Schoorl, J.M., *et al.*, 2002. *Soil Sci. Soc. Am. J.* 66: 1610-1619.
- Zbinden, S. & D.R. Lee, 2005. *World Development* 33: 255-272.

Redefining landscape economics: A proposal to integrate economics approaches and landscape disciplines

C. Tagliaferro, M. Antrop, V. Van Eetvelde, W.G. Hutchinson, A. Longo
Gibson Institute for Food Land and the Environment, School of Biological Sciences,
David Keir Building, Stranmillis Road, BT9 5AG Belfast, UK
Contact: ctagliaferro01@qub.ac.uk

Introduction

The need to implement effective incentive systems for landscape planning and management requires policymakers, stakeholders and planners to understand the values that communities attach to landscape. Placing monetary values on landscape and its characteristics has been challenging economists for the last decades because of the complexity of components to take into account when analysing landscape. In order to address this issue, the new discipline of landscape economics needs interdisciplinary approach, integrating analytical methodologies and involving researchers from the different landscape disciplines. Only in this way it is possible to define a new valuation procedure that integrates the real landscape - as it exists in the territory - with economic modelling approaches. Some attempts in this direction include Geoghegan *et al.*, 1997; Bell & Irwin, 2002; Campbell, 2007.

The methodology here presented aims at giving a contribution bridging knowledge and methodologies of different landscape disciplines. It integrates landscape ecology, landscape preference studies and environmental economics, through the analysis of biophysical and cultural components of the landscape and the public's preferences for the landscape using discrete choice experiments. We argue that this approach represents a common framework where landscape scientists and economists can collaborate on a common goal.

Methods and results

The case study area is the Peninsula of Sorrento, in the South of Italy. It represents a good example of highly valuable Mediterranean landscape that embodies strong identity and cultural values and provides a substantial contribution to the tourist activities in the area. The growth of tourism activities and the decline in traditional farming practices due to economic pressures are leading towards a loss of this unique landscape. The methodology steps are schematically represented in Figure 1.

The first step of our approach is the identification of the landscape types in the study case area, which form the bases for the selection of the 'attributes' to be used in the monetary valuation of the landscape through the application of choice experiments. A parametric landscape classification methodology using GIS-techniques is applied to the study area (Van Eetvelde & Antrop, 2008), to identify landscape types and help describe them in terms of their attributes – quantified with metrics (visual indicators). Digital maps have been analysed and integrated with the GIS software to identify landscape structural components. The urban density degree and the presence of scattered settlements is also analysed in detail. Subsequently, principal components analysis is used to define homogeneous clusters for all these components, which gives rise to classification of six main landscape types and ten sub-landscape-types (distinct on the basis of altitude and settlement degree).

Based on the landscape classification, the second stage involves taking more than 300 pictures of the study area. Location of the pictures is geo-referenced; a viewshed analysis of all the pictures is conducted and the attributes of the landscape covered by the view area are quantified in visual indicators (McGarigal & Marks, 1995; Ode *et al.*, 2008). An example of such indicators is reported in Table 1. Finally, based on these attributes, a sequential experimental design with a Bayesian information structure is used to increase the sampling efficiency of a discrete choice experiment survey. The results from this are used to quantify

the non-market benefits of landscapes and their attributes. These values may provide policymakers, stakeholders and planners with a better understanding of the public interest for landscape.

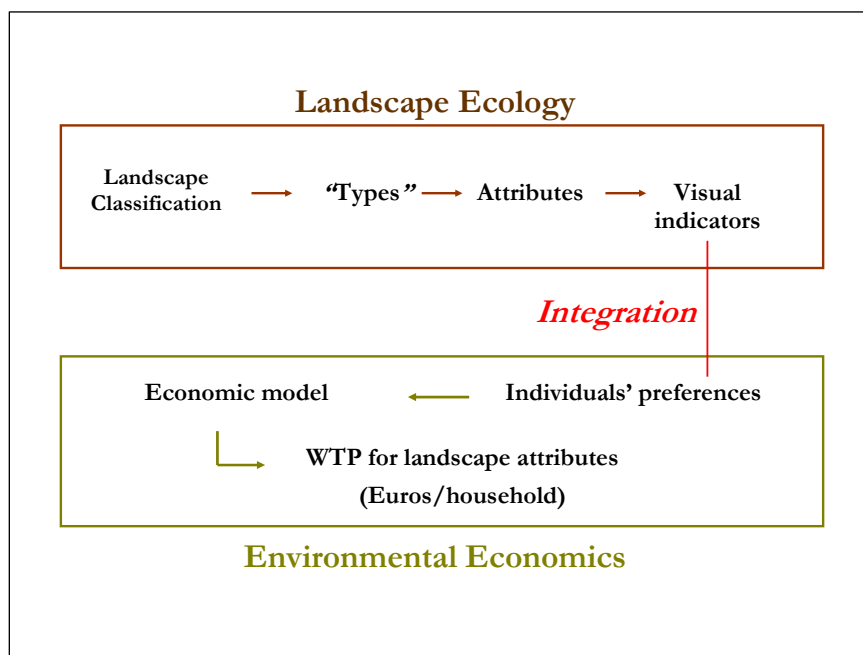

Figure 1. Schematic representation of the methodology main steps.

Table 1. Example of visual indicators.

Visual indicator	Meaning	Attribute represented
N. of elements	Number of different landscape patches	Degree of fragmentation
Built area	% of area covered by artificial areas	Presence and degree of urbanization
Naturalism index	% of area covered by natural systems	Degree of natural character of the area
Shape index	Relation between perimeter and area of patches, adjusted for a constant related to the type of data file used (raster or vector)	Shape complexity related to the geometry of patches
Total area of viewshed	Hectares covered by the picture/viewshed	Depth of the view

References

- Bell, K.P. & E.G. Irwin, 2002. *Agricultural Economics* 27: 217-232.
- Campbell, D., 2007. *Journal of Agricultural Economics* 58: 497-483.
- Geoghegan, J., *et al.*, 1997. *Ecol. Econ.* 23: 251-264.
- McGarigal, K. & B.J. Marks, 1995. FRAGSTATS: spatial pattern analysis program for quantifying landscape structure. General Technical Report PNW-GTR-351. US Department of Agriculture, Forest Service, Pacific Northwest Research Station, Portland, OR.
- Ode, A., *et al.*, 2008. *Landscape Research* 33(1): 89-117.
- Van Eetvelde, V. & M. Antrop, 2008. A stepwise multi-scaled landscape typology and characterization for trans-regional integration, applied on the federal state of Belgium. Submitted to *Landscape and Urban Planning* (January, 2008).

Towards indicators of multi-functionality: Assessing jointness between commodity and non-commodity outputs

Nadine Turpin, Lee Stapleton, Guy Garrod, Eric Perret, Floor Brouwer
UMR 1273 Métafort, 24 avenue des Landais, B.P. 50085,
63172 Aubiere Cedex, France
Contact: nadine.turpin@cemagref.fr

Introduction

Multi-functionality is one way to reconcile agriculture with sustainable development: agriculture, beyond the production of food and fiber, also provides important social, environmental and economic functions to society. In general, much of the current literature on agricultural multi-functionality is qualitative and narrative, and focuses on demonstrating the existence of social and/or environmental functions. This paper goes beyond qualitative analysis and seeks to measure a degree of multi-functionality. More precisely, the objective of this paper is to provide a theoretical backdrop to the design of indicators that measure the degree of multi-functionality involved in the co-production of commodity and non-commodity outputs by farms. It is important that decision makers can measure the sustainable development implications of a given policy intervention in terms of how this affects the multi-functional attributes of a given area. Policy formulation that aims at supplying commodity and non-commodity outputs separately will lead to higher implementation costs than when the policy considers multi-functionality and encourages farmers to supply these outputs jointly (OECD, 2001). More specifically, measuring the degree of jointness will provide insights to a potential decrease of the use of public funds to support agriculture and its associated amenities in the context of the European Union's (EU) Common Agricultural Policy (CAP).

Methods

A brief review of the start-of-the-art in agricultural multi-functionality research emphasizes that much of the current literature on the subject is qualitative rather than quantitative. This literature review serves to highlight how there is a pressing need for operational indicators of multi-functionality which can, for example, provide insights into the likely effects of a decrease in the availability of public funds to support agriculture and its associated amenities in the context of the EU's CAP.

Therein lies the rationale and motivation for the work presented below whereby we present a theoretical framework for joint supply based on the assumption that the degree of jointness has consequences both in terms of commodity production costs and non-commodity production. Based on the jointness definition, the assessment of indicators of multi-functionality relied on three sequential stages: identification of jointness, qualitative assessment of jointness, quantitative assessment of jointness.

Results and discussion

Identification of jointness was carried out at the level of the farm gate for both an EU sample and a regional case study of Auvergne, France. Full functionalities of SEAMLESS-IF have been used, including various sets of indicators and their aggregated values (Van Ittersum *et al.*, 2008). Identification of jointness with a direct use of the integrated framework requires the possibility of displaying dual values of active environmental constraints and cross-elasticities of non-commodity outputs relative to commodity outputs.

Qualitative assessment of jointness examined the relationship between farm income and a set of environmental and social indicators; both at farm and regional levels (Turpin *et al.*, 2006). It is worthwhile noting that for the Auvergne case-study it was possible to highlight, for example, that the marginal effect of environmental subsidies on farm income is not

constant over time (Figure 1). Moreover, the regional landscape is a patchwork of highly multi-functional farms alongside less multi-functional farms. The impact of policies on landscape multi-functionality would be in terms of both specific on-farm multi-functionality and the spatial distribution of multi-functionality across farms.

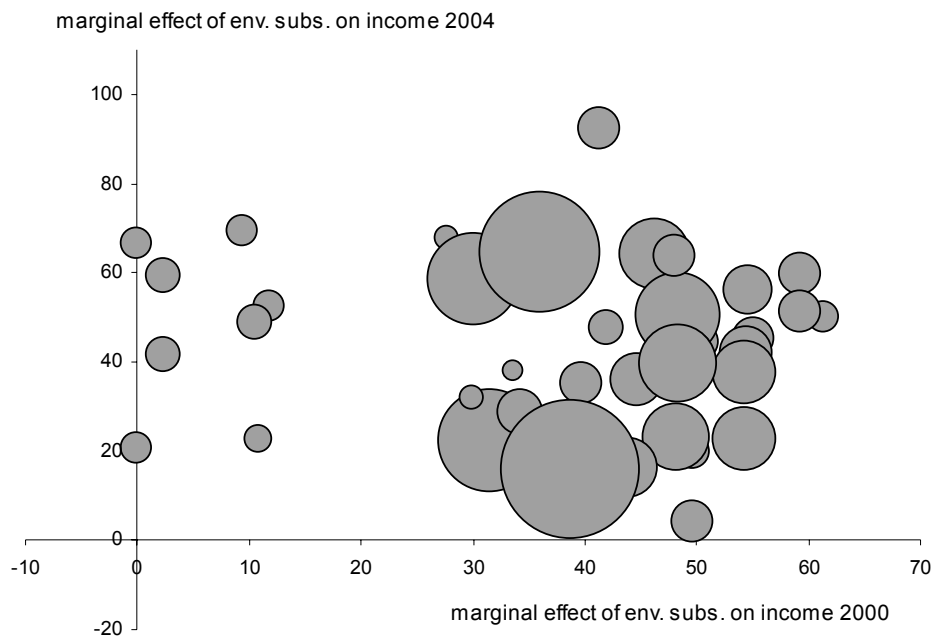

Figure 1. Total marginal effect of environmental subsidies on farm income for FADN farm groups in Auvergne (the size of the dots represent the share of the total agricultural area for each group of farms).

Moving to assessing the final stage in our framework, quantitative assessment of jointness, we extended the approach used to identify jointness at the farm gate level for an EU sample. The results outlined in this paper serve to illustrate that multi-functionality of agriculture is far from being negligible.

References

- OECD, 2001. Multifunctionality: Towards an analytical framework. Paris.
- Turpin, N., *et al.*, 2006. Towards indicators of multifunctionality: Assessing jointness between commodity and non-commodity outputs. PD2.2.3, SEAMLESS integrated project, EU 6th Framework Programme (contract no. 010036-2), www.SEAMLESS-IP.org, 62 pp.
- Van Ittersum, M.K., *et al.*, 2008. *Agricultural Systems* 96: 150-165.

Valuation of ecosystem services and decision making: Combining a CBA with MCA

C.M. Van der Heide, Frans J. Sijtsma, Petra Van Egmond, Sonja Kruitwagen,
Arjen Van Hinsberg, Frank J. Dietz
Public Issues Division, LEI Wageningen UR,
P.O. Box 29703, 2502 LS The Hague, The Netherlands
Contact: Martijn.vanderheide@wur.nl

Introduction

To evaluate the effects of land use projects, the technique of cost-benefit analysis (CBA) is widely used. CBA is a policy assessment method that quantifies in monetary terms the value of all consequences of a programme, policy or other government intervention – usually denoted by the term ‘project’ – to all members of society. That is, CBA has been defined in terms of what the gains and losses are to society, and therefore, as cost-benefits analysts claim, the method can provide an aid to decision-makers in evaluating projects with non-market environmental consequences. Nevertheless, although CBA is probably the most widely practiced method of project appraisal, there are a number of difficulties posed by applying it to land use projects in agricultural areas. One of the most prominent areas of difficulty is the monetary valuation of the effects that these projects have on the state of agro-biodiversity in the area under consideration. As a result, adaptations of the method are suggested in performing an evaluation of major decisions regarding land use projects with non-market environmental consequences.

In this context, multi-criteria analysis (MCA) can be used for such an adaptation. MCA is a non-monetary evaluation method, which compares attributes of different project alternatives by assigning a scoring and weighting systems. It is a flexible methodological approach, because it can deal with quantitative, qualitative or mixed data and does not impose any limitation on the number and nature of criteria. The technique usually provides an explicit relative weighting system for the different criteria. The set of weights describe quantitatively how important each criterion is with respect to the other criteria and reflects the preferences of those who assign the weights, or can be based on expert judgment.

Methods

The combination of CBA with MCA is called ‘MCCBA’ and appears to be a helpful approach to deal with the increasingly complex nature of land use projects in agricultural areas. That is, by using MCCBA, the physical effects of land use projects on agro-biodiversity can be determined and evaluated in combination with effects which can be fruitfully monetarized. After quantifying the effects of a project physically, the outcome of a MCCBA is a combination of aggregated monetary scores (i.e. monetary values of marketed goods) and aggregated non-monetary scores (which are related to the effects of the project on agro-biodiversity). That is, the outcome of a MCCBA consists of the monetary net social benefits (which equal the social benefits minus the social costs) complemented with aggregated non-monetary scores.

This paper focuses on the possibilities of aggregating these physical non-monetary scores into a single indicator. Developing such an indicator makes it possible to bypass the controversial field of monetary valuation, which is generally based on eliciting respondents’ preferences for non-marketed goods. The indicator does *not* capture the final trade-off between the costs and benefits to society from a given project alternative; neither does it reveal the consequences of the alternative for societal welfare. Nevertheless, one single indicator for measuring biodiversity effects improves the information about all the relevant physical effects of a land use projects, and makes alternative projects better comparable.

Note that, like the conventional CBA, a MCCBA for land use projects is expected to be undertaken by specialists (and not by just some laymen) who are perfectly capable of integrating the expert judgment of MCA into the combined framework of MCCBA.

Preliminary outline of the paper

1. The paper starts with a description of the difficulties related to the valuation of ecosystem services, and how these difficulties impinge upon the performance of a CBA for a policy design. We present a short review of the international literature, and provide an introduction to three case studies of projects applying a CBA to evaluate land-use changes in the Netherlands. Each of these three case studies uses a different approaches to capture the impacts of land-use changes on ecosystem services.
2. Then we explore the two evaluation methods, CBA and MCA, and we describe their advantages and disadvantages. This description forms the input for the next section.
3. The third section provides the theoretical basis for the combination of CBA and MCA. This MCCBA-combination provides the best of both ‘worlds’ (i.e. methods).
4. We then discuss the development of a widely applicable indicator for (agro-)biodiversity that proves to be useful within the MCCBA-combination. The indicator is developed on the basis of information that is easily available from Environmental Impact Assessments (EIAs).
5. In the fifth section we present the application of this (agro-)biodiversity indicator in the three case studies, which are introduced in section 1.
6. Finally, we conclude our paper with a discussion of the pros and cons of our approach. Here, we pay particular attention to: (i) the two different ‘worlds’ of CBA and MCA, and the contribution of the MCCBA to bring both worlds closer together; and (ii) available data and data demands for further international application of the MCCBA.

Analysing, forecasting and valuating the effects of landscape change on the ecosystem service of biological pest control

W. Van der Werf, D.A. Landis, M.M. Gardiner, A.C. Costamagna, J.M. Baveco,
F.J.J.A. Bianchi, N.C. Schellhorn, W. Zhang
Wageningen University, Centre for Crop Systems Analysis,
P.O. Box 430, 6700 AK Wageningen, The Netherlands
Contact: wopke.vanderwerf@wur.nl

Introduction

Landscapes are changing rapidly worldwide. Empirical evidence is mounting that these changes may affect the suppression of pests in agricultural crops. A suite of modelling techniques is available and in development to extend empirical results to realistic spatial images of the distribution of the ecosystem service of biological control over agricultural landscapes and highlight the economic impacts of landscape change on the value of ecosystem services. These models can play a role in functional landscape design and policy support.

Natural pest regulation is an important ecosystem service without which the productivity of plants in natural and managed systems would be severely impaired, and agriculture might well be impossible. Constanza *et al.* (1997) estimated the value of this ecosystem service at more than 400 billion US\$ per year at a world-wide scale (but see Pearce (1998) and Bockstael *et al.* (2000) for a critique of Constanza's methods). In agricultural landscapes in the temperate zone, the natural pest regulation function is often positively related with the presence of non-crop habitats (Bianchi *et al.*, 2006) and several recent studies have shown effects of landscape context on biological control (Tschardt & Brandl, 2004; Tschardt *et al.*, 2005). Non-crop habitats may stimulate natural enemy populations by the provision of (alternative) food sources, hibernation habitat and prey or hosts (Landis *et al.*, 2000). As a consequence, non-crop habitats often serve as reservoirs of natural enemies, which can colonize and suppress herbivore populations in arable fields. Interest is increasing in the design of landscapes that maximize biological control as an ecosystem service, thus helping make agriculture less dependent on technological inputs (Fiedler *et al.*, 2008). Spatially explicit simulation models for natural enemy movement and impact in artificial and real landscapes can elucidate the economic returns to landscape manipulations aiming at higher levels of the ecosystem service of biological control (Zhang, 2007).

Empirical studies

Convincing evidence that landscape composition affects biological control is provided by empirical studies with 'sentinels'. For instance, Bianchi *et al.* (2008) placed second and third instar larvae of the diamond back moth, *Plutella xylostella*, on experimental Brussels sprout plants in twenty two fields in different landscapes throughout the Netherlands in July 2006. After two days of exposure, the *P. xylostella* larvae were recovered, dissected and checked for the presence of parasitoid eggs. Parasitism rates were positively related with area of forests within circles of 1, 2 and 10 km around the site, forest edges at a scale of 1 and 2 km and road verges at a scale of 1 km.

Gardiner *et al.* (2008) found a significant ($P < 0.01$) positive relationship between land use diversity within a 1.5 km radius around a site and the biological control of soybean aphid in soybeans. A strong negative relationship ($P < 0.001$) was found between the corn acreage around a site and biological aphid control. On average, the proportion aphid reduction on plants that were exposed to predators was 77% in comparison to those plants that were shielded from predators and where aphid population growth was essentially exponential. These proportions reduction translate into small but significant savings in crop protection

costs for growers that use pesticides and vast savings for growers that rely on biological control alone. An increase in corn acreage for biofuels would carry quantifiable costs due to loss of ecosystem service value (Landis *et al.*, 2008).

Bio-economic modelling

In silico studies can be made in many different ways. Spatial probability distributions of natural enemy impact can be estimated from sentinel data (Van der Werf *et al.*, 2008). By combining the estimated kernel functions with landscape maps, maps of impact across the landscape can be made (Baveco *et al.*, 2008). A second approach for *in silico* studies is based on estimating an initial effect of predators by exclusion (Gardiner *et al.*, 2008) and extending this effect over a whole growing season using a validated model for pest population growth (Costamagna *et al.*, 2007). A third approach is based upon modelling the predator & prey population processes from the bottom up, i.e. on the basis of detailed description of individual processes (Bianchi & Van der Werf, 2003, 2004; Bianchi *et al.*, 2007).

Process-based landscape simulations, such as those presented in Bianchi & Van der Werf (2003, 2004) and in Bianchi *et al.* (2007), allow analysis of what would constitute optimal landscapes for providing biological control. Such simulations elucidate basic design characteristics of pest suppressive landscapes but are still subject to large uncertainties, primarily due to fragmentary knowledge on the movement of pest natural enemies across landscapes and habitat use by beneficial insects. Economic analyses of the simulations and simulated or empirical maps offer insights on economically optimal landscape patterns (Zhang, 2007) and may assist in land use planning and land use policy.

References

- Baveco, J.M., *et al.*, 2008. IOBC-WPRS Bull. 34: 21-24.
- Bianchi, F.J.J.A. & W. Van der Werf, 2003. Env. Entomol. 32: 1290-1304.
- Bianchi, F.J.J.A. & W. Van der Werf, 2004. Ecol. Mod. 171: 177-193.
- Bianchi, F.J.J.A., *et al.*, 2006. Proc. of the Royal Soc. B: Biological Sciences 273: 1715-1727.
- Bianchi, F.J.J.A., *et al.*, 2007. Landscape Ecol. 22: 1541-1554.
- Bianchi, F.J.J.A., *et al.*, 2008. Landscape Ecol. 93: 595-602.
- Bockstael, N.E., *et al.*, 2000. Env. Science & Techn. 34: 1384-1389.
- Costamagna, A.C., *et al.*, 2007. Agric. and Forest Entomol. 9: 297-305.
- Costanza, R., *et al.*, 1997. Nature 387: 253-260.
- Fiedler, A.K., *et al.*, 2008. Biological Control 45: 254-271.
- Gardiner, M.M., *et al.*, 2008. Ecol. Appl. (in press)
- Landis, D.A., *et al.*, 2000. Ann. Rev. of Entomol. 45: 175-201.
- Landis, D.A., *et al.*, 2008. Proc. Nat. Acad. Sci. 105: 20552-20557.
- Pearce, D., 1998. Environment 40: 23-28.
- Tscharntke, T. & R. Brandl, 2004. Ann. Rev. of Entomol. 49: 405-430.
- Tscharntke, T., *et al.*, 2005. Annal. Zool. Fennici 42: 421-432.
- Van der Werf, W., *et al.*, 2008. IOBC-WPRS Bull. 34: 113-116.
- Zhang, W., 2007. Optimal Pest Management in the Presence of Natural Pest Control Service.
http://www.aec.msu.edu/agecon/theses/fulltext/zhang_phd.pdf

Understanding agricultural ecosystem services with ARIES (ARtificial Intelligence for Ecosystem Services): Perspectives for assisted policy making

Ferdinando Villa, Marta Ceroni, Kenneth Bagstad, Gary W. Johnson Jr., Sergey Krivov
Ecoinformatics Collaboratory, Gund Institute for Ecological Economics,
Univ. of Vermont, 617 Main Street, Burlington, VT, 05405-0001, USA
Contact: Ferdinando.Villa@uvm.edu

Introduction

Agricultural practices depend on ecosystem services (ES; Farber *et al.*, 2006) and at the same time produce new ecosystem services. Because the dynamics, spatial and temporal scales, and range of values of ecosystem services production and usage are not well understood, it is difficult to locate agriculture within a broader context of ecosystem services-informed policy making. As a result, agricultural policy making often lacks understanding of the short- and long-term repercussions of decisions taken on the overall portfolio of valuable services produced by nature and necessary for human well-being.

ARIES (Ecoinformatics Collaboratory, 2008) is a new methodology and web application meant to assess ecosystem services and illuminate their values to humans in order to make environmental decisions easier and more effective. By creating *ad-hoc*, probabilistic models of both provision and usage of ES in a region of interest, ARIES helps discover, understand, and quantify environmental assets, their likely beneficiaries, and what factors influence their

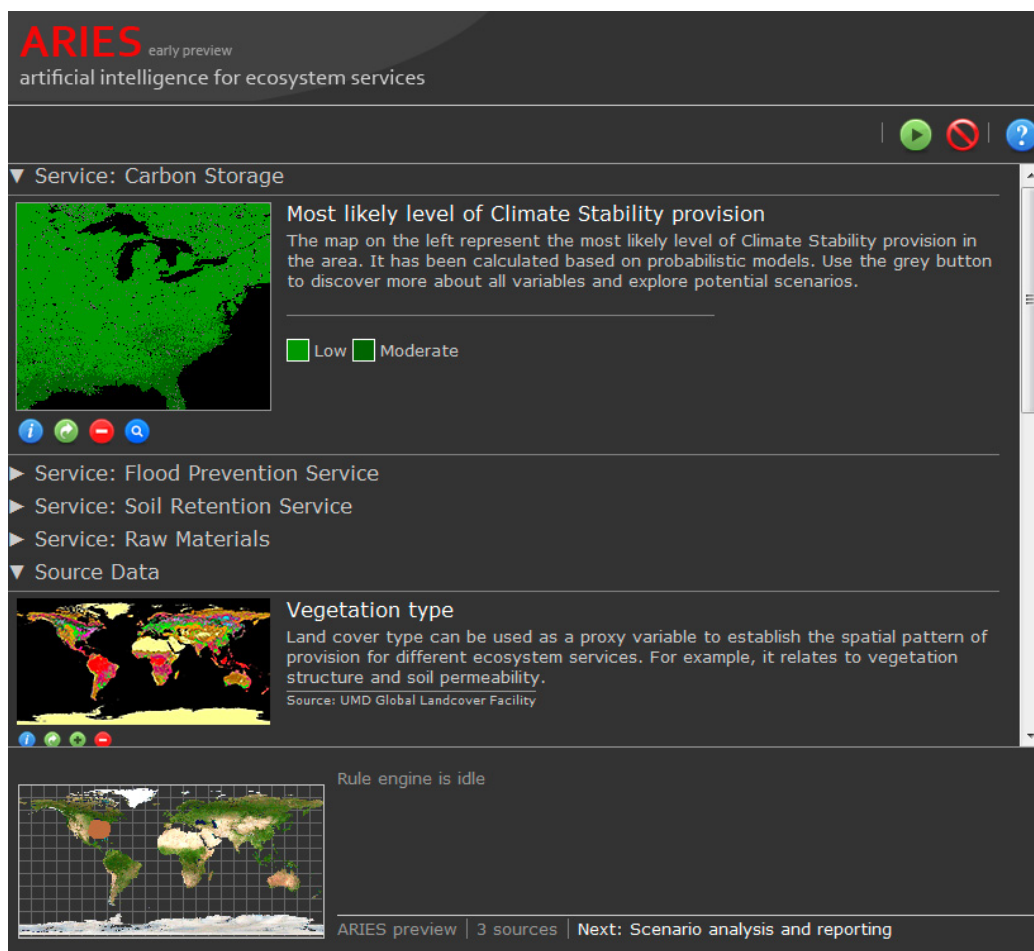

Figure 1. A screenshot from the ARIES toolkit calculating the potential of an area to provide climate stability through carbon sequestration and storage.

value according to specified needs and priorities. In this contribution, we discuss the use of ARIES to understand how the consequences of agricultural decision-making may propagate along the causal chain of the broader spectrum of Ecosystem Services and illustrate perspectives for integration of ES thinking into agriculture.

Methods

Ecosystem services dynamics can be seen as a generalized source-sink problem, where ecosystems are the source of benefits that meet the needs of specific human beneficiaries. Modelling ES in a given spatial and temporal context requires: (1) determining the currencies of these benefits, such as water, CO₂ etc; (2) determining likely surfaces of both provision and usage relative to the area and time of interest; (3) quantifying the rates of flow of the correspondent benefits. It is the rate of flow (current or potential) that can be directly related to the value of the ES, both in abstract and in economic terms.

Most of the many difficulties of modelling ES depend on the high heterogeneity of behaviour exhibited by the benefits they produce. Among these:

1. Provision and usage happen at entirely independent scales in space and time. Therefore, a scale-explicit approach needs to be taken, and theoretical instruments that can tackle multi-scale systems are lacking.
2. The ‘currency’ of benefit provision is rarely an easily modelled biophysical quantity. Easier cases include, e.g., CO₂: quantification of its exchange from vegetation to atmosphere may be all that’s needed to assess benefits of carbon sequestration. Things are much more complex with currencies like sense of identity or avoided risk of flooding.
3. Little clarity exists in the literature about quantifiable definition of ES, their benefits, and the modalities of their propagation from ecosystem to human beneficiary.

The ARIES methodology is based on explicit conceptualizations (ontologies: Villa *et al.*, 2009) that lay out first of all a novel vision of ES, based on the breakdown into individual benefits, each of which is modelled independently, then linked to the others. Domain ontologies in ARIES result from a large-scale expert consensus. Artificial intelligence techniques (machine reasoning, pattern recognition) examine source data and extract from the ontologies models that best represent the situation at hand. ARIES builds *ad-hoc*, probabilistic Bayesian Network models (Cowell *et al.*, 1999) that inform the users of the full probability distribution of the outcomes of their decisions.

The result of an ARIES user session is an **environmental asset portfolio** that describes in depth the spatial distribution of benefits produced the area, their potential and realized values, and the causal relationships that link the values to each other, to their likely beneficiaries, and to actual or potential policies. Users can enter a scenario explorer module to explore the likely changes in Ecosystem Service (ES) provision and usage engendered by changed environmental conditions, consequent to either natural change or their own actions.

We will discuss the ARIES methodology and demonstrate the software toolkit to highlight its potential in informing ES-centric decision making in agriculture.

References

- Cowell, R.G., *et al.*, 1999. Probabilistic Networks and Expert Systems. New York, Springer.
- Ecoinformatics Collaboratory, 2008. ARIES: Artificial Intelligence for Ecosystem Services. White paper: <http://ecoinformatics.uvm.edu/aries/uploads/media/ARIES.pdf>
- Farber, S., *et al.*, 2006. Bioscience 56: 121-133.
- Villa, F., *et al.*, 2009. Modelling with knowledge: A review of emerging semantic approaches to environmental modelling. Environmental Modelling & Software. (in press)

Policy options for safeguarding the provision of public goods and services in intensive and extensive farming systems

Henk Westhoek, Anne Gerdien Prins, Henk Van Zeijts
Netherlands Environmental Assessment Agency,
P.O. Box 303, 3720 AH Bilthoven, The Netherlands
Contact: Henk.Westhoek@pbl.nl

Introduction

The concept of agriculture providing valuable non-commodity outputs next to agricultural commodities, has now been more or less generally accepted. Some of these non-commodity outputs have the characteristics of (positive) externalities or public goods (OECD, 2001; OECD, 2003). This can include aspects like biodiversity, landscape and water management. However, as a result of intensification of agriculture in many regions, over the last fifty years, the automatic delivery of these non-commodity outputs has come under stress. This has, for example, resulted in strong downward trends for biodiversity in agricultural landscapes, such as for farmland birds (EEA, 2005). Another potential driver for the decline of biodiversity lies in the marginalization of agriculture in other regions. The discontinuation of traditional forms of management, often in the form of extensive grazing systems, might lead to changes in vegetation, landscape and the accompanying wildlife. Small-scale mosaics of land use and landscape elements might be lost, resulting in a reduction of biodiversity. The policy measures needed to safeguard the delivery of non-commodity outputs will probably differ between those situations where intensification of agriculture is more likely, and those with risks of marginalization. This paper explores the future of the delivery of non-commodity output in relation to policies, with special attention to the situation in the EU.

Methods

The need for policies to ensure a continued, or even enhanced delivery of public goods and services, will be assessed for the current situation and for the future, using the results of the scenarios study Eururalis (Eickhout & Prins, 2008; Rienks, 2008; Verburg *et al.*, 2008). Currently, situations do exist where it is clear that policy targets (such as halting biodiversity loss, by 2010) are unlikely to be met and where policy intervention might be needed. The exploration of the expected future delivery of public goods by agriculture depends strongly on the future of agriculture itself. The Eururalis scenarios show different developments in intensification and marginalization, both drivers of biodiversity loss, due to other developments in macroeconomic growth, population, technology and the role of the government. The results of this study will be used to evaluate future changes in the delivery of public goods to different regions of the EU. The costs and the effects of different policy options will be assessed.

Results and discussion

The results for the different Eururalis-scenarios show that land abandonment will occur in all scenarios, but the rate will differ from 2% to 7%, depending on the scenario (Table 1). In the Continental Market scenario with a continuation of the existing farm support, the rate of land abandonment because of marginalization is the lowest, whereas the rate is the highest in the Global Co-operation scenario with less protection. Maps with projected land use show that there are areas in Europe where land abandonment occurs in all scenarios (Figure 1). If it is publicly accepted that agricultural practices should continue in these regions – because of the role of agriculture in the provision of goods and services (such as maintaining traditional landscapes and biodiversity) – policy action is needed. During the conference, maps will be presented, showing where these regions are located. In addition, estimations will be given of

farm-support programmes needed to safeguard the continued provision of public goods.

Furthermore, from the results of Eururalis and other studies on the future of European agriculture it can be derived where intensification of agricultural practices is likely to take place, with a consequent lower delivery of non-commodity outputs. If it is publicly accepted that the delivery of these non-commodity outputs will continue at the present (or higher) level, targeted policy will be needed to ensure this. This will be further elaborated at the conference.

Table 1. Projected land use in the EU27 under four different Eururalis scenarios.

	Global Economy	Continental Market	Global Co-operation	Regional Communities
Agricultural area in 2000 (% of all land)	47.9	47.9	47.9	47.9
Agriculture land in 2030 (% of all land)	43.6	47.0	41.9	42.8
Agricultural area change (% of agricultural land)	-9	-1.9	-12.6	-10.7
Agricultural area change (% of all land)	-4.3	-0.9	-6.0	-5.1
Abandoned areas in 2030 (% of all land)	4.4	2.2	6.7	5.9

Source: Eururalis 2.0 (Rienks, 2008; Eickhout & Prins, 2008)

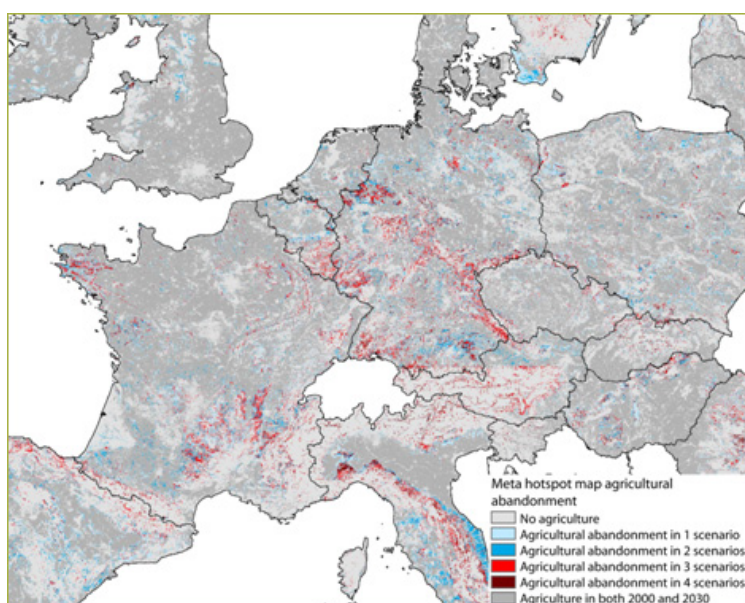

Figure 1. Hotspot map of land abandonment, showing where in Europe and if so, in how many of the four Eururalis scenarios. Source: Rienks (2008).

References

- EEA, 2005. Agriculture and environment in EU-15 - the IRENA indicator report 6/2005. European Environment Agency, Copenhagen.
- Eickhout, B. & A.G. Prins, 2008. Eururalis 2.0. Technical background and indicator documentation. Wageningen University and Research and Netherlands Environmental Assessment Agency, Bilthoven.
- OECD, 2001. Multifunctionality. Towards an analytical framework. OECD, Paris.
- OECD, 2003. Multifunctionality, the policy implications. OECD, Paris.
- Rienks, W.A. (Ed), 2008. The future of rural Europe: An anthology based on the results of the Eururalis 2.0 scenario study. Wageningen University and Research and Netherlands Environmental Assessment Agency, Wageningen.
- Verburg, P.H., *et al.*, 2008. *Annals of Regional Science* 42: 57-77.

Translating spatial policy into future landscape functions

L. Willemen, L. Hein, P.H. Verburg
Environmental Systems Analysis Group/Land Dynamics Group,
Wageningen University, P.O. Box 47,
6700 AA Wageningen, The Netherlands
Contact: Louise.Willemen@wur.nl

Introduction

Most rural regions contain a multitude of other landscape functions in addition to agricultural production. The spatial variability of these functions depends on the spatial configuration of the landscape. Spatial policies generally aim to influence the landscape in such a way that the provision of one or more landscape services is improved. For example by creating zones around natural areas to improve wildlife habitats, re-allotment of arable land to stimulate agricultural production, or creating access to natural areas to boost recreational activities. However, spatial policies will affect each single landscape functions in a different manner.

This paper presents an assessment of the effect of changes in spatial configuration of the landscape on the provision of landscape services, using the rural Gelderse Vallei region in The Netherlands as case study area. We analyse the change in supplied landscape services, and we estimate the change in economic value of these services, as a consequence of growth trend and a set of policies proposed for the Gelderse Vallei.

Methodology

The overall methodology consists of three steps:

1. Mapping landscape functions before policy implementation
2. Translating spatial policy and trends into future landscape function maps
3. Valuation of (future) landscape services in monetary units, using basic economic indicators.

We base our study on set of integrated spatial policies which were designed for our study region (the so-called Reconstruction Act). As baseline we use the situation in the year 2000, as end point of our assessment we use the year 2015. We include eight different landscape functions in our analysis, which all relate to one or more specific spatial policies: residential, intensive livestock, cultural heritage, drinking water, tourism, plant habitat, arable production, and leisure cycling function.

The first step of our methodology, the mapping of landscape functions, is based on linking landscape indicators to landscape functions (Willemen *et al.*, 2008). Hereafter spatial policies and growth trends together with (empirically) quantified relations between landscape indicators are used to quantify and map the future landscape functions. As a last step, landscape services are valued in monetary unites based on economic statistical data for the region.

Results and discussion

For each landscape function the provided landscape services in 2000 and 2015 are mapped and their economic value is estimated. As an example, the change in the leisure cycling function is presented in Figure 1.

In the period 2000–2015, the gross revenues related to the leisure cycling function are estimated to increase from 6.5 to 19.8 million € yr⁻¹. These numbers are based on the trend on the average spending per cyclist per day trip. The economic growth of this landscape function indicates that although the spatial pattern is not expected to change a lot, the total value of the leisure function in the region is likely do so. The analysis of the intensive livestock function

shows opposite results, its spatial pattern is expected to change drastically in 15 year, but the economic value for the study area will remain equal over time.

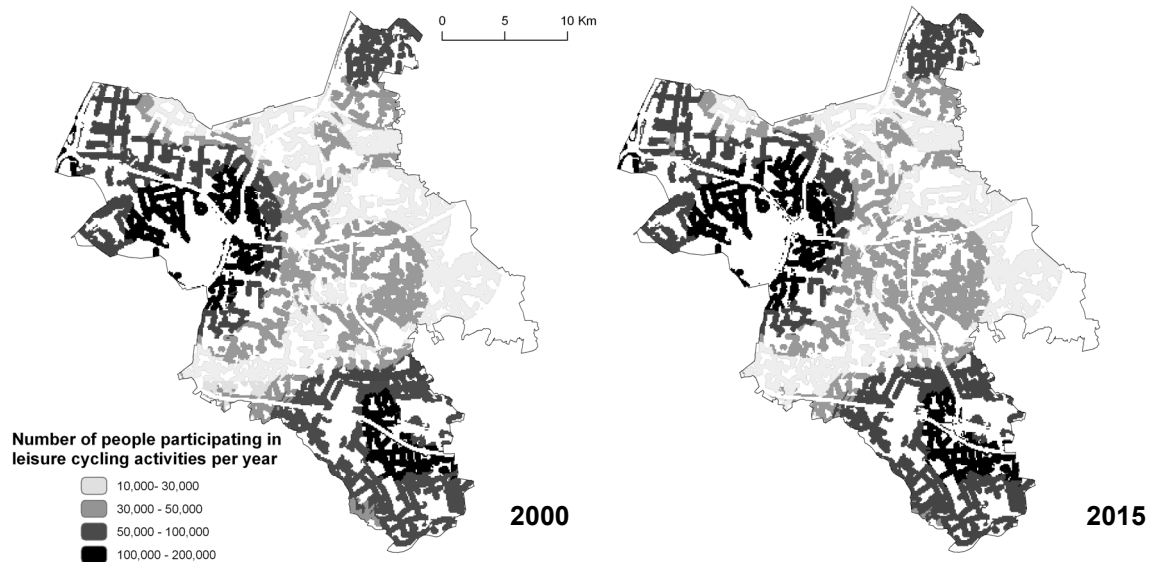

Figure 1. Change in leisure cycling function between 2000 and 2015.

By assessing change in landscape function both in terms of landscape services and in monetary units, the overall contribution to society of future landscape functions a region can be explored. Because of the high level of uncertainties in extrapolation methods and data, the presented study should be seen as a contribution to methodological development rather than a complete *ex-ante* evaluation to be used by policymakers.

Reference

Willemsen, L., *et al.*, 2008. *Landsc. Urban Plann.* 88: 34-43.

Theme A
Methodology for integrated assessment

**Session A4: The organization of tools for impact
assessment: Standards or diversity?**

Session organizers:

Katharina Helming
ZALF, Müncheberg, Germany

Roger Moore
CEH, Wallingford, UK

Impact Assessment practice to support sustainable policy measures in Europe¹

Peter De Smedt

EC - DG Research, Marsveldstraat 21, 1050 Brussels, Belgium

Contact: peter.de-smedt@ec.europa.eu

Introduction

Sustainable Development (SD) has become an overall policy objective in Europe. This is confirmed by the recent issuing of a renewed European SD Strategy in 2006 and a variety of national and regional SD strategies. Making the concept of SD operational for public policies raises important challenges in terms of relevancy, accuracy and legitimacy. The growing interferences between a wide range of global, regional and local developments are increasing the necessity for new forms of knowledge in order to underpin policies in general, and sustainable development strategies in particular. Without prospective approaches, including foresight and a variety of assessment tools, sustainable policy measures have a risk to lack a solid foundation.

Methods

The purpose of this paper is to analyse how, in Europe, policy instruments have been developed in order to provide a solid foundation for sustainable policy measures. The analysis involved the set-up of a scoping study during Spring 2008 to evaluate and compare different current practices. The selected Impact Assessment (IA) exercises and research policy cases have been analysed on the basis of a set of criteria developed for this scoping study. The criteria for evaluating the use of IA tools incorporates: (i) the relevancy, i.e. 'How closely connected or appropriate IA of the EC and novel IA policy cases are to the renewed EU SDS'; (ii) the accuracy, i.e. 'The quality or state of being exact or precise and correct in all detail, of being capable of, or successful in reaching the intended target'; and (iii) the legitimacy, i.e. 'The extent to which the IA conforms to a given standard (= EU SDS and EC IA Guidelines)'.

Results and discussion

The empirical evidence of this scoping study confirms a broad variety of successfully established IA-related initiatives in Europe and the interviewed policymakers and researchers find the IA approaches legitimate on a conceptual basis. Formal activities and guidance for IA, for example, are well established within the EC. Both communities however acknowledge that the full potential of IA tools to support sustainable policy measures in practice is not yet met. Researchers often find the scope of the current IA exercise too narrow and too sectoral to support real change in order to anticipate the unsustainable developments. Yet, the contribution of a formal IA exercise should be evaluated in its full context as being part of a broader policy process. The framing of the policy question, for example, has most often been established before the IA exercise was initiated. In addition, research projects often struggle to bridge the gap between science and the formal policy process. The tools used in any such process-based application must be simple, based as far as possible on rigorous analysis, while recognizing explicitly where value judgements are included (Turnpenny, 2008). Moreover, whilst being simplifications of reality, many scientific models remain so complex that they are seen rather as black boxes instead of transparent analytical tools. Hence, some of what modellers see to be the great strengths of modelling tools are felt by non-modellers to be

¹ Keynote presentation

serious weaknesses (Lotze-Campen, 2008). Consequently, research outcomes do not fully reach the policymakers.

These findings support that, although IA can provide researchers and policymakers with a relevant and legitimate common tool, in practice both communities only show a limited collaboration. Still, the scoping study reveals some evidence of effective close collaboration between researchers and policymakers. The study also confirms – and this is in contrast with most scientific literature (such as Weaver & Jordan, 2008) – that these promising experiments are not only limited to research projects, but can also be found in formal IA experiences within the EC. This supports the importance of an intensive collaboration where researchers and policymakers interact on equal basis to support a more integrated and explorative approach. As Cash and colleagues (2003) also describe, an assessment process is often more effective if the knowledge being produced and communicated at the interface between science and policy is perceived by both sides to be credible, e.g., meets scientific standards, legitimate, e.g., produced by a fair process that reflects the interests of the stakeholders – and salient, e.g., answers questions seen to be relevant by potential users.

Conclusions

Decision-making can only proceed in a sustainable way if the effects of new policy measures are explored and understood before they are introduced. Due to the nature and importance of SD, science and policy have both an important responsibility in this matter. Most practice of sustainability is based on a set of theories. However, the connection in the other direction, i.e. between practice and theory, has traditionally been ignored (Gunderson *et al.*, 2007). Sustainable assessment provides a means where both communities of practice – researchers and policymakers – can and should collaborate. To become more effective IA practice should go beyond the traditional supply approach of science. This is needed because the dialogue linking researchers and policymakers will not happen by itself (Liberatore, 2001). Further research and policy initiatives should, therefore, include a joint collaboration between researchers and policymakers to develop a shared understanding of what constitutes a satisfactory IA (Lee, 2006). This will provide cross-fertilization and learning opportunities among researchers and policymakers, providing a solid foundation for sustainable policy measures.

References

- Cash, D.W., *et al.*, 2003. Proceedings of the National Academy of Sciences of the United States of America 100: 8086-8091.
- Gunderson, L., *et al.*, 2007. Ecology and Society 12: 40.
- Lee, N., 2006. Environmental Impact Assessment Review 26: 57-78.
- Liberatore, A., 2001. From science/policy interface to science/policy/society dialogue. In: Social Sciences for Knowledge and Decision Making. OECD Publishing, Paris.
- Lotze-Campen, H., 2008. Int. J. Innovation and Sustainable Development 3: 70-92.
- Turnpenny, J., 2008. Int. J. Innovation and Sustainable Development 3: 33-47.
- Weaver, P.M. & A. Jordan, 2008. Int. J. Innovation and Sustainable Development 3: 9-32.

A methodology for enhanced flexibility of integrated assessment of policy impacts in agriculture

F. Ewert, M.K. Van Ittersum, I. Bezlepkina, O. Therond, E. Andersen, H. Belhouchette, C. Bockstaller, F. Brouwer, T. Heckelei, S. Janssen, B. Jonsson, M.J.R. Knapen, M. Kuiper, K. Louhichi, J. Alkan Olsson, L. Ruinelli, A.E. Rizzoli, N. Turpin, J. Wery, J.J.F. Wien, J. Wolf

Institute of Crop Science and Resource Conservation, University of Bonn,
Katzenburgweg 5, D-53115 Bonn, Germany

(Former address: Plant Production Systems, Wageningen University, The Netherlands)

Contact: Frank.ewert@uni-bonn.de

Introduction

Agriculture interrelates with the socio-economic and natural environment and faces increasingly the problem of managing its multiple functions in a sustainable way. Growing emphasis is on adequate policies that can support both agriculture and sustainable development. Integrated assessment and modelling (IAM) can provide insight into the potential impacts of policy changes. An increasing number of IA models is being developed, but these are mainly monolithic and are targeted to answer specific problems. Approaches that allow flexible IA for a range of issues and functions are scarce. Recently, a methodology for policy support in agriculture has been developed that attempts to overcome some of the limitations of earlier IA models. The final project version of the proposed framework (SEAMLESS-IF) will be released shortly and initial results from the testing of the framework are available. The present paper provides a first evaluation of this methodology to improve flexibility of IAM in agriculture.

Method

SEAMLESS-IF is a component-based framework for agricultural systems to assess, *ex-ante*, agricultural and agri-environmental policies and technologies across a range of scales, from field–farm to region and European Union, as well as some global interactions. The framework is based on a software infrastructure that allows a flexible (re-)use and linkage of components. The components considered include individual models, database and indicators that are linked depending on the IA problem to be addressed. Usability of SEAMLESS-IF is supported by a Graphical User Interface (GUI) specifically developed to support interactions with end-users for all steps of the IA procedure. The methodology is described in more detail in Vvan Ittersum *et al.* (2008) and Ewert *et al.* (2009). Two example applications are used to demonstrate the flexible application of SEAMLESS-IF. These examples refer to (i) the impacts on European agriculture of changes in world trade regulations and (ii) regional impacts of the Nitrate Directive in combination with agro-management changes. The improved flexibility of SEAMLESS-IF is assessed with respect to its individual framework components (such as the indicator framework and library, database and models including their linking) and the phases and steps of the IA procedure (such as system, problem and scenario description, and the visualization of results).

Results

A summary of the results of the evaluation for the different framework components and the IA steps is provided in Table 1, whereas detailed information can be obtained from Ewert *et al.* (2009). A high level of flexibility has been achieved for most framework components. For some components, e.g., the indicator framework the flexibility to change this or add new frameworks is still limited, which may be subject to future development. Importantly, we show that improving the flexibility of IAM requires flexibility in model linking but also a

Table 1. Achieved degree of flexibility in SEAMLESS-IF for selected IA steps and framework components.

IA step / framework component	Characteristics	Degree of flexibility
System description	Spatial and temporal extent and resolution	Flexible
Problem and scenario description	Defines policies, farm characteristics, changes in external conditions and indicators	Flexible
Indicator framework	Considers four classifiers such as level of organization, environmental and economic goals, etc.	Limited
Indicator library	Organizes indicators according to the indicator framework characteristics	Very flexible
Database	Database of all model inputs and outputs including indicators and assessment results	Very flexible
Model linking	Linking of models available in SEAMLESS-IF and considered in the SEAMLESS-IF ontology	Very flexible
Visualization of results	Presentation and evaluation of results in form of tables, graphs, maps.	Flexible

generic set up of all IA steps. This includes the problem and scenario definition, the selection and specification of indicators and the indicator framework, the structuring of the database, and the visualization of results. A very important aspect is the flexibility to integrate, select and link data, models and indicators depending on the application. For instance, the linking of cropping and farming system models allows consideration of a range of crop successions, crop management options and their combinations which was not possible in earlier frameworks. Technical coupling and reusability of model components are greatly improved through adequate software architecture (with SEAMLESS-IF using OpenMI) and the use of ontology strongly supports the conceptual consistency of data-model-indicator linkages.

Conclusions

We demonstrate that the proposed framework enhances flexibility in IAM and that it is a good basis to further improve integrated modelling for policy impact assessment in agriculture. The presented framework has also limitations which require further development, e.g., the integration of new models (which requires specific programming expertise) or the propagation of model uncertainties (which requires a close link to the end-users). Also, the scientific basis for linking models across disciplines and scales is still weak and needs specific attention in future research. Importantly, enhancing flexibility can have negative trade-offs affecting model performance, quality of simulation outcomes and framework understanding and transparency. Accordingly, finding the right balance between specific and generic model solutions is crucially important when trying to improve flexibility in IAM.

References

- Ewert, F., *et al.*, 2008. Environmental Science & Policy. (in review)
 Van Ittersum, M.K., *et al.*, 2008. Agricultural Systems 96: 150-165.

Choose complexity: How to bundle knowledge in Integrated Assessment Tools? Comparing implicit knowledge integration in SENSOR and PLUREL

K. Fricke, K. Helming, S. Sieber
Leibniz-Centre for Agricultural Landscape Research e.V., Eberswalder Str. 84,
15374 Müncheberg, Germany
Contact: katharina.fricke@zalf.de

Introduction

In the frame of sustainability impact assessment, tools for decision support are required that facilitate the ex-ante assessment of land use and planning decisions on the multifunctional performance of rural land use as well as of rural-urban linkages. Here, the FP6-founded project SENSOR is developing Sustainability Impact Assessment Tools (SIAT) to analyse European policy options related to rural land use, while the project PLUREL aims inter alia at developing a Sustainability Impact Assessment Tool Kit for Rural-Urban Regions (SIAT-RUR) to display policy impacts on rural-urban linkages at European level. Both Integrated Projects (IPs) face the challenge of integrating interdisciplinary knowledge such as land use, socio-economics, environmental economics and landscape research.

Methods

This paper focuses on the knowledge integration in both tools while outlining end user requirements towards its domain structure, design and architecture. Taking into account the differences in the conceptual modelling approaches that reflect the altering prerequisites of the two projects, both tools follow a comparable approach. SIAT is a scenario-driven meta-model based on response functions describing relations between (1) policy options and land use changes and (2) land use changes and sustainability indicators. These response functions are derived from existing economic and environmental models as well as expert-driven knowledge rules at national and regional level. Building upon this analytical design of the SIAT, the SIAT-RUR (1) anticipates consequences of selected global driving forces and European policies on rural-urban land use types and (2) analyses how they affect social, economic and environmental services and functionalities of the rural-urban regions. The latter tool will support policymakers, scientists and interested lay persons in analysing urbanization processes and trends in European regions, and will provide especially policymakers with support in the development of strategies for a better guidance of these processes.

A systematic approach is developed to handle, focus and if necessary reduce the complexity of the interdisciplinary knowledge integrated into these tools in order to improve their performance and acceptance and thus their usability for discussion support (compare Figure 1). Thus, the research question focuses on the level of explicit and implicit knowledge of integrated Impact Assessment and its application in tools. This approach is derived from the exemplary frameworks of both IPs and tested towards its general transferability concerning a thematic shift in the initial question of these tools. Hereby, special regard is paid to the concepts of handling complexity and their appliance in the conception phase of decision support tools as well as the end user requirements towards these tools.

Here, the focus is to develop an approach that minimizes the complexity by both reducing input variables and nevertheless handling complexity of the integration of interdisciplinary knowledge fields. This has to be regarded already in the development process of meta-models for the sustainability assessment of land use changes and relevant land use policies in European regions. Merely then tools can facilitate end users to select the suitable tool for their particular needs are deduced. First of all, the developed approach focuses on retrieving the requirements on the content and the needed performance of the tools. Subsequently, the

complexity of a broad variety of different input variables that are necessary to assess the impacts consistent to different spatial scales is reduced. While maintaining the overall transparency, the inherent knowledge of the decision making process is incorporated as implicit knowledge. Meanwhile, the differentiating requirements of end users, stakeholders and scientists accompany the development of these Impact Assessment Tools in participatory processes.

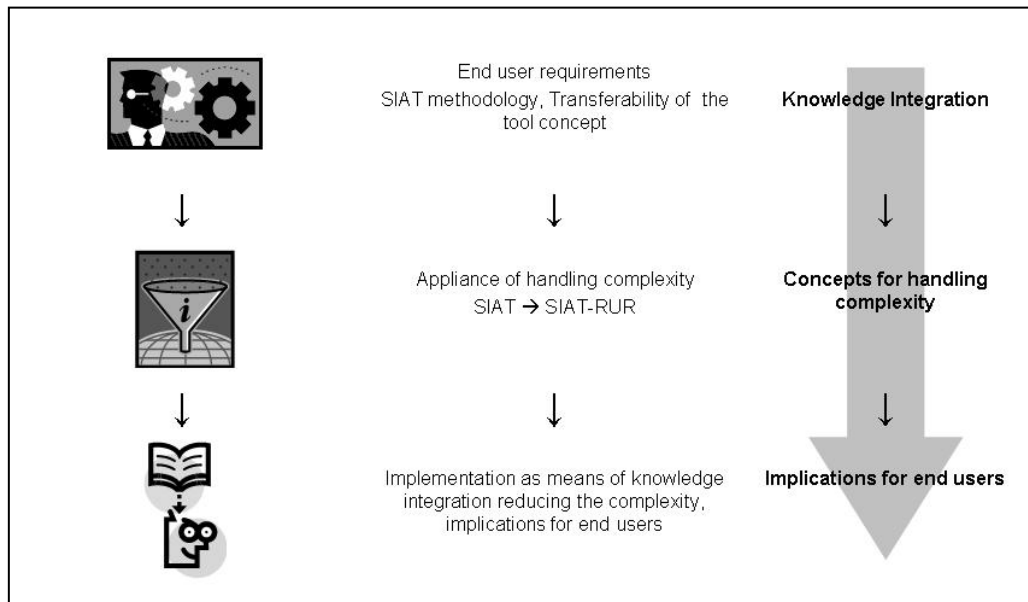

Figure 1. Central thread of how to bundle complex information in SIA-Tools for end users.

Results and discussion

The paper analyses the conceptual approaches towards the SIAT and the SIAT-RUR taking into account the different requirements concerning the content and the functionality of the tools. A reliable and satisfying way of knowledge integration reduces the complexity of the interdisciplinary cognition. Accordingly this ensures a distinguished user-friendliness of a SIA-Tool while considering requirements and options for meta-information and structures. This methodology to integrate interdisciplinary knowledge is regarded as a systemic approach to handle the complexity in such tools and to enable the transferability of general tool concepts. The implementation of an overall and transferable concept of knowledge integration in tools such as SIAT and SIAT-RUR is seen as useful concept of handling the complexity for stakeholder and end user discussions and therefore support these interest groups in choosing the right tool.

References

- Helming, K., *et al.*, 2008. In: Eds K. Helming, *et al.*, Sustainability impact assessment of land use changes. Springer, pp. 77-105.
- Sieber, S., *et al.*, 2008. In: Eds K. Helming, *et al.*, Sustainability impact assessment of land use changes. Springer, pp. 107-128.

Swiss Agricultural Life Cycle Assessment (SALCA): An integrated environmental assessment concept for agriculture

G. Gaillard, T. Nemecek

Agroscope Reckenholz-Tänikon Research Station ART, CH-8046 Zurich, Switzerland

Contact: gerard.gaillard@art.admin.ch

Objectives and rationale

The need for an environmental assessment of agricultural activities has been dramatically increased during last years. The most important stakeholders in agriculture (farmers, authorities, food and energy industries, NGO's) require different environmental information and tools for their own purposes and according to their own context (farm management tool, sector monitoring, food chain management, citizen and consumer information). Since often the needs concern the same objects (e.g., a specific crop) and require a common background (system analysis, data), it becomes clear for the practitioner that he has to look for synergies between these different applications of agricultural environmental know-how. Instead of developing a large number of tools in order to cover all types of applications (a tool for national policy, a tool for food industry, a tool for farm management and so on), respectively instead of separately developing modules of environmental assessment (here a database, there a method for biodiversity, and other where an environmental communication tool), a general concept is required integrating method, data and tools in order to deal with the increasing demand in an efficient way. Considering this challenge, we developed the SALCA (Swiss Agricultural Life Cycle Assessment) integrated concept with the objective of performing a comprehensive environmental assessment for a large variety of agricultural systems.

SALCA

SALCA consists of the following components:

- *Database* for life cycle inventories for agriculture.
The database is developed in close co-operation with *ecoinvent* (especially regarding data format and quality criteria), which makes the agricultural inventory data compatible with all the other economic sectors. In this way, we developed a consistent set of Swiss, European and American inventory data which is easily available for all interested people (Nemecek & Kägi, 2007). Regarding agricultural production data, the close collaboration with FADN (Farm Accounting Data Network) services supported by a network of 200 farms allows us to grant the required representativeness for Switzerland (Alig *et al.*, 2008).
- *Models* for the calculation of direct emissions from field and farm. The non-linearity inherent to agricultural processes requires for a credible environmental assessment the consideration of specific models for direct emissions. Together with environmental scientists in their respective discipline, we developed or adapted models for the most current emissions encountered in agriculture and for some of them a separate documentation is available online: Nitrate (Richner *et al.*, 2006), phosphorus (Prasuhn, 2006), heavy metals (Freiermuth, 2006).
- *A selection of impact assessment methods*. The impact assessment methods developed by the scientific community mostly are not focused on agriculture. A major support is to assess and select a set of impact assessment methods appropriate for agricultural applications. As an example a systematic comparison of 7 methods proposed in Europe for assessing the eco- and human toxicological impact was performed with a focus on the pesticide active ingredients (Kägi *et al.*, 2008).
- *Methods for the assessment of impacts on biodiversity and soil quality*. There is enough evidence that the restriction to the usual impact categories (like energy, greenhouse warming potential or eutrophication) does not enable a correct consideration of all

environmental impacts of agricultural activities. For these reasons and for a Mid-European context of application, we developed two methods in order to cope with the environmental impacts commonly summarized under the expression 'land use': SALCA-biodiversity (Jeanneret *et al.*, 2006) and SALCA soil quality (Oberholzer *et al.*, 2006).

- *Calculation tools* for agricultural systems (farm, annual crop, perennial crop). The repetition of similar cases together with a coherent system analysis required for consistent comparisons (e.g., at crop rotation level, between farm types) the development of calculation tools for some archetypical cases (such as farm, crop) based on a commercial LCA (Life Cycle Assessment) software. Furthermore, an overall assessment requires the integration of tools especially developed for direct emissions and impact assessment in a consistent way allowing a precise calculation under consideration of complex interfaces (Nemecek *et al.*, 2009).
- *Interpretation schemes* for agricultural LCA. Especially for stakeholder not currently dealing with environmental information like delivered by LCA, it is central to integrate environmental results delivered by the tools in such a way that they can be used by the stakeholder. An example of it is the interpretation and communication concept for environmental farm management (Alig *et al.*, 2008).

Analysis and conclusion

The close link of all these components proved to be efficient in many ways and is being tested with success in different countries (Switzerland of course, but also France, Japan and several European countries in the frame of European research projects). Major advantages are:

- Knowledge developed for one specific application and user is available in short delays for all other types of application and users
- Consistency is granted over all applications of SALCA according to a coherent set of quality criteria
- Development costs are minimized due to a modular re-use of the SALCA components.

Based on the SALCA experience, we are convinced that efficient environmental tools require such an integrated approach to meet the challenges of satisfying the very different needs of agricultural stakeholder – farmers, industry, state and consumers – with the required quality.

References

- Alig, M., *et al.*, 2008. LCM in agriculture: How to communicate? Proceedings of the European SETAC conference.
- Freiermuth, R., 2006. Heavy metals. <http://www.art.admin.ch/themen/00617/00785/index.html?lang=en>
- Jeanneret, P., *et al.*, 2006. <http://www.art.admin.ch/themen/00617/00785/index.html?lang=en>
- Kägi, T., *et al.*, 2008. Multicriteria comparison of RA and LCA toxicity methods with focus on pesticide application strategies, submitted to LCAFood08 Conference Proceedings.
- Nemecek, T. & T. Kägi, 2007. Life Cycle Inventories of Agricultural Production Systems. Final report ecoinvent V2.0 No. 15. Agroscope Reckenholz-Taenikon Research Station ART, Swiss Centre for Life Cycle Inventories, Zurich and Dübendorf, CH, online at: www.ecoinvent.ch.
- Nemecek, T., *et al.*, 2009. AgSAP Conference, these proceedings.
- Oberholzer, H.R., *et al.*, 2006. <http://www.art.admin.ch/themen/00617/00785/index.html?lang=en>
- Prasuhn, V., 2006. <http://www.art.admin.ch/themen/00617/00785/index.html?lang=en>
- Richner, W., *et al.*, 2006. <http://www.art.admin.ch/themen/00617/00785/index.html?lang=en>

Linking agricultural pollution to receiving waters using OpenMI

L. Khanh Hoang, S. Van Griensven, J. Cools, L. Benedetti, A. Mynett
 Department of Hydroinformatics and Knowledge Management, UNESCO-IHE,
 P.O. Box 3015, 2601 DA Delft, The Netherlands
 Contact: hnklinh@yahoo.com

Introduction

The EU Water Framework Directive (WFD) has introduced a new approach in water resources protection in which there is a change from focusing on the control of point sources of pollution (emission-based regulations) to integrated pollution prevention at river basin level and setting water quality objectives for the receiving water (immission-based regulations). This new policy requires the integration of all water quality issues, related to both point and diffuse pollution sources, at river basin scale. With this new approach, it is necessary to integrate catchment modelling (which aims at estimating the flows of water and pollutants released from a draining catchment into the receiving water) with modelling of water quality processes in the receiving water. Due to the past and present efforts in waste water treatment for industries and households, agricultural pollution is becoming the major concern, being often to the main cause of nitrification and eutrication of water bodies.

Methodology

This study aims at integrated catchment modelling using the Soil and Water Assessment Tool (SWAT; Arnold *et al.*, 2002) by linking it to several river model software (WEST[®], SOBEK) of different complexity, using the Open-MI model integration framework (Gregerson *et al.*, 2007). SWAT was made Open-MI compliant by converting the model engine into a component (Getnet, 2008). A comparison of the different river modelling software is done based on performance before and after calibration, on flexibility and applicability.

The chosen case study is the Grote Nete river basin (Belgium) in which there are pollution problems from agriculture and from households and industries which directly discharge wastewater to the river. Several scenarios with the aim at improving the water quality in the Grote Nete river are evaluated with the models. A comparison is made by comparing the curve of pollutant source reduction versus receiving water quality obtained for each river model.

Discussion and results

There is a large difference in concepts and process description for river water quality modelling (Table 1). A proper selection is therefore required.

Model integration through software such as Open-MI (Figure 1) is a good development and allows for a case and problem dependent choice of the most appropriate software for each subsystems. While Open-MI helps to tackle the technical aspects of water quality models, this is not the most critical problem. Differences in concepts, description of variables, differences in discretization between models are more difficult to overcome.

Table 1. comparison of the river water quality models.

	SWAT	WEST	SOBEK
Hydraulic routing	Variable storage Muskingum method	Continuous stirred tank reactors in series	1D Saint Venant equation
Water quality	Qual2E	RWQM1	DELWAQ
OpenMI integration	Water quantity and quality done	Ongoing	Water quantity done, water quality ongoing

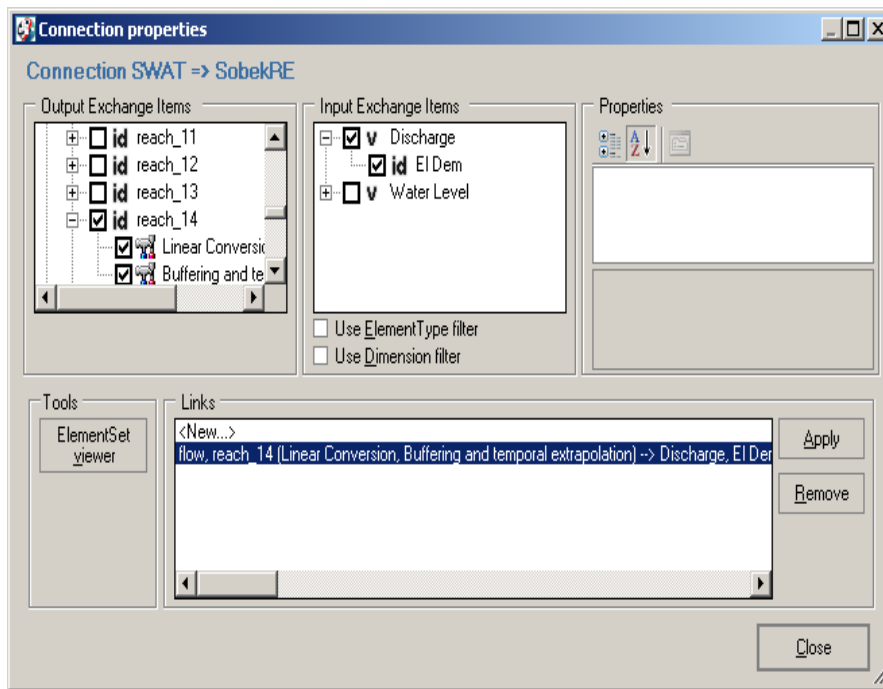

Figure 1. OpenMI configuration editor link property from SWAT to SOBEK-RE model.

The integrated model between SWAT and WEST is built by linking the catchment modelling SWAT and river model using WEST. SWAT provides result of flow and pollutant from draining catchment as the input for river model in WEST which then uses continuous stirred Tank Reactors (CSTRs) in series approach as routing method. Figure 2 shows the comparison of flow simulation between integrated model SWAT_WEST and SWAT which uses Muskingum routing method.

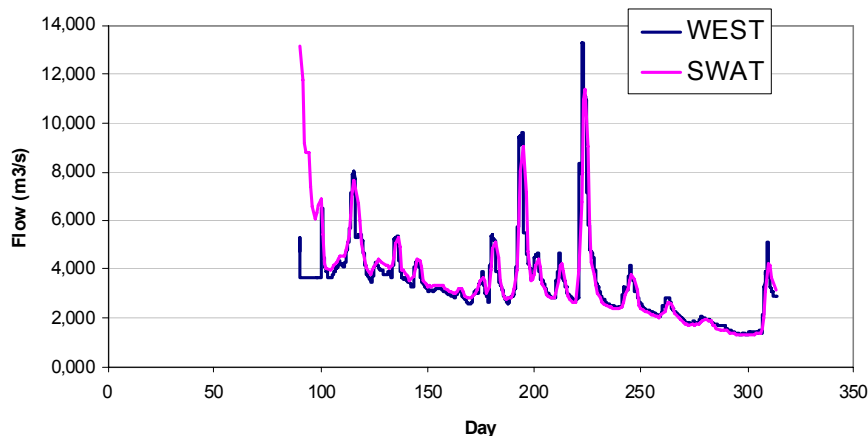

Figure 2. Comparison of flow simulation between SWAT and SWAT-WEST.

References

- Arnold, J.G., *et al.*, 2002. Soil and water assessment tool, theoretical documentation, Grassland, soil and water research laboratory - Agricultural Research Service, Texas, US.
- Getnet, D.B., 2008. Integrated Sediment Transport Modelling using Open-MI (SWAT and SOBEK-RE) for the Blue Nile river basin. MSc thesis Water Science and Technology, IHE Institute for Water Education.
- Gregerson, J.B., *et al.*, 2007. Journal of Hydroinformatics 9: 175-191.

A methodological framework for sustainability impact assessment of land use policies in developing countries: Re-using and complementing approaches

P. Reidsma, H. König, S. Feng, I. Bezlepkina, H. Van Keulen,
M.K. Van Ittersum, F. Brouwer
Plant Production Systems, Wageningen University, P.O. Box 430,
6700 AK Wageningen, The Netherlands
Contact: pytrik.reidsma@wur.nl

Introduction

Enhancement of sustainable development is an important issue in developing countries. Land use patterns and land use changes are considered critical to sustainable development. To improve systematic knowledge on the impact of land use policies on sustainable development in developing countries, a methodological framework is developed in the LUPIS project (www.lupis.eu). The framework builds on knowledge and tools developed within a European context in two integrated projects SENSOR (www.sensor-ip.org; Helming *et al.*, 2008) and SEAMLESS (www.seamless-ip.org; Van Ittersum *et al.*, 2008). The SENSOR methodology develops *ex-ante* impact assessment tools at regional scale for EU policies related to land use, with a focus on cross-sectoral trade-offs and sustainability side-effects. The SEAMLESS methodology concentrates on the agricultural sector and targets at assessing agricultural and environmental policies and technological innovations at multiple scales.

The goal of this paper is to present the LUPIS framework through an illustration of the case study in China, where the land use problem considered is the water pollution in Taihu Lake Basin. Re-using the methodologies developed in the SENSOR and SEAMLESS projects allows realization of the dual objectives of the LUPIS project: (1) test the applicability of European approaches in the context of developing countries and (2) analyse, for several case study countries (including China, India, Indonesia, Mali, Kenya, Tunisia and Brazil), the impacts of land use policies on a specific land use problem and sustainable development of the selected region.

Methodological framework

The LUPIS methodological framework enables the complementary use of the methodologies from SENSOR and SEAMLESS, and of additional tools, for assessment of land use policies and sustainable development in developing countries (Reidsma *et al.*, 2008). Since the interest is on *ex-ante* assessment, modelling tools that can be used for simulations are core elements of the LUPIS framework. Models can be complex mathematical models, with high data requirements, simple models that are easy to parameterize, and/or knowledge rules as used in SENSOR. To structure the analysis, the methodological framework for sustainability impact assessment (SIA) considers three phases, like SEAMLESS (Figure 1). The first phase, pre-modelling, deals with problem analysis and the selection of indicators. In the second phase, modelling, the impacts of policies on indicators are assessed. The selected set of assessment tools can vary for the various case study sites, in dependence of data and model availability. In the last phase, post-modelling, the impacts of policies on sustainable development are evaluated, through an assessment and aggregation of indicators.

As part of the LUPIS framework, a common indicator framework is developed that guides the selection of environmental, economic, social and institutional indicators, and specifies procedures to aggregate single indicators. Following the SENSOR methodology, Land Use Functions are used as a processed illustration of aggregation of single indicators that are tailored to assess goods and services associated with land use (Pérez-Soba *et al.*, 2008). Both,

LUFs and single indicators are evaluated for sustainable development in the post-modelling phase.

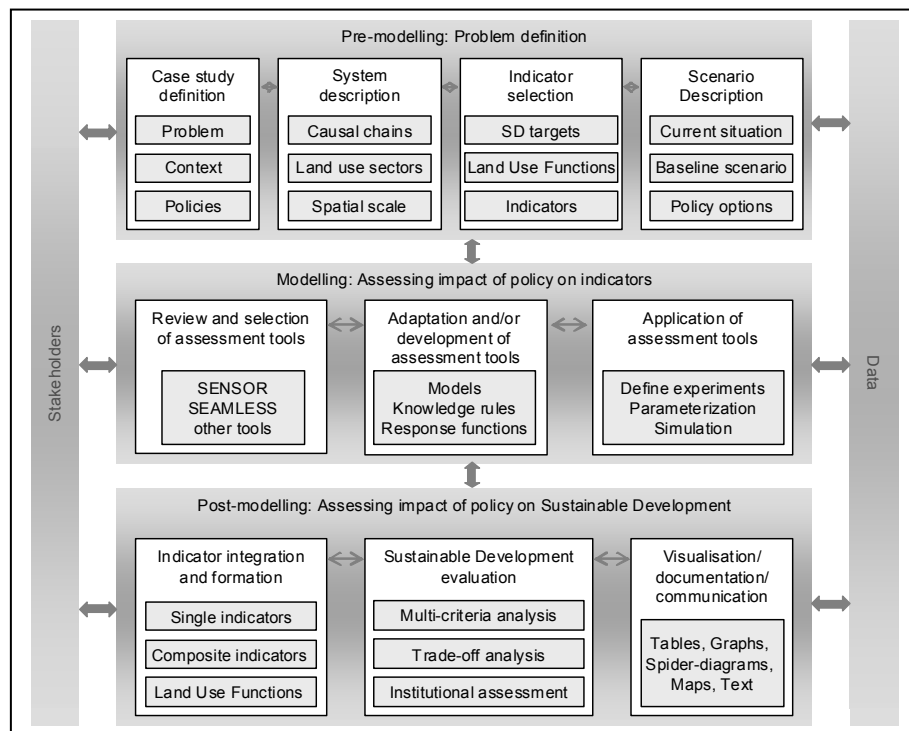

Figure 1. Methodological framework for SIA in LUPIS case studies.

Discussion and conclusion

A first evaluation of the framework for the various LUPIS case study regions has indicated that it is impossible to indiscriminately re-use the modelling frameworks that are being developed in SEAMLESS and SENSOR within LUPIS. In China, the main focus is on the development of bio-economic models at farm and regional scale to assess the impact of policies and technological innovations in the agricultural sector on reducing water pollution and sustainable development at large. The generic model developed in SEAMLESS (Louhichi *et al.*, 2007) is used as a basis, but needs adaptation for case study specific issues. These can partly be based on other models developed for application in South-east Asia. Other drivers of water pollution, such as industry and domestic sewage, and related indicators will be assessed with knowledge rules to complement the SIA.

Hence, the SEAMLESS and SENSOR models and other tools are viewed as a set of methodologies, from which can be selected for application in non-EU contexts, and which can be complemented by other approaches. As the framework is generic and flexible, the main procedures as depicted in Figure 1, are considered to match all LUPIS case studies.

References

- Helming, K., *et al.* (Eds), 2008. Sustainability Impact Assessment of Land Use Changes. Springer, Berlin.
- Louhichi, K., *et al.*, 2007. PD 3.3.11, SEAMLESS Integrated project.
- Pérez-Soba, M., *et al.*, 2008. In: Sustainability impact assessment of land use changes, Ed. K. Helming, *et al.*, Springer, Berlin, pp. 375-404.
- Reidsma, P., *et al.*, 2008. D4.1, LUPIS Integrated Project, Wageningen.
- Van Ittersum, M.K., *et al.*, 2008. Agricultural Systems 96: 150-165.

From models to indicators: Ontology as a knowledge representation system

O. Therond, N. Turpin, S. Janssen, I.N. Athanasiadis, M.J.R. Knapen, C. Bockstaller,
J. Alkan Olsson, F. Ewert, I. Bezlepkina
INRA, UMR 1248 AGIR, F-31326 Castanet Tolosan, France
Contact: Olivier.Therond@toulouse.inra.fr

Introduction

Evaluation of policies requires targeted and systematic approaches to assess their economical, environmental and social impacts at a wide range of scales. Integrated Assessment and Modelling (IAM) (Parker *et al.*, 2002) has been proposed as a method to *ex-ante* assess indicators for such policy impact assessment. In IAM these indicators have to be linked to model outputs and to user-relevant concepts, like scale and indicator framework and dimension.

Among the various IAM tools currently developed, SEAMLESS-IF has been built as a joint effort of thirty partners and their researchers (ca 150), each of them providing specific knowledge in his own discipline (Van Ittersum *et al.*, 2008). In the course of such tool development crossbreeding between different scientific knowledge is necessary as each discipline uses with its own way notions and concepts that sound similar, like resource efficiency, profitability, productivity, environmental soundness or social viability. For IAM projects, no explicit procedure was found in literature to homogenize meaning across concepts, scales and disciplines. To solve this problem of multitude of meanings for indicators and the related concepts, the SEAMLESS project developed an indicator ontology i.e. a finite list of concepts and the relationships between these concepts. This indicator ontology shared by all scientists from various disciplines and backgrounds working on an integration task, serves as a knowledge-level specification of the joint conceptualization (for more information on the ontology concept and objectives see Janssen *et al.*, 2009) and enabled implementing indicators in the IAM platform. The ontology supports and facilitates the communication of complex concepts needed to define, present, compute and displays social, economical and environmental indicators at the wide range of scales investigated by SEAMLESS-IF. This paper describes the ontology for indicators as developed in the SEAMLESS project and the process of ontology development.

Methods

Impact indicators in SEAMLESS are primarily based on modelling chain outputs. The development of such indicators necessitated a strong iterative and structured interaction between indicators, database, models and software developers as well as tool evaluators. The indicator development and implementation work started from a literature study on sustainability indicators and frameworks, evolved through the development of the indicator ontology, the definition of indicators that can be computed by the SEAMLESS modelling chains and the needed scaling procedures and other post-modelling processing. It resulted in implementing the SEAMLESS indicator tools offering all the services necessary to manipulate impact indicators for policy impact assessment focusing on the agricultural systems. The developed work steps were accompanied by a cyclical evaluation-improvement procedure involving most of the different type of developers.

Results and discussion

The specific SEAMLESS indicator ontology allows:

- To define 'Indicator Group' i.e. an indicator impact-oriented family grouping together a set of indicators providing information on the same impact but at different scales (Bockstaller *et al.*, 2009). This indicator group allows highlighting links between indicators presenting

different spatial and/or temporal extents but providing information on the same process (e.g., the nitrate leaching group brings together the Nitrate leaching in kg N-NO₃ ha⁻¹ y⁻¹ at field and farm level and the share of the area with nitrate leaching over a given threshold computed at landscape or regional level).

- For each indicator group to have a specific link to an indicator group fact sheet describing all the characteristics of the indicators (purpose, impact, described processes, scales, detailed description of calculation, information needed for interpretation, possibilities of up-scaling/aggregation and evaluation of the indicator).
- To establish the location within the so called Goal Oriented Framework (GOF) of each indicator (Alkan Olsson *et al.*, 2009). The GOF aims at guiding the user in the selection of indicators, preventing him from focusing on a single issue, and facilitating the communication between researchers and policy experts related to different sustainability dimensions.
- To define thresholds as reference value to interpret the indicator value.
- To highlight indicator tradeoff i.e. a relation of antagonism between different indicators.
- To define the model output used to compute the indicator and by this way the functional link between indicator and the modelling chains.
- To identify the list of intermediate variable of the modelling chain necessary to interpret and understand the causality chain lying behind the indicator values.
- To describe the spatial and temporal resolution and extent of each indicator (i.e the investigated process scales and the policy decision scales).

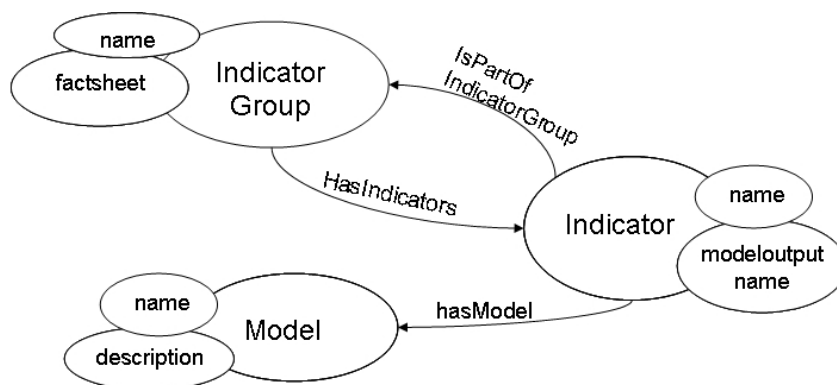

Figure 1. the concepts IndicatorGroup, Indicator and Model (large ellipses), with some of the attributes (small ellipses) and the relationships between them (arrows with name).

There are many indicators databases around the world¹ where indicator ontologies include metadata and semantic interoperability between the various indicators. The main specificity of the SEAMLESS indicator ontology is to allow implementing sustainability indicators in an IAM platform. This ontology structures all the knowledge and data in relation to indicators, so that an indicator, in a transparent and explicit way, can be linked to the relevant modelling chain outputs, be selected, assessed and displayed using the specific IAM tools and be enriched with all the user-oriented information necessary to perform well qualified policy impact assessment. The indicator ontology is a separate product of the SEAMLESS research project and can now be reused in other research projects working with indicators and models.

Reference:

Alkan Olsson, J., *et al.*, 2009. Environ. Sci. and Pol. (in review)
 Bockstaller, C., *et al.*, 2009. AgSAP Conference 2009, these proceedings.
 Janssen, S., *et al.*, 2009. Environmental Modelling and Software. (in review)
 Parker, P., *et al.*, 2002. Env. Mod. & Soft. 17(3): 209-217.
 Van Ittersum, M.K., *et al.*, 2008. Agricultural Systems 96: 150-165.

¹ For a recent survey and an operationalized ontology, see <http://www.sdi.gov/>

Theme B
State-of-the-art of components for integrated systems

**Session B1: Large scale integrated policy assessment:
Tools and applications**

Session organizer:

Thomas Heckelei
University of Bonn, Germany

Impacts of EU biofuels directives on global markets and EU environmental quality: An integrated PE, global CGE analysis¹

Wolfgang Britz, Thomas Hertel
Nussallee 21, 53229 Bonn, Germany
Contact: Wolfgang.Britz@ilr.uni-bonn.de

Overview

Both the EU and the US have implemented biofuel mandates with the aim of reducing their dependency on fossil fuels while simultaneously abating Green House Gas (GHG) emissions. However, recent studies (Searchinger *et al.*, 2008; Fargione *et al.*, 2008) have questioned the value of these mandates for reducing global warming. These studies have emphasized the important role of indirect Land Use Change (iLUC) in increasing GHG emissions associated with first generation biofuels. The basic idea is that the diversion of agricultural products into the energy economy will induce crop land conversion, as additional land is brought into production in order to meet the rather price-inelastic global demand for food. If these converted lands are high in carbon content such as tropical forests or peat bogs, then the net impact of the biofuels programme on GHG emissions may be adverse. Indeed, in the case of corn ethanol produced in the US, Searchinger *et al.* (2008) suggest that GHG emissions could even double, when compared to the continued use of petroleum products. While their analytical framework is relatively simple, these papers make a compelling case for considering iLUC in any assessment of the environmental impacts of biofuel mandates. Accordingly, these mandates have now included provisions restricting the renewable fuel standards to biofuels which meet minimum GHG reduction standards. For example, the 2007 US Energy Act requires that incremental corn ethanol contribute to at least a 20% reduction in GHG emissions, relative to petroleum products. This, in turn, has generated a great demand for studies of iLUC and biofuels. The California Air Resources Board has similar guidelines for biofuels to qualify for the Low Carbon Fuel Standard.

The studies of iLUC have included both partial equilibrium (OECD, 2008; Tokgoz *et al.*, 2008) and general equilibrium analyses (Keeney & Hertel, 2008; Banse *et al.*, 2008). Each of these approaches has its strengths and limitations. The partial equilibrium studies typically offer greater commodity detail, while the general equilibrium studies are better at capturing the linkages between the farm and non-farm sectors – in particular the energy sectors in the case of biofuels, and they also include explicit competition for land between agricultural and other uses. In the present paper, we develop a methodology for linking partial with general equilibrium models in order to capitalize on the strengths of each approach. We focus particularly on the impacts of EU biofuels programmes on global land use and GHG emissions.

Methods

Biofuels mandates provoke simultaneous adjustments in the markets for both fossil fuels and agricultural raw products, and the ensuing effects will depend *inter alia* on the interplay with policy instruments in these markets. Subsidizing biofuel processing or production of biofuel feedstocks, to give an example, will reduce transport fuel prices and thus stimulate energy demand, whereas obligatory blending could increase fuel prices and depress demand. The effects on the overall economy thus depend on the method for implementation of the biofuel policy, which is why CGE models have been used to analyse this issue. The CGE model which we will build upon in this paper is GTAP (Hertel, 1997). In particular, we utilize the biofuels version of that model (Birur *et al.*, 2008), augmented with land use by Agro-Ecological Zones (Hertel *et al.*, 2009) and by-products (Taheripour *et al.*, 2008). This model

¹ Keynote presentation

has been widely used to establish the links between energy policies and global land use. However, its capability to model detailed agricultural impacts in the EU is limited – both due to commodity and regional aggregation (the GTAP model only includes national production functions – albeit augmented by sub-national Agro-Ecological Zones).

In contrast to their general equilibrium counterparts, agricultural partial equilibrium models profit from their specialized nature by offering more detail regarding dis-aggregation in space and products, as well as improved treatment of domestic agricultural policies. Often, their supply response is also judged more robust as their results had been validated over time years in different policy relevant applications. We hence enrich the general equilibrium, global analysis by integrating the CAPRI model of EU agriculture (Britz *et al.*, 2007), into the analysis. In order to achieve a mutually consistent supply behavior of GTAP and CAPRI; an aggregate, agricultural supply response for CAPRI is derived from the detailed, regional programming models of CAPRI. This multi-product crop revenue function provides the basis for communication between the two models and it is explicitly incorporated into GTAP.

Specifically, we utilize a normalized quadratic, revenue function, calibrated to the aggregated EU-wide Hessian obtained from the CAPRI model – aggregated from the 250 region-NUTS level to the level of the 18 GTAP AEZs associated with the EU-27. The modified GTAP model is then used to analyse the impacts of the (recently revised) 2015 EU biofuel mandates on global trade, production and global land use. Secondly, the changes in equilibrium agricultural product prices simulated by GTAP are subsequently used as a shock to CAPRI. CAPRI then simulates the resulting regional changes in farming practices driving by the price changes which in turn allow calculation of different environmental indicators, including changes to Global Warming emissions.

Anticipated results

Existing studies and analysis with CAPRI show that around 50% of the EU's 10% biofuel mandates would be covered by non-EU production, either directly by imports of biofuels or by changes in EU net-trade of biofuel feedstocks or their substitutes. The EU's changed net-trade status in these markets will provoke land-use changes in other regions of the world, and, as global demand increases, this will raise food prices, worldwide. Inside the EU, the shifts towards wheat replacing coarse grains, increasing rape seed shares and the increase in agricultural raw product prices lead to a higher intensity in agricultural practices, e.g., to higher mineral fertilizer applications resulting in a higher nutrient load. In addition, we expect fallow land and extensive fodder production on arable land to be reduced as a result of these mandates. Preliminary results from GTAP suggest that land cover change induced by EU policies may be particularly important in Brazil, Eastern Europe, Canada and Africa. Land cover changes will be disaggregated into net changes in cropland, grazing land and forestry and associated carbon fluxes will be reported based on the figures reported in Searchinger *et al.* (2008).

Selected references

- Banse, M., *et al.*, 2007. European Review of Agricultural Economics 35(2): 117-141.
Britz, W., *et al.*, (Eds) 2007. Description of the CAPRI Modeling System, Final report of the CAPRI-Dynaspat Project. Inst. for Food and Resource Economics, Univ. of Bonn.
Fargione, J., *et al.*, 2008, Land clearing and the biofuel carbon debt. Science 319 (5867).
Hertel, T.W., *et al.*, 2009. Chapter 6 in: Eds T.W. Hertel, *et al.*, Economic Analysis of Land Use in Global Climate Change Policy. Routledge. (forthcoming)
Keeney, R. & T.W. Hertel, 2008. GTAP Working Paper No. 52.
OECD, 2008. Biofuel support policies: An economic assessment. OECD, Paris.
Searchinger, T., *et al.*, 2008. Science 319 (5867): 1238-1240.
Tokgoz, S., *et al.*, 2007. <http://www.card.iastate.edu/publications/synopsis.aspx?id=1050>

Modelling global N and P surface balances: Implementation of the millennium ecosystem assessment scenarios

A.F. Bouwman, A.H.W. Beusen, G. Billen
Netherlands Environmental Assessment Agency,
P.O. Box 303, 3720 MA Bilthoven, The Netherlands
Contact: Lex.bouwman@pbl.nl

Introduction

Global population, food production, and energy consumption have increased approximately 2.5-, 3-, and 5-fold, respectively, during the past five decades (Grübler *et al.*, 1995; FAO, 2008). Through activities such as fertilizer use, fossil fuel consumption, and the cultivation of leguminous crops, humans have more than doubled the rate at which biologically available nitrogen (N) enters the terrestrial biosphere compared to pre-industrial levels (Galloway *et al.*, 2004). The global phosphorus (P) cycle has also been greatly altered by human activity. P production from rock phosphate and subsequent use as fertilizer, detergent, animal feed supplement and other technical uses has more than doubled P inputs to the environment over natural, background P from weathering (Mackenzie *et al.*, 1998; United States Geological Survey, 2008).

Method

This paper describes the implementation of the four Millennium Ecosystem Assessment (MA) scenarios (Alcamo *et al.*, 2006) for 2000–2050 to develop spatially explicit global N and P surface balances for agriculture and natural ecosystems. We implemented the data from the original MA work covering the period 2000–2050 in the IMAGE model (Bouwman *et al.*, 2006) to calculate the N and P surface balances and surpluses for nonpoint sources developed for the MA scenarios. The surface inputs are specified for natural ecosystems (with inputs from biological N₂-fixation and atmospheric N deposition) and agricultural systems (N and P fertilizers, animal manure, biological N₂-fixation by leguminous crops, atmospheric N deposition). We consider two output terms, i.e., crop nutrient export in harvested crop products and grass and hay consumption by grazing animals, and ammonia volatilization. We present the N and P surplus, which is an important indicator for the nutrient losses to the environment.

Discussion

The MA scenario storylines allow for describing contrasting future developments in agricultural land use, differences being related to the efficiency of nutrient use in agriculture. In one scenario oriented towards closing N and P cycles (pro-active approach), the overall global agricultural efficiency increases to values of 50% for N and 54% for P. In scenarios with a reactive approach to environmental problems, the efficiencies are somewhat lower (44% for N and 46–48% for P). The scenarios with a reactive approach to environmental problems show increases in agricultural N and P surpluses in all developing countries (Figure 1). In the scenarios with a proactive attitude, N surpluses decrease and P surpluses show no change or a slight increase, except for Africa where surpluses increase in all scenarios. In Europe and North America the N surplus will decline in all scenarios, most strongly in the environment-oriented scenarios; P surpluses decline (proactive) or increase slowly (reactive approach to environmental problems). In North Asia (Russian Federation) with strongly declining population in all scenarios, the N surplus shows slow or moderate changes, and P surplus will increase in globalization scenarios with strong economic growth and decrease in scenarios with regional orientation.

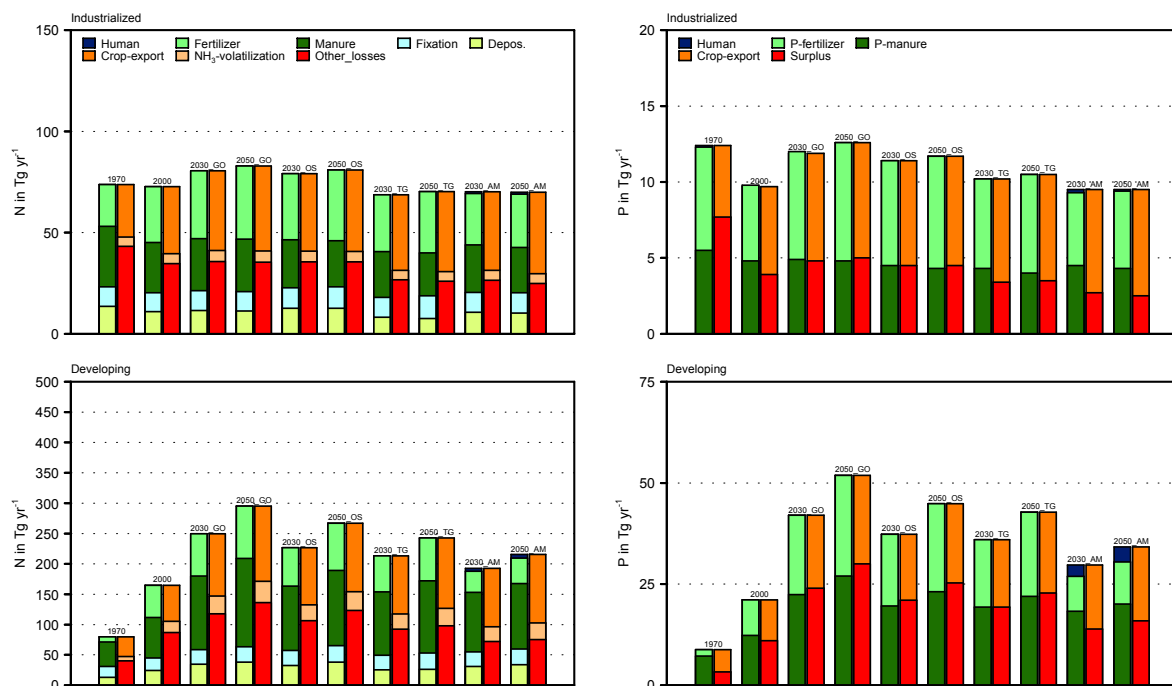

Figure 1. Surface N balance (panels on the left) and surface P balance (panels on the right) for industrialized (top) and developing countries (bottom).

References

- Alcamo, J., *et al.*, 2006. In: Eds S.R. Carpenter, *et al.*, Ecosystems and human well-being: scenarios. Island Press, Washington DC, pp. 279-354.
- Bouwman, A.F., *et al.* (Eds), 2006. Integrated modelling of global environmental change. An overview of IMAGE 2.4. Publication 500110002/2006, Netherlands Environmental Assessment Agency, Bilthoven, 228 pp.
- FAO, 2008. FAOSTAT database collections (www.apps.fao.org), Food and Agriculture Organization of the United Nations, Rome.
- Galloway, J.N., *et al.*, 2004. Biogeochemistry 70: 153-226.
- Grübler, A., *et al.*, 1995. Global energy perspectives to 2050 and beyond, World Energy Council /International Institute for Applied Systems Analysis, Laxenburg, Austria.
- Mackenzie, F.T., *et al.*, 1998. In: Eds J.N. Galloway & J.M. Melillo, Asian Change in the Context of Global Climate Change. Cambridge University Press, New York.
- United States Geological Survey, 2008. Mineral commodity summaries (<http://minerals.usgs.gov/minerals/pubs/mcs/>). Digital Data Series DDS-37, US Geological Survey.

Incorporating livestock in global integrated assessments of land use and agro-ecosystems services

M. Herrero, P.K. Thornton, M. Rosegrant, P. Havlik, S. Msangi, S. Fritz, H. Lotze-Campen, A. Notenbaert, A. Popp, B. Eickhout, C. Muller, J. Van de Steeg, D. Gerten, T. Sulser, C. Ringler, S. Wood, H.A. Freeman

International Livestock Research Institute, P.O. Box 30709-00100, Nairobi, Kenya

Contact: m.herrero@cgiar.org

Introduction

The World is changing at unprecedented rates due to a range of drivers such as increased human population, rural/urban migrations, income increases, dietary changes, climate change and others. These changes exert significant pressures on the use of resources, and at least in some places, they hamper the functioning of agro-ecosystems and affect several aspects of human well-being (nutrition, mortality, incomes and others). In the process, the poor become more vulnerable and the sustainability of ecosystems for future generations gets compromised. The last decades have seen a crop of forward looking integrated assessments that try to understand better these effects and to find solutions (policies, technologies, investments) to satisfy the global requirements of future food production, ecosystem functioning, poverty reduction and others. Notable examples of these assessments are the Millennium Ecosystem Assessment (MA, 2005), the Comprehensive Assessment of Water in Agriculture (CA, 2007), IPCC's Fourth Assessment Report (IPCC, 2007), GEO4 (UNEP, 2007) and the International Assessment of Agriculture, Science and Technology Development (IAASTD, 2008). Some of these have not considered livestock at all, or as explicitly as it is required in order to fully elucidate the impacts and contribution of livestock on the use of land and other resources, food security and other dimensions of human well being and ecosystems functioning. This is somewhat surprising considering that livestock systems are the largest land use system on Earth (Reid *et al.*, 2008) and that they play a key role in the livelihoods of many people around the World, especially the poor. This paper examines the key elements and feedbacks of livestock systems that could be included to improve integrated assessments of land use, agro-ecosystems services and human well-being.

Methods

We reviewed the main global assessments mentioned above and the tools and models they used. We identified gaps of where the key linkages with livestock were missing in these models and proposed the key aspects and ways of incorporating them for future assessments. This led to the development of a framework for incorporating spatially differentiated livestock systems, livestock numbers and productivities by species, management parameters and use of resources for use in a range of global integrated assessment models.

Results and discussion

Some key features of livestock systems that need to be incorporated in global integrated assessments are presented in Table 1. They all relate to dynamic aspects of livestock production, competition and trade-offs for resources, sometimes between systems and others with other sectors (i.e. water, grains), to the sustainability of ecosystems and to how they support humans (food). Including these important dimensions will allow us to understand the beneficial and negative aspects of global livestock production in the future, and to develop policies to ensure that livestock keeps having an important role in global food security and in the livelihoods of the poor.

Table 1. Some aspects of livestock systems that need to be represented in global integrated assessments.

Land use	Better estimates of global rangeland productivity. Rangeland composition and dynamics for assessing future change. Better estimates of carrying capacity of rangelands. Feed supply, both for monogastrics and ruminants.
Livestock productivity	Consumption of feeds by different species. Changes in the productivity of different species as genetics and feeding changes over time by production system.
Livestock numbers	Better understanding of what drives the spatial distributions of animals (ruminants, pigs and poultry). Feasibility of animal numbers in different systems due to resource constraints.
Water use by livestock	Water embedded in the production of feeds for different species and water intake by animals. Competition for water between livestock and other sectors.
Livestock systems and their changes	Improved definitions of livestock systems (i.e. industrial, mixed, pastoralist, etc). Systems transitions between pastoral and mixed systems due to intensification, service and technology provision and others. Systems transitions between mixed and industrial systems. Disaggregated food supply (milk, meat, others) from different systems. Intensification thresholds of livestock production. Environmental impacts in different livestock systems (excretions, etc).
Livestock and climate change	Animal species changes due to changes in environmental and production conditions. Mitigation measures for greenhouse gases. Feeding animals under different climate change scenarios.

References

- CA, 2007. Water for Food, Water for Life: A Comprehensive Assessment of Water Management in Agriculture. Ed. D. Molden, Earthscan, London, and IWMI, Colombo.
- UNEP, 2007. GEO4: Global Environment Outlook 4, Environment for Development. United Nations Environment Programme. Online at www.unep.org/GEO/geo4/
- IAASTD, 2008. The International Assessment of Agricultural Science and Technology for Development. Island Press, Washington DC.
- IPCC (Intergovernmental Panel on Climate Change), 2007. Climate Change 2007: Impacts, Adaptation and Vulnerability. Summary for policy makers. Online at <http://www.ipcc.cg/SPM13apr07.pdf>
- MA, 2005. The Millennium Ecosystem Assessment. Ecosystems and Human Well-being: Scenarios, Volume 2. Island Press.
- Reid, R.S., *et al.*, 2008. In: Eds K.A. Galvin, *et al.*, Fragmentation in Semi-Arid and Arid Landscapes. Springer, Dordrecht, The Netherlands, pp. 1-24.

What if not all land is created equal? The role of heterogeneous land when assessing the impact of trade liberalization on developing countries

Marijke Kuiper

International Trade and Development, Public Issues Division,
LEI, Wageningen UR, P.O. Box 29703, 2502 LS The Hague, The Netherlands
Contact: marijke.kuiper@wur.nl

Introduction

The impact of trade liberalization on developing countries has become a central topic in discussions on international trade in the context of World Trade Organization (WTO) negotiations. The GTAP database plays a prominent role in this debate by providing the basis for the great majority of international trade models. In this paper, we focus on one aspect of GTAP-based models: the modelling of land. Land is a key input in agriculture, which is the most important sector in terms of employment and foreign exchange earnings in many developing countries. In addition to the importance for developing countries, agriculture is also the most contested area in the current WTO negotiations. One reason is the relative high levels of current protection in agriculture compared to manufactured goods. This relatively high current level of protection also implies that global gains from liberalization of agriculture will be high (Hertel *et al.*, 2007). The way in which land is treated in trade models, therefore, appears crucial for understanding the impact of trade liberalization in developing countries.

The GTAP database distinguishes one type of land, next to two types of labour (skilled and unskilled), capital and natural resources. A casual look at the map already suggests that having a single type of land may not be well-suited for analysing the impact on developing countries. Most rich countries are located in the temperate zones, whereas developing countries are predominately found in the tropics. In this paper we explore whether the expected impact of trade liberalization on developing countries is affected by differences in land endowments. We hypothesize that developing countries have less productive land, implying that benefits from trade liberalization are less than expected based on currently used models with a single type of land.

Methodology

Our analysis relies upon a recent GTAP-compatible land use dataset containing data on land endowments, harvested area and yields by crop, agro-ecological zone and country. These data allow us to compute a yield by crop and agro-ecological zone. Ignoring for now differences between countries we can establish for each crop the agro-ecological zone with the highest yield. Normalizing the yields to range from 0 to 1 for the highest yield provides an overview of potential of each AEZ for the eight crops distinguished in the GTAP database (Figure 1). Figure 1 clearly indicates the variability in suitability for different crops with the tropical AEZs (AEZ 1–6) being less productive than those in the temperate zones (AEZ 7–12), supporting our hypothesis that developing countries may gain less from agricultural trade liberalization than commonly expected.

Given the prominent role of agriculture in our analysis we start from the GTAP-AGR model, a version of the GTAP model dedicated to analysing agricultural policy questions (Keeny & Hertel, 2005). Instead of defining production by AEZ we maintain a single production function by crop (as in GTAP-AGR) but redefine the single type of land as a land aggregate composed of land of different AEZs. We then add a nest to the production function to determine the composition of this land aggregate. By assuring that this land nest captures the productivity differences of land across AEZs we incorporate the same amount of information in the model as with defining production by AEZ (differences in yields across AEZs) without having an explosion of the model's dimensions.

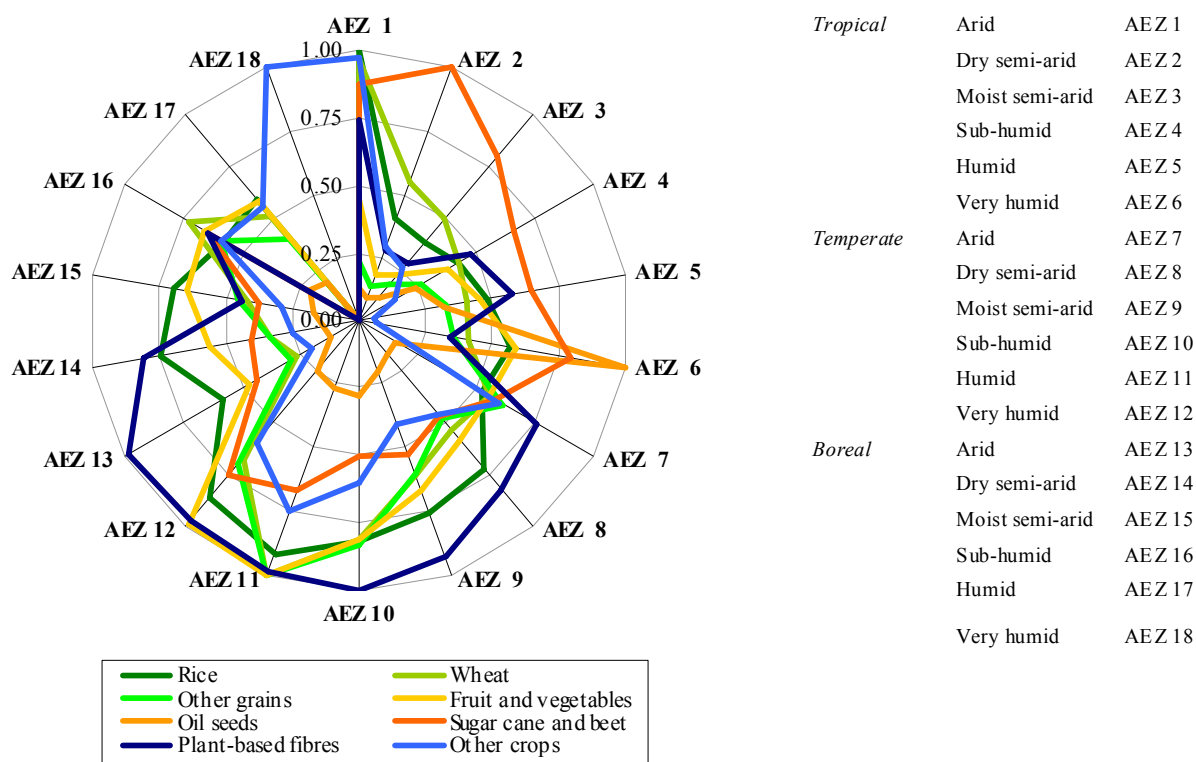

Figure 1. Normalized yields by GTAP crop and agro-ecological zone (AEZ).

First results

The aim of this study is to assess whether heterogeneity of land affects the expected impact of trade liberalization on developing countries. We, therefore, compare the results of the model including the productivity differences across AEZs (SEAMTAP) with the findings of GTAP-AGR. We also compare the impact of changing the standard assumption of full employment to presence of unemployment in all but the high income countries.

A first test run with the model reducing all tariffs by 25% results in a rather varied picture although with limited differences in total welfare between the models with and without productivity (between -0.9 and +1.6 percent point difference). Most country groups gain less when accounting for productivity of AEZs, with the exception of LDCs with moist/sub-humid land, middle income countries with arid/dry and moist/sub-humid land and high income countries with dry/arid land. These exceptions show an increase in their land productivity measure signalling a better match between crops and AEZs. Accounting for unemployment in developing countries changes welfare effects considerably: all developing countries see a welfare increase while all high income countries face a decline in welfare. Effects of accounting for productivity are less pronounced when unemployment is introduced in the model (between -0.2 and +0.8). The full results reported in the final paper will be based on a baseline projection to 2014 and 2020 and assess the impact of a realistic representation of the WTO negotiation results of July 2008.

References

- Hertel, T.W., *et al.*, 2007. *Economic Policy* 22(50): 289-337.
- Keeney, R. & T. Hertel, 2005. *GTAP-AGR: A Framework for Assessing the Implications of Multilateral Changes in Agricultural Policies* Technical Paper 24. Publisher, Purdue.

Integrated economic-environmental modelling for domestic policy development and assessment: The Canadian experience

Hugues Morand, George Achuo, Robert J. MacGregor, Alexandre Lefebvre
 930 Carling Ave., Floor 6, Room 689, Ottawa ON, Canada, K1A 0C5
 Contact: morandh@agr.gc.ca

Introduction

Understanding how changes to policies and programmes will impact the agricultural sector's economic and environmental performance is critical for the policy development and evaluation process (Junkins, 2005). Demand for this type of work continues to increase as Governments are expected to be accountable for achieving outcomes and demonstrate measured progress towards goals. Achieving this necessitates linking biophysical models to economic models (Lefebvre *et al.*, 2005). Under the National Agri-Environmental Health Analysis and Reporting Program (NAHARP), Agriculture and Agri-Food Canada (AAFC) has been developing an integrated economic – environmental modelling capacity to assess (*ex-post*) or predict (*ex-ante*) the combined economic and environmental impacts or effectiveness of proposed programmes and measures, and identify trade-offs in policy formulation. The presentation will: (1) provide an overview of this integrated system; (2) use *ex-ante* definition of regional environmental targets as an illustrative application for policy implementation; and (3) discuss challenges as well as more recent applications and developments.

Methods

The integrated modelling system uses an economic model to estimate changes in farm resource allocation (crops and livestock) relative to a baseline level for selected scenarios, and feeds this information into biophysical models to assess a suite of potential environmental impacts (Figure 1).

The economic model used is the Canadian Regional Agriculture Model (CRAM) which is a sector equilibrium, static, non-linear optimization model maximizing producer plus consumer surplus minus transportation costs (Horner *et al.*, 1992). CRAM is referred to as a positive mathematical programming (PMP) model (Howitt, 1995). The basic commodity coverage includes grains and oilseeds, forage, beef, hogs, dairy and poultry. Biofuels are a

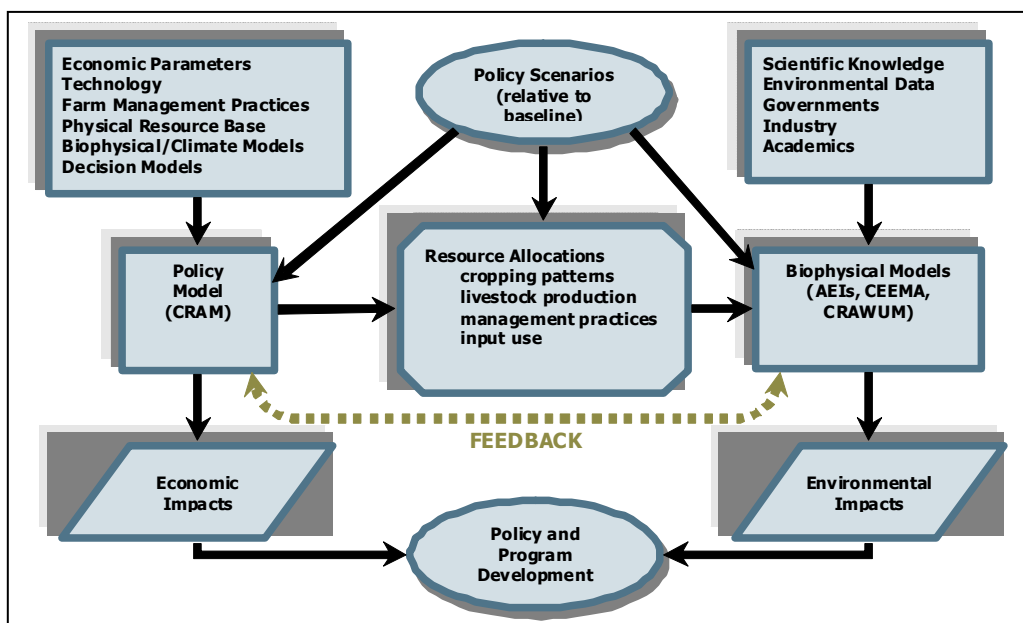

Figure 1. Integrated Economic – Environmental Modelling System.

recent inclusion in the model as a value added activity for grains and oilseeds. Spatially, CRAM covers 55 cropping regions based on Statistics Canada Census of Agriculture while provinces are the smallest spatial units for the livestock component of the model. CRAM runs with GAMS© and uses MINOS as its solver.

Depending on purposes and issues to be analysed, CRAM has been linked over the years to the following biophysical models: Environmental Policy Integrated Climate Model (EPIC); Agri-Environmental Indicators (AEIs); Canadian Economic and Emissions Model for Agriculture (CEEMA); and Canadian Regional Agriculture Water Use Model (CRAWUM). EPIC is a plant growth model which has been used to forecast yields to be integrated into CRAM to assess economic impacts of climate change. AEIs allow tracking progress of the sector in terms of environmental performance, and CRAM results are fed into AEIs to look at impacts of changes in production patterns on water, air, soil and biodiversity. Using CRAM outputs as inputs, CEEMA calculates greenhouse gas emissions from the agricultural sector using IPCC tier two coefficients. Finally, CRAWUM is aimed at assessing the total agricultural demand for water by sub-sectors and regions using CRAM irrigated areas and livestock activity levels.

Results and discussion

This modelling approach has been used in the analysis of possible strategies for mitigating GHG emissions from agriculture (Kulshreshtha *et al.*, 2002), developing environmental outcome targets for the Agricultural Policy Framework (APF) implementation agreements (Heigh & Junkins, 2004), estimating regional environmental impacts of agricultural trade liberalization (OECD, 2004), and most recently to estimate regional environmental impacts of a 5% biofuels mandate on all transportation fuel used in Canada.

Projects relying on this integrated modelling system which are currently underway include an *ex-post* assessment of APF with respect to initial targets, environmental assessments of business risk management programmes such as crop insurance and income stabilization programmes as well as cellulosic-based biofuels strategy, integrated analysis of adaptation to climate change, and assessment of the potential to enhance the provision of ecosystem services from the agricultural sector. Finally, in order to facilitate the use of AEIs by policy analysts and reduce the burden on scientists, a totally automated interface between CRAM and AEIs is being developed.

References

- Heigh, L. & B. Junkins, 2004. Quantitative Analysis of the Impact of Agricultural Management Strategies on Environmental Indicators. Agriculture and Agri-Food Canada, Ottawa, Ontario, Canada.
- Horner, G.L., *et al.*, 1992. The Canadian Regional Agriculture Model: Structure, Operation and Development. Policy Branch, Agriculture Canada, Technical Report 1/92.
- Howitt, R.E., 1995. American Journal of Agricultural Economics 77(2): 329-342.
- Junkins, B., 2005. In: Eds A. Lefebvre, *et al.*, Environmental Sustainability of Canadian Agriculture: Agri-Environmental Indicator Report Series – Report no. 2. Agriculture and Agri-Food Canada, Ottawa, Ontario, Canada, pp. 36-39.
- Kulshreshtha, S., *et al.*, 2002. Canadian Economic and Emissions Model for Agriculture (CEEMA 2.0): Technical Documentation, CSALE Working Paper no. 12, University of Saskatchewan, Saskatoon, Saskatchewan, Canada.
- Lefebvre, A., *et al.* (Eds), 2005. Environmental Sustainability of Canadian Agriculture: Agri-Environmental Indicator Report Series – Report no. 2. Agriculture and Agri-Food Canada, Ottawa, Ontario, Canada.
- OECD, 2004. Agriculture, trade and environment: Arable crops sector. Organisation for Economic Co-operation and Development, Paris, France.

Comparison of econometric techniques for deriving consolidated databases: The AGROSAM case

M. Müller, I. Pérez Dominguez, W. Britz, T. Heckelei
Institute for Prospective Technological Studies of the European Commission,
Seville, Spain
Contact: Marc.Mueller@ec.europa.eu

Introduction

Integrated policy impact assessment at Pan-European or global scale requires large-scale consolidated databases to feed economic or biophysical models or components. A key data set for economic analysis are social accounting matrices (SAM) which represent the monetary flows between productive sectors and institutions and thus may serve a large variety of quantitative tools, especially Computable General Equilibrium (CGE) models. However, the datasets underlying the SAMs, namely national Supply- and Use Tables (SUT) or symmetric Input-Output Tables (IOT), are typically highly aggregated by sectors and commodities and thus provide little detail for sub-sector specific analysis. The agricultural sector is e.g. often represented as one row and column only in the national datasets.

This coarse representation is one reason for the limited application of CGEs for analysis of the Common Agricultural Policy. The AgroSAM project (Müller & Pérez Dominguez, 2008) hosted at the Institute for Prospective Technological Studies of the European Commission (IPTS) addresses this issue by combining national SUTs for the EU Member States with the highly disaggregated information on the agricultural sector provided by the CAPRI model database (Britz, 2005). One of the main challenges for AgroSAM consists in overcoming definitional and structural differences between the SUTs based on the European System of National Accounts (ESA95) and the CAPRI database which is mainly structured according to the Economic Accounts for Agriculture (EAA, Eurostat, 1997). As such, the AgroSAM project is one example for constructing large-scale data bases for impact assessment where different data sources are combined and consolidated.

Methods

As a result of the structural deviations between the databases to be combined, the totals of the agricultural sub-sectors based on the EAA do not match the corresponding values in the SUTs, and the obtained, disaggregated SAMs were not automatically balanced. So far a cross-entropy (CE) framework balances the SAMs by staying as close as possible to the information obtained from the CAPRI database while respecting the totals indicated by the SUTs. The supports for the agricultural SAM entries are centered on priors derived from the original CAPRI data. The spread of the supports around the priors steering the deviation between final, balanced SAM entries and priors is so far based on a subjective evaluation of the reliability such that, e.g., entries relating to cereals will deviate less from the priors compared to entries relating to fodder crops.

A CE application requires for each estimate matching priors and weights, and in the case of more than two supports, additional constraints. The resulting high number of variables and constraints may cause computational difficulties for large-scale datasets during estimation and will increase estimation time. Additionally, the implicit posterior density depends on the interaction between the choice of supports, the a priori probabilities and the entropy criterion. Both problems were addressed by Heckelei *et al.* (2008) and Witzke & Britz (2005) by motivating a Highest Posterior Density (HPD) estimator which refrains from discrete support points but still allows to express confidence by using informative priors on the variance of each estimate.

The aim of this paper is to compare the performance of CE and HPD estimators in the context of the SAM balancing based on prior information. For this we investigate the differences in the estimations and the performance gains in computation on the example of selected SAMs for EU Member States. Further on, we test a less subjective way of defining the second moment of the prior distributions by using the production values of the commodities, value of sold quantities and subsidies paid to the sectors to define the variance. The weights are motivated firstly by assuming that the economic importance of an activity will steer to a certain extent the resources spend to generate statistical data for it. Secondly, a high economic sectoral value implies aggregation over a large number of individual agents. If the error in the aggregated value depends on individual reporting errors centered around zero, the probability of an error in the aggregates reduces with the number of reporting individuals. Both arguments support using production values, values of sold quantities and subsidies received as a basis to define the expected variance of the priors.

Results and discussion

Currently, AgroSAMs with their highly dis-aggregated agricultural sector while keeping the full sectoral breakdown from the national SUTS are available for 21 EU Member States in 2000, and estimation for the remaining six Member States is underway. The paper will firstly present the large difference in agricultural detail between existing SAMs with an agricultural breakdown as the GTAP data base and the new AgroSAMs. Secondly, it will discuss the differences in results, implementation and computational viewpoints between the CGE framework and a HDP one. The dataset is a key input in the FP VII project CAPRI-RD where it will provide the basis to populate regional CGEs at NUTS II. In addition, we expect to contribute to the current methodological work around SAM balancing and database-combination, a common problem shared by large model chains like SEAMLESS, where partial and general equilibrium models are combined.

References

- Britz, W. (Ed.), 2005. CAPRI Modelling System Documentation. URL: <http://www.ilr1.uni-bonn.de/agpo/rsrch/capri/capri-documentation.pdf>, University of Bonn.
- Eurostat, 1997. Manual on the Economic Accounts for Agriculture and Forestry EAA/EAF 97 (Rev. 1.1).
- Heckelei, T., *et al.*, 2008. A Bayesian Alternative to Generalized Cross Entropy Solutions for Underdetermined Econometric Models. Agricultural and Resource Economics, Discussion Paper 2008:2, Bonn, Germany.
- Mueller, M. & I. Pérez Dominguez, 2008. Compilation of Social Accounting Matrices with a Detailed Representation of the Agricultural Sector (AgroSAM). Presented at the 11th Annual Conference on Global Economic Analysis, Helsinki, Finland.
- Witzke, H.-P. & W. Britz, 2005. Consolidating trade flows and market balances globally using a Highest Posteriori Density estimator. Presented at the 8th Annual Conference on Global Economic Analysis, Lübeck, Germany.

Agriculture and natural resources in a changing world: The role of irrigation

T. Sauer, P. Havlík, U.A. Schneider, G. Kindermann, M. Obersteiner
Research Unit Sustainability and Global Change (FNU), Hamburg University,
Bundesstrasse 55 (Pavillon), 20146 Hamburg, Germany
Contact: timm.sauer@zmaw.de

Introduction

Fertile land and fresh water constitute two of the most fundamental resources for food production. These resources are affected by environmental, political, economic, and technical developments. Regional impacts may transmit to the world through increased trade. With a global forest and agricultural sector model, we quantify the impacts of increased demand for food due to population growth and economic development on potential land and water use. In particular, we investigate producer adaptation regarding crop and irrigation choice, agricultural market adjustments, and changes in the values of land and water. To our knowledge this is the first large scale assessment of agricultural water use under explicit consideration of alternative irrigation options in their particular biophysical, economic, and technical context, accounting for international trade, motivation-based farming, and quantified aggregated impacts on land scarcity, water scarcity, and food supply.

Methods

We apply a mathematical programming-based, price-endogenous sector model of the agricultural and forestry sectors. The model depicts production, consumption, and international trade in 11 world regions. It was programmed using GAMS software (General Algebraic Modeling System). Market and trade equilibrium in global agricultural markets are simulated to reveal commodity and factor prices, levels of domestic production, export and import quantities, resource usage, and environmental impacts. The agricultural sector is represented by more than 40 crops, and an aggregated livestock sector. For crop management, the model can choose between different irrigation systems. Four types of irrigation are portrayed: basin and furrow surface irrigation, localized drip, and sprinkler irrigation. For each method, we evaluate biophysical and technical suitability to exclude inappropriate irrigation system applications. Micro-economic data include production costs, resource requirements, and expected yields. Production costs contain all expenses for management and inputs required to reach the respective management-related yield. The interdisciplinary range of factors that determine irrigation decisions in our model is shown in Table 1. Actual water use is finally computed considering irrigation cost per spatial unit for all appropriate combinations of regional geographic background, crop type, and irrigation system.

Results and discussion

This study integrates alternative irrigation methods into a global agricultural and forest model to estimate regional adaptations in agricultural water use for different development scenarios. The new model combines the heterogeneity of irrigation technologies and natural resources with micro and macro-economic drivers. The integration of explicit irrigation systems into a partial equilibrium model of the agricultural and forestry sectors improves global land use change assessments and evaluation of interdependencies between policies, land use related externalities and food supply.

Our simulations show that agricultural responses to population and economic growth include considerable increases in irrigated area and agricultural water use, but reductions in the average water use intensity. Furthermore, we show that irrigation is a complex decision beyond the binary decision of adopting irrigation or not. Different irrigation systems are

preferred under different exogenous conditions. To accurately estimate land and water scarcity, the likely adaptation of farmers to different irrigation methods needs to be quantified. Negligence of these adaptations would bias the burden of development on land and water scarcity. Without technical progress in agriculture, a population and income level as predicted under our scenario for 2030 would require substantial price adjustments for land, water, and food to equilibrate supply and demand (compare Figure 1).

Table 1. Biophysical, technical, and economic determinants of irrigation choice.

Crop characteristics	Water application efficiency	Crop market prices
Soil infiltration rate	Operation time per event	Investment capital cost
Slope inclination	Level of pressurization	Energy prices
Length of growing period	(energy and labour requirement)	Labour cost
Water resource availability	Coverage per system unit	Land and water prices (resource economics)

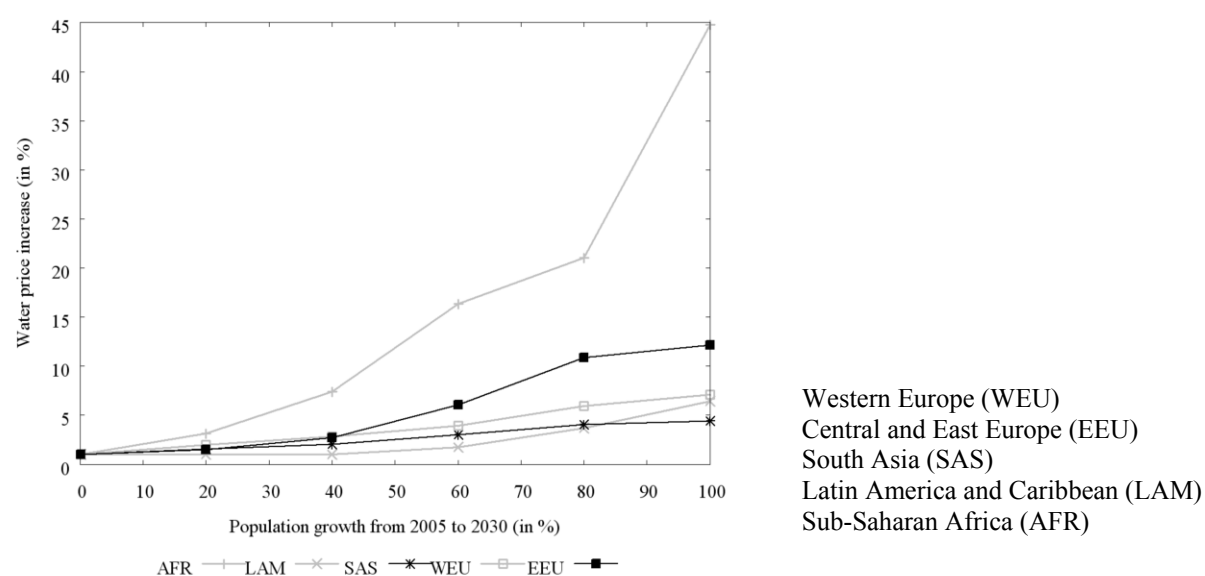

Figure 1. Results: Water price index by region.

Selected references (examples)

- Alexandratos, N., *et al.* (Eds), 2006. World agriculture: Towards 2030/2050 - Prospects for food, nutrition, agriculture and major commodity groups. FAO, Global Perspective Studies Unit, Rome.
- Brouwer, C., *et al.*, 1988. Irrigation Water Management: Irrigation Methods. FAO Irrigation Water Management Training manual no 5, Rome.
- Buchanan, J.R. & T.L. Cross (Eds), 2002. Irrigation Cost Analysis Handbook. Agricultural Extension Service, The University of Tennessee, PB1721.
- Cowie, A., *et al.*, 2007. Environmental Science & Policy 10: 335-352.
- Foley, J.A., *et al.*, 2005. Science 309: 570-574.
- Wallace, J.S., 2000. Agriculture, Ecosystems and Environment 82: 105-119.
- Wichelns, D. & J.D. Oster, 2006. Agricultural Water Management 86: 114-127.

The fate of nitrogen in the Brazilian soybean chain

E.M.A. Smaling, R. Roscoe, J.P. Lesschen, A.F. Bouwman, E. Comunello
International Institute for Geo-Information Science and Earth Observation (ITC),
P.O. Box 6, 7500 AA Enschede, The Netherlands
Contact: smaling@itc.nl

Introduction

With economic growth, urbanization and changing diets, world demand for plant-derived oils and their derivatives is soaring. Oils are used *inter alia* in the food, feed and cosmetics industry, and increasingly as a biofuel. Soybean is one of the major booming oil crops. In addition to oil, it offers a very valuable by-product, i.e. protein-rich soy meal, a raw material for animal feed. Increasing demand, mainly from China has been met with a supply response that is particularly strong in Brazil and Argentina. Recognizing that soybean (i) is a highly important commodity for the Brazilian economy, (ii) contributes to the conversion of forest and savanna land, and (iii) travels long distances, ending up in many different foods and feeds worldwide, there is a need to better understand the dynamics of the soybean sector, and how economic and environmental targets can be realized simultaneously. In this study, nitrogen (N) is used as a marker. N stocks and flows in and between the compartments of the Brazilian soybean chain are quantified, to find out where in the process N remains inside or disappears from the food chain. Compartments include forest and savanna conversion, soybean cultivation, transport and processing, animal and human consumption, and waste disposal (Figure 1).

Methods

Spatial data sets on soybean area and yields, soils and rainfall were collected at municipality level, for three time periods (1993–1995; 1998–2000; 2003–2005) and put together in a GIS. Export to China and the European Union was included. Nitrogen dynamics by forest and savanna conversion was taken from literature, whereas the nutrient balance model NUTMON model (Lesschen *et al.*, 2007) was used to calculate the cultivation part (Phase 2 in Figure 1). For the calculation of the fate of nitrogen during Phase 3–5 (Figure 1), several assumptions were made, based on literature and expert knowledge.

Results

Amazon forest and Cerrado savannah has most often been replaced by pastures. These are increasingly replaced by soybean farms. Some parts of the Amazon are converted into soybean fields directly. Soybean has also replaced other arable crops, and its growth can only partially be linked to forest and savanna removal. Estimates (Phase 1) of N losses in forest and savanna that can be attributed to soybean range between 2000 and 6000 million kg of N yr⁻¹. This comes on top of biodiversity loss, destruction of living areas, and the creation of increasingly dry conditions due to reduced air circulation on the continent. Estimates (Phase 2) of N losses in soybean fields were 182 million kg of N yr⁻¹ in 1993–1995, but in 2003–2005, there is a gain of 62 million kg of N, due to generally improved practices of conservation agriculture, and due to the N-fixing nature of (the leguminous species) soybean. Other nutrients may be limiting, and/or having negative nutrient balances though (P, K, trace elements), but this was not investigated. Also, the issue of genetically modified soybean (currently estimated at 43%), and massive use of pesticides and associated health risks are not dealt with here. Of the total soybean production, 75% is turned into soy meal, 20% into soy oil, and about 5% is lost during processing and transport. As soy oil contains no N, it is no longer relevant for the chain studied here. The soy meal is largely fed to animals, mainly to pigs and chickens. During animal production and human consumption, a series of N losses come to the fore, production of animal manure being the main (recyclable) loss. The N

remaining in consumed meat for humans is about 20% of the N available in the harvested soybeans. Finally, of the N excreted by humans into sewerage systems, 32% ends up in surface waters.



Figure 1. Five phases of the soybean chain studied.

Reference

Lesschen, J.P., *et al.*, 2007. Nutrient Cycling Agroecosyst. 78: 111-131.

Spatial planning of livestock production and manure abatement

B. Van der Straeten, J. Buysse, S. Nolte, F.L. Marchand, L. Lauwers,
D. Claeys, G. Van Huylenbroeck
Ghent University, Department of Agricultural Economics,
Coupure links 653, 9000 Ghent, Belgium
Contact: Bart.VanderStraeten@ugent.be

Introduction

Some Western European countries (e.g., The Netherlands and Belgium) experienced a large expansion in animal production. An excess of nutrients resulted from the feed compounds trade balance and led to a high pressure on the environment (Feinerman & Komen, 2005; Nesme *et al.*, 2005). As a consequence of the Nitrate Directive (91/676/EEC), the Flemish region has introduced a manure decree in 1991 which describes how manure should be disposed. There are currently two options to dispose excess manure. Firstly, the manure can be transported to farms with a manure deficit. Secondly, the manure could be processed. Despite the fact that manure transport is running to its limits, the processing capacity has not sufficiently developed yet to solve the manure excess problem.

One of the problems of the development of the processing capacity for private investors and policymakers is the uncertainty of the development of the manure excess. The regional concentration of animal production is very diverse and together with high transport costs this creates a huge spatial differences in the demand for manure processing. Due to the interplay between transport and processing, it is difficult to predict where demand for processing capacity will arise. A simple, but incorrect, indicator of this demand is the comparison of animal production density and available disposal capacity, which is currently used to make a spatial differentiation of the policy interventions. However, this indicator ignores the possibility to transport to neighbouring regions with a manure deficit and disregards the fertilizing behaviour of the farms. Regions with high animal production density enclosed by other regions with high animal production density have indeed a higher demand for processing manure than the same regions surrounded by regions with a low animal production density. The type of manure has to be taken into account as well, because both transport and processing costs are very different.

Therefore, a spatial mathematical programming model is built based on a multi-agent system (MP-MAS) that simulates the individual farmer's behaviour confronted with all spatial aspects of transport, spreading and processing the manure.

The paper shows how spatial mathematical programming can be used for environmental and regional planning decisions (*ex-ante* and *ex-post*) and how the MP-MAS approach can be extended to a very large dataset (38,000 farms) that contains the complete population. The developed model and simulation results can provide valuable information that can reduce risk to enhance the development of manure processing. The model results can also reduce costs because transport costs of manure are very high and location of the processing plants is therefore very important.

Methods

MP-MAS has two major advantages. First, it allows to deal with the regional heterogeneity of manure production, processing and fertilization behaviour. Secondly, the model optimizes at farm level and takes interactions between farms and their environment into account (Boulanger & Brechet, 2005). The cost of manure allocation decision of each individual agent is minimized subject to legal constraints of the manure policy, manure transport costs and manure abatement limitations.

The cost-minimized transports do not necessarily correspond to actual transports. Therefore, the model is called a normative programming model, but the actual utilization of available manure on the land is based on the empirical data.

Transport costs in the model are proportional to the distance between the farms based on distances between municipalities. Farms within a municipality have the same distance to all other farms, which allows to reduce the size of the between-farms transport matrix considerably and making simulations possible with limited computer resources.

Results and discussion

The simulation results provide information for investors on the optimal location of processing plants or additional animal production by showing the demand for additional manure processing capacity. The spatial data on demand for processing also indicate that the current developed processing capacity corresponds already quite good with the demand for processing, but the total capacity is not sufficient.

Investments in manure processing not only depend on the needed capacity, but also on the willingness to pay for manure disposal. The model calculates this willingness to pay and shows that it increases with an increasing density of animal production and decreases as a results of investments in additional capacity (Figure 1). Figure 1 shows the simulated willingness to pay for each municipality in Flanders.

The simulation results are also useful for policymakers because they show the total manure disposal cost of different incentive policies for manure processing. The results indicate that the current manure processing obligation is not efficient because it results in an additional manure disposal cost of 4.01%.

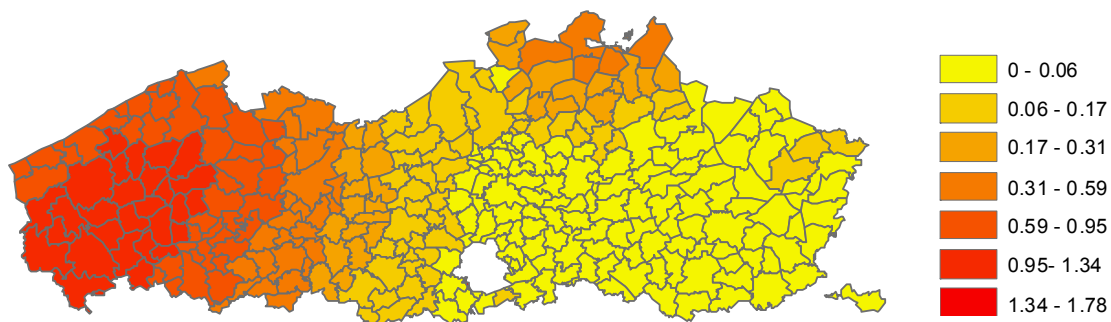

Figure 1. Willingness to pay for allocating one kg of nitrogen in each municipality in Flanders (€ per kg N).

References

- Boulangier, P.M.& T. Brechet, 2005. *Ecological Economics* 55(3): 337-350.
- Feinerman, E. & M.H.C. Komen, 2005. *Environmental & Resource Economics* 32: 367-388.
- Nesme, T., *et al.*, 2005. *Agricultural Systems* 83(3): 297-314.

The impact of modulation: Modelling first and second pillar CAP policies

H. Van Meijl, T. Jansson, M. Banse, G.B. Woltjer
LEI, Wageningen University and Research Centre,
P.O. Box 29703, 2502 LS The Hague, The Netherlands
Contact: hans.vanmeijl@wur.nl

Introduction

The aim of this paper is to assess the economic impact of the transfer of funds from direct income support to farmers (Pillar One) to rural development money (Pillar Two) of the Common Agricultural Policy (CAP) through the compulsory modulation mechanism, as provided for under Article 10 of Council Regulation (EC) No 1782/2003. Modulation was introduced, originally as a voluntary mechanism, in 2000 as a means of increasing support for rural development within the CAP. This is achieved by transferring a proportion of the Pillar One budget to the funding of rural development measures under Pillar Two. This requirement became mandatory in 2003 as a result of the Mid Term Evaluation of the CAP. This currently applies to the EU-15, however compulsory modulation will apply to the twelve new Member States that acceded to the EU in 2004 and 2007 when their Pillar One payments reach the same level as those of the EU-15. For the 2007–13 programming period, compulsory modulation increases the financial support available to rural development measures by 8 billion euros to 88 billion euros.

Scope of the Study and Methodological Approach

This paper, therefore, aims to provide a quantitative and qualitative assessment of the impacts of this transfer of funds from Pillar One to Pillar Two of the CAP through the use of the compulsory modulation mechanisms on the social and economic performance of the agriculture sector and rural areas. More specifically, it studies the impact on the environment, the competitiveness of the agriculture sector, on rural communities and national rural development budgets. The study also considers the re-distribution effects of modulation, within and between Member States, between economic sectors and types of holdings. This study is innovative as it is the first that models explicitly the various measures (all three axis) of the second pillar of the CAP in a quantitative way.

Specifically, it considers the impacts of compulsory modulation under two distinct scenarios, within the time horizon of 2013, and across the EU27. The first scenario consists of the current rules under which compulsory modulation operates (5% modulation rate and associated franchise and distribution rules). The second scenario comprises the changes proposed under the CAP 'Health Check' in May 2008 (an additional 8% by 2013, with further increases according to farm size).

Methods

In the Modulation project the commodity focus and regional / territorial focus have to be connected. The global economy-wide dimension is covered by an economic general equilibrium model (LEITAP, see Van Meijl *et al.*, 2006). ESIM – an EU-wide partial equilibrium model – is providing more agricultural detail for the EU-25 countries, CAPRI, an EU25 regional partial equilibrium model, is distributing this impact to the regional (NUTS2) level (see Britz, 2005). ESIM's main contribution is the projection of developments in EU agricultural markets into the future. CAPRI's main contribution is changes in CAP policies and the regional impact (NUTS2 level). To cover modulation impacts the CAPRI model is extended with article 69 payments within the first pillar and with the second pillar measures. LFA, N2000 and Agri Environmental payments are directly implemented in CAPRI, and the remaining measures are captured by linking the costs and production technology of CAPRI to

simulation results of LEITAP, where those other measures are explicitly implemented. LEITAP is a global computable general equilibrium model that covers the whole economy (Van Meijl & Tongeren, 2002; Van Meijl *et al.*, 2006; Banse *et al.*, 2008). A key feature of modulation is that some measures like physical and human capital investment have dynamic impacts. To include these dynamics the LEITAP model is extended to a recursive dynamic version with endogenous technological change by specifying a relation between investments and productivity change.

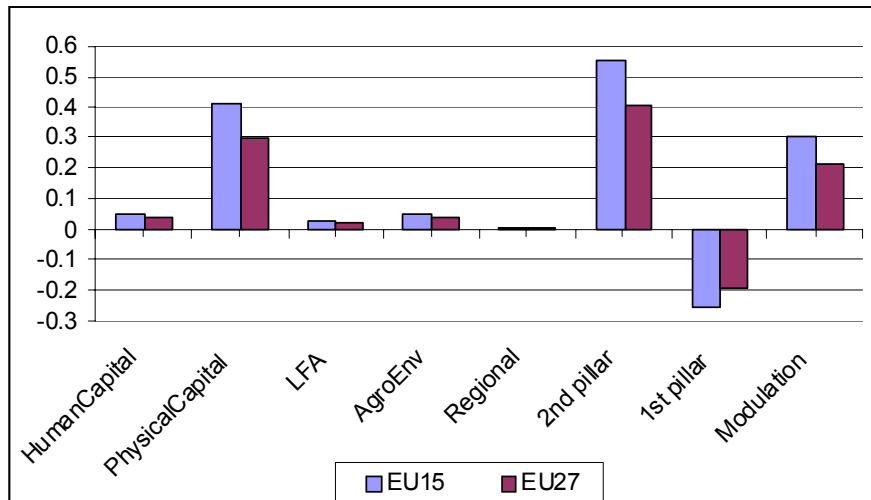

Figure1. Production volume of primary agriculture (% change progressive modulation relative to baseline in 2013).

Results and discussion

The overall production effect due to progressive modulation is positive for primary agriculture in the EU15 and EU27. The impact for EU15 is larger than for the EU27 as for the NMS modulation hold only for the last years while it is in place for the EU15 for the whole period. Next to the overall impact of progressive modulation this Figure shows the impact of various groups of second pillar measures, the impact of the whole second pillar and the impact of reducing the first pillar. The positive production effect is due to a positive effect of redistributing the second pillar money. Within pillar two measures, especially impact of physical capital investments is largest. A small positive impact have human capital investments, LFA payments and agri-environmental payments. Reducing the first pillar has a slightly negative impact on production due to that part of the payments are still coupled in some countries in the baseline scenario and due to that decoupled payments have minor production effects. Modulation has further a positive impact on competitiveness, environment and quality of life.

References

- Banse, M., *et al.*, 2008. European Review of Agricultural Economics 35: 117-141.
 Britz, W. (Ed.), 2005. CAPRI documentation. Available at www.ilr.uni-bonn.de
 Van Meijl, H. & F.W. Van Tongeren, 2002. Eur. Rev. of Agric. Economics 29(4): 445-470.
 Van Meijl, H., *et al.*, 2006. Agriculture, Ecosystems and Environment 114: 21-38.

Environmental impacts of the European livestock sector on different scales, and prospects for reduction

Henk Westhoek, Bas Eickhout, Nico Hoogervorst, Trudy Rood,
Elke Stehfest, Geert B. Woltjer
Netherlands Environmental Assessment Agency (PBL),
P.O. Box 303, 3720 AH Bilthoven, The Netherlands
Contact: Henk.Westhoek@pbl.nl

Introduction

The European livestock sector is a large agricultural sector, employing many people, producing good and safe meat, and dairy and other products for mainly European customers. The (European) livestock sector has large impacts on rural areas, both inside and outside Europe and both positive and negative. The positive impacts include the maintenance of traditional agricultural landscapes through grazing animals, with accompanying biodiversity. The contribution to rural economies and the production of traditional, regional products also are considered to be positive.

However, livestock production has considerable negative impacts, such as the emission of greenhouse gases and nutrients, and the conversion of nature areas – both inside and outside Europe (Steinfeld *et al.*, 2006). Especially, large impacts on nature areas outside Europe, which are needed for the cultivation of feed products (notably soy beans), are often brought to the fore. The imported animal feed contains large quantities of nutrients, which lead to eutrophication in areas with intensive livestock production (Bouwman *et al.*, 2005; Grote *et al.*, 2005).

In regions outside Europe, the consumption of animal products is rapidly rising, leading to a projected doubling of the global consumption, over the next 50 years (FAO, 2003). Issues, such as animal welfare, animal health and human health are also reasons for assessing whether changes in production systems and/or consumption patterns might be needed, to reduce the adverse societal impacts of livestock production (McMichael & Bambrick, 2005; Walker *et al.*, 2005). This paper aims to identify a number of plausible pathways to reduce the environmental impacts of livestock production.

Methods

Starting from an analysis of issues accompanying livestock production, several options to reduce negative impacts by the livestock sector will be defined. The discussion about the effects of livestock production is more prominent in northwestern Europe. But, given the fact that much of the relevant regulation (on environmental, animal welfare, veterinarian aspects, market regulation) is on a European scale, most ‘improvement options’ will have to be implemented on a European scale, too.

These options will include both technical options and policy options. For plausible technical options we allow some time for them to become economically feasible, in the long run. At the other end of the spectrum we examine policy-oriented options, like changing trade regimes (import tariffs) for meat or feed stuffs produced outside the EU. The effects of dietary changes also will be investigated, in terms of both of a reduction in meat and dairy consumption, and a shift between meat types.

The effect of all options will be evaluated, qualitatively and quantitatively for a number of environmental impacts (notably land-use changes and emission of greenhouse gases and nutrients), to realize an integrated assessment of these options. This assessment will be done on a global scale, since we expect many global displacement effects caused by the different policy options. For this assessment, we will couple a CGE model (LEITAP, based on GTAP) and an environmental impact model (IMAGE). Previous coupling of these two models proved

to be very fruitful (Nowicki *et al.*, 2006; Ten Brink *et al.*, 2007; Eickhout *et al.*, 2007; Verburg *et al.*, 2008). Chain analyses and LCAs for products of the livestock sector and their substitutes are also used to estimate environmental impacts and option potentials. Recently, we evaluated the effect of the EU biofuel policy proposal, using these three different kinds of methodological approaches (Eickhout *et al.*, 2007). Experiences gained in the biofuel case will be evaluated and used in this case.

Results and discussion

At the conference, results will be presented followed by a discussion, since this issue concerns a work-in-progress. From the modelling framework we expect results for a number of indicators, which together make an integrated assessment of the effects of different policy options possible. These indicators include human consumption of meat, dairy and other sources of protein, the volume of livestock production, the quantity of land used needed for this production (distinguished between cropland and pastures) and emissions of greenhouses gases from livestock and agricultural land. Given the modelling framework, we expect that we are better able to dynamically model the effects of lowering the consumption of animal products in Europe on a global scale. This will probably lead to more realistic results than a static approach would do. The dynamic modelling approach includes effects on food prices, prices of agricultural commodities and factor prices.

References

- Bouwman, A.F., *et al.*, 2005. *Pedosphere* 15: 137-155.
- Eickhout, B., *et al.*, 2007. *Land Use Policy* 24(3): 562-575.
- FAO, 2003. *World agriculture: Towards 2015/2030* FAO, Rome.
- Grote, U., *et al.*, 2005. *Environmental Science & Policy* 8: 439-451.
- McMichael, A.J. & H.J. Bambrick, 2005. *Public Health Nutrition* 8: 341-343.
- Nowicki, P.L., *et al.*, 2006. *Scenar 2020: Scenario study on agriculture and the rural world* EC Directorate Gen. for Agriculture and Rural Development, Brussels.
- Steinfeld, H., *et al.*, 2006. *Livestock's long shadow: Environmental issues and options*. FAO, Rome.
- Ten Brink, B., *et al.*, 2007. *Cross-roads of Life on Earth: Exploring means to meet the 2010 Biodiversity Target* CBD Technical Series No. 31. Secretariat of the Convention on Biological Diversity, Quebec.
- Verburg, P.H., *et al.*, 2008. *Annals of Regional Science* 42: 57-77.
- Walker, P., *et al.*, 2005. *Public Health Nutrition* 8: 348-356.

Agricultural policy and land use

G.B. Woltjer

LEI, P.O. Box 29703, 2502 LS Den Haag, The Netherlands

Contact: Geert.Woltjer@wur.nl

Introduction

Agricultural policy has fundamental consequences for land use and therefore environmental services like biodiversity. This paper will address these issues through a general equilibrium model of the world economy in combination with a biophysical land use model where land use issues can be analysed. The focus will be on methodological issues with respect to the use of information from biophysical models of land use in a general equilibrium economic model.

The LEITAP model

LEITAP2 is developed at the Dutch agricultural research institute LEI, part of Wageningen University and Research (WUR). The name is derived from the base model from which it is derived, GTAP, and the name of the institute where it is developed. Compared with the original version of the LEITAP model it is extended and stylized a lot.

The LEITAP2 model is based on the general equilibrium model GTAP (Hertel & Tsigas, 1997), developed at Purdue University, United States. It uses the carbon market and the rough characteristics of the production structure of GTAP-E (Burniaux & Truong, 2001). It uses the international capital flow accounting system of the dynamic GTAP model GTAP-DYN and includes also some parts of the agricultural variant of GTAP, GTAP-AGR.

The LEITAP2 model includes a lot of extensions compared with the GTAP model. The different extensions of the model can be switched on or off through a simple change in coefficients form. First, an integrated production structure, with energy nesting (including biofuels), feed and fertilizer nesting is included. The feed and fertilizer nest is also an extension compared with LEITAP1. Second, there is a possibility to include dynamic international investment in the model (was not available in LEITAP1). This will probably be extended towards a model of investment between sectors in the near future. Third, production quota can be implemented, in a more general way than in LEITAP1. Fourth, EU-policy, including first and second pillar measures, can be switched on (also new compared with LEITAP1). Fifth, land supply is modelled, based on biophysical model outcomes. Compared with LEITAP1 the theoretical structure of the interactions between the models has been improved a lot. Sixth, substitution between different types of land is modelled in a dynamic way (in LEITAP1 this was static). Seventh, a dynamics of capital and labor mobility between agricultural and non-agricultural sectors can be switched on (only static mobility was available in LEITAP1). Eighth, the GTAP-E carbon market is implemented and will probably be extended in the near future (New compared with LEITAP1).

Results and discussion

This is work in progress. Results will be presented at the conference. The focus of the paper will be on methodological issues, where results are only presented to show the effect of the model improvements. Special focus will be given on the relationship between the biophysical models IMAGE (Bouwman *et al.*, 2006; Eickhout *et al.*, 2007) and DYNA-CLUE (Verburg *et al.*, 2002, 2006) and the LEITAP2 with respect to land supply, land productivity and land use changes.

The map in Figure 1 gives an indication of the type of results that can be expected. The map shows the second pillar effect of 13% modulation, i.e. a scenario where 13% of the first pillar money is taken away and used for a combination of Less Favored Area Policy (15%), Agri-Environmental Schemes (25%), Investment subsidies (25%) and regional measures

(35%). These measures have different effects in different regions. In eastern Europe, the land saving effects of technological improvements are most important and generate a decrease in agricultural land use, while for example in France the land use increasing measures like LFA and Agri-Environmental schemes are more important and generate an increase in land use.

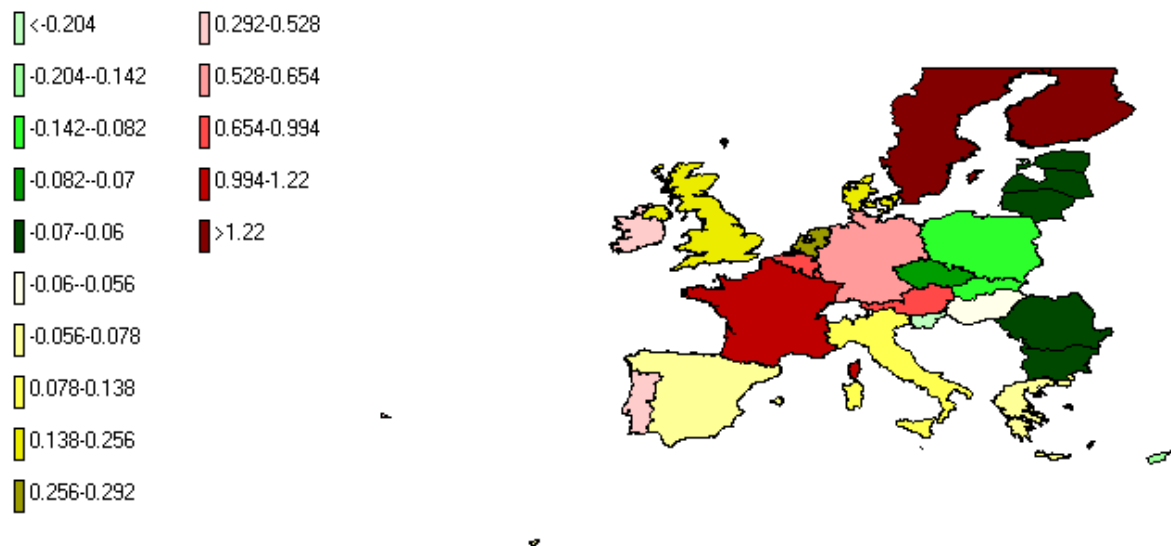

Figure 1. Second pillar effect of 13% modulation on agricultural land use in the EU27.

References

- Bouwman, A.F., *et al.*, 2006. Integrated modelling of global environmental change. An overview of IMAGE 2.4, Netherlands Environmental Assessment Agency (MNP), Bilthoven, The Netherlands.
- Burniaux, J.-M. & P. Truong, 2001. GTAP-E: An energy-environmental version of the GTAP Model. GTAP Technical Paper no. 16, Center for Global Trade Analysis, Purdue University, USA.
- Eickhout, B., *et al.*, 2007. Land Use Policy 24: 562-575.
- Hertel, T.W. & M.E. Tsigas, 1997. Chapter 2 in Ed. T.W. Hertel, Global trade analysis: Modeling and applications, Cambridge University Press, UK.
- Verburg, P.H., *et al.*, 2002. Environmental Management 30: 391-405.
- Verburg, P.H., *et al.*, 2006. Agriculture, Ecosystems & Environment 114(1): 39-56.

Farm structural change in European regions

A. Zimmermann, T. Heckeley

Institute for Food and Resource Economics, Nussallee 21, 53115 Bonn, Germany

Contact: andrea.zimmermann@ilr.uni-bonn.de

Introduction

As the aggregate outcome of farm level structural adjustments in response to policy changes, structural change links the farm with the regional level and plays a prominent role in the integrated assessment of the agricultural sector (Van Ittersum *et al.*, 2008). Our study thereby focuses on the economic aspects of farm structural change. The purpose of the study is twofold: (1) the direction of structural change defined as the change of the number of farms in different farm types shall be identified for EU15 regions, and (2) the key exogenous factors leading to and their impact on the structural developments shall be detected.

The analysis is conducted for a multi-dimensional farm typology combining ten specialization classes (e.g., arable, dairy, mixed farming) and three economic size classes based on the European standard grouping of farms (Andersen *et al.*, 2006). The farm types cover the whole farming sector and are mutually exclusive. In total 30 farm types plus an entry/exit class are considered. The movement of farms between the farm types is represented by transition probabilities which are derived using a non-stationary Markov chain approach. The econometric specification makes use of FADN data on the transitions of sample farms between the different farm types and combines it with data on the total number of farms per farm type from 1990 to 2003. Exogenous factors assumed to influence structural change apart from a trend variable are the unemployment rate and prices for various agricultural outputs. Results for the transition probabilities as well as for the impact of the exogenous variables will be shown for selected regions across Europe.

Methods

Methodologically, a two-step Markov chain estimation is applied, where in the first estimation step non-stationary Markovian transition probabilities are derived:

$$n_{j(t)} = \sum_{i=1}^N n_{i(t-1)} p_{ijt} ,$$

with n being the number of farms in farm type j at time t and depending on the number of farms in all farm types i in the period before ($t-1$) multiplied by their respective transition probabilities p_{ij} to move from farm type i to farm type j in one time period. The probability constraints, non-negativity ($p_{ij} \geq 0$) and summing-up to unity ($\sum_{j=1}^N p_{ij}$) must hold. For estimation of the first step a generalized cross-entropy estimator (GCE) similar to Karantininis (2002) and Stokes (2006) is applied. The prior information on the transition probabilities necessary for the GCE is derived from the actual movements of the FADN sample farms (micro data), whereas the Markov equation is equipped with data on the total number of farms per farm type and region (macro data). In the second estimation step, the transition probabilities obtained with the GCE are used as left-hand side variable and regressed against a set of explanatory variables using ordinary least squares (OLS). Since the probabilities relate non-linearly to explanatory variables and coefficients (MacRae, 1977), the equations are linearized by transformation of the transition probabilities into log-odd ratios (Stavins & Stanton, 1980).

Results and discussion

Results will be shown for four European FADN regions: The Netherlands, Brandenburg (Germany), Midi-Pyrénées (France), and Andalucia (Spain). The estimated transition

probability matrices exhibit typical characteristics with high probability values for staying in the same farm type as in the period before on the diagonal and lower values which tend to concentrate around these, i.e. for transitions between size classes within the same specialization classes. Transitions between specialization classes take mainly place between various farm types and the mixed farming categories (mixed and mixed livestock). Also, different mobility schemes between regions can be identified, e.g. with farms in Brandenburg exhibiting nearly no structural change, whereas in Midi-Pyrénées significantly more and larger non-zero probabilities can be found at the off-diagonals. In Brandenburg and Andalucia the total number of farms seems to stay rather stable as the probabilities for both entry and exit are very close to zero for all farm types. In The Netherlands and Midi-Pyrénées nearly no market entries, but for most farm types significant large exit probabilities are reported.

In the second estimation step, transition probabilities being equal or greater than 0.01 are regressed against a number of explanatory variables. The probabilities below 0.01 are subsumed in a rest category. As explanatory variables apart from the constant and a trend, the unemployment rate of a country as well as prices of different agricultural outputs are used. The unemployment rate is assumed to impact especially the exit category (Garvey, 2006), whereas price developments are mainly thought to have an effect on transitions between farm types. Due to the non-linear character of the model, the impact of the exogenous variables on structural change is given in the form of elasticities (Zepeda, 1995). As expected from the results on the transition probabilities the trend only weakly impacts the transition probabilities in Brandenburg and Andalucia, whereas significantly larger impacts can be found for The Netherlands and Midi-Pyrénées. The influence of the unemployment rate on structural change in the agricultural sector is very weak in Andalucia and weak in The Netherlands. In Germany the unemployment rate is negatively correlated with exits from the sector which is in line with the authors' expectations. So far, the prices for milk, wheat, and pigs have been considered and proven to be of significance to the analysis. Their impact on the transition probabilities will be analysed in detail in the paper.

References

- Andersen, E., *et al.*, 2006. SEAMLESS Report No. 12, www.SEAMLESS-IP.org, 30 pp.
- Garvey, E., 2006. SEAMLESS Report No. 15, www.SEAMLESS-IP.org, 35 pp.
- Karantininis, K., 2002. *J. Econometrics* 107: 275-290.
- MacRae, E.C., 1977. *Econometrica* 45: 183-198.
- Stavins, R.N. & B.F. Stanton, 1980. *Using Markov Models to Predict the Size Distribution of Dairy Farms*. Cornell University, Ithaca, New York.
- Stokes, J.R., 2006. *Agr. Resource Econ. Rev.* 35: 357-373.
- Van Ittersum, M.K., *et al.*, 2008. *Agricultural Systems* 96: 150-165.
- Zepeda, L., 1995. *Europ. Rev. Agr. Econ.* 22: 41-60.

Theme B
State-of-the-art of components for integrated systems

Session B2: Indicators for integrated assessment

Session organizers:

Maria Luisa Paracchini
JRC, Ispra, Italy

Nadine Turpin
CEMAGREF, Clermont Ferrand, France

Sustainability Solution Space: An indicator based tool for assessing the sustainability of agricultural systems¹

Claudia R. Binder, A. Schmid, J.K. Steinberger
Social and Industrial Ecology
Department of Geography
University of Zürich
Winterthurerstrasse 190
8057 Zürich, Switzerland
Contact: claudia.binder@geo.uzh.ch

Introduction

This paper introduces the method of Sustainability Solution Space (SSP) for assessing the sustainability of agricultural systems. Current integrative and indicator-based assessment approaches in agriculture usually have three main shortcomings: (i) there is an overall focus on assessing the ecological aspects of agriculture neglecting to some extent economic and social aspects; (ii) research has so far focused on filling important gaps in knowledge and technology, but has missed to include the step towards utilization and implementation of this knowledge; and (iii) the assessment results themselves are difficult to be implemented in decision-making, as conflicting goals and the interaction between indicators has not been sufficiently considered. We propose that for filling this gap an approach is needed which fulfils *systemic criteria*, i.e., sufficient representation of the system including functional interaction among indicators, which allows to depict goal conflicts; *normative criteria*, i.e., considering the different value perspectives of stakeholders by including them in the process and designing sustainability ranges rather than threshold values; and *procedural criteria*, i.e. pursuing the assessment in a true transdisciplinary process.

Methods

The core components of the SSP procedure (Wiek & Binder, 2005) are described in Table 1. Preliminary to constructing an SSP the function the sustainability space has to fulfil has to be defined (*prerequisite phase*). Who will use this tool and for what purposes? The transdisciplinary approach in this prerequisite phase allows for including and balancing the different views and objectives stakeholders might have.

The method itself consists of a systemic, a normative and an integrative module (Table 1). The modules are interdependent; constructing an SSP is, thus, not a linear procedure but an iterative process. The *system module* is the basis for the sustainability solution space. It (i) describes and defines the system with its characteristics and its main problems, (ii) derives indicators (environmental, economic and social), and (iii) determines the relationship among the indicators. Note that the system module is already constructed in a transdisciplinary process, i.e. with participation of stakeholders. The *normative module* sets the criteria for defining sustainability ranges. It includes both the stakeholder as well as the scientific view. For each indicator a sustainability range is defined, i.e., a minimum and maximum value is set according to the selected criteria. The *integrative module*, finally, integrates the normative module and the system module. With a computer tool (see below) the sustainability solution space is calculated. It shows within which ranges the values of the indicators are sustainable and allow for analysing trade-offs of measures.

Based on the SSP the system of the milk value added chain is described with a set of 17 indicators, 8 ecological (derived from LCA data) and 9 socio-economic. The sustainability thresholds were obtained through literature research and stakeholder interviews. The

¹ Keynote presentation

relationship among the indicators was developed in a transdisciplinary workshop. The SSP programme takes a geometric approach to determine the intersection space corresponding to the satisfaction of the normative ranges while taking into account the functional interactions of the indicators. We show some results of the sustainability solution space for the Swiss milk value added chain and discuss the prerequisites, advantages and shortcomings of the method.

Table 1. Steps of SSP adapted to sustainability assessment of agriculture (after Wiek & Binder, 2005; Schmid, 2008; Binder *et al.*, 2008, 2009)

Step	Description
Prerequisite	
	Goals setting
	Stakeholder involvement
	Scale
Module I: Systemic Module	
Step 1	Characterizing the region to be assessed
Step 2	Problem-oriented derivation of indicators (e.g., ecological, economic and social)
Step 3	Analysing the inter- and intra-linkages among the indicators as well as their dynamics
Module II: Normative Module	
Step 4	Specifying the sustainability ranges for the indicators
Module III: Integrative Module	
Step 5	Defining the solution space for decision making
Step 6	Analysing trade-offs

References

- Binder, C.R., *et al.*, 2008. Nachhaltigkeit in der Schweizerischen Milchwertschöpfungskette. Schlussbericht, Soziale und Industrielle Ökologie, Geographisches Institut. Universität Zürich, Switzerland, 35 pp.
- Binder, C.R., *et al.*, 2009. Analyzing the normative, systemic and procedural dimension of indicator-based sustainability assessments in agriculture: A review. Submitted.
- Schmid, A., 2008. Nachhaltigkeit in der Schweizer Milchwertschöpfungskette: Transdisziplinäre Untersuchung der sozialen und ökonomischen Dimension mit einer indikatorenbasierten Systemanalyse und Nachhaltigkeitsbewertung mittels Solution Space for Sustainability. Master thesis, Social and Industrial Ecology, Department of Geography, University of Zürich, Switzerland.
- Wiek, A. & C.R. Binder, 2005. Environmental Impact Assessment Review 25(6): 589-608.

Model and indicators of sustainable development in rural areas from the local perspective

M. Adamowicz, A. Smarzewska

Szkoła Główna Gospodarstwa Wiejskiego, Nowoursynowska 166, Warsaw, Poland

Contact: mieczyslaw_adamowicz@sggw.pl

Introduction

In the conditions of decreasing agriculture role in the rural economy and the development of multifunctional agriculture it seems reasonable to discuss the concept of sustainable development in relation to whole local arrangements involving both agriculture and its surroundings. The concept of sustainable development in rural areas requires an application of appropriate indicators and measurement systems (Borys, 2005). The paper attempts to create a model of sustainable development in rural areas from the local perspective (NUTS 5) which is empirically verified on selected rural districts from Lubelskie and Mazowieckie provinces. The key role in shaping sustainable development can be assigned to the local government, due to its decision-making rights and its potential to benefit from financial and administrative instruments, strategic and operational instruments as well as educational instruments. Local authorities held responsibility for the results of decision made, therefore, they should manage their resources effectively. Thus, the attempt to conduct the analysis of agriculture and rural societies should take into account a territorial approach that proves useful while determining a country's policy for rural areas. In addition to the implementation of its own tasks, the economic policy of a district's self-government should also address any developmental problems concerning agriculture as rural areas. Local authorities should perceive agriculture as one of the areas of the rural economy and create conditions for undertaking measures facilitating non-agricultural economic functions and to create new jobs outside agriculture.

Methods

This work attempts at establishing the model of stable (Turner, 1993) and sustainable development in local district (Meyer, 2004; Meyer & Elbe, 2005). The aim of creating this model is to present the district self-government with the possibility of choosing the direction which leads to achieving the state of a fully-balanced integrated order or partial orders. In order to present the progress of local governments in implementing the concept of sustainable development and to assess its level, 30 rural districts from Mazowieckie and Lubelskie provinces were chosen on purpose to conduct relevant research. As a result of the research conducted two groups of rural districts that applied the concept of stable and sustainable development differently were distinguished. All researched districts undertook measures concerning specific dimensions of sustainable development; however, these measures were not implemented in a balanced manner. Detailed values of local indicators of sustainable development created the so called general indicator for sustainable development (GISD) of the researched rural districts. Based on it, ranks of individual districts were compared with the entire research sample. General indicators for sustainable development of districts were organized hierarchically, namely, from 1 to 30 – in reference to the research sample. Rank 1 was assigned to districts with the lowest value of GISD, whereas rank 30 to the district which achieved the highest value of this indicator.

Results and discussion

The aforementioned discussion proved that for the new concept of sustainable development it is worth to apply a definition which describes this development as a process of changes, in which such qualities as stability and sustainability are put into practice and considered positive, at least within the anthropocentric system of values. The measurement of sustainable

development of rural districts on the basis of indicators suggested will allow determining the level of this sustainability (the level of sustainability in limited substitution of capitals or the level of sustainability in capitals complementarity) in relation to the proposed model of sustainable development and will enable to assess the efficiency of local self-governments' activities. The rating process made it possible to distinguish districts at different levels of development, which were described as relatively below average, relatively average or relatively above average. Districts with rank from 1 to 10 were defined as districts with sustainable development level relatively below average, districts with rank from 11 to 20 were assessed as districts with the average rank of sustainable development and districts with rank between 21 and 30 were classified as districts with the development level relatively above the average, in reference to the entire research sample. It should be assumed that sustainable development measurement should be conducted at both the regional and supra-regional levels. Too large differences in the values of local indicators of sustainable development of researched districts concerning the social and institutional, economic as well as environmental and spatial aspects may prove the level of sustainability between them is low and it may affect the position of a given district in the GISD ranking. The greater the differences between the specific aspects of development the more likely a drop in the GISD ranking of the general indicator of sustainable development for a given district measured at the regional level i.e. comparing the values of local indicators of researched districts of a given province with the values of indicators of researched districts from the other province.

Slight differences in the value of local indicators of sustainable development in researched districts between the aspects of sustainable development determine whether a district would keep the GISD at the same level or not, both at the local and regional levels (the district examined remains within the group of a certain level of sustainable development without either an increase or fall out from a given group of districts). Therefore, it seems necessary to conduct the measurement process of sustainable development in order to determine its level and to assess its evolution. It seems reasonable to discuss the concept of sustainable development in relation to whole local arrangements involving both agriculture and its entire surroundings. Since it is not enough to conclude that the concept of sustainable development is being implemented, but it is necessary to make an attempt to measure the level of this development in a given district on the basis of sustainable development indicators at the local level. Sustainable development measurement can be interpreted at the regional level i.e. in reference to researched districts of a given province or at the supra-regional level i.e. in comparison to researched districts from a different province. The choice of the perspective may influence the hierarchy of districts in the GISD ranking of districts from researched provinces. Therefore, it is possible to state that the sustainability of aspects of development influences whether or not a certain district will keep its position in the GISD ranking and indicates that the concept of sustainable development can be more effectively applied in these rural districts as opposed to districts characterized by high value differences between the aspects of sustainable development.

References

- Borys, T. (Ed.), 2005. Wskaźniki zrównoważonego rozwoju (Sustainable Development Indicators'), Wydawnictwo Ekonomia i Środowisko, Warszawa-Białystok.
- Meyer, W., 2005. Evaluation, design and data collection. Part III: Investigating sustainability. EASY-ECO Training, 27 september 2005, Bratysława.
- Meyer, W. & S. Elbe, 2004. Local Network Governance. Perspectives and problems for the German rural sector, XI World Congress of Rural Sociology – Globalisation, Risks and Resistance in Rural Economics and Societies, 25-30 July 2004, Trondheim.
- Turner, R.K. (Ed.), 1993. Sustainable Environmental Economics and Management: Principle and Practice. Belhaven Press, New York, London, 389 pp.

A structured set of indicators for integrated assessment of future agri-environmental policies

C. Bockstaller, N. Turpin, L. Stapleton, M. Van der Heide, O. Therond, T. Pinto-Correia, V. Voltr, M. Raley, I. Bezlepkina, J.P. Bousset, J. Alkan Olsson, F. Ewert
INRA, UMR Nancy-Université - INRA Agronomie et Environnement Nancy-Colmar,
BP 20507, 68021 Colmar Cedex, France
Contact: christian.bockstaller@colmar.inra.fr

Introduction

Ex-ante integrated impact assessment of new policies is a prerequisite for them to efficiently support sustainable development (SD). Recently, SEAMLESS Integrated Framework has been developed to assess *ex-ante* impacts of agricultural and agri-environmental policies and technologies on agricultural systems across a range of scales, from field–farm to region and the European Union (Van Ittersum *et al.*, 2008). The aim of this paper is to present the set of sustainability indicators developed within the SEAMLESS project.

Methods

An indicator list was developed within the SEAMLESS project which is structured and presented through a new indicator framework, i.e. a goal-oriented indicator framework (GOF). This framework covers a broad range of themes linked to the three main dimensions (environmental, economic, social) of sustainability, and generic themes across the three dimensions (Alkan Olsson *et al.*, 2009), for two domains; the sustainability of agriculture itself and the impact of agriculture on the rest of the world, i.e. on SD. Three objectives underpinned the development of the SEAMLESS-IF indicator list across scales: (i) to provide policy-makers and stakeholders with indicators which they usually use and/or which they would like to use; (ii) to ensure scientific soundness of SEAMLESS-IF indicators, i.e. their relevance to represent impacts at stake; (iii) to cover the various themes in each dimension of the GOF (see Table 1). Within SEAMLESS-IF indicators are primarily assessed by models (and model chains) and thus their development has been constrained by the nature of the available model outputs. Outputs from three main models integrated in SEAMLESS-IF are used for the indicator calculation: the agricultural sector model SEAMCAP; the farming system model FSSIM; and the cropping system model APES. However, despite the range of scales covered by the SEAMLESS-IF model chains some key indicators can currently not be assessed directly from model outputs. However despite the high range of scales covered by the SEAMLESS model chains some of key indicators cannot currently be assessed at certain scales using model outputs. To address this problem generic upscaling procedures has been developed and associated to each indicator that needs to be upscaled.

Results and discussion

Examples of indicators are shown in Table 1. Across scales a total of 80 environmental, 140 economic and only 11 social indicators are or are about to be integrated into SEAMLESS-IF. This new structured set of indicators offered by SEAMLESS-IF enables a multi-scale integrated assessment of SD from the farming systems to the agri-environmental zones and the EU level. In comparison with many former initiatives the broad spectrum covered and the type of the proposed indicators allows for a deeper analysis of environmental pressures and impacts, economic costs and benefits and socio-demographic dynamics. For example, through the integration of the APES model, indicators assessing emissions like nitrate leaching can be calculated considering key processes, which is not the case for simple indicators describing farmers' practices like nitrogen use (Bockstaller *et al.*, 2008). However, this requires a detailed description of fertilization and pesticides management for a given area. Another

example is the assessment of economic indicators at NUTS2 level with two related model chains, that enables capturing complementary impacts of policy options, Social indicators in this list were derived from economic data, on labour and income distribution since no social model is, until now, integrated in SEAMLESS-IF.

Table 1. Example of environmental indicators within the goal-oriented indicator framework (GOF) at different scales (farm, normal font; Nuts 2, italic; member state or EU level, bold).

Themes	Domain 1 Impacts on the agricultural sector			Domain 2 Impacts on the rest of the world		
	Dimension of sustainable development			Dimension of sustainable development		
	Environmental	Economic	Social	Environmental	Economic	Social
Ultimate goals	Pesticide use	Net farm income Percent of subsidies in farm income <i>Percent of subsidies in farm income</i> Agricultural income	<i>Equity</i> Equity Monetary poverty rate	Nitrate leaching Pesticide leaching Crop diversity <i>Percent of area with high leaching</i> Nitrate surplus		<i>Equity</i> Equity
	Soil Org.Mat. change <i>P balance</i> N₂O emissions	Direct payments Direct payments Productivity of farm inputs Value of farm production	Labour use <i>Total labour use</i> <i>Potential employment</i>	Volatization <i>NH₃ emissions</i> <i>P balance</i> N₂O emissions	First pillar CAP expenditure export subsidy outlays profit of the agr. processing industry Terms of trade	<i>Fairness</i>
	Soil erosion Water use by irrigation Energy use by min. fertilizer Use of mineral P	Share of animal production <i>Share of animal production</i> Share of animal production Total costs	Labour use <i>Labour use</i> Labour use	Soil erosion Water use by irrigation Energy use by min. fertilizer Use of mineral P	<i>Land shadow prices</i> Land value	Labour use <i>Labour use</i> Labour use

Conclusion

The SEAMLESS-IF multi-scale approach with its explicit upscaling procedures, as well as the integration of the indicators into a generic flexible software system linked to a large database mark an important progress with respect to the creation of an efficient set of indicators to assess the sustainability of future agri-environmental policies. However, some methodological issues remain unclear, such as the determination of reference values and the aggregation of indicators into composite indices. For the latter, methods have been explored (Bockstaller *et al.*, 2009). Furthermore, there are still themes not covered by the GOF, e.g., impacts on biodiversity, and only few indicators are available representing the social dimension. However, as SEAMLESS-IF is a flexible system further extension of the indicator list is possible through the integration of new models.

References

- Alkan Olsson, J., *et al.*, 2009. Environ. Sci. Pol. (in review)
 Bockstaller, C., *et al.*, 2008. Agron. Sustain. Dev. 28: 139-149.
 Bockstaller, C., *et al.*, 2009. AgSAP Conference 2009, these proceedings.
 Van Ittersum, M.K., *et al.*, 2008. Agricultural Systems 96: 150-165.

From a disaggregated set of indicators to a synthetic, composite assessment of sustainability: Paths and pitfalls

C. Bockstaller, L. Stapleton, M. Van der Heide, G. Geniaux, S. Bellon, E. Josien,
M. Raley, J. Alkan Olsson
INRA, UMR Nancy-Université - INRA Agronomie et Environnement Nancy-Colmar,
BP 20507, 68021 Colmar Cedex, France
Contact: christian.bockstalller@colmar.inra.fr

Introduction

SEAMLESS-IF endeavours to capture the complexity of sustainable development by incorporating a wide range of indicators grouped along three dimensions (Van Ittersum *et al.*, 2008). Presenting outputs corresponding to disaggregated indicators in a table or a figure can be considered as a preliminary step in the analysis of a given action or, rather, a policy in the context of the SEAMLESS project. However, the question of aggregation arises when one intends to conclude about the sustainability of a policy, or furthermore to compare two or more policy options via a set of indicators. This contribution reviews different methods of combining diverse information in an explicit, consistent and transparent way, and presenting it in an easily intelligible form to facilitate *ex-ante* policy evaluation.

Aggregating a set of indicator values into a single, composite value

The most common and intuitive approach is to combine different source of information into a single value, e.g., indicator scores into a global index or composite indicator. This is in many cases calculated by means of a sum or a weighted mean (Rosnoblet *et al.*, 2006). Some assessment methods deliver a single score resulting from the sum of scores without an explicit standardization of the single indicator values. This kind of approach presents several methodological flaws like the risk of adding apples and pears. Several possible techniques for normalization exist: linear scaling techniques, Gaussian normalization, distance to target, ranking by experts, categorical scales, etc. (Geniaux *et al.*, 2005). Another approach is to convert all value into the same unit, monetary or physical (e.g., Ecological Footprint). Aggregation methods based on a common monetary unit like in cost-benefit analysis raise the issue of how to value non market goods and services like environmental assets, water quality, biodiversity, etc. (Van der Heide *et al.*, 2009).

Multi-criteria analysis

A serious drawback of using a single composite indicator is the loss of information through the aggregation and hidden compensation. A possible solution to these problems is multi-criteria analysis (MCA). MCA has its roots in management science and operational research and is a methodology for selecting between or prioritizing different options described by a set of criteria. Central to MCA is: (1) some form of criteria or scale for selecting between or prioritizing different options; (2) a table to show the performance of the different options relative to each other (Table 1). This is based on a weighting, rating or ranking procedure by a group of experts or stakeholders (Josien *et al.*, 2006); (3) statistical analysis or some alternative methods for drawing conclusions or highlighting the key findings from the MCA. Such analysis lays on a multitude of very different approaches, e.g., a utility function in the case of a compensatory approach (allowing compensation between criteria) or pair-wise comparisons like, for example, outranking approaches which are mostly non compensatory. In this case, the number of criteria has to be limited.

Multi-criteria assessment based on a qualitative method (dashboards)

Qualitative approaches can also be considered as a way to aggregate. These types of

approaches lead to a conclusion in the form of a quantitative value, or as classes of a given criteria (e.g., sustainability). Technically, therefore, the dashboard approach can be considered as a hybrid approach combining qualitative and quantitative elements. Such approaches are based on decision rules expressed in “if then” language, presented either as decision trees based on qualitative multi-attribute decision modelling or in the form of a dashboard (Figure 1). The number of criteria included in the analysis can be increased when those are structured in a hierarchical tree.

Table 1. Hypothetical data on ranks and rates of economic themes by a group of experts.

Expert	Theme ¹	Rank (between 1 and 9)	Rate (total 100)
1	Viability	1	50
1	Performance	3	30
1	Capital	5	20
2	Viability	3	40
etc.			

¹ From the goal-oriented indicator framework (GOF) developed in the SEAMLESS project (Alkan Olsson *et al.*, 2009)

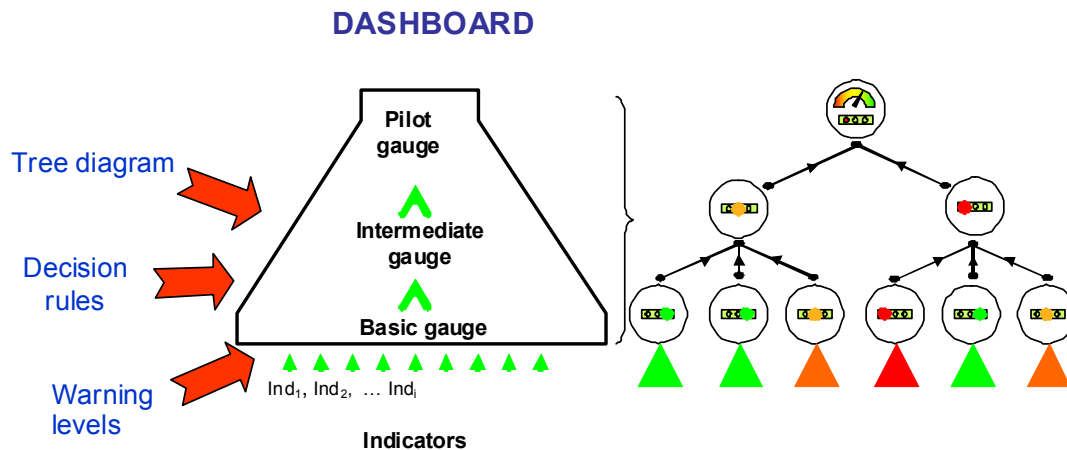

Figure 1. Overview of the ‘dashboard’ concept according to Girardin *et al.* (2005).

Conclusions

The MCA approach allowing a transparent weighting procedure as shown in Table 1 can serve as a basis to a more qualitative approach using a dashboard presentation. This approach provides a presentation of aggregation results in an easily intelligible form. However, implementation in an assessment framework like SEAMLESS-IF remains open because it requires additional software development work, which is beyond the means of the project.

References

- Alkan Olsson, J., *et al.*, 2009. Environ. Sci. Pol. (in review)
- Geniaux, G., *et al.*, 2005. PD 2.2.1 SEAMLESS project, pp. 148.
- Girardin, P., *et al.*, 2005. Indicateurs et tableaux de bord. Guide pratique pour l'évaluation. Lavoisier, Londres, Paris, New York, 39 pp.
- Josien, E., *et al.*, 2006. PD 2.6.1 SEAMLESS project, 42 pp.
- Rosnoblet, J., *et al.*, 2006. In: Eds M. Fotyma & B. Kaminska, 9th ESA Congress, Warsaw, Poland, pp. 707-708.
- Van der Heide, M., *et al.*, 2009. SEAMLESS book. (in review)
- Van Ittersum, M.K., *et al.*, 2008. Agricultural Systems 96: 150-165.

Contextualization of on farm *ex-ante* evaluation of the sustainability of innovative cropping systems in viticulture, using a multiple criteria assessment tool (DEXi)

S. Delmotte, C. Gary, A. Ripoche, J.M. Barbier, J. Wery
INRA, UMR System, 2 place Pierre Viala,
34060 Montpellier Cedex 2, France
Contact: gary@supagro.inra.fr

Introduction

Grape producers face an economic and environmental crisis, the latter relating to the generally high use of pesticides in vineyards. In relation to them, various stakeholders expect some environmental improvements. Researchers are proposing novel cropping systems that should be evaluated *ex ante* with respect to their contribution to sustainable development, meaning both their environmental impacts and their economical and social adoptability by farmers. Farms producing grape are very diverse in terms of size, soils, availability of staff and equipment, and objectives of production (wine grade). In this context, we hypothesized that the evaluation of a candidate cropping system should be carried out in the farm context, taking into account information in relation with its adoptability.

Methods

To evaluate and compare cropping systems, Multiple Criteria Decision Aiding (MCDA) methodologies seem to be relevant (Sadok *et al.*, 2008). A decision support tool called DEXi (Bohanec, 2008) was adopted; it enables to design decision trees based on a hierarchy of criteria. The qualitative classes (such as 'low', 'medium' and 'high' for example) of criteria are aggregated into a single note, which is in the present case the contribution of the cropping system to sustainable development. It is necessary to define scales to convert values of indicators into classes of criteria. The criteria are then aggregated using 'if... then...' decision rules to obtain final classes for the overall criteria. Some criteria and indicators were derived from a list proposed for field crops (MASC v.1.0, 2008) and adapted to viticulture by a group of four experts. Two theoretical farms were defined, with contrasting production objectives (low vs. high grade wine) and availability of labour and equipment. A process of aggregation was then proposed to take into account these characteristics in the evaluation, and several cropping systems were compared.

Results

The impact of cropping systems on environment was evaluated through five attributes (Figure 1): the pressure on biodiversity, the energy use and the impacts on the soil, water (both surface and below ground) and air compartments. The economic adoptability of cropping systems was evaluated through (i) the satisfaction of production objectives on average, and the stability of production over the years, (ii) the total cost of implementation of the cropping system. It indirectly reflected the efficiency of production and the productivity of labour. For the social and human dimensions of sustainability, four attributes were considered: the difficulties to implement the candidate system, the task overlap, the health risk, the social recognition and the free time left to the farmer.

One parameterization of the decision tree was obtained for each farm context. It differed on five points: (i) the calculation of the indicators of performance depended on the yield and quality objectives of the farmer, (ii) some of the indicators were calculated in reference to the actual system practiced by the farmer (iii) some qualitative criteria could take values that reflected the opinion of the farmers (Figure 1 in grey), (iv) the scale to convert an indicator value into a class of criteria could be fixed by them and reflect their objectives and

constraints, (v) the aggregation of the criteria had to be set up by stakeholders for the environmental criteria and by the farmers for the social and economics criteria, in order to represent their priorities among the attributes (Figure 1 in dotted lines).

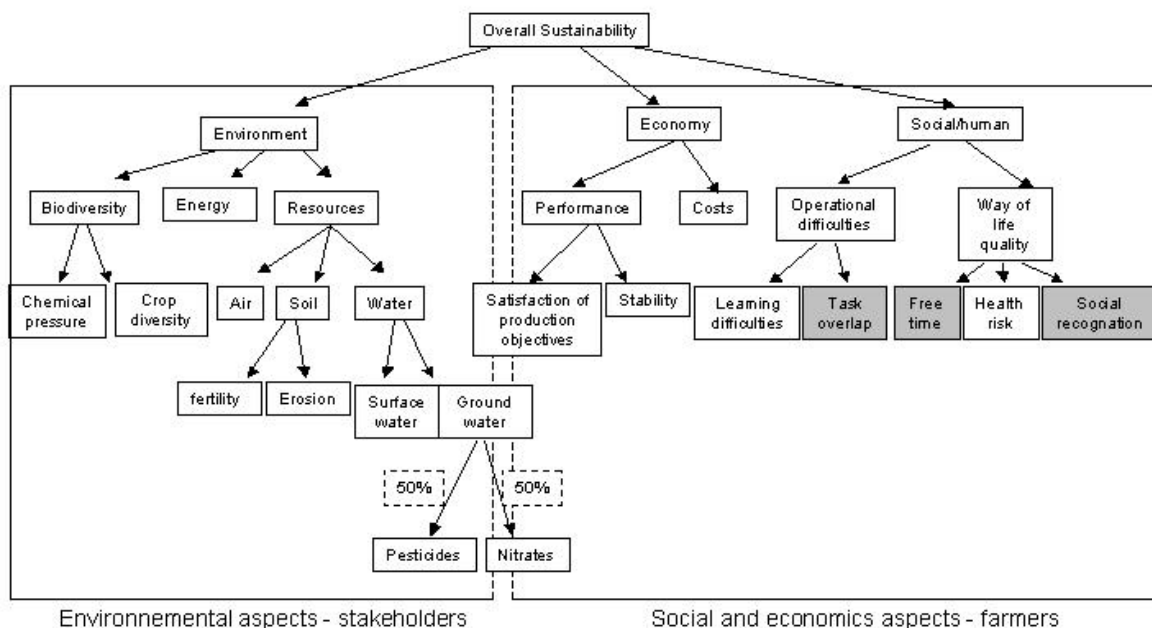

Figure 1. Splitting up of the sustainability of cropping systems into environmental, economical and social/human criteria.

It resulted that the economical and social performances of some cropping systems differed among the two farms (e.g., integrated farming with non-permanent cover cropping had a lower social score and a higher economical score in the farm with low availability of labour and equipment).

Discussion

In the present research, we aimed at developing a tool that could be used by extensionists, farmers and stakeholders. The contextualization of the evaluation of cropping systems was tested for the two theoretical farms by using role games with experts, mainly researchers and extensionists. It proved to be powerful for discussing the decision tree and considering the local and farming contexts. The evaluation outputs appeared sound to the experts, particularly with respect to the adoptability of innovations, that is a crucial dimension of sustainability.

The method must now be tested in a real case and participatory methods must be chosen. We propose to consult stakeholders of the area where the evaluation takes place to define the utility functions for the environmental criteria. Independently, farmers would be consulted to define scale and utility functions for social and economical criteria.

Acknowledgements

The authors thank A. Biarnès, L. Bouchet and C. Clipet for their expert contribution.

References

- Bohanec, M., 2008. DEXi: A Program for Multi-Attribute Decision Making, version 2.0. <http://www-ai.ijs.si/MarkoBohanec/dexi.html>.
- MASCV1.0, 2008. IDDN.FR.001.040014.000.R.P.2008.000.30100.
- Sadok, W., *et al.*, 2008. *Agronomy for Sustainable Development* 28: 163-174.

Assessing the environmental sustainability of the CAP: A DPSIR framework approach

G. Giannoccaro, J.M. Pistón, J. Berbel
ETSIAM – University of Cordoba, Dpt. of Agricultural Economics,
Sociology and Policy, Campus de Rabanales Edificio C5 14014 - Spain
Contact: es2gigig@uco.es

Agriculture plays only a small part in the economies of European Union (EU) member countries, accounting for about 2% of GDP and 5% of EU employment. But in terms of its impact on the environment and natural resources, the role of agriculture is more significant, accounting for 45% of EU total land use and over 30% of total water use (OECD, 2001a). In addition, agriculture in the rural areas is the major beneficiary of the Common Agricultural Policy (CAP) in most EU countries; therefore, environmental concern about resource depletion, and conservation of biodiversity, habitats and landscapes, inevitably involve environmental sustainability issues (EC, 2001).

Assessing the CAP impact might help in re-addressing the CAP in the wider framework of EU environmental objectives.

There are currently numerous scientific works on the assessment of environmental impacts in relation to the agricultural activity, but most of them come from the researches published by OECD (OECD, 2001b) and they deal with indicator definition and calculation. However, the indicator set definition for sustainability assessment has become a high priority both in scientific research and policy agendas.

This research will focus on the development of the environmental sustainability evaluation framework, proposing a consistent and comprehensive methodology referred to as the DPSIR framework (EEA, 2001), in order to study the interactions between CAP and environmental issues in rural areas. The approach consists of taking into account all environmental themes (soil, air, water and biodiversity) involving the agricultural system in rural areas. Each environmental theme will be accounted according to the DPSIR model, forces, pressures, state, impacts and responses (i.e. CAP supports, both the first and the second pillar). Stress will be made on the trends in agricultural impacts in rural areas and the influence of CAP on environmental sustainability (Table 1).

Further, by some deep interviews, we will attempt to highlight the changes in farmers' behaviour in the event of CAP support modification. To achieve this, a preliminary application case will be undertaken in Andalusia (Spain).

Table 1. DPSIR design for CAP environmental sustainability assessment.

	Environmental themes	Force	Pressure	State/Impact*	Response
Agricultural systems	Soil	From scientific documents highlighting the relationship between environment and agriculture.	Official reports about pressures (see OECD, 2008) focusing on the main problems within rural areas, and interview results.	Selected indicator values (time series and threshold values). Official data.	CAP response definition and budget trend amounts. Official data. Interview results. Farmers' behaviour recognition.
	Water				
	Air				
	Biodiversity				

* Because of the restricted framework on farming activities, the impact of the agricultural sector is ineffective.

Spatial effects are the crucial aspect of environmental sustainability issues. Essentially, there is a horizontal and a vertical component. The horizontal component depends on the scale of application limited to the plot, farm or landscape (watershed, region or state), respectively. On the contrary, the vertical component refers to the administrative issues.

We propose an approach that takes into account the main agricultural systems in rural areas as the horizontal component, and aggregation at NUT 3 level as the vertical component, focusing on household farms in rural areas.

The framework is restricted to on-farm activities (only cultivation practices) of the production cycle. This means that impacts caused by off-stream activities such as transport, food transformation and packaging are not accounted for.

References

- EEA, 2001. Environmental Signals 2001. European Environment Agency, Copenhagen.
- European Commission, 2001. Statistical Information needed for Indicators to monitor the Integration of Environmental concerns into the Common Agricultural Policy. COM 144 final.
- OECD, 2001a. Measuring the Environmental Impacts of the Common Agricultural Policy: Challenges, Recent Trends and Outlook, and Future Directions. The Common Agriculture Policy and the Environmental Challenge - New Tasks for the Public Administrations? Maastricht, 14-15th May 2001.
- OECD, 2001b. Environmental Indicators for Agriculture, Volume 3 - Methods and Results. OECD, Paris.
- OECD, 2008. Environmental Performance of Agriculture in OECD Countries since 1990. OECD, Paris.

Agri-environmental nitrogen indicators for EU27

A. Leip, F. Weiss, W. Britz
European Commission – DG Joint Research Centre,
Institute for Environment and Sustainability,
TP.050, 21014 Ispra (VA), Italy
Contact: adrian.leip@jrc.it

Introduction

Nitrogen is a key element to ensure modern agriculture's output, sustaining the live and lifestyle of billions of people. But nitrogen accounts also for key environmental problems that challenge the well functioning of today's societies. One molecule of nitrogen can contribute to one or many environmental problems, including eutrophication, groundwater pollution, climate change, and may affect human health via ozone formation or biodiversity via nitrogen deposition on natural areas. This multiple impact of nitrogen is often referred to as the 'nitrogen cascade' (Galloway *et al.*, 2003).

Accordingly, nitrogen plays an important role in several agri-environmental indicators such as NH₃ emissions, fertilizer N impact, gross N surplus, nitrates in water, GHG emissions (EEA, 2005). Many of these indicators, however, are so far calculated independently and with sometimes contradicting data sources (see, e.g., Grizzetti *et al.*, 2007). This includes also the first overview of the "European Nitrogen Case" that was presented by Van Egmond *et al.* (2002) at the second International Nitrogen Conference held in Potomac (USA). Thus, a system that calculates the detailed nitrogen balance and the related indicators for agriculture in Europe on the basis of consistent data sets and advanced methodologies is highly desirable.

A closed balance of nitrogen is calculated in the CAPRI model, i.e., next to monetary values and product balances, also the nutrient fluxes are in accordance with the law of mass-conservation (Britz *et al.*, 2007). We present national nitrogen budget and related indicators for the agricultural sector in EU27, but also for individual European countries, on the basis of the CAPRI database for the year 2002.

Methods

In CAPRI, different parts of the agricultural sector are linked by the flow of (mass and) nitrogen: the crop sector receives manure nitrogen from the livestock sector in the exchange of animal feed; the animal sector receives feed and concentrates also from the agricultural market and sells products for processing and consumption; the industry produces synthetic fertilizer as major nitrogen input to agricultural soils that produce food and fiber for societal use. Nitrogen losses occur both in livestock production system and from agricultural soils. The nitrogen balance of the livestock sector is closed by estimating manure nitrogen excretion as the difference from nitrogen intake with feed and nitrogen output (or retention) in products; the soil nitrogen balance is closed by estimating soil nitrogen surplus from total nitrogen input and quantified nitrogen output. Both manure excretion and nitrogen surplus are cross-checked by independent data sources; soil surplus is split into nitrate leaching, NH₃ volatilization, denitrification (N₂O and N₂ emissions) using emission factors. The main nitrogen fluxes thus determined are schematically shown in Figure 1.

Results and discussion

The largest N-input to EU27 agriculture (not considering Cyprus and Malta) is the application of mineral fertilizer (11.3 Mt N), with almost equal amount coming from the livestock sector (9.3 Mt N as manure). Only 14% of this nitrogen is available for human consumption. Net import amounts to only 2% of the total N productivity (feed and food). The situation is very different in the Netherlands, where a net N import of almost 200 kt N adds to an input of 290

kt N in mineral fertilizers and 440 kt N in manure, reflecting the importance of the animal sector in the Netherlands, which depends to a large degree on the import of feed concentrates.

This short selection of examples shows that the CAPRI modelling system is a powerful tool for deriving nitrogen related agri-environmental indicators. These become even stronger if downscaled (Leip *et al.*, 2008; Britz & Leip, 2009) to the regional or watershed level.

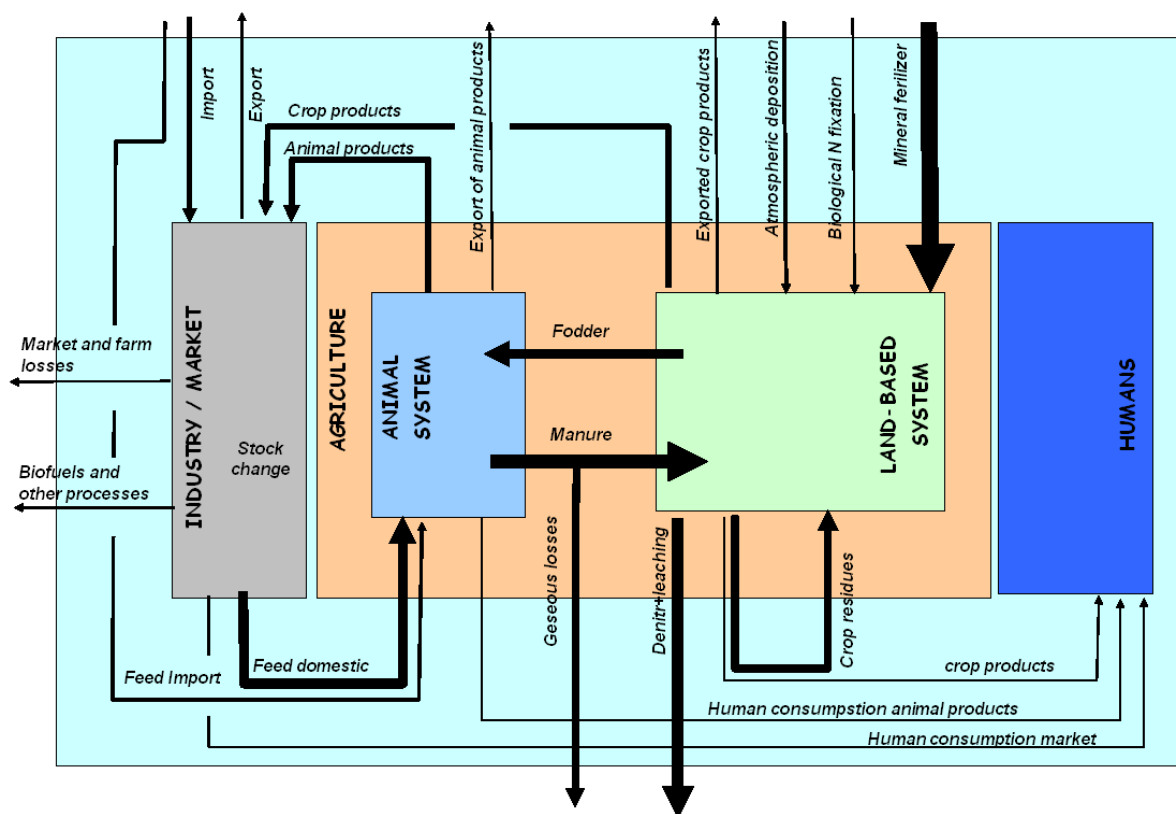

Figure 1. Schematic representation of N-flows to and from the agricultural system.

References

- Britz, W. & A. Leip, 2009. Development of marginal emission factors for N losses from agricultural soils with the DNDC-CAPRI meta-model. *Agriculture Ecosystems & Environment*. (submitted)
- Britz, W., *et al.*, 2007. Description of the CAPRI Modeling System. Final report of the CAPRI-DynaSpat Projec. Institute for Food and Resource Economics, University of Bonn, Bonn, Germany.
- EEA, 2005. Agriculture and Environment in EU15 - the IRENA indicator report, EEA Report No. 6/2005, Copenhagen: European Environment Agency, 128.
- Galloway, J.N., *et al.*, 2003. *BioScience* 53(4): 341-356.
- Grizzetti, B., *et al.*, 2007. Spatialised European Nutrient Balance, EUR 22692 EN, Luxembourg: Office for Official Publications of the European Communities.
- Leip, A., *et al.*, 2008. *Biogeosciences* 5(1): 73-94.
- Van Egmond, K., *et al.*, 2002. *Ambio* 31(2): 72-78.

Sustainability of Flemish farms: Advising farmers and policymakers

M. Meul, S. Van Passel
University College Ghent, Voskenslaan 270, B-9000 Ghent, Belgium
Contact: marijke.meul@hogent.be

Introduction

Today, ‘sustainability’ has rightfully gained its place in the vision, mission and strategy of companies, organizations and governments, also in agriculture. However, putting the theoretical concept into practice often proves to be very difficult. Hence, the objective of this paper is to address the ‘sustainability-paradox’ between intention and action, by presenting two complementary methods that are helpful to advise both farmers and policy makers concerning sustainability of Flemish farms.

Methods

During the last decade, there has been an explosion of activity to develop sustainable development indicators, in order to determine whether sustainable development is actually being achieved. Hereby, two major approaches can be distinguished: (i) a set of indicators listed or presented together within a single table or diagram (visual integration) and (ii) a single, composite index of sustainability (numerical integration). Each approach has its pros and cons and one has to choose a particular approach depending on the specific goal and intended use. We present two approaches in this paper: a visual integration approach (MOTIFS) and a numerical integration approach (the sustainable value approach). Both approaches have already proven to be useful to assess the farm sustainability of Flemish dairy farms.

MOTIFS

MOTIFS (Meul *et al.*, 2008a) is an indicator-based sustainability monitoring tool for Flemish dairy farms. It allows us to monitor farm progress towards integrated sustainability, i.e. taking into account economic, ecological as well as social aspects, using a set of relevant indicators. The tool offers a visual aggregation of indicator scores into an adapted radar graph, considering ten sustainability themes related to ecological, economic and social aspects.

Sustainable Value approach

The sustainable value approach is developed by Figge & Hahn (2004) and it shows in monetary terms the value that a company creates or destroys by the use of a set of different resources. A positive value contribution indicates that a resource is used in a value-creating way by a company. To determine how much value is created by the entire bundle of resources, the sustainable value can be calculated by summing up all value contributions and by dividing this value by the number of resources. More information of an application of the sustainable value approach for Flemish farms can be found in Van Passel *et al.* (2007).

Case-studies

MOTIFS has been applied on 20 Flemish dairy farms participating in a Leader+ project ‘Strong with Milk, 2006–2008’ with the aim to monitor sustainability and stimulate communication and exchange of knowledge between farmers. For a number of selected sustainability themes, farmer discussion groups were organized, in which the MOTIFS-results were discussed.

The sustainable value approach is currently applied in a European funded project (within the 6th FP) called SVAPPAS, with a major aim to develop and adapt the sustainable value methodology for the assessment of sustainability at farm, sector, national or cross-national

level. Besides, the methodology is tested for different case study areas and the data needs and data availability to arrive at a standard approach for sustainability analysis of farms and farm policies are assessed.

Discussion and conclusions

Both methods can and should be used complementary to assess sustainability performance of Flemish farms and to advise both farmers and policymakers on sustainability aspects. This is shown in Figure 1.

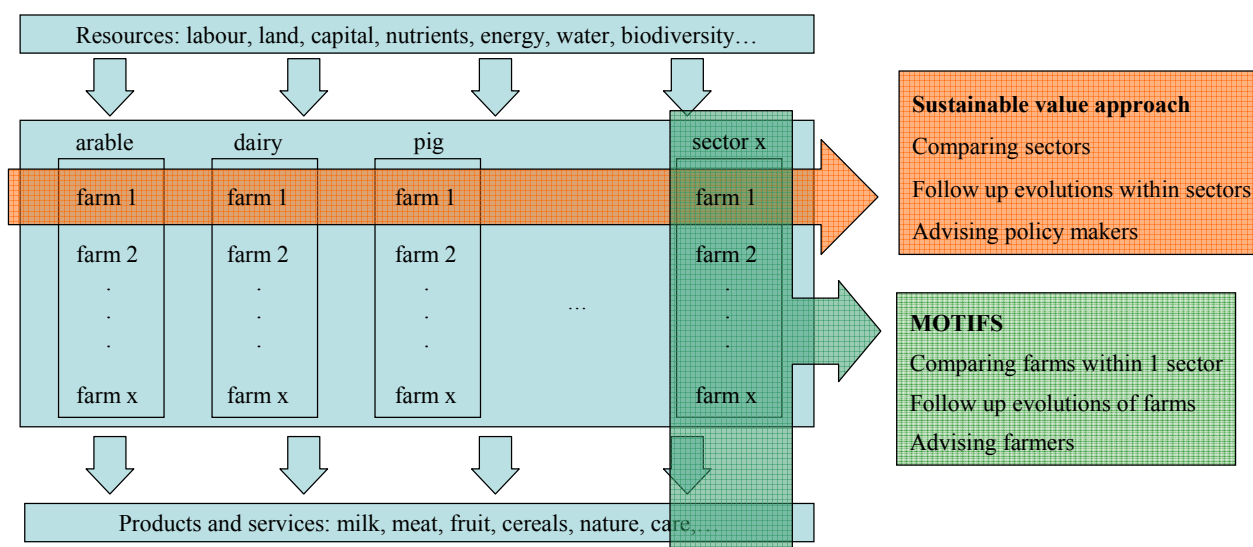

Figure 1. Complementary use of the sustainable value approach and MOTIFS for sustainability assessment and advice to farmers and policymakers within the Flemish farming sector.

MOTIFS is designed to guide farmers towards a higher level of sustainability. The visual integration of relevant themes of ecological, economic and social sustainability aspects and sustainable entrepreneurship, allows an immediate and integrated interpretation of a farm's overall sustainability level and gives an overview of the farm's strengths and weaknesses. MOTIFS was found particularly interesting to be used in a discussion group of farmers to mutually compare results and exchange knowledge and expertise (Meul *et al.*, 2008b). Moreover, by using the monitoring system to compare farm performances of an individual farm over time, the farmer can follow-up whether management actions actually result in the aimed effect. This makes MOTIFS a useful management tool for farmers.

The sustainable value integrates sustainability aspects in a numerical way. The approach is extremely suitable to support decision makers in their selection of good resource users and to follow up structural or sector evolutions. Policymakers can be informed on which are good and bad performing sectors, so they may e.g. decide to help bad performers to improve their sustainable resource use. The method can also be used to identify major characteristics within a specific sector that influence the sustainability performance of the related farms. For example, Van Passel *et al.* (2007) found that both structural and managerial characteristics have an impact on the sustainable value of Flemish dairy farms.

References

- Figge, F. & T. Hahn, 2004. *Ecological Economics* 48: 173-187.
- Meul, M., *et al.*, 2008a. *Agronomy for Sustainable Development* 28: 321-332.
- Meul, M., *et al.*, 2008b. *Ecological indicators*. (in press, available online)
- Van Passel, S., *et al.*, 2007. *Ecological Economics* 62: 149-161.

Rural regions in Europe: A new typology based on a multi-sectoral point of view

J. Scholz, S. Herrmann
Institute for Environmental Planning, Leibniz University Hannover,
Herrenhäuserstraße 2, 30419 Hannover, Germany
Contact: scholz@umwelt.uni-hannover.de

Introduction

The situation of rural areas in Europe is strongly discussed. Old recipes are no longer valid to cope with current problems like demographic change, decreasing importance of agriculture or impact of global change. Therefore, new approaches are needed to direct rural policies to support the specific endogenous potential of rural areas.

One major objective of the recently started EU FP 7 project 'RUFUS' (Rural future Networks, www.rufus-eu.de) is to generate a tool to specify the different dimensions of potentials (social, economic, ecological) of rural regions. This characterization tool consists of a typology of rural regions based on an indicator set developed by an interdisciplinary methodology. By means of the typology, different types of rural regions with specific characteristics concerning their development potential are derived.

This typology is framed by two additional project parts. First, a policy baseline assessment delivers the basis for the typology concerning the policy sectors which have an impact on rural areas (Nadin & Van Nes, 2008). On the other hand, the results of the typology serve as basis for recommendations for integrated, multi-sectoral rural policy. Figure 1 shows the relationships between these three investigation steps. The derived types will be reviewed by regional stakeholders in case studies for each project country.

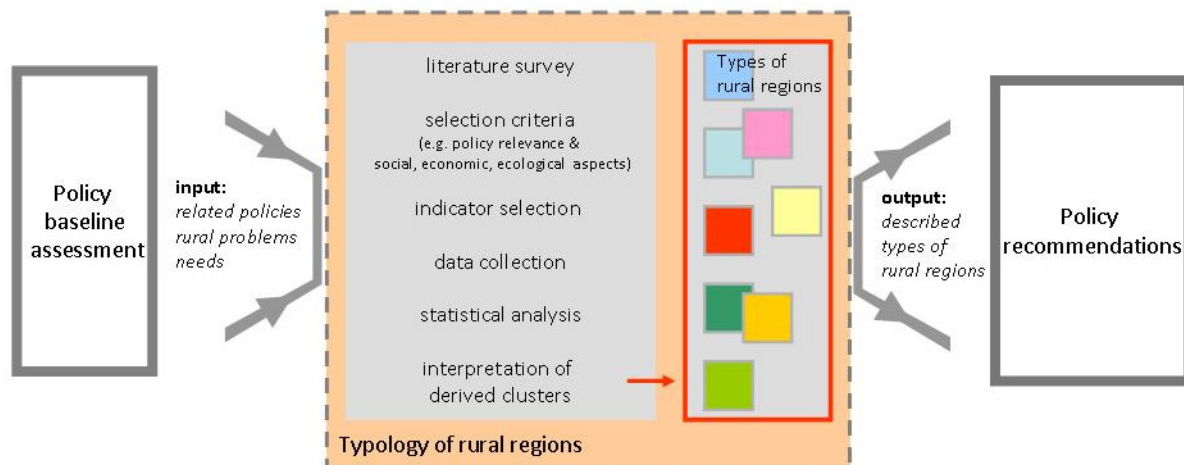

Figure 1. Workflow of RUFUS typology.

Extending existing rural typologies (e.g., Boscacci *et al.*, 1999; OECD 2006) RUFUS is targeted on a typology with a multi-sectoral (policies), multi-disciplinary approach for indicator selection. The aim is to derive a set of indicators to draw a coherent picture of rural areas in Europe. A set of qualitative and quantitative indicators is used to cluster European regions regarding common characteristics of current state and development potentials. The main objective is to highlight the diversity of rural regions among themselves, not the comparison between rural and urban regions.

Working results of the first year of the RUFUS project will be presented, in particular the first types of the RUFUS typology.

Methods

The methodology consists of the following steps.

I. Basic settings

The typology is based on available data sets. No primary data selection was initiated. Most of the data are taken from existing data bases like ESPON, EUROSTAT, CORINE Land Cover and Landsat. Furthermore, additional indicators, especially social and ecological data sets, were provided by each project country. Therefore, the project is able to extend general indicator sets by regional information.

The reference units are the NUTS 3 regions of the project countries. The focus of the typology is centered on the project countries: the Netherlands, United Kingdom, Sweden, France, Hungary, Italy, Poland, Portugal and Germany.

II. Indicator selection

On the basis of the policy baseline assessment (Figure 1) selection criteria are derived for the indicator selection. Two important selection criteria are the policy relevance and a balance of social, economic and ecological indicators. Innovative indicators, especially for development potentials and for social issues, have to be derived. Furthermore, the selection of indicators is also strongly related to the analysed countries because the typology should reflect national and regional differences. To reduce the number of indicators, statistical techniques are applied (correlation value). The final indicator set is used by the second statistical process: the cluster analysis.

III. Cluster-analysis

By using multi-variate statistical techniques (cluster analysis) the regions (NUTS 3) of selected European countries are clustered by common indicator characteristics. By varying the indicator set, different cluster sets can be developed. A hierarchical cluster analysis (Backhaus *et al.*, 2008) will be performed.

IV. Typology

Each cluster will be defined as a specific type by interpreting and describing their characteristic aspects and their capability to reveal development potentials. Finally each type should reflect the multi-sectoral approach to serve as basis for policy recommendations.

Results and discussion

The initial results of the RUFUS typology procedure so far are: the development of selection criteria, the adaptation of the statistical methodology and the derivation of types, based on a sustainable set of indicators.

Within the presentation different examples of the new types will be described. The appropriateness of these types as well as pros and cons of the multi-sectoral approach will be discussed. The question how typologies can serve as basis for policy recommendations will also be answered.

References

- Backhaus, K., *et al.*, 2006. Multivariate Analysemethoden. Eine anwendungsorientierte Einführung, Berlin.
- Boscacci, F., *et al.*, 1999. A typology of rural areas in Europe, Milan.
- OECD, 2006. The new Rural Paradigm. Policies and Governance, Organisation for Economic Co-Operation and Development, Paris.
- Nadin, V. & A. Van Nes, 2008. Position Paper. Baseline assessment. (unpublished)

Theme B
State-of-the-art of components for integrated systems

Session B3: Cropping systems modelling

Session organizers:

Jim Jones

University of Florida, Gainesville, USA

Mike Robertson

CSIRO, Sustainable Ecosystems, Australia

Graham Russell

University of Edinburgh, UK

Cropping systems modelling: Past performance and future prospects¹

B.A. Keating, M.J. Robertson, P.S. Carberry, D.P. Holzworth, N.I. Huth
CSIRO Sustainable Ecosystems, 306 Carmody Rd., St Lucia 4067 QLD Australia
Contact: Brian.Keating@csiro.au

Introduction

Cropping systems models integrate climate, soil, and crop characteristics to simulate crop growth and productivity, resource use, and changes in soil, nutrient and water characteristics. In more elaborate modelling systems, pastures, animals and forests might feature as components of multi-paddock simulators. In this paper, we review developments in cropping systems models and their evolution from simpler crop models over the last 25 years. We trace the history of key modelling efforts in Europe, North America and Australia. In particular we explore:

- (a) Developing scale in cropping systems modelling efforts;
- (b) The evolving focus from crop models to cropping systems simulators;
- (c) Innovation in construction of cropping systems models;
- (d) The evolving focus for model application.

Developing scale in cropping systems modelling efforts

The development and wider application of many crop models did not always extend far beyond the original authors, reflecting both the incentives that existed for publishing new models and oftentimes the difficulties in transferring models supposedly ‘validated’ on a limited set of data to different environmental or management conditions. There were exceptions to these isolated model development efforts and there are now a small number of cropping systems simulators that dominate applications in the literature (Table 1). These include the DSSAT-ICASA effort (based on the CERES and GRO models initially) coming out of the USA, which did much to champion the cause of crop and cropping systems models worldwide, the Wageningen models (e.g., SUCROS, MACROS, ORYZA, WOFOST) and perhaps as importantly, the students from around the world that studied crop modelling and systems analysis at Wageningen University in The Netherlands, CROPSYST from Italy but with a broad international participation and the APSIM modelling system from Australia.

Evolution from crop models to cropping systems simulators

We have seen an evolution from crop models that focused on yield prediction of individual crops in response to genetics and resource supply to cropping systems models that focused on the systems level interactions between crops, pastures, soils, environment and management. The early crop models on the 1980s (e.g., CERES, GRO models) invested in sufficient physiological detail to predict crop yield response to resource supply (water, nutrients) and weather, as modified by management decisions and genetic characteristics. There were ‘systems simulators’ available at this time (e.g., EPIC, CENTURY) but they lacked physiological detail and were limited in their simulation of crop yield in response to management and environmental factors. By placing the focus of cropping systems simulators on the soil (not the crop) but retaining the crop physiological detail and management responsiveness in crop modules to the systems simulator.

Innovation in construction of cropping systems simulators

The quality and robustness of the computer code in the early models was variable but generally poor. As often as not, crop physiologists taught themselves FORTRAN and went

¹ Keynote presentation

Table 1. Frequency of web-based references for different modelling efforts using the search terms, 'crop model' and 'cropping systems model' (Google search engine 1/1/2009).

Modelling Effort	Cropping systems		Reference
	Crop model	model	
CERES	3930	207	Jones & Kiniry (1986)
DSSAT	2340	117	Jones <i>et al.</i> (2003)
APSIM	1110	507	McCown <i>et al.</i> (1996)
ORYZA	989	47	Bouman <i>et al.</i> (2001)
MACROS	228	9	Penning de Vries <i>et al.</i> (1989)
WOFOST	819	21	Van Diepen <i>et al.</i> (1989)
CROPSYST	495	209	Stöckle <i>et al.</i> (2003)

off and 'hacked' code. This was a viable strategy for simple crop models but quickly became untenable in the early 1990s as crop models were morphing into increasingly complex 'cropping systems' models. We can identify three forms of innovation relevant to cropping systems simulator construction over the last 25 years. These are:

- *Software engineering innovation* - developments in terms of modularity and protocols for inter-module communications, multi-language simulators, reusable code components, version control and regression tests, etc.,
- *Science innovation* - developments in plant physiological and soil chemical/physical concepts and their translation to robust model algorithms,
- *Application innovation* - Developments in model interfaces, visualization, scaling up techniques (summary models, cross-scale model linkages) and model delivery systems (such as web-based applications).

Evolving focus for model application

We have seen the forces stimulating model development and application as evolving from an initial focus on investigation of crop physiological function through a period where decision support for farm-level decision making dominated to the present day when models are extensively used in policy development and program implementation concerning land use planning, environmental protection, climate change impacts and adaptation assessment and greenhouse gas mitigation. Over the last 20 years the use of simulation models in agronomic and farming systems research has gone from being a 'fringe' activity to a tool accepted by the mainstream agronomic research community in diverse applications.

At the same time as there has been an acceptance of cropping systems modelling by the broader agronomic research community, we argue that the rate of innovation in scope, design and predictive capacity has gradually declined. We present and discuss the evidence for this contention and explore likely sources for future innovation in cropping systems models including novel delivery systems (e.g., via the internet), linking models at different scales to deal with farm business and environmental issues, the ability to simulate livestock in cropping systems, and the derivation of summary models to aid agricultural extension and education.

References

- Bouman, B.A.M., *et al.*, 2001. ORYZA2000: Modelling lowland rice. IRRI and WU, 235 pp.
- Jones, J.W., *et al.*, 2003. European Journal of Agronomy 18: 235-265.
- Jones, C.A. & J.R. Kiniry, 1986. CERES-Maize: A simulation model of maize growth and development. Texas A&M University Press, College Station, TX, USA.
- McCown, R.L., *et al.*, 1996. Agricultural Systems 50: 255-271.
- Penning de Vries, F.W.T., *et al.*, 1989. Simulation of ecophysiological processes of growth in several annual crops. Pudoc, Wageningen, The Netherlands.
- Stöckle, C.O., *et al.*, 2003. European Journal of Agronomy 18: 289-307.
- Van Diepen, C.A., *et al.*, 1989. Soil Use and Management 5: 16-24.

APES, an agricultural production and externalities simulator evaluated for two main crops in Midi-Pyrenees

M. Adam, H. Belhouchette, E. Casellas, O. Therond, J. Wery
 Plant Production Systems Group, Wageningen UR, Haarweg 333, P.O. Box 430,
 6700 AK Wageningen, The Netherlands
 Contact: myriam.adam@wur.nl

Introduction

An agricultural production and externalities simulator (APES) has been developed within the SEAMLESS project (Van Ittersum *et al.*, 2008), as part of a modelling chain enabling *ex-ante* impact assessment of agricultural and environmental policies and technological innovations. The reason to include such model was to predict the impact of different land-bound activities on regional agriculture from a bottom-up perspective. A first step towards this objective is to evaluate the performance of APES at field level for the main crops of the investigated regions. We conducted this analysis for Midi-Pyrenees to subsequently include this model for the assessment of the impact of the Nitrate Directive on the agricultural systems of South of France (Belhouchette *et al.*, 2009). This study uses the APES Modelling Solution (Casellas *et al.*, 2009) developed to simulate arable crop activity with a focus on two contrasting crops.

Methods

APES is a modular system of biophysical components that simulates biophysical impacts of crop management, soil and climate on cropping systems. APES integrates various existing modelling approaches representing the soil-water budget, soil-plant nitrogen budget, crop phenology, crop canopy and root growth, biomass production and partitioning, crop yield, residue production and decomposition, soil erosion. Data were collected in INRA-Toulouse (station Auzeville) from 1996–2002, for two major crops in different fields and management practices in Midi-Pyrenees (Table 1).

The key phenological stages have been estimated using data for emergence, flowering and harvesting time. The performance at field level of the model with default parameter values

Table 1. Main soil properties and management practices of the experimental data sets.

Plot name and year	Main soil properties			Main management practices		
	Soil type	Organic matter content (%)	Bulk density (t m ⁻³)	Sowing date (DOY)	Irrigation (mm)	Fertilization (kg ha ⁻¹)
Maize						
T3-1996	Clay loam	0.97	1.32	102	186	183
T4-1996	Clay loam	1.00	1.30	102	144	183
X3-1997	Clay loam	0.83	1.34	102	158	171
X4-1997	Clay loam	0.80	1.29	102	134	171
Y3-1997	Loam	0.71	1.37	101	125	171
Y4-1996	Clay loam	0.69	1.34	102	176	204
Z1-1999	Clay loam	0.59	1.30	99	311	201
Z6-1998	Clay loam	0.79	1.29	125	286	206
Durum wheat						
T1-2000	Clay loam	0.70	1.33	312	0	106
T4-1998	Clay loam	1.00	1.30	316	0	185
X4-1996	Clay loam	0.82	1.29	309	0	138
Y5-1999	Loam	0.63	1.36	336	0	77
Y7-1997	Clay loam	0.66	1.33	341	43	169

were evaluated comparing observed data with simulated data (grain yield, nitrogen uptake and leached) using statistical criteria such as mean, standard deviation (SDV), the root mean square error (RMSE) and the Pearson correlation coefficient (r).

Results and discussion

Figure 1 summarizes the main simulation outputs compared to the experimental data. Overall, we have a slight underestimation in yield (-10% for maize to -5% for wheat) and a significant overestimation of nitrogen uptake ($+30\%$ for maize and $+20\%$ for wheat) which might explain the low level of nitrate leaching simulated. The overestimation of nitrogen uptake is likely to be due to a too high nitrogen concentration in plant tissue. Another potential cause of the low nitrogen leached can be a too low water drainage.

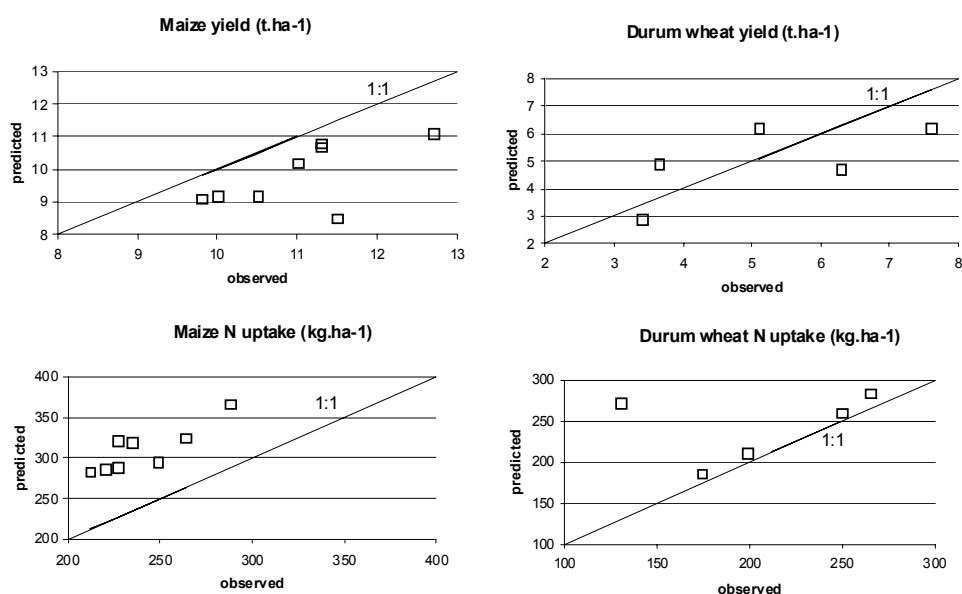

Figure 1. Observed and simulated grain yield and crop nitrogen uptake for maize and winter durum wheat in Auzeville, Midi Pyrenees (France) from 1996–2002.

However, as the use of the model targets the assessment of the impact of management practices induced by the Nitrate Directive (low N fertilization), the most important criteria for the accuracy of the model lies on its ability to capture differences in management practices. Model performance is evaluated through the relationship between observed data and the simulated outputs for different years and field managements. The correlation coefficient (r) was 0.62 and 0.66 for yield and 0.84 and 0.32 for nitrogen uptake for maize and durum wheat, respectively. This evaluation is a first step to demonstrate the good behaviour of the model in various conditions for two contrasting crops. It shows the need for improvement in some parts of the model related to plant nitrogen dynamics. Further testing on other crops will be carried out according to Casellas *et al.* (2009). After proper calibration at field scale, APES performance at regional level will be evaluated following the methodology of Wallach *et al.* (2009). Finally, the performances of APES in a modelling chain will be tested to assess the impact of crop management on environmental externalities in several European regions.

References

- Belhouchette, H., *et al.*, 2009. AgSAP Conference 2009, these proceedings.
- Casellas, E., *et al.*, 2009. AgSAP Conference 2009, these proceedings.
- Van Ittersum, M.K., *et al.*, 2008. *Agricultural Systems* 96: 150-165.
- Wallach, D., *et al.*, 2009. AgSAP Conference 2009, these proceedings.

Performances of two crop models in various conditions: The importance of underlying assumptions

H. Belhouchette, M. Adam, E. Casellas, F. Celette, M. Corbeels, J. Wery
UMR-SYTEM, 2, Place Pierre Viala,
34060 Montpellier Cedex 1, France
Contact: Hatem.Belhouchette@supagro.inra.fr

Introduction

APES, a modular model was developed in the SEAMLESS project (Van Ittersum *et al.*, 2008) to assess, in different EU regions, the impact of farm management on crop production and environmental externalities. Such purpose assumes the capability of APES to simulate cropping systems in a wide range of climate, soil and crop management. The main topic of this study is to evaluate APES, under different stresses and management practices (temperature, water and nitrogen), to simulate crop production and nitrogen and water dynamics. For this evaluation, APES was compared to the CropSyst (Stöckle *et al.*, 2003) model (widely evaluated and used under different biophysical conditions and management practices). An explicit description of the limitations and specificities of each modelling approach is related to the behaviour of each model in different situations.

Methods

Both models were calibrated independently, using the same experimental data sets collected for rainfed durum wheat in the Midi-Pyrenees region (Mahmood, 2008; Adam *et al.*, 2009). Soil is mainly clay-loamy and weather data were collected on site, including rainfall, temperature and radiation. The performance of each model has been tested, under different scenarios, to define how they reacted to different gradients of temperature (scenario 1: T_{average} to $T_{\text{average}} + 4^{\circ}\text{C}$ + no water stress+ no N stresses), irrigation regime (scenario 2: T_{average} + no N stress + irrigation doses from 0 to 700 mm) and nitrogen fertilization (scenario 3: T_{average} + no water stress + N fertilization from 0 to 200 kg N ha⁻¹). The behavior of the two models under different scenarios was defined analysing model outputs such as leaf area index, above ground biomass and grain yield, water uptake and nitrogen uptake and leaching enabled.

Results and discussion

Temperature impact on leaf area development and biomass accumulation

The dynamics of the total leaf area development and biomass accumulation generated by the two models are different (data not shown). When the average temperature increases, the LAI decreases in CropSyst, while in APES it remains constant (data not shown). The approaches used in each model explain these differences. LAI development in CropSyst at potential production is directly dependent on biomass production, following a logistic curve with a LAI_{max}. In APES, LAI development is simulated following two phases, the first one being the juvenile phase with an exponential growth, followed by a linear growth directly dependent on biomass production. Another important (indirect) effect occurs through simulated biomass production: in CropSyst there is a temperature effect on the radiation use efficiency during early growth, while in APES the RUE is considered constant through the crop cycle. This means that in CropSyst simulated biomass at the beginning of the cycle decreases with increased average temperature, while in APES, it remains constant. Concerning leaf senescence, the decrease of the LAI in APES is the same as in CropSyst, even though different approaches are used. In APES, senescence responds to shading, temperature and ageing (leaf duration), while in CropSyst only the ageing factor is directly considered by simulating the leaf area duration.

Water-limited conditions

Figure 1 illustrates the total biomass trend when irrigation increases gradually from 0 to 700 mm. CropSyst is more sensitive than APES to the low amounts of water, but more biomass is simulated with the larger irrigation scenario. In APES, water stress (actual transpiration /potential transpiration) is only effective above a given threshold level. On the other hand, in CropSyst, water stress affects linearly the biomass accumulation from emergence to flowering. After the growing period, the harvest index is adjusted to account for sensitivity to water stress during flowering and/or grain filling. The ‘threshold value’ in APES causes a lower water stress sensitivity (also linked to the function continuity) than CropSyst for equivalent levels of Actual/Potential transpiration (Figure 2).

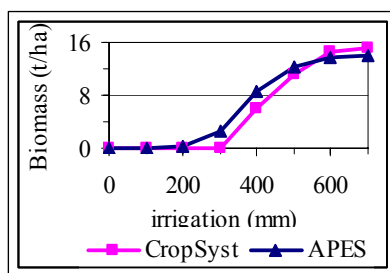

Figure 1. Simulated total biomass for different amounts of irrigation

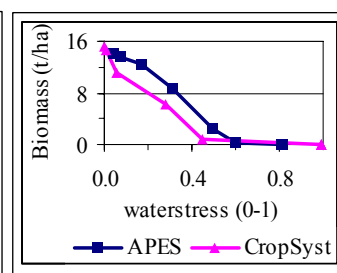

Figure 2. Total biomass simulated for different amounts of irrigation v.s. water

Nitrogen-limited conditions biomass and nitrogen balance

APES simulates more biomass than CropSyst when N fertilization increases gradually from 0 to 150 kg ha⁻¹ (Table 1). In both models, the crop experiences N stress when its N concentration drops below a critical value for unrestricted growth (NNI approach, Lemaire, 1989).

The two models simulate N transformation in a similar way using first-order kinetics. Both models include routines for the simulation of soil temperature, and its effect on N transformations. The main difference between the two models is that in CropSyst the microbial community is considered as not limiting to the nitrogen transformation process, which is driven only by water and temperature. While, APES, based on the formalism of G'DAY model represents the role of soil micro-organisms in a mechanistic way through the mineralization-immobilization turnover processes during organic matter decomposition.

N (kg ha ⁻¹)	Biomass (t ha ⁻¹)		N leaching (kg ha ⁻¹)		Total mineralization (kg ha ⁻¹)		N uptake (kg ha ⁻¹)	
	CropSyst	APES	CropSyst	APES	CropSyst	APES	CropSyst	APES
0	6.5	7.2	1.4	7.2	27.0	31.7	80.0	157.0
50	9.9	13.3	1.0	13.3	26.7	22.8	130.0	194.0
100	12.7	14.9	0.9	14.8	26.4	24.2	180.0	213.0
150	14.7	14.9	0.9	14.8	26.3	22.2	230.0	215.0

Table 1. Biomass and nitrogen balance: percentage difference between CropSyst and APES.

Conclusions

From our model comparison it appears that even if models use different approaches to simulate growth, water and N dynamics, the final results in term of crop production and externalities are very similar. However, under specific conditions of water, N or/and temperature stress, some modules are more suitable to be used than others. The following main conclusions can be drawn. CropSyst seems more sensitive to heat stress than APES, especially to predict phenology and biomass accumulation. For water stress and N stress, the results seem more ambiguous due to the complexity of the approaches used that relate both to crop and soil processes.

References

- Adam, M., *et al.*, 2009. AgSAP Conference 2009, these proceedings.
 Lemaire, G. (Ed.), 1997. Diagnosis of the nitrogen status in crops. Berlin, Springer, 239 pp.
 Mahmood, F., 2008. Mémoire de Master, SupAgro-Montpellier, 39 pp.
 Stöckle, C.O., *et al.*, 2003. European J. of Agronomy 18(3-4): 289-307.
 Van Ittersum, M.K., *et al.*, 2008. Agricultural Systems 96: 150-165.

A methodology for the evaluation and improvement of a generic biophysical Soil-Plant-Atmosphere crop model based on ‘Mini-Application’

E. Casellas, J.E. Bergez, H. Belhouchette, O. Therond, M. Adam, A. Metay, J. Wery
 INRA, UMR SYSTEM 2, Place Viala, 34060 Montpellier Cedex 1, France
 Contact: casellas@supagro.inra.fr

Introduction

The modelling platform for integrated assessment of scenarios, SEAMLESS-IF (<http://www.seamless-ip.org/>) has been developed for impact assessment of agricultural systems from field to global scales. The field function is modelled with APES (<http://www.apesimulator.org/>), a dynamic soil-plant-atmosphere model (SPA) simulating the behaviour of a large range of crops (arable crops, vineyards, agro-forestry, grassland...). APES has been developed as a shared effort among several research groups and provides an extensible and modular modelling framework. The development of the different components was then performed independently, i.e. component by component. Biophysical “composite” models usually show a high level of interactions between the different composing sub-models. Those may be either direct and/or indirect. Stand-alone model components present only part of the reality and different sources of errors can be compensated by a proper parameter calibration for a given range of conditions. As each component is independent with its own underlying assumptions (explicit and/or non-explicit), some incompatibilities may appear. The overall consistency and robustness of the resulting model has therefore to be tested. Furthermore, some investigation and/or adaptation may then be required on some components and their combination to simulate a given type of crop. A specific methodology was developed to perform this iterative evaluation-improvement procedure allowing linking of components in a ‘Modelling Solution’ of APES (APES-MS, i.e. a given list of components, the links among them and the model options selected for each component).

‘Classical’ model evaluation is usually only based on a quantitative comparison with observed data, in a more or less broad range of conditions and crop management, and usually for a few simulated outputs of the model. We defined a more extensive and broad-range evaluation procedure based not only on this type of quantitative evaluation but also on conceptual and qualitative evaluation for the whole range of conditions for which the model will be used and with the key state and flow variables. The objective of this paper is to present this procedure, based on relevant Mini-Applications (MA), and its main outcomes.

Methods

In this approach, we assume that all individual components have already been calibrated and evaluated as independent stand-alone components. We then focus on the composite model as a whole and on the interactions among the different components. Our evaluation-improvement procedure is based on three steps: (i) a *conceptual evaluation* that aims to evaluate the relevancy and consistency of the concepts of the different components put together in an APES instance; (ii) a *qualitative evaluation* of APES-MS based on

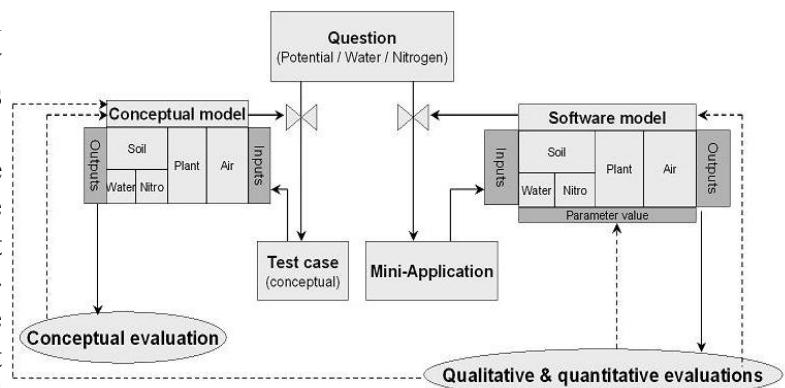

Figure 1. Schema of methodology for conceptual, qualitative and quantitative evaluations steps for an SPA modular model.

trends of key variables in comparison with expert knowledge; (iii) *a quantitative evaluation* using specific MA test cases for which we have observed data and/or expert knowledge. These three steps allow identification of the main problems to solve and the type of improvement (model calibration, change of model structure, Figure 1). For the qualitative and quantitative evaluations, MA are first described as a crop/soil/climate/agro-management combination representative of the future use of the model and for which we have sufficient expert knowledge to describe *a priori* the evolution of the major state and flow variables. The model is then challenged for some specific processes by varying the input conditions and investigating how it reacts compared to expected behaviour in such conditions as defined by the conceptual evaluation. To properly run a MA, agronomists, modellers and computer scientists are required.

Each of these evaluations is managed using a 3-step process. In a first step, Plant-Atmosphere functions are analysed without the influence of the soil resources. This corresponds to theoretical 'potential' plant growth (no effect of water or nitrogen on plant production). It allows the evaluation of temperature and light effects decoupled from soil effects. In a second step, the effect of water constraints both on soil water dynamics and interactions with plants are evaluated. We first make sure that fully-irrigated plants react in the same way as in potential production. We can then use simulations with observed irrigations, which allow investigating soil water / plant interactions (e.g., water extraction by plants or plant water stress impact). The third step is simulating water- and nitrogen-limited conditions, enabling the investigation of soil nitrogen dynamics and interactions with plant and soil water. Again we make sure that with full irrigation and full fertilization we can reach 'potential' plant growth. We finally use observed irrigation and fertilization to investigate soil nitrogen dynamics and its interactions with soil water and plants (e.g., plant nitrogen extraction or nitrate leaching). For nitrogen issues, some bare soil simulations with controlled temperature and soil water content have also been used to investigate internal soil nitrogen dynamics without any plant and soil water interactions.

Results and discussion

The three types of evaluations using the three different steps have proved to be necessary to ensure the proper development of the APES-MS. This procedure was used during dedicated workshops, each one combining an MA and an APES-MS, and covering the set of crop types supposed to be simulated by APES in the SEAMLESS project. We only give below some examples of the outputs of these workshops and how it helped to improve the model.

During the conceptual evaluation of the plant and soil water interactions, we noticed that there was a process for plant water demand reduction that was handled both in plant and water extraction components, leading to an overestimation of water stress and the impossibility to reach potential production.

An example of qualitative evaluation can be illustrated by the expected sigmoid plant response to water effect of progressive irrigation doses (this water being the only one coming in the system as we removed rain to the weather file).

An example of quantitative evaluation can be taken from the MA held in the Midi-Pyrenees with durum wheat that has been compared to various observed field data (Adam *et al.*, 2009) resulting in a new parameter calibration.

MA described in detail can be run again with improved APES-MS, this is part of the quality of model construction. This methodology is still to be investigated (for dispersed work of several team members in particular). But it was still very efficient in improving APES-MS and created a collective dynamic between agronomists, modellers and informatics.

References

Adam M., *et al.*, 2009. AgSAP Conference 2009, these proceedings.

Using a cropping system model for large scale impact assessment in Europe

E. Casellas, O. Therond, H. Belhouchette, D. Wallach, R.J. Oomen, G. Russell,
F. Ewert, H. Hengsdijk, M.K. Van Ittersum, M. Adam, J. Wery
INRA, UMR-SYTEM, 2, Place Pierre Viala,
34060 Montpellier Cedex 1, France
Contact: casellas@supagro.inra.fr

Introduction

Agricultural policy of the European Commission aims at improving agricultural sustainability at field, farm, regional and EU scales. Ex-ante assessment of the possible economic, production and environmental consequences of policies may support decision making. The SEAMLESS project (Van Ittersum *et al.*, 2008) provides an integrated assessment and modelling platform to support such policy assessments. This platform uses the cropping system model APES (<http://www.apesimulator.org/>) to predict yields and externalities such as nitrogen leaching of agricultural activities. Like other cropping system models APES operates at the field level using daily time steps. To predict crop yields and externalities at the scale of the European Union APES need to be used for a much larger geographic area. How to do so, and how to evaluate the model at this scale, are the problems addressed in this paper.

Methods

The APES cropping system model includes components that take into account water and nitrogen stress but not yield reductions due to diseases or weeds. Model inputs are daily weather, soil characteristics, initial soil conditions and management practices. A large number of annual crops (cotton, maize, oats, peas, potatoes, rape, rice, rye, sorghum, soya, spring barley, spring soft wheat, sugar beet, sunflower, triticale, winter barley, winter soft wheat, winter durum wheat) can be simulated in rotations.

The first problem in using a field level model for a large area is the spatial soil-climate heterogeneity. Therefore, Europe is divided into zones with relatively homogeneous properties from an agronomic perspective. In SEAMLESS, Europe is divided into AgroEnvironmental Zones (AEnZ), which are combinations of 13 environmental zones (primarily based on statistical analysis of climate and geomorphological variables), a soil classification (based on 6 topsoil organic carbon classes) and NUTS2 administrative regions (Baruth *et al.*, 2006). A total of 195 AEnZ in 16 sample regions (from Andalusia-Spain to Etela-Suomi-Finland and from Southern and Eastland-Ireland to Thessalia-Greece) have been chosen to represent the biophysical conditions of Europe. For each AEnZ, historical weather (from the MARS database) and soil characteristics (from the European soil database) are available.

Classical model evaluations for APES have been carried out at the field level (Adam *et al.*, 2009; Casellas *et al.*, 2009), but for large areas it is important to add an additional evaluation allowing to compare model results with corresponding observed values in each AEnZ, for a range of regions throughout Europe. Therefore, current management practices for the major crops in each AEnZ need to be specified. Such data do not exist at a pan-European level; the Farm Accountancy Data Network (FADN) contains data about input use but at the farm level rather than the crop level, and does not specify timing of input use. We therefore developed a new data base, taking advantage of the fact that SEAMLESS has a large number of partners throughout Europe. These partners identified local experts who in turn specified the major regional crop rotations and associated yield levels. In addition, the experts estimated average (over fields and years) management activities for these crops, i.e. sowing and harvesting date, nitrogen input, total amount of irrigation water and number of irrigations. Then, based on that information, experts and agronomists developed generic decision rules specifying detailed

management practices for each crop (Oomen *et al.*, 2009). These management rules are important not just for quality evaluation of model outputs, but also for simulation of current practices.

The APES model has simulated 21 crops in each AEnZ of the 16 sample regions, for a period of 25 years. The first five simulation years are used for initialization of the soil conditions. Average date of physiological maturity (assumed to be the same as harvest date in expert data) and average yields are calculated using results from the remaining 20 years. Three criteria are used to assess the agreement between model and observed data. First, we calculate the average number of degree days up to the ‘observed’ (i.e. expert value) harvest date for each AEnZ. This value can be compared to the model parameter value that represents the required number of degree days to maturity (determined by modellers according literature information and field level calibrations). The ratio of the two is the first error factor, k_{pheno} . Secondly, simulated yields in each AEnZ are compared to the yields as specified by local experts. The ratio is the second error factor, k_{yield1} . Finally, one can first calibrate the phenology parameters of the model (by multiplying all these parameters – that represent degree days to different phenological stages – by k_{pheno}) and then calculate a new yield error factor k_{yield2} . The difference between k_{yield1} and k_{yield2} indicates to what extent the error in yield can be reduced by correcting for the errors in phenology. Remaining errors can still refer to many issues, i.e. misspecification and parameterization of the model, flaws in soil, climate and agro-management data, and to the fact that pests and diseases are not modelled in APES. Runs of APES and calculation of the error factors are currently underway and will be presented at the Conference.

Results and discussion

The feasibility of using a cropping system model at the scale of Europe is closely related to the availability of input data and evaluation data. In general, weather and soil data are available in existing European data bases resulting in the AEnZs as described. The model can be run for given management to predict yields and environmental effects at European scale. For model evaluation, we have created a new data base that contains current crop management and evaluation data for AEnZ throughout Europe, based on expert opinions.

The assessment criteria as discussed here serve two functions. Firstly, they indicate the degree of agreement between model and observed data. It will be of particular interest to analyse systematic patterns in the error factors, e.g. across regions. Secondly, the error factors can be used as correction factor to modify model outputs. The effectiveness of such a factor in improving prediction of externalities and estimation of alternative agro-management options still needs to be assessed.

References

- Adam, M., *et al.*, 2009. AgSAP Conference 2009, these proceedings.
- Baruth, B., *et al.*, 2006. PD4.3.2. A spatial framework for environmental data, SEAMLESS integrated project, EU 6th Framework Program, contract no. 010036-2, www.SEAMLESS-IP.org. 35 pp.
- Casellas, E., *et al.*, 2009. AgSAP Conference 2009, these proceedings.
- Oomen, R.J., *et al.*, 2009. AgSAP Conference 2009, these proceedings.
- Van Ittersum, M.K., *et al.*, 2008. *Agricultural Systems* 96: 150-165.

Spatializing a bio-decisional crop-model to assess the sensitivity of a region to modifications in agricultural practices

L. Clavel, M.-H. Charron, D. Baudet, J. Soudais, D. Leenhardt
INRA, UMR1248 - AGIR (Agrosystèmes et développement territorial),
B.P. 52627, 31326 Castanet Tolosan Cedex, France
Contact: Lucie.clavel@toulouse.inra.fr

Introduction

Recent societal expectations, e.g., food security and environmental resource quality and availability, need to consider agriculture not only at its traditional spatial scale, the field plot, but at higher spatial scales and complexity levels. They also suggest considering new ways of producing and managing crops. Crop models that simulate the crop growth and yield for a given soil and climate combination can be used to measure the impact of new management practices at the plot scale. To account for more complexity, it is useful to use cropping systems models that integrate constraints and behaviours of farmers. To account for larger spatial extents that include multiple fields and a great diversity of cropping systems, a solution is to distribute or spatialize these models over the considered area (Faivre *et al.*, 2004).

We propose here a way to distribute a bio-decisional crop model over a large agricultural area in order to assess its sensitivity to modifications of crop management practices.

Methods

The study area is the Neste System, a catchment in south-western France. This 800,000 ha area gathers the catchment areas of 18 rivers artificially supplied with water by a single canal (the Neste canal). The land is mainly dedicated to agriculture: 500,000 ha are cultivated from which 50,000 ha are irrigated (Hurand, 2000). Thanks to the canal and European common agricultural policy, the irrigated area has been multiplied by around three since the 1970s. As a consequence, eight years out of ten, the system faces a lack of water that threatens the environmental equilibrium of the rivers and the satisfaction of agricultural water needs.

Since irrigation is a key issue of this area, we decided to select a model that could represent modifications of irrigation practices. The MO_uSTICS model is a bio-decisional crop model. It integrates (i) a crop model (STICS, Brisson *et al.*, 1998) that simulates the growth of different crops in the Neste system and (ii) a decisional model that, instead of simulating the water needs of the considered crop, explicitly simulates irrigation applications through farmers' decision rules that depend on crop, soil, climate and water resource constraints (Bergez *et al.*, 2001).

Cropping system, soil and weather information is required as input data for running MO_uSTICS. To account for the spatial variability of these input data, we divided the Neste system into 67 support units (SUs) resulting from the intersection between water management units (sections of the 18 river catchments) and Small Agricultural Regions (delineated according to agriculture-related criteria, mainly soil and climate conditions). We associated with each SU one daily weather series interpolated by Météo-France (Prats & Pérarnaud, 2001). We classified the soils of the study area into 13 main classes. For each SU, we determined the proportion of each soil class by GIS. Experts from local extension services helped us to identify ten farm types for the whole area according to economic, technical orientation and irrigation criteria. We used agricultural census data (Agreste, 2000) to calculate for each SU, the average Usable Agricultural Area and crop distribution for each farm type (distinguishing between irrigated and non-irrigated). Finally, we redistributed the farm types over the SUs by using expert information describing the relationship between farm types and soil types. This process allowed us to identify, for each SU, the area of each crop×soil combination. We stored this information into matrices (one per SU) that made

explicit the farm type, the soil and the crop (Figure 1) (Clavel & Leenhardt, 2008). Management practices associated with each combination were determined by expertise.

MO_uSTICS can be run for each crop×soil×farm type combination of the matrix with different crop management practices scenarios (Table 1). In order to assess the irrigation demand and the crop production at SU level, we can multiply the MO_uSTICS outputs with the areas stored in the matrix corresponding to the SU. As the matrices present the same organization for each SU, outputs can be aggregated at levels greater than the SU: Small Agricultural regions, water management units, and the whole system.

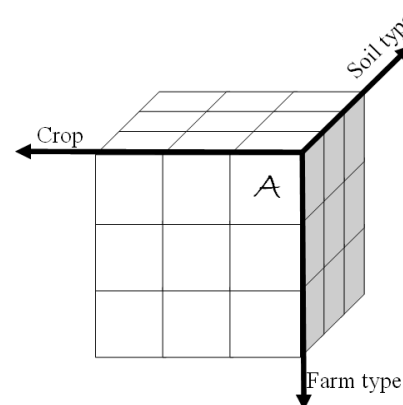

Figure 1. Each cell of the matrix contains the area A of a given crop×soil×farm type combination. Such matrix is built for all SUs.

Table 1. Simple scenarios can be tested in a first step.

Scenario	Purpose	Alternatives
Scenario 1	Reducing number of water applications	At sowing; at last application; increase of the period between 2 application
Scenario 2	Reducing water volume applied	5 mm; 10 mm; 15 mm etc.
Scenario 3	Change maize earliness	Early; $\frac{1}{2}$ early; $\frac{1}{2}$ late; late

Results and discussion

The work is in progress, we will quantify the effect of given practices on the whole area. This effect will be assessed by two main variables: irrigation water demand and crop production. By comparing various scenarios we intend to estimate to which practices the system is most sensitive to, and this at the different scales considered (farm, Small Agricultural Region, water management unit, whole system).

Spatializing a bio-decisional crop model can show the effective impact of cropping systems innovations at broader scales than the plot. This type of tool can be used in prospective research for assessing which cropping systems should be modified over a region for achieving dual aims in term of environment and production. In the frame of the present study, it is planned to use the tool to evaluate more complex cropping systems scenarios built with stakeholders.

References

- Agreste, 2000. La Statistique Agricole, Recensement Agricole 2000. Le recensement agricole en bref. <http://www.agreste.agriculture.gouv.fr/>
- Bergez, J.E., *et al.*, 2001. Ecological Modelling 137: 43-60.
- Brisson, N., *et al.*, 1998. Agronomie 18: 311-346.
- Clavel, L. & D. Leenhardt, 2008. International Environmental Modelling and Software Society. International Congress on Environmental Modelling and Software.
- Faivre, R., *et al.*, 2004. Agronomie 24: 205-217.
- Hurand, P., 2000. La gestion opérationnelle d'un système complexe: 'Le système Neste'. CACG, 23 pp.
- Prats, S. & V. Pérarnaud, 2001. Projet ADEAUMIS. Contribution de Météo-France, 19 pp.

The SoilC&N module of APES: Simulating the immobilization-mineralization turnover for predicting short- and long-term C and N dynamics in the soil

M. Corbeels, E. Casellas, F. Celette, A. Mérot

UMR-SYTEM, Centre de coopération International en Recherche Agronomique pour le Développement, 2, Place Pierre Viala, 34060 Montpellier Cedex 1, France

Contact: marc.corbeels@cirad.fr

Introduction

Carbon (C) and nitrogen (N) dynamics in the soil can be described by a number of approaches, ranging from simple empirical regression equations to complex and detailed process-based models. The disadvantage of empirical models is that they are site and time specific and they need to be parameterized for each new situation. Simple two-compartment models comprising a labile and stable organic matter pool can be analytically solved and parameter estimation for a given situation is relatively simple (e.g., ICBM, Kätterer & Andrén, 2001). However, these types of models do not incorporate important feedbacks of soil C and N to changing environment. More comprehensive models, such as CENTURY (Parton *et al.*, 1987), have been developed for this purpose. Most of these models do not consider explicitly microbial physiology as the driving factor of N immobilization-mineralization turnover, while this is fundamental for an adequate description of decomposition (e.g., Van Veen *et al.*, 1984).

Model description: novel features for simulating soil C and N dynamics

SoilC&N, a decomposition model for C and N cycling in the soil is briefly presented here (Figure 1). More details of the model are given in Corbeels *et al.* (2005). It was adapted for use as a module in the APES crop growth simulator (www.apesimulator.org). The distinctive features of this model are: (1) growth of microbial biomass is the process that drives N mineralization-immobilization, and microbial succession is simulated; (2) decomposition of plant residues may be N-limited, depending on soil inorganic N availability relative to N requirements for microbial growth; (3) N:C ratio of microbial biomass active in decomposing plant residues is a function of residue quality and N availability; (4) ‘quality’ of leaf and fine

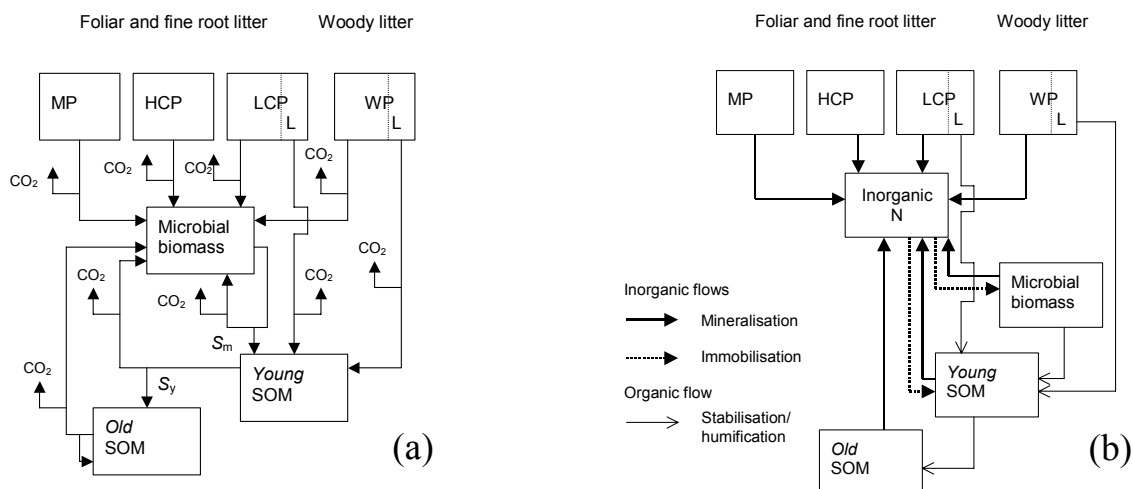

Figure 1. Pools and fluxes of (a) C and (b) N in the SoilC&N model. MP: metabolic pool; HCP: holocellulosic pool; LCP: ligno-cellulosic pool; L: lignin; SOM: soil organic matter; S_m: stabilization coefficient for microbial biomass; S_y: stabilization coefficient for *Young* SOM (from Corbeels *et al.*, 2005).

root residues is expressed in terms of measurable biochemical fractions; and (5) N:C ratios of soil organic matter (SOM) pools are not prescribed but are instead simulated output variables determined by plant residue characteristics and soil inorganic N availability.

The model includes above- and below-ground plant residue pools and three SOM pools (microbial biomass, *Young* and *Old* SOM) with different turnover times (Figure 1). Rates of decomposition are modified by temperature, moisture, lignin content of the residues and N availability. Stabilization of SOM is simulated by transferring fractions of decomposed microbial biomass and *Young* SOM into more recalcitrant forms (respectively into *Young* and *Old* SOM). Nitrogen is mineralized to, or immobilized from, the soil inorganic N pool to maintain the N:C ratio of decomposing microbial biomass within a specified range. Balancing potential microbial N demand against inorganic N availability determines whether the activity of decomposers is limited by N. If so, then simulated microbial use efficiency and decomposition fluxes are reduced. The maximum rate of microbial N uptake is proportional to soil inorganic N content. Lignin transformation to *Young* SOM promotes additional N immobilization into the *Young* SOM pool, which simulates the process of chemical N immobilization.

Application examples

Short term dynamics of N supply

SoilC&N can be used as a stand alone model or coupled to a plant production model to simulate within-season soil N mineralization dynamics from SOM and added organic sources. The model responds to quality of added organic matter and predicts N immobilization or mineralization rates in time. The N immobilization peak depends on the biochemical quality of the plant residues and the available inorganic N. When soil inorganic N becomes severely limiting, decomposition of residues is slowed down. With a proper parameterization of plant residue ‘quality’, the model can acceptably predict N dynamics from crop residues ranging from green leguminous leaves to woody residues.

Global change modelling

Coupled to a plant production model, SoilC&N is particularly suited to simulating the impacts of land-use change and consequences of climate change on soil carbon storage and N availability for plants. For example, the model is able to predict long-term storage of soil C following a change in land-use from forest to cropland, as a result of simulated changes in microbial activity, soil N availability and SOM C:N ratios to changes in plant residue quantity and quality. The incorporation of the feedbacks in the model between plant residue quality, N availability and microbial activity increases the mechanistic integrity of the model, compared to other models such as CENTURY or RothC (Coleman *et al.*, 1997). Climate change can strongly affect simulated microbial activity via the water and temperature factors that modify the rates of decomposition.

In conclusion, the ability of SoilC&N to adequately describe both short-term events such as soil N supply during one growing season, and long-term dynamics, e.g., soil C storage over several decades, is an important asset when coupling to a plant production model.

References

- Coleman, K., *et al.*, 1997. *Geoderma* 81: 29-44.
- Corbeels, M., *et al.*, 2005. *Ecol. Model.* 187: 426-448.
- Kätterer, T. & O. Andrén, 2001. *Ecol. Model.* 136: 191-207.
- Parton, W.J., *et al.*, 1987. *Soil. Sci. Soc. Am. J.* 51: 1173-1179.
- Van Veen, J.A., *et al.*, 1984. *Plant and Soil* 76: 257-274.

APES: The Agricultural Production and Externalities Simulator

M. Donatelli¹, G. Russell, A.E. Rizzoli
Agriculture Research Council,
Bologna, Italy
Contact: marcello.donatelli@jrc.it

Introduction

Many simulation tools allow the impact of agricultural management on production activities in specific environments to be studied (e.g., Brisson *et al.*, 2003; Keating *et al.*, 2003; Jones *et al.*, 2003; Stöckle *et al.*, 2003; Van Ittersum *et al.*, 2003). Such tools are usually targeted at one or more specific production activities: arable crops or cropping systems, grassland, orchards, agro-forestry, livestock etc. Some include an estimate of system externalities which may have a negative environmental impact, for example, erosion, nitrogen leaching or the fate of pesticides. Very often, the structure of such systems neither allows an easy addition or modification of models for new agricultural production activities, nor the use of different approaches for the simulation of processes via alternative formulations. Furthermore, documentation of such tools is often not up-to-date, and may not follow a single standard, which makes it difficult to access information. Finally, when such systems are proprietary systems of either research groups or projects, it may not be possible for third parties to effectively develop the system further. There was, thus, a need within project SEAMLESS (Van Ittersum *et al.*, 2008) for a flexible and open modelling platform that could be extended and adapted to achieve the SEAMLESS modelling goals. APES, the Agricultural Production and Externalities Simulator, was thus developed as a simulation model system for estimating the biophysical behaviour of agricultural production systems at the field scale in response to the interaction of weather, soil and agro-technical management options.

Methods

APES is based on a set of models (components in software terms) that are used to simulate the behaviour of different domains within the weather-soil-plant system (Figure 1). It was designed to allow the subsequent incorporation of additional models to simulate additional processes, such as plant pests, and the replacement of models with alternative versions. Biophysical processes are simulated using deterministic approaches based on mechanistic representations. APES includes utilities for managing appropriate weather and soil data including cases where there are incomplete data. The AgroManagement component was designed to represent farmers' decisions realistically, taking into account the state of the crop and the environment. The system permits the analysis of multiple years to take account of rotations and varying weather patterns. Associated with APES are procedures for modelling new crops by adjusting parameters, for adjusting parameters to take account of differences between regions and to calibrate the models. It exists as both a stand-alone version and an integrated version within SEAMLESS-IF. Finally, there are internal checks on the validity of combining particular sets of inputs and outputs.

Results and discussion

APES has now been run to provide inputs for farm system models both for regions where there is a complete set of input data and for those where the available information is incomplete, which is often the case when predictions have to be made at regional level. Parameter sets for 20 crops are already included together with several types of grassland and

¹ Currently seconded to the Joint Research Centre, Institute for the Protection and Security of the Citizen, MARS Agri4cast, Ispra, Italy.

vineyards. APES has already been used successfully to model vineyards intercropped with grass and for a series of mini-applications involving contrasting crop-environment combinations for locations where there are good test data.

Users of APES can choose a modelling solution to meet their particular requirements, where a modelling solution is a combination of components and options within components. The criteria for selecting the currently available modelling solutions were based on the need to: (1) account for specific processes to simulate soil-land use interactions, (2) obtain input data to run simulations, (3) simulate agricultural production activities of interest (e.g., crops, grasses, vineyards, agro-forestry), and (4) simulate agro-management decisions and their impact on the system. The Graphical User Interface (GUI) allows users to run simulations and explore the outputs of APES in response to changing inputs. The GUI is also made with components and tools which can be re-used in different systems.

Part of the rationale of APES was to ensure wide availability of relevant information. Descriptions of APES, including help files and video tutorials, are thus available on a website (<http://www.apesimulator.org> or through <http://www.seamless-ip.org>). There is an APES newsletter (news-subscribe@apesimulator.it). Subscribers can receive news of updates.

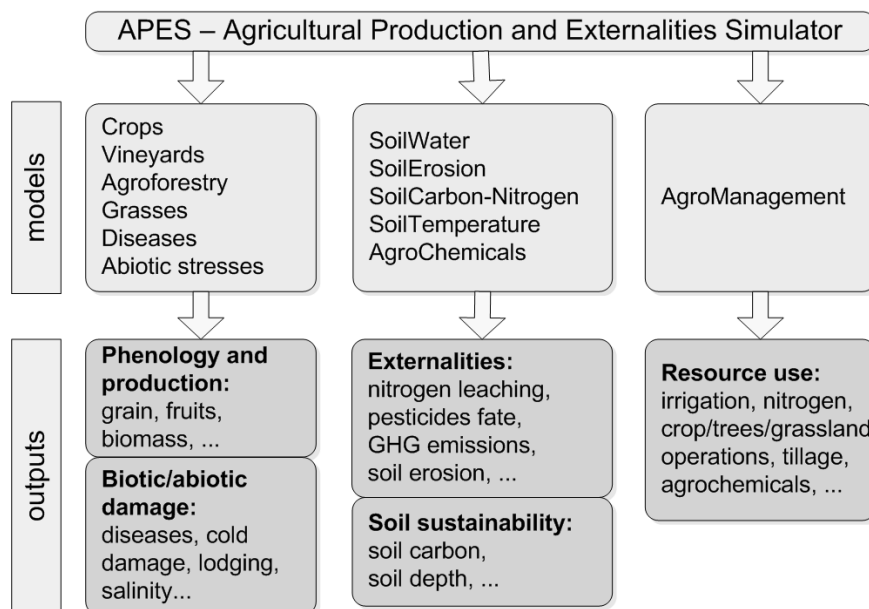

Figure 1. The main typologies of APES models and outputs.

References

- Brisson, N.C., *et al.*, 2003. *Eur. J. Agron.* 18: 309-332.
 Jones, J.W., *et al.*, 2003. *Eur. J. Agron.* 18: 235-265.
 Keating, B.A., *et al.*, 2003. *Eur. J. Agron.* 18: 267-288.
 Stöckle, C.O., *et al.*, 2003. *Eur. J. Agron.* 18: 289-307.
 Van Ittersum, M.K., *et al.*, 2003. *Eur. J. Agron.* 18: 87-393.
 Van Ittersum, M.K., *et al.*, 2008. *Eur. J. Agron.* 96: 150-165.

The effects of climate change on the phenology of cereal crops in Hungary

Éva Erdélyi

Corvinus University of Budapest, Department of Mathematics and Informatics,
1048 Budapest, Villányi út 29-43, Hungary
Contact: eva.erdelyi@uni-corvinus.hu

Introduction

Using geographical analogues Gaál & Horváth (2006) showed that the possible future climate in Hungary would be similar to the present climate of South-Southeast Europe. Increased mean annual temperatures in our region, if limited to two or three degrees, could generally be expected to extend the growing season. In the case of crops where phenological phases depend on accumulated heat units (Varga-Haszonits, 1987), phenophases could become shorter. In this paper we investigated the effects of climate change on the growing periods of maize and winter wheat, which are the two most widely cultivated plants in Hungary.

Materials and methods

Weather data. Climate scenarios can be defined as relevant and adequate pictures of how the climate may look in the future. During our research, we applied the principles defined by IPCC (1996) and used the most commonly accepted scenarios presented in international reports, which give predictions for the middle of the century. We have used climate models of the United Kingdom Meteorological Office and the Geophysical Fluid Dynamics Laboratory (USA). In this work five climate scenarios from these General Circulation Models were downscaled to Debrecen, an important centre of agricultural production in Hungary to provide 31 years of daily values for temperature, precipitation and solar radiation. These were compared with baseline data representing the current climate.

Crop model. We used the 4M crop model (Fodor, 2002), which has been developed by the Hungarian Agricultural Model Designer Group. It contains several sub-models to describe the physiological interactions of soil-plant systems and offers the possibility of developing different systems models for the specific purposes of the users. The CERES model was chosen as the starting point and was adapted for Hungarian conditions. The simulations were run using, as weather inputs, the data from the climate scenarios and the historical data of the reference period.

Results and discussion

The phenological phases of maize shortened (Table 1) and began earlier as a result of temperature increase in all scenarios. In case of winter wheat we compared only the historical data and the UKTR scenario. Like maize, the starting dates of the phenological phases were earlier, especially in the first growing period (Figure 1). Harvesting is predicted to occur on average eight days earlier in the future.

Table 1. The length in days of the phenological phases of maize for six climate scenarios.

Phenophase	BASE	GFDL25	GFDL55	UKHI	UKLO	UKTR
2	16	16	13	7	6	14
3	25	24	22	16	15	24
4	7	7	6	6	6	6
5	43	40	40	37	35	40
6	14	12	12	11	11	13
7	56	42	42	32	33	52

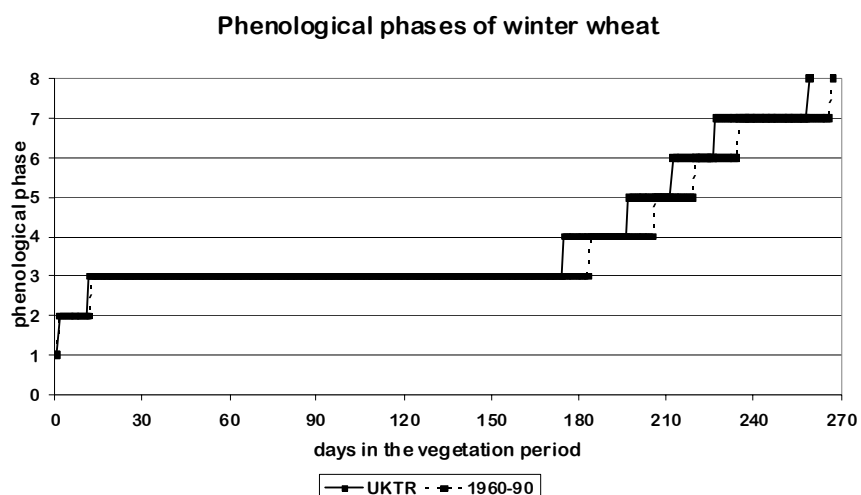

Figure 1. Comparison of the starting dates of the phenological phases of winter wheat for the reference period 1960–90 with the UKTR climate scenario for Debrecen.

Climate change has already had significant impacts in Hungary on the environment, human health and society. Considering the possible changes we have to answer many questions in order to prepare for the future (Erdélyi, 2006). Living under changing climate conditions, one of our most urgent tasks is to create well-designed descriptive-forecasting systems (Erdélyi *et al.*, 2006), as well as to define the optimal preparation, adaptation and response strategies to the changing conditions. Modelling is a good tool for investigating future circumstances without the need for carrying out expensive and long experiments. It helps identify strategies for preparing for the future and can take account of the many direct and indirect ways in which climate change can affect agriculture.

References

- Erdélyi, É., 2006. Climate change and temperature needs of winter wheat. Ecological problems of our days – from global to local scale. Keszthely, pp. 274-279.
- Erdélyi, É., *et al.*, 2006. How climate change influences the field crop production I. and II.– Use of Spatial Analogy and Yield variability of maize. 4th International Eco-conference – Safe Food, Novi Sad, pp. 1-12.
- Fodor, N., *et al.*, 2002. European J. of Agron. 18: 389-393.
- Gaál, M. & L. Horváth, 2006. Geographical analogies in climate change research. HAICTA, Greece, pp. 840-846.
- IPCC, Climate Change, 1996. In: Eds. J.T. Houghton, *et al.*, The Science of Climate Change. Cambridge University Press, Cambridge.
- Varga-Haszonits, Z., 1987. Agrometeorológiai információk és hasznosításuk, Mezőgazdasági Kiadó, Budapest.

Estimating external costs from the application of plant protection products in Europe

P. Fantke, A. Kuhn, S. Wagner, R. Friedrich
 Institute of Energy Economics and the Rational Use of Energy (IER),
 Hessbruehlstr. 49a, 70565 Stuttgart, Germany
 Contact: Peter.Fantke@ier.uni-stuttgart.de

Introduction

Widespread public concern exists about the hazards posed by plant protection products (PPPs) and other organic compounds that are released into the atmosphere, water and soil by agricultural activities. Humans are exposed to these contaminants via multiple pathways, i.e., inhalation, dermal exposure and ingestion of different food items and drinking water. However, for most currently used PPPs we do not yet fully understand their behaviour in and between the atmosphere, water and soil and their effects on human health and the environment at different concentrations. As an example, there exist numerous PPPs that are subject to transformation processes leading to an altered mode of action in humans (Hodgson & Rose, 2008). The present paper aims to give an insight into the challenges of conducting a full chain assessment of PPPs for estimating external costs due to human health impacts at the European scale as a basis for national and international policy making.

Methods

When assessing and valuing welfare losses due to the application of PPPs, most questions are interdisciplinary and complex. Linking concentrations of PPPs in the food chain, which is the most important exposure route for humans (Juraske, 2007), to specific health effects demonstrates the complexity of such questions (Figure 1). To provide a comprehensive answer to the even more specific question “How much and in which way do changes in the application of PPPs affect human health throughout Europe?”, an integrated assessment modelling approach is therefore required. A typical integrated assessment model (IAM) is RAINS (Amann, 2004), which addresses health and ecosystem impacts of particulate pollution, acidification, and eutrophication from air pollution sources. Furthermore, questions that are generally tackled by IAMs range from sustainable development (Malkina-Pykh, 2002) to policy assessment, e.g., impacts of agricultural policies at different scales on the whole agricultural sector (Van Ittersum *et al.*, 2008).

For a full chain approach from the application of PPPs to the estimation of health effects and related external costs it is

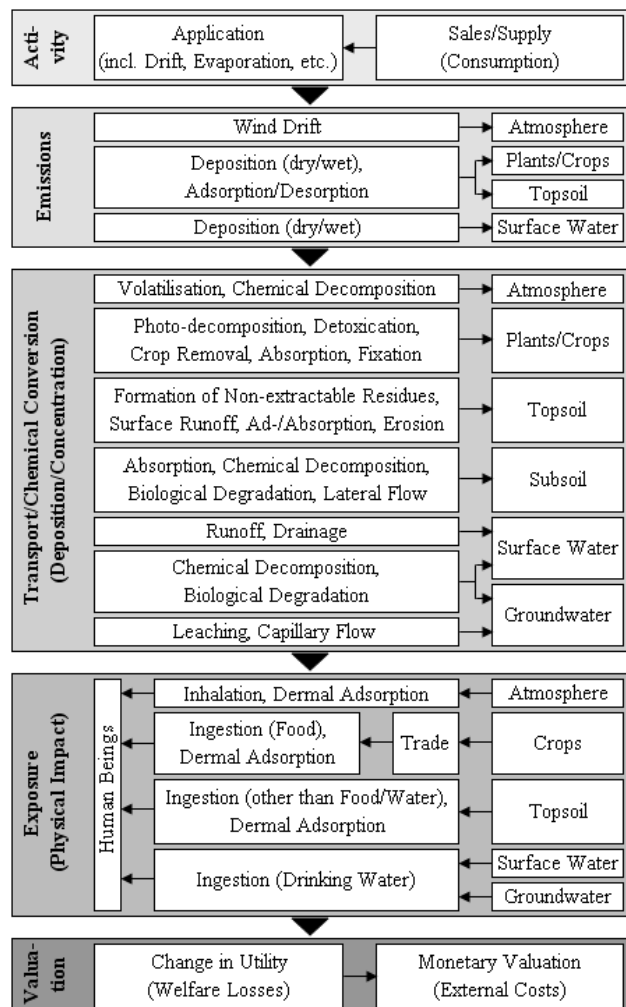

Figure 1. Conceptual structure of a full chain assessment of PPPs. Arrows denote a PPP's environmental pathway.

essential not only to consider the atmosphere as the receiving compartment as only 30–50% of the applied chemical is normally lost to air (Van den Berg *et al.*, 1999). It is, thus, necessary to consider all compartments, i.e., agricultural soils, surface water and groundwater, and the surface of plants, where it is important to distinguish between the chemical fraction that resides at the surface and the fraction that penetrates the plant tissues (Leistra, 2006). The crop component of the IAM needs to be able to take account of differences between crops and management operations as the impact of a PPP can be significantly increased by incorrect application. In addition, all relevant emission routes have to be considered for the exposure assessment, i.e., spray drift and runoff to surface water, leaching to groundwater, and accumulation in topsoils and field crops (Peeters *et al.*, 2008). The long-range transport potential of a PPP must also be considered. Trade of different crops is included as an extension of the natural fate. The most challenging part of the effect assessment is the consideration of mixture toxicity as in reality chemical contaminants rarely, if ever, occur in isolation, and interactions of components in a mixture can cause complex and substantial changes in the apparent properties of its constituents, resulting in synergistic or antagonistic effects (Knauert *et al.*, 2008).

Results and discussion

An integrated assessment model for estimating human health impacts and damage from the application of PPPs in Europe is being developed within two EU projects, EXIOPOL¹ and HEIMTSA². The most limiting information is that related to epidemiologically-derived effects, and spatially resolved emission/application data. Several emission data sets have been reviewed for most European countries. These, however, mainly refer to consumption of PPPs, grouped according to their intended purpose, e.g., insecticides, at national levels. Application statistics on single crops are really needed at sub-national level for all EU countries, but are – except for the UK – not available at present. The existing consumption and application data will now be processed and combined with all relevant fate and exposure pathways in order to derive human health impacts and damages. First results, i.e., external cost estimates due to application of current PPPs for most European countries, are expected to be available in late 2009.

References

- Amann, M., 2004. The RAINS model: Documentation of the model approach prepared for the RAINS peer review 2004. IIASA, Laxenburg, Austria.
- Hodgson, E. & R.L. Rose, 2008. *Pest Management Science* 64: 617-621.
- Juraske, R., 2007. *Advances in Life Cycle Impact Assessment of Pesticides: Methodological Improvements and Experimental Studies*. Universitat Rovira i Virgili, Tarragona.
- Knauert, S., *et al.*, 2008. In: *Proceedings of SETAC Europe 18th Annual Meeting*, Warsaw, pp. 247-248.
- Leistra, M., 2006. Estimating input data for computations on the volatilisation of pesticides from plant canopies and competing processes. Alterra, Wageningen, 80 pp.
- Malkina-Pykh, I.G., 2002. *Ecological Indicators* 2: 93-108.
- Peeters, F.M., *et al.*, 2008. PRIMET version 2.0. A Decision Support System for assessing Pesticide Risks in the tropics to Man, Environment and Trade. Alterra, Wageningen.
- Van den Berg, F., *et al.*, 1999. *Water, Air & Soil Pollution* 115: 195-218.
- Van Ittersum, M.K., *et al.*, 2008. *Agric. Syst.* 96: 150-165.

¹ <http://www.feem-project.net/exiopoli/>

² <http://www.heimtsa.eu>

Modelling water and nitrogen interactions in durum wheat: A first step towards the conception of joint management strategies for irrigation and nitrogen fertilization

S. Guillaume, J.E. Bergez, E. Justes
INRA, UMR 1248-AGIR, B.P. 52627, 31326 Castanet Tolosan Cedex, France
Contact: Solenne.Guillaume@toulouse.inra.fr

Introduction

In durum wheat production, grain protein concentration is of great importance because it determines the quality of the grain and thus the selling price to the producer. Grain protein concentration is strongly influenced by nitrogen nutrition status, which is a function of the rates and dates of N-fertilizer application, but also by soil water status, which influences soil nitrogen availability.

Due to climate change, farmers will have to deal with the reduction of water supply from rainfall during wheat growth. Irrigation may be needed to ensure an adequate yield and quality. This must be considered together with nitrogen fertilization to maximize N availability for the crop and to minimize N losses. Moreover, the response may depend on the cultivar of durum wheat that is grown.

Biophysical models may be useful tools to evaluate the impact of irrigation and N fertilization on production levels. However existing models do not always accurately simulate yield and grain protein concentration and only a few of them are parameterized for durum wheat. Moreover, they do not take into account the constraints met by farmers that lead (or not) to a decision to adopt a particular irrigation strategy.

The aim of this study is to improve a generic biophysical crop model to obtain a specific crop model for durum wheat which simulates yield and grain protein concentration under different water and nitrogen availabilities.

Methods

The proposed method is based on six main steps:

- 1) A soil-crop model has to be chosen based on its ability: (i) to represent the main processes of the crop growth such as biomass accumulation and grain N accumulation, (ii) to take into account water and nitrogen dynamics and (iii) to provide outputs at the crop management scale for irrigation and N fertilization.
- 2) A database of field observations is needed to calibrate and evaluate the model. It has to encompass observations from a range of contrasting irrigation and N fertilization strategies made in pedoclimatic situations typical of durum wheat growing areas.
- 3) The model has to be parameterized using the information in the database while limiting as much as possible compensation effects between parameters due to mathematical optimization.
- 4) An in-depth model evaluation has to be conducted to assess the accuracy and the robustness of the model and to identify processes that need to be improved.
- 5) "Faulty" processes have to be changed by new model equations (options) identified from the literature or coming from other models.
- 6) New model evaluations have to be conducted before and after parameterization and after equation implementation in order to compare the accuracy and the robustness of the different options.

Results and discussion

The STICS model was chosen as the base model for improvement. STICS is a generic model that simulates crop growth, grain yield and grain nitrogen concentration affected by nitrogen

and water stress at field scale with a daily time step (Brisson *et al.*, 2003). A total of 763 year/site/management combinations distributed over 13 years (1995–2007) and 10 sites and representing 19 durum wheat cultivars were introduced into the database. Parameter estimation was conducted on a subset of the total database following several independent steps and using a simplex algorithm. Evaluation of the effectiveness of the modified model was based on the comparison between observed and simulated values using Root Mean Square Error and model efficiency as indicators. Equations from SIRIUS (Jamieson & Semenov, 2000), AZODYN (Jeuffroy, 1999; Jeuffroy *et al.*, 2000) and CERES-WHEAT (Ritchie *et al.*, 1998) were analysed to identify new formalisms (Figure 1). We introduced new equations into STICS in order to provide a new version specific for durum wheat that can simulate more accurately grain yield and grain protein concentration for various cultivars under different simulation options.

The next step of the project will be to develop a decision support model that represents farmers' decision rules and to connect this decision model to the biophysical one in order to evaluate strategies that jointly manage irrigation and nitrogen fertilization.

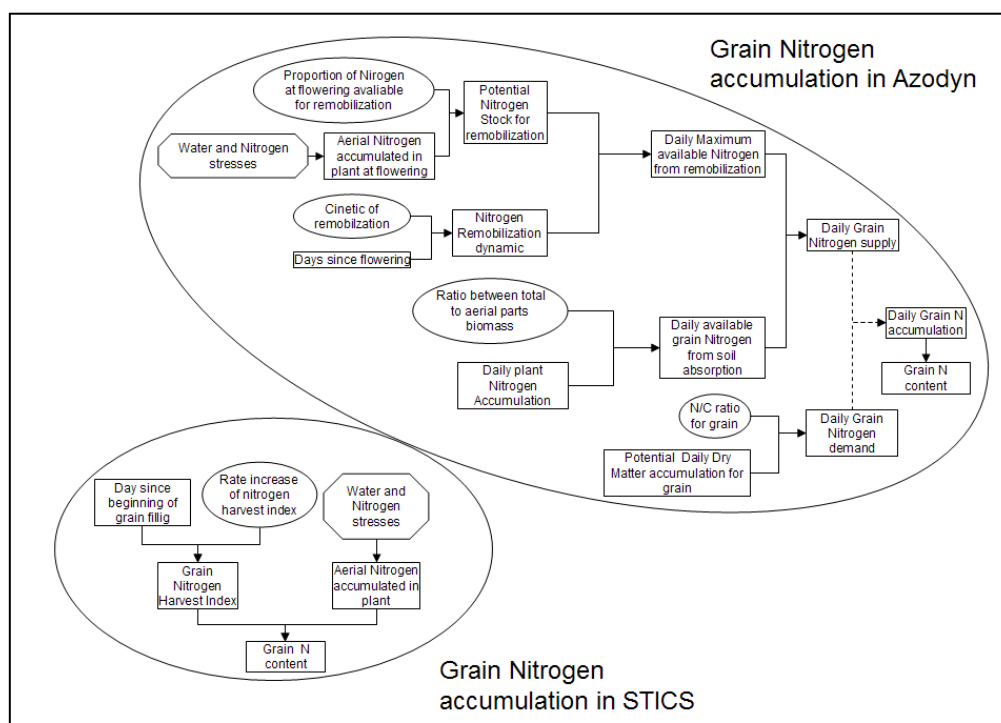

Figure 1. Variables, parameters and stress indices used in the models STICS and AZODYN to simulate Grain nitrogen concentration. Boxes are state variables, squares are model parameters and hexagons are related to water and nitrogen stress. Solid arrows indicate information flows. Dotted arrows indicate that the state variable with the minimum value is considered to determine the value of N accumulation.

References

- Brisson, N., *et al.*, 2003. *Eur. J. Agron.* 18: 309-332.
 Jamieson, P.D. & M.A. Semenov, 2000. *Field Crops Res.* 68: 21-29.
 Jeuffroy, M.H. & S. Recous, 1999. *Eur. J. Agron.* 10: 129-144.
 Jeuffroy, M.H., *et al.*, 2000. In: Eds P. Maillard & R. Bonhomme, *Fonctionnement des peuplements végétaux sous contraintes environnementales*. INRA, Paris, pp. 289-304.
 Ritchie, J., *et al.*, 1998. In: Eds G.Y. Tsuji, *et al.*, *Understanding options for agricultural production*. Kluwer Academic Publishers, Dordrecht, pp. 79-98.

Optimization of upland rice breeding programme based on a crop modelling approach

A.B. Heinemann

Embrapa Rice & Beans – Rod. GO-462, km 12,
75375-000 Santo Antônio de Goiás, GO, Brasil

Contact: alexbh@cnpaf.embrapa.br

Introduction

Sub-tropical flooded rice cultivated in the South of Brasil accounts for 65% of Brazilian rice production. However, in the South the area available for increasing rice production is limited. Also for food safety and logistical reasons, it is not appropriate to concentrate rice production in one region. Hence, there is increasing interest in improving the upland rice systems of Goiás State, in the Brazilian savannas. In the early 1970s, at the start of the development of savanna agriculture in Brasil, upland rice was grown in Goiás State. However, from 1985 onwards, these efforts were primarily targeted on the more favourable climatic zones (Pinheiro *et al.*, 2006) in the northwest of Brasil as a consequence of direct selection for grain yield and quality, and blast resistance. The average upland rice yields in Goiás State are only 1800 kg ha⁻¹ due to high spatial and temporal rainfall variability. An environmental characterization of Goiás State, based on stress patterns could improve the local upland rice breeding programme, allowing the identification and development of superior genotypes for particular regions that could be combined into elite varieties. This study explores how to adjust the local breeding systems to optimally fit the range of environments found in Goiás State. The objectives were to (a) determine the drought patterns for upland rice in Goiás State; and (b) develop modelling strategies that can improve the efficiency of the upland rice breeding programme there.

Methods

In this study, the target population environment (TPE) corresponds to Goiás State, located in the central part of Brasil. To characterize TPE, 12 locations with soil and climatic data were selected. The most common soil types, covering 46% of the region, are Oxisols and Ultisols. Soil water holding capacity is about 100 mm m⁻¹. Rooting depth is generally limited by soil acidity which increases with depth, and may be as shallow as 0.3 m under low input management. This was taken into account in the modelling study by setting the maximum rooting depth to 0.4 m (low input scenario) and 0.8 m (well managed cropping system scenario). One reference upland rice varietal type (short cycle), based on the characteristics of the most commonly planted genotypes in the region, was parameterized using the crop model RICE06, implemented on the ECOTROP modelling platform of CIRAD (Kouressy *et al.*, 2008).

The relative water stress impact on yield (RWSI) was evaluated by expressing attainable yield as a fraction of potential yield. Simulations were undertaken for a range of sowing dates, sites and years, using recommended management practices. Sowing dates were defined at 15-day intervals during the main planting season defined as 01 November–31 December.

To develop a typology of drought patterns for rice, a matrix consisting of location, sowing date, year and growth phase (100 °Cd periods) was established for the simulated mean daily water stress index. Following Chapman *et al.* (2000), a hierarchical agglomerative clustering method was used to classify the drought stresses into three main groups based on the similarities in the phenological patterns of water stress index.

Results and discussion

Three predominant stress patterns were observed, called low (L), mid-season (M) and terminal (T) stress (Figure 1). The most severe but less frequent stress pattern, T (Table 1)

began about 600 °Cd after emergence (38 DAE), at the beginning of reproductive phase and was most intense between 800 (52 DAE) and 900 °Cd (59 Days After Emergence). The T stress pattern also affected grain filling, particularly under conditions of shallow soil, and reduced potential yield by 50% in both soil types. The L pattern was most frequent for deep soils (46%) and the M pattern for shallow soils (48%) with smaller relative effects on yield. The overall, weighted yield reduction confounding all stress patterns was 18% for deep soil and 36% for shallow soil (Table 1).

The results of the present study on rice TPE indicated that yield reduction caused by drought (RWSI) is less than 50% overall for both soil depths (Table 1). On deep soils, the L (for both short and medium duration TPEs), plus the M (short-duration) stress patterns represent 84% of all the stress pattern frequencies, i.e., the drought environment that causes yield reduction of < 50% occurs with a frequency of 20% in deep soils. Consequently, for the deep soil, water deficit is not the main constraint to be addressed by the upland rice breeding programme, especially if it is largely avoided by planting around November 15.

The frequency of severe drought is likely to be much higher for shallow soils, which in Goiás State are typical of small, family based holdings associated with low inputs. An additional drought screen (i.e., specific site, planting date combination) may therefore be necessary to ensure that germplasm can be selected that is suitably adapted to the types of stress experienced in shallow unimproved soils.

Table 1. Potential yield (GY_{pot}, without water limitation), attainable yield (GY_{att}, with water limitation), relative water stress impact (RWSI) on yield and stress frequency (S.F).

Stress type	GY _{pot} (kg ha ⁻¹)	GY _{att} (kg ha ⁻¹)	RWSI (%)	S.F. (%)	0.8 m Soil Depth		0.4 m Soil Depth	
					GY _{pot} (kg ha ⁻¹)	GY _{att} (kg ha ⁻¹)	RWSI (%)	S.F. (%)
L	3937	3718	6	46	3927	3516	10	23
M	4120	3378	18	38	4027	2742	32	48
T	4217	1982	53	16	4270	1634	62	29
Average	4051	3311	18		4074	2599	36	

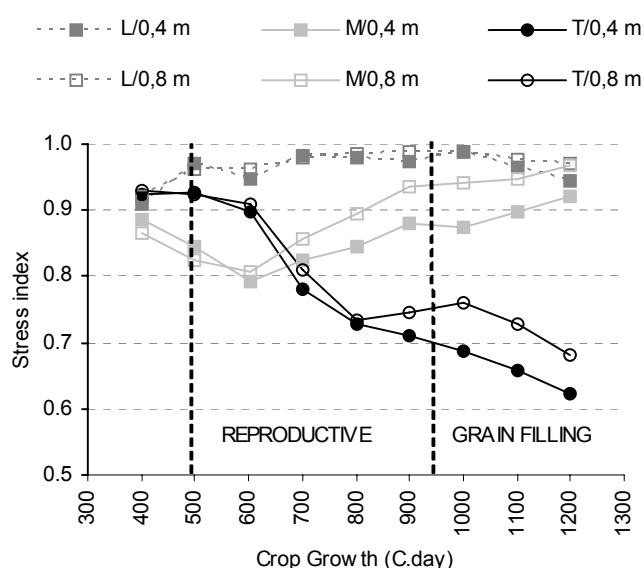

Figure 1. Stress patterns from the cluster analysis. The legends indicate the different stress types (L - low; M - mid-season; T - terminal) and rooting depth limitations (0.4 and 0.8 m).

References

- Chapman, S.C., *et al.*, 2000. *Aust. J. Agric. Sci.* 51: 209-221.
 Kouressy, M., 2008. *Agric. and Forest Meteorol.* 148: 357-371.
 Pinheiro, B. da S., *et al.*, 2006. *Field Crops Res.* 97: 34-42.

Extracting useful information from daily GCM rainfall for cropping system modelling

A.V.M. Ines, J.W. Hansen

International Research Institute for Climate and Society

The Earth Institute at Columbia University, NY, USA

Contact: ines@iri.columbia.edu

Introduction

There is a growing interest in using daily GCM outputs for crop yield predictions because of GCM capability to simulate seasonal climate in advance and the daily weather requirements of cropping system models (Ines & Hansen, 2006; Baigorria *et al.*, 2007, 2008). However, given that GCM simulate climate at very coarse spatial resolution, the simulated weather are usually biased relative to a point location limiting their direct applications to crop simulation models (Cohen, 1990). GCM can predict better inter-annual climate variability than the absolute meteorological values (Baigorria *et al.*, 2008). GCM rainfall for example is characterized by having high frequencies and low intensities resulting into too many rainfall events with too little amounts during rainy seasons (Ines & Hansen, 2006). The biases in rainfall frequency and amounts will result into under-prediction of crop yields if directly used in crop simulation models (Mavromatis & Jones, 1998). For this reason, Ines & Hansen (2006) developed a simultaneous bias correction approach to correct the biases in GCM rainfall frequency and intensity. While they observed improvements in simulated yields with bias corrected daily GCM rainfall, the under-prediction of crop yield was still evident which they attributed to the inability of the bias correction method to correct the temporal structure of daily GCM rainfall mismatching the lengths and distributions of dry spells. In this paper, we explore a strategy to extract useful information from the bias corrected GCM rainfall to improve the simulation of dry spell lengths and their distributions with the aim of predicting better crop yields using cropping system models.

Methods

We used the bias correction method of Ines & Hansen (2006) to correct rainfall frequencies and intensities of ECHAM4.5 grid daily rainfall (1970–1995, 24 ensemble members) encompassing our study location in the Machakos district of eastern Kenya (1°35' S, 37°14' E). After bias correction, we derived the monthly rainfall frequencies for all years, for each ensemble member and then used them to condition a weather generator (Hansen & Ines, 2005). The stochastic disaggregation was applied in two ways; (i) for each ensemble member using their respective rainfall frequencies to condition the weather generator, and (ii) using the mean of monthly rainfall frequencies from all ensemble members to condition the weather generator. We used 24 realizations in our stochastic disaggregation matching the number of ensemble members of the GCM, and then we replicated ten times. We tested the performance of our bias corrected-disaggregated GCM based-rainfall by linking them to CERES-Maize to simulate yield. A local maize variety 'Katumani B' was used in the simulations. The cropping season is from October-February. For comparison, we ran the crop model using observed, uncorrected and bias-corrected GCM rainfall. For all simulations, we used long-term average minimum, maximum temperature and solar radiation values conditioned on dry and wet days.

Results and discussion

Table 1 shows the performance of the bias corrected-disaggregated GCM-based rainfall on crop yield prediction. The combined bias correction (BC)-stochastic disaggregation (DisAg) using mean of monthly rainfall frequencies of all ensemble members to condition the weather generator (BC-DisAg2) showed the best performance in which all indicators have improved

Table 1. Performance of the proposed combined BC-DisAg on prediction of yield. Note: R - correlation; MBE - mean bias error; d - index of agreement (Willmot, 1982), MSE - mean squared errors; subscripts _R and _S indicate random and systematic components.

Method	R (-)	MBE (Mg ha ⁻¹)	d (-)	MSE (Mg ha ⁻¹) ²	MSE _R (Mg ha ⁻¹) ²	MSE _S (Mg ha ⁻¹) ²
Uncorrected	0.61	-2.35	-1.14	6.61	1.06	5.55
BC only	0.70	-1.04	0.50	1.95	0.86	1.09
BC-DisAg1	0.63	-0.41	0.63	1.22	1.01	0.21
BC-DisAg2	0.73	-0.20	0.74	0.91	0.79	0.12

considerably compared to bias correction only. The yield mean bias is reduced and the prediction skill and d-statistics have increased suggesting that the BC-DisAg2 method attempts to correct random and systematic error components of the simulated yield. Using each ensemble member rainfall frequency to condition the weather generator (BC-DisAg1) only performed fairly compared to using BC only; most of the improvements are observed on yield mean bias. This performance of BC-DisAg2 can be attributed to its better skill in simulating dry spell length distributions (Figure 1c) as the weather generator we used applied a hybrid first- and second-order Markov process in simulating rainfall occurrence. BC only slightly improved the dry spell length distributions (Figure 1b) compared to Uncorrected GCM runs (Figure 1a) and since GCM rainfall is highly auto-correlated, the longer dry spells have not been corrected by deterministic bias correction.

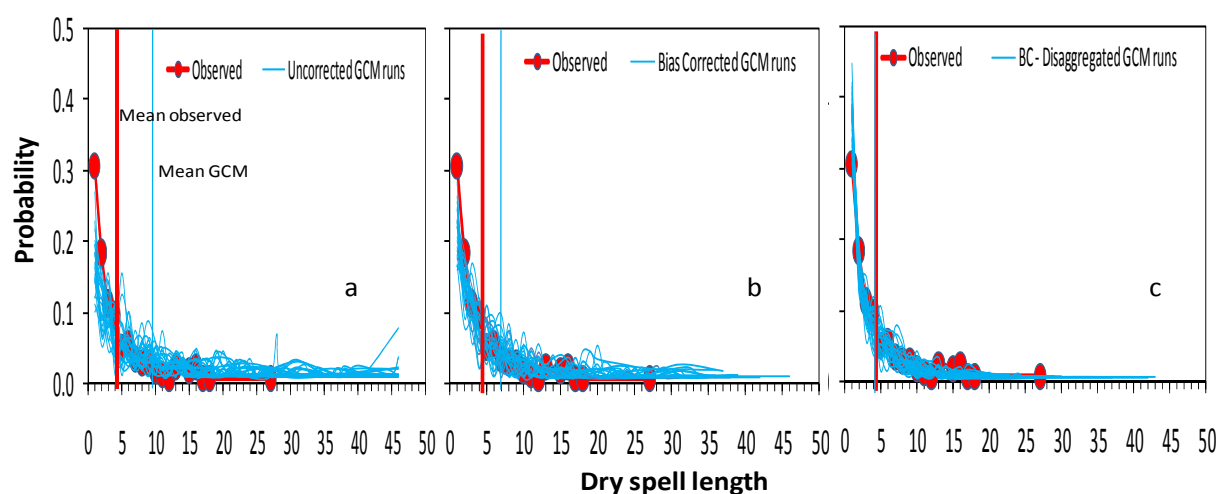

Figure 1. PDF of dry spell lengths during anthesis period (Nov. 15–Dec. 31) from (a) uncorrected, (b) BC only and (c) BC-DisAg2 (best trial).

References

- Baigorria, G., *et al.*, 2007. *Clim. Res.* 34: 211-222.
 Baigorria, G., *et al.*, 2008. *Agric. For. Meteorol.* 148: 1353-1361.
 Cohen, S.J., 1990. *Bull. Am. Meteorol. Soc.* 71: 520-526.
 Hansen, J.W. & A.V.M. Ines, 2005. *Agric. For. Meteorol.* 131: 233-246.
 Ines, A.V.M. & J.W. Hansen, 2006. *Agric. For. Meteorol.* 138: 44-53.
 Mavromatis, T. & P.D. Jones, 1998. *Clim. Change* 41: 583-614.
 Willmot, C.J., 1982. *Bull. Am. Meteorol. Soc.* 63: 1309-1313.

Uncertainties in simulating crop performance in degraded soils and low input production systems

J.W. Jones, J. Naab, D. Fatondji, K. Dzotsi, S. Adiku, J. He
P.O. Box 110570, University of Florida, Gainesville, FL 32611, USA
Contact: jimj@ufl.edu

Introduction

Models are increasingly being used as research tools to predict outcomes of cropping systems under different climate, soil, and management conditions in both developed and developing countries. Many papers have been published on research that demonstrated that cropping system models perform adequately for the intended purposes and then used the models to study impacts of different cultivars, irrigation, fertility, and cultural management practices on yield and other predicted outputs. Many of these studies have emphasized the importance of incorporating climate uncertainty to adequately consider risks to production and profitability (e.g., Hammer & Muchow, 1991; Thornton & Wilkens, 1998). Impacts of, and adaptation to, climate change have made extensive use of crop models, and now these models are being used for simulating years of crop rotation for projecting long term changes in soil carbon and other properties that affect sustainability of production in different environments.

Typically in these studies, researchers are interested in only a few factors that may limit growth and yield, such as water and nitrogen in addition to climate. There may be a number of factors that limit production in farmers' fields that present challenges to model users. This is particularly true in developing countries where (i) soils are low in fertility and hold very little water, (ii) where farmers typically do not apply fertilizer or irrigate, (iii) there is considerable annual variability in climate, and (iv) subsistence farming practices are used. Matthews & Stephens (2002) pointed out the difficulties of obtaining inputs to operate cropping system models in developing countries, and this presents one of the challenges in reliable use of cropping system models in those countries. However, there is another major challenge that has been ignored in most previous studies, even if inputs for model studies were collected – uncertainty in environmental parameters and inputs. Model developers routinely emphasize the importance of obtaining accurate genetic coefficients in order to apply cropping system models in local studies, which suggests that without reliable values for these parameters, the models will not adequately simulate the responses to climate and management that users are studying. Little attention has been given to uncertainty analysis of different soil and management inputs relative to prediction of cropping system performance. Based on studies conducted in West Africa, we hypothesize that uncertainty in soil parameters, initial conditions, and nutrient inputs contribute more to prediction uncertainty than genetic parameters in low input, rainfed cropping systems on low fertility and water holding soils.

The objectives of this study were (1) to quantify the uncertainty of simulated crop production as affected by estimated uncertainties in important soil parameters, soil initial conditions, genetic coefficients, and nutrient inputs; and (2) to determine which uncertain inputs dominate model output uncertainty under different environments and management conditions.

Methods

We conducted an uncertainty analysis on three cropping systems with contrasting climate, soil, and management inputs, two in West Africa and one in the USA. We also quantified the contributions of uncertainties in different soil and genetic parameters on that uncertainty using global sensitivity analysis. The first crop was irrigated maize grown in Gainesville, Florida with high nitrogen input to represent a typical high input production system. We used the

fully irrigated, high nitrogen fertilizer treatment from a 1982 experiment (Bennett *et al.*, 1989). The data from this experiment are distributed in DSSAT (Jones *et al.*, 2003) and have been used in training workshops for and testing different maize model versions. The second crop was low input maize represented by an experiment conducted in 2004 by Naab (2005) in Wa, Ghana, using the treatment that had no nitrogen added but adequate P and other inputs. The third crop was millet with the data taken from a millet experiment conducted in 1999 in Damari, Niger by Fatondji *et al.* (2006) in which a rainfall harvesting planting technique was compared with traditional flat planting. We used their flat planted, 3000 kg ha⁻¹ manure application treatment as the basis for the uncertainty and sensitivity analysis. Soils in all three experiments were sandy with low water holding capacities and low organic matter contents. The two experiments in West Africa were rainfed. Soil parameters, initial conditions, management details, and genetic coefficients were based on prior simulation studies by the authors of the studies.

A Monte Carlo approach was used to generate 5000 sample sets of inputs for each of the three sites from estimated distributions of soil inputs (water holding limits, rainfall runoff parameter, initial values of soil water, carbon, nitrate, and ammonium, and manure input N concentration) and genetic coefficients. Soil water limits were sampled taking into account correlations between the inputs, based on the approach used by He (2008). The DSSAT-Maize and Millet models were simulated using each sample of inputs to create 5000 outputs for each site. Distributions of simulated biomass and grain yield were generated and compared with observed responses. Also, first order and total sensitivities of these outputs to each uncertain input were computed using the Sobol decomposition of variances.

Results and discussion

Results are presented showing empirical model output distributions of biomass and grain yield for each of the three cases. First order global sensitivities of these outputs to each of the uncertain inputs are compared and ranked for each case study. The implications of this research will be discussed relative to use of cropping system models in harsh environments, the importance of characterizing and communicating uncertainties in model outputs when analysing cropping system performances, suggestions for reducing uncertainties when evaluating models for specific experimental conditions, and practical implications relative to communicating results to decision makers.

References

- Bennett, J.M., *et al.*, 1989. *Field Crops Res.* 19: 297-311.
- Fatondji, D., *et al.*, 2006. *Nutr. Cycling in Agroecosyst.* 76: 203-217.
- Hammer, G.L. & R.C. Muchow, 1991. In: *Climatic Risk in Crop Production: Models and Management for the Semi-Arid Tropics and Subtropics.* CAB International, Wallingford, UK, pp. 205-232.
- He, J., 2008. *Best Management Practice Development with the CERES-Maize Model for Sweet Corn Production in North Florida*, PhD Dissertation, University of Florida, 329 pp.
- Jones, J.W., *et al.*, 2003. *Eur. J. Agron.* 18: 235-265.
- Matthews, R.B. & W. Stephens, 2002. *Crop-soil Simulation Models: Applications in Developing Countries.* CABI Publishing, Wallingford, UK, 280 pp.
- Naab, J.B., 2005. *Measuring and Assessing Soil Carbon Sequestration by Agricultural Systems in Developing Countries*, 2004 Annual Report. Savanna Agricultural Research Institute, Wa, Ghana.
- Thornton, P.K. & P.W. Wilkens, 1998. In: *Understanding Options for Agricultural Production: Systems Approaches for Sustainable Agricultural Development.* Kluwer Academic Publishers, Dordrecht, pp. 329-345.

Crop systems evaluation for strategic investment decisions

J. Koo, S. Wood, Z. Guo

International Food Policy Research Institute, 2033 K St., NW, Washington, DC 20006, USA

Contact: j.koo@cgiar.org

Introduction

Investors in development and policymakers have a growing need for data and tools to help them target and prioritize interventions so as to achieve the greatest possible food security impacts in cost-effective ways. Although crop systems modelling has been used successfully as a cross-disciplinary decision support tool, many crop models have been developed for use on comparatively small unit areas, which are typically assumed to be homogeneous in crop growth, environmental conditions, and management regimes. However, typical investment or policy-making decision covers large areas with significant heterogeneity in crop growth conditions and thus crop responses to potential interventions. Potential benefits and pitfalls of increasing the spatial resolution in crop systems modelling studies of large areas have been discussed and tested, but the choices of models and scenarios in these studies have been relatively simple and limited in scope, due to incomplete spatially-explicit knowledge of the crop systems attributes, a lack of sufficiently high-resolution data at regional or global scales required to evaluate such models and results, and the computational cost of running these models over a large area at a high resolution under multiple scenarios. Despite many challenges, a Sub-Saharan Africa (SSA) and South Asia (SA) region-wide decision-support platform employing crop systems models at its core is being developed by a network of crop modellers facilitated by the HarvestChoice project (<http://HarvestChoice.org>) to help meet the demand for a large scale analytical research platform with accompanying data. The platform is being developed to assess the spatially-explicit likely-changes in crop yield and biomass production and regional resource and market implications of technology and management innovations, under different scenarios of changes in crop management practices and agricultural policy at a grid-based regional scale. This paper discusses the platform development process, and presents a series of use-cases describing potential analytical uses of the platform for the high-spatial-resolution regional estimation of: (1) crop calendar, (2) baseline crop productivity level, and (3) impacts of biotic and abiotic stresses on crop production, under a range of management and climate change scenarios.

Methods

The analytical crop systems modelling platform is being developed by focusing on following issues: (1) characterizing cropping systems based on a blend of macro and micro data, (2) compiling/developing regional-scale crop model input data layers in a standard format, including climate/weather, soil properties, pest and disease prevalence, and model evaluation datasets, (3) developing a set of regional-scale scenarios of potential changes in R&D investment, technology and market access, and farm-scale adoption, (4) developing a database of spatially-explicit pre-run crop systems model results that allow users to assess the potential impacts of scenarios of changes based on the user-defined baseline, and (5) developing a suite of tools to provide an easy interface for running crop growth models in a grid-based regional context with pre-loaded yet modifiable datasets and user-defined scenarios.

Based on the preliminary version of the datasets and tools being compiled and developed, a spatially-explicit database of model results based on following use-cases was developed:

1. Crop- and site-specific length of growing period (LGP) and cropping calendar and their comparison with existing regional databases developed using rule-based systems and observations;

2. Baseline production under a range of supplementary nutrient and water management practices for two representative varieties for each crop, under current and future climate, with:
 - a. Impacts of drought on growth stage-specific water stress and yield,
 - b. Pest infestation based on the surveyed and simulated pest prevalence data and estimated damage,
 - c. Drought and pest infestation occurring simultaneously.

Each case used DSSAT v4.02 (Jones *et al.*, 2003) model for maize and groundnut at a 5 arc-minute (approximately 10 km) grid in SSA. For current and future climate, 30 years of daily weather for each grid cell was simulated using WeatherMan (Hoogenboom *et al.*, 2006), MarkSim (Jones & Thornton, 2000), and WorldClim (Hijmans *et al.*, 2005). Representative soil profiles for major soils in each grid cell were compiled using the Harmonized World Soil Database 1.0 (FAO, IIASA, ISRIC, ISSCAS, JRC, 2008) and the ISRIC-WISE 1.1 (Batjes, 2002). Crop yield in each grid cell was estimated as a weighted average based on the relative area of each soil type.

Results and discussion

Overall outputs of the use-cases showed that location-specific information on the potential changes of crop production under a wide range of scenarios can be useful to help set investment priorities and identify efficient technology development and adaptation strategies. These outputs will be integrated with an economic evaluation to provide insights into the potential spatial and socio-economic patterns of impact under simulated investment, policy, and environmental change scenarios at regional and global scales.

The performance of crop systems models can be compromised if the environmental or production conditions of interest greatly differ from those used during model development and evaluation, and the risk can be relatively higher in the regional-scale application. As part of the analytical platform development, a set of field measurement data are being compiled from multiple sources (e.g., CGIAR field trial database, national/sub-national agricultural census data) for use as modelling control points. Rigorous efforts on model evaluation will be critical in gaining the confidence of scientists, analysts, investors, and policymakers.

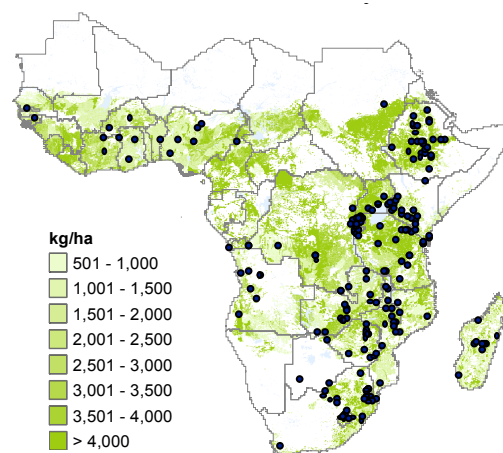

Figure 1. Simulated rainfed/low-input maize yield potential in Sub-Saharan Africa and CIMMYT maize field trial locations (dots).

References

- Batjes, N.H., 2002. A Homogenized Soil Profile Data Set for Global and Regional Environmental Research (WISE, version 1.1) 2002/01. International Soil Reference and Information Centre, Wageningen, The Netherlands.
- FAO, IIASA, ISRIC, ISSCAS, and JRC, 2008. Harmonized World Soil Database [Online]. Available by FAO (Rome, Italy) and IIASA, Laxenburg, Austria.
- Hijmans, R.J., *et al.*, 2005. *Int. J. Climatol.* 25: 1965-1978.
- Jones, J.W., *et al.*, 2003. *Eur. J. Agron.* 18: 235-265.
- Jones, P.G. & P.K. Thornton, 2000. *Agron. J.* 92: 445-453.
- Hoogenboom, G., *et al.*, 2006. *Weatherman*. Release 4.0.2.0. Univ. of Hawaii, Honolulu, HI.

A modelling approach to optimize the management of pea-barley intercropping in Europe

M. Launay, N. Brisson, S. Satger, H. Hauggaard-Nielsen, G. Corre-Hellou, E. Kasynova, E.S. Jensen, M.J. Gooding, C. Dahlmann, P. Von Fragstein, A. Pristeri, M. Romeo, M. Monti
Unité Agroclim, INRA, Site Agroparc, 84914 Avignon Cedex 9, France
Contact: Marie.Launay@avignon.inra.fr

Introduction

Intercropping, defined as two or more species grown mixed together in the same field during the same cropping season, may be a good strategy for low input agriculture. Indeed, available resources, such as light, water and nutrients can be more efficiently utilized by the intercrop as a result of complementary acquisition strategies. Grain legume-cereal intercrops, and especially pea-barley intercrops, have been shown to maximize the biomass produced per unit of nitrogen available (Hauggaard-Nielsen & Jensen, 2001). Given the complexity of intercropping systems modelling can be a helpful tool to improve understanding of interspecific interactions (Brisson *et al.*, 2004) and to test various agronomic strategies. We have used a modelling approach to test pea-barley systems in three sites in three northern European countries involved in the INTERCROP FP5 EU project, in order to take into account soil and weather variability. The strategies being tested, which were selected according to their feasibility for farmers, were compared by answering the following questions: (i) how do pea-barley intercrops (IC) compare with sole crops (SC) as regards yield and quality and their stability? (ii) in order to increase the crops' access to light, would it be worth delaying the sowing date of the quick-growing species? (iii) how can the use of nitrogen resources be optimized by choosing the most suitable preceding crop and/or the most appropriate soil? To answer those questions, a virtual experiment was carried out using 10 years' weather data from Angers (France), Reading (UK) and Roskilde (Denmark) sites.

Materials and methods

The STICS growth model (Brisson *et al.*, 2003), extended to intercropping (Brisson *et al.*, 2004), has already been evaluated on pea-barley intercrops (Corre-Hellou & Brisson, 2007).

Weather records for about 10 years from Angers (France), Reading (UK) and Roskilde (Denmark) were used for the simulations. The simulation protocol depended on the question being addressed:

- Pea-barley IC/SC comparison in terms of quantity, quality and stability: the simulation design mimicked the experimental design from the INTERCROP project (pea SC, barley SC, additive pea-barley IC and replacement pea-barley IC);
- Delay in sowing dates: 2 weeks' delay between pea and barley sowing for both density treatments (additive and replacement designs) were simulated.
- Test of soil nitrogen availability: the agronomic design mimicked the additive and replacement pea-barley IC of the INTERCROP experimental design, using two hypotheses of soil nitrogen availability factorially combined to give four combinations:
 - 20% increase in the soil organic nitrogen content compared to the actual one of the field sites.
 - two initial mineral nitrogen profiles at sowing accounting for two types of preceding crop (oilseed rape and maize, for example).

Results and discussion

(i) The model showed the value of intercropping for making the best use of environmental resources as regards yield and quality, but indicated a site effect as regards yield stability. Total IC yield was more stable over the years than any of the SC yields. It identified factors

explaining the competitiveness of the two species: pea growth appears to be strongly linked to soil moisture through nodulation activity, and barley yield was determined by nitrogen uptake through rooting, and by light interception due to its height relative to pea.

(ii) Sowing barley before pea involves a reduction of only 5% of the grain yield Land Equivalent Ratio (LER) averaged over all three sites. There was no effect in Angers and only a small one in Roskilde. Although the effect was not statistically significant even in Reading, a reduction of 10% would be agronomically important. In Angers, where barley is more competitive than peas, it appears that sowing peas before barley is preferable while in Roskilde and Reading, simultaneous sowing is equally good (Table 1). This shows that the sowing strategy must be adapted to the location, being dependent on temperature and thus latitude.

Table 1. Simulated Grain yield LER for additive and replacement designs, when sowing barley before pea, barley and pea at the same date, and pea before barley, at Danish, English, and French locations.

Grain Yield LER		Additive		
		Barley before pea	Same sowing date	Pea before barley
Location	Roskilde (Denmark)	1.17 a	1.21 a	1.20 a
	Reading (UK)	1.12 a	1.24 a	1.22 a
	Angers (France)	1.11 a	1.11 a	1.28 b
All sites		1.13 a	1.19 a	1.24 a

Values are the mean over years. In each row, grain yield LER values followed by the same letter are not significantly different at $p < 0.01$.

(iii) Grain yield and plant N content responses to soil initial mineral nitrogen content are higher than to soil organic nitrogen. Increasing nitrogen availability at the beginning of growth reduces the proportion of pea in the IC yield, as already shown experimentally for a wheat-pea intercrop by Ghaley *et al.* (2005). Barley responded more to the organic nitrogen increase in Reading (UK) and Angers (France) than in Roskilde (Denmark). In Roskilde, low temperatures slow down mineralization during winter (barley grain yield is increased by 9% in Reading whereas it does not increase in Roskilde when organic nitrogen content was 20% more than the nominal content of the soil). Similarly, the bigger barley response to initial mineral nitrogen content in Roskilde and Angers was due to wetter conditions in Reading resulting in increased leaching of nitrogen (barley grain yield was increased by 27% in Roskilde and Angers whereas it was increased by only 13% in Reading with a 12 g N m⁻² increase in initial mineral N content). These results underline the importance of a long term strategy, including mineralization management through organic residue supply and rotation management, in order to increase soil nitrogen availability, and favour total grain yield and N accumulation of the intercrop.

References

- Brisson, N., *et al.*, 2003. *Eur. J. Agron.* 18: 309-332.
 Brisson, N., *et al.*, 2004. *Agronomie* 24: 409-421.
 Corre-Hellou, G. & N. Brisson, 2007. *Field Crops Res.* 103: 76-85.
 Ghaley, B.B., *et al.*, 2005. *Nutrient Cycling in Agroecosystems* 73: 201-212.
 Hauggaard-Nielsen, H. & E.S. Jensen, 2001. *Field Crops Res.* 72: 185-196.

Establishment of quinoa (*Chenopodium quinoa* Willd.) and simulation of its cultivation with the STICS crop model

Sophie Lebonvallet, Nadine Brisson, Jean-Pierre Raffailac, Marie Launay
Agroclim, INRA Domaine St Paul Site Agroparc, 84914 Avignon Cedex 9, France
Contact: foflebonval@yahoo.fr

Introduction

Quinoa is a species native to South America, grown mainly on the high Andean plateau (Mujica *et al.*, 2001). It appeared on the international market about twenty years ago, thanks partly to its high nutritive value and partly to its production under an organic farming label. Bolivia is today the main world exporter (Laguna, 2002).

This work aims to explain the issues involved in quinoa establishment and the methods of cultivation on the Bolivian Altiplano. The climatic risks for agriculture there are very high (low and very variable rainfall, frequent frosts, especially during the final stages of development of the crop) which keep yields fairly low, from 0.6 to 1 t ha⁻¹ on average. Crop establishment, therefore, should not be too late, to avoid the crop experiencing frost after flowering, which would destroy the yield (Bois *et al.*, 2005). However it should not be too early, so that the young plants are not subjected to too severe drought. The sowing period is in fact just at the start of the rainy season; the soil water content at this time depends on the water accumulated during the previous rainy season, its movement during the winter and on the first rains, which are irregular, of the new rainy season (Vacher *et al.*, 1994). The cultural practices used, the success of establishment and good growth of the young plants are, therefore, determinant phases for the rest of the growing period and the yield.

Methods

Due to the small number of studies and small amount of data available on quinoa, we decided to study all these aspects by modelling and numerical experimentation, by adapting the crop model STICS (Brisson *et al.*, 2003) to quinoa and to its growing conditions in the Bolivian Altiplano. This allowed us to rapidly generate a large amount of data.

Formalisms had to be added to or modified in STICS in order to better represent the conditions of the Bolivian Altiplano and the cultivation techniques used for quinoa. They are concerned in particular with taking account of altitude in the climatic data, the effect of drought, cold and soil capping on seed germination and establishment of the crop, and also the traditional method of sowing in poquets (Figure 1). The model was parameterized for quinoa using data from a set of experimental plots laid down by IRD between 2001 and 2006 (Raffailac *et al.*, 2007).

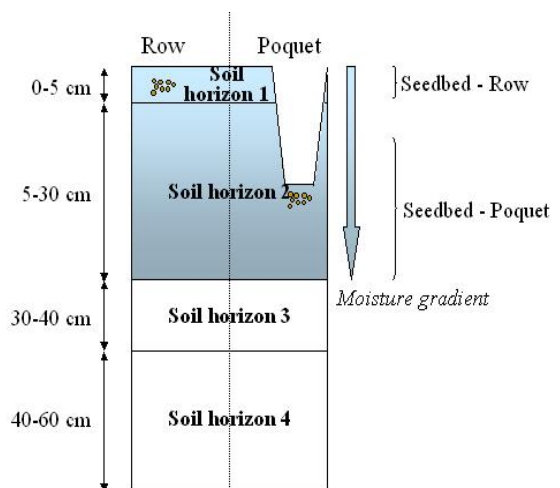

Figure 1. Sowing in row/poquet.

Results and discussion

STICS proved to be able to simulate the growth of quinoa with an efficiency of 60-80%, which is relatively satisfactory.

Firstly, the model was used just to study the effect of cultural practices on the establishment of quinoa. These practices differ from the north to the south of the Altiplano in terms of date, depth and type of sowing (row or poquet), ploughing date, and the

susceptibility of the soil to crusting. All these effects were factorially combined for sites, years and soil types, leading to the simulation of more than 11,000 cases. From this large-scale numerical experimentation there emerged various results underlining the adaptation of techniques to their environment. First of all, these results illustrate the variability in optimal sowing depths and dates, which explains the difficulties encountered by the farmers and their low yields. They also enable us to better understand the role of traditional sowing in poquets (higher soil moisture, reduced time for germination and emergence). They underline the value of traditional manual sowing at several depths (a method of control against drought and frost due to the successive flushes of emergence) and explain the early ploughing, in the middle of the previous rainy season more than six months before sowing in the driest regions, to provide the maximum amount of stored soil water at the time of sowing.

Secondly, the model was used to study the effect of cultural practices over the whole of the growing period, and thus on the yield. The results obtained, particularly for the effect of sowing date, illustrate perfectly the difficulty of managing the climatic risks in the Altiplano, which is very much a compromise between a yield which is moderate but reliable and one which is high but uncertain. Furthermore, paradoxically, this shows how a variable sowing at several depths reduces the yield variability and leads to much more uniform yields than in the case of sowing at a single depth.

Thirdly and finally, different rotations were studied to see the effect of the duration of fallow. In fact, traditionally the quinoa crop was preceded by 10-50 years of fallow, which allowed regeneration of the soil fertility thanks to the natural vegetation which could grow and then be incorporated into the soil (Hervé *et al.*, 2003). However, since the quinoa « boom » and its entry into world commerce, the necessary increase in production has led to these fallow periods being reduced, sometimes to only two years, which could explain, among other reasons, the observed fall in yields. Thus, the simulations carried out can show that the reduction in the length of the fallow period results in a fall in the soil water and nitrogen reserve, which results in practice in lower yields, especially in the southern region of the Altiplano, where the conditions are much more difficult.

Lastly, the use of the model, guided by these questions, has allowed us to better understand the system, the issues involved in crop establishment, and the sustainability problems in this environment which is restrictive and subject to great variability. This work has some limitations in terms of processes being simulated too simplistically compared with reality, due to a shortage of data because of difficult experimental conditions or processes which are not taken into account; but in a situation where quinoa is beginning to be studied more and more, it nevertheless opens the way to more advanced research, both to improve the tool created here, but also to use this tool in other work on sustainability, effects of climate change, cartography, decision aids etc.

References

- Bois, J.F., *et al.*, 2006. *European Journal of Agronomy* 25: 299-308.
- Brisson, N., *et al.*, 2003. *European Journal of Agronomy* 18: 309-332.
- Hervé, D., *et al.*, 2003. *Nature Sciences Societes* 11: 243-254.
- Laguna, P., 2002. *Debate Agrario, Analisis y Alternativas* 34: 95-169.
- Mujica, A., *et al.*, 2001. In: *Quinua, ancestral cultivo andino, alimento del presente y futuro*, Eds Mujica *et al.*, CIP, UNAP. FAO, CD Cultivos Andinos, Chili.
- Raffaillac, J.P., *et al.*, 2007. *Una red agronómica quinua en el altiplano boliviano. Congreso Internacional de la Quinua, CIHDE & Univ. Ed. A. Prat, 23-26 octubre de 2007, Chili.*
- Vacher, J.J., *et al.*, 1994. In: Eds. D. Hervé, *et al.*, *Dinamicas del descanso de la tierra en los Andes*. IBTA-ORSTOM, La Paz, pp. 127-139.

An integrative modelling approach to simulate the agricultural system through a combination of a decisional, technical and biophysical sub-system

A. Mérot, J.E. Bergez, J.C. Mailhol, J. Wery
 UMR System, SupAgro, 2 place Pierre Viala, 34090 Montpellier, France
 Contact: anne.merot@supagro.inra.fr

Introduction

Because farmers allocate resources, such as equipment or water at farm level, innovative cropping systems should be designed at this level. However it is not easy to perform because modellers have to cope with a diversity of processes and scales. Integrative modelling is therefore required to evaluate cropping systems *ex-ante*.

Due to environmental impacts, conventional water management practices in southern France (Crau Plain) must be modified in order to ensure higher water productivity and lower environmental impacts while maintaining high hay production. In this context, farmers, water managers and policymakers expressed the need for information to face these challenges. In this work, we illustrate the use of a conceptual framework (Le Gal *et al.*, 2007), based on three sub-systems (biophysical, technical, decisional), to guide a process of integrative modelling. The example of the dynamic bio-decisional model IRRIGATE, representing the functioning of the cropping system at farm scale for water management, will be used as an example.

Methods

The conceptual framework is based on three sub-systems (Le Gal *et al.*, 2007). The decision sub-system can be defined as the farmer's combination of objectives, rules, indicators and constraints to adopt and implement technical practices. The technical sub-system determined by the decision sub-system is the 'combination of techniques applied by farmers to the biophysical system in order to fulfil production objectives' (Le Gal *et al.*, 2007). The biophysical sub-system under the control of the technical sub-system is defined by the interactions between physical and biological components, such as water, soil, climate and pests, and the plant growth/development processes. Each sub-system can be described as a combination of components in interaction, status variables with associated dynamic, temporal and spatial scales, a set of inputs and a set of outputs.

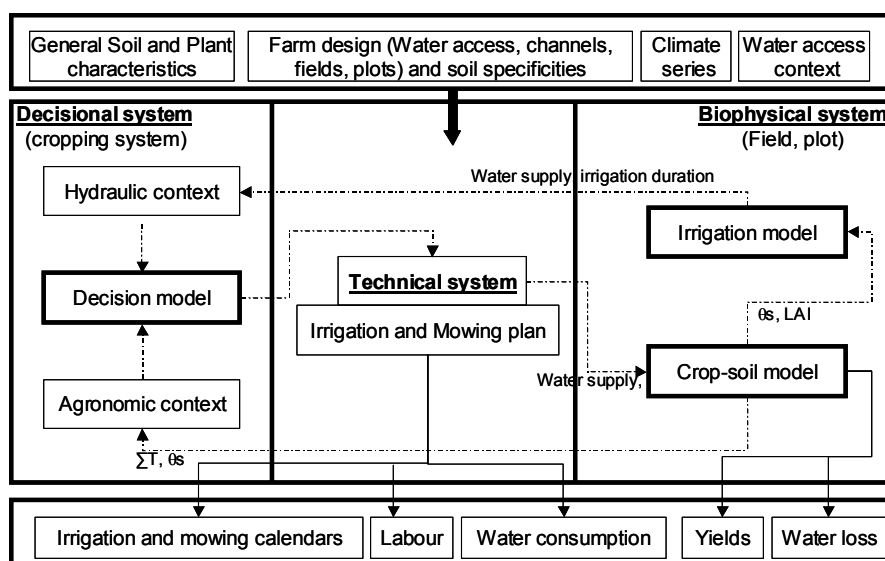

Figure 1. The conceptual model of the studied agricultural system based on the framework.

Integrative modelling process can be summarized by four scientific questions: Which processes of each sub-system to model? Which formalisms to represent these processes? How to integrate these formalisms in a temporal and spatial multi-scale context? How to evaluate the integrative model? Based on the conceptual framework and following a six-step methodology, we built the integrative bio-decisional model composed of modules each corresponding to a sub-system: (i) identification of the limits of the system; (ii) identification for each sub-system of the status/flow variables, their interactions in terms of information exchange and fluxes, the main dynamics of the variables; (iii) identification of the temporal and spatial scales associated with these processes; (iv) qualification/quantification of these interactions by in-field experiments and surveys; (v) simplification of the modelling of each sub-system by choosing the most important processes and associated formalisms; (vi) integration of the modules to simulate the functioning of the cropping system and evaluation. This last stage implies also the transition from the conceptual model to the numerical model.

Results and discussion

Description of the three sub-systems (Figure 1): The biophysical sub-system is a soil-plant-water system. The water component corresponds to the dynamics of run-off and infiltration. The plant component has three status variables (actual evapotranspiration, Leaf Area Index and biomass) and represents plant growth and water uptake in soil. The soil component connects the water and plant components. It is linked to the soil water dynamics. The technical sub-system combines two components, one for each practice simulated: mowing and irrigation (Mérot *et al.*, 2008a). The decisional sub-system is divided into nine components, each corresponding to a decision rule. The decision process addresses the question of ‘do I mow or do I irrigate’, with an interactions between the decisions (Mérot *et al.*, 2008a). The links with the status of the biophysical sub-system is given by three indicators: the soil water deficit, the leaf area index, and the crop development stage. The decisional sub-system generates daily irrigation and mowing schedules for the entire season, which composes the technical sub-system.

The bio-decisional model IRRIGATE (Figure 1): The bio-decisional model IRRIGATE was built from the conceptual framework. It includes: (i) a dynamic decision model at farm scale (Mérot *et al.*, 2008a) simulating irrigation and mowing management, (ii) a dynamic crop model at field scale (Mérot *et al.*, 2008b) simulating plant and soil functioning in relation to water supply, and (iii) a hydraulic model at border scale (Mailhol & Mérot, 2008) simulating an irrigation event according to both the biophysical and the water distribution context. They are written as three independent and modular modules.

The conceptual framework helps us to structure cropping system models as a combination of a biophysical, technical and decisional system. It leads to a better delimitation of the three sub-systems, to a better description of their major interactions and it facilitates up-scaling and down-scaling. The same scientific investment is done for the analysis and the modelling of each sub-system. Compared to classical crop models, the representation of the biophysical system can be different when linked with the decision system. However, this conceptualization does not avoid three important difficulties of an integrative approach: (i) a higher complexity in the modelling process, (ii) generality and robustness of the integrative model, (iii) evaluation of the model.

References

- Le Gall, P.Y., *et al.*, 2007. Farming Systems design 2007. Sept 10-12, 2007, Catania.
- Mailhol, J.C. & A. Mérot, 2008. Irrigation Science 26(4): 289-302.
- Mérot, A., *et al.*, 2008a. Agricultural Systems 98: 108-118.
- Mérot, A., *et al.*, 2008b. European Journal of Agronomy 29: 163-174.

Modelling cover-cropped vineyards with APES: A modular simulation platform

A. Metay, C. Gary, E. Casellas, A. Ripoche, K. Kansou, J. Wery
Supagro UMR SYSTEM (Supagro, INRA, CIRAD), 2 Place Viala,
34060 Montpellier Cedex 2, France
Contact: metay@supagro.inra.fr

Introduction

Introducing a cover crop into vineyards is a recently introduced practice in wine production areas (Celette *et al.*, 2008) that provides a variety of environmental and agronomic services. For example, it reduces runoff and, therefore, soil erosion (Battany & Grismer, 2000; Le Bissonais *et al.*, 2004). In fertile zones, it can also inhibit the excessive vegetative development of grapevine that would be unfavourable to high quality wine production (Smart *et al.*, 1991) and favourable to fungal diseases. However, the risk of excessive competition for soil water between the intercrop and the grapevine has markedly limited the adoption of this practice in Mediterranean regions. As it is not easy to quantify the trade-off over long-term experiments, we have taken advantage of the APES simulation platform which was designed within the EU FP-6 SEAMLESS project (Van Ittersum *et al.*, 2008) to assess the agronomic performance and environmental impacts of these cropping systems. Specific components were developed for the simulation of cover cropped vineyards and evaluated with a field experiment database in south-eastern France.

Methods

Modelling APES (Agricultural Production and Externalities Simulator) is a field scale modular simulation system describing the soil-plant-atmosphere behaviour under specific climate and technical management conditions (<http://www.apesimulator.org/>). The concepts used in the simulation of biophysical processes are based on existing models and published studies. The main novelty is in the modular programming approach used in the model implementation. The simulation of cover cropped vineyards requires the use of both the Crop and Tree components, and of climate, soil and resource arbitration components.

In the Crop component, crop development depends on thermal time. Crop growth is based on radiation interception by green leaf area and its conversion into dry matter; the model simulates both potential growth and attainable growth, as affected by water and nitrogen limitations. Dry matter and nitrogen are partitioned between the growing organs on the basis of partitioning tables with fixed parameters for each phase of the crop cycle. Parameters and modelling approaches can differ according to the crop simulated; in the present study, the 'Winter barley' parameter set was used.

The Tree component is a generic perennial woody crop model that has been calibrated for grapevine. It simulates the vineyard growth, production and product quality. It is similar to the Crop component, with some additional features that are specific to woody crops. As vines are generally planted in rows, their canopy is heterogeneous, and so the Tree component converts the daily carbon increment into an increase in crown dimensions which then affect the light interception component (Pronk *et al.*, 2003). As woody crops are perennial, carbon and nitrogen can be stored during a crop cycle and used during the next one, particularly at budbreak (Castelan-Estrada, 2001). The Tree component calculates quality variables for fruit crops. For grapevine, the dynamics of fruit water and sugar contents depends on the thermal time during the second phase of berry growth (Ollat *et al.*, 2002).

Intercropping can be simulated in APES. The light interception component enables light to be partitioned between two crops (grapevine and barley in the present case). The water and nitrogen uptake components compute water and nitrogen demand in each soil layer in

proportion to the fraction of root from each crop that is present in the layer.

Field experiment The experiment (Celette *et al.*, 2008) was carried out from 2003 to 2006 on a vineyard (cv. Aranel/Fercal) near Montpellier (43°31' N-3°51' E). The climate is Mediterranean with a water deficit occurring from April to September i.e. from budburst to harvest. Soil was a deep and homogeneous clay loam with low organic matter and nitrogen content. Two treatments were studied: a vineyard on bare soil obtained with chemical weed control and a vineyard with a temporary intercrop of barley (*Hordeum vulgare* L.) sown between the rows in autumn, covering about 60% of the area and destroyed at grapevine flowering.

Results and discussion

The APES model adequately simulated grapevine phenology (not shown) and inter-annual variations of yield for vineyard on bare soil (Figure 1). Canopy development of grapevine was simulated with and without competition with barley (Figure 2). Cover cropping generated a depression of grapevine LAI, particularly during the dry summers of 2005 and 2006. The model also simulated a decreasing LAI for barley year after year, which was not observed in the field.

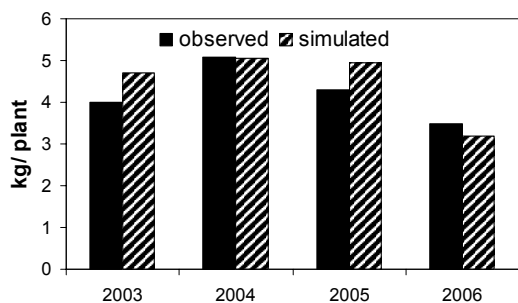

Figure 1. Fruit fresh yield (kg/plant) in a vineyard on bare soil, from 2003 to 2006.

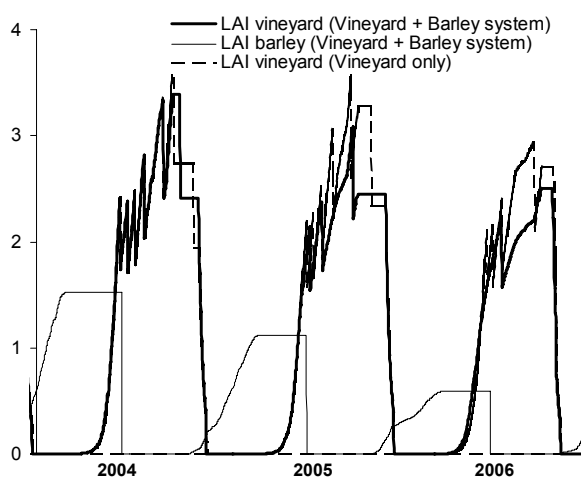

Figure 2. Simulated LAI of vineyard and barley for two treatments: vineyard only, vineyard and barley with water and nitrogen stresses.

These first results show that the setting of various components in the APES modular platform was fully functional for adaptation to a perennial plant intercropped with an annual crop and provided crop and soil outputs within realistic ranges of values. In the present research, the consequences for grapevine yield of inter-annual climate variability were correctly simulated. Competition for soil resources was simulated and generated trends of vegetative development that were qualitatively correct. Nevertheless, the effectiveness of the resource arbitration simulation should be explored in more detail particularly with respect to intercrop behaviour.

References

- Battany, M.C. & Grismer, M.E., 2000. *Hydrol. Process.* 14: 1289-1304.
 Castelan-Estrada, M., 2001. PhD Thesis INA Paris-Grignon, France, 121 pp.
 Celette, F., *et al.*, 2008. *Eur. J. Agron.* 29: 153-162.
 Le Bissonais, Y. *et al.*, 2004. *Agronomie* 24: 129-136.
 Ollat, N., *et al.*, 2002. *Journal International des Sciences de la Vigne et du Vin* 36: 109-131.
 Pronk, A., *et al.*, 2003. *Neth. J. Agric. Sci.* 51: 279-295.
 Smart, R.E., *et al.*, 1991. *South African Journal of Enology and Viticulture* 11: 3-17.
 Van Ittersum, M.K., *et al.*, 2008. *Agricultural Systems* 96: 150-165.

A systems approach to optimizing agronomic and economic performance of legume-based organic maize production

S.B. Mirsky, J.R. Teasdale, R.A. Mangum, M.A. Cavigelli, J. Maul, J.T. Spargo
10300 Baltimore Avenue, Bldg 001, Rm 117,
BARC-West Beltsville, Maryland, 20705, USA
Contact: steven.mirsky@ars.usda.gov

Introduction

Incentive-driven agricultural management practices (i.e., cover crop subsidy programs) that enhance nonmarket agro-ecosystem services could have long-term impacts on environmental stewardship as well as crop productivity (Boody & DeVore, 2006; REAP, 2007). Cover crops are a multi-functional management tool that can improve soil fertility, reduce soil erosion, sequester soil carbon, increase soil water infiltration and storage and suppress weeds. This multi-functional management practice can improve soil conservation, reduce nontarget pollutants, and decrease a cropping system's C footprint. There is interest in developing cover crop-based organic no-tillage (no-till) field maize (*Zea mays* L.) production systems which combine two different soil building strategies, organic farming and no-till farming. However, this management system has had limited success in achieving adequate crop yields, primarily due to the challenges in achieving adequate cover crop-based fertility and weed management. Weed suppression from natural levels (3,000-10,000 kg ha⁻¹) of cover crop surface residues has been incomplete (Mirsky *et al.*, 2007). When utilizing cover crops for weed suppression in reduced tillage and herbicide cropping systems, integrating multiple management tactics is necessary (Williams *et al.*, 1998). Coupling a new approach to cover crop surface residue management for organic no-till systems, the roller/crimper, with additional cultural and mechanical weed management tactics may increase the potential success of organic no-till field crop production. More information is also needed to determine how nitrogen (N) availability to maize in congruence with these weed management tactics would be affected by rolling versus ploughing and delaying maize planting dates. Therefore, the objective of this experiment was to evaluate how cover crop and weed management tactics in tillage and reduced tillage organic field maize production optimizes nitrogen availability, weed suppression, and maize performance.

Methods

This experiment was established on a certified organic field site in Beltsville, Maryland (United States). *Vicia villosa* Roth. was established in the fall and terminated in the spring with either a roller/crimper or by disking. Since *V. villosa* can only be killed adequately by rolling after flowering begins (Teasdale & Rosencrance, 2003), the cover crop was terminated on three dates by ploughing: early May (vegetative); mid-May (75% flowering); and late-May (early pod stage); and on two dates by rolling, mid- and late-May. Maize was planted 7 to 10 days after rolling or disking. A no management control and cultivation treatment (disked twice; rotary hoed twice; and sweep cultivated three times for tilled plots; and high residue cultivated no-till plots) was included for both tilled and no-till systems. Weed-free plots were included for each cover crop kill method by termination date treatment to assess the influence of treatment effects on maize in the absence of weed competition. Nitrogen availability and associated maize stress were determined by measuring: (1) N content of cover crop and maize; (2) soil mineral N content to a depth of 30 cm prior to significant soil mineralization in late March and when maize was at the V5 stage (i.e., pre-sidedress nitrate test); (3) maize ear leaf N; and (4) chlorophyll content of ear leaf. Weed and maize emergence patterns, weed and maize biomass, and maize population and grain yield were also measured. In addition, relative

water content and soil water content to a depth of 30 cm were assessed to estimate drought stress.

Results and discussion

Delay in cover crop termination increased maize yields due to higher levels of N availability compared to earlier termination dates. Delayed maize planting permitted more cover crop biomass production and N content, and greater available N for a succeeding maize crop. This response in *V. villosa* and the resulting influence on maize has also been demonstrated by other researchers (Clark *et al.*, 1994; Wagger, 1989). Despite no seed treatment or pesticide application, maize in the tilled system had a higher population density than in the no-till system. This is in contrast to the no-till system which had significantly decreased maize populations due to a seedling pest (i.e., *Delia platura* Mg.). Delay to the latest cover crop termination date reduced the effects of insect damage to the maize population. This was attributed, in part, to faster emergence and growth of maize due to warmer soil temperature. However, a delay in cover crop termination can also decrease crop available soil water due to increased evapotranspiration from the cover crop and increased heat units in the summer.

As expected, the ploughed maize had superior weed control. However, delays in cover crop termination resulted in greater weed suppression for both tilled and no-tilled systems. The timing of cover crop termination also influenced the weed community structure. The effect of shifts in weed community structure on weed competitiveness and crop performance will be discussed. Structural equation models will be employed to determine the relationship between cover crop and weed management on maize agronomic and economic performance. Optimization of organic no-till maize agronomic and economic performance will require cropping system models that can integrate both the challenges of legume-based fertility, drought stress, and pest management.

References

- Boody, G. & B. DeVore, 2006. *Bioscience* 56: 839-845.
- Clark, A.J., *et al.*, 1994. *Agon. J.* 86: 1065-1070.
- Mirsky, S.B., *et al.*, 2007. In: 7th European Weed Research Society Workshop on Physical and Cultural Weed Control. Salem, Germany.
- REAP, 2007. Resource Enhancement and Protection Act of Pennsylvania.
<http://www.cbf.org/REAP>. (accessed 8 Nov. 2007).
- Teasdale, J.R. & R.C. Rosencrance, 2003. *Amer. J. Altern. Agric.* 18: 95-102.
- Waggoner, M.G., 1989. *Agron. J.* 81, 533-538.
- Williams, M.M., *et al.*, 1998. *Weed Sci.* 46: 595-603.

Development of generic management rules for crop growth simulation models

R.J. Oomen, H. Hengsdijk, O. Therond, J.E. Bergez, G. Russell, E. Casellas,
S. Janssen, M.K. Van Ittersum
Wageningen University, Haarweg 333, 6709 RZ Wageningen, The Netherlands
Contact: Roelof.Oomen@wur.nl

Introduction

Crop growth simulation models are powerful tools for assessing the effects of management practices or policy changes on the environment and agricultural production (Van Ittersum & Donatelli, 2003). Assessments can be made at a very fine scale, e.g., for one farm, or at a much coarser scale, e.g. assessing the impacts of the implementation of the Water Framework Directive on European agricultural systems. These models simulate the behaviour of crops or cropping systems taking into account soil, climate, agro-management and crop characteristics. An example of such a model is the Agricultural Production and Externalities Simulator (APES; Donatelli *et al.*, 2009), which allows entire crop rotations to be simulated taking into account the specific characteristics of such systems. Whatever the scale of the assessment, the usually large data demands of these cropping systems models have to be met. Obtaining the required input data becomes a challenge when cropping systems models are applied to assessments for large and heterogeneous areas such as Europe. Soil and daily climate data are available from the European databases assembled by the Joint Research Centre of the European Union. However, little detailed data is available on the management of crops, i.e. the timing, amount and type of input used and the application method. This agro-management information refers to all operations relevant for crop production, for example tillage, sowing, fertilization and irrigation (crop protection is not taken into account). Surveys aimed at collecting detailed management information are cumbersome as they require the involvement of many experts and they only provide average information on agro-management that is in fact flexible and variable in practice as it depends on factors associated with soil, climate and crop conditions.

In this paper, we describe an approach that has been applied to generate agro-management information for 21 crops and 19 regions in the EU on the basis of 'easily-obtainable' survey data and generic expert rules. We compare this agro-management information with detailed agromanagement information from a survey carried out in four EU regions. This research has been conducted within the SEAMLESS project (Van Ittersum *et al.*, 2008).

Methodology

Two surveys were carried out, one for collecting detailed agro-management information for crops grown in four EU regions, and one for collecting more general and easy-to-obtain information on agro-management in 19 regions (Borkowski *et al.*, 2007). The detailed survey contains data on crop sequence (i.e. rotations) and inputs, outputs and timings of all management operations. The simple survey has crop sequence data combined with aggregate agro-management data and inputs and outputs, and provides only the average timing of sowing.

Both in the detailed survey and in APES, management events are defined as the combination of a timing rule, governing when the event takes place, and an 'impact', describing the agro-management operation (Donatelli *et al.*, 2006). These operations are grouped into tillage, irrigation, fertilization, crop protection and sowing/planting and harvesting. Timing rules can be based on actual observed dates or on (a combination of) biophysical conditions like rainfall, plant available water (PAW) in the soil, crop phenological stage, etc.

The crop experts amongst the authors of this contribution developed a set of generic agro-management rules and operations for management events that allow simple survey data to be transformed into APES compatible inputs.

Results and discussion

The simple agro-management data to be extended by these so-called ‘simple management rules’ consists of an average sowing week, fertilizer amount, and an irrigation amount and average number of irrigation events. When converted, the result is a set of two tillage events, a sowing and a harvesting event, zero to four fertilization events and an irrigation rule triggering the specified number of irrigation events.

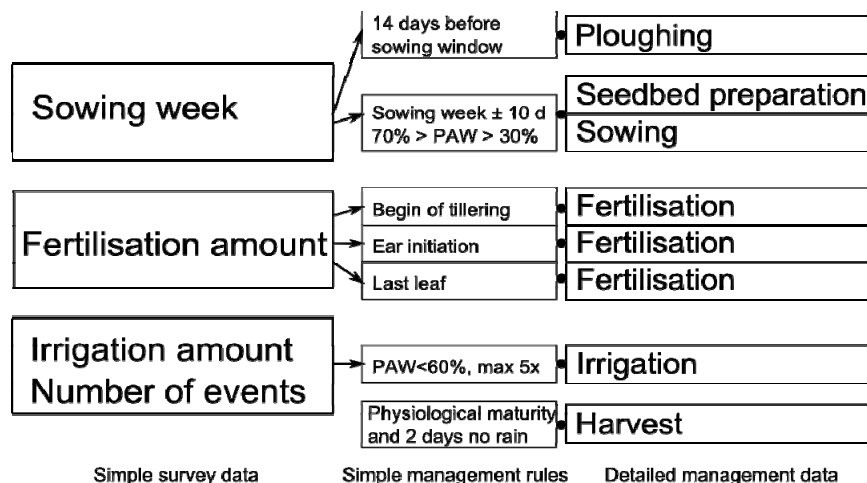

Figure 1. Example of the application of simple management rules to wheat agro-management.

The generated detailed agro-management has been compared to the surveyed detailed agro-management from a number of sample regions and the simple management rule parameters were tuned such that they result in the best matching agro-management in most cases. For further tuning of the rule parameters we compare simulations of both types of detailed agro-management, i.e. surveyed and generated, in terms of both yields and externalities.

Conclusions

Using crop growth simulation models with little information on crop management poses a big challenge for coarse scale applications. However, given easily obtainable management data we developed a consistent and generic set of rules summarizing agricultural knowledge. These rules can then be used to generate detailed event-based agro-management for regions where such information is lacking (see Casellas *et al.*, 2009). The generated agro-management data are evaluated as to their suitability for using in a coarse scale application for answering research questions at, e.g., country or continental level.

References

- Borkowski, N., *et al.*, 2007. In: Eds M. Donatelli *et al.*, Farming Systems Design 2007. Int. Symposium on Integrated Analysis of Farm Production Systems. Catania, Italy.
- Casellas, E., *et al.*, 2009. AgSAP Conference 2009, these proceedings.
- Donatelli, M., *et al.*, 2006. Proceedings of the iEMSS 2006 Conference, Vermont.
- Donatelli, M., *et al.*, 2009. In: Eds F. Brouwer & M.K. Van Ittersum, Springer Academic Publishing, Dordrecht. (forthcoming)
- Van Ittersum, M.K. & M. Donatelli, 2003. Eur. J. Agron. 18: 187-394.
- Van Ittersum, M.K., *et al.*, 2008. Agricultural Systems 96: 150-165.

Crop rotation modelling for integrated environmental assessment: Case study results and empirical evidence

Martin Schönhart, Erwin Schmid, Uwe A. Schneider, Peter Liebhard
Department of Economics and Social Sciences, BOKU Vienna,
Feistmantelstrasse 4, 1180 Vienna, Austria
Contact: martin.schoenhart@boku.ac.at

Introduction

Crop rotations are commonly regarded as an important factor for the sustainability of agricultural systems (Ball *et al.*, 2005). They influence environmental quality (e.g., soil, water), the utilization of natural resources, and the aesthetics of agricultural landscapes. Furthermore, they are a common way of managing risks on the farm and are the consequence of farmers' decision making. Integrated agricultural land use models increasingly acknowledge the role of crop rotations in assessing the economic and environmental impacts of agricultural production systems. However, since empirical data on crop rotations are usually not, or hardly, available, different types of crop rotation model have been developed. The software tool ROTAT (Dogliotti *et al.*, 2003) for example has been developed to provide all possible combinations of crop rotations from a given set of crops and according to agronomic criteria. Similarly the rule-based model ROTOR (Bachinger & Zander, 2007) generates agronomically sustainable crop rotations taking into account plant nutrition, weed infestation and phytosanitary effects. Detlefsen & Jensen (2007) developed a network flow model to find optimal rotations by maximizing the gross margins for each sequence of crops. Constraints are the shares of crops to be modelled in the year of interest. El-Nazer & McCarl (1986) developed a procedure for the identification of optimal long-run crop rotations to be integrated into linear programming (LP) models. In their study, empirical data on the economic effect of crop sequences was derived from regression analysis. While the first example considers (only) agronomic criteria in delineating crop rotations, the latter two generate optimized rotations based on gross margins derived from empirical data.

Here, we present the crop rotation optimization model CropRota that integrates agronomic criteria and historical crop mixes at farm or regional scales. CropRota is validated against seven years of field survey data from an Austrian farm.

Methods and data

CropRota is a linear optimization model that derives optimal crop rotations from observed crop mix data. Crop mix data are relative shares of crops on a farm, region, or any other spatial unit in a time period. A crop rotation cross ('Fruchtfolgekreuz') serves as a value point matrix ranging between 0 and 10 points. It provides agronomic judgments about all available pre-crop – main crop sequences. Judgments are ranging from 'agronomically impossible' (0 points) to 'highly recommendable' sequences (10 points). This value point matrix is maximized in CropRota using six decision variables that contain the optimal sequence of crops indexed by one to up to six crop sequences per rotation. The decision variables also provide the relative shares of the crop rotations based on the observed or statistical crop mixes, which are used as constraints. Therefore, this procedure implicitly integrates economic relationships. Consequently, one can construct the crop mix by using crop rotations and their relative shares. CropRota currently considers more than 30 crops. Further constraints can be implemented to restrict prohibitive crop combinations and sequences in a rotation, e.g., a limitation on the frequency of sugar beet, potatoes or rape seed to one year in four in a rotation.

In this preliminary analysis, we apply CropRota to a crop farm in Lower Austria. The model was validated by comparing the model output with observed crop sequences in the

fields of the farm between the years 2001 and 2007. In this period, 10 different crops were grown in 28 fields occupying 42.5 ha in total. For the final analysis we will validate CropRota using the same type of data from several hundred farms, which have been made available recently.

Results and discussion

Two approaches A and B have been assessed. In approach A, crop rotations for each single year were modelled based on annual crop mixes. In B, one average crop mix was calculated for the years 2001 to 2007. In approach A, CropRota derived 26 different crop rotations with two to six crop sequences. In approach B, 10 crop rotations were identified. To validate the model we compare the frequencies of observed and modelled two-crop sequences.

In Figure 1 such a comparison between observed and modelled outcomes is shown for likely crop sequences with sugar beet (SBEET) and winter wheat (WWHEAT). For example, corn silage (SILCORN) follows sugar beet (SBEET) on about 2% of the total farm land. For most cases, annually modelled crop rotations (approach A) are closer to the observed crop sequences than in approach B. Furthermore, the assumption of constant annual crop mixes as well as the restrictions on the frequency of certain crops (e.g., sugar beet) in a rotation have proven to be acceptable for this farm.

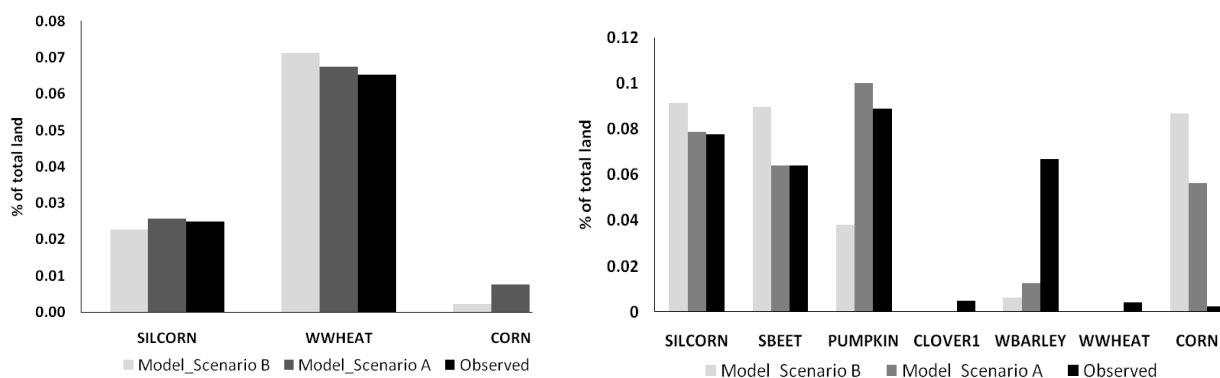

Figure 1. Comparison between model and empirical results on crops following SBEET (left) and WWHEAT (right).

The pilot case study application of CropRota to a single farm and some simple model validation exercises show the potential of CropRota as a valuable tool for identifying likely crop rotations. These crop rotations provide important information for biophysical process models and economic land use optimization models, which are increasingly used to jointly assess economic and environmental impacts of alternative agricultural systems.

References

- Bachinger, J. & P. Zander, 2007. *Eur. J. Agron.* 26: 130-143.
 Ball, B.C., *et al.*, 2005. *Can. J. Soil Sci.* 85, 557-577.
 Detlefsen, N.K. & A.L. Jensen, 2007. *Agric. Syst.* 94: 566-572.
 Dogliotti, S., *et al.*, 2003. *Eur. J. Agron.* 19: 239-250.
 El-Nazer, T. & B.A. McCarl, 1986. *Amer. J. Agric. Econ.* 68: 127-136.

Implications of heterogeneous urinary-N return for modelling pasture production and N losses from grazed pastures under climate change

V.O. Snow, M. Lieffering, B.R. Cullen, I.R. Johnson

AgResearch – Grasslands Research Centre, PB 11-008, Palmerston North, New Zealand

Contact: Val.Snow@agresearch.co.nz

Introduction

Urine excretions in grazed systems cover only a few percents of the paddock area during any one grazing resulting in very high N concentrations, 500–1000 kg N ha⁻¹, in urine-affected areas of the paddock. These areas are the primary source of leaching and are also important in denitrification processes. Previous work (Snow *et al.*, 2008) concluded that the non-linearities in the processes that contributed to leaching necessitated an explicit representation of urine patches in the model, but that simpler uniform urine return models could adequately simulate pasture production and N fixation. Here, we reconsider that conclusion in the context of climate change simulations and examine the effect of climate change on pasture species composition and on N₂O emissions.

Methods

EcoMod is a dynamic biophysical simulation model (Johnson *et al.*, 2008) with a simulation option that allows heterogeneous urine return (Snow *et al.*, 2008). Two soil types were simulated; a clay loam and a sand with plant available soil water of 210 and 100 mm respectively to 1 m deep. Under current climatic conditions, Manawatu, New Zealand is on the ecotone of C₄ occurrence in pasture. A pasture species mix of a C₃ grass (perennial ryegrass), a legume (white clover) and a C₄ grass (Paspalum) was set up in the model. The mix of the three species responded dynamically to the growing conditions, changing within and between simulations. Every 28 days the pasture was grazed. At each grazing 15% of the ingested N was removed from the simulation to mimic export in animal production. The remaining nutrients were partitioned between dung and urine according to the algorithm in Johnson *et al.* (2008). Dung was returned uniformly to the paddock. For each soil type and climate change scenario, simulations were run with the urine returned heterogeneously to 2% of the paddock at each grazing (Het) or returned uniformly over the paddock (Uni).

Three climate scenarios were simulated. The base '2000' scenario was obtained for the period 1972 to 2007 for the Manawatu climate (New Zealand, 40.35 °S 175.61 °E). Average air temperature was 13 °C (ranging between monthly averages of 4.3 °C in July and 22.3 °C in January). Annual rainfall was 951 mm/yr distributed evenly through the year and had low variability with 740 and 1201 mm yr⁻¹ in the driest and wettest years, respectively. Two climate change scenarios were simulated based on the 'A1B' projection (MfE 2008). The '2030' scenario was for a 0.7 °C increase in temperature and a 10% increase in rainfall. The '2080' scenario was a 2.1 °C increase in temperature and a 20%

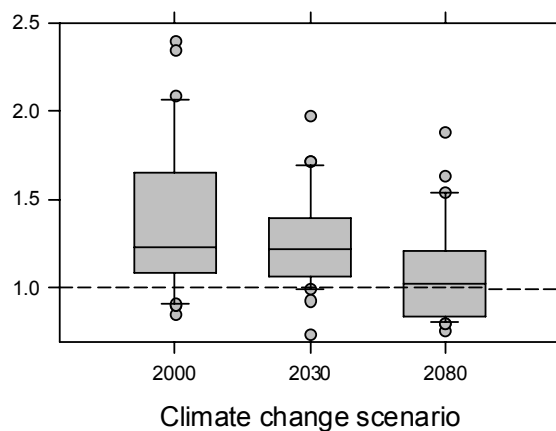

Figure 1. Box-whisker plots showing the ratio between modelled N₂O denitrification by the Het model and the Uni model for the clay loam soil. The dashed line indicates the ideal 1:1 ratio.

increase in rainfall. The values quoted are the annual averages and actual changes varied by season as described in MfE (2008) and were supplied to the model by modifying the weather file.

Results and discussion

The differences between N leaching modelled by the Het and Uni assumptions (data not shown) were so large that it was not possible to correct a Uni model to appropriately simulate leaching in a grazed system. The ratio between N₂O emission modelled by the Het and Uni assumptions for the scenarios on the clay loam soil are shown in Figure 1. The moderate variation and skew in the ratio for the '2000' scenario, compared to values for leaching shown by Snow *et al.* (2008), suggests that provided year-to-year variation is not very important the effect of urine patches on modelled denitrification can probably be corrected by a rate parameter change. However different corrections would be needed for different soil types (data not shown here) and for different climate change scenarios (Figure 1). For example, if a Uni model was calibrated to give appropriate results it would overestimate N₂O emission for the '2080' scenario by some 25%. A model with uniform urine return might also be inappropriate when simulating mitigation measures directed at N₂O emissions in grazed systems.

There is a clear separation caused by climate change scenario with greater C4 dominance in the '2030' and '2080' scenarios than the base '2000' scenario (Figure 2). However spreading the urine uniformly over the entire paddock suppressed the increase in the contribution of white clover in the '2030' and '2080' scenarios to the species mix. There was a similar effect on pasture protein concentration (data not shown). Other results showed that there were relatively minor differences between the Het and Uni models for drainage and intake but larger differences for N fixation.

These results suggest that, in grazed systems, a model used to assess the impacts of climate change should include an explicit representation of urine patches. With the later climate change scenarios pasture N concentration declined and so did the concentration of N in the urine patches. However, the concentrations were still too high to allow reasonable simulation of leaching, denitrification or pasture species mix with a model assumption of spatially uniform return of urine.

References

- Johnson, I.R., *et al.*, 2008. Aust. J. Exp. Agric. 48: 621-631.
 MfE, 2008. Climate change effects and impacts assessment. Ministry for the Environment, Wellington. xviii + 149 p. (www.mfe.govt.nz/publications/climate/climate-change-effect-impacts-assessments-may08)
 Snow, V.O., *et al.*, 2008. Aust. J. Agr. Res. (in review)

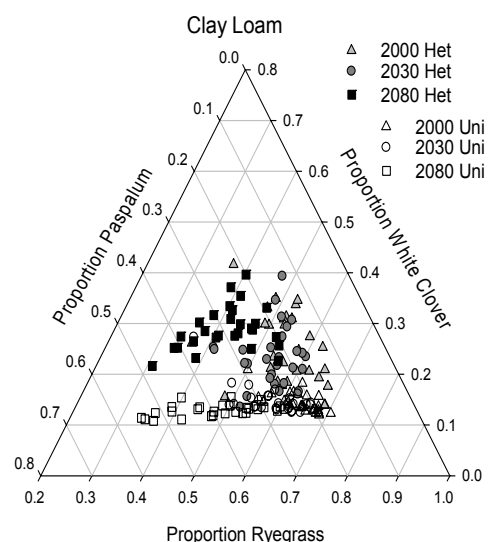

Figure 2. Ternary diagram showing the effect of heterogeneity assumption and climate change scenario on pasture species mix. Only the clay loam data are shown.

The interaction between sub-optimally available resources for crop production as implemented in the simplified model FIELD

P. Tittonell, M. Corbeels, K.E. Giller

PPS, Wageningen University, P.O. Box 430, 6700 AK Wageningen, The Netherlands

Contact: pablo.tittonell@cirad.fr

Introduction

Crop production in the tropics, and particularly in sub-Saharan Africa (SSA), takes place under sub-optimum conditions in terms of resource availability. FIELD (Field-scale resource Interactions, use Efficiency and Long-term soil fertility Development) is a simplified model of the cropping system developed with the primary aim of simulating interactions between sub-optimally available resources (light, water, nutrients, labour) determining short term responses and long term trends in crop productivity within smallholder farms (Tittonell *et al.*, 2007, 2008). The model simulates crop responses to applied and/or available nutrients (N, P, K), considering the agro-ecological potential and climatic variability of a certain site, the heterogeneity in soil fertility within the farm, and keeps track of changes in soil carbon and nutrient stocks in time. Central to the calculation of crop yields is the simulation of the interaction between water, N, P and K. Such interactions are represented following the concepts used in the model QUEFTS (Janssen *et al.*, 1990) but expressed in a generic rather than empirical way to be able to perform dynamic, long term simulations. This allows an implementation of a ‘Liebscher’ approach – where the effect of one limiting resource acts by reducing the efficiency with which another resource is used – rather than a ‘von Liebig’ type of function. Here, we illustrate this by showing how the interaction between nutrients taken up by a crop are simulated in FIELD, with a few examples from SSA.

Resource availability, interactions and crop response

The approach taken in FIELD is represented with the 3-quadrant diagram of De Wit & Van Keulen (1987) but including a fourth quadrant: resource availability (Figure 1). Nutrient inputs to the soil (e.g., applied fertilizers or manure) may become more or less available depending on their form, timing and placement, and on the characteristics of the soil/landscape where the crop grows (the $Av_0 - Av_I$ range); e.g., applied/available nutrients may be temporarily or permanently ‘lost’ in P-fixing red soils or by N leaching in sandy soils. The ability of the crop to intercept and take up the available nutrients depends on root architecture and activity (the $In_0 - In_I$ range), and together with the previous quadrant they determine nutrient capture efficiency. Nutrients taken up are ‘converted’ into crop biomass with an efficiency that is the inverse of the average nutrient concentration in different plant parts (Co_0 and Co_I represent their maximum concentration and dilution, respectively). The conjunction of these effects leads to different patterns in the observed response of crops to nutrient inputs (R_{T1} , R_{T2} and R_{T3}), which determine the agronomic result or input use efficiency. The ability of a crop to convert resource

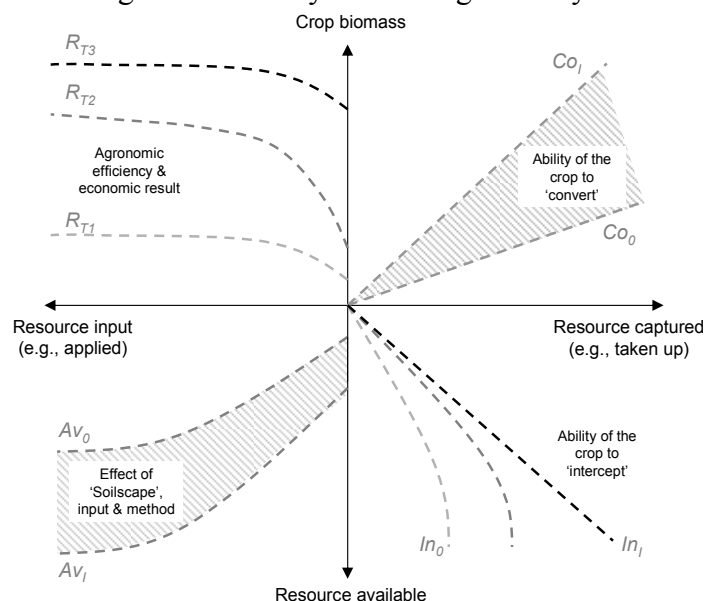

Figure 1. Four-quadrant diagram (see text).

A into biomass depends on the availability and uptake of resources B , C , etc. (Figure 1 upper-right quadrant). For example, the N conversion efficiency (NCE) of tropical maize varies between 60 and 170 kg DM kg N⁻¹ taken up (based on maximum and minimum N concentrations in plant); even when N is in ample supply, poor P availability or limited water supply will lead to a relative ‘concentration’ of N in the plant (i.e., a poorer NCE). In the model FIELD, the maximum NCE (or maximum dilution of N in plant) is corrected for the availability of P and K; similarly, the maximum P conversion efficiency is corrected for N and K; etc. These correction factors (CF) are calculated by relating the availability of the balancing nutrient to its target value, which is derived from the product of the water-limited production level and its average concentration in the plant.

N and P use efficiencies within heterogeneous smallholder farms – an example

The response to nutrient applications by crops growing on smallholder farms is highly variable. On-farm research trials are conducted to analyse the origin and magnitude of such variability and evaluate nutrient management strategies for improved crop productivity. Figure 2 corresponds with the upper-right quadrant in Figure 1 and was built with data from multi-locational on-farm trials in Kenya (Ky) and Zimbabwe (Zb) (Vanlauwe *et al.*, 2006; Zingore *et al.*, 2007), and with simulated data using the simple FIELD approach as described above.

The prediction of crop yield across fields with different soil types and history of management, receiving varying doses of N, P and K as organic and/or mineral fertilizers was satisfactory (RMSE 2.2 and 1.2 t DM ha⁻¹, Ky and Zb), as was the prediction of N uptake (RMSE 22 and 30 kg N ha⁻¹, Ky and Zb) (data not shown). The prediction of NCE was within the range of measurements at both locations (Figure 2), but in the case of Kenya the model tended to underestimate NCE. This could be due to an overestimation of water stress in FIELD, which would require simple calibration against data from different seasons and/or locations.

In conclusion, a generic approach to nutrient interactions allowed us to capture the variability in crop responses observed in the field, as a result of spatial soil heterogeneity (both inherent and due to past management), rainfall variability and/or poor agronomy. These factors affect nutrient use efficiency operating mostly on the efficiency of nutrient capture (Tittonell *et al.*, 2007). A simple model with few parameters, adapted to the data-scarce environments of SSA, is a useful tool for *ex-ante* assessment of the impact of soil fertility management interventions. This is of particular importance in light of the major investments in soil fertility planned for SSA (e.g., www.agra-alliance.org).

References

- De Wit, C.T. & H. Van Keulen, 1987. *Geoderma* 40: 253-265.
 Janssen, B.H., *et al.*, 1990. *Geoderma* 46: 299-318.
 Tittonell, P., *et al.*, 2007. *Field Crops Res.* 100: 348-368.
 Tittonell, P., *et al.*, 2008. *Agron. J.* 100: 1511-1526.
 Vanlauwe, B., *et al.*, 2006. *Nutr. Cycl. Agroecosyst.* 76: 171-182.
 Zingore, S., *et al.*, 2007. *Field Crops Res.* 101: 296-305.

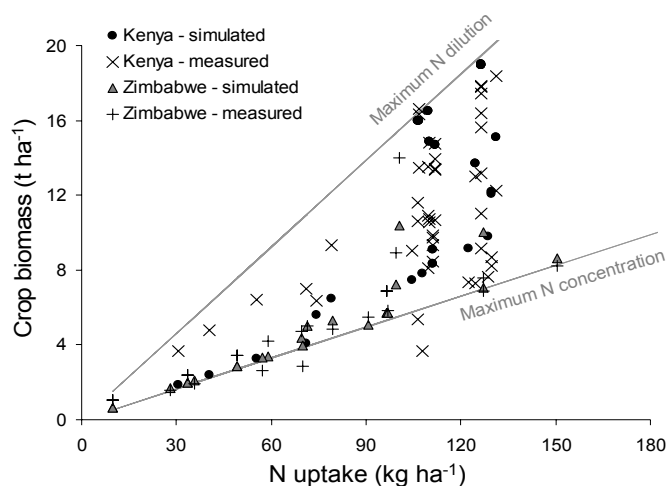

Figure 2. Simulated and measured N uptake and crop biomass (see text for explanation).

The effect of conservation agriculture practices in Europe

M. Van der Velde, F. Bouraoui, P. Prospero, J.M. Terres, B.S. Elbersen
IES-Joint Research Centre of the European Commission,
Via Fermi 2749, 21027 Ispra (VA), Italy
Contact: marijn.van-der-velde@jrc.it

Introduction

The Common Agricultural Policy (CAP) is increasingly aiming at enhancing the sustainability of agro-ecosystems while responding to the sustained demand for quality and reliable food production. Environmental requirements such as cross compliance are part of the policy instruments available to address the integration of environmental concerns into the CAP. We wish to assess the potential environmental benefits of adopting conservation agriculture practices and adopting standards of good agricultural and environmental condition. Ideally we wish to identify those regions in Europe where the adoption of conservation farming and/or soil conservation practices would have the biggest potential benefits for the environment. At the same time we aim to study if trade-offs exist between conservation and production through the modification of plant-soil-water interactions in the agricultural system.

Methods

We used a pan-European spatialized version of the EPIC model (Williams, 1995) that runs on a 10 by 10 km grid with relevant meteorological, land use, terrain, soil and management information (Figure 1). Daily meteorological data were obtained from JRC's MARS climatic database given on a 50 by 50 km grid, land use information was obtained combining satellite land cover data (CORINE 2000) and farm structure survey statistics on crop areas (Grizzetti *et al.*, 2007), digital terrain information was derived from SRTM (Shuttle Radar Topographic Mission), soil data were obtained from the European Soil Bureau Database (ESBD 2.0) and sowing dates were determined using a potential heat units programme (for more details see Williams, 1995; Bouraoui & Aloe, 2007; Van der Velde *et al.*, 2008). This approach allows us to include relevant soil functions such as water storage capacity in evaluating environmental responses to changes in crop management practices.

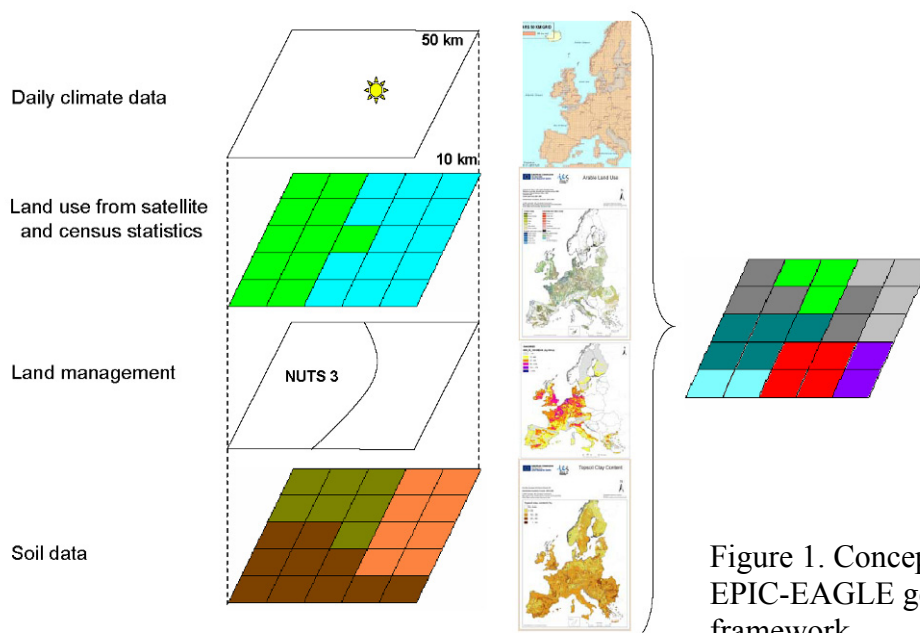

Figure 1. Conceptual design of the EPIC-EAGLE geospatial modelling framework.

We consider the environmental effects of no-till and the introduction of a cover crop (clover) in respectively barley and maize. The no-till scenario is compared to conventional tillage under barley. The cover crop scenario is compared to irrigated and non-irrigated maize without the growth of the cover crop during winter months. Currently, the EPIC-EAGLE is set-up so that plant nutrient requirements are satisfied by chemical NO₃-N application. This may be interpretable as a form of optimal precision fertilizer management.

Results and discussion

We emphasize that the simulation results should solely be used as indications, and should be used along with other information to come to informed policy decisions. Our modelling results indicate that no-till practices will be effectively reducing erosion across Europe compared to conventional tillage practices. Modelling does not reveal any significant differences in yield between tilled and non-tilled barley. Also, crop water stress is not very different. Largest reductions in soil loss are obtained in areas with steeper slopes and/or high annual precipitation rates such as the north west of Spain. In absolute terms low-lying areas, such as the Netherlands, benefit much less from no-till practices. The reduction of erosion also leads to lower N transported with runoff. Nitrate leaching and fertilizer use are fairly similar between the no-till scenario and the reference.

Preliminary results indicate that the introduction of a cover crop leads to a reduction of erosion under non-irrigated maize over most of Europe, although certain parts experience a slight increase in erosion (~20%). Modelled yields are lower when a clover cover crop is grown in the winter months. The explanation is given by the increase in water stress that generally occurs at the start of the maize growing season associated with soil moisture depletion by cover crop water use in early spring. Soil moisture depletion by the cover crop potentially is a problem if rainfall in the month previous to maize sowing is not sufficient to replenish soil moisture in the root zone. Similarly, reduced soil moisture leads to smaller maize cover and thus a larger exposure of bare soil and subsequent increases in erosion that may not be off-set by the reduced erosion in the winter months. The model results suggest that a trade-off may exist between lowering erosion and increasing water stress (decreasing yields) when using a cover crop in water-limited environments. Modelling further suggest that if a slight increase in water stress is allowed, for example determined by a minimal reduction in yields <0.25 ton ha⁻¹, erosion will be substantially reduced across Europe when using a cover crop in non-irrigated maize.

References

- Bouraoui, F. & A. Aloe, 2007. European Agrochemicals Geospatial Loss Estimator: Model development and applications. EUR – Scientific and technical research series, 22690, Office for Official Publications of the European Communities, Luxembourg, 118 pp.
- Grizzetti, B., *et al.*, 2007. Spatialised European nutrient balance. EUR – Scientific and Technical Research series, 22692, Office for Official Publications of the European Communities, Luxembourg, 98 pp.
- Van der Velde, M., *et al.*, 2008. Global Change Biology 14: 1-14.
- Williams, J.R., 1995. In: Ed. V.P. Singh, Computer models of watershed hydrology. Water Resources Publications, Littleton CO, USA, pp. 909-1000.

Disclaimer: The statements expressed here are purely those of the authors and may not in any circumstance be regarded as stating an official position of the European Commission

Toward gene-based crop simulation models for use in climate change studies

Stephen M. Welch, Amity Wilczek, Judith L. Roe, Brooke Moyer, Martha Cooper, Johanna Schmitt, Sanjoy Das, Praveen Koduru, Xinye Cai
Kansas State University, Department of Agronomy, Manhattan KS 66506, USA
Contact: welchsm@ksu.edu

Introduction

Several lines of reasoning point toward the urgent need to develop crop simulation models that are more firmly grounded in genetics than those that are currently available. For example, current general climate models are including increasingly realistic plant physiology in their descriptions of land surface processes (e.g., Foley *et al.*, 1996). These sub-models do allow the distribution of plant types to change under the impact of competition, but they make no provision for changes in life history or physiology due to natural selection. However, Ward *et al.* (2000) has shown that CO₂ itself can act as a selection agent leading, in as few as five generations, to earlier flowering plants with reduced final biomass. Even without the onus of climate change, both commercial and private breeders are under increasing pressure both to shorten product development cycles and/or to develop genotypes with prescribed characteristics. Molecular genetics, in principle, has the potential to meet this need. A major difficulty, however, has been interrelating features at the gene level with desired, environmentally-influenced endpoint phenotypes – the genotype-to-phenotype (G2P) problem (Cooper *et al.*, 2002). These two issues converge when one considers that, on the scale of the North American Prairie, changing crop physiology has the power to alter climate at the same time that changing climate is altering the target population of environments for plant breeders.

Methods

We believe that the G2P problem is best solved using a two-pronged approach that seeks to build from molecular levels toward physiology, while simultaneously exploiting physiological information to augment research at the genetic level. Tardieu (2003) and Tardieu *et al.* (2005) identified a class of models they termed *genetic meta-mechanisms* which, to us, constitute the proper common meeting ground. These models capture the underlying behaviour of the genetically-controlled processes without necessarily incorporating all of the detail. Specifically, they said these models should meet two criteria:

1. Models should reproduce phenotypes in a wide range of environments;
2. Model constants that were asserted to be genotypic properties should associate with defined genomic regions in a manner independent of the environments in which measurements were made.

The first criterion corresponds to standard goodness-of-fit tests long applied to crop models. The second, however, mandates that to be considered as ‘gene-based’, one should be able to show, either by reference to specific genes or at the resolution of association mapping studies, that (i) there are or are likely to be gene(s) that control the properties that a given constant parameterizes and (ii) that the values that the constant takes in different lines do not result from detectable $G \times E$ effects. Stated in the usual vernacular of crop modelling, ‘genetic coefficients’ that take on different values in different environments constitute prima facie evidence of some invalidity, which may be in the model itself or in the measurement of environmental data used to drive it (Welch *et al.*, 2002).

To meet the needs alluded to in the introduction, there is a third criterion which should be explicitly added:

3. Models should be able to reproduce the results of selection.

For plant breeders, this equates to models that predict the phenotypes of offspring from the genetics of the parents. The model of Reymond *et al.* (2003) meets this test. In the broader context, it means that one should be able to predict the evolution of phenotype from a knowledge of the genotypes present (natural variation), the progression of environments, and the relationship of phenotype to fitness, and the selection gradients. Classical quantitative genetics has been seen to fail this test by overestimating the response to selection (Coors, 1999).

Results and discussion

We present two studies that move in the directions just described. In the first, a classical photothermal model of flowering time was linked to the known underlying genetic network of *Arabidopsis thaliana* (Wilczek *et al.*, 2009). The model was parameterized with literature data and phenotypic measurements from several mutant lines planted in common gardens from Valencia, Spain, to Oulu Finland. The model was independently verified from a combination of growth chamber studies and repeated-planting field data. The model reveals a narrow window in late summer when flowering times become exquisitely sensitive to germination date and rapid cycling life histories transition into winter annuals. This has significant consequences for patterns of selection. The model also has been used to characterize 206 natural accessions and suggests a possible genetic trade-off wherein slowed short day development rates limit premature flowering at high latitudes in lines with lower chilling requirements. Because of its exceptionally low computational requirements this model would be directly usable within general climate models.

None of the three criteria above constrain the mathematical forms that might be used for gene meta-mechanisms, so they might, in fact, be networks. The second, *in silico* study uses genetic programming and particle swarm optimization methods to extract plausible network structures from synthetic phenotype and gene expression data generated by a known network (Cai *et al.*, 2009). The best networks found had structural features that were reminiscent of the true network. Although the actual network structure was not recovered, all three of the above criteria were met, including the critical third one. This shows that partial or only partially correct network structures can serve useful roles in crop simulation.

Between them, these two studies illustrate the dual G2P & P2G approach that we feel is the way forward to truly gene-based plant simulation.

References

- Cai, X., *et al.*, 2009. Int. J. Bioinformatics Res. and Appl. (in press)
- Cooper, M., *et al.*, 2002. In Silico Biol. 2: 151-164.
- Coors, J.G., 1999. In: Eds J.G. Coors & S. Pandey, The genetics and exploitation of heterosis in crops. ASA-CSSA-SSSA, Madison, Wisconsin, USA, pp. 225-245.
- Foley, J.A., *et al.*, 1996. Global Biogeochemical Cycles 10: 603-628.
- Reymond, M., *et al.*, 2003. Plant Physiology 131: 664-675.
- Tardieu, F., 2003. Trends in Plant Science 8: 9-14.
- Tardieu, F., *et al.* 2005. Australian Journal of Agricultural Research 56: 937-946.
- Ward, J.K., *et al.*, 2000. Oecologia 123: 330-341.
- Welch, S.M., *et al.*, 2002. Trans. ASAE 45: 1163-1175.
- Wilczek, A., *et al.*, 2009. Science. (under review)

Theme B
State-of-the-art of components for integrated systems

Session B4: Bio-economic farm modelling

Session organizers:

Guillermo Flichman
IAMM, Montpellier, France

Pytrik Reidsma
Wageningen University, The Netherlands

Some conceptual issues for modelling the interaction between agriculture and environment through the bio-economic mathematical programming models¹

G. Flichman, K. Louhichi
CIHEAM-IAMM, 3191 Route de Mende, 34093 Montpellier, France
Contact: flichman@iamm.fr

In the last years, there has been a significant development of bio-economic models, especially those integrating biophysical models (called also agronomic or cropping system models) and economic mathematical programming models. This development was enhanced by the conjunction of several factors such as the multiplicity of objectives in new agricultural policies, the increase of demand for multi-disciplinary approaches for integrated assessment, the call for more dialogue and cooperation between scientists from diverse disciplines. An important number of bio-economic models was developed and tested on different farming systems and under various agro-ecological conditions (Janssen & Van Ittersum, 2007). This rich body of literature on empirical applications of bio-economic models was not followed by a conceptual development related to this type of models. Indeed, there is not enough literature regarding the interaction between this models and the economic theory, their main interest compared to conventional economic approaches, their specifications and contributions in strengthening collaboration and improving integration between different disciplines.

The aim of this paper is to develop some conceptual and theoretical issues related to bio-economic models (principally the farm models) and to present the suitable way to use this type of approach for modelling the relations between agriculture and environment and more largely for the integrated assessment.

A bio-economic model is known generally as a linkage between models from different disciplines to provide multi-disciplinary and multi-scales answers to a given problem. In reality, the philosophy behind this approach is more complicated. A bio-economic model should not be a simple link between models through an exchange of information but a real integration in both conceptual and technical terms. This has twofold implications: first, we are facing a new approach which should have a clear position in the economic and agronomic theory corpus, and second, the construction of each model should take into account the specificity and the conceptual basis of the other. We try to better understand the economic theoretical issues behind the used mathematical programming models and also to present the main specifications that these economic models should have to ensure a consistent integration with the agronomic ones.

For modelling the relation between agriculture and the environment, economic theory has summoned up several approaches: the application of the standard micro-economic analysis (i.e. 'Environmental Economics'), the integration of original methods and tools based on the agent's revealed preferences into the conventional theoretical corpus (i.e. the so-called 'London School'), or the exploration of new methodologies and knowledge stemming from other disciplines in particular from Natural Sciences (i.e., Constanza & Daly, 1987). From this classification it appears at first sight that the bio-economic modelling method is a part of the *Ecological Economics* approach. However, as the bio-economic models are often based on optimization models it could also be possible to situate this method under the conventional economic theory (i.e., 'Environmental Economics'). The arguments behind each of both theses will be developed in detail in the final version of this paper.

Regarding integration, these models should have a set of specifications ensuring a consistent integration with the agronomic models. The first specification is the primal based

¹ Keynote presentation

approach: technology should be explicitly represented to deal simultaneously with biophysical and economic aspects and to quantify all the inputs and outputs associated to agricultural activities (i.e. production processes) in physical and economic terms. A dual based approach, based only on costs cannot fulfil these purposes.

The second specification is that the models should be *activity based*, what means that one product can be produced by several different activities¹ (Koopmans, 1951), and each activity produces several products. Each activity is defined by the technical coefficients that represent the use of inputs needed to produce one unit of output. What is important to stress for our purpose is the fact that all the basic information concerning production is related with activities and not with products. This characteristic allows taking into account the positive and the negative *jointness* (i.e., joint production, see Baumgärtner *et al.*, 2001) associated to the production process, and making a suitable integrated assessment of new policies which are mainly linked to activities and not to products.

The last specification is that the inputs and the outputs (including externalities) should be represented in *discrete forms* and expressed in transparent way (i.e., yield and cost functions per product are expressed as discrete functions) in order to make easily the integration with biophysical models and also to ensure that the impact of each input can be assessed separately with respect to the others. Indeed, the biophysical model provides a set of multi-inputs and multi-outputs production functions, which are unsuitable to be properly represented through continuous forms. Moreover, the complex problems related to non-linearity in the relation between agricultural production and environment can not be expressed easily or at all applying 'well-behaved' functional forms.

All these specifications are illustrated in the Farm System Simulator (FSSIM) developed within the EU FP6 SEAMLESS project (Van Ittersum *et al.*, 2008). FSSIM is a bio-economic model simulating farm level behaviour given a set of biophysical, socio-economic and region-specific policy constraints, and its responses to technological innovations and policy changes. It is a primal based approach to account for selected positive and negative jointness in outputs associated with the production process. FSSIM is based on discrete production functions and a limited number of externalities functions which are expressed in physical terms (Louhichi *et al.*, 2007). These specifications enable FSSIM to directly explore the impacts of some policy changes not only on the relationship between market and non-market goods, but also on the production process itself.

References

- Baumgärtner, S., *et al.*, 2001. *Ecological Economics* 36: 365-372.
- Costanza, R. & E. Daly, 1987. *Ecological Modelling* 38: 1-7.
- Janssen, S. & M.K. Van Ittersum, 2007. *Agricultural Systems* 94: 622-636.
- Koopmans, T., 1951. *Activity Analysis of Production and Allocation*. Proc. of a Conference, Cowles Commission, New York. <http://cowles.econ.yale.edu/P/cm/m13/index.htm>
- Louhichi, K., *et al.*, 2007. A generic template for FSSIM for all farming systems, SEAMLESS PD3.3.11, 82 pp.
- Van Ittersum, M.K., *et al.*, 2008. *Agricultural Systems* 96: 150-165.

¹ This method, which precludes the separate measurement of alternative processes to produce the same commodity, or the recognition of joint production, can be and is being supplemented by the study of engineering information (Koopmans, 1951).

Integrated home garden model for food security, nutrition and poverty alleviation

M. Akkas Ali, M. Robiul Alam, M.S.H. Molla, M.A. Momin
On-Farm Research Division, Agricultural Research Station, Panba 6600, Bangladesh
Contact: makkas62@yahoo.com

Introduction

In Bangladesh, more than 30,000 children are suffering from blindness each year and majorities of its population are in lack of the required amount of vitamins (81%), protein (60%) and minerals (Mahmud, 1985). There are about 17.5 millions of homesteads in the country which can help producing sufficient vegetables and fruits for the concerned families. Farmers practice different patterns of vegetables and fruits in the vicinity of the household, but almost all are unplanned, poor yielded and non-scientific. Thus, it was felt that a complete model is needed for homestead production. A model was applied to nine possible production units to avoid the shortfalls stated above with the following objectives (i) Maximum utilization of homestead spaces and time round the year with fruit and vegetables, (ii) Ensure food security round the year and build up food for family consumption with nutritional quality, (iii) Create employment opportunity for family members, cash generation and develop women members for decision making and gender equity.

Materials and methods

The study was carried out at the Farming Systems Research and Development (FSRD) site, Pabna during 2001–2005 with 15 female-participating farm families. Nine cropping patterns were used for 9 production niches of each homestead (viz. open land, fence, trellis, non-fruit tree, partial shady area, roofs of cottage, marshy land, home boundary and backyard) and the selection of crop varieties were finalized with the active participation of the co-operators in accordance with their need for assessment, preference and resources in decision-making process. There was a flexibility of plot and/or space sizes of each production niche to avoid complexity of the study. Recommended crop production technologies were used for the study. To attain environmental benefit some technologies like composting with kitchen and house waste, bio-pesticides, use of BARI cooking oven and use of bi-gas plant were also tested. The collected data were checked, processed and analysed for interpretation.

Results and discussion

Production of vegetable and fruits The production of vegetables increased remarkably in the integrated model (Table 1). Average production was 746 kg family⁻¹ during 2001-05, which was above 4 times compared to a previous (178 kg) model (Islam *et al.*, 1996). Highest production was obtained from the creeper group due to better management with improved skill in production practices. The total production from newly included spaces was 2.38 times higher than the open space. The fruit yield from existing trees was 810 kg family⁻¹ y⁻¹ where main contribution was from mango. Mango yield was increased by about 3.37 times due to better pest and agronomic management. The new fruit trees introduced in the model and management of existing fruit trees are expected to increase production remarkably.

Food security and family nutrition Adequate amount of nutritious fruits and vegetables were supplied round the year averaging 710 g d⁻¹ person⁻¹ (Table 1). The average consumption of fruits was 920 g d⁻¹ family⁻¹, much higher than daily requirement and 3.3 times higher (280 g) than non-project areas (Akhtar *et al.*, 2000). The average production per day of both vegetables and fruits were 2.04 and 2.22 kg which all together, was 2.84 times higher than the need for family consumption and 5 times higher than the national average (396 g) family⁻¹.

As production of food items lead to its added consumption and also increase distribution (22%) to relatives and sale (35%) to the buyers (Table 1). The percent consumption of vegetables and fruits were 45 and 42% of production only. The supply of nutrients from fruits and vegetables of the tested model surplus the need for most of the wanting essential nutrients like Vitamin A, C, calcium and iron-previously deficient in the diet. An ample amount of Vitamin B1, B2, protein and energy were also obtained from the supplied food of the model (Table 2).

Table 1. Average yield of vegetable, fruits, gross return, disposal pattern and income of the model. Currency: US\$ 1 = Tk (Taka) 68.

Crops	Yield family ⁻¹ (kg)	Return family ⁻¹ (kg)	Disposal of the produce family ⁻¹ (kg)			
			Consumption	Distribution	Sale	Cash income (Tk.)
Vegetables	746	2,832	337 (45%)	105 (15%)	304 (41%)	1,143
Mean family ⁻¹ d ⁻¹	2.04	8	0.92	0.29	0.83	3.13
Fruits	810	8,664	334 (42%)	238 (29%)	238 (29%)	1,979
Mean family ⁻¹ d ⁻¹	2.22	24	0.92	0.80	0.65	5.42
Grand total (Veg. + Fruits)	1,556	11,496	671 (43%)	343 (22%)	542 (35%)	3,122
G. Mean family ⁻¹ d ⁻¹	4.26 (710 g)	31.5	1.84	0.94	1.48	8.55
Total cost for the model (Tk.)	-	350	-	-	-	-
Benefit cost ratio	-	32.85	-	-	-	-

Table 2. Average yield of vegetables, fruits and nutrient contents of integrated model.

Crops	Yield (kg)	Content of nutrients							
		Carotene (µgm)	Vit.C (µgm)	Vit.B-1 (µgm)	Vit.B-2 (µgm)	Calcium (µgm)	Iron (µgm)	Energy (kcal)	Protein (gm)
Vegetables	746	14,959	320,298	1306	655	1409,927	113,322	767,412	16,861
Mean family ⁻¹ d ⁻¹	2.04	41	878	4	2	3,863	310	2,102	46
Fruits	810	29,597	187,588	404.9	318	82,117	21,864	397,511	6,164
Mean family ⁻¹ d ⁻¹	2.22	81	514	1.11	0.87	225	60	1,089	16.89
Total both resources	4,026	122	1,392	5.11	2.87	4,088	370	3,191	6.89
Daily needs family ⁻¹ *	1.5	10	260	7.0	6.3	3,000	145	14,100	284
% requirement supplied	284	1,220	535	73	46	136	255	23	22

* Estimated from data provided by Haque (1985) for six members per family.

Income generation, poverty reduction, empowerment of women and gender equity The average gross return was obtained Tk. 11,496 per family from the model with a very little cash investment (Tk. 350 y⁻¹, 1 US\$ = Taka 68). The average BCR on cash cost basis was over 32.85. This cash is generating round the year enabling the poor co-operators to meet up immediate family needs like purchase of edible oil, lighting fuel (kerosene), pulse, salt and spices. Sufficient amount of nutrients supplying from the food of the model, which is helped in crossing poverty level (23% energy, Table 2). The women members were actively participated in the program and involved in majority of the gardening activities, earned 24% of family income, and participated in different group activities, trainings and field days. Even 40% women alone made decision in different activities. This empowerment enabled women in attaining gender equity and increase prestige in the family as well as in the society.

References

- Akhtar, M.S. *et al.*, 2000. Annual report 2000. OFRD, BARI, ARS, Pabna, pp. 7-18.
 Islam, S., *et al.*, 1996. In: 14th International Symposium on Sustainable Farming Systems, Colombo, Sri Lanka, pp. 81-89.
 Mahmud, S.A., 1985. Introductory: Cultivation and nutritional identity of fruits and vegetables. 1985. Dept. of Agricultural Extension, Khamarbari, Dhaka.

Economic impact of voluntary agri-environmental measures: The case study of a ‘Test-Action’ in a basin of south-western France¹

M. Ben El Ghali, A. Ridier, C. Kephaliacos, G. Nguyen
Toulouse University, LEREPS, ENFA, France
Contact: elghali_ma@yahoo.fr

Introduction

The impact of pesticides and nitrogen use on water quality is one of the principal environmental issues today. To handle this problem, the European Union has adopted, since 2006, compulsory legal measures addressed to farmer within the framework of the cross compliance of the CAP 1st pillar subsidies (environmental regulations and Good Environmental and Agricultural Practices - GAECS). But voluntary measures are also applied for a long time inside the Rural Development Policy inside the CAP. Some of these measures are local initiatives (Territorial Action Plans organized in small regions, Test-Actions initiated in France by Water Basin Agencies of the Ministry of Ecology). The research presented here concerns such a local program in a river basin in the Midi Pyrénées region (region of Gers-Amont). For this program concerning new farm management practices, we have observed that the rate of contracting measures concerning the change of farming practices is low (compared to measures subsidizing investment projects). The issue is to analyse and explain the reasons for this low adoption rate of voluntary measures concerning rotation practices and soil management.

Methodology

This research is based on mathematical programming methods, developed at the farm-level, in order to analyse the impact of the new practices on the farm income and on labour organization. Thus, labour is explicitly accounted for in the model because it seems to be an essential component in the adoption decision of new agricultural practices.

After including agronomic data (yields defined as a combination of crop, soil type, previous crop, agro-management type) as well as economic data (costs, premiums, prices, resources requirement...), the mathematical programming model seeks to represent the farmer's observed behaviour and projects responses under new agricultural practices. The main outputs generated by this model are the land use, the input use according to different cropping techniques (soil type, previous crop, etc.), the farm income and the needs in labour. Labour data is explicitly introduced according to the type and number of farm operations and to the time needs for each operation.

The general structure of the economic farm model is formulated as follows:

$$\text{Maximize: } U = p'y'x - c'x + s'x$$

$$\text{Subject to: } Ax \leq B; x \geq 0$$

U represents the utility function of the farmer (here the expected gross margin), p is the vector of producer prices, y is the vector of yields for each cropping activity, c is the vector of costs per unit of cropping activity, s is the vector of subsidies per unit of cropping activity (depending on the regulation of the CAP), x are the quantities produced for each crop, A is the matrix of technical coefficients, B is the vector of available resource levels.

The model is calibrated for two typical crop farms corresponding to two main areas in the river basin: the first farm type is specialized in maize and located in alluvial corridors, the second farm type is located in hillsides and its cropping plan is specialized in ‘dry cereals’. After validation of the model according to these typical farms, a set of two measures corresponding to the program ‘Action-test’ is simulated: (1) the ‘long rotation’ consisting in

¹ Research financed within the framework of the European project Life ‘Concert’eau’.

setting up a higher number of crops; (2) the ‘minimum level of soil maintenance’ by using techniques without ploughing. This set of measures is performed for the year 2005.

Results and discussion

The results of the simulated scenarios are compared to a reference scenario, which represents the farms situations before setting up voluntary test-actions.

The technical results show that the long rotation requirement has been respected for farms situated in the area predominated by irrigated maize (Figure 2). In this area, colza and sunflower are introduced. However in the dryness cereals area (Figure 1) the changes are not very important, farmers in this region already and traditionally cultivate many crops in order to face the risk of market prices and yields variability.

The implementation of the measure of ‘minimum level of soil maintenance’ can explain the changes in crop pattern: this technique reduces the time required by 6% for ‘dry cereals’ farm and by 7% for the maize farm. Thus, the farmer can optimize his time availability and reduce the labour peak periods in order to practice new crops that are more profitable (Table 1).

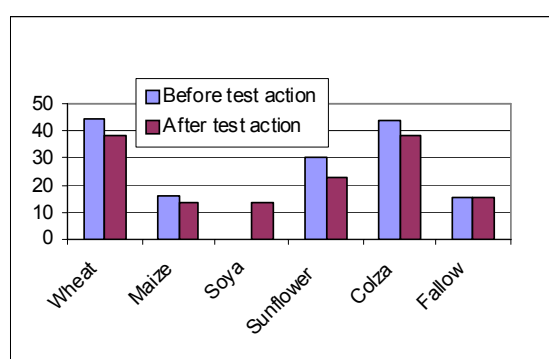

Figure 1. Crop pattern for farm type 1 (150 ha) in cereal areas (area 1).

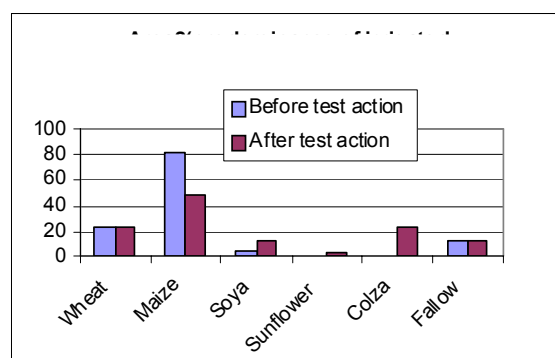

Figure 2. Crop pattern for farm type 2 (120 ha) in irrigated maize area (area 2).

The economic results: the changes of economic results before and after test-action show that, even if the crop pattern is unchanged, farmers’ net income on farm type 1 increases with 3.5%, mainly because of the premium allocated in compensation of the set of measures. In farm type 2, the farm income increases with 8.3%, mainly because of the additional income due to more profitable new crops and additional premiums received in response to the respect of the long rotation and no ploughing technique (Table 1).

Table 1. Economic results of scenarios simulations.

	SC1: Before test-action	SC2: after test-action	Variation %
Area 1: dryness cereals			
Gross Margin in €	63,320	65,530	3.49
Time labour in hour	1330	1247	-6.24
Area2: irrigated maize			
Gross Margin in €	71,560	77,482	8.28
Time labour in hour	1178	1085	-7.89

Conclusion

The results show that, according to different agronomic contexts, the implementation of new farming practices can be an opportunity for farmers to re-allocate their available time towards more profitable crops or projects. This results also confirm that the quantity and the quality of labour spent in the change of practices is probably the main obstacle to the adoption of innovative farming practices.

An appraisal of risk on perennial energy crops in France

G. Bocquého, F. Jacquet, L. Bamière

INRA, Avenue Lucien Brétignières, 78850 Thiverval-Grignon, France

Contact: gbocqueho@grignon.inra.fr

Introduction

Ligno-cellulosic crops are said to be a credible agricultural biomass in the long term to produce biofuels. They have already been widely spread in some of Northern Europe countries, for instance *Salix* in Sweden or *miscanthus* in Great-Britain. As for France, ligno-cellulosic crops for energy have just been introduced into farming systems for three years, but at a very quick rate. Ligno-cellulosic crops are mainly *miscanthus*, switchgrass and short rotation coppices of several forest species. As new and perennial crops, sold on an emerging energy market, they show a novel combination of features that make them original in comparison with French traditional crops, for food as well for energy purposes. In particular they can require an extensive investment cost for planting, first incomes being received a few years later, while the land they are planted on is tied up. Such crops could then be qualified as risky ones. Nevertheless French farmers keep on converting farmland to these crops in increasing numbers, and despite weak incentives for the Common Agricultural Policy. Indeed they can be grown on set aside lands, like any other non-food crop, while the 2003 energy crops scheme applies to both annual and permanent energy crops. The aid was worth less than € 32 ha⁻¹ in 2007 (to be compared with the € 89 ha⁻¹ subsidy on cereals on average in France in 2007). French government offers no additional aid.

We were interested in investigating the outward paradox between the raising number of farmers willing to adopt perennial energy crops and the risky nature of these new crops, given their lengthy establishment period and the uncertainty on market outlets for them. Policy makers and other stakeholders also need to assess the economic benefits for farmers and the extent to which they would be willing to convert their farmland to ligno-cellulosic production.

Methods

Firstly we built up two simple micro-economic models of farmers' behaviour, basing us upon a literature review of *miscanthus* and switchgrass characteristics. We simulated farmers' decisions when they face the opportunity to invest in *miscanthus*, assuming they only had to make one decision, which is to choose the number of hectares to convert from wheat to *miscanthus* in order to maximize their total utility of profit. Optimal solution was constrained by the total arable area and profits were subject to uncertain selling prices, uncertainty being higher on wheat prices. The first model only took into account static variability of incomes, whereas the second one also included their intertemporal variability (Hardaker *et al.*, 1997; Weil, 2002).

Secondly, we lead field interviews¹ with French producers of *miscanthus* or switchgrass, following a semi-directive questionnaire. A sample of eleven farmers with different structural characteristics (age, production system) has been selected in the main producing regions (Eure-et-Loir, Indre-et-Loire and Calvados) We were seeking to assess their perception of the various types of risks they bear when they are cultivating perennial energy grass, and to understand their motives for planting them.

¹ This part of the work was financed by the European Union through the Network of Excellence Bioenergy, and was done inside a partnership with IIIIEE, Lünd University, Sweden.

Results and discussion

According to our calculations, in 2008 in France area cultivated with perennial energy crops increased by 30% in relation to 2007, to get to a total of 1565 ha in more than 300 farms (AUP, 2008). Western and Northern France is especially concerned, with plantations mainly dating back to 2007 or 2008. Three quarters of the total area is miscanthus, while 11% is willow, 7% is switchgrass, and 8% is false acacia or poplar tree. However, permanent species are still a very small share of the total of energy crops cultivated in France (0.25%). Fodder dehydration plants buy directly to the farmers 33% of the miscanthus grown and 26% of the short rotation coppices

The results of our simulations are given in Table 1. We found that diversifying a farmer's portfolio of activities with miscanthus is optimal if we take into account the variability of incomes due to selling prices, but it is no more optimal if we consider also the expected cash flows throughout time.

Table 1. Simulation results.

			Wheat	Miscanthus
	Gross annualized margin (€/ha/year)		502.6	409.9
Static risk only	Optimal areas of crops (ha)	Correlated prices	74.1	25.9
		Independent prices	63.2	36.8
	Expected annualized gross income (€ ha ⁻¹ yr ⁻¹)	Correlated prices		478.6
		Independent prices		468.5
Static risk and intertemporal variability	Optimal areas of crops (ha)	Correlated prices	99.6	0.4
		Independent prices	98.9	1.1
	Expected annualized gross income (€ ha ⁻¹ yr ⁻¹)	Correlated prices		502.3
		Independent prices		501.6

Our field surveys showed that French farmers see perennial energy grass as globally less risky than cereals, apart from a market outlet risk which can be strong because of an emerging market. However this is usually shared with buyers thanks to contractual arrangements of different kinds and the farmers seldom grow more than 10% of their arable land. The following motives for investing in perennial energy grass have been set out: positioning themselves on a new market, using marginal lands, saving time, and getting involved in an environment-friendly activity.

Further research will deepen the analysis with the aim to conduct to an integrated assessment of growing perennial energy crops. On the one hand we plan to include environmental outputs (water, soil fertility) in the assessment by collaborating with researchers from others disciplines. On the other hand, we will strengthen the analysis on farmers' behaviour, focusing on risk and intertemporal substitution attitudes (Epstein & Zin, 1989), and real options theory (Dixit & Pindyck, 1994).

References

- Agence Unique de Paiement, 2008. Statistiques sur les cultures ligno-cellulosiques bénéficiant des aides PAC. French Ministry for Agriculture and Fisheries, Paris.
- Dixit, A.K. & R.S. Pindyck, 1994. Investment under uncertainty. Princeton University Press, Princeton, 476 pp.
- Epstein, L.G. & S.E. Zin, 1989. *Econometrica* 57: 937-969.
- Hardaker, J.B., *et al.*, 1997. Coping with risk in agriculture. CAB International, Wallingford, 274 pp.
- Weil, P., 2002. In: Risques, Les cahiers de l'assurance. Vol. 49, SCEPRA, Paris, pp. 70-76.

Economic analysis of cover crop (white mustard) adoption to reduce take-all disease and N-leaching

G. Goulevant, S. De Cara, F. Jacquet, A. Reynaud, M.H. Jeuffroy, P. Lucas, F. Montfort
INRA-Economie Publique,
BP01-78850 Thiverval Grignon, France
Contact: fjacquet@grignon.inra.fr

Introduction

Winter wheat is a major crop in the world with more than 220 millions ha out of 1500 millions ha of arable crops. In the European Union, it represents one quarter of arable crops, leading to frequent occurrence of wheat in main field crop rotations. However, due to its low N uptake during winter, N-leaching risks can be high during this winter crop, in particular, in conditions of warm climate in autumn and rainy conditions during winter.

There are several ways to reduce nitrate leaching in a winter crop rotation. Reduction of N-leaching can be achieved by straw incorporation of the preceding crop, leading to a decrease in net mineralization between harvest and late autumn. Another solution is to use cover crop (or catch crop) such as white mustard. The efficiency of cover crop or catch crop to reduce nitrate leaching has been widely demonstrated (Meisinger *et al.*, 1991), especially before spring crops. The rationale is that the use of an over-winter cover crop decreases nitrate leaching (by retaining nitrogen via crop N uptake). As a result, autumn cover crop in order to reduce nitrate leaching before spring crops is currently strongly encouraged by public policies.

Despite important public subsidies, we do not observe a strong development of catch crops. The main explanations are a low private benefit for farmers, as the sowing of a catch crop is costly for farmers, and a supplement work to do just after harvest, in a period with already a heavy work calendar. As a result, the economic private incentives for introducing winter cover crop in wheat rotations are low. Adoption requires then high subsidies by public authorities.

In this paper, we introduce another kind of benefit for the farmer of using cover crops which has not yet been analysed in the literature. It is well known that producing the same crop in the same field year after year is unsustainable because of the decline in yields. In the specific case of wheat, the main problem is related to the development of the take-all disease. The take-all disease is a problem related to soil-borne pathogens, *Gaeumannomyces graminis tritici* (Ggt), that infect the roots of that crop, but that die out while the field is planted by a different non-host crop. Agronomic studies have shown that some cover crops could have an impact on the take-all disease. According to Ennaïfar *et al.* (2007), the take-all disease caused by Ggt, and the incidence on the following winter wheat, can be decreased by a white mustard when residues are ploughed in soil. Kirkegaard *et al.* (1994) have also shown that Brassica crops may have positive effects on growth and yield of wheat by reducing Ggt inoculum releasing.

In this paper, we argue that the benefit of the reduction in the take-all disease risk should be taken into account by a farmer when choosing to adopt cover crops. This has strong policy implications since in such a case it may reduce the amount of public subsidies required to induce adoption. Evaluating these effects requires however a coupling of an agronomic crop growth model describing the link between climate variability and wheat yield, with a model simulating take all incidence and severity, and with an optimization-driven micro-economic model describing the adoption by a risk-averse farmer of the cover crop.

Methods

To model the process of cover-crop adoption by a farmer producing wheat taking into account N-leaching and take-all disease, we coupled three types of models. First, the wheat growth process and the N-leaching are simulated by STICS, which is a generic soil-crop model simulating the crop growth from sowing to harvest at a daily time scale (Brisson *et al.*, 1998). From the characteristics of the climate, the soil, the grown variety and the crop management applied, STICS calculates output variables relative to the production (quantity and quality of harvested grains), to the environment (drainage and nitrate leaching) and to the evolution of the soil characteristics under the influence of the crop. Second, the take-all disease model is the one developed by Ennaïfar *et al.* (2007) allowing to simulate take-all incidence and severity according to climate characteristics. Third, the economic model is a standard optimization-driven micro-economic model describing the behaviour of a risk-averse farmer producing wheat. This micro-economic model has been written in GAMS. To control for local conditions, we have calibrated the three models for two very different regions: Le Rheu in Brittany (48°07' N; 1°47' W) and Grignon close to Paris (48°50' N; 1°57' E).

Our approach has then been the following. First we have studied the behaviour of the farmer without risk of take-all disease. The decision variables of the farmer included four ways for managing the winter crop: a bare soil from harvest of preceding crop to sowing (the wheat sowing being in early October), wheat volunteers as cover crop, a white mustard as cover crop with an early destruction and white mustard with a late destruction. The micro-economic model has been simulated in various contexts including various levels for the taxes on N-leaching or for cover crop adoption subsidies. In each of these contexts, we analysed the optimal adoption decisions. A similar analysis has been conducted including the risk of take-all disease and a comparison of the farmer decisions without take-all risk has been realized.

Results and discussion

Preliminary results suggest that the cost for inducing cover crop adoption is significantly lower when the farmer internalizes the take-all risk.

References

- Brisson, N., *et al.*, 1998. *Agronomie* 18: 311-346.
- Ennaïfar, S., *et al.*, 2007. *European Journal of Plant Pathology* 118: 127-143.
- Kirkegaard, J.A., *et al.*, 1994. *Australian Journal of Agricultural Research* 45: 529-545.
- Macdonald, A.J., *et al.*, 2005. *Plant and Soil* 273: 355-373.
- Meisinger, J.J., *et al.*, 1991. In: Ed. W.L. Hargrove, *Cover crops for clean water*. Soil and Water Conservation Society, Jackson, Tennessee, USA, pp. 57-68.

Farming Systems SIMulator: First generic bio-economic farm model

S. Janssen, K. Louhichi, A. Kanellopoulos, P. Zander, G. Flichman, H. Hengsdijk, Hongtao Li, T. Heckelei, G. Stokstad, N. Borkowski, M. Hecker, A. Oude Lansink, M. Blanco, E. Meuter, M.K. Van Ittersum
Plant Production Systems Group, Wageningen University,
P.O. Box 430, 6700 AK Wageningen, The Netherlands
Contact: sander.janssen@wur.nl

Introduction

Policymakers and farmers have an interest in making *ex-ante* assessments of the outcomes of their choices in terms of policy and farm plan (cf. Zander & Kächele, 1999; EC, 2005). A Bio-Economic Farm Model (BEFM) is defined as a model that links formulations describing farmers' resource management decisions to formulations that describe current and alternative production possibilities in terms of required inputs to achieve certain outputs and associated externalities. Janssen & Van Ittersum (2007) recently reviewed the usefulness of BEFMs for predicting the impact of policy changes and identified a lack of re-use of BEFMs, e.g., models were only used for one purpose and location for which they were initially developed and not for other purposes or locations afterwards. Instead in cropping systems models, the re-use for diverse purposes and locations is wide-spread. This lack of re-use for other purposes and locations might hinder the usefulness of BEFM for policy assessment. In SEAMLESS (System for Environmental and Agricultural Modelling: Linking European Science and Society), we choose to develop the Farming Systems SIMulator (FSSIM) as a generic bio-economic farm model. Here we define generic as being useful for a range of agri-environmental zones, different farm types, different innovations or policy questions and applications that require different level of detail in input or output data. The objective of this contribution is to introduce FSSIM as a generic BEFM model, to present its structure and how it can be applied for different purposes.

Generic features of FSSIM

FSSIM has several features that make it generic. First, it has not been built as a monolithic model, but it is the result of a combination of several components. Second, the structure of FSSIM can be adapted to the purpose for which it is being used and third, it has been coupled to different user interfaces. Each of these features will now be discussed in some more detail.

FSSIM exists out of two main modules, FSSIM-Mathematical Programming (MP) and FSSIM Agricultural Management (AM) (Figure 1). FSSIM-MP captures resources, socio-economic and policy constraints and the farmer's major objectives (Louhichi *et al.*, 2007). The aim of FSSIM-AM is to describe, generate and quantify production techniques of current and alternative production enterprises which can be simulated by a cropping system model such as the Agricultural Production and Externality Simulator (APES; Donatelli *et al.*, 2009) in terms of production and environmental effects. The fully quantified activities, i.e. the complete sets of agricultural inputs and outputs, are assessed in FSSIM-MP on their contribution to the farmer's and policy goals considered. As FSSIM-AM and MP are quite large entities, these have been further sub-divided into components or sub-modules that have a more specific role and a stand-alone value (Figure 1). Components exist for collecting data on current activities (either with detailed or aggregated information on agricultural management), for specifying livestock activities or livestock related constraints, for specifying policies and for calibration (Janssen *et al.*, 2008).

Conceptually, FSSIM fulfils two main purposes. The first purpose is to provide supply-response functions for so-called NUTS2-regions (corresponding to provinces in many cases) that can be upscaled to EU level, while the second purpose is to allow detailed regional

impact assessment of agricultural and environmental policies and technological innovations on farming practices and sustainability of the different farming systems. The dual purpose of FSSIM resulted in applications that were more data intensive and applications that were less data intensive.

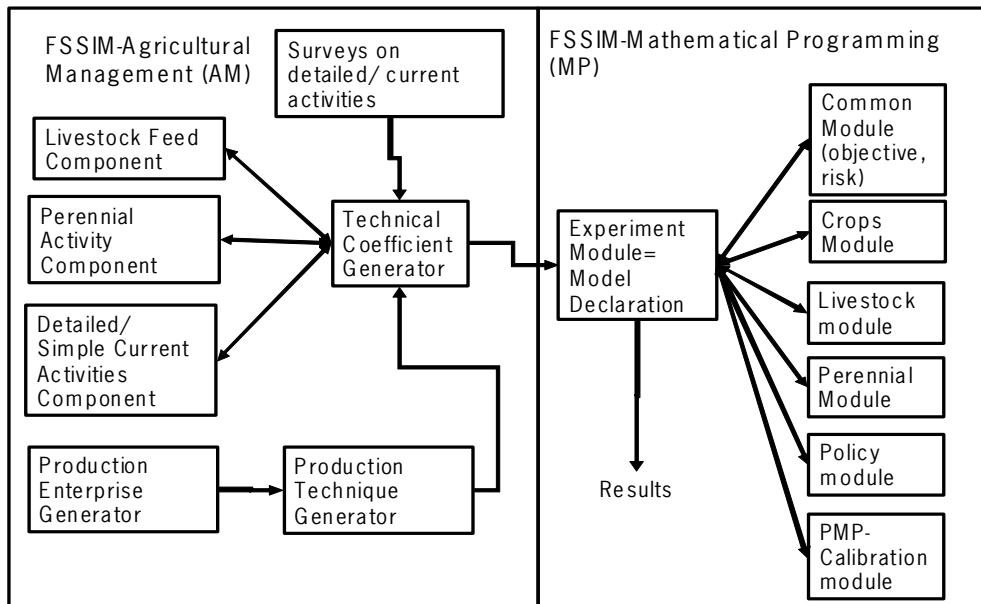

Figure1. FSSIM-MP and AM with their individual components or modules.

FSSIM has been coupled to two distinct graphical user interfaces, e.g., SEAMLESS-IF and FSSIM-GUI. In the SEAMLESS-IF, FSSIM is integrated with other models and is run as part of a model chain. The FSSIM-GUI (Meuter *et al.*, 2009) allows modellers and integrative modellers to make model runs with one or more components of FSSIM. The FSSIM-GUI should, thus, help modellers and integrative modellers to evaluate components one by one and work with FSSIM across data-sets.

Concluding remarks

FSSIM has been applied to 11 regions to assess supply responses for EU, to 4 regions for a more comprehensive regional analysis, to both arable and livestock systems and to one region (Mali) outside the EU. The distinction between two different purposes, the subdivision of FSSIM in different modules and the coupling to the different user interfaces has proven to be useful for achieving an appropriate configuration of the model with respect to data availability, research question and location.

References

- Donatelli, M., *et al.*, 2009. In: Eds. F. Brouwer, M.K. Van Ittersum, *et al.*, APES: The Agricultural Production and Externalities Simulator. Springer. (forthcoming)
- EC, 2005. Impact Assessment Guidelines. European Commission, Brussels, 99 pp.
- Janssen, S. & M.K. Van Ittersum, 2007. *Agricultural Systems* 94: 622-636.
- Janssen, S., *et al.*, 2008. Integration of all FSSIM components within SEAMLESS-IF and a stand alone Graphical User Interface for FSSIM. D3.3.12, 53 pp.
- Louhichi, K., *et al.*, 2007. A generic template for FSSIM for all farming systems. PD3.3.11, SEAMLESS integrated project, EU 6th Framework program, contract no. 010036-2 www.SEAMLESS-IP.org pp. 82.
- Meuter, E., *et al.*, 2009. AgSAP Conference 2009, these proceedings.
- Zander, P. & H. Kächele, 1999. *Agricultural Systems* 59: 311-325.

Using time driven activity-based costing data for modelling complex innovations: The case of batch farrowing

L. Lauwers, P. Everaert, J. Van Meensel, K. Bryon
ILVO – Social Sciences Unit,
Burg. Van Gansberghelaan 115,
9820 Merelbeke, Belgium
Contact: Ludwig.lauwers@ilvo.vlaanderen.be

Introduction

Time-driven activity-based costing, TD-ABC (Kaplan & Anderson, 2004) has been successfully adopted in complex decision-making processes (Everaert *et al.*, 2007). Originated as a tool for the assessment of activity-specific labour use in a multi-activity processing environment, the method is able to link activities to various input factors. Moreover, recent work of Bryon *et al.* (2008), applying TD-ABC for evaluating conversion to batch farrowing in farm farming, show that the method can be adapted for *ex-ante* evaluation in a multi-criteria decision-making situation. TD-ABC is rather simple to apply, provided a thorough system analysis and decomposition of activities into basic tasks is possible. As such, the method can be considered as a well-grounded budgeting. The question arises whether this mass of information can also be used, without much extra efforts, in optimization models.

This paper examines whether TD-ABC and linear programming, LP, can be combined in one simple spreadsheet model, in order to take profit of both methods. The model uses data of a former study on batch farrowing, which has been found as a valuable innovation from corporate social responsibility (CSR) viewpoint (Bryon *et al.*, 2008) and of an ongoing study on the economic-ecological efficiency in pig production (Van Meensel & Lauwers, 2008). The model is first used for a case farm (433 sows) and then generalized to a sample of 120 farrow-to-finishing farms.

Methods

The pig production process is decomposed in various main activities. In total, 20 activities are analysed, of which the major labour-consuming are given in Table 1. TD-ABC models highlight the time required for performing an activity, based on all possible variants of the activity. The TD-ABC model considers drivers and time equations. The characteristics that drive the variants of the activity are called time-drivers, because they ‘drive’ the time spent for a particular case. Time equations model how time drivers drive the time spent for an activity. In complex environments where the time needed to perform an activity is driven by many drivers, TD-ABC can include multiple drivers for each activity.

Results and discussion

Table 1 gives an overview of estimated work load. In total 385 hours of labour is saved while moving from the 1-week to the 4-week system, or from 13.92 to 13.03 hours per sow per year. Figures are expressed per sow as a production unit, also including the piglet and finishing pigs. The method is not only used for its original objective, but extended to CSR criteria, like labour income, nitrogen emission and animal welfare (Table 2).

This information is brought in a spreadsheet based LP, constructed for evaluating choice options in pig farms, in this case, to compare the batch farrowing systems on a 2 to 5 weekly basis. Starting points are the different economic, ecological and sociological outcomes of the time-drivers assessed with the adapted TD-ABC method. The LP model then chooses the farrowing system, characterized by a binary variable, with the highest utility to the farmer.

Table 1. Labour need for the different systems (in minutes/year).

Activity	1-week system	4-week system	Difference
Feeding and controlling pigs	109099	113706	+4607
Controlling sows	35259	35259	0
Feeding piglets at sow	32850	24635	-8215
Feeding sows	28991	28861	-130
Farrowing	24960	15600	-9360
Moving sows	16744	14404	-2340

Table 2. TD-ABC based estimation of change in CSR criteria for the two systems.

Activity	1-week system	4-week system	Difference
Labour income (Euro/sow.year)	21	36	+15
Nitrogen emission (kg N/sow.year)	137	138	+1
Animal welfare	Determined quantitatively		++

Feasibility of batch farrowing is finally simulated for a sample of 120 farrow-to-finishing farms. With respect to the innovation, we conclude that batch farrowing is an eco-efficient production process, which satisfies CSR objectives. The added value of the method is:

- comprehensible, farm-specific and transparent decomposition of production process;
- easy template to fill in specific farm features, usable for optimization modelling, which gives the opportunity costs of a priori assigned decisions options.
- sufficient opportunities for a handsome sensitivity analysis

As such, the frame work allow for Monte Carlo simulations of uncertain parameters, providing extra information for farmers reluctant for new farming systems with uncertainty.

References

- Bryon, K., *et al.*, 2008. Contribution of batch farrowing to more sustainable pig production. Master thesis, Ghent University, Belgium.
- Everaert, P., *et al.*, 2008. Intern. J. of Phys. Distr. and Logistics Management 38(3): 172-191.
- Kaplan, R.S. & S.R. Anderson, 2004. Harvard Business Review 82(11): 131.
- Kaplan, R.S. & S.R. Anderson, 2007. Time-driven activity-based costing, a simpler and more powerful path to higher profits. Harvard Business School Press, Massachusetts.
- Van Meensel, J. & L. Lauwers, 2008. An Excel work sheet for economic-ecological efficiency diagnosis and linear programming planning in pig production (work in progress).

Higher prices, less nature management? Modelling farmers' decisions on dairy farms

Hans Leneman, Raymond Schrijver
LEI, Wageningen UR,
P.O. Box 29703, 2502 LS The Hague, The Netherlands
Contact: hans.leneman@wur.nl

Introduction

The prices of grain, compound feed and milk in particular have risen strongly recently. This paper comprises an analysis of the possible consequences of the changing market conditions within the agricultural sector for the willingness to participate in agricultural nature management. We focus on decisions by dairy farmers in the Netherlands to participate in nature management schemes.

Methods

The basis for the analysis is the profile and the motives of the agricultural nature managers and the way in which nature management can fit in with farm economics. We deduced the profile and the motives of dairy farmers from literature. We combined this with results of FIONA, a Linear Programming model at farm level (Groeneveld & Schrijver, 2006), originating from the model presented by Berentsen (1999) (Figure 1). FIONA is especially designed to fit in nature management in the operational management on farms.

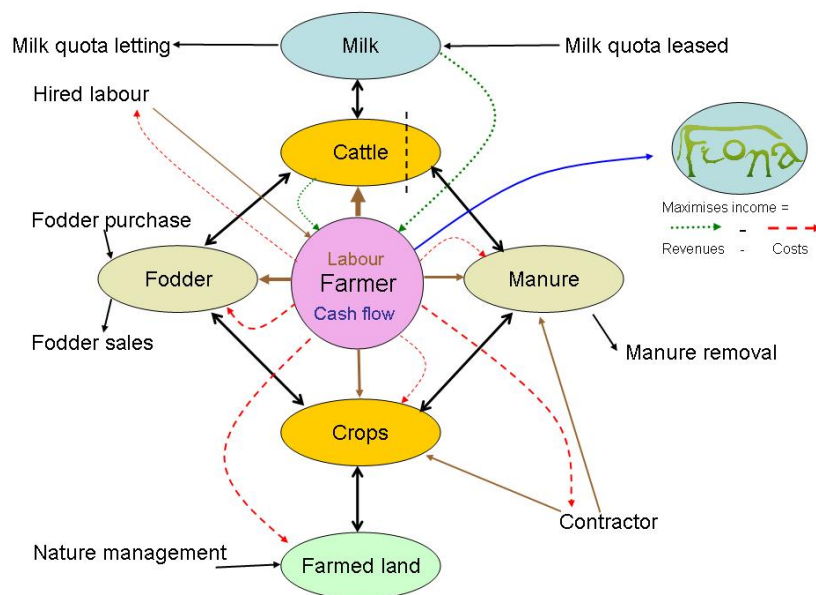

Figure 1. FIONA (Farm based Optimization model for Nature and Agriculture).

Results of FIONA are presented using cost curves, which illustrate the relation between costs and the optimum area of nature management. These cost curves are determined for an average and a more intensified farm planning. Nature management consists of a meadow bird protection scheme, with a good actual participation. The curves were estimated by entering different area of the scheme (1, 3, 5... 29 ha). The compensation payment was not taken into account.

Results and discussion

Nature management on dairy farms stands for more than 60% of the total area under nature management and this management is mainly aimed at meadow birds (Voskuilen & De Koeijer, 2006). Dutch farmers' participation has an economical motive; they are satisfied with the compensation they receive. They also start their nature management activities because of general interest in nature and landscape. Data show that both motives are equally important (Leneman & Graveland, 2004). Another factor that explains farmers' participation is the presence of environmental cooperatives. These cooperatives lower the administrative burden for individual farmers, related to an application with the government.

Results of FIONA point at two effects of higher prices of milk and compound feed. First, it will lead to a decline of the area of nature management. We estimated that participation will decrease with some 20–40%, depending on the farm intensity, using a milk price of 45 € per 100 kg. If the compensation is increased by € 100 per ha, this decrease could be prevented. The second effect is a higher threshold for new participants. The margins of profit on the first hectares nature management will be lowered by a third.

Based on literature and on farm simulation results, we expect participation of dairy farmers in nature management schemes to decrease, as prices for milk, grain and compound feed rise.

References

- Berentsen, P.B.M., 1999. Economic-environmental modelling of Dutch dairy farms incorporating technical and institutional change. PhD thesis, Wageningen Agricultural University, Wageningen, The Netherlands.
- Groeneveld, R.A. & R.A.M. Schrijver, 2006. FIONA1.0 – Technical description Werkdocument 36 Wettelijke Onderzoekstaken Natuur & Milieu, Wageningen, 30 pp. (in Dutch)
- Leneman, H. & C. Graveland, 2004. Deelnamebereidheid en continuïteit van het Agrarisch Natuurbeheer. Rapport 7.04.06. LEI, Wageningen UR, Den Haag, 2004. (in Dutch)
- Voskuilen, M.J. & T.J. de Koeijer, 2006. Profiel deelnemers agrarisch natuurbeheer. WOt-rapport 27. Wettelijke Onderzoekstaken Natuur & Milieu, Wageningen. (in Dutch)

EU dairy farming in the face of change: An exploration using a bio-economic farm model

K. Louhichi, H. Hengsdijk, S. Janssen, G. Bigot, E. Perret, M.K. Van Ittersum
CIHEAM-IAMM; 3191 Route de Mende, 34093 Montpellier, France
Contact: Louhichi@iamm.fr

Introduction

Dairy farmers in the European Union (EU) face important challenges associated with changes in policy and market conditions. First, the European Commission has proposed to abolish the milk quota system in 2015 as part of the reform of the Common Agricultural Policy (CAP). The milk quota system was introduced in 1984 because of the surplus of milk production in the EU and the heavy burden on budget costs of intervention in the market for dairy products. Anticipating the complete abolishment of the quota system in 2015, the EU has decided to increase the milk quota with 2% per year in the beginning of 2008. Second, dairy farmers have been confronted recently with a sharp increase of the price of feed concentrates due to a number of reasons among others the increased demand for biofuels. Feed concentrates are one of the major inputs in dairy farming that have contributed to the productivity increase of the EU dairy sector during the last decades.

Both developments imply that EU dairy farmers need to cope with more volatile market conditions with respect to both milk prices and prices of concentrates. An ex-ante assessment of the likely consequences of the market instability supports the dairy sector and policy makers to adapt to these changing conditions. The aim of this paper is to explore the effects of changes in milk quota regime and in feed concentrate prices on farm income, resource use and milk production using a bio-economic farm model. This model has been applied in two EU regions with contrasting dairy farming systems, i.e. an intensive system (about 1.5 dairycow per ha) in Flevoland (Netherlands) and a more extensive system (about 0.5 dairycow per ha) in Auvergne (France).

Methods

The used method is based on the Farm System Simulator (FSSIM) developed within the EU FP6 SEAMLESS project (Van Ittersum *et al.*, 2008). FSSIM is a bio-economic farm model which simulates the behaviour of farmers given a set of biophysical, socio-economic and region-specific policy constraints, and their responses under technological innovations and policy changes. It consist of a static comparative programming model, which maximizes a non-linear utility function defined as a combination of expected income and risk, according to the Mean-Standard deviation method (Louhichi *et al.*, 2007). FSSIM integrates a large number of crop and animal activities to facilitate the endogenously matching between feed availability and feed requirements in mixed farming system. The model is calibrated on average farm data applying a variant of the Positive Mathematical Programming (PMP) approach and information from the Farm Accountancy Data Network (FADN). In this case study, FSSIM is applied for two dairy farm types as identified in the EU-wide farm typology developed within the SEAMLESS project (Andersen *et al.*, 2007).

Two different policy scenarios are simulated and compared to a baseline scenario incorporating policy changes formulated in the 2003 CAP reform. The first scenario, simulates the reform of the milk quota regime based on an annual increase of milk quota by 2% during the period 2008–2013 and the second scenario, adds to the previous one a progressive increase of feed concentrates prices from 0 to 100%.

Results and discussion

Compared to the baseline scenario, the implementation of the milk quota reform leads to a slight increase of both milk production and farm income in the two regions (Point of intersection of the lines with the Y-axis in Figure 1): milk production and farm income increase with 2% and 9%, respectively, in Flevoland and with 1% and 4%, respectively, in Auvergne. The increase in milk production is associated with the intensification of milk production in both regions, i.e. higher milk yields per cow. The economic effects in Flevoland are associated with a strong increase of the farm gate nitrogen surplus mainly due to an increase in the use of mineral fertilizers.

Results of the gradual increase of the concentrate prices show the strong dependency of the intensive farm type in Flevoland on feed concentrates as farm income is much more affected than the extensive farm type in Auvergne. The response of farmers to the gradual increase of concentrate prices differs between both farm types, i.e. a strong a reduction in the number of animals (i.e. selling of animals) in Flevoland and an extensification of production system (i.e. lower supplement feed import) in Auvergne. The slightly higher farm income as a result of the relaxation of milk quota is completely lost in both farm types if current concentrate prices increase by more than 40%. The increase of concentrate prices has a positive impact on the farm gate nitrogen surplus due to the lower import of nitrogen in concentrates.

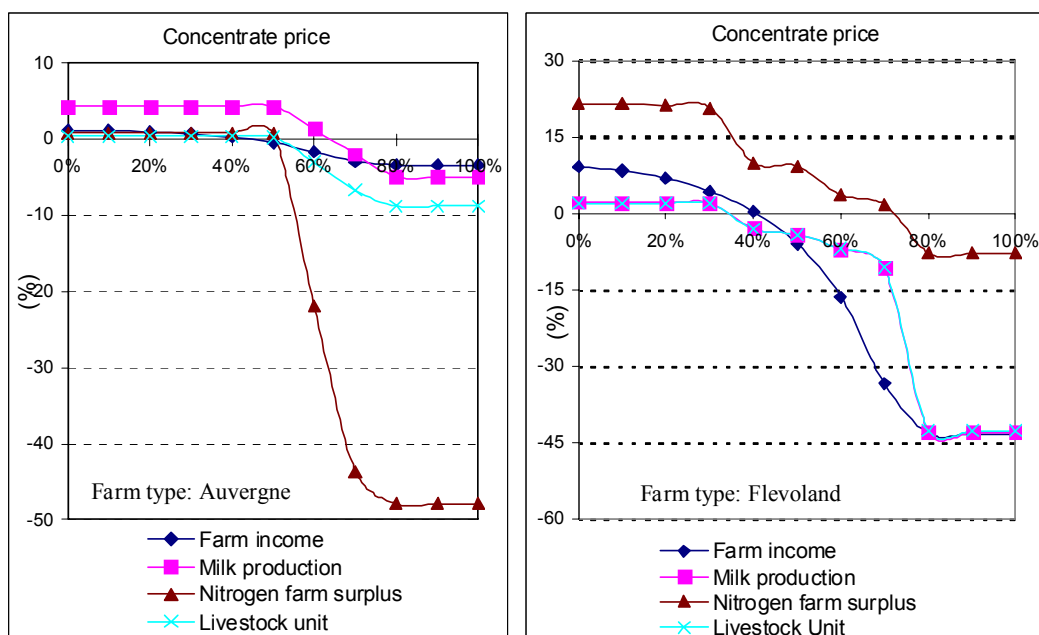

Figure 1. Change of farm income, milk production, livestock units and nitrogen surplus due to the increase of the milk quota and of the concentrate price (% change to baseline).

This case study shows that future policy and market changes may affect EU dairy farming differently depending on the characteristics of the prevailing farming systems. The application of this bio-economic modelling approach illustrates its potentials to integrate technical, economic and environmental knowledge and to make the policy debate on the CAP reforms more transparent thus contributing to well-informed decision-making.

References

- Andersen, E., *et al.*, 2007. *J. Environ. Manage.* 82: 353-362.
 Louhichi, K., *et al.*, 2007. A generic template for FSSIM for all farming systems, SEAMLESS PD3.3.11, 82 pp.
 Van Ittersum, M.K., *et al.*, 2008. *Agricultural Systems* 96: 150-165.

Dynamics of suckler cow farms under stochastic crop yields: A recursive discrete stochastic programming approach

C. Mosnier, A. Reynaud, J. Agabriel, M. Lherm
INRA, UR1213 Herbivore, 63122 Clermont-Ferrand, France
Contact: cmosnier@clermont.inra.fr

Introduction

Farming is inherently a risky business. Seasonal weather conditions and market prices account for important sources of variability, a variability enhanced by climate change. This changing environment challenges French suckler cow farmers¹ who continuously have to adapt their production management. These farms indeed rely on forage production which is very sensitive to weather conditions According to Boyer (2008), first recipients of the French fund for agricultural calamities are herbivorous farms, mainly because of drought on forage crops.

Different on-farm strategies can be used to manage weather risks. A previous work undertaken by Mosnier *et al.* (2008) focused on simulating production adjustments to crop yield shocks in those farms. However, this study did include neither farmers expectation regarding beef prices and crop yield variability nor their risk aversion. Two kinds of risks can be anticipated: embedded risks which occur when farmers plan to adjust their decisions following the realization of some uncertain events (such as for instance the possibility to use feed stocks or buy some feed when crop and pasture production are too low) and non embedded ones when farmers do not consider the possibility of mitigating risks impacts once the shocks have occurred. This study aims at better assessing how seasonal weather conditions affect farm outcomes, on both short and mid terms, by taking into account both risk anticipation and adjustment capacity.

Methods

Two well known modelling approaches can take into account embedded risks: Discrete Stochastic Programming (DSP) and Stochastic Dynamic Programming (SDP). Previous bio-economic livestock farm models using DSP approach are though limited by the number of decisions stages introduced and by their short time span (one year in the case of Lambert, 1989; Kingswell *et al.*, 1993; Jacquet & Pluvinage, 1997; Lien & Hardaker, 2001). Model size increases with the number of decisions stages considered. Livestock farm models using these SDP approach have to reduce the number of activities considered (Moxnes *et al.*, Kobayashi *et al.*, 2007): model size explodes with the number of dynamic variable. To overcome the modelling limitations, we propose to use a sequence of recursive DSP model as proposed by Blanco & Flichman (2001).

Our model is formulated to represent average French suckler cow farms which consist of beef cattle production based on a suckler cow herd and of grain and forage crop production. This production system must be managed monthly by a farmer in order to maximize their expected utility of profit over a 5-year planning horizon, under beef price risks and two annual weather-related embedded risks. We assume both inter-temporal preferences which favour present and regular income and a constant relative risk aversion. The recursive process is introduced so as that only decisions made during the current period are binding. Farmers are supposed to revise partly their plan each month, if new information becomes available. The bio-economic model is coupled with sub-models estimating pasture growth (Jouven *et al.*, 2006) and animal requirement according to their theoretical live weight (INRA, 2007). Our model is free to adjust diet composition and diet energy content for each kind of animals

¹ Suckler cows system consists of raising cows with their mother milks.

(the herd is divided into 12 annual animal classes) as long as intake capacity constraints are not exceeded and weight gains lie within an interval of plus or minus 10% of the theoretical ones. Herd size and herd composition are optimized too, thanks to the monthly sales of animals. Eventually, land allocation to forage and cereal crop production, haymaking, and feed stock management (purchase and sale) are chosen endogenously. Structural constraints such as land, labour and building, limit production possibilities. The model is parameterized in order to represent average suckler cow farms located in the north of Massif Central (an area famous for its Charolais beef production) that finish most animals, grow mainly pasture crops and also, to a lesser extent, cereal crops.

Results and discussion

We simulate a sequence of 60 years: the 10 first years correspond to average weather conditions (average yield over the period 1990–2006) and the subsequent 50 years to stochastic ones. Each year, values for stochastic variables are randomly drawn from a sample containing six states (defined upon observations over the period 1990–2006) that have the same probability. We suppose that states of crop prices, cereal and forage crop yields are linked. Farmers anticipate two states of weather condition and beef prices: a bad and a good ones equal to average observation minus or plus one standard deviation.

Preliminary results reveal firstly that, at equilibrium, production under risk is at the same level than without: the stocking rate is not lowered in order to constitute hay stock or to decrease farm exposure to production risk. Farmers indeed plan to sell less concentrate and buy some additional straw if some unfavourable weather conditions would happen.

Secondly, it appears that weather shocks of the previous year affect the production system the following years. When two bad years occur in a row, stocking rate drops even more during the second year. Taking into account explicitly the value of feed and animal stock variation into the calculation of profit enables to consider most of weather effects the year of the shock: when a good year occurs, feed stocks are built and during the bad one this stock is depleted. Good correlations between this calculation of profit and shock intensity are found. Eventually, very bad years damage more farm economic results than good years benefit them. Consequently, over the last 50 years time span, average profit is much lesser than the average one estimated for an average year.

References

- Blanco, M. & G. Flichman, 2001. Working paper, Institut Agronomique Méditerranéen, Montpellier.
- Boyer, P., 2008. Notes et Etudes Econ.
- INRA, 2007. Alimentation des bovins, ovins, caprins. QUAE, 307pp
- Jacquet, F. & J. Pluvillage, 1997. *Agric. Syst.* 53: 387-407.
- Jouven, M., *et al.*, 2006. *Grass and For. Sc.* 61: 112-124.
- Kingswell, R.S., *et al.*, 1993. *Agr. Econ.* 8: 211-226.
- Kobayashi, M., *et al.*, 2007. *Amer. J. Agr. Econ.* 89(3): 205-817.
- Lambert, D.K., 1989. *West. J. of Agr. Econ.* 14(1): 9.
- Lien, G. & J.B. Hardaker, 2001. *Eur. Rev. of Agr. Econ.* 28(1): 17-36.
- Mosnier, C., *et al.*, 2008. In: 12th Congress of the European Association of Agricultural Economics.
- Moxnes, E., *et al.*, 2001. *Ecological Modelling* 145(2-3): 225-241.

A dynamic bio-economic model to simulate optimal adjustments of suckler cow farm management to production and markets shocks

Claire Mosnier, Jacques Agabriel, Michel Lherm, Arnaud Reynaud
URH, INRA Clermont-Ferrand-Theix,
63122 Saint Genes Champanelle, France
Contact: claire.mosnier@clermont.inra.fr

Introduction

Tactical adjustments to seasonal weather conditions and beef price may generate additional incomes or avoid losses in French beef cattle farms. Due to the length of the suckler cow production cycle, adjustment decisions may impact not only on current production and profit but also on future farm outcomes. To better understand the consequences of shocks and subsequent production adjustments on the evolution of farm earnings and production over time, we built an original dynamic recursive bio-economic farm model. Some bio-economic models have already tested some tactical decisions on production but none has yet introduced simultaneously the possibility of adjusting herd size and herd composition, diet composition and diet energy content, as well as crop rotation, haymaking and feed stocks, taking into account both their short and long term consequences. This is the objective of the model developed here.

Methods

The model is formulated to represent average French suckler cow farms. Such farms consist of beef cattle production based on a suckler cow herd and of grain and forage crop production. This production system must be managed by a farmer over a finite horizon of T years. Each year starts in April at the beginning of the grazing season and is divided into monthly intervals.

The cattle herd is characterized by twelve annual animal classes which differ in age, sex and fattening or storage objective. Classes are described by two dynamic variables: the number of animals and their average live weight. These dynamics can be controlled by monthly decisions related to animal sales, diet, reproduction and rate of fattening. Concerning crop production, five feeds (grazed grass, hay, maize silage, grains and straw) can be produced from four different crop productions (permanent and temporary pasture, maize, two kinds of cereals). They are characterized by their qualities and their quantities. Feed quantities are dynamic variables as their values depend on balance between previous stock and decisions of produce consumed by the herd, produce purchased and sold. Grass production is calculated on a monthly basis thanks to an herbage growth model developed by Jouven *et al.* (2006) and filled with weather data from Nevers meteorological station (Météo France). Cattle production is parameterized for the Charolais.

Our model assumes that farmers make decisions to maximize their utility of net profit over a 5-year planning horizon. Introducing the utility function takes into account farmer inter-temporal preferences which may favour current or regular income. Net profit is defined as the difference between annual receipts (sales and Common Agricultural Policy - CAP- payments) and costs (variable and fixed). Moreover, it is assumed that farmers adjust their decisions when new information becomes available. This is modelled thanks to a recursive sequence of multi-periodic optimizations. Each optimization is reinitialized by incorporating dynamic variable values of the previous optimization and updated market, weather or CAP conditions.

Originalities of our model lie first in our specification of the production system. It indeed introduced a higher degree of flexibility than other bio-economic livestock models found in the literature. On the one hand, most dynamic bio-economic models allow animal diet composition to vary but dynamics of animal live weights remain exogenously given. To date,

these characteristics are fully endogenous only in Lambert (1989) and Kobayashi *et al.* (2007). However, live weight management is not individualized for the different kinds of animals whereas it might be of interest for farmers to favour for instance animals for sales. On the other hand, some models explicitly incorporate feed stock dynamics (Barbier & Bergeron, 1999; Louhichi *et al.*, 2004 etc.), but they concern dynamics of conserved forage. None of them have explicitly integrated standing grass biomass stock dynamics. This confers on our model possibilities of modulating forage use (grazing or haymaking) according to seasonal conditions, given that current use will affect future availability of hay and standing biomass. Secondly, like most of these models, decision variables are made to maximize a sum of discounted utility of annual gross margin. However, time preferences and farmer anticipations are explicitly taken into account. The recursive dynamic framework adopted gives us the possibility of simulating impacts of non-expected shocks on farmer decisions over both the short and the long term.

Results and discussion

Comparison of model outputs with a panel dataset of 25 farms over the period 2000-2006 demonstrates that it realistically predicts evolution of net profit, CAP subsidies, animal sales and adjustments of concentrate feed in the diet. Adjustments of pasture cut, crop product receipt, animal live weight and percentage of finished females point out some divergences due in part to better control of biological process in the model, to the absence of feed security stocks and to an unrealistically easy switch between several animal productions. The application provided here helps to understand how the different sources of adjustments – animal sales, crop product sales and purchases, animal diet, and haymaking – can be combined to face temporary crop yield and beef price shocks, and above all how the optimal mix is modified according to shock intensity. It can contribute as well to assessing the farm's capacity to handle shocks. However, 'ability to manage shocks or hazards is a complex function of existing behaviour that themselves represent long term or structural adaptation to predictable shocks, crisis behaviour and by external responses (policy) to a predicted and actual crisis. The next step will be to introduce risk anticipation in the decision sub model in order to study jointly shock anticipation decisions and shock adjustment decisions.

References

- Barbier, B. & G. Bergeron, 1999. *Agric. Syst.* 60: 1-16.
Jouven, M., *et al.*, 2006. *Grass and For. Science* 61: 112-124.
Kobayashi, M., *et al.*, 2007. *Amer. J. Agr. Econ.* 89(3): 205-217.
Lambert, D.K., 1989. *West. J. of Agr. Econ.* 14(1): 9.
Louhichi, K., *et al.*, 2004. *Anim. Res.* 53: 363-382.

Modelling Nitrogen balance for a regional scale livestock-pasture system as a discussion support tool

U.D. Nidumolu¹, M. Lubbers, V. Alary, P. Lecomte, H. Van Keulen
CIRAD, Département Elevage et Médecine Vétérinaire, Ile de la Réunion
Contact: uday.nidumolu@csiro.au

Introduction

Since the end of the 1980s, Réunion Island (located about 800 km east of Madagascar in the Indian Ocean) has developed intensive livestock farming in order to increase its self-sufficiency in food and to preserve agricultural employment. Although these objectives have been reached, considerable amounts of livestock effluent are produced. Because of the shortage of land suitable for spreading manure and the mismatch between the types of the manure produced and the needs of existing crops, livestock enterprises generate increasing risks of pollution. These include emerging conflicts with other activities, such as tourism, due to bad odour. Mastering the management of livestock wastes is, therefore, deemed necessary by local authorities (Aubry *et al.*, 2006). As argued by Flamant *et al.* (1999), the sustainability of livestock farming should be assessed primarily in relation to local conditions, as representations of visible or potential crises originating from conflicting interests of animal husbandry and other local activities with respect to land use. According to Thornton & Herrero (2001) and quoted by Aubry *et al.* (2006), the likely trends of smallholder crop-livestock systems development within the next 20–30 years will require models to enable analysis of these complex systems, assess their impacts, and help farmers improve their performances. Currently, there is a major concern regarding agri-environmental issues. Farmers are viewed not only as food suppliers but also as the custodians of the countryside. This role of farmers has been officially acknowledged in the EU Common Agricultural Policy (CAP) through a number of regulations that enforce agri-environment schemes and cross-compliance (Pacini *et al.*, 2004). A detailed study on the Nitrogen issues in livestock is given in a recent FAO publication (Steinfeld *et al.*, 2006). In keeping tune with this trend, in the development of the regional model the objective was more to calculate N as an environmental indicator which is introduced by two sources (i) by way of fertilizer for fodder requirements and (ii) by the manure excreted by the dairy animals.

Method

The model was developed in a linear programming with multi-purpose method. It was implemented under GAMS 'General Algebraic modelling system' with objective function which will be optimized by taking account of the different constraints existing on the farm and in the region where the model performed. These constraints include: land, labour, etc. Ksheera is a mechanistic model, using a normative approach (Janssen & Van Ittersum, 2007). It performs dynamically with a step of 6 months to calculate the objective function. The main objectives of the model are to optimize: (i) income, (ii) nitrogen excess, and (iii) labour hours. The classical one-dimensional approaches are less effective because of multi-parameters which should be taken into account before making decision. As the model uses a normative approach, the bench marking with the reality is difficult (Hazell & Norton, 1986). The comparison is based on a reference year and the validation was attempted for the first six months of this year. The error rate is less than 10%. Environmental policy is included in terms of N management and the indicator chosen is N contributed from the dairy farms per ha. For details of the model please refer to Nidumolu *et al.* (2008) and Nidumolu (2007).

¹ Current affiliation: CSIRO Sustainable Ecosystems/SARDI, Bldg 11a, Hartley Grove St, Waite Campus, Urrbrae 5064, South Australia, Australia.

Results and discussion

Based on the calculation for N (by way of fertilizer and manure) the following outputs are derived for the four sub-regions for Year 1 – Year 6 (for base scenario) and are given in the Table 1 below.

Table 1. Nitrogen (kg per ha) calculated from N in fertilizer and N in manure.

Year	Cafre	Joseph	Ouest	Palm
1	320	236	141	347
2	336	240	149	364
3	330	234	207	361
4	341	242	215	375
5	339	240	214	374
6	343	242	215	376

The sustainability of dairy farms will depend increasingly not only on profitable milk production but also on farmers' ability to comply with nutrient management regulations (Powell, 2003). The model calculates the N per ha by both fertilizer and manure. The innovation is the dynamism of the model (both land and animals) over a time-step of six months. By a logical extension of the dynamism of land and animals, the fertilizer use (and N use) and manure N excreted by animals is dynamic over the same time step. N in the context of Réunion is a management option than a modelling problem. Therefore, the idea is to use the results of the model in terms of N calculations to discuss N management options. The driving forces for discussing these options are EU Nitrate Directive, fertilizer costs, manure transportation issues, transformation options (compost for ease of transport, efficiency etc) and manure as a source of energy. The management options are discussed based on the empirical values calculated by the model.

References

- Aubry, C., *et al.*, 2006. *Agricultural Systems* 88: 294-315.
- Flamant, J.C., *et al.*, 1999. *Livestock Production Science* 61: 275-286.
- Hazell, P. & R.D. Norton, 1986. *Mathematical Programming for economic analysis in agriculture*. MacMillan, London, 400 pp.
- Jansen, S. & M.K. Van Ittersum, 2007. *Agricultural Systems* 94: 622-636.
- Nidumolu, U.B., 2007. Report on the EU Marie Curie 'MODLAIT' project at CIRAD EMVT - Pole Elevage, Saint Pierre, La Réunion 2005-2007, 120 pp.
- Nidumolu, U.B., *et al.*, 2008. In: *Proceedings of Australian Agronomy Conference*, 21-25 September 2008, Adelaide.
- Pacini, C., *et al.*, 2004. *Agriculture, Ecosystems and Environment* 102: 349-364.
- Powell, M., 2003. U.S. Dairy Forage Research Ctr., Madison, WI.
- Steinfeld, H., *et al.*, 2006. *Livestock's Long Shadow: Environmental Issues and Options*. FAO Publication, Rome. P 408.
- Thornton, P.K. & M. Herrero, 2001. *Agricultural Systems* 70: 581-602.

Linking cropping systems models with farm bio-economic models to examine the relationship between profit and natural resource condition

Michael J. Robertson, Andrew Moore, Andrew Bathgate
CSIRO Sustainable Ecosystems, PMB 5, PO Wembley, WA 6913, Australia
Contact: Michael.Robertson@csiro.au

Introduction

Natural resource indicators are used by catchment management organizations (CMOs) in Australia as targets for land use management. However, the nature of the trade-off function between natural resource management (NRM) outcomes and whole-farm profit is ill-defined. Defining the function will assist CMOs and farmers to evaluate the achievability of particular targets, and help determine the size of economic incentives required to offset any expected loss in farm profit associated with meeting targets. More generally, it will also allow for quantification of the NRM impact of broadacre farming and the scope for more positive NRM outcomes through changes in land use and management.

This paper brings together two modelling approaches to address the challenge of defining NRM-profit trade-offs. Dynamic biophysically-based simulation models of agricultural systems, such as APSIM (Keating *et al.*, 2003) and GRAZPLAN (Donnelly *et al.*, 2002), can produce estimates of production, soil states and processes in relation to weather and management and are commonly applied at point (i.e. field) scale. Whole-farm linear programming models, such as MIDAS (Kingwell & Pannell, 1987), represent the biological, physical, technical and managerial relationships of a mixed farm that is representative of production systems within a defined region. The MIDAS model allocates available resources in order to maximize the objective function of whole-farm profit, subject to resource, environmental and managerial constraints.

In this paper, we use the biophysical models to derive values for NRM indicators (leakage, bare ground) under a range of land uses and use these in MIDAS to explore the trade-offs between profit and the indicators when subject to a range of constraints. The analysis was conducted in two contrasting mixed farming regions in the cereal-livestock zone of Australia to explore potential regional differences in the trade-offs.

Methods

Versions of the whole-farm economic model, MIDAS have been developed for each of the southern mainland states of Australia. Versions representative of two contrasting regions were used in this analysis. In one, from the Mediterranean systems of Western Australia, farming systems are dominated by cereals, oilseeds, grain legumes and sheep production from annual pastures. In the other, from the uniform rainfall zone in southern New South Wales, farming systems have similar proportions of cropping and pastures, including the perennial pasture species, lucerne.

APSIM and GRAZPLAN biophysical sub-models were linked into a soil-crop-pasture-animal model and simulations were conducted for all possible rotations of crops and pastures on all soil types in each MIDAS model. The large set of simulations required was generated automatically from a much smaller set of templates and executed on several hundred computers that were managed with the Condor CPU cycle-harvesting software. Rotations were simulated over 100 years of historical daily climate at both locations using realistic management settings extracted from MIDAS (e.g., N fertilizer rates, stocking rates, flock structure, grazing management). Simulated yields and pasture utilizations were checked for consistency against those in MIDAS and were generally realistic. For each rotation x soil type combination, long-term mean values of the NRM indicators were calculated for: water leakage (mm yr^{-1}) and nitrate leaching (kg N yr^{-1}) below the root zone, ground cover (live

and dead plant cover), and rate of change in soil organic carbon in the 0-10 cm layer. Ground cover was expressed as the proportion of days where cover was less than certain thresholds.

Values of the NRM indicators for each rotation and soil type were entered into MIDAS. The following sensitivity analyses were then run:

1. Holding the value of the indicator constant at a range of levels and optimizing for whole farm profit. Plotting the value of optimum profit against each NRM indicator level enabled the profit-NRM indicator response to be described.
2. Holding the percentage of the farm under cropping constant at a range of levels and deriving the NRM indicator obtained when whole-farm profit was optimized. By plotting the resulting NRM indicators against percentage crop, the influence of enterprise mix (crop vs. livestock) on NRM indicators was examined.

Results and discussion

This analysis is the first of its type to combine biophysical data on NRM indicators within a whole-farm economic model. It revealed a number of points:

- Win-wins are possible in the system where gains in the indicator (e.g., less leakage) are matched by improvements in whole-farm profit.
- Trade-off situations are also apparent and in the case of leakage the ability to improve the NRM indicator is dependent upon the availability and profitability of perennial pastures, such as lucerne. In some cases substantial profits will have to be foregone to reach NRM targets.
- NRM indicators vary in terms of their responsiveness to enterprise mix, with groundcover less responsive than leakage.
- NRM indicators can respond negatively, positively or neutrally to changes in enterprise mix, highlighting that NRM is a multi-dimensional concept.
- Methodological challenges include ensuring that simulated plant production from the biophysical models is similar to that in the whole-farm model; the computational challenge of simulating a large number of rotation × soil type combinations; and maintaining the rank order of soil type 'performance' in both types of model.

These analyses will be useful in the quantification of the NRM impact of broadacre farming and the scope for more positive NRM outcomes through changes in land use and management. More complex analyses will be required to consider optimization where more than one NRM indicator is being considered

References

- Donnelly, J.R., *et al.*, 2002. *Agricultural Systems* 74: 115-139.
- Keating, B.A., *et al.*, 2003. *Eur. J. of Agronomy* 18: 267-288.
- Kingwell, R.S. & D.J. Pannell (Eds), 1987. *MIDAS, a bioeconomic model of a dryland farm system*. Pudoc, Wageningen.

Adoption of new forage technology: Impact on the socio-economic sustainability of milk production in Moc Chau, Vietnam (DAIVIE model)

P. Salgado, M. Lubbers, R. Schipper, H. Van Keulen, V. Alary, P. Lecomte
 CIRAD, UPR Systèmes d'élevage, Montpellier, 34398 France
 Contact: paulo.salgado@cirad.fr

Introduction

In Vietnam, livestock make up about 30% of the total agricultural products and is a strategic policy of the Vietnamese government due to its potential contribution to employment creation and income generation. As many countries in Asia, Vietnam does not have a dairy tradition. However, with the changes of food habits, the consumption of dairy products significantly increased. The 100,000 dairy herds produced approximately 235,000 tons of milk in 2007 which satisfies 30% of the domestic consumption. Even if there are real opportunities for dairy development in Vietnam, there are still major constraints including low management skills of farmers, lack of suitable forage resources for cattle feeding and high cost of concentrated feeds. New policies and agricultural innovations are being proposed in order to solve the main issues related to the sustainability of the dairy sector. Agronomist researchers provided alternative solutions using new forage technologies based on temperate forage species. The first questions are: which are the good decisions to be implemented? How to assess and evaluate the impacts of agricultural innovations? For this type of exercise, modelling appears as an interesting decision tool because it helps to assess the complex interactions found in the farm system as well as to analyse the configuration of alternative technical innovations (Louhichi *et al.*, 2004).

Methods

Participatory methods were employed to analyse the farming systems and establish appropriate research and development activities. The first priority was to test and select alternative forage plants, namely temperate species, which are resistant to cold temperatures and able to produce enough quantity and good quality grass during winter. The forage experiments were carried out under normal farming conditions and monitored by a team composed of farmers, extension workers and researchers. Periodic surveys and meetings were conducted to measure and observe species adaptation and evolution and, further, served as a platform for discussion and evaluation process.

An exhaustive assessment survey with 120 representative dairy farms of Moc Chau district was carried out in 2006 in order to establish a farm typology (Warter, 2006). Three main criteria were selected: soil quality, herd dimension, and experience of farmers in dairy activity. The adoption of temperate forage species by farmers started in 2004. In order to assess and evaluate the impact of the new forage technology adoption, the modelling approach was used. A descriptive farm-level linear programming (LP) model was created under GAMS (General Algebraic Modelling System) using a bio-economic and integrative approach. The stake of the model was to develop the essential interrelationships between animal nutrient requirements and farm feed (nutrients) supplies related to profit maximization. Two indicators (profit and labour time) were selected to evaluate the impact of the forage

Table 1. Socio-economic impact of oat adoption in average farm types.

Typology criterion	No adoption		Oat adoption		Difference (%)	
	profit (€)	labour	profit (€)	labour	profit	labour
Soil fertility	17,118	20	18,994	27	+11	+35
Experience	21,627	27	25,321	37	+17	+37
Herd dimension	14,859	19	17,009	25	+14	+32

innovation on the socio-economic sustainability of dairy farms. Using this mathematical and data-processing tool, it will be possible to identify and confirm the factors constraining the adoption of the new forage technology and tackle the question of the socio-economic sustainability of farms.

Results and discussion

The *Avena* species (oats) proved to be the best solution in terms of agro-ecological adaptation, high production yields, excellent nutritive value and low production costs. In addition, the use of oats allows regular production of milk throughout the lactation period. In the first year of the scaling-up experiments (2004), 2.0 ha of temperate forage species were planted in Moc Chau dairy basin by 36 farmers. Two years later, the area for oat production was about 60 ha and more than 140 farmers (28% of total farmers) were involved. However, the opinion of few farmers related to the potentialities of temperate forage evidenced some dissatisfaction judgments which possibly influenced further adoption. The reasons used by farmers to justify their no-adoption includes: low growth capacity of oat in poor soils; insufficient number of harvest periods; high input costs; labour-intensive. In order to realize the importance of these adoption factors we create a multi-period farm-scale model (DAIVIE). The DAIVIE model evaluate the impact of oat forage adoption, over the profit (total income – total costs), labour time and more generally on sustainability of farms in Moc Chau dairy basin. The model takes into account the interactions between the different components of the farm system (forage, feeding, and livestock) and the market as well as between the past and present decisions in which effects will have an impact in the future (Alary, 2000).

In all the tested scenarios the model selected the oat production as the optimal solution to maximize farmer profits. This selection confirms the observations in the field concerning the economic interest of oat use during the winter period. The results obtained for the total profit (8 years) and labour time (days/month) in average farm types are presented in Table 1.

The model showed that the adoption of oat forage will lead to an increase in the farmer's income. This is directly related to an increase in the selling of milk and young animals, as well as the reduction in the feeding costs. However, the amount of increase depended on the typology and farm type used. The impact of oat forage adoption for the farmers is an increase in labour time during the winter period. According to the model results, the experience of farmers in dairy activity and the dimension of their herd did not seem to be crucial factors for the adoption of the oat technology. On the other hand, the forage yields and the additional labour needed are likely the main issues constraining the successful adoption of oat by dairy farmers. These results are in total agreement with previous field evaluation process (Salgado, 2008). Almost all farmers declared that the technical protocol for oat production is rather simple and do not pose difficulties even for farmers with less experience in dairy breeding. For labour requirements, it is important to note that during the winter period farmers are engaged in other activities in addition to milk production. Farmers' decisions are governed not only by productivity considerations but also by other factors, such as traditional practices and cultural preferences. The introduction of labour-intensive technologies will result in higher costs for hiring agricultural workers to perform additional tasks and in some cases farmers are not interested to hire labour.

Finally, DAIVIE model conceptualization illustrates the importance of the interdisciplinary work between modellers, agronomist and socio-economist researchers in order to obtain an accurate mathematical approach and a fine representation of a dairy farm system.

References

- Alary, V., 2000. L'harmattan, Paris, 236 pp.
- Louhichi, K., *et al.*, 2004. Animal Research 53: 1-19.
- Salgado, P., 2008. Rapport scientifique, CIRAD, Montpellier, 95 pp.
- Warter, J.L., 2006. Rapport de stage ISTOM, 57 pp.

Integration of biophysical and economic models for spatially explicit land use and landscape analysis on farm level

Martin Schönhart, Thomas Schauppenlehner, Erwin Schmid
Department of Economics and Social Sciences, BOKU Vienna, 1180 Vienna, Austria
Contact: martin.schoenhart@boku.ac.at

Introduction

According to Keating & McCown (2001), two key components constitute agricultural systems: the 'biophysical production system' and the 'management system'. Integrated land use modelling aims at the acknowledgement of both by increasingly combining biophysical and economic models that are frequently connected via GIS-tools to make them spatially explicit. Such model system is expected to deliver more accurate results while at the same time permit interdisciplinary research questions to be solved (Antle *et al.*, 2001). Comprehensive *ex-ante* assessments of land use changes and induced effects to the natural and social environment become feasible. Nevertheless, exact definition of interfaces between data and models as well as consistency criteria for data and model integration are one of the biggest challenges faced by modellers.

In this article we present such integration procedure, its challenges and trade-offs for a modelling system containing the land use model FAMOS[space] and the biophysical process model EPIC (Williams, 1995). Spatially-explicit data on field scales are available and build the fundament for both models. This system is developed to analyse land use and landscape changes by developing a set of alternative policy scenarios as well as to assess production and environmental impacts of agricultural systems in the Austrian 'Mostviertel Region'.

Methods and data

FAMOS [space] is an integer programming model at farm scale with spatial contexts. Land use and production decisions at field-scale are modelled at the farm level by maximizing total gross margins. Important decision variables encompass choices in crop and livestock production, crop rotation, tillage systems, animal housing systems, input intensities, farming systems (i.e. organic or conventional farming), and environmentally friendly management measures (e.g., winter cover crops). A key feature of the model is the acknowledgement of historical farm-specific production patterns in animal and crop production, e.g., crop rotations. Crop yields and environmental impacts of agricultural systems are simulated with EPIC for each site (e.g., field) and are integrated into FAMOS[space]. A site represents homogeneous soil and topographical conditions. Furthermore, landscape structures are assessed via landscape metrics.

The site data represents field properties which emerge through integration (e.g., zonal statistics) of various data sources, e.g., digital soil map, land use map, and elevation map, weather data, crop management data. Like in other land use models, soil is regarded as 'integrated landscape element' (Frede *et al.*, 2002). Land use data are also describing the geography of the fields and are taken from the INVEKOS-GIS data base of the Austrian ministry of agriculture (BMLFUW).

Results and discussion

In a first model run, we applied the model system (EPIC and FAMOS[space]) to a typical farm (arable land: 14 ha, grass land: 12 ha) in our project region 'Mostviertel'. We used EPIC to simulate crop and straw yields, soil sediment loads, and soil organic carbon (SOC) for different sites and alternative productions systems and over a period of 10 years. Figure 1a shows average SOC for the topsoil (0.3 m). As expected, for all CR removing of straw from the field leads to lower average SOC contents on average. Although sites are quite similar on this farm, variations in crop yields can be observed (compare to Figure 1b).

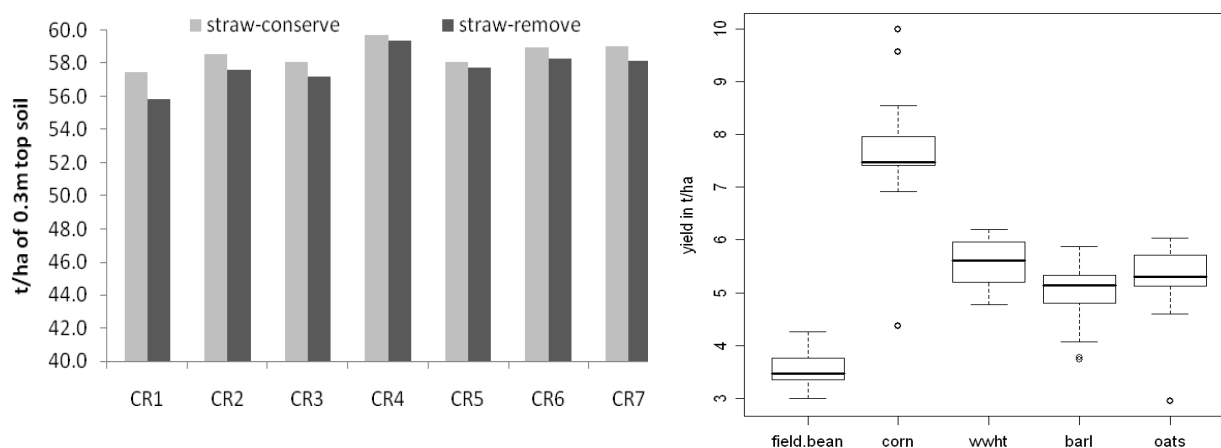

Figures 1. Variation in average SOC for different crop rotations (CR) and straw management systems (a) and variation in crops yields (t dry matter ha⁻¹) for different arable crops (b).

The EPIC output is available in flat file structure and needs further processing to input in FAMOS[space]. Therefore, a data interface was developed to transform EPIC output data to a relational database. Table 1 presents various figures which are outputs of FAMOS[space]. Under current production conditions, the farm can generate 29,800 € of total gross margins from animal and plant production as well as agricultural subsidies. Straw from grain production can be sold or used in animal production systems. Without application of organic fertilizers, this may cause SOC depletion over the long run. As counter measure, we introduced an environmental payment for arable land subsidizing straw conservation. Depending on the subsidy level, increasing farm incomes are accompanied by potentially higher SOC-contents and shifts in the CR-system.

Table 1. Farm management strategies and average SOC for different SOC-subsidy levels.

SOC-Subsidy (€/ha)	Farm income (€)	Straw-Management	weighted SOC (t/ha)	CR1 (ha)	CR5 (ha)	CR6 (ha)
0	29,800	straw removed	56.61	9.7	0.6	3.8
100	29,800	straw removed	56.61	9.7	0.6	3.8
150	30,500	straw conserved	58.74	-	10.4	3.8
200	31,300	straw conserved	58.74	-	10.4	3.8

This straightforward application of the model system (EPIC and FAMOS[space]) gives insights into model features and challenges of model development. Foremost, the trade-off between variation in model input data and model complexity has to be solved. The combination of five soil classes, two management strategies, and seven CR already results in 70 EPIC runs. Still, more detailed variations in soil slope classes as well as management strategies are necessary. Next steps in model development will be the specification of environmental payment programs, the linkage of GIS and economic data and the integration of further environmental indicators. In the final paper, the application of the model system will cover the analysis on the landscape level in the 'Mostviertel Region'.

References

- Antle, J.M., *et al.*, 2001. *Ecosystems* 4: 723-735.
- Frede, H.-G., *et al.*, 2002. *Journal of Plant Nutrition and Soil Science* 165: 460-467.
- Keating, B.A. & R.L. McCown, 2001. *Agricultural Systems* 70: 555-579.
- Williams, J.R., 1995. In: Ed. V.P. Singh, *Computer Models of Watershed Hydrology*. Water Resources Publications, Colorado, pp. 909-1000.

A bio-economic model to analyse the performance of the cotton sector in Mali

B. Traoré, K. Louhichi, B. Rapidel
Institut d'Economie Rurale (IER), Mali
Contact: boubasiditraore@yahoo.fr

Introduction

Mali's cotton production was doubled and nears record levels in the last decade attributed to the increased planted area, as well as favourable weather and few pest problems. However, this record was not followed by an improvement of cotton productivity (i.e. yield's level) which practically stagnated since several years (IER/CMDT/OHVN, 1998). This condition, overlapped with the increase of world cotton price (Nubukpo & Keita, 2006) and the volatile of the input price due to a number of reasons among others the rise of petrol prices, has led in the last years to a drop of farm income in most of the cotton farms. To enhance farms performance and support farmers and policymakers to design the future strategies to adopt face this new context, an *ex-ante* assessment could be very useful. The objective of this paper is to contribute on this issue by assessing the impact of this conjunction of factors on farm income, land use and cotton production and to anticipate the effects of the likely management strategies to adopt in this context. This impact assessment is performed through a generic bio-economic farm model developed within the EU FP6 SEAMLESS project. This model is applied in a set of farm types representative of the cotton farm in the Sikasso Malian region.

Methodology

The used method is based on the bio-economic farm model 'FSSIM' (Farm System Simulator) developed within the EU FP6 SEAMLESS project to assess the economic and environmental impact of agricultural and environmental policies and technological innovations (Louhichi *et al.*, 2007). The principal specifications of this farm model are: (i) a static comparative model with a limited number of variants depending on the farm types and conditions to be simulated; (ii) a risk programming model with a basic specification relating to the Mean-Standard deviation method in which expected utility is defined under two arguments: expected income and risk; and (iii) a positive model in the sense that its empirical applications exploit the observed behavior of economic agents and where the main objective is to reproduce the observed production situation as precisely as possible. For our case study, FSSIM model was calibrated using average farm data collected through a farmer survey carried out in a sample of cotton farms. FSSIM was applied on a set of farm types in order to explore farmer's response to change on the market conditions, particularly the increase of input and output prices, and to simulate the impact of some agro-management strategies developed recently to handle the problem of market instability and yield stagnation. In this paper we show the results of only one policy scenario combining a 15% decrease of the producer cotton price and a 23% increase of the nitrogen fertilizer price. This policy scenario was compared to a 'status quo' scenario representing the current situation.

Results and discussion

The model was applied to the three identified farm types, however, for several reasons we have decided to show in this paper the results of only one farm type called 'large farm'. The main characteristics of this farm type are an extensive agro-sylvo-pastoral system based on cotton crop grown on biennial and triennial rotations and a farm size around the 12 ha. The results of FSSIM calibration in the selected farm type was compared to the reference run. It shows that the model reproduce approximately the real decision-making process of farmers, for both the bio-technical management and the economic results. Indeed, the percent deviation

between the observed and the simulated area of the principal crops such as cotton, sorghum, millet and mani does not exceed 2%. The only difference was represented by the substitution of groundnut by maize which is overestimated. However, it is necessary to recall that only the current cropping techniques were taken into account in the calibration phase. Farmers and researchers have approved the results of the calibration phase and have judged positively the model quality.

After model calibration and validation, we started simulation by dropping 15% the cotton producer price and increasing the nitrogen fertilizer price by 23%. The results of this simulated scenario are shown in Table 1, in comparison to reference run.

As expected, the conjunction of the increase of nitrogen fertilizer price and the decrease of cotton producer price have systematically involves the reduction of allocation area reserved for the cotton crop and maze-bean (mani) association. The cumulated effect of these two scenarios gives similar results to the effect of each scenario tested separately. Any time, the reduction of cotton area is more significant in the combined effect. The income seems to be less affected that is certainly explained by the increasing of allocation area reserved for maze and mile which made it possible to deaden the negative effect. In all cases, the sorghum allocation varied very little.

Table 1. Impact of the change on cotton and urea prices on land use and farm income in the large farm type.

	Crop allocation					Farm income (€)
	Mani	Cotton	Maze	Mile	Sorghum	
Reference run (%)	9.10	28.93	12.38	32.20	17.39	2313
Dropping of cotton price of 15%	-0.72	-2.82	3.30	1.20	-0.95	-4.8
Raising of N fertilizer price of 23%	-2.26	-0.30	-0.31	1.65	1.22	-1.5
Cumulated effect of two variables	-1.26	-3.50	4.16	1.92	-1.32	-3.01

In farmer's opinion, these results correspond to their rotation management strategy which according to external pressures gives priority to the cereals which make it possible to ensure family consumption. Farmers prefer to decrease the allocation reserved for the cotton crop which is consuming much nitrate fertilizer.

Reference

- IER/CMDT/OHVN, 1998. Mémoire de réunion de concertation sur la baisse de rendement de la variété NTA 88-6 au cours de la campagne 97/98. Institut d'Economie Rurale, Tarla, Mali.
- Louhichi, K., *et al.*, 2007. A Generic Mathematical Programming Model (FSSIM-MP) for farming systems analysis. Farming System Design 2007, Catania, Italy.
- Nubukpo, K. & M.S. Keita, 2006. Cahiers Agricultures 1(15), janvier-février 2006.

Exploring production-theoretical insights for economic-environmental trade-off analysis

J. Van Meensel, L. Lauwers, G. Van Huylenbroeck, S. Van Passel
ILVO – Social Sciences Unit
Burg. Van Gansberghelaan 115, 9820 Merelbeke, Belgium
Contact: jef.vanmeensel@ilvo.vlaanderen.be

Introduction

Decision making becomes more and more complex for farms. On the one hand, farms have to keep competitive under strengthening competition. On the other hand, the internalization of environmental effects forces farms to take into account environmental performance.

In order to provide better guidance for improving economic and/or environmental performance, the trade-off between both performances has to be explored. Trade-offs can be positive or negative. A positive trade-off implies that economic and environmental performance improve simultaneously. A negative trade-off implies that economic performance improves, while environmental performance diminishes or vice versa.

The objective of this paper is to provide a framework for economic-environmental trade-off analysis. The framework provides a reference basis for evaluating in a consistent manner the effect of different types of measures influencing economic and/or environmental performance.

Methods

Based on a literature review, various economic-environmental trade-off paradigms and theories are combined and different trade-off measures are put forward. The trade-off between economic and environmental performance is typically presented by the marginal abatement cost (MAC) curve that links a firm's emission level to the cost of additional units of emission reduction (McKittrick, 1998). Conventional theory bases the MAC curve on the assumptions that production and pollution abatement are separable and actual production is efficient. These assumptions imply that a firm can control its emission by either investing in pollution control equipment or by reducing output.

Numerous authors argue that conventional assumptions underlying abatement cost analysis provide too little flexibility to describe accurately economic-environmental trade-off possibilities. Hill *et al.* (1999), for example, distinguish three main stages in the process of farm level transition to environmentally sound production practices: (1) efficiency improvement, (2) substitution of inputs or production processes and (3) redesign, that is, output reduction or the use of new or additive technology for environmental purposes.

For our research, we distinguish between integrated and additive trade-off measures¹. While integrated measures address input-output transformation and the relation with negative externalities and profit generation, additive measures aim at pollution abatement after externalities have already been generated. Since additive measures are costly, they always imply a negative trade-off, improving environmental performance and diminishing economic performance. Some integrated measures, however, imply a positive trade-off.

In order to analyse besides additive also integrated trade-off measures, production-theoretical foundations of input-output transformation and the link with economic and environmental performance have to be elaborated. Production, profit and emission functions that are theoretically consistent are constructed, taking into account the materials balance principle for pollution. Numerous textbooks (e.g., Varian, 2003) describe the relationship

¹ Rennings (2000) also distinguishes between integrated and additive measures but only focuses on measures that improve environmental performance, without considering economic performance.

between production, (marginal) costs and (marginal) revenues and economic performance. We construct a similar linkage between production and environmental performance (Figure 1).

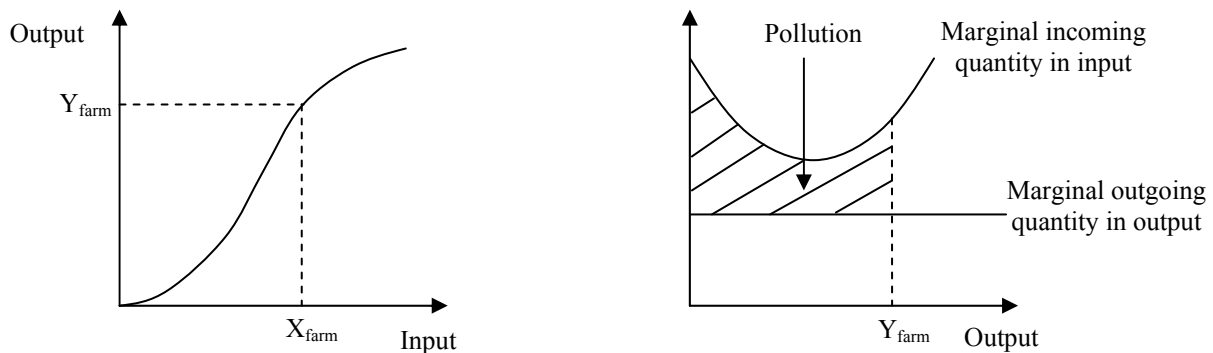

Figure 1. Production and environmental performance of a farm.

Results and discussion

The relation between production, economic and environmental performance constitutes a framework for analysing besides additive also integrated trade-off measures. Consider for example efficiency improvement. It is shown that a technical efficiency improvement always implies a positive economic-environmental trade-off. Input re-arrangement implies a positive or negative trade-off, depending on the input-output technology of the farm, the input combination the farm is currently using and the proportions of respectively input prices and environmental coefficients of inputs. A similar reasoning applies to output re-arrangement.

Farms exhibiting economies of scale can increase their economic performance through scaling up. This increase in output, however, results in more pollution (cf. Figure 1), so there will be a negative economic-environmental trade-off. Vice versa, farms exhibiting diseconomies of scale can increase their economic and environmental performance simultaneously through scaling down. Consequently, a positive trade-off is established.

Certain measures, like improving output quality or buying the same inputs at lower prices, improve economic performance, without affecting environmental performance. Contrarily, using the same inputs, but with less harmful impact on the environment, results in a better environmental performance without influencing economic performance.

References

- Hill, S.B., *et al.*, 1999. *Agriculture, Ecosystems and Environment* 73: 107-110.
 McKittrick, R., 2002. *Journal of Environmental Economics and Management* 37: 306-314.
 Rennings, K., 2000. *Ecological Economics* 32: 319-332.
 Varian, H.R., 2003. *Intermediate microeconomics: A modern approach*. W.W. Norton & Company, London, 688 pp.

A whole farm simulation model to improve multi-criteria system efficiency

J. Vayssières, M. Vigne, V. Slegten, P. Lecomte
CIRAD Département ES, Station de Ligne Paradis,
7 Ch. de l'IRAT, 97410 La Réunion, France
jonathan.vayssieres@cirad.fr

Introduction

World population is expected to increase by about 40% in just over 40 years. An obvious question is “How are we going to satisfy food requirements while preserving the environment”? The answer to this question can at least partly be found in the concept and practice of ecological intensification. It seeks to increase the efficiency of resources use in agricultural systems. Taking the example of dairy farming systems in Réunion tropical island we examine how a whole farm model can be used to design more sustainable and efficient farms.

Methods

A wide variety of separate crop and livestock models exists, but integrated crop–livestock simulation models are comparatively under-developed (Thornton & Herrero, 2001). GAMEDE is a simulation model that represents dynamically the whole dairy farm functioning. It is composed of two sub-systems: (i) a decision system that simulates management actions performed by the farmer on a daily basis, and (ii) a biophysical system that simulates consequences of these actions on daily biomass flows and main ecological processes (crop growth, livestock production, manure conditioning). The model calculates numerous technico-economic, social, and environmental indicators. Environmental indicators are based on (i) ‘farm gate balance’ methods: the apparent nitrogen surplus and efficiency (Nevens *et al.*, 2006), and (ii) ‘life cycle analysis’ methods: the energy balance and efficiency (Bochu, 2007). The model’s detailed description and evaluation is proposed in a separate paper (Vayssières *et al.*, 2009).

Inspired by participative modelling approaches around multi-agent systems (Antona *et al.*, 2005), GAMEDE has been designed and used with six farmers chosen to represent dairy system diversity in Réunion. The model is not used to assess the impact of policies but rather to describe practices, to analyse differences in efficiency and to test *ex-ante* improvement solutions, directly with farmers (Carberry, 2002). Value of computer-generated quantitative information in farmers’ decision-making was assessed by qualitative interviews conducted by an external observer (Kerdoncuff, 2007).

Results and discussion

One of the six farms is used here to illustrate GAMEDE’s relevancy to explore ‘hypothetical’ options. Farm 2 can be considered as an average farm in terms of technical and environmental results. Starting from a project of the farmer, ‘the building of cow cubicles’, we considered a serial of hypothetical scenarios. The three most relevant are presented here (Table 1).

- Scenario 1. With cubicles, cows’ pastures would be converted into silage grasslands because animals could stay in the barn all the day. The surplus and more concentrated organic fertilizer available would allow the farmer to stop mineral fertilizers without reducing land productivity and with still an overall silage surplus.
- Scenario 2. This surplus of silage would be used to replace a part of imported forages. Moreover we realized, from the model dynamic representations, that some pastures were under-exploited with the actual rationing practices. A reduction of concentrate quantities distributed to heifers and dry cows would allow a better valorization of these pastures without affecting weight of replacement animals and then milk production of descendent cows.
- Scenario 3. Reduction of calving interval is also an alternative to improve farm efficiency.

Table 1. Effects of different practice changes on sustainability indicators of farm 2.

Scenario	Land eff. (UFL/ha / yr)	Work efficiency (€/ h)	Concentrate efficiency (milk L/ kg FM of conc.)	Nitrogen efficiency (Dmnl)	Energy efficiency (Dmnl)	Work time (h/ w)	Gross Margin (€/ yr)
0. actual practices	4 600	13.8	1.16	0.26	0.35	85.1	61 300
1. better valorization of on-farm produced organic fertilizers	+ 10	- 8.5	0	+ 24	0	+ 8	0
2. better valorization of on-farm produced forages	+ 1	+ 14	+ 8	+ 9	+ 6	- 2	+ 13
3. improvement of herd reproduction performances by 5%	- 2	+ 7	+ 1	+ 7	+ 3	0	+ 6
Total effect	+ 9	+ 12.5	+ 9	+ 40	+ 9	+ 6	+ 19

Values of Table 1 are calculated with GAMEDE and are means for the 2004-2006 period. Except for the first line (scenario 0.), which is in absolute value, all values are percentages of variation of farm results with reference to values of scenario 0.

As described for farm 2, interactive simulations have shown that farmers can improve the efficiency of their systems just by changing their day to day management practices. Contrary to preconceived ideas, environmental impact of dairy farming systems can be reduced while maintaining or improving farmers' revenue. In fact, the principal limitation to the adoption of these "environmentally friendly practices" is not economical but social: the work time surplus that is required.

Three of the six farmers involved in the project have adopted more efficient practices found during interactive simulations. The others have stopped dairy activity, mainly for economical reasons, while no solution was found to improve the efficiency of their farm in the respect to their workload capacity. In both cases, farmers have attached importance in their decision making to representations produced during GAMEDE design and simulations. The interactive simulations were certainly limited to six farms but diffusion of participative methods and systemic knowledge has been quick and wide. Today, one year after the participative modelling experience, extension services plan farmers meetings similar to the ones organized around the model and they now consider the family objectives and labour ability as important aspects to be taken account in reasoning advice to farmers. Moreover the dairy sector now defends farming system diversity, whereas till two years ago it had a Dairy cooperative prescribed unique model, because indicators regarded by advisers are not only the production but also the global efficiency of the system.

Using the type of tool proposed in this study directly with producers could be an alternative to environmental policy directives (often badly accepted by farmers) to identify and promote environmentally friendly practices adapted to each farm specificity. This approach is especially relevant in developing countries, where agricultural policy and control are less operational than in Europe and where many smallholder farming systems rely on crop-livestock interactions.

References

- Antona, M., *et al.*, 2005. *Nature Sciences et Sociétés* 13: 165-168.
 Bochu, J.L., 2007. Rapport scientifique. ADEME, 248 p.
 Carberry, P.S., *et al.*, 2002. *Agricultural Systems* 74: 141-177.
 Kerdoncuff, M., 2007. SUPAGRO. Montpellier, 60 pp.
 Nevens, F., *et al.*, 2006. *Agricultural Systems* 88: 142-155.
 Thornton, P. & M. Herrero, 2001. *Agricultural Systems* 70: 581-602.
 Vayssières, J., *et al.*, 2009. *Agricultural Systems*. (submitted)

Theme B
State-of-the-art of components for integrated systems

Session B5: Integrated assessment methods for regional and landscape levels

Session organizers:

John Antle

Montana State University, USA

Daniel Auclair

INRA, Montpellier, France

Integrated assessment modelling: How to assess regional impacts?¹

J.J. Stoorvogel

Land Dynamics Group, Wageningen University,
P.O. Box 47, 6700 AA Wageningen, The Netherlands
Contact: jetse.stoorvogel@wur.nl

Introduction

The Kenyan government identified in its strategy to revitalize Kenyan Agriculture numerous possible interventions to combat soil fertility decline (Government of Kenya, 2004). However, the document does not include an analysis of the potential impact of these interventions. The 2003 reform of the European Common Agricultural Policy (CAP) fundamentally changes the support of agriculture in Europe (Osterburg *et al.*, 2007). Although the changes aim to support landscape functions, the impact is still unknown. In the Ecuadorian Andes, various NGO's and farmer organizations have been concerned with the intensive use of pesticides in the potato production system (Crissman *et al.*, 1998). Their concern was the start of a political debate towards more sustainable management practices and an improvement of environmental quality and human health. A debate that started without information on the actual impacts of pesticide use and the consequences of alternative management practices.

The three cases above differ significantly from each other but, at the same time, they all require some type of integrated assessment to properly explore the potential impacts of interventions and to take informed decisions. Environmental problems cross the borders of academic disciplines and need an integrated approach in which knowledge from various disciplines is integrated.

Tools for integrated assessment

The broad range of tools that are currently available for integrated assessment (e.g., Bouma *et al.*, 2007) is the direct consequence of the plethora of questions that are being asked. Where some of the questions have a more explorative character and aim at the identification of the window of opportunities, others focus on the prediction of changes after technological changes or policy interventions. But at the same time unique agro-ecological conditions may require specific approaches. It simply matters whether we deal with, for example, a rather uniform commercial potato-pasture rotation in the Ecuadorian Andes or with complex subsistence, mixed cropping systems in Machakos district, Kenya. Different research groups are working on these problems and developed different approaches to the problem. Where some focus on multi-agent techniques, others focus more on econometric approaches, fuzzy logic and optimization models. It seems logical that due to the variety of questions, conditions, and approaches, we have a large number of tools available. The question that remains unanswered is why the actual use of these tools for integrated assessment is still so limited?

Case studies

In this paper, we look at three very distinct case studies: (1) the subsistence, small scale production system in Machakos district (Kenya), (2) the National Landscape Arkemheen-Eemland in The Netherlands with its commercial agriculture in combination with its unique environmental characteristics, and (3) the commercial potato-pasture system in the Carchi area in the Ecuadorian Andes (Figure 1). The three cases deal with different regional issues like poverty, the conservation of an historical peat landscape, and environmental quality. At

¹ Keynote presentation



Figure 1. Case study areas (source: Google Earth).

the same time the three cases differ in terms of agro-ecological conditions, inherent variation of the systems, and their dynamics.

As a result it is logical that the three case studies require different approaches to integrated assessment modelling. The specific conditions in the three case studies are linked to a review of different modeling approaches to illustrate how case specific the different approaches are.

Discussion

Despite the wide variation of available modelling approaches, the actual application is still rather limited. Data availability and model complexity are certainly two of the most important causes behind this limited use. As a result we can only conclude that there is a call for models with reduced complexity and reduced data requirements. This can be accomplished by modelling aggregate effects rather than modelling all the inherent variation in cases where the variation is relatively limited or aggregate results are required. In other cases, one can wonder whether it is necessary to explicitly model all the processes of the system. If the system is driven by a few key processes one can search for a reduced form that focuses on those processes. Finally, one has to evaluate seriously whether statistical or more mechanistic approaches are required.

Integrated assessment modelling is the result of a serious call from society to evaluate environmental systems in an integrated manner. Although the modelling tools provide a solid basis, further development is necessary to make them applicable in practice and answer the policy questions.

References

- Bouma, J., *et al.*, 2007. *Adv. Agron.* 93: 257-311.
- Crissman, C.C., *et al.*, 1998. *Economic, environmental, and health tradeoffs in agriculture.* Kluwer Academic Publishers, Dordrecht, The Netherlands.
- Government of Kenya, 2004. *Strategy for Revitalizing Agriculture 2004-2014.* Nairobi, Kenya.
- Osterburg, B., *et al.*, 2007. *Landscape issues of the EU common agricultural policy reform: Implications for modelling.* In: Eds. Ülo Mander *et al.*, *Multifunctional land use: Meeting future demands for landscape goods and services.* Springer, Berlin, pp. 269-279.

Integrated Assessment of crop and water allocation under conditions of uncertain water supply in the Khorezm Region of Uzbekistan, Central Asia

I. Bobojonov, E. Berg, C. Martius, J.P.A. Lamers, J. Franz
Centre for Development Research, University of Bonn,
Walter-Flex-Str. 3, 53113 Bonn, Germany
Contact: ihtiyor@uni-bonn.de

Introduction

Low water productivity, poor irrigation system efficiency, and low field application efficiencies have resulted in shallow, saline groundwater tables and secondary soil salinization endangering land productivity. In the Khorezm region of Uzbekistan, this is exacerbated by increasing water variability in the Amu Darya River, the main supplier of irrigation water. This reduces the probability of sufficient water supply in particular to the tail-end water users, which, in turn, increases income risks of farmers (Bucknall *et al.*, 2003).

Farmers in this region are not free in their decision-making on land and water allocation, and more than 70% of the area is allocated to cotton and winter wheat due to the state procurement system which leaves little room for crop diversification. This study analyses the potential economic and ecological gains of different policy recommendations affecting water availability and use. Mathematical programming models have been used in a systems perspective where socio-economic and environmental aspects of land and water use are simultaneously considered.

Methods

Primary and secondary data sources were used, such as literature, statistical data and information collected in the Khorezm region by the ZEF/UNESCO project within the Center for Development Research, University of Bonn, as well as via farm, household, and market surveys to obtain information on crops, cultivated area, production factors, and prices.

The Expected Value-Variance (EV) approach, combined with chance constrained programming (Charnes & Cooper, 1959; Berg, 2003), was selected for its suitability in taking into account multi-dimensional sources of risk associated with irrigated agriculture. Risk associated with price fluctuations and yield variability is considered in the objective function of the model, while risk associated with unreliable water supply is accounted for in the constraints part of the model. Optimization of water and land allocation is carried out for 300 fields, belonging to 99 farmers in one Water Users Association (WUA) in Khorezm. The spatial data (e.g., water distribution canals, distances) and agro-ecological properties (e.g., soil fertility, soil texture) of these fields were imported from GIS data into the mathematical programming model.

Optimal spatial cropping pattern and water distribution is found by allocating crops according to the agro-ecological comparative advantages (e.g., soil fertility, distance from the water source) and risk associated with each type of crop growing activity. Several farm and WUA level constraints are taken into account in the optimization process. Cotton, winter wheat, rice, maize (for grain), fodder crops, potatoes, vegetables and melons are the main crops in the model. Each of these crops could be cultivated with different levels of water use.

The model was calibrated using different Constant Relative Risk Aversion (CRRA) levels. Following the model calibration with the observed situation in the WUA, the findings of the base run were compared to those of various scenarios. The analyses and comparisons improved the understanding of the influence of different policy changes on the ecological and economic situation. The scenarios included the introduction of a direct water price, water-wise technologies (such as drip irrigation), a change in the state procurement policy, different water availability levels in the region, and various combinations of these factors. The effects

of changes in these variables on economic, social-welfare and ecological indicators were assessed.

Results and discussion

Under the current system (status quo), the income of agricultural producers is relatively low due to the cropping of winter wheat and cotton enforced on up to 70% of total arable area, and owing to the low, state-fixed prices of these commodities at concurrently rising input prices. The model simulations demonstrated the scope of direct water pricing for increasing water use efficiency (WUE). However, the introduction of water pricing sharply decreased the expected income on farm as well as on WUA level under the existing state order regime. Unless the existing state procurement system is changed, this bears the danger of bringing more poverty to the region and increasing the income risk of agricultural producers. Water pricing seems nevertheless to be a promising solution for WUE increase under a liberalized market economy. Expected incomes of farmers were still several times higher when water pricing was introduced under a liberalized market economy condition.

Simulation findings also indicated that farms located at the tail end of the irrigation system have to cope with the highest income losses during water scarce years, which could be buffered by measures such as insurance policies for the 'drought' years. The introduction of water-wise innovations will not automatically bring about widespread environmental improvements owing to the high initial investments for such technologies. Under the present regime, it would be economical beneficial to employ technologies such as drip irrigation and laser-guided land levelling on a very limited area because farmers have very limited farm capital for such investments. Thus, this model successfully allows exploring different options for technology and policy improvement under a farm risk perspective, while concurrently addressing economic and ecological effects.

References

- Berg, E., 2003. Modeling the impacts of uncertainty and attitudes towards risk on production decisions in arable farming. Poster Paper submitted for the 25th International Conference of IAAE, Durban, South Africa.
- Bucknall, L., *et al.*, 2003. Irrigation in Central Asia. Social, Economic and Environment Considerations. World Bank.
- Charnes, A.W. & W. Cooper, 1959. *Management Science* 6(1): 73-79.

An agent-based model for assessing the impacts of decoupled agricultural support on landscape values

Mark Brady, Konrad Kellermann
SLI, Box 730,
22007 Lund, Sweden
Contact: mark.brady@sli.lu.se

Introduction

In this paper, we present a spatial, dynamic agent-based simulation model of an agricultural landscape for assessing the impact of agricultural policy reform on landscape mosaic and biodiversity value. To make the empirical assessment feasible it was carried out using a regional case-study approach to capture some of the diversity of agricultural and socio-economic conditions in the EU-25, these being; high-cost or marginal regions (Jönköping and Västerbotten Counties in Sweden), EU-10 (Vysočina in the Czech Republic) and high-value Mediterranean agriculture (Marche and Calabria in Italy). Three policy scenarios were evaluated and simulations extended from 2001 to 2013 (the final year of the current programme period). The reference scenario represents continuation of the **Agenda 2000** framework. The principle ingredients of this ‘coupled’ policy are payments based on crop area and livestock numbers. The second scenario or **Reform** reflects the decoupled policies implemented in each country in 2005. These payments are conditioned on land being maintained in “Good Environmental and Agricultural Condition” (GAEC). The third scenario is a hypothetical pure income transfer or **Bond** in which farmers have no obligations in return for support. It should illustrate the effects of eliminating or reducing decoupled payments, which will be natural policy considerations in the scheduled reviews of the CAP in 2008 and 2013.

Methods

A fundamental insight from the literature is that a standard static or marginal economic analysis is likely to provide misleading results because decoupling has the capacity to affect farmers’ strategic decisions – whether to enter or exit farming, make new investments, renegotiate land contracts, etc. As such the analysis requires a dynamic framework where changes in the farmers’ opportunity set can be considered. The consideration of space is important to obtain a realistic model of structural development and its impacts on the landscape. The more fragmented and dispersed fields are in a region the lower the potential for profitable farm expansion. The size distribution of fields is also a defining characteristic of an agricultural landscape and its mosaic. Finally the availability of agricultural and semi-natural habitat is important for conservation of biodiversity in Europe.

To take these aspects into account we chose to extend the AgriPoliS model which is fully described in Happe *et al.* (2006). The principle advantage of AgriPoliS compared with other agricultural-economic models is that it can simulate agricultural development in a region over time and in space. It is also based on individual farms (or agents) which makes it possible to model the policy framework in detail and analyse impacts at both the farm and aggregate levels. Farm decision making is modelled using mixed-integer programming. Fundamental to AgriPoliS is that it models the competition for land between farms via a land market. The dynamic nature of the model makes it possible to consider farmers entry and exit decisions as well as investment and land rental activities. We extended the landscape modelling in AgriPoliS in several ways to make landscape analysis possible, the details of which are documented in Kellermann *et al.* (2007). Indicators for measuring biodiversity value (based on species-area relationships) and mosaic (Shannon Index) were also introduced (Brady *et al.*, 2007).

Results and discussion

The decoupling **Reform** caused a significant reduction in the cultivated area in high-cost regions, yet the GAEC condition ensured that this land was not abandoned. However, converting land to GAEC resulted in an increase in the area of the dominating land-use in high-cost regions, i.e., grass, and hence reductions in mosaic value (Figure 1a). In regions where cultivation of commodities remained profitable after decoupling (EU-10 and Mediterranean regions) it produced a small negative to positive impact depending on the regional crop mix in both decoupling scenarios. The positive impact can be explained by the relative increase in profitability and hence area of previously unsupported crops.

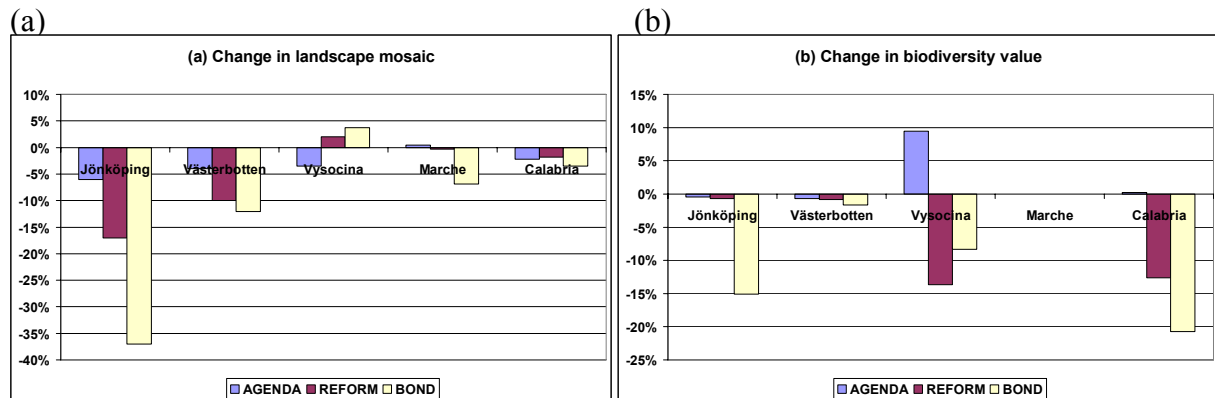

Figure 1. Impacts of decoupling on landscape values (a) mosaic and (b) biodiversity.

The type of decoupling (with or without GAEC) was found to be potentially very important for maintaining biodiversity value in high-cost regions (Figure 1b). For example a large portion of biodiversity value in Jönköping is associated with semi-natural grassland. GAEC for this land requires that it be grazed annually which is almost identical to the condition associated with Pillar II agri-environmental payments. Without the GAEC condition biodiversity value would have fallen by almost 15% or 26 red-listed species. A similar result did not emerge for Västerbotten because the area of semi-natural habitat is minimal. Similarly, the case of Vysocina illustrated that small changes in land use can have significant implications for biodiversity value in regions where marginal biodiversity value is high which is the case for pasture in this region.

Overall our results show that decoupling has potentially quite negative consequences for the landscape but these will be regionally specific and might be offset by interaction with existing environmental and national support schemes. A minimum land management requirement, as embodied in the GAEC condition, was not necessarily sufficient to preserve landscape and biodiversity values.

References

- Brady, M., *et al.*, 2007. Environmental Impacts of Decoupled Agricultural Support: A Regional Assessment, IDEMA Deliverable 24/SLI- Working Paper 2007: 1. www.sli.lu.se/IDEMA.
- Happe, K., *et al.*, 2006. Ecology and Society 11: 49. <http://www.ecologyandsociety.org/vol11/iss1/art49/>.
- Kellermann, K., *et al.*, 2007. AgriPoliS 2.0. Documentation of the Extended Model, IDEMA Deliverable 20, IAMO www.sli.lu.se/IDEMA. Halle, Germany.

Generic bio-economic modelling of plant diseases: An exploration

A. Breukers, W. Van der Werf, M. Mourits, A. Oude Lansink
 P.O. Box 8120, 6700 EW Wageningen, The Netherlands
 Contact: Annemarie.Breukers@wur.nl

Introduction

Cost-effective management of pests and diseases in plant production chains requires a thorough understanding of the system's dynamics and the effects of control measures. Existing analytical models of plant disease epidemics often do not match with managers' perception of the system (McRoberts *et al.*, 2003; Madden, 2006) while simulation models generally have a case-specificity that limits the domain of application and does not enable generic insights (e.g., Thackray *et al.*, 2004; Willocquet & Savary, 2004; Breukers *et al.*, 2006). Consequently, there is a need among plant health risk managers for generic tools that fit with their perception of the system and yet provide plausible results. To meet this need, we developed a generic bio-economic conceptual framework for plant disease epidemics and disease management. In this framework dynamical processes in the plant production chain are modelled from the perspective of a plant disease manager operating at the national level, i.e. a plant health authority such as the Dutch Phytosanitary Service.

The conceptual framework

The framework considers the true world as a collection of objects, structured in compartments. Objects represent (aggregations of) entities that can become infected or infested with the disease of interest. All objects of the same type are grouped in one compartment. Examples of compartments and corresponding objects are a production chain containing lot objects of a particular crop, arable land containing arable field objects, and woodland containing forest objects. Objects can multiply, die, and transmit disease within and between compartments via one or more pathways. Pathways may be partly or completely blocked by control measures. The likelihoods of birth, death, infection, and control differ periodically over time due to seasonality in crop production activities. This periodic variation is represented in the framework by splitting one time step (normally a year) in a series of periods, called phases. Figure 1 provides a diagrammatic representation of the system.

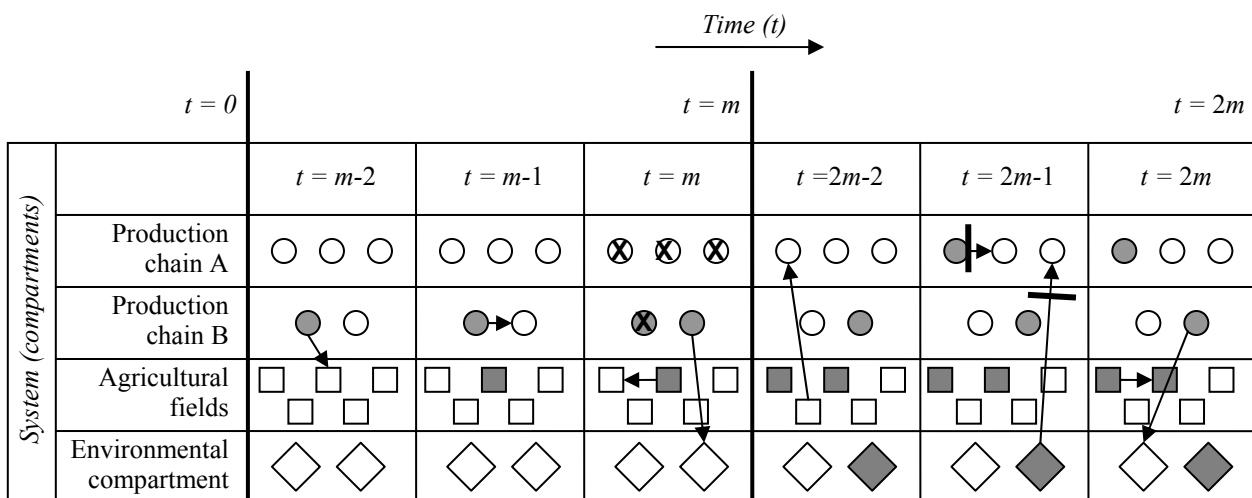

Figure 1. Schematic representation of modelled system according to the generic framework. Figures represent objects; shaded ones are infested. Arrows indicate transmission between objects; a bar indicates that transmission is blocked by a control measure. Objects with a cross are removed from the compartment.

The framework is structured according to the theory of periodic matrix modelling (Skellam, 1966), where each phase has its own transition matrix. Adjustments and extensions to this structure were made to overcome some inherent limitations of matrix modelling. First, nonlinearity is introduced to account for the probability of multiple infection, which is a function of the fraction infested within a compartment. Second, memory is introduced to represent history effects of crop rotation on disease dynamics. Control measures are included as parameters that affect susceptibility of healthy objects (preventive measures), or transmission (reactive measures) and survival (eradication measures) of infested objects. An economic module quantifies the losses from crop damage and the direct costs of control measures. Indirect costs, such as impacts on trade and product prices, are not accounted for.

Results and discussion

The conceptual framework as described above was translated into a functional prototype model for three pathogens: *Ralstonia solanacearum*, a bacterium that causes brown rot of potatoes, *Phytophthora infestans*, an oomycete causing potato late blight, and *Meloidogyne chitwoodi*, a nematode causing damage to many root crops. Table 1 shows the compartments and types of objects defined for each of the three cases.

The three model applications comprise pathogens with very different biology, dispersal pathways, host sites, and potential control measures. Yet, simulation results for each pathogen were plausible based on expert judgment and agreement with empirical evidence, confirming that the framework is generic as well as valid for evaluating options for disease management at the production chain level. Important strengths of the modelling framework are thus genericity, plausibility in three case studies, and congruence with the level of decision making of plant health authorities that have a responsibility for mitigating economic impacts of plant disease at the national level.

The generic framework presented and tested in this paper provides a new analytical method for obtaining insight into dynamics and control of plant diseases. While its basic structure resembles a periodic matrix model, it deals with more complex systems for which the assumptions of matrix modelling (e.g., linearity in transition parameters, unrestricted population growth) do not hold. Also, it contains several unique features not captured by existing epidemiological models, and thus provides a valuable contribution to fundamental plant disease modelling.

Table 1. Overview of types of objects per case study. Each object type represents one compartment.

<i>Compartment types</i>	<i>R. solanacearum</i>	<i>P. infestans</i>	<i>M. chitwoodi</i>
production chains	<ul style="list-style-type: none"> • Seed potato lots • Ware potato lots 	<ul style="list-style-type: none"> • Seed potato lots • Ware potato lots 	<ul style="list-style-type: none"> • Seed potato lots • Ware potato lots • Flower bulb lots • Other root crop lots • Non-root crop lots
arable land	<ul style="list-style-type: none"> • Fields, not detected • Fields, detected 	<ul style="list-style-type: none"> • Fields 	<ul style="list-style-type: none"> • Fields, not detected • Fields, detected
environmental	<ul style="list-style-type: none"> • Surface water 	<ul style="list-style-type: none"> • Waste piles 	

References

- Breukers, A., *et al.*, 2006. *Agricultural Economics* 38: 137-149.
- Madden, L.V., 2006. *European Journal of Plant Pathology* 115(1): 3-23.
- McRoberts, N., *et al.*, 2003. *Australasian Plant Pathology* 32(2): 167-180.
- Skellam, J.G., 1966. Seasonal periodicity in theoretical population ecology. *Proceedings of the 5th Berkeley Symposium on Mathematical Statistics and probability*, Berkeley CA.
- Thackray, D.J., *et al.*, 2004. *Virus Research* 100(1): 67-82.
- Willoquet, L. & S. Savary, 2004. *Phytopathology* 94(8): 883-891.

Integration of agriculture, groundwater and economic models using the Open Modeling Interface (OpenMI): Application to the Ogallala Aquifer

Tom Bulatewicz, Xiaoying Yang, Jeffrey M. Peterson, Scott Staggenborg,
David R. Steward, Stephen M. Welch
Kansas State University,
Dept. of Computing and Information Sciences,
Manhattan KS 66506, USA
Contact: tombz@ksu.edu

Introduction

Developing comprehensive understanding of agricultural systems requires knowledge that crosses traditionally isolated disciplinary procedures, approaches, methodologies, and ontologies. This study describes current efforts to address this challenge by an interdisciplinary team of engineers and scientists at Kansas State University. This builds upon ongoing projects funded by the USDA/ARS Ogallala Aquifer Initiative, which seeks to understand the economic and environmental risks associated with policy change. It also builds upon the Kansas NSF funded Ecoforecasting Initiative, which seeks to forecast ecological and environmental change.

Methods

This study brings together three core models for agriculture, groundwater and economics. The agriculture simulation is provided by the Environmental Policy Integrated Climate (EPIC) model that uses the inputs of crop type, weather, soils, and production practices to produce field-scale outputs of yield, irrigated water use, biomass, percolation to groundwater, and runoff. The groundwater model is based upon the Analytic Element Method and uses inputs of well pumping rates, geologic aquifer parameters, and groundwater/surface water interactions to produce outputs of groundwater elevation and flow rates across wide geographic areas. The economic model is based upon the polychotomous choice selectivity model and uses inputs of market input and output prices and factors that affect economic decisions such as type of irrigation, climate, soils, and historical land use to produce outputs of crop selection and irrigated water use at the field-scale.

Building on earlier work (Steward *et al.*, 2008; Bulatewicz *et al.*, 2008), we have integrated these three models using the Open Modeling Interface (OpenMI), which describes a standard way for models to interact. A wrapper program was written for each model that conformed the model to the standard interface. As part of each wrapper, we chose a selection of model inputs and outputs that can be exchanged with other models through the interface. In this way, each model has no knowledge of the other models, mitigating the challenging task of integrating the three models in different compositions as well as allowing for further integration with other OpenMI-compliant models. The input data to the integrated model was provided by a geo-database (Yang *et al.*, 2008).

The models have been integrated such that each one exchanges data with the other two on an annual basis as illustrated in Figure 1. The economic model informs the crop model about what crops are likely to be grown in a particular year. This decision is based in part on the saturated thickness of the aquifer as estimated by the groundwater model. The saturated thickness of the aquifer is in turn influenced by the amount of irrigation water that is pumped to grow the crops simulated by the crop model. Although the models use different time steps internally, data is exchanged once per year.

Results and discussion

The Open Modeling Interface provides an effective integration methodology to bring together traditionally isolated modelling approaches. Results will be shown that illustrate the impacts of policy change on agricultural production as well as groundwater resources and economic activity. These findings provide a scientific support to guide policy analysis and management decisions.

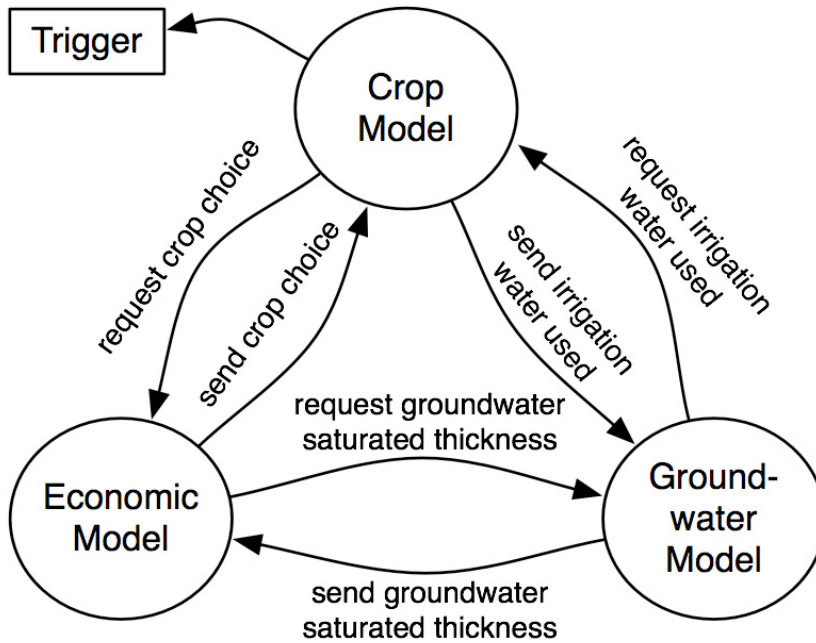

Figure 1. The three models and the pattern of data exchange between them.

References

Bulatewicz, T., *et al.*, 2008. *Journal of Hydrology*. (in review)
 Steward, D.R., *et al.*, 2008. *Water Resources Research*. (accepted)
 Yang, X., *et al.*, 2008. *International Journal of GIS*. (in review)

How to design technical and organizational innovations to promote sustainable development in catchments with intensive use of pesticides

C. Gary, J.M. Barbier, P. Rio, P. Andrieux, J.M. Blazy, X. Louchart, M. Bonin,
J.L. Diman, F. Causeret, H. Ozier-Lafontaine
INRA, 2 place Pierre Viala, 34060 Montpellier Cedex 2, France
Contact: gary@supagro.inra.fr

Introduction

The sustainable development of agriculture in regions where perennial crops such as grapevine in south France and banana in the French West Indies dominate is questioned in relation to their high use of pesticides. The resulting degradation of the environment generates damages for various activities including agriculture. The cost of adopting alternative crop protection strategies and/or restoring water quality is high. The consequences on human health and environment generates conflicts with other stakeholders with feedback consequences on agriculture in terms of policy (regulations), market and social recognition. The observed low diffusion of low-input cropping systems results from technical, economic and organizational limitations at several scales, from field and farm to catchment and region. Then any proposal of alternative technologies should be embodied in sets of consistent innovations of different natures and at different scales.

In terms of research methodology, the challenge is to design novel agricultural systems and carry out *ex-ante* their assessment in a way that connects various scales and balances all dimensions of sustainability (Van Ittersum *et al.*, 2008). Various methods of integrated assessment have been proposed; they are all based on systems analysis, they mobilize in a concerted way several disciplines and use models as a mean to explore the effectiveness of various scenarios (Parker *et al.*, 2002).

In the present project, skills in human (economy, geography, sociology) and biophysical (agronomy, hydrology, engineering) sciences were gathered to (i) design innovative farming systems that would reduce the use and diffusion of pesticides, (ii) evaluate their ecological effectiveness and likelihood of adoption by farmers and (iii) identify the organizations and regulations that would favour sustainable development in the studied catchments.

Methods

A generic framework was adopted to organize the various scientific disciplines and approaches (Figure 1). The focus was more on the integration and consistency of these approaches than on the formal connection of a set of models differing in various ways: static/dynamic, mechanistic/empirical, biophysical/decisional, field/farm/catchment.

The influence of the institutional context was examined in two ways. First, a typology of mechanisms of incitation or repression was built and their potential impact on farming systems assessed with linear programming. Second, the role of networks of information among farmers in relation with the diffusion of innovations was studied and modelled with Multi-Agent Systems.

The design of innovative farming systems was made according to two approaches. In the grapevine catchment, surveys were carried out to analyse the diversity of farmers' strategies of weeding, soil management and crop protection. Some of these existing strategies were identified as innovative. In the banana catchment, it was considered that an input of novel techniques had to be introduced. To this end, a process of prototyping was engaged with experts (agronomists, geneticists, nematologists) after the typology of farming systems. It produced innovative cropping systems and bio-economic modelling was used to select those potentially fitting with the various types of farming systems.

The economic and environmental performances of the innovative farming systems were

assessed with biophysical models and/or indicators. This assessment focused on farm scale in the case of banana (the innovation resulting from the adoption of novel cropping systems by farmers) and on catchment scale in the case of grapevine (the innovation resulting from new distributions of performing types of farming systems within the population of farms). At last the adoptability of the most effective farming systems was evaluated with new surveys and the conditions of adoption were identified with an econometric model.

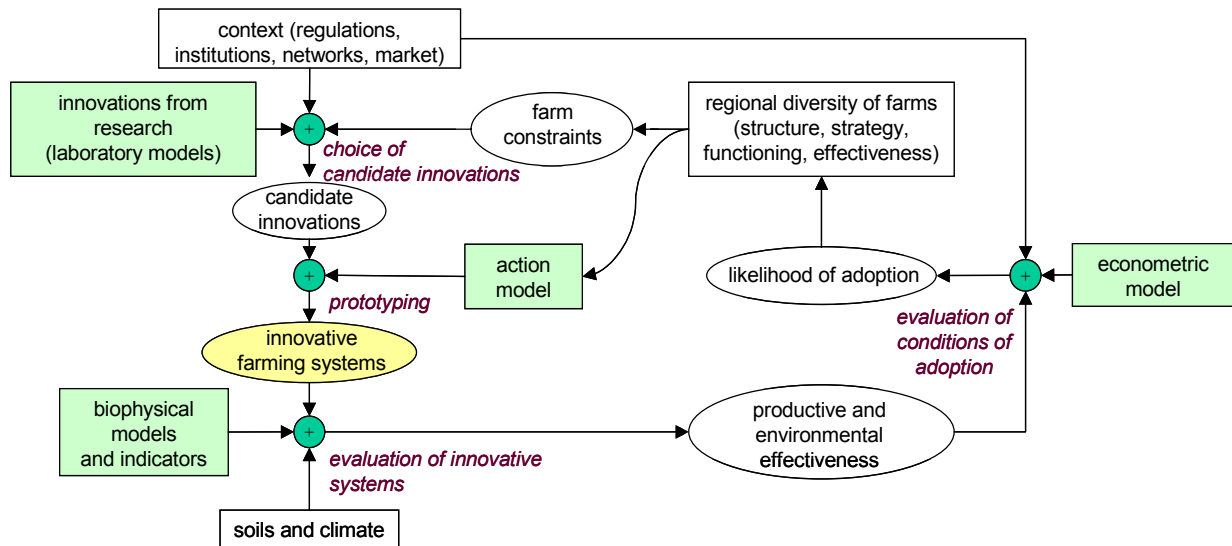

Figure 1. Scientific framework for the integrated assessment of innovative farming systems (grey rectangles are models, white rectangles, the real world, and ovals outputs).

Results and discussion

Government and farmers' institutions recently introduced new instruments and, in some cases, their theoretical effectiveness could be assessed. The fluxes of information within farmers' networks appeared to limit the diffusion of innovation. Yet the process of design of innovative farming systems differed among grapevine and banana catchments, this social context was considered as a forcing variable in both cases. The economic and ecological crisis was more severe in banana catchments, which justified the interest for radical technical innovations and for their thorough assessment at farm scale.

A set of assessment tools were produced, from field to farm and catchment, including breakthroughs such as the coupled simulation of the dynamics of crop and nematode development in banana fields, or the coupled simulation of cultivation techniques and resulting surface transfer of water and pesticide distributed within a grapevine catchment. Attention was paid to the likelihood of adoption of innovative systems by farmers, in relation to the economy and organization of their farm and to the innovation and policy attributes. Combined with the evaluation of crop production and externalities, it provided a framework for an appraisal of the contribution to sustainable development of existing and alternative farming systems. The coupling of various scales and criteria of evaluation should facilitate the analysis of the consequences of specific policies designed to promote novel farming systems. In this perspective, the interaction with stakeholders, including policymakers, will have to be more formalized.

References

- Parker, P., *et al.*, 2002. *Environmental Modelling & Software* 17: 209-217.
 Van Ittersum, M.K., *et al.*, 2008. *Agricultural Systems* 96: 150-165.

Visualizing changes in agricultural landscapes

S. Griffon, D. Auclair
CIRAD, UMR AMAP, TA A-51/PS2,
34398 Montpellier Cedex 5, France
Contact: sgriffon@cirad.fr

Introduction

Rural land managers, foresters and farmers, but also local decision makers, local authorities and members of local governments, are increasingly aware of the necessity to take into account the perception of the landscape by the general public, and to predict the evolution of landscapes according to management decisions (Bergen *et al.*, 1995). Different management choices can lead to similar, or to very different landscapes. The positioning of woodlots, of fields, and of agro-forestry areas, the type of silvi-cultural management (selective or systematic thinning, artificial pruning, clear-cut or shelterwood systems, reforestation, choice of species, etc...) or agricultural system (rotation, land attribution, crop allocation, etc...) and the balance between forest and agriculture, are susceptible of drastically modifying the visual aspect of the landscape. Although land managers generally have a good experience of what result can be expected from their decisions, they are often faced with difficulty when trying to communicate the visual impact of a future management option to all the stakeholders (local and regional decision makers, land managers, landscape planners, and various communities involved in outdoor activities). Three-dimensional visualization of the landscape provides means that are better understood than maps, especially for the general public. With such methods, visual changes of the landscape can be shown very impressively, which can allow for an intuitive assessment of the visual landscape quality.

The present work describes a landscape visualization tool which has been developed within the SEAMLESS project (Van Ittersum *et al.*, 2008). This landscape visualization component should be launched at the end of a policy simulation to allow for exploration of landscape changes, as a post-model analysis, to be used as a basis for discussion and negotiation within the community.

Methods

The users (modeller or policy-maker, or any other stakeholder) who are interested in a specific landscape should initially start with a description of the area they wish to visualize. This requires a description, preferably mapped in GIS format, of environmental data such as land cover and land use. Pressures causing changes in landscape can be simulated by a bio-economic farm model (such as the FSSIM module of the SEAMLESS project). This is then translated into changes in the spatial configuration of the landscape. A 3D data conversion plug-in has been developed and integrated into the open-source GIS software QGIS (<http://www.qgis.org/>). It works as an external module that allocates each agricultural parcel to a specific land-use by importing the proportion of each land-use class computed by the bio-economical farm model and distributing it on the field pattern according to specific rules (in the present version, randomly). Then the plug-in can export the extent selected by users (most reasonably around 10 km by 10 km). Data are cropped, fused and formatted to be visualized. The generation of the 3D model and its rendering is done by a specific software component, that we have called here 'Seamless Landscape Explorer' (SLE).

SLE is then launched and the user can edit the geo-typical configuration (land-use textures and vegetation) for each land-use class. A dynamically optimized elevation mesh from the digital terrain elevation raster is first computed using the Geographic MipMaps technique (De Boer, 2000). Then the mesh is textured with Texture Splatting technique and with satellite imageries or thematic maps and vegetation can be spatialized according to user parameters.

The different layers of vegetation consist in trees, shrubs, small plants, and other objects, such as rocks, are added to complete the impression of natural complexity. The rendering is done in real time.

The example of application presented here concerns the Mediterranean territory of Pic Saint Loup (near Montpellier, Hérault, France), where four scenarios were studied, as part of a participatory process for planning the regional peri-urban and agri-environmental policy (Nespoulous, 2004). The scenarios concern high or low biodiversity and high or low urban pressure. Land-use maps were produced for each scenario and the resulting scenes were processed with SLE.

Results and discussion

Figure 1 shows an example of land-use change according to two scenarios: biodiversity with agriculture (left) and peri-urban pressure with environmental concern (right).

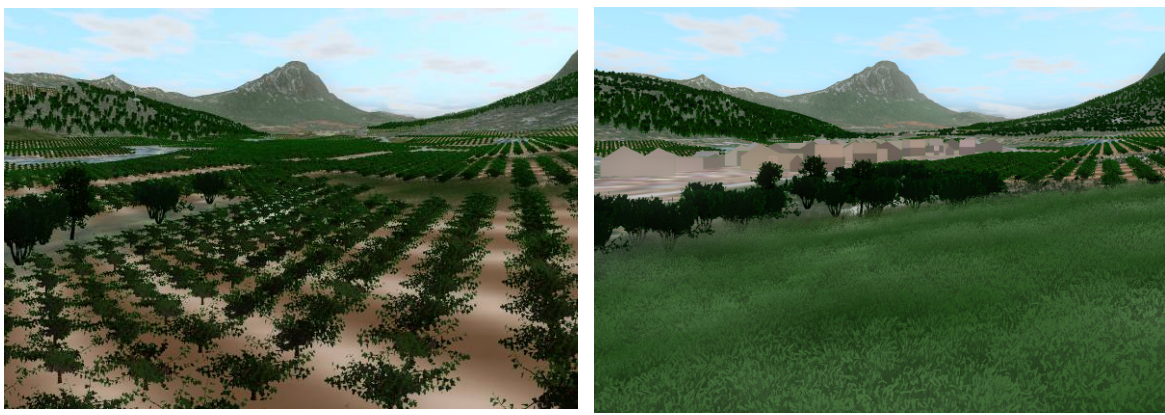

Figure 1. Example of Pic Saint Loup landscape change.

These images, as well as fly-over videos, were discussed with stakeholders (both professional and general public). These computer simulations were used as a support for understanding and characterizing the landscape.

Decisions support systems are increasingly being applied in spatial planning, and virtual landscapes become an important part of decision making. Planners recognize realism as an important factor in this type of visualization (Appleton & Lovett, 2005). It is important to define an appropriate level of realism, because the ‘photorealism’ can have potential negative effects if it is not linked to real-world data. The tool presented here provides the opportunity to control several aspects, in particular the viewpoint. In the example shown here, the Pic Saint Loup mountain in the distance is important for local stakeholders to recognize clearly their familiar landscape.

References

- Appleton, K. & A. Lovett, 2005. *Computers, Environment and Urban Systems* 29: 321-339.
- Bergen, S.D., *et al.*, 1995. *Journal of Forestry* 93: 33-37.
- De Boer, W.H., 2000. http://www.flipcode.com/articles/article_geomipmaps.shtml
- Nespoulous, A., 2004. MA Thesis, Univ. Montpellier, 89 pp.
- Van Ittersum, M.K., *et al.*, 2008. *Agricultural Systems* 96: 150-165.

Integrated analysis of the effects of agricultural management and spatial planning on environmental quality at landscape scale

J. Kros, T.J.A. Gies, J.C. Voogd, R. Smidt, W. De Vries
Alterra, Wageningen University and Research Centre,
P.O. Box 47, 6700 AA Wageningen, The Netherlands
Contact: Hans.Kros@wur.nl

Introduction

An important threat of terrestrial Natura 2000 sites in The Netherlands is atmospheric nitrogen (N) deposition. High N deposition may lead to adverse effect on terrestrial ecosystems, such as the loss of plant species diversity. For the setting of emission standards and deposition targets, critical nitrogen deposition loads are used. In The Netherlands most (almost 70%) of the N deposition on the Natura 2000 sites is coming from ammonia emission from agricultural sources. Consequently, most emphasis is lead on the reduction of ammonia emission from agriculture. Because most of the emitted ammonia is deposited at a distance of less than 30 km, the landscape scale is the typical scale for looking for solutions.

Models that simultaneously assess atmospheric emissions from complex agricultural landscapes and deposition to nearby areas have been limited so-far. An example is the model INITIATOR2 (Integrated Nutrient Impact Assessment Tool On a Regional scale) that can be used for an integrated assessment of the effectiveness of policies aiming at the simultaneous reduction of all relevant element fluxes (nutrient and contaminants) to atmosphere, ground water and surface water (De Vries *et al.*, 2005). INITIATOR2 predicts atmospheric emissions of ammonia and greenhouse gases (CO₂, CH₄ and N₂O) from housing and manure storage systems and from soils and also the accumulation, leaching and runoff of nitrogen (N), phosphate (P) and metals from soils. This paper is aiming at the effectiveness of emission control measures in agriculture on the deposition on Natura 2000 sites, using the INITIATOR2 and focusing on the NH₃ emission and resulting N deposition. This integrated modelling system is used for predicting current and future deposition, to identify which measures are most promising for one province in The Netherlands and to identify the side effects on other emissions such as N₂O and CH₄ and leaching of N.

Modelling approach and measures

To gain insight in the environmental impacts of management measures on the environment, INITIATOR2 was applied to predict atmospheric emissions of ammonia from housing and manure storage systems and from soils. A database (GIAB) with spatially explicit data on animal numbers in many animal categories, agricultural practices and land management, such as manure application techniques available data for each farm in The Netherlands was used for the year 2004, being a reference year for the calculations (Anonymous, 2004). Furthermore, spatially explicit input data related to soil parameters (soil map 1: 50.000) and hydrology was used to make the model predictions. The NH₃ emissions in the field and those from housing systems form the input of an atmospheric transport model (OPS, Van Jaarsveld, 1995) to assess the N deposition on agricultural and non-agricultural systems.

Evaluated measures were amongst others (i) emission reduction from poultry and pig housing system by using air washers, (ii) low protein feeding, (iii) reducing fertilizer amount, (iv) conversion towards biological dairy farms, and (v) moving farms to a larger distance from the Natura 2000 sites.

Results and discussion

The critical N deposition of the Natura 2000 sites occurring in Overijssel (province located in the North-eastern part of the country) is exceeded in almost 60% of the area (Figure 1).

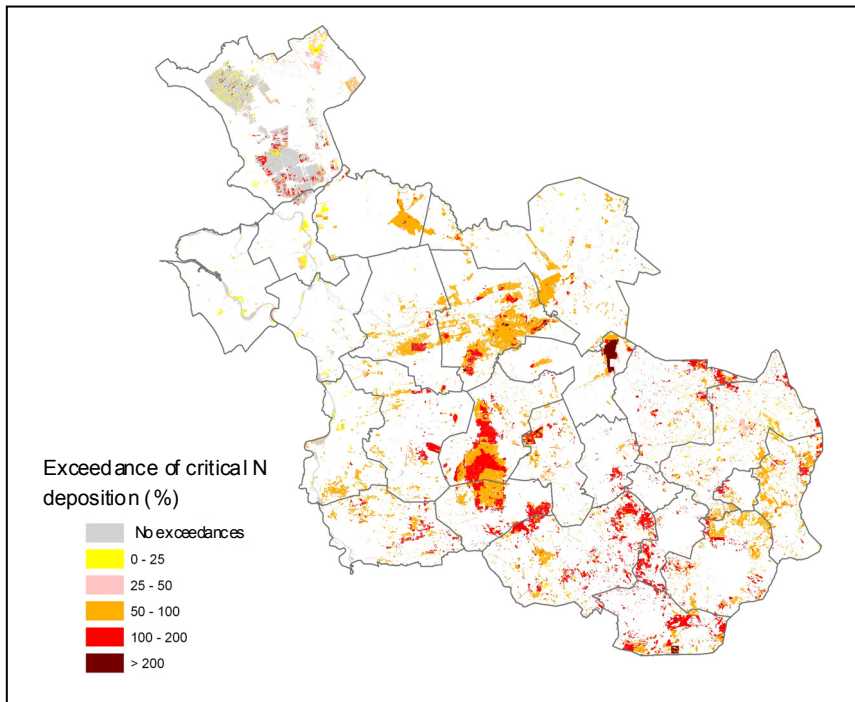

Figure 1. Relative exceedances of the critical N deposition for nature target types in the province of Overijssel, The Netherlands.

Shifting from traditional agricultural management towards biological dairy farming within zones of 3 km surrounding the Natura 2000 sites resulted in almost a reduction of 50% of the emissions from that zone. The N deposition on the Natura 2000, however, resulted in a reduction of only 7%. This is due to a large part of the N deposition (more than 70%) that is originated from other sources than ammonia or from sources outside this province. At the AgSAP conference also other emission (N_2O , CH_4) and the leaching of N will be presented as well as the relation between generic measures and local measures. It is concluded that measures in a zone surrounding a nature areas are especially beneficial for local situations with close-by high emissions, but for an overall protection more stringent generic measures are necessary.

References

- Anonymous, 2004. Statistics for agriculture and horticulture, 2004 (in Dutch). Landbouw Economisch Instituut (LEI) en Centraal Bureau voor de Statistiek (CBS), Den Haag.
- De Vries, W., *et al.*, 2005 In: Eds. Z. Zhu, *et al.*, 3rd International Nitrogen Conference - Contributed papers. Science Press USA Inc., Monmouth Junction, pp. 859-870.
- Van Jaarsveld, H.J.A., 1995. Modelling the long-term atmospheric behaviour of pollutants on various spatial scales. PhD Thesis, Universiteit Utrecht, Utrecht, 235 pp.

Assessment of nitrogen balances at farm and regional level

Bernhard Osterburg, Thomas G. Schmidt
Institute of Rural Studies, Johann Heinrich von Thünen-Institut (vTI),
Bundesallee 50, 38116 Braunschweig, Germany
Contact: bernhard.osterburg@vti.bund.de

Introduction

Nitrate leaching into ground water caused by agricultural nitrogen (N) surplus is a main challenge of environmental policies in many European areas. The implementation of the EU Water Framework Directive (WFD) calls for new efforts to reduce N surplus and groundwater pollution in order to achieve a good status of water bodies by 2015, or at least reach trends for the better (EC, 2004). Regions with high animal stocking densities are more likely to face problems of achieving these targets, due to high organic N inputs and less efficient use of N from animal excretions.

N balances are the point of departure for analysing nitrate pollution of the groundwater, and for identifying mitigation options. Established approaches (e.g., PARCOM guidelines (PARCOM, 1995), OECD N balance database (OECD, 2001)) deal with figures from agricultural statistics at national level. Core problem of assessing N balances at the landscape level is the lack of regional data for mineral fertilizer input. Therefore, in most approaches, normative estimates for mineral inputs are applied in order to disaggregate national data. In these approaches, livestock density and fixed factors for N efficiency (N output/input relation) are used without broader knowledge about real distribution of N efficiency in the farming sector. The assessment of regional N balances presented in this contribution seeks for improvements regarding the depiction of mineral N input.

Methods

The main data input for the calculation is agricultural census data containing numbers of crops, animals and farm types for the municipality level (LAU-2, formerly NUTS 5 of the EU classification), as well as several additional pieces of information like regional yields and farm import or export of manure. Parameters for manure production by animal category as well as N contents of agricultural products were provided by the Agricultural Chamber of Lower Saxony. In addition, accounts of 6,600 farms (2-year average from 1999/2000 and 2000/2001), containing information on physical mineral fertilizer input, were used to model mineral N input. Organic manure from livestock is calculated as fixed output coefficients per livestock species multiplied by herd size according to the agricultural statistics. N excretion of dairy cows is computed in dependence of milk yield per cow and year. As endogenous variables, N output, legume N-fixation, N from animal excretion, soil quality index and the regional density of pig production (as a proxy for manure imports not stated in the accounts) were used. The model derived from farm data is applied to the regional farm survey data, using the sales of mineral fertilizer recorded in agricultural statistics on federal the state level as consistency frame.

The N uptake is calculated as the nitrogen in cash and forage crops. Ammonia losses into the atmosphere are assessed separately, as they are part of the N deposition, too. The uptake of cash crops is calculated on the basis of statistical regional average yield and acreage per crop type. In order to cope with the uncertainties related to roughage production, an estimation based on animal input-output assures consistency between roughage as well as fodder concentrate input, and manure and animal product outputs. A multiple regression equation for concentrate input is derived from farm accounting data, allowing for an improved estimation of roughage production. Endogenous variables explaining the N intake from concentrates are livestock category, milk yield, and livestock stocking density per hectare of forage area.

Results and discussion

Mineral nitrogen input per hectare is simulated for each farm using the new model, and compared with real data from farm accounts. The R-square (coefficient of determination) of the regression model is about 0.3, thus the model performance is rather weak. This is due to high variance of mineral N input per hectare even in farm groups with similar structures. However, an analysis of residual values between real and estimated mineral N input values (both for structural or regional characteristics) shows that the model estimates do not contain systematic deviations for specific subgroups, so that positive and negative deviations cancel out each other (see Figure 1). Therefore, the results are regarded to be sufficiently exact to depict the average situation of different regions, farm types and structures.

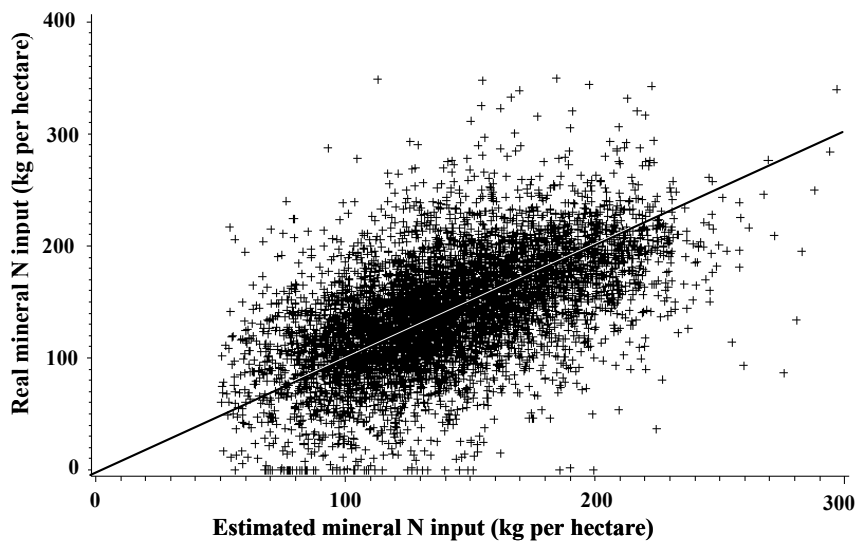

Figure 1. Estimated and real mineral fertilizer input per hectare for 6,600 farms.

An assessment of regional N balances using normative assumptions helps to identify regional hot spots of N surplus, e.g. based on statistics of livestock stocking densities. However, for using N balances as a basis for policy recommendations, more knowledge on the productive use of nitrogen at farm level is needed. The high variance of mineral N inputs indicates that there are considerable ‘hot spots’ due to different individual farm performance. Obviously, management and advice are important factors for N efficiency and resulting N surplus at farm level. The data analysis shows that average N efficiency of animal manure is higher in farms with high livestock density. Thus, recommending a lower livestock density, allowing for spatial reallocation of the livestock herd, does not automatically tackle the underlying problem of low N efficiency. The results show that micro data analysis is needed to better identify sources of N emissions and to reveal scope for further improvements of N efficiency.

References

- EC, 2004. Monitoring under the Water Framework Directive, Guidance Document No 7. Produced by Working Group 2.7 – Monitoring, Common Implementation Strategy for the Water Framework Directive (2000/60/EC). European Commission, Brussels.
- OECD, 2001. Nitrogen balance data-base. Organisation for Economic Co-operation and Development, Paris.
- PARCOM - Paris Commission for the Environmental Protection of the North East Atlantic (1995) PARCOM Guidelines for Calculating Mineral Balances; Oslo and Paris Conventions for the Prevention of Marine Pollution Programmes and Measures Committee (PRAM), Oviedo: 20-24 February 1995, Annex 15 (Ref: § 7.19).

Assessing the institutional compatibility of new policies

Christian Schleyer, Insa Theesfeld, Olivier Aznar

Humboldt-Universität zu Berlin, Department of Agricultural Economics and Social Sciences,
Division of Resource Economics, Philippstr. 13, Building 12, 10099 Berlin, Germany

Contact: christian_schleyer@hotmail.com

Introduction

Policy assessment from an institutional perspective follows the concept of institutions for sustainability, which is defined as the necessary institutional structure capable of delivering economic, social, and environmental sustainability objectives. Thus, the effectiveness of a policy and the cost-effectiveness of its implementation depend to a large extent on the degree of compatibility between this policy option and the respective institutional context. However, not least because institutions usually relate to a great diversity of situations, the state-of-the-art in institutional economics offers hardly any standardized procedures for institutional analysis that can easily be combined with environmental and agricultural models widely used for policy impact assessment (Theesfeld *et al.*, 2008). To assess the compatibility between policy options and various institutional contexts a standardized methodology has been developed within the SEAMLESS-Integrated Project (Van Ittersum *et al.*, 2008) that provides for an institutional dimension in modelling: the ‘Procedure for Institutional Compatibility Assessment’ (PICA) (Schleyer *et al.*, 2007).

Following an overview about the state-of-the-art in approaches for policy assessment, this contribution will focus on the PICA methodology. Here, the four distinct steps are elaborated on using the EU Nitrate Directive as a concrete policy example to illustrate the procedure (see Figure 1). Finally, some ideas will be presented how PICA serves as a tool for pre- and postmodel analysis of environmental and agricultural models for policy impact assessment in a complementary way.

Method

PICA comprises four distinct steps:

- (1) Policy options are clustered according to the type of intervention (regulatory, economic, and advisory), the area of intervention (hierarchy/bureaucracy, market, and self-organized network), possibly involved property rights changes, and the attributes of the natural resource addressed. This classification allows identifying the generic structure of a policy option.
- (2) Each policy cluster is linked to specific sets of crucial institutional aspects (CIA) that may constrain or foster policy implementation.
- (3) Institutional indicators are used to evaluate the potential of a respective CIA.
- (4) The information provided by the institutional indicators is used for a qualitative assessment of each identified CIA. Subsequently, the CIA and the related assessments are arranged in thematic categories of institutional compatibility leading to qualitative statements about the probable effectiveness of a policy option.

Results and discussion

PICA allows for a systematic institutional *ex-ante* assessment of (agricultural, environmental, and rural development) policies. This enables policymakers and decision makers in charge of implementing policies to identify at an early stage (potential) institutional incompatibilities between policy options and the various institutional contexts in different countries and

regions. In addition, PICA provides hints for a better policy design in terms of effectiveness and cost-efficiency. This may include redesigning or adapting the policy options and the design of complementary policy measures.

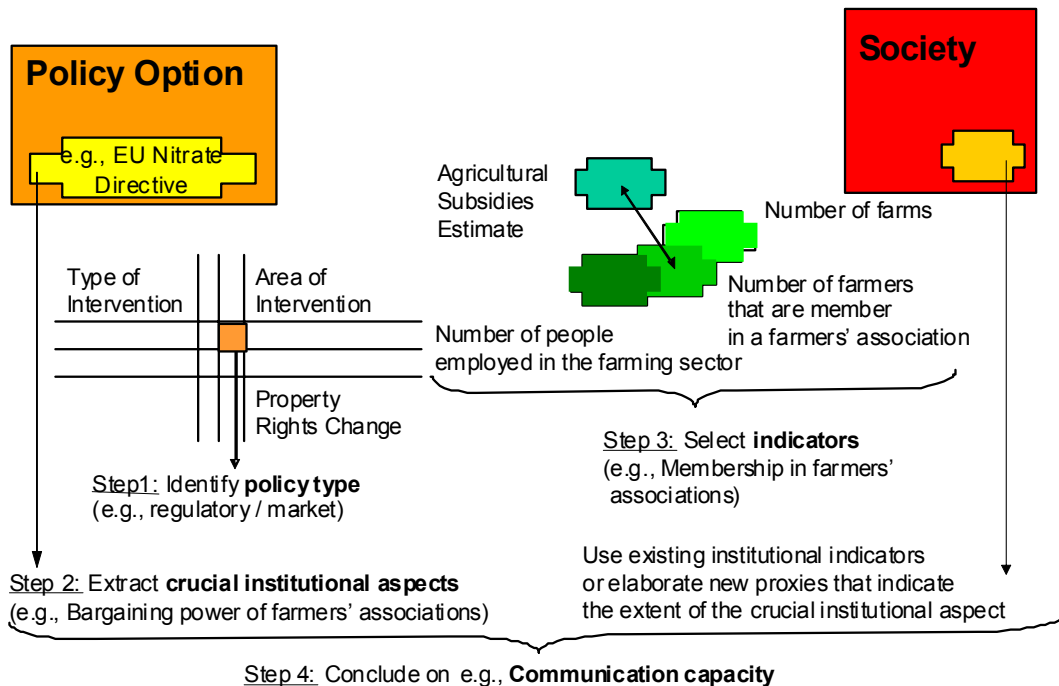

Figure 1. PICA applied to the policy option 'EU Nitrate Directive'.

References

- Schleyer, C., *et al.*, 2007. Approach towards an operational tool to apply institutional analysis for the assessment of policy feasibility within SEAMLESS-IF, SEAMLESS Report No.29, SEAMLESS integrated project, EU 6th Framework Programme, contract no. 010036-2, www.SEAMLESS-IP.org, 169 pp.
- Theesfeld, I., *et al.*, 2008. *Ex-ante* Policy Assessment from an Institutional Perspective: A Procedure for Institutional Compatibility Assessment. Eds V. Beckmann & K. Hagedorn, Institutional Change in Agriculture and Natural Resources (ICAR) Discussion Paper 20/2008.
- Van Ittersum, M.K., *et al.*, 2008. *Agricultural Systems* 96: 150-165.

Assessing sustainable agriculture development using the MicroLEIS DSS in Souma area, Iran

F. Shahbazi, A.A. Jafarzadeh, M.R. Shahbazi
 Soil Science Department, Faculty of Agriculture, University of Tabriz,
 51664-16471 Tabriz, Iran
 Contact: shahbazi@tabrizu.ac.ir

Introduction

This study was performed in the Souma area with about 4100 ha extension which has located between 44°35' to 44°40' east longitude and 37°50' to 37°55' north latitude in the North-West of Iran (west Azarbaijan). Site, soil and climate data of study area were stored in SDBm plus (De la Rosa *et al.*, 2002) and CDBm, major components of MicroLEIS DSS. The agricultural land uses considered for evaluation were wheat (*Triticum aestivum*), alfalfa (*Medicago sativa*), sugar beet (*Beta vulgaris*), potato (*Solanum tubersum*), and maize (*Zea mays*) crops which are relevant in the region. Sustainable agriculture development for these crops is important and also necessary. A specific agricultural use and management system on land that is most suitable according to agro-ecological potentialities and limitations is the best way to achieve sustainability (FAO, 1978). Since the early 1990s, and in this conceptual framework was developed the land evaluation decision support system MicroLEIS DSS (De la Rosa *et al.*, 2004). The MicroLEIS DSS system has been widely used over the last 20 years for many different purposes which the highest number is for Europe mainly Spain and other Mediterranean and Semi-arid countries, additionally, the South America countries also have many users. This system has been applied for the first time in west Asia (Iran), for land use planning in Ahar region (Shahbazi *et al.*, 2008).

Methods

MicroLEIS DSS system, through its 12 land evaluation models, analyses the influence of selected soil indicators on critical soil functions referred to: (1) land productivity (agricultural and forest soil suitability, crop growth, and natural fertility), and (2) land degradation (runoff and leaching potential, erosion resistance, subsoil compaction, workability, and pollutant absorption and mobility). In this research work, bioclimatic deficiency evaluation, segregation of agricultural lands, restoration of marginal areas, and diversification of crop rotation to achievement the sustainable agriculture is more importantly attended (Table 1).

Table 1. Micro LEIS land evaluation models according to the soil function simulated and the specific strategy supported.

Constituent model	Soil function (Modelling type)	Specific strategy
Land use planning-related		
Terraza	Bioclimatic deficiency (Parametric)	Quantification of crop water supply and frost risk limitation
Cervatana	General land capability (Qualitative)	Segregation of best agricultural and marginal agricultural lands
Sierra	Forestry land suitability (Qualitative/Neural network)	Restoration of semi-natural habitats in marginal agricultural lands: selection of forest species (61 species)
Almagra	Agricultural soil suitability (Qualitative)	Diversification of crop rotation in best agricultural lands: for traditional crops (12 crops)

Input variables are physical/chemical soil parameters (e.g., useful depth, stoniness, texture, water retention, reaction, carbonate content, salinity, or cation exchange capacity) collected in standard soil surveys, monthly agro-climatic parameters for long-term period (from the 36 consecutive years of Urmieh meteorological station), and agricultural crop and management. Validation tests as far as possible have been done in the study area.

Results and discussion

The predicted results of applying the four agro-ecological land evaluation models (Terraza, Cervatana, Sierra and Almagra) constituents of MicroLEIS DSS are presented and discussed for nine applicable soil series. Results showed that the annual yield reduction of maize is the highest amounts (74%) between the selected crops (Table 2).

Table 2. Evaluating results: Bioclimatic classes and annual reduction of crop production.

Selected Land uses	Rys%	Bioclimatic classes
Wheat	0	H1
Alfalfa	39	H2
Potato	55	H3
Sugar beet	60	H4
Maize	74	H4

Soil and erosion risk factors in total of 810 ha, caused to be urgently reforested with Swamp Pine species. The rest of study area (3300 ha), are considered as agricultural lands. Also results obtained from the model application and integrating with GIS are presented and discussed in this research work (e.g., Figure 1). Cultivation of irrigated maize can be recommended in the study area with attention to Terraza and Almagra model results.

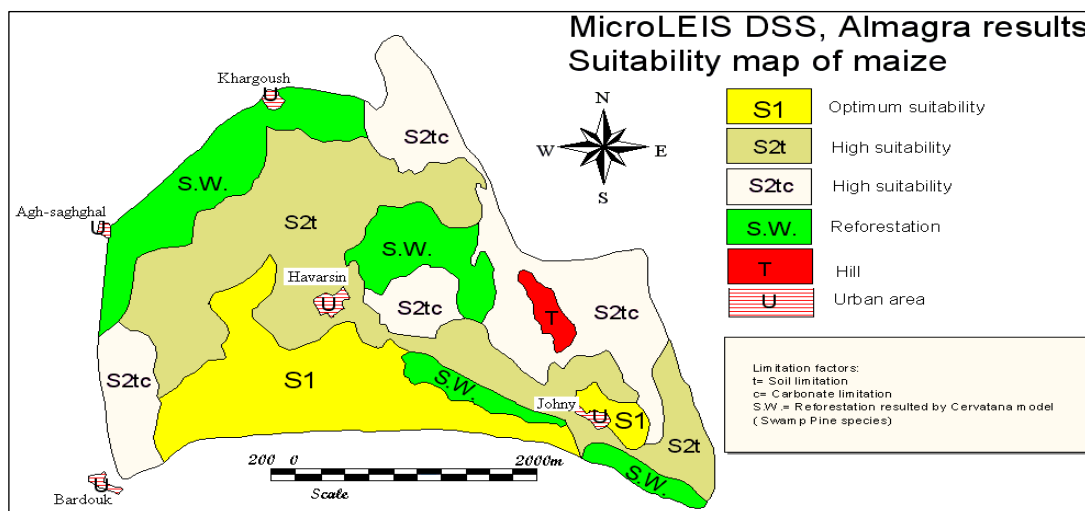

Figure 1. Maize suitability map of study area.

References

- De la Rosa, D., *et al.*, 2002. Environmental Modelling and Software 17: 721-731
 De la Rosa, D., *et al.*, 2004. Environmental Modelling and Software 19: 929-942.
 FAO, 1978. Report on the agro-ecological zones project. World Soil Resources Report 48, Rome.
 Shahbazi, F., *et al.*, 2008. Int. Journal of Agrophysics 22: 277-286.

Assessing and predicting agro-structural change in the Alpine Region

T. Streifeneder, C. Hoffmann, F.V. Ruffini
Eurac Research, Drususalle 1, 39100 Bozen, Italy
Contact: thomas.streifeneder@eurac.edu

Introduction

In the past decades, mountain agriculture in the Alps has been affected by a profound structural change, with distinct variations noted between individual regions (MacDonald *et al.*, 2000; Streifeneder *et al.*, 2007). Regions with moderate farm abandonment rates are located mostly in the northern Germanic parts of the Alps, in contrast to the high abandonment rates of those regions in the southern Romanic areas of the Alpine bow (Figure 1).

Based on the data from the AGRALP-project (www.eurac.edu/agralp), the present approach assesses the future of agro-structural change until 2020. Therefore, a multiple regression model has been created that utilizes agro-structural, socio-economic and geo-statistical data. The model's focus, thus, concentrates on the following research questions:

- a) What factors most influence the future development of the agricultural sector?
- b) What future farm abandonment rates can be expected?
- c) What consequences for economic, social and landscape structures can be expected as a result of the predicted agro-structural development?

Methods

The analysis was based on a comprehensive harmonized statistical database for integrated assessment, with key indicators on the regional level (NUTS level 2) and the municipal level (LAU 2 level). The prediction of the agro-structural change was adapted to the approach of Weiss (2007). The forecasting process was conducted in two steps:

- a) Clustering: By means of relevant driving factors only available on NUTS 2 (e.g., GDP, unemployment rate, accommodations, etc.), six homogenous clusters were built from the 27 Alpine NUTS 2 areas.
- b) Model building: Based on municipal data, a multiple regression model was devised for each of these clusters aiming at:
 - assigning the significance of the independent variables, and
 - estimating the future development of the agro-structural change until 2020 following three different scenarios that are essentially adapted to the Scenar 2020 approach (EC, 2006) and considers the results of the Seamless project.

1) Trend Extrapolation Scenario (Baseline):

Based on the long time-series of the Institute's database, the trends of the observed developments are extrapolated to estimate future changes.

2) Alternative Scenario 1 (Liberalization):

The liberalization approach is adapted to the predictions of the WTO. Assumed in this approach are significant changes to the CAP in Europe regarding direct payments and subsidies for agro-environmental measures or less-favoured areas.

3) Alternative Scenario 2 (Regionalization):

Characteristics of this scenario include slight modification of the current CAP measures (e.g., stronger modulation), a moderate decrease in direct payments and subsidies, special compensation measures for mountain areas as well as small-structured (e.g., dairy cow premium) farms, and higher product prices due to diversification strategies (e.g., high quality products, agro-tourism).

Results and discussion

In the Alps, variances between areas with and without agriculture will be more pronounced in the future. In all scenarios, stronger declines are detected in the southern regions (Italy) than in the northern regions (Austria, Switzerland). This can be attributed to the regional prevalence of small-structured farms and over-aged farmers, as well as to the lack of farm successors. Negative impact from agro-structural change is felt mainly in peripheral regions that lack tourist appeal, have limited infrastructure, and have poor accessibility. The *Baseline Scenario* leads to an annual farm-abandonment of around 2–3%. Depending on the level of progress of agro-structural change and the regional framework conditions, full-time and part-time farming industries develop quite heterogeneously. Overall, part-time farming increases. The *Liberalization Scenario* records an annual farm-abandonment of 3–5%. Areas that until now have only been moderately affected become more strongly affected under agro-structural change. Full-time farms face a greater impetus to capitulate, as they can no longer expand or specialize. Part-time farms are generally endangered with abandonment.

Within the *Regionalization Scenario* the farm-abandonment rate does not exceed 1–2%. Full-time farms are less affected; the abandonment rate of part-time farms is low.

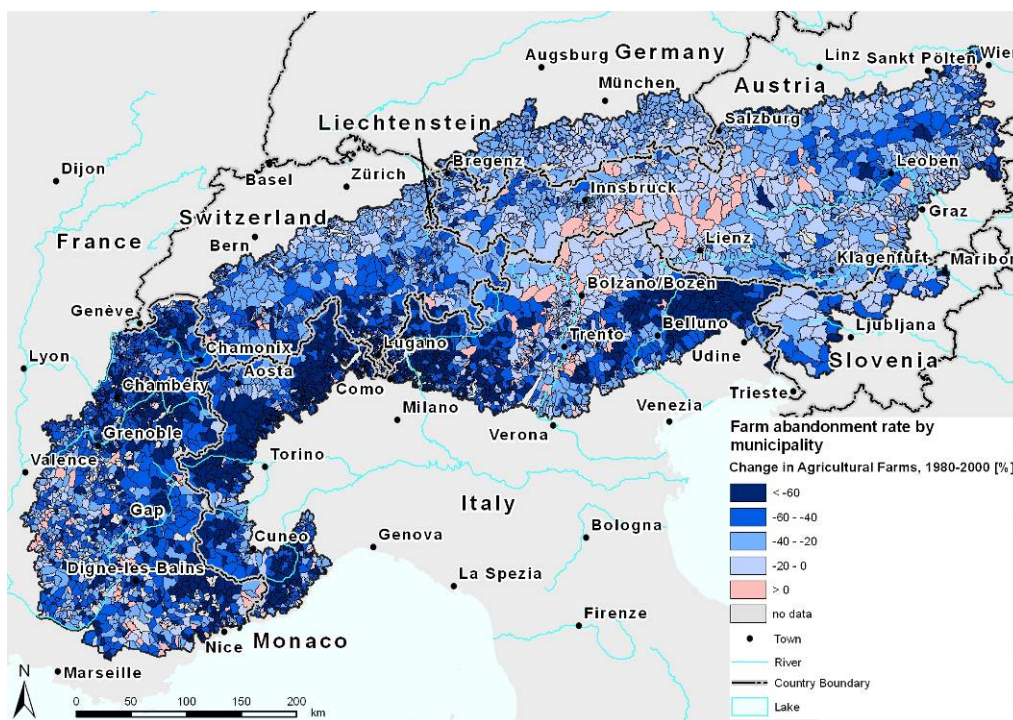

Figure 1. The farm abandonment rate depicts large regional differences in the Alpine Convention area (5,954 municipalities).

References

- European Commission, 2006. SCENAR 2020 - Scenario study on agriculture and the rural world. EC, Directorate-General Agriculture and Rural Development.
- MacDonald, D., *et al.*, 2000. *Journal of Environmental Management* 59: 47-69.
- Streifeneder, T., *et al.*, 2007. *Journal of Alpine Research* 95(3): 27-52.
- Weiss, F., 2007. Modellierung landwirtschaftlichen Strukturwandels in Österreich: Vergleich einer Modellprognose mit den Ergebnissen der Strukturhebungen (1999-2005). DP-33-2007. Universität für Bodenkultur, Vienna.

**Sustainability impact assessment of EU policies at regional level:
An analysis of land use dynamics and environmental effects
with the MEA-Scope tool**

Sandra Uthes, Claudia Sattler, Amanda Osuch,
Kathrin Happe, Annette Piorr, Peter Zander
Leibniz-Centre for Agricultural Landscape Research (ZALF),
Eberswalder Strasse 84, D-14374 Müncheberg, Germany
Contact: sandra.uthes@zalf.de

Introduction

Sustainability impact assessment of EU agricultural policies is an important issue addressed by a number of EU impact assessment tools. Yet social and environmental impacts are poorly covered in many tools particularly in those that act at comparatively aggregate scales, e.g., with administrative regions as smallest scale. The EU-STREP MEA-Scope (2004-2007) has developed a spatial bio-economic modelling tool for ex ante policy impact assessment that attempts to describe economic and social events by modelling the behavior of individual agents, while the geographic information attached to every agent also allows for a regional or local approach to policy analysis. The MEA-Scope tool has proved useful in evaluating economic and ecological impacts of policy changes at the micro level (Happe *et al.*, 2006, Piorr *et al.*, 2008). This paper analyses the spatial distribution of a number of environmental indicators subject to different scenarios of the Common Agricultural Policy (CAP), i.a. Agenda 2000, single farm payment, phasing out of direct payments with and without agri-environmental measures, in four EU case study areas: Ostprignitz-Ruppin, Germany (DE); River Gudenå, Denmark (DK); Mugello, Italy (IT); Piešťany, Slovakia (SK).

Methodology

The MEA-Scope tool is based on three farm-level models, in which the development of spatially localized single farms in reaction to different CAP scenarios is tracked over a time horizon of 10 to 15 years. The models are loosely coupled in a hierarchical order. The agent-based model AgriPoliS simulates the interactions among the farms on the land market and their investment decision, the bio-economic farm model MODAM simulates the cropping and livestock patterns of the farms being the basis for a fuzzy-logic-based environmental impact assessment, and the process-oriented dynamic simulation model FASSET simulates on-farm matter flows. Typical farms of the Farm Accountancy Data Network (FADN) and various GIS data sources are used to reproduce farm structure and farm localization in the regions (Kjeldsen *et al.*, 2006). The resulting single farms own or rent particular plots of land with different soil, climate and elevation characteristics (grid cell size 1 ha). Farm activities encompass land use and production decisions, rental activities, labour allocation decisions and investments. During the simulation, a farm can change its characteristics such as farm size, labour endowment, specialization and production activities. The fuzzy-logic based impact assessment procedure (Sattler *et al.*, 2006) delivers an Index of Goal Achievement (IGA) for a number of region-specific abiotic and biotic indicators (listed in Table 1) not all of which are relevant to all regions as indicated by the respective column of each region. The term 'goal achievement' refers to indicator-related goal definitions, such as 'prevention of nitrate leaching' or 'enhancement of habitat quality for skylarks'. The closer the index value is to one the higher is the assessed suitability of a particular agricultural management option to contribute to goal achievement. Area-weighted aggregation of the IGAs allows for comparing environmental impacts of the policy scenarios among land capability classes, farms or regions.

Table 1. Environmental indicators implemented in the MEA-Scope tool.

	Abbrev.	Indicator	DE	DK	IT	SK
Abiotic	NO3	Nitrate entry into groundwater	x	x	x	x
	NP	Nutrient (N/P) entry into surface water	x			x
	Pest	Pesticide entry into ground and surface water	x	x	x	
	GWR	Groundwater recharge/proliferation	x			
	WaEro	Water erosion	x	x	x	x
Biotic	Amph	Red belly toad (amphibians)	x		x	x
	Sky	Skylarks (field breeding birds)	x	x		x
	Hare	Field hares (mammals)	x	x	x	
	Hover	Hover flies (beneficial insects)	x			
	Flora	Wild flora species (winter annuals)	x	x	x	x

Results and discussion

The same scenarios applied to different regions can lead to opposite or conflicting results with regard to the environmental and economic performance of the farms in the regions. Although decoupling direct payments, for example, led to a clear intensification on arable land in all regions, this overall intensification was not necessarily accompanied by an increasing mean farm income. In the no direct payments scenario, for example, 2nd pillar programs were of particular relevance for biotic indicators in all regions, but participation in these programs could only partly compensate occurring income losses from the 1st pillar of the CAP.

Spatial distribution analysis allows identifying winners and losers, where environmental hot spots are likely to occur, and how the environmental performance of different farms (e.g., the index of goal achievement for amphibians, Figure 1) changes over time under the different CAP options.

The modelling results demonstrate how much the diversity of European regions matters for practical policy implementation. An explicitly spatial focus as adopted in the MEA-Scope tool is, therefore, argued to be crucial for future policy analysis.

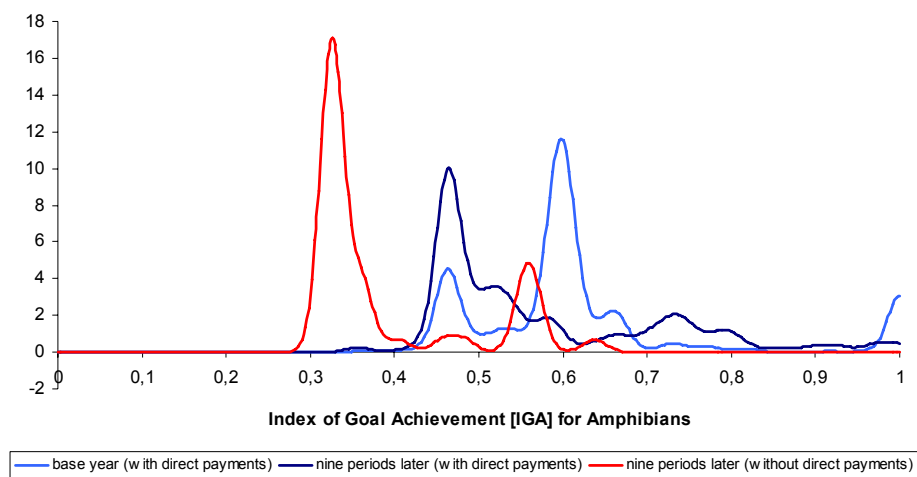

Figure 1. Kernel density distribution of the Index of Goal Achievement for Amphibians [0 to 1] among the farms of the German region Ostprignitz-Ruppin (n=585) with 0 indicating lowest and 1 indicating maximum possible goal achievement.

References

- Happe, K., *et al.*, 2006. *Agrarwirtschaft* 55(5-6): 268-279.
 Kjeldsen, C., *et al.*, 2006. *Danish Journal of Geography* 106(2): 35-43.
 Piorr, A., *et al.*, 2008. *Environ. Sci. Policy*. (accepted)
 Sattler, C., *et al.*, 2006. *IARGE* 5(2-3): 309-325.

Assessment of mitigation measures for air pollutants and greenhouse gases from agricultural systems in Germany at high spatial resolution

S. Wagner, O. Beletskaya, U. Kummer, J. Theloke, E. Angenendt, R. Friedrich, J. Zeddies
 Institute of Energy Economics and the Rational Use of Energy (IER),
 Universität Stuttgart, 70565 Stuttgart, Germany
 Contact: susanne.wagner@ier.uni-stuttgart.de

Introduction

Agriculture is one of the main sources of air pollutants (NH₃, PM) and greenhouse gases (CH₄, N₂O, CO₂). As these emissions have adverse impacts on the environment and human health, respective policies demand their reduction. A detailed analysis of emissions impacts, mitigation measures and their costs at farm level is important, because mitigation measures influence directly farm management and consequently its revenues. Due to the variability of emissions, mitigation potentials and costs across regions, an application of different modelling approaches to the regional level is also necessary. To further develop emissions mitigation strategies, spatially resolved emission data help to identify highly affected areas and regional key drivers. This paper presents a method for integrated assessment of emission reduction measures in agricultural systems in Germany with response to the environment, farm economics and agricultural management at high spatial resolution. Provided that data requirements, i.e., statistical, technical and farm accountancy data, are met, this method is applicable to other countries as well.

Methods

In a project devoted to mitigation of emissions from German agriculture, an economic-ecological model (**E**conomic **F**arm **E**mission **M**odel (**EFEM**)) and a model for high spatial resolution of emissions (**E**mission **C**alculation **M**odel (**ECM**)) are combined for the development of regionalized cost-efficient multi-pollutant mitigation strategies and the assessment of agriculture's contribution to emissions compared to other sectors (see Figure 1). This approach allows scaling up emissions from farm to regional scale, and furthermore, to the national level.

EFEM is targeted to optimize farm managements of four farm types (arable, mixed, fodder- and livestock-production farms) and to assess the emission of air pollutants and greenhouse gases from different agricultural activities at different scales. Thereafter, an assessment of political and technical strategies will be carried out, and different simulations and scenarios will be compared.

For **EFEM** three German regions are considered: Brandenburg, Lower Saxony and Baden-Württemberg. Activities such as animal husbandry, crop production, fodder preparation, manure management, land preparation and

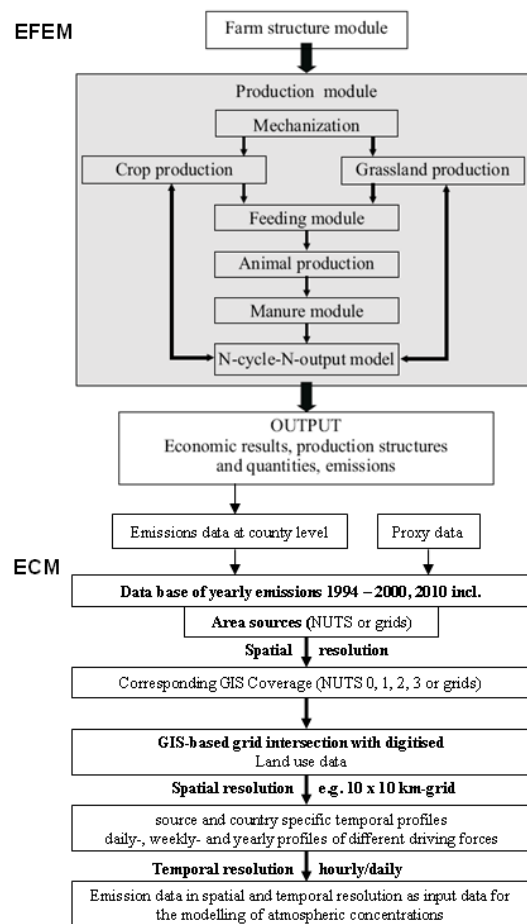

Figure 1: Combination of EFEM (Triebe, 2007) and ECM (Pregger *et al.*, 2007, adapted).

harvesting operations are built into **EFEM** as real or potential sources of different emissions. Emission intensities, farm and regional capacities are compiled within the production module with the help of linear programming. Emission factors have been either determined or taken from studies about European agricultural particulate emission and adopted for **EFEM**.

Emissions data at county level resulting from **EFEM** will be integrated into **ECM**, which allows the calculation of spatially resolved emission information, complemented by proxy data such as animal numbers and agricultural area (Pregger *et al.*, 2007). Emission data are spatially resolved by intersection with the CORINE land use data which are available for western Europe with a resolution of 250 m × 250 m (EEA, 1997), comprising land use categories such as arable land and pastures. Emissions in the model areas are resolved in a 5 × 5 km grid. By parameterization, the results are extrapolated to the whole of Germany at a 10 × 10 km grid.

Results and discussion

An implementation of the **EFEM**-modelling approach allows selection of the most efficient mitigation options, regarding technical and non-technical measures in particular under consideration of the economic impacts to the recipients as well as other regional effects. The effects of mitigation options for air pollution and greenhouse gas emissions from agricultural activities in Germany will be assessed on the base of comparison of the reference year 2003 and scenario 2013. **ECM** provides high resolution emission data for the whole of Germany for the reference situation and scenarios that can be depicted in maps. They allow identifying regions with higher emission concentrations and therefore developing regionalized mitigation strategies. **ECM** also calculates and visualizes contribution of different agricultural activities to total emissions. The quality of the high resolution emission data is determined by the accuracy of input data. Proxy data for spatial allocation can be obtained from official statistics; CORINE land use data are the best available for the time being. A literature review on emission factors evidenced, however, that, especially for particulate matter, more measured data are required. The combination of **EFEM** and **ECM** results in an improved German emission inventory. A validation of the emission inventory is considered necessary; therefore, validation experiments, i.e. comparisons of model results with measurements, are essential.

References

- EEA, 1997. ETC Landcover Data. European Environment Agency, European Topic Centre on Land Cover, Kiruna.
- Pregger, T., *et al.*, 2007. Documentation of the anthropogenic GHG emission data for Europe provided in the frame of CarboEurope GHG and CarboEurope IP. Institute of Energy Economics and the Rational Use of Energy (IER), Universität Stuttgart.
- Triebe, S., 2007. Möglichkeiten zur Verminderung von Treibhausgasen aus der Landwirtschaft in der Bundesländern Brandenburg und Niedersachsen. EUL Verlag, Köln.

Regionally optimized animal farm manure transports in an area with high intensity animal farming systems

Sylvia Warnecke, Markus Biberacher, Gabriele Broll
ISPA, Hochschule Vechta, P.O. Box 1553, 49364 Vechta, Germany
Contact: swarnecke@ispa.uni-vechta.de

Introduction

Within the past decades, the north-western part of the county Lower Saxony, Germany, has emerged as a European centre of high intensity animal agriculture. In several districts of Lower Saxony, which comprises 2.9 million hectare of agricultural land, nutrients from animal farm manure are in surplus to what can be sustainably used as fertilizer on the existing farm land. Long-term over-application of animal farm manure in those districts resulted in nutrient enrichments in soils and waters (e.g., Leinweber *et al.*, 1993). The German Fertilizer Ordinance (DüV, 2006), implementing the European Nitrates Directive, regulates fertilizer use on the farm level and defines a threshold limit for the application of animal farm manures. This results in an export of the excess manure into districts with lower animal densities (Warnecke *et al.*, 2008). Logistics and transportation are costly, especially for manures with high water contents. Thus, this study aims at optimizing the flows of animal farm manure between the districts in Lower Saxony to avoid over-application in the surplus districts and at the same time make use of the fertilizer value in districts with lower animal densities. A linear optimization model is used for the integrated assessment of (a) the impact of national policies on the extend of animal farm manure transports in Lower Saxony and (b) the impact of farm level decisions and techniques on these transports (e.g., systems altering the composition of the manure).

Methods

On basis of Biberacher (2007) and Biberacher *et al.* (2008) a linear optimization model is established to find an optimal regional (potentially supra-district) usage of the existing animal farm manures on the available agricultural acreage (model input) while complying with legal and environmental standards and considering transport distances and market prices for nutrients (model constraints). With special focus on type (dung or slurry) and composition (content of N, P, K and water) of the manures (determined as described in Warnecke *et al.*, 2008), the model output is the overall minimal transport effort for manures at the lowest transportation costs (Figure 1). The modelling language is GAMS. The model is linked to an Excel template serving as an interface for data input and result visualization.

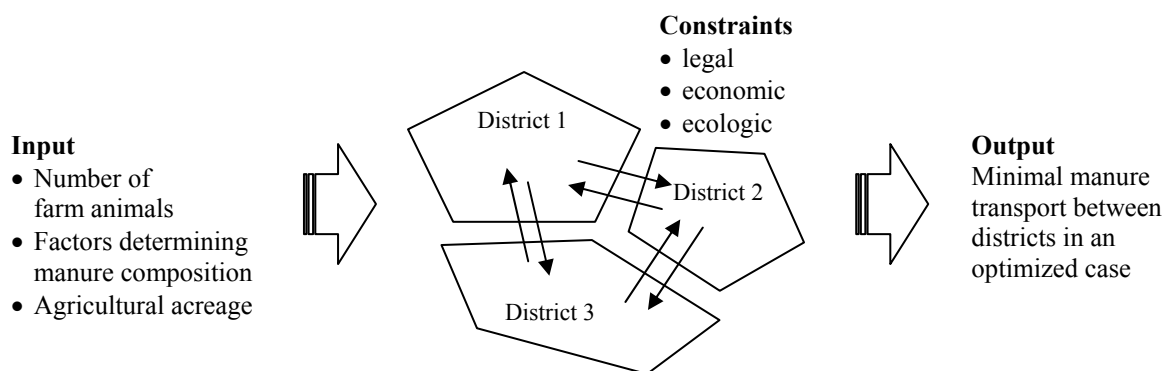

Figure 1. Model framework and workflow.

Special emphasis is dedicated to “if ... then” analyses to show the impacts of changing constraints on the overall optimal solution. Hence, the model allows the definition of a comprehensive and integrative pool for farm manure management options that are available on the different scales, serving as information to the individual decision makers.

Results and discussion

Initial calculations have been done for the 45 districts of Lower Saxony for the year 2008. The basic scenario’s constraint assumption is the application limit of animal farm manures (170 kg N ha⁻¹ yr⁻¹) as defined by the German Fertilizer Ordinance’s regulations (DüV, 2006). If a maximal amount of animal farm manure equivalent to 170 kg N ha⁻¹ yr⁻¹ is applied to the available agricultural acreage of the individual districts, then almost 340,000 t of poultry dung have to be exported from two districts to five adjacent districts (Table 1). Hence, the nutrients in water rich slurries can be completely used as fertilizers in the districts of their origin.

Table 1. Animal farm manure transports between districts in an optimized case.

From district	To district	Manure category	[tons yr ⁻¹]
Vechta	Diepholz	poultry dung	165,673
Cloppenburg	Oldenburg district	poultry dung	69,526
Cloppenburg	Emsland	poultry dung	56,493
Cloppenburg	Ammerland	poultry dung	44,156
Cloppenburg	Oldenburg city	poultry dung	3,640

These initial results are subject to change with the following additional input parameters and constraints which are being incorporated into the model: As biogas production plays an important role in Lower Saxony data on the amount of nutrients that enter the agricultural material flows with the renewable raw materials are added to the input data. The digestates from the fermentation process are, just like the slurries, costly to transport. They compete for agricultural acreage close to their location of production. For this reason, further on-farm transformation processes are included into the model, e.g., slurry or digestate treatment techniques that alter the nutrient:water ratio. Additionally, further legal, economic and environmental constraints will be considered.

In the end, specific scenarios are supposed to show the most relevant impacting parameters and hence options for regulating regional animal farm manure and digestate flows most efficiently. As spatial units – as opposed to individual farms – are analysed in this study, the results will be of particular relevance for policymakers and extension work.

References

- Biberacher, M., 2007. Modelling and optimisation of future energy systems. Using spatial and temporal methods. VDM Verlag Dr. Müller. ISBN-13: 9783836424356
- Biberacher, M., *et al.*, 2008. In: Eds M. Sánchez-Marrè, *et al.*, Proceedings of the iEMSs Fourth Biennial Meeting. S. 1306-1313.
- DüV, 2006. Verordnung über die Anwendung von Düngemitteln, Bodenhilfsstoffen, Kultursubstraten und Pflanzenhilfsmitteln nach den Grundsätzen der guten fachlichen Praxis beim Düngen (Düngeverordnung - DüV).
- Leinweber, P., *et al.*, 1993. Phosphorversorgung der Böden im agrarischen Intensivgebiet Südoldenburg. Vechtaer Druckerei und Verlag GmbH, 62 pp.
- Warnecke, S., *et al.*, 2008. In: IAMO Forum 2008 “Agri-Food Business: Global Challenges – Innovative Solutions”, Proceedings CD. Online: http://www.iamo.de/uploads/media/5b.1_Warnecke_CD.pdf

Theme B
State-of-the-art of components for integrated systems

Session B6: Software infrastructures and tools for integrated assessment

Session organizers:

Robert Argent

Bureau of Meteorology, Canberra, Australia

Jan Erik Wien

Alterra, Wageningen UR, The Netherlands

Andrea E. Rizzoli

IDSIA, Lugano, Switzerland

Integrated modelling tools, mass collaboration and the opportunities ahead¹

R.V. Moore, J.J.F. Wien

NERC Natural Environment Research Council – Centre for Ecology & Hydrology,
Wallingford, Oxfordshire, OX10 8BB, United Kingdom

Contact: rvm@ceh.ac.uk

Introduction

Some modellers have long dreamed of a time when linking models would be as simple as drag and drop. When it happened, they would be able to explore and predict the wider consequences of events and may be foresee, for example, that the move to biofuels could lead to food shortages. The barriers to progress have been technical and cultural. ICT advances have now swept away enough of the technical problems to make linking operationally feasible, though many challenging issues remain to be addressed. However, it is the new internet and the cultural changes following in its wake that may well open up opportunities beyond the original dream. This talk will summarize the driving forces behind integrated modelling and then speculate on where they may take us.

Driving forces behind the development of integrated modelling tools

At least three forces are driving integrated modelling: events, policy and industry. **Events**, such as climate change, affect almost every aspect of life. To understand those effects and plan our response requires not just the ability to model the individual environmental, social and economic processes but also their *interactions*. With respect to **policy**, the impact assessment (IA) guidelines used by European Commission officials emphasize the importance of achieving an integrated form of assessment, covering social, environmental and economic impacts jointly (EC, 2005). This requires consideration of the wider implications of measures before they are implemented, leading to a need for integrated modelling and hence integrated modelling tools. In this context, **industry** covers the model and software developers, the consultants, who use the modelling tools, and their clients, often governments or their agencies. Amongst the developers, the driving forces are the need to make model linkage simpler and hence cheaper, combined with their need to grasp the opportunities for consultancy created by the events and policies. For the end users the driver is the need to implement integrated management. Integrated management requires that the tools should not only predict the response of an individual process such as a river during flood conditions, but be able to predict how many interacting processes will respond to different management policies.

Integrated modelling at present

The introduction of standard model linking interfaces, such as the OpenMI (Gijssbers *et al.*, 2002), and frameworks for component based model integration, like SEAMLESS-IF (Van Ittersum *et al.*, 2008) has opened up enormous opportunities for exploring how processes interact. Now models from any discipline can, if complying with the standards, be linked with increased efficiency, reduced costs and risks, leading to more easily re-used tools. It is, therefore, easier to consider questions such as ‘What will be the impact of climate change on ecosystem services?’ Already developers are creating tools that put the whole model integration and run process within the range of a much wider user community, the first example of such a toolset being OpenWeb².

One of the practical barriers to collaboration on integrated modelling between European competent authorities relates to the licence issues surrounding data and models. When it

¹ Keynote presentation

² <http://www.hrwallingford.co.uk/index.aspx?activities=company&topic=Research&facets=company&subtopic=OpenWEB>

becomes practical to link models across networks and the models to be linked no longer have to be located on one machine, then many of the real and imaginary barriers to interdepartmental collaboration caused by data and model ownership issues come down. Some of the present difficulties should be removed by version 2.0 of the OpenMI in 2009/10. An important point to note about the driving forces is that they emerge from problems whose resolution requires knowledge from several disciplines. Often, more knowledge is needed than any individual or organisation can possess. The creation of standards and frameworks like the OpenMI and SEAMLESS-IF is also beyond the intellectual and financial resources of most individual organisations. Collaboration is, therefore, not merely desirable but essential. Although, the OpenMI has had substantial funding to date, this situation is unlikely to continue. A community of practice therefore needs to be built around the OpenMI, which has sufficient interest in the future of the OpenMI to sustain it with ideas and so maintain its relevance. There is now evidence to believe this is happening across Europe and in the US. Individuals are working on ways of extending the OpenMI's usefulness, and feeding the results back to the OpenMI Technical Committee. It is the task for the OpenMI to learn how to sustain this virtuous circle.

Challenges and opportunities ahead

The new internet will make global communication very much easier for both people and computers. Access to knowledge will become far more widespread. It is therefore possible to consider IA tools based, for example, on Twitter services (<http://twitter.com/>), a free networking and micro-blogging service that allows its users to send and read other users' information. The combined and shared knowledge of large groups of experts and stakeholders, in this way, could be used for massive collaborative assessments and solutions. Wikis and other collaborative platforms, have proved to be successful when based on the four principles openness, peering, sharing, and acting globally (Tapscott & Williams, 2006), as are interactive virtual worlds (e.g., Second Life, <http://secondlife.com/>) where users, for example residents in an area, can interact with each other through avatars. Residents can explore, meet other residents, socialize, participate and cooperate in individual and group activities, possibly solving environmental problems. Combined with integrated models these environments could enrich IA's with visual impact assessments that show impacts of policies or events in virtual but realistic future worlds. Stakeholders could participate by testing strategies and building a better understanding of the aspects of the real world which the virtual world depicts (Wien & Van der Wal, 2004).

There are still many challenges ahead, e.g. on how a viable collaborating community is to be created that will enable the opportunities opened up by integrated modelling to be exploited for the benefit of society. Will it happen spontaneously or does its creation require positive action by those with an interest in it happening? Will mass collaboration enabled by Web 2.0 technologies be the critical success factor for the future of integrated modelling?

References

- European Commission, 2005. Impact Assessment Guidelines. Brussels.
- Gijsbers, P.J.A., *et al.*, 2002. Towards OMI, an Open Modeling Interface and Environment to harmonise European developments in water related simulation software. Proceedings of Hydroinformatics, Cardiff. IWA Publishing, London, pp. 1268-1275.
- Tapscott, D. & A.D. Williams, 2006. Wikinomics. How mass collaboration changes everything. Atlantic Books, London.
- Van Ittersum, M.K., *et al.*, 2008. Agricultural Systems 96: 150-165.
- Wien, J.J.F. & T. Van der Wal, 2004. Real learning in virtual worlds; the essence of playing games, proceedings of the 8th international workshop on experimental learning in chains and networks, Wageningen, The Netherlands.

The Trade-off Analysis software: Modelling tools to support informed policy decision making

J.M. Antle, J.J. Stoorvogel, R.O. Valdivia
Montana State U., Bozeman, MT 59717 USA
Contact: Jantle@montana.edu

Introduction

Trade-off Analysis (TOA) is a participatory approach to integrated assessment of agricultural systems designed to bring together policy decision makers, stakeholders, and a research team to provide quantitative assessment of policy options (Stoorvogel *et al.*, 2004). The approach is based on the identification of quantifiable sustainability indicators and alternative policy and technology scenarios. Trade-offs are defined as the inter-relationships between the sustainability indicators observed as key parameters, such as the prices farmers face, are varied.

The Trade-off Analysis software was developed as a tool to implement analysis of the trade-offs among key environmental and economic indicators, and how those trade-offs change with technology and policy scenarios identified by stakeholders. The TOA software integrates spatially referenced data and disciplinary models to simulate agricultural systems on a site-specific basis and then aggregate results to the level of spatial units (such as watersheds, political units) relevant for policy analysis. The TOA approach has been used to study various issues including technology transfer, poverty, food security, climate change, and ecosystem services with applications in Ecuador, Peru, Ghana, Kenya, Nepal, The Netherlands, Panama, Senegal, Uganda and United States.

Methodology

The TOA software (see below) has a modular structure designed to 'loosely couple' disciplinary models to estimate and simulate an agricultural system under alternative technology and policy scenarios. In the estimation step, the software implements the DSSAT crop models to simulate 'inherent productivity' of crops on a site-specific basis using spatially-referenced soil and climate data. The inherent productivities are used with field-level and farm-level data to estimate systems of output supply and input demand equations for each activity in the system. These equations are used to construct an econometric-process simulation model that determines land management as a function of economic variables and inherent productivities. In the simulation step, the user samples a set of sites from the region to be simulated, specifies the technology or policy scenario, and defines the 'trade-off variable' that the model uses to generate changes in behavior that give rise to trade-offs in the system (e.g., crop or input prices). The econometric-process model is then simulated, and results are passed to environmental process models. Finally, the economic and environmental outcomes at each sample point can then be aggregated and displayed graphically, or saved for analysis and display using spatial analysis and other data analysis tools.

Recent extensions of the TOA software have been made to address extensions of the basic framework. First, feedbacks from environmental changes (e.g., soil erosion) to crop productivity and management have been incorporated. Second, a market equilibrium model has been linked to the TOA system, so that users can solve for the market equilibrium prices that would result from introduction of technology and policy scenarios.

The analysis of agricultural systems using spatially referenced data and highly detailed disciplinary models requires a large amount of high-quality data. Often such models are more detailed than needed to provide policy guidance. An alternative approach, referred to as a minimum-data (MD) approach by Antle & Valdivia (2006), is to use data that characterize the

spatial distributions of relevant economic and environmental variables within an ecozone, together with relatively simple economic decision models. The MD approach has been utilized in a number of recent studies of ecosystem service supply, and has been adopted for new projects on climate change and desertification in North Africa and East Africa.

Using the TOA modelling tools

The TOA software, documentation, and several example applications are publicly available at www.tradeoffs.nl. However, users should be aware that its use requires knowledge of the disciplinary models and data – a team with appropriate training is recommended. The TOA-MD model has been implemented with software and documentation available on the internet at www.tradeoffs.montana.edu. The TOA team provides training periodically to interested users through courses and web-based training.

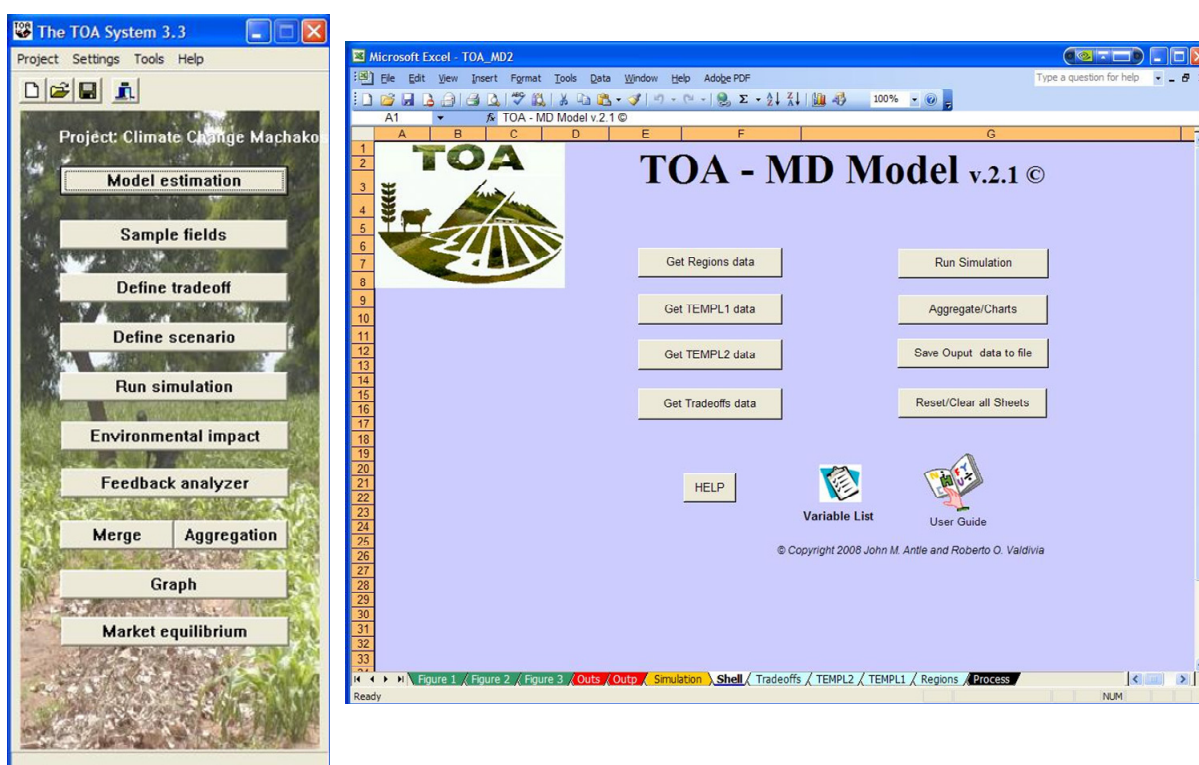

Figure 1. Trade-off Analysis and Minimum Data software.

References

- Antle, J.M. & R.O. Valdivia, 2006. *Australian Journal of Agricultural and Resource Economics* 50(1): 1-15.
- Stoorvogel, J.J., *et al.*, 2004. *Agricultural Systems* 80(1): 43-66.

Granular ontologies for integrated assessment of agricultural systems

Ioannis N. Athanasiadis, S. Janssen, E. Andersen, A.E. Rizzoli, J.J.F. Wien
Dalle Molle Institute for Artificial Intelligence, Lugano, Switzerland
Contact: ioannis@idsia.ch

Introduction

The key features of integrated assessment studies are interdisciplinary research, participatory processes involving stakeholders, and knowledge integration. Integrated assessment studies of agricultural systems need to meet such objectives. This paper introduces a remedy to tackle the complexity of agricultural modelling and data management, by utilizing a set of ontologies for domain modelling and management of agricultural knowledge.

An *ontology* consists of a finite list of concepts and the relationships among these concepts (Antoniou & Van Harmelen, 2004). Typically, an ontology is specified in a formal language, which is understandable by computers, as the Web Ontology Language (OWL) (McGuinness & Van Harmelen, 2004). An ontology captures the concepts involved in a certain domain and their relationships. A *shared ontology* is a collaborative product by a group of researchers, which captures the common understanding of the domain, as it perceived by a community.

A shared ontology in the case of an integrated assessment study is required to take under account different scales, dimensions, databases, methodologies, models, indicators, typologies and stakeholders involved. Such an effort requires an explicit procedure for building the shared ontology, while avoiding getting confused by the project complexity. In this work, we describe the content and structure of a set of shared ontologies that we developed as part of the SEAMLESS-IP project (<http://www.seamless-ip.org>).

Case study

The SEAMLESS project (*System for Environmental and Agricultural Modelling: Linking European Science and Society*) (Van Ittersum *et al.*, 2008) develops a computerized and integrated framework (SEAMLESS-IF) to assess the impacts on environmental and economic sustainability of a wide range of policies and technological improvements across a number of scales. In SEAMLESS-IF, different types of models and indicators are linked into model chains, where each model uses the outputs of another model as its inputs and ultimately indicators are calculated.

Methods

To arrive at a shared ontology that specifies the domain of models, indicators, scales, dimensions and assessment questions in SEAMLESS-IF, a collaborative group (*task-force*) was set up. The task force was formed by a core of three scientists with different backgrounds, which were responsible to stimulate discussions, capture the domain specifications, and translate them into an ontology written in OWL. In the task-force were included for achieving certain goals, a community of dozens of domain-experts. Domain experts (agronomists, economists, social scientists, and data experts) were involved in different parts of the work, on activities related to their expertise, together with the core group. The task-force adopted a collaborative approach (Holsapple & Joshi, 2002), in which researchers formed work-groups to reach to a common understanding of a particular domain and ultimately produced a shared ontology. An iterative prototyping approach was used to develop versions of the shared ontology, which were subsequently reviewed by panels of experts and further improved.

Results and discussion

The collaboration of scientists involved in the task-force resulted to a shared ontology, covering scales, models, indicators and dimensions relevant to the SEAMLESS project. Instead of making one large ontology, spanning across different sub-domains of the project, we developed eleven small ontologies, each one of which refers to a distinct aspect of the project. Common concepts and relationships are shared across granular ontologies.

The content of the eleven small ontologies is:

1. Crop.owl formalizes the domain related to crops, crop products and grouping of crops. Several models refer to such concepts at different scales, and this ontology clarifies these concepts.
2. Farm.owl describes concepts about farms and geographical regions, in which these farms are found, along with soil and climate information.
3. Prodent.owl contains concepts related to rotations and choices in production made by farmers (production enterprise).
4. Activity.owl gives an overview of the different types of activities (e.g., arable, livestock, and perennial) farmers.
5. Livestock.owl specifies in more detail livestock activities.
6. Agrirule.owl specifies in more detail arable activities.
7. Capri.owl provides concepts related to the CAPRI model (Heckelei & Britz, 2001).
8. Farmopt.owl provides concepts related to farm economics and optimization of farm income.
9. Indi.owl specifies concepts relevant to indicators and the use of indicators in integrated assessment (Turpin *et al.*, 2009).
10. Seamproj.owl describes SEAMLESS-specific scenarios and integrated assessment problems.
11. Pica.owl specifies the analysis of institutional compatibility assessments.

There are two main advantages in defining smaller ontologies as part of the larger shared ontology. One is that interactions between different domains become explicit. It becomes apparent which are the concepts shared across sub-domains, which typically are the issues of conflict in interdisciplinary research, and the critical points for software development and interoperability of model components. Second, ontologies of finer granularity can be re-used independently of the rest. They could also be extended or substituted by new (finer) conceptualizations.

The SEAMLESS-IP ontologies are available for download and re-use on <http://ontologies.seamless-ip.org>.

References

- Antoniou, G. & F. Van Harmelen, 2004. A Semantic Web Primer. The MIT Press, pp. 238.
- Heckelei, T. & W. Britz, 2001. Concept and explorative application of an EU-wide regional agricultural sector model (CAPRI-Project). 65th EAAE Seminar, pp. 281-290.
- Holsapple, C.W. & K.D. Joshi, 2002. Communications of the ACM 45(2): 42-47.
- McGuinness, D. & F. Van Harmelen, 2004. OWL Web Ontology Language Overview. www.w3.org/TR/owl-features/.
- Turpin, N., *et al.*, 2009. AgSAP Conference 2009, these proceedings.
- Van Ittersum, M.K., *et al.*, 2008. Agricultural Systems 96: 150-165.

A software tool to support multi-criteria-based assessment of animal welfare¹

R. Botreau, I. Veissier, P. Champciaux, J.-P. Brun, A. Lamadon, P. Perny
INRA, UR1213 Herbivores, Site de Theix, 63122 Saint-Genès-Champanelle, France
Contact: rbotrea@clermont.inra.fr

Introduction

During the last decades, numerous trade groups (producers, processors, retailers, restaurant chains...) have put in place certification schemes. Most of these schemes are meant to ensure product quality and an increasing number of them takes into account other concerns like the protection of the environment or animal welfare (e.g., IKB by the Dutch meat industry, Swedish Broiler Control, or McDonald's Europe). However, there is no common standard for assessing animal welfare. One objective of the European project Welfare Quality® (2004–2009) is to design an overall assessment of animal welfare of cattle, pigs and poultry on the farm or at the slaughterhouse, and to turn this assessment into product information. This information could be delivered as such to consumers or, alternatively, be used by stakeholders (producers, retailers...) to certify products.

To assess all dimensions of welfare on an animal unit (health, behaviour, stress...), numerous measures are to be collected on that unit. Then, the data need to be interpreted in terms of welfare and integrated into an overall assessment. We designed a mathematical model for such an assessment following a sequential multi-criteria process: four welfare principles (good feeding, good housing, good health and appropriate behaviour), subdivided into 12 criteria (e.g., absence of hunger and thirst for good feeding) are defined and assessed on a 0-100 scale, and then aggregated by comparison to predefined reference profiles which delimit four welfare categories (Excellent, Good, Basic, Not classified) at unit-level (Botreau *et al.*, 2009). This assessment model was tuned according to expert opinion and this resulted in calculation of scores based on various functions. To facilitate the implementation of the assessment system, we propose a software tool for data acquisition and processing.

Development of data acquisition and web-based software, and database

The *objectives* of the tool are to ease the acquisition of data and their storage, to automate the scores and overall assessment calculations, to present a synthesis of results to users (producers, retailers, consumers...), and to simulate potential improvements. The tool is organized in four interconnected modules (Figure 1):

- *Module 1* facilitates the acquisition of data directly on farms or at slaughter. This software is to be used by the assessor on a lap-top or a Tablet PC. In addition to data collection, this module makes some basic calculations at unit level (e.g., % animals affected by a given problem) and prepares files containing only necessary data at unit-level to be sent to Module 2. We call such data 'raw data'. These files (XML format) are exported to the database by the assessor.
- *Module 2* is a database storing the data collected on farms and slaughterplants across years (from Module 1) and their related scores calculated in Module 3. The database can be consulted through Module 4.
- *Module 3* is a calculation application importing raw data from Module 2, calculating criterion- and principle-scores and overall welfare assessment, and exporting these to Module 2. Module 3 may also be used by Module 4.

¹ The present study is part of the Welfare Quality® research project which has been co-financed by the European Commission, within the 6th Framework Programme, contract No. FOOD-CT-2004-506508. The text represents the authors' views and does not necessarily represent a position of the Commission who will not be liable for the use made of such information.

- *Module 4* is an interactive platform to enable dialog with stakeholders. This module provides information on measures and the calculation of scores and overall assessment. Figures are produced on the distribution of results among a given population (all animal units, only those visited on one year, in one country etc.) while producers are given access to their own data. Simulations are also possible, e.g., producers can simulate an improvement or a decrease in one or several measures and see the consequences on their scores and overall assessment. To execute a simulation, Module 4 may import data from Module 2 or create a new set of measures to work on, and calculations are made by Module 3.

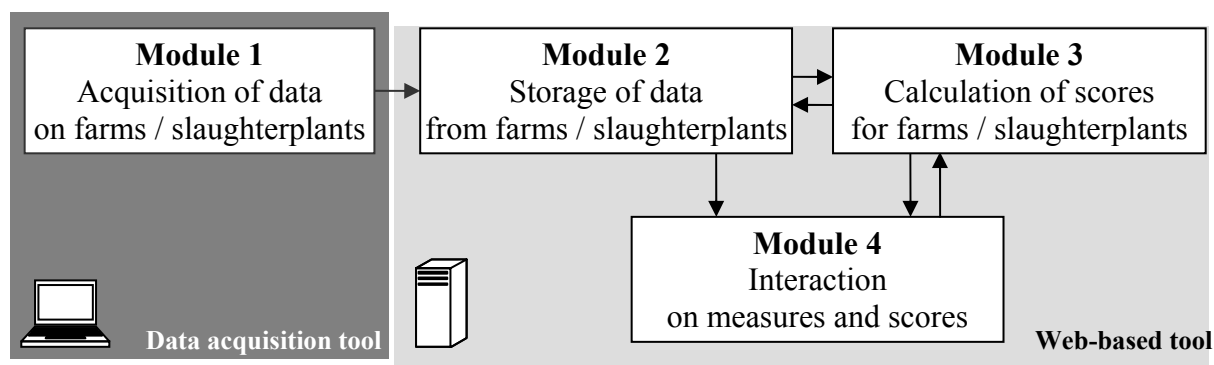

Figure 1. Software modules to ease the implementation of Welfare Quality® assessment system.

Module 1 is a local application for data acquisition on farms or slaughterplants, whereas Modules 2 to 4 correspond to a web customer-server application based on a MySQL database. The support used for each application is presented in Table 1.

Table 1. Modules' development.

Module	Function	Development tool	Database	Support
Module 1	Data acquisition	WinDev 12*	HyperFile*	PC
Module 2	Database management	WAMP5	MySQL	Web server
Module 3	Calculation of scores	(PHP MySQL)		
Module 4	Interactions on results			

* PC SOFT products

Since different user-types may have access to the web-based software (producers, assessors, certification bodies, researchers or mere visitors), several user-profiles are defined and have restricted access.

Discussion

A prototype of the tool for assessing dairy cow welfare on farms is developed. It will be extended to other animal types studied in Welfare Quality® (veal calves, fattening pigs...).

Overall assessment of animal welfare is by definition a complex exercise and support tools are necessary for calculations to be used by stakeholders. We hope the present tool will help stakeholders figure out the kind of results that can be obtained with the assessment system designed in Welfare Quality®. It can show them how improvements on farms or at slaughter are likely to affect the results of the assessment of these units. The tool shall also help the taking up of the assessment system by easing the collection of data and making the assessment more transparent (since all intermediate scores are accessible).

Reference

Botreau, R., *et al.*, 2009. Foundations of Computing and Decision Sciences.

The role of the Object Modelling System (OMS) for integrated assessments of conservation on agricultural land in the United States

J. Carlson, O. David, J. Ascough, F. Geter, L. Ahuja
Agricultural Systems Research Unit, Agricultural Research Service,
U.S. Department of Agriculture, 2150 Centre Avenue, Building D,
Fort Collins, Colorado 80526, USA
Contact: Jack.Carlson@ars.usda.gov

Introduction

Operators of approximately 2.1 million farms, ranches, and small woodlands make daily decisions to manage a combined 1.1 billion acres of private land, about 50% of the land base of the United States. Federal and state conservation programs deliver technical and financial assistance to help operators to sustain the health of the land to maintain its productivity over the long term. Federal programs deliver about \$3 billion annually to help defray the cost of installing and maintaining practices contained in the operator's conservation plan. These practices reduce erosion, control nutrient and pesticide leaching and runoff, increase soil tilth, prevent overgrazing, improve wildlife habitat, and provide other ecosystem services.

U.S. Department of Agriculture (USDA) agencies deliver conservation program services through a network of approximately 3,000 offices at the state, area, and county levels. Field conservationists work with farm operators to develop conservation plans, and the national database system contains 1.4 million active plans covering 300 million acres. These plans provide the basis for financial assistance through 200,000 active program contracts, also maintained in the system.

Up to 35 thousand conservation plans are serviced each work day. About 5,000 field conservationists use the system each week, and during peak periods, the system accommodates as high as 2,000 concurrent sessions. Each night data is summarized and processed to a data mart for daily reporting to agency managers on the progress with delivering program services. Although the system can measure this progress, it cannot yet adequately evaluate its impact on improving the health and sustainability of the land.

The 2002 Farm Bill established the Conservation Effects Assessment Project (CEAP), which uses existing stand alone agro-environmental models for evaluating program effectiveness. However, current efforts do not yet meet the CEAP vision of a consistent national integrated assessment process.

Methods

CEAP analysts at multiple locations must be able to run calibrated and certified agro-environmental models deployed to a centralized platform. Achieving an integrated assessment infrastructure for CEAP involves (1) adopting a modelling framework; (2) establishing a high performance model run-time platform; (3) creating an integrated assessment model base; and (4) provisioning data for all areas in the national assessment. The analyses performed examined recent developments in cloud computing, multi-threading support to on-line commercial applications, lightweight non-invasive programming framework technology, semantic web technology, service oriented architecture (SOA), and opportunities to leverage existing resources and capabilities within participating agencies. The findings were applied to define an improved integrated assessment infrastructure.

Results and discussion

In February 2008, USDA agencies adopted the Object Modelling System (OMS) framework (Figure 1) to support integrated assessment, through formal agreement to manage it as part of an approved technical architecture. OMS (Ahuja *et al.*, 2005; David & Ahuja, 2006)

developed in Java on the NetBeans platform contains a component builder, model builder, repository, core framework services, data access and visualization tools. A Java Annotation Specification is being added to remove model component dependency on the framework API. Model components will be developed using Plain Old Java Objects (POJOs) and bound to the framework at run time. Therefore, model components can be more easily adapted to other frameworks, and their longevity expected to increase.

The OMS team has defined a run-time platform that enables multi-threading and deploying models and components as services in an elastic computing cloud. The platform supports the situation when many analysts across the country run a model concurrently and the situation of the modeller spooling many model runs concurrently for sensitivity analysis.

The CEAP strategy has established the concept of a model base, containing related models and components. The integrated assessment model base contains core components from J2Ks, a combination of the J2000 and SWAT models, with components added from other models as requirements evolve. The architecture supports the CEAP analyst running models tailored to particular scenarios and region. A knowledge base will help ensure consistency in assessments across regions.

The OMS team is defining a data provisioning architecture, featuring a data mart with web services designed to support the requirements of the model base. Data stewardship responsibility will be organized by integrated assessment regions.

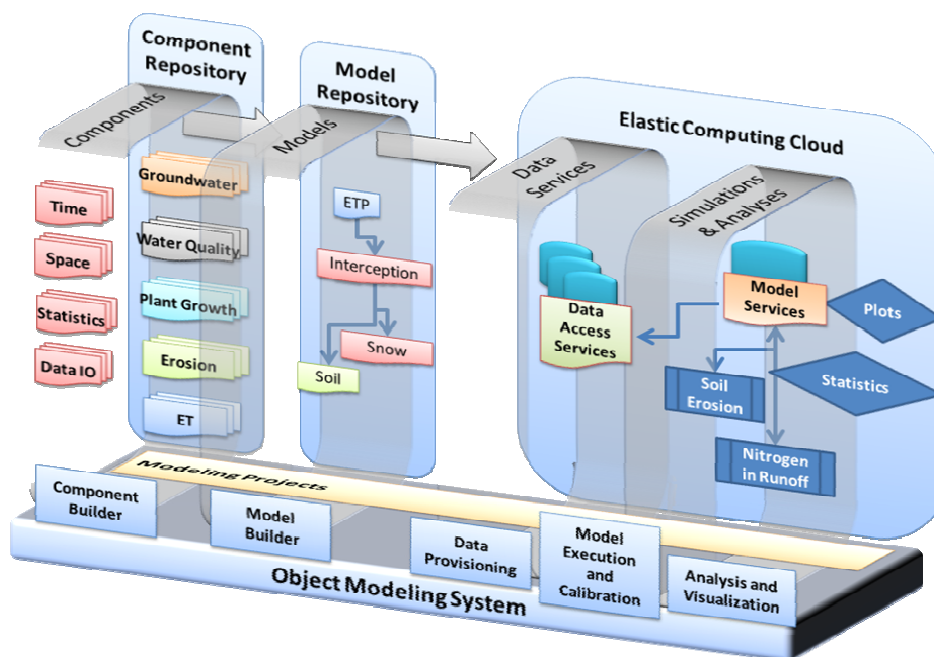

Figure 1. High-level OMS architecture.

References

- Ahuja, L., *et al.*, 2005. *Advances in Geosciences* 4: 29-36.
 David, O. & L. Ahuja, 2006. *The Object Modeling System – A Modeling Platform*. Proc. 3rd Federal Interagency Modeling Conference, Reno, Nevada, 33 pp.

OptimiSTICS, a software for STICS crop model parameter estimation and evaluation which was build up to function with other dynamical models

E. Justes, P. Lecharpentier, S. Buis, M. Launay, J. Bourges, J. Soudais, P. Clastre,
 J.E. Bergez, P. Debaeke, D. Wallach, M. Guérif
 INRA, UMR INRA/INP-ENSAT 1248 AGIR,
 31326 Castanet-Tolosan Cedex, France
 Contact: Eric.Justes@toulouse.inra.fr

Introduction

Because of the inherent complexity of crop models, it is important to have a range of software tools for automating the runs of such models, analysing their behaviour, evaluating results and estimating parameters. The calibration of soil-crop models in particular is a difficult task which requires both the development of procedures adapted to the specificities of models and the development of software tools to implement those procedures. The purpose of this paper is to describe a package for model calibration and evaluation with a focus on OptimiSTICS, which has been implemented to work with the STICS soil-crop model (Brisson *et al.*, 1998), but was develop to function with other dynamic models in the OptiLib software version.

Methods

Optimistics is a software or a data-processing utility which makes it possible to automate the optimization of the parameters of the STICS model. This tool makes part of a library of functions developed for model STICS but which are adaptable to other models. The software package is written in the MATLAB[®] mathematical programming language. The package further contains a series of tools such as: (i) full factorial design where the factors can be parameters or input variables (MultiSimLib), (ii) global sensitivity analysis using the EFAST method (SensiLib), (iii) evaluation tools to compare observed versus simulated data (OptiLib and OptimiSTICS tools). Thus, given a set of site-year-management combinations and a set of observed data, OptimiSTICS runs the model and, based on the comparison of observed and calculated results, calculates mean difference, mean squared error, the decomposition of mean squared error into systematic and unsystematic contributions, modelling efficiency, linear regression between calculated and observed. It also automatically creates various types of figures: (i) measured vs simulated data for all SU and for each SU in dynamics, (ii) residuals according to observed data, (iii) evolution of convergence criteria during optimization, ... OptimiSTICS allows one to estimate parameter values in stages or steps, with different parameters and different observed data used at each stage (Figure 1).

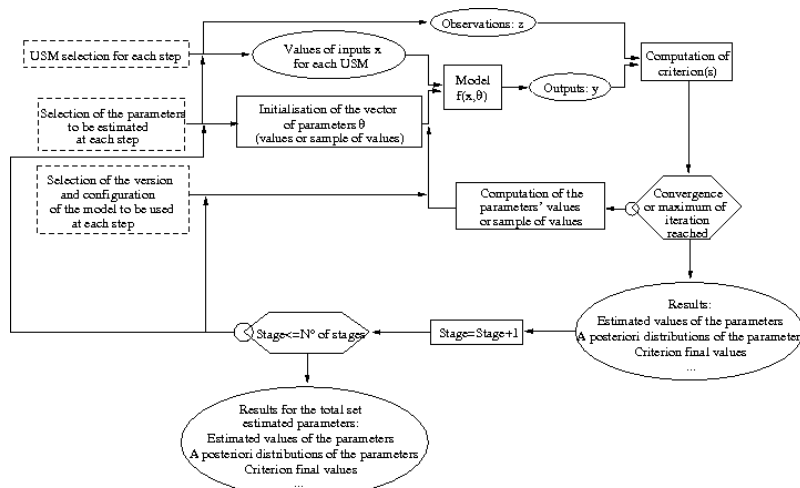

Figure 1. Algorithm diagram of iterative process.

In each stage, the software allows one to designate groups of SU (corresponding to genotypes, or soils, or managements ...) and groups of parameters that will have some specific values differing between groups of SU and others as applying to the crop species in general. A stage may involve only a single type of output or it may involve several types of output. If only a single type of output is involved, ordinary least squares is used.

This procedure is automated and based on a description of the stages by the user. The advantage of this approach is that each set of parameters is adjusted using only data that it affects strongly. Furthermore, one can order the stages so that one first adjusts parameters to state variables that strongly affect other state variables. The goal is to reduce the risk of obtaining parameter values not ‘actual processes based’ due to compensation of errors.

There is an option to first do a log transformation of the data, which is appropriate when model error is likely to be approximately proportional to the size of the response. When several data types are used, the error for each data type should be weighted by the inverse of the standard deviation of model error for that data type. To face the problem of possible correlations between errors, the software provides two options. In the first, all errors are treated as independent. This tends to give more importance to data types and plots with many measurement dates. In the second option, an average squared measurement error is calculated for each measurement type in each plot. That average error is treated as though it were the single error for that data type and plot. In this case, each data type in each plot contributes just one term to the overall squared error, regardless of the number of measurement dates. For each option, the weight for each data type can be calculated automatically, using the method of concentrated likelihood, or provided by the user. Once again, there is an option of log transformation for each data type. The simplex algorithm is used for searching for the parameter values that minimize the ordinary or weighted least squares criteria. The ‘fminsearchbnd’ function of Matlab[®] (D’Errico, 2005) was implemented. One can automatically request several runs with different starting points, to improve the chances of converging to a global minimum.

One further option, which has been programmed but not yet thoroughly tested, is a Bayesian parameter estimation approach. An importance sampling algorithm is used here (Guérif *et al.*, 2006). The user specifies the prior distribution and the form of the likelihood and the algorithm then calculates a weighted sample which approximates the posterior distribution.

Results and discussion

The parameter estimation tools of the software package are quite recent, but we can already draw some conclusions from our initial studies. OptimiSTICS allows one to implement complex parameter estimation procedures that would be extremely time-consuming to carry out otherwise. This has allowed us to use our data set to estimate parameter values for STICS (last 6.2 version) for several varieties of maize, winter wheat, durum wheat, sunflower, sorghum, spring pea and soybean.

The parameter estimation package allows one to fully automate the stage-by-stage estimation of parameters. However, we have found that initially it is important to work with one stage at a time, in order to evaluate the results at each stage.

The parameter estimation software allows one to estimate model parameters in several different ways. One can choose from two different ways of weighting different measurements, one can input weights or calculate them automatically, one can log transform the data or not, one can define the stages of parameter estimation in different ways, etc. Then more than a software package to estimate models’ parameters and evaluate models’ efficiencies, OptimiSTICS tool will also have a methodological role in testing and comparing different approaches to parameter estimation.

References

- Brisson, N., *et al.*, 1998. *Agronomie* 18: 311-346.
D’Errico, J., 2005. <http://www.mathworks.com/matlabcentral/fileexchange/8277>.
Guérif, M., *et al.*, 2006. In: Eds D. Wallach *et al.*, *Working with Dynamic Crop Models*. Elsevier.

ProST: A process support tool for supporting water stress mitigation through a participatory approach

Ayalew Kassahun

Applied Information Technology Group, Wageningen University,
Hollandseweg 1, 6706 KN, Wageningen, The Netherlands

Contact: ayalew.kassahun@wur.nl

Introduction

Participatory approach to solving water management problems is now widely recognized as essential because the solutions affect many stakeholders and a variety of policy areas. In such a process achieving common understanding, trust and confidence is challenging. It is essential to make the process explicit so that all participants have clear and realistic expectations and leave audit trail to ensure transparency. Pahl-Wostl & Hare (2004) found that when stakeholders don't know what is going to happen next or lose track of the goals of the whole project, trust between them and the researchers is lost. To achieve a broadly accepted water management plan they suggest that the project goals, roles of participants and the activities of the process should be discussed and made explicit. ProST, a Process Support Tool, built in the context of the AquaStress Project addresses this problem. ProST is part of a suite of loosely integrated tools made available to the user community by the AquaStress project (Kassahun *et al.*, 2008). ProST along with a knowledge base system and a web portal constitute the main part of I3S.

Methods

A participatory process for water management can be viewed as a collection of interrelated tasks done by a team of researchers and stakeholders to solve a particular problem. Currently available tools to define and manage processes can be roughly classified in two groups: *project management* and *workflow management* tools. Project management tools are used to manage a one-off and mostly long-lived processes and workflow management tools are used to manage repetitive and mainly short-lived processes. However, in the field of water management such tools are rarely used in practice.

A process support tool for supporting collaboration and participatory problem solving should incorporate the necessary features from both project and workflow management systems. Workflow management follows a life cycle roughly comprising of three steps: (i) design & model, (ii) operational implementation and (iii) analyse & improve (Hollingsworth, 2004). In conventional workflow management, a project manager or a business analyst designs a process. Thereafter the process is implemented, meaning the process is executed many number of times. Tasks are dispatched to individual workers, while managers monitor the progress of work and make the necessary decisions. While following the well tested workflow life cycle can be beneficial for ProST the emphasis for support is mainly on enabling stakeholders to participate actively in the planning and the execution of work.

Like a project management system ProST should support long-lived processes like water stress mitigation projects. Project Management Institute considers projects as a one-off process (PMI, 2000). Unlike conventional project management, participatory processes for water stress mitigation projects are not purely one-off processes but one-of-a-kind processes with recurring elements, which means project teams can reuse parts of water stress mitigation project plans that previously were successfully applied elsewhere. In AquaStress, a default and reusable participatory process for water stress mitigation is being defined based on experiences from AquaStress test cases.

Results

A process support tool ProST was developed that provides process support in three phases: *process definition*, *project set-up* and *project execution* as shown in Figure 1. In the process definition phase members of project team collaboratively plan a water stress mitigation project. The plan describes the tasks to be done and any relevant information that can be of use in executing the tasks. During *project set-up* the project leader(s) imports the process definition for their site or case study from the knowledge base into ProST and initialize their project by enlisting users, selecting tasks and setting-up authorization settings.

The main function of ProST is in the *project execution* phase. Once the project is set up, individual members of the team use ProST to guide them in carrying out their tasks based on their authorization. An important aspect of ProST is that it not only allows users to look forward and know what is going to happen next, but also to look backward and see what has been done by themselves and other team members. A flexible reporting tool enables users and project managers to generate reports and analyse the progress of the project.

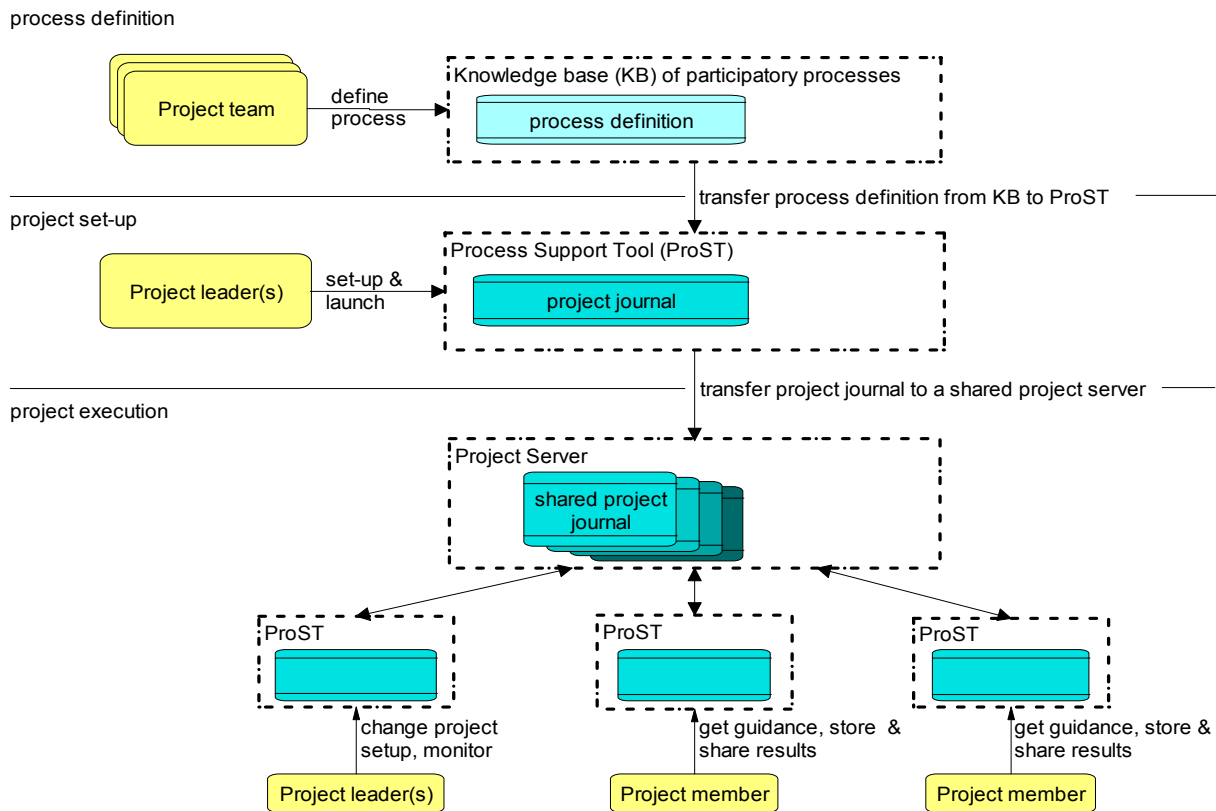

Figure 1. The steps of supporting participatory water stress mitigation project.

References

Hollingsworth, D., 2004. Workflow Management Coalition: 295-312.
 Kassahun, A., *et al.*, 2008. Integrated solution support systems for water management. iEMSS 2008, International Congress on Environmental Modelling and Software Barcelona.
 Pahl-Wostl, C. & M. Hare, 2004. Journal of Community & Applied Social Psychology 14(3): 193-206.
 PMI, 2000. Guide to the Project Management Body of Knowledge (PMBok® guide) Pennsylvania, USA, Project Management Institute, Inc.

Use of OpenMI in SEAMLESS

M.J. Rob Knapen, Ioannis N. Athanasiadis, Benny Jonsson, David Huber, J.J.F. Wien,
Andrea E. Rizzoli, Sander Janssen
Group Systems, Alterra, Wageningen UR, P.O. Box 47, 6700 AA Wageningen
Contact: Rob.knapen@wur.nl

Introduction

Integrated Assessment (IA) is one option for ex-ante analysis of the impacts of policy changes and technological innovations on agriculture. Integrated Assessment and Modelling (IAM; Parker *et al.*, 2002) is based on quantitative analysis involving the use of different modelling tools. This paper focuses on an IAM approach, in which comprehensive models are linked into model chains. When models are executed in a model chain at run time, they need to exchange data. The Open Modelling Interface and Environment (OpenMI; Moore & Tindall, 2005) has been proposed as a standard to facilitate the exchange of data at run time between models.

SEAMLESS, System for Environmental and Agricultural Modelling: Linking Science and Society (SEAMLESS; Van Ittersum *et al.*, 2008) is an IAM research project, in which a linking is achieved between a set of models from biophysical and economic disciplines. In SEAMLESS the OpenMI 1.4 standard was adopted for linking models at run time through exchange items. As OpenMI is originally targeted at the hydrological domain, focusing on models that only exchange time series of floating point values, it needed some extension to support richer data types and other types of simulation engines before it could be applied to the biophysical and economic models in SEAMLESS. This paper describes the adapted version of OpenMI we developed for SEAMLESS and discusses the use of OpenMI for model coupling in this context.

Methods

In OpenMI 1.4 (OpenMI, 2009) each model should have an interface and be wrapped as a linkable component. Each linkable component has zero or more input exchange items and zero or more output exchange items, which describe the data the model requires to run and the data it produces. The input exchange items can be derived from other models or from data sources, while the output exchange items give what the model produces. Each linkable component has a `getValues`-method (Moore & Tindall, 2005) which is called by another linkable component as a request to get input data for a specified simulation time and geographic region. This results in a pull-based approach in which one linkable component pulls data from another linkable component.

Within SEAMLESS, existing and new models are wrapped to make them OpenMI compliant (so that they provide the standard OpenMI API for model components) and then linked into a model chain. Special components – the triggers – are also added to the chain and are eventually used to start the pull-based calculation. Following the links in the chain each model is initiated to perform its run, requesting other models for data first when this is needed. SEAMLESS uses the Java-version of OpenMI as the SEAMLESS framework is fully build in Java, however the wrapped models are written not only in Java but also in GAMS (General Algebraic Modelling System, 2009) and C#.

Results and discussion

For SEAMLESS an adaptation software layer had to be developed to make the original OpenMI 1.4 suitable for use in the project. In its core it is build around the exchange of time series of floating point typed quantitative data, which is enough to work with hydrological models. The models used in SEAMLESS are from the economic and biophysical domain and

are not operating on time series of floating point numbers but use complex data structures as their input and output exchange items (e.g., a Crop, a Farm, or a EU Member State). An ontology is used to define concepts for these data structures, and models exchange instances of those concepts. Accordingly most of the adaptations in the SEAMLESS OpenMI Layer are used to facilitate model components that exchange concepts. Within this layer the most important classes are (see Figure 1):

- SeamChain: A convenience class for building SEAMLESS model chains and executing them. It is based on standard OpenMI classes.
- SeamLinkableComponent: An extended version of the LinkableComponent of OpenMI. It defines input and output exchange items that support the use of the concepts defined in the ontology.
- SeamTrigger: An specific version of the OpenMI Trigger class. It requires as input a Problem concept, which describes the research problem and a IIndicatorValue concept, which describe the results of a model run.
- SeamExchangeItem: Base class for SEAMLESS exchange items that support the use of concepts defined in the ontology. Subclasses for input (concept needed by the model) and output (concept produced by the model) exchange items are implemented.

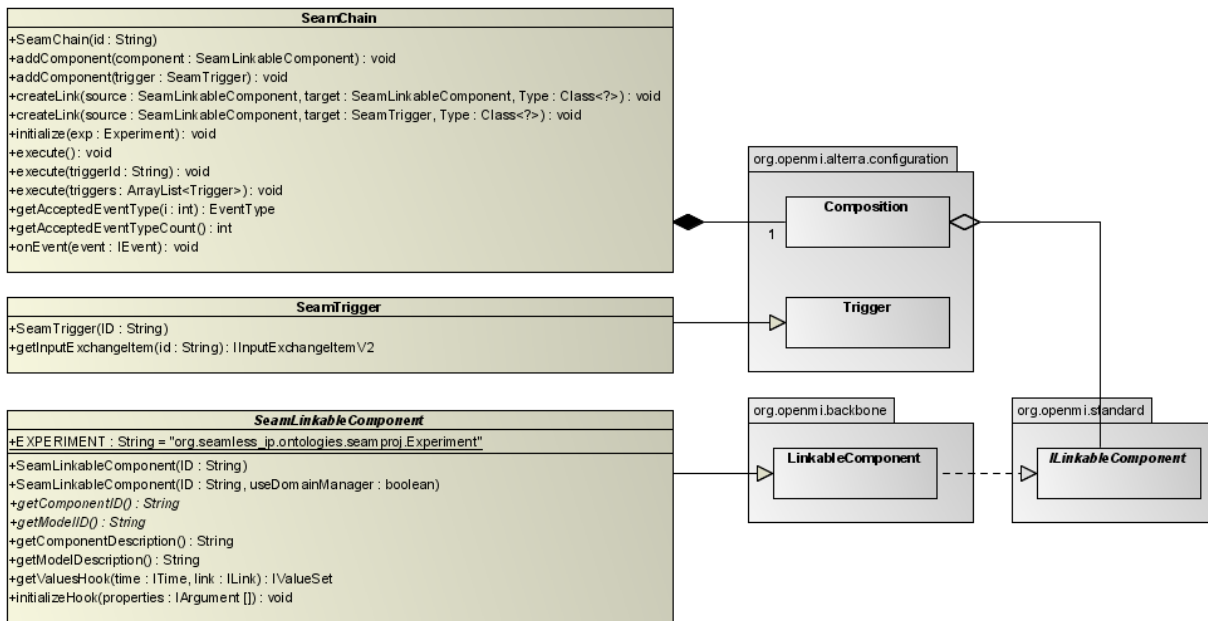

Figure 1. Simplified UML class diagram, which illustrates the SeamChain, SeamTrigger and SeamLinkableComponent and their relation with the OpenMI Standard.

The described OpenMI extensions already are contributed to the OpenMI Association (as open source) and are under discussion for inclusion in the OpenMI 2.0 standard that is under development. This will increase the applicability of OpenMI for domains outside of the hydrological domain.

References

General Algebraic Modeling System, 2009. www.gams.com.
 Moore, R.V. & C.I. Tindall, 2005. *Env. Science & Policy* 8(3): 279-286.
 OpenMI, 2009. www.openmi.org.
 Parker, P., *et al.*, 2002. *Env. Mod. & Soft.* 17(3): 209.
 Van Ittersum, M.K., *et al.*, 2008. *Agricultural Systems* 96: 150-165.

A graphical user interface for a generic bio-economic farm model (FSSIM)

Eelco Meuter, Sander Janssen, Martin K. Van Ittersum
Plant Production Systems Group, WU, P.O. Box 430,
6700 AK Wageningen, The Netherlands
Contact: eelco.meuter@wur.nl

Introduction

The Farm Systems SIMulator (FSSIM; Van Ittersum *et al.*, 2008; Janssen *et al.*, 2009) is a Bio-Economic Farm Model (BEFM) that is designed as a component based model. It is to be used for the range of agri-environmental conditions in the European Union, the farm types that occur in these conditions and a broad range of innovation and policy questions that may be relevant to those farm types. A bio-economic farm model links formulations describing farmers' resource management decisions to formulations that describe current and alternative production possibilities in terms of required inputs to achieve certain outputs and associated externalities. Janssen & Van Ittersum (2007) found that implementations of BEFMs are hardly ever re-used by the research community for new problems or applications. In addition to a modular structure, one of the features that could stimulate the use of these BEFMs by a larger community is an easy to use and accessible graphical user interface (GUI). We developed such user interface for FSSIM as the FSSIM-GUI.

This contribution introduces the functionality, the software architecture and technical implementation choices of the FSSIM-GUI.

Functionality

The aim of the stand-alone FSSIM-GUI is to have an intuitive, easy to use user interface that allows users to initialize, run and modify data for the simulation of farm systems which are modelled by the FSSIM components. The application is web-based, which makes the application easy accessible for the research and farmer's community. The functionality is primarily targeted at users with no or little experience in the use of BEFMs in general. The user interface has a public and restricted part. Within the public part of the website, we inform the user about FSSIM and its components. The user must register in order to gain access to the restricted part. By registering users, the simulations executed by each user can be stored, retrieved and repeated at a later stage by that user. Also, modifications of input data or outputs created through a simulation are stored on a central database and accessible for the user that created the simulation.

In order to run a simulation a user must create a new model experiment. This experiment contains meta-data about the purpose and assumptions of the simulation. Then, the user selects and parameterizes the FSSIM components with default or user-defined variables, such as components to generate and quantify alternative cropping or livestock activities, to assess current activities or to simulate farm behaviour in response to defined policies (i.e. the mathematical programming model). After a successful simulation, the output is stored in the database and the user can view some of the key aspects of the output or export it for further analysis.

Architecture

The application has a service-oriented architecture, which is a software design that consists of two parts; a set of services and the service infrastructure. A service is a declaration that clearly defines a specific functionality of the application. This functionality can be used by other services within the application or any other client. A service infrastructure is a framework that deals with the information flows between services and tiers. The actual implementation of the service declaration registers the service at the infrastructure and can use the infrastructure to

perform its task in a simple and efficient manner. The tiers are loosely coupled via the service declarations and service infrastructure.

The application has three tiers; a data tier, a service tier and a user interface tier. The first tier, the data tier, is an object-oriented data model representing the variables for the different model components and user management. In order to persist the data, the data model is mapped to a relational database using an object relational mapping tool that is part of the service infrastructure. The second tier is the service tier, which contains the service declarations and its implementation. These service declarations are the gateway to the functionality of the application and hides all technicalities, e.g., the implementation and linkages between tiers, for a client (which can be a user interface, another service or another application). It clearly specifies what the application can do. The third tier, the user interface, is actually a client of the application. It only uses the registered service declarations and the service infrastructure to manage the simulation runs. The user interface implements an event model that handles the different actions from a user in order to successfully use FSSIM.

Technical Implementation

We opted to exploit the leading technologies and industry standards for complex web-based application and to use only open source technology. After considering the service infrastructures Spring and Java Enterprise 5, more precisely Enterprise Java Beans 3 (EJB, JSR 220), we choose the standard EJB, knowing that EJB can be easily incorporated into the Spring framework. The choice of EJB also allows to choose different object relational tools like Hibernate or Toplink depending on the choice of database and different application servers that implement Java Enterprise 5. We choose JBoss as service infrastructure. JBoss is a popular application server with native support for Hibernate. Based upon these choices and the actual implementation of the application services we limit ourselves to comply to Java 1.5.

The graphical user interface is built in Adobe Flex 3, a leading technology for building rich internet applications; internet sites that have a look and feel of a desktop application. As Flex is based on a different technology, called Actionscript, than Java, we choose Granite Data Services as an infrastructure to connect the service tier to the GUI. Granite is an open source tool that uses the same protocol and a similar implementation to connect Flex to Java as the popular Adobe Flex Data Services or BlazeDS. Also, Granite is not limited to one CPU. The Java data model is automatically mapped to an Actionscript data model by Granite. The Actionscript data model allows the developer of the GUI to have access to the same data types as defined in the data tier of the application.

Conclusions

With this contribution we aim to demonstrate the functionality of the FSSIM-GUI as well as informing the research community about the advantages and challenges of using a service oriented architecture in combination with leading state-of-the-art technologies and industry standards. The FSSIM-GUI is available at <http://fssim.seamless-ip.org> and published under the GNU public license, respecting the separate licenses and copyrights for the included third-party open source libraries.

References

- Janssen, S. & M.K. Van Ittersum, 2007. *Agricultural Systems* 94: 622-636.
Janssen, S., *et al.*, 2009. AgSAP Conference 2009, these proceedings.
Van Ittersum, M.K., *et al.*, 2008. *Agricultural Systems* 96: 150-165.
<http://java.sun.com/javase/technologies/javase5.jsp> <http://java.sun.com/products/ejb/>
<http://www.springframework.org/> <http://www.jboss.org/>
<http://www.hibernate.org/> <https://glassfish.dev.java.net/>
<http://www.graniteds.org/confluence/pages/viewpage.action?pageId=229378>

What are the key factors for successful integration of life cycle assessment into FADN?

T. Nemecek, S. Blaser, D. Dux, G. Gaillard
Agroscope Reckenholz-Tänikon Research Station ART, 8046 Zurich, Switzerland
Contact: thomas.nemecek@art.admin.ch

Objectives and rationale

Farmers, authorities and stakeholders have an increasing need to assess the sustainability of individual farms as well of the whole agricultural sector. Since several decades, the economic situation of the Swiss agricultural sector is regularly monitored by a farm accountancy data network (FADN). On the contrary, no such monitoring was carried out for the environmental impacts of the farms. A feasibility study on 50 farms was performed to check the possibility to implement a combined economic-environmental analysis by coupling FADN to environmental life cycle assessment (LCA). The study concluded that a valuable assessment of farms is feasible, provided that data collection and analysis could be automated (Rossier & Gaillard, 2001). Therefore, a monitoring project was initiated in 2004, with data collection on 60, 170 and 170 farms in the years 2006, 2007 and 2008. The farms were selected by a stratified sampling procedure using the criteria of farm type, region (lowlands, hills and mountains) and farming system (integrated or organic).

The two main goals of the project are an analysis of environmental performance of the farms with feedback to the farmer as a basis for environmental management and an environmental monitoring of the agricultural sector. Furthermore, the results will serve for various research projects.

Software infrastructure for environmental and economic farm assessment

The software infrastructure was based on the three existing software tools, namely the farm management software AGRO-TECH, the LCA method and tools SALCA (Swiss Agricultural Life Cycle Assessment) and the FADN database. These tools however had to be adapted (e.g., allocation between farm branches) and extended (e.g., data collection) in order to cover all needs of the integrated assessment. Furthermore, interfaces were built for data extraction from the farm management software for calculating an LCA (SALCAprep) and for validation of the LCA results and export to the FADN database (SALCAcheck). A modular structure with flexible interface programming was chosen to implement the software environment. The workflow is presented in Figure 1. An LCA centre with specifically trained staff was created for the purpose of centralized data collection and LCA calculation. Several feedback loops are included in the workflow, e.g., data correction by the farmer after the plausibility check by SALCAprep or validation of the LCA results by SALCAcheck. The latter component compares the environmental performance of each individual farm to average reference farms (benchmarking) and the farmer gets a feedback concerning the relative environmental impacts of his farm, together with an analysis of possible improvement measures. The FADN evaluation centre collects in economic and environmental data in the FADN database and uses them for feedbacks to farmers (for environmental management), sectoral monitoring and research projects.

Due to the high data requirements, ensuring data quality is a key issue. The main measures are clear user guidelines, a hotline for the farmers, checks during data entry in the farm management software (mandatory fields and range checks), plausibility checks during data extraction in SALCAprep (mandatory fields, range checks and conditional checks) complemented by visual control by staff of the LCA centre, validation of the LCA results in SALCAcheck (comparison to benchmarks) as well as plausibility checks with general farm data and economic results before importing into the FADN database.

Key factors for successful integrated assessment

After three years of data collection and the second year of data analysis, we can preliminarily conclude about the key factors for an integrated assessment of economic-environmental performance of farms:

- Automation is crucial to process a large number of datasets in an acceptable time. However, it is a challenge, since farms are complex enterprises in a large variety of pedo-climatic and socio-economic conditions.
- Keeping a strict modular structure of individual components enables to manage the complexity.
- Ensuring the data quality is essential, checks are needed at several levels.
- Finally a feedback to farmers is a key to motivate the farmers to participate and to provide high quality datasets; the economic remuneration is only one element for motivation.

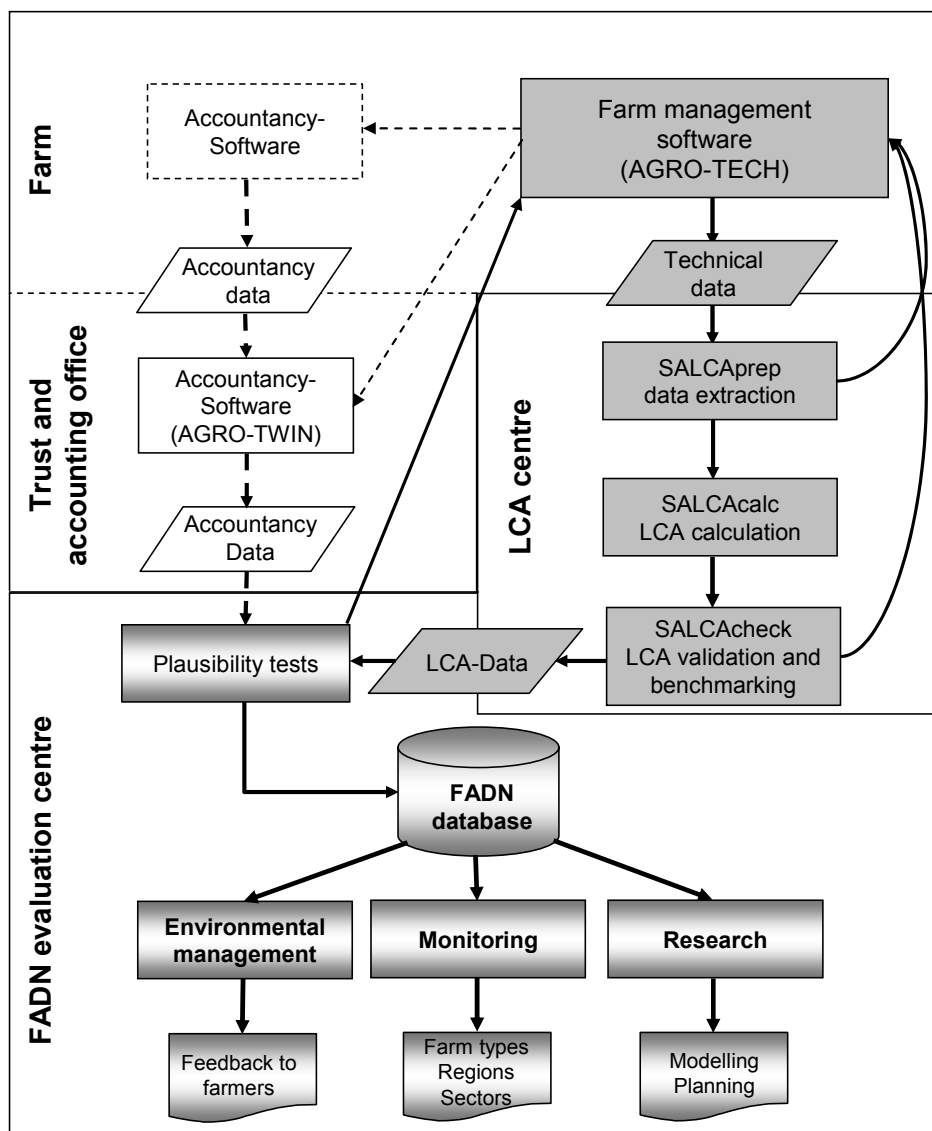

Figure 1. Flow chart for the data from the farm to the centralized evaluation.

Reference

Rossier, D. & G. Gaillard, 2001. Bilan écologique de l'exploitation agricole: Méthode et application à 50 entreprises. Forschungsanstalt für Agrarökologie und Landbau (FAL), Zürich, 176 pp.

An integrated framework for management of spatial and temporal data on a drained watershed

O. Salazar, A. Joel, I. Wesström

Swedish University of Agricultural Sciences, Department of Soil and Environment,

P.O. Box 7014, Uppsala 750 07, Sweden

Contact: Osvaldo.Salazar@mark.slu.se

Introduction

The mechanisms determining the hydrology of drained watershed are complicated and depend on many factors. The development of watershed scale models has provided methods to describe the hydrologic components in these areas. Distributed models treat the watershed as a spatially variable physical system with various functioning hydrological units, which is more realistic and has significant theoretical advantages that make it more useful than other types of models. Although spatial and temporal variations in such models are necessary, these may be stated with the integration of geographical information system (GIS) with models.

This study describes the development and evaluation of a watershed integrated framework that operates with Arc Hydro schematic features (Maidment, 2002) in the ArcGIS 9 ModelBuilder environment (ESRI, 2004). This framework is based on the field hydrology DRAINMOD model (Skaggs, 1978) and uses a distributed approach to route water from the field edge to the watershed outlet. This modelling approach was tested and compared based on the ability to predict discharge on a 750 ha artificially drained watershed in a coastal area in south-east Sweden where coarse-textured is the dominant soil type.

Methods

The Kleva watershed is typical of agricultural landscapes in the coastal area of Öland Island in the Baltic Sea. It is a 750 ha artificially drained watershed located in Mörbylånga in Kalmar County in south-east Sweden (56°31' N, 16°23' E) (Figure 1). The watershed was divided into 95 fields. Each field was assumed homogeneous about soils, land use, and water management practices. Hydrology data collected during six periods between 2003 and 2008 were used to test the framework.

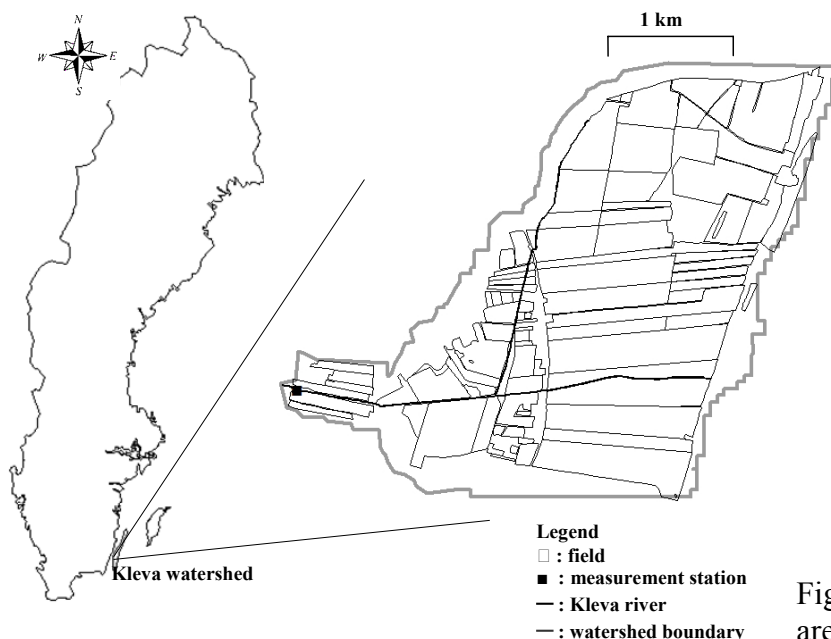

Figure 1. Diagram of the study area in Kleva watershed.

In this study, a framework proposed by Whiteaker *et al.* (2006) for integrating Arc Hydro features with a schematic network to simulate hydrologic watershed behaviour was used. The DRAINMOD model version 5.1 was run to simulate a water balance on each field with input based on the individual characteristics of each field. Daily drainage outflow and runoff predicted by the model was summed on each field and stored in a time series of outflow. A distributed approach was used to route the time series of daily DRAINMOD-simulated outflow from each field drainage point to the watershed outlet, where the outflow from each field were summed through the stream network to predict the discharge at the outlet-watershed. The performance of the framework was evaluated considering the uncertainties of the model inputs using the Generalized Likelihood Uncertainty Estimation (GLUE) methodology (Beven & Binley, 1992).

Results and discussion

The GLUE estimates (uncertainty bands 5% and 95%) and measured monthly discharges were in a satisfactory agreement. Overall the relative discharge volume deviation (E_d) indicated that neither over prediction nor under prediction was found during the calibration and validation periods (Table 1). However, compared with observed values, the relative discharge volume deviation at 5% ($E_{d,5\%}$) showed a positive value during Period 5. This positive value was caused by an over prediction of the GLUE estimates occurred during January-March in Period 5, when exceptionally mild weather conditions were registered. During this period DRAINMOD had difficulties to divide rain and snow, and consequently to predict flow events correctly.

Table 1. Relative discharge volume deviation between observed and 5% ($E_{d,5\%}$) and 95% ($E_{d,95\%}$) prediction intervals for calibration (Period 1 to Period 3) and validation (Period 4 to Period 6).

Period	n^a	$E_{d,5\%}^b$	$E_{d,95\%}^c$
	9	-0.5	0.2
2	12	-0.3	0.3
3	3	-0.5	1.9
1-3	24	-0.4	0.3
4	6	-0.4	0.1
5	6	0.2	1.0
6	8	-0.5	0.7
4-6	20	-0.2	0.5

^a n is the number of months; ^b a positive value indicates that the discharges are outside the prediction interval
^c a negative value indicates that the discharges are outside the prediction interval.

It was concluded that major discrepancies in discharge predictions were due to errors in snow accumulation and melt in mild winter periods. The results indicated that the framework can be an effective tool for describing the discharge from artificially drained watersheds under cold conditions in south-east Sweden.

References

- Beven, K. & A. Binley, 1992. *Hydrol. Process.* 6: 279-298.
- ESRI, 2004. ArcGIS 9, What is ArcGIS? Environmental System Research Institute (ESRI), Redlands, CA, USA.
- Maidment, D.R., 2002. Arc Hydro: GIS for water resources. Redlands, CA, ESRI Press.
- Skaggs, R.W., 1978. A water management model for shallow water table soils. Technical Report 134. Water Resource Research Institute, NCSU, Raleigh, NC, 178 pp.
- Whiteaker, T.L., *et al.*, 2006. *Trans. GIS* 10: 219-237.

Groundwater concepts and agriculture: A GIScience data model study

David R. Steward, Xiaoying Yang, Willem J. De Lange

Kansas State University, Civil Engineering, 2118 Fiedler Hall, Manhattan, KS 66506, USA

Contact: steward@ksu.edu

Introduction

Groundwater is important for agriculture, providing a secure water source through drought. In semi-arid regions across the world, modern society is wrestling with how to balance short-term and long-term water needs for irrigated agriculture. It is important to develop scientific support to guide societal planning and policy.

Methods

Understanding the impacts and interactions between agriculture and groundwater resources is supported by a large number of models. Groundwater models utilize a variety of numerical techniques based upon the Analytic Element Method, the Finite Difference Method and the Finite Element Method. These computational tools currently lack data interoperability between groundwater models that employ different mathematics, data types, and legacy input/output file formats. Even so, existing groundwater modeling methods are all rooted in the same fundamental hydrologic properties of mass, flux, pathways, and residence time.

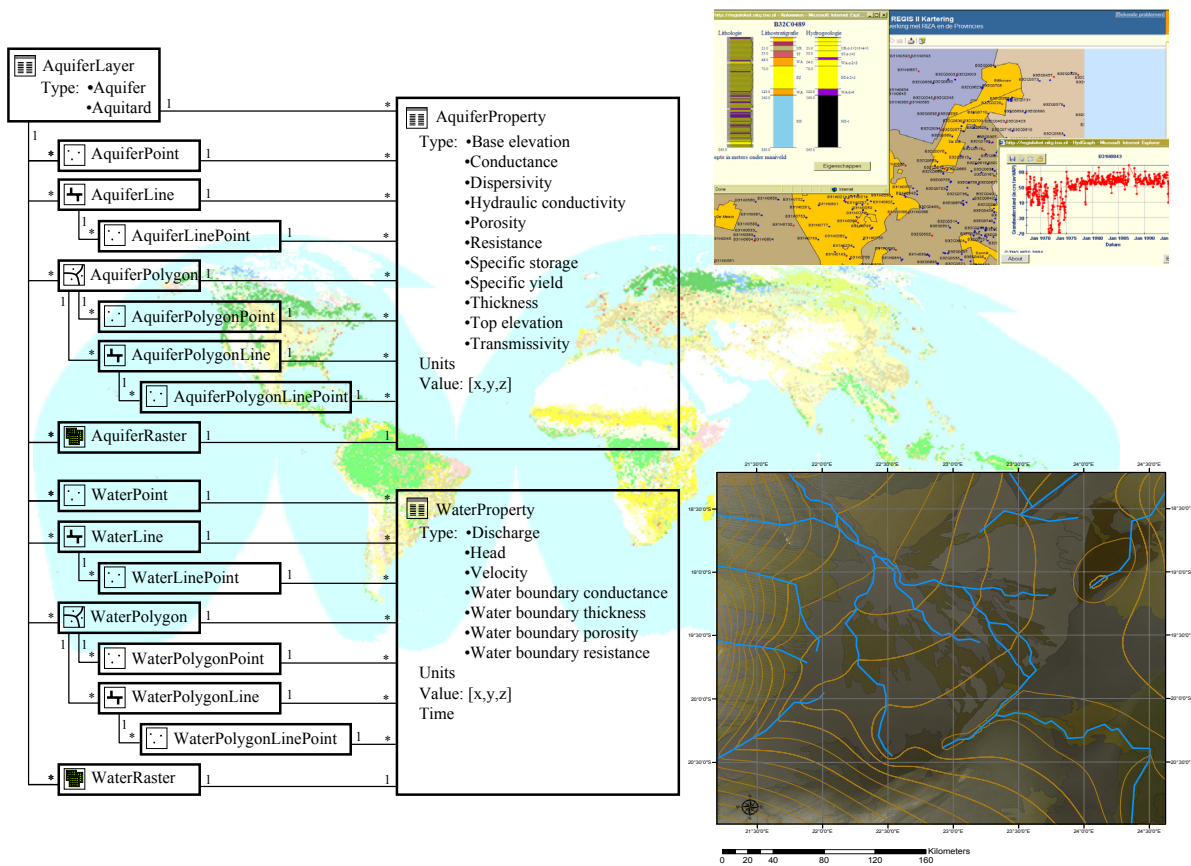

Figure 1. The GIS concepts datamodel is used to organize datasets across the world and supports a wide range of groundwater modelling tools, which in turn are related to data for other processes such as agriculture and economics (Steward & Bernard, 2006; Steward *et al.*, 2008, 2009; Steward & Ahring, 2009; Yang *et al.*, 2009).

These fundamental groundwater system concepts serve as the basis of in designing a new object-oriented conceptual groundwater data model. Geographic Information Science (GIScience)-based tools and methodology provide a framework for quantitative analysis where a groundwater system as a series of aquifer layers with defined aquifer properties and water boundary conditions. This data model provides a mechanism to structure and organize groundwater datasets pertinent to agriculture, and to store a conceptual view of groundwater that is common across groundwater models.

This data model is not intended to compete with existing Graphical User Interfaces (GUIs) for existing tools. Instead, the data model provides a central storage mechanism. With built-in database management capabilities, well-defined domain, relationships, and topological rules, spatial data models improve data storage efficiency and enforce data integrity.

Results and discussion

The groundwater concepts data model addresses current lack of data interoperability across models, provides flexibility in management of data and naming conventions, and provides enhanced data integrity. Case studies (in the references Steward & Bernard, 2006; Steward *et al.*, 2008, 2009; Steward & Ahring, 2009, in review) illustrate the new conceptual groundwater data model's utility as an effective mechanism for structuring and organizing groundwater datasets and storing a conceptual model of groundwater, and its flexibility to support groundwater models across existing modeling techniques.

References

- Steward, D.R. & E.A. Bernard, 2006. *Ground Water* 44(1): 56-61.
- Steward, D.R., *et al.*, 2008. *Proceedings of The Royal Society of London, Series A*, 464: 223-248.
- Steward, D.R. & T. Ahring, 2009. *Journal of Engineering Mathematics*. (in press)
- Steward, D.R., *et al.*, 2009. *Water Resources Research*. (accepted with minor revisions)
- Yang, X., *et al.*, 2009. *International Journal of GIS*. (accepted with minor revisions)

Tools for transparent spatial integrated assessments

P.J.F.M. Verweij, M. Van Eupen, J. Roos-Klein Lankorst, W. Nieuwenhuizen
Alterra, Wageningen-UR, P.O. Box 47,
6700 AA Wageningen, The Netherlands
Contact: Peter.Verweij@wur.nl

Introduction

Model-based sustainability impact assessments (SIA) have a strong integrated character, analysing environmental, social and economic impacts and side effects of an intended policy option.

Societies see the emergence of new governance concepts, based on the assumption that processes of planning and decision taking are no longer hierarchical but the product of complex interactions between governmental and nongovernmental organizations, and the general public (the model of ‘co-production of knowledge’; Callon, 1999). All involved are seeking to influence the collectively binding decisions that have consequences for their interests. To account for this changing governance and the increased number of stakeholders involved, decisions need to be assessed in an integrated context.

This paper discusses the OSIRIS modelling environment (Verweij, 2004) which is a generic framework for qualitative knowledge rule based reasoning. OSIRIS was originally developed from Dutch spatial landscape planning perspective, but has spread to a wider community within and outside of Europe, such as Brasil (Jongman, 2004), West Africa and Asia (Van Eupen *et al.*, 2007).

Method

Alterra, a research institute of Wageningen University, develops solutions for applied and basic research across a number of environmental domains, including ecology, hydrology, agriculture, landscape and spatial planning. Around 2001 many of the disciplines were assessing (integrated) impacts of spatial plans. At the same time, the in-house software engineering group was developing software tools to facilitate singular discipline impact assessments. Similarities and differences in system requirements were analysed in order to facilitate the integration of knowledge from different disciplines and reduce time and effort building software tools. Analysis was done around: (i) existing systems (e.g., LEDESS, Harms *et al.*, 2000) by interviews and studying available tools and literature and; (ii) outline of future projects, e.g., MENES (Boogaard, 2003), KELK (Roos-KleinLankhorst *et al.*, 2004). The analysis resulted in a common conceptual model framework consisting of: (a) spatial explicit scenarios in terms of spatial strategy (e.g., clustering, or diffuse) and area based quantities; (b) the need to transparently explicate knowledge by rules-of-thumb, like knowledge matrices and decision trees; and (c) be able to drill down in modelled results by looking up the rules-of-thumb.

Results and discussion

As an example of an application, Osiris was used to build a model, which determines how vegetation and fauna are affected when, abiotic parameters in the Yellow River Delta are changed (such as flooding frequency and groundwater availability) (Van Eupen *et al.*, 2007). Strong advantage of the used OSIRIS modelling environment was found both during development of the model and final application of the scenarios:

- The tool was used in several workshops in which typologies were determined and relationships between them have been defined by means of rules of thumb. Participants needed to think in a structured way following the conceptual framework of spatial

strategies and typologies linked with available spatial data and the available expert knowledge.

- In the application of scenarios drilling down allowed exploring causal relationships of impacts of spatial plans by looking up the rules of thumb as defined by participants during the workshop itself. This knowledge transparency makes it possible to have several iterations of fine-tuning the model during a single stakeholder workshop.

The OSIRIS modelling framework is a useful tool to interactively implement expert knowledge and determine impacts of spatial scenarios in all kind of domains. This improves communication and is helpful in the decision making process.

References

- Boogaard, H.L., *et al.*, 2003. *Agro Informatica* 16 1: 5-8. (in Dutch)
- Callon, M., 1999. *Science, Technology, and Society* 4(1): 81-94.
- Harms, W.B., *et al.*, 2000. In: Eds Ü. Mander & R. Jongman, *Landscape Perspectives of Land Use Changes*, WIT, Southampton, UK. *Advances in Ecological Sciences* 6, 1-17.
- Jongman, R.G., *et al.*, 2004. *The Pantanal Taquari project: Decision Support System for catchment based river management*. Final Report, Programme Partners for Water. Alterra, Wageningen.
- Roos-Klein Lankhorst, J., *et al.*, 2004. *VBK Editorial Management* 12(4): 38-39.
- Van Eupen, M., *et al.*, 2007. *Impact modelling of scenarios on vegetation and fauna in the Yellow River Delta*. Yellow River Delta Environmental Flow Study Sino-Dutch Study Programme Final Report 2007 YRCC, Yellow River Water Resources Protection Bureau, Alterra, Delft Hydraulics, Arcadis Euroconsult, RUN.
- Verweij, P.J.F.M., 2004, *Osiris manual W!SL*, Wageningen.

Parameter estimation software for crop models

D. Wallach, F. Van Evert, Myriam Adam
INRA UMR AGIR,
BP 52627, 31326 Castanet Tolosan Cedex, France
Contact: wallach@toulouse.inra.fr

Introduction

Parameter estimation is a major aspect of crop modelling. Together with the functional forms of the equations, it is a major determinant of prediction quality. On the other hand, it is a difficult and time-consuming exercise, and requires expertise in regression analysis not always available in a modelling project. This suggests that it is of major interest to provide software to automate model parameter estimation. That is the purpose of the work reported here. There are two separate problems that must be addressed. The first is to provide algorithms that are appropriate for crop models. The second is to make these algorithms available to a large number of models.

Parameter estimation for crop models is generally based on a least squares approach, but in the case of crop models the problem is complicated by the complexity of the data and the models. Different algorithms may be appropriate in different cases, and for complex data there is no standardized approach. Therefore the software includes several different estimation algorithms, and others can easily be added.

The software consists of functions in the R statistical computing language (R Development Core Team, 2007), which is freely available. Coupling with modelling software is separated into specific functions. We have coupled the software with two different platforms, namely the MODCOM modelling platform (Hillyer *et al.*, 2003), which is used in the SEAMLESS project (Van Ittersum *et al.*, 2008) and the RECORD modelling platform (Chabrier *et al.*, 2007). Both are built around a simulation motor based on the DEVS paradigm (Zeigler & Praehofer, 2000). A major attraction of linking the software to such platforms is that in this way it is not specific to a particular model. Rather, it is available to any model or any model components that are implemented on those platforms.

Methods

The initial version of the software has five different algorithms for parameter estimation. The different parameter estimation methods correspond to different hypotheses about model error (Makowski *et al.*, 2006). The first is ordinary least squares, which is appropriate for the case of a single measured variable such as yield. The second algorithm minimizes the likelihood for the case where several different variables are measured, but the same measurements are available for each field. This leads to a determinant criterion (Bates & Watts, 1988). The third and fourth algorithms both involve minimizing a weighted least squares criterion. They are adapted to the case where several different variables are measured and different fields may have different measured variables (or variables measured at different times). The third algorithm assumes independence between errors; the fourth uses an empirical criterion to avoid giving extra weight to fields with many measurements (Wallach *et al.*, 2001). In algorithms three and four the user can input error variances for each variable or they can be estimated together with the parameter values. Also, the user can either treat the original data or first do a log transformation, which is indicated in the case where model error is expected to increase as the measured value increases (Bates & Watts, 1988). The fifth algorithm is a Bayesian algorithm, based on importance sampling. This algorithm calculates a probability distribution for each estimated parameter.

The MODCOM software is written in the C sharp language. Information is passed from the R functions to MODCOM using Microsoft COM technology. The R software requires the

following information, which must be stored in a data base: the observed data, the name of the model to be run, the paths to the input files for the contexts of the data (for example climate, soil and management files for each context), the list of model parameters and indicators as to which are to be estimated and finally information related to the correspondence between the data and the model output. At each iteration the R routine sets the parameter values in MODCOM to the current values, executes the model for each context, retrieves the results, calculates the criterion to be minimized and determines the parameter values for the next iteration. The search algorithms are built into available R functions.

Results and discussion

It is envisioned that the software be used in several different ways. First, it can be used to estimate parameters for individual model components, using data that concern a single component decoupled from the rest of the model. Second, it can be used to estimate parameters using the full model and multiple types of measurements. Finally, it can be used as a methodological tool to compare different estimation algorithms.

When a model does not agree well with data, the problem no doubt arises from both the way the equations describe the processes and from the values of the parameters. It is hoped that by providing a convenient and flexible set of parameter estimation algorithms, the software we propose will allow modellers to deal more simply and more efficiently with the parameter value aspect of the problem. It should then be possible to better evaluate the role of the process equations in model error.

References

- Bates, D.M. & D.G. Watts, 1988. Non linear regression analysis and its applications. Wiley, New York.
- Chabrier, P., *et al.*, 2007. In: Farm Systems Design 2007, an international symposium on Methodologies for Integrated Analysis of Farm Production Systems, Catania, Sicily, Italy.
- Hillyer, C., *et al.*, 2003. European Journal of Agronomy 18: 333-343.
- Makowski, D., *et al.*, 2006. In: Eds D. Wallach *et al.*, Working with dynamic crop models. Elsevier, Amsterdam, pp. 101-150.
- R Development Core Team. 2007. A language and Environment for Statistical Computing. R Foundation for Statistical Computing, Vienna, Austria.
- Van Ittersum, M.K., *et al.*, 2008. Agricultural Systems 96: 150-165.
- Wallach, D., *et al.*, 2001. Agronomy Journal 93: 757-766.
- Zeigler, B.P. & H. Praehofer, 2000. Theory of modeling and simulation. Academic Press.

Architecture of SEAMLESS-IF as framework application for integrated modelling

J.J.F. Wien, A.E. Rizzoli, M.J.R. Knapen, I.N. Athanasiadis, S. Janssen, L. Ruinelli,
F. Villa, M. Svensson, P. Wallman, B. Jonsson
Alterra, Wageningen UR, P.O. Box 47, 6700 AA Wageningen
Contact: jan-erik.wien@wur.nl

Introduction

The SEAMLESS (System for Environmental and Agricultural Modelling; Linking European Science and Society) consortium develops a computerized and integrated framework (SEAMLESS-IF) to assess the impacts on environmental and economic sustainability of a wide range of policies and technological improvements across a number of scales (Van Ittersum *et al.*, 2008). In the SEAMLESS-IF, different type of models and indicators are linked into model chains, where each model uses the outputs of another model as its inputs and ultimately indicators are calculated. This integrated modelling requires interoperability, which is the ability of two or more systems or components to exchange information and to use the information that has been exchanged (IEE, 1990). This paper describes the software architecture and design of SEAMLESS-IF with emphasis on semantic interoperability.

Semantic interoperability

In the SEAMLESS project, a large number of scientists co-operate working on a wide range of issues, like different type of models, data and databases, indicators, assessment problems and user interaction, and they need support for specifying data, models, projects and their relationships. Semantic interoperability is the ability of systems/components to share and understand information at the level of formally defined and mutually accepted domain concepts. In SEAMLESS, we employ semantic modelling and we have developed an ontology to establish a set of shared domain concepts. All the commonly shared data types in SEAMLESS are declared in the ontology (starting from projects, up to the model exchange items). This is an important shift in everyday practice of modellers: modellers specify the data requirements of their models on a higher level, i.e. that of an ontology, This ontology is automatically transformed into a relational database model, to which 'data collecting' activities need to comply with.

Client server architecture

As seen in Figure 1, SEAMLESS-IF is based on a layered, client-server architecture. The end user interacts with the system by means of two web-based Graphical User Interfaces (GUI) which run as clients. The client-server architecture of SEAMLESS-IF allows for future clients to be developed and linked to the server, in order to cater for specific needs of different user groups. The currently available clients are:

- PE GUI, the policy expert GUI: through this interface an expert can evaluate the impact of alternative agricultural policies from the different aspects of sustainability;
- IM GUI, the integrative modeller GUI: the module that guides the end-user to manage projects and request the execution of model chains, in order to produce results to be later used by policy experts;

The above client applications interact with the software services provided by the SeamFrame Server, which include:

- The Modelling Environment: a programming framework that offers a series of facilities to encapsulate and wrap existing models for execution by the processing environment. It allows to deliver model components wrapped by a SeamFrame specific interface,

compliant with the Open Modelling Interface (OpenMI) standard (www.openmi.org) (Gijsbers *et al.*, 2006), so that it can be executed by the Processing Environment.

- The Processing Environment: both a programming framework and a software application that receives user requests for the execution of chains of model-components. It enables model composition and execution. The actual exchange of data among the models is based on the OpenMI that provides a standardized interface to define, describe and transfer data between software components that run sequentially.

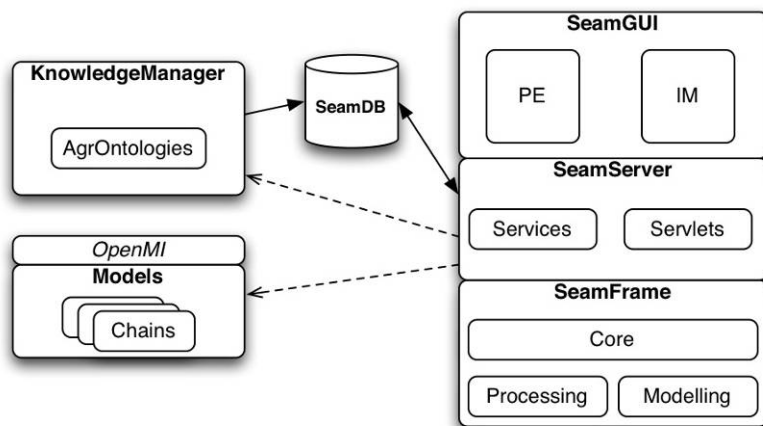

Figure 1. SEAMLESS-IF architecture.

Technical Implementation

The current software stack for SeamServer consists of an application server (the market leader Tomcat), data storage (PostgreSQL) and a data access layer (Hibernate). The business logic, where the preparation and management of experiments to be run by the processing environment happens, is based on the Spring Framework, a Java based solution delivering the a full-stack Java/JEE application framework. Finally, the remoting technology we adopted is BlazeDS, a server-based Java remoting and web messaging technology that allows the connection to Adobe® Flex® and Adobe AIR™ applications for delivering rich Internet application (RIA).

Results and discussion

SEAMLESS has achieved a very important shift in integrated modelling practice, i.e. modellers specify the data requirements of their models in a higher level, i.e. that of an ontology. This ontology is then automatically transformed into a relational database model, to which ‘data collecting’ activities need to comply with. This ensures the match between data collection and data requirement for running the model-chain. It also provides the required semantic interoperability. The client and server technologies that were adopted in SEAMLESS-IF have advantages in the field of:

- Maintainability: Less custom source code to maintain, instead leveraging of popular open source frameworks and source code generated from a higher level ontology.
- Stability and security: Replacing custom coding with well-known and tested open source frameworks.
- Performance: Replacing XML with the binary AMF format. Tests shows that this is at least 4 times faster.
- Flexibility: Use of well-known design patterns, program by interfaces and Spring dependency injection.

References

- IEE, 1990. IEEE Standard Computer Dictionary: A Compilation of IEEE Standard Computer Glossaries. New York, NY.
- Gijsbers, P.J.A., *et al.*, 2006. In: Proceedings of HIC 2006. Nice, France, pp. 72-81.
- Van Ittersum, M.K. *et al.*, 2008. Agricultural Systems 96: 150-165.

Theme B
State-of-the-art of components for integrated systems

Session B7: Databases for integrated assessment of agriculture and rural development

Session organizers:

Erling Andersen

University of Copenhagen, Denmark

Haluk Kasnakoglu

Middle East Technical University, Ankara, Turkey

Usefulness, feasibility, limitations and sustainability of an integrated international database on agricultural statistics¹

Haluk Kasnakoglu
Mesa Koru, Sardunya E/21, 06810 Ankara, Turkey
Contact: haluk.kasnakoglu@gmail.com

Introduction

An international database on agricultural statistics has a minimum of four dimensions, namely subject (domain), item, space and time. The subjects include quantities and values of resources, production, trade and consumption. The items vary for subjects but are in general factors of production, products and commodities for consumption. The space consists of the sub-regions, regions, regions and groupings. Finally the time dimension may range from days to months, years and decades. A statistical database contains data points on different combinations of elements from these dimensions. An integrated database is one where data within and between different domains and dimensions are comparable, consistent and compatible and hence can be used together to harvest the added value from combining data points both within and between different domains and dimensions (Figure 1).

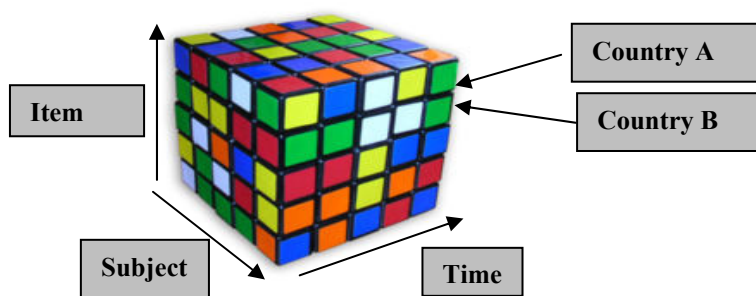

Figure 1. Integrated database structure.

Usefulness

There is no doubt that being able to use data points from different domains over different dimensions adds value. Statistics on yields for a specific commodity is of little use if it cannot be compared over time and space and with other commodities. The information on yield changes gains an additional value if the change in production quantity can be valued by introducing product prices and even more so by introducing the changes in costs of production to compute the value added implications of yield increases. Apart from the added value of new information generated, an integrated database contributes to the consistency, comparability and compatibility of data in different domains and over different dimensions as well as the analysis conducted with such databases.

Few examples of non-integrated data

Unfortunately there does not exist an integrated statistical database on food and agriculture at the international level. Furthermore there are very few cases at the national level where agricultural statistics are fully integrated within themselves and with the rest of the statistical system. As a result the users must live/struggle with inconsistencies such as the following:

- 52 Billion US\$ total world cereal imports is 13% larger than 46 Billion US\$ total world cereal exports for 2005.
- Kenya imports 141,000 tons of rice from Pakistan paying 26 million US\$ in while Pakistan exports 334,000 tons receiving 56 million US\$ from Kenya in 2004.

¹ Keynote presentation

- 2.0 million tons of cereal production reported in the world for 2006 in one database while 10% higher production (2.2 million tons) reported in another database for the same year by the same organization.

Feasibility

The pre-requisites for integrating databases in different domains are common definitions, scalable and mapped classifications and a conceptual integration framework. Candidates for classifications are ISIC, HS and CPC with fairly good mapping to each other. Good integrating frameworks are economic accounts (to integrate real data with monetary data and resource data with output data) and supply utilization accounts (to integrate production, trade and consumption data). Integration involves aggregations as well as disaggregations to match the differences in the sizes and dimensions of different domains. The process of integration brings to light the inconsistencies and flows in the constituting datasets. This implies a serious process of reconciliation where it is unavoidable to modify some first-hand data. This requires on the one hand, the use of well accepted state-of-art estimation methodologies supported by good meta data but at the same time very good communication techniques and political strength as what is at stake are the revision of official statistics reported by countries. In summary, the ingredients for an integrated database are available but putting them together and even more so selling it is challenging.

FAOSTAT experience

FAO with its well known database FAOSTAT is the international organization responsible from compilation and dissemination of food and agriculture statistics. FAOSTAT has long been producing time series data on production, trade, selected resources and prices. FAO has also been estimating the numbers of undernourished to monitor progress toward the FAO Food Summit and UN MDG goals of reducing hunger in the world. This involves constructing supply utilization accounts and food balance sheets which are already major steps toward integrating food and agriculture statistics. FAO has recently made an effort to construct a fully integrated database within the framework of modernization and update of FAOSTAT and disseminated it on June 2006. The integrated component of **new** FAOSTAT referred to as the “Core” was short lived and has been turned-off at the end of 2007 hence going back to **old** FAOSTAT era with a new face. The main reasons for the unsuccessful attempt were more on the socio-political side than on the technical side. Among the factors that have contributed to the failure of the attempt one can list:

- Resentment by staff to new technology and methodology which implied more reliance on machinery and models and less on human labour and judgment and hence need for re-training and re-positioning.
- More work for existing users to understand and adapt to the new user interface and classifications.
- Revisions in the past series with implications on the analysis conducted with them, including revisions in the FAO’s politically sensitive estimates and projections of number and prevalence of undernourishment (which proved to be supported with the recent developments in world markets and FAO’s new estimates of hunger published).
- Lack of resources for a more user friendly user interface and communication.

Concluding remarks

It must be understood that an integrated database is a non-unique analytical database and is not necessarily one which will satisfy all needs equally well. It will necessarily mean loss of some detail and estimation in the process of standardization of data dimensions and some deviation from official data in the process of data integration and reconciliation. On the other hand it should not be considered as a substitute but complementary to the existing datasets.

Integrating farming system, environmental and socio-economic data: The SEAMLESS database

E. Andersen, B. Baruth, B.S. Elbersen, G.W. Hazeu, S. Janssen, I. Staritsky,
I.J. Terluin, C.A. Van Diepen, D. Verhoog
Forest & Landscape, UoC, Rolighedsvej 23,
1958 Frederiksberg C, Denmark
Contact: eran@life.ku.dk

Introduction

The SEAMLESS integrated project has developed a computerized, integrated and working framework (SEAMLESS-IF) to assess environmental, economic and social effects of alternative agricultural and environmental policy options at multiple scales (Van Ittersum *et al.*, 2008). This includes an integrated database combining farming systems, environmental and socio-economic data covering the European Union (EU25).

In the integrated database all data used in the project are stored including model input and output data, contextual data and spatial information for assessment and visualization of indicators. The database is implemented and managed in the open source object-relational database management system Postgres with an extension to handle geographical data using PostGIS and Geoserver. It is expected that a Web Feature Service (WFS) will be used in the final version of the system to visualize model results.

To reach an integrated database all the data that are included in the SEAMLESS database are either processed from the original datasets and adapted to the use in the SEAMLESS project or, in a few cases only, gathered specifically for the project. This paper describes how data was processed to fit the integrated structure of the database and how the different data on farming, the environment and on socio-economic issues are linked.

Methods

Three different modes of processing data for integration in the SEAMLESS database are described relating to (a) farming system data, (b) biophysical data, and (c) data on allocation of farm types.

In the SEAMLESS database data on farming systems stemming from the EU wide dataset Farm Accountancy Data Network (FADN) have been aggregated to farm types. This is based on a farm typology elaborated in earlier projects and adapted to SEAMLESS. The typology includes 189 different farm types based on a combination of three different dimensions: size (3 classes), combined specialization and land use (21 classes) and intensity (3 classes) (Andersen *et al.*, 2006).

The biophysical data in the SEAMLESS database are processed to a spatial framework based on an agri-environmental zonation aiming to stratify Europe according to the main biophysical factors that determine the agronomic production capacity (Hazeu *et al.*, 2006). However, to ensure linkages to farming system modelling, also administrative regions (NUTS2 regions) are used to delineate the agri-environmental zones. The spatial framework and the included biophysical data can thus be described as follows: (1) Each administrative region is divided into one or more climate-zones, described by one time series of climate data. (2) Each climate-zone is divided into more agri-environmental zones, described by one set of soil characteristics. To reach this the original climate data has been processed from a 50 km grid and the soil data has been selected as the dominating soil unit within the specific agri-environmental zone.

In order to use both the farm type information and the biophysical data as input data for the integrated modelling in SEAMLESS additional information on the location of the farm types was added to all farm types. This is achieved by applying statistical procedures to reach an

optimal distribution of crops taking into account information on altitude and Less Favoured Areas (Elbersen *et al.*, 2006). The result of this is that the database includes information on the area within an agri-environmental zone managed by a certain farm type, whereas all other characteristics of the farm types are given for administrative regions.

Results and discussion

The SEAMLESS database consists of 379 tables including 2,379 different fields and the number of records in the database now exceeds 12 million. The different tables are linked by a total of 487 relations. The database, thus, integrates data on farming systems with environmental and socio-economic data covering the territory of the European Union (EU25).

The most important feature of the integrated database is that it ensures consistency between the data coming from very different domains and sources and across spatial and temporal scales. Other important aspects are that the integrated database facilitates easy access compared to storing the data in several separate databases and that transparency in relation to modelling is facilitated by storing data and model outputs together. Finally, it should also be mentioned that the processing needed for the integration of the data enhances the options for respecting the rights of the holders of the original data.

One of the few shortcomings of an integrated database is the loss of detail compared to some of the original datasets due to the processing for integration. This seems to be inevitable for integrated databases and probably also for integrated assessments as such. However, the loss of detail is mediated by the gain of knowledge of the complex relations between the different domains included.

References

- Andersen, E., *et al.*, 2006. SEAMLESS Report No.12, SEAMLESS integrated project, SEAMLESS-IP.org, 30 pp.
- Elbersen, B.S., *et al.*, 2006. SEAMLESS Report No.19, SEAMLESS integrated project, www.SEAMLESS-IP.org, 107 pp.
- Hazeu, G.W., *et al.*, 2006. SEAMLESS Report No.14, SEAMLESS integrated project, www.SEAMLESS-IP.org, 55 pp.
- Van Ittersum, M.K., *et al.*, 2008. *Agricultural Systems* 96: 150-165.

European environmental stratifications: an overview

G.W. Hazeu, E. Andersen, B. Baruth, M.J. Metzger, C.A. Múcher, M. Pérez-Soba,
Ch. Renetzeder, C.A. Van Diepen
Alterra, Wageningen UR, P.O. Box 47, 6700 AA Wageningen, The Netherlands
Contact: gerard.hazeu@wur.nl

Introduction

Different environmental stratifications of Europe are developed within different European projects. All stratifications aim to divide environmental gradients into convenient units and to use these units as areas in which objects and variables might have relatively consistent characteristics (Jongman *et al.*, 2006). The stratifications can be used as basis for up-scaling and as a sampling framework. However, as the objectives of the projects are different also the characteristics of the stratifications will be distinct from each other.

This paper presents an overview of the Environmental Stratification (EnS/EnZ), the Agri-Environmental Zonation (AEnZ), the Spatial Regional Reference Framework (SRRF), the European Landscape Classification (LANMAP) and the FARO typology. The objectives, similarities and differences between these typologies will be described.

Methods

The different environmental stratifications are reviewed regarding their objectives and applications. Robustness of the classifications, spatial extent and the different thematic domains are considered. Some stratifications are not purely environmental classifications as they incorporate also administrative or socio-economic data to suit the user's needs. The stratifications are described and compared regarding (i) the themes and number of dimensions (represented by the so-called basic datasets); (ii) the spatial and temporal scales of their dimensions; and (iii) the modes of processing the basic data (e.g., statistical methods and expert judgment).

Results and discussion

The Environmental Stratification of Europe (EnS) consists of 84 strata, which have been aggregated into 13 Environmental Zones (EnZ) (Metzger *et al.*, 2005). The stratification has a 1km² resolution. The EnS has been constructed using tried and tested statistical procedures. Climate data, data on geomorphology, oceanity and northing (latitude) are data used in the statistical approach. It forms an appropriate stratification for stratified random sampling of ecological resources, the selection of sites for representative studies across the continent and for the provision of strata for modelling exercises and reporting at European scale.

The Agri-Environmental Zonation (AEnZ) is meant to stratify Europe on main biophysical factors that determine the agronomic production capacity in Europe. It is an agri-environmental framework used for modelling within the SEAMLESS project (Van Ittersum *et al.*, 2008). The environmental zones (EnZ) are combined with organic carbon topsoil data (OCTOP) to cover the wide range of agri-environmental diversity of Europe. Furthermore the EnZs/OCTOP land units are combined with 270 administrative NUTS2 regions into 3513 so-called Seamzones (Hazeu *et al.*, 2006).

The aim of the European Landscape Map (LANMAP2) is to distinguish different landscape types, their geographical distribution and their key characteristics. It is used as a tool to overarch fragmented and yet integrate relevant regional and national approaches. LANMAP2 was produced on basis of state of the art technology and four core data layers with a high spatial resolution: (i) climate, (ii) altitude, (iii) parent material and (iv) land use. The European Landscape Classification is a hierarchical classification. Level one is based on climate only and has eight classes. Level two is based on climate and altitude and has 31

classes. Level three is based on climate, altitude and parent material and has 76 classes. Level four is based on all four data layers and is the most detailed level and has 350 landscape types (Mücher *et al.*, 2006).

The Spatial Regional Reference Framework (SRRF) was developed in the FP6 IP SENSOR project (Renetzeder *et al.*, 2008). The framework stratifies European territory into 27 relatively homogeneous clusters, integrating biophysical (climate, elevation and parent material), socio-economic (land cover and ESPON/EUROSTAT data) and regional administrative (NUTS-X¹) aspects. It supports the regional assessment of the impact of European policies affecting the sustainability of the land.

The FP6 FARO-EU project has developed a new typology to describe the different ruralities of EU27 (Van Eupen *et al.*, in prep.). It has three dimensions, i.e. one biophysical (13 EnZ described above) and two socio-economic (economic density and accessibility). It is the first rural typology with a high spatial resolution (1 km²) that can be aggregated to any administrative level. The FARO-EU typology provides European rural policies with a flexible framework to analyse current trends as well as future projections, and to support flex policy rural development.

The classifications have the climate dimension in common. Furthermore, data on geomorphology (altitude, slope), soil data or parent material and sometimes land cover data are important to refine the stratifications. Spatial and thematic detail of the stratifications is determined by the datasets. The stratifications serve the need to have a spatial framework that describes systematically the variation in environment and socio-economic issues. Such spatial frameworks are needed to assess impacts of policies and monitor changes. The different stratifications serve different objectives and the usefulness of a stratification depends on the user needs.

References

- Hazeu, G.W., *et al.*, 2006. Regional typologies of ecological and biophysical context, SEAMLESS Report No.14, SEAMLESS integrated project, www.seamless-ip.org, 55 pp.
- Jongman, R., *et al.*, 2006. *Landscape Ecology* 21: 409-419.
- Metzger, M.J., *et al.*, 2005. *Global Ecology and Biogeography* 14: 549-563.
- Mücher, C.A., *et al.*, 2006. In: Eds. R.G.H. Bunce & R.H.G. Jongman, *Landscape Ecology in the Mediterranean: Inside and outside approaches*. Proceedings of the European IALE Conference 29 March - 2 April 2005 Faro, Portugal. IALE Publication Series 3, pp. 233-243.
- Renetzeder, Ch., *et al.*, 2008. In: Eds K. Helming, *et al.*, *Sustainability impact assessment of land use changes*. Springer-Verlag, pp. 249-268.
- Van Eupen, M., *et al.*, (in prep.). A high spatial resolution typology of rurality in Europe.
- Van Ittersum, M.K., *et al.*, 2008. *Agricultural Systems* 96: 150-165.

¹ NUTS (Nomenclature of Units for Territorial Statistics) is a hierarchical classification of areas that provides a breakdown of the EU's economic territory. NUTS-X is a combination of NUTS-2 and NUTS-3. The NUTS-X coverage has been prepared following an initial approach by EEA within the IRENA project framework, and extended to EU-25 + Bulgaria and Rumania + Norway and Switzerland by the M3 Alterra team. The result is a NUTS-X map with 475 units.

Detailed spatial distribution of farming systems in Europe: A basic starting point for the further environmental assessment of changes in farming and CAP reform

M. Kempen, B.S. Elbersen, I. Staritsky, E. Andersen

Institute for Food and Resource Economics, University Bonn, Nussallee 21, Bonn, Germany

Contact: markus.kempen@ilr.uni-bonn.de

Introduction

Because of the regional variation in climate, natural resources (soils, vegetation, etc.) and social structures, the increasing move towards de-centralization of policy implementation and reorientation of the Common Agricultural Policy (CAP) to deliver more environmental benefits, there is an increasing need to appraise the multi-functional effects of agriculture at a range of scales. This integrated and multi-scale approach requires the use of farm information that is as spatially explicit as possible as this enables to relate market response behaviour to environmental performance of farms. In this context, a methodology was developed to spatially allocate farm information to a specific environmental endowment. At this moment the EU farm information is only available at the administrative level of the regions (NUTS 1 or NUTS 2 regions). The spatial allocation approach adds a spatial dimension to all individual farms contained in the Farm Accountancy Data Network (FADN) making it possible to aggregate these both to natural and to administrative regions.

This spatial dimension is a reference to biophysical units with relatively homogenous conditions for farming, either a Homogenous Spatial Mapping Unit (HSMU) or a Farm Mapping Unit (FMU) (a cluster of HSMUs). Since HSMUs can be clustered to any administrative or biophysical entity the farms can also be grouped to these different spatial entities. For the presentation of the allocation results we have chosen to group the farms to Agri-environmental zones (Hazeu *et al.*, 2006).

Methods

The allocation approach of FADN farm types builds on the methodology developed in the CAPRI-Dynaspat project (Kempen *et al.*, 2006) and uses the detailed land use maps resulting from this project as a main input. The Dynaspat approach disaggregates the crop information in the Farm Structural Survey (FSS) from the NUTS 1/2 regions to the much smaller Homogeneous Spatial Mapping Units (HSMUs) by developing allocation algorithms in a statistical procedure. First a locally weighted logit model (Anselin *et al.*, 2004) is applied to analyse crop observations from the LUCAS survey (EC, 2003). Then a Bayesian highest posterior density estimator is applied to achieve consistency between the prior probabilities resulting from the previous step and regional statistical data. The HSMUs are defined by relatively homogeneous production conditions for agriculture, e.g., soil conditions (FAO, 1998; Driessen *et al.*, 2001) or prevailing land use (Gallego, 2002); rather than administrative boundaries. For the spatial allocation of the FADN farm information the land use information and other attributes assigned to the HSMUs in the Dynaspat project are taken as the main input basis. The methodology for the farm allocation (e.g., Elbersen *et al.*, 2006) is very similar to that used for producing the land use allocation in Dynaspat. The main difference is however, that instead of using the HSMUs as the basic spatial entities to which farms are allocated a clustering of HSMUs, so-called Farm Mapping Units, are used. This clustering is necessary to reduce the complexity of the allocation procedure. The final allocated results are still linked back to the original HSMUs of which the FMUs are composed. For the presentation of the results in this paper the FADN-farms who have obtained a spatial dimension through a link to an FMU and an HSMU are aggregated to farm types (see Andersen *et al.*, 2006) and then to larger agri-environmental zones.

FADN records report for each sample farm whether it is located in a specific altitude zones and in a Less Favored non-Less Favored Area (LFA). Following HSMUs are aggregated into FMUs, which are homogeneous regarding soil type, Nuts2/3 boundaries, altitude zone and Less Favored Area classification. Finally each sample farm is allocated to a FMU achieving the best possible fit on:

- Information on LFA and altitude zones;
- Cropping patterns of FMUs and farms belonging to it;
- Yield levels of FMUs and farms belonging to it;
- Farm structure information at Nuts2/3 level

Applying a *Bayesian Highest Posterior Density* method allows to find the optimal allocation of farms based on information available at different spatial levels.

Results and discussion

The results of the disaggregation approach for FADN farm information are delivering good results in terms of validation at least for the old Member States. However, for the allocation results of the FADN farms for the new MS the validation delivered lower probabilities. This lower accuracy is not necessarily related to the quality of the allocation procedure, but more likely to the quality of the FADN data used in the allocation. The FADN sample size in the new Member States is significantly smaller than in the old Member States and leaves out many small farms.

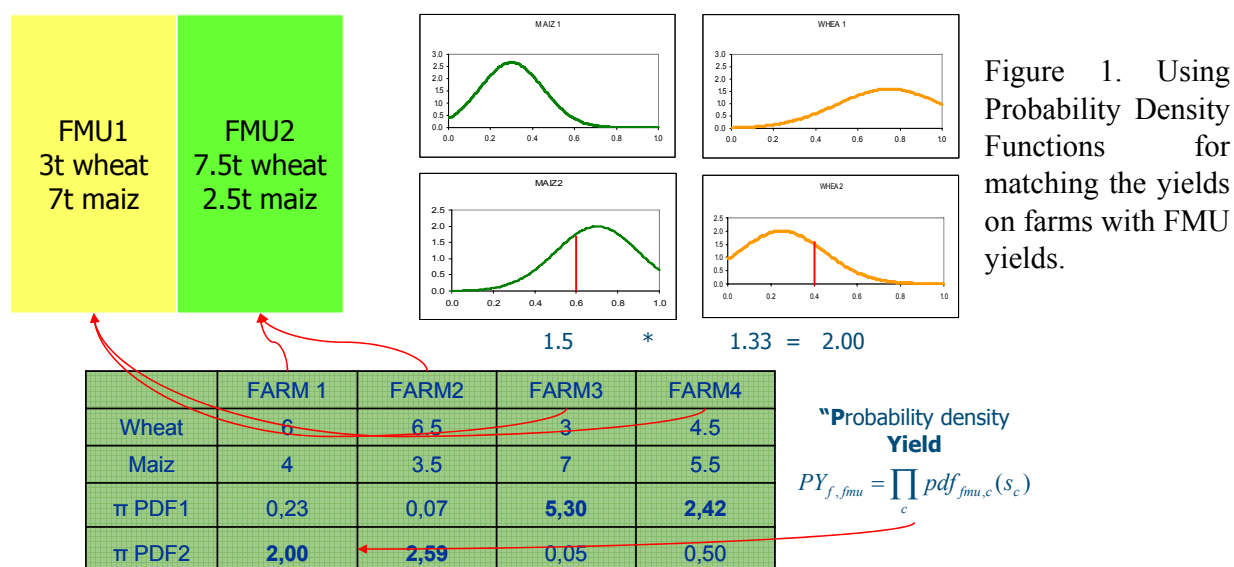

References

Andersen, E., *et al.*, 2006. SEAMLESS report no. 12, May 2006.
 Anselin, L., *et al.*, 2004. Advances in Spatial Econometrics. Springer Verlag, Berlin.
 Driessen, P., *et al.*, 2001. World Soil Resources Reports 94. FAO, Rome.
 EC, 2003. The Lucas survey. European statisticians monitor territory. Theme 5: Agriculture and fisheries, Series Office for Official Publications of the EC, Luxembourg, pp. 24-40.
 Elbersen, B., *et al.*, 2006. SEAMLESS report no. 19, November 2006.
 FAO, 1998. World Reference Base for Soil Resources. World Soil Resources Reports 84. FAO, ISRIC and ISSS.
 Gallego, J., 2002. Fine scale profile of CORINE Land Cover classes with LUCAS data, in European Commission (ed.): Building Agro Environmental Indicators. Focussing on the European area frame survey LUCAS, Vol. EUR Report 20521 EN.
 Hazeu, G.W., *et al.*, 2006. SEAMLESS report no. 14, June 2006
 Kempen, M., *et al.*, 2006. A statistical approach for spatial disaggregation of crop production in the EU. University of Bonn and JRC-Ispra.

Need for a theoretical framework in building an integrated database

P. Lavelle, X. Arnauld de Sartre, S. Dolédec, B. Hubert, I. Veiga
Université Paris VI, UMR Biodiversité et Fonctionnement du Sol,
Centre IRD Ile de France, 32 rue Henri Varagnat,
93143 Bondy Cedex, France
Contact: Patrick.Lavelle@bondy.ird.fr

Introduction

Our goal in this communication is to discuss our experience in building a database that aims to integrate socio-economic, environmental and agronomical dimensions of family farming in the Amazon.

In two Amazonian regions that represent most of the diversity of man made landscapes in the ecoregion, we aimed to analyse and model the relationships that link (1) socio-economic parameters; (2) composition and structure of landscapes; (3) biodiversity (of plants, birds, Drosophilidae, Lepidoptera Saturnidae, ants, termites, earthworms), and (4) crop production and other ecosystem goods and services (EGS) used by family farmers.

After presenting the method used to build a common database, we will stress the need to clearly define, at the same time as building the database, a theoretical framework that can help to analyse the data collected.

Methods

In two Amazonian countries (Brazil and Colombia), an original sampling protocol allowed us to collect fully compatible socio-economic, landscape, agronomic and ecological datasets in order to measure and understand the variations of EGS among family farms. Those datasets are supposed to allow rigorous statistical analyses, in order to formulate new hypotheses on the mechanisms that link these different sets of variables.

Work has been divided in five groups:

- WP1 - SOCEC: assessment of relevant socio-economic parameters;
- WP2 - LANDSCAPE: a quantitative analysis of the composition and structure of the 6 landscape «windows» in the two countries;
- WP3 - BIODIVERSITY: an assessment of the diversity of seven different groups of ecosystem engineers that matter for EGS production (plants, earthworms, termites, ants) and/or species that indicate specific trends and responses in patterns of biodiversity (birds, Saturnidae, Drosophilidae);
- WP4 - ECOSYSTEM SERVICES: a quantification of a few basic EGS: soil services (C storage, chemical fertility, water infiltration and storage), production of food, fiber and fuel and other products, landscape control of disease (Chagas);
- WP5 - MODELLING: identification of the statistical relationships that link (1) socio-economic context to (2) composition and structure of landscape, (3) biodiversity for the seven groups and (4) provision of EGS. These relationships will be used to simulate the consequences of different socio-economic scenarios using a multi-agent modelling approach.

Groups 1 to 4 have collected their own datasets, which can be linked to one another, as indicated in Figure 1.

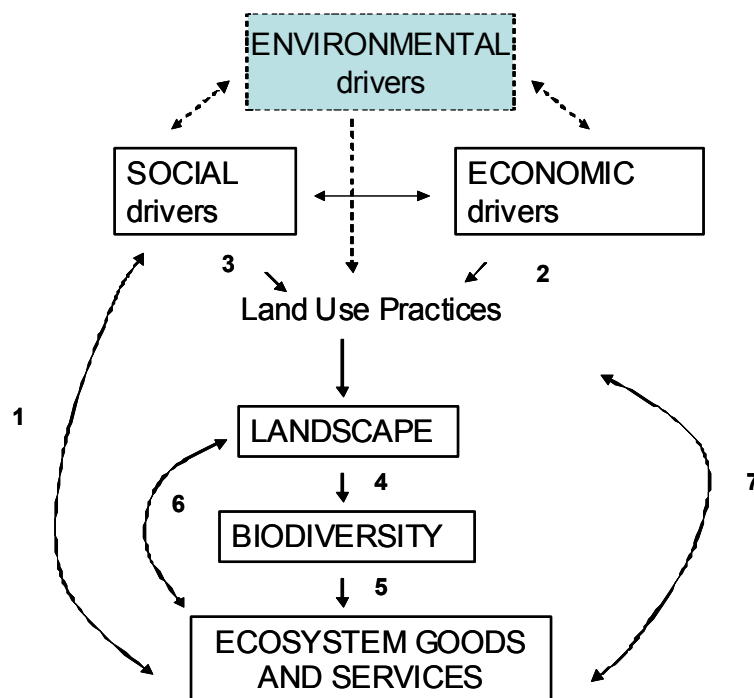

Figure 1. A simple empirical model of the impact of socio-economic changes on ecosystems and the production of ecosystem goods and services

Data collection was organized in two phases:

- 150 farms in three windows with different land use histories and practices have been characterized on the basis of socio-economic and landscape variables.
- A sample of 27 farms in each country, representative of the diversity of farms in the three windows of the country, was selected. Biodiversity and EGS production have been measured in each farm in these samples.

Due to this sampling method, which allows us to work in different scales, and to the pluridisciplinary structure of our team, we needed to define a common theoretical framework to build and analyse the database containing all the datasets collected.

Results and discussion

The database, currently under construction, will be presented at this session.

Although statistical analyses enabled us to identify links among the different sets of variables, to separate variables with significant co-variations and threshold effects in their relationships, we found that it was necessary to develop a conceptual framework to guide the analysis. To illustrate the need for a framework, we will present an example of an analysis of a part of the data.

This discussion is based on the Panarchy Theory (Gunderson & Holling, 2002), which served as a basis for our modelling. During our seminars, we suggested that different team members define their own vision of the database organization based on this theoretical framework.

Reference

Gunderson, L.H. & C.S. Holling (Eds), 2002. Panarchy. Understanding Transformations in Human and Natural Systems. Island Press, Washington-Covelo-London, 438 pp.

Some reflections on the design and use of typologies of EU regions in socio-economic analyses

Ida J. Terluin, David Verhoog, Frans E. Godeschalk
LEI, Agricultural Economics Research Institute,
P.O. Box 29703, 2502 LS The Hague,
The Netherlands
Contact: ida.terluin@wur.nl

Introduction

Typologies of EU regions can help to identify regions with similar characteristics. As such, they may facilitate the study and interpretation of types of regions. In literature, it is suggested that a number of questions should be taken into account in the design of a typology (Berry & Smith (1972) cited in Guffens & Latten, 1979; Hauer & Van der Knaap, 1973). These questions include among others:

- (a) What is the purpose of the typology?
- (b) What is the individual unit in the classification?
- (c) What are the differentiating characteristics on which the typology is to be based?
- (d) Which method will be used for the classification?
- (e) How many types will be distinguished in the typology?

In these questions, no attention is paid to problems which may arise due to lack of data. Such problems might play in particular a role in the definition of the individual unit in the typology and the selection of differentiating characteristics. This may result in 'second best' typologies, using less appropriate individual units or differentiating characteristics. In rural development analyses these problems often arise, especially when data from different data sources, like Eurostat REGIO, EU Farm Structure Survey and the Farm Accountancy Data Network, are integrated.

The objective of this paper is twofold. First, the design and use of typologies in recent studies on socio-economic analyses in EU regions is discussed. Second, it is explored to which extent these typologies can be used for impact assessment of agricultural and rural policies in the EU (Van Ittersum *et al.*, 2008).

Methods

For the discussion of regional typologies, a framework with questions is developed. This framework includes the questions (a)–(e) above, questions on used data, questions on the integration of different data sources and questions whether the typology has been used for impact assessment of agricultural and rural policies in the EU.

The set of regional typologies, that will be discussed, covers among others the OECD rural typology (OECD, 1996), a typology based on GDP/capita, a typology derived from the integration of regions in the national/global economy (EC, 1997), a typology of leading and lagging regions (Terluin, 2003; Bollman *et al.*, 2005), an LFA typology (ESPON 2.1.3 project, 2004; Terluin *et al.*, 1994), a typology based on population change (Johansson and Rauhut, 2005) and a typology of agricultural regions (ESPON 2.1.3 project, 2004).

Results and discussion

Based on the discussion of the different regional typologies in this paper, we hope to identify a number of regional typologies that are useful for impact assessment of agricultural and rural policies in the EU. On the whole, such typologies have in common that they are simple, highly transparent and easy to understand.

Table 1. Useful typologies of EU regions for impact assessment of agricultural and rural policies.

Name of typology	Regional level	Policy
Typology x	NUTS ..	LFA
Typology y	NUTS	Modulation
etc	etc	etc

References

- Berry, B.J.L. & K.B. Smith, 1972. City classification handbook: Methods and applications. John Wiley Interscience, New York.
- Bollman, R., *et al.*, 2005. Paper for the Congress of the European Regional Science Association 'Land Use and Water Management in a Sustainable Network Society', Vrije Universiteit Amsterdam, 23-27 August 2005.
- ESPON 2.1.3 project, 2004. The territorial impact of the CAP and Rural Development Policy. www.espon.lu
- European Commission (EC), 1997. Rural developments: Situation and outlook. CAP 2000 Working Document, Brussels.
- Hauer, J. & G.A. Van der Knaap, 1973. Sociale geografie en ruimtelijk onderzoek, kwantitatieve methoden (Human geography and spatial analysis; statistical methods). Universitaire Pers, Rotterdam.
- Johansson, M. & D. Rauhut (Eds), 2005. The spatial effects of demographic trends and migration. Final report ESPON project 1.1.4, Stockholm.
- OECD, 1996. Territorial indicators of employment: Focusing on rural development. Paris.
- Terluin, I.J., 2003. Journal of Rural Studies 19(3): 327-344.
- Terluin, I.J., *et al.*, 1994. The agricultural income situation in Less Favoured Areas of the EC. Luxembourg/Brussels.
- Van Ittersum, M.K., *et al.*, 2008. Agricultural Systems 96: 150-165.

Theme C
**Case studies and application of tools and
empirical methods**

**Session C1: Integrated assessment of biomass for biofuel
or renewables: Trade-offs with feed and food**

Session organizers:

Martin Banse

LEI, Wageningen UR, The Netherlands

Ken Moore

Iowa State University, USA

Challenges in modelling environmental bio-energy potential(s)¹

Jan-Erik Petersen
European Environment Agency,
Kongens Nytorv 6,
1050 Copenhagen K, Denmark
Contact: Jan-Erik.Petersen@eea.europa.eu

Introduction

The presentation summarizes experience from EEA projects and information gathered through a number of expert workshops to describe the main challenges when aiming to model the bio-energy potential of a given geographic region. Particular attention is given to the range of environmental factors to be considered, the analysis of scale effects and the impact of indirect land use change on total environmental potential. The discussion of modelling frames includes questions relating to governance approaches to improving the environmental profile of bio-energy production.

Methodological considerations in modelling bio-energy production

Bio-energy production has potentially significant effects on energy and agricultural markets, it implies considerable changes in the nature and intensity of global land use and leads to often strong environmental impacts that can be negative or positive. Analysing and modelling the overall effects of bio-energy policies is therefore a very complex exercise that ideally involves a combination of (bio-)energy, agro-economic, global land use and biophysical modelling approaches. Such an integration has until now not really been achieved and there is still a considerable need to analyse and develop approaches for model integration.

Given the focus of the conference the current review is mainly limited to (agro-)economic and land use models. The multiple pathways and technologies for utilizing biomass in energy production are a complex modelling field on its own but not covered in detail in this review. Within the modelling approaches discussed an attempt is made to cover the following issues:

- *Key characteristics* are the regional disaggregation (grid cells, NUTSx, countries, country aggregates), regional coverage (region, country, Europe, world), time horizon in applications, and the drivers (economic, political, technical) of a model.
- Relevant *environmental impacts* include total greenhouse gas balance (before and after taking indirect effects into account) and a number of environmental issues relating to type and intensity of energy cropping and associated land use change. These relate to soil erosion, quality and quantity of water in affected aquifers and surface waters, landscapes and biodiversity.
- *Biomass production details* provide crucial information for an environmental assessment. Important questions are, for example, types of land use changes (within arable land, between permanent grassland or forestry and arable land) farming system properties (farm type, rotation, land cover in winter, fertilizer use, irrigation) and the area of set aside and fallow land.
- Regarding energy crops a rich coverage of *biomass uses* is of interest and hence the alternative uses for food, feed, energy and manufacturing, possibly differentiated (transport fuels, heating, electricity). For each processing alternative technical details may be crucial for the economic and environmental balance (by-products, economies of scale in processing, logistic constraints render location issues crucial).

¹ Keynote presentation

As biofuels in particular are under close environmental scrutiny several policy measures have been proposed for improving their greenhouse gas balance and minimizing other environmental impacts. The most prominent approach is the introduction of so-called 'sustainability standards' but other options also exist, e.g., differentiated incentives in electricity feed-in schemes, producer training and advice etc. Current agro-economic and land use modelling approaches do not yet take such policy measures into account. This will be necessary, however, if one wants to determine the likely environmental impact of a given bio-energy production approach and/or policy. On the other hand, (agro-)economic and other models can also help determine the likelihood of success for different bio-energy policy instruments in limiting environmental impact. The final section discusses, therefore, options for integrating certain policy approaches into different modelling frameworks and proposes some key questions to be addressed.

Documents used:

- Petersen, J.-E., 2008. Informal consultation meeting between OECD, EEA and invited technical experts: Linking economic and biophysical modelling in relation to bio-energy. Summary document published on the web: <http://bioenergy.ew.eea.europa.eu/>
- Britz, W., *et al.*, 2008. Review of European spatial modelling approaches for assessing the implications of bioenergy production in an environmental perspective. Unpublished report to the European Environment Agency, Copenhagen.

Life cycle assessment of the sugarcane production system in Brasil

Paola J. Bocardo, Kazumi Kondoh, Juliana C.S. Cruz, Dorothea S. Kimura
Tokyo University of Agriculture and Technology,
3-5-8 Saiwai-cho, Fuchu, Tokyo 183-8509, Japan
Contact: pjbocardo@yahoo.com.br

Introduction

The area allocated to sugarcane in Brasil for the crop-year 2008/09 is around 9 million of hectares and approximately 559 million tonnes of cane will be crushed to produce alcohol and sugar (SIAMIG, 2008). Part of this amount is harvested by hands after burning leaves, releasing to the environment a high quantity of ash, potentially causing serious disease problems for the population, resulting in social and environmental problems (Campos, 2003). The harvest by hands has been substitute by machines, due to economic, legal and environmental issues (Galdo, 2007). Thus, life cycle assessment (LCA) can be utilized to analyse the whole life cycle of the Brazilian sugarcane system. The objectives of this study were: (1) to analyse the dioxide carbon (CO₂) emission during sugarcane production in Brasil, comparing burning and green harvest without burning, and (2) to compare the socio-economic and environmental aspects of these harvesting systems. Based on these analyses, the cultivation method with the least CO₂ emission and the best socio-economic aspects will be discussed.

Material and methods

System boundaries and functional unit

The sugarcane system flowchart involved cultivation (land preparation and growth management), harvest and transport. The processes considered for the cultivation were: (1) land preparation (lime, gypsum, fertilizer and defensive applications, planting and covering); (2) growth management (cover fertilizing, defensive, irrigation and mill mud application); (3) harvest (burning and green cane); and (4) transportation (inputs, cane and workers) (Figure 1). The functional unit was 1 t of raw cane.

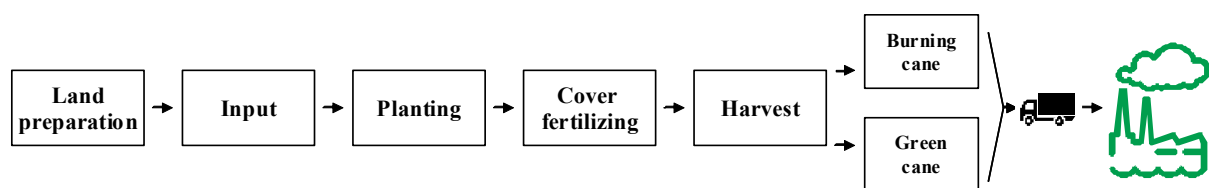

Figure 1. Flowchart for the life cycle of sugarcane production system.

Inventory analysis

The data collection included the input and output of the sugarcane cultivation, harvest and transport. Model, fuel consumption, wagon/passenger's capacity, performance and distance were considered for the data of machines/implements, trucks and buses for labour transport. For lime, gypsum, fertilizers and pesticide application, the kind, amount/ha and times of application/year were considered. The climate conditions were related to the air and soil characteristics, as humidity, type of soil, nutrient leaching, gas emissions, temperature and precipitation. For the social data, the kind of work, cost/time, numbers of workers required in each stage, performance and level of education were collected.

Data sources and methods

Information about production was obtained from private sugarcane companies, institutes and specialist's opinions in universities. For the carbon (C) balance calculations each component of this system was considered separately. The emissions from machines, trucks and burning were converted into CO₂ equivalents by calculating the consumed fuel for each management practice. In case no data were available, it was obtained from the literature. The worker's condition was analysed descriptively and the total of workers required to produce 1 t of raw cane related to social aspect. For the economic aspect, the cost to produce 1 t of raw cane was calculated.

Selection and definition of impact categories

Considering the C stock compartments (plants, trash and soil), the C storage in the plants by photosynthesis was 5.7 t C ha⁻¹, trash 0.5 Mg C ha⁻¹ yr⁻¹ and soil 1.0 Mg C ha⁻¹ yr⁻¹. Generally, the green cane system can mitigate 5 Mg C-CO₂ ha⁻¹ yr⁻¹ in a period of 3 years (Campos, 2003). This mitigation potential can be changed, if the fossil fuel used by the harvesting machine and the vehicles are considered. The social conditions are different in both systems. It has been reported that one machine substitutes 100 workers (Ustilin & Severo, 2001). Field work under hot conditions can cause severe health problems. The labour's salary depends on the amount of cane harvested in tones per day, inducing exhaustive work. Thus, the working conditions for the burning system should be changed where the burning harvest is inevitable.

Conclusion

About 45% (4 million of hectares) of the total sugarcane area in Brasil requires burning at harvest due to topography. This can aggravate the environment and socio-economic aspects in sugarcane production system, such as carbon sequestration and working conditions. A holistic analysis considering carbon flows as well as socio-economic aspects is needed to create a sustainable system.

References

- Campos, D.C., 2003. Potencialidade do Sistema de Colheita sem Queima da Cana-de-acucar para o Sequestro de Carbono. Doctor Thesis, Universidade de Sao Paulo, Brasil, 103 pp.
- Galdo, M.V., 2007. Dinamica do carbono no solo no agroecossistema cana-de-acucar. Doctor Thesis, Universidade de Sao Paulo, Brasil, 101 pp.
- SIAMIG, 2008. Safra da cana-de-acucar 2008/09. Boletim eletronico numero 288. www.siamig1.com.br/index.php?option=com_content&task=view&id=275&Itemid=107. Accessed Sept. 09, 2008.
- Ustilin, E.J. & J.R. Severo, 2008. Proteger o ambiente e continuar gerando empregos. www.cna.org.br/Gleba99N/Set01/cana01.htm. Accessed Sept. 13, 2008.

Application of Life Cycle Assessment methodology to compare sunflower oil and diesel for fulfilling farm energy needs

L. Coletto, A. Brigi, A. Calgaro, S.G. Sandrini, S. Bona
Dipartimento di Agronomia Ambientale e Produzioni Vegetali,
AGRIPOLIS - Facoltà di Agraria - Università di Padova,
Viale dell'Università n. 16 - 35020 Legnaro (PD), Italy
Contact: lucia.coletto@unipd.it

Introduction

The recent European policy is aimed to develop energy production systems that minimize environmental impact and to promote the production of biomass for energy purposes (oil crops included) (CEC, 2001). Among these, of particular relevance in Italy is sunflower oil. Sunflower is particularly worth to be studied as it is well adapted to Italian conditions and requires very low inputs. Furthermore, the chemical/physical properties of sunflower oil affect its performances if used as fuel in endothermic engines (Schlick *et al.*, 1988). Vegetable oils are interesting alternatives to fossil fuel owing to their relatively low production costs, easiness to produce and, therefore, suitable in situations where home-produced energy at low cost is required (Al-Hasan, 2002; Scrosta, 2005; Riello & Bona, 2005).

Life Cycle Assessment (LCA) is a methodology to assess the environmental impact associated with a product, an activity or a process. Nowadays LCA is mainly applied to industrial products or processes, but its use is increasingly widespread in agriculture.

In this study, the suitability of LCA methodology to analyse the environmental impact of the use of sunflower oil on the farms to meet their internal energy requirements is investigated. LCA is used to analyse the effective possibility of using sunflower oil instead of diesel and to estimate the consequent changes in farm organization.

Methods

The case study consisted of 19 simulated farms of 10 ha differing in crops (maize, soybeans, wheat) and in hectares for each cultivated species: 3 farms had monospecific system while the other 16 differed for percentage of land occupied by the over cited crops (e.g., 7.5 ha of maize and 2.5 ha of soybeans). In order to obtain the necessary oil supply, during the study the crop distribution was rearranged assigning land to grow sunflower (e.g., 7.5 ha of maize and 2.5 ha of soybeans become 4.7 ha of maize, 1.6 ha of soybeans and 3.7 ha of sunflower). The crops were transformed into energy data using the parameters defined by Riello & Bona (2005). The sunflower area was defined on the farm's energy requirement basis, whereas the land devoted to the other crops reflected, where possible, the percentage distribution before the introduction of sunflower. We also hypothesized that all the farm tractors were converted for the use of sunflower oil as fuel. The two managements (sunflower oil vs. diesel) were compared with LCA methodology using SimaPro 7.18 based on Eco-indicator 99 methods.

The LCIs (Life Cycle Inventory) included soil cultivation, sowing, weed control, fertilization, pest and pathogen control, harvest and drying of the grains, processes. Machine infrastructure and shed were included. Inputs of fertilizers, pesticides and seed as well as their transports to the farm were also considered. The direct emissions from the field were also included in the inventories. The *system boundary* was at the farm gate. Sunflower oil production process was included in machine inventory. The Project was financed by Progetto FISIR-SIMBIO-VEG.

Results and discussion

The resulting index, eco-indicator 99 value, evaluated the impact associated with different energy source (sunflower oil vs. diesel) on the following environmental effects: production of carcinogens, respiratory organics and inorganics, effect on climate change, radiation, ozone layer, acidification/eutrophication, minerals and fossil fuels consumption. Those effects could be grouped in three categories: Human Health, Ecosystem Quality, Resource. Figures 1a, 1b, 1c and 1d represent the relative advantage/disadvantage of the conversion of the considered farms from fossil fuels to sunflower oil.

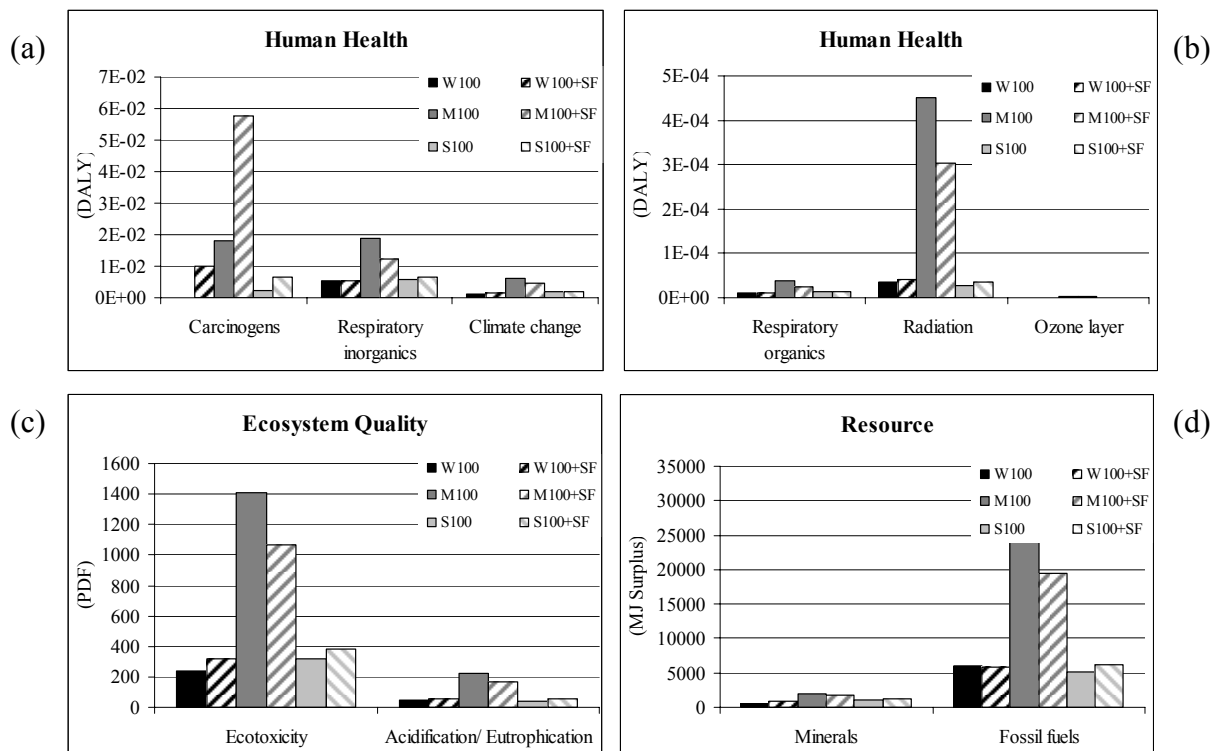

Figure 1. Impacts of maize (M), soybeans (S) and wheat (W) cultivated with diesel machinery compared to the same crops cultivated with sunflower (SF) oil machinery. Figure a and b represents human health's impact (data expressed as years of life lost by humans); figure c the ecosystem quality (data expressed as biodiversity lost) while figure d represents the use of resources (MJ per hectare).

The higher carcinogens impact observed in crops cultivated with sunflower oil machinery was due to the introduction in the farm of a sunflower mill produced by a factory with emissions in all the compartments. In general, allocating a portion of farm land to cultivate sunflower for producing oil for energy was environmentally positive, in particular if the crop substitutes maize. The main environmental disadvantages were found for wheat while soybean had an intermediate impact.

References

- Al-Hasan, M., 2002. Biomass and Bioenergy 23: 381-386.
 CEC, 2001. Commission of the European Communities, COM (2001) 68 final.
 Riello, L. & S. Bona, 2005. Ed. Veneto Agricoltura, Padova, 80 pp.
 Schlick, M.L., *et al.*, 1988. Trans. ASAE, 31, 1345-1349.
 Scrosta, V., 2005. PhD thesis, University of Marche, Italy, 106 pp.

Family production systems with *dende* (*Elaeis guineensis*) and the alternative of biodiesel: Analysis in the Cajaíba community, municipality of Valença (Bahia-Brasil)

Alynsou Dos Santos Rocha, Maciene Mendes da Silva
Universidade Federal da Bahia, Rua Jose Seabra s/n, antigo Colégio Padre Vieira,
Centro Barreiras, Bahia - Brasil
Contact: alynsou@bol.com.br

Introduction

In this paper, family production systems with *dende* (*Elaeis guineensis*) in the Cajaíba community, municipality of Valença (2006), state of Bahia (Brasil), are compared with the alternative of biodiesel. The analysis focused on the dynamics of production considering the non-agricultural activities that have become alternatives for the family farmers.

Biodiesel – biofuel produced from vegetal raw-materials – is presented as an energy source that has few environmental impacts when compared to non-renewable fuels (oil), due to the possibility of a reduction in pollutants emitted from automobiles equipped with combustion engines. Concomitantly, economic and social advantages are posited when the diversity of crops is valued with benefit potential, especially for family farming. Regarding the production of vegetable oil crops (for example: soy – *Glycine max*; *mamona* – *Ricinus communis*; *babaçu* – *Orrbignya speciosa*; and *dende*), the gradual insertion of biodiesel might mean an important step to the economic development of Brazilian regions such as the semi-arid (north-eastern) and other areas of family farming in the state of Bahia, that produces some of main raw materials for biodiesel (Garcia, 2008).

Specifically for Bahia, *dende* farming appears to have significant potential for biodiesel production due to the climate and soil conditions conducive to crop development, particularly in the South. It is added to the fact of a new economic alternative to local family farming, considering the productive *dende* chain (still) narrowly linked to oil production for the food industry (Bahia, 2005). In this context, the National Program of Production and Use of Biodiesel (PNPB) – initiative of the Federal Government of Brasil, created in 2004, combines an attempt to diversify the Brazilian energy matrix with tax, credit and marketing incentives, whose objective is to implement the production and use of biodiesel, at the same time promoting socioeconomic development – must consider the organization of the productive agents widely, the traditional techniques already used by the primary producers, the importance of the *dende* farming to the productive units and the local prices received and the dynamics of the market faced by the family farmers (Chiaranda *et al.*, 2005).

Methods

The Agrarian Systems methodology is applied on the case study in the Cajaíba community. This methodology analyses not only the economic relations concerning to the production systems; the social and ecological aspects are analysed as well, and mainly the relations between them. This systematic approach is used in Brasil by the National Institute of Colonization and Agrarian Reform (INCRA) in its reports about rural settlements, but its applicability is broader, and may also be used on the evaluation of diverse types of production systems such as capitalist and family production units, as well as others. The method can be summarized as follows: (a) analysis of secondary data on the agrarian systems; (b) landscape characteristics; (c) characterization of farmers, unit and systems of production (crop, creation and raw-materials transformation subsystems); (d) elaboration of typology of producers and production systems; (e) crop subsystems characterization; (f) creation subsystems characterization; (g) transformation subsystems characterization; (h) combination of the

subsystems; and (i) economic evaluation of the production systems in order to identify to the family farmers income composition (Brasil, 2008).

Results and discussions

The results achieved indicate that in all types of family farming production systems studied the *dende* subsystem not always is the most important crop in the farmer's income composition. Also, the production analyses have revealed that the *dende* might potentially be raw-material to the biodiesel industry. One of positives aspects that confirm this observation is the high degree of oil per hectare when *dende* is compared to other vegetable oil crops. However, some impediments had been observed: not addition of values, due to the frequent traditional aspect of the production; useful life of the *dendezeiros* (*dende* trees) exceeded, causing low productivity; small scale producers without the possibility of expansion; existence of more lucrative alternatives, such as the *dende* oil to the food industry.

Regarding to the viability of *dende* as raw-material for biodiesel some questionable points emerge. The oil price practised, for example, on the first auction to the PNPB, R\$ 102.50 (Brazilian currency) per ton of fresh product (*in natura*, entire), results in positive incomes to the producers. However, the market value of these same products when destined for others ends, approximately R\$ 130.00, is higher than biodiesel. Also, to devote the production of *dende* only for the PNPB means to give up the local subsystem of transformation (*Rodão* or *big wheel*). This subsystem increases strongly the farmers' incomes.

Considering oil prices for biodiesel compared to other products and observing the dynamics of production systems, the PNPB goal of the socioeconomic inclusion of family farmers would not be feasible because most family farmers are oriented to oil production for the food industry with traditional techniques and equipment. The unfeasibility is based on the prices received by family farmers who adhere to PNPB, which are below those realized in the local-regional market. Additionally the resistance to allocating areas for only one crop, would generate disequilibrium in the entire productive unit, causing economic losses to the family farmers.

References

- Bahia, 2005. Secretaria de Agricultura, Irrigação e Reforma Agrária (SEAGRI). Cultura-dendê. Available on: www.bahia.ba.gov.br/seagri/Dende.htm. Accessed may 07, 2005.
- Brasil, 2008. Instituto Nacional de Colonização e Reforma Agrária (INCRA). Guia Metodológico: Análise-Diagnóstico de Sistemas Agrários, 65 pp.
- Chiaranda, M., *et al.*, 2005. A produção de biodiesel no Brasil e aspectos do PNPB. Grupo de Estudos e Extensão em Desenvolvimento Econômico e Social. Departamento de Economia Administração e Sociologia. ESALQ-USP. Piracicaba (SP), 32 pp.
- Garcia, J.R., 2008. O Programa Nacional de Produção e Uso de Biodiesel e a Agricultura Familiar do Nordeste: Panorama, Perspectivas e Desafios. Workshop FEA/Unicamp – Produção de Biodiesel Através de Agricultura Familiar. IE/UNICAMP, 15 pp.
- Valença, 2006. Memorial da Câmara Municipal de Valença. Available on: www.cmvalenca.ba.gov.br. Accessed June 30, 2006.

The availability of crop residues for energy, assessing global potentials

T. Guille, A. Fallot, F. Jacquet, P. Havlík
INRA-Économie publique, Avenue Lucien Brétignières,
78850 Thiverval Grignon, France
Contact: thomas.guille@grignon.inra.fr

Introduction

The research presented aims at globally assessing the potential availability of crop residues for energy through an updated series of data and hypotheses on the determinants of the potential volumes. Such systematic work is necessary in a context where second generation biofuels need to ensure large biomass potentials at low cost. Crop residues are therefore considered as a privileged resource, without production cost of the feedstock or impact on competition for land, contrary to dedicated energy crops or plantations. The few potential assessments that have been conducted at the global level show widely varying results with diverse definitions of potential availability, use of fixed recuperability factor only differentiated according to the kind of crop residue (primary or secondary) and little critical review on the significance of results (Hall *et al.*, 1993; Berndes *et al.*, 2003; Hoogwijk *et al.*, 2003; Kim & Dale, 2004; Smeets *et al.*, 2007). In this context, our work aims to estimate the global availability of crop residues for energy and focuses on residues that could be collected without competing with preservation of soil fertility and animal feeding.

Methods

The updated assessment proposed proceeds in various steps, progressively accounting for crop characteristics, current agricultural practices and uses of the crop residues. Hypotheses are made on the priority residue uses for soil conservation and animal feeding. Calculations are based on most recent FAO statistics available in July 2008 on crop production, residue to product ratios and estimations of current residue use, through recuperability factors. The recuperability factors are differentiated according to crop species and residue type using available knowledge in soil science and others disciplines. An emphasis is put on the level of extraction of residues, this latter playing a crucial role in the evaluation of the effective availability of crop residues for a sustainable energy production. Afterwards, a critical overview of other assessments enables us to compare approaches (methodologies, hypotheses) and results.

Results and discussion

Results at a world level indicate that agricultural activities generate more than 3.36 billions tonnes of agricultural residues, representing 54.6 EJ yr⁻¹. Given the hypotheses we detail, some 21.4% of these residues are potentially available for energy, i.e. 719 million dry tonnes representing 11.9 EJ yr⁻¹ (approximately 3% of the current final energy demand). The largest potentials are from wheat and rice straw, bagasse and rice husk. The richest countries in crop residues are China, India, the US and Brasil (cf. Figure 1). Compared to other assessments, our estimation stands at lower levels. Differences illustrate the importance of hypotheses on the priority uses of crop residues. At last, even though our estimation is low, it shows that the potential of crop residues for energy clearly exist for a sustainable energy production.

This work is a first step in the evaluation of the availability of crop residue for energy, based on physical availability. It doesn't take into account harvesting and transporting costs and opportunity costs associated with alternative residue uses (soil fertility, soil protection against erosion, animal feeding, etc.). This work will be done by introducing crop residues in a global land use model – GLOBIOM (Global Biomass Optimization Model) – developed at IIASA (Havlík *et al.*, 2008). It will allow us to take into account the competition with animal

feeding and to provide an analysis on the global supply of crop residues for energy and its impacts according to different scenarios and policy objectives.

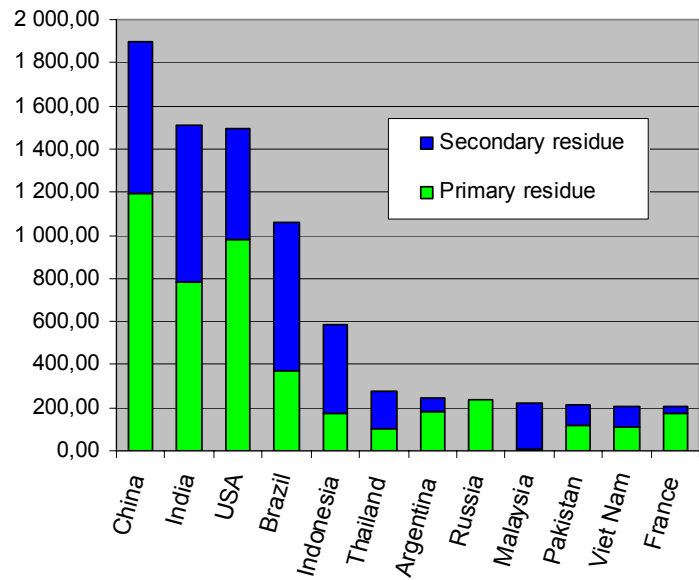

Figure 1. Countries with the largest potential of crop residues for energy (in PJ).

References

- Berndes, G., *et al.*, 2003. *Biomass and Bioenergy* 25(1): 1-28.
- Hall, D.O., *et al.*, 1993. In: Eds T.B. Johansson, *et al.*, *Renewable energy – sources for fuels and electricity*. Island Press, Washington, pp. 593-651.
- Havlik, P., *et al.*, 2008. *Avoided Deforestation and Biofuel Production: A Global Analysis*. Yale Student Chapter of ISTF 2008 Conference, March 27-29 2008, New Haven, USA.
- Hoogwijk, M., *et al.*, 2003. *Biomass and Bioenergy* 25(2): 119-133.
- Kim, S. & B.E. Dale, 2004. *Biomass and Bioenergy* 26(4): 361-375.
- Smeets, E.M.W., *et al.*, 2007. *Progress in Energy and Combustion Science* 33: 56-106.

Soil optimized suitability analysis for allocation of energy grasses

L. Kukk, E. Suuster, A. Astover, M. Noormets, H. Roostalu
Institute of Agricultural and Environmental Sciences, Estonian University of Life Sciences,
1 Fr. R. Kreutzwaldi St., 51014 Tartu, Estonia
Contact: liia.kukk@emu.ee

Introduction

In recent years interest in producing bio-energy has increased. Several studies have estimated agricultural bio-energy potential at global, EU and national scales (Voivontas *et al.*, 2001; Hoogwijk *et al.*, 2005; Edwards *et al.*, 2005), but final decisions and recommendations about land use conversion to energy crops must be made at a more detailed spatial scale. Allocation of land to energy crops should take account of local pedo-climatic conditions. Thus soil-crop specific models are required for sustainable bio-energy planning. In Estonia, a large-scale digital soil map is available but is not often used in the decision-making process. The value of soil information can be realized only when it is actually used but the application of collected soil information has still been modest because of poor availability, and limited knowledge of the decision makers. The aim of the present study was to develop and use a model for allocation of energy grasses based on soil data using the example of one municipality in Estonia.

Methods

Municipality Aseri is located in north-eastern Estonia. A map layer of agricultural field parcels (3,029 ha) from the Agricultural Registers and Information Board was used for analysis. The most important land reserves for bio-energy production in Estonia are abandoned agricultural areas, which are classed as agricultural land. Therefore, our study provided suitability maps for total agricultural land and for abandoned fields separately. We considered that field parcels without any applications for CAP single area payments to be abandoned. The digital soil map at scale 1:10,000 was used in the current study but the qualitative nature of information from the soil map makes it difficult for non-soil scientists to understand and soil suitability is not a characteristic that can be directly read from a soil map. To overcome this shortcoming a supplementary database of soil mapping units (based on soil type and texture) was created with crop-specific suitability indexes. These were previously developed on the basis of perennial biomass yields from a network of field experiments and from agricultural enterprises (Kask, 1994; Kõlli, 1994). We evaluated areas suitable for reed canarygrass (*Phalaris arundinacea* L.), Caucasian goat's-rue (*Galega orientalis* Lam.) and alfalfa (*Medicago sativa* L.) as these energy crops have been investigated in Nordic conditions and can grow in a soil conditions that range from Leptosols (dry) to Histosols (wet). Soils were classified into three categories: not suitable, moderately suitable and suitable. Thereafter the field boundaries were superimposed on the soil classes and weighted average suitability scores were calculated for each field parcel. Fields with a weighted average suitability score less than 1 were considered as unsuitable for the selected energy crops. Priority was given to the crop with the highest suitability score.

Results and discussion

Of the total agricultural land in Aseri municipality abandoned areas form 416 ha (14%) (Figure 1). Alfalfa, reed canarygrass and Caucasian goat's-rue could be grown successfully on 49%, 28% and 2% of the total agricultural land respectively. Alfalfa could be grown on 34% of the abandoned fields. Similarly, 37% and 5% of the abandoned areas were suitable for growing reed canarygrass and Caucasian goat's-rue. Approximately a quarter of both total

agricultural land and abandoned areas is not suitable for the studied energy grasses. Further bio-energy analysis should be supplemented with economic and environmental criteria.

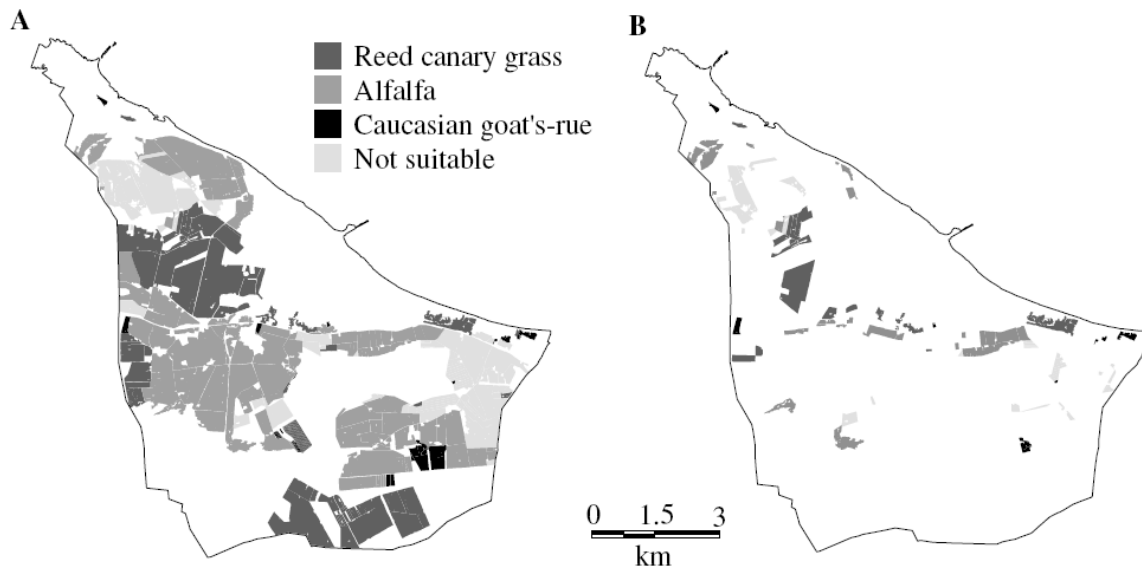

Figure 1. Soil optimized suitability maps for energy crops on total agricultural land (A) and on abandoned agricultural land (B).

Supplementing the existing database of the soil map with suitability indices has provided knowledge-based recommendations about suitability for bio-energy production for each agricultural field. This approach makes soil information more self-explanatory and accessible for stakeholders. This case study serves as a pilot study for further development of field-specific resource management for bio-energy planning and can be used as a tool in knowledge-based decision-making processes throughout Estonia.

References

- Edwards, R., *et al.*, 2005. In: Eds L. Sjunnesson, *et al.*, 14th European Biomass Conference, 17-21 October 2005, Paris, France.
- Hoogwijk, M., *et al.*, 2005. *Biomass and Bioenergy* 29: 225-257.
- Kask, R., 1994. *J. Agric. Sci.* 5: 405-423. (in Estonian)
- Kõlli, R., 1994. Soil suitability and agrogroups. Estonian Agricultural University, Tartu, 85 pp. (in Estonian).
- Voivontas, D., *et al.*, 2001. *Biomass and Bioenergy* 20: 101-112.

Environmental impacts of agricultural land allocation between bio-energy crops and food/feed crops

J. Lankoski, M. Ollikainen
2, rue Andre-Pascal, 75775 Paris Cedex 16, France
Contact: jussi.lankoski@oecd.org

Introduction

This paper analyses the multiple environmental effects of land allocation between bio-energy crops and food/feed crops. It adopts an integrated economic and natural science modelling approach: an economic model of farmers' decision making is combined with a biophysical model predicting the effects of farming practices on crop yields and multiple environmental effects. The analysed environmental effects include GHG emissions over the life cycle, nitrogen and phosphorus runoff, herbicide runoff and the quality of wildlife habitats.

Methods

This paper focuses on three environmental issues: surface water quality, climate, and biodiversity. Both nitrogen and phosphorus runoff from cultivated fields to watercourses is estimated. As regards pesticide runoff, the focus is on herbicide runoff (MCPA as an active ingredient)¹. Greenhouse gas emissions are modelled on the basis of life cycle assessment (LCA) estimates provided by Mäkinen *et al.* (2006). In this paper, the following elements are included: (i) CO₂-eq emissions related to the transportation of crops, (ii) CO₂-eq emissions related to the manufacturing, transportation and application of fertilizers, herbicide, and lime (iii) CO₂ emissions from soil and (iv) CO₂-eq emissions from tillage practices, such as plowing, harrowing and planting as well as CO₂-eq emissions from harvesting and grain drying. The effects of land allocation on biodiversity are quantified by a wildlife habitat indicator - a habitat quality index, developed by Lehtonen *et al.* (2008). This index measures the impacts of land use on the quality of wildlife habitats. The monetary valuation of environmental effects is used to aggregate the environmental effects. These valuation estimates are based on published Finnish valuation studies quantifying the consumers' willingness to pay for reducing nutrient and herbicide runoff or to promote biodiversity. The price of emission allowances is used as a proxy for the climate damage (CO₂-eq emissions). The empirical application is on crop production in south-western Finland, which represents 20% of cultivated land in Finland. Reed canary grass (RCG, a perennial grass with 14 years rotation period) represents second generation biodiesel, while rape represents first generation biodiesel, barley is used for ethanol, oats is used for feed, and wheat is the food crop.

Results and discussion

Table 1 shows that reed canary grass (RCG) is cultivated in the 8 lowest productivity parcels with low nitrogen use intensity. The low nitrogen application rate is due to the high unit transportation costs and thus a low effective output price for RCG. However, support payments and low production costs make it profitable to cultivate RCG in the lowest productivity parcels.

Table 2 presents total environmental effects. It illustrates that reed canary grass performs well as regards environmental impacts. Its good environmental performance is mainly driven by low CO₂-eq emissions. This is explained by the fact that RCG sequesters carbon and thus soil CO₂ emissions for it are negative, whereas for other crops, which are cultivated with conventional tillage, soil CO₂ emissions are significant.

¹ For details of nutrient and herbicide runoff modelling see Lankoski *et al.* (2006).

Table 1. Land allocation, input use intensity, production and farmers' profits.

Crop	Land area ha	N-use kg ha ⁻¹	Herbicide use kg ha ⁻¹	Production kg ha ⁻¹	Total production kg	Profits € ha ⁻¹	Total profits €
RCG	8	8.9	-	2969	23 753	139	1109
Barley	8	84.8	0.83	3743	29 940	168	1344
Oat	18	58.1	0.72	3103	55 850	150	2694
Rape	8	69.1	0.84	1669	13 352	188	1502
Total	42	-	-	-	122 895	-	6649

 Table 2. Total nitrogen runoff, total phosphorus runoff, total herbicide runoff, total CO₂-eq emissions.

Crop	N-runoff kg	P-runoff kg	Herbicide runoff, kg	CO ₂ -eq emissions, t	Habitat index value
RCG	26	6	-	0.5	
Barley	53	10	0.08	23	
Oat	99	22	0.14	46	
Rape	48	10	0.08	21	
Total	227	47	0.30	90	130.5

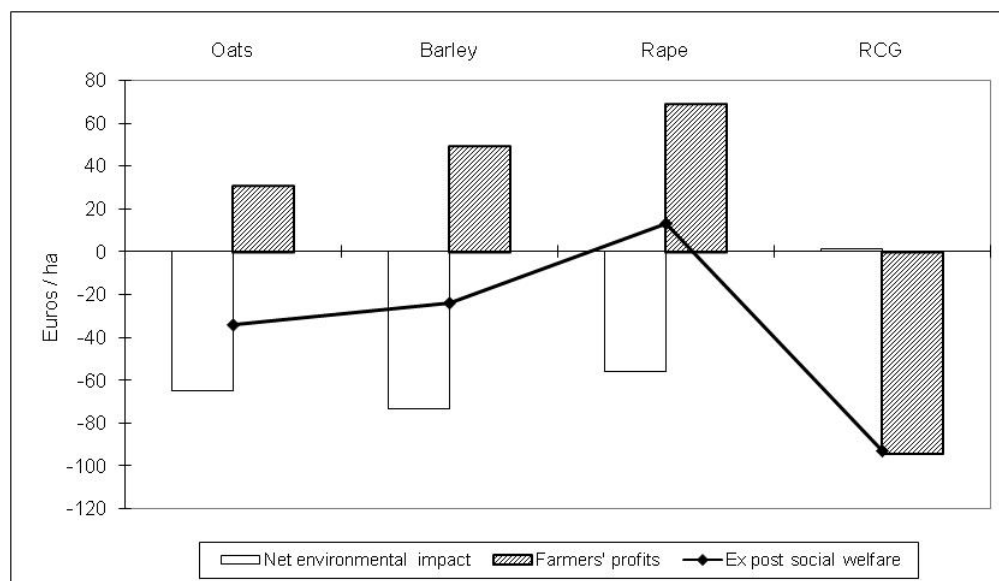

 Figure 1. *Ex-post* social welfare for alternative land uses (€ ha⁻¹).

Figure 1 shows that the land use type that delivers the best environmental performance (reed canary grass) is the least profitable for farmers. This social welfare ranking illustrates that ex-post social welfare of alternative land use types is mainly driven by profitability of land use rather than the social valuation of environmental effects.

References

- Lankoski, J., *et al.*, 2006. European Review of Agricultural Economics 33: 193-221.
 Lehtonen, H., *et al.*, 2008. Unpublished manuscript.
 Mäkinen, T., *et al.*, 2006. Greenhouse gas balances and new business opportunities for biomass-based transportation fuels and agri-biomass in Finland. VTT Tiedotteita 2357. Espoo, Finland. (in Finnish with English abstract)

Biofuels: The way forward

A. Leip¹, Robert W. Howarth, Stefan Bringezu
European Commission – DG Joint Research Centre,
Institute for Environment and Sustainability, TP.050,
21014 Ispra (VA), Italy
Contact: adrian.leip@jrc.it

Introduction

In response to calls for energy security, minimizing climate change, and rural development, several nations (U.S., European Union, Brasil) have or will shortly establish mandatory targets for the incorporation of biofuels into their liquid fuel portfolio. Global production of liquid biofuels tripled between 2000 and 2007, yet still contributed only 1.8% of the world's liquid transportation fuels in 2007, while requiring 5–6% of the global harvest of all grains (corn, wheat, rice, and others), 8% of vegetable oil, and 28% of the sugar cane harvest.

A number of recent papers have pointed out that there are hard biophysical constraints on production – the amount of carbon fixed by all crops globally is already exceeded by the carbon burned by fossil fuels, and producing biofuels on all currently abandoned land might yield only ~7% of our current energy use (Campbell *et al.*, 2008; Field *et al.*, 2008). Legitimate concerns exist about the relative climate benefit of various biofuels (Crutzen *et al.*, 2008), and competition for arable land between food, fiber, fuel and other ecosystem services (Robertson *et al.*, 2008; Searchinger *et al.*, 2008). Biodiversity might be affected by the increased production of liquid biofuels (Raghu *et al.*, 2006) and freshwater scarcity might be aggravated (de Fraiture *et al.*, 2008). The environmental consequences of liquid biofuels depend on what crops or materials are used, where and how these feedstocks are grown, how the biofuel is produced and used, and how much is produced and consumed. Both positive and negative effects on the environment can occur.

Methods

This paper reviews the key environmental problems and future perspectives for a sustainable production of liquid biofuels on the basis of the SCOPE rapid assessment workshop and its products, a policy brief and discussion chapters on the topics of (i) mitigation strategies (ii) quantitative, integrated biofuels assessment; (iii) biofuels and developing countries; and (iv) final land limits.

Results and discussion

The magnitude of the environmental consequences depends on *how*, *where*, and *how much* biofuels are produced and consumed, as illustrated by the following examples (SCOPE biofuel project, 2009).

How?

- The corn grown in the Mississippi River basin to produce ethanol is often heavily fertilized, contributing to the Dead Zone downstream in the Gulf of Mexico.
- Producing ethanol from switchgrass and other perennial plants requires far less fertilizer, resulting in much less nutrient pollution of aquatic ecosystems.

¹ This presentation summarizes results of the SCOPE rapid assessment, hold in Gummersbach 22-25 September 2008, See http://www.eeb.cornell.edu/howarth/SCOPEBiofuels_home.html

Where?

- Oil palm plantations established on cleared tropical forests result in loss of biodiversity from one of the world's hot spots of diversity and huge emissions of greenhouse gases when peat soils are drained.
- Oil from jatropha grown on degraded lands in Mali powers generators for electricity for cell phone microwave towers and provides local jobs with no adverse environmental impact.

How much?

- Massive land-use conversions, especially in the tropics, would be required to produce enough biofuels to meet just 10% of the current global use of gasoline and diesel. Many biofuel technologies can be pursued in an environmentally benign manner when land requirements are small and biofuel crops are not competing with food crops.

A balanced and comprehensive assessment of liquid biofuels production poses a challenge for both scientists and decision makers. Recommendations of the workshop include:

- Current mandates and targets for liquid biofuels should be reconsidered in light of the potential adverse environmental consequences, potential displacement or competition with food crops, and difficulty of meeting these goals without large-scale land conversion. Non-food biomass should be preferentially used for material purposes.
- Policy instruments are needed to help adjust the overall demand for (non-food) biomass at levels which can be supplied by sustainable production; (i) increase efficient use of biomass and mineral resources; (ii) reduce fuel consumption for transportation.
- Biofuels based on low input cultivation of non-food crops offers promise in developing countries as a source of energy, in part because energy use is often very low at present. Biofuel markets can serve as an opportunity to trigger additional investments that could lead to increased production of food as well as biofuel crops by small-scale farmers. Further research on the use of indigenous non-food crops should be encouraged.

References

- Campbell, J.E., *et al.*, 2008. *Environ. Sci. Technol.* 42(15): 5791-5794.
- Crutzen, P.J., *et al.*, 2008. *Atmos. Chem. Phys.* 8: 389-395.
- de Fraiture, C., *et al.*, 2008. *Water Policy* 10(S1): 67-81.
- Field, C.B., *et al.*, 2008. *Trends in Ecology & Evolution* 23(2): 65-72.
- Raghu, S., *et al.*, 2006. *Science* 313(5794): 1742-10.1126/science.1129313
- Robertson, G.P., *et al.*, 2008. *Science* 322(5898): 49-50.
- SCOPE biofuel project. 2009. *Biofuels: Environmental Consequences and Interactions with Changing Land Use*.
- Searchinger, T., *et al.*, 2008. *Science* 319(5867): 1238-1240.

Exploring the land, water and energy linkages in agriculture: An expanded partial-equilibrium approach to modelling environmental impacts

Siwa Msangi, Rüdiger Schaldach, Christina Kölling, Jennifer Koch, Joseph Alcamo
c/o International Food Policy Research Institute,
2033 K Street NW, Washington, DC 20006, USA
Contact: s.msangi@cgiar.org

Introduction

The increasing concern over global food prices and their implications for human well-being has encouraged policy analysts and researchers to look more closely at the constraints facing agriculture, in terms of both policy restrictions and distortions, as well as physical limits of growth. The realization that energy and agricultural markets are now becoming more closely tied together, has also highlighted the need to better understand the economic as well as physical linkages that cause the increase in the demand for energy products to translate into increased demand pressure (and prices) within agricultural markets. The ongoing increases in the price of both energy and food products have direct consequences for human well-being, and also have implications for the environment and future trade-offs that will inevitably occur between the need to provide food, feed, fiber and fuel for a growing world population, while maintaining the quality of ecosystems and the ability to provision needed services from them.

In this paper, we explore the implications of socio-economic and environmental drivers of change for agricultural food production systems, global markets, and the impacts of land and water use change over time, within a linked modelling framework. The linkage that is created is between a global, partial-equilibrium, agricultural market model and a global spatially-explicit land-use change model. The linkage is both dynamic in nature and explicit in the physical quantities of agricultural production (decomposed into yield and area), projected consumption of crop and animal products, and the geographical area needed for future crop production, in relation to other important land uses that are required for future growth needs such as settlement areas. By creating a strong linkage between the various components of the agro-ecosystem that are of key relevance to future agricultural growth – and to the main drivers of change that affect their evolution over time – we are better able to model and ultimately to understand the impacts of important factors, such as biofuels production growth.

Methods

The methodology that is used to model the trade-offs between the increasing demands of food, feed and fuel and the pressures on both agricultural and non-agricultural land uses is to establish a linkage between a global, partial-equilibrium model of agricultural production, consumption and trade, IMPACT (Rosegrant *et al.*, 2001), and a global land-use change model, LandSHIFT (Schaldach *et al.*, 2008) that operates on a geographic raster with a resolution of five arc-minutes (Schaldach *et al.*, 2008). While there are now a class of computable general equilibrium modelling tools that have been developed to handle questions of land-use change – their construction is often too coarse in resolution and not as explicit in the actual quantities of either consumption, production or land-use change that are occurring to be useful for environmental assessments. The linked model system seeks to overcome these limitations by applying of a pair of models that are more disaggregated over the key food commodities, key land-use change processes (e.g., settlement and agriculture) and spatial regions that are of greatest concern to the policy research community. Moreover it takes into consideration biophysical constraints such as water availability and climate change effects on crop growth. It is precisely in those regions (like Sub-Saharan Africa) and for those staple commodities (maize, cassava or sorghum) that GTAP-based general equilibrium models tend

to aggregate over into classifications that no longer allow for a detailed examination of the impacts upon them. The fact that these models also focus on quantities, rather than production and consumption values, allows us to derive results that are much more relevant to natural resource managers, and environmental scientists and analysts who are interested in the absolute quantities of change as a foremost indicator.

Results and discussion

The first result of the ongoing research is a prototype version of the coupled IMPACT-LandShift model and an exemplary application for a simulation study of the impacts of biofuel development in India. By taking into account the key drivers of change that are both socio-economic and environmental in nature, and how they affect the way in which the demand and supply sides of agricultural markets behave (Figure 1), we are able to gain a better understanding of how future trends might result in positive or negative impacts in human and environmental well-being in various parts of the world.

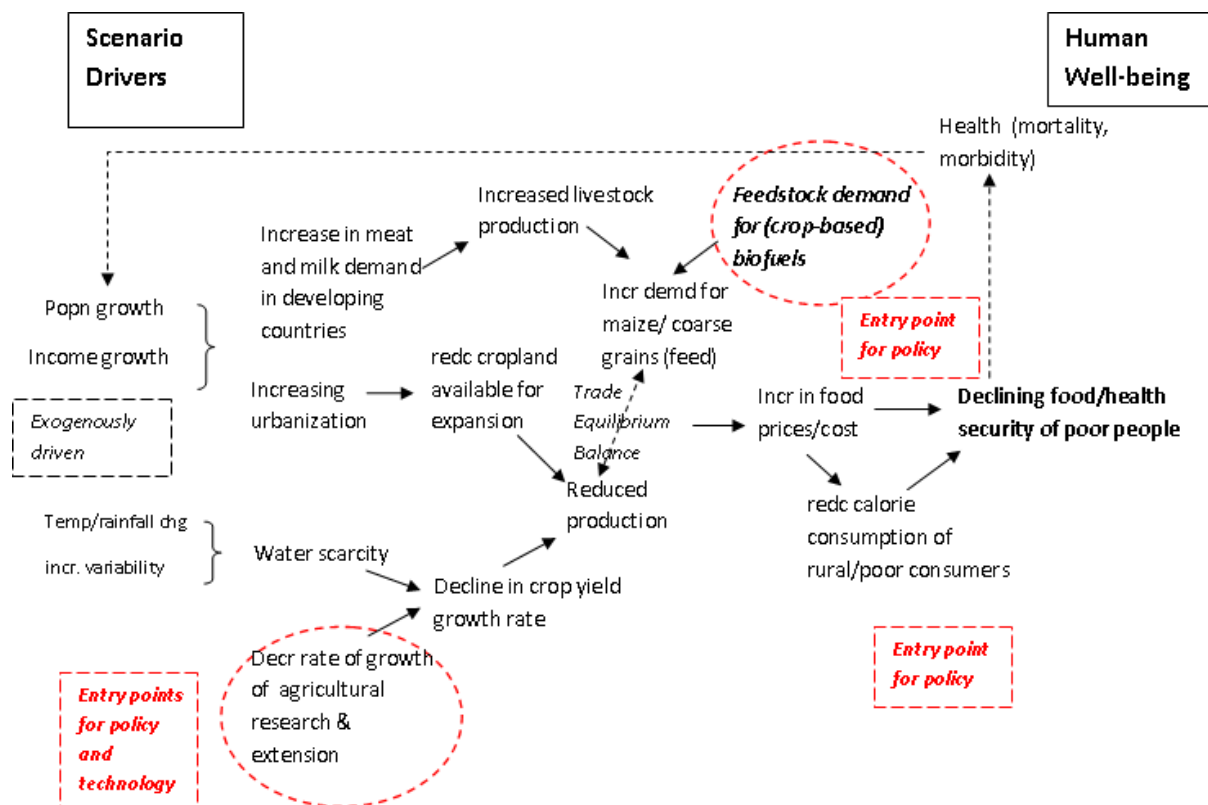

Figure 1. Key drivers of change that will be modelled.

References

Rosegrant, M.W., *et al.*, 2001. Global food projections to 2020: Emerging trends and alternative futures. Washington DC, International Food Policy Research Institute.
 Schaldach, R., *et al.*, 2008. Simulating the impact of biofuel development on country-wide land-use change in India. Biomass and Bioenergy. (under review)

Energy from agricultural residues and the trade-off to the food system

S. Nonhebel

Center for Energy and Environmental Studies, University of Groningen,
Nijenborgh 4, 9747 AG Groningen, The Netherlands
Contact: s.nonhebel@rug.nl

Introduction

Using biomass as an energy source is often mentioned as an option to mitigate the increasing greenhouse effect. Biomass for energy purposes can be obtained from dedicated energy crops and/or from agricultural residues. The available amount of residues is large and suggests a significant energy potential. It is estimated that in The Netherlands potentially 190 PJ can be obtained from these residues; on a global scale values of over 12 EJ are mentioned. However, most of these residues are currently used as livestock feed, which forms the basis for important proteins in the human diet. Use of residues for energy generation is likely to affect the supply of proteins in human diets, and therefore adaptations in the food system are required to compensate for this loss.

This paper focuses on the question: what are the consequences of using residues for energy generation instead of using them for livestock feed. It studies the adaptations required in the food system to compensate for the loss of residues. Three different systems are recognized: the present one where residues are used for livestock feed (Figure 1a) and energy is obtained from energy crops (wood), and two systems where residues are used for energy generation. The loss of livestock feed is compensated for by growing extra protein crops (in combination with a change to a vegetarian lifestyle; Figure 1b) or by the growing of extra feed crops (Figure 1c).

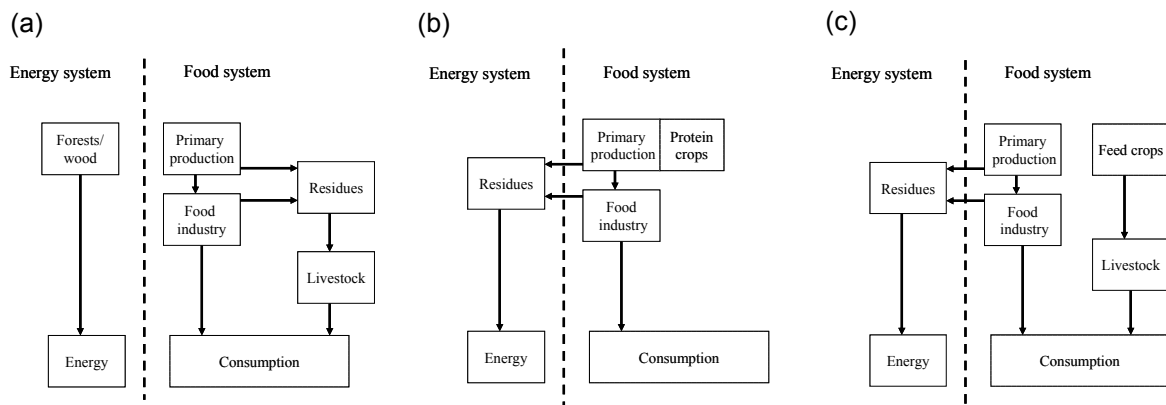

Figure 1. Schematic presentation of the three systems studied: Energy Crops system (a), Vegetarian System (b), Feed Crops System (c).

Method

For all three systems the magnitude of the various flows is quantified through determining:

1. The magnitude of available residues in kg/person.
2. The amount of meat that can be produced on basis of these residues
3. The amount of beans/pulses needed to compensate for this amount of meat in the menu
4. Quantity of wheat required as livestock feed
5. The value of the residues as energy source
6. The amount of wood from biomass plantations to compensate for energy in residues.
7. Finally the acreage needed for producing the beans, the wheat and the wood in the various systems.

Results

Table 1 shows the acreage required for the production of proteins and energy in the three systems studied. No acreage is attributed to the agricultural residues since it is assumed that they are ‘unwanted’ by-products of food production. This implies that in the Vegetarian System (Figure 1b) and the Feed Crops System (Figure 1c) no land is attributed to energy and that in the Energy Crop System (Figure 1a) no land is attributed to the meat production. The production of 36 kg beans in the Vegetarian System requires 120 m². In the Energy Crops System 80 m² is needed for the production of 2.2 GJ energy (121 kg wood), and the production of 120 kg wheat in the Fodder Crops System requires 170 m².

Table 1. Comparison of the acreage required for producing proteins (33 kg pork (on residues or 120 kg wheat as fodder) or 36 kg beans) and 2.2 GJ energy (on residues or 121 kg wood) in the three different food-energy production systems.

Energy crops (Figure 1a)		Vegetarian (Figure 1b)		Feed crops (Figure 1c)	
	m ²		m ²		m ²
33 kg pork	0	36 kg beans	120	120 kg wheat	170
121 kg wood	80	2.2 GJ energy	0	2.2 GJ energy	0
Total	80	Total	120	Total	170

The large differences that occur between the systems are striking. The Energy Crops System and the Fodder Crops System produce the same commodities (energy and pork) but the Fodder Crops System requires nearly 100 m² more to do so. The Vegetarian system also requires a larger acreage than the Energy Crops System (120 m²). It should be noted that values mentioned concern values per person per year. 33 kg pork is over 70% of the annual meat consumption per person. And 120 m² seems a small amount of land but multiplying it with the number of inhabitants results in vast amounts of land needed.

Conclusion

The analysis above allows some general conclusions on use of agricultural residues for energy generation. When residues have a value as livestock feed, use of these residues as an energy source results in tremendous trade-offs to the food system. These trade-offs are due to the fact that the loss of livestock feed needs to be compensated for to maintain a healthy diet for the human population. The loss in the food system is far larger (120–170 m²) than the gain in the energy system (80 m²).

Assessing the environmental effects of an increasing biogas production on agricultural farms

J. Schuler, G. Uckert, P. Zander
Leibniz-Centre for Agricultural Landscape Research (ZALF e.V.),
Institute for Socioeconomics,
Eberswalder Str. 84, 15374 Müncheberg, Germany
Contact: jschuler@zalf.de

Introduction

Biogas production has been developed and fostered to mitigate negative externalities of fossil energy use. But with the large scale adoption of this technology, negative side effects of the increased biomass production became apparent. Therefore, this study aimed to identify the trade off with nature conservation objectives, to explore efficiency and conditions of biogas production and to contribute to the development of novel production systems taking into account environmental objectives. On the basis of bio-economic farm modelling, the study investigated the economic and environmental performance of novel cropping systems, their impact on habitat conditions and conditions and possibilities to maintain or improve the profitability of biogas plants.

Methodology

The assessment of the environmental and economic effects was based on an adaptation of the modelling system MODAM (Zander & Kächele, 1999; Schuler & Kächele, 2003). For the purpose of this study, a biogas module was introduced into the farm model. The module implements linkages to other parts of the farming system such as crop production and livestock production through competition for area, fodder and slurry usage. The substrate usage of biogas plants is optimized on the basis of biogas potential of substrates and the requirements of the fermenter with respect to structure, energy content and dry matter share of the substrate.

For the environmental assessment, available indicators from the bio-economic system MODAM were used (Happe *et al.*, 2006; Sattler *et al.*, 2006; Sattler, 2008; Schuler & Sattler, 2008). The indicators are based on expert knowledge and allow the comparison of different scenarios through a dimensionless index system.

The model was applied to both existing farms from a case study as well as a set of prototype farms representing typical farms of North-Eastern Germany. Different novel production systems were introduced and a number of scenarios (prices, different methane yield levels, installed fermenter and energy units) were examined with respect to environmental and economic impacts.

Results and discussion

The modelling results show that the cultivation of energy crops is not harming the environment *per se*. Depending on the crops used and the intensity of the cultivation, the overall effects can differ. Furthermore, the efficiency of the biogas fermenter has a large effect on the environment. Full capacity utilization of the biogas plant and less efficiency of the biogas process is leading to a higher biogas substrate demand and accordingly a higher area consumption for the energy crops. The increase of competition at the expense of primarily set-aside areas showed the most harmful effects.

Figure 1 shows the overall effects of different farm types on a set of environmental indicators. The farm types differ in the crops used and the biogas yield that is achieved in each fermenter (representing different skills levels), K0 is a reference farm with no biogas plant installed.

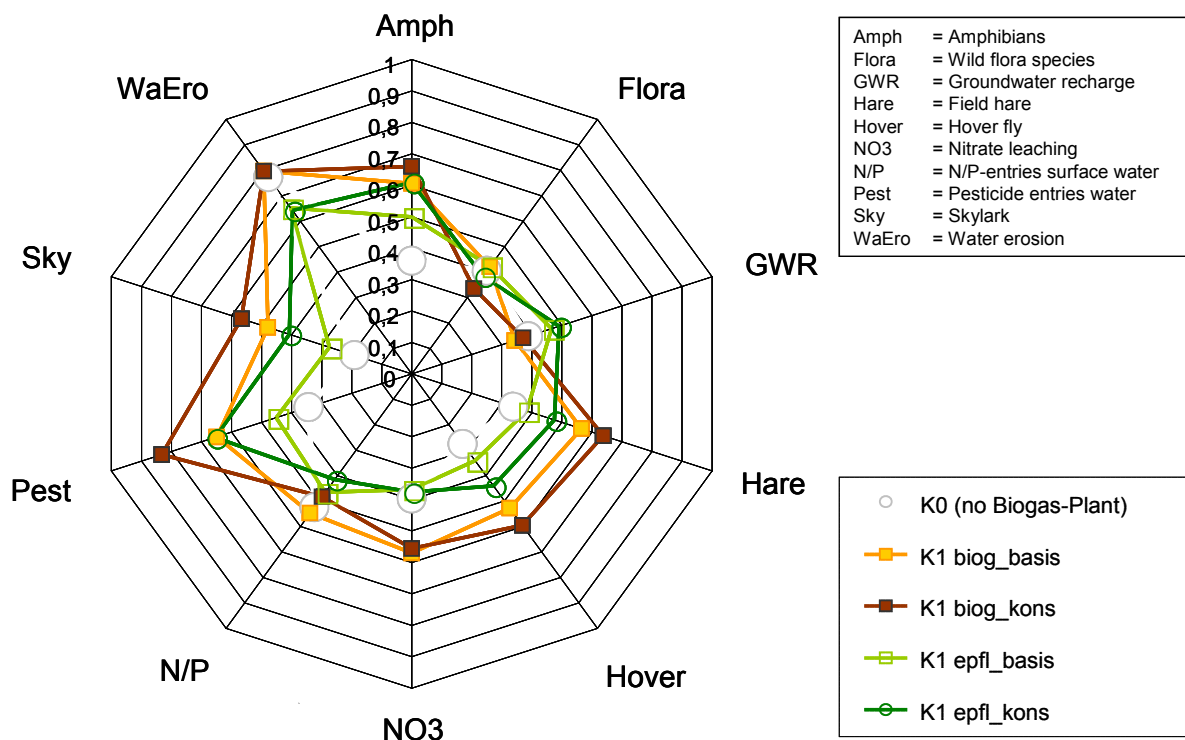

Figure 1. Environmental effects of different resulting land use patterns for a selection of regionally relevant indicators. (Farms K0= no biogas plant, K1= biogas plant installed, biog = standard cropping practices used for energy production, epfl = adapted cropping practices for energy production, basis = high biogas yields, kons = low biogas yields; 1 = positive, 0 = negative effects).

In summary, the introduction of biogas plants can improve the environmental impact of arable farms, if they make use of the possibilities to reduce input intensity and through a more diversified crop rotation. In livestock farms these effects are less pronounced as extensification options are less probable to occur and energy and fodder crops are largely identical, thus narrowing the crop rotation.

References

- Happe, K., *et al.*, 2006. *Agrarwirtschaft* 55(5/6): 268-279.
- Sattler, C., 2008. *Ökologische Bewertung und Akzeptanzanalyse pflanzenbaulicher Produktionsverfahren*. Dissertation, Humboldt-Universität zu Berlin. dissertation.de - Verlag im Internet GmbH, 236 pp.
- Sattler, C., *et al.*, 2006. Determination of trade-off functions to analyse the provision of agricultural non-commodities. *International Journal of Agricultural resources, Governance & Ecology* 5, No. 2/3, pp. 309-325.
- Schuler, J. & H. Kächele, 2003. *Environmental Science and Policy* 6(1): 51-55.
- Schuler, J. & C. Sattler, 2008. *Land Use Policy*, doi:10.1016/j.landusepol.2008.05.001
- Zander, P. & H. Kächele, 1999. *Agricultural Systems* 59(3): 311-325.

First and second generation biofuels up to 2030: Possible scenarios and their environmental impacts

Elke Stehfest, Geert B. Woltjer, Anne Gerdien Prins, Bas Eickhout, Martin Banse
Netherlands Environmental Assessment Agency (PBL),
Postbus 303, 3720 AH Bilthoven, The Netherlands
Contact: Elke.Stehfest@pbl.nl

Introduction

Until recently biofuels seemed to be an attractive alternative to fossil fuels in order to reduce greenhouse gas emissions and climate change, and to increase energy security. However, concerns about the induced land-use change, their small greenhouse gas savings, and the impact on global food prices has dampened this enthusiasm substantially. Initially ambitious targets of bio-energy use for example in the European Union have been reduced, and options to avoid the negative impacts have been introduced, e.g., via sustainability criteria. The interaction with the agricultural sector via competition of land, and indirect land use effects are highly complex and therefore hard to control, and the discussion on appropriate biofuel policies continues.

In this paper, we explore possible scenarios of biofuel use and production under different European and international biofuel targets using a coupled agro-economic and integrated assessment model.

Methods

We used the LEITAP model, a modified GTAP model and database, (Van Meijl *et al.*, 2006), coupled to the integrated assessment model IMAGE (MNP 2006). The LEITAP model is used to calculate agricultural production, trade and consumption of food crops and bio-energy crops over the time period 2000-2030. Its projections of agricultural production and intensification are passed to the IMAGE model, which allocates land use on a 5 minutes grid, and calculates resulting environmental impacts, greenhouse gas balances and climate change under the respective scenario. The coupling between the two models has been initiated in the EUruralis framework (Verburg *et al.*, 2008), is described in detail elsewhere (Eickhout *et al.*, 2008). Also the work presented here as been carried out as a part of the EUruralis project.

As a reference case we developed a ‘business as usual’ scenario, with continuous high economic growth, moderate population growth, and no new policies. Following this approach, biofuel policies of the European Union are set to the current 6% target in 2020. On top of this reference case, we explore possible developments and policy options relevant for European and global bio-energy. These options include variations of the European target, variations of the bio-energy policies in countries outside the European Union, possible contributions of second generation biofuels, technological development in both the food crop and the bio-energy sector, and different scenarios of nature conservation excluding bio-energy crop production on designated areas like forests or high value grasslands.

Results and discussion

For the reference scenario and the variants listed in Table 1 the LEITAP–IMAGE model suite calculates European and global land use effect, the full greenhouse gas balance of biofuel and thereby their expected climate mitigation potential. While food prices are not the focus of the study, they are also briefly reported.

(Results will be produced during the next months, and can, therefore, not be reported yet).

Table 1. Different options for the bio-energy scenarios explored in this study.

Category	Options
Target EU	No bio-energy policy, 6% EU baseline target, 10% high EU target
Worldwide bio-energy policies	Baseline, and high implementation of biofuels in other countries
Other sources of bio-energy	Different contributions from forest products and agricultural residues
Technological development bio-energy	Different development of technological improvement for bio-energy due to R&D investments and external assumptions
Agricultural intensification	Different assumptions on the increase in crop productivity
Restricted areas	Free bio-energy production, or restricting bio-energy production to non-forested lands, degraded soils, or excluding high biodiversity areas.

References

- Eickhout, B., *et al.*, 2008. In: Eds T.W. Hertel, *et al.*, GTAP Working Paper No. 47 Chapter 9 of the forthcoming book Economic Analysis of Land Use in Global Climate Change Policy.
- MNP, 2006. Integrated modelling of global environmental change. An overview of IMAGE 2.4. Netherlands Environmental Assessment Agency (MNP), The Netherlands.
- Van Meijl, H., *et al.*, 2006. Agriculture, Ecosystems and Environment 114: 21-38.
- Verburg, P.H., *et al.*, 2008. Annals of Regional Science 42: 57-77.

Spatial assessment of abandoned agricultural land for bio-energy production

E. Suuster, L. Kukk, A. Astover, M. Noormets

Institute of Agricultural and Environmental Sciences, Estonian University of Life Sciences,
1 Fr. R. Kreutzwaldi St., 51014 Tartu, Estonia

Contact: elsa.suuster@emu.ee

Introduction

Increasing dependency on fossil energy has forced researchers to think more about alternative energy carriers, e.g., bio-energy. In Estonia there is great potential for cultivating energy crops due to the availability of a lot of abandoned agricultural land. The decline in arable land use in Estonia was regionally variable and especially high in marginal districts with low soil quality (Peterson & Aunap, 1998; Astover *et al.*, 2006). Therefore, the planning of bio-energy production on abandoned areas requires precise location-specific analysis. The aim of present study was to investigate the amount and location of abandoned agricultural land and to analyse its suitability for producing energy crops in Saare County. Saare County is one of the 15 counties in Estonia situated in the country's western part. The county's total area covers 6.7% (292,219 ha) from Estonia's surface.

Methods

The study identified abandoned field parcels in Saare County, using the Estonian Basic Map (1:10,000) and field layer of Agricultural Registers and Information Board (ARIB) and databases of Common Agriculture Policy (CAP) payments in 2007. We considered field parcels without any applications for single area payments as entirely abandoned and parcels where area payments covered 50–99% of total area as partially abandoned. Agricultural areas outside of ARIBs fields (not valid for CAP subsidy schemes) were estimated also as entirely abandoned and determined from the Estonian Basic Map. For this, field layer of ARIB fields was cut out from basic map. Remaining agricultural areas from basic map were thereafter cleaned topologically: (i) areas less than 0.3 ha were eliminated, (ii) areas with perimeter-area ratio over 5 were eliminated, and (iii) visual assessment and manual correction of area boundaries based on orthophotos. These approaches enabled eliminate small unsuitable areas for bio-energy crops for further analysis. A GIS environment, MapInfo Professional 7.5, enabled us to perform topology analysis of the field layers and the soil map polygons. We identified the soils of abandoned land using the Estonian Land Board's digital soil map (scale 1:10,000) and assessed the suitability of these areas, depending on the soil type and texture, for short rotation energy forestry and energy grasses (Kõlli, 1994; Laas, 2004). The areas suitable for potential bio-energy production were evaluated for willow (*Salix sp*), grey alder (*Alnus incana*), hybrid aspen (*Populus × wettsteinii* Hämet – Ahti), reed canary grass (*Phalaris arundinacea L.*), Caucasian goat's-rue (*Galega orientalis Lam.*) and alfalfa (*Medicago sativa*).

Results and discussion

The total agricultural land in Saare County included for analysis in the current study is 76,454 ha (68,654 ha ARIB fields and 7,800 ha from basic map) which represents 26% of the county's total land area. Total abandoned area formed 27,046 ha of which entirely and partially abandoned accordingly 22,648 and 4,398 ha. Most of the entirely abandoned agricultural land is situated on the coastal line of the county (Figure 1). Abandoned fields mean size is 5 ha and entirely abandoned fields, 2.7 ha. The field's size could significantly limit re-using agricultural land again in the future.

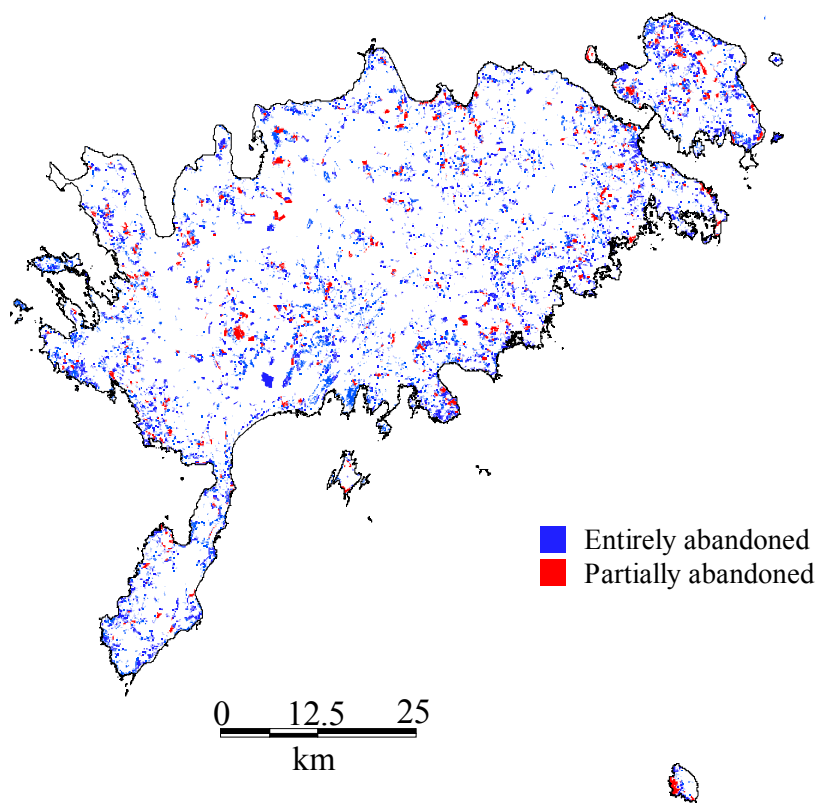

Figure 1. Location of entirely and partially abandoned agricultural land in Saare County.

On the entirely abandoned agricultural land *Calcaric Cambisols*, *Leptosols* and *Fluvisols* dominate. The textures of these soils are mainly sands, loam, sandy loam and the same materials with more stones in it. From total abandoned agricultural land Caucasian goat's-rue could be cultivated on 15,267 ha, alfalfa 14,439 ha and grey alder 14,389 ha. The potential bio-energy production from these fields would form accordingly 493, 466 and 697 GWh. Reed canary grass could be grown in 10,704 ha producing 395 GWh of bio-energy. Hybrid aspen and willows are suitable for 1/5 of total abandoned agricultural land. Their potential bio-energy production for each is 147 GWh. The energy consumption of Saare County in 2004 totalled 614 GWh (Hallemaa, 2006). Growing Caucasian goat's-rue, alfalfa or grey alder in suitable abandoned areas in Saare County, it is possible to cover the entire islands energy consumption without reducing current food production.

References

- Astover, A., *et al.*, 2006. *Archives of Agronomy and Soil Science* 52(2): 223-231.
- Hallemaa, H., 2006. Sustainability of energy use. *Counties in Figures 2001–2005*. Tallinn, pp. 18-38. (in Estonian)
- Kõlli, R., 1994. Soil suitability and agrogroups. Estonian Agricultural University, Tartu, 85 pp. (in Estonian)
- Laas, E., 2004. In: Ed. E. Asi, *Afforestation of arable land: A methodical guide for afforestation of arable land*. Centre of Forest Protection and Silviculture, Tartu, pp. 31-57. (in Estonian)
- Peterson, U. & R. Aunap, 1998. *Landscape and Urban Planning* 41(3-4): 193-201.

Enhancing the assessment of biofuels feedstock production through more realistic representation of farming systems

P.J. Thorburn, D. O'Connell, T. Grant
CSIRO Sustainable Ecosystems, 306 Carmody Rd,
St. Lucia Qld 4068, Australia
Contact: Peter.Thorburn@csiro.au

Introduction

In common with global trends, there is growing interest in biofuels in Australia to help reduce greenhouse gas (GHG) emissions and provide a more sustainable energy supply. The Australian biofuels industry currently only supplies less than 0.5% of the total transport fuels (O'Connell *et al.*, 2007) using waste starch and C-Molasses for ethanol, and used vegetable oil and tallow for biodiesel. Expansion of biofuel supplies requires different feedstock sources because the supply of traditional feedstocks is reaching its limit. The sustainability of these new feedstocks needs to be assessed. GHG emissions of biofuels have long been of critical interest to policy makers as a key aspect of sustainability, and have been fundamental to the argument for government support.

While the GHG emission profiles for a range of standard first generation biofuels have been well studied (O'Connell *et al.*, 2007), many of these assessments paid limited attention to the details of the farming systems producing the feedstocks. For example, average values for management inputs and practices were used and inter-regional variation ignored. Further, soil carbon (C) is generally assumed to be constant, an assumption not met in regions recently cleared of native vegetation (Fargione *et al.*, 2008). Additionally, nitrogen (N) fertilizer is an important input to many farming systems. Apart from the energy inputs associated with fertilizer manufacture, it is increasingly recognized that emissions of nitrous oxide, a potent GHG, have been underestimated in assessments of GHG emissions from biofuels production (Crutzen *et al.*, 2008). This paper describes our work linking agricultural simulation models to life cycle assessments to enhance the assessment of GHG emissions in the feedstock production end of the biofuels value chain, using sugarcane production in Australia as a case study.

Methods

We compared GHG emission profiles of three contrasting Australian sugarcane production systems: (1) The Tully region, in the super-humid tropics where weed control is a major issue and crop residues are conserved; (2) The Burdekin region, in the dry tropics where sugarcane production fully irrigated and crop residues are burnt at harvest; and (3) The Maryborough region, in the subtropics where sugarcane production uses supplementary irrigation and crop residues are also conserved. These production systems were simulated over a ~40 year period with the APSIM-Sugarcane model. Model outputs for annual production, soil C and N losses to the environment were used in the life cycle assessment (LCA), together with details of the farm management practices such as tillage, pesticide applications, etc. employed in the regions. In the Tully region, the site modelled was adjacent to a native forest remnant, and soil C in the forest was used to represent soil C at the commencement of cropping (44 years previous). This allowed us to also examine the impact of forest clearing and soil C run-down in the LCA. Finally, uncertainty in nitrous oxide (N₂O) emissions was investigated by undertaking LCA's with either standard, constant emission factors (used in Australian GHG inventories) or N₂O emissions modelled explicitly in APSIM (Thorburn *et al.*, 2008).

Results and discussion

GHG emission varied by ~50% between the different sugarcane production systems (Figure 1a). Tully has the highest carbon dioxide emissions because of the greatest application of

herbicides to control weeds in this wet environment. However, the Burdekin has high methane emissions from burning of the crop residues, resulting in the highest total GHG emissions. Ceasing burning would be an option for increasing sustainability of sugarcane production in this region.

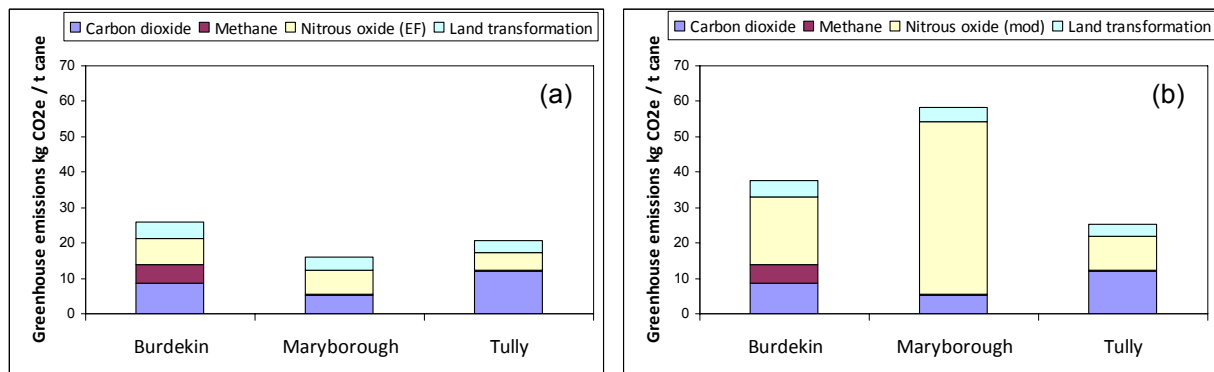

Figure 1. Greenhouse gas emission profiles for sugarcane production in three contrasting regions in Australia with N₂O emissions (a) estimates with constant emission factors, or (b) mechanistically modelled for each production system.

Soil C was predicted to be declining marginally ($\sim 80 \text{ kg ha}^{-1} \text{ yr}^{-1}$) in each region under current production systems. At Tully however, including the initial rapid run-down of soil C following clearing of the native forest increased average soil C decline to $> 500 \text{ kg ha}^{-1} \text{ yr}^{-1}$. Including emissions due to this change in soil C increased total GHG emission for Tully by 180% (data not shown). GHG emissions are further increased by an order of magnitude if emissions from forest clearing are included. It would take ~ 59 years of producing ethanol from C-Molasses before carbon neutrality from petrol offsets was reached if forests were cleared for biofuel production in this region, illustrating the small net GHG benefits for ethanol production from sugarcane in newly cleared land.

N₂O emissions using constant emission factors reflect the different N fertilizer application rates in these regions (Figure 1a). However, when N₂O emissions were explicitly modelled, they increase markedly at all sites, especially Maryborough (Figure 1b), illustrating the conservative nature of standard N₂O emission factors. The large impact at Maryborough is due to the relative over-fertilization of sugarcane in that region compared with yields, suggesting that GHG emissions from sugarcane production in this region could be reduced.

This study illustrates some of the complexities of assessing emission profiles for biofuels. Agricultural production systems vary, responding to differing environments, infrastructure constraints/opportunities and local customs. It will be important to capture the specifics of the farming system when assessing GHG emission from biofuel feedstock production. As well there is uncertainty in representation of N₂O emissions. Standard emission factors for N₂O are used because of the complexity of the processes resulting in N₂O emissions. However, agricultural simulation models are developing and becoming an increasingly useful tool in assessing sustainability of biofuels feedstock production.

References

- Crutzen, P.J., *et al.*, 2008. *Atmos. Chem. Phys.* 8: 389-395.
 Fargione, J., *et al.*, 2008. *Science* 319, 1235.
 O'Connell D., *et al.*, 2007. *Biofuels in Australia – issues and prospects*. Rural Industries Research and Development Corporation, Canberra, Australia.
 Thorburn, P.J., *et al.*, 2008. *Agric. Ecosys. Env.* (submitted)

Greenhouse gas emissions from grassland swards: A Scottish perspective

C.F.E. Topp, R.M. Rees
SAC, West Mains Road, Edinburgh, UK, EH9 3JG
Contact: Kairsty.Topp@sac.ac.uk

Introduction

Emissions of nitrous oxide from grasslands in Scotland have been shown to be high by comparison to other European countries (Flechard *et al.*, 2007). Agriculture was responsible for 79% of total N₂O emissions in Scotland in 2006 (Jackson *et al.*, 2007). Despite this, grasslands tend to operate as net greenhouse gas sinks largely as a consequence of their high CO₂ sink strength (Soussana *et al.*, 2007). Hence, it is important, that the opposing effects of C uptake and N₂O release are taken into account when assessing future climate and management scenarios in order to calculate a net greenhouse gas balance. Improved grasslands are an important part of the Scottish landscape covering about 22% of the agricultural land area in 2005. The manure and fertilizer management of these grasslands is known to have a significant impact on their N₂O emissions and hence greenhouse gas balance. Modifications to their management based upon an assessment of current and future climatic conditions could, therefore, play a valuable role in reducing greenhouse gas emissions. The DNDC (DenitrificationDecomposition) model (Saggar *et al.*, 2004; Li *et al.*, 1992; Li *et al.*, 2006), which has been extensively applied around the world, simulates the daily fluxes and pool sizes of carbon and nitrogen in agroecosystems. The objective of this study was to use the model to explore the impact of different fertilizer and manuring strategies on greenhouses gas emissions at two cut grassland sites in Scotland.

Methods

Two sites, located near Edinburgh (Cowpark) and Dumfries (Crichton), were used to assess the impact of fertilizer and manure applications on the global warming potential (GWP) of grasslands. The DNDC model was used to simulate management for 30 years, with the results presented for the final 20 years as this gives time for the soil pools to stabilize. The fertilizer treatment was three applications each of 100 kg N in mid March, mid May and mid July. Slurry applications were made in mid April and mid June with 150 kg of available N being applied at each application. Three cuts of silage were taken per year with cuts in mid June, late August and late October. The weather generator Earwig (Kilsby *et al.*, 2007) was used to create 30 years of baseline (1961–1990) and 2020 low and medium-high UKCIP scenarios (<http://www.ukcip.org.uk/>).

Results and discussion

At both Crichton and Cowpark there was a net uptake of GHGs (negative GWP) driven by the large carbon sink strength and all management and climate combinations. Nevertheless, there was a reduction in the GHG sink strength (less negative GWP) when baseline conditions were compared with either of the 2020 climate scenarios (Figure 1). At Crichton this was due to the combination of a small increase in N₂O emission and a small decline in the C sink, while at Cowpark the change was mostly due to a reduction in the C sink. Both the fertilizer and slurry treatments were net GHG sinks under all climates (Figure 1), but the slurry treatment at both sites resulted in a greater net carbon uptake than the fertilizer treatment. However, the environmental benefits of the slurry were counterbalanced by the increase in nitrate leaching, which was particularly noticeable at the wetter Crichton site. There was also a significant increase in the soil organic matter pool size for the slurry treatment relative to the fertilizer treatment.

The results suggest that the net sink strength for greenhouse gases in the grasslands that have been studied will decline by up to 40% over the next 20 years. This is driven largely by the predicted changes in climate, and the effects highlight the potential for strong regional differences in ecosystem responses. The warmer and wetter conditions in the west of Scotland are predicted to lead to increased losses of N₂O. In contrast, drier summers and overall increases in temperature in the east would reduce the carbon sink strength, but have little impact on N₂O emissions. However, there are clearly uncertainties associated with these predictions. This is partly a consequence of model uncertainties, although predicted greenhouse gas fluxes are broadly consistent with those from measurements at Scottish sites (Jones *et al.*, 2006; Jones *et al.*, 2007). In addition, there are also uncertainties about future climates. However, as a consequence of our changing climate, this study indicates that over a relatively short period of time the GHG sink strength may show a significant decline in Scottish grasslands. These feedback effects will make targets for significant reductions in greenhouse gas emissions even more challenging.

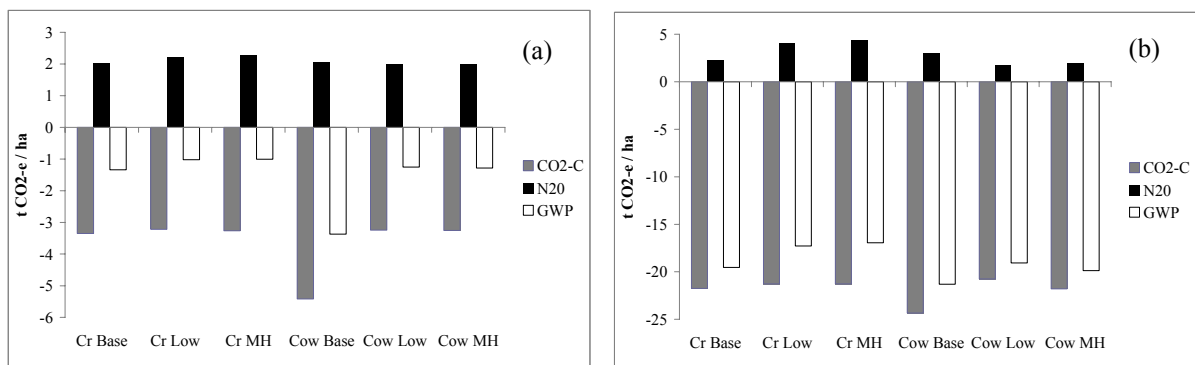

Figure 1. Carbon sequestration, N₂O and global warming potential for the (a) fertilizer treatment and (b) slurry treatment for Crichton (Cr) and Cowpark (Cow) weather conditions for current (Base), and the low (Low) and medium-high (MH) UKCIP02 emission scenarios.

Acknowledgments

RERAD and EU project NitroEurope IP (Contract no: 017841) funded this work.

References

- Flechard, C.R., *et al.*, 2007. *Agriculture, Ecosystems & Environment* 121: 135-152.
- Jackson, J., *et al.*, 2007. *Greenhouse gas inventories for England, Scotland, Wales and Northern Ireland:1990-2005*. AEA Technology PLC, Oxon, UK, 40 pp.
- Jones, S.K., *et al.*, 2006. *Soil Use and Management* 22: 132-142.
- Jones, S.K., *et al.*, 2007. *Agriculture, Ecosystems & Environment* 121: 74-83.
- Kilsby, C.G., *et al.*, 2007. *Environmental Modelling and Software* 22: 1705-1719.
- Li, C., *et al.*, 1992. *J. Geophys. Res.* 97: 9759-9776.
- Li, C.S., *et al.*, 2006. *Ecological Modelling* 196: 116-130.
- Saggar, S., *et al.*, 2004. *Nutrient Cycling in Agroecosystems* 68: 243-255.
- Soussana, J.F., *et al.*, 2007. *Agriculture, Ecosystems & Environment* 121: 121-134.

Water implications of biofuel crop cultivation and set-aside suspension in the European Union

M. Van der Velde, G. Wriedt, F. Bouraoui
IES-Joint Research Centre of the European Commission,
Via Fermi 2749, 21027 Ispra (VA), Italy
Contact: marijn.van-der-velde@jrc.it

Introduction

The Common Agricultural Policy (CAP) of the European Union (EU) is in a process of review. On the 20th of May 2008, European Commissioner Mariann Fischer Boel presented the so-called CAP 'Health Check' proposals (CEU, 2008). The proposals were adopted on the 20th of November 2008 (EC, 2008) and will be published in December 2008. One of the consequences of the Health Check is the abolishment of set-aside in 2009. Set-aside, withdrawing land from agricultural production, became an instrument of the CAP in 1988. The primary objective of set-aside was reducing surplus production and an accompanying objective was the protection of the environment and natural resources. It has been applied under various conditions, voluntary or obligatory, for different percentages of arable land.

The crops that are likely to be grown on previously set-aside land include wheat and oilseed rape because of expected market demand. Oilseed rape cultivation is stimulated by the role agriculture has been given in mitigating climate change. The abolishment of set-aside combined with the increase in rapeseed cultivation for biodiesel may lead to additional pressures on European waters. The EU's Water Framework Directive (EP & CEU, 2000) aims to protect European waters by reducing polluting discharges in ground- and surface water. The link between water and agriculture has become increasingly important over the last several years. One of the challenges of the current CAP reform is to meet the environmental objectives of the Water Framework Directive (WFD) while ensuring food supply and finding the right balance for the role of agriculture in climate mitigation.

Methods

We assume that the arable land that previously had been set-aside has been completely converted to a mix of oilseed rape, common wheat and durum wheat. We use a pan-European spatialized version of the EPIC model (Williams, 1995) that runs on a 10 by 10 km grid with relevant meteorological, land use, terrain, soil and management information. The model previously has been tuned for oilseed rape, common wheat and durum wheat yields using regional yields from across Europe as described by Van der Velde *et al.* (2008) for oilseed rape. To ensure that the proposed changes to the CAP minimally impact the targets set by the WFD it is pertinent to have relevant agricultural information available at the river basin level and therefore we summarized our modelling results at that scale.

Results and discussion

We identified river basins with a high share of utilized agricultural area as well as those river basins with a high percentage of set aside compared to the total utilized agricultural area and identified those basins where pressures on water resources resulting from set-aside conversion and related increased usage of fertilizers are likely to be most immediate.

The release of set aside's production capacity requires safeguards to continue the ecological and sustainable benefits of this instrument. Proposed policy changes specifically related to water quality and quantity issues include additional GAEC standards on water management and landscape features.

Our results suggest that a more continuous river-basin approach coupled with farm-scale measures is needed to enable off-setting the additional agrichemical loading and soil particle

transport by increasing the buffering capacity of the agricultural-ecological landscape continuum. Increasing the buffer capacity of the agricultural-ecological continuum will be beneficial to retain soil, water and nutrients in the landscape. This will allow us to reap more resilient environmental services and will help agriculture in adapting to increasing water scarcity and droughts that are expected across Europe under further climate change.

We argue that careful consideration should be given to the objectives of the CAP as evaluated by the Health Check to ensure that they do not impinge on the environmental targets set by the Water Framework Directive.

References

- CEU, 2008. Proposal for a Council regulation. Establishing common rules for direct support schemes for farmers under the common agricultural policy and establishing certain support schemes for farmers (*etc.*). Commission of the European Communities, COM(2008) 306 final, 161 pp, Brussels, Belgium.
- EC, 2008. Agriculture: CAP Health Check will help farmers meet new challenges. European Commission, Press Communication, IP/08/1749, Brussels, Belgium, 2 pp.
- EP & CEU, 2000. Directive 2000/60/EC establishing a framework for Community action in the field of water policy. European Parliament and the Council of the European Union, Official Journal of the European Union, Brussels, Belgium, L 327/1-73.
- EP & CEU, 2003. Directive 2003/30/EC on the promotion of the use of biofuels or other renewable fuels for transport. European Parliament and the Council of the European Union, Official Journal of the European Union, Brussels, Belgium, L 123/42-46.
- Van der Velde, M., *et al.*, 2008. Global Change Biology 14: 1-14.
- Williams, J.R., 1995. In: Ed. V.P. Singh, Computer models of watershed hydrology. Water Resources Publications, Highland Ranch, CO, USA, pp. 909-1000.

Disclaimer: The statements expressed here are purely those of the authors and may not in any circumstance be regarded as stating an official position of the European Commission

Bio-ethanol from sugar beet in The Netherlands: Sustainability assessment

G.W.J. Van de Ven, C.L.M. De Visser, H. Langeveld, S.C. De Vries, L. Van den Brink
Plant Production Systems, Wageningen University,
P.O. Box 430, 6700 AK Wageningen, The Netherlands
Contact: Gerrie.vandeVen@wur.nl

Introduction

The European Union imposed a minimum percentage of biofuels to be blended with fossil transport fuels. A crop offering perspectives for bio-ethanol production in Europe is sugar beet due to the high sugar yields per ha. The aim of this study is to (partly) apply the Dutch Framework for sustainable biomass production (Cramer *et al.*, 2007) and to assess the sustainability of ethanol production from sugar beet in The Netherlands from real farm data.

Methodology

The Dutch Framework for sustainable biomass production aims at certification of biomass production. The indicators cover a wide range of subjects related to the people-planet-profit principles. Minimum/maximum values have to be quantified or relevant information has to be reported. We have selected the *indicators* relevant for the Dutch production situation and added the indicator *net energy production*.

We analysed the real data of two farms of Wageningen-UR over three years (2005–2007). Sugar beet cultivation was according to normal commercial practices. Both farms are located in regions with sugar beet in the standard rotation, on old marine clay (Westmaas) and on former peat soil (Valthermond). Both farms are well managed with yields above average.

The bio-ethanol production chain is divided into four phases: (i) cultivation of sugar beet; (ii) transport to the processing plant; (iii) conversion of sugar beet into ethanol and by-products; (iv) distribution of bio-ethanol to users. The energy requirements and greenhouse gas (GHG) emissions have been quantified for each phase separately. Energy use during cultivation is the sum of direct and indirect energy required for the use of machinery, diesel, seeds, nutrients (inorganic and organic) and crop protection agents, based on farm registration and standard energy contents (Mortimer *et al.*, 2004; Bos *et al.*, 2007). The transport and distribution distance are set at 100 km. Conversion of sugar beet into ethanol is according to Mortimer *et al.* (model 4a; 2004), as no real processing data were available. The energy yield is calculated from product yield and their lower heating values.

GHG emissions (CO₂, N₂O, CH₄, expressed in kg CO₂ equivalents) for manufacturing inputs, transport and conversion are based on Mortimer *et al.* (2004). N₂O emission during cultivation, resulting from manure application, crop remains and decomposition of organic matter, is calculated according to IPCC (2006). We assume that frequency of sugar beet cultivation is increased from 1:8 (Westmaas) and 1:6 (Valthermond) to 1:4 on both farms, i.e. limit to good agricultural practice. The changes in *soil organic matter* (SOM) have been quantified according to Yang & Janssen (2000). Qualitative indicators are effects of *changing land use* and *no abuse of laws and regulations* with respect to biodiversity and environment. At both farms the latter indicator is met.

Results and discussion

Total *energy production* in ethanol and by-products (vinasse and pulp) exceeds the total energy input by a factor 2.25 and net energy production is 140–195 GJ ha⁻¹. If only the energy output with ethanol is considered net energy yield is 35–50 GJ ha⁻¹. However, if part of the energy input is allocated to the by-products, based on the lower heating values this is 42%, the result is a net energy production in ethanol of 75–110 GJ ha⁻¹. Hence, net energy production per ha is positive.

Cultivation requires 10–18% of the energy input and conversion, 75–82%. Total *GHG emission* varies between 8.3 and 11.6 t CO₂ equivalents per ha, cultivation being responsible for 35–50%. This implies that measures to reduce energy input should be focused at improving conversion technologies, and measures to decrease GHG-emission need attention during cultivation of sugar beet.

Figure 1 shows that direct N₂O emission, from crop residues, decomposition of SOM and nutrient application, is the major contributor to GHG emission during cultivation. In Valthermond, this is substantially higher than in Westmaas, as the mineralization rate is 50 kg N/ha more. One would expect lower nutrient application rates, but these are similar on both locations. In Valthermond, animal manure is applied, which has a lower uptake efficiency and we assumed that manure application leads to similar GHG emissions as fertilizer per kg of nutrient applied. If the GHG related to production of manure is not taken into account, the GHG emission in Valthermond will decrease by 0.8–1.3 t CO₂-equivalents.

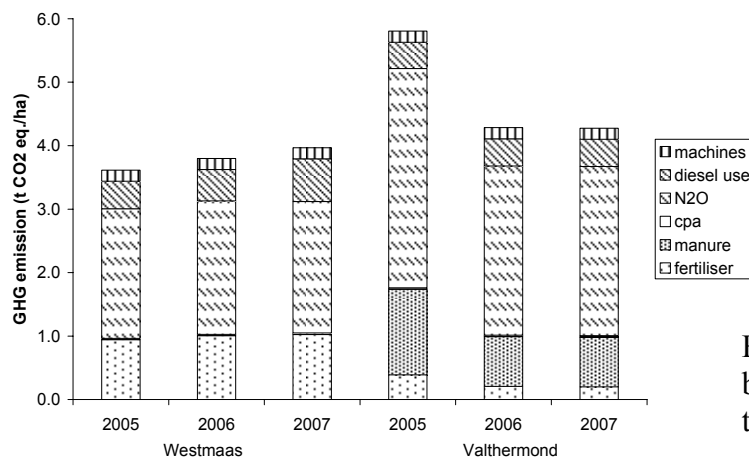

Figure 1. GHG emission from sugar beet cultivation during three years at two locations.

Compared to gasoline the total GHG emission is reduced by 22–39%, if allocation is not taken into account and 50–65% if allocation to by-products is taken into account. Hence, it depends on assumptions and calculation methods, if the criteria of 30% reduction is met.

SOM content is hardly affected by growing sugar beet more frequently. It replaces corn in Westmaas and barley in Valthermond and under current practices the effects of differences in effective organic matter applied with these crops are too small to assess.

In The Netherlands, the area under sugar beet was 83,000 ha in 2006, 10.6% of the total arable area. Good agricultural practice limits the maximum area to 180,000 ha. *Changing land use* will consist of replacing the least profitable crops first, e.g., grass seed, maize and some small crops. Grass seed and maize are feed crops and replacing them on a large scale may ultimately increase milk/meat prices. Sugar beet will only be grown for ethanol, if it is more profitable than sugar production, depending on the EU market regulations for sugar. These are being reformed towards world market prices, improving the scope for bio-ethanol production. However, average cultivation costs were €1400 ha⁻¹. At yields of 6.1–6.4 t ha⁻¹, ethanol has to receive about €225 t⁻¹ to compensate variable costs.

References

- Bos, J. *et al.*, 2007. Energy use, GHG emission and C-sequestration, report 140, WUR, 79 pp.
- Cramer, J., *et al.*, 2007. Testing framework for sustainable biomass. Final report from the project group 'Sustainable production of biomass'. Commissioned by the Energy Transition's Interdepartmental Programme Management (IPM), 62 pp.
- IPCC, 2006. IPCC guidelines for national GHG inventories. Volume 4, Hayama, Japan.
- Mortimer, N.D., *et al.*, 2004. Energy and GHG emissions from bio-ethanol production from wheat grain and sugar beet production. Final report for British Sugar plc., UK, 180 pp.
- Yang, H. & B.H. Janssen, 2000. *Eur. J. Soil Science* 51: 517-529.

Energy maize for phytoremediation of metal-enriched soils and production of energy: The Campine region, Belgium

V. Van Slycken, N. Witters, E. Meers, K. Adriaensen, T. Thewys,
J. Vangronsveld, F.M.G. Tack
Laboratory of Analytical Chemistry and Applied Ecochemistry,
Ghent University, Coupure Links 653, 9000 Gent, Belgium
Contact: stijn.vanslycken@ugent.be

Introduction

Atmospheric deposition of trace metals (e.g., Cd, Zn and Pb) from metal refinery activities over the last century has caused elevated concentrations in agricultural soils in the Campine region. Regional policy therefore prescribes that the soils should be remediated, while at the same time it is desirable to keep the income of the farmers constant. Both goals can be achieved using phytoremediation in combination with the growth of energy crops and brings us to the concept of a multi-functional biomass system (Berndes *et al.*, 2008). Phytoremediation involves the use of plants for the removal of pollutants from the environment or to render them harmless (Garbisu & Alkorta, 2001).

Methods

For the study of phytoremediation potentials with energy maize samples were collected from a field (6ha) situated on a moderately contaminated soil in Lommel, Belgium. The planting and management of this site is part of a demonstration project in the context of the INTERREG-project BENEKEMPEN.

The concentrations of Cd in this study area vary between 0.5 and 12 mg Cd kg⁻¹ soil. Other trace metals (e.g., Cu, Pb and Zn) together with the pH and soil conductivity were more homogeneously distributed throughout the field. As the concentrations of Cd in the sampled plots are exceeding the threshold values for remediation for agricultural land (2 mg kg⁻¹) in Flanders, this study will mainly focus on phytoremediation purposes of Cd. In this field 1 ha was reserved for investigations with energy maize. Regional policy prescribes that the soils should be remediated, while at the same time it is desirable to keep the income of the farmers at a constant level. Therefore, the impact on the revenue of the farmer originating from the phytoremediation activities is calculated. To take into account the uncertainty involved, sensitivity analyses are performed for several variables. The final aspect included is the energy component of the project: an input-output ratio is calculated and avoided CO₂ emissions are given.

Results and discussion

In the site for screening of energy maize, the total concentration measured in an *aqua regia* destruction is 5 ± 1 mg Cd kg⁻¹ soil. In 2007, a yield of 20 ± 3 ton dry biomass/ha was obtained. No significant difference in Cd concentration between the cultivars could be measured for each plant compartment (stem, leaves, bract, rachis, grain). Also no great significant difference was found in yearly removal of trace element between different the investigated cultivars, so that the yearly removal of Cd can be estimated at 18 ± 6 g Cd ha⁻¹. For total removal of 5 mg Cd kg⁻¹ soil to 1.2 mg Cd kg⁻¹ soil (acceptable value) more than 800 years will be needed when energy maize is used.

Nevertheless, the Cd concentration in the biomass is exceeding legal threshold values for fodder crops (1.1 mg Cd kg⁻¹ dry matter) which implies that the biomass produced cannot be used as fodder but must be applied for other industrial purposes such as energy generation. Batch-tests for anaerobic digestion, performed at OWS (Organic Waste Systems, Belgium) showed no difference in biogas potential of the silage of the contaminated maize in

comparison with a reference material. This points out that energy maize does not have as its main goal remediation of the contaminated soil, but as a more valuable alternative for the farmers. Energy maize as an alternative crop offers great potential, but further research on metal balance in this process and the disposal of the digestate is still ongoing.

Economic measurements need to be included to fully evaluate phytoremediation purposes. We start from the assumption that basic activities remain (dairy cattle rearing). Therefore, energy maize is grown and fodder maize has to be bought outside the contaminated area. When the biomass from energy maize is used for energy production by digestion, the basic income of the farmer can be supported by using and selling renewable energy (heat and electricity) out of this polluted biomass. When farmers digest the maize themselves and former activities and revenues thereof remain, their average yearly net income will grow with € 227 ha⁻¹, to be added to the basic income of € 1.047 ha⁻¹ (2005). However, Risks, legal norms and extra efforts needed in such a project cannot be underestimated. A farmer can therefore decide to sell the polluted energy maize by contracts with an energy partner that converts the polluted biomass into energy. In the latter case, the average yearly income of the farmer grows with € 115 ha⁻¹.

As already mentioned, the project is conceived as a multi-functional biomass system. Another environmental benefit, besides remediation, of this project is the production of 'green' energy. Taking into account all energy input (going from transport of fodder to processing the waste product), digestion of energy maize delivers for each part of fossil energy input, 8–12 parts of renewable energy. One hectare of energy maize delivers a net yield of 80 GJ electricity and 30 GJ heat, to be sold locally or to be used on the farm. In a traditional installation (coal), this amount of electricity would cause an emission of 9.6 t CO₂.

To study the possibilities for phytoremediation of trace elements in the Campine region, using energy crops, an integrated study is needed. The agronomical study of energy maize shows that the produced biomass is comparable with energy maize grown on non-contaminated sites. Because of the low concentration of trace elements in the different plant parts, a long remediation period is needed. Nevertheless, the high biomass and low concentration are very promising for its use in the non-food industry, including the provisional results for usage in energy generation by anaerobic digestion. Moreover, the economic outlook for the farmers in the contaminated region is positive, as simulations have shown. In this paper, energy maize is, therefore, presented as a sustainable alternative for traditional farming activities. Research is also ongoing for other crops like short rotation coppice and rapeseed. These crops can show even higher extraction rates, but have disadvantages concerning economic, energetic or social aspects. All this information combined with metal balances in the different energy flows will allow full comprehension of the feasibility of the various phytoremediation approaches for a safe management of metal enriched agricultural soils.

References

- Berndes, G., *et al.*, 2008. Biofuels, Bioprod. Bioref. 2: 16-25.
Garbisu, C. & I. Alkorta, 2001. Bioresource Technology 77: 229-236.

Theme C
**Case studies and application of tools and
empirical methods**

**Session C2: Modelling adaptation strategies to cope
with climate change**

Session organizers:

Jim Hansen

Int. Research Institute for Climate Prediction, New York, USA

Lennart Olsson

Lund University, Sweden

Will global mitigation policy enhance or undermine local adaptation?¹

H. Meinke^a, R. Nelson^b

^aCCSA, Wageningen University, The Netherlands, ^bCCAF, CSIRO, Australia
Contact: holger.meinke@wur.nl

Introduction

Adapting to climate change combined with providing the policy frameworks that facilitate sound adaptation is essential for the survival of our agricultural sectors. Yet decision makers' research needs on both sides – practice and policy – are often neglected as their interests cross disciplinary and institutional divides. This can lead to maladaptation, as shown by some of the recent expansion of biofuel production in the wake of policies with unintended consequences. Bridging the practice – science – policy divide requires all three to adapt. Proactively designed and sustainable adaptation action will only occur if and when climate-related risks are treated holistically in conjunction with other drivers of risk (e.g., market, environment or social risks), supported by policies that take multiple domains and outcomes (e.g., sustainable development) into account. We call for adaptation science to provide integrated vulnerability assessments that are policy relevant and trigger regionally appropriate adaptation responses.

Results and discussion

Proactively designed adaptation does not come easily to a sector that values tradition and whose decision needs are rarely met by the climate change science community. Adaptation requires changed attitudes and practice by all participants, including the science and policy communities (Nelson *et al.*, 2009a, b) and the recognition that science will only ever provide partial answers to societal problems (Jasanoff, 2007). The insidious nature of ongoing climate variability and future change poses a particular challenge: climate is a widely acknowledged risk factor for most agricultural activities, but without being the sole or even dominant driver for most of them. Yet without due consideration of climatic impacts, the dual goals of agricultural production – profitability and sustainability – cannot be achieved. Further, the considerable opportunities that are created by good climatic conditions and new, climate-related policy measures often fail to translate into real benefits.

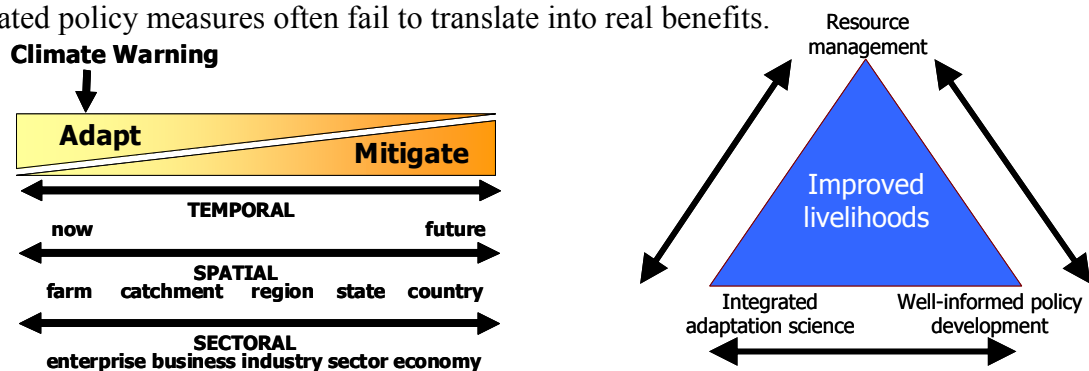

Figure 1. Temporal, spatial and sectoral dimensions of adaptation and mitigation (left) and the role of integrated adaptation science to inform policy as well as practice (right).

Garnaut (2008) states that '*Contemplating the adaptation challenges ... helps to focus our minds on the more difficult dimensions of mitigation choices*'. This is a call for the proactive design of adaptation options backed by well-informed policies, an essential requirement for vibrant rural sectors in charge of their own destinies (Figure 1). Adaptation science (AS), a special form of sustainability science at the boundary between science and society, can build social networks that institutionally connect agricultural and climate science with decision

¹ Keynote presentation

makers, thus generating ‘social capital’ needed to create adaptive capacity. Through new ‘boundary-spanning organizations’ (Guston, 2001), AS provides novel applications that explicitly recognize science’s ability to reduce, but not to eliminate uncertainty.

Australia, which only recently committed itself to the Kyoto targets, has a rich history of applied climate risk management (due mainly to its highly variable, semi-arid climate) and plays a key role in agricultural climate adaptation research (Howden *et al.*, 2007; Meinke *et al.*, 2007). Garnaut (2008) identified seasonal climate forecasts as a key technology in Australia’s adaptation challenge. Yet their impact has been disappointing, a direct consequence of their low compatibility with decision making under uncertainty (Hayman *et al.*, 2007). The insidious nature of climate results in highly variable co-limitations that cannot be overcome via single technological fixes. By defining forecast quality as the *characteristics of a forecast product and/or forecast service that enables action and satisfies identified and agreed needs of the user community*, the issue of co-limitations could be addressed. It is therefore paramount not to focus on single scientific measures of a forecast (e.g., skill or lead time). Instead, science is required to acknowledge co-limiting factors such as knowledge barriers, sound governance and the ability to compare choices, chances and consequences.

Based on a review of supply and demand for integrated vulnerability assessments, we conclude that our conceptual understanding of the issues has progressed to the point where it is no longer acceptable to substitute impact modelling for integrated vulnerability assessments when providing policy advice. For instance, confining an analysis to biophysical impacts suggests that inland Australia is most vulnerable due to high exposure to a variable climate. When farm incomes are used as a more integrative measure of exposure, the spatial vulnerability of agricultural communities becomes considerably more complex (Figure 2).

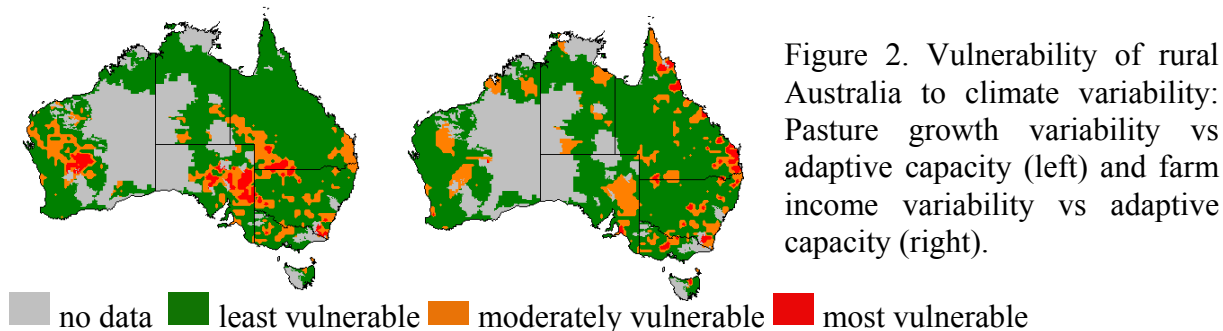

We further conclude that policy relevant vulnerability assessments that support adaptation action flow from collaboration between scientists from diverse disciplines and agencies. Our work is an overt attempt to create policy relevant measures of vulnerability that trigger appropriate action by or on behalf of specific individuals, communities and governments to reduce it. We show how interdisciplinary collaboration can overcome methodological challenges to providing policy relevant vulnerability assessments while impact modelling can lead to entirely erroneous conclusions about the vulnerability of agricultural communities. Rural communities that are vulnerable to climate variability and change tend to be vulnerable for a complex set of interacting environmental, economic and social reasons.

References

- Garnaut, R., 2008. Cambridge University Press, Port Melbourne, Australia, 634 pp.
 Guston, D., 2001. Cambridge University Press, Cambridge.
 Hayman, P., *et al.*, 2007. Australian Journal of Agricultural Research 58: 975-984.
 Howden, S.M., *et al.*, 2007. PNAS 104(5): 19691-19696
 Jasanoff, S., 2007. Nature 450: 33.
 Meinke, H., *et al.*, 2007. Aust. J. Agric. Res. 58: 935-938.
 Nelson, R., *et al.*, 2009a, b. Part I & II - Environmental Science and Policy. (submitted)

Exploring options to improve adaptation to climate change in crop production of south-eastern South America

W.E. Baethgen, J.W. Hansen, A.V.M. Ines, A.M. Greene, L. Goddard
IRI, 61 Route 9W, Monell Building, Palisades, NY 10964-8000, USA
Contact: baethgen@iri.columbia.edu

Introduction

Even under the most optimistic scenarios of globally coordinated actions to drastically reduce the net emissions of greenhouse gases (GHG) during the next decades, climate science confirms that warming is already unavoidable due to past emissions (Meehl *et al.*, 2007), and therefore adaptation will be necessary to address the impacts resulting from such global warming. Much of the research on expected impacts of climate change and options to improve adaptation to possible climate change scenarios (IPCC WG2, 2007) does not include any measure of the uncertainties that are intrinsic to the climate projections, and assumes that technology remains unchanged throughout the decades that are covered in the study period. These two limitations can drastically reduce the value of climate change research for informing policy and decision making. Decisions that are based on deterministic climate scenarios (i.e., scenarios lacking any measure of uncertainty or probabilistic ranges) are likely to be inadequate and may even be maladaptive. Furthermore, policies based on adaptation studies on adaptation to climate change that consider possible changes in technology can be directed to stimulate the use of technologies that reduce vulnerability to climate.

We describe methods that are intended to overcome the limitations mentioned above. We propose methods for establishing a suite of possible climate change scenarios based on GCM projections and on the changes observed in the climate over the last several decades. We then use crop simulation models to explore different levels of adaptive measures including technological changes.

Methods

Our study region is Southeastern South America (SESA: southern Brasil, Uruguay, central Argentina), one of the main world's food baskets. We use three methods for establishing climate change scenarios. First, we modify the observed weather data (last 30 years) with anomalies (i.e., GCM climate change scenarios minus GCM climatology) from GCMs available from IPCC to create a climate dataset with possible expected anomalies in the means and no change in the variability for each one of the GCMs available from IPCC. We may also explore ensembles having different relative weights for the component GCMs (e.g., Greene *et al.*, 2006.). Second, we statistically characterize the changes observed in temperature and precipitation in SESA throughout the last 70 to 100 years, and use the observed changes in precipitation and temperatures (means, variability, dry spell length, storm intensity, etc.), to project the observed trends into the near future. Third, we identify coincidences in the GCM projections for the region (e.g., changes in temperatures and rainfall in different seasons), and use stochastic weather generators (Semenov & Barrow, 1997; Semenov, 2007) to create 'synthetic' daily weather datasets that incorporate the changes for which most of the GCM agree (e.g., summer precipitation increase, minimum temperature increase, etc.). The method is also used to create new datasets that increase the variability of rainfall (both amounts per rainfall event and number of rainy days) and temperature, and hence increase frequency of extreme events.

Results and discussion

This process results in a large number of possible future climate scenarios that reflect different sources of uncertainty (e.g., uncertainty related to socioeconomic scenarios used in

the GCMs, uncertainties on the projections of changes observed in the last 70-100 years, etc.). The suite of possible climate change scenarios are thereafter used as input for crop simulation models (in our study we use one for wheat and one for maize) to study the impact of those possible climate scenarios on the expected yields in the study region. The models that we use (DSSAT) allow for considering different technologies (different cultivar characteristics, sowing dates, fertilizer strategies, irrigation, etc.) and therefore, we explore adaptive measures that work best under the various expected climate scenarios. We explore different degrees of technology changes: from selecting cultivars that already exist, to improved crop breeding and pest management strategies that are under development and/or can be the result of future investments in adaptation.

The results are expressed in formats (graphs, maps) that include measures of the uncertainty (e.g., median, 10th, 90th percentiles; probability of exceedance of given values, etc.), as opposed to only mean expected values. The research is helpful for the climate science community to emphasize the need of connecting the climate data with tools that ‘translate’ climate scenarios into results with socio-economic relevance. Furthermore, it is useful for the agricultural community to show the need and benefits of using several methods to establish climate change scenarios which will allow communicating the uncertainties of the results. Furthermore, it demonstrates the importance of including technology changes in climate change impact studies.

References

- Greene, A.M., *et al.*, 2006. *J. Climate* (19)17: 4326-4343.
- IPCC WG2, 2007. In: Eds M.L. Parry, *et al.*, *Climate Change 2007: Impacts, Adaptation and Vulnerability. Contribution of Working Group II to the Fourth Assessment Report of the Intergovernmental Panel on Climate Change*. Cambridge University Press, Cambridge, UK, 976 pp.
- Meehl, G.A., *et al.*, 2007. In: Eds S. Solomon, *et al.*, *Climate Change 2007: The Physical Science Basis. Contribution of Working Group I to the Fourth Assessment Report of the Intergovernmental Panel on Climate Change*, Cambridge University Press, Cambridge, UK.
- Semenov, M.A., 2007. *Agric. Forest Meteorology* 144: 127-138.
- Semenov, M.A. & E.M. Barrow, 1997. *Climatic Change* 35: 397-414.

Assessment and predictions of agricultural drought for the Upper Blue Nile Basin, Ethiopia

Y.G. Bezabij, R. Sintanyeho, A. Van Griensven
Department of Hydroinformatics and Knowledge Management,
UNESCO-IHE Institute for Water Education, P. O. Box 3015,
2601 DA Delft, The Netherlands
Contact: bezabl@unesco-ihe.org

Introduction

Recent scientific studies indicate that drought is driven by natural variation of climate forced by the internal interactions of the atmosphere and feedbacks from the oceans and land surface. This makes drought phenomenon dependent not only on local but also on global weather circulation and interactions. ENSO is attributed to the occurrence of drought in most parts of the globe where its impact causes economic losses for developed and loss of life for developing nations.

Methods

To successfully mitigate these impacts of drought necessitates reliable forecasting tools with longer lead time. Integration of physically based models with data driven models can give an answer by compensating each other's drawbacks. Here, the physically based hydrologic model 'Soil and Water Assessment tool' (Arnold *et al.*, 2002) is used in combination with recursive feed forward Artificial Neural Network (ANN) data driven provide predictions in the form of short term (couple of days) forecasts of soil moisture conditions, mid-term early warning of ENSO events (seasonal) and long-term predictions (several years) of climate change impacts on soil water and the cropping season.

The models are developed by making use of open source remotely sensed data and GCM outputs downscaled using statistical downscaling method. In this study an attempt is made to knit the oceanic sea surface temperature (SST) with the land hydrological variables. The SWAT model, being calibrated and validated by ground stations data, and the ANN are used for the assessment and prediction of the soil moisture stress. Two indicators are used: the Soil Water Deficit Index and the evapotranspiration deficit indices (ETDI) as proposed by Narasimhan & Srinivasan (2005).

Results and discussion

As seen in Figure 1, the north, central and western part of the Blue Nile region is most affected by drought (negative SMDI).

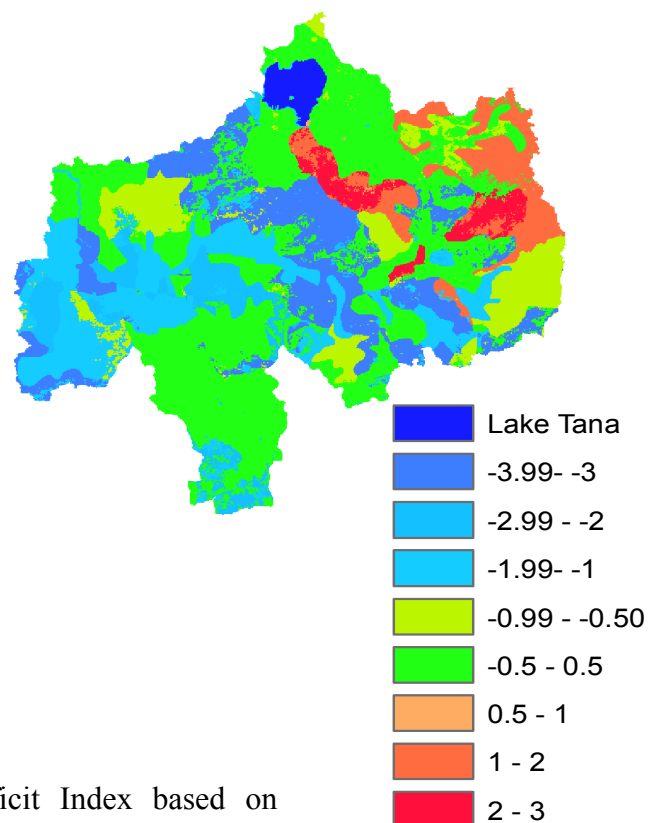

Figure 1. Soil Moisture Deficit Index based on SWAT simulations for the Upper Blue Nile (January 2005) (Tessema, 2007).

It is known that drought left a scar and that this will be worsened by the impacts of climate change and by desertification. The need to mitigate the impacts of drought asks for an integration of our presented forecasts and predictions into communication tools for stakeholders and decision makers. The short-term forecasts are useful for day to day crop agricultural and water management, the medium term provides an early warning to activate planning for disaster prevention and the long term predictions play a role in the assessment of drought trend under the continuing climate change caused by either natural or anthropogenic factors. These predictions are to be incorporated in strategic planning and policy considering the effects of climate change.

Acknowledgement

The authors wish to thank the Nile Basin Capacity Building Network for supporting the research of Yisehak Gebregziabher Bezabij.

References

- Arnold, J.G., *et al.*, 2002. Soil and water assessment tool, theoretical documentation, Grassland, soil and water research laboratory – Agricultural Research Service, Texas, US.
- Narasimhan, B. & R. Srinivasan, 2005. Agricultural and Forest Meteorology 133: 69-88.
- Tessema, R., 2007. Agricultural Drought Assessment for Upper Blue Nile Basin, Ethiopia using SWAT. MSc Thesis, UNESCO-IHE, Delft, The Netherlands.

Pre-requisites for crop models used to test strategies for adapting to, or mitigating effects of climate change

K.J. Boote, J.W. Jones, G. Hoogenboom, C. Rosenzweig
Agronomy Dept, Univ of Florida, Gainesville, FL 32611-0500, USA
Contact: kjboote@ufl.edu

Introduction

Climate change for a given region can be characterized by increased day and/or night temperature, increased carbon dioxide (CO₂), altered rainfall frequency and intensity, as well as extended growing season. Simulation models for different crops can be used as strategic tools to evaluate the consequences of climate change on production, and to evaluate shifts in crops, sowing dates, cultivars, irrigation, and fertility management practices to adapt/mitigate the effects of climate change. Genetic improvement in heat and drought tolerance can be tested in a hypothetical manner. Mitigation strategies to enhance C sequestration can be tested. There are several pre-conditions to successful use of crop models for such strategic tests. First, the crop models must be accurately parameterized as to temperature and CO₂ effects on growth and development. This is not easily accomplished, as the modelling community has not focused sufficiently on full testing and improvement of crop models relative to the latest scientific literature, and some models are too simple in their ability to fully reproduce interactions of these climate change factors. Secondly, accurate representation of the effects of rainfall variation requires two pre-conditions: good models of soil water balance and evapotranspiration as well as accurate parameterization of soils for the specific regions. Insufficiently detailed mechanisms in the model can be a limitation, particularly relative to simulated responses to CO₂, increased temperature, increased vapour pressure deficit, and their interactions. The third pre-condition, is that the crop models must have good soil temperature prediction, good prediction of emergence and early growth, as well as code to mimic frost or freeze susceptibility in the seedling phase and grain-filling phase. Models lacking frost or freeze damage are poorly suited to evaluate the concepts of varying sowing dates to escape effects of hot temperatures or drought in summer.

Methods

Example simulations are presented for climate change impact assessment and adaptation options for soybean and maize production in Iowa, Florida, and India, with and without irrigation, where variables of sowing date, cultivar, and N fertilization were modified. These three cases represent contrasting environments of continental climate with a good soil in Iowa, subtropical climate with a sandy soil in Florida, and tropical arid monsoon climate in India with a moderately good soil. These cases have either rainfall or frost hazards that limit growing seasons. The soybean, maize, and sorghum models in DSSAT V4.0 (Jones *et al.*, 2003) were used to predict growth and yield for 30 years of historic weather, compared to weather from climate change projections for those regions by 2100. Consequences of very early to very late sowing dates were illustrated, to highlight differences in the three models relative to temperature or drought termination of growth. CROPGRO-Soybean has explicitly defined Tmin values, which reduce leaf area index and/or terminate crop development, from frost damage and freeze kill, respectively (Boote *et al.*, 1998). CERES-Maize lacks actual freeze kill, but does have a reasonably robust simulation of crop maturation due to slowed grain filling (less than 10% of 'normal' for 5 consecutive days) or 'crop failure' caused by near-zero assimilate supply attributed to low temperature effects on radiation use efficiency, limited water supply, or N stress. CERES-Sorghum lacks such signalling and may simulate through freezing winter into the next year. Hypothetical genetic improvement in life cycle, daylength sensitivity, heat-stress tolerance of grain-set, and drought tolerance were evaluated.

Maize hybrids with longer life cycles or soybean maturity groups with greater photoperiod sensitivity may be needed to fully utilize longer growing season in good regions. Alternately, shorter cycle cultivars sown early may be needed to avoid rainfall deficits in mid-summer, as practiced for soybean production in some regions such as Texas, Arkansas, and Mississippi. Costs of fuel, N fertilizer, irrigation, and drying versus crop value can be evaluated to decide on optimum economic crop or biofuel choice for a given farmer, using the pricing structure in the seasonal analysis of the DSSAT software. To adequately consider crop choice, one should have models that consider the disease-pest benefits of rotation as well as the carry-over of N and water from one season to the next.

Results and discussion

For the Ames, Iowa location under current weather, early sowing (May 1) was optimum for maize and soybean yield, while yield was progressively reduced for later sowing because the crop used less of the available season. As sowing was progressively delayed from June 1 into July under current weather, the simulated maize and soybean crop yields were reduced because of shorter season and increased occurrence of freeze in fall before maturity. Full season maize and MG 3 soybean were optimum cultivar types. Sorghum simulations did not perform well at Ames, Iowa, especially if sowing was delayed.

For the Gainesville, Florida location under current weather, the optimum sowing date for maize was March 1 if irrigated, but was May 1 and later under rainfed conditions. Interestingly, late sowing in Florida has not been a common production practice because of insect damage, but that may change with new insect-resistant hybrids. For soybean, April 15 sowing date and MG 8 cultivar were optimal under rainfed and irrigated conditions.

For the Patancheru, India location under current weather, the optimum soybean maturity group was MG 8, as shorter cycle cultivars had lower yield, and longer cycle cultivars had similar high yield, but left less residual soil water. The optimum sowing date for soybean and maize at Patancheru would be as early as possible after onset of reliable monsoon. Under rainfed conditions, later sowing caused lower yield and also less residual water in the soil. Under irrigated conditions, maize yield was increased with later sowing, because growth was shifted to a cooler time of year, even under current weather. Soybean yield was increased under irrigation, but yield was reduced with later sowing because of daylength effects to shorten the life cycle.

It is important for future global climate change assessments, that crop models be improved, tested, and be well-parameterized for temperature and CO₂ effects on photosynthesis, grain-set, grain-filling rate, and grain-filling duration, especially for use under temperature conditions of future climate. The models also need to include termination of growth due to freeze kill or terminal water deficit. The different model formulations tested here, illustrate the value to consider multiple viable crop models in such assessments, rather than just one selected model per crop. Just as the various global climate models give different climate projections, different models for the same crop will also vary in their predicted crop response to a given climate scenario, thus providing information to improve crop models and understand uncertainties.

References

- Boote, K.J., *et al.*, 1998. In: Eds R.M. Peart & R.B. Curry, Agricultural Systems Modeling and Simulation. Marcel Dekker, Inc, New York, pp. 651-692.
- Jones, J.W., *et al.*, 2003. *Europ. J. of Agronomy* 18: 235-265.

A minimum-data approach to *ex-ante* assessment of climate change adaptation strategies in resource-poor countries

L. Claessens, J.J. Stoorvogel, J.M. Antle, R.O. Valdivia, M. Herrero
International Potato Center, P.O. Box 25171, 00603 Nairobi, Kenya
Contact: l.claessens@cgiar.org

Introduction

The changing climate is exacerbating existing vulnerabilities of the poorest people who depend on semi-subsistence agriculture for their survival (Slingo *et al.*, 2005; IPCC, 2007). Sub-Saharan Africa (SSA) in particular is predicted to experience considerable negative impacts of climate change (e.g., Thornton *et al.*, 2006). The IPCC Fourth Assessment emphasizes that adaptation strategies are essential and these must be developed within the broader economic development policy context (IPCC, 2007). Addressing adaptation in the context of small-scale, semi-subsistence agriculture in SSA raises special challenges that cannot be addressed adequately by the approaches taken thus far in most studies (Adger, 2003). Most of the existing research has focused on impacts of climate change and adaptation to climate change in the agricultures of industrialized countries. In the relatively few studies conducted in Africa, agricultural research has either focused on individual crops (e.g., Jones & Thornton, 2003), has used aggregated data and models (e.g., Winters *et al.*, 1998, Mendelsohn *et al.*, 2000), or used statistical analysis too general to be useful for site-specific adaptation strategies (e.g., Kurukulasuriya & Mendelsohn, 2006). One of the important constraints to carrying out this type of research is that the data demands are high, because site-specific biophysical and economic data are required, typically obtained from costly multi-year farm-level surveys. The development and application of relatively simple and reliable methods for *ex-ante* evaluation of adaptation strategies at the household and system levels are needed to provide timely assessments of the potential impacts in the context of climate change.

Methods

This paper describes and applies a new approach to *ex-ante* impact assessment that produces locally useful, site-specific results that can also be aggregated for regional policy analysis. The methodology makes use of the kinds of data that are more often available, especially in resource-poor countries. The stochastic approach uses and integrates available socio-economic and biophysical data on farmers' land use allocation, production and input and output use. Spatially heterogeneous characteristics of the agricultural system regarding resources and productivity are analysed and compared for both current climate conditions and predicted climate changes. A variety of possible adaptation strategies is then assessed for their capability to overcome or reduce the adverse effects of climate change. A static expected profit maximization model is used to characterize the opportunity cost of adaptation (Antle & Valdivia, 2006). The model represents the impact of climate change as the 'compensating variation', i.e., the loss in income that producers experience relative to the base climate scenario.

Results and discussion

We apply the methodology to the mixed crop-livestock system of Vihiga district in western Kenya. After characterizing the current agricultural system with actual climate data, the effects of a perturbed climate on biophysical and economic indicators are analysed and a variety of adaptation strategies (agricultural technologies and policies) are tested (results from earlier work in Machakos, Kenya, are given in Figure 1). Despite the limitations, the minimum-data approach offers a flexible framework for evaluating adaptation strategies using scarce data of resource-poor countries in SSA and other parts of the world. It allows a rapid

integrative analysis for timely advice to policymakers and for exploration of technology and policy options.

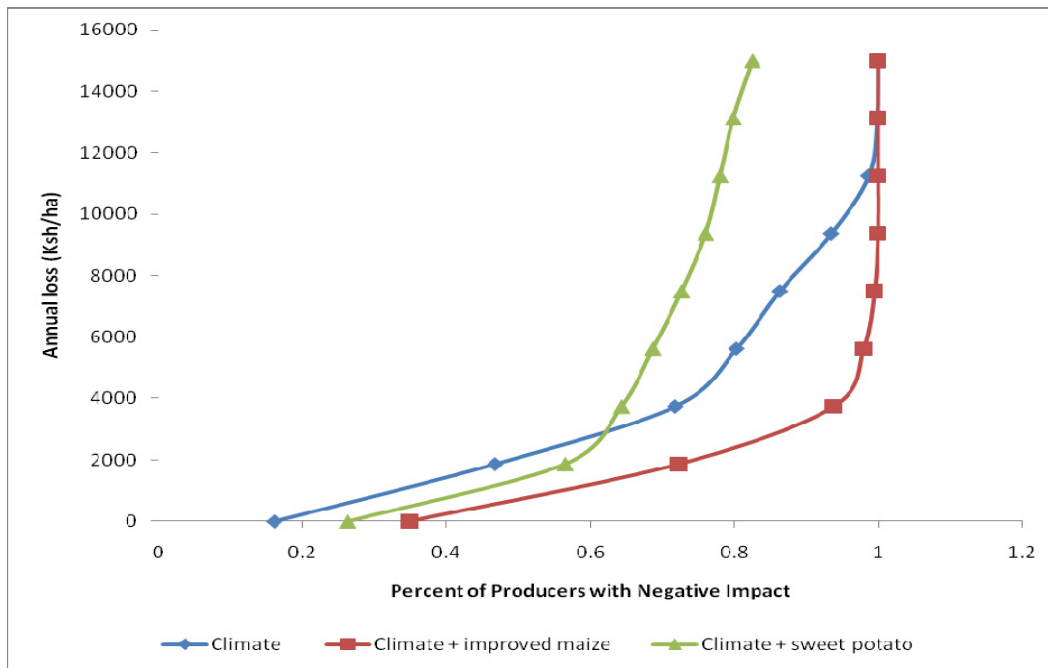

Figure 1. Impact of climate change and adaptation strategies on farmers in Machakos, Kenya.

References

- Adger, W.N., *et al.*, 2003. Progress in Development Studies 3: 179-195.
- Antle, J.M. & R.O. Valdivia, 2006. American J. of Agricultural Economics 88: 1174-1180.
- IPCC (Intergovernmental Panel on Climate Change), 2007. Climate Change 2007: Impacts, Adaptation and Vulnerability. Contribution of Working Group II to the Fourth Assessment Report of the Intergovernmental Panel on Climate Change, Cambridge University Press, Cambridge, UK.
- Slingo, J.M., *et al.*, 2005. Philosophical Transactions of the Royal Society, London, Series B 360: 1983-1989.
- Jones, P.G. & P.K. Thornton, 2003. Global Environmental Change 13: 51-59.
- Kurukulasuriya, P. & R. Mendelsohn, 2006. Crop Selection: Adapting Climate Change in Africa. CEEPA Publication 26. <http://www.ceepa.co.za/docs/CDPNo26.pdf>
- Mendelsohn, R., *et al.*, 2000. Climatic Change 45: 553-569.
- Thornton, P.K., *et al.*, 2006. Mapping climate vulnerability and poverty in Africa. ILRI, Nairobi, Kenya, May 2006, 200 pp.
- Winters, P., *et al.*, 1998. Environmental and Resource Economics 12, 1-24.

Sensitivity of southern African maize yields to the definition of onset under conditions of climate change

O. Crespo, S. Hachigonta, M. Tadross
Climate Systems Analysis Group, EnGeo Department, University of Cape Town,
Private Bag X3, Rondebosch 7701, Cape Town, South Africa
Contact: olivier.crespo@csag.uct.ac.za

Introduction

Climate change has led national and international decision makers to look for adaptation guidelines and decision tools regarding its potential impacts. The likely impacts can be simulated using climate sensitive models, which simulate the system of interest, subject to future hypothetical climate conditions. With respect to agricultural impacts previous work has simulated the variability of yield and soil organic nitrogen levels over three South African climate regions (Walker & Schulze, 2008), whilst Lobell *et al.* (2008) studied crop adaptation over southern Africa using multiple General Circulation Models (GCMs). Here we present a simulation-based method (using the FAO agrometshell crop model) aimed at analysing the sensitivity of yield (as represented by the Water Satisfaction Index - WSI) to the definition of climate-related adaptation options (i.e. rainfall onset) under statistically downscaled control and future climate scenarios.

Ultimately the work will be expanded to include a variety of crop models and simulate the sensitivity to other management options such as application of irrigation and fertilizer, as well as including additional uncertainty attributable to the parameterization of crop growth within the models. The objective of the work is to highlight which adaptation options are likely to generate the most effective changes in yield given the current climate and uncertainty in the projections of future climate conditions in each region.

Materials and methods

The preliminary stage of this study uses the Agrometshell crop model, developed by the Food and Agriculture Organisation's, Environment and Natural Resources Service (Agrometshell, 2004). The model is based on crop-specific water balances and simulates the behaviour of crops over southern Africa, forced by statistically downscaled climate data from 6+ General Circulation Models (GCMs)

The initial step is to run the crop model 1000 times for each year, varying the onset definition (due to the assumed total rainfall needed before and after planting) in each case. The sensitivity part of the method is based on the Fourier amplitude sensitivity test as introduced by Saltelli *et al.* (1999). This allows us to understand how the amount of rainfall before and after planting, contributes to the WSI (yield) variance. The sensitivity of yield (to definition of onset) under present climate conditions highlights regions where adaptation decisions about changing sowing dates and definitions significantly alter yields. By repeating this using the long-term future (2050s) scenarios of climate change, we can evaluate if these adaptation decisions/options are robust given change in future climate.

Results and discussion

Figure 1 shows the change in Maize WSI when applying the statistically downscaled climate scenario (GFDL model) to the Agrometshell crop model, as an example of the information that is generated. Maize WSI calculations for each individual year are based on a matrix of 1000 simulations defining the start on the growing season. A total of 20 years is used for control (1979–1999) and future (2046–2065) scenarios.

The model outputs show crop reduction (approx. -9%) for maize in southern parts of Zimbabwe and some slight changes (approx. +5%) are observed over region around Lesotho

(Figure 1a). Maize WSI is projected to increase in most parts of Zambia, parts of east South Africa and northern Mozambique. Figure 1b shows the change in the contribution of rainfall before planting to the final WSI between the current and future climate as simulated by the GFDL model. The model shows a significant increase in the sensitivity to pre-planting rainfall around Lesotho (approx. +20%) and a significant decrease in sensitivity over Malawi (about -15%). Although the projected changes in sensitivity to onset definition and total WSI differs between models, similar changes emerge over some regions, e.g., central Zimbabwe.

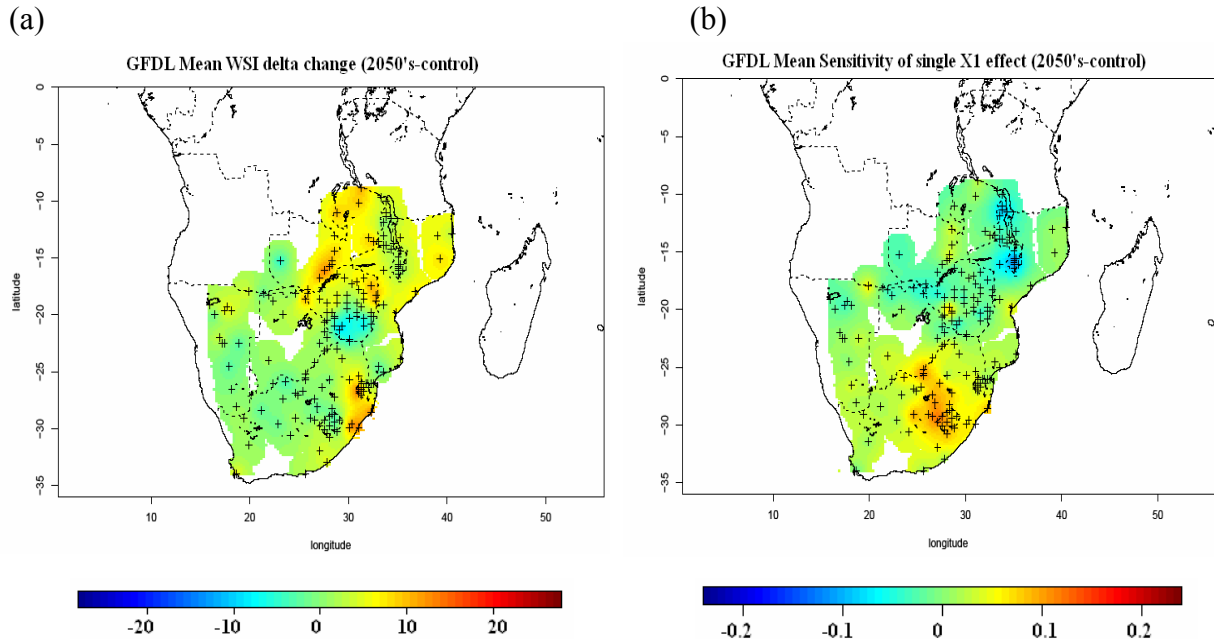

Figure 1. (a) Change in mean WSI over the region, and (b) % change in mean X1 (rainfall in first 10 days after planting date) sensitivity.

References

- Agrometshell, 2004. Food and Agriculture Organisation of the United Nations, Environment and Natural Resources Service.
- Lobell, D.B., *et al.*, 2008. *Science* 319: 607-610.
- Saltelli, A., *et al.*, 1999. *Technometrics* 41: 39-56.
- Walker, N.J. & R.E. Schulze, 2008. *Agriculture, Ecosystems & Environment* 124: 114-124.

Assessment of nitrogen and green house gas fluxes at the European scale in response to land use and livestock change

W. De Vries, J. Kros, G.J. Reinds, H.J.J. Wieggers, G.L. Velthof, D.A. Oudendag, G.J. Nabuurs, M.J. Schelhaas, M. Pérez-Soba, W.P. De Winter, J. Van den Akker, M.M. Bakker, P.H. Verburg, J. Liski, B. Eickhout, A.F. Bouwman
Alterra, Wageningen University and Research Centre,
P.O. Box 47, 6700 AA Wageningen, The Netherlands
Contact: wim.devries@wur.nl

Introduction

Studies on responses of N and GHG emissions in Europe to global change strongly focused on the impacts of climate change and land use change on carbon exchange (e.g., Smith *et al.*, 2005). Moreover, considerable attention has been given to the combined impact of climate change and forest management on the European (forest sector) carbon budget (e.g., Nabuurs *et al.*, 2002). A study on the combined impacts of land use change, agricultural change (management) and forest management on all major N and GHG fluxes (NH₃, NO, N₂O, CO₂ and CH₄ emissions and N leaching and runoff) at the European scale is still missing. This paper describes such a study, using an integrated model called INTEGRATOR (De Vries *et al.*, 2008), based on a detailed schematization to assess N and GHG emissions from both agricultural and natural terrestrial ecosystems, including grassland, arable land, forests, heathlands and peat lands. The INTEGRATOR model is presented and its predictions of past, present and future N and GHG fluxes in response to (i) reconstructions of land use and land management changes in the period 1970–2000 and (ii) projections for the period 2000–2030 under the IPCC A1 and B2 scenario.

Methods

INTEGRATOR links various modules, calculating N and GHG emissions from industrial sources, housing and manure storage systems, agricultural and non-agricultural soils and surface waters, while accounting for the interaction between different sources through an emission-deposition model for NH₃ and NO_x. To assess the impact of scenarios and policies (e.g., measures related to various EU directives) on future N and GHG emissions, INTEGRATOR is coupled with models that predict changes in land cover and agricultural management and climate in response to such scenarios and policies. The INTEGRATOR concept is based on an appropriate balance between model complexity and data availability by: (i) using relatively simple and transparent model formulations based on the use and adaptation of available simple model approaches, (ii) including empirical model approaches, using statistical relations between model outputs and environmental variables, and (iii) focusing on the derivation of high resolution spatially explicit input data. INTEGRATOR includes sub models, to predict:

- NH₃, NO_x, N₂O and CH₄ emissions from housing and manure storage systems and agricultural soils (the adapted MITERRA-Europe model, Velthof *et al.*, 2008);
- NO_x, N₂O and CH₄ emissions from non-agricultural terrestrial systems (empirical relationships);
- CO₂ emissions from agricultural and non-agricultural terrestrial systems (the YASSO soil model, Liski *et al.*, 2005), in combination with (i) EFISCEN (Nabuurs *et al.*, 2002) for forest, (ii) MITERRA-Europe for agriculture, and (iii) empirical relationships for peatlands;
- N₂O emissions from ground water and surface waters;
- N deposition (an emission-deposition matrix for NH₃ and NO_x, accounting for the interaction between agricultural and non-agricultural soils.

To derive a complete N and GHG budget, background emissions and energy emissions are also included in INTEGRATOR, based on literature data and IMAGE model calculations.

Results and discussion

At the conference results will be given of temporal changes in NH₃, NO_x, N₂O, CH₄ and CO₂ emissions for the period 1970–2030 in response to (i) reconstructions of land use and land management changes in the period 1970 and (ii) projections for the period 2000–2030 under the IPCC A1 and B2 scenario. As an example, we present the NH₃ and N₂O emissions from agricultural systems for the year 2000 as calculated with INTEGRATOR (using the adapted MITERRA sub-model) for the year 2000 and standard approaches such as the IPCC reports by the various countries and emission factor models, in view of N emissions, such as EDGAR, GAINS and IMAGE (Figure 1). Results of total emissions appear to be quite comparable for NH₃ but for N₂O there is considerable more scatter.

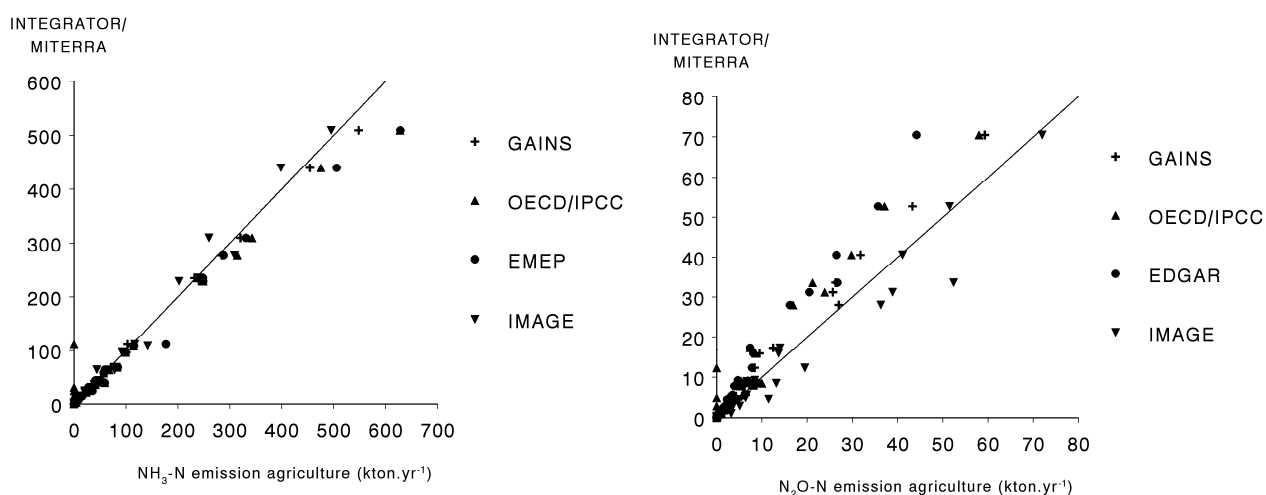

Figure 1. A comparison of country emissions for NH₃, N₂O and NO_x within EU 27 as derived with INTEGRATOR/MITERRA, compared to OECD/IPCC, EDGAR, GAINS and IMAGE for the year 2000.

References

- De Vries, W., *et al.*, 2008. INTEGRATOR: A modelling tool for European-wide scenario assessments of nitrogen budgets and greenhouse gas emissions. Calculation procedures and application methodology of a prototype. Alterra Report, Wageningen.
- Liski, J., *et al.*, 2005. *Ecol. Model.* 189(1-2): 168-182.
- Nabuurs, G.J., *et al.*, 2002. *Change Biol.* 8: 304-316.
- Smith, J.U., *et al.*, 2005. *Glob. Change Biol.* 11(12): 2141-2152.
- Velthof, G.L., *et al.*, 2008. Integrated assessment of nitrogen emissions from agriculture in EU-27 using MITERRA-EUROPE. *Environ. Pollut.* (in press)

SimKat: A virtual laboratory to explore the impact of climate change scenarios on the Western Australian wheat-belt

A. Dray, S. Asseng, P. Perez, S.P. Charles, B. Bates
RMAP/RSPAS, Coombs Building, Australian National University,
Canberra ACT 0200, Australia
Contact: anne.dray@anu.edu.au

Introduction

The impact of climate change on an entire agricultural region is often not clear (IPCC Report, 2007) due to the complex interactions between individual farmers' behaviour with the biophysical landscape, the large range of multiple external and internal factors and the further complication of continuous changes to climate variables in time and space. As a striking example, the wheat-belt of Western Australia is one of the most vulnerable regions to climate change in Australia. Rainfall has already declined by more than 15% in the last decades and it is projected to further decline. Farm numbers are plummeting and the natural resource base is threatened by various soil degradation processes including salinity. The agricultural future of the region is highly unpredictable due to the complex and adaptive nature of human-landscape interactions. Nevertheless, policymakers relentlessly ask experts for such predictions to assist in anticipating upcoming issues and to take immediate decisions to influence future socio-economic and environmental settings of the region for the better. It is fair to recognize that, to date, scientific research has provided answers to their questions that are only partly adequate and the best available biophysical science is insufficient. It is now of critical importance to understand the long-term consequences of climate change on these already threatened social-ecological systems and to anticipate ways for local farmers to adapt.

Methods

This paper builds on a simulation model prototype that focussed on salinity changes in the wheat-belt region of Western Australia (Asseng *et al.*, 2008). The model used an agent-based modelling framework and was developed with the CORMAS platform (Bousquet *et al.*, 1998). It combined simplified biophysical processes of paddock cover with an extension to include CO₂ impact, dry-land salinity changes and rainfall. Simulated farmers (agents) in the model made individual land use decisions based on the performance of their past land cover productivity and market returns. In addition, farmers in the model could display various attitudes towards market signals and salinity mitigation.

In this extended version, we use the model as an exploratory tool to focus on likely climate change scenarios and their impact on the viability of an agricultural region. We explored the impact of the worst case scenario for CO₂ atmospheric concentration trend given by the IPCC Report 2007: the A1F1 storyline which corresponds to very rapid economic growth and reliance on fossil intensive energy as currently the most likely scenario (Raupach *et al.*, 2007). Additionally, we overlap climate change trend impacting upon maximum yield grain with technological trends influencing farmers' ability to crop (Ewert *et al.*, 2005). As input data for rainfall, we use 50 generated rainfall series covering the 2001–2050 period. These were generated stochastically using a downscaling technique that relates changes in atmospheric predictors from a GCM (in this case the CSIRO Mk3 GCM) to multi-site daily rainfall (Charles *et al.*, 1999). The stochastic nature of the generated series accounts for the variability in the timing of daily rainfall sequences resulting from natural climate variability and long-term climate change.

Results and discussion

Simulated scenarios will be discussed related to the impact of rainfall variability, drought sequences and atmospheric CO₂ increase on individual and regional farm viability (farm survival and size) and environmental sustainability (i.e. salinity extension). The scenarios will provide means to closely analyse the resilience of a region to potential impacts of climate uncertainty (based on ensemble data) and prolonged period of extreme dry periods on an agricultural region. The model does not aim at predicting but rather delineating the range of possible outcomes resulting from coupling climate change rainfall scenarios with likely CO₂ and technology trends.

We aim to expand the potentialities of this model into an interactive modelling tool of climate change consequences at a much deeper level to inform future agricultural policies. An iterative and participatory process with policymakers and relevant stakeholders will allow for discussion on available sustainable land use options or conditions of social and economic resilience of farming communities. This approach is seen as a first step towards participative citizenship mediated by computer-assisted tools in order to build mutual understanding, trust and respect amongst stakeholders and to secure effective decisions at different levels of implementation. In the context of the Western Australian wheat-belt, this approach might be the only way to anticipate the potential success or failure of policy interventions in relation to climate change impact and adaptation and therefore contribute to safeguarding the social, ecological and economic fabric of the region.

References

- Asseng, S., *et al.*, 2008. Human-landscape interactions in a salinity-prone agricultural region of the Western Australian Wheat-Belt. Submitted to Ecological Modelling.
- Bousquet, F., *et al.*, 1998. Lecture Notes in Artificial Intelligence 1416: 826-837.
- Charles, S.P., *et al.*, 1999. Journal of Geophysical Research – Atmospheres 104(D24): 31657-31669.
- Ewert, F., *et al.*, 2005. Agriculture, Ecosystems and Environment 107: 101-116.
- IPCC Report, 2007. In: Eds B. Metz *et al.*, Climate Change, Cambridge Press, UK and New York, USA.
- Raupach, M.R., *et al.*, 2007. PNAS 104(24): 10288-10293.

GHG mitigation through bio-energy production *versus* avoided deforestation and afforestation: A quantitative analysis

P. Havlik, U.A. Schneider, E. Schmid, H. Böttcher, G. Kindermann,
S. Leduc, M. Obersteiner
IIASA, Forestry Program, Schlossplatz 1, 2361 Laxenburg, Austria
Contact: havlik.petr@gmail.com

Introduction

By first principles, land is a fixed production factor where a change in the extent of one land use type will impact on other land uses. Concerns about the environmental effects of direct and indirect land use changes due to bio-energy production have been recently expressed, e.g., by Petersen (2008). These effects do not concern only biodiversity conservation, water quality, and other natural resources, but might negatively influence also the total greenhouse gas (GHG) balance of biofuels deployment (Searchinger *et al.*, 2008). Already Righelato & Spracklen (2007) argued that where competition between biofuels and forests arises, afforestation and forest restoration (A/R) may be more efficient mitigation strategy than biofuel production. Marland *et al.* (2007) commented then that this result is not general and will depend among others on the specific site. In this paper, we present recent developments and refined results of GLOBIOM – a global partial equilibrium model integrating the agricultural, bio-energy and forestry sectors (Havlik *et al.*, 2008). The main aim is to study the land use implications and resulting GHG effects of the deployment of different bio-energy production technologies. Next we analyse the relative cost efficiency of bio-energy production and A/R under various economic and policy scenarios.

Methods

The applied model contains detailed description of both the agricultural and forestry sectors. Within the agricultural sector all the major crops and the pertinent management alternatives in terms of fertilization and irrigation are represented. The livestock sector covers explicitly the main animal categories and the pertinent production systems. Also within the forestry sector, choice between several management strategies differentiated mainly by the rotation period is available for each site. Both crop yields and mean annual forest harvests are estimated for the different management strategies by means of biophysical models, like EPIC, which are applied geographically explicit on sub-national level (homogeneous response units, HRU). Finally, three bio-energy production pathways are taken into account in the model: (1) biofuels based on conventional feedstocks (sugar cane, maize, soybeans and rapeseed), sometimes referred to as biofuels of the first generation (ethanol and biodiesel); (2) biofuels based on woody feedstock, representing the second generation technologies assuming gasification technologies; and (3) heat and power generated by direct combustion of woody biomass. Optimization occurs in the model through maximization of the market surplus under technological and resource constraints. Prices and international trade flows are endogenously computed for 27 world regions.

Results and discussion

Current results show that there is strong competition between traditional forests and biofuel production. In 2030 scenarios of no avoided deforestation policies and 10 percents fossil fuel substitution by ethanol, some additional 100 million hectares of forest would disappear due to agricultural land expansion. A similar area of traditional forests would be converted to short rotation forest plantations if second generation technologies were deployed. Yet, second generation appears to be preferable with respect to the total greenhouse gas balance, and food security in least developed countries, Figure 1. Under avoided deforestation scenarios we find

that a carbon tax of 15 USD per ton of CO₂ would be necessary to prevent deforestation induced by biofuel expansion. Work is ongoing on the analysis of direct heat and power production, and on chains using biomass from forest residues rather than forest plantations.

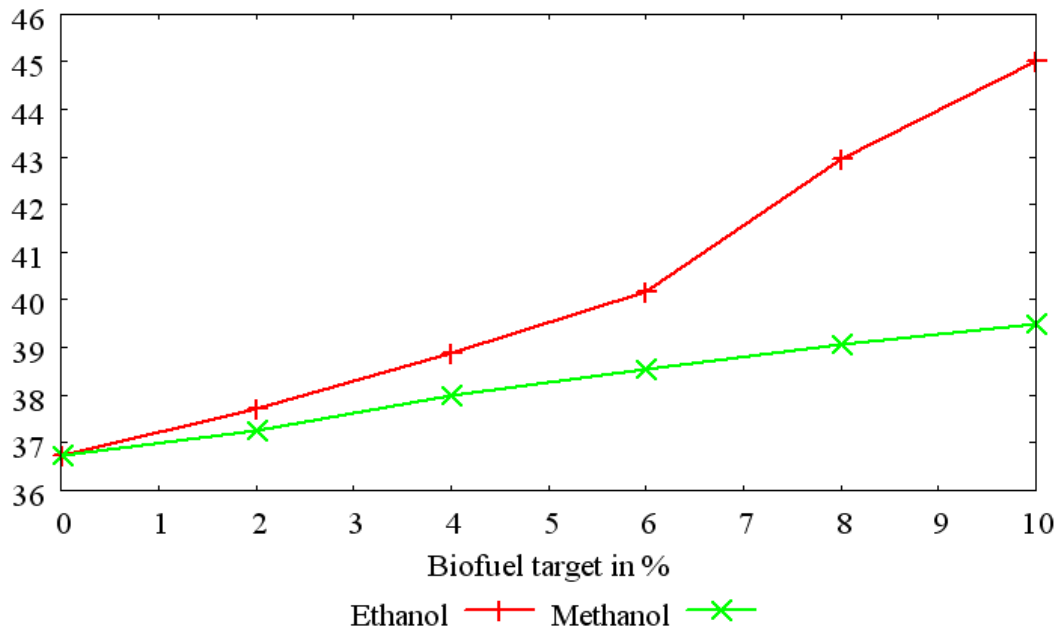

Figure 1. Prevalence of malnutrition in Sub-Saharan Africa [%], in relation to the global biofuel target by 2030 depending on the transformation pathway.

References

- Havlik, P., *et al.*, 2008. Avoided deforestation and biofuel production: A global analysis. Yale Student Chapter of ISTF 2008 Conference, March 27-29, 2008, New Haven, USA.
- Marland, G., *et al.*, 2007. *Science* 318: 1066-1068.
- Petersen, J.E., 2008. *European Review of Agricultural Economics* 35: 385-408.
- Righelato, R. & D.V. Spracklen, 2007. *Science* 317: 902.
- Searchinger, T., *et al.*, 2008. *Science* 319: 1238-1240.

Impact assessment of climate change on agriculture: Econometric-process analysis under partial equilibrium

Iddo Kan, Ayal Kimhi, Kyrill Shraberman
Department of Agricultural Economics and Management,
The Hebrew University of Jerusalem, P.O.B. 12, Rehovot 76100, Israel
Contact: kan@agri.huji.ac.il

Introduction and methods

The objective of integrated assessment studies of climate-change impacts is to simulate behaviors of natural-economic systems outside the range of observed behaviors. Due to the large set of factors influencing agricultural production, the challenge of predicting farmers' adaptation to climate changes attracted many researchers and stimulated the development of various methodological approaches. A class of studies relies on mathematical programming models, in which production technologies are represented explicitly (e.g., Howitt *et al.*, 2003; Kan *et al.*, 2007). This approach was criticized since technological parameters are generally derived from experimental-based data rather than from representative samples of the farming population. An alternative methodology, known as the *Ricardian* approach (Mendelsohn *et al.*, 1994), applies econometric techniques to real-world farming data in order to estimate reduced-form equations, which explain spatial-temporal variations in agricultural returns by differences in economic and environmental variables. A major drawback of this technique is attributed to the inability to link the outcomes to general- or partial-equilibrium models, because production is not explicitly represented by the estimated return functions. Consequently, prices must be considered exogenous throughout simulations of climate-change scenarios (Cline, 1996). Antle & Capalbo (2001) developed the *econometric-process* modelling approach, in which econometrically estimated agricultural production models are integrated with biophysical and economic equilibria models. We adopt this approach for assessing climate-change impacts on agriculture under partial equilibrium in the vegetative agricultural outputs markets. The following procedure is applied: first, village-level data are used for estimating equations explaining crop acreages by climate factors and output prices; then, a production model translates these land-use equations into production units and aggregates across villages to obtain regional or nationwide agricultural-products supply functions; finally, the resultant supply functions are incorporated into a partial-equilibrium model to be used for applying the impact assessment with respect to climate changes. The study compares between climate-change impacts assessed under the constant-prices assumption versus the case of endogenous partial-equilibrium prices.

The study contributes to the integrated assessment methodology by developing an innovative estimation procedure which takes into account the presence of corner solutions. While in aggregated regional-scale data all crops are likely to be grown in all regions, farm or village level data may exhibit a wide range of cropping portfolios. This phenomena matters since the impact of explanatory variables on the land allocation among crops may depend on the chosen set of crops. We develop an estimation procedure based on a sample selection model where selection is specified as a multinomial logit model. Specifically, we modify the method developed by Bourguignon *et al.* (2007).

Application

The analysis is applied to the case of Israel, utilizing both the sharp spatial climate gradient throughout the country and the fact that the Israeli farming sector is technologically advanced; hence, representing modern adaptation to various climate conditions. Furthermore, the isolation of the Israeli vegetative agricultural markets, mainly due to high import taxes, supports the assessment under partial equilibria. A panel data of 746 villages (about 85% of

all in Israel) over the years 1992–2002 is used for estimating acreage functions of four groups of crops, which are treated as composite goods: deciduous, other plantations, field-crops and vegetables. Acreage shares are translated into production quantities using state-wide production data, and composite-good demand functions are derived using demand elasticities estimated by Hadas (2001) for the main Israeli vegetative agricultural products. Climate change forecasts for 2041–2050 are from Alpert *et al.* (2008) for the A1B IPCC-2001 scenario. These forecasts predict a 10% reduction in annual precipitation, increases in winter temperatures and in the frequency of extreme temperatures during the summer.

Results and discussion

The following table compares between the impact of climate change on the producer surplus of the Israeli vegetative agricultural sector, assessed by the aforementioned *Econometric-Process* model for the cases of partial equilibrium (endogenous prices) and constant-prices. Also presented is an evaluation obtained from a *Ricardian* analysis based on the same data set. Values are in million dollars per year in terms of 2002 dollars.

Base Period (1992-2001)	Future Period (2041-2050)		
	<i>Econometric-Process Model</i>		<i>Ricardian Model</i>
	Partial Equilibrium	Constant Prices	
260	220	107	425

Considering prices endogenously in the *Econometric-Process* model lessens the forecasted impacts on farmers' surpluses from a reduction of 59% to only 15%. The *Ricardian* model, on the other hand, predicts an increase in farming incomes of 64%. These differences reveal the sensitivity of the evaluated impacts on the agricultural sector to the assessment methodology, which in turn casts on the recommendations for governmental intervention.

We claim that the estimates derived by the partial equilibrium econometric-process analysis are preferential due to the relative comprehensiveness of the model. Computable consumer surpluses are increased by \$0.94 millions per year; hence, the overall effect on consumers' and producers' surpluses amounts to a reduction of \$41 millions per year. The model indicates that the reduction in precipitation constitutes the most significant climate-change effect, to which farmers react by reducing the land share of field crops – the mostly rain-fed based crops. If the government will cut water quotas for irrigation by 20% in order to secure water for the urban sector, farmers would react by replacing some vegetable lands with plantations, resulting in price changes that ultimately increase farmers' and consumers' surpluses by \$7 millions relative to the un-intervention scenario. On the other hand, if the government would keep irrigation quotas by desalination, while increasing water prices correspondingly such that the overall production costs will rise by 10%, farmers will increase field-crops areas, leading to a reduction of \$154 millions in farmers' plus consumers' surplus.

References

- Alpert, P., *et al.*, 2008. *Global and Planetary Change* 63: 163-170.
- Antle, J.M. & S.M. Capalbo, 2001. *Amer. J. Agr. Econ.* 83(2): 389-401.
- Bourguignon, F., *et al.*, 2007. *Journal of Economic Surveys* 21: 174-205.
- Cline, W.R., 1996. *American Economic Review* 86: 1309-1311.
- Hadas, E., 2001. *Economic Aspects of Agricultural Trade Among Israel, Gaza and the West-Bank*. PhD thesis, The Hebrew University of Jerusalem. (in Hebrew)
- Howitt, R., *et al.*, 2003. *Impacts of Global Climate Change on California's Agricultural Water Demand*. Department of Agricultural and Resource Economics, UC, Davis, California.
- Kan, I., *et al.*, 2007. *Assessing Climate Change Impacts on Water, Land-Use and Economic Return in Agriculture*. Available at SSRN: <http://ssrn.com/abstract=1020562>
- Mendelsohn, R., *et al.*, 1994. *American Economic Review* 84: 753-771.

Counter measures of agricultural sector for post-Kyoto Protocol

Chang-Gil Kim

Korea Rural Economic Institute

4-102 Hoegidong Dongdaemoonku, Seoul 130-710, Korea

Contact: changgil@krei.re.kr

Introduction

The comprehensive consideration of the internal and external changes in conditions pertaining to the post-Kyoto Protocol scheme indicates that Korea is highly likely to be mandated to reduce greenhouse gas emission from the second commitment period (2013–2017). This paper is to analyse the impact of the post-Kyoto Protocol implementation on the agricultural sector and to propose systematic countermeasures in preparation for the implementation of the Protocol. The analytical results show that the participation of the agricultural sector in the emission trading program is found to increase earnings and boost national economy. With regard to future implementation of the Kyoto Protocol, the agricultural sector can take it as a good opportunity because its greenhouse gas emission tends to decrease and it may contribute to emission reduction by providing greenhouse gas sinks. On the other hand, when mandatory greenhouse gas reduction is imposed resulting in the enforcement of relevant policies such as emission trading scheme, carbon tax and regulations on energy use, it would have significant impacts on the cost of agricultural products, the distribution of agricultural resources and the farming household income. Therefore, it is necessary to develop appropriate measures to comply with the post-Kyoto Protocol.

Methods

In order to measure the impacts of 3 emission reduction scenarios on the agricultural sector when the reduction commitment level at 2013 is set to 5% below 2000 emission levels, dynamic CGE (computable general equilibrium) model, a general equilibrium approach was used. Three types of emission reduction scenarios to comply with the UNFCCC were analysed: Scenario 1 that implemented emission reduction objective individually; Scenario 2 in which all industrial sectors participated in emission trading system (ETS); and Scenario 3 in which only non-agricultural sectors participated in ETS. In addition, greenhouse gas reduction potential (reduction capacity) is calculated by subtracting annual emissions when the reduction measures are not taken from those when the measures are taken. When there are emission reduction measures in force and more powerful measures can be put into force additionally, more emission is reduced and reduction potential increases more.

Results and discussion

Comparing economic effects of emission reduction by each scenario, the economic effects of emission trading system (Scenario 2) over individual implementation (Scenario 1) appeared to be USD 74.3 million in the arable sector, USD 550 million in the livestock sector and USD 7.7 million in the agriculture-related industry, totaling USD 632 million in the entire agricultural sector. Also, economic effects in the non-agricultural industries amounted to USD 41,724 million in the manufacturing and service industry, USD 2,802 million in the fossil fuel industry, totaling USD 45,144 million. So, it was estimated that if all industrial sectors including the agricultural sector participated in ETS, an additional economic effect of USD 4,746 million would be generated

Emission reduction capacity of greenhouse gas reduction measures in the arable and the livestock sectors in 2020 appeared to be $3,675 \times 10^3$ t CO₂, about 25.3% of total emissions in the agricultural sector. It was expected that emissions after greenhouse gas reduction would be $10,828 \times 10^3$ t CO₂ in 2020, which would be about 31% less than 2000 level ($15,693 \times 10^3$ t

CO₂). When 5% below baseline (2000) is decided as allowable emission level in 2013 under the Kyoto Protocol, surplus emissions would exceed by 44×10^3 t CO₂ the emission cap when greenhouse gas reduction measures are not in force in 2013, and thus reduction objective would be imposed. However, it is estimated that if greenhouse gas reduction measures continue to be in force, surplus emissions of about 875×10^3 t CO₂ would be generated in 2020. Though surplus emission before reduction in 2020 was 406×10^3 t CO₂, it increased 10 times to $4,081 \times 10^3$ t CO₂ when reduction measures were taken. Therefore, if emission trading system is put in force among domestic industries, it would be serve as an important opportunity for the agricultural sector.

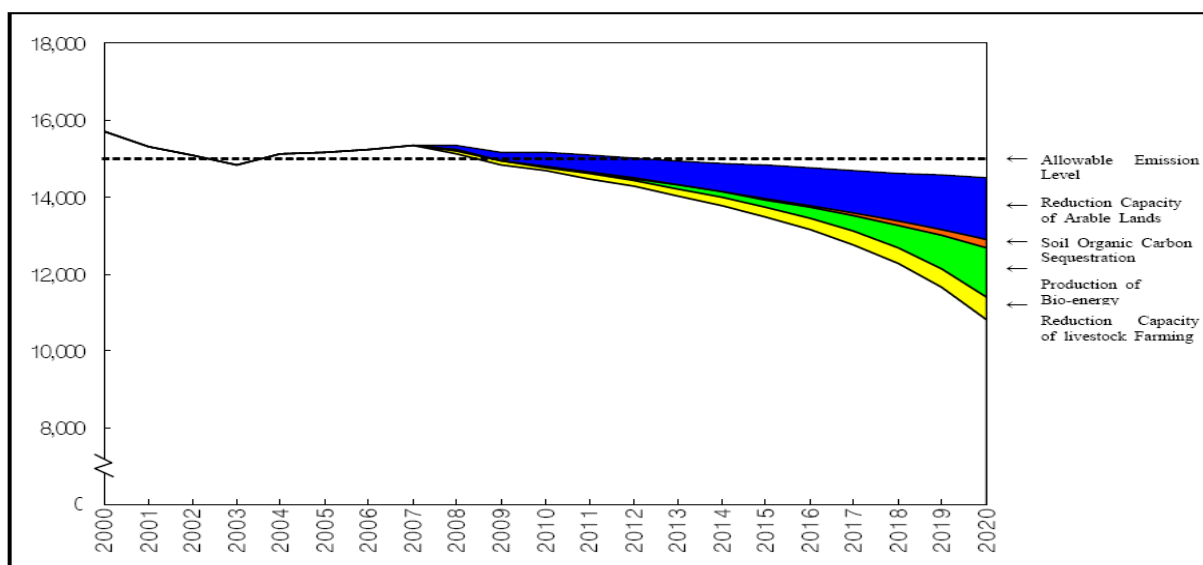

Figure 1. Estimation of reduction potential in agricultural sector. Unit: 10^3 t CO₂

As for basic policies for establishing measures to comply with the Kyoto Protocol in the agricultural sector, it is suggested in this paper that the government should take this opportunity for establishing a sustainable agricultural system, combining and consolidating agricultural policies and greenhouse gas policies, positively and actively coping with the domestic and international negotiations, scientifically analysing the amounts of greenhouse gas emission and capture, and adapting to global warming. The implementation strategy for the agricultural sector will be approached in three stages with 2030 as the target year: foundation establishment stage (2008–2012), take-off stage (2013–2018) and settlement stage (2019–2030). A stage-by-stage road map would be presented to establish an environment-friendly low-carbon agricultural production system through programme implementation in each sector of greenhouse gas reduction, capture and adaptation.

References

- Beach, R.H., *et al.*, 2006. Mitigation Potential and Cost for Global Agricultural Greenhouse Gas Emissions. Contributed Paper at the IAAE Conference.
- Kim, Chang-Gil, *et al.*, 2006. Impacts of the UNFCCC on Agricultural Sector. Research Report R520. Korea Rural Economic Institute.
- Kim, Chang-Gil, *et al.*, 2007. Korean Journal of Agricultural Economics 48(2): 1-30.
- Schneider, U. & B.A. McCarl, 2002. The Potential of U.S. Agriculture and Forestry to Mitigate GHG Emissions: An Agricultural Sector Analysis. CARD Working Paper 02-WP 300, Iowa State University, USA.

Analysis of land use combination to minimize global warming potential from farmland and farmland surplus Nitrogen and to maximize income using eco-balance analysis

S.D. Kimura, Y. Toma, Z. Mu, R. Hatano
Graduate School of Agriculture, Tokyo University of Agriculture and
Technology 3-5-8 Saiwaicho Fuchu, Tokyo, 183-8509 Japan
Contact: skimura@cc.tuat.ac.jp

Introduction

To meet the needs of growing population in the 21st century, we need to create a sustainable nutrient management system that finds a balance between food/feed production and environmental loads. To provide a criteria for choosing the most environmental friendly management methods to farmers and policy makers, the relation of productivity and environmental load must be analysed comprehensive and quantitatively. A challenge is to reflect the regional specific condition of soil, climate and land use methods to the criteria. In this study, monitoring results of green house gas emissions (GHG) from different land uses conducted in a watershed scale were parameterized to calculate the GHG emission at a watershed scale. Management methods and productivity were obtained by farmer's inquiry and the result was analysed using a method defined as 'eco-balance' analysis (Kimura *et al.*, 2007). The objective of this study was to quantify GHG emission from different agricultural land uses and to quantify the total global warming potential (GWP) and nitrogen (N) flow at a watershed scale. The quantified results were used to analyse the land use combination which maximize the productivity and minimize the GWP and farmland surplus N.

Methods

The study was conducted at the Ikushunbetsu River watershed in central Hokkaido. Greenhouse gas fluxes were measured at 21 fields (9 land use types, totally 47 year × place) using closed chamber method from 2002 to 2007. Carbon dioxide (CO₂) flux from soil organic carbon (C) decomposition was measured on bare soil, nitrous oxide (N₂O) and methane (CH₄) fluxes were measured on planted soils. Annual cumulative flux of each gas was parameterized using soil, climate and management parameters. The GHGs were converted into GWP (IPCC, 2001). Carbon (C) sequestration (kg C ha⁻¹ yr⁻¹) was calculated as below:

$$\text{C sequestration} = \text{net primary production} + \text{C in manure} - \text{soil organic C decomposition} - \text{C in harvested products}$$

Nitrous oxide flux (kg N ha⁻¹ yr⁻¹) of an upland field was estimated using emission factors (EF: proportion of N₂O emission to applied nitrogen) on the basis of the following assumption (Toma *et al.*, 2008):

$$\text{N}_2\text{O flux} = \text{EF}_{\text{chemical fertilizer}} \times \text{applied chemical fertilizer} + \text{EF}_{\text{organic matter}} \times \text{applied organic matter} + \text{background N}_2\text{O emission}$$

The CH₄, CO₂ and N₂O flux for a paddy rice field showed a high correlation with the applied amount of straw and were expressed as a function of amount of straw residues (Naser *et al.*, 2007). Farmland surplus N (kg N ha⁻¹ yr⁻¹) was calculated based on the following equation:

$$\text{Farmland surplus N} = \text{N input to farmland} - \text{N exported from farmland in products} - \text{denitrification} - \text{NH}_3 \text{ volatilization from chemical fertilizer and manure} - \text{N}_2\text{O emission}$$

Farmer's inquiry and ground survey analysis were conducted in 2002, 2005 and 2007 to obtain the management practices and land use distribution in the study area. Amount of yield was multiplied by the ratio of main product to by product to calculate the net primary production. All inputs were converted into C and N units. Values not obtained from our monitoring were obtained from literature (see for more detail Kimura *et al.*, 2007). Productivity was evaluated by the price of sold product per area for each year.

Results and discussion

The average annual income per ha ranged from 250,000 to 1,060,000 Yen for 2002, 330,000 to 1,330,000 Yen for 2005 and 360,000 to 1,170,000 for 2007. Due to different amount of yield and cost per kg yield, the land use with the highest income was different among the years. On the other hand, land uses with low or high GWP and farmland surplus N were always the same under the present management method. The income was compared to the GWP and farmland surplus N for each land use and the present situation in 2002 (Figure 1). Changing the land use proportion in the watershed, the average value can move only inside line connecting the situation where one land use is 100%. The area marked with the slashed lines can reduce the GWP and farmland surplus N lower than the present situation while maintaining the income by changing the land use combinations. The land use combinations were analysed by changing the land uses combinations from 0 to 100% in 10% interval. The average GWP and surplus N reduced to 39–87% and 75–82%, respectively, for the 3 years. The average income for all the possible combination increased by 20%, 24% and 14% for 2002, 2005 and 2007, respectively. All major land uses can be conducted in the present management methods. In case a land use with high environmental impact is desired, land uses with low environmental impact must be combined.

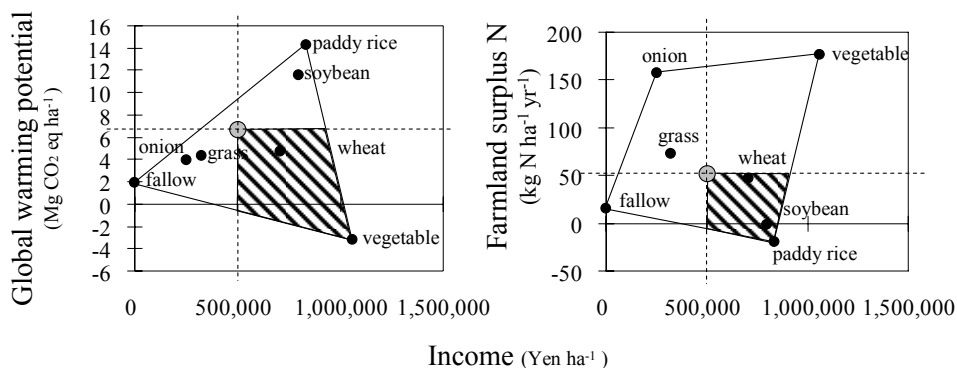

Figure 1. Relation of global warming potential (GWP) and farmland surplus N in relation to income. The gray big circle represents the watershed average in 2002, the black small circles relation if only one land use occupies 100% of the watershed. The dotted lines indicate the value of income, GWP and farmland surplus in 2002, the area with the slashed lines the possible area where GWP and farmland surplus N can be reduced from the present situation while maintaining the income by changing the land use combination.

This study showed how monitoring data can be used to screen land use combinations with less environmental impact. The target can be changed according to the environmental and economic condition of the area. Using this analysis, incentives to choose land use combinations with lower GWP and farmland surplus N can be created.

References

- IPCC, 2001. The scientific basis. Cambridge University Press, Cambridge, UK.
 Kimura, S.D., *et al.*, 2007. Soil Sci. Plant Nutr. 53: 373-386.
 Naser, H.M., *et al.*, 2007. Soil Sci. Plant Nutr. 53: 95-101.
 Toma, Y., *et al.*, 2008. Soil Sci. Plant Nutr. 53: 692-703.

Modelling the costs of climate change on grazing systems

M. Lieffering, P. Newton

AgResearch Grasslands, Tennant Drive, Palmerston North, New Zealand

Contact: mark.lieffering@agresearch.co.nz

Introduction

For countries such as New Zealand that derive a large proportion of their GDP from grasslands, an authoritative assessment of the potential responses to the main components of anthropogenically induced global change (increasing levels of atmospheric CO₂ and changes in climatic factors such as temperatures and rainfall) is an essential first step in determining where adaptations will be necessary, how these might be achieved and their costs. Long-term effects such as changes in botanical composition and changes in the availability of plant nutrients are of central importance in determining the influence of global change on grassland ecosystems. Any satisfactory simulation of the future must take account of these higher-order effects and feedbacks and to this end we have developed an ecosystem model that simulates annual and seasonal pasture growth responses satisfactorily (EcoMod; described in Johnson *et al.*, 2008). EcoMod mechanistically simulates plant, soil and animal processes in grazed grasslands, enabling us to examine future climate and management changes that are beyond our current experience. An assessment of responses of grazing systems to climate change must consider the effects on not only direct ecosystem services such as pasture production, but also other inputs/outputs such as nutrient leaching, soil C sequestration and greenhouse gas (GHG) emissions. In this paper, we illustrate the use of EcoMod to determine the potential effects of climate change on pastoral ecosystem inputs/outputs in an area of New Zealand that is projected to be 0.7 °C warmer and 15% drier by 2050.

Methods

We modelled a single paddock of ryegrass and white clover on a hypothetical N.Z. dairy farm. We ran simulations from 1966 to 2006 using actual climate data and from 2006 to 2050 using climate change projections superimposed on cycled historical climate data. The projections used were annually incremented increases in minimum (+0.8 °C) and maximum (+0.6 °C) temperatures by 2050 to 6.7 and 17.0 °C, respectively, while rainfall decreased 15% from 714 mm to 606 mm per year. Atmospheric CO₂ increased in annual increments to 450 ppmv by 2050. Cows (40 cows ha⁻¹) began grazing the paddock when pasture dry matter (DM) was 2800 kg DM ha⁻¹ and were taken off when the residual reached 1600 kg DM ha⁻¹. Cows weighed a minimum of 400 kg, had a lactation length of 270 days and a potential peak daily milk production of 35 litres d⁻¹. All energy for milk production was from the pasture grown (i.e. no supplementary feed was supplied) and all pasture management was done using grazing. Soils were parameterized based on the soil type typical of this region and N fertilizer was added whenever soil test values fell below a threshold. All other nutrients were assumed to be non-limiting and it was assumed that dung and urine were homogeneously returned to the soil. In order to smooth out interannual variation, results are presented as 20 year means centered around and referred to as '1990' (present) and '2040' (climate change). To explore the effects and potential costs and benefits of a simple adaptation strategy, we ran simulations with and without irrigation. Irrigation occurred when soil moisture levels caused more than a 20% decrease in plant growth; this resulted in 6 irrigation events of about 50 mm per year under present conditions and 7 irrigations under climate change.

Results and discussion

Under non-irrigated conditions, climate change resulted in decreased pasture intake and milk production (Table 1). The majority of growth occurred in spring though the largest decrease

in growth rate was in autumn due to increased soil moisture stress. As a result of lower pasture growth, simulated fertilizer inputs decreased, though because clover content increased (data not shown), N fixed increased leading to an overall increase in N inputs and greater NO₃ leaching. Due to lower pasture intake and animal production, enteric CH₄ emissions decreased while soil C changed little.

Table 1. The modelled effects of climate change on some key pasture inputs and outputs of a hypothetical grazed dairy farm in Canterbury, N.Z. All data are on an annual 20 year average basis.

	Non-irrigated			Irrigated		
	1990	2040	%change	1990	2040	%change
Pasture intake (t ha ⁻¹)	7.3	6.6	-10	17.4	18.8	+8
Growth rates (kg ha ⁻¹ d ⁻¹)						
Spring	37.3	33.7	-10	67.3	75.3	+12
Summer	20.6	19.9	-4	80.2	86.7	+8
Autumn	9.2	5.2	-43	28.9	29.0	0
Winter	12.2	13.2	+8	14.6	16.4	+12
Milk production (l ha ⁻¹)	8073	7229	-11	18757	20543	+10
Fertilizer N (kg N ha ⁻¹)	21.4	12.1	-43	130.7	147.9	+13
N fixed (kg N ha ⁻¹)	116.0	138.9	+20	68.8	78.7	+14
Total N inputs (kg N ha ⁻¹)	137.4	151.1	+10	199.5	226.5	+14
NO ₃ leached (kg ha ⁻¹)	70.3	79.3	+13	46.1	25.9	-44
CH ₄ emitted (t CO _{2e} ha ⁻¹)	3.0	2.7	-10	7.3	7.9	+8
soil C (t ha ⁻¹)	181.5	177.2	-2	169.2	153.4	-9

An obvious mitigation strategy to lower rainfall with climate change is irrigation. Under irrigated conditions, the warmer temperatures in 2040 resulted in greater pasture intake and milk production. However, to sustain this extra growth total N inputs were greater but NO₃ leaching decreased while enteric CH₄ increased because of the higher animal production.

As shown here, simulation modelling enables us to explore future changes that are beyond our current experience and look at the potential trade-offs of implementing adaptation strategies. For example, with irrigation, CH₄ emissions increased under climate change while NO₃ leaching decreased. Because all of the inputs/outputs can be assigned at least nominal monetary values (e.g., installing an irrigation system, the value of the pasture, GHG and NO₃ emission charges), by integrating these biophysical results with farm business models and upscaling to regional levels, the costs of climate change nationally can be explored.

Reference

Johnson, I., *et al.*, 2008. Australian Journal of Experimental Agriculture 48(5): 621-631.

Testing adaptation options in a +2 °C warmer climate

M. Moriondo, R. Ferrise, M. Bindi
Department of Agronomy and Land Management,
P.le Cascine 18, CAP 50144 Firenze, Italy
Contact: marco.moriondo@unifi.it

Introduction

The results of recent global climate monitoring as well as the simulations of general and regional circulation models (GCM and RCM, respectively) stressed out that the future climate will be significantly different than that experienced in the past, resulting in significant impact on different economic sectors (e.g. agriculture, forestry, energy consumptions, tourism, etc.) (Hanson *et al.*, 2006).

A particular attention should be devoted to the study of climate change impact in agriculture. Since this economic sector, representing the major land use across the globe, is a major economic, social, and cultural activity, and it provides a wide range of ecosystem services. Importantly, agriculture in its many different forms and locations remains highly sensitive to climate variations, since crop yield is largely determined by the weather conditions during plant life cycle and even with minor deviations from the normal weather, management practices and yield are seriously threatened.

As a consequence, understanding the potential impacts of climate change on the agriculture has become increasingly important and is of a main concern especially for the sustainability of agricultural system and for adopting reliable adaptation options to cope with.

Building on these premises, this work aims at assessing the effect of different adaptation strategies in crop managing in a +2 °C warmer climate.

Methods

The general framework of this paper provides the use of climate future data, as simulated by a GCM, as input of CropSyst model in a period corresponding to a +2 °C global warming (2026–2060; New, 2005) respect to pre-industrial level. Since the results of a typical GCM simulations may be inappropriate, especially for impact assessment at local scale in agriculture, a simple GCM statistical downscaling software (LARS WG) was used to reproduce both present and future climate (Tmin, Tmax, rainfall and global radiation) at a spatial resolution suitable for impact assessment on a regional scale (50 × 50 km).

According to LARS WG procedure (Semenov & Barrow, 1997), available observed daily weather data for a given site were used to determine a set of parameters for probability distributions of weather variables as well as correlations between them (calibration stage). This set of parameters is then used to generate both the synthetic weather time series describing the present period and as a baseline to be perturbed using forcing factors derived from the GCM.

In this work observed daily data (including Tmin, Tmax, rainfall and radiation) for the period 1975–2005 and spatially interpolated at a resolution 50 × 50 km over EU (provided by MARS project [www](http://www.mars-project.org).) were used in the calibration phase of the stochastic weather generator. After calibration, 100 years of synthetic daily weather data were produced for each grid point to represent the current baseline 1975–2005.

The results of HadCM3 for A2 scenario in 2030–2060, over the European domain, were used to derive the forcing factors for the downscaling procedure. These factors were computed for each GCM grid point as monthly average differences of Tmin, Tmax, rainfall and radiation respect to the reference period (1975–2005). For temperature and rainfall the relative change in standard deviation and in duration of wet and dry spell were also calculated.

CropSyst model was run for +2 °C scenario to simulate growth and development of barley, wheat, sunflower, soybean and maize in business as usual condition (BAU) (using common agricultural practices including sowing dates, fertilization, rainfed conditions) and using different adaptation strategies. These included early and late sowing date (respectively -15 and +15 dd with respect to BAU), short and long cycle variety (-20% and +20% with respect to BAU), irrigation, fertilization (+20% with respect to BAU).

According to A2 scenario, CO₂ air concentration was set to 550 ppm for the considered period and consequently crop biomass accumulation in CropSyst was set to increase by 18% with respect to present conditions (350 ppm).

Results and discussion

The general picture simulated by HadCM3 for a +2 °C warmer climate showed a clear pattern in the change of rainfall distribution with a general annual rainfall increase in Northern Europe above 55 °N, no changes in central Europe roughly between 45° and 55 °N and a sensible decrease over the Mediterranean basin. Annual maximum and minimum temperature increased following a strong longitudinal gradient from -10° to 40 °E. Both increased temperature and the changed rainfall pattern had significant impacts on selected adaptation strategies efficiency. As expected the use of irrigation increased crop yield respect to BAU especially at lower latitudes where the decrease in rainfall is more evident. In contrast higher fertilization did not increase crop growth probably because the BAU fertilization is close to the optimum threshold indicated in CropSyst. The use of longer cycle varieties resulted in a increased yield due to the lengthening of time for biomass accumulation. This strategy resulted more effective in northern region where no changes or even increase in rainfall rate were simulated. However, the effectiveness of this strategy was reduced at lower latitudes due to the projected decrease in rainfall especially in summer. On the other hand, shorter cycle varieties resulted in a decrease of yield especially in areas with better growing conditions (i.e. Northern Europe). Changing sowing dates gave not significant results but in southern regions where an earlier sowing allowed the crops to escape the spring-summer drought.

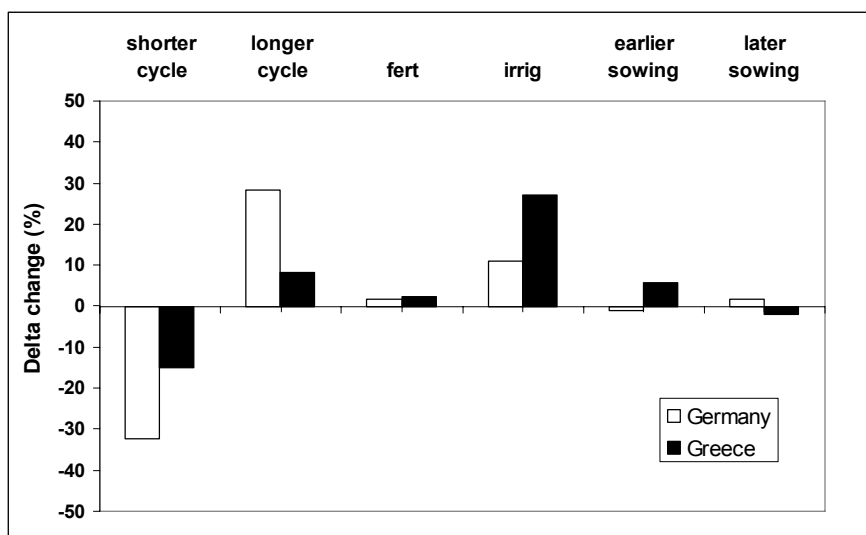

Figure 1. Relative change (%) in crop yield considering different adaptation options at higher (Germany) and lower (Greece) latitudes.

References

Hanson, C.E., *et al.*, 2007. *Clim. Change* 81: 163-177.
 New, M., 2005. In: Ed. L.D. Rosentrater, Evidence and implications of dangerous climate change in the Arctic. WWF International Arctic Programme.
 Semenov, M.A. & E.M. Barrow, 1997. *Climatic Change* 35: 397-414.

Simulation of climate scenarios and the bio-economic assessment of different agricultural management systems in the Marchfeld region

F. Strauss, E. Schmid, E. Moltchanova

University of Natural Resources and Applied Life Sciences, Institute of Sustainable Economic Development, Feistmantelstraße 4, 1180 Vienna, Austria

Contact: franziska.strauss@boku.ac.at

Introduction

The aim of this analysis is to assess the impacts of climate change on crop yields, soil organic carbon stocks, and Nitrogen leaching, as well as on the profitability of different crop production systems in the Marchfeld region. Rischbeck (2007) used downscaling methods from global climate models to predict climate change for the Marchfeld region. In this study we develop regional climate scenarios for the next 30 years using a linear regression model based on daily weather observations from 1975 to 2006 at the weather station in Grosz Enzersdorf. The climate scenarios are integrated together with other site specific data such as soil types, two crop rotations (corn-winter wheat-sunflower-winter wheat-spring barley, and sugar beet-winter wheat-field peas-winter wheat-spring barley) and different crop managements systems (conventional, reduced or minimum tillage with or without irrigation, as well as with or without straw removal) in the biophysical process model EPIC (Environmental Policy Integrated Climate; Williams, 1995; Izaurrealde *et al.*, 2006). The most important modules in EPIC are weather simulation, hydrology, erosion and sedimentation, Nitrogen-, Phosphor-, Potassium- and Carbon-cycles, plant growth, soil qualities and tillage operations. Hence, panel data of crop yields, soil organic carbon stocks and Nitrogen leaching were simulated with EPIC depending on the site data including 30 climate scenarios, and the twelve crop production systems. Moreover, the simulated crop yields are used to assess the economic profitability of the different production systems in the region.

Data and method

The data source for the climate scenarios are daily weather observations from 1975 to 2006 in Grosz Enzersdorf. Trends for temperature, solar radiation, relative humidity, wind and precipitation were calculated by means of linear regression, in which the residuals were reallocated randomly by retention of the monthly sequences. This process of reallocation was repeated 30 times to capture the variability and uncertainty in the climate scenarios.

EPIC simulations over 64 years (1975 to 2038) were performed to analyse the impact of climate change and of different crop production systems on crop yields, soil fertility and Nitrogen leaching. Furthermore, the variable production costs were calculated for each crop and production system (BMLFUW, 2008).

In the profitability analysis we compare stochastic producer prices, based on historical price time series, and average variable production costs. The historical price time series provide a basis for the generation of stochastic prices for the two periods from 1975 to 2006 and from 2007 to 2038. We presume that prices are subjects to normal distribution from which prices are taken randomly (no trends are accounted in this analysis). Frequency distributions show, how often the average variable costs are above or below the stochastic producer prices. The redistribution of frequency gives information about likely impacts of climate change on the profitability of crop production in the Marchfeld region.

Results and discussion

The simulation results of both crop rotations show that soil organic carbon stock reaches its maximum under minimum tillage and without straw removal. On average, the soil organic carbon stock is 109.93 t/ha in this region. Nitrogen leaching is lowest with minimum tillage

and with straw removal and is on average 22.14 kg ha^{-1} . Under *c.p.* both ecological indicators are decreasing over time on average. The decrease of soil organic carbon stock is related to the increase of soil temperature and thereby to higher CO_2 respiration. Moreover, an increase in annual precipitation leads to higher sediment transportation rates. The combination of an average annual increase of temperature by $1.3 \text{ }^\circ\text{C}$ with an increase of CO_2 concentration to 443 ppm in 2038 and an increase of annual precipitation by 100 mm leads to less Nitrogen leaching on average in this region. This is mainly due to higher biomass production and therefore higher Nitrogen uptakes by crops. All crop yields show a positive trend over time on average. Corn yields increase by about 0.5 t ha^{-1} , and spring barley and sunflower by about 0.02 to 0.07 t ha^{-1} (dry matter). Using irrigation, the variability of crop yields as measured by the standard deviations is somewhat reduced in most cases.

The profitability analysis (Table 1) indicates that production of corn is most profitable with minimum tillage and irrigation. The percentages describe how often average variable costs are below stochastic producer prices. The production of sugar beets is most profitable in this region. The production of winter wheat, sunflower, field peas and spring barley is most profitable with minimum tillage and without irrigation. Not removing straw from the field has positive crop yield effects for winter wheat and sunflower. The production of field peas does not seem to be economically viable in this region, however, within a crop rotation system other benefits account obviously more. The comparison between the periods 1975 to 2006 and 2007 to 2038 shows that the profitability of corn is increasing without irrigation and decreasing with irrigation, but the production of corn is profitable in both periods. The profitability of winter wheat, spring barley and field peas is slightly increasing whereas the profitability of sugar beet and sunflower remains nearly unchanged between the two time periods. The major conclusion of this analysis is that minimum tillage represents a profitable and ecological sound production system, especially under the impact of climate change.

Table 1. Profitability in % (SB=sugar beet, C=corn, W=winter wheat, P=field peas, SF=sunflower, SB=spring barley) for different tillage operations (conventional, reduced or minimum) and alternatives in management (I=irrigation, nI=no irrigation, S=straw removal, nS=no straw removal).

	Conventional				Reduced				Minimum			
	I/S	nI/S	I/nS	nI/nS	I/S	nI/S	I/nS	nI/nS	I/S	nI/S	I/nS	nI/nS
SB 1975-2006	100	97	100	97	100	97	100	97	100	97	100	97
SB 2007-2038	100	98	100	98	100	98	100	99	100	99	100	99
C 1975-2006	81	55	81	55	82	57	82	58	82	59	83	59
C 2007-2038	74	67	74	68	79	69	80	69	81	70	82	70
W 1975-2006	54	70	55	70	61	74	62	74	67	76	69	76
W 2007-2038	46	74	47	74	57	79	62	80	65	83	69	84
P 1975-2006	0	2	0	2	0	6	0	5	2	9	2	9
P 2007-2038	2	9	2	9	3	12	3	12	4	16	4	16
SF 1975-2006	39	55	39	55	34	54	36	55	34	56	36	56
SF 2007-2038	27	57	27	59	23	53	33	61	25	56	36	64
SB 1975-2006	2	28	2	28	3	41	3	41	8	47	6	47
SB 2007-2038	6	33	6	33	9	43	9	43	15	51	15	51

References

- Bundesministerium für Land- und Forstwirtschaft, Umwelt und Wasserwirtschaft, 2008. Deckungsbeiträge und Daten für die Betriebsplanung, Berger, Horn (BMLFUW).
- Izaurrealde, R.C., *et al.*, 2006. Ecological Modelling 192(3-4): 362-384.
- Rischbeck, P., 2007. Der Einfluss von Klimaänderung, Bodenbearbeitung und Saattermin auf den Wasserhaushalt und das Ertragspotential von Getreide im Marchfeld. Dissertation at University of Natural Resources and Applied Life Sciences, Vienna, 1-155.
- Williams, J.R., 1995. In: Ed. V.P. Singh, Computer Models of Watershed Hydrology. Water Resource Publications, Highlands Ranch, Colorado, pp. 909-1000.

Energy use efficiency and greenhouse gases emissions of dairy farms of an isolated territory: Reunion Island from 2000 to 2007

M. Vigne, J. Vayssières, J.L. Bochu, P. Lecomte
CIRAD, UPR Systèmes d'Élevage, Pole Kappa, 97410 St Pierre, La Reunion
Contact: mathieu.vigne@cirad.fr

Introduction

Criteria to assess agricultural systems have widely evolved during the past few decades. Technical and economic indicators are associated with environmental criteria such as nutrient or energy balance. In a context of external inputs dependence, Reunion Island, a French territory (2,500 km²) situated in the Indian Ocean, is an interesting field to study the links between local development policy, farm functioning and energy use. The aim of this study is to assess non-renewable energy (NRE) consumptions and greenhouse gases emissions of Reunion dairy farms and to characterize farm management impact on environmental indicators, more particularly on greenhouse gases (GHG) emissions.

Methods

Based on a techno-economic survey on dairy farms carried in 2000 by Taché (2001), the energy and GHG balances on 31 dairy farms for 2000 and 14 for 2007 have been established according to PLANETE methodology adapted to local context (Vigne, 2007). Based on Life Cycle Analysis (Bochu, 2007), PLANETE is a national French tool to quantify energy consumptions and GHG emissions at the farm scale. Direct and indirect energy use is estimated according to standards all along the cycle and translated in fuel equivalent litre (EQF). GHG emissions, carbon dioxide (CO₂), methane (CH₄) and nitrous oxide (N₂O), are estimated and summarized in tons of equivalent CO₂ (teqCO₂) based on their global warming potential. Evolution of indicators are analysed along time and farm management options are discussed.

Results and discussion

Average results for NRE and GHG emissions are listed in Table 1.

Environmental indicators of dairy production in Reunion Island have been improved between 2000 and 2007. The energy efficiency increased by 13% whereas the energy consumption per 100 liters of milk decreased by 4.2 EQF (16%). Moreover, emissions of greenhouse gases decreased from 2.32 to 1.73 teqCO₂ for 1000 liters of milk produced on the farm (-25%). We can observe an increase of the proportion of CO₂ (+22%) in the total emission while the contributions of CH₄ and N₂O decreased.

All these variations are in conformity with management changes and the sustainability objectives of the dairy sector: enhancing milk productivity, farmers income and reducing environmental impacts from this activity.

Decrease of total energy consumption and GHG emissions are mainly linked to the improvement of the overall transformation of the farm imported feed supplements into milk (R² - 0.80;). Due to a better management, average efficiency of dairy farms to transform this major input into milk has significantly increased from 1.25 to 1.32 L kg⁻¹.

Increase of CO₂ emissions is linked to changes in feeding management. During 2000 and 2007, average farm input of concentrates summarized per cow per day has increased from 11.5 to 14.6 kg. These importations, subsidized by local policies, led to an increase of CO₂ emitted for production and transport (+21%; +32%, respectively). On the other hand, increase of the concentrates in the ration contributed to the reduction of animal CH₄ emissions by 17%. Studies have shown that due to fermentation profile modification, higher proportion of supplements tend to lower animal CH₄ emissions (Giger-Reverdin *et al.*, 2000).

Table 1. Energy use and GHG emission in dairy farm.

Indicators	2000 (<i>n</i> = 31)		2007 (<i>n</i> =14)		Variation (%)
	Average	<i>SD</i>	Average	<i>SD</i>	
Energy Efficiency	0.39	0.09	0.44	0.05	+13
Energy use (EQF/100 l of milk)	26.2	6.8	22.0	2.9	-16
GHG emission (teqCO ₂ /10 ³ l milk)	2.32	0.57	1.73	0.21	-25
Proportion of each gas (%) :					
Emission of CO ₂	44.9	4.8	54.7	4.5	+22
Consuming direct energy	4.7	1.3	5.8	1.9	+23
Mineral fertilizers production	1.5	0.7	0.7	0.4	-53
Feeds production	18.4	3.7	22.3	4.3	+21
Buildings and machinery	4.4	1.9	4.9	3.0	+11
Transports to supply inputs to the island	15.9	2.9	21.0	3.3	+32
Emission of CH ₄ by animals	27.8	3.1	23.2	1.7	-17
Emission of N ₂ O	27.3	3.6	22.1	3.4	-9
Fertilizer production	1.9	1.1	1.1	0.7	-42
Soil N fertilization	12.8	2.2	10.2	2.1	-20
Manure	12.6	1.5	10.6	1.1	-16

Valorization of manure as organic fertilizer in substitution of mineral fertilizer is one of the main recommendation from local technical support to improve N balance and to enhance the income of farmers. Results of this study shows a decline of the nitrogen (N) fertilizer input, from 165 unit N per ha in 2000 to 111 unit N per ha today. This decrease has a direct effect on emissions of GHG. CO₂ and N₂O emissions for fertilizer production declined of 53% and 23%, respectively. N₂O emissions resulting of N fertilizer applied on the soil (volatilization and denitrification) declined of 20 %.

Applied to annual accounting databases LCA tools are useful to assess effect of local support and development policies, and more particularly, the effect of local technical support's message on climate change. Indeed, results show local development policy for dairy sector in Reunion Island have been effectively diffused and had a positive effect on environmental impact from 2000 to 2007.

In addition, this analysis highlights the need to address issues to decrease impact of local productions on environment. For example, transport of inputs from metropolitan France to Reunion Island (10,000 km) is responsible for 25% of total energy use. Despite strong political and socio-economic relationship, this high energy use underlines the interest to shift to closer Indian ocean regional markets for inputs, which would reduce impact on the environment of transport. An other opportunity could be to use manure in biogas process to take advantage from CH₄ valorization and reduce emissions during soil application of manure.

References

- Bochu, J.L., 2007. Synthèse 2006 des bilans PLANETE. Rapport scientifique ADEME, 248 pp.
- Giger-Reverdin, S., *et al.*, 2000. Modélisation empirique des facteurs de variations des rejets de méthane par les ruminants. VIIème Rencontres autour de la Recherche sur les Ruminants. Paris, France, pp. 187-190.
- Taché, C., 2001. Diagnostic des exploitations laitières de l'île de La Réunion. Rapport de stage ISTOM, 96 pp.
- Vigne, M., 2007. Evaluation du bilan énergétiques des exploitations bovines laitières à la Réunion. Rapport de Stage CIRAD-UM II, 76 pp.

Mujika community climate: Cropping systems modelling exercise

S. Walker, D. Nanja, P. Gondwe, J. Dimes, *et al.*
University of the Free State, P.O. Box 339,
Bloemfontein 9300, South Africa
Contact: walkers.sci@ufs.ac.za

Introduction

In the semi-arid regions of SADC there is widespread dependence on subsistence farming which results in a high level of poverty among community members. There is a high variability in the rainfall received, both in amount and distribution through the growing season as well as large differences between seasons. These factors have contributed to the poor coping strategies and few practical adaptations in the cropping systems in these areas. The main staple crop is maize and it is grown during the summer rainfall season, mainly from November to March. The Zambian Department of Meteorology has been working with this community and has been disseminating seasonal and other weather forecasts via radio for the past few years. The purpose of this exercise was to bring together the community's perceptions of their natural resources and the potential for crop production in this area using a cropping systems model.

Methods

This community exercise was part of a larger capacity building climate change IRDC project in both Zambia and Zimbabwe (ICRISAT, 2008). Mujika is situated at approximately 16° S latitude and 27.5° E longitude and is at an altitude of 1020 m in the Southern Province of Zambia receiving an annual rainfall of about 800 mm.

The programme for this particular intervention was to meet with some members of the community on the first day and then do some model runs on the second day. During the third day the model outputs were to be shared with the community (Carberry *et al.*, 2004). Community members who are farmers from villages in Mujika and Njola districts were selected by the camp extension officer to attend the meeting. Following the introductions and a brief outline of the vision of the project on the first day, the group divided into their village groups for the natural resources mapping exercise. Each village first drew a map of their own area – including houses, roads, fields and sources of water. Then each farmer proceeded to draw an individual map of their own farm, again including the homes and fields. Using a dialogue method with translation into Tonga, the farmers then also added specific details of the natural resources including soil type and water resources. As part of the exercise was to compare the farmers production with the model output, other information about the past two seasons' production was also requested and written on their maps – such as land preparation method, planting dates, fertilization, weeding and grain production. As a task for homework, they were requested to consider what variations in management or adaptations they might make if the season was to be drier or wetter than normal. On the second day the researchers met and discussed the individual maps and farm management activities. After compiling the available climate data into the necessary format for APSIM, the model was run for several management scenarios. These outputs were then transferred into simple graphs for presentation to the farmers on the third day. The first activity on the third day was to receive the report back on the possible intervention that the farmers could envisage implementing. The latest seasonal forecast from the Zambian Department of Meteorology was given to the farmers. This was followed by reports from three individual farmers, and then an introduction to crop modelling. Some of the model results from two particular farmer's resource maps were shown. Following this, a discussion ensued around the proposed mother-baby trials for the coming season (Snapp, 2002; Rusike *et al.*, 2006).

Results and discussion

A total of 40 farmers (equal numbers of male and female) attending the meeting were from the following villages – Bulimo, Homooyo, Kayumba, Malomo, Nkabika and Sikaula. From the farmers' maps it became clear that there were two dominant soil types, namely a sandy loam and a clay soil occurring mainly in the low lying parts of the landscape. The farmers plant a wide variety of different maize varieties (up to 19) with most planting medium length varieties (500 and 600 series) and they usually only weed their lands once per season. The farmers use either cattle manure or inorganic fertilizer as a basal and/or top dressing. The tillage is done either by hand hoe or with an animal drawn plough and some form small basins as a water harvesting technique.

The seasonal rainfall forecast was for normal rainfall amount during the Oc-Nov-Dec season and normal to above normal for the January-February-March season. The farmers said that they would continue to plant the 500 and 600 series varieties after the first rains had been received and try to do the weeding and top dressing at the optimal time. They all expected a good yield this season as the forecast was for normal to above normal rainfall.

The rainfall variability was discussed using the graph of the daily rainfall from the previous season, showing that it rained almost every day during December 2007, which the farmers clearly remembered. This had resulted in waterlogged fields and poor maize production. The variation between seasons was also illustrated by looking at the graph of the last 11 years of seasonal rainfall amounts and the various low and high rainfall seasons were discussed. This graph was then compared with the model predicted yield graph, which showed that in one high rainfall year the yield was still low and in one low rainfall season the yield was average. The farmers also compared the yields that they could remember from the various years, agreeing that the model had done a good job of simulating the yields over the last 11 years.

One of the farmers, Constantine Manianga from Homooya village, who had applied manure to a certain field in two consecutive years then, commented on the model simulations of his particular field. The model had been run with the fertilizer and manure applications as reported on his farm resource map. In the last two seasons (06/07 and 07/08) the model had accurately predicted his yields as one year his reported yield was slightly higher and the other slightly lower than the predicted values. He said that this gave him confidence in the use of the model to show the effect of various interventions.

The effect of additions of the recommended basal and top dressing fertilizer on the grain produced on the clay soil was then illustrated with a graph comparing the predicted yield with and without fertilizer over the past 11 years. Most of these yields were above those reported by the farmers, so they were encouraged to include fertilizer treatments in the mother-baby trials in the coming season. There was much discussion around which treatments were of most concern, including different varieties; different tillage practices; planting dates and fertility. However, it was not possible to come to a consensus on which were the most important to be included in the trials. Unfortunately, due to lack of time the discussion had to be cut short and will be resumed at the next meeting of the farmers with the researchers and extension officer.

References

- Carberry, P., *et al.*, 2004. In: Eds R.J. Delve & M.E. Probert, Modeling Nutrient Management in Tropical Cropping Systems. ACIAR Proceedings 114: 32-46.
- ICRISAT, 2008. Building adaptive capacity to cope with increasing vulnerability due to climate change. Inception Workshop Report, 7-8 June 2007, Bulawayo, Zimbabwe.
- Rusike, J., *et al.*, 2006. *Int. J. Agric. Sustain.* 4(2): 1-17.
- Snapp, S., 2002. In: Eds M.R. Bellon & J. Reeves, Quantitative analysis of data from participatory methods in plant breeding. CIMMYT, Mexico.

Theme C
**Case studies and application of tools and
empirical methods**

Session C3: Application of integrated assessment tools

Session organizers:

Marijke Kuiper

LEI, Wageningen UR, The Netherlands

Jacques Wery

UMR System (Agro.M-CIRAD-INRA), Montpellier, France

Effects of trade liberalization on EU agriculture: A typical macro level application of SEAMLESS-IF

M. Adenäuer, M. Kuiper, K. Louhichi
Nussallee 21, 53115 Bonn, Germany
Contact: marcel.adenaeuer@ilr.uni-bonn.de

Introduction

EU trade policy is determined in Brussels by EU institutions but has ramifications that may differ for EU member states and regions within member states which affect the political feasibility of the agreement reached by the EU commission. Furthermore (economic) trade policy may have environmental and social impacts which could support or conflict with other policies at EU, national or regional level. Furthermore EU trade policies have to be in line with WTO commitments.

In this paper, we assess the impact of a reduction in tariffs and EU export subsidies along the lines of the proposed modalities for agriculture of July 2008 of the World Trade Organization (WTO) negotiations (Doha Development Round). These modalities include reductions in tariffs (with exceptions for sensitive products) and removal of export subsidies. The modalities are not yet fully specified due to the breakdown of the negotiations in July. We explore different potential negotiation outcomes by assessing the impact of not arriving at a provision for sensitive products (one of the most contested elements in the agricultural modalities), and varying tariff reductions to both the upper and lower bounds in the modalities. These additional three scenarios provide an indication of the sensitivity of our conclusions to variations in negotiation outcomes.

Apart from providing an integrated assessment of the July 2008 agricultural modalities in terms of its economic and environmental impact, a second objective of our paper is to evaluate to what extent an integrated assessment that accounts for detail in agricultural production adds insights that cannot be derived from other existing models. To this end we compare the results of a chain of models to the results from applying the same scenarios in the existing CAPRI model.

Methods

We make use of the model chain FSSIM-EXPAMOD-SEAMCAP-FSSIM, reaching from the field to the global market level, as realized in SEAMLESS-IF (Van Ittersum *et al.*, 2008). Producer response is modelled using farm level simulation models (FSSIM) developed in the SEAMLESS project (Louhichi *et al.*, 2007). These models are available only for a subset of the EU regions and therefore an extrapolation procedure is employed to determine supply response at NUTS2 level using the EXPAMOD model (Bezlepkina *et al.*, 2007). The resulting elasticities of agricultural supply are then used in SEAMCAP, a special version of the agricultural sector model CAPRI (Britz *et al.*, 2007), to arrive at a consistent modelling of agricultural production from field to market level. In SEAMCAP we apply the trade liberalization shock and obtain a new price quantity equilibrium. The new equilibrium prices are then transferred back to FSSIM in order to obtain feedback on farm type level to the trade liberalization. This provides an assessment of the July 2008 agricultural modalities from farm to market level.

To achieve our second aim we also compare the results to an analysis of the same scenarios, but with the standard version of CAPRI in order to assess the value added of an integrated assessment with SEAMLESS-IF.

Results and discussion

The first analysis with the stand-alone CAPRI model reveals considerable impacts of trade liberalization on the European agricultural sector. On the economic side we observe increasing partial welfare due to consumers benefiting from lower prices. This comes at the cost of farmers who will suffer from those price changes. We further find out that the animal sector is more heavily affected than the crop sector mainly due to meat markets currently being subject to stronger border protection compared to most of the major crop products. This in turn leads to a quite diverse picture of income changes across European NUTS2 regions and farm types.

In terms of environmental indicators the analysed scenarios reveal positive aspects. Lower prices across the whole agricultural sector tend to reduce the production of agricultural commodities and for example animal herd sizes what particularly reduces methane emissions and nitrate surplus from manure application.

First findings indicate that different results will be obtained with the SEAMLESS-IF model chain than with the same application in the standard stand-alone CAPRI model, since the agricultural supply response in the model chain differs from that in the standard CAPRI model. A different supply response implies that the changes in agricultural production will vary between the SEAMCAP in SEAMLESS-IF and the stand-alone CAPRI model, which will affect all other components of these two models (like welfare of consumer and market prices). Furthermore, a deeper look into changes occurring at farm type level including corresponding environmental impacts is possible when using the SEAMLESS-IF model chain.

References

- Bezlepkina, I., *et al.*, 2007. EXPAMOD: Component to statistically extrapolate from FSSIM models to other farm types and regions including aggregation to NUTS2: motivation, description and prototype, PD3.6.11.2, SEAMLESS integrated project, EU 6th Framework Programme, contract no. 010036-2. www.SEAMLESS-IP.org, 28 pp.
- Britz, W., *et al.*, 2007. Description of the CAPRI Modeling System, Final report of the CAPRI-DYNASPAT project; Universität Bonn, available on http://www.ilr1.uni-bonn.de/agpo/rsrch/capri/Final_Report_Model_Description.pdf
- Louhichi, K., *et al.*, 2007. A generic Template for FSSIM for all farming systems, PD3.3.11, SEAMLESS integrated project, EU 6th Framework programme, contract no. 010036-2, www.SEAMLESS-IP.org, 85 pp.
- Van Ittersum, M.K., *et al.*, 2008. *Agricultural Systems* 96: 150-165.

***Ex-ante* institutional compatibility assessment of policy options: Insights from empirical applications and interactions with policy experts**

L. Amblard, C. Mann, C. Schleyer
Cemagref, UMR Métafort, 24 avenue des Landais, 63 172 Aubière, France
Contact: laurence.amblard@cemagref.fr

Introduction

The Procedure for Institutional Compatibility Assessment (PICA) has been developed in the EU-project SEAMLESS-IF (Van Ittersum *et al.*, 2008) as a formalized methodology to assess *ex-ante* the compatibility between policy options and different institutional contexts (Theesfeld *et al.*, 2008). In 2007 and 2008, PICA was applied to the implementation of the policy option 'EU Nitrate Directive' in the regions of Auvergne and Midi-Pyrénées in France. Additionally, interactions with policy experts as one important group of end-users of PICA were tested in order to define their preferred modes of interaction. This paper presents the results of the application of PICA to the implementation of the EU-Nitrate Directive in Auvergne and Midi-Pyrénées. The contribution of the tool to integrated *ex-ante* policy assessment within SEAMLESS-IF (S-IF) is highlighted by the combination of the PICA statements and the results of the *ex-ante* assessment of the EU Nitrate Directive carried out by the other SEAMLESS models in Midi-Pyrénées. Further, the implications of the empirical applications for methodological improvement of PICA are discussed. Finally, the testing activities provide insights with regard to the use of PICA from the point of view of the future 'integrative modeller' running the tool as well as from the perspective of policy experts.

Methods

Within a first testing, PICA was applied *ex-ante* to the implementation of the policy option 'EU Nitrate Directive' in the 'département' Puy-de-Dôme in Auvergne, France. For methodological purposes, two additional analyses were carried out in the neighbouring 'département' Allier, where the Nitrate Directive has been implemented since 1994. A 'simulation' of running PICA before the actual implementation of the EU Nitrate Directive as well as an *ex-post* evaluation of the process were realized. Empirical methods used include literature reviews, statistical data analysis and interviews with scientists and stakeholders involved in the implementation process of the EU Nitrate Directive in Allier and Puy-de-Dôme. The second application was conducted on the case of the implementation of the EU Nitrate Directive in Midi-Pyrénées. An external expert with a background in institutional economics carried out the PICA assessment within a given timeframe of two months. The requests and experiences of the external expert were documented to improve the quality of the already available information on PICA and for the development of training materials for future applications of this tool. The interactions with policy experts regarding the use of PICA were also tested, using meetings between Cemagref researchers and policy experts from the regional services of the French Ministries of Agriculture and Environment as platforms. During workshops carried out by the SEAMLESS-PICA team, the perception of PICA by policy experts and their preferred modes of interaction were evaluated.

Results

The empirical application of PICA in Puy-de-Dôme shows that the most important factors potentially affecting the implementation of the EU Nitrate Directive in this 'département' are related to the influence of farmers' organizations. The restrictions on fertilization which could be imposed by the Directive in the vulnerable zone are likely to affect the capacity of farmers to fulfil the terms of the contracts for high quality products with the two large cooperatives present in the area. As a result, these two cooperatives may seek to use their high bargaining

power to influence the choice of the measures in the action programme to be implemented in the vulnerable zone. Also, the opportunity costs borne by farmers are likely to constraint the implementation of the policy. Indeed, the farmers under contract with the cooperatives will incur income losses if they have to change their fertilization practices so that they can not fulfil the requirements agreed on in these contracts. Then, one could expect a low degree of compliance with the mandatory rules in case these rules prevent farmers to fulfil the terms of the contracts they depend on economically.

In contrast, the opportunity costs borne by crop farmers to change their practices in Midi-Pyrénées do not seem to be high, thus not necessarily hampering the implementation process. This finding is in line with the aggregated result of the CropSyst-FSSIM assessment that the loss of income induced by the adoption of alternative activities is marginal (Louhichi *et al.*, 2008). However, while the modelling of cross-compliance in FSSIM rests on the assumption of full monitoring such that any non-compliance is detected, the PICA assessment reveals that the low resources devoted to the administrations in charge of monitoring as well as the high information asymmetry between the administrations and the farmers in Midi-Pyrénées are two important factors which may prevent the detection of non-compliance. Moreover, beyond economic reasons and controlling issues, psychological factors were found to have a strong influence on farmers' behaviour in the region, which may also lead them not to comply with the EU Nitrate Directive. Given these institutional features, the compliance of crop farmers with the EU Nitrate Directive measure and thus the decrease in nitrate leaching in Midi-Pyrénées may be not as significant as predicted by the model chain.

Discussion

The two first empirical applications of PICA proved to bring relevant results with regard to the potential institutional constraints to the implementation of the EU Nitrate Directive in Auvergne and Midi-Pyrénées. Relating PICA statements to the model chain results illustrates the added value of taking into account an institutional perspective within SEAMLESS-IF *ex-ante* policy assessment. Further, the two assessments helped to evaluate the procedure from a methodological perspective. The ability of PICA to 'predict' *ex-ante* the institutional factors potentially affecting the implementation of a policy option and the tool's capacity to account for differences between distinct institutional contexts were validated. Regarding the empirical methods used, the applications brought valuable insights on the combination of qualitative and quantitative data, the choice of qualitative methods and the integration of stakeholders' points of view for the collection of the information needed. Finally, the application of PICA by an external expert offered the opportunity to define the conditions for successful future applications in terms of competencies, timeframe and information/training to be provided while the analysis of the perception of policy experts helped to identify improvements of the communication on the tool and to specify further the modes of interaction with end-users.

References

- Louhichi, K., *et al.*, 2008. Application of FSSIM in two Test Case regions to assess agro-environmental policies at farm and regional level - PD6.3.2.2, SEAMLESS integrated project, EU 6th Framework programme, contract no. 010036-2, www.SEAMLESS-IP.org, 62p.
- Theesfeld, I., *et al.*, 2008. *Ex-ante* policy assessment from an institutional perspective. A Procedure for Institutional Compatibility Assessment (PICA). ICAR Discussion Paper, Humboldt University Berlin, 25 pp.
- Van Ittersum, M.K., *et al.*, 2008. *Agricultural Systems* 96: 150-165.

Challenges in the application of multi-criteria assessment (MCA) tool for the evaluation of irrigation management alternatives: PLEIADeS project

Paula Antunes, Rui Santos, Vanja Karadzic
CENSE - Ecological Economics and Environmental Management Group,
Faculty of Sciences and Technology, New University of Lisbon,
Campus da Caparica, 2829-516 Caparica, Portugal
Contact: mpa@fct.unl.pt

Irrigated agriculture remains the dominant single water user at the global level. Hence, it is the key strategic focus for efficient water use. The existent literature and on-field experience provide information on promising water saving projects, dealing with the water use efficiency and water productivity, irrigation system performance, use of non-conventional water sources, focus on participatory management, etc. Even though most of these programmes substantially contribute to increase of irrigation efficiency, they have been sector oriented and restricted to certain pilot areas, hence missing an integrated management approach. To address this issue PLEIADeS (Participatory multi-Level EO-assisted tools for Irrigation Water Management and Agricultural Decision-Support) STREP-F6 research project was developed with the overall objective of improving the technical, environmental and economic performance of irrigation schemes by means of New Technologies (NT): Earth Observation (EO) satellites, Geographical Information Systems (GIS) and Information and Communication Technologies (ICT) that can facilitate integrated management (including the integration of different spatial scales) and active stakeholder participation. Within the scope of the project, Multi-criteria Assessment (MCA), as an integrated assessment tool is used for evaluation of different irrigation management options, combining economic, technical, environmental, and social aspects. In this paper we describe a distinct MCA framework; developed taking into consideration differences in the assessment scope, involvement of stakeholders' and information needs, thus aiming for application beyond the scope of the PLEIADeS project.

The overall evaluation is based on approach derived from the concept of social multi-criteria evaluation - SMCE (Munda, 2004), involving an institutional analysis and the active participation of stakeholders in several stages of the process, namely in the identification of the alternative actions, in the definition of the evaluation criteria, on the assessment of trade-offs among alternatives/criteria and on the definition of an aggregation procedure. Taking into account differences in the irrigation management setting in 12 PLEIADeS pilot areas worldwide, the general MCA framework is applied for two levels of assessment:

1. Basic, not driven by any of the pilot areas, but based on a general approach to assess irrigation efficiency, environmental performance as well as for the economic analysis of irrigation systems. The result of the analysis is just an overall assessment of the alternatives, and therefore does not need to accommodate a complex decision structure. This very general approach may enable a certain level of direct comparisons across the different pilots in PLEIADeS.
2. Advanced, 'tailored approach' to pilot area specific irrigation management setting. Focus is on evaluation and comparison of alternatives, designed with stakeholders in a participatory setting (workshops). Alternatives should be constructed as a group of actions that better inform the actors taking part in a decision process.

For each level the proposed MCA framework defines: (a) necessary level of information detail; (b) intensity and impact of stakeholders' involvement; (c) aggregation rule and d) presentation technique.

Table 1. How MCA differs between basic and advanced levels of assessment.

Differences addressed	Levels of assessment	
	BASIC	ADVANCED
INFORMATION USED	Existing information and data (e.g., background of irrigation scheme, technical annual reports, historical and institutional analysis). Information used based on qualitative assessments	Full stakeholder analysis resulting in the pilot area report, including precise description of the irrigation management setting. Alternatives designed considering relevant stakeholders' and experts' contributions Qualitative & quantitative data and information coming from scientific and technical reports, interviews, consultation, etc.
STAKEHOLDERS' INVOLVEMENT (who and how?)	Informal meetings and consultation with the project partners that could facilitate understanding the problem and constructing alternatives Stakeholders' not directly involved in the assessment process.	Interviews and consultations: mapping views, preferences and values Workshops: 1 st round: framing the problem and discussion including different perspectives (farmers, irrigation scheme managers, river basin authorities') 2 nd round: generation of alternatives & criteria; 3 rd round: presenting and discussion of results
AGGREGATION RULE	No aggregation	Combination of different aggregation methods
PRESENTATION TECHNIQUE	General impact matrix with qualitative criteria scores Graphical display	Graphical: rank bars, diagrams SMCE – dendogram of coalitions; ranking of alternatives Combination with GIS

On the base level, two types of questionnaire surveys were distributed to PLEIADeS pilot areas' stakeholders', used to explore their values, awareness and knowledge about irrigation efficiency, environmental problems, economy (water pricing), society (culture, history, tradition) and technology (available irrigation technologies). All interviews were recorded and transcribed, facilitating construction of the first set of irrigation management alternatives and criteria. We selected the case study of Caia, Guadiana river basin, Portugal for the MCA advanced level. The assessment process in this case is combined with other participatory techniques (Antunes *et al.*, 2006, Kallis *et al.*, 2006), i.e. workshop, where participants are directly involved in alternative and criteria selection, weighting and aggregation procedure. Ultimately, MCA application will aim to address the specific question of evaluating the effect of NT-assisted tools on water productivity and performance of pilot irrigation systems using an extended evaluation.

References

- Antunes, P., *et al.*, 2006. Land Use Policy 23: 44-52
Kallis, G., *et al.*, 2006. Environment and Planning C: Government and Policy, 24: 215-234.
Munda, G., 2004. European Journal of Operational Research 158: 662-677.

A crop-farm-indicators modelling chain to assess farmer's decision in response to socio-economic scenarios

H. Belhouchette, K. Louhichi, O. Therond, J. Wery, G. Flichman
UMR-SYTEM, 2, Place Pierre Viala,
34060 Montpellier Cedex 1, France
Contact: Hatem.Belhouchette@supagro.inra.fr

Introduction

Bio-economic models can be used to assess the impact of policy and environmental measures with economic and environmental indicators. Focusing on agricultural systems, the strategies adopted by farmers in term of cropping systems and the associated crop managements at field level are essential in such studies. The objective of this paper is to present a study using such models to assess impacts of the nitrate directive in the Midi-Pyrenees region (France) by analysing, at farm and regional level, the farm income and three environmental indicators: nitrate leaching, erosion and water consumption. In addition, several intermediate variables are calculated and analysed at field level for a better comprehension of the farmer's strategies.

Methods

Two scenarios, the 2003 CAP reform (reference scenario) and the Nitrate Directive (policy scenario), with a time horizon of 2013, have been built and compared for two representative arable farm types in the Midi-Pyrenees region. The main structural difference between the two farm types is the irrigable land which is 37% and 13% of total land, respectively, for farm 1 (FT1) and 2 (FT2). For this purpose, the modelling chain: CropSyst-FSSIM-Indicators developed in the SEAMLESS project has been used (Louhichi *et al.*, 2008). Different types of data characterizing the biophysical context in the region (soil×climate), the current cropping systems (rotation, crop management) and farm resources (irrigated land, labour) have been collected to calibrate and run the models. In addition, different alternative activities with low nitrogen fertilization, in compliance with the Nitrate Directive, have been described. Current and alternative activity productions and externalities have been assessed with the CropSyst model. For each alternative activity an additional cost of 5% of total current activity cost is added as transaction cost in order to represent the additional knowledge and workload needed by farmers to acquire information on these activities. In addition, 3% of cross-compliance restriction is implemented if the farmer doesn't respect the Nitrate Directive.

Results and discussion

Figure 1 shows the difference of crop pattern for policy and reference scenarios. More cereals and irrigated grain maize are cultivated in FT1 when the Nitrate Directive is implemented. However, the area of spring crops is reduced by almost 50%. In FT2, characterized by a low irrigable area, the irrigated maize area remains marginal, with no change of spring crops and a slight increase of cereal area (data not shown). To understand those modifications and their environmental consequences we compared (Table 1):

- **activity share:** The model results show that few alternative activities (low N fertilizer) have been adopted when the policy scenario was implemented. This implies that the penalty of 3% is not enough to force farmers to respect the cross-compliance condition. In fact, in both farm types only 5ha (less than 10% of total cereal area) of cereals were cultivated with alternative nitrogen fertilization.

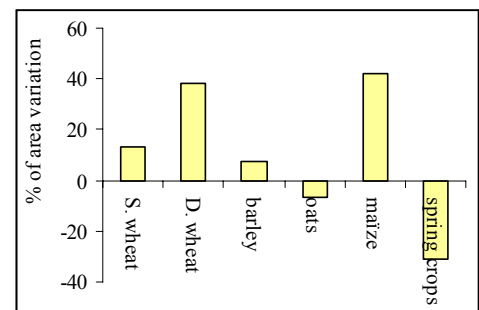

Figure 1. Policy to reference scenario: % of area variation in FT1.

- **Farm income:** no significant changes are observed for farm income when the policy scenario is compared to the reference one. For FT1 the reduction of total premium induced by the decrease of spring crops (−4700 euros) is compensated by the increase of the total premium allocated mainly for wheat (durum and soft) and for maize (+ 5000 euros). The same tendency is observed for FT2.

- **Nitrate leaching:**

The impact of policy scenario on the total nitrogen leaching for both farm types is low (+4% for FT1 and −8% for FT2). The partial adoption of alternative activities seems to be the origin of this low

Table 1. Economic and environmental indicators at farm scale.

	FT1		FT2	
	Reference	Policy	Reference	Policy
Farm income (euros ha ⁻¹)	835	830	761	761
Premium (euros)	36143	35057	38767	37600
Labour (h ha ⁻¹)	3	9	3	3
Nitrogen leaching (kg ha ⁻¹)	43	45	54	51
Soil erosion (t ha ⁻¹)	1.9	1.6	2.6	1.9
Water use (mm)	41	60	8	5

variation. The reduction of the total nitrogen leaching caused by the decrease of spring crops, barley and oats is replaced by the increase of wheat and maize (data not shown). In addition, more nitrogen was leached with maize in the policy scenario because maize is cultivated as a mono-crop (producing 41 kg ha⁻¹ of N leached), than in the reference one, where almost 50% of the area is cultivated with maize/soybean rotation (with 31 kg ha⁻¹ of N leached).

- **Soil erosion:** The major changes occurred on soil erosion which was reduced by 16 to 29%, respectively, for FT1 and FT2, mainly because of the reduction of spring crops (sunflower, soybean, and peas) to the benefit of maize and winter wheat, thereby reducing the bare soil area during winter. The total soil erosion induced by maize seems to be inconsistent because, the total soil erosion induced by this crop decreases despite the increase of its area (data not shown). This result comes from the fact that all maize, in the reference scenario, is cultivated on clay-loam soil (with 1.2 t ha⁻¹ yr⁻¹ of erosion); while, in the policy scenario, 50% of maize is produced on clay calcareous soil, which is less sensitive to soil erosion (with 0.3 t ha⁻¹ yr⁻¹ of erosion) than the clay-loam soil.

- **Water use:** The total water use increased in FT1 (+19 mm) and slightly dropped in FT2 (−3 mm) when the policy scenario is implemented. The area allocated to irrigated maize, which partially depends on the irrigable area, in both farm types seems to be the origin of water use variation. In FT2, the marginal decrease of the irrigated area reserved for maize is compensated by the increase of the area of irrigated peas (+1.5 ha) which need few water in comparison to maize. As a consequence of a such strategy, the total labour by farm type increased by 6 h ha⁻¹ for FT1 and by 1 h ha⁻¹ for FT2.

These results show that this modelling chain can be functional for complex scenarios combining economic and environmental drivers with technological changes, and provided relevant results at farm and regional scale (data not shown), when discussed with local experts. Results of this study indicate that the modification of environmental regulations may lead to several changes in crop rotations on each soil type and by consequence in the crop management options and their spatial allocation. So, even if the farm profitability (farm income) did not change, several modifications occurred at field scale depending of the biophysical context and the economic and social constraints. This work highlights some key methodological aspects for future improvements and further uses of the meso backbone modelling chain of SEAMLESS-IF: (i) organization of iterative and cyclical interactions with local experts, (ii) development of sound methodologies for model calibration and validation at field, farm and regional levels.

Reference

Louhichi, K., *et al.*, 2008. Application of FSSIM. www.SEAMLESS-IP.org, 67 pp.

Land-Use Management using a soil survey geographic database for the Viisoara-Aiton hills (Transylvanian Plain-Romania)¹

H. Cacovean, T. Man, T. Rusu, D.C. Weindorf, I. Fodorean, C. Moldovan, V. Puiu, A. Pop
O.S.P.A., 1 Fagului street, 400483 Cluj-Napoca, Romania
Contact: turda75@yahoo.com

Introduction

In Romania, the determination of the best management practices (BMPs) for land resource management is complicated by a lack of modern means for land evaluation and a lack of soil quality. Quantifying agricultural landscape patterns and their change is essential for monitoring and assessment of the ecological consequences of recent transformations in agriculture of the Viisoara-Aiton Hills (Irvin *et al.*, 1997; Wu, *et al.*, 1997). Using GIS-based land-use data and pedological data we have constructed an analysis of the surrounding of the urban center of Turda with landscape metrics to quantify the spatial patterns of the agricultural transformations in the Viisoara-Aiton Hills. Modernization of the agricultural practices is a major force driving land-use change, which inevitably affects the structure, function and dynamics of the land-use cover and ecosystem.

Material and methods

The Viisoara-Aiton Hills, located in the southern part of the Transylvanian Plain (Romania), was chosen for this study. This region has a surface of 8,670 ha and represents the most important agricultural area in the province of Cluj. This province is well developed and economically important in Romania. Agriculture is an important economic branch in this geographic area, with corn (*Zea mays*) and wheat (*Triticum aestivum*) being the major crops. Existing soil maps of the area contain 4 classes and 26 types of soil, not including significant inclusions that could also occur within each map unit. Each soil layer has unique physicochemical properties, and an area-weighted number was computed, representing the value of the property for each map unit (Richardson *et al.*, 1977). In this study, we considered organic matter (OM) content, clay content, soil reaction and soil texture that are the main variables to assess the land-use management of that area (Fix & Burt, 1996). From these properties, interpolated maps were generated using geographic information system (GIS) software (Blaszczynski, 1997). The topographical map, as obtained from the Military Topography Department (1996), was used to realize the physiographic layer and because the physiographic region of Viisoara-Aiton Hills is closely related to soil cover. This region consists of one physiographic region and by referencing the physiographic map of the Transylvanian Plain we merged all soil types within the same region and formed a final physiographic layer. The four thematic maps were coupled with aerial photos and used to evaluate land use/management in relation to quantified soil properties (Lark, 1999; Park *et al.*, 2001). The objectives of this study were to: (1) identify land-use change; (2) evaluate the influence of soil cover on land-use; and (3) assess land-use potential and present management alternatives.

Results and discussion

To evaluate the importance and influence of OM content, clay content, soil reaction and soil texture on land-use patterns, we correlated land-use distribution with soil types/properties. Corn farmland had the lowest OM content, while wheat and alfalfa farmland approached average values. In terms of clay content, grassland showed the lowest value of all land-use types. The percentage of each textural class of the surface horizon that was used for wheat,

¹ In cooperation with University of Babes-Bolyai, Romania; USAMV, Romania; Louisiana State Univ., USA.

corn and grassland. We find four textural classes in that region and without any difference for the wheat and corn. Land capability classes are generally used to make land-use assessments, determine erodible areas and review land-use potential. An examination of land suitability class for a forest steppe conditions is important in the determination of land-use alternatives. By overlaying the suitability class with the land-use map, we obtained a map that highlighted those surfaces with lower suitability classes: ~1,256 ha of Class II, 3,478 ha of Class III, 2,145 ha, and 1,791 ha of Class IV. Those lands with suitability Class IV or higher are unsuitable for cultivation, and should be used for conservation practices such as grassland.

References

- Blaszczynski, J.S., 1997. *Photogrammetric Engineering and Remote Sensing* 63: 183-191.
Fix, R.E. & T.P. Burt, 1996. *Earth Surf. Processes Landforms* 20: 817-827.
Irvin, B.J., *et al.*, 1997. *Geoderma* 77: 137-154.
Lark, R.M., 1999. *Geoderma* 92: 141-165.
Park, S.J., *et al.*, 2001. *Geoderma* 103: 249-272.
Richardson, A.J., *et al.*, 1977. *Eng. Remote Sensing* 43: 207-216.
Wu, J., *et al.*, 1997. *J. Soil Water Cons.* 52: 352-358.

Organic crop rotations evaluated using LCA (Life Cycle Assessment)

L. Coletto, S. Bona, S.G. Sandrini, A. Brigi, G. Florio, P. Sambo
Dipartimento di Agronomia Ambientale e Produzioni Vegetali,
AGRIPOLIS - Facoltà di Agraria - Università di Padova,
Viale dell'Università n. 16 - 35020 Legnaro (PD), Italy
Contact: lucia.coletto@unipd.it

Introduction

Frequently, when dealing with cropping system evaluation, the focus is only on individual effects such as nitrate leaching or ammonia volatilization (Bach & Becker, 1995) although agricultural production systems may have a wide range of environmental impacts (e.g., climate change, acidification, eutrophication, etc.). The analysis of individual effects does not permit an overall evaluation from an environmental point of view. The life cycle assessment (LCA) methodology was designed to study all environmental impacts connected to an entire production system (Consoli *et al.*, 1993). In the case of cropping systems this includes not only on-field activities but also all impacts related to the production of farm inputs, such as emissions and resource consumption due to the production and transport of fertilizers.

The aim of this work was to investigate the environmental impact of different cover crops inserted in different crop rotations. We utilize LCA for analysing the different cover crops as this is a valid tool for comparing similar products and allows the identification of possible improvements of products and processes during their whole life cycle.

Methods

The LCA methodology has been applied to the crops of the rotations conducted in the Experimental Farm of Padova University (Project financed by: Progetto FISR - SIMBIO-VEG). Crops included in the LCA calculation were: the cover crops, oat-vetch-pea (OVP), rye-vetch (RV) and forage sorghum (FS); the crops, soybean (SO), maize (MA) and einkorn (EK), in comparison with bare soil (BS).

The main objective was to evaluate the environmental impacts of cover crops placed in different 3-year crop rotations representative of the current systems of the region (Table 1). The three crop rotations under control differ only for the cover crops not for the crop sequence, allowing to focus on the analysis of the effect of cover crops (in S1 and S2) compared to bare soil in the same rotation. The data represents the values accumulated since the start of field trial (September 2005) until autumn of 2008. As we worked on 3-year crop rotations and as all phases of all crop rotations were present each year, we averaged the values obtained from each rotation.

The results refer to the impact categories proposed by SETAC (Consoli *et al.*, 1993).

Table 1. Crop rotations under investigation in the organic field trial.

S1 = EK – FS – OVP – SO – OVP – MA
S2 = EK – FS – RV – SO – RV – MA
Tn = EK – BS – SO – BS – MA

Results and discussion

As expected, the lack of cover crops (Figure 1) in a crop rotation induces a decrease in the number of tillage which leads to a decrease in consumption of fossil fuels (for the construction and utilization of machineries and tractors).

Despite the significant use of fossil fuel, emission of greenhouse gases of all types of cover crops were negative, which means that crops uptake greenhouse gases (the largest amount is

attributable to CO₂). It is interesting to note that even in the case of bare soil, there is a storage of CO₂.

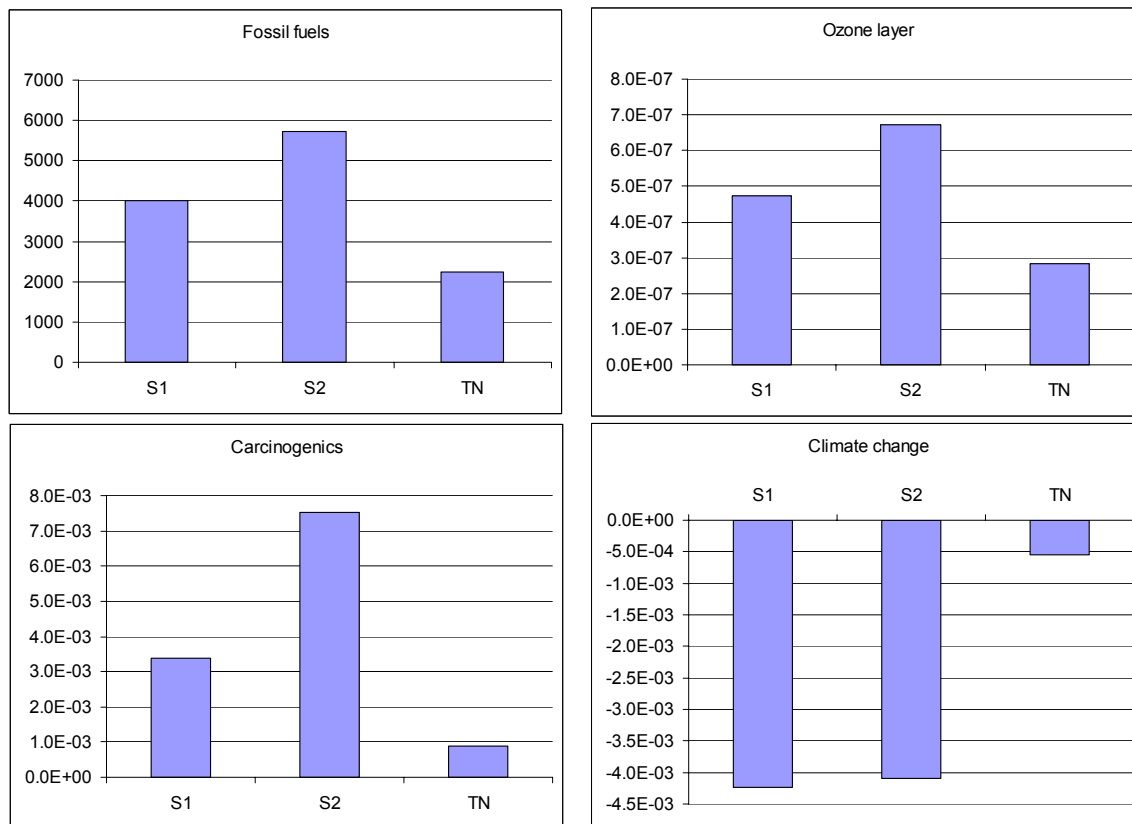

Figure 1. Amount of ‘fossil fuels’ used (MJ per hectare), gases affecting ‘ozone layer’ and ‘carcinogenics’ into the atmosphere (data expressed as years of life lost by humans) and substances affecting the ‘climate change’ (data expressed as years of life lost by humans) as a function of cover crop per hectare and per year of cultivated area.

Carcinogenic and ozone layer substances emissions (it must be note that in this category all tractors emissions and those used for constructing the tractors, for transporting, etc., are included), in the case of the two types of cover crops, were higher than those of the bare soil. This can be explained mainly by an increase of machinery utilization.

The evaluation crop production is very often limited at field level and it does not include all the processes which contribute to the emissions in all the compartments. This is especially true for organic productions. The introduction of cover crops induces positive effects on the climate change emissions (CO₂ storage in the soil) but not in terms of carcinogenics for the more elevated number of tillages.

References

- Bach, M. & R. Becker, 1995. Regional differenzierte Abschätzung des Nitratreintrages aus diffusen Quellen in das Grundwasser-Untersuchung für die Bundesrepublik (Regionally differentiated estimation of nitrate immissions to groundwater from non-point sources – investigations in Germany). Institut für Landeskultur, University of Gießen.
- Consoli, F., *et al.* (Eds), 1993. Guidelines for Life-Cycle Assessment: A ‘Code of Practice’. Society of Environmental Toxicology and Chemistry (SETAC), Brussels.

Using MASC to evaluate the sustainability of cropping systems: Application to multi-criteria assessment of organic cropping systems in Southern France

B. Colomb, F. Angevin, J.E. Bergez, M. Blouin, F. Carpy-Goulard, A. Glandières, L. Prieur
UMR 1248 AGIR, BP 52627, 31326 Castanet Tolosan, France
Contact: colomb@toulouse.inra.fr

Introduction

Cropping systems can be defined as ‘a set of management procedures applied to a given, uniformly treated area, which may be a field, part of a field or a group of fields’ (Sebillotte, 1990). Despite the importance of this spatio-temporal scale, very few tools are available to assess the sustainability of such an entity. Sustainability assessment is a typical decision-making problem requiring multi-criteria decision-aid methods (Sadok *et al.*, 2008). The availability of proper methodologies and tools to identify innovative and sustainable cropping systems is a major request from agricultural advisors. The MASC (Multi-attribute Assessment of the Sustainability of Cropping Systems) model was developed to perform a sustainability assessment of cropping systems using a multi-criteria qualitative analysis (Sadok *et al.*, 2007, 2009). The objective of this paper is to assess the ability of the model to be used by a group of organic farming advisors and to discriminate the economic performances, the social acceptance and the environmental impacts of cropping systems currently practiced on organic arable farms in southern France.

Methods

MASC has been programmed through the DEXi technology developed by Bohanec *et al.* (2008). The model is based on a decision tree that breaks the decisional problems of the sustainability assessment down into simpler units, referring to the economical, social and environmental dimensions of sustainability. The aggregation processes throughout the decision tree are based on ‘if-then’ qualitative rules, entered by the user (Sadok *et al.*, 2008). These rules reflect scientific knowledge as well as expert representations and preferences, and result in a weighting pattern of the basic attributes to calculate the aggregated ones. As input data the model requires a vector of 32 elementary criteria characterizing cropping systems (e.g., profitability; health risks; pesticides emissions; energy consumption; phosphorus use autonomy; crop diversity ...). The assessment process involves the calculation of these criteria and their homogenization into qualitative information for input into the model. The user group has to specify how qualitative criteria should be assessed, taking into account the specificities of the regional context and of the crop sequences under evaluation. Threshold values, derived from local benchmarking of performances or impacts, should be specified to get qualitative value (such as ‘low’ or ‘acceptable’) from quantitative measurements or estimates (e.g., energy efficiency ratio).

As part of a multi-disciplinary and participative research project designed to identify ways to promote organic farming in the Midi-Pyrenees Region, a group of five advisors was set up to test the model. Two members of the MASC designer group joined the advisors group to help them to fit the model to their own objectives and contexts. Fifty crop sequences were then analysed with MASC. Six crop sequences (six year long, 2001–2007) were chosen from the Experimentation and Research Center on Organic Farming located in Auch (Prieur, 2006), affiliated to the ITAB (National Organic Farming Institute). Forty-four sequences (4 year long, 2002–2005) were chosen by the advisors amongst 20 representative stockless organic farms located in the Midi Pyrenees region. The intensification levels of these crop sequences widely differed, depending on the use of off-farm N sources on cereals (bread wheat, rye), and on irrigation of pulse crops.

Results and discussion

It took four full-day work sessions for the group to fully grasp and properly parameterize the model. The economical and the social dimensions both required one day each. The other two days were devoted to the understanding and parameterization of the three components of the environmental dimension: abiotic resources conservation, biodiversity conservation and environmental quality (impacts on waters, soils or the atmosphere). For each criteria, discussions aimed at: (i) developing a common understanding of which performance or impact is under evaluation, (ii) establishing a detailed calculation procedure of the assessment indicators either qualitative or quantitative, and (iii) proposing a set of threshold values as a basis for a nominal scale. Even if it can be seen as a time-consuming process this step is fundamental as it allows participants to share the same representation of the cropping systems and of how sustainability is described.

MASC discriminated efficiently the different stockless organic cropping systems, as a function of the intensification level used by the farmers, thanks to the fine tuning of the model done by the advisors (Figure 1). The graphical representation was done using an ordinal scale

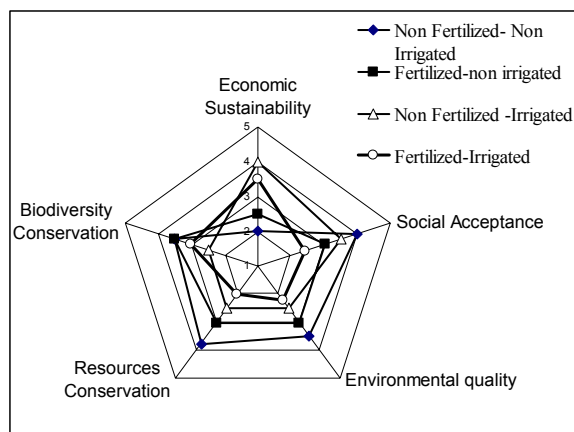

Figure 1. Comparative assessment of stockless organic cropping systems in Southern France with MASC, as a function of the intensification level.

to associate numbers to the qualitative assessments of the different indicators (1 for very low up to 5 for very high). Economic performances ranged from low to high, depending on market prices (wheat and soybean for human consumption being the most profitable crops) and the amount of European, national and local subsidies that could be captured by the organic farmers. Social acceptance for the farmers varied from low to very high, depending mainly onto the labour requirement (higher in irrigated crop sequences, since irrigation implies more mechanical interventions for weed control). The environmental sustainability varied from

medium to high, the energy balance being the main driving factor of the observed variability. The advisors gained confidence in the model as a screening tool to rank existing cropping systems and to deliver sound assessments of their sustainability. They are willing to use it in a collaborative approach with farmers to design and evaluate *ex-ante* innovative cropping systems. However, the advisors group worried about the effect of the uncertainty attached to the assessment of the basic criteria, of the location/depth of some criteria in the tree, and of the weighting pattern used for aggregation on the final rating. To tackle these issues and to better understand the model itself, different sensitivity analyses are in progress. This experiment additionally showed that an additional companion tool is needed to help calculating and managing the 32 criteria required by MASC.

References

- Bohanec, M., *et al.*, 2008. <http://www-ai.ijs.si/MarkoBohanec/dexi.html>
- Prieur, L., 2006. Organic eprints. Orgprints ID Numbers 6745.
- Sadok, W., *et al.*, 2007. In: Eds. M. Donatelli, *et al.*, Farming Systems Design 2007, Int. Symposium on Methodologies on Integrated Analysis on Farm Production Systems, 10-12 September 2007, Catania (IT), pp. 193-194.
- Sadok, W., *et al.*, 2008. *Agronomy for Sustainable Development* 28: 163-174.
- Sadok, W., *et al.*, 2009. *Agronomy for Sustainable Development*. (accepted)
- Sebillotte, M., 1990. In: Eds. L. Combe & D. Picard, *Un point sur les systèmes de culture*. INRA éditions, Paris (FR), pp. 165-196.

Building crop producers' capacity to adapt to climate change and climate variability with Yield Prophet

Zvi Hochman, James Hunt, Bill Long, Dean P. Holzworth, Anthony Whitbread,
Stephen Van Rees, Peter DeVoil
CSIRO Sustainable Ecosystems, 306 Carmody Road,
St Lucia Qld 4067, Australia
Contact: Zvi.Hochman@csiro.au

Introduction

Much of Australia's grain cropping zone has experienced a decade of below average seasons. Despite a growing awareness of the scientific evidence for climate change, there is still a great deal of uncertainty in farming communities about the relative roles of climate change and climate variability in explaining this extended period of hot and dry seasons. This uncertainty is hindering farmers from developing strategies to deal with climate change. In this paper, we describe how Yield Prophet[®] (www.yieldprophet.com.au; Hochman *et al.*, 2008), an Internet enabled user interface to the cropping system simulator APSIM (Keating *et al.*, 2003), has been further developed to provide farmers and agronomic advisers with a tool that allows them to investigate adaptation options in response to the simultaneous impacts of climate change scenarios and climate variability on future crop production in their fields.

Methods

The effect of an increase in atmospheric CO₂ concentration and temperature on wheat and barley crop growth is captured in the APSIM wheat model with two functions that influence key model parameters (Radiation Use Efficiency and Transpiration Efficiency) that were derived from literature (Van Ittersum *et al.*, 2003). Monthly mean climate change scenarios for the year 2030 are obtained from the OzClim website (www.csiro.au/ozclim/home.do) for the location of user defined patched point data set (PPD) met stations. IPCC climate change scenarios used for the report are A1F1 emissions using the GFDL-CM2.1 model with high climate sensitivity ('worst case') and B1 emissions using the NCAR:CCSM3 model with low climate sensitivity ('best case'). In order to capture the changes in extremes of the distribution of temperatures, past trends were investigated using M-quantile regressions (Breckling & Chambers, 1988) for reference meteorological data sets in each region. These transformations were then applied in conjunction with the mean monthly temperature changes (from IPCC scenarios above) to historic climate data. The historic daily rainfall series is adjusted by the monthly mean change.

Yield Prophet[®] subscribers enter paddock specific information such as soil type and nearest PPD meteorological station into the Yield Prophet[®] website. The Climate Change Report uses the user's current field's sowing date, cultivar and plant density and runs crop yield simulations comparing 100 years of historical data with 100 years of data transformed as described above for the best and worst case scenarios. The Climate Adaptation Report enables users to enter 'adaptation' strategies by changing sowing rules, cultivar, plant density, N fertilizer, tillage and stubble retention under a climate change scenario of their choosing ('best case', 'worst case' and a 'moderate' scenario represented by IPCC A1B emission scenarios using the Max Planck ECHAM5/MPI-OM model and medium climate sensitivity). Farmers or their advisers initiate reports and the information is used to generate one hundred year continuous wheat simulations in APSIM, describing wheat yield probabilities for the historic data, and the chosen scenarios.

Results and discussion

A summary of regional differences in the Australian cropping zone in both climate change impacts and in efficacies of various adaptation strategies will be presented. Outputs generated by the climate change reports include an assessment of observed climate change to date through presentation of (1) a time series and 10 year running mean of grain yield potential for the last 100 years given current crop management, and (2) a comparison of yield potential probabilities of the past 30 years compared to the previous 70 years. A forward-looking view is presented by contrasting past climate with the best and worst case scenarios for 2030 (Figure 1), which in this example illustrates the importance of a ‘stereoscopic’ view of climate change and climate variability. Contrasting yield potential of past years with that of the best case scenario for 2030 reveals a similar median yield but with greater variability and hence risk. The worst case scenario for this field is driven by lower rainfalls and higher temperatures in August, September and October, which approximately corresponds to the period of cereal crop growth from floral initiation to grain fill.

Impact of Climate Change Scenarios on Potential Yield (nitrogen unlimited) of the Current Crop

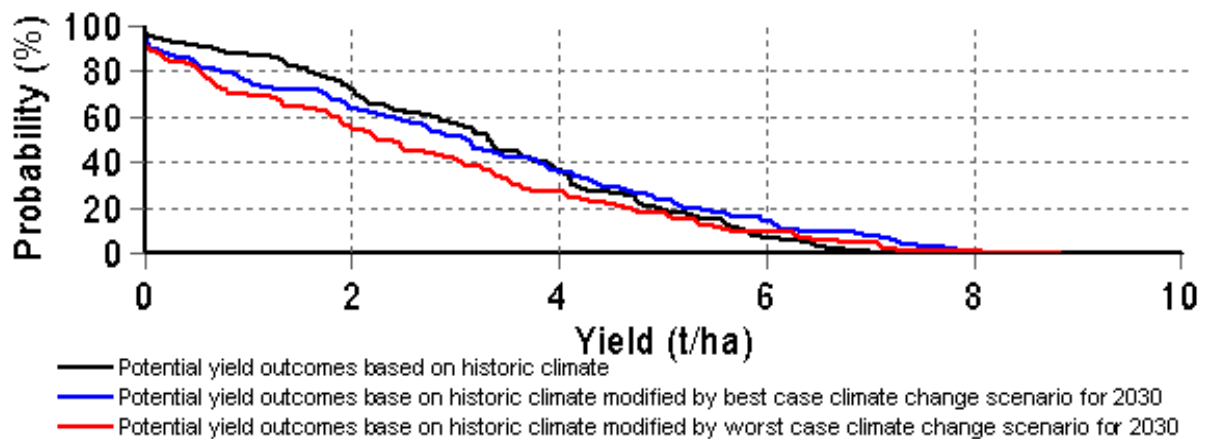

Figure 1. Yield Prophet Climate Change report output showing wheat yield implications of climate change scenarios compared with the historically based expectation for a specific field in Victoria.

References

- Breckling, J. & R. Chambers, 1988. *Biometrika* 75: 761-771.
- Hochman, Z., *et al.*, 2008. Re-inventing model-based decision support with Australian dryland farmers: 4. Yield Prophet[®] helps farmers monitor and manage crops in a variable climate. *Agricultural Systems*. (in review)
- Keating, B.A., *et al.*, 2003. *European Journal of Agronomy* 18: 267-288.
- Van Ittersum, M.K., *et al.*, 2003. *Agriculture, Ecosystems and Environment* 97: 255-273.

A decision support to choose between changes of agricultural practices: A spatially distributed Costs/Effectiveness assessment framework

J.M. Lescot, P. Bordenave

Cemagref, ADER Research Unit, 33612 Cestas Cedex, France

Contact: jean-marie.lescot@bordeaux.cemagref.fr

Introduction

Compliance with the Water Framework Directive implies a reduction of the impact of agricultural pressures on the environment. In France within the Adour-Garonne River Basin District, in most of the territories of the Pilot River Basin entitled Gascogne Rivers, pollution of drinking water by pesticides and nitrates originating from agriculture is the most important issue. Nitrogen surplus range from 30 to 80 kilograms of Nitrogen per year and for pesticides 65% of water quality controls present at least one molecule with concentration higher than 0.1 microgrammes per liter. The work from which results are presented here has been initiated first in the whole Gers river basin and is being refined in the upstream part of this basin throughout the European Life Environment project Concert'Eau¹. Here we focus mainly on the environmental and economic assessment in a spatially distributed Cost/Effectiveness (C/E) analysis framework for comparison of measures or scenarios (combination of measures) dealing with changes of agricultural practices.

Methods

Simulation and Assessment of the scenarios: a Cost Effectiveness Analysis framework

Measures considered for changing agricultural practices were already considered in the French Agro environmental programmes or totally new ones as defined by the actors. Amongst these scenarios, we can notice planting hedges around farming plots and on watercourses banks, grass strips or good agricultural practices (catch crops, long rotations, no plowing, mechanical weeding). Only results concerning the latest measures will be considered in this paper.

Effectiveness assessment - Hydrological modelling

Effectiveness of the measures on the reduction of Nitrogen and pesticides in the outlets was assessed first when measures were applied on the whole upstream part of the River Gers basin and second within this upstream part, only on zones with priority (defined for their vulnerability). Eleven standard crop rotations with management sequences were first defined in the area by Cluster Analysis and only the main crop rotation assigned to a district.

Assessment was carried out using the spatially distributed hydrological SWAT model². The comparison of the hydrological effectiveness was carried out and considered in terms of relative reduction of a particular pollutant (main herbicides and fungicides used for cereals, maize and sunflower within the basin) with the measure implementation.

Costs assessment - Economic modelling

Costs were assessed with a an aggregate-level Linear Programming modelling approach that simulates the agricultural land use at the watershed level calculating the economic returns and the costs that would result if particular measures were applied. Such model which is a widely

¹ The objective of the Concert'eau project was to develop a Collaborative Technological Platform as a decision support based first on the definition of scenarios of changes of agricultural practices by the actors, second on the economic, social and environmental simulations and evaluations of the scenarios and finally on a comparison of the scenarios regarding their economic, social and environmental efficiency assessment.

² The Soil and Water Assessment Tool model is a watershed scale model developed to predict the impact of land management practices on water, sediment, and agricultural chemical yields in watersheds with varying soils, land use, and management conditions over long periods of time.

accepted means of modelling large area (Norton & Schieffer, 1980) is developed in mix integer linear programming using GAMS software (Rosenthal, 1998). The economic assessment is achieved by modelling at the district level. Costs calculation is based on the assumption that the levels of incentive linked with the measure needed to make it appear in optimal modelled solutions represent the direct costs of its implementation. Transition from farm to district/watershed level analysis is achieved by aggregating the resources of districts and modelling the aggregated variables as a single large farm. Thus, only one standard crop rotation (as with the hydrological modelling) is assigned to a district. For construction of the technical coefficients matrix, technical data that consist of input and output flows were provided from expertise on the farming systems in the area and from technical and economical regional references on crops and livestock. Ratios between outputs and inputs have been assumed constant (deterministic model) as well as their prices using their mean value for the current year. Optimization runs for the aggregate-level watershed show the trade offs and abatement cost curves illustrating the relationship between costs and implementation of each measure for the different districts.

Results and discussion

Results of the environmental effectiveness calculations demonstrate that for the conditions prevailing in the upper stream of the Gers river, Nitrogen and pesticides loss may in some case be decreased effectively by implementing measures. For a given measure, costs of implementation may vary extremely between districts because of the distribution of crops and farming systems. Similarly effectiveness varies greatly between Hydraulic Response Units because of spatially variable catchment properties (topography and soils defining channel processes) and agricultural activities (crops and management practices) related to farming systems. For example, a longer crop rotation measure for districts with a maize as single crop farming systems will be implemented at a much higher costs than districts with already more diversified systems where costs are very low or null. Effectiveness of the measure will depend of the changes of practices, crops and land cover differently according to the various locations within the river basin. Uncertainty of models outcomes, by itself a strong concern, could be partially overcome when C/E ratios are used in comparison and not with their absolute values. A combined C/E approach could help to indicate the optimal spatial allocation of variants of farm good management practices such that desired regional and sub-regional nitrate and pesticides concentrations are obtained at minimum regional costs. Furthermore, such measures collectively defined by actors could be supposed to be more easily accepted by farmers.

Conclusion

The framework presented here could be useful for policies analysis to shed light on resource allocation problem for river basin management. The policies are envisaged here in terms of alternative allocations of resources, the objective being to find the changes of crops and practices that will contribute most to goals achievement at the minimum costs. Such approach could help water districts better target implementation of measures and financial compensation. When choosing between measures, policies should have then to consider the trade-off between costs and environmental effects, as highest environmental effects of measures could entail larger costs too.

References

- Norton, R.D. & G.W. Schieffer, 1980. *Eur. Rev. Agric. Econ.* 7: 229-265.
Rosenthal, R.E., 1998. *GAMS user's guide*. GAMS Development Corporation, 1217 Potomac Street, N.W., Washington, DC 20007, USA.

Quantification of the impacts of Cross Compliance measures on European air, soil and water quality

J.P. Lesschen, J. Kros, G.L. Velthof, D.A. Oudendag, M. Kempen, W. De Vries
Alterra, Soil Science Centre,
P.O. Box 47, 6700 AA Wageningen, The Netherlands
Contact: janpeter.lesschen@wur.nl

Introduction

The EU Cross Compliance instrument implies that farmers receive payments subject to meeting Statutory Management Requirements (SMRs) related to environment, food safety, animal and plant health and animal welfare, as well as standards of good agricultural and environmental conditions (GAECs). Within the Cross Compliance Analysis Tool (CCAT) project (<http://www.ccat.nl/UK/>) an analytical tool is being developed that enables the integrated assessment of the impact of cross compliance at different geographical scales ranging from the European (markets) to regional and farm levels. Impacts assessed by the tool include effects on agricultural markets, producer's income, land use, soil, water, air, climate, biodiversity and landscapes, as well as food safety, animal welfare and health.

This paper describes the approach and application of the environmental impact tool at European scale to evaluate cross compliance measures on environmental effect indicators. The overall objective of the modelling framework is to assess the impact of cross compliance measures on air, soil and water quality in terms of:

- Atmospheric emission of ammonia and greenhouse gases (air quality and climate);
- Accumulation or release of soil organic carbon (organic matter), phosphorous and heavy metals balances (chemical soil quality);
- Nitrogen balance and leaching and runoff of nitrogen (water quality).

Methods

For the environmental impact assessment at the European level the MITERRA-Europe model is used in combination with the agricultural sector model CAPRI (Heckelei & Britz, 2001). The MITERRA-Europe model was developed to assess the effects and interactions of policies and measures in agriculture on N losses on a regional level in the EU-27 countries (Velthof *et al.*, 2008). MITERRA-Europe is partly based on the existing models CAPRI and RAINS, supplemented with a N leaching module and a measures module. It is a deterministic and static N cycling model which calculates N emissions on an annual basis, using N emission factors and N leaching fractions. The model has been extended with a module to calculate changes in soil organic carbon stocks. The CAPRI model in combination with MITERRA-Europe outputs (manure excretion and fertilizer use) predicts: (i) cost of the measures, (ii) the changes in animal numbers and (iii) the change in crop shares, whereas MITERRA-Europe in combination with CAPRI outputs predicts the environmental indicators (see Figure 1).

The environmental impact indicators for the atmosphere are: emissions of ammonia and greenhouse gases N₂O and CH₄; for soil quality: change in soil organic carbon content in the topsoil, the balances of N and P as well as balances for the metals Cd, Pb, Cu and Zn, and for water quality the NO₃ leachate fluxes and concentrations. This paper will focus on the impacts of the cross compliance measures from the Nitrate Directive, which are balanced N fertilizer application, maximum manure N application standard, limitation to N application in winter and wet periods, limitation to N application on sloping grounds, manure storage with minimum risk on leaching, appropriate application techniques, buffer zones and growing winter crops.

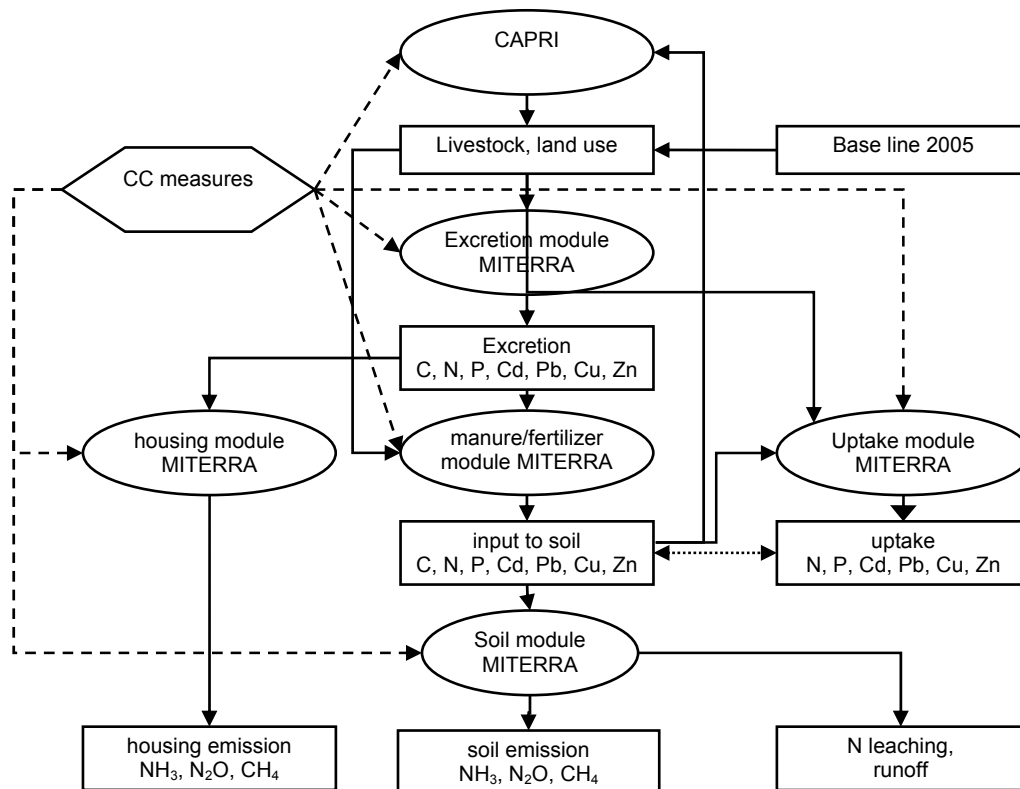

Figure 1. Approach to predict air, soil and water quality indicators within CCAT.

Results and discussion

At the AgSAP conference the quantified impacts of Cross Compliance measures on European air, soil and water quality will be presented. The results will focus on the application with measures from the Nitrate directive. The impacts of cross compliance measures on air, soil and water quality will be presented based on calculated cross compliance levels for the Nitrate Directive for 2005 (Elbersen *et al.*, 2009). In addition, the environmental impact will be simulated for scenarios with different cross compliance levels.

References

- Elbersen, B.S., *et al.*, 2009. Compliance and costs of compliance: A procedure to obtain estimates at a disaggregated level. Abstract for the Integrated Assessment of Agriculture and Sustainable Development Conference.
- Heckelei, T. & W. Britz, 2001. In: Eds Th. Heckelei *et al.*, Agricultural Sector Modeling and Policy Information Systems, Proceedings of the 65th European Seminar of the European Association of Agricultural Economists (EAAE), March 2000, Bonn. Wissenschaftsverlag Vauk Kiel KG, pp. 281-290.
- Velthof, G.L., *et al.*, 2008. Integrated assessment of nitrogen emissions from agriculture in EU-27 using MITERRA-Europe. *Journal of Environmental Quality*. (in press)

Assessment of flood prevention contribution of multi-functional agricultural land: Results of a case study in Lower Austria

J. Neuwirth, K. Wagner, H. Janetschek
Marxergasse 2, 1030 Vienna, Austria
Contact: Julia.neuwirth@awi.bmlfuw.gv.at

Introduction

Agricultural land fulfils a broad range of functions, e.g., production of food, forage and raw material, habitats for different species, space for recreation and protection against hazards. During the last years the increase of extreme weather incidents as well as flood disasters caused serious damages. In consequence this called forth increasing demands on agricultural land in terms of flood prevention and its usage for retention purposes. An ongoing discussion has started about types of land use adapted to flooding and related compensation payments. Furthermore, the new Directive on the Assessment and Management of Floods together with the existing Water Framework Directive stipulate flood risk management plans by 2015. Since suitable basics in spatial planning with respect to agricultural land are missing so far, this paper assesses the multi-functionality of agricultural lands extended by flood prevention contribution and flood sensitivity.

Methodology

The basics for our analysis are the results derived from the ILUP project¹, which has assessed the multi-functionality of agricultural land (Wagner, 2007). In the project “Agriculture and Flooding”² we adapted the underlying methodology of the ILUP project to analyse the contribution of agricultural land to flood prevention (Wagner *et al.*, 2008). In the following we overlapped the results of both projects with each other in an exemplary model region to visualize the variety of society’s demands on agricultural lands.

In order to assess the multi-functionality the model community of “Seitenstetten” in Lower Austria was subdivided into functional areas due to geomorphologic conditions and homogeneity in agricultural land use. Six main functions of agricultural land were identified: production, hazard protection, resource protection, diversity, recreation and spatial structuring. An evaluation model was developed for each function. The results of each function were transformed into a common scale from 1 (unimportant) to 5 (highly important) to facilitate a comparison of the different functions. Information for the assessment of multi-functionality originates from the Austrian digital soil map, data of the Integrated Administration and Control System (IACS), the Austrian hazard risk map, aerial pictures, the statistical census and various Austrian basic maps.

In order to assess the flood prevention contribution and the flood sensitivity of agricultural land indicators for natural properties, the flooding frequency and the type of agricultural land use were defined considering the regional data availability. For the purpose of linking these results with the results of the assessment of multi-functionality we also applied a scale from 1 (very low flood prevention and very low flood sensitivity, respectively) to 5 (very high flood prevention and very high flood sensitivity, respectively). Required information stem from the Austrian digital soil map, the digital flood risk map and from the IACS land-use data as well as from data about available water capacity and erosion (Murer *et al.*, 2004; Strauss, 2007). An overlaying of all results in the model community “Seitenstetten” using GIS reflects the broad range of functions fulfilled by agricultural land.

¹ Interreg III B project “ILUP - Integrated Land Use Planning and River Basin Management”.

² This is a sub-project of the project “Flood Risk II” by the Austrian Federal Ministry of Agriculture, Forestry, Environment and Water Management.

Results and discussion

The community was divided into three functional areas depending on geologic units and predominant land use (see Figure 1). The agricultural land of the southern area (area 1) is mostly characterized by grassland for agricultural production as well as resource protection. Diversity and recreation are at medium level while flood prevention and flood sensitivity are at lower levels. The production function dominates in the north-western area (area 2) with resource protection, diversity, recreation and spatial structuring at medium level. The contribution of agricultural land to flood prevention is low to middle, but flood sensitivity is low. The north-eastern area (area 3) also has a very high production function and diversity, recreation, hazard and resource protection show medium values. In this area the flood prevention contribution is on a middle level and flood sensitivity is low to middle.

The results show that the management of agricultural land in the sample area is already adapted to the regional flood risk: The agricultural usage of land with a higher flood sensitivity targets more on flood prevention than in areas with flood sensitivities on the lowest level. Values of flood sensitivity equal or higher than the respective values of flood prevention would have given a hint that changes in land use are urgently needed.

The developed method is an appropriate tool for assessing, comparing and visualizing various functions of agricultural land. An illustration of the multi-functionality of agricultural land is useful for setting priorities and for the development of future management plans on a regional scale. Future research of greater river catchment areas can provide indications of functional relations among different functions of agricultural lands.

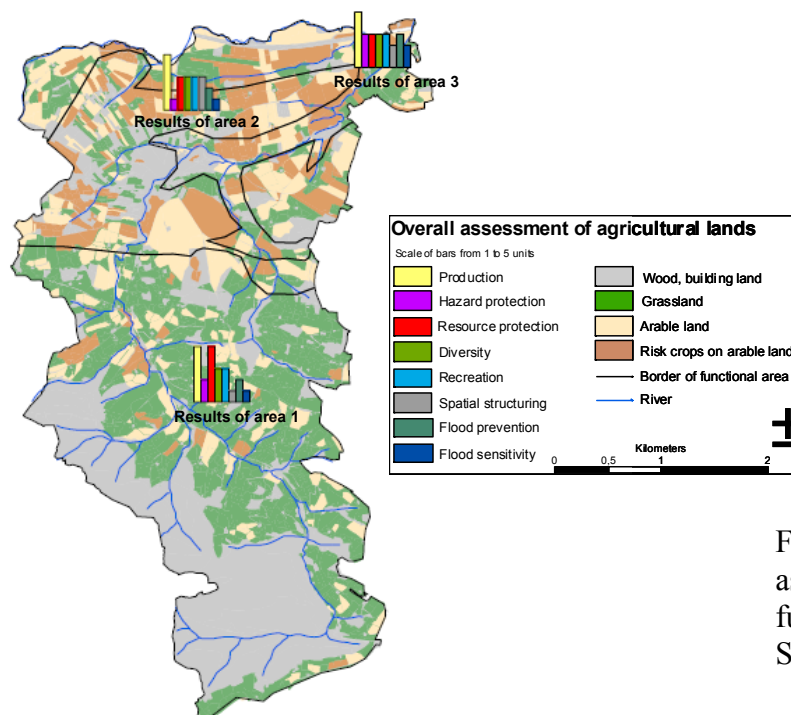

Figure 1. Results of the assessment of different functions in the community of Seitenstetten.

References

- Murer, E., *et al.*, 2004. Die nutzbare Feldkapazität der mineralischen Böden der landwirtschaftlichen Nutzfläche Österreichs. Serial publication of the Austrian Federal Agency for Water Management, Volume 20, Vienna, pp. 72-78.
- Strauss, P., 2007. Flächenhafter Bodenabtrag durch Wasser, in Hydrological Atlas of Austria, 3. Edition, Map Board 8.4. Austrian Federal Ministry of Agriculture, Forestry, Environment and Water Management.
- Wagner, K., 2007. Landwirtschaftliche Grundlagen für eine Integrierte Regionalplanung. Serial publication of the Austrian Federal Institute of Agricultural Economics, Vienna.
- Wagner, K., *et al.*, 2008. Projektforschungsbericht Landwirtschaft und Hochwasser. Austrian Federal Institute of Agricultural Economics, Vienna.

Silvo-arable agro-forestry in Europe: Systems for meeting food and industry crop requirements with improved resource-use efficiency

J. Palma, A.R. Graves, P.J. Burgess, W. Van der Werf, F. Herzog
FORCHANGE – Forest Ecosystems Management under Global Change,
Centro de Estudos Florestais, Instituto Superior de Agronomia,
Universidade Técnica de Lisboa, Tapada da Ajuda, 1349-017 Lisboa, Portugal
Contact: joaopalma@isa.ist.pt

Introduction

European agriculture is facing competing demands for food and bio-energy crops. Silvo-arable agro-forestry (SAF) integrates trees and arable crops on the same area of land. An important benefit of integrated tree and crop systems is that they can make more efficient use of resources and produce more biomass, than when grown separately. However, performance in Europe is variable and methods that combine environmental and economic indicators are needed to evaluate in what circumstances, SAF offers a viable alternative.

Method

Data on nineteen Landscape Test Sites (LTS) were randomly selected in Spain, France and The Netherlands and used with the YieldSAFE model (Van der Werf *et al.*, 2007) to predict the yield of integrated crops and trees in silvo-arable systems. Crops were grown in rotations typical of each LTS and five tree species were selected including poplar (*Populus* spp), wild cherry (*Prunus avium*), oak (*Quercus ilex*), pine (*Pinus pinea*) and walnut (*Juglans* hybr.). Tree density was assumed to be 113 trees ha⁻¹ and yields were predicted for 10% and 50% of both the least and most productive portions of each LTS. The Land Equivalent Ratio (LER, Eqn 1) was calculated for each tree and crop combination to assess biophysical benefits in comparison with arable and forestry systems, and the infinite net present value was calculated assuming no-payments, pre-2005 CAP payments, and post-2005 CAP payments, to assess economic benefits (Graves *et al.*, 2007).

$$LER = \frac{\text{Tree silvoarable yield}}{\text{Tree monoculture yield}} + \frac{\text{Crop silvoarable yield}}{\text{Crop monoculture yield}} \quad \text{Eqn 1}$$

Soil erosion, nitrogen leaching, carbon sequestration and landscape biodiversity were also assessed (Palma *et al.*, 2007a) and the environmental and economic data were then integrated in a Multi Criteria Decision Analysis (MCDA) with the outranking method 'promethee II' to assess the sustainability of each system (Palma *et al.*, 2007b).

Results and discussion

The predicted LER were consistently greater than 1, indicating that growing crops and trees in integrated SAF systems was more productive than separating them in arable and forestry systems. The LERs formed a convex arc with maximum values obtained when the trees and crops had similar relative yields, and minimum values obtained when the tree or crop components were dominant (Figure 1A). The greater productivity of SAF is primarily due to its capacity to capture more light, water, and nutrient resources per unit area than the respective monoculture systems (Cannell *et al.*, 1996). Thus, the higher LER for the SAF systems modelled here, were found to be partly due to complementary capture of light by trees and crops when they were combined on the same area of land (Graves *et al.*, 2007).

The integrated environmental and economic analysis (Figure 1B) showed that the performance rank of arable systems increased when CAP payments were included, whilst the opposite was true for the SAF, indicating that CAP payments favour arable systems. Although the post-2005 CAP reform corrects the payment distortion evident in the pre-2005 CAP

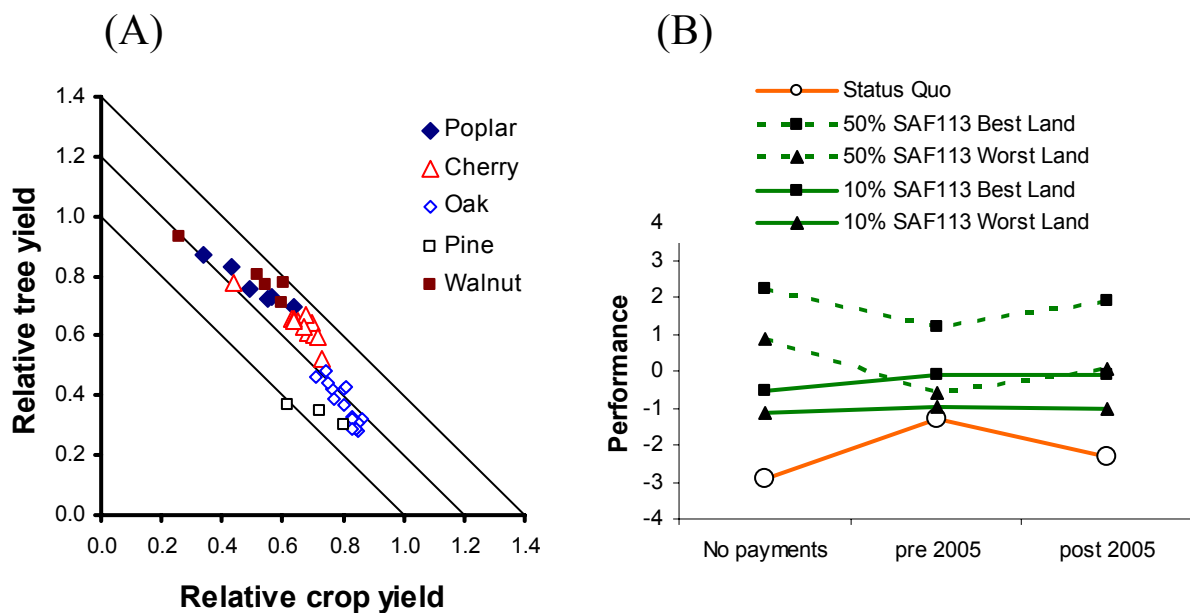

Figure 1. (A) Land equivalent ratio of silvo-arable agro-forestry plot scale results for different tree species in the system design. (B) Results from multi-criteria analysis showing performance of economic and environmental indicators under different system designs and payment scenarios in Spain, France and the Netherlands.

payment scenario, subsidies still favor conventional arable systems. Nevertheless, the evaluation for all three countries showed that SAF is preferable to the ‘Status Quo’ under all payment schemes, and that it would also be preferable to maximize use of SAF on the better land within each LTS (Figure 1B: 50% SAF113 Best Land). With its capacity to increase biomass productivity because of greater resource capture, SAF could be an important means of addressing the increased demand for bio-energy crops in Europe, at the same time delivering environmental benefits. National governments in Europe should, therefore, make use of new EU regulations that allow support for the establishment of SAF systems

References

- Cannell, M.G.R., *et al.*, 1996. *Agrofor. Syst.* 34: 27-31.
 Graves, A.R., *et al.*, 2007. *Ecological Engineering* 29: 434-449.
 Palma, J., *et al.*, 2007a. *Modelling Agriculture Ecosystems & Environment* 119: 320-334.
 Palma, J., *et al.*, 2007b. *Ecological Economics* 63: 759-767.
 Van der Werf, W., *et al.*, 2007. *Ecological Engineering* 29: 419-433.

Integrated impact assessment of agro-environmental schemes on soil erosion and water quality

M. Perugini, M. Toderi, G. Seddaiu, R. Orsini, G. De Sanctis, P.P. Roggero
Dep. of Environmental and Crop Sciences,
Polytechnic University of Marche, Italy
Contact: m.perugini@univpm.it

Introduction

The EU demands to the National authorities of the European members an ex-post evaluation of Rural Development Plans (RDPs). The EU Commission has provided a set of indicators and evaluation criteria to be adopted for the RDPs assessment (e.g., Docs. STAR VI/43517/02, VI/12004/00, VI/8865/99). An interdisciplinary team of the Department of Environmental and Crop Sciences of the Polytechnic University of Marche was mandated to carry out a quantitative evaluation of agro-environmental measures of the Marche RDP 2000-06. The aim of the quantitative evaluation was to analyse the effects of the application of the agro-environmental measures F1 (low-input) and F2 (organic farming) of the RDP on the main biophysical processes which control the impact of cropping systems on water and soil quality. Moreover this work should provide an assessment of different tools and methodologies useful for a generalization of the results at regional level.

Methodology

The assessment was focussed on the analysis of some agro-environmental indicators on soil erosion, nitrate pollution of runoff water and soil fertility. Previous research experiences in the Marche Region showed the complexity of processes which control environmental impacts and the inadequacy of EU indicators (e.g., nitrogen surplus) to explain and evaluate these processes. Cropping systems, come from interviews to farmers of the whole area, and water runoff were continuously monitored in the decade 1998-2008 in two micro-catchments (60–80 ha) of the hilly rural area of Serra de' Conti (Ancona) and in an irrigated low-land farm in a NVZ (nitrate vulnerable zone).

In the two micro-catchments we quantified soil erosion and nitrate leaching in runoff and in subsurface flow by an automatic sampler combined with a displacer meter at the close section of micro-catchments. In the NZV case study only the nitrate leaching was monitored. One of the two micro-catchments is characterized by a high diversification of the land use with the presence of an organic farmer who grows legumes and perennials like vineyard. The second one is more intensive with a biennial rotation between durum wheat and a spring crop. Cropping system were also monitored by surveys, in particular crops, N inputs and outputs were determined to calculate the nitrogen surplus, one of the key indicators for impact assessment in the EU STAR documents.

The results of the monitoring systems were also used to calibrate and validate two mathematical models, EUROSEM and DSSAT for soil erosion and N leaching simulation under different cropping systems adopted within the RDP.

The agro-environmental schemes evaluation aimed also to assess the relationship between cropping systems and plant and animal biodiversity through the application of an innovative methodology based on the quantification of several bio-indicators such as carabids beetles populations and maturity indexes of the vegetation. These aspects are not reported here.

In order to achieve a deeper analysis of the complex system of interest and to take into account the social, political and human dimension of the studied environmental issues, a system thinking methodology as Soft System Methodology (Checkland & Scholes, 1999) was explored throughout the assessment.

Results

The synthesis of the results of the impact assessment of the agro-environmental measures on soil erosion and water quality are reported in Table 1.

Table 1. Main results of the impact assessment of the agro-environmental schemes on water quality and soil erosion.

Environmental issue	Main results
Water nitrate pollution	<ul style="list-style-type: none"> - the more diversified was the catchment (in terms of number of crops) the lower was the N surplus at the same environmental conditions - organic farming led to a reduction of N surplus up to 200% compared to the traditional farming systems at catchment scale - in low-land intensive farming systems, low impact farming practices led to have less than 10 kg ha⁻¹ of N surplus - according to model simulations, in low-land intensive farming systems, organic farming could lead to higher N leaching risks than low impact practices (+52%) during autumn due to the mineralization of the buried crop residuals and simultaneous soil water surplus and bare soil - the percentage of bare soil during sensitive periods is a key factor to influence N leaching as well as crop diversification at catchment scale
Soil erosion	<ul style="list-style-type: none"> - the more diversified was the catchment the lower was the soil erosion at the same environmental conditions - soil erosion could be reduced by -33%÷-21 in relation to crops spatial distribution in the catchment - soil erosion was not influenced by N fertilization reduction - soil erosion occurred occasionally in relation to intense rainfall and proportion of bare soil at catchment scale - permanent crops could lead to a reduction of soil losses up to 90% compared to a bare soil at catchment scale

Conclusions

The integrated impact assessment of the agro-environmental schemes of the Marche RDP 2000–06 showed that one of the key factors controlling soil erosion and water pollution by nitrate is the degree of temporal and spatial diversification of cropping systems, particularly in hilly areas and in complex systems such as organic farming. However, a better distribution of same crops in time and space is still not taken into account in the more recent agro-environmental schemes (e.g., RDP 2007–2013) and also by EU. In fact the incentives promote the substitution by crops which are considered to have less impact on the environment. Interventions favouring temporal and spatial diversification of cropping systems would guarantee a more efficient use of funding resources and achievement of the schemes objectives. Mathematical models application at field level and single crop as Marche Region asked, showed that organic farming practices for durum wheat and corn within the agro-environmental scheme would lead to a higher environmental impact than low impact measures, since it did not consider the overall changes in farming practices, included changes in crop rotations, related to the adoption of organic farming. The monitoring at catchment scale allowed to take into consideration the changes associated to organic farming adoption showing a general positive benefit of their application. Therefore, a stand-alone model-based approach, could lead to a misinterpretation of the whole impact of agro-environmental measures.

Reference

Checkland, P. & J. Scholes, 1999. Soft systems methodology in action. J. Wiley & Sons, West Sussex, England.

Assessing the effects of Cross Compliance obligations on European biodiversity and landscapes

J.J. Oñate, B.S. Elbersen, P. Martinez Alonso, B. Peco, J. Roos-Klein Lankhorst
Universidad Autónoma de Madrid, Ciudad Universitaria de Cantoblanco, 28049-Spain
Contact: juan.onate@uam.es

Introduction

Despite the increasing consideration of environmental issues in the successive reforms of the European Common Agricultural Policy (CAP), the dual process of intensification and abandonment driven by its economic incentives has continued to entail profound changes in the European agro-ecosystems over the last decades. The Structural and Sustainable Development Indicator 'Farmland Birds' (EC, 2005), continues to worsen (EEA, 2006) also despite the spatial importance of those agricultural systems usually characterized as extensive (EEA, 2004). In this paper we assess the effects on biodiversity and landscape that could be expected from the most recently introduced CAP instrument targeting environmental preservation, namely the Cross Compliance policy (hereafter CC).

CC was introduced as part of the 2003 CAP Reform (Regulation 1782/2003). It involves Member States making receipt the Single Farm Payment (SFP) conditional on farmers meeting two sets of obligations: (a) the Statutory Management Requirements (SMRs), related to 19 pieces of EU environmental, public, animal and plant health and animal welfare legislation (listed in Annex III of the Regulation); (b) the Good Agricultural and Environmental Conditions (GAECs), related to the appropriate management of soils and the minimum maintenance of agricultural land and its features (Annex IV). Since SMRs and GAECs obligations apply to all farmers claiming the SFP and to the entire farm holding, CC is likely to impact, to a greater or lesser degree, on most of the processes related to European agriculture which are affecting biodiversity or landscape. This paper presents a methodology to qualitatively assess these impacts and shows preliminary results of this assessment.

Methods

Past experience in scientifically assessing the impact of agriculture on biodiversity and landscape has relied in the approach Before-After Control-Impact (BACI approach, e.g., Bro *et al.*, 2004). This consists in the comparison of trends in biodiversity on treatment fields and control fields both before and after implementation of the considered treatment. This *ex-post* approach has been applied to the impact assessment of agri-environmental schemes, yet on the basis of pressure (e.g., Primdahl *et al.*, 2003) or state (e.g., Kleijn *et al.*, 2006) indicators.

However, the application of BACI approach to the assessment of CC effects is not feasible at the moment because baseline data on the state of biodiversity at the field level before CC implementation are rarely available and because there are not fields without treatment available to perform the comparison, since CC obligations are compulsory for all farmers in any given region. Alternatively, we have applied an *ex-ante* assessment approach through the use of pressure indicators on the basis of literature analysis and expert knowledge (e.g., Llusia & Oñate, 2005; Petit & Elbersen, 2006).

Our analysis focuses on those SMRs and GAECs targeting the preservation of landscapes and biodiversity (Birds and Habitats Directives, and GAECs targeted on habitat/landscape preservation, including, e.g., measures against soil erosion). The assessment is performed in the following steps: (1) Collection of concrete CC obligations promulgated by Member States or regions; (2) Identification and qualitative assessment of the potential effects of each obligation; (3) Weighting of potential effects according to UAA; (4) Translating the potential effectiveness to an expected effectiveness per region; (5) Aggregation of results to compute the final expected effectiveness.

For the identification of potential effects, we have considered both, direct effects on species and/or habitats listed in the Birds and Habitat directives, and indirect effects on biodiversity and landscape through changes in the structural and/or functional characteristics of the agro-ecosystems. The potential effect of each obligation has been categorized in one out of four semi quantitative classes (0, 1, 2, 3) and applied to the impact fields biodiversity and landscape separately. Then the effect of each obligation has been weighted by the regional UAA where it is to be implemented to obtain a potential effectiveness, under the logic that the greater the targeted UAA, the higher the effectiveness will be. Both, share of UAA and absolute hectares of UAA at NUTS2 level are considered as weighting factors, reflecting respectively the magnitude and the extent of the potential effects.

To come from a *potential* effectiveness to an estimate of the *expected* effectiveness, the potential effectiveness is multiplied by the level of compliance with the evaluated obligation, collected from Member States. Different scenarios are considered, including the baseline compliance situation in 2005, and 75% and 100% compliance.

The expected effectiveness is then expressed in aggregated terms for each impact field (biodiversity or landscape), according to the expression:

$$\text{ExpEff}_j = \sum_{i=1}^{i=n} ((PE_i * UAA_i) * CL_i)$$

Where, *ExpEff* is expected effectiveness for impact field *j*, *i* is each considered obligation, *PE_i* is the potential effect for obligation *i*, *UAA_i* is the share or ha of UAA targeted by obligation *i*, and *CL_i* is the compliance level reported for obligation *i*.

Subsequent aggregations of results are computed adding the expected effectiveness values for different impact fields under each directive or GAEC groups, and finally in a total figure of CC expected effectiveness per region and scenario.

Results and discussion

Expected effectiveness of CC obligations on the preservation of landscapes and biodiversity varies strongly among regions in Europe. This is especially caused by differences in the way national and regional authorities have defined SMRs and GAEC obligations in their implementation of CC. Nevertheless, remarkable differences in effectiveness among SMRs and GAECs related obligations appear even inside a single region. These differences are discussed and recommendations are made.

References

- Bro, E., *et al.*, 2004. Journal of Applied Ecology 41: 846-857.
- EC, 2005. Sustainable Development Indicators to monitor the implementation of the EU Sustainable Development Strategy. SEC(2005) 161 final. Commission of the European Communities. Brussels.
- EEA, 2004. High nature value farmland. Characteristics, trends and policy challenges. European Environment Agency, Office for Official Publications of the European Communities. Luxembourg.
- EEA, 2006. Species diversity (CSI 009) - Assessment DRAFT created May 2006. European Environment Agency, Available at: <http://themes.eea.europa.eu/indicators/>
- Kleijn, D., *et al.*, 2006. Ecology Letters 9: 243-254.
- Llusia, D. & J.J. Oñate, 2005. Ardeola 52: 31-42.
- Petit, S. & B.S. Elbersen, 2006. Ambio 35: 297-303.
- Primdahl, J., *et al.*, 2003. Journal of Environmental Management 67: 129-138.

Integrated model of paddy rice production and related environmental effects

Hiroki Sasaki

OECD Directorate for Trade and Agriculture
2, rue André-Pascal 75775 Paris Cedex 16, France

Contact: hiroki.sasaki@oecd.org

Introduction

Lankoski & Ollikainen (2003) have developed an analytical framework for analysing joint production of commodity and non-commodity outputs as well as negative externalities under heterogeneous land quality and this is the point of departure for this modelling analysis.

In the model, the optimal land use allocation and nitrogen application were considered under a representative Japanese farm that consists of paddy field and upland production.

Methods

The model consists of a quadratic nitrogen response function for cultivated crops and exponential nitrogen runoff (purification) function, damage functions from nitrogen runoff and benefit functions from nitrogen purification. By assumption, there are 60 land quality classes consisting of parcels of size of 10a each, so that the overall amount of the agricultural land is 6 ha. The sums of consumer and producer surplus are maximized under exogenous crop prices and input costs. The social welfare function for agriculture can be expressed as

$$SW = \int_0^1 \sum \pi^i + 6563z_1 - 650z_2 \quad \text{for } i=1,2$$

where, π^i denotes farmer's profit function, z denotes the nitrogen runoff (purification) and social value of marginal benefit which is estimated on the basis of Shiratani *et al.* (2004). Monetary value of nitrogen runoff and purification per kg are given by -650 JPY kg^{-1} and $+6563$ JPY kg^{-1} , respectively.

Results and discussion

Preliminary results reveal that under the private optimum fertilizer use is higher than under the social optimum. Under the social optimum, more land is allocated to paddy fields due to their positive (i.e. reduced negative) environmental externalities. Paddy fields even remove N when the N application is below 11.2 kg per 10a, according to the estimated N runoff functions. It is well known that paddy fields could function as an N purification type of land use, but this depends on the types of agricultural activities and nitrogen concentrations of irrigation waters.

Table 1. Input use and land allocation: comparing private and social optima.

Optimum	Parcels		Nitrogen runoff (kg)		Profit (000JPY)	Runoff damage/ purification (000JPY)	Social welfare (000JPY)	SW/SO
	Rice	Wheat	Rice	Wheat				
Private optimum	44	16	-1	153	1873	-92	1781	0.84
Social optimum	60	0	-48	0	1823	310	2133	1.00

In the next step, additional externalities, such as GHG emissions and sequestration and biodiversity (measured by indices), will be incorporated into the model. Then the effects of alternative agri-environmental policies will be analysed.

Japan is now undertaking market-oriented agricultural policy reforms and accelerating the implementation of agri-environmental policies. The present farm level model could provide valuable new insights into the design for mixed-policies.

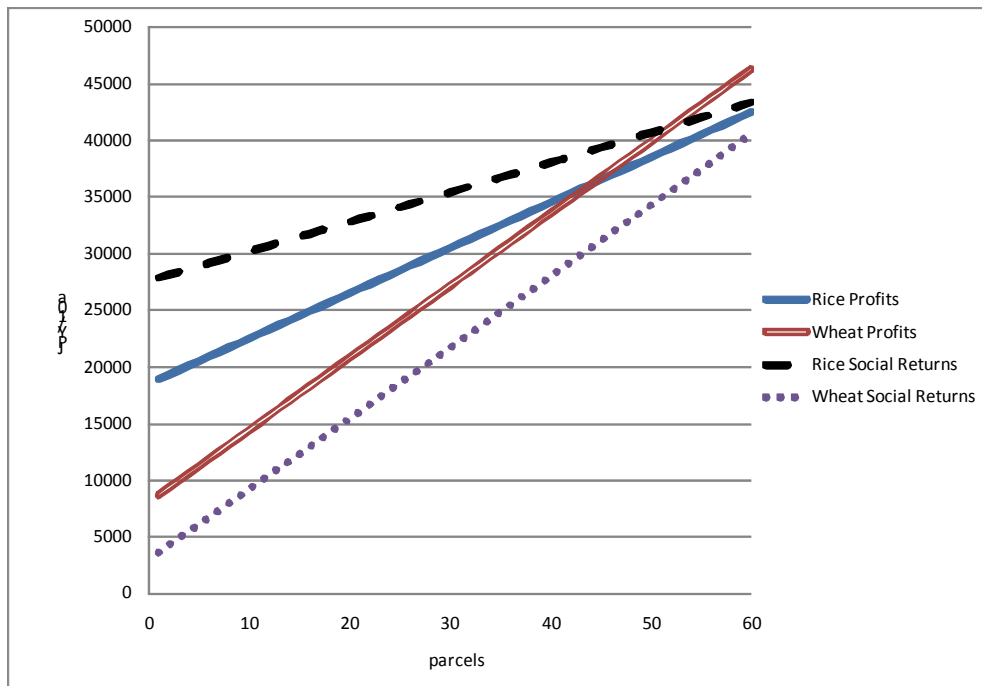

Figure 1. Private profits and social returns.

References

- Lankoski, L. & M. Ollikainen, 2003. *European Review of Agricultural Economics* 30: 51-75.
 Shiratani, E., *et al.*, 2004. *Journal of Japan Society on Water Environment* 27(7): 491-494.
 (in Japanese with English summary)

Can regional policies mitigate the environmental effects of price raise? A typical application of SEAMLESS framework at meso level in Auvergne

N. Turpin, J.P. Bousset, G. Bigot, E. Josien, E. Perret

Nadine Turpin, UMR 1273 Métafort, 24, Avenue des Landais, 63172 Aubiere Cedex, France

Contact: nadine.turpin@cemagref.fr

Introduction

Growing concern for the local competition for resource allocation between economic development and natural resource restoration highlights the difficulties of coordinating agricultural and environmental policies at EU, national and regional levels. More precisely, local policy makers have to face the general evolution of economic forces (like prices changes, increased competition between countries for labour and resources use), they have to coordinate their action with EU wide policies, and operate through specific regional stakes. This paper explores the ways a regional agro-environmental policy can improve the sustainability of the farming systems in a region, in a context of general food price increase and related environmental threats. The newly developed SEAMLESS integrated framework (Van Ittersum *et al.*, 2008) provides interesting features to address this multi-scale issue.

Methods

The region of the Mountains and Uplands of Auvergne has been selected because of its specific livestock production, essentially milk production for typical cheeses and grass calves production, produced with labels like Protected Designation of Origin. The main stakes for this region are the preservation of the high level of biodiversity, the natural landscapes and the water quality with a stabilization of the rural population.

We assume in this paper that the level of increase for agricultural products prices and for production costs modifies the relative profitability of agricultural production over Europe. Following Bigot *et al.* (2008), the expected effects in France are a shift of breeding activities towards the western part of the country, where breeding activities are highly competitive, and towards mountainous areas where it is possible to supply high quality cheese and meat (and where crops become less and less profitable because of climate and mechanization difficulties).

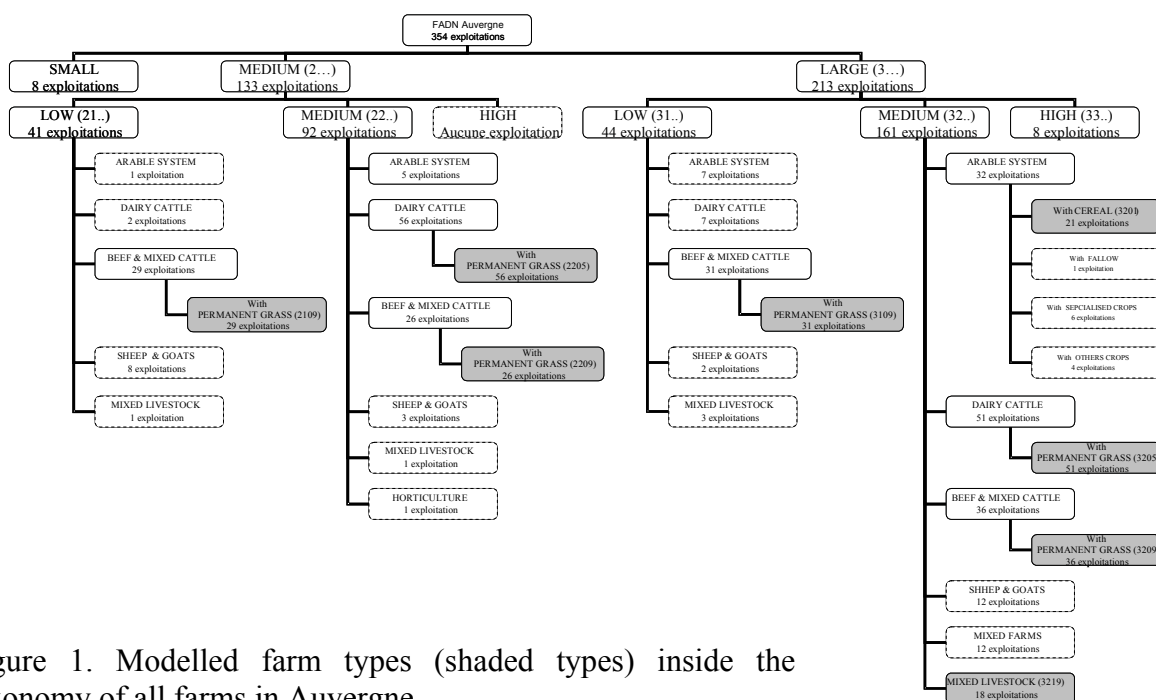

Figure 1. Modelled farm types (shaded types) inside the taxonomy of all farms in Auvergne.

In mountainous areas, increasing the breeding activities may hamper the environment quality, so we explored the possibility of designing agro-environmental schemes that enable breeding intensification with respect to the environment quality. The policy option takes the form of a regional premium targeted to farmers who limit their inputs, such as fertilizers and fuel.

So far, the farms in Auvergne are represented using eight farm types (see Figure 1), including one arable farm and seven breeding farms (dairy and beef farms that differ in their intensity). With the Farm System Simulator (FSSIM, see Louhichi *et al.* (2007) for a complete description of the model), we compared several levels of price increase, of production costs increase and of premium levels, associated with various levels of constraints for the farm, and we analyse which FADN farm types commit themselves to the agro-environmental scheme. The simulations are formulated on the period 2003–2013 with the application of the 2003 CAP reform.

Results and discussion

The results highlight that the modelled farms commitment to the agro-environmental scheme is strongly dependant on the level of farm production prices, the relative level of production costs, and of course the premium level (see Figure 2 for the adoption scheme for the arable farm type).

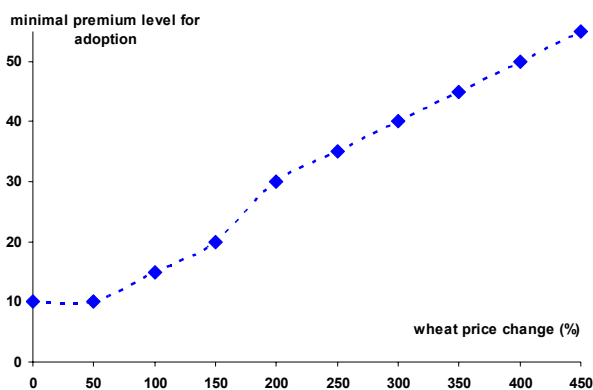

Figure 2. Wheat price change and minimal level of the regional premium for the arable farm type to commit

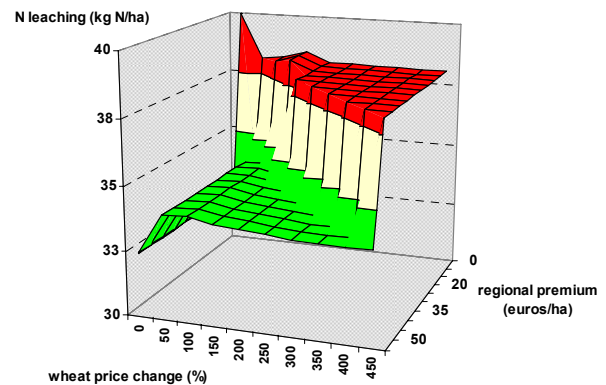

Figure 3. Consequences of the arable farm type commitment on N leaching.

More important, the farm types that adopt the regional agro-environmental scheme (for a given premium) are not the same depending on the relative increase of prices for products and production costs. The environmental effects are thus very sensitive to these assumptions, and the modelling framework enables analysing the trade-off between farm income and environment effects of the policy options. Last, the modelling outputs can help policy makers to design efficient policies as soon as they rely on accurate spatial farm typologies.

References

- Bigot, G., *et al.*, 2008 A typical application of SEAMLESS-IF at Meso level: the Green Intensification scenario applied in Auvergne, SEAMLESS integrated project, EU 6th Framework Programme, contract no. 010036-2, www.SEAMLESS-IP.org, 34 pp.
- Louhichi, K., *et al.*, 2007 A generic Template for FSSIM for all farming systems, PD3.3.11, SEAMLESS integrated project, EU 6th Framework programme, contract no. 010036-2, www.SEAMLESS-IP.org, 82 pp.
- Van Ittersum, M.K., *et al.*, 2008. *Agricultural Systems* 96: 150-165.

Theme C
**Case studies and application of tools and
empirical methods**

**Session C4: Systems analysis informing policy:
Case studies from agricultural systems and rural regions
in the face of change**

Session organizers:

Brian Keating

CSIRO, Sustainable Ecosystems, Brisbane, Australia

Pablo Tittonell

CIRAD, Montpellier, France

Systems analysis informing policy¹

David Pannell

School of Agricultural & Resource Economics, Univ. Western Australia,
Crawley 6009, Australia

Contact: David.Pannell@uwa.edu.au

Good policy needs good science, particularly good systems analysis. In practice, science is often lacking, and systems analysis can be particularly lacking. For example, in agri-environmental policy, the science used often relates to the level and timing of environmental threats, but much less often is there a systems analysis conducted to assist with understanding of the impacts of alternative agricultural management practices on desired policy outcomes.

A large number of reasons have been identified why it can be hard for science (in general, not just systems analysis) to connect with Policy, including the following:

- Non-scientific considerations matter, such as legal mandates, societal desires, economic benefits and costs, rights, distributional equity and procedural fairness.
- There may be political or bureaucratic objectives unrelated to the public interest, so that research that seeks to advance the public interest is not wanted.
- Policy attention tends to be directed to certain issues with high currency, especially crises, and this may leave little scope for research in other areas to influence policy at that time.
- “The capacity of science to provide information may require more time than policymakers are willing to accept, especially for politically hot issues” (Clark *et al.*, 1998).
- Policymakers often rely primarily on locally based and trusted experts with whom they are familiar.
- There may be suspicion about motivations of scientists, so that they are treated as just another interest or lobby group.
- “University reward systems rarely recognize inter-disciplinary work, outreach efforts, and publications outside of academic journals” (Jacobs, 2002).
- Research findings may be communicated in ways that policymakers cannot understand, using jargon, technical language, or mathematics.
- In some situations there is rapid turnover or movement of staff in government policy agencies, leading to lack of expertise by responsible staff.

Systems analysis can contribute to overcoming a number of these barriers to uptake. For example, the following common features of systems analysis are valuable in this regard:

- Taking a solution-oriented approach.
- Working with intended users. This will help to ensure that the solution being proposed is in fact practical and sufficiently simple and can a researcher’s credibility with policymakers.
- Distinguishing between knowledge and values.
- Working as a multidisciplinary team. A team that includes ‘integrators’ can span the disciplines and draw them together in a way that is relevant to policy.

On the other hand, there are some requirements of good policy engagement that are not necessarily met by systems analysts, and to which they need to pay particular attention:

- Understanding the policymaker’s perspective.
- Ensure communication is brief, with clear messages, using simple language, free of jargon.
- Developing relationships with policymakers to establish mutual understanding and trust.
- Keeping communications and the solutions that one offers as simple as possible.

¹ Keynote presentation

- Being pragmatic and accepting compromise.
- Being patient and persistent.
- Being resilient. Numerous problems, frustration and setbacks will arise.
- Being prepared to respond quickly to requests for information.
- Identifying and cultivating a champion for your work within the policy organization.
- Avoiding any appearance of vested interest.

Change is a constant reality in the world of agri-environmental policy. Economic, social, political and physical conditions change over time, and policy must adapt. Systems analysis is a particularly valuable tool under conditions of change, providing a means to integrate existing knowledge and predicted changes in a problem-solving framework that can assist policymakers to consider the changes properly. On the other hand, the time frame for policy development is often short, and sometimes is extremely short, providing little opportunity for new analyses to be conducted to address current pressing policy issues. This highlights the need for analysts to be ahead of the game if possible, or at least well tuned into current policy concerns and ready to respond rapidly.

An Australian case study is outlined, where systems analysis is used as a core element of a strategy to attempt to influence agri-environmental policy. Since 1990, the main environmental programs for rural Australia have been very poorly informed by science, and by systems science in particular. Since 2000 the author has been attempting to alter this. The efforts have involved various forms of systems analysis, from complex to simple, with the simple tools proving to be particularly important for policy engagement. For example, detailed farm-level bio-economic modelling was used to investigate the economic attractiveness to farmers of a range of farming practices needed to improve management of dryland salinity. A catchment scale model was used to estimate trade-offs between river salinity, water yield, and farm economics. Simple graphical tools were developed to assist policymakers to understand the benefits of salinity mitigation in different circumstances, and to assist with the selection of appropriate policy tools.

The author had intensive involvement with both environmental managers and with policymakers at national, state and local levels, and attempted to put into place all of the strategies described above. The success of these efforts has been encouraging, and is still growing. These experiences will be described and lessons highlighted.

References

- Clark, R.N., *et al.*, 1998. Integrating science and policy in natural resource management: Lessons and opportunities from North America. Gen. Tech. Rep. PNW-GTR-441. Portland, OR: U.S. Department of Agriculture, Forest Service, Pacific Northwest Research Station, 22 pp.
- Jacobs, K., 2002. Connecting science, policy and decision-making: A handbook for researchers and science agencies. NOAA Office of Global Programs, Boulder, Colorado, 25 pp.

Assessing poverty-sustainability trade-offs in semi-subsistence agricultural systems: A case study of policy options in Machakos, Kenya

J.M. Antle, J.J. Stoorvogel, R.O. Valdivia
Montana State University, Bozeman, MT 59717 USA
Contact: jantle@montana.edu

Introduction

There is a growing demand for quantitative policy analysis that can address environment-poverty trade-offs in the poorest regions of the world (World Bank, 2008). This paper uses an econometric-process simulation model (Antle & Capalbo, 2001) with the Trade-off Analysis software (Stoorvogel *et al.*, 2004) to implement spatially-explicit integrated assessment models of semi-subsistence agricultural systems. We use this model to investigate the potential impacts of technology and policy options being considered by the Government of Kenya to address poverty and sustainability in the agricultural systems of Machakos, Kenya.

Methods

Modelling semi-subsistence agricultural systems (SSAS) poses special challenges that have not been addressed adequately in the recent literature. SSAS typically involve complex patterns of inter-cropping, exhibit high rates of crop failure, use non-essential inputs such as mineral fertilizer. Often SSAS involve dynamically interacting crop and livestock sub-systems, as crop residues are fed to livestock and manure is used to recycle organic matter and nutrients back to crops. To be able to analyse impacts on poverty, a whole-farm approach is needed that integrates crops and livestock and also accounts for off-farm income.

In this paper, we utilize a spatially-explicit econometric-process simulation model to implement policy analysis of SSAS. The case study utilizes data collected by the Nutrient Monitoring (NUTMON) project (De Jager *et al.*, 1998). In related work, procedures were developed to extract data from the NUTMON system (Vallejo *et al.*, 2009) so that they could be utilized with the Trade-off Analysis (TOA) modelling system. The TOA software is used to simulate the system by integrating spatially-referenced data with site-specific biophysical models (crop growth, nutrient balance) and economic models.

Results and discussion

We consider technology policy interventions identified by the NUTMON research team's interactions with stakeholders ranging from farmers to government officials, as well as the Government of Kenya's official policy documents. The policy options include enhancing prices of key cash crops, such as maize and vegetables, making mineral fertilizer available to all farmers at lower cost (e.g., by reducing import impediments and improving transportation and marketing infrastructure, credit availability, etc.), and increasing organic nutrient intensity and per capita incomes through policies that increase farm size (e.g., by promoting rural development and off-farm employment opportunities).

An illustrative result is presented in Figure 1. These curves show the relationship in the Machakos region between the poverty rate and soil nitrogen depletion (kg N season^{-1} , estimated by the NUTMON model) constructed by varying the maize price above and below its base value (the mid-point represents the base price), for the base scenario, for a fertilizer use scenario, for a rural development scenario, and for the two scenarios combined. In the fertilizer scenario, fertilizer prices are reduced by 50% and all farmers use a positive quantity of fertilizer as determined by their fertilizer demand functions (as compared to only 30% using a positive amount in the base population). The rural development scenario assumes that household size is reduced by 25% and that average farm size is doubled. The results show a trade-off between poverty and sustainability (except at high maize prices, where nutrient

applications are high enough to offset export of nutrients through grain harvested). The fertilizer use and rural development scenarios have substantially different impacts on poverty and nutrient depletion. The two policies combined clearly have the greatest impact on both dimensions.

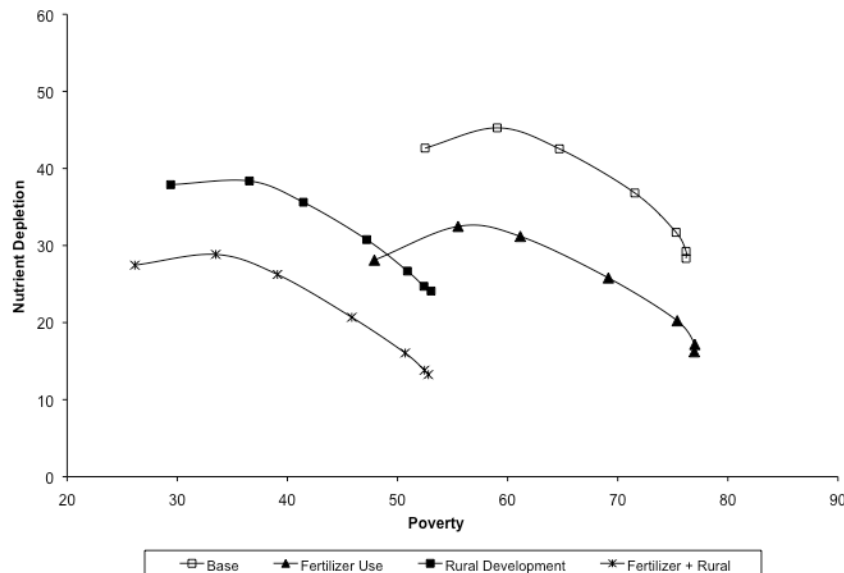

Figure 1. Relationship in the Machakos region between the poverty rate and soil nitrogen depletion (kg N season⁻¹, estimated by the NUTMON model).

Discussion

This paper uses a spatially-explicit integrated assessment model to investigate the impacts of technology and policy options on poverty-sustainability trade-offs in Machakos, Kenya. Results suggest substantially different impacts of fertilizer use and rural development policy interventions on poverty and sustainability, and indicates that a multi-faceted development policy would be most effective at reducing poverty and enhancing sustainability. Analysis also suggests a positive, win-win outcome (lower poverty and nutrient depletion) would be possible with policies that would improve vegetable prices and increase investment in irrigation for vegetable production.

References

- Antle, J.M. & S.M. Capalbo, 2001. *American Jour. of Agric. Economics* 83(2): 389-401.
- De Jager, A., *et al.*, 1998. *Agriculture, Ecosystems and Environment* 71(1-3): 37-48.
- Stoorvogel, J.J., *et al.*, 2004. *Agricultural Systems* 80(1): 43-66.
- Vallejo, A.M., *et al.*, 2009. *Agricultural, Ecosystems and Environment*. (revision submitted)

Performance analysis on the changes of farmland property right system: An explanation of the diversification of Chinese farmland system in transition

Zhigang Chen, Futian Qu, Xianjin Huang

Department of Land Resources and Tourism Sciences, Nanjing University, Hankou Road 22,
Nanjing 210093, P.R. China
Contact: zgchen@nju.edu.cn

Introduction

Since the household contracted responsibility system was carried out across China, various innovations in farmland tenure system aiming at improving the household contracted responsibility have appeared in different areas of China. Generally speaking, 'the two-field system' is carried out in most areas, the scale management and stock cooperation system are implemented in coastal developed areas, the auction of the use right of 'four wastes' (including barren hills, barren hillsides, barren hillocks and desolated beaches) is put into practice in the less developed north-western and south-western China regions which have vast land and small population (Zhang, 2001). These innovative forms of the farmland system with different emphases on the rights of the farmland have made great achievements in their respective representative regions. However, they do not have generality in China whose regional differences are so great, but often they are the institutional arrangements in a specific period and region. Why do these systems have eminent performance in one area but little performance or even negative effects in another area. This paper tries to explain the diversity of the farmland tenure systems through the performance analysis on the changes of farmland property right system.

Methods

According to theories of neo-institutional economics, the emergence of an institution is inevitably in accordance with people's demand for the institution which will produce the corresponding performance (North, 1990). Therefore, a theoretical hypothesis is made that in different areas with different economic development, the demands of the people for the use right, transfer right and benefit right of the farmland are different and this difference is the main reason for the innovation of the farmland tenure system with different emphases on the rights of the farmland.

In order to test the above theoretical hypothesis, an econometric analysis on changes of the farmland system and farmland performance is made. The basic model chosen to conduct the empirical analysis is Cobb-Douglas production function with variables representing the farmland property right. The econometric model can be written as follows:

$$\ln Y = C + a_1 \ln L + a_2 \ln F + a_3 \ln M + a_4 USE + a_5 TRAN + a_6 TAX + e_i$$

where, Y means the output of farmland, L , F and M mean the labour force and capital input (including fertilizer and agricultural machinery), respectively. The use right (USE) is reflected by the left time limit of the land use right, which can represent the peasants' confidence in the reliability of the use right. The transfer right ($TRAN$) adopts dummy variables and the value is 1 from 1995 and the previous years are all 0. Benefit right can be measured by the burden of the agricultural tax (TAX). C is the constant term, and e_i is the random disturbance term.

The data for model estimation are the panel data of several provinces of China in recent 22 years. Therefore, this paper estimates the above econometric model of the areas with different economic development respectively using the fixed effects model and the random effects model of the panel data.

Results and discussion

The estimated results show that the fixed effects model is better than the random effects model. Table 1 lists a part of estimated results of the fixed effects model. It is concluded that the peasants in different areas have different demands with regard to the use right, the transfer right and the benefit right of the farmland. It is just this different demand that the improvement of various rights in the changing process of the farmland system has different degree of influences on the performance of the farmland. Specifically, no matter developed areas or underdeveloped areas, the improvement of the use right of the farmland is very important to the peasants; the improvement of the benefit right of the peasants is more in agreement with the will of the peasants in the less developed areas; the evolution of the transfer right has a more significant influence on the performance of the farmland in the developed areas. So the research conclusions of this paper to some extent give a reasonable explanation to the diversification of the innovation of Chinese farmland system.

Table 1. The estimated results of the fixed effects model of different areas.

Explanatory variable	Expected symbol	Developed areas		Less-developed areas	
		coef.	standardized coef.	coef.	standardized coef.
USE	+	0.001 (0.002)	0.073	0.002 (0.002)	0.070
TRAN	+	0.074 (0.047)	0.198	-0.019 (0.043)	-0.029
TAX	-	0.009 (0.039)	0.036	-0.084 (0.047)	-0.115
R ²		0.557		0.750	
F value		18.16		28.43	

Note: the value in the brackets is the standard deviation of the corresponding coefficient.

It is worth mentioning that the research conclusions of the present paper also provide some policy implications for the reform of Chinese farmland system in the future. China has a vast territory and the regional differences are great, so the reform of the farmland system must consider the real situation of different areas and proceeds emphatically and hierarchically. It is assumed that the reform scheme with optimal cost-income ratio should be arranged according to different needs of the peasants.

References

- North, D., 1990. *Institutions, Institutional Change and Economic Performance*. Cambridge University Press, UK.
- Zhang, H.Y., 2001. *The political economy of land tenure system reform in China*. PhD thesis of Southwest Agricultural University of China. (in Chinese)

Assessing the sustainability of Irish agriculture

E.J. Dillon, T. Hennessy, S. Hynes
 Rural Economy Research Centre, Teagasc, Athenry, Co. Galway, Ireland
 Contact: Emma.Dillon@teagasc.ie

Introduction

Indicators encompassing the multi-dimensional nature of sustainability (economic, environmental and social) are developed here using National Farm Survey (NFS) data over a ten-year period (1996–2006) to assess the overall sustainability of Irish agriculture. This is the first such study undertaken for Ireland and the results show great change over the decade. The effect of a number of policy scenarios on the sustainability of Irish farming is then examined, in particular the possible impact of milk quota expansion on agricultural sustainability. Economic viability was found to be generally in decline over the ten-year period, however, when individual farming systems were taken into account, some were found to perform better than others. Unsurprisingly the more intensive farming systems (primarily dairy) were found to pollute more on average, and a case is then made for the potential trading of emissions permits across farms. Irish agriculture is experiencing a period of fundamental change, not least in terms of the ever-changing rural demographic; the challenge therefore lies in ensuring that farms remain economically, environmentally and socially sustainable in the long-run.

Methods

Indicators of Irish agricultural sustainability are designed and outlined here using Irish NFS data (1996–2006), which is collected as part of the FADN dataset. It is a random sample of 1,200 farms representing approximately 115,000 farms nationally. Within the NFS, the farm system variable is broken down into six different categories as follows: Dairying, Dairying and Other, Cattle rearing, Cattle Other, Mainly Sheep and Tillage Systems (Connolly, 2007). The system titles refer to the dominant enterprise in each group (another enterprise could be present on the farm also). Indicators calculated here give a benchmark measure of agricultural sustainability in the country. Indicators were chosen according to their overall suitability (based on the general literature) and the availability of data. A number of indicators are illustrated in Table 1 below with information on how some of these are calculated and how they change over the period discussed in more detail in the following section.

Table 1. Sustainability indicators.

Sustainability areas	Indicators	Measurement units
Economic	Viability	%
	Direct payments as a % of Gross Output	%
	Market Return	€/farm
Environmental <i>air quality</i> <i>water quality</i>	Methane emissions	kg per farm
	Organic nitrogen	kg per ha
	Organic phosphorous	
Social	Demographic viability	%
	Isolation	%

Results and discussion

In terms of economic indicators, the economic viability of farms is a pertinent issue. Based on the work of Hennessy (2004) and Frawley & Commins (1996), an economically viable farm is defined as having (a) the capacity to remunerate family labour at the average agricultural wage, and (b) the capacity to provide an additional 5% return on non-land assets. In the absence of an average Irish agricultural wage, the minimum wage for agricultural workers as set by the Labour Court annually is used here. A viability threshold is then calculable with those farms rising above this value deemed economically viable and those falling below it unviable. A poor degree of viability across all systems is reported upon in general between 1996 and 2006 with between 28% and 41% of farms only, classified as economically viable over the ten-year period. On the whole, it can be seen throughout the period that the dairying and tillage systems tend to have a relatively higher proportion of viable farms compared to other systems. Direct payments as a proportion of gross output can be thought of as another important economic indicator. There is no threshold value as such here; however the relative change over the ten-year period examined is of interest. The influence of direct payments is seen to be greater in 2006 than in 1996 for all systems. Such payments are evidently of huge significance to Irish farmers and therefore any future reform should prove central to the future sustainability of Irish farming.

In terms of the environmental indicators chosen, methane emissions are the most important pollutant arising from Irish agriculture and can, therefore, be thought of as a valuable indicator of environmental sustainability. Based on livestock emission factors, methane emissions (kg ha^{-1}) can be calculated (see O'Mara *et al.*, 2007). Emission factors represent the quantity of gas produced by an animal over a specific period of time and by multiplying emissions factors for each animal type by the size of the herd, total emissions from a particular source category can be generated for each farm in the NFS. Methane emissions were found to be, as expected, much higher for dairying than for other systems. A case could then be made then for the future trading of emissions permits across systems in order to reduce greenhouse gas emissions and thus improve the environmental sustainability of Irish farms in general going forward.

Undoubtedly, the task of choosing the most relevant indicators of social sustainability using variables available in the NFS proved most difficult. Taking into account the percentage of farm households which have at least one household member below 45 years of age (i.e., those defined as demographically viable), a slight decline is found over the ten-year period examined here, across all systems. This indicator can perhaps be thought of as an indicator of succession (with the likelihood of someone taking over the farm worsening slightly over the period). Those at risk of isolation (i.e., one-person farm households, many of whom are elderly) can be thought of as another indicator of social sustainability. There was relatively little change in this indicator over the period 1996–2006.

Finally in terms of future agricultural sustainability in an Irish context, the possible impact of milk quota expansion on the sustainability of Irish farming is examined.

References

- Connolly, L., 2007. Overview of the changing structure of Irish agriculture monitored by the National Farm Survey. Presentation made to the Agricultural Economics Society of Ireland AGM, Rural Economy Research Centre, 30th October 2007, Teagasc, Athenry.
- Frawley, J.P. & P. Commins, 1996. The Changing Structure of Irish Farming, Trends Prospects. Rural Economy Research Series No. 1, Teagasc, Dublin.
- Hennessy, T.C., 2004. Projecting Farm Numbers. Report of the Agri Vision 2015 Committee. Dept of Agriculture and Food.
- O'Mara, F., *et al.*, 2007. Climate Change – Estimation of Emissions of Greenhouse Gases from Agriculture and Strategies for their Reduction. EPA Report.

***Ex-ante* assessment of the abolishment of the EU set aside policy: Results from a bio-economic farm analysis**

A. Kanellopoulos, H. Hengsdijk, S. Janssen, M.K. Van Ittersum
Wageningen University, P.O. Box 8130, 6706 KN Wageningen, The Netherlands
Contact: Argyris.Kanellopoulos@wur.nl

Introduction

The set-aside policy was introduced by the European Union (EU) in 1988 to (i) reduce the large and costly cereal surpluses produced under the guaranteed price system of the Common Agricultural Policy (CAP), and (ii) to provide environmental benefits following considerable damage to agro-ecosystems and nature as a result of the intensification of agriculture. Although the implementation of the set aside policy differs across the EU, in general the measure entails the obligation for leaving a proportion of farm land uncultivated or put to non-food purposes for a certain period in exchange for subsidy payments. The area under set-aside in the EU totaled 3.8 million ha in 2007.

Since the tightening of the cereal markets and associated increase in global cereal prices in 2007, the EU decided to abolish temporarily the obligation for set aside. There is strong political pressure to permanently abandon the set aside measure in the future. This could have major implications for arable farming systems in the EU.

The objective of this study is to evaluate *ex-ante* the possible consequences of abandoning the set aside policy on farm income, cropping pattern and environment. For this purpose we use the Farm System Simulator (FSSIM), which is a generic bio-economic farm model to simulate the behaviour of farm types across the EU25 and to enable the *ex-ante* evaluation of a broad range of policy measures. FSSIM has been developed within the 6th framework EU project 'System for Environmental and Agricultural Modelling; Linking European Science and Society' (SEAMLESS) (Van Ittersum *et al.*, 2008).

Methods

FSSIM maximizes the farmer's utility, defined as the total gross margin minus risk, subject to a set of resource and policy constraints (Louhichi *et al.*, 2007). The model is calibrated using Positive Mathematical Programming (PMP) which guarantees exact reproduction of activity levels observed in the base year (Howitt, 1995).

The large number and wide variety of farming systems in the EU25 do not allow for application of FSSIM to individual farms. Therefore, a farm typology has been developed combining socio-economic and biophysical farm characteristics (Andersen *et al.*, 2007). In total 40 different arable farm types were identified for 11 regions across the EU25. The model has been calibrated using data from 2003 (base year) and is applied to explore possible effects in the year 2013 using expected prices estimated with the Common Agricultural Policy Regional Impact Analysis model (Britz *et al.*, 2007). In addition, the levels of area subsidies in 2003 were recalculated according to the CAP reform. In the base year, the observed set aside area is used as a constraint in FSSIM, and farmers receive a region-specific subsidy. In the exploration, this constraint is relaxed and the set aside subsidy is set to 0 € ha⁻¹.

Data from the Farm Accounting Data Network (FADN) are used to quantify available farm resources while production activities (crop rotations) and associated technical coefficients are characterized through a dedicated survey (Borkowski *et al.*, 2007).

Results and discussion

The simulated economic and environmental indicators and the cropping patterns of six farm types (each with a set aside area greater than 12.5% of the farm area) in four EU regions are presented in Table 1.

Table 1. Simulation results of FSSIM for 2003 and 2013 of 6 farm types in four regions.

	Brandenburg		Denmark		Castilla y Leon				Midi-Pyrénées			
Size of farm type* :	Large		Medium		Large		Medium		Large		Large	
<i>Economic indicators</i>	2003	2013	2003	2013	2003	2013	2003	2013	2003	2013	2003	2013
Utility (1000€)	232.9	219.0	31.2	41.0	125.2	133.7	53.1	52.8	135.2	128.3	72.1	88.2
Income (1000€)	234.3	222.6	32.0	42.3	125.2	133.7	53.6	53.1	140.5	131.7	73.7	91.6
Subsidy share (%)	50	23	32	7	24	9	13	14	32	18	44	29
<i>Environmental indicators</i>												
Water use (m)	-	-	-	-	-	-	8	5	4	5	3	3
N-use (kg N/ha)	92	112	116	158	127	145	65	52	56	43	117	104
<i>Cropping pattern (aggregated crop groups)</i>												
Barley (ha)	35.4	24.4	13.1	0.6	26.7	17.7	-	-	-	-	1.6	-
Grass (ha)	-	-	1.2	13.2	3.8	17.5	-	-	-	-	-	-
Maize (ha)	44.4	59.3	2.7	11.8	5.6	11.1	-	-	-	-	25.6	29.7
Oil seed (ha)	68.9	193.5	3.2	9.4	8.0	21.5	2.0	2.7	6.8	25.8	17.7	37.1
Other cereals (ha)	106.1	87.5	3.5	1.0	6.2	5.6	-	-	-	-	-	-
Protein crops (ha)	36.5	24.4	0.9	-	6.2	4.5	0.5	1.0	5.1	5.6	3.6	0.9
Root crops (ha)	1.0	0.4	0.3	0.1	4.5	0.6	4.0	0.6	1.2	0.8	-	-
Set aside (ha)	116.8	27.5	7.1	3.6	18.1	13.7	12.1	12.5	71.3	75.1	18.9	15.6
Wheat (ha)	52.7	44.6	7.9	0.3	41.1	28.2	10.0	11.9	79.1	56.1	23.7	7.8
<i>Total farm size (ha)</i>	462	462	40	40	120	120	28.6	29	163	163	91	91

* Large farm: >40 ESU, Medium farm: 16 ESU ≤ size ≤ 40 ESU, Small farm: <16 ESU.

Abolishment of the set aside policy results in a reduction of the set aside area in most farm types. Nevertheless, in none of the regions all set-aside land is put into production. The main reasons are the limited management and machinery capacity and the risk averse attitude of the farmer. In Castilla y Leon, the set-aside area even increases slightly because of the 40% decrease in sugar beet price and subsidy reduction of irrigated soft wheat. The areas of both crops are reduced substantially and the excess land is allocated to sunflower and to set-aside.

Except for the medium farm type in Castilla y Leon, there is a shift from cereal crops to oil seed crops (sunflower, rape seed) and maize. The main reason for this change is the large reduction of subsidies which reduces the marginal gross margin of cereals in year 2013 despite the expected increase of their market prices. The share of subsidies in farm income reduces substantially for most farm types. In the medium farm type of Denmark and in the large farm type of Midi-Pyrenees, total farm income increases with 32 and 24%, respectively. For the other farm types, income remains the same or slightly decreases i.e. the maximum income decrease is 6%.

Average nitrogen use increases in Brandenburg and Denmark and decreases in Castilla y Leon and Midi-Pyrénées. This is associated with the type of oil seed crop grown, i.e. rape seed in Brandenburg and Denmark and the more nitrogen demanding sunflower in Castilla y Leon and Midi-Pyrénées. The environmental effects of abolishing the obligatory set-aside policy can be different between regions and depend on the existing alternative technologies and land uses. Environmental policies that account for particularities of each region are more appropriate for achieving environmental goals at EU level.

References

- Andersen, E., *et al.*, 2007. Journal of Environmental Management 82: 353-362.
- Borkowski, N., *et al.*, 2007. FSD 2007: An international symposium on Methodologies for Integrated Analysis of Farm Production Systems, Catania, Italy, Vol. 1, pp. 33-34.
- Britz, W., *et al.*, 2007. SEAMLESS integrated project PD 3.5.1.1, 116 pp.
- Howitt, R.E., 1995. American Journal of Agricultural Economics 77: 329-342.
- Louhichi, K., *et al.*, 2007. SEAMLESS integrated project PD 3.3.11, 82 pp.
- Van Ittersum, M.K., *et al.*, 2008. Agricultural Systems 96: 150-165.

Direct and indirect impacts of CAP changes on the economy of rural areas: Integrated assessment of farm households' adaptation strategies in Eastern and Western Germany

Andrej Lange, Annette Piorr, Rosemarie Siebert, Davide Viaggi
Leibniz-Centre for Agricultural Landscape Research (ZALF),
Eberswalder Str. 84, 15374 Müncheberg, Germany
Contact: andrej.lange@zalf.de

Introduction

A lot of recent research underlines the impact of the CAP reform on various types of farms across Europe. However, there is little research on interdependencies between CAP policies, agriculture, entrepreneurial activities in other economic sectors and related land use changes. This is particular of interest for remote areas which have less long-term economic development alternatives. Farm size and specialization, land use characteristics and socio-economic situation determine the scope and direction of the adaptation potential of rural farm households. The CAP-IRE project (*Assessing the multiple Impacts of the Common Agricultural Policies (CAP) on Rural Economies*), funded under the 7th Framework Programme, addresses these issues. The research project provides valuable results for a better understanding of described interdependent processes and assessment of CAP policy effects. The CAP-IRE project includes eleven case study regions in nine European countries. This contribution will focus on two German regions, the Lahn-Dill district in Hessen and the district Ostprignitz-Ruppin in the East German state of Brandenburg.

Variability in farm structure and socio-economic situation between the two case study areas provide for a sharper picture of how changes in CAP measures are reflected and reacted upon.

The case study approach focuses on policy impacts of current and future CAP development on farm households and their adaptation strategies towards these changes. Objectives are to identify key determinants of development in selected regions and to assess trends of change. An analysis of farm household reactions towards different scenarios of CAP changes provides the basis for developing concepts and tools for future policy-making, based on improved understanding of long-term socio-economic mechanisms.

Methodology

Based on a detailed regional analysis, socio-economic key indicators for both regions are gathered, compared and reflected in terms of economic structure and performance, demographic development and policy aspects. Main target of the research is the farm household as central connecting agent between policy and socio-economic changes as well as between agriculture and activities in other economic sectors.

The analytical approach links future CAP scenarios to empirical data on farm-level adaptations, including structural change, investment management decisions, off farm work, chain effects and networking. Results are analysed and interpreted at regional scale, assessing the developments' impacts on the socio-economic situation of rural and partially remote regions. The comparison of an Eastern German and a Western German area provide insight into the particularities of local farmers' perceptions and projections of different CAP payment schemes in relation to farm structure and socio-economic background. Respondents are confronted with future CAP policy scenarios with a time frame of ten years, including a complete phasing out of CAP payments and a shift from market and income support to rural development measures.

The analysis focuses on local experts' assessment in a two-tier procedure: detailed in-depth face-to-face interviews with selected farm households provide the basis for a larger survey

among farm businesses in both regions. Since participatory procedures are emphasized, strong stakeholder involvement accompanies the analysis. Local participatory network groups comprising of actors in regional administration, agriculture, regional planning and regional entrepreneurial representatives assess the relevancy of research questions for their region, validate the survey findings and are consulted throughout the process.

Results

Local experts emphasize the role of farm enterprises for climate protection, food and energy security, and regional development as well as the need for more transparency and information dissemination. The effects of climate change on regional rural economies are likely to play a larger role in the future. CAP is perceived to exert strong influence on farm household structure, with some negative effects on family farming. Links to other regional economic sectors such as recreation industry, energy production and food processing and will increase in importance for farm businesses.

The paper presents results of the in-depth farm household surveys, addressing farmers' assessment of CAP changes as well as their reaction to incentives for economic diversification. Differences between the Western German and the Eastern German region with regard to perceived socio-economic changes and adaptation abilities of farming households will be elaborated upon. Specific socio-economic characteristics of both regions and their development will be compared and analysed in terms of their reaction to CAP payment changes.

Outlook

The essential findings from this survey will in a second step guide the large surveys of the CAP-IRE project on CAP scenarios and farm household adaptation strategies. These surveys will focus on environmental sustainability, interactions between rural communities and the rest of the world and governance issues.

References

- Brouwer, F., 2006. Main trends in agriculture. Agriculture for sustainable development: a dialogue on societal demand, pressures and options for policy. SASSPO-SSP4-022698.
- Gallerani, V., *et al.*, 2007: Report on the empirical analysis on farmers' investment behaviour in conventional and emerging farming systems under different policy scenarios 150369-2005 F1SC IT – Final report, Bologna.
- Happe, K., *et al.*, 2006. German Journal of Agricultural Economics 55: 268-279.
- Pierr, A., *et al.*, 2007. In: Eds Ü. Mander, *et al.*, Multifunctional land use: meeting future demands for landscape goods and services. Springer Verlag, Berlin, pp. 167-182.
- Pierr, A., *et al.*, 2009. Integrated assessment of future CAP policies: land use changes, spatial patterns and targeting. In: Environmental Science and Policy. Special Issue: Sensitive Region Policy. (in prep.)
- Ray, C., 2001. Sociologia Ruralis 41: 280-295.
- Shucksmith, M., *et al.* (Eds), 2005. The CAP and the regions. The territorial impact of the common agricultural policy. CABI Publishing, Wallingford.
- Uthes, S., *et al.*, 2008. Ökologisches Wirtschaften 1: 30-34.

Alpine grazing trends in Switzerland: Economic importance and impact on biotic communities

Gabriele Mack, Christian Flury, Thomas Walter
Agroscope Reckenholz-Tänikon ART Research Station, 8356 Ettenhausen, Switzerland
Contact: Gabriele.mack@art.admin.ch

Introduction

Alpine grazing fulfils important functions for the environment, agriculture and the regional economy as well as society (cf. Rudmann, 2004). In Switzerland, a decline in summering has been observed since 2000 (Table 1). In addition to this, grazing has been dropped in marginal areas. On easily accessible summering grounds, however, alpine grazing is predominant. Differences in grazing intensity affect the existence and variety of species. The aim of this paper is to highlight the economic importance of summering for Swiss agriculture, to forecast numbers and herds of summered animals and to estimate the impact on flora and fauna in grassland.

Methods

The Swiss Agricultural Sectoral Information and Forecasting system (SILAS) is used to forecast summering trends and analyse their economic significance for Swiss agriculture (Mack *et al.*, 2008). The SILAS model is based on regional farms assigned to production zones defined by increasingly difficult production conditions. It optimizes regional land use and regional animal stocks, including summering, by maximizing the factor income according to the economic accounts for agriculture. Summering is represented in the model by the amount of available pasture sustaining livestock units during an average alpine grazing season and by summered animal activities, these encompassing a production segment in the region of origin and an alpine grazing season of 100 days. The economic significance of summering is estimated on the basis of its contribution to the factor income. Summering herd changes impact grazing intensity, which influences the number of common, rare and threatened species. Trends within high nature-value flora and fauna communities are estimated by a heuristic analysis.

Results and discussion

Forecasts using the SILAS model show that herds of summered animals are still in decline and that the current trend will continue, despite the fact that direct payments for summering animals will be increased by 10% from 2009 on (Table 1). Compared with 2005 the number of summered animals will decline by 8.4% until 2011, with the trend varying depending on animal category. The decline in summered animals is significant to the extent that total roughage consuming livestock units (RCLU) will increase slightly between 2005 and 2011.

Table 1. Forecast of summered RCLU and total RCLU (Change from 2005 to 2011).

Animal category	Trend 2000/2005		Forecast 2005/2011	
	summered RCLU	<i>total RCLU</i>	summered RCLU	<i>total RCLU</i>
Dairy cows	-5%	-8%	-16%	+2%
Suckling cows	+53%	+74%	-5%	-4%
Yearlings	-10%	-8%	-0%	+2%
Sheep	-10%	+7%	-9%	-9%
Goats	+16%	+37%	0%	-1%
Total	-5%	-4%	-8%	+1%

Source: Own calculations (for further information on data sources see Mack *et al.*, 2008).

Summering is of major economic importance to Swiss agriculture despite declining animal numbers. In 2007, the factor income from summering was CHF 282 mill., equivalent to 11% of total factor income. Direct payments for summered animals were the major income source (CHF 202 mill.) in 2007. By 2011 the factor income will drop to CHF 271 mill. Here it is worth noting its economic importance to the mountain region, where roughly one third of total factor income is linked to summering. Therefore direct payments for summering contribute substantially to securing the survival of mountain agriculture and are hence also relevant for income-related and social policy considerations. In spite of this high income contribution, the forecasts show that the payments can not prevent a decrease of summered animals. Additional calculations show that policymakers need to increase direct payments for summered animals by 25% to maintain summering in future.

In addition to land utilization, changes affecting summered animals also influence the nature-value of grassland. Different trends are conceivable here, depending on the location and land configuration of alpine farms: (1) Less land will be stocked as intensively as before. In this case, primarily high-yielding and easily accessible areas will continue to be farmed. Low yielding and less accessible marginal areas will be abandoned. In the medium to long term a decline in high nature-value grassland is anticipated due to the succession towards forests (Sc. 1 in Figure 1). (2) Less land will be stocked more intensively than before. This trend reinforces the effects discussed in point 1, with the proportion of land no longer grazed increasing by the intensification factor. The areas used on a moderately intense level today will also lose nature-value if use is intensified (Sc. 2 in Figure 1). (3) The area will be less intensively stocked than today (Sc. 3 in Figure 1). This would have a positive effect on high nature-value grassland. To realize the third scenario (Sc. 3), policymakers need to change the direct payment system from payments linked to summered livestock units to payments linked to pastured area.

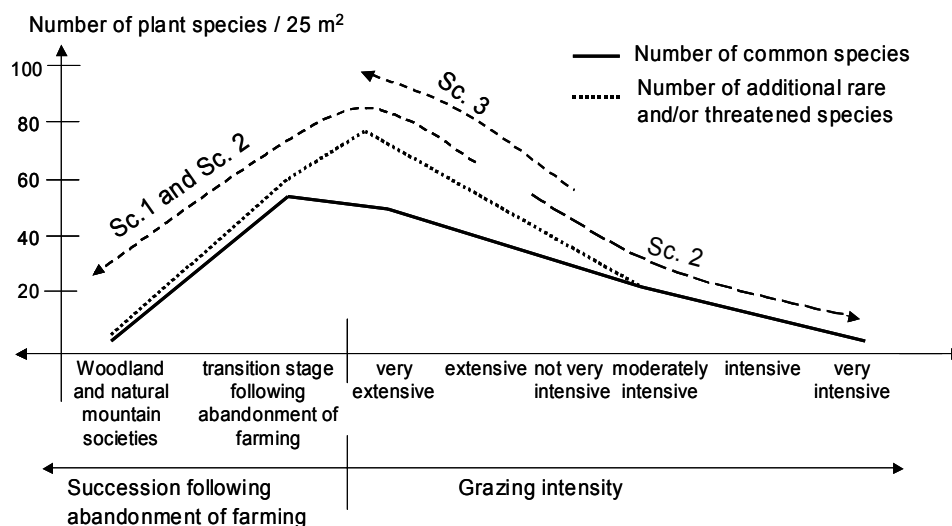

Figure 1. Plant species (indicating high nature-value) at varying grazing intensities and after abandonment of farming. The arrows show the changes anticipated for each scenario. Source: derived from Dietl (1995).

References

- Dietl, W., 1995. *Ökologie und Naturschutz* 4: 239-249.
- Mack, G., *et al.*, 2008. Entwicklung der Alpung in der Schweiz: Ökonomische Bedeutung und ökologische Auswirkungen. *Yearbook of Socioeconomics in Agriculture* 2008, 259-300.
- Rudmann, C., 2004. Langfristige Sicherung der Funktionen der schweizerischen Alpbetriebe: Ein Beitrag zur Umsetzung des Nachhaltigkeitskonzeptes. Diss. ETH No. 15680, 267 pp.

Impact Assessment of policy changes on the arable sector using the FSSIM model: Case study of the Zachodniopomorskie NUTS2 region

E. Majewski, A. Was, H. Belhoucette, K. Louhichi, I. Mouratiadou
Warsaw University of Life Sciences,
Nowoursynowska 166, 02-787 Warsaw, Poland
Contact: Edward_Majewski@sggw.pl

Introduction

Agricultural policy reforms and changes in the market environment have a direct impact on farmers' decision-making. A process of continuous adjustment to such changes can be observed in the Zachodniopomorskie test case region, since the transformation of Poland into a market economy in 1989 and the introduction of the EU Common Agricultural Policy (CAP) in 2004. An interesting question is how farmers are likely to react to expected further policy developments and changing market conditions and macroeconomic environments.

The FSSIM-MP (Louhichi *et al.*, 2007) farm-level bio-economic model was used to assess the impact of a number of policy scenarios regarding different sugar market regimes and a policy promoting biofuel production. The main crops included in the analysis are cereals, oil-seed rape and sugar beet, which are the dominant crops in Zachodniopomorskie.

Methods

The most common FADN farm types in the region, namely arable (FT1), livestock mixed (FT7) and mixed (FT8), were modelled, so as to explore the impacts of the following policy scenarios:

1. **Baseline 2013** – a reference for comparison to further policy scenarios. It assumes the 2004 CAP regime as introduced in Poland and the continuation of the 2006 sugar reform. All economic parameters regarding prices and costs changes as estimated for the year 2013 were incorporated.
2. **Quota Restructured 2013**. Under this scenario the A quota¹ was cut by 50% and the B quota was increased by the double of the A quota reduction. Sugar beet prices and compensation in accordance with the 2006 sugar reform remained as in the Baseline scenario.
3. **No quota 2013**. Complete liberalization of the sugar market was assumed. The quotas were removed, and the sugar beet price was set equal to the double of the present C quota price.
4. **Biofuel Policy**. It has been assumed that a policy fostering the use of grains and canola for biofuel production would result in a growing demand for those crops and consequently higher prices. A 20% price increase of potential biofuel crops was assumed.

The FSSIM-MP used for modelling is a mathematical programming model with a non-linear objective function. The model maximizes utility function considering assumed level of risk:

$$U = P'x + S'x - d'x - x'Qx/2 - K - \Phi \sigma \quad \text{Subject to: } Ax \leq B; \quad x \geq 0$$

where, **U** is the utility, **P** - vector of gross margin for each agricultural activity, **S** - vector of subsidies, **d** - vector of parameters of the cost function, **Q** - symmetric, positive (semi-) definite matrix of the cost function (the estimation of the vector **d** and the matrix **Q** depends on the calibration approaches), **x** - vector of the level of agricultural activities, **K** – farm level fixed costs (including annuity), **A** - matrix of technical coefficients, **B** - vector of available resource levels, **Φ** - scalar for the risk aversion coefficient, σ - standard deviation of income according to states of nature defined under two different sources of variation: yield and prices.

¹ Sugar quota is a total quantity of sugar allocated to a country. **A** quota – quantity which can be distributed to the EU market, **B** quota – can be traded with export subsidies, **C** quota – can be exported at world prices beyond the EU markets (without export subsidies) (Buisse *et al.*, 2007).

Agricultural activities are defined in FSSIM-MP as a combination of crop rotation, soil type, production technique and production orientation. The model was run twice: (1) including only activities that are currently practiced in the area, and (2) introducing also alternative activities, regarding rotations and crops that farmers might consider in the future. The first model run shows the impacts of the policy scenarios on production patterns and farm incomes. The second model run allows also the examination of further adjustments of production structures and technologies to different policy environments.

Results and discussion

Table 1 shows the economic results for FT1. Increased farm incomes can be observed, in comparison to the Base 2004 situation. This is partly due to the growing amount of direct CAP payments, which rise from 55% of the negotiated rates in 2004 to 100% of the rates in 2013, in accordance with the scheme of the introduction of CAP payments in Poland. This is also why the premiums as a share of farm incomes increase.

Table 1. Economic results for the arable farm.

Specification	Base 2004	Baseline (Sugar Reform)	Quota Restructured	No Quota (Liberalization)	Biofuel Policy
Farm income (Euros)	26098	30137	33241	27561	35645
Premiums (Euros)	5671	11192	11662	10693	10957
Gross production (Euros)	30084	35705	38339	37926	41883
Total costs (Euros)	21740	27290	27290	29470	28293
Total labour use (Hours)	765	779	779	934	782
Premium share of income (%)	22	37	35	39	31

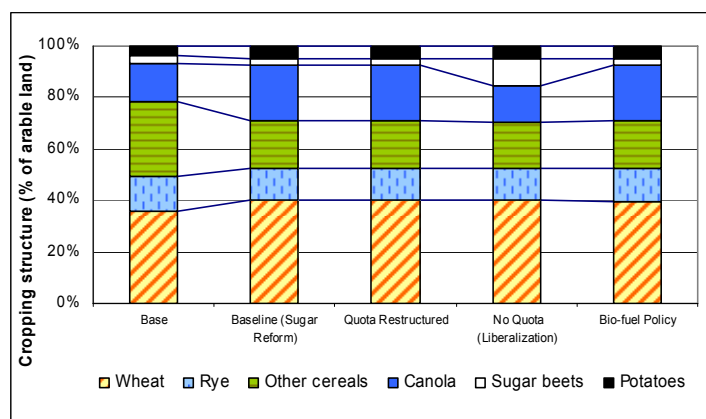

Figure 1. Cropping structure in FT 1 under different policy scenarios.

Changes in the level of farm incomes correspond with shifts in the cropping structure (Figure 1). The most significant change is an increase of land dedicated to sugar beet production under the No Quota scenario. The share of cereals and oil-seed rape do not increase much between the Baseline and the Biofuel Policy scenarios, although these crops are much more profitable under the latter. The reason is that the initial share of land occupied by these crops was already very high. Other model

results include changes in the supply of different commodities, and in environmental indicators such as nitrogen input, nitrate leaching, and organic matter balance. Connecting FSSIM-MP to the entire model chain, comprising also a biophysical model APES, allowing a broader range of agricultural policy aspects and a larger set of indicators.

References

- Buysse, B., *et al.*, 2007. Eur. Rev. Agric. Econ. 34(1): 21-52.
 Louhichi, K., *et al.*, 2007. A generic template for FSSIM for all farming systems, SEAMLESS PD3.3.11, 82 pp.

Introducing flat rate direct payments taking into account social concerns and ecological non-commodities

F.L. Marchand, D. Claeys, L. Lauwers, J. Buysse, B. Van der Straeten, G. Van Huylenbroeck
Institute for Agriculture and Fisheries Research – Social Science Unit,
Burg. Van Gansberghelaan 115 bus 2, 9820 Merelbeke, Belgium
Contact: Fleur.marchand@ilvo.vlaanderen.be

Introduction

Direct payments to producers were decoupled since the June 2003 reform of the European Common Agricultural Policy (CAP). Farmers get a single farm payment by activating payment entitlements with eligible area. In Flanders the single farm payment is calculated according to the historical model (based on individual entitlements in the reference period 2000–2002). Nowadays the European Commission wants to fine tune the modernized CAP, well known as ‘Health Check’. One of the proposals of the European Commission proposes is moving away from historical payments. The effects of a flat rate introduction (equal payments per hectare of cultivated land) on shifts in farm activity and impacts on farmers’ income of arable, dairy and cattle farms were investigated by Marchand *et al.* (2008). The impact analysis of direct payments’ reallocation was merely financially oriented. The aim of current research is to make the direct payments more goal-orientated and more acceptable to the public by taking into account also social concerns and ecological non-commodities of agriculture. We examine how flat rate payments are distributed in relation to some social and ecological aspects and which effects this redistribution may cause. How many payments do retiring farmers receive at the expense of the active farmers? When retiring farmers are excluded, does redistribution have an effect according to farm size, region and farm type? Are ecological non-commodities rewarded at this time? With respect to this question, we analyse if areas where agriculture is important to policy purposes in the scope of biodiversity and valuable areas favored or not? Depending on the results of this more sustainable-oriented analysis, suggestions to redistribute direct payments will be discussed.

Methods

The farm-based sector model SEPALÉ, system for evaluation of agricultural and agro-environmental policies (Buysse, 2006) is used for assessing the impact on production and income of arable, dairy and cattle farms (cfr. Marchand *et al.*, 2008). SEPALÉ is a positive mathematical programming (PMP) that maximizes profit at farm level. As farms can be selected according to farm size, region and farm type, simulations can be run for specific subsectors, size classes or regions. A representative sample of FADN farms is used as input.

Marchand *et al.* (2008) simulated the flat rate scenarios FR1 and FR2. For the scenario FR1 the total value of payment entitlements and coupled subsidies in 2005 are grouped and divided by the total available eligible area, excluding potatoes, vegetables, fruit and permanent cultures. These crops are not allowed to be cultivated with payment entitlements. The scenario FR2, based on the reform of the common market organization for fruit and vegetables, does also take potatoes, vegetables, fruit and permanent cultures into account. Following assumptions are made: farm cannot start new activities, neither payment entitlements nor milk quota can be traded and the total area can be activated.

In comparison with Marchand *et al.* (2008) two new flat rate scenarios FR3 and FR4 were simulated analogous to FR1 and FR2, but in FR3 and FR4 retiring farmers are excluded from the beneficiaries. This option can be seen (i) as a sensitivity analysis to the major policy concerns that are incorporated in FR1 and FR2 and (ii) as a socially adjusted scenario which has been revealed by some stakeholders.

A distinction between areas where agriculture is important to policy purposes in the scope of biodiversity and valuable areas will be calculated by comparing the amount of direct payments in the different agricultural regions in Flanders (Kempen, Leemstreek, Polders, Zandstreek, Zandleemstreek) and the importance of biodiversity and valuable areas according Biological Evaluation Map of Belgium (De Blust *et al.*, 1985).

Results and discussion

The scenarios FR3 and FR4 are socially adjusted scenarios of FR1 and FR2 by the exclusion of retiring farmers to receive farm payments. They mainly cause a smaller decrease or a bigger increase in the specific farm activities or may even turn a negative shift in a positive one. Only in a few cases (e.g., silage and grain corn), the decrease is slightly bigger, however, negligible. Without any exception, all the changes in income were less negative or more positive in FR3 and FR4 compared to FR1 and FR2, respectively (Figure 1). Only for cattle farms in both scenarios and for dairy farms with other cattle in scenario FR4, the loss on income persisted.

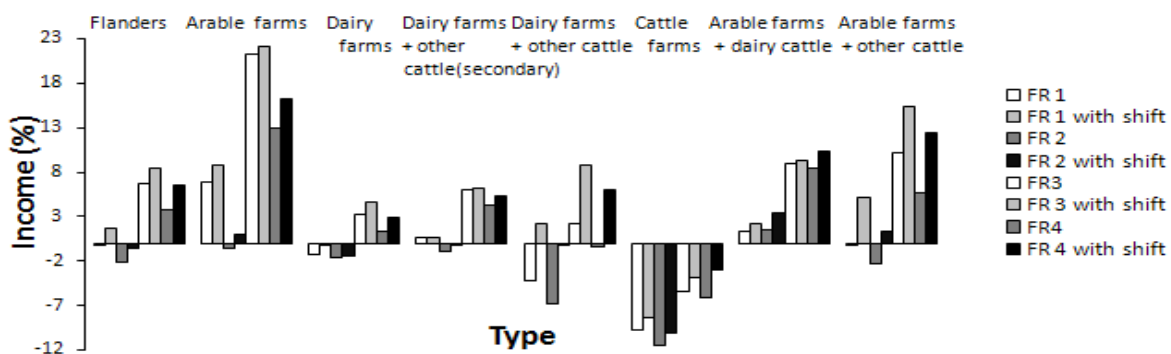

Figure 1. Change in income of Flemish firms, categorized in farm types, caused by two flat-rate scenarios (FR 1; FR 2: with CMO-reform = areas of potatoes, vegetables and fruits included; FR 3 with retired farmers excluded; FR 4 with CMO-reform and retired farmers excluded) with and without possible shift in farm activities.

We could thus observe in the model results that almost all farm activities shift in a similar but more positive way when retiring farmers are excluded from receiving payments. Furthermore, all effects on income were more positive and in many cases a negative effect on income was turned into a positive effect. As the funds are redistributed within a smaller section of the farmers, these results are logic. As no surprises in the socially adjusted redistribution are expected as it is an issue in the stakeholders' debate, this option should be at stake at policy level. The simulations according to the regional biodiversity patterns are not yet finished. Depending on the results of the flat rate payment distribution in relation to ecologically important policy issues, redistribution will be simulated and results will be discussed.

References

- Buysse, J., 2006. Farm-level mathematical programming tools for agricultural policy support. PhD Dissertation, University of Ghent, Belgium, 177 pp.
- De Blust, G., *et al.*, 1985. Biologische waarderingskaart van België: algemene verklarende tekst. Ministerie van Volksgezondheid en Gezin- Instituut voor Hygiëne en Epidemiologie. Brugge, Belgium, 98 pp.
- Marchand, F.L., *et al.*, 2008. In: EAAE Seminar "Modelling Agricultural and Rural Development Policies", presented in Sevilla, 2008.

Investigating the economic and water quality effects of the 2003 CAP reform on arable cropping systems: A Scottish case study

Ioanna Mouratiadou, Cairistiona F.E. Topp, Graham Russell
SAC, King's Buildings, West Mains Road, Edinburgh, EH9 3JG, UK
Contact: I.Mouratiadou@sms.ed.ac.uk

Introduction

The 2003 Common Agricultural Policy (CAP) Reform aimed to promote the socio-economic and environmental sustainability of agricultural systems. An important question is how far the Reform has indeed encouraged farmers to contribute to achieving broad economic and environmental goals. The effects of the Reform on economic decision making and associated viability of farms can be explored by analysing data on current farmers' decisions. However, these represent the combined effects of all the changes that took place during that period. Mathematical Programming Modelling provides an alternative for policy assessment that allows the impact of different factors affecting agricultural production to be studied separately. Water quality is a major environmental factor that is affected by agricultural production. The effects of the Reform on water quality are not easy to predict, as they are the result of the interaction of changes in farmers' production decisions with biophysical factors and there are significant time lags between the cause and effect of the environmental problems. The effects of farmers' decisions on water quality can be simulated using appropriately constructed biophysical models to estimate production and pollution functions.

The overall aims of the paper are (1) to explore the economic and water resource effects of the 2003 CAP Reform on arable cropping systems in Scotland and (2) to evaluate the methodology used with special reference to agricultural and environmental policy assessment.

Methods

The analysis uses the case study area of the Lunan catchment, a representative catchment of Eastern Scotland. June Census Data (JCD) were analysed to quantify the changes in land use after the Reform. The data set consists of information on cropping areas of different crops for the individual farms in the area, for the years 2000–2007. The JCD were then multiplied by nitrogen (N) input and nitrate leaching coefficients, to explore changes of nitrate leaching. The nitrate leaching coefficients were estimated with the NDICEA model (Van der Burgt *et al.*, 2006), a process-based simulation model which simulates soil water dynamics, N mineralization and inorganic N dynamics on a weekly time-step. Finally, the outputs of NDICEA were incorporated into the Mathematical Programming component of the Farm Systems Simulator (FSSIM-MP) (Van Ittersum *et al.*, 2008; Louhichi *et al.*, 2007), which was used to identify the effects of a range of scenarios on the average general cropping and average cereal farms. FSSIM-MP is a bio-economic model developed under the EU FP6 Project SEAMLESS. The model is based on profit maximization and risk aversion and specifies agricultural activities in terms of rotations, soil types, and management techniques. The results of the JCD analysis and FSSIM-MP modelling on land use for contrasting scenarios (Table 1) were compared to identify the drivers of change and to test model reliability.

Results and discussion

The analysis of both the JCD and modelling results show only small changes in the cropping pattern of the two farm types. Overall, a shift towards higher yielding and therefore more profitable crops was observed, partly as a result of the CAP Reform but mainly due to changes in crop prices. The most significant change (Figure 1) was a decrease in the area of barley and an increase in the area of wheat. Scenario 1 captured the direction of changes for

Table 1. Scenarios (Modelling and JCD Analysis).

	Base year (2001–2003)	JCD (2006–2007)	Scenario 1	Scenario 2	Scenario 3
Scenario	JCD analysis	JCD analysis			
Source	FSSIM-MP		FSSIM-MP modelling		
Assumed Prices	2001–2003	-	2001–2003	2006–2007	
EU CAP	Agenda 2000	2003 CAP Reform			
Measures	None	None	Cross-compliance N quota	None	

most crops regarding the general cropping farm, and showed an increase in the area of all crops after a reduction of set-aside for the cereal farm. These results were further augmented and much closer to the changes shown by the JCD analysis under Scenarios 2 and 3. Farm incomes did not decline significantly after the introduction of the Reform. Indeed, significantly higher incomes were achieved after the introduction of new crop prices. Cereal farms appear to have lower income per hectare, to be more dependant on premiums and to be more sensitive to price changes than general cropping farms. Overall N use and nitrate leaching do not differ significantly between the scenarios for either of the two farm types. The average N use is only above the quota for Scenario 3 on the cereal farm. However, although N use is higher in this case, the leaching does not seem to increase due to higher uptake by N intensive crops. This also explains why nitrate leaching did not change from 2000–2007, suggesting that more restrictive input quotas will yield no major improvements while discouraging farmers from growing profitable but high N demanding crops.

Bio-economic modelling provides a framework for simultaneously analysing the economic and environmental impacts of farmers' decision-making, as it enables agricultural systems to be represented in economic and biophysical terms. In spite of a lack of detailed input data, this approach can help in explaining the drivers of changes. Although the comparison of model predictions with actual data constitutes a form of model testing and increases confidence in the model outcomes, not all potential modelling scenarios have been tested and model predictions should not be accepted blindly. Rather, the outcomes should be considered as hypotheses that become the input to further discussions with experts and policymakers.

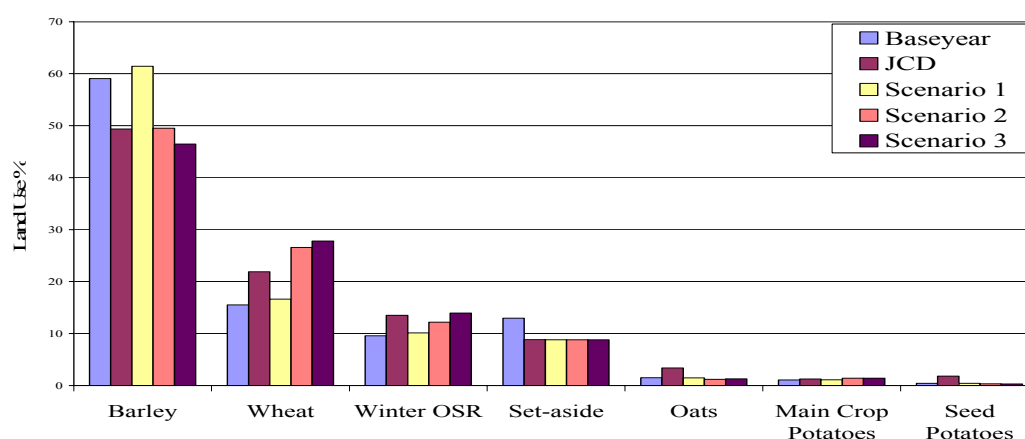

Figure 1. Modelling results and current levels - cereal farm.

References

- Louhichi, K., *et al.*, 2007. A generic Template for FSSIM for all Farming Systems, PD3.3.11, SEAMLESS integrated project, EU 6th Framework Programme, contract 010036-2, 82 pp.
- Van der Burgt, G.J.H.M., *et al.*, 2006. Nutrient Cycling in Agroecosystems 74: 275-294.
- Van Ittersum, M.K., *et al.*, 2008. Agricultural Systems 96: 150-165.

Systems analysis underpinning development of management action targets to meet water quality objectives in sugarcane production systems

P.J. Thorburn, J. Brodie, R. Milla, E. Shannon, S. Attard, T. Anderson, A. Davis
CSIRO Sustainable Ecosystems, 306 Carmody Rd, St. Lucia Qld 4068, Australia
Contact: Peter.Thorburn@csiro.au

Introduction

In response to concerns about the health of the Great Barrier Reef (GBR), governments in Australia have developed the Reef Water Quality Protection Plan to significantly reduce discharge of pollutants from industries in catchments draining into the GBR lagoon. These reductions will be achieved through development and implementation of Water Quality Improvement Plans (WQIPs) in reef catchments. A WQIP requires identification of management practices and targets for their adoption (management action targets) to meet stated regional water quality objectives and provide progressive (quantified) reductions in pollutant loads. Agriculture is an important land use in GBR catchments and has been identified as an important source of diffuse pollution. Thus agricultural industries and local catchment authorities are challenged with developing management practices and adoption targets to meet water quality objectives.

Agricultural industries in these catchments, especially crop production, do not have a long history of research into environmental impacts of different farming systems. Thus modelling and systems analysis have an important role to play in identifying both management practices and targets for their adoption to meet water quality objectives. Furthermore, given the importance of adoption, it is necessary to have wide stakeholder involvement in and acceptance of the process and its outputs. This paper describes the process used to characterize the water quality impact of different management practices for sugarcane production in the lower Burdekin catchment, and explore the consequences of and reach agreement amongst stakeholders for different levels of adoption of the various practices. This participative process involved staff from agricultural advisory agencies, farmers and the systems analysts, to define adoptable management practices for the Burdekin WQIP.

Identification of management practices

Nitrogen (N) had been identified as the main pollutant from sugarcane production in the Burdekin region (Brodie & Bainbridge, 2008), so management practices concentrated loss of N via runoff and deep drainage. Workshops were held with local farmers and extension officers to explore possible management practices to reduce long-term N losses. These practices classified the range of current management practices in the region and those under development that had potential to deliver water quality benefits. Five classes of management practices, termed E to A (from 'bad' to 'good'), were identified combining decreasing tillage intensity, reducing N application rate improved irrigation scheduling. Classes E to C represented practices common in the Burdekin region; Class B was similar to the currently promoted 'best practice'; with Class A being the possible future best practice that is currently under investigation. The long-term N losses (Figure 1) and productivity of these management classes was simulated with APSIM-Sugarcane for the dominant soil types in the four main districts (Delta fine textured, Delta coarse textured, Mona Park and Mulgrave) in the region, based on experimental studies of water quality in sugarcane production in these districts.

Extension officers were interviewed to estimate the proportion of farmers practicing these classes in each of the four districts. The majority (50–60%) of farmers were practicing Class D, with fewer practicing Classes E and C. From these adoption estimates and the areas of the districts, the regional average N fertilizer use (211 kg ha^{-1}) was determined. This N use compared well with data on actual use in the past five years (220 kg ha^{-1}), suggesting that the

distribution of management practices were plausible. The water quality impacts of the adoption estimates and N loss predictions was also plausible: The recent N load estimations in the region (3000–4500 t yr⁻¹, Brodie & Bainbridge, 2008) compare favourably with predicted long term N loads (5500 t yr⁻¹) that are based on under current conditions, rather than historical (and variable) N usage and areas under sugarcane.

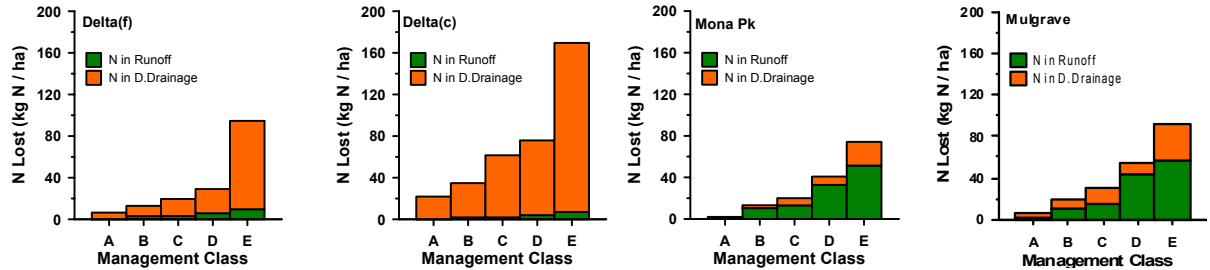

Figure 1. Predicted long-term annual losses of N via runoff and deep drainage at the four sites under five classes of management practices designed to meet water quality targets.

Setting management action targets

The hydraulic connections in the region are simple, with transport of water and chemicals to the river and creeks rapid so processes such as in-stream denitrification negligible. Reflecting this simplicity, a simple regional ‘calculator’ was constructed to allow participative exploration of the relationship of between different patterns of adoption and regional N loads (Figure 2). The calculator was used in a facilitated workshop with local farmers and extension officers to determine targets for the adoption of the different practices to meet regional water quality objectives; i.e. predicted N loads reduced 4400 t yr⁻¹ by 2013. This target would be met by having a net shift of 10% of farmers from Class E to Class B practices.

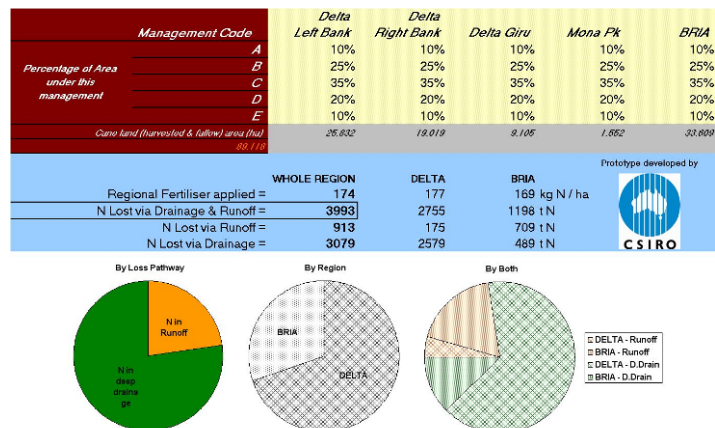

Figure 2. Screen from the regional nitrogen load calculator used participatively with stakeholders to assess the water quality benefits from adoption of various management practices.

Discussion

The analyses undertaken and the process used has provided the local catchment management authority, Burdekin Dry Tropics NRM, with quantitative and agreed targets for the adoption of management practices for sugarcane production in the lower Burdekin catchment. This will underpin funding of incentive schemes facilitating practice change, the means of assessing the effectiveness of those funds, and the water quality improvement resultant from them. This provides a sound basis for implementing the Reef Water Quality Protection Plan.

Reference

Brodie, J. & Z. Bainbridge, 2008 ACTFR Report No. 06/01. Aust. Cent. Tropical Freshwater Research, Townsville.

Efficiency of environmental policies in agriculture in the Czech Republic: The case of dairy cattle

M. Havlikova, C. Kroeze
Wageningen University, Environmental Sciences,
Environmental Systems Analysis Group, P.O. Box 47,
6700 AA Wageningen, The Netherlands
Contact: carolien.kroeze@wur.nl

Introduction

Dairy cattle production is one of the traditional sectors in the Czech Republic, and an essential part of Czech agriculture. It is also a source of various air, soil and water pollutants. The impact of agriculture is, therefore, increasingly considered in environmental policy making. Current policies in the Czech Republic focus on minimizing emissions of nitrate and ammonia. It can be questioned, however, how effective it is to primarily reduce these two pollutants.

We developed a model (DAIRY) that can be used to analyse the cost-effectiveness of policies for the simultaneous abatement of acidification, terrestrial and aquatic eutrophication, human toxicity and global warming caused by dairy production in the Czech Republic. In this paper we evaluate the current and future environmental impact of dairy cattle in the Czech Republic. To this end, a number of scenarios are developed and analysed with the DAIRY model. Several environmental targets are used as model input. These include reduction targets for ammonia emissions and for the overall environmental impact (OEI). The scenarios also differ with respect to the underlying assumption on changes in animal management and animal numbers. We present future environmental trends, and the costs associated with cost-optimal sets of reduction measures as selected by the model.

Dairy model description

The DAIRY model considers seven pollutants: ammonia (NH₃), nitrous oxide (N₂O), methane (CH₄), particulate matter (PM_{2.5}, PM₁₀) and nitrate (NO₃) emitted by dairy cattle. Several processes give rise to emissions: grazing, milking, housing, storage, application, indirect emissions and leaching. The model distinguishes between nine study regions within the Czech Republic which differ in dairy cattle intensity, environmental sensitivity and population density. Fifteen emission reduction measures are included to abate the above mentioned emissions. Six are primarily aimed at reducing ammonia emissions, five at reducing greenhouse gas emissions such as nitrous oxide and methane, and four at reducing nitrate leaching. In addition, the model considers unintended side-effect of the measures on other pollutants. Emissions are calculated by study region, based on emission factor approaches and from a process-based model. The potential environmental impact is calculated using so-called characterization factors, which are region specific for human toxicity, country specific for acidification, and for terrestrial and aquatic eutrophication. They are generic for global warming. The individual impact categories are aggregated into an overall environmental impact (OEI) indicator by means of normalization and valuation factors as usual in Multi-Criteria Analysis. The model is modified from Brink *et al.* (2005). For a more detailed description of the model see Havlikova *et al.* (2008) and Havlikova & Kroeze (2009).

Model results: Discussion and conclusions

We present DAIRY model results for three scenarios (Table 1). These scenarios use either reduction targets for ammonia or for the overall environmental impact. In the AMMONIA Scenario, the restriction is that the model can only select from measures aimed at reducing

ammonia, while in the EUPLAN and IMPACT Scenarios the model can also select measures aimed at reducing other pollutants that, as a side effect, also reduce ammonia emissions. The AMMONIA and EUPLAN scenarios define targets for ammonia emissions alone, while the IMPACT scenario aims to reduce the overall environmental impact (OEI).

The results indicate that the AMMONIA and EUPLAN scenarios (1–3% reduction in OEI; costs 11–16 MEuro yr⁻¹) are less cost-effective in reducing the OEI than the IMPACT scenarios (21% reduction; 12 MEuro yr⁻¹). We conclude that it seems more cost-effective to aim at an overall reduction of the environmental impact, than on reducing ammonia emissions alone. It is interesting that in all three scenarios stable adaptation and manure efficiency improvement are selected as cost-effective measures by the model. This indicates that these are robust solutions for environmental pollution problems caused by dairy cattle in the Czech Republic. The policy implications would be that implementation of these measures may serve multiple purposes.

Table 1. Overview of scenarios for the year 2020 as analysed in the present study.

Scenario	Aim of analysis	Measures selected in cost-optimal solution	Total reduction costs (MEuro/year)	Change in OEI (%) [*]
AMMONIA	Minimizing total reduction costs in the Czech Republic to reduce NH ₃ emissions by 15% relative to 2005 in each study region, model can only select technical measures to reduce NH ₃	- Stable adaptation - Low nitrogen feed - Covered manure storage	11	-1%
EUPLAN	Minimizing total reduction costs in the Czech Republic to reduce NH ₃ emissions by 30% relative to 2005 in each study region, model considers all technical measures.	- Manure efficiency improvement - Stable adaptation - Low nitrogen feed	16	-3%
IMPACT	Minimizing total reduction costs in the Czech Republic to reduce the OEI emissions by 30% relative to 2005 at the national level	- Manure timing application - Manure efficiency improvement - Stable adaptation	12	-21%

^{*} Relative to a No Control scenario for the year 2020, assuming no environmental policies for agriculture in the Czech Republic (see Havlikova & Kroeze, 2009).

References

- Brink, C., *et al.*, 2005. *Ecological Economics* 53: 59-74.
 Havlikova, M. & C. Kroeze, 2009. Cost-effective reduction of environmental impact of dairy cattle in the Czech Republic. Submitted to the *Environmental Modelling and Assessment*.
 Havlikova, M., *et al.*, 2008. *The Science of the Total Environment* 396: 121-131.

Theme D
Integrated assessment: Science and impact

**Session D1: Stakeholder involvement in designing, use and
evaluation of integrated assessment models**

Session organizers:

Sylvia Herrmann

Leibniz University, Hannover, Germany

Johanna Alkan Olsson

Lund University, Sweden

Elske Van de Fliert

The University of Queensland, Brisbane, Australia

The role of models in supporting processes of change towards sustainable resource governance¹

Claudia Pahl-Wostl

Institute of Environmental Systems Research Department of Mathematics & Computer
Science University of Osnabrück,

49069 Osnabrück, Germany

Contact: Pahl@usf.Uni-Osnabrueck.de

Numerous arguments have been put forward regarding the need for a major change in resource governance to guarantee the sustainability of social-ecological systems, in particular given the challenges of global change. Regarding the system metaphor governance of resources has to be characterized as navigating complex adaptive systems in an uncertain environment rather than as solving multi-objective optimization problems of predictable and controllable systems. Goal oriented, instrumental approaches have to be complemented by a procedural understanding which portrays sustainable development as a societal search and learning process. Processes of social learning play a major role where stakeholders at different scales are connected in flexible networks and where the capacity and trust is developed to collaborate in a wide range of formal and informal relationships from formal legal structures and contracts to informal, voluntary agreements.

Such a perspective suggests as well a new role of models in analysing and supporting learning and decision-making processes. Participatory modelling and scenario building approaches may be instrumental in supporting processes of social learning and in developing innovative approaches in dealing with uncertainties. The paper will give an overview on recent developments and illustrate potential and limitations with emphasis on challenges posed by water management.

¹ Keynote presentation

Models as social learning tools in participatory integrated assessment

Joop De Kraker, Carolien Kroeze, Paul Kirschner
School of Science & Netherlands Laboratory for Lifelong Learning,
Open Universiteit Nederland, P.O. Box 2960, 6401 DL Heerlen, The Netherlands
Contact: joop.dekraker@ou.nl

Introduction

Integrated assessments (IA) are increasingly being conducted in interaction with stakeholders. The major reasons for participation of stakeholders are to (1) account for diversity in perspectives on the problem and possible solutions, (2) tap relevant non-scientific sources of knowledge, and (3) enhance the basis of support for the outcomes of the assessment. The degree of participation may vary from 'informing' to 'co-production' and 'mutual learning' (Van de Kerkhof, 2006). The role of learning in participatory integrated assessments (PIAs) has received considerable recent attention. Studies on learning in PIA-projects make clear that learning can take place in many ways (Tuinstra *et al.*, 2008). Scientists can learn from stakeholders and vice versa. When this concerns acquiring new technical knowledge and insights on, for example, important constraints or effective strategies, we speak of 'instrumental' or 'single-loop' learning. Learning may also concern the underlying values, beliefs and objectives that determine how stakeholders frame the problem. When a PIA results not only in a change in knowledge, but also in a change in the stakeholders' perspective on the problem, we speak of 'social' or 'double-loop' learning (Argyris & Schön, 1996). Whereas the emphasis used to be on instrumental learning in IA-projects aiming at decision support for policymakers, attention has shifted to social learning in PIA-projects that concern problems characterized by complexity, uncertainty, multiple stakeholders and diverging perspectives (Pahl-Wostl, 2007). To deal with such 'wicked problems' in a sustainable way, requires a shared understanding and reframing of the problem by the stakeholders serving as a basis for the development of new, collectively supported and pursued solutions. This new and shared perspective on the problem and its solutions is precisely what social learning promises to offer (Wals, 2007).

This contribution reviews the recent literature on social learning in PIAs to assess whether and how the integrative environmental models typically used in IAs can serve as tools to support social learning among stakeholders.

Models as social learning tools: state of the art

From its inception, IA recognized that models could play an important role in supporting stakeholder learning, including social learning (e.g., Rotmans, 1998). This role, however, has rarely been an object of critical examination. An exception is the retrospective evaluation of the role of models in major PIA-projects by Siebenhüner & Barth (2005), who concluded that models had only supported instrumental learning, and who doubted whether models would even have the potential to support social learning in PIAs. This conclusion is not surprising given the mismatch they observed between the models used and the needs of the stakeholders in the cases studied. As such, it is unlikely to be a generally valid conclusion. A mismatch between the perspective of the model developers and the intended users was also the reason for the limited potential of an integrated land-use model to support social learning in natural resource management by farmer communities in the Sahel (Van Paassen, 2004). A study by Sterk (2007) on the contribution of land-use modelling under conditions closer resembling a PIA found proof of a positive effect on social learning, such as adapted problem definitions, a changed solution space, and the formation of new coalitions to tackle the problem. All three studies suggest the need to involve stakeholders in model development and/or the production of model results to make models more effective as tools for social learning. A variety of such

participatory approaches have been proposed and to a certain extent have been developed and implemented over the past five years. These include model-based interactive back casting with an active role for stakeholders in scenario development (Robinson, 2003), participatory assessment of model quality and uncertainty (Van der Sluijs *et al.*, 2005), participatory development of agent-based models by including stakeholder perspectives and objectives in an interactive way (Tabara & Pahl-Wostl, 2007), and interactive combinations of modelling with role playing or gaming (Valkering *et al.*, 2008). The effectiveness of these approaches in supporting social learning in the context of PIAs has not been evaluated thus far.

Conclusions

Only a small number of studies have assessed the role of models as social learning tools in PIAs. Some of these studies were post-hoc, and none deeply studied the learning processes involved. During recent years a variety of participatory approaches have been developed that may enhance the effectiveness of models as social learning tools, but they have not yet been evaluated as such. One could speak of a ‘paradox of model-supported social learning’ (cf. Armitage *et al.*, 2008): many authors have stressed its importance, but evidence is scarce and validated guidelines on how the contribution of models could be enhanced are lacking. This indicates the need to study the role of models as social learning tools in on-going PIAs, enabling due attention for the processes by which social learning takes place. To identify how models could be designed and deployed to better support these processes, such studies could greatly benefit from the methods and insights of educational technology and collaborative learning (e.g., Clark & Linn, 2003; Van Bruggen & Kirschner, 2003).

References

- Argyris, C. & D. Schön, 1996. Organisational learning. A theory of action perspective. Addison-Wesley Publishing Company, Massachusetts, USA.
- Armitage, D., *et al.*, 2008. Global Environmental Change 18: 86-98.
- Clark, D. & M.C. Linn, 2003. The Journal of the Learning Sciences 12: 451-493.
- Pahl-Wostl, C., 2007. Env. Modelling & Software 22: 561-569.
- Robinson, J., 2003. Futures 35: 839-856.
- Rotmans, J., 1998. Env. Modelling and Assessment 3: 155-179.
- Siebenhüner, B. & V. Barth, 2005. Env. Impact Ass. Review 25: 367-389.
- Sterk, B., 2007. A window of opportunities. The contributions of land use modelling to societal learning. PhD thesis, Wageningen University, The Netherlands.
- Tabara, J.D. & C. Pahl-Wostl, 2007. Ecology and Society 12, 3. (online)
- Tuinstra, W., *et al.*, 2008. Int. J. of Innovation and Sustainable Development. 3: 128-152.
- Valkering, P., *et al.*, 2008. MATISSE Working Paper 25.
- Van Bruggen, J.M. & P.A. Kirschner, 2003. In: Eds. J. Andriessen, *et al.*, Cognitions: Arguing to learn. Kluwer Academic Press, Dordrecht, pp. 177-203.
- Van de Kerkhof, M., 2006. The Integrated Assessment Journal 6: 7-34.
- Van der Sluijs, J.P., *et al.*, 2005. Risk Analysis 25: 481-492.
- Van Paassen, A., 2004. Bridging the gap: computer model enhanced learning about natural resource management in Burkina Faso. PhD thesis, Wageningen University.
- Wals, A. (Ed.), 2007. Social Learning: Towards a more sustainable world. Wageningen Academic Publishers, Wageningen, The Netherlands.

Application of an integrated monitoring tool for sustainable dairy farming in Flanders

K. De Mey, K. D'Haene, M. Meul

Institute for Agricultural and Fisheries Research – Social Sciences Unit,
Burg. Van Gansberghelaan 115 Box 2, 9820 Merelbeke, Belgium

Contact: karen.demey@ilvo.vlaanderen.be

Introduction

Modern society increasingly recognizes the importance of sustainable farming systems and expects that the agricultural sector undertakes considerable efforts to produce in a social and ecological sound way, without overlooking the economic liveability of a farm. In order to convert the theoretical concept of sustainability into a tangible concept at farm level, an indicator-based Monitoring Tool for Integrated Farm Sustainability (MOTIFS) was designed in Flanders (Meul *et al.*, 2008). MOTIFS (Figure 1) is a graphical tool which integrates indicators for economic, ecological and social sustainability themes and sustainable entrepreneurship. The tool allows for an immediate and holistic interpretation of the farm's overall sustainability level and gives an overview of the farm's strengths and weaknesses. In this paper, we describe two applications of MOTIFS. Both are used to introduce the tool into practice and to validate its end-use value, which allows optimizing and continuously improving the tool and its application.

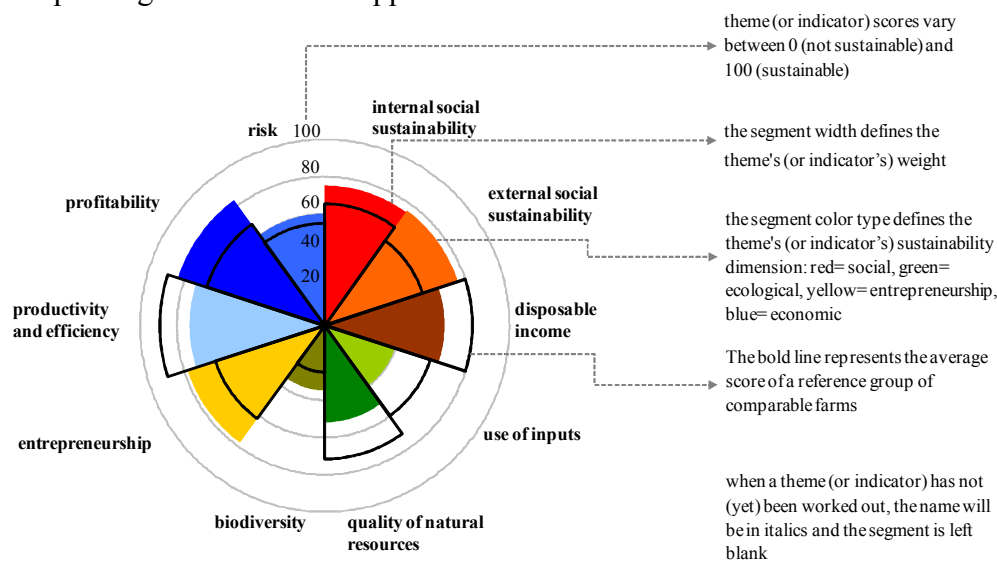

Figure 1. MOTIFS, presented with a legend concerning its reading and interpretation.

Methods

We look at two types of application of MOTIFS on Flemish dairy farms: (1) an application in a European Leader+ project, and (2) an application in two existing farmer groups from Flemish farm consultancy agencies. These applications allow us to obtain an overview of the opportunities and bottlenecks for future applications of MOTIFS.

First, MOTIFS has been applied on 20 Flemish dairy farms participating in the Leader+ project 'Strong with Milk, 2006–2008' with the aim to monitor sustainability and stimulate communication and exchange of knowledge between farmers (Schoonhoven, 2008). For a number of selected sustainability themes, the project leader regularly collected on-farm data through farm accountings and direct farmer inquiries, calculated the indicators and discussed the results with each farmer individually. Additionally, farmer discussion groups were organized, in which the results for a specific sustainability theme were discussed, together with an invited expert. For a first end-use validation of MOTIFS, a qualitative research

approach was used, consisting of semi-structured interviews with the potential end-users, i.e. farmers and farm consultants.

In a second, on-going application, MOTIFS is applied by two groups of dairy farmers that are member of two different farm consultancy agencies. Both groups consist of approximately 10 farmers who meet on regular basis to discuss their farm economic accounting under guidance of a farm consultant. In close cooperation with the groups' farm consultants, the data already available in the farm accountings (economic and environmental farm figures) are linked to a basic system for automatic calculation of MOTIFS. The discussion of the sustainability results is integrated in the regular farmer meetings that are directed by the farm consultant. The first meeting elaborated the entire tool and its principles, while following meetings deal with a specific theme. Feedback on the end-use value of MOTIFS is gathered through interviews and questionnaires with end-users and direct observations in farmer meetings.

Results and discussion

Both types of application of MOTIFS learned that both farmers and farm consultants find the tool useful to give an objective overview of all important sustainability aspects of a farm and its management. It is a good starting point to touch upon other than only economic and technical issues, as is usually done in the regular farmer meetings. Particularly the farm consultants indicate it as a practical tool to base their advice on and to steer farmers towards a larger awareness of an integrated sustainable farm management. However, it becomes clear from the use of MOTIFS that it takes time to become familiar with the type of presentation and that for some indicators that are new to farmers and consultants, it is not easy to immediately interpret the results. It is therefore important to assist potential users in the application of MOTIFS and provide support in the interpretation of the results, especially in the beginning of the implementation. The 'Strong with Milk' project demonstrated that MOTIFS can be a valuable communication tool since it allows to compare individual farm results and to discuss about tangible aspects of farm management in discussion groups. However, additional information and hard figures are still necessary to give precise advice or take decisions on specific management measures.

The cooperation with the farm consultancy agencies allows the development of a user-friendly electronic system that is integrated in their existing accounting programs in order to easily calculate MOTIFS. For this purpose, data available in farm accountings is tailored to the data necessary for calculating MOTIFS. As the cooperation with farm consultancy agencies is still at an initial stage, the end-use value and willingness of dairy farmers and consultants to use MOTIFS in practice need to be further examined. A preliminary finding is that the use of MOTIFS by farm consultancy agencies is fairly different than its use in a project like 'Strong with Milk'. Farm consultants are mostly economic-technically oriented with a strong focus on current farm income, and although they want to broaden their view and incorporate other sustainability aspects, it is difficult to change their advising system. Consequently, they try to deal only with the economic-technical aspects of MOTIFS.

As the implementation of MOTIFS on Flemish farms is, however, constantly evolving, with a continuous feedback between research and practice, we will look in the next phase of the research at the entire process of implementing a sustainability monitoring tool like MOTIFS 'from theory towards practice'. The purpose will be to look from a broader perspective at critical success factors arising in the adoption process of sustainability monitoring tools and sustainability measures.

References

- Meul, M., *et al.*, 2008. *Agron. Sustain. Dev.* 28: 321-332.
Schoonhoven, D., 2008. *Sterk met Melk! Een handleiding om duurzaam melk te produceren.* Plaatselijke Groep Leader+ Meetjesland, 59 pp. (in Dutch)

Analysis of stakeholder - researcher interactions for designing a generic grassland model suited for a diversity of farmers' practices

M. Duru, G. Martin
UMR1248 INRA-ENSAT, Chemin de Borde Rouge, BP 52627,
31326 Castanet Tolosan, France
Contact: mduru@toulouse.inra.fr

Introduction

In order to provide support to farmers, a lot of attention has been given by researchers to the development of crop models, which are used to study the adaptation of farmers' management practices to new challenges, such as new policies. In practice, few models are effectively used by farmers or advisors in spite of their ability to integrate a great deal of relevant knowledge. Models designed for decision support systems are considered to have little relevance to real world situations (Woodward *et al.*, 2008), being too prescriptive and unable to account for farmers' management preferences. Participatory research is encouraged to avoid these problems (Nowotny *et al.*, 2001) but there are no methodological guidelines for this. In addition, there is such a range of farmers' targets and constraints (Vanclay, 2004) that a generic crop model might fail to meet the stakeholders' expectations. To be adopted, even a technical change needs to be satisfactory in terms of its wider consequences i.e. social (labour) and environmental, giving rise to questions such as how to conduct participatory research making use of crop models and how to design experiments to enrich a generic crop model.

We hypothesize that by coupling on-farm observations, analytical experiments, and stakeholder-researcher workshops, it is possible to produce a generic crop model well fitted for local situations. We draw some lessons based on the critical analysis of participatory research projects concerned with different versions of a grassland model simulating herbage growth and nutritive value. This model was targeted to learn about the effect of management practices. To analyse these projects, we used the grid of David (2001) which suggests that participatory research aimed at building cognitive or decision tools for management should alternate phases of model formalization and model contextualization.

Materials and methods

The analysis is based on research projects focusing on grazing management in the Aveyron plateau (1988–1997), and on management of species-rich grasslands on mountains (Pyrenees: 1997–2004 and Massif Central: 2005 onwards). Starting from a very simple model structure, targeted experiments driven by on-farm observations provided the data for the model. Three main successive developments of the model were the modelling of grazing intensity, flexibility in management and biodiversity.

These projects combined different methods, successively and/or concomitantly: (i) on-farm observations and surveys for problem finding and model evaluation; (ii) targeted experiments and integration into the grassland model (model formalization); (iii) stakeholder surveys and training sessions (model contextualization).

Some lessons drawn from these case studies

We find that, as in other management domains (David, 2001), it may be advantageous to combine successively or roughly simultaneously different methods for building a model intended to provide relevant information for advisors and farmers at a local level.

On-farm observations are involved in model formalization and contextualization. They allow key performance criteria used by farmers to be identified, but usually leave aside by researchers, e.g., the timing of herbage growth on a seasonal time scale; flexibility, i.e. timing of grassland use, or the possibility of bringing forward or delaying the use of a meadow

Table 1. Description of the three projects (columns) using the David grid (lines).

Aim and innovation required	Studying grazing management practices by modelling herbage availability	Studying grazing management practices by modelling flexibility in grassland use	Studying management for agri-environmental value by modelling species-rich grasslands
Problem finding model evaluation	On-farm surveys and measurements	On-farm soft observations	On-farm deep observations
Changes in model formalization	Added processes: leaf senescence, stem elongation	Added agri-environmental targets (thresholds for minimum and maximum herbage N content)	Key model variables for different plant functional types (tissue composition, leaf life span etc.)
Process of model contextualization (who, when, what)	Advisory services (operational training) Before, during and after Graphs for defining herbage thresholds to meet different management aims	Advisory services (operational training) After Graphs for defining defoliation regimes allowing to remain within the thresholds	Advisory services Interactions during the process of knowledge formalization Typology grid to assess agri-environmental value
References (not listed)	Cros <i>et al.</i> , 2003; Duru <i>et al.</i> , 2000	Duru & Delaby, 2003; Duru <i>et al.</i> , 2007	Duru <i>et al.</i> , 2008

within a given time interval. Furthermore, on-farm observations may identify management practices that look suboptimal over the short term and on small spatial scales, but that may be valuable when considering longer time scales and higher organizational levels.

Experiments targeted by on-farm observations and surveys, as well as training sessions with farm advisors, are a useful step to gather results to be integrated into the model. A new paradigm can emerge, e.g., Duru (2009) for modelling feeding value.

Training sessions at each stage of the model design have shown that whereas the questions which arise about grassland management are very diverse, it is an acceptable simplification to choose a limited number of biophysical processes to put into the model and to parameterize them for key driving factors. This may interest a large group of stakeholders and may be applicable to a wide range of local farming situations. The model does not provide a complete response to advisors' questions, but it is a support for discussion, simulations giving indications of what may happen to some key performance indicators when changing driving factors. In this way, running the model for a given field or season gives partial but interesting information for planning grassland management for the whole farm over a number of years.

From our experience, using our grassland model as a teaching aid during training sessions with advisors provided an integrated view of the response of herbage growth to abiotic factors and management practices. It was used as a cognitive tool highlighting how these driving variables interact. Currently, the model is not used by the grassland experts themselves: researchers need to act as intermediaries.

By being contextualized, this research produces socially robust knowledge supported by certified knowledge (academic publications), but more than this, it incorporates the results of multiple interactions and applications with stakeholders. However this is long-term research.

References

- David, A., 2001. Les nouvelles fondations des sciences de gestion. Editions FNEGE, 213 pp.
- Duru, M., 2009. Renouveler les questions de recherche par la recherche en partenariat. (in press)
- Nowotny, H., *et al.*, 2001. Re-Thinking Science. Polity Press, Cambridge.
- Vanclay, F., 2004. Aust. J. of Exp. Agric. 44: 213-222.
- Woodward, S.J., *et al.*, 2008. New Zealand J. of Agric. Res. 51: 235-252.

Accounting for user's uncertainty information needs in Integrated Assessment models: The case of the SEAMLESS Integrated Framework

Silke Gabbert, M.K. Van Ittersum, F. Ewert, C. Kroeze, S. Stalpers, J. Alkan Olsson
Wageningen University, Environmental Economics and Natural Resources Group,
Hollandseweg 1, 6706 KN Wageningen, The Netherlands
Contact: silke.gabbert@wur.nl

Introduction

Integrated Assessment (IA) models are computer models which serve as tools to analyse complex real world problems and to portray their social, economic, environmental and institutional dimensions. Given the problems addressed and the complexity of IA models themselves they are subject to various types and sources of uncertainties. To become useful tools, therefore, assessments of uncertainties in IA models are inevitable.

Current practice is that IA models are predominantly designed from the modellers' perspective, without consulting model users. Only little attention has been paid to the question which uncertainty information is demanded by model users. This is surprising as scientists have recognized the need to analyse the model users' perspective of uncertainty assessment in IA models (e.g., Gough, 1999; Walker *et al.*, 2003; Gabbert, 2008), and as model users have repeatedly stressed the need for a more user-oriented analysis of uncertainties in these models (e.g., IIASA, 2002; CEC, 2004). This may also be attractive to give uncertainty analysis focus, as the number of sources to be investigated is often enormous.

The objective of our paper is, therefore, to suggest an approach for uncertainty analysis in IA models that explicitly accounts for model user perspectives on uncertainties. Our intention is to complement existing frameworks and analytical concepts for uncertainty analysis in IA models in order to strengthen their usefulness as 'science-policy interfaces'. As an illustrative example, our approach is applied to the SEAMLESS Integrated Framework.

Approach

We define the general objective of uncertainty analysis as to identify and assess model imperfections of any type and source (either in a quantitative or qualitative way) in order to create confidence in model outcomes. Since Integrated Assessment is a highly interactive process, involving different stakeholder groups, we combine the typology of sources and types of uncertainties from Walker *et al.* (2003) with an investigation of perspectives of model users. Model users can be analysts, i.e. researchers using an IA model for research purposes, or public decision makers, who use IA models as scientific underpinning in concrete decision contexts. The IA model, i.e. the (computerized) formalization of a given (complex) problem transforms different inputs (assumptions, parameters, data, mathematical relationships) into information that aids decision making on this problem.

The usefulness of IA models as decision-support tools crucially depends on whether the model users feel confident with model outcomes. This requires to investigate whether the uncertainty information provided by model builders and analysts adequately reflects the "model users' uncertainty information needs" (Gabbert, 2008). User needs can be identified either from a theoretical perspective, applying assumptions on decision-maker's preferences, or empirically by using, for example, questionnaires, interviews, round tables, or workshops. Which of these approaches is most appropriate depends on the IA model considered, the user groups involved and the interaction between model builders and users.

The SEAMLESS Integrated Framework includes IA models for assessing and comparing alternative agricultural and environmental policy options (Van Ittersum *et al.*, 2008). The SEAMLESS modelling team has been in close interaction with the intended users, in

particular with policy experts on the European and national level. Their uncertainty information needs were identified by means of a questionnaire. The questionnaire investigated the user perspective on uncertainty analysis in SEAMLESS-IF in a comprehensive way, addressing the user's perception of 'uncertainty' and 'uncertainty analysis', aspects that users consider important for creating confidence in model outcomes, the location of uncertainties in the model and on user's preferences for uncertainty documentation. Ten completed questionnaires were analysed.

Results and discussion

We conclude that various understandings of 'uncertainty' exist. This underlines the need for model developers and model users to agree with model users on a consistent and commonly accepted terminology before performing uncertainty analysis. While there has been general awareness for the existence of different types and sources of uncertainties, we observe that they do not seem equally relevant to model users. For policy experts using SEAMLESS-IF uncertainties within the model seem to be more relevant than uncertainties associated with the context of the problem (i.e. lying beyond model boundaries). Hence, instead of addressing each potential type and source of uncertainties, it is probably sufficient to focus on selected types and sources of uncertainties that are most relevant for model users.

In addition, users of SEAMLESS-IF wish to get insight into the impact of uncertainties on key model outcomes. This indicates that uncertainty analysis is considered a means for better understanding and interpreting model results. Hence, confidence in the outcomes of SEAMLESS-IF can be created if uncertainty analysis responds to this need. Thus, the set of user-relevant types and sources of uncertainties can be further limited if focusing on relevant model outcomes. Finally, our results point to a high relevance of uncertainty communication. Thus, technical uncertainty analysis needs to be accompanied by regular and transparent information of model users about (planned) modelling activities.

References

- CEC, 2004. Service contract for Review of the RAINS Integrated Assessment Model – Reference ENV.C1/SER/2003/0079. European Commission, Brussels.
- Gabbert, S., 2008. *J. of Env. Ass. Pol. And Managem.* (submitted)
- Gough, C., 1999. *Int. J. of Env. and Poll.* 11: 462-478.
- Harremoës, P. & R.K. Turner, 2001. *Reg. Env. Change* 2: 57-65.
- IIASA, 2002. *Uncertainty Treatment in Integrated Assessment Modelling: Conclusions from a workshop held at IIASA in Laxenburg (Austria), 24-25 January 2002.* IIASA, Laxenburg, Austria.
- Jakeman, A.J. & R.A. Letcher, 2003. *Env. Mod. & Software* 18: 491-501.
- Janssen, P.H.M., *et al.*, 2005. *Water Sc. & Techn.* 52: 125-131.
- Sundqist, G., *et al.*, 2002. *Env. Science & Policy* 5: 147-156.
- Van Asselt, M.B.A., 2000. *Perspectives on Uncertainty and Risk. The PRIMA Approach to Decision Support.* Kluwer Academic Publishers, Boston.
- Van der Sluijs, J.P., 1997. *Anchoring amid uncertainty. On the management of uncertainties in risk assessment of anthropogenic climate change.* CIF-Gegevens Koninklijke Bibliotheek, Den Haag.
- Van Ittersum, M.K., *et al.*, 2008. *Agricultural Systems* 96: 150-165.
- Walker, W.E., *et al.*, 2003. *Integr. Assessm.* 4: 5-17.

Modellers, model results and local stakeholders – dynamics in combining expert and lay knowledge in locally grounded policy formulation

A. Jonsson, J. Alkan Olsson, L. Andersson

Centre for Climate and Policy Research, Department of Water and Environmental Studies,
Linköping University, 601 74 Norrköping, Sweden

Contact: Anna.jonsson@tema.liu.se

Introduction

The involvement of stakeholders is today seen as crucial for the mitigation of environmental problems (Jonsson *et al.*, 2005). This is also acknowledged by the EU directive on water (Council of the European Communities, 2000) which strongly emphasize the need for increased stakeholder participation in water management. It is argued that public participation may contribute to achieve several interrelated goals such as better-informed stakeholder groups, transfer of knowledge from local stakeholder groups to regional and national planning authorities, socially accepted mitigation measures (leading to higher efficiency in implementation) and reduction of conflicts between stakeholder groups (Pahl-Wostl, 2002). At the same time models are more and more frequently used in this natural resource management which to a certain extent is a contradiction as models often lead to an increased use of expert knowledge (Alkan Olsson & Berg, 2005).

The aim of this paper is to assess this possible contradiction and to discuss aspects of combining different types of knowledge in the formulation of a locally suggested remedy plan for water management along EU WFD ambitions. Specifically, the case concerns a project aiming at the development of a methodology for participatory modelling (DEMO) as a way to involve farmers and other local stakeholders in water resource management.

Methodology

The methodology is based on dialogues between stakeholders and researchers, where the set-up, running and presentation of results of a catchment model (HBV-NP) (Arheimer & Brandt, 1998), served as a platform for discussion. Issues dealing with understanding present conditions and formulating a locally suggested remedy plan to reduce nutrient transport to the Kagebo Bay in the Baltic Sea were in focus throughout the process. Included stakeholders were farmers, rural households (permanent and summer cottages), municipal environmental officers, hydrological modelling experts, and process leaders with a background in social science. The paper presents results from a sequence of around 50 stakeholder meetings involving around 100 different stakeholders as well as results from 45 individual interviews with involved stakeholders. The focus is to understand whether involved stakeholders saw the presented model results as useful or not, in what way and how this helped in the process of formulating the remedy plan. Moreover, the resulting dynamics between involved experts, lay stakeholders and the model itself are discussed.

Results and discussion

The involved stakeholders perceive the employed model as a useful in relation to three issues. Firstly, they appreciated the models ability to give a general picture of the nutrient status in the drainage area. Several interviewees argued that the discussions around the models gave a clearer picture of what the problem and who the polluter is. Some interviewees also argued that the discussion on the pollution status created a feeling that *“this is our problem and we have to solve it”*. In the discussions on source-appointment it was found that the emission of phosphorous from rural households not connected to wastewater treatment plants were relatively high, this information changed the stakeholders’ understanding of who actually is the polluter in the drainage area. This new insight was highly motivating for the involved

farmers who before had seen their agricultural activities as the major polluter. On several occasions source-appointments provided by the model clarified the contribution of pollutants from the traffic which by some stakeholders were seen as larger than it actually was.

The second issue is related to the models capacity to estimate the needed quantity of reduction to achieve locally as well as nationally defined goals both at a sub-catchment level as well as in the total drainage area. The participating stakeholders argued that the pollutant load estimated by the model and compared with national defined goals helped them to create a realistic and for them legitimate definition of local goals for reduction.

The third issue relate to the measure packages prepared using the model. In these packages the needed reductions to achieve nationally and locally defined reduction goals were related to actual measures. However, when it came to the selection or priority making of measures it became obvious that there were many other factors influencing stakeholders' decisions such as the easiness to implement the measure, the cost of implementation as well as the possible economic benefit for implementing it as some of the farm measures were linked to money contributions for example buffer strips and the creation of wetlands. Moreover, equality between stakeholders in the drainage area regarding the burden of implementing measures was seen as more important than finding the most cost-efficient spot for implementation. The exception was the construction of wetlands, were stakeholders signaled a will to discuss environmentally efficient locations provided that they were technically and economically feasible and that the concerned land owner(s) were willing to engage in such a project.

The model employed in this particular process has assisted in creating a consensus around the nutrient pollution problem in the drainage area. It has put environmental changes in a tangible spatial and temporal perspective which may serve as a basis for effective planning and mitigation. It has also assisted in increasing the tolerance and understanding between stakeholder groups, which indirectly may decrease future conflicts in relation to implementation of measures. In this particular study it is evident that the decision on which measures to implement and were to implement them were also influenced by factors outside the scope of the model. Most stakeholders concluded that it was the process in itself that had been influential on their understanding and possible future action. One major problem as to the dynamic between the involved stakeholders, scientists and modellers were the timing of the delivery of results. Stakeholders facing model results were often spurred to ask new questions that often required immediate additional runs of the model which was not possible in this case. Moreover as this particular model do not have a ready user interface consequently a substantial amount of after preparation of model results was needed and therefore the time issue was also important for the involved scientists. This indicates that the model use cannot be separated from the employed participatory methodology or the policy context in which the process takes place. Hence the usefulness of the model in aiding to formulate locally suggested remedy plans is highly dependent on the ways in which the model is used as well as how easily accessible the model result is. However compared to traditional use of models in environmental decision making the experts' role was radically transformed from a one-way communication of final results to assistance in various steps of a participatory process.

References

- Alkan Olsson J. & K. Berg, 2005. *Ambio* 7: 507-512.
- Arheimer, B. & M. Brandt, 1998. *Ambio* 27(6): 471-480.
- Council of the European Communities, 2000. Directive 2000/60/EG of the European Parliament and of the Council of 23 October 2000 establishing a framework for Community action in the field of water policy. Official Journal of the European Communities, 22.12.2000, L327/1.
- Jonsson, A., *et al.*, 2005. *Ambio* 7: 489-494.
- Pahl-Wostl, C., 2002. *Integrated Assessment* 3(1): 3-14.

Transition towards more adaptive irrigation management: the impact of innovative technologies: A case study in Caia, Guadiana River Basin

Vanja Karadzic, Paula Antunes, Rui Santos, Anna Osann
CENSE - Ecological Economics and Environmental Management Group,
Faculty of Sciences and Technology, New University of Lisbon,
Campus da Caparica, 2829-516 Caparica, Portugal
Contact: v.karadzic@fct.unl.pt

Irrigation management has to become more adaptive to the increasing pressures and uncertainties coming from forces of major global climate, social, economic and political changes. While ‘adaptation’ could be defined as a change within the given regime structure and management paradigm, ‘transition’ refers to change in management paradigm, accomplished through structural changes of dominant practices, rules, shared assumptions, interests and beliefs that underlie political policy (Rotmans *et al.*, 2001). In this paper, we hypothesize that innovation technologies, in the case of irrigation management in Portugal, could contribute to transition towards more adaptive water management (Bogliotti C. & M. Todorovic, 2007).

The context for this work is a research and technological-development project PLEIADeS (Participatory multi-Level EO-assisted tools for Irrigation Water Management and Agricultural Decision-Support), developed with the overall objective of improving the technical, environmental and economic performance of irrigation schemes by means of New Technologies (NT). We selected the case study of Caia, Guadiana River Basin, Portugal, because it was used as a pilot zone for many local and European projects, through which the Associação de Beneficiários do Caia (Caia Water District Management Board) developed technological skills in GIS and automatic management of irrigation and pumping systems. Furthermore, within the scope of the PLEIADeS project local stakeholders have been involved since the beginning in the design of the new irrigation technology, thus they are not expressing confusion and aversion towards it.

Transition Management (TM) and Strategic Niche Management (SNM) are explored as analytical frameworks for understanding potential transition dynamics. We use transition multi-level model (Geels, 2002) to reflect on global pressures (climate change, EU water and agricultural policies, cultural trends) influencing water management regime (dominant practices, rules, procedures, embedded into infrastructures and institutions). As an example climate change is inducing a new paradigm to water management: moving from responsive mode to climate change concerns towards developing and investing in programs targeted at climate change, opening opportunities for innovations and adjustment of organizational structures. Other global trends are analysed in a similar way. SNM (Hoogma *et al.*, 2002) is used to analyse the introduction of PLEIADeS irrigation technology into the Caia pilot irrigation management setting. We do this on the basis of three internal niche processes: articulation of expectations, building of social networks and learning processes. According to the SNM concept, the interaction between these processes forms the foundation for understanding success or failure of innovation technology (Raven, 2005). Using internal niche dynamics, characteristics of the PLEIADeS irrigation technology are explained, as well as its contribution to the achievement of the ‘good level’ in these processes. We focus on this connection (global pressures-innovations), while striving to design NT implementation strategy on how to manage specific innovation project, with a focus on its learning potential and design of reflexive learning processes (see Figure 1). Analysed impacts of innovation technology would lead to the answer what kind of change is demanded on the regime level, taking into account macro (global) and innovation niche pressures.

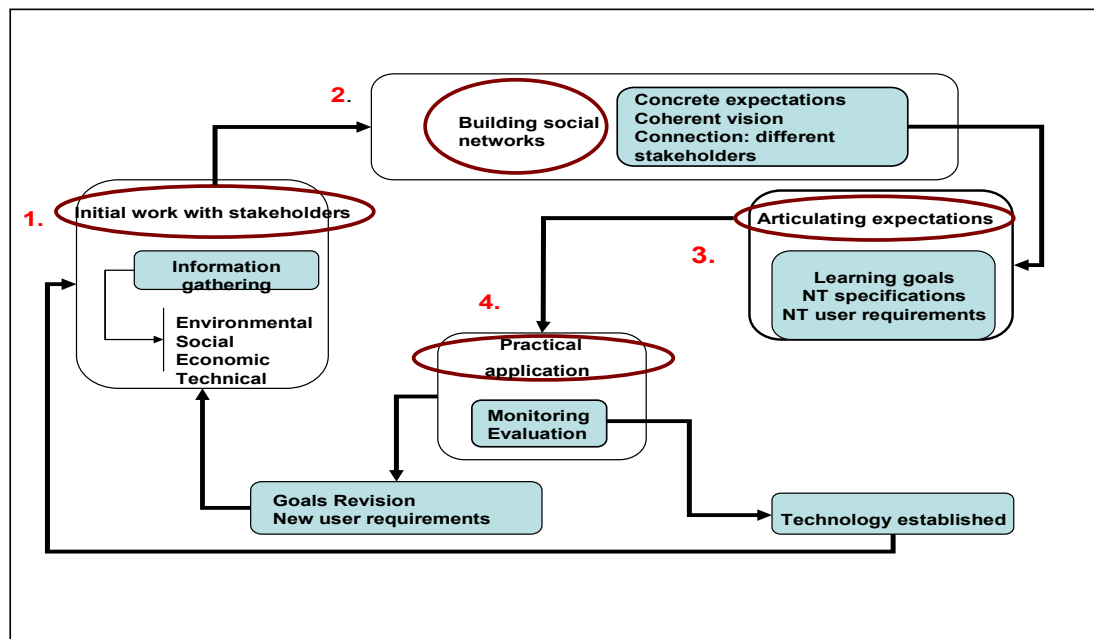

Figure 1. Reflexive design of learning processes in the context of PLEIADeS / SPIDER technology.

References

- Bogliotti C. & M. Todorovic, 2007. Identifying research and development targets for the management of limited water resources in the Mediterranean: Background and a brief outline of the WASAMED case. Presentation at the Int. Conf. Water saving in Mediterranean agriculture & Future Research Needs, Valenzano, Italy. WASAMED Project.
- Geels, F.W., 2002. Research Policy 31: 1257-1274.
- Hoogma, R., *et al.*, 2002. Experimenting for sustainable transport: the approach of strategic niche management. Spon Press, London and New York.
- Raven, R.P.J.M., 2005. Strategic niche management for biomass. PhD thesis, Technische Universiteit, Eindhoven.
- Rotmans, J., *et al.*, 2001. Foresight 3: 1-17.

Prospecting the behaviour of agro-ecosystems: experiences in using FALLOW model with natural resource managers

Betha Lusiana, Desi Suyamto, Rachmat Mulia, Meine Van Noordwijk, Georg Cadisch
Institute for Plant Production and Agroecology in the Tropics and SubTropics,
University of Hohenheim, Garbenstr. 13, Stuttgart 70559, Germany
Contact: B.lusiana@cgiar.org

Introduction

Agro-ecosystems involve trade-offs between multiple functions related to food security, environmental services, stakeholders' interest, policy interventions and technological innovations. Integrated Natural Resource Management requires a dynamic and efficient approach to help natural resource managers and policymakers in assessing the various plausible options in managing the landscape and finding ways to balance the immediate human needs and ecosystems functions. Negotiation support tools can help facilitate stakeholders to prospect and discuss the behaviour of agro-ecosystems. The use of simulation models and scenario analysis in negotiation support tools is an efficient approach to conduct such dynamic trade-offs analysis with scale-dependent properties. But the challenges remain: (i) Can envisioning tools such as simulation models and scenario analysis help decision makers and natural resource managers to explore plausible options effectively and efficiently?, and (ii) What are the essential factors for a simulation model or model results to be valuable for natural resource management in decision making?

Methods

Figure 1 presents the steps of activities conducted in this study. To explore the model users' perceptions of a potential model to be used, surveys were carried out in Indonesia, Philippines and Kenya focusing on salience, credibility and legitimacy of model simulation, scenarios performed and output results (McNie, 2007).

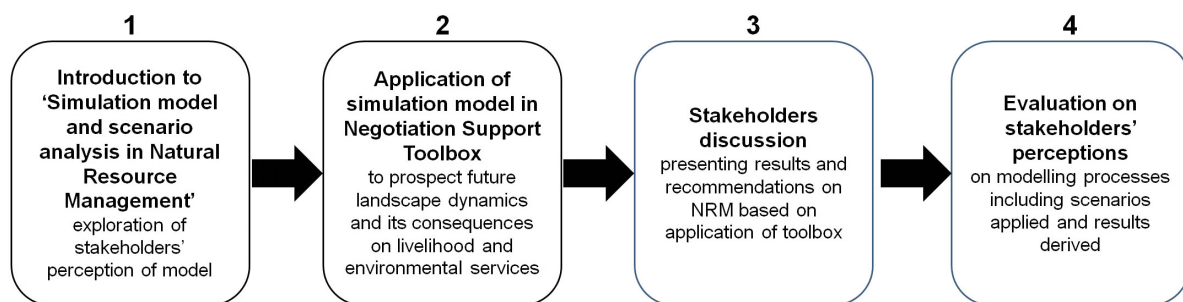

Figure 1. Steps of activities to evaluate stakeholders' perceptions of using simulation model for natural resource management.

In step 2, in order to prospect the impacts of possible natural resource management options, the landscape simulation model FALLOW was used together with potential model users (natural resource managers/policymakers and researchers) in West Aceh, Sumatra, Indonesia. The FALLOW model was developed as an impact assessment tool at landscape level to help integrate understanding of landscape-mosaic resource interactions (Van Noordwijk, 2002). The model was applied to explore the trade-offs between carbon stocks and livelihoods in forested and non-forested landscapes (Van Noordwijk, *et al.*, 2008).

A stakeholders' discussion was then held to gain model users' feedback and evaluation on model results presented, including scenario analysis used.

Results and discussion

In step 1, survey result based on 115 respondents of potential model users (52% of lecturers/researchers and 34% natural resource managers/policymakers) revealed that salience and credibility of simulation model are considered as more important characteristics than legitimacy (Table 1).

Table 1. Users' perspectives of simulation model.

Rank	Criteria	
1	Clear and understandable theory and processes underlying the model Model output is useful and applicable for managing natural resources	Salience and Credibility
2	Model output has similar patterns to what is observed in the field Model is easy to use and parameterize	
3	Model output is attractive and easy to understand	Legitimacy
4	Model was developed by well known scientist	
5	Model has previously been used by policymakers	

We tested these findings further by using the model to simulate a study site of 315 km² in West Aceh and presented its results to stakeholders (step 2 and 3) We particularly focused on results of land use dynamics and its impact on livelihood (farmers' welfare, indicated by non-primary expenses) and carbon sequestration based on baseline ('business-as-usual') condition and with natural resource management interventions (Figure 2).

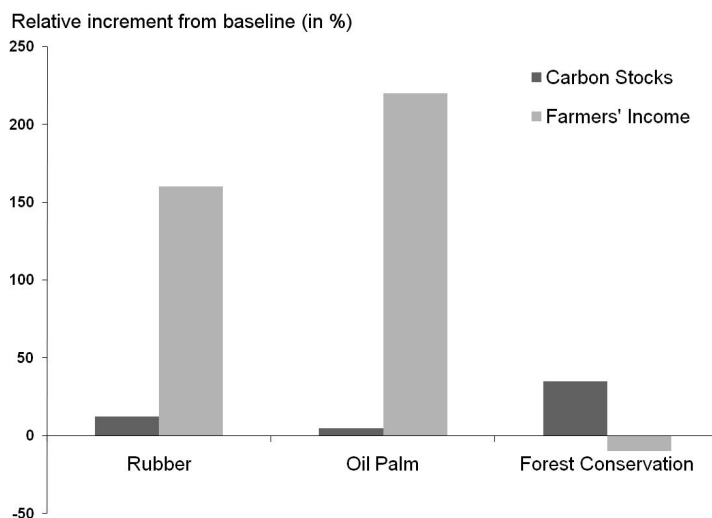

Figure 2. Relative increment (compared to current baseline) of carbon stocks and farmers welfare under scenarios of improving smallholder rubber systems (Rubber), improving smallholder oil palm plantation (Oil Palm) and protecting 50% of existing forest (Forest Conservation), based on 25 years on simulation.

This activity is on-going. The information we will gain from stakeholders are (i) how easy can they understand the modelling results, (ii) how much do they trust the results, (iii) how relevant do they find the scenarios applied are for them and (iv) how useful are the results in making decisions for natural resource management. Results of this outcome will be an essential basis for informed discussions among natural resource managers in land use planning of West Aceh landscape as well as for further model development.

References

- McNie, E.C., 2007. *Environmental Science and Policy* 10: 17-38.
 Van Noordwijk M., 2002. *Ecological Modelling* 149: 113-126.
 Van Noordwijk, M., *et al.*, 2008. *Agriculture, Ecosystem and Environment* 126: 98-112.

Learning by doing: Designing and conducting impact assessment studies for citrus Farmer Field Schools in Vietnam

O. Nicetic, E. Van de Fliert, Ho Van Chien, R. Spooner-Hart, Z. O'Leary, D. Rae
University of Western Sydney, Hawkesbury Campus, Richmond, NSW Australia
Contact: o.nicetic@uws.edu.au

Introduction

The Farmer Field School (FFS) is not just an extension method; it rather serves as a platform for adaptive research and experiential learning to address sustainable development of a complex agro-ecosystem, like that in citrus production. Actors of the platform include a variety of users: farmers; extension and technical personnel of government departments; non-government organizations and private companies; scientists from universities and research institutions; and government officials involved in policy making. Consequently, assessment of impact, and particularly sustainability aspects related to it, is very complex since it should not focus on farmers involved in the process alone, but on a suite of beneficiaries and the broader community. Ultimately, the results of the impact assessments and verdict on effectiveness of FFS will depend on who was included as an 'object' of the assessment. A further dilemma is who should conduct the evaluation: an 'objective' outsider with limited grounded knowledge about the underlying principles of the approach, or an insider with sufficient insight but who is potentially 'subjective' (Van den Berg & Jiggins, 2007). Another issue is precisely what should/can be measured. While economic indicators are commonly used, it can be extraordinarily difficult to identify and quantify all costs, as environmental and social indicators are often limited due to difficulties in capturing change and the cost involved in rigorous evaluation (Bartlett, 2005; Fleischer *et al.*, 2004).

We could state many more uncertainties about how to conduct impact assessment that leads us to conclude that there is no defined methodological protocol for assessing FFS. Differences in impact assessment methodology rather than differences in impacts themselves are a probable reason why several studies on impact and cost effectiveness of FFS had positive results, while some others come to less positive conclusions (Feder *et al.*, 2004).

This paper reports on impact assessment processes and outcomes of an AusAID CARD funded project conducted in 2005 and 2006, which initial goal was to implement IPM in citrus using the FFS approach. However, the actual interaction between project stakeholders (including Vietnamese and Australian researchers, trainers and farmers) during the course of FFS lead to a total reformulation of the citrus IPM strategies and practices. Farmers' opinions and experiences in the first cycle of the learning process seemed more appropriate under the prevailing conditions than the methods determined by researchers in the initial FFS design. These interactive participatory learning processes that all project stakeholders went through became equally important in terms of capacity building as the implementation of the IPM FFS itself. We sought to assess the effectiveness of FFS in capacity building of all stakeholders taking in account impact of the process of development of new practices, not only the impact of the changed practices itself.

Methods

Impact assessment was done by the project management team and includes three major parts: (a) analysis of knowledge, attitudes and practices (KAP) of farmers, pre and post FFS attendance, (b) analysis of economic, social and environment impact as a result of the changed practices 12 months after farmers completed FFS and (c) impact of participating in the FFS process on stakeholders themselves and their social environment. The KAP survey was conducted with 710 farmers in 2005 and 1,659 in 2006 from 12 provinces in the Mekong Delta and Central coastal provinces of Vietnam. Impacts were assessed using semi-structured

interviews and group discussions with farmers that allowed the team to identify changes in their agricultural practices, major economic impacts and changes in their environment. Farmers were also asked to describe impacts of participating in FFS on their family life and interaction with community. A total of 60 farmers were interviewed from 9 provinces. Originally, only KAP analyses were planned to be used in assessment of FFS effectiveness. During participatory evaluation of the process at the end of the first year it was, however, concluded that results of KAP analysis did not capture the essence of the FFSs impact on farmers and their community. The project team together with trainers then developed other assessments tools including semi-structured interviews and group discussion in an attempt to improve the assessment.

Results and discussion

The KAP analysis showed that attitudes of farmers were influenced by participation in FFS particularly in relation to pest control methods. Farmers increased their level of agreement that pesticide can cause pest resurgence and agreed less to the statements that application of pesticide will increase the yield, that pesticide are cheap and easy to use, and that advanced farmers use a lot of pesticide. Farmers' knowledge about pests and diseases significantly improved as a result of participation in FFSs, with a significant increase in number of farmers giving correct answers recorded across all provinces but with steeper increase at Central coast due to the lower level of knowledge at the beginning of FFSs. As citrus is a perennial crop with a year-long growing season, most practices were not possible to change within the timeframe of FFS. Only change of practice recorded was reduction of number of sprays in Mekong delta from 7 to 6.5 and from 7.7 to 6.0 in 2005 and 2006, respectively.

Major changes in practices recorded in interviews with farmers a year after FFS completion were visible in the increased use of compost and manure followed by a change in number of pesticide spray used (slight decrease) and a significant change from use of broad spectrum pesticides (primarily synthetic pyrethroids) to less disruptive pesticide like mineral spray oils and imidacloprid. Major economic impact was reduction of input costs. It was estimated that cost of FFS per participant represented only 1.60% of their net annual profit. Major environmental impacts were the increase of beneficial arthropods and an increase in abundance of fish in canals.

Participation in FFS raised confidence in ability of participants to manage citrus agro-eco system. It improves relationship between farmers who participated in FFS and increased their influence in community. It increases activities in growers clubs that resulted in formation of several cooperatives. Attendance in the FFS assisted in transition of farm management from father to son (4 cases) and daughter (1 case) and from husband to wife (3 cases). Even though by combining more objective and robust KAP analysis with more subjective and inherently biased semi-structured interviews and group discussions, we captured a wide range of impacts and developed rich picture of FFS impacts. These, however, could not be precisely quantified which confirms the complexity of the assessment process and need for development of interactive, participatory assessment tools that will be able to quantify impacts of FFS.

References

- Bartlett, A., 2005. Farmer field schools to promote integrated pest management in Asia: The FAO experience. Proceedings of the 'Workshop on Scaling Up Case Studies in Agriculture', International Rice Institute, 16-18 August 2005, Bangkok.
- Feder, G., *et al.*, 2004. Review of Agricultural Economics 26: 45-62.
- Fleischer, G., *et al.*, 2004. In: Eds W. Rivera & G Alex, Demand-driven approaches to agricultural extension: Case studies of international initiatives. Agricultural Development Discussion Paper 10: 40-49.
- Van den Berg, H. & J. Jiggins, 2007. World Development 4: 663-686.

SEAMLESS training material on concepts and models for Integrated Assessment of agriculture and sustainable development

P. Reidsma, J. Alkan Olsson, I. Bezlepkina, S. Brogaard, J. Queste,
R. Fischer, M.K. Van Ittersum
Plant Production Systems, Wageningen University,
P.O. Box 430, 6700AK Wageningen, The Netherlands
Contact: pytrik.reidsma@wur.nl

Introduction

Concerns about environmental problems, food security and climate change have put sustainability in agricultural development prominently on policy agendas. There has been a shift from supporting agricultural production towards policies supporting sustainable (rural) development in a broader sense. Hereby, important drivers of change in agricultural systems, (e.g., globalization, liberalization, environmental policies, climate change) request integrated analyses considering the full set of natural, economic, social and institutional aspects of sustainability at multiple scales (i.e. field, farm, region, market and global levels). Such integrated assessment of agricultural systems requires integration of knowledge from different disciplines.

Over the past years, there tends to be an increase in large research projects with the aim to develop integrated assessment tools for various domains. One example is a large European research consortium that has developed an integrated modelling framework to support analysis of relationships between agricultural systems and sustainable development: SEAMLESS-IF (System for Environmental and Agricultural Modelling; Linking European Science and Society – Integrated Framework; Van Ittersum *et al.*, 2008). The SEAMLESS-IF is a computerized integrated framework that assesses and compares *ex-ante*, alternative agricultural and environmental policy options, allowing (1) analysis at the full range of scales (farm to EU and global), (2) analysis of the environmental, economic and social contributions of a multi-functional agriculture towards sustainable rural development and (3) analysis of a broad range of issues, such as environmental policies and liberalization.

Integrated assessment projects require a new generation of scientists with strong integrative skills, both conceptually, methodologically and technically. Such scientists may have a strong disciplinary background supplemented with inter- and transdisciplinary skills or they may have a mainly interdisciplinary training. Developing ‘T-shaped skills’ (broad scientific overview combined with in-depth knowledge of specific subjects) allows for scientific, communicative and co-operative flexibility (Bouma, 1997). We anticipate that new courses and curricula are needed which on the one hand capitalize and disseminate experiences and capacity from large integrated assessment projects and on the other hand train a new generation of scientists. This contribution reports, as an example, modular training material developed from the SEAMLESS project. This training material can be used for undergraduates, postgraduates and experts from research and policy institutes, and parts of it can also be useful for discussions with other stakeholders.

Training and courses

SEAMLESS training material is based on a modular structure (Figure 1; Reidsma *et al.*, 2008). The underlying principle is that several modules can be flexibly combined together and some specific ones can be added depending on the course duration, intensity and the audience to easily produce ‘à la carte’ courses. One of the courses developed is the post-graduate course of one week, which can be considered as an example of how to use the SEAMLESS training modules to create a course.

The objectives of the course are (1) to present concepts for integrated assessment of agricultural systems, (2) to gain theoretical and practical understanding of the methods, models and tools used in integrated assessment of agricultural systems, (3) to understand how integrated assessment and modelling can support *ex-ante* impact assessment and decision-making processes and (4) to understand how own specific research relates to an integrated assessment and modelling perspective.

In the course, SEAMLESS-IF and its research tools are used as an example to present how concepts and models can be integrated to assess complex agricultural systems. The course is problem orientated, so all lectures are linked to practical applications, such as environmental policies within the Nitrate Framework Directive or trade policies.

The post-graduate course is an advanced course and can form a basis for researchers that want to learn about methods for integrated assessment and/or that want to continue working with the framework or with individual components (advanced level). When training policy experts or other stakeholders the focus will be more on basic and intermediate level modules. The courses and their set-up will be evaluated, which can improve training material and identify gaps in SEAMLESS-IF.

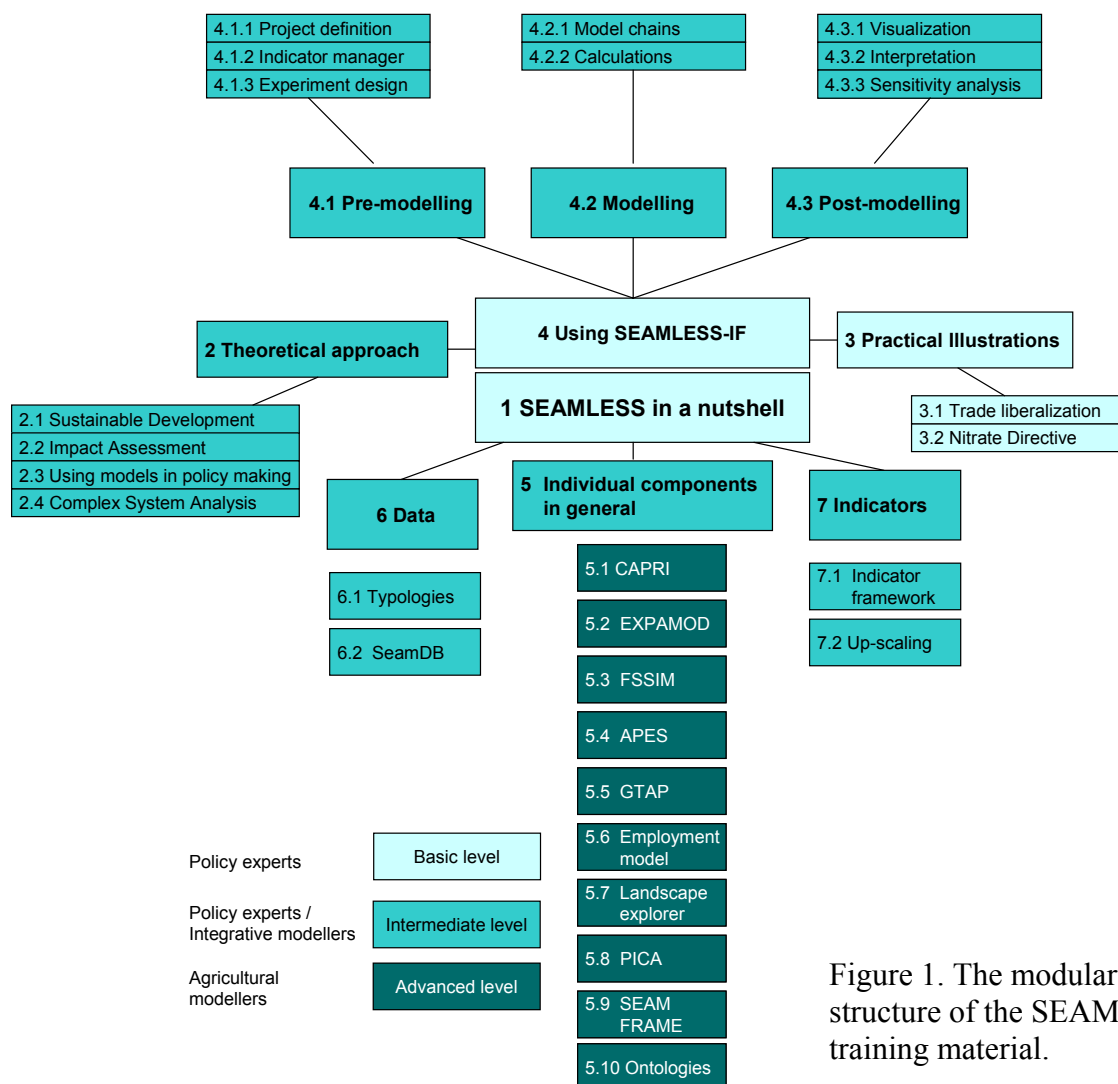

Figure 1. The modular structure of the SEAMLESS training material.

References

- Bouma, J., 1997. *Geoderma* 78: 1-12.
 Reidsma, P., *et al.*, 2008. PD7.5.2, SEAMLESS Integrated Project.
 Van Ittersum, M.K., *et al.*, 2008. *Agricultural Systems* 96: 150-165.

Serious Gaming as a tool to create sustainability awareness, discussion and negotiation among stakeholders in cattle systems, the case of Los Angelitos¹

E.N. Speelman, L.E. García-Barrios
Biological Farming Systems Group, Wageningen University,
Marijkeweg 22, 6709 PG Wageningen, The Netherlands
Contact: erika.speelman@wur.nl

Introduction

Ever since the Brundtland Report, sustainability has been on many agendas in a wide range of disciplines. In the field of Natural Resource Management Systems (NRMS), sustainability has become a prime focus point of researchers, NGO's and governments. However, reaching sustainability is not an easy task. NRMS are usually highly complex systems in which a wide range of stakeholders at different scales pursue different goals from the system and evaluate system's performance with a stakeholder-specific set of indicators. The social process of NRMS has become increasingly complex, interdependent and uncertain (Gunderson, 1999). Recently, new methods have been developed to search together with stakeholders for more sustainable management, and to stimulate interaction among stakeholders to help to frame and reframe problems. Simulation models, especially those that combine computer simulation and role-playing have shown to stimulate learning and discussion (see www.commod.com; Speelman & García-Barrios, 2006; García-Barrios *et al.*, 2008). Role-playing can have significant influence on the way players will behave in the future (Gurung *et al.*, 2006). In general, human beings have problems dealing with complexity and tend to use short-term, adaptive and ad hoc problem solving strategies that are successful only within certain limits (Dörner, 1997). These 'serious games' can help people to develop a better sense of scoping and consensus building when dealing collectively with complex systems.

The state of Chiapas, Mexico is one of the biodiversity hotspots in Mexico. The Sepultura reserve was created to preserve this natural richness. However, the establishment of the reserve has limited farmers, who live in the reserve, in expanding their farming area. In order to maintain their livelihoods these farmers have now moved to highly unsustainable forms of land use, i.e., intense cattle herding. Trees have virtually disappeared from farming areas. This in combination with the high grazing pressure has led to very little soil cover at the beginning of the rainy season; resulting in very high erosion levels.

We have recently started developing a participatory modelling project in the region. The project aims for bringing together the relevant stakeholders from different scales to discuss the challenges that the area is facing and to develop (simulation) tools that aid the social learning process. Within this effort, the modelling game named Los Angelitos (Speelman & García-Barrios, 2008) was developed.

Methods

The model was developed in Netlogo 3.1 (Wilensky, 1999). A micro-watershed suitable for the game was selected from an areal photograph of La Sepultura. The image was uploaded in Netlogo to create the landscape of the game, as seen in the user interface (Figure 1). Simple minimalistic modelling was used to develop the submodels, included some published plant growth and grazing models, i.e. García-Barrios *et al.* (2008).

Los Angelitos combines role-playing with simulation and elements of board games. Users take on the role of farmers. They select and appropriate an area; after which they decide their land use, i.e., forest, maize or grass, and the number of cows. Users and the systems are subject to perturbations in the form of pop-up cards.

¹ This **demo presentation** will show the development of the Netlogo game 'Los Angelitos' in Los Angeles, Chiapas, Mexico. The work is still ongoing.

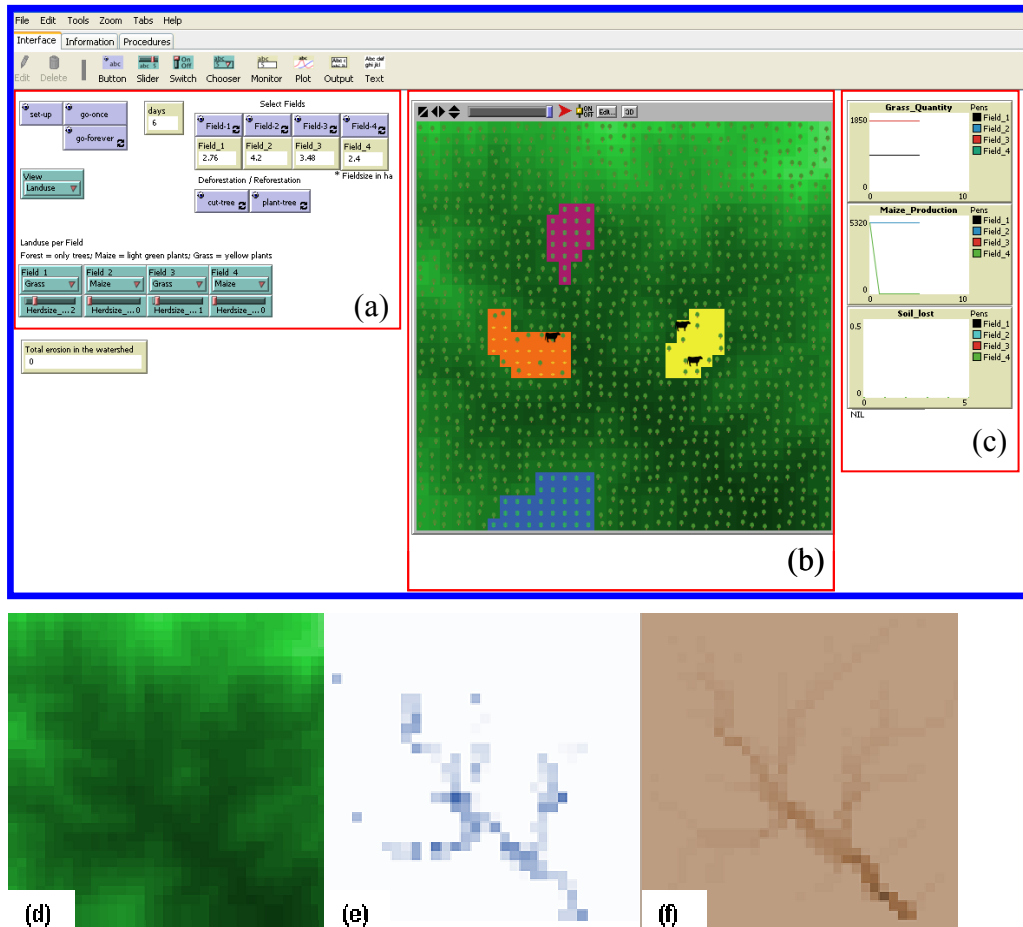

Figure 1. User Interface of the simulation game ‘Los Angelitos’ with (a) buttons and sliders controlling the simulation and the individual fields, (b) view of the virtual landscape (users can select from a range of different views such as land use (shown here), elevation (d), runoff (e), and erosion (f), and (c) graphs showing different outputs of the simulation.

Results and discussion

Some first model-stakeholder interactions showed that farmers from the local communities were very positive about the game. They were instantly intrigued by how decisions of neighbour stakeholders affected their fields and the system as a whole. As part of the project a modelling workshop was organized in July, 2008. During this workshop (inter)national researchers and local stakeholders interacted and discussed the future of serious games. The workshop and especially the input of farmers profoundly helped the further development of the model.

References

- Dörner, D., 1997. The logic of failure. recognizing and avoiding error in complex situations. Addison-Wesley, Reading, Massachusetts, 222 pp.
- García-Barrios, L.E., *et al.*, 2008. *Ecol. Mod.* 210: 115-126.
- Gunderson, L., 1999. *Conserv. Ecol.* 3 (1): 7.
- Gurung, T.R., *et al.*, 2006. *Ecol. Soc.* 11 (2): 36.
- Speelman, E.N. & L.E. García-Barrios, 2006. *Proceedings Agent 2006*, pp. 289-305.
- Speelman, E.N. & L.E. García-Barrios, 2008. ‘Los Angelitos’, unpublished-software.
- Wilensky, U., 1999. ‘Netlogo’, Center for Connected Learning and Computer-based Modeling, Northwestern University. Evanston, IL.

Understanding and modelling socio-ecological networks to support multi-scale governance of sustainable dairy farming systems

E.N. Speelman, J.C.J. Groot, H. Van Keulen, K. Kok, W.A.H. Rossing
Wageningen University- Plant Sciences group, Biological Farming Systems Group,
Marijkeweg 22, 6709 PG Wageningen, The Netherlands
Contact: erika.speelman@wur.nl

Introduction

The performance of farming systems is increasingly evaluated for new functions and services in addition to their primary function of producing food and fibres. In addition, with increased pressure on resources and increased connectivity between scales, relationships between stakeholders have become more apparent and more intense. The seemingly independent actions of different stakeholders involved can produce unwanted and uncontrollable consequences for all (Bouwen & Taillieu, 2004), which contributes to conflict and separation between social actors and groups of stakeholders. This has often led to conflicts (e.g., Senegal: D'Aquino *et al.*, 2003; Mexico: Speelman *et al.*, 2006; Bhutan: Gurung *et al.*, 2006). The knowledge required to search for alternative management is usually not held by one social actor, instead each stakeholder has her or his own version of reality; joining these partial realities aids to frame and reframe problems (Spector & Anderson, 2000).

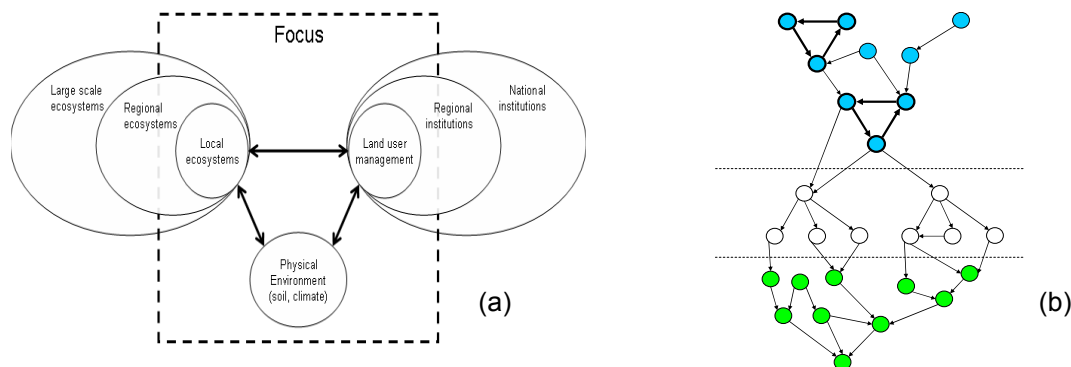

Figure 1. (a) Conceptual framework for the analysis of linked social-ecological systems. Local ecosystems are nested within other ecosystems. Management practices are embedded in institutions, and these can be nested within other sets of institutions. Modified from Berkes & Folke (2002) and Olsson (2003). (b) Hypothetical network of social (blue), farm (white) and natural (green) entities.

The way by which stakeholders are connected and how stakeholders' actions influence, affect or even determine underlying natural entities and other stakeholders (Figure 1) is not yet fully understood. Currently, an increased interest has risen in network theory and so far many types of systems have been subject to investigation with methods based on network theory e.g. proteins, food webs, organizations. Network characteristics, structure and motifs have been identified in various studies. However, studies of socio-ecological network are still rare. A fuller understanding of socio-ecological networks in farming systems (see Figure 1a) can aid research and implementation of more sustainable management options. For instance, understanding an innovation network can guide the dissemination process of promising alternative management.

Recently, tools aiming for bringing relevant stakeholders together for social learning, discussion and negotiation have been developed which combine tools from both social and environmental sciences, e.g., role-playing and modelling. A site-specific approach 'Companion modelling' (Barreteau *et al.*, 2001) and a generic tool 'Negotiated design of

Sustainable Production Systems among Social Agents with Conflicting Interests” (García-Barrios & Pimm, 2005) have been developed. Both approaches have proven through widespread implementation (see www.commod.org and García-Barrios *et al.*, 2008) to be able to create an interactive setting in which stakeholders learn, discuss and negotiate important issues and future management.

However, both approaches focus mainly at stakeholders of one scale, whereas more-difficult-to-solve conflicts often arise between stakeholders of different scales. As their partial realities are more likely to differ dramatically, making communication more challenging. Creating a setting in which stakeholders from different scales meet, discuss and play with a simulation model is therefore very important. The current approaches demand for the development of tools that are suitable for a wide variety of users from low to higher governance levels, e.g., farmers and regional managers. Additionally, the current site-specific approach is very costly and has a small reach whereas the generic tool is less costly and has a larger reach, but is too abstract for use at lower governance levels. A new tool yet to be developed should therefore be ‘medium-generic’, meaning that it should sufficiently reflect stakeholders’ reality, but at the other hand sufficiently generic to be interesting and appealing to other similar stakeholders in other areas who fight similar issues. The innovative aspect of the proposed research is focused on filling this gap between the current approaches.

Methods

The proposed research consists of developing a ‘medium-generic’ simulation tool appealing to a wide range of stakeholders aiming for social learning, information dissemination, discussion and negotiation. As far as we know, no efforts of this kind have yet been made in dairy systems nor in socio-ecological systems. The tool or toolbox to be developed will be based on solid literature review as well as a case study, to ensure that it will address a more wide-spread problem which is also present for analysis in a specific case. Therefore, this study will focus on a case study of dairy systems in an area in the state of Michoacán, Mexico. The research will consist of three main components: (a) data collection, (b) participatory modelling, and (c) application of the modelling tool or toolbox. During the data collection phase, information on (i) common problems in dairy farming systems, (ii) current relevant modelling approaches will be gathered, and (iii) case study specific information concerning biophysical and social networks. After which a participatory modelling process will start in the case study area. The applicability outside the borders of the specific case study will be assessed through its application in two more areas.

References

- Barreteau, O., *et al.*, 2001. *J. Artif. Soc. Social Simul.* 4(2): 5.
- Berkes, F. & C. Folke, 2002. In: Eds L.H. Gunderson & C.S. Holling, *Panarchy: Understanding transformations in human and natural systems*. Island Press, Washington, DC, pp. 121-146.
- Bouwen, R. & T. Taillieu, 2004. *J. Commun. Appl. Social Psychol.* 14: 137-153.
- D’Aquino, P., *et al.*, 2003. *J. Artif. Soc. Social Simul.* 6(3): 5.
- García-Barrios, L.E. & M. Pimm, 2005. *Negotiated design of sustainable production systems among social agents with conflicting interests*. Software.
- García-Barrios, L.E., *et al.*, 2008. *Ecol. Mod.* 210: 115-126.
- Gurung, T.R., *et al.*, 2006. *Ecol. Soc.* 11(2): 36.
- Olsson, P., 2003. *Doctoral Thesis*, Stockholm University, Sweden, 37 pp.
- Spector, M. & T. Anderson (Eds.), 2000. *Integrated and Holistic Perspectives on learning, Instruction and Technology: Understanding Complexity*. Kluwer Academic Publishers, Dordrecht, 300 pp.
- Speelman, E.N., *et al.*, 2006. *Outlook Agric.* 35: 57-64.

Specifying impact assessment simulations in interaction with end-users: The example of SEAMLESS-IF

M. Taverne, O. Therond, J.P. Bousset, J. Alkan Olsson, F. Ewert, M.K. Van Ittersum, J. Wery
Cemagref, 24 Avenue des Landais - BP 50085,
63 172 Aubiere Cedex, France
Contact: marie.taverne@cemagref.fr

Introduction

The SEAMLESS Integrated Framework (IF) aims at assessing *ex-ante* impacts of agricultural and environmental policies and technical innovation with modelling chains that enable the simulation of biophysical, economical and social changes in processes related to agriculture (Van Ittersum *et al.*, 2008). End-users and experts of SEAMLESS-IF will have to interact for the definition of simulations to be performed within this integrated assessment and modelling framework. Indeed, only the end-users can define the issue of the impact assessment at stake, the changes in driving forces (policies or agricultural practices) to investigate, the concerned contexts, the critical uncertainties and the domains requiring impact assessment (Alcamo, 2008). Due to the complexity of this framework, a thorough knowledge of the framework, its model chains and the underlying assumptions are required to define the simulation experiments. As a consequence, end-users are unlikely to be able to use this framework without support from framework experts.

Several degrees of intensity of interaction with users are foreseeable. This is because the experts of the framework are not equally skilled to understand the problems expressed by end-users, to make end-users' assumptions and expectations more explicit and to share their expertise of the framework. At the same time end-users do not have equivalent ability to understand the way the framework works, including the model assumptions and variables (inputs, outputs, parameters). And further, the translation of a problem defined by end-users into simulation parameters (models inputs) by a framework expert could create a lack of transparency if there are no guidelines and visualization techniques that are easy to use to support the discussion (Alcamo, 2008).

The purpose of this contribution is to present tools, which may be useful to assist in the process of interaction between end-users and experts of the framework, to specify simulations in SEAMLESS-IF enabling well qualified impact assessments.

Methods

Two tools that can contribute to the joint specification of simulations were developed and used during the project. One tool is a template to develop *story lines*, which was elaborated during case studies for model evaluation. In impact assessment practices, story lines are used to describe qualitative images of the future (qualitative scenarios) with expert knowledge. They can be the only final outcome of an impact assessment or can precede model simulations and be revised and combined with the quantified impacts (Alcamo, 2008). During the development of SEAMLESS-IF, story line development was a step to specify the simulations to be performed in case studies. Further, this exercise aims at helping common understanding between end-users and framework experts about agricultural systems and corresponding processes to be assessed. The tool uses a table template which allows to describe, in a few words, changes in driving forces (e.g., policy or technology) to be assessed, to define in a hierarchical way systems and sub-systems that may be affected by these changes (e.g., market, territory, farms and fields) and to qualitatively describe the expected impacts of each investigated change. The development of story lines makes end-users to describe, more or less freely, the narratives underpinning their policy assessment questions and the associated assumptions while the story line template helps SEAMLESS-IF experts to

capture narrative information necessary to set up an impact assessment within SEAMLESS-IF.

A second tool was specifically elaborated to support interactions between SEAMLESS researchers and end-users during the evaluation of the framework in 'real' conditions. It is a *problem framing guideline*, gathering information that requires specification to perform simulations. Three versions of this guideline have been developed with different degree of detail. The less directive version provides a set of pre-defined general questions to be asked by SEAMLESS-IF experts to end-users. An intermediate version adds indications on SEAMLESS-IF capabilities (scales, modelled processes, etc.), so that experts can check the possibility to address end-user's questions. The most directive version is a set of tables providing in-depth guidance to SEAMLESS experts and end-users for collecting required information. Tables are structured according to the topics to be discussed and to SEAMLESS-IF capabilities. This *guideline* more directly matches the information to be specified in SEAMLESS-IF than the *story line template*.

During the development of SEAMLESS-IF, interactions between experts and end-users to specify simulations started in 2007. To lead these interactions, the experts had the choice among the three versions of the *problem framing guideline* and the template for *story line* development.

Results and discussion

Intensity of interactions varied a lot according to end-users' willingness to interact with experts to specify the problem to be assessed and also to the researchers' confidence in their skills to manage such discussions. Some of these interactions were detailed enough to specify simulations to be performed. Some of the experts led these detailed interactions with tables provided in the *guideline* because they preferred a well-defined structure. Other experts who led detailed interactions preferred rather free discussions with end-users, i.e. they either asked open questions inspired from the *problem framing guideline* to end-users (less directive version) or asked questions enabling to fill out the *story line template*.

If precise enough, information collected with the *problem framing guideline* is sufficient to fully specify the simulation. With information provided by *story lines*, the expert of the framework can deduce the needs in terms of simulation parameters and can explain the limits of the modelling framework to the end-user, providing he has a thorough knowledge of the framework and is used to translate story lines into simulation parameters. Each end-user who was asked to fill-in the concrete tables provided in the *guideline* or to develop a *story line* found the exercise very useful to frame the problem and to stimulate interactions (even without simulation perspective for some of them). This should improve the relevance, credibility, legitimacy and transparency of the simulations.

We conclude that interactions between end-users and experts of the framework require several accompanying tools, considering the diverse expectations and skills. Interactions between end-users and experts of the framework will affect the understanding of the framework by end-users, the chances of doing simulations that meet their needs and the traceability and transparency of the whole process. Our observations will be further evaluated once SEAMLESS-IF will be applied to answer end-users' concerns and to support decision-making. The design of methods and tools to support interaction between experts of the framework and end-users will be developed further in the future as the framework is used. Observations of how problems are specified and a synthesis of these experiences will help to improve the use of SEAMLESS-IF in close interaction with end-users.

References

- Alcamo, J. (Ed.), 2008. Environmental futures: The practices of environmental scenario analysis. Elsevier, Amsterdam, 197 pp.
- Van Ittersum, M.K., *et al.*, 2008. Agricultural Systems 96: 150-165.

Agricultural decision support systems: Tools to facilitate co-learning for stakeholders and scientists

P.J. Thorburn, E. Jakku

CSIRO Sustainable Ecosystems, 306 Carmody Rd, St. Lucia Qld 4068, Australia

Contact: Peter.Thorburn@csiro.au

Introduction

The development of decision support systems (DSSs) has been one way in which agricultural scientists have attempted to help farmers deal with the complexity of optimizing farming systems. DSSs can be described as *knowledge intensive* innovations, because they require people to learn new knowledge and skills to operate the technology effectively and adopt its 'outputs'. There has been a move to employing participatory action research (PAR) techniques in the application of DSSs, in an attempt to increase their generally low impact. The shift towards participatory application of agricultural DSSs opens opportunities for new ways of thinking about application process. The sociology of both science and technology describes how science and technology are produced through social relationships and practices, and so might inform and guide participatory DSS application. In the paper we develop a framework based on these sociological principles that describes the participatory process as a co-learning venture. We illustrate the application of the framework through a case study of the use of agricultural DSSs for improved management of sugarcane production systems.

Sociological framework

We propose that participatory DSS application is an interplay between three concepts in science and technology studies; *Interpretative flexibility* (Hess, 1997), *Technological frames* (Bijker, 1995) and *Boundary objects* (Cash, 2001); illustrated by Figure 1. A DSS can act as a boundary object, creating a temporary bridge that promotes dialogue between the various people involved in its application, while remaining flexible enough to be utilized by the different parties for their own purposes. Interpretive flexibility allows the DSS to serve as a boundary object, and highlights the different goals people have when working with DSSs. Through the negotiation, cooperation and co-learning that the DSS-as-boundary-object can facilitate, the parties involved may arrive at an increasingly shared understanding of the problem. This works towards increasingly congruent technological frames. Obviously any technology, including a DSS, is conditioned by, and embedded in (Figure 1) its external social, cultural, political, economic and biophysical context which must be considered during these interactions.

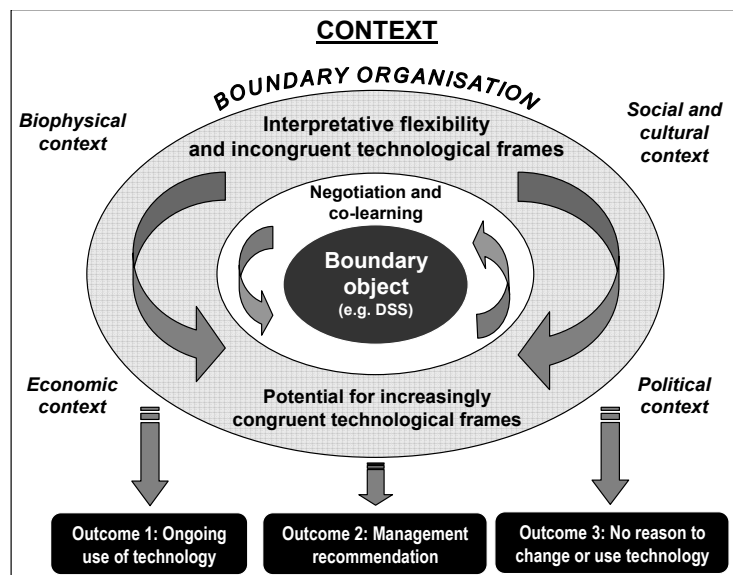

Figure 1. Theoretical framework of the context, processes and outcomes of participatory DSS development.

Participatory DSS application leads to three potential outcomes (Figure 1): (i) Acceptance by potential users of the need for, and value of ongoing use of the DSS, a process that corresponds more to classical DSS development. (ii) A better understanding of the problem and its context, leading to the development of a new management heuristic that can be extended as a management recommendation for farmers. (iii) The stakeholders involved may find that there is no opportunity for, or little benefit from changing current management practice. If some parties, e.g., the scientists, disagree with this view, the technological frames are obviously incongruent.

Case study

The framework was assessed through a case study in the Australian wet tropics, at Tully. A group of farmers and extension officers wanted to increase sustainability of nitrogen (N) fertilizer management within sugarcane farming in their region in response to concerns over health of the nearby Great Barrier Reef. They thought that seasonal climate forecasting could possibly help reduce environmental N losses, whilst increasing crop yields. These issues were examined in a participatory approach, by simulating various management practices thought to potentially increase sustainability of local sugarcane production systems with the APSIM-Sugarcane model. Semi-structured, in-depth interviews were conducted with all case study participants and their comments compared with the elements of the framework.

The range of expectations the participants initially held about possible direction of the study illustrates the interpretative flexibility that shaped their initial reactions to the study: *...I was curious to see how you could use the nitrogen application part of, with it, which I understand we probably all have our own ideas through experience, about putting on nitrogen in different wet years and dry years, and things like that. (Farmer)* APSIM acted as a boundary object, allowing the participants to explore nitrogen management and gained a better understanding of the nitrogen cycle and the consequences of different nitrogen management scenarios in that environment: *I was just fascinated with the different responses of the soil typesI'm very enthusiastic about it, opened up a lot of possibilities, scenarios, something like that. (Farmer)* At the conclusion of the study there was a degree of incongruence amongst the technological frames of the case study members: *I don't think I've learnt much more ... (Farmer) ...We're looking at (recommending) a lower N rate in ... wetter conditions. (Extension officer)*

Discussion

The framework describes the social context and processes that shape participatory DSS application. The concepts of interpretative flexibility and technological frames reinforce the importance of acknowledging the different perspectives held by people involved in the participatory process, and then the need/opportunity to work towards a shared understanding. When used as a boundary object, a DSS encourages co-learning between those involved in its development. Appreciating the way in which a DSS can act as a boundary object recognizes how cooperation and co-learning among those involved in that process can occur, despite the fact that these people can hold diverse perceptions of a DSS or the issue it is designed to address. The framework, and the concepts on which it's based, highlight that participatory DSS application is a valuable learning process leading to knowledge acquisition.

References

- Bijker, W., 1995 Of bicycles, bakelites, and bulbs: Toward a theory of socio-technical change. Massachusetts Institute of Technology Press, Cambridge, Massachusetts.
- Cash, D., 2001 Sci. Technol. and Human Values 26: 431-453.
- Hess, D., 1997 Science studies: An advanced introduction. New York University Press, New York.

Participatory modelling for Renewable Resource Management: A critical assessment

Annemarie Van Paassen, Cécile Barnaud, Guy Trébuil
Communication science, Wageningen UR, Hollandseweg 1,
6706 KN Wageningen, The Netherlands
Contact: Annemarie.vanPaassen@wur.nl

Introduction

The objective of Integrated Assessment Models (IAM) of agriculture and sustainable development is to support learning of societal actors about possible actions. Multi-Agent System (MAS) models, integrate biophysical and socio-cultural dynamics in the assessment. They assume that socio-cultural aspects only change slowly and that policymakers should know what is biophysically feasible and social acceptable in a specific location. For MAS modellers *the* challenge is to capture the local socio-cultural behaviour in their models so many opt for a participatory modelling approach. In this article, we problematize the collaboration between MAS modellers and the stakeholders involved: What are critical aspects of participatory modelling for societal learning and action, and what could be an effective role for the scientist? To answer this question, we studied Companion Modelling (ComMod, <http://www.commod.org>) activities at Mae Salaep village in northern Thailand.

Methods

There are different forms of knowledge each with their assumptions about governance and change, and on the role that scientists can play. Post-modern scientists who embrace the theory elaborated by Funtowicz & Ravetz (1994) recognize the high complexity and dynamics of socio-ecological systems. Society needs to opt for adaptive management. As resource users have both high stakes and contextual knowledge, scientists are called to engage in collaborative forms of research. Adaptive management refers to joint experiential learning for ecologically sustainable development. Most of the research for adaptive management concerns the exploration of socio-ecological system dynamics, dialogue and deliberation to select the best alternative. However, deliberative approaches ignore the distorting effect of dominant discourses, power relations and conflict. As a result, we now see a variety of research aims and intended outcomes:

- the generation of socially robust knowledge for effective policy making;
- enhancing social learning and capacity building for sustainable development;
- learning, empowerment and advocacy for transformation for more equitable sustainable development.

To gain insight in the actual role of ComMod, we use reflexive research. Fischer (1995) developed a critical reflexive evaluation method to assess the effectiveness of an intervention and link it to a wider socio-political and ideological perspective. Here we reflect, together with ComMod designers, on the goal and the theory of action (espoused theories and tacit theories-in-use; Argyrus, 1992) and the effects of the ComMod activities on the stakeholders.

Results and discussion

ComModians recognize the high uncertainty of Renewable Resource Management (RRM) and the existence of multiple legitimate perspectives. They use the co-construction of models to facilitate learning about a RRM problem at stake. Core activities of a ComMod process are Role Playing Games (RPGs) and MAS computer simulations. In this case, scientists started with a preliminary problem analysis, to develop a first conceptual model and a related RPG. The local stakeholders were invited to play the RPG, to enact and share their knowledge and perspectives, to criticize and validate the model. ComMod discussed the problem situation

and options for improvement within homogeneous sub-groups and at a plenary meeting. Scientists integrated the proposed options into a MAS model, to jointly explore the long-term effects of the proposed RRM options. In this way, ComMod scientists intend (a) to generate a rich multiple perspective of the socio-ecological system and its dynamics, and (b) to support communication and negotiation for collective decision making.

In Mae Salaep village, ComMod scientists developed a RPG and a model to represent the risk of soil erosion to test whether this enabled scientists and farmers to share knowledge for mitigating land degradation. From observed game behaviour and individual interviews, scientists learned that farmers like the RPGs as they were 'fun' and 'resembled reality'. The farmers' understanding of the MAS model was mixed. Nevertheless, they proposed to use the tools to explore what they considered an appropriate solution for the soil erosion: perennial crops. They wanted to examine how rural credit and irrigation possibilities could support the expansion of plantations. Scientists agreed and engaged themselves in an iterative process of joint learning. To enhance engagement of the stakeholders, scientists formulated a new goal: was it possible for ComMod to enhance communication and learning amongst participants? This was the espoused theory. However, from the start of the 2nd ComMod cycle (on the village credit system) the main designer also considered the diversity of interests, local power relations and their influence on plenary discussions (Barnaud *et al.*, 2008). Though prioritizing local knowledge, she did not start with a plenary 'conception workshop' but opted for individual interviews. The theory-in-use was to ensure that the conceptual model would reveal the situation of the poor as well as the affluent. The subsequent RPGs and simulations showed that the credit regulations prohibited the poor farmers to use formal credit for long-term investments in orchards or plantations. At first, more affluent participants remarked the poor just had to rely on informal credit arrangements, but later they agreed that the formal credit rules should cover the needs of everyone. Participants noted the game and simulations gave them more insight in the credit system dynamics, and it stimulated 'inclusive problem-solving'. Unfortunately, high-level authorities, not involved in the process, had to decide upon a change of formal credit rules. For the next cycle on water sharing (Barnaud *et al.*, 2007), scientists again took care to integrate all interests in the model, and they organized extra sub-group discussions and participatory simulations to empower the poor for the plenary discussions. To link up with political decision makers, a higher-level authority was invited to attend the plenary discussion. This time the poor organized themselves around a charismatic leader and started to persuade other farmers. In the end, the village representative agreed to collaborate, but the local authority evaded public commitment. Despite the official discourse of decentralization, the participatory bottom-up approach did not (yet?) fit the administrative procedures and culture of decision making. The foreign scientists refrained from further action; it was deemed inappropriate to get involved in local politics or advocacy.

This is a challenge for ComMod scientists. Formally, they aimed at an inclusive process of knowledge exchange and social learning for sustainable development. However, by doing so they also put the situation of the marginalized on the political agenda. This was accepted by the village community. However, introducing participatory learning and decision making in the wider context of an hierarchical bureaucracy proved difficult. To create space for transformation, scientists need a long-term socio-political perspective and strategic alliances with an influential NGO, policy research institutes, brokers, etc.

References

- Argyris, C., 1992. On organizational learning. Blackwell Publishers, Massachusetts.
- Barnaud, C., *et al.*, 2007. Simulation and Gaming Journal 38: 398-420.
- Barnaud, C., *et al.*, 2008. Ecological Economics 66: 615-625.
- Fischer, F., 1995. Evaluating Public Policy. Nelson-Hall Publishers, Chicago, 296 pp.
- Funtowicz, S.O. & J.R. Ravetz, 1994. Ecological Economics 10: 197-2007.

Using explorative models to enhance expert learning about farm context and farmer rationalities in Burkina Faso

A. Van Paassen, N. De Ridder, L. Stroosnijder
Communication science, WUR, Hollandseweg 1,
6706 KN Wageningen, The Netherlands
Contact: Annemarie.vanPaassen@wur.nl

Introduction

In 1997, after a decade of agronomic research, the Antenne Sahelienne of the Wageningen University decided to integrate this knowledge in a Multiple Goal Linear Programme (MGLP) model to make it accessible for local users. As Burkina Faso was in the process of delegating natural resource management (NRM) authorities to village committees, the so-called SHARES models (Stroosnijder & Van Rheenen, 2001) focussed on the optimization of land related activities within the village boundary. In this paper we present the action research that agricultural staff of the Integrated Rural Development Project – PEDI undertook to test the potential of SHARES in two villages to enhance communication and learning for NRM.

Methods

In an iterative process of action, reflection and learning, staff members tried the potential of the modelling tool for their own learning and for extension purposes. First, local data were gathered to run SHARES for two villages in the province Sanmatenga: a heavily populated village in the South and a village with abundant land in the North. In the latter both arable farming and extensive livestock rearing were possible. Both villages differed considerably in access to, and use and management of their natural resources.

To assess the utility of the SHARES model for learning, a theory of learning was elaborated. It is based on the work of Ajzen & Madden (1986) about Planned Action and Argyrus & Schön (1996) about 1st order and 2nd order learning (Figure 1).

People engage in 1st order learning when they feel that things are different from the way they want. They look for information and experiment to gain the knowledge necessary to attain a desired situation. The motivation and focus of learning depends on the (perceived)

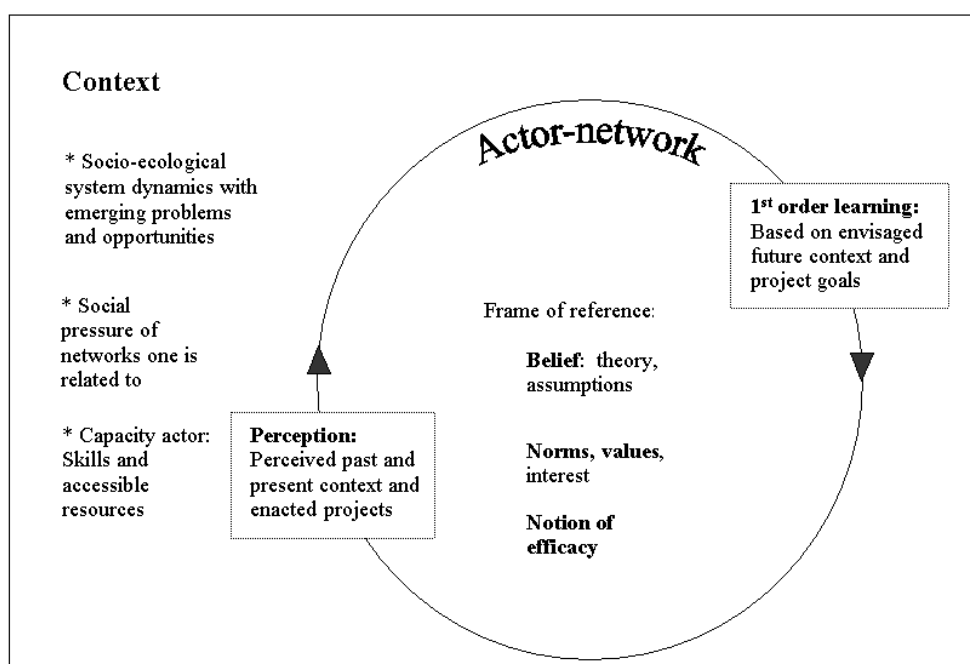

Figure 1. The learning actor (-network).

context and the internalized frame of reference. In social life, actors have different perspectives and project goals. So, collective learning cannot do without 2nd order learning: gaining insight in each other's frame of reference to attain mutual understanding and convergence of project goals. Models embody the perspective and projects goals of the designers. Actors are interested to use modelling tools for 1st order learning, when they perceive a match of perspective (system elements included, level of inquiry) and project goal (David, 2001).

With this theoretical model, we first explored whether the SHARES model could answers questions relevant to the farmers and/or agricultural extension officers (1st order learning). Did the model match their perspective, envisaged projects and learning issues? Subsequently the modelling tools were used to discuss the frame of reference of the scientists and the PEDI staff, as embodied in the model, with those of various farmer categories (2nd order learning).

Results and discussion

SHARES ambition was to enhance learning about village NRM, but the first matching trials proved that the model lacked several relevant components (on forestry, water and pasture management). The prime focus was on arable farming, so it was decided to downscale the level of inquiry to the farm. At the farm level, farmers and extension officers were in the process of fine-tuning fertilization practices, but SHARES lacked the technical details to support operational questions (1st order learning). MGLP models are summary models, made to explore long-term orientations, and they may be used to trigger 2nd order learning. The agricultural staff was interested to discuss farm orientations as they realized that farmers still farmed differently than they expected.

SHARES generated a gamut of farming options for four distinctive farmer categories in the two villages. This provided the agricultural staff with important insights. They learned more about overall socio-ecological system dynamics; the intimate relation between crop choice, livestock practices, and farm output. They were surprised by the low farming potential of the heavily populated village: despite intensive farming, these farmers could hardly satisfy their basic needs.

The model results were visualized in simple pictures to invite farmers to position themselves with respect to their applied farm strategy. This triggered a debate about the technical-economic optimization perspective of the experts, embodied in the model. Within the village, there was social pressure not to optimize income from arable farming, but to stay focussed on household food security. In addition, investment and optimization of income occurred in less risky activities such as livestock rearing and petty trade. This resulted in different farm-household dynamics than anticipated by the extension staff.

In sum, SHARES provided extension officers critical details about the farm system dynamics and the biophysical production boundaries of different farm categories (context variables) and proved to be a valuable tool to better understand farm frame of reference. This latter aspect is important, because most extension workers focus on operational questions without real knowledge of the farm potential and farmer rationality.

References

- Ajzen, I. & J.T. Madden, 1986. *Journal of Experimental Psychology* 22: 453-474.
- Argyris, C. & D.A. Schön, 1996. *Organizational learning II: Theory, method and practice*. Addison-Wesley, Reading MA.
- David, A., 2001. *European Journal of Operational Research* 1: 459-480.
- Stroosnijder, L. & T. Van Rheenen (Eds), 2001. *Agro-silvo-pastoral land use in Sahelian villages*. *Advances in Geocology* 33. Reiskirchen, Germany, 408 pp.

Theme D
Integrated assessment: Science and impact

**Session D2: Role of integrated assessment for policy
making and evaluation**

Session organizers:

Floor Brouwer

LEI, Wageningen UR, The Netherlands

Hayo Haanstra

Ministry of Agriculture, Nature and Food quality, The Netherlands

Insa Theesfeld

*Leibniz Inst. of Agric. Development in Central and Eastern Europe,
Halle, Germany*

Participatory IA tool development: Lessons learnt in the SEAMLESS project

J. Alkan Olsson, M.K. Van Ittersum, A.-K. Bäcklund, S. Brogaard, F. Brouwer
Lund University Centre for Sustainability Studies (LUCSUS),
P.O. Box 170, 221 00 Lund, Sweden
Contact: Johanna.alkan_olsson@lucsus.lu.se

Introduction

During the preparation of the World Summit for Sustainable Development a model for science was established; interdisciplinarity, policy-relevance, holistic perspectives and stakeholder involvement were its cornerstones. This scientific model has evolved and has been given diverse names, including; reflexive science (Beck *et al.*, 1994), Mode 2 science (Gibbons *et al.*, 1994) and sustainability science (Kasemir *et al.*, 2003).

In 2003 the European Commission introduced a formal procedure for Impact Assessment (IA) of its future policies. The political call for IA includes several of the characteristics of the new model for science (EC, 2002). It is, therefore, no surprise that several large projects funded by the European Union (EU) have included participatory elements in their setup. An example of such a project is the SEAMLESS project that has developed a computerized framework to assist in the impact assessments of new agricultural and environmental policies across a range of scales (Van Ittersum *et al.*, 2008).

Following the intentions in Mode 2 science the aim of the SEAMLESS stakeholder interactions has been to collect user requirements and provide feedback into the project in order to increase the policy relevance and user friendliness of the framework. The general set up of the user interactions is depicted in Figure 1, however, the form and content has slightly evolved over time.

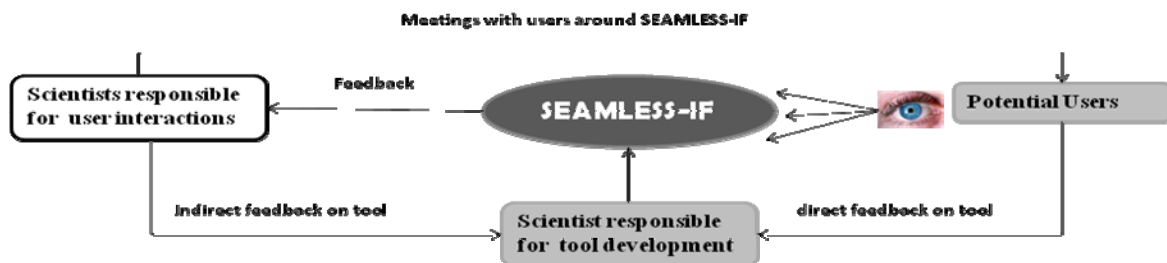

Figure 1. General setup of user interactions in SEAMLESS.

The aim of the paper is to analyse and discuss lessons learnt from a development process in interaction with potential users. This will be done by analysing, from the perspective of the SEAMLESS project (i) the accomplishment and problems with the user interaction set up; (ii) the accomplishment and problems with uptake of collected user information by the project.

Methods

The analysis is based on the experiences made by the scientists engaging in discussions with users. It is also based on minutes from various types of stakeholder meetings, i.e. in this paper the notes from the User Forum and targeted meetings with experts in the Commission services. The achievements of the SEAMLESS user interactions will be analysed in terms of how the form of the interactions has facilitated the collection of requirements and how the nature of the discussed issues and the communication structure in the project have influenced the uptake of these requirements.

Results and discussion

Since the beginning the User Forum, which gathered every 6 months, was the core activity. The establishment of the UF was an achievement in itself – it is not trivial that representatives from the Commission DGs commit themselves to closely interact with individual research projects throughout their lifetime. Interviews with representatives from DGs responsible for IA were also an early activity. The so-called targeted meetings were developed later as a response to the need of discussing specific issues with specific DG units or persons.

By help of the UF it was envisaged in which way the framework could contribute to the impact assessment work in the DGs. The limited experience of direct work with modelling tools in most of the DGs formed the understanding that the system should have two different user interfaces. The possibility to run the system should be restricted to people with knowledge in modelling. But the policy officers should be provided with an interface where they can alter parameters in already modelled issues to test alternative answers by help of minor changes. This interface was also adapted to the structure of the Commission's work procedures. The scientists in charge of the user interactions were primarily responsible for feeding back the user requirements into the project. This was not always an ideal set up; sometimes direct interactions between users and developers would have been more effective. However, at most of the meetings developers were present and could answer technical questions, as well as more directly bring ideas of users back into the development process.

A recurring theme on the agenda of interactions was the selection of indicators to be included in the indicator library of SEAMLESS-IF. Generally this was very effective, in the sense that the project was able to both include lists of indicators that are already adopted in IA processes and to tap indicators from newly developed lists by for instance the European Environment Agency. Also, indicators proposed by the scientists from SEAMLESS were discussed. A continuous challenge was to balance the desired indicators with the possibilities of the models included in SEAMLESS-IF to actually assess the indicators. Clearly not all desired indicators can be assessed by the models presently included in the framework. This was compensated by the fact that the framework was designed such that new model components allowing computation of new indicators can be added at a later stage.

The interaction with potential users has contributed to a more policy relevant SEAMLESS-IF, where design of the workflow of an assessment and the corresponding interface for the policy experts are clearly shaped as a result of the participatory process. Scientists and co-ordination of the project have learned that participatory development is a time and resource consuming process, which is hard to plan before the start of the project. There is a clear tension between the request (from the funding agency) to define a clear proposal before the start of the participatory process, detailing the scientific approach and the consortium, resulting in restricted flexibility to adapt to issues emerging from the participatory process. It is therefore important for a research project to define the ambition of the participatory process at an early stage.

In order to meet the Mode 2 scientific requirements, the interaction has to be built into the research from the beginning and relevant stakeholders appointed in the same manner as the technical components for a project is chosen.

References

- Beck, U., *et al.*, 1994. Reflexive modernization: Politics, tradition and aesthetics in the modern social order. Polity Press, Oxford, UK.
- EC, 2002. Communication on Impact Assessment, COM 2002(276).
- Gibbons, M., *et al.*, 1994. The new production of knowledge. SAGE Publ., London, 174 pp.
- Kasemir, B., *et al.* (Eds), 2003. Public Participation in Sustainability Science. Cambridge University Press, Cambridge, 281 pp.
- Van Ittersum, M.K., *et al.*, 2008. Agricultural Systems 96: 150-165.

Multiple agendas and cultures in a participatory development of computerized IA tools: The experience of SEAMLESS

A.-K. Bäcklund, J. Alkan Olsson, S. Brogaard, M. Taverne, J.P. Bousset,
J. Wery, M.K. Van Ittersum
Department of Social Geography, Lund University,
P.O. Box 170, 22100 Lund, Sweden
Contact: Ann-Katrin.Backlund@keg.lu.se

Introduction

Integrated Impact assessment (IA) is gradually making inroad in European policy making. The European Commission places great aspirations on the IA system as a way to achieve better policy and law making but *also* as a tool for improved legitimacy of government and increased consensus in European politics. This is reinforced by opening up for the possibility of stakeholders to influence every step of the work process. In order to increase the credibility and legitimacy of the assessments, which have been questioned, there is a call for using more science based methods. As a result there is an increasing interest in using modelling tools to support assessment work (Bäcklund *et al.*, 2009). However, the use of science based models in a decision process is not always straightforward. The reasons for this are multiple, but mainly linked to the different agendas, cultures and dynamics of the political respectively scientific communities. The SEAMLESS project has developed a computerized framework to assist impact assessments of agricultural and environmental policies across a range of scales (Van Ittersum *et al.*, 2008). To develop this tool the researchers in the project have engaged in a participatory process with potential users. This included a more formal way through the so called User Forum meeting every six months and specific evaluation sessions in the test cases throughout the duration of the project as well less formal ways, i.e. through personal interviews, e-mails, and targeted meetings on specific issues. The aim of this paper is to, based on the experiences gained in the interactions, identify policy/science interfaces and discuss the different approaches to the use of modelling tools between policy developers and tool developers.

Methods

The empirical material consists of comments and reactions expressed at the SEAMLESS User Forum and during individual interviews with personnel mostly from DGs of the European Commission as well as during interactions at regional level when evaluating the framework, in France, Poland and Mali.

When analysing the interaction between science & technology and the policy process the criteria of credibility, salience, and legitimacy are frequently used (Cash *et al.*, 2003). *Credibility* concerns the scientific adequacy of evidence and arguments. *Salience* concerns the relevance, appropriateness, usefulness and timing of the information. *Legitimacy* is achieved when the production of knowledge has been conducted in an unbiased way and has treated opposing views and interests in a fair manner. The paper will use these concepts to analyse the stakeholders' comments on the developed tool.

Results and discussion

Stakeholders' comments were of two types, i.e. requests concerning the technical performance of the tool and strategic comments. The technical comments were often possible to meet by development of the components of the tool, workflow for IA and the Graphical User Interface. The strategic comments have a more profound political dimension highlighting the differences in how modelling results are used in the political and scientific communities and were therefore not as easily transformed into the tool. When analysing the

stakeholder strategic comments using the concepts Credibility, Saliency and Legitimacy it becomes evident that these attributes are tightly coupled and efforts to enhance one may lead to trade offs with the others.

Credibility The issue of uncertainty of the modelling outcome is very important to the users, particularly when dealing with politically hot issues. A participant stated: “*If I do not get precise information how could I otherwise motivate the results to an angry stakeholder phoning me up*”. To deal with this demand we engaged with users to assess their perspectives as to uncertainty analysis (Gabbert *et al.*, 2009).

Saliency The approached policy developers also argued that is important that tools give answers to *policy relevant questions*. Similarly, it was argued that it is important that these tools do not produce too much or irrelevant information. The continued stakeholder interactions have been a way to identify this demand. However, the models used in SEAMLESS have a particular scope which to a certain extent can be enlarged but for some issues additional models are needed or science simply lacks the methods to provide an analysis.

Legitimacy In order to meet the demand for legitimacy a tool has to be flexible as to what to assess. It must be possible to incorporate stakeholders’ views and be sensitive to the political process. It was also essential that a tool assisting in IA is transparent, i.e. it should be easy understandable how the assessment has been done and what the underlying assumptions are. The participants repeatedly expressed their concern for lack of transparency of the modelling system. One official argued that “*Scientists are lining up arguing that they have a new model that can assist me in assessing this or that. If I am not able to understand the underlying assumptions of a model how could I judge which model to use?*” Legitimacy is achieved when the production of knowledge has been conducted in an unbiased way and has treated opposing interests in a fair manner. If the modelling system is a black box, where assumptions and other critical parameters are not clear and understandable, the outcome might not be perceived as legitimate. We have dealt with this demand in SEAMLESS through spending significant resources on a transparent user interface, extensive documentation of each of the models, a possibility to use and assess each of the models standalone and providing access to intermediate results of an analysis performed through a model chain.

However, assessment tools cannot only be regarded as technical/scientific applications but also as tools for communication between science and policy (Bäcklund *et al.*, 2009). Therefore, to improve the usability of these types of tools it is essential that scientists increase their understanding of the social and institutional dynamic and conflicting interests and cultures of policy developers.

References

- Bäcklund, A.-K., *et al.*, 2009. In: Eds F. Brouwer & M.K. Van Ittersum, Environmental and agricultural modelling: Integrated approaches for policy impact assessment. Springer, Dordrecht. (forthcoming)
- Cash, D.W., *et al.*, 2003. Proc. of the National Acad. of Science of USA 100(14): 8086-8091.
- Gabbert, S., *et al.*, 2009. AgSAP Conference 2009, these proceedings.
- Van Ittersum, M.K., *et al.*, 2008. Agricultural Systems 96: 150-165.

Integrated assessment for the development of Progressive Coordinative Action (PCA) plan: An approach for sustainable agriculture

B.M. Dahal

Environment and Public Health Organization (ENPHO),

P.O. Box 4102 KTM, Kathmandu, Nepal

Contact: binodm_dahal@yahoo.com

Introduction

This paper focuses on how to achieve the sustainable agricultural production through an integrated assessment at a given time. Integrated assessment (IA) is considered as a 'higher-order approach' tool to analysis of any system with interconnectedness between all the possible factors for the sustainable development of a community (Gough *et al.*, 1998). Integrated assessment seeks to recognize and incorporate the uncertainty and divergent interests that characterize current situation regarding the sustainable development of a specific sector. IA specialists emphasize the importance of on going participation in the process by both scientific experts and all stakeholders, such as policy-makers and the general public. Thus, Gough *et al.* (1998) and Schneider (1997) dispute that the emerging practices of IA can promote broad and justifiable participation in the value- laden, complex, and uncertain decisions that we increasingly face. But the history of the developing countries regarding to sustainable development of any discipline is difference that the planning and policy only can not meet the target. Therefore, the IA or IAM should be able to develop a Progressive Coordinative Action (PCA) which can contribute to confer techno-social solution for the sustainability of an agricultural system.

The concept of PCA was developed after the several series of discussion and interview with farmers of two communities of Nepal. Although the communities have difference characteristic in terms of social and economic conditions, both of them gave an emphasis on coordinative action to over come the problems regarding the sustainability of agriculture. However, this concept has not been implemented yet; the following theoretical outline has been drawn for its execution.

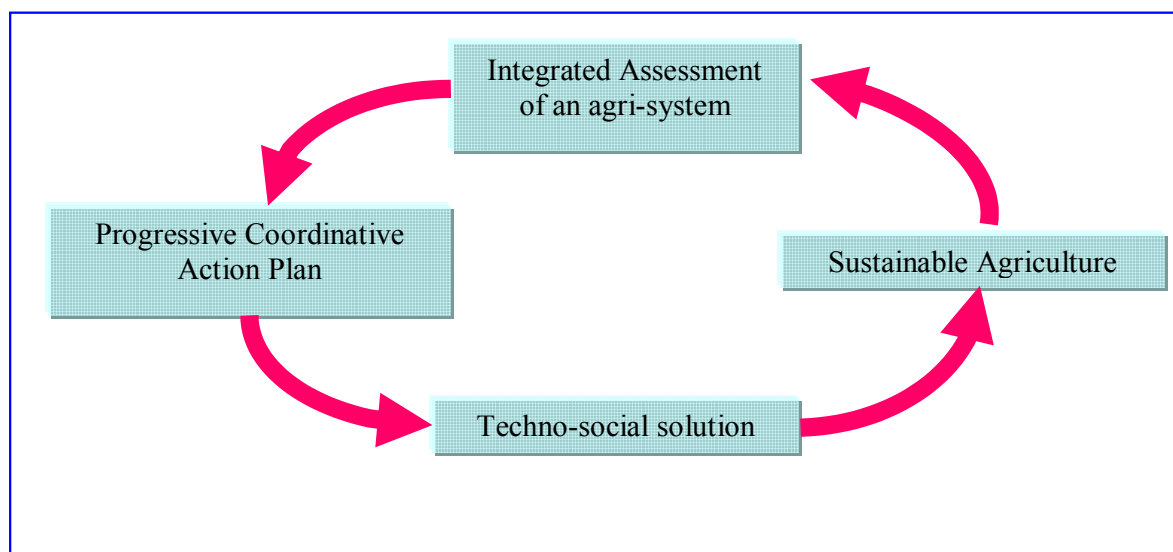

Figure1. Sustainable development cycle for agriculture and role of IA and PCA.

What is Progressive Coordinative Action (PCA)?

It is proposed the phrase 'Progressive Coordinative Action Plan' to describe an output of integrated assessment of an agricultural system. The PCA plan helps to find techno-social solution for sustainability of agriculture on the basis of information generated from Integrated Assessment (Figure 1). Therefore, IA is a root action for development of PCA which enforce to generate a techno-social solution for the improvement of all related factors.

In such case, The PCA plan mainly focuses on Social, Natural and technical sector to get optimum productivity, to reduce environment and economic problems. Further more it gives prominence to develop coordinative project.

Expected achievements of PCA plan

The PCA plan focus to activate all factors related to the agricultural production system on the basis of Integrated Assessment Information. Therefore, it can achieve the tangible agricultural sustainability (Figure 2). The system can self sustained because the key stakeholders are main implementer of the plan. Further more, the PCA play an important role to reduce the environmental risk and health risk of farmers, individual farmer attitudes toward public concerns therefore, low risk of acceptance of adopted technology etc.

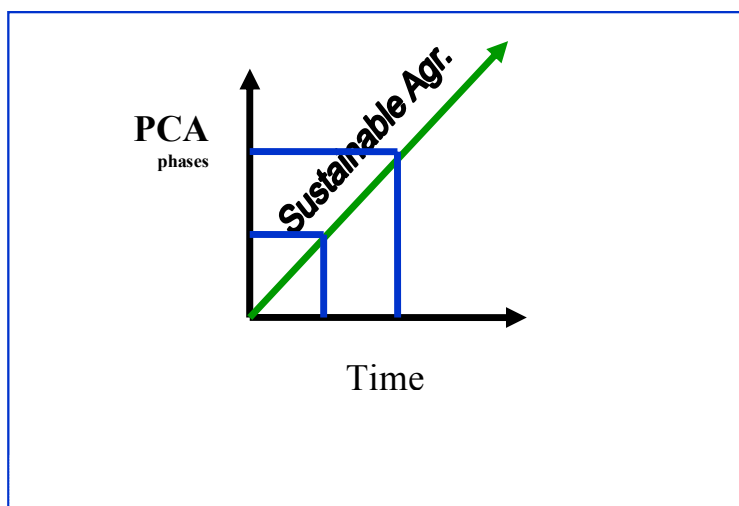

Figure 2. Tangible achievement of sustainable agriculture through PCA plan.

Conclusion

PCA can be a tool for sustainable development of agriculture in the context of development countries which is possible to achieve only through an Integrated Assessment.

References

- Gough, C., *et al.*, 1998. *Environ. Mod. Assess.* 3: 19-29.
- Schneider, S.H., 1997. *Environ. Mod. Assess.* 2: 229-248.

Better regulation by the use of Integrated Assessment? SEAMLESS integrated framework and European policy making

Robert Fischer, Insa Theesfeld
Humboldt-University of Berlin,
Department of Agricultural Economics and Social Sciences,
Division of Resource Economics,
Philippstr. 13, 10099 Berlin, Germany
Contact: Robert.Fischer@staff.hu-berlin.de

Introduction

For three reasons there will be great demand for external integrated assessments (assessing environmental, economic, social and institutional impacts of policy options) within the European Union: First due to the lack of resources of the European Commission, second because it is now compulsory for the Commission to do an *ex-ante* impact assessment at the European level and third because the EU has committed itself to a strategy for sustainable development.

Methods and theoretical concept

The paper provides an institutional analysis for the use of integrated assessment tools. It sheds light on institutional constraints immanent in the procedure of *ex-ante* impact assessment in the European Union political context. In doing so, the paper focuses on the requirements for the production of scientific expertise for policy making.

The paper argues that scientific knowledge within impact assessments has two functions that are both unavoidable and legitimate: The technocratic function is to increase quality of policy proposals and inform policymakers, the Machiavellian function is to increase legitimacy and to persuade the public. Thus integrated assessments could be used to assess economic, ecologic and social impacts but they could also be used as a rhetorical device and political tool to gain or maintain power.

The use of integrated assessment tools heavily depends on an appropriate institutionalization of the science-policy relationship and smooth interaction of this science-policy interface with the political environment. From an institutional perspective a crucial reason hindering a successful uptake of integrative assessment tools could be a misfit between the knowledge produced by scientific experts and the requirements within the political system. If there could be a misfit or not will be illustrated using the case of SEAMLESS-IF as an example. SEAMLESS-IF is a computerized framework to assist in the impact assessments of new agricultural and environmental policies across a range of scales that has been developed in the SEAMLESS project (Van Ittersum *et al.*, 2008).

On the one hand, the produced knowledge of integrated assessment tools may not fit because the knowledge itself may be insufficient, unsound, intransparent, incomprehensible, biased, or useless. On the other hand, it could be that the knowledge is pretty reliable and comprehensible but, nevertheless it does not fit into the policy-making context because of bad timing, insufficient administrative procedures, improper organizational linking, ignoring of political power play or disturbing balanced institutional equilibriums. In this latter case the question for any integrated assessment would be how to cope with the institutional constraint of being used or misused in the political process. All *ex-ante* policy assessment studies do face inherent and unavoidable political characteristics concerning the provision of the inputs and the use of the outputs: (a) during the data collection phase studies are often drawn into the political process by providing false or misleading information by relevant actors and interviewee, (b) during the assessments, the public authority who commissioned the *ex-ante* assessment may convey certain expectations to the evaluators and, (c) during the

interpretation of the results: the studies may be used as political instrument to justify preconceived legislative actions.

Concerning the latter, the policy experts who will use integrated assessment tools will have their own interests and expectations about the outcome of the assessment. If the impact assessment fails to meet these expectations it is not of much use for the civil servants and politicians and it is likely that they will take no notice of the produced knowledge. On the other hand if it meets the expectations of civil servants and politicians it will be part of the political process and it will be perceived by the public as intertwined with it. From this it follows that the scientific knowledge produced within an assessment procedure will be contested by different stakeholders and the public. Therefore, this scientific expertise requires additional efforts compared to normal academic science organized in disciplines at universities. In this context of scientific expertise for policy making there is an increasing demand for interdisciplinary, transparency, usability, legitimacy, completeness and credibility. Remarkably the European Commission has picked up these principles in its guidelines and documents on impact assessment. However, the newly established demand for impact assessments could lead to some allied perils. It could increase different expert opinions, counter assessments and different policy recommendations and with this plurality it might even decrease credibility of integrative modelling tools.

Results

From the perspective of science and technology studies there is a difference between scientific knowledge and expertise for policy making. There are additional requirements for the production of expert knowledge that result from these differences. From an institutional economics perspective the introduction of impact assessments and the use of integrative modelling tools has to meet the demands of the institutional environment already in place before doing an assessment.

References

- Fischer, R., 2008. Uptake of SEAMLESS-IF: Reflections on demands and institutional implications of the implementation and application of *ex-ante* assessment within the European Union, PD7.2.3, SEAMLESS integrated project, EU 6th Framework Programme, contract no. 010036-2, www.SEAMLESS-IP.org.
- Fischer, R., 2009. Democratising scientific advice: New dimensions of science-based policy-making in the European Commission? In: European Integration Online Papers. (forthcoming)
- Van Ittersum, M.K., *et al.*, 2008. *Agricultural Systems* 96: 150-165.

A multi-criteria approach to environmental policy

N. Hasnain, H. ApSimon, T. Oxley

Centre for Environmental Policy, Imperial College London, SW7 2AX London, UK

Contact: n.hasnain@imperial.ac.uk

Introduction

There is growing emphasis on the need to control ammonia emissions in Europe. Arising mainly from agriculture, ammonia causes eutrophication and acidification of eco-systems and can also form secondary particulates which are of concern for human health. As a result of this concern, ammonia became one of the pollutants addressed under the Convention on Long-Range Transboundary Air Pollution of the UN/ECE, where integrated assessment modelling, in particular the RAINS model of IIASA provided a solid, scientific basis to the negotiations leading up to the Gothenburg protocol (Hordijk & Amann, 2007). The same modelling approach was subsequently adopted by the European Commission to set emission ceilings for ammonia and other pollutants under the National Emission Ceilings Directive. Meanwhile at the UK level, more detailed assessment of ammonia emissions reflecting national farming practices and conditions has been linked to a national integrated assessment model, UKIAM, exploring implementation of emission abatement strategies at a much finer scale (Oxley *et al.*, 2003).

Despite these success stories of integrated assessment models, the models remain narrowly focused and do not take into account many stakeholder interests which could give rise to difficulties at the implementation stage of a policy. This study explores the use of multi-criteria decision analysis as a complementary assessment tool to help address environmental problems more diversely (Hasnain, 2009).

Methodology

An initial assessment of tools and studies undertaken under the UN/ECE and at the national level in the UK was carried out to identify the current state-of-the-art. These tools include integrated assessment models such as RAINS, its extension GAINS (Greenhouse gas Air pollution INteraction and Synergies) (Klaassen *et al.*, 2004), and UKIAM. The models use information on projected emissions, dispersion and deposition of pollutants, geographical variations in environmental impact, and finally, abatement costs to advise policymakers on cost-effective solutions. In addition, these models can be linked with other models to assess impacts upon other components of the nitrogen cycle, such as nitrate leaching.

Despite having a sound scientific basis, these models focus only on technical measures and do not address wider stakeholder issues. For instance, implementing any abatement policy will impinge on several stakeholders, most notably farmers, who have to implement measures and bear additional costs. There may be the issue of how this additional burden is supported and whether consumers are willing to bear some of these costs. Another drawback of focusing only on technical measures is the exclusion of animal welfare concerns that may bring into question some abatement measures. For instance reducing dairy cattle numbers and meeting demand by intensifying milk output from each animal may impinge upon animal welfare; these non-technical concerns need to be factored into the analyses to ensure difficulties and opposition do not arise at the implementation stage.

The first step taken is to identify relevant stakeholders. These are policymakers, scientists, producers, consumers, together with NGOs concerned with biodiversity and animal welfare. Criteria are identified for example, health, ecosystem protected, affordability, compliance etc. to capture different environmental and stakeholder concerns. For each criterion, a suitable indicator is selected, and when not available, developed. Using modelling data from integrated assessment models, surveys and interviews with key stakeholders these criteria are

weighted and compared on a dimensionless scale for selected scenarios. Scenarios are chosen to reflect changing consumer patterns, land use and application of abatement measures.

Results and discussion

The performance of each criterion with respect to individual scenarios is evaluated. In addition, the criteria are weighted by different stakeholders (Table 1). These are then normalized to give the relative weighting of each criterion on a dimensionless scale. The performance of the criterion is combined with its normalized weighting to give the overall value for a scenario (Figure 1). Figure 1 also gives the relative contribution of each criterion to the value of the scenario.

Table 1. Stakeholder weighting of criteria between 0–100.

Stakeholder	Compliance	Affordability	Health	NO3 leached	Ecosystem protected	N2O	WTP
NGO	80	30	100	60	90	70	50
Scientist	10	0	15	25	25	25	0
Public	10	15	20	10	18	15	20
Public	5	5	10	5	20	5	50
Dairy farmer	8	60	10	5	7	5	5
Farmer	20	40	10	10	10	5	5
DEFRA	25	20	20	5	10	15	5
DEFRA	1	6	2	4	3	5	7
EA	25	8	10	15	25	15	2
EU	100	10	50	30	50	40	20

From our analysis, we conclude that despite significant improvements in integrated assessment approaches over the years, boundaries of analysis of current integrated assessment models needs to be widened to take into consideration wider stakeholder concerns. In the case of ammonia abatement, this means firstly developing scenarios that reflect changing consumer and land use patterns along with environmental protection and compliance, and secondly use of suitable criteria that address stakeholder concerns. A multi-criteria approach

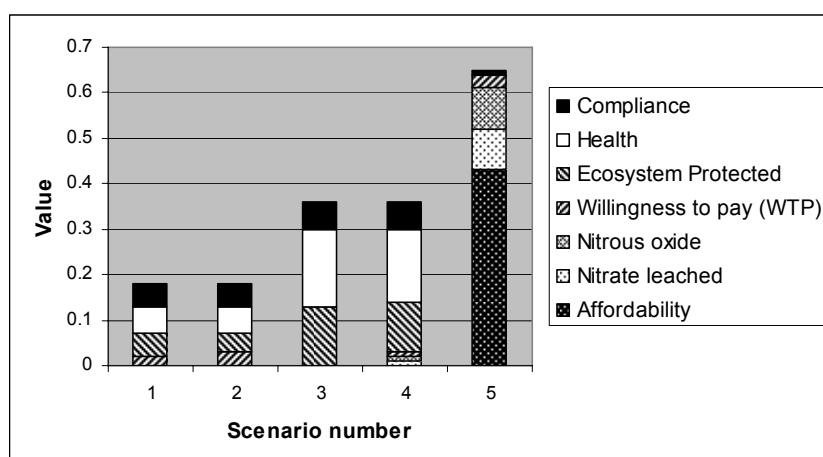

is suggested as a means of supplementing existing policy tools as it enables the analysis of multiple criteria under one framework, highlighting issues of concern.

Figure 1. Public valuation of criteria for each scenario.

References

- Hasnain, N., 2009. A multi-criteria approach to environmental policy: a case study in agricultural ammonia emissions. PhD Thesis, Centre for Environmental Policy, Imperial College London.
- Hordijk, L. & M. Amann, 2007. *Environmental Policy & Law* 37(4): 336-340.
- Klaassen, G., *et al.*, 2004. The Extension of the RAINS Model to Greenhouse Gases. IIASA Interim Report IR-04-015, Laxenburg, Austria.
- Oxley, T., *et al.*, 2003. *Integrated Assessment* 4(4): 236-249.

Exploring receptivity through innovative actions

V. Hernández Jiménez

Rural Planning Department, School of Agronomy

Polytechnic University of Madrid - Spain

Contact: veronica.hernandez.jimenez@upm.es

Introduction

Resolution of land use conflicts requires understanding the complex relationships between social systems and territorial policies. However, this would always depend on the receptivity of the systems. In this paper we describe on-going research about stakeholder receptivity and its relationship with innovation, following ideas developed by Jeffrey & Seaton (2003). This paper is carried out under the ISBP – Integrative Systems and the Boundary Problem – research project (Winder, 2006), funded by EU FP6.

Methods

Stakeholders' receptivity is characterized by using both direct features (based on interviews) and indirect features (based on policy actions, public speeches, position documents and others). Then, we can classify it into different categories, for example open receptivity, forced receptivity and no receptivity. Discussion will bring up the following topics: how stakeholders' receptivity influence innovative actions, which (cultural) constraints imposed the lack of receptivity, and, how receptivity could improve as part of a collaborative process.

Results

Qualitative methods have been carried out to better understand how the role of society could be strength in the decision making process. The rich picture (Figure 1) is a technique of mapping actors and conflicts which is based on building trust between researchers and the

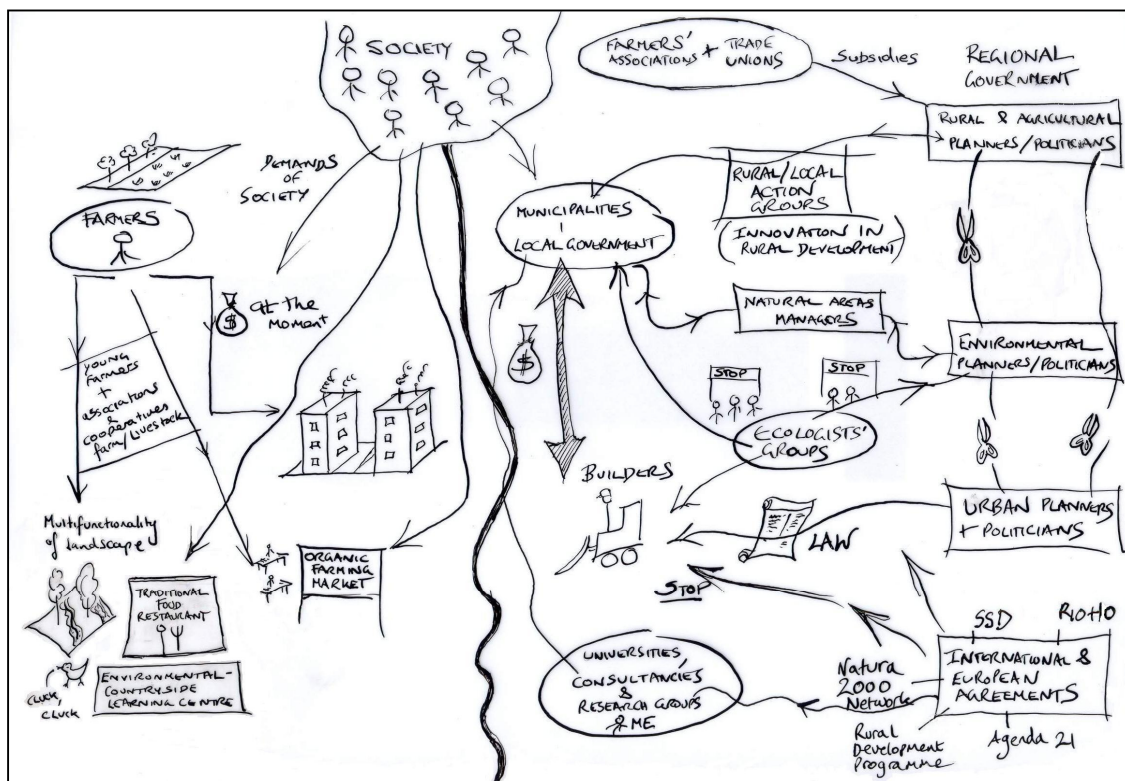

Figure 1. A rich picture. Current situation of land use conflicts in Madrid region as it is perceived by the researcher (Hernández Jiménez, 2007).

stakeholders involved. Although it might be difficult to understand due to the hand-writing, this attempts to explain the need of simplify science in order to reach from local politicians towards the national decision-makers.

Conclusions

We present work focused on the emergent process of developing agrarian parks to protect highly productive land and agricultural activities in areas of intensive urban development. The conclusions explore the reasons why similar land management options cannot be adopted equally in every region. We describe the development process and compare stakeholder maps in both areas to deal with these differences in an attempt of providing tools and guidelines for the global and local decision making processes.

References

- Hernández Jiménez, V., 2007. Participatory Planning in the region of Madrid (Spain): An integrative perspective. PhD thesis, Newcastle University, UK.
- Jeffrey, P. & R. Seaton, 2003. *Environmental Sciences* 1(3): 277-300.
- Winder, N. (Ed.), 2006. ISBP Problem Statement. <http://www.tigress.ac/isbp> (July, 2007)

Determinants of policy-oriented research design

B. König, K. Helming, K. Tscherning, H. König, K. Diehl
Leibniz-Centre for Agricultural Landscape Research (ZALF) e.V.,
Eberswalder Str. 84, 15374 Müncheberg, Germany
Contact: koenig@zalf.de

Introduction

Science, policy and the public have different logics in following the agenda for a sustainable development. Therefore, scientists have to deal with the different perspectives of politics in order to make scientific advances useful to enable political framing of the conditions for sustainable development. At the same time scientists are ethically bound to their professional standards. This can impose some challenges to research design, investigation and result communication. What is more, engagement of scientists at the science-policy interface is experienced in many cases as rewarding but also immensely frustrating (Pannell, 2008), given the poor uptake of research results in policy-making processes.

Several authors have dedicated their exploratory interest to the understanding of the different environments of science on the one side and politics on the other in order to explain reasons for this low adoption phenomenon (e.g., Pielke, 2004; Lackey, 2007; Pielke, 2007).

In this paper, we argue that efficient science policy interface requires the consideration of policy requirements already from the onset of the design of the research project. This procedural view shall illustrate how practical challenges of science-policy-interaction occur and how they can be addressed.

Method

This paper is based on an extensive literature review, which informed the policy-oriented SENSOR project about principles of science-policy interaction. Based on this, the science-policy interaction experiences of the SENSOR coordination team were theoretically reflected.

Results and discussion

With science policy on the one side and the key role knowledge should play today for legitimizing political decisions on the other, science and policy are two societal fields reflexively influencing the preconditions of action for each other. But what conclusions have to be drawn for policy relevant research design?

We argue that a precondition for policy relevant research design is the understanding of the political background, actors and their logics that should be informed by science. The SENSOR project provides one example for incorporating this understanding and translating its meaning into the research process (Tabbush *et al.*, 2008; Thiel & König, 2008).

Politicians ask science to deliver information which helps to grasp the wider picture, to reveal the central causal relationships and to help to make broad developments visible, to enable them to evaluate with overview and orientation on future developments (Kropp & Wagner, 2007). Sustainability, including the assessments of conflicting targets, is one field where politicians ask for scientific expertise to balance emotional public debates by avoiding risky and controversial decisions through neutral scientific evidence (Bogner & Torgersen, 2005). Science with a policy perspective should make a broad range of action options visible for decision makers, providing state of the art scientific knowledge for each option (Pielke, 2004).

To date most research projects are designed by more or less interdisciplinary composed group of scientists acting with the intention to close knowledge gaps in their particular field of research. However, these knowledge gaps might not be identical with those identified in the policy-making process. Moreover, policy making might require a different perspective to the

research issue and different methodological approaches. These perspectives and questions have to be considered in order to make the research results exploitable for policy design. To overcome this inconsistency, policymakers would ideally be directly involved in shaping the research questions, setting up the research group and designing the research project. However, this 'ideal' approach is hindered by numerous restrictions (see Pannell & Roberts, 2008). Facilitation means are, therefore, warranted that support research designers in adopting the perspectives of policymakers in the elaboration and execution of research projects. These means should feed into the research design process as early as possible, preferably already at the level of topic selection and definition of evaluation criteria at the research funding level, and further from the onset of project design at the project coordination level. Research has to consider the relevant spatial and temporal dimension associated to the policy question, has to analyse how policy affects the particular issue under question – the policy sensitivity of the underlying process.

The central focus of our contribution lies in the transfer functions (e.g., scaling, translation, communication and timing) policy relevant research projects have to fulfill to close the gaps at the science-policy interface and how these functions can be facilitated by research design and management. By doing so, we want to draw meaningful conclusions in research project design and management to meet adoption criteria such as legitimacy, relevancy, credibility, evidence and the like

References

- Bogner, A. & H. Torgersen, 2005. In: Eds A. Bogner & H. Torgersen, *Wozu Experten? Ambivalenzen der Beziehung von Wissenschaft und Politik*. Verlag für Sozialwissenschaften, Wiesbaden, pp. 7-29.
- Kropp, C. & J. Wagner, 2007. In: Eds C. Kropp, *et al.*, *Die Zukunft der Wissenskommunikation. Perspektiven für einen reflexiven Dialog von Wissenschaft und Politik - am Beispiel des Agrarbereichs*. Ed. Sigma, Berlin, S. 7-15.
- Lackey, R.T., 2007. *Conservation Biology* 21(1): 12-17.
- Pannell, D.J. & A.M. Roberts, 2008. *Conducting and delivering integrated research to influence land-use policy: An Australian case study*. INFFER Working Paper 0803, University of Western Australia, Perth. <http://cyllene.uwa.au/~dpannell/dp0803.htm>
- Pielke Jr, R.A., 2004. *Environmental Science & Policy* 7 (2004), pp. 405-417.
- Pielke Jr, R.A., 2007. *The honest broker. Making sense of science in policy and politics*. Cambridge University Press, Cambridge, 188 pp.
- Tabbush, P., *et al.*, 2008. In: Eds K. Helming, *et al.*, *Sustainability Impact Assessment of Land Use Changes*. Springer, Heidelberg, pp. 35-54.
- Thiel, A. & B. König, 2008. In: Eds K. Helming, *et al.*, *Sustainability Impact Assessment of Land Use Changes*. Springer, Heidelberg, pp. 55-74.

Integrated impact assessment as a new institution: The political dimensions of modelling-tool use

Martina Padmanabhan

Institut für Wirtschafts- und Sozialwissenschaften des Landbaus,
Landwirtschaft-Gärtnerische Fakultät,
Humboldt Universität zu Berlin, Germany
Contact: Martina.padmanabhan@agrar.hu-berlin.de

Introduction

Modelling tools are not pure and isolated instruments which simply evaluate the potential outcomes of different policy options as information to policymakers. Rather this instrumental perspective on the role of modelling tools ignores the intrinsic political characteristic of the policy-making process. The aim of the paper is to reflect on the political nature of modelling-tools in the process of policy making by analysing the rationales of policy developers in the European Union in their use of *ex-ante* models with an institutional approach. Within the highly dynamic environment of impact assessment and greater importance paid to participation and transparency in the European Union, the current use of existing modelling tools can provide knowledge for a better understanding of the policy-science interface. The focus on the *ex-ante* evaluation of policies with the outspoken aim of sustainability in a cross-sectoral manner poses questions of its institutional arrangements within the policy-making process, which is by very nature a political one (Padmanabhan & Beckmann, 2009).

This paper reflects on the experiences collected during the formulation of SIAT (Sustainability Impact Assessment Tool), developed for the *ex-ante* assessment of policy outcomes on integrated sustainability issues concerning land use by the SENSOR consortium. As Thiel and colleagues (Thiel *et al.*, 2007; Thiel & König, 2008) mention any policy assessment procedure encounters existing implicit or explicit policy assessment practices and thereby reconfigures them, resulting in institutional change. Though 'good' Impact Assessment is an integral to policy development, only those regarding salient new regulations, substantial revisions or expenditure programmes require in-depth modelling according to the principle of proportionate analysis. Salience depends on the type of issues and interests a proposal impinges upon and their political significance at the European level. The quality of the Impact Assessment is of increasing importance for getting a policy adopted by the hierarchy and other European legislative bodies. As Thiel (2008) shows, individual desk officers have different reactions to Impact Assessments. DGs and units that are intensely involved in Impact Assessments recruit economists for Impact Assessments or establish units that provide back-up capacity. Desk officers have a preference to get the Impact Assessment procedure right in order to guide policies to adoption, motivated by a career advance which implies gains in remuneration and prestige. Superiors often have less technical know-how but more sensitivity for the political aspects of a proposal. Desk officers apply a heuristic of criteria (partly codified in guidelines) that indicate how to steer policy development and Impact Assessment:

Methods

To analyse the institutional setting for model end users in the European Commission, qualitative interviews were conducted in different Direction Generale, building on a previous round of expert interviews. The literature review, document and interview analysis builds on the Institutional Analysis and Design Framework by Ostrom (2005). An overview to the fast moving environment of impact assessment in the European Commission is given. The literature section reviews the recent findings on evidence-based policy support tools.

Results and discussion

The findings are structured as follows: At the example of an integrated *ex-ante* assessment tool, the institutional analysis focus on dimensions relevant to this cross-sectoral approach. The political term of multi-functional agriculture provides a key rationale and indicates the necessity to reflect on political colourings within research. In the same line, the concept of land use as a central feature to bundle different use perspectives on resources is inherently political, as it frames issues beyond organizational terrain. A further challenge and at the same time an interesting entry-point into the discussion on norms and values, which translate into political interests, is the outspoken policy goal of sustainability. While the overarching policy goal is fixed, the increasing demand for stakeholder participation in the policy-making process poses questions of influence on the assessment and vulnerability to manipulation. Visualizing policy outcomes in a spatial manner of coloured maps on different levels is highly sensitive and can bear political risks for users. The credibility of the data pool on which results rest is linked to the reputation of researchers and organizations within the community and therefore an outcome of a social process of recognition and denial open to political interventions. From these deliberations on former dimensions of an *ex-ante* impact assessment modelling tool, consequences for the targeting of its end-users and their political characteristic can be drawn.

As a conclusions the paper reflects on the political dimensions of the Sustainability Impact Assessment Tool developed by SENSOR and on the institutionalizing of policy evaluation instruments.

Reference

- Ostrom, E., 2005. Understanding Institutional Diversity. Princeton University Press, Princeton, NJ.
- Thiel, A., *et al.*, 2007. In: Eds K. Helming & H. Wiggering, SENSOR Report Series 2007/01, www.sensor-ip.eu, ZALF, Germany.
- Thiel, A., 2008. Changing administrative culture and political debate? A review of Impact Assessment practices in the European Commission, in: Zeitschrift für Umweltpolitik & Umweltrecht
- Thiel, A. & B. König, 2008. In: Eds K. Helming, *et al.*, Sustainability Impact Assessment of land use policies. Springer, Heidelberg.
- Padmanabhan, M. & V. Beckmann, 2009. Institutions and Sustainability: Introduction and Overview. In: Eds V. Beckmann & M. Padmanabhan, Institutions and Sustainability. Springer, Heidelberg. (forthcoming)

Contribution of the development process to the actual implementation and use of Integrated Spatial Decision Support Systems

H. Van Delden, R. Vanhout
RIKS, P.O. Box 463, 6200 AL Maastricht, The Netherlands
Contact: hvdelden@riks.nl

Introduction

Integrated Spatial Decision Support Systems (ISDSSs) are rapidly gaining traction in the planning and policy-making community. They can have a high added value for planning processes by bringing scientific knowledge to the decision makers' table. However, only a few ISDSSs are in actual use for the preparation of spatial policies. Several reasons for this are recognized in academic literature, most notably a lack of transparency, inflexibility and a focus on technical capabilities rather than on real planning problems (Vonk *et al.*, 2005). In order to deploy an ISDSS as an instrument for strategic policy making, it seems crucial that it matches the perceptions, experiences and operational procedures (the tacit knowledge) of the policymakers and that it enhances their current policy practices rather than replace existing and well-embedded ones (see, e.g., Van Delden, 2003).

Based on practical experience, and more thoroughly discussed in earlier papers (e.g., Van Delden *et al.*, 2007), there are seven elements that seem to determine the success or failure of the implementation of an ISDSS:

- 1) Strategic value: to what extent does the system provide an added value to the current planning practice?
- 2) Availability of appropriate data and models: what is available at present or can easily be collected?
- 3) Credibility of the system: do the users have faith in underlying assumptions?
- 4) Domain language of the system: does it fit the worldview of the end users and connect to their perception?
- 5) Institutional embedment: where will the system be based in the organization and who is actually going to use the system?
- 6) Culture: are people willing to adopt and use the system and is there commitment to give the system a place in the planning process?
- 7) Ease of use: does the user interface allow a quick and simple use and provide easy access to all relevant functionality?

Methods

This paper discusses the lessons learned in the design & development of spatial decision support systems over the past decades. It builds on practical experience of ISDSS development using the GEONAMICA software environment for spatial modelling and (geo)simulation (Hurkens *et al.*, 2008). GEONAMICA has been the basis for many integrated spatial decision support systems that vary greatly in their application domain (urban and rural areas, coastal zones, river basins) and spatial extent (cities, countries, EU-27), based on the requirements of the user. Examples of ISDSSs developed with GEONAMICA are WadBos, Environment Explorer (Engelen *et al.*, 2003), MedAction (Van Delden *et al.*, 2007), Xplorah, Elbe-DSS, LUMOCAP and MOLAND (Barredo *et al.*, 2003).

From the development of several ISDSS over the past decades important lessons for ISDSS development processes can be learned. An ideal development process can best be described as an iterative process of communication and social learning amongst three involved parties. Such a process, that mirrors insights in other planning support domains, is depicted in Figure 1 and described in more detail in Hurkens *et al.* (2008).

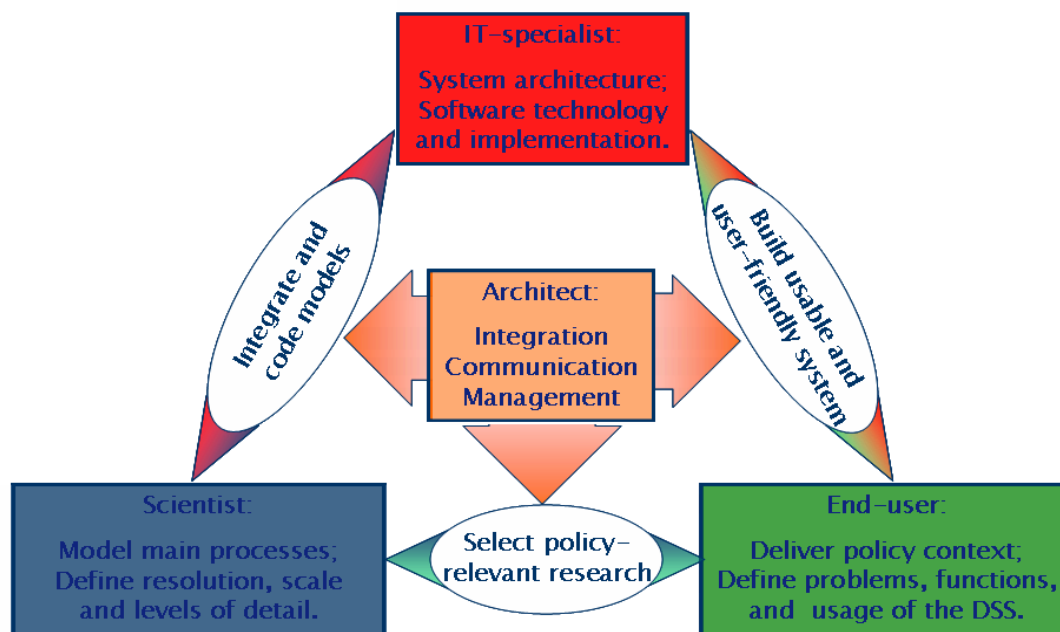

Figure 1. Main parties, responsibilities and integration issues during the development of a SDSS.

Results and discussion

In the introduction of this abstract we have posed seven elements that determine the success or failure of the implementation of an ISDSS. After a closer investigation of the development process of ISDSS, it becomes clear that this process plays a crucial role in the actual uptake of an ISDSS. Through close interaction between the different parties involved (end-users, scientists, IT-specialists and architect) the ISDSS under development can be greatly enhanced on items related to its usefulness and usability. Moreover, an iterative development process can also lead to an improved uptake of the system in the organizations and overcome some of the problems mentioned regarding the institutional context and the willingness of people to use and adopt it as part of their daily practice. The presentation will detail on the contribution of the development process to each of the seven elements mentioned.

References

- Barredo, J., *et al.*, 2003. Sustainable urban and regional planning: The MOLAND activities on urban scenario modelling and forecast. Office for Official Publications of the European Communities, Luxembourg.
- Engelen, G., *et al.*, 2003. *Integrated Assessment* 4(2): 97-105.
- Hurkens, J., *et al.*, 2008. In: Eds M. Sánchez-Marrè, *et al.*, *Proceedings of the iEMSs Fourth Biennial Meeting: 'Integrating Sciences and Information Technology for Environmental Assessment and Decision Making'*. International Environmental Modelling and Software Society, Barcelona, Spain.
- Van Delden, H., 2003. *Design and use of decision support systems for spatial planning. Framing Land Use Dynamics: Integrating knowledge on spatial dynamics in socio-economic and environmental systems for spatial planning in western urbanised countries.* Faculty of Geographical Sciences, Utrecht University, Utrecht, The Netherlands.
- Van Delden, H., *et al.*, 2007. *Environmental Modelling and Software* 22(2): 223-238.
- Vonk, G., *et al.*, 2005. *Environment and Planning A*, 37: 909-924.

Design and institutional embedment of the meta-model Sustainability Impact Assessment Tools (SIAT)

S. Sieber, P.J.F.M. Verweij, K. Müller, K. Tscherning, K. Helming
Leibniz-Centre for Agricultural Landscape Research e.V.,
Eberswalder Str 84, 15374 Müncheberg, Germany
Contact: stefan.sieber@zalf.de

Introduction

The European Union funded Integrated Project SENSOR develops *ex-ante* Sustainability Impact Assessment Tools (SIAT) to support decision making on policies related to multi-functional land use in European regions (Helming *et al.*, 2008). The meta-modelling approach SIAT is the central product of the SENSOR project, which innovates sustainability impact assessment towards an integrated perspective of region-explicit economic, environmental and social trade-off impact analysis. This paper illustrates the process of *end user involvements* and *software prototyping* to design the SIAT under limiting budget capacities. It concludes on a feasible design process under specific project-funded conditions.

The meta-model SIAT

Current operational tools for Impact Assessment (IA) are compared to SIAT mostly restricted to precise, quantitative sector information on aspects of economic, social or environmental impacts that are mainly designed for *ex-post* analysis (Bartolomeo *et al.*, 2004). Along with institutional integration processes, these *ex-ante* impact assessment tools are accompanied with increased requirements on system- and interdisciplinary complexity (Tamborra, 2002).

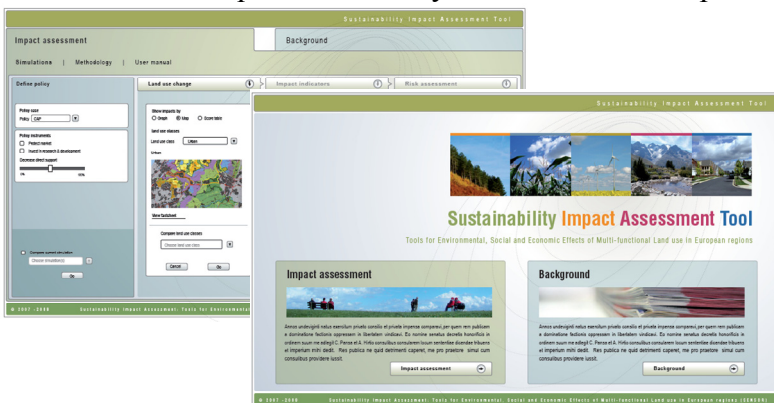

Figure 1. Design of prototype II.

The challenge of developing SIAT is the transformation of interdisciplinary knowledge into a *meta-model design* that allows high (a) technical performance, (b) a high level of integration and (c) compatibility and flexibility for further developments and assures (d) standard criteria such as reliability, plausibility, accuracy and explicitness of simulation results.

The integrated analysis by means of SIAT allows iterative policy scenario solving across the six sectors agriculture, forestry, energy, transport, nature conservation and tourism related to multi-functional land use in 570 European regions at the level of the EU 27 (Sieber *et al.*, 2008). End users are able to preselect policy variables (e.g., subsidy) and to choose intensities (e.g., Million Euro) to be simulated by using pre-calculated response functions from a model framework. 45 implemented impact indicators analyse trade-offs among sets of iteratively solved scenarios in a broad sustainability view of 'quick scan' analysis.

SIAT development process

Software prototyping focuses on the design process towards the final model version, which should be tailored for the specific use of end user groups. Typically, subsets of features

demonstrate functionalities of specific domains to be developed step-wise in collaborative discussions with interdisciplinary researcher.

The SIAT prototype I was released in 2006 (Verweij *et al.*, 2006). This version contained a small subset of the features to demonstrate the functionality of simulating land use-related policy impacts. Group discussions as well as individual interviews with potential end users surveyed expectations and requirements for the operational prototyping. The feedback has supported accurate estimates on given capacities for software specification and the level of integration on thematic areas (variety on indicators, fact sheet information etc.). As a result, the final version of SIAT is being developed until May 2009.

Concluding findings

The meta-model concept caused specific needs for knowledge integration by means of non-standard technical solution finding. A balanced resource allocation between (i) technical model advancements and (ii) increased levels of integration by covering an escalated number of thematic areas for impact assessment and (iii) institutional embedment to survey and meet end user requirements are predominant objectives. While the ratio between resource use for (i) and (ii) is relatively pre-defined, institutional embedment seems to be more flexible and a key factor for success for a high model acceptance and thus probability of further funding:

- Group discussions with end users is a valuable instrument, whereas key contacts to potential end users and permanently alternate meetings are most crucial obstacle. Technical requirements and desired analytical objectives could be surveyed.
- Targeted inputs of experts in bilateral interview form are essential, because 'strategic opinions' in group discussion are by-passed and thus sincere options can be focused. Design questions on anticipated, most likely research requirements could be answered.
- Understanding interactive development processes with end users helped to steer the general model design towards a presumed, most likely acceptability; clear, detailed requirements lacked often.
- Knowing the institution regarding its organizational structure is an empiric key for efficient result-oriented end user collaboration on specific requirements of integrated impact assessment models (Sieber *et al.*, 2008).

Becoming acquainted the organizational structure and requirements through group discussions and individual interviews is key for success, but often rather general and diverse requests cause the need for presumptions. Strategic behaviour is major obstacle for honest feedback. The presentation will present SIAT and conclude on *risks* and *success factor* as well as *best practices*, which are newly elaborated and base on experiences of the development process of SIAT. Explanations are made by means of applied economic theory.

References

- Bartolomeo, M., *et al.*, 2004. Approaches to Impact Assessment in six OECD countries and at the European Commission. IQ-Tools Project report, WP1A.
- Helming, K., *et al.*, 2008. In: K. Helming, *et al.*, Sustainability impact assessment of land use changes. Springer, pp. 77-105.
- Sieber, S., *et al.*, 2008. In: K. Helming, *et al.*, Sustainability impact assessment of land use changes. Springer, pp. 107-128.
- Tamborra, M., 2002. Socio-economic tools for sustainability impact assessment – the contribution of EU research to sustainable development. Energy, environment and sustainable development. EUR 20437.1 Office for official publications of the European Communities, Luxembourg, 2002.
- Verweij, P.J., *et al.*, 2007. SIAT - a Sustainable Impact Assessment Tool for Understanding the drivers in integrated impact assessment. International Conference IEMSS, Vermont, USA, 6 pp.

Bridging the gap between science and decision makers for sustainable development of multi-functional land use in developing countries

H. König, K. Helming, P. Reidsma, L. Zhen, S. Feng, S. Sieber, F. Brouwer
Leibniz-Centre for Agricultural Landscape Research, ZALF e.V.,
Eberswalder Strasse 84, 15374 Müncheberg, Germany
Contact: Hannes.Koenig@zalf.de

Introduction

Sustainable land use is a key issue to improve food security, control land degradation and reduce poverty, especially in developing and transition countries. Global changes and growing demands on resources have resulted in dynamic changes of land and related sustainability issues. Hence policy- and decision makers have increasing demand for *ex-ante* assessment tools to support decision making processes in a sustainable way. The EU-funded projects LUPIS (www.lupis.eu) and SENSOR-TTC (www.sensor-ip.org; Helming et al., 2008) develop methods and tools for assessing policy- and/or alternative problem scenario impacts on land use and sustainable development (SD) in a selected number of case study regions in Africa, Asia and Latin America.

When developing scientific tools, the focus is often on specific scientific questions, while the applicability and usability for stakeholders is often neglected. To have impact however, communication with stakeholders and usability of tools is of major importance. Therefore, the assessment, communication and visualization tool 'Pro-Vision' is developed. Pro-Vision is used to support the impact assessment procedure considering participatory approaches and to evaluate anticipated impacts on sustainable development issues.

Methodology

In Pro-Vision, the analytical chain is developed based on the Driver-Pressure-State-Impact-Response (DPSIR) framework (OECD, 2003), to structure different case study regions and to identify cause-effect relations between policies/problems, land use changes and regional sustainability issues. The DPSIR framework is used to (a) develop regional specific land use change scenarios, and to (b) evaluate possible impacts of land use changes on sustainable development (Figure 1).

For the scenario development, Pro-Vision is first applied to elaborate and visualize alternative land use change scenarios, e.g., during regional stakeholder workshops. Stakeholders and experts are asked to specify possible land conversion dynamics (type specifications, suitability and allocation dynamics), and to discuss possible scenario outcomes.

For the second part, Pro-Vision is used to evaluate possible land use change impacts on sustainable development. The concept of Land Use Functions (LUFs) as developed by Pérez-Soba *et al.* (2008) is used in the Pro-Vision tool to assess in an integrative way the economic, environmental and social impacts that land use changes have on sustainable development. Land Use Functions are developed to illustrate most relevant sustainability issues at regional level and are defined as goods and services associated with land use (e.g., economic: food production; environmental: maintenance of ecosystem processes; social: provision of work). For the evaluation of impacts, stakeholders and experts are asked to identify a key set of Land Use Functions and to define causal-chain dependencies between land use and sustainability. This is done by assigning region specific weights between land use types and Land Use Functions.

In the final step, sustainable development can be interpreted using the LUFs framework, to allow stakeholders, and scientists identifying at a glance those functions of the land which are fostered or hindered under various scenarios of land use changes, and making it possible to explore the trade-offs between them.

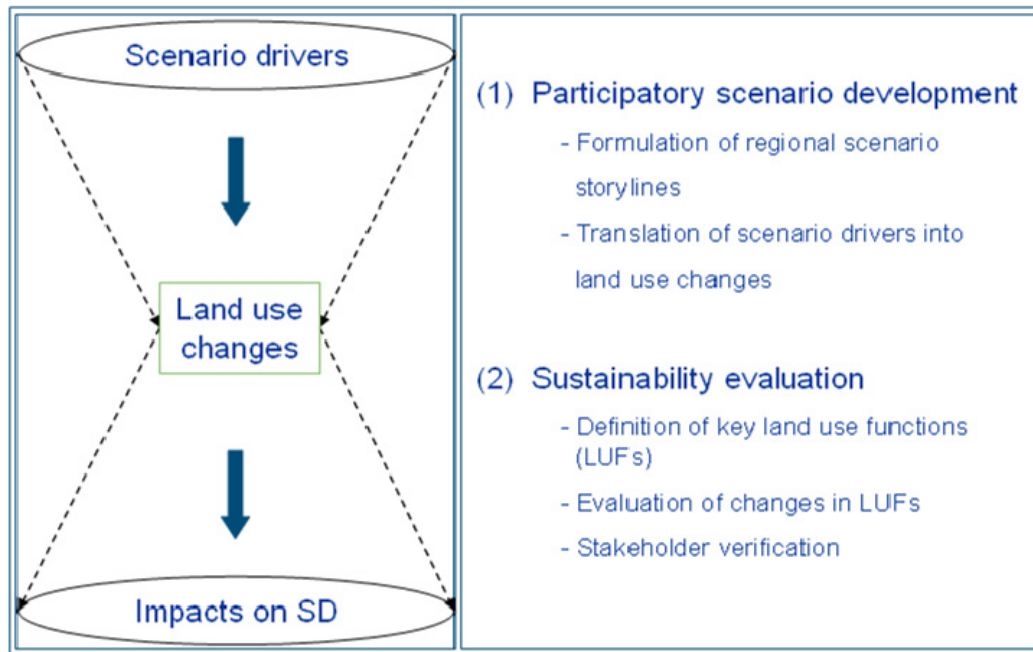

Figure 1. The methodological framework of the Pro-Vision tool is based on the DPSIR framework, and is used to support (a) participatory scenario development and (b) sustainability evaluation.

Results, discussion and conclusion

The two projects LUPIS and SENSOR-TTC aim at assessing alternative policy/problem scenarios in different case study regions. The methodological framework of both projects builds upon European assessment methods (Reidsma *et al.*, 2008; Helming *et al.*, 2008), and is currently being adapted and tested in a selected number of case study regions in China and Brazil to identify strengths and weaknesses of this approach, and also to provide a primer for sustainability impact assessment in developing countries. A heterogeneous set of land use related problems is assessed: water pollution in China, and side effects of infrastructure projects and land conversion in Brazil.

By using Pro-Vision, integrated assessments of land use policies are possible that do not depend on the use of complex tools, but by complementing quantitative and qualitative approaches which are insightful for decision makers and other stakeholders. In order to bridge the gap between scientists and decision makers, participatory communication and visualization tools are needed to support the understanding of complex causal-chain relationships between policies and their impacts on regional sustainability issues. The Pro-Vision tool has been developed to support this process. Pro-Vision enables users and stakeholders to identify causal-chain relationships between land use changes and regional sustainability issues and improve their decision-making process.

References

- Helming, K., *et al.*, (Eds), 2008. Sustainability Impact Assessment of Land Use Changes. Springer, Berlin.
- OECD, 1993. Core set of indicators for Environmental Performance Reviews. Environmental Monographs 83. OECD, Paris, France.
- Pérez-Soba, M., *et al.*, 2008. In: Ed. K. Helming, *et al.*, Sustainability impact assessment of land use changes. Springer, Berlin, pp. 375-404.
- Reidsma, P., *et al.*, 2008. D4.1, LUPIS Integrated Project, Wageningen University.

Authors Index

- Achuo, G., 152
 Adam, M., 194, 196, 198, 200, 342
 Adamowicz, M., 174
 Adams, D., 34
 Adenäuer, M., 24, 52, 436
 Adiku, S., 218
 Adriaensen, K., 396
 Agabriel, J., 264, 266
 Aguerre, V., 60
 Ahuja, L., 324
 Akkas Ali, M., 248
 Alary, V., 268, 272
 Albrecht, A., 40
 Alcamo, J., 378
 Alkan Olsson, J., 6, 66, 130, 140, 176, 178, 504, 506, 514, 520, 530, 532
 Amblard, L., 438
 Andersen, E., 6, 56, 130, 320, 350, 352, 354
 Anderson, T., 490
 Andersson, L., 506
 Andrieux, P., 294
 Angenendt, E., 310
 Angevin, F., 448
 Antle, J.M., 48, 68, 110, 318, 408, 472
 Antrop, M., 112
 Antunes, P., 36, 440, 508
 ApSimon, H., 538
 Arnauld de Sartre, X., 356
 Arriaza, M., 16, 84
 Ascough, J., 324
 Asseng, S., 414
 Astover, A., 372, 386
 Athanasiadis, I.N., 140, 320, 330, 344
 Attard, S., 490
 Auclair, D., 296
 Ayanu, Y.Z., 28
 Aznar, O., 302
 Bäcklund, A.-K., 530, 532
 Baethgen, W.E., 402
 Bagstad, K., 120
 Baijukya, F., 40
 Bakker, F., 102
 Bakker, M.M., 412
 Bamière, L., 252
 Banse, M., 162, 384
 Barbier, J.M., 180, 294
 Barnaud, C., 524
 Barroso, F., 100
 Baruth, B., 350, 352
 Bates, B., 414
 Bathgate, A., 270
 Baudet, D., 202
 Baveco, J.M., 118
 Beça, P., 36
 Beletskaya, O., 310
 Belhouchette, H., 130, 194, 196, 198, 200, 442, 484
 Bellon, S., 178
 Ben El Ghali, M., 250
 Benedetti, L., 136
 Berbel, J., 96, 182
 Berg, E., 286
 Berges, R., 78
 Bergez, J.E., 198, 212, 226, 232, 326, 448
 Berkhoff, K., 18
 Beusen, A.H.W., 146
 Bezabij, Y.G., 404
 Bezlepkina, I., 56, 58, 66, 130, 138, 140, 176, 514
 Bianchi, F.J.J.A., 118
 Biberacher, M., 312
 Bigot, G., 262, 466
 Billen, G., 146
 Binder, C.R., 172
 Bindi, M., 426
 Blanco, M., 256
 Blandford, D., 86
 Blaser, S., 334
 Blazy, J.M., 294
 Blouin, M., 448
 Bobojonov, I., 286
 Bocardo, P.J., 364
 Bochu, J.L., 430
 Bockstaller, C., 66, 130, 140, 176, 178
 Bocquého, G., 252
 Bona, S., 366, 446
 Bonin, M., 294
 Boote, K.J., 406
 Bordenave, P., 452
 Borkowski, N., 256
 Bossio, D., 22
 Botreau, R., 322
 Böttcher, H., 416
 Bouraoui, F., 240, 392
 Bourges, J., 326
 Bousset, J.P., 100, 176, 466, 520, 532
 Bouwman, A.F., 146, 158, 412
 Brady, M., 288

- Breukers, A., 290
 Brigi, A., 366, 446
 Bringezu, S., 376
 Brisson, N., 222, 224
 Britz, W., 50, 52, 144, 154, 184
 Brodie, J., 490
 Brogaard, S., 514, 530, 532
 Broll, G., 312
 Brouwer, F., 6, 64, 114, 130, 138, 530, 550
 Brun, J.-P., 322
 Bryon, K., 258
 Buckwell, A., 82
 Buis, S., 326
 Bulatewicz, T., 292
 Bunce, R.G.H., 94
 Burgess, P.J., 458
 Burghard, M., 64
 Bursztyn, M., 102
 Buysse, J., 160, 486
 Cacovean, H., 444
 Cadisch, G., 26, 28, 510
 Cai, X., 242
 Calgaro, A., 366
 Carberry, P.S., 192
 Carlson, J., 324
 Carpy-Goulard, F., 448
 Casellas, E., 194, 196, 198, 200, 204, 228, 232
 Causeret, F., 294
 Cavigelli, M.A., 230
 Celette, E., 196, 204
 Ceroni, M., 120
 Champciaux, P., 322
 Charles, S.P., 414
 Charron, M.-H., 202
 Chen, Z., 474
 Christen, O., 20
 Ciaian, P., 42
 Claessens, L., 110, 408
 Claeys, D., 160, 486
 Clastre, P., 326
 Clavel, L., 202
 Coletto, L., 366, 446
 Colomb, B., 448
 Comunello, E., 158
 Cools, J., 136
 Cooper, M., 242
 Corbeels, M., 40, 196, 204, 238
 Corporaal, A., 108
 Corre-Hellou, G., 222
 Costamagna, A.C., 118
 Crespo, O., 410
 Cruz, J.C.S., 364
 Cullen, B.R., 236
 D'Haene, K., 500
 Dahal, B.M., 534
 Dahlmann, C., 222
 Daniell, T., 32
 Das, S., 242
 David, O., 324
 Davis, A., 490
 De Blaeij, A., 88
 De Cara, S., 254
 De Castro, V.M., 102
 De Koeijer, T.J., 108
 De Kraker, J., 498
 De la Flor Tejero, I., 14
 De Lange, W.J., 338
 De Mey, K., 500
 De Ridder, N., 40, 526
 De Sanctis, G., 460
 De Smedt, P., 128
 De Visser, C.L.M., 394
 De Vries, S.C., 394
 De Vries, W., 74, 298, 412, 454
 De Winter, W.P., 412
 Debaeke, P., 326
 Debortoli, N., 102
 Deffuant, G., 64
 Delmotte, S., 180
 DeVoil, P., 450
 Dhillion, S.S., 90
 Diehl, K., 542
 Dietz, F.J., 116
 Dillon, E.J., 476
 Diman, J.L., 294
 Dimes, J., 432
 Dirkx, G.H.P., 92
 Dixon, J., 22
 Dogliotti, S., 60
 Dolédec, S., 356
 Donatelli, M., 206
 Dos Santos Rocha, A., 368
 Dray, A., 414
 Duru, M., 502
 Dury, J., 62
 Dux, D., 334
 Dzotsi, K., 218
 Eickhout, B., 148, 164, 384, 412
 Elbersen, B.S., 54, 74, 94, 240, 350, 354, 462
 Elzen, B., 38

- Emmett, B.A., 106
 Erdélyi, É., 208
 Evans, C.D., 106
 Everaert, P., 258
 Ewert, F., 6, 56, 66, 70, 130, 140, 176, 200, 504, 520
 Fallot, A., 370
 Fantke, P., 210
 Fatondji, D., 218
 Feng, S., 138, 550
 Ferrise, R., 426
 Fischer, R., 514, 536
 Flichman, G., 56, 246, 256, 442
 Florio, G., 446
 Flury, C., 482
 Fodorean, I., 444
 Franz, J., 286
 Freeman, H.A., 22, 148
 Fricke, K., 132
 Friedrich, R., 210, 310
 Fritz, S., 148
 Gaasland, I., 86
 Gabbert, S., 504
 Gaillard, G., 134, 334
 Garcia-Barrios, L.E., 516
 Gardiner, M.M., 118
 Garrod, G., 114
 Gary, C., 180, 228, 294
 Geniaux, G., 178
 Gerard, B., 22
 Gerten, D., 148
 Geter, F., 324
 Giannoccaro, G., 96, 182
 Gies, T.J.A., 298
 Giller, K.E., 40, 62, 238
 Glandières, A., 448
 Goddard, L., 402
 Godeschalk, F.E., 358
 Gondwe, P., 432
 Gooding, M.J., 222
 Goulevat, G., 254
 Grabaum, R., 34
 Grant, T., 388
 Graves, A.R., 458
 Greene, A.M., 402
 Griffon, S., 296
 Groot, J.C.J., 518
 Guérif, M., 326
 Guillaume, S., 212
 Guille, T., 370
 Guo, Z., 220
 Hachigonta, S., 410
 Hallett, P., 32
 Hansen, J.W., 216, 402
 Happe, K., 64, 308
 Hasnain, N., 538
 Hatano, R., 422
 Hauggaard-Nielsen, H., 222
 Havlik, P., 148, 156, 370, 416
 Havlikova, M., 492
 Hawes, C., 32
 Hazeu, G.W., 350, 352
 He, J., 218
 Heckelei, T., 6, 56, 58, 130, 154, 168, 256
 Hecker, M., 256
 Hein, L., 124
 Heinemann, A.B., 214
 Helming, K., 14, 132, 542, 548, 550
 Hengsdijk, H., 200, 232, 256, 262, 478
 Hennessy, T., 476
 Hernández Jiménez, V., 540
 Herrero, M., 22, 40, 148, 408
 Herrmann, S., 18, 188
 Hertel, T., 144
 Herzog, F., 458
 Hilger, T., 26, 28
 Ho Van Chien, 512
 Hochman, Z., 450
 Hoffmann, C., 306
 Hoffmann, V., 26
 Holzworth, D.P., 192, 450
 Hood, A., 34
 Hoogenboom, G., 406
 Hoogervorst, N., 164
 Howart, R.W., 376
 Huang, X., 474
 Huber, D., 330
 Hubert, B., 356
 Hugenschmidt, C., 28
 Hunt, J., 450
 Hutchinson, W.G., 112
 Huth, N.I., 192
 Hynes, S., 476
 Ines, A.V.M., 216, 402
 Jacquet, F., 252, 254, 370
 Jafarzadeh, A.A., 304
 Jakku, E., 522
 Janetschek, H., 456
 Janssen, S., 66, 130, 140, 232, 256, 262, 320, 330, 332, 344, 350, 478
 Jansson, T., 24, 162
 Jensen, E.S., 222

- Jeuffroy, M.H., 254
 Joel, A., 336
 Johnson Jr, G.W., 120
 Johnson, I.R., 236
 Jones, J.W., 218, 406
 Jones, M.L.M., 98
 Jongeneel, R., 54
 Jonsson, A., 506
 Jonsson, B., 130, 330, 344
 Josien, E., 178, 466
 Justes, E., 212, 326
 K'ungu, J., 40
 Kaizzi, C., 40
 Kan, I., 418
 Kanellopoulos, A., 58, 256, 478
 Kansou, K., 228
 Karadzic, V., 440, 508
 Karanja, S., 40
 Kasnakoglu, H., 348
 Kassahun, A., 328
 Kasynova, E., 222
 Keating, B.A., 192
 Kellermann, K., 288
 Kempen, M., 54, 74, 354, 454
 Kephaliacos, C., 250
 Khanh Hoang, L., 136
 Kim, C.-G., 420
 Kimhi, A., 418
 Kimura, D.S., 364
 Kimura, S.D., 422
 Kindermann, G., 156, 416
 Kirschner, P., 498
 Knapen, M.J.R., 130, 140, 330, 344
 Koch, J., 378
 Koduru, P., 242
 Kok, K., 518
 Kölking, C., 378
 Kondoh, K., 364
 König, B., 542
 König, H., 138, 542, 550
 Koo, J., 220
 Kopeva, D., 64
 Krivov, S., 120
 Kroeze, C., 492, 498, 504
 Kros, J., 74, 298, 412, 454
 Kruitwagen, S., 116
 Kruska, R., 22
 Kuhn, A., 210
 Kuiper, M., 24, 130, 150, 436
 Kukk, L., 372, 386
 Kummer, U., 310
 Lamadon, A., 322
 Lamers, J.P.A., 286
 Landis, D.A., 118
 Lange, A., 480
 Langeveld, H., 394
 Lankoski, J., 374
 Laplana, R., 64
 Launay, M., 222, 224, 326
 Lauwers, L., 160, 258, 278, 486
 Lavelle, P., 356
 Lebonvallet, S., 224
 Lecharpentier, P., 326
 Lecomte, P., 268, 272, 280, 430
 Leduc, S., 416
 Leenhardt, D., 202
 Lefebvre, A., 152
 Leffelaar, P.A., 70
 Legg, W.J., 4
 Leip, A., 184, 376
 Leneman, H., 260
 Lescot, J.M., 452
 Lesschen, J.P., 74, 158, 454
 Lherm, M., 264, 266
 Li, H., 256
 Liebhart, P., 234
 Lieferring, M., 236, 424
 Linderhof, V., 88
 Lindoso, D., 102
 Lippe, M., 26, 28
 Liski, J., 412
 Long, B., 450
 Longo, A., 112
 López-Baldovín, M.J., 84
 Lotze-Campen, H., 148
 Louchart, X., 294
 Louhichi, K., 104, 130, 246, 256, 262, 276,
 436, 442, 484
 Lubbers, M., 268, 272
 Lucas, P., 254
 Lusiana, B., 510
 MacGregor, R.J., 152
 Machado, C., 100
 Mack, G., 482
 Mailhol, J.C., 226
 Majewski, E., 484
 Man, T., 444
 Mangum, R.A., 230
 Mann, C., 438
 Mapfumo, P., 40
 Marchand, F.L., 160, 486
 Marohn, C., 28

- Martin, G., 502
 Martinez Alonso, P., 462
 Martius, C., 286
 Maul, J., 230
 McRoberts, N., 30, 32
 Meers, E., 396
 Meinke, H., 400
 Mendes da Silva, M., 368
 Mérot, A., 204, 226
 Metay, A., 198, 228
 Metzger, M.J., 352
 Meul, M., 186, 500
 Meuter, E., 256, 332
 Meyer, B., 34
 Michelin, Y., 100
 Mikk, M., 54
 Milla, R., 490
 Mirsky, S.B., 230
 Moldovan, C., 444
 Molla, M.S.H., 248
 Moltchanova, E., 428
 Momin, M.A., 248
 Montfort, F., 254
 Monti, M., 222
 Moore, A., 270
 Moore, R.V., 316
 Morand, H., 152
 Moriondo, M., 426
 Mosnier, C., 264, 266
 Mouratiadou, I., 484, 488
 Mourits, M., 290
 Moyer, B., 242
 Msangi, S., 22, 148, 378
 Mu, Z., 422
 Mücher, C.A., 352
 Mulia, R., 510
 Muller, C., 148
 Müller, K., 548
 Müller, M., 154
 Mwale, M., 40
 Mynett, A., 136
 Naab, J., 218
 Nabuurs, G.J., 412
 Nanja, D., 432
 Neef, A., 26
 Nekhay, O., 16
 Nelson, R., 400
 Nemecek, T., 134, 334
 Neuwirth, J., 456
 Newton, P., 424
 Nguyen, G., 250
 Nicetic, O., 512
 Nidumolu, U.D., 268
 Nieuwenhuizen, W., 340
 Nolte, S., 160
 Nonhebel, S., 380
 Noormets, M., 372, 386
 Notenbaert, A., 22, 148
 Nowicki, P., 14
 Nwage, D., 40
 O'Connell, D., 388
 O'Leary, Z., 512
 Obersteiner, M., 156, 416
 Ollikainen, M., 374
 Oñate, J.J., 462
 Oomen, R.J., 200, 232
 Orsini, R., 460
 Osann, A., 508
 Osterburg, B., 300
 Osuch, A., 308
 Oude Lansink, A., 58, 256, 290
 Oudendag, D.A., 412, 454
 Oxley, T., 538
 Ozier-Lafontaine, H., 294
 Pacini, C., 40, 98
 Pacini, G.C., 60
 Padmanabhan, M., 544
 Pahl-Wostl, C., 497
 Palma, J., 458
 Pannell, D., 470
 Paracchini, M.L., 42, 98
 Peco, B., 462
 Peepson, A., 54
 Pérez Dominguez, I., 58, 154
 Perez, P., 414
 Pérez-Soba, M., 98, 352, 412
 Perny, P., 322
 Perret, E., 114, 262, 466
 Perugini, M., 460
 Petersen, J.-E., 362
 Peterson, J.M., 292
 Philips, A., 34
 Picchi, P., 100
 Pingali, P., 11
 Pinto-Correira, T., 100, 176
 Piorr, A., 78, 308, 480
 Pistón, J.M., 182
 Polman, N., 88
 Pop, A., 444
 Popp, A., 148
 Prieur, L., 448
 Prins, A.G., 122, 384

- Pristeri, A., 222
 Prosperi, M., 96
 Prosperi, P., 240
 Puiu, V., 444
 Qu, F., 474
 Queste, J., 514
 Quiroz, C., 40
 Rae, D., 512
 Raffailac, J.-P., 224
 Raley, M., 176, 178
 Rapidel, B., 276
 Rees, R.M., 390
 Reidsma, P., 138, 514, 550
 Reinds, G.J., 412
 Renetzeder, Ch., 352
 Reynaud, A., 254, 264, 266
 Ridier, A., 250
 Rienks, W., 14
 Righi, E., 60
 Ringler, C., 148
 Rio, P., 294
 Ripoche, A., 180, 228
 Rizzoli, A.E., 130, 206, 320, 330, 344
 Robertson, M.J., 192, 270
 Robiul Alam, M., 248
 Rodrigues-Filho, S., 102
 Roe, J.L., 242
 Roggero, P.P., 460
 Romeo, M., 222
 Romstad, E., 58, 104
 Rood, T., 164
 Roos-Klein Lankhorst, J., 340, 462
 Roostalu, H., 372
 Roscoe, R., 158
 Rosegrant, M., 148
 Rosenzweig, C., 406
 Rossing, W.A.H., 60, 518
 Rotmans, J., 8
 Rowe, E.C., 106
 Rudrum, D.P., 108
 Ruffini, F.V., 306
 Rufino, M.C., 40, 62
 Ruinelli, L., 130, 344
 Russell, G., 200, 206, 232, 488
 Rusu, T., 444
 Salazar, O., 336
 Salgado, P., 272
 Sambo, P., 446
 Sandrini, S.G., 366, 446
 Sanogo, O.M., 40
 Santos, R., 36, 440, 508
 Sasaki, H., 464
 Satger, S., 222
 Sattler, C., 308
 Sauer, T., 156
 Schaldach, R., 378
 Schauppenlehner, T., 274
 Schelhaas, M.J., 412
 Schellhorn, N.C., 118
 Schipper, R., 272
 Schleyer, C., 302, 438
 Schmid, A., 172
 Schmid, E., 234, 274, 416, 428
 Schmidt, T.G., 300
 Schmitt, J., 242
 Schneider, U.A., 156, 234, 416
 Scholz, J., 188
 Schönhart, M., 234, 274
 Schoorl, J.M., 110
 Schrijver, R.A.M., 108, 260
 Schuler, J., 382
 Schuler, U., 28
 Seddaiu, G., 460
 Shahbazi, F., 304
 Shahbazi, M.R., 304
 Shannon, E., 490
 Shraberman, K., 418
 Sieber, S., 132, 548, 550
 Siebert, R., 480
 Sijtsma, F.J., 116
 Sintanyeho, R., 404
 Slegten, V., 280
 Smaling, E.M.A., 158
 Smart, S., 106
 Smarzewska, A., 174
 Smidt, R., 298
 Smith, J., 40
 Snow, V.O., 236
 Soudais, J., 202, 326
 Spargo, J.T., 230
 Speelman, E.N., 516, 518
 Spoelstra, S.F., 38
 Spooner-Hart, R., 512
 Squire, G.R., 32
 Staggenborg, S., 292
 Stalpers, S., 504
 Stapleton, L., 64, 114, 176, 178
 Staritsky, I., 350, 354
 Stehfest, E., 164, 384
 Steinberger, J.K., 172
 Steward, D.R., 292, 338
 Stockstad, G., 256

- Stomph, T.J., 72
 Stoorvogel, J.J., 68, 110, 284, 318, 408, 472
 Strauss, F., 428
 Streifeneder, T., 306
 Stroosnijder, L., 526
 Stuczynski, T., 42
 Sulser, T., 148
 Suuster, E., 372, 386
 Suyamto, D., 510
 Svensson, M., 344
 Tack, F.M.G., 396
 Tadross, M., 410
 Tagliaferro, C., 112
 Taverne, M., 520, 532
 Teasdale, J.R., 230
 Temme, A., 110
 Terluin, I.J., 350, 358
 Terres, J.M., 240
 Thai Minh, T., 26
 Theesfeld, I., 302, 536
 Theloke, J., 310
 Therond, O., 56, 66, 130, 140, 176, 194, 198, 200, 232, 442, 520
 Thewys, T., 396
 Thorburn, P.J., 388, 490, 522
 Thornton, P.K., 22, 148
 Tittonell, P., 40, 62, 238
 Toderi, M., 460
 Toma, Y., 422
 Topp, C.F.E., 30, 32, 390, 488
 Traoré, B., 276
 Trébuil, G., 524
 Truchet, S., 100
 Tscherning, K., 542, 548
 Turpin, N., 56, 64, 66, 100, 114, 130, 140, 176, 466
 Uckert, G., 382
 Uthes, S., 308
 Valdivia, R.O., 68, 318, 408, 472
 Van Bussel, L.G.J., 70
 Van de Fliert, E., 512
 Van de Giessen, N., 72
 Van de Steeg, J., 22, 148
 Van de Ven, G.W.J., 394
 Van Delden, H., 42, 546
 Van den Akker, J., 412
 Van den Brink, L., 394
 Van der Heide, C.M., 116
 Van der Heide, M., 176, 178
 Van der Straeten, B., 160, 486
 Van der Velde, M., 240, 392
 Van der Werf, W., 110, 290, 458
 Van Diepen, C.A., 350, 352
 Van Doorn, A., 94
 Van Eetvelde, V., 112
 Van Egmond, P., 116
 Van Eupen, M., 340
 Van Evert, F., 342
 Van Griensven, A., 404
 Van Griensven, S., 136
 Van Hinsberg, A., 116
 Van Huylenbroeck, G., 160, 278, 486
 Van Ittersum, M.K., 6, 14, 56, 130, 138, 200, 232, 256, 262, 332, 478, 504, 514, 520, 530, 532
 Van Keulen, H., 70, 138, 268, 272, 518
 Van Meensel, J., 258, 278
 Van Meijl, H., 162
 Van Noordwijk, M., 510
 Van Os, J., 74
 Van Paassen, A., 524, 526
 Van Passel, S., 44, 186
 Van Rees, S., 450
 Van Slycken, V., 396
 Van Wijk, M.T., 40, 62
 Van Zeijts, H., 122
 Vangronsveld, J., 396
 Vanhout, R., 42, 546
 Vanlauwe, B., 40
 Vårdal, E., 86
 Vayssières, J., 280, 430
 Veiga, I., 356
 Veissier, I., 322
 Velthof, G.L., 412, 454
 Verburg, P.H., 124, 412
 Verhoog, D., 350, 358
 Verweij, P.J.F.M., 340, 548
 Viaggi, D., 480
 Vigne, M., 280, 430
 Villa, F., 120, 344
 Volkery, A., 14
 Voltr, V., 176
 Von Braun, J., 2
 Von Fragstein, P., 222
 Voogd, J.C., 298
 Wagner, K., 456
 Wagner, S., 210, 310
 Walker, R.L., 32
 Walker, S., 432
 Wallach, D., 200, 326, 342
 Wallman, P., 344

Walter, T., 482
Warnecke, S., 312
Was, A., 484
Watson, C.A., 32
Watson, D., 34
Wauters, E., 44
Weindorf, D.C., 444
Weiss, F., 184
Welch, S.M., 242, 292
Wery, J., 6, 130, 180, 194, 196, 198, 200,
226, 228, 442, 520, 532
Wesström, I., 336
Westhoek, H., 122, 164
Whitbread, A., 450
Wieggers, H.J.J., 412
Wien, J.J.F., 6, 130, 316, 320, 330, 344
Wilczek, A., 242
Willemen, L., 124
Witters, N., 396
Wolf, J., 130
Woltjer, G.B., 162, 164, 166, 384
Wood, S., 22, 148, 220
Wriedt, G., 392
Wustenberghs, H., 44
Yang, X., 292, 338
Yeboah, E., 40
Young, M., 32
Zakayo, S., 76
Zander, P., 104, 256, 308, 382
Zasada, I., 78
Zeddies, J., 310
Zhen, L., 550
Zhang, W., 118
Zimmermann, A., 168
Zingore, S., 62