



**HAL**  
open science

## Use and misuse of modelling for projections of climate change impacts on crops and pastures

Jean-François J.-F. Soussana, Anne-Isabelle Graux, Francesco Tubiello

### ► To cite this version:

Jean-François J.-F. Soussana, Anne-Isabelle Graux, Francesco Tubiello. Use and misuse of modelling for projections of climate change impacts on crops and pastures. Annual Meeting of the Society-for-Experimental-Biology, Society of Experimental Biology (SEB). London, GBR., Jun 2009, Glasgow, United Kingdom. 10.1016/j.cbpa.2009.04.555 . hal-02755309

**HAL Id: hal-02755309**

**<https://hal.inrae.fr/hal-02755309>**

Submitted on 3 Jun 2020

**HAL** is a multi-disciplinary open access archive for the deposit and dissemination of scientific research documents, whether they are published or not. The documents may come from teaching and research institutions in France or abroad, or from public or private research centers.

L'archive ouverte pluridisciplinaire **HAL**, est destinée au dépôt et à la diffusion de documents scientifiques de niveau recherche, publiés ou non, émanant des établissements d'enseignement et de recherche français ou étrangers, des laboratoires publics ou privés.



# **Use and misuse of modelling for projections of climate change impacts on crops and pastures**

Jean-François Soussana<sup>1</sup>, Anne-Isabelle Graux<sup>1</sup>  
and Francesco N. Tubiello<sup>2</sup>

1. INRA, Grassland Ecosystem Research, Clermont-Ferrand, France
2. Joint Research Centre, European Commission, Ispra, Italy.

# Outline

- Climate change and food supply
- Uncertainties in projections of impacts
- Modelling crops under elevated CO<sub>2</sub>
- Extreme climate events
- Biotic interactions
- Perspectives

# What is climate change?

**Increase in the main greenhouse gases**

Carbon dioxide ( $\text{CO}_2$ )

Methane ( $\text{CH}_4$ )

Nitrous oxide ( $\text{N}_2\text{O}$ )

**Changes in climate**

Temperature

Precipitation

Extreme events

**Over the coming decades and centuries**

# Global increase in anthropogenic greenhouse gas emissions

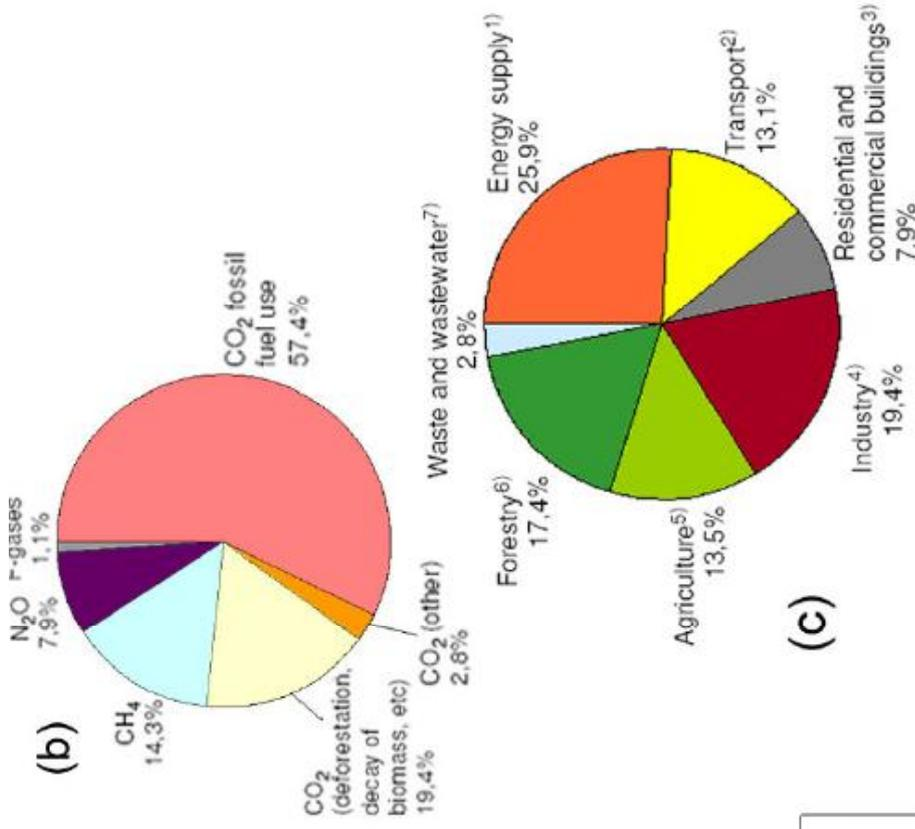
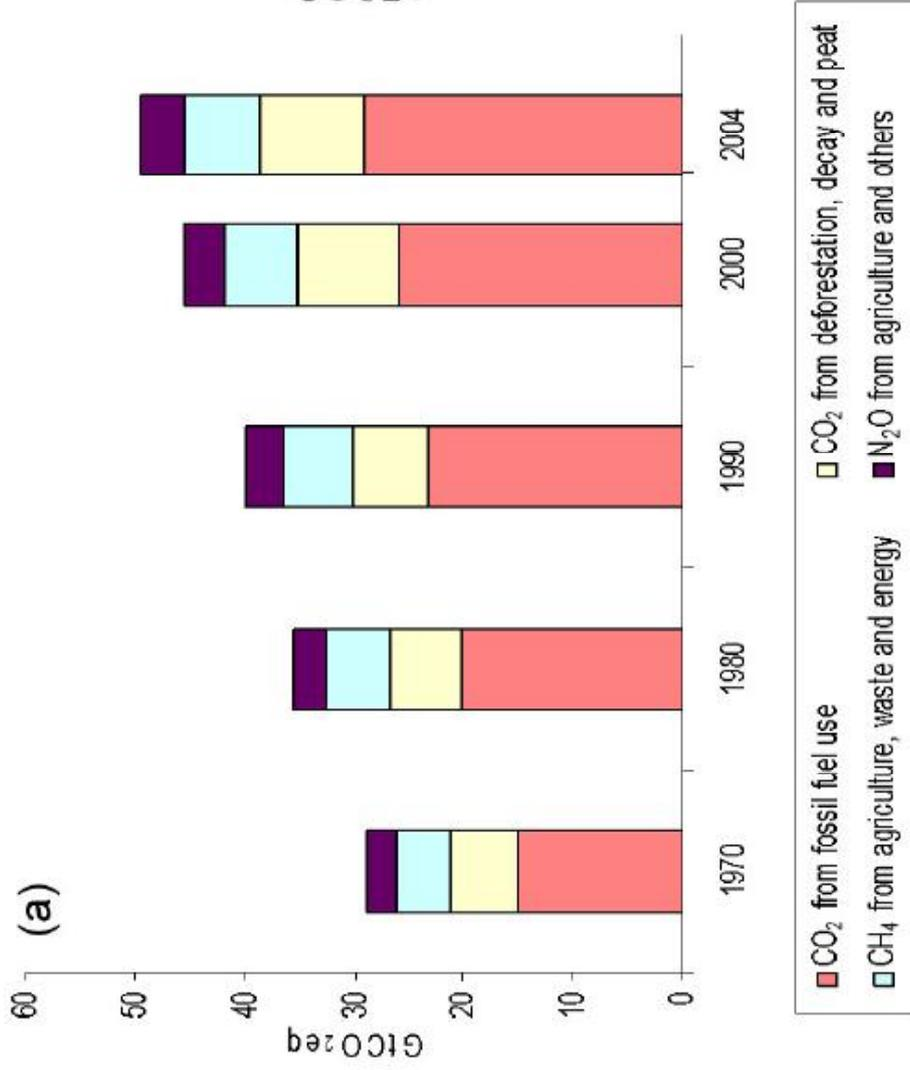

IPCC 2007

Global greenhouse gas emissions covered by the Kyoto protocol have increased by 70 % from 1970 to 2004

# Atmospheric CO<sub>2</sub> in the past

The last 400 '000 years

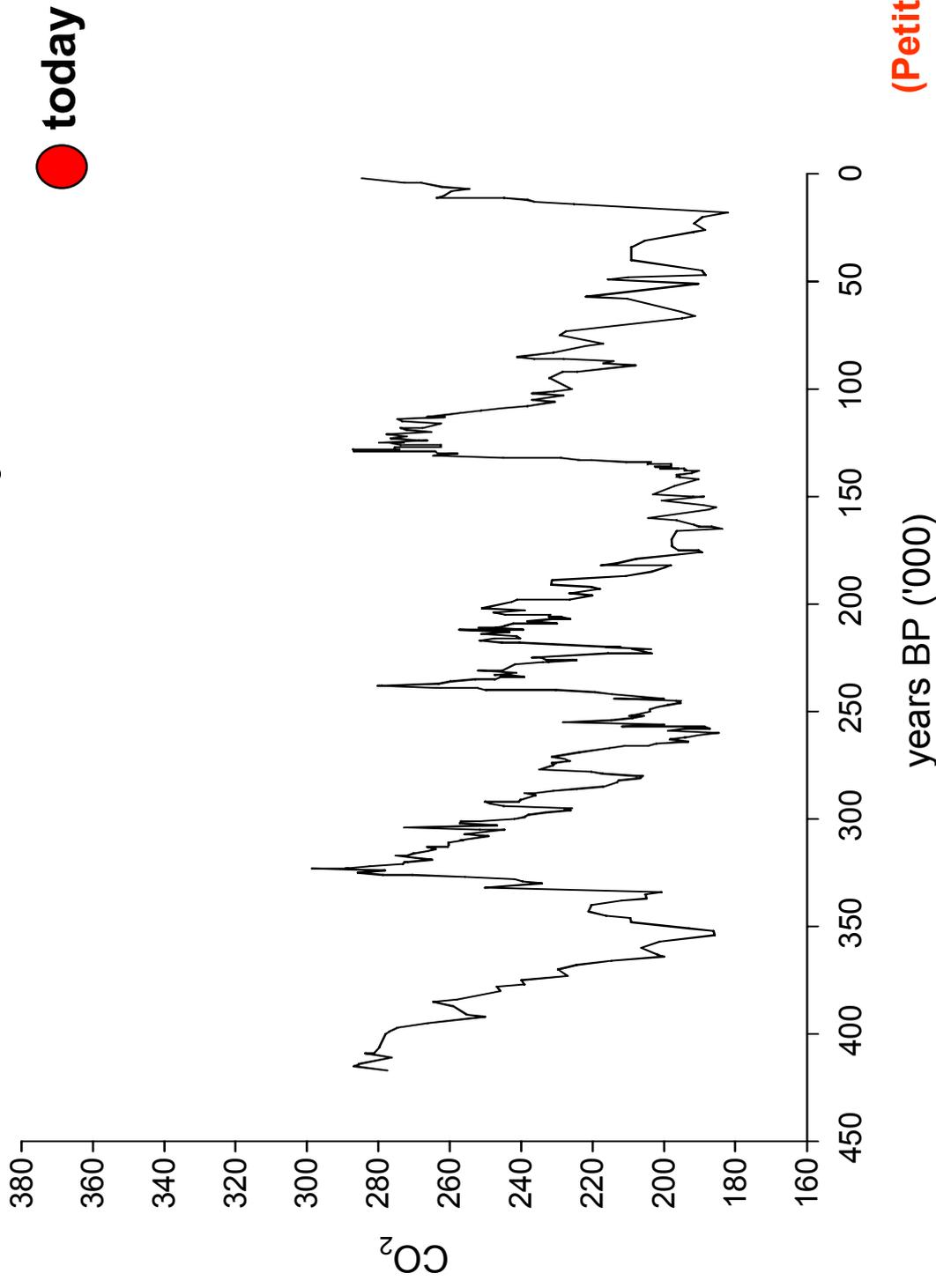

(Petit et al., 1999)

# Global warmingsince1880

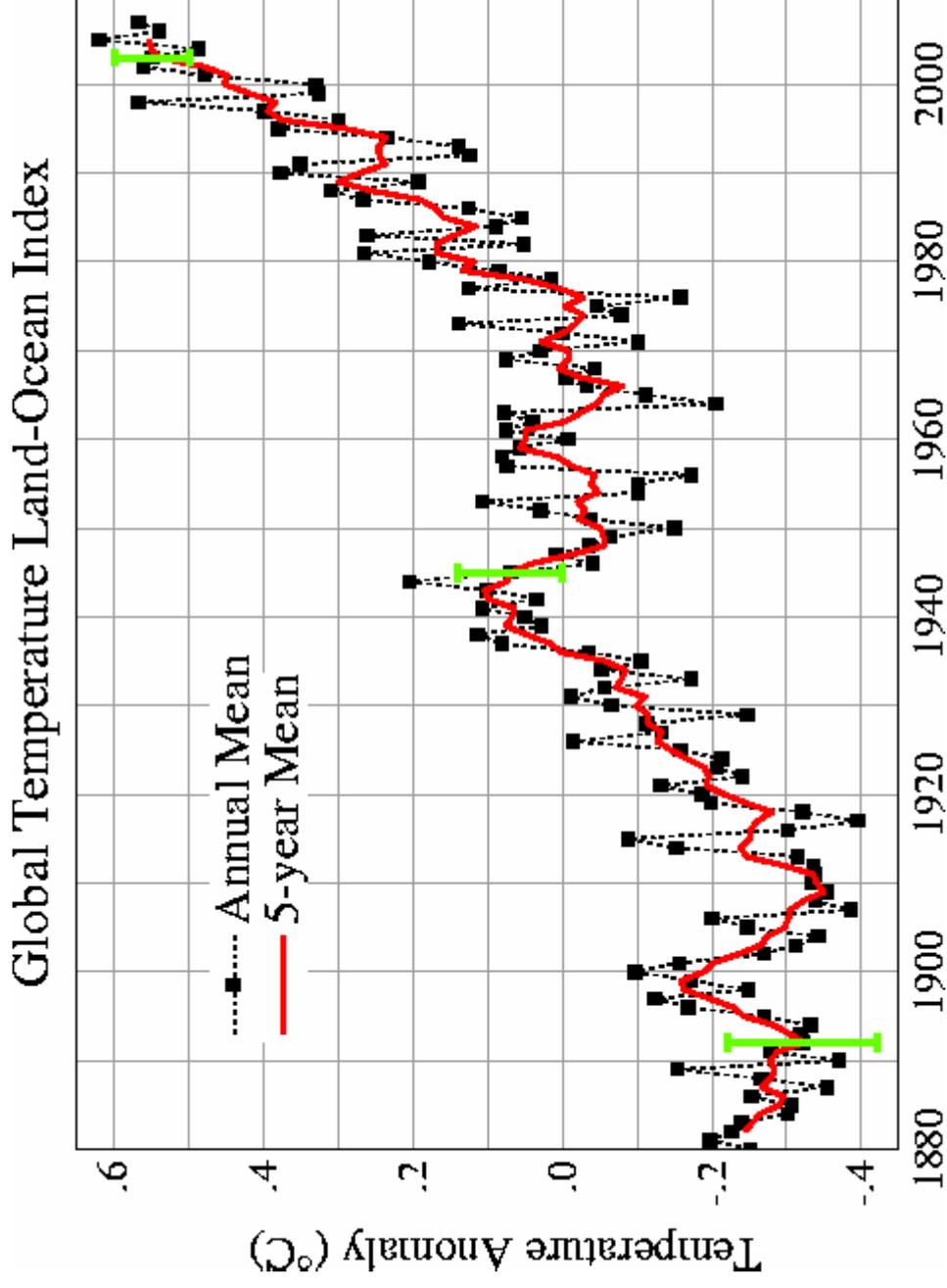

(NASA, 2008)

# Projected changes in annual water runoff

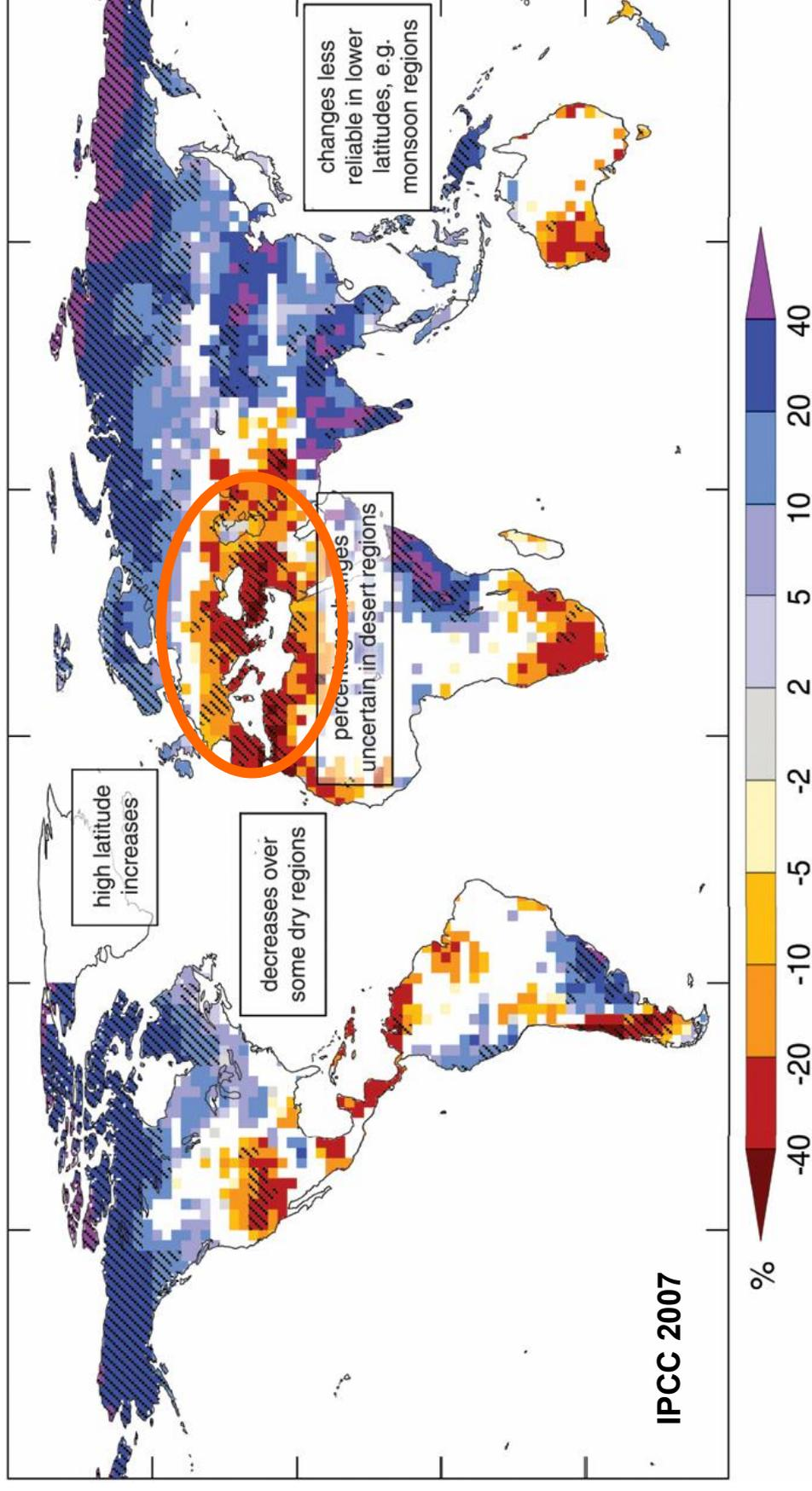

Frequency of severe summer droughts is likely to double over South Europe (Lehner et al., 2006)

# The global food supply challenge

Crops cover ~ **1.5 billion ha**, **10%** of global ice-free land;  
Pastures add another **2.5 billion ha**; or **20%**

Density of Poor Livestock Keepers

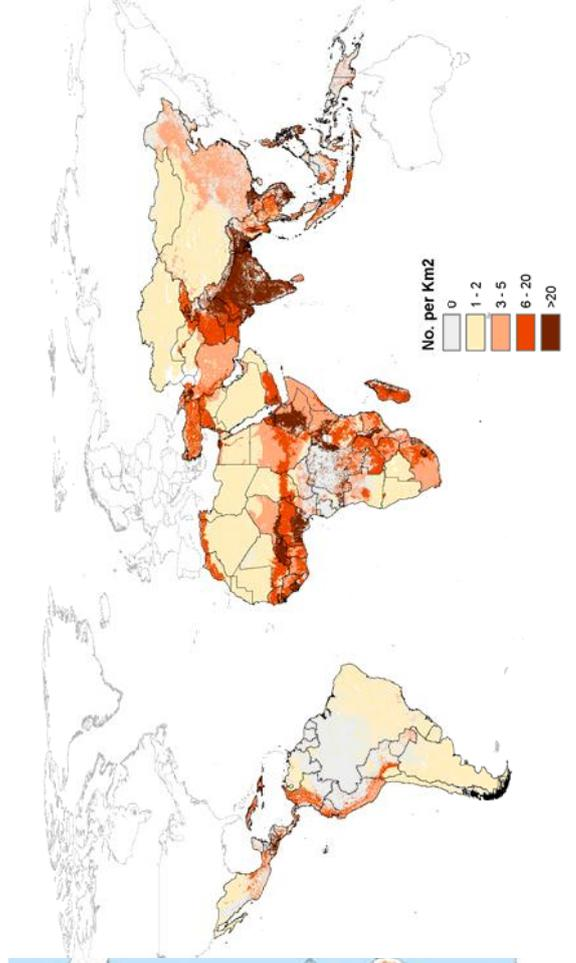
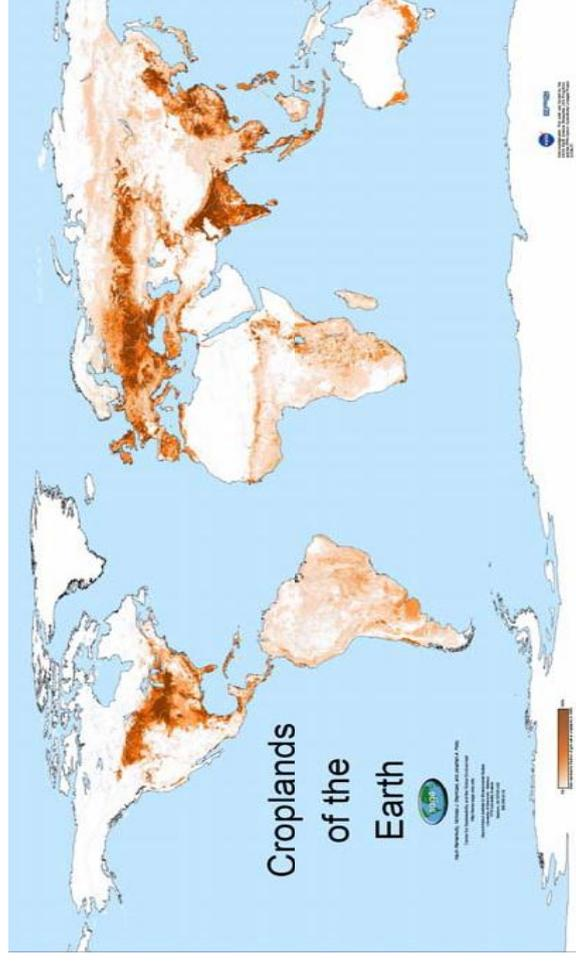

Kruska and Thornton, 2009

The number of undernourished people has reached **1 billion** for the first time ever  
(FAO, 2009)

Existing projections indicate that future population and economic growth will require a **doubling of current food production**:

Increase from 2 to 4 billion tons of grains annually.

# Modelled climate change impactson wheat yields: **with** or **without** adaptation

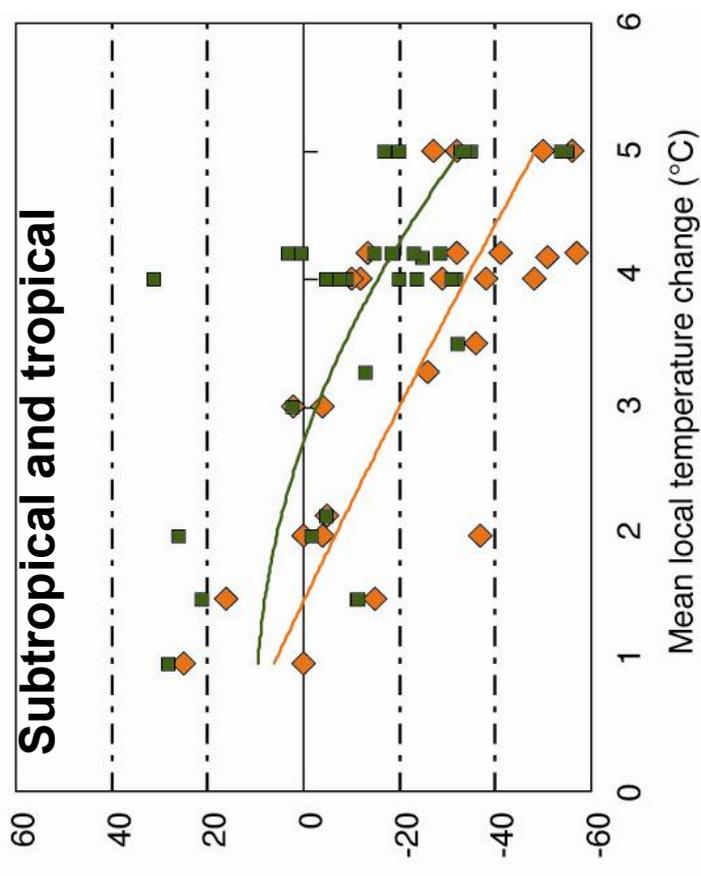
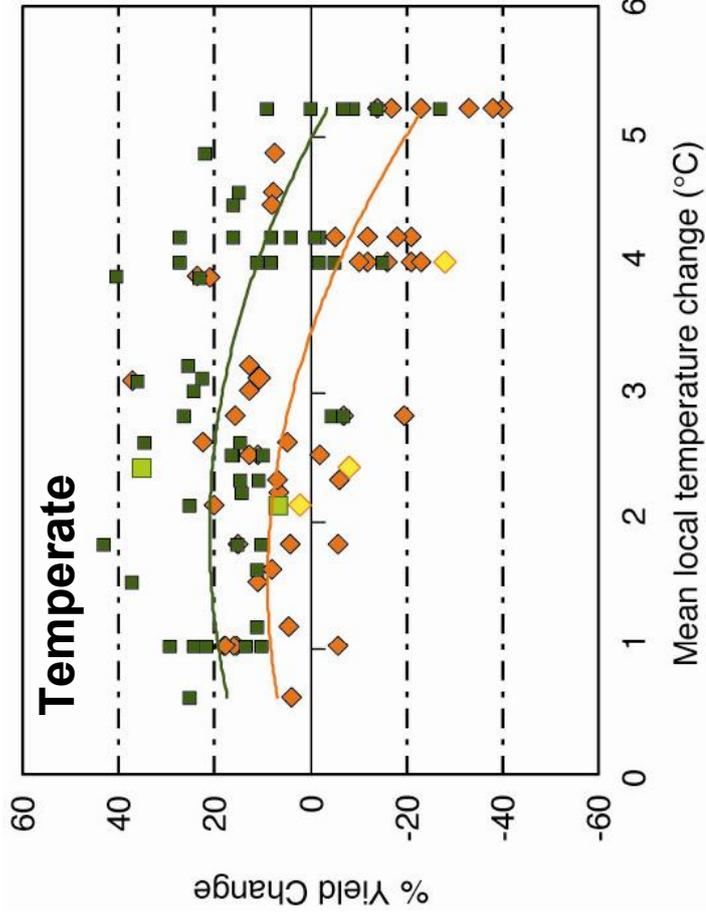

Increased frequency of heat stress, droughts, and floods negatively affect crop yields and livestock beyond the impacts of mean climate change, **creating the possibility for surprises, with impacts that are larger, and occurring earlier**, than predicted using changes in mean variables alone.

(IPCC,2007)

1°Uncertainties in climate change  
projections for crops and pastures

# From GHG emissions to climate change impacts

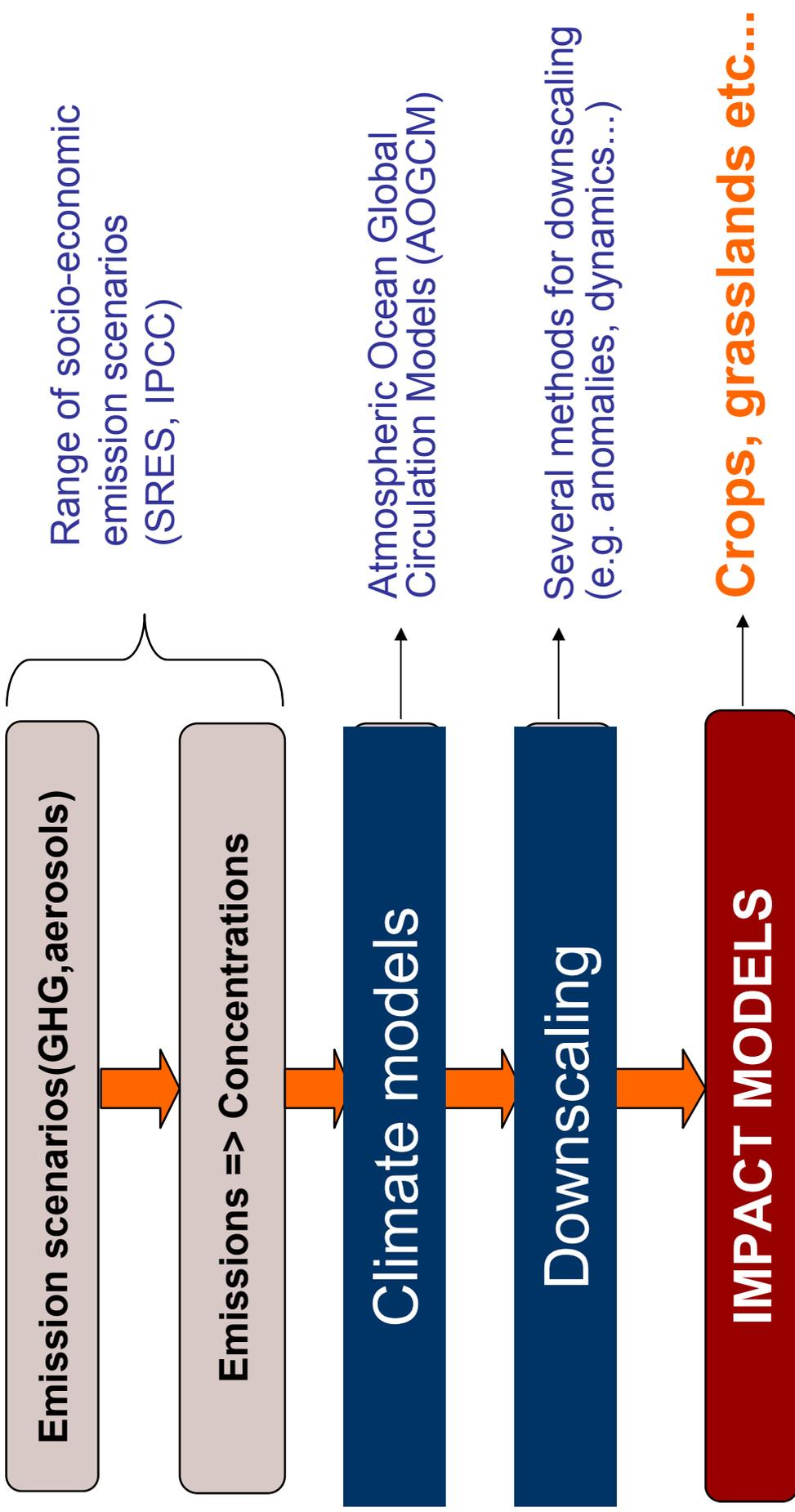

# Crop & grassland models classification

Empiric	Functional	Mechanistic
Usually obtained from regressions between yields and local meteorological variables.	Based on laws and empirical relationships.	Based on the physical laws of the soil-water-plant-atmosphere continuum.
Valid only for the place and conditions where they were obtained.	Usable under many conditions, after local calibrations.	Theoretically valid to any meteorological, soil or crop conditions.
Few input data is required, generally available.	Standard information is required, available in many places.	Detailed input data is needed, generally not available.

# Exemple of site based modelling: climate change impacts on forage DM yields in France

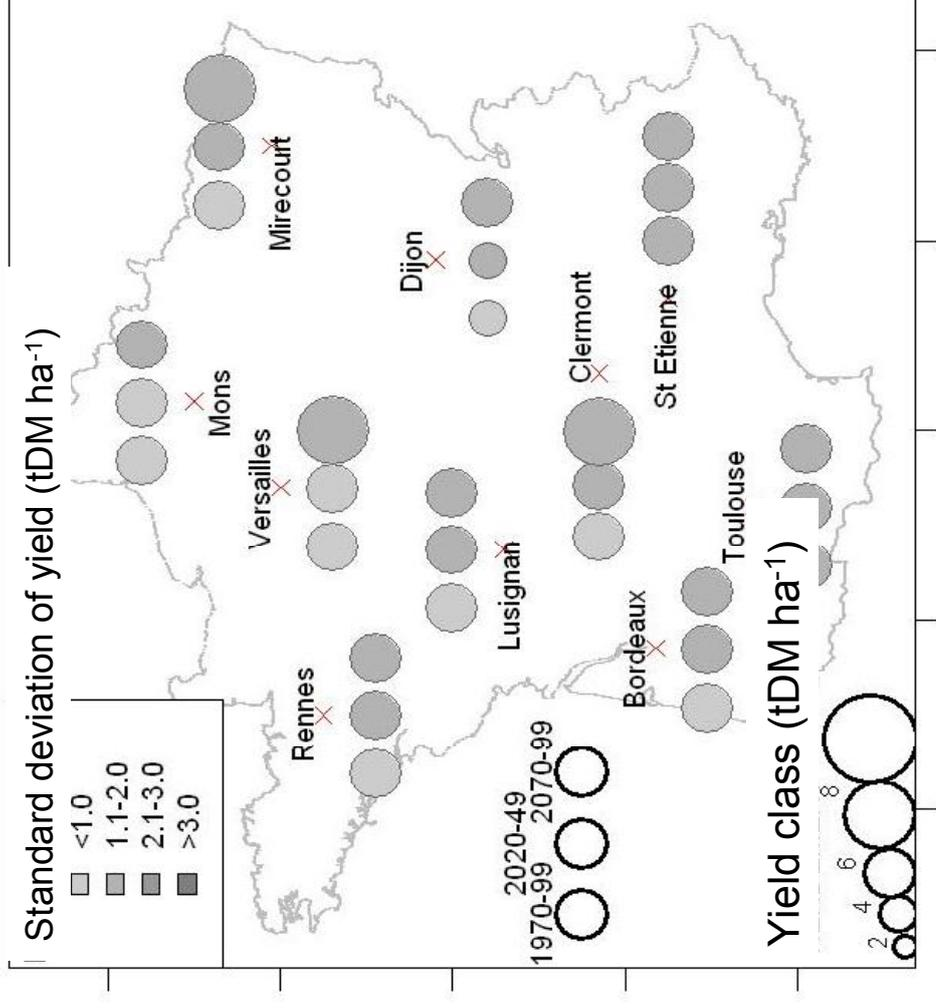

Mechanistic grassland model, PASIM;

Low emission scenario, A1B; climate model ARPEGE;

Downscaling by statistical disaggregation, Boéet al., 2006;

Low input long-term grassland; shallow soil.

(Graux et al., in preparation)

# Projected wheat yields with downscaled scenarios: increased variability over time of wheat yield (grown after maize or rapeseed)

- Toulouse

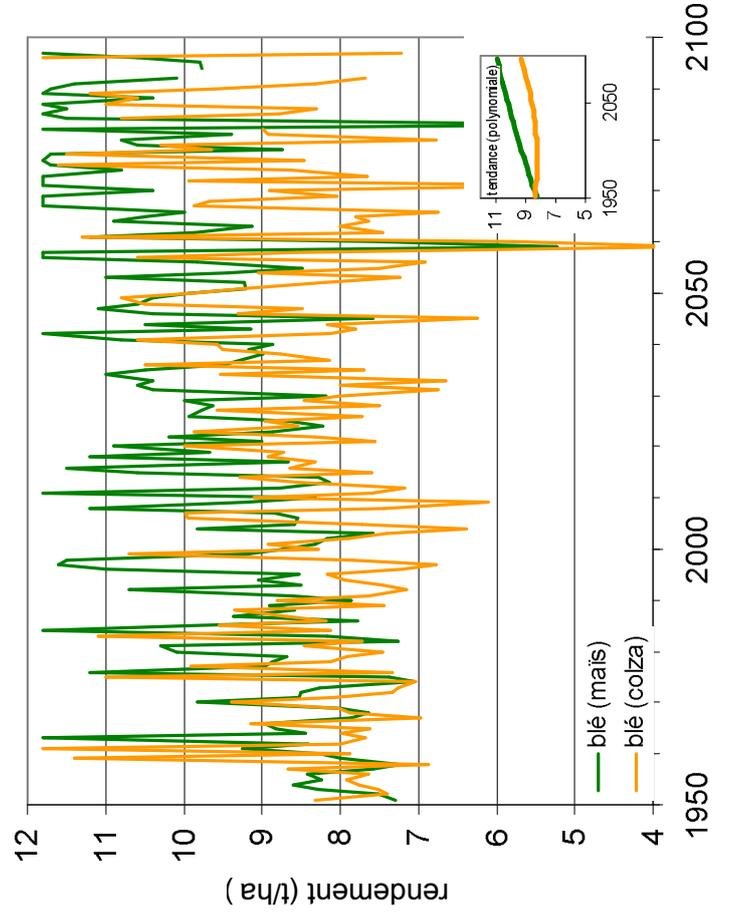

- Colmar

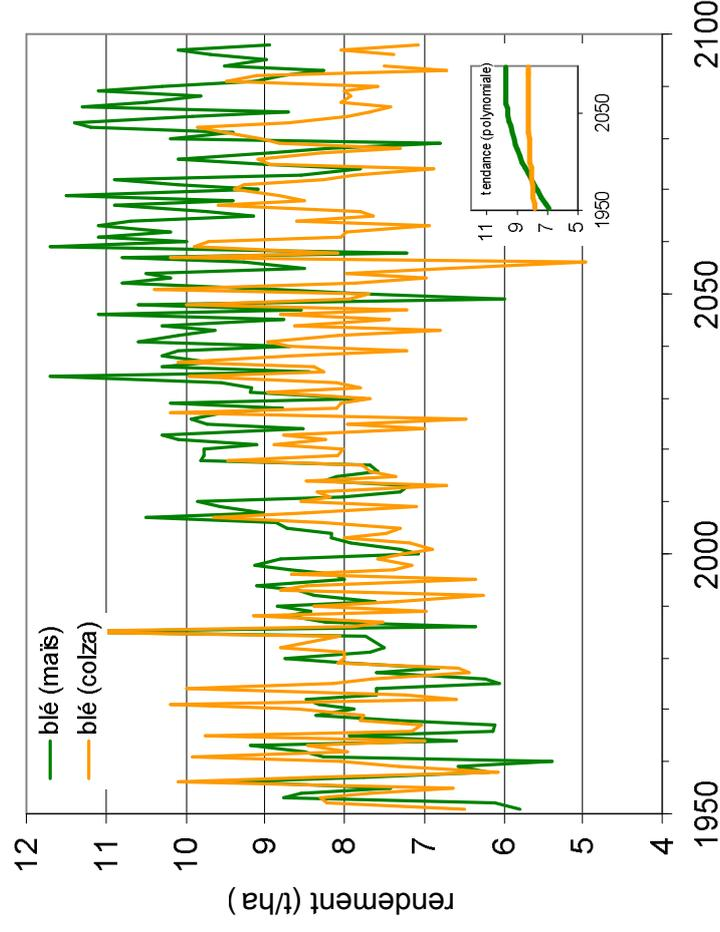

Increased interannual variation has a negative impact *per se*

(Brisson et al., in preparation)

# An uncertainty cascade

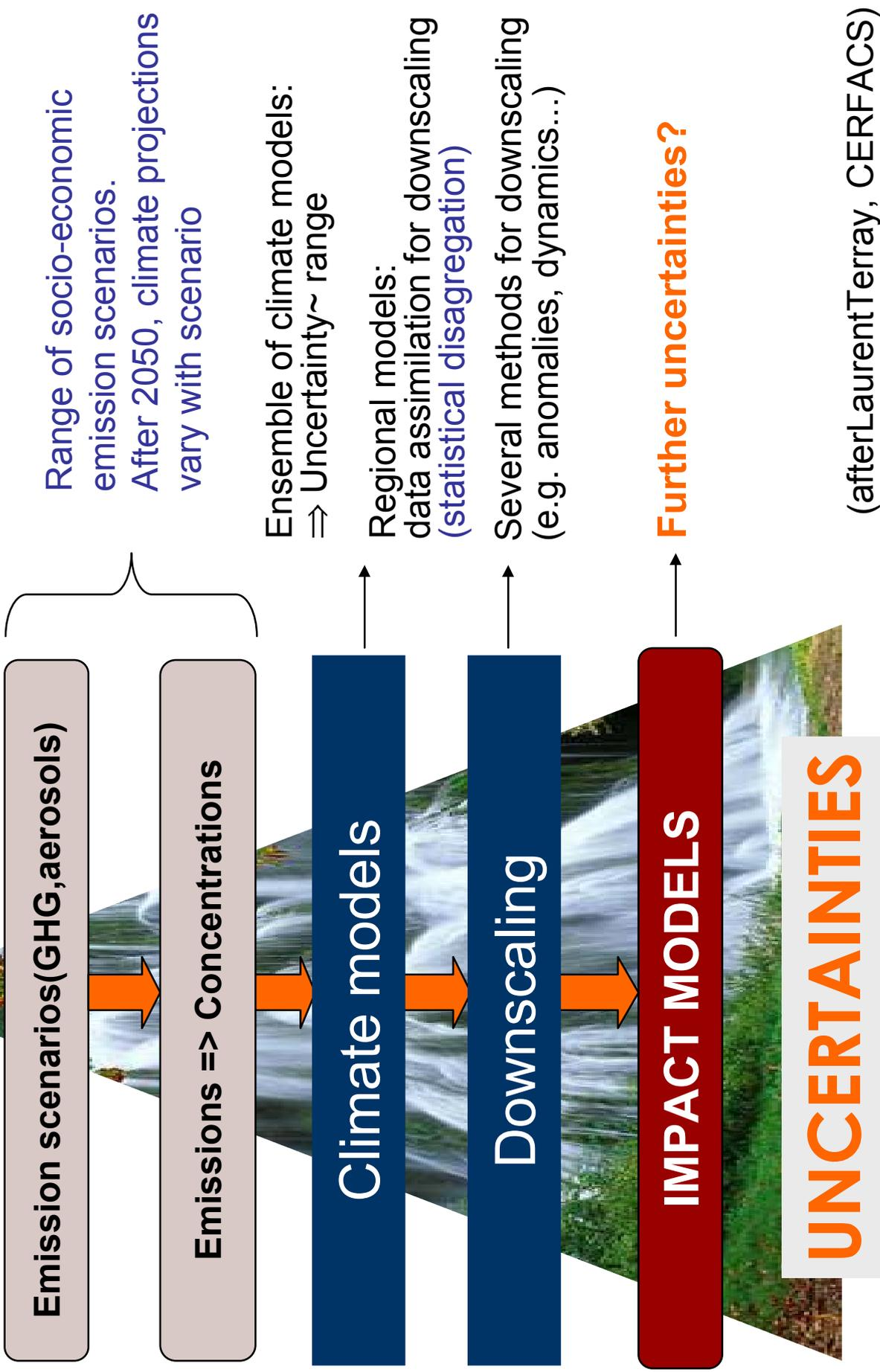

# Climate change signal compared to sources of variability & uncertainty

Variance decomposition analysis:  
interannual variability is used to scale variance of other factors

<b>Factors</b>	<b>Weight (%)</b>
Interannual variability	100.00
Management (intensive vs. extensive)	50.18
Climate change	6.03
SRES scenario	2.99
Downscaling method	2.61
GCM initialization	0.24

Forage DM yield simulated by PASIM mechanistic model  
Comparing two managementsthrree IPCC SRES scenarios, two initializations of  
ARPEGE GCM model, three downscaling methods and

(Graux et al., in preparation)

# Upscaling : simulated crop yield changes (%) by 2080s relative to 1961-1990

High emission scenario (IPCC A2), two climate models:

(left) HadCM3, (right) ECHAM4, DSSAT crop model (Jones et al., 2003)

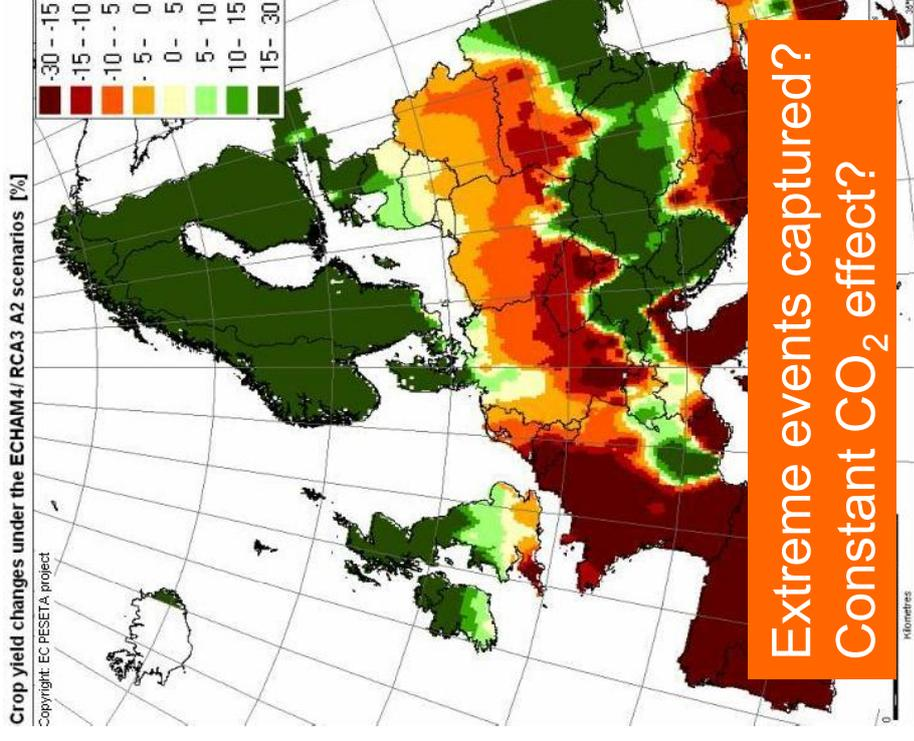
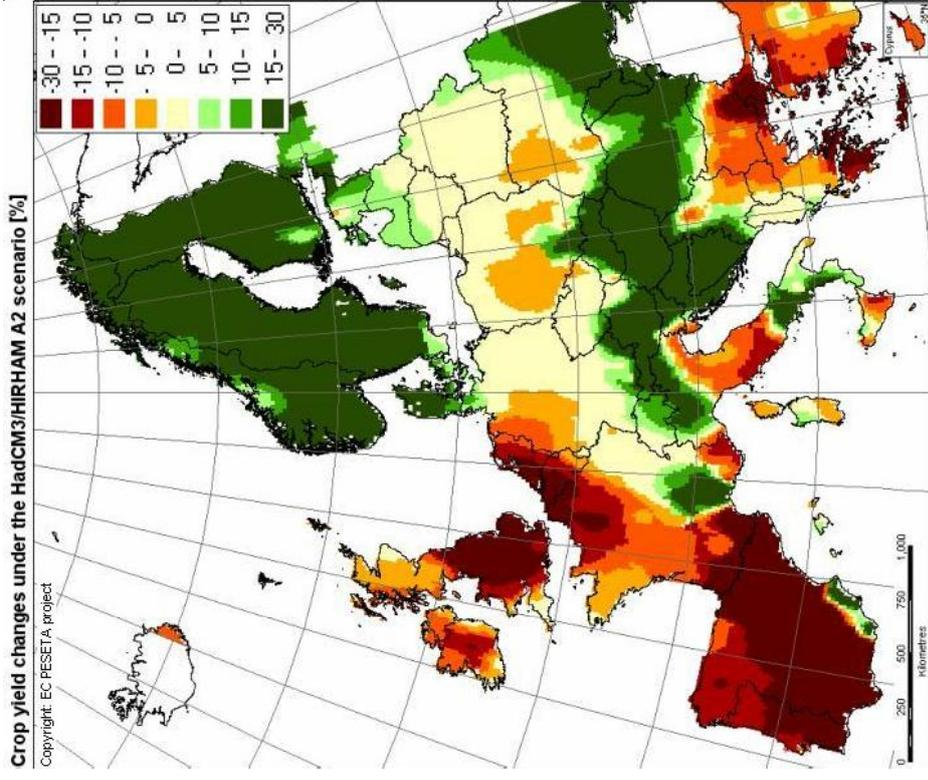

Extreme events captured?  
Constant CO<sub>2</sub> effect?

Map elaboration by EC JRC/IES. Livestock not considered

(EC PESETA project)

# Modelling food insecurity by 2030

30% of farmers in developing countries are currently food-insecure

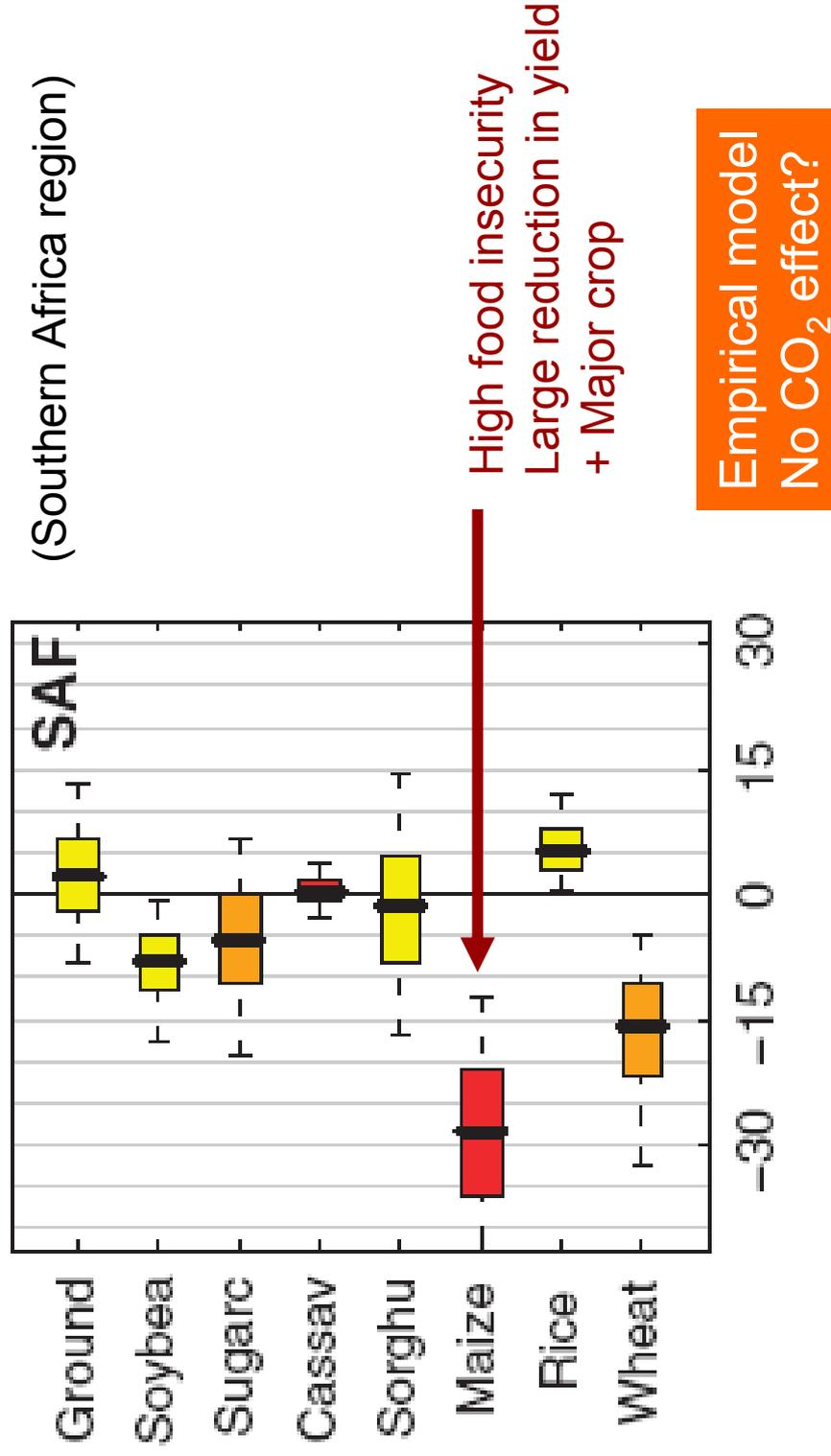

Regional climate models ensemble, **statistical** approach of crop modelling  
=> Climate change may decrease local yields while contributing to a global increase in commodity prices by 2030

(Lobell et al., 2008, Science)

# Scaling agro-economics from site to region?

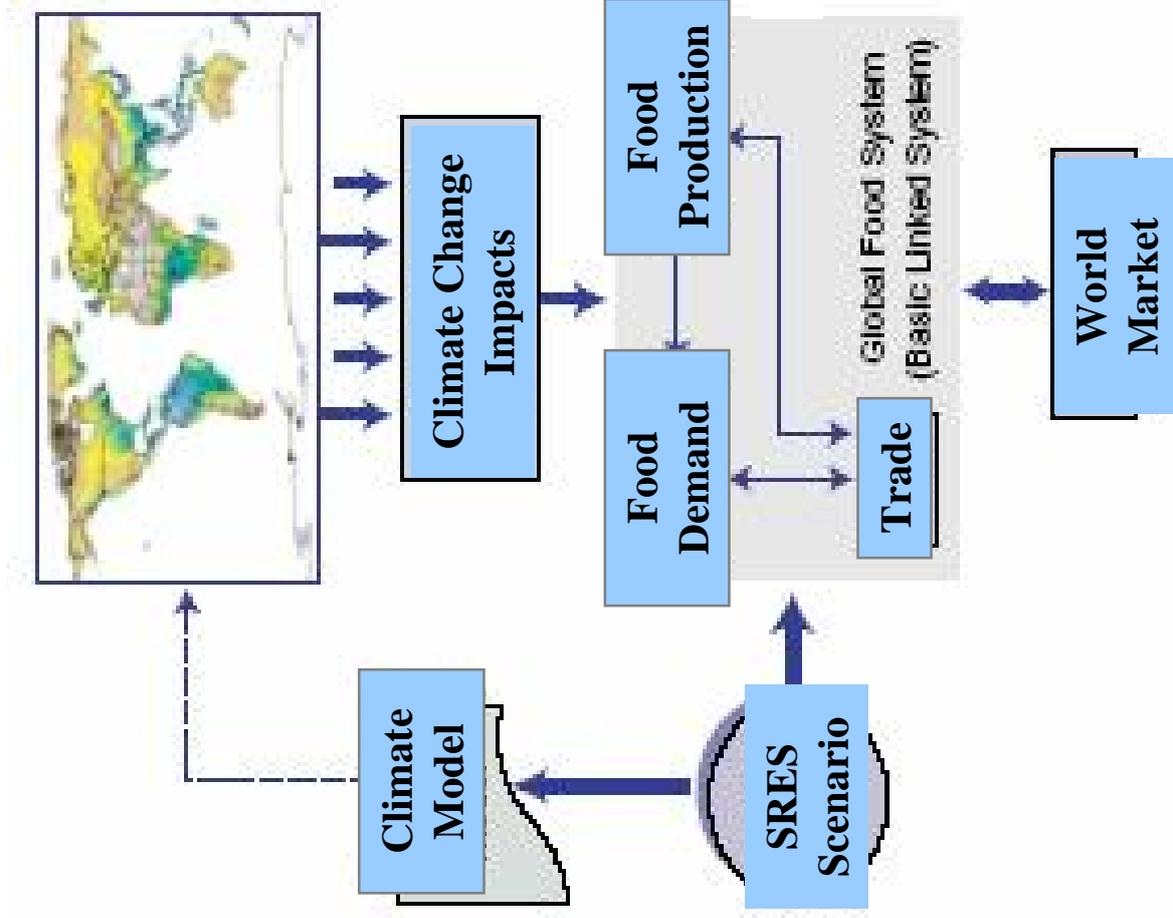

## Global AgroEcological Zones

Issues: World trade tends to dominate over physiological processes;

Economic models 'toostable'

## Socio-economic model

Validation?  
Uncertainty?  
Constant CO<sub>2</sub> effect?

(Tubiello and Fischer, 2007, Tech. Forecast. & Soc. Change)

# 2°Modelling crops and pastures under elevated CO<sub>2</sub>

# Functional vs. mechanistic crop models



Modules in STICS,  
a functional model  
(Brisson et al., 2003, EJA)

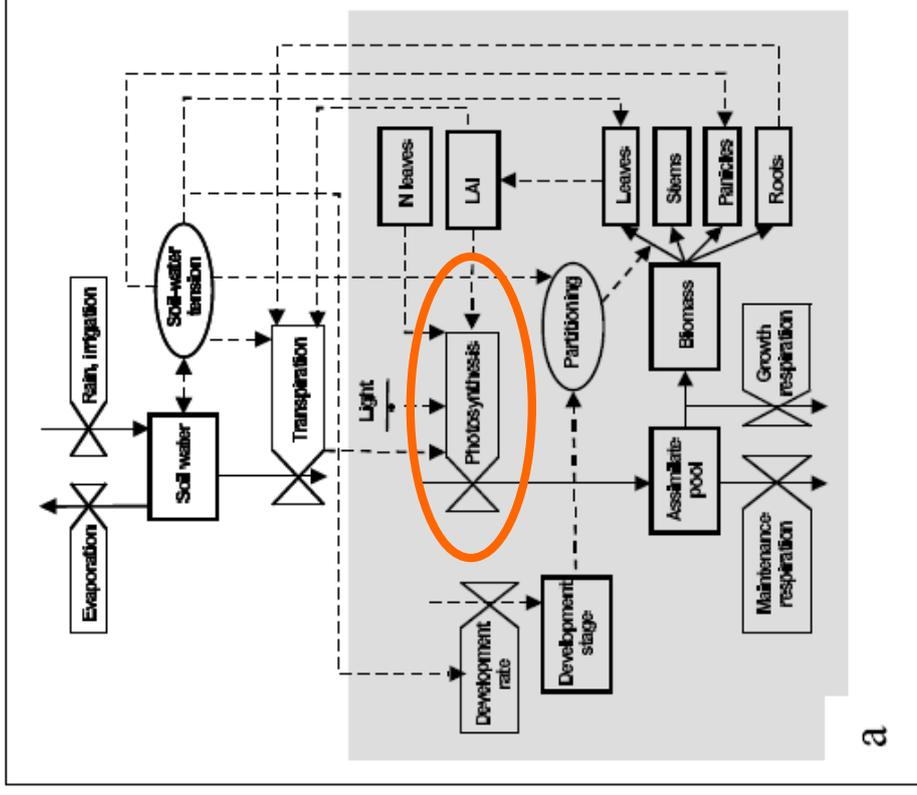

Photosynthetic submodel in Oryza2000,  
a mechanistic model  
(Van Itersum et al., 2003, EJA)

# Elevated CO<sub>2</sub> experiments (FACE, Free Air Carbon dioxide Enrichment)

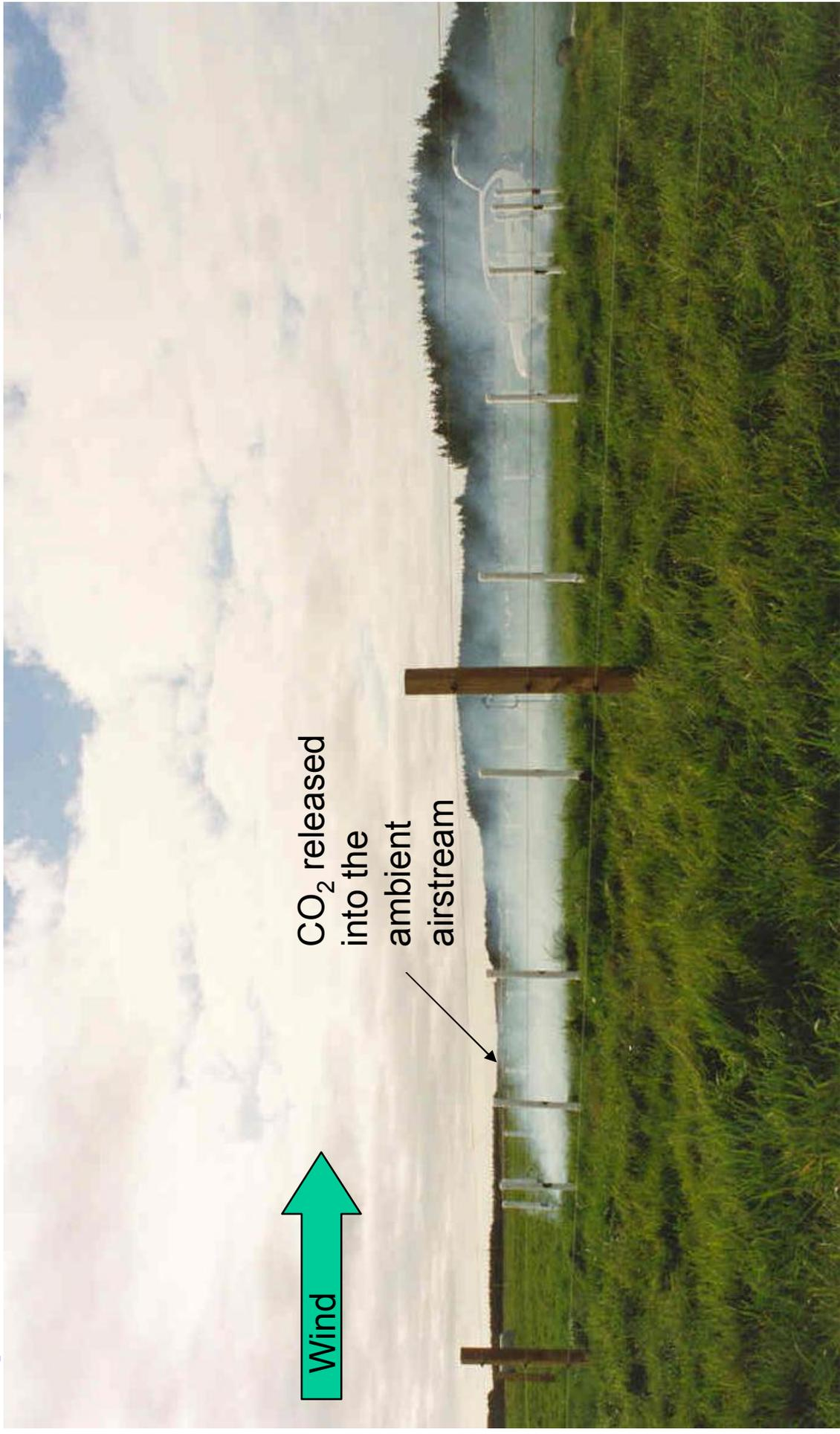

(New-Zealand, FACE)

# Are grain yields well simulated under elevated CO<sub>2</sub>?

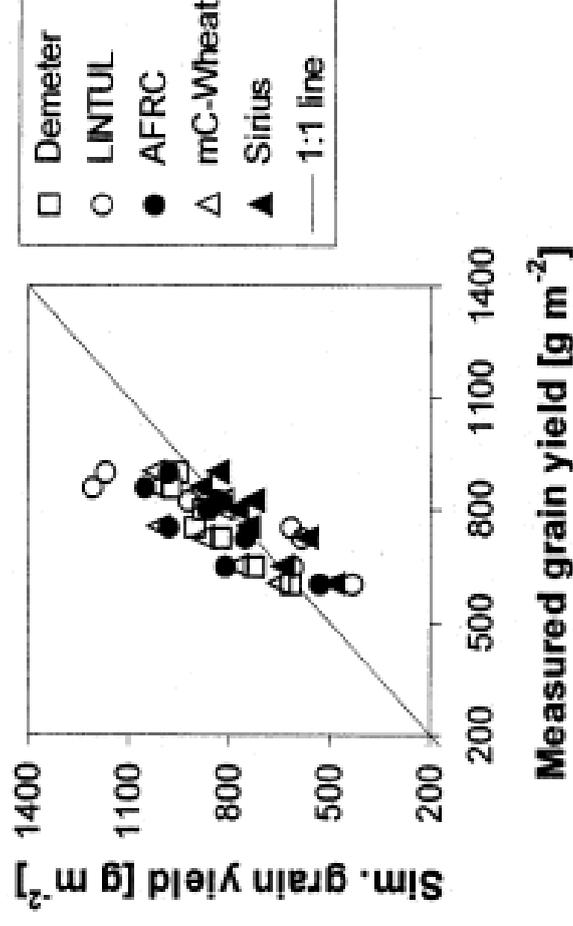

Simulated vs. observed (FACE Maricopa) wheat grain yield data.  
Two CO<sub>2</sub> and two drought (well watered and water-stressed) treatments

(Tubiello and Ewert, 2002)

# Simulated vs. observed CO<sub>2</sub> response ratio

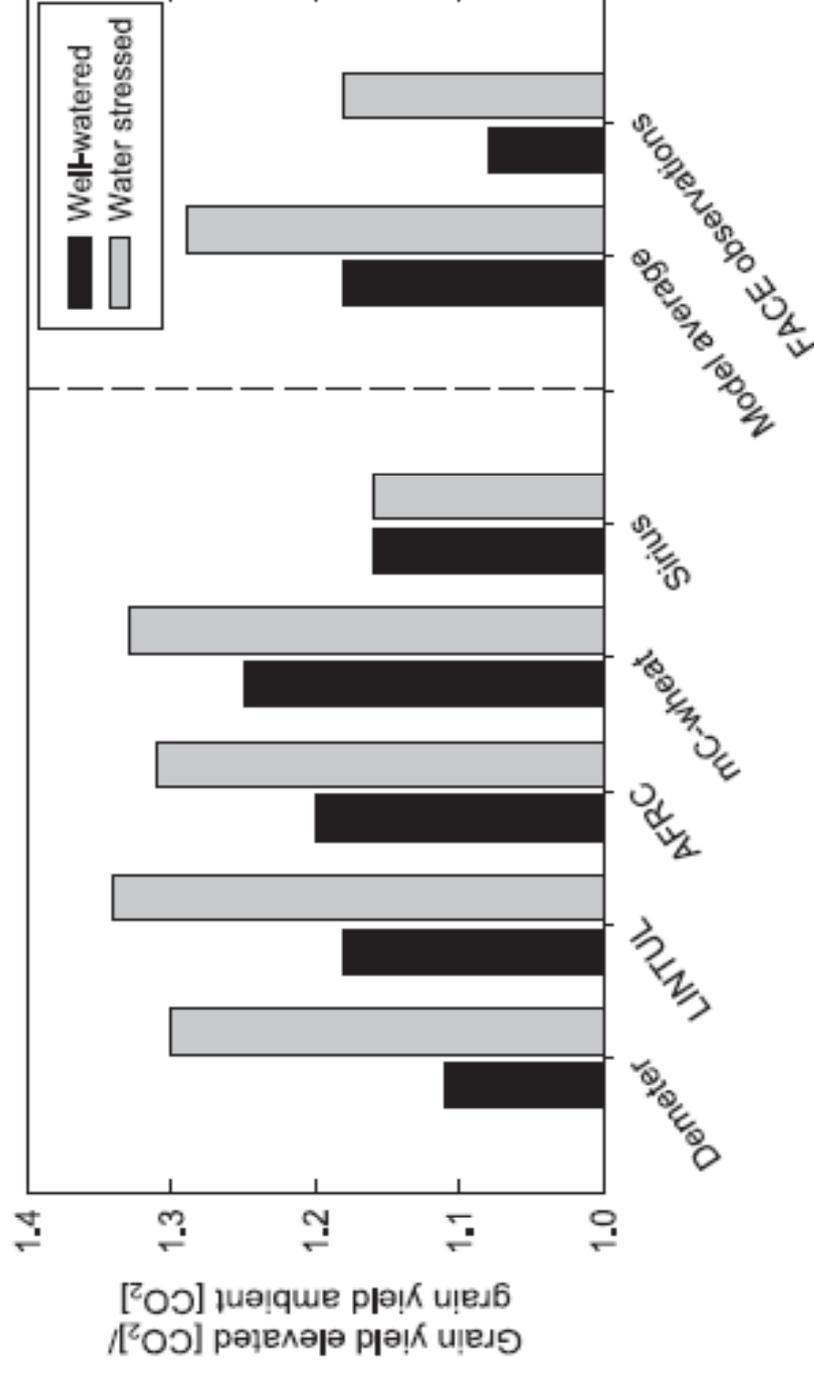

(same data as Tubiello and Ewert, 2002)

Average simulated CO<sub>2</sub> response ratio is higher than observed by +0.1  
Interactions between CO<sub>2</sub> and water stress are captured by most models

(Long et al. 2008, New Phytol.)

# FACE studies: acclimation to elevated CO<sub>2</sub> of maximal carboxylation capacity

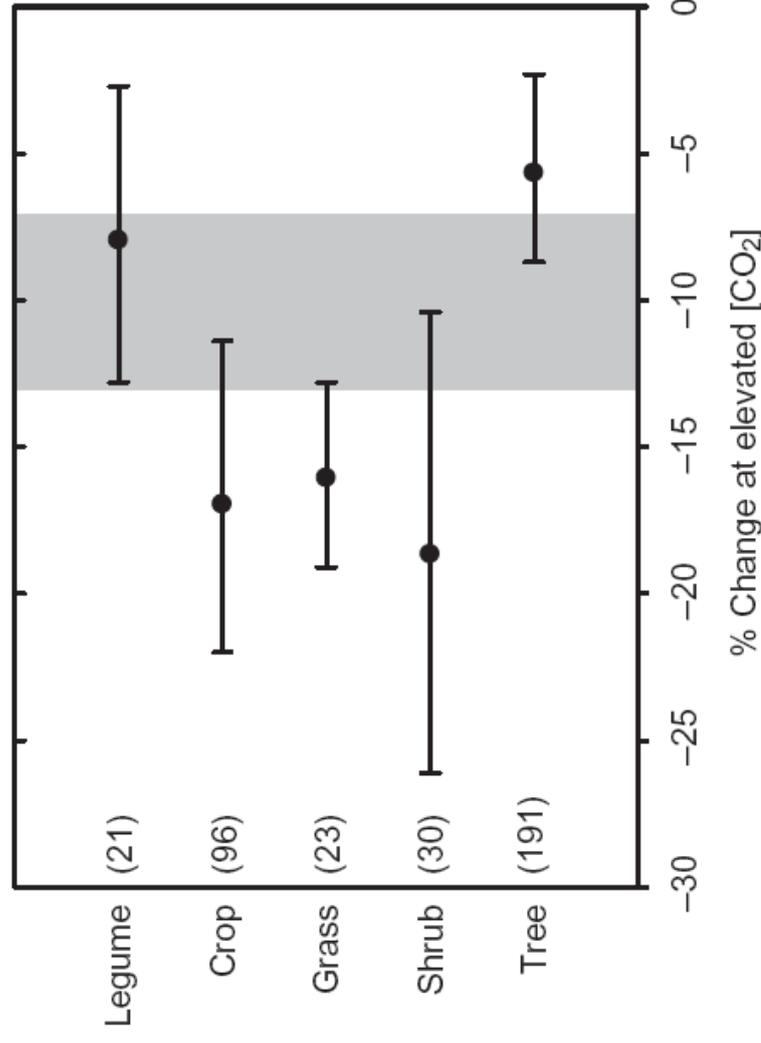

(Ainsworth *et al.*, 2007, PCE)

# Observed increase in WSC pools in laminae and sheath of perennial ryegrass monocultures under elevated CO<sub>2</sub> (mean of two N supplies)

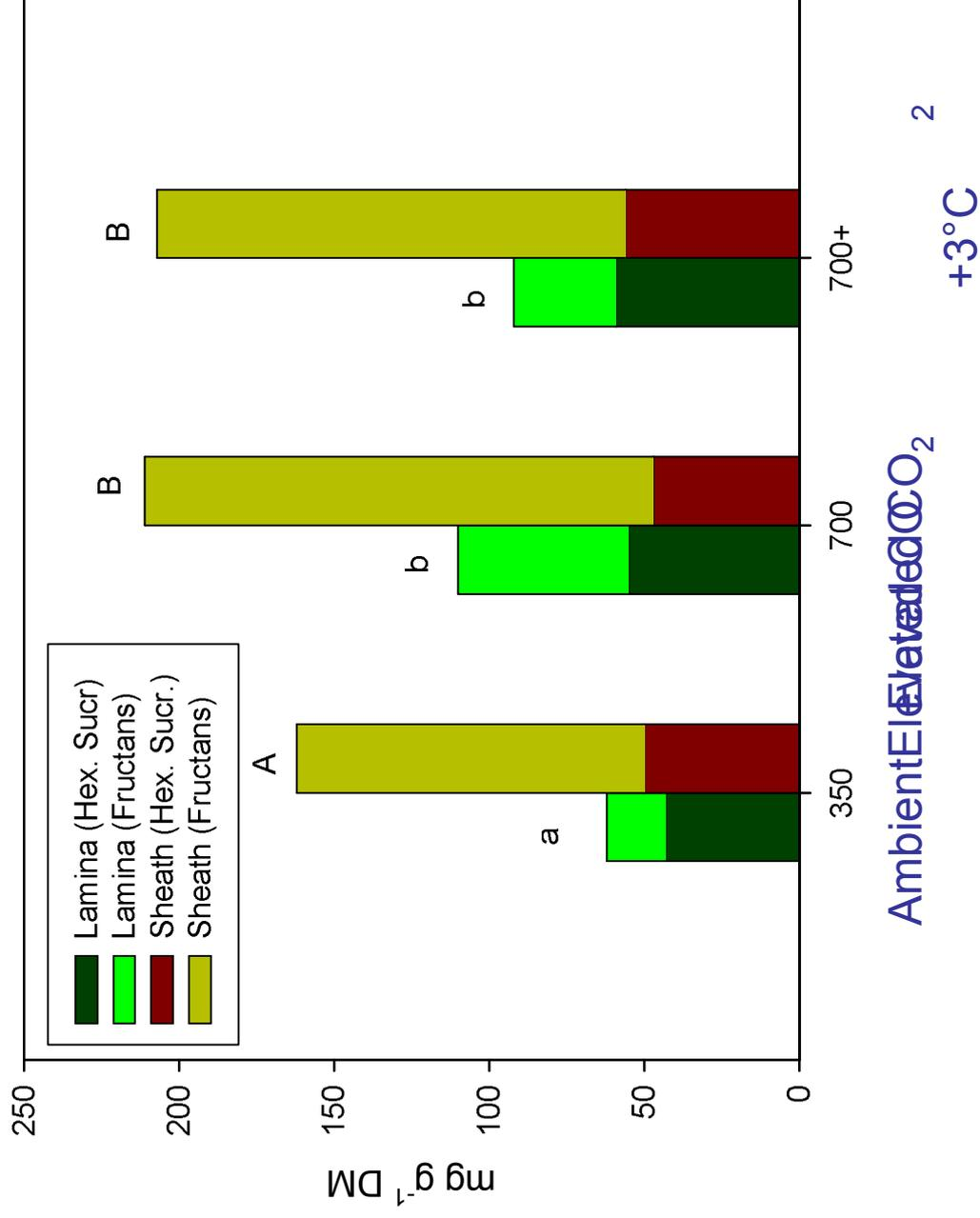

# Observed response to elevated CO<sub>2</sub> in *Lolium perenne* monocultures

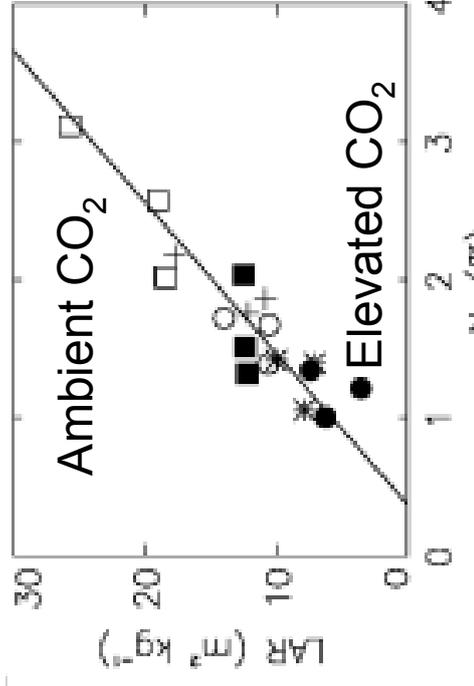

CO<sub>2</sub> induced changes in N content, root fraction and reserve pools are not simulated by functional models

(Soussana et al., 1996; Casella & Soussana, 1997; Calvet & Soussana, 2001)

Leaf area per unit root + shoot mass declines under elevated CO<sub>2</sub>

This decline correlates with that in shoot N content

# Fixed response ratios to atmospheric CO<sub>2</sub> concentration in functional crop models

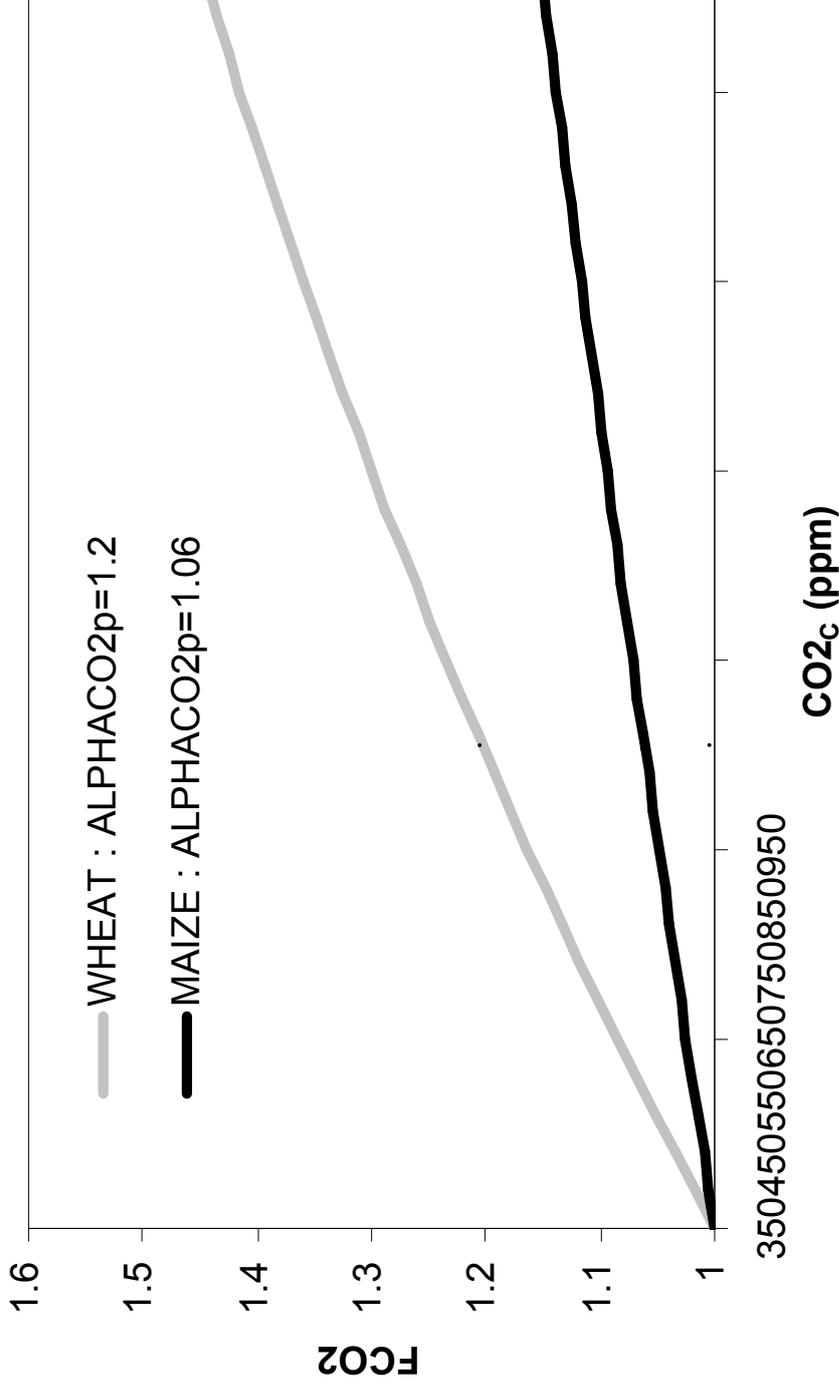

STICS model (similar responses for e.g. CERES, EPIC, AEZ)

# Interaction between CO<sub>2</sub> and temperature on leaf photosynthesis

(Farquhar's et al., 1980, biogeochemical model)

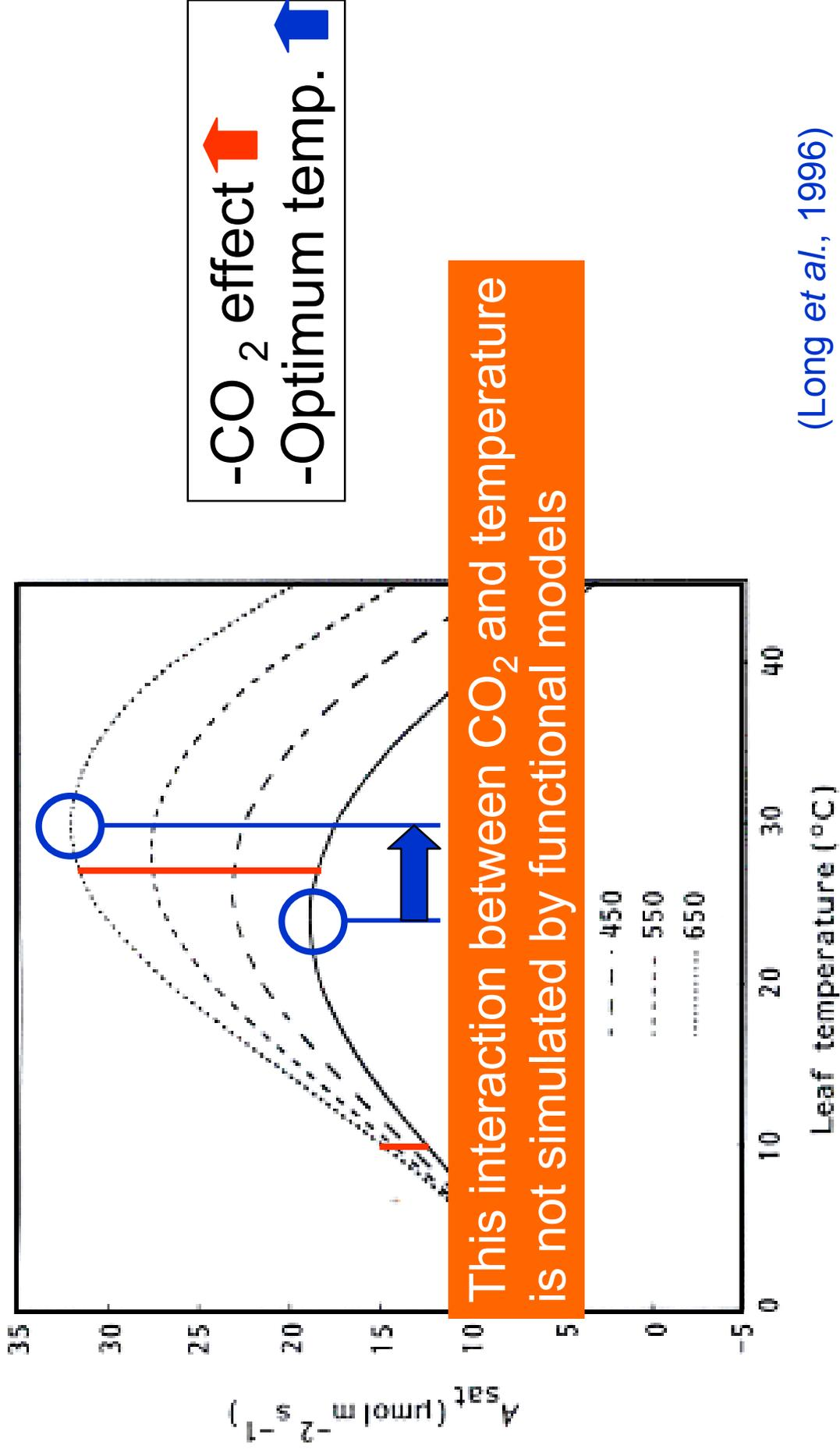

(Long et al., 1996)

# Issues of scale in coupling with hydrology

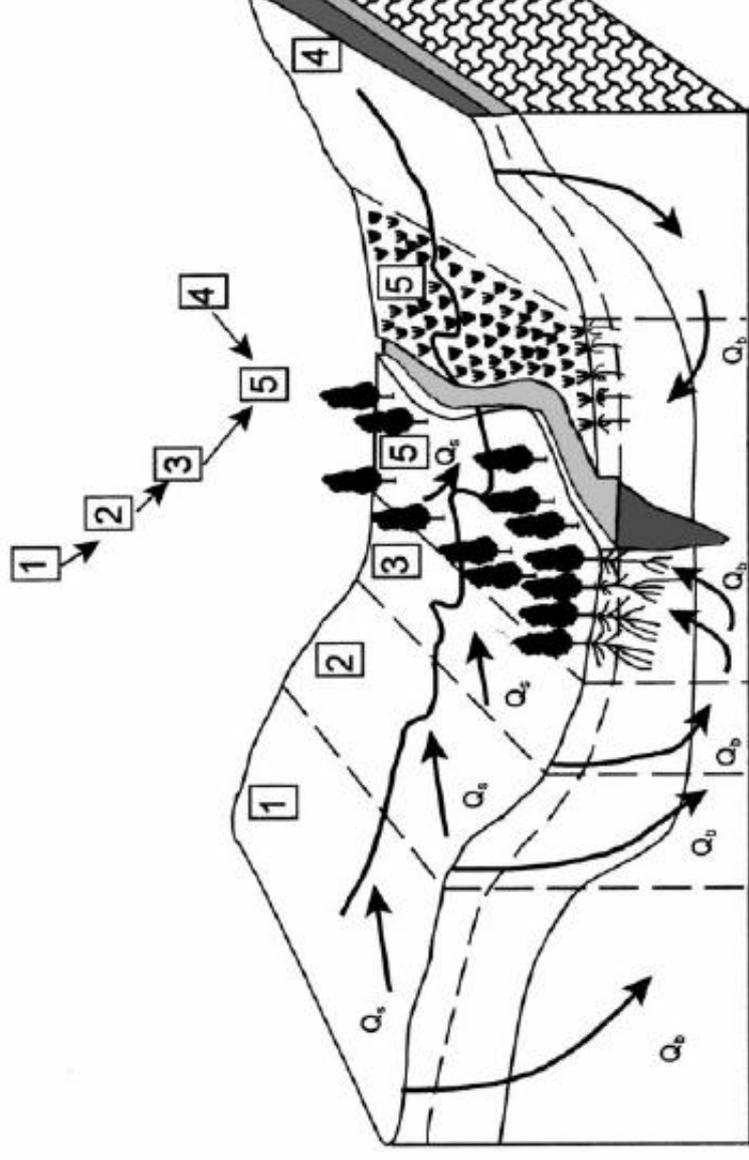

Schematic view of lateral water flows in a river basin

Changes in hydrology will directly affect crops and grasslands  
Coupled hydrology – crop models needed?

(Schulze, 2000, AGEE)

# 3°Modelling the impacts of extreme climate events

# Summer 2003 heat and drought extreme



# Increased summer heat wave and drought by 2050

A) Number of consecutive days in a summer heat wave. Mean over 20 yrs

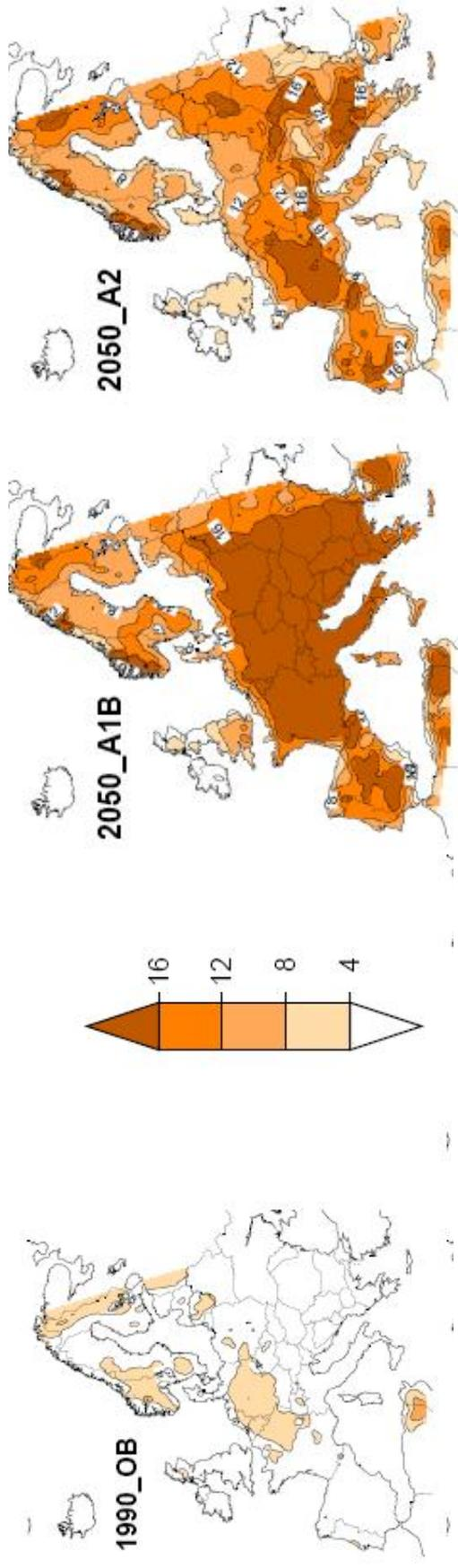

B) Number of consecutive dry days (<1 mm) during summer. Mean over 20 yrs

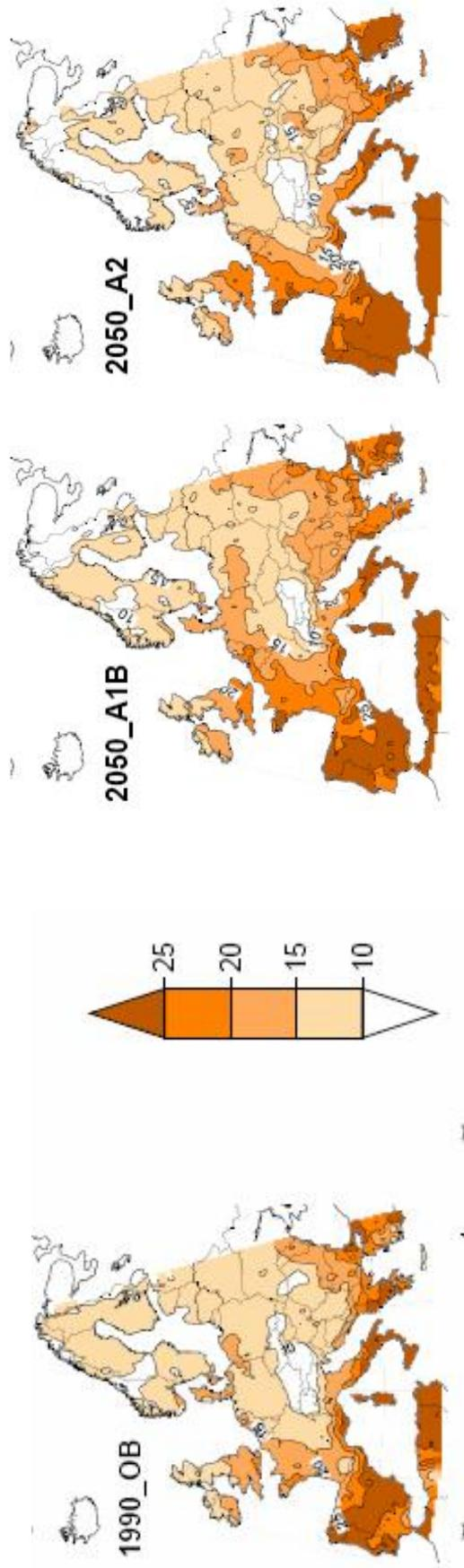

(ARPEGE model, M Déqué, CNRM, Météo France)

# Warmer than warmest summer

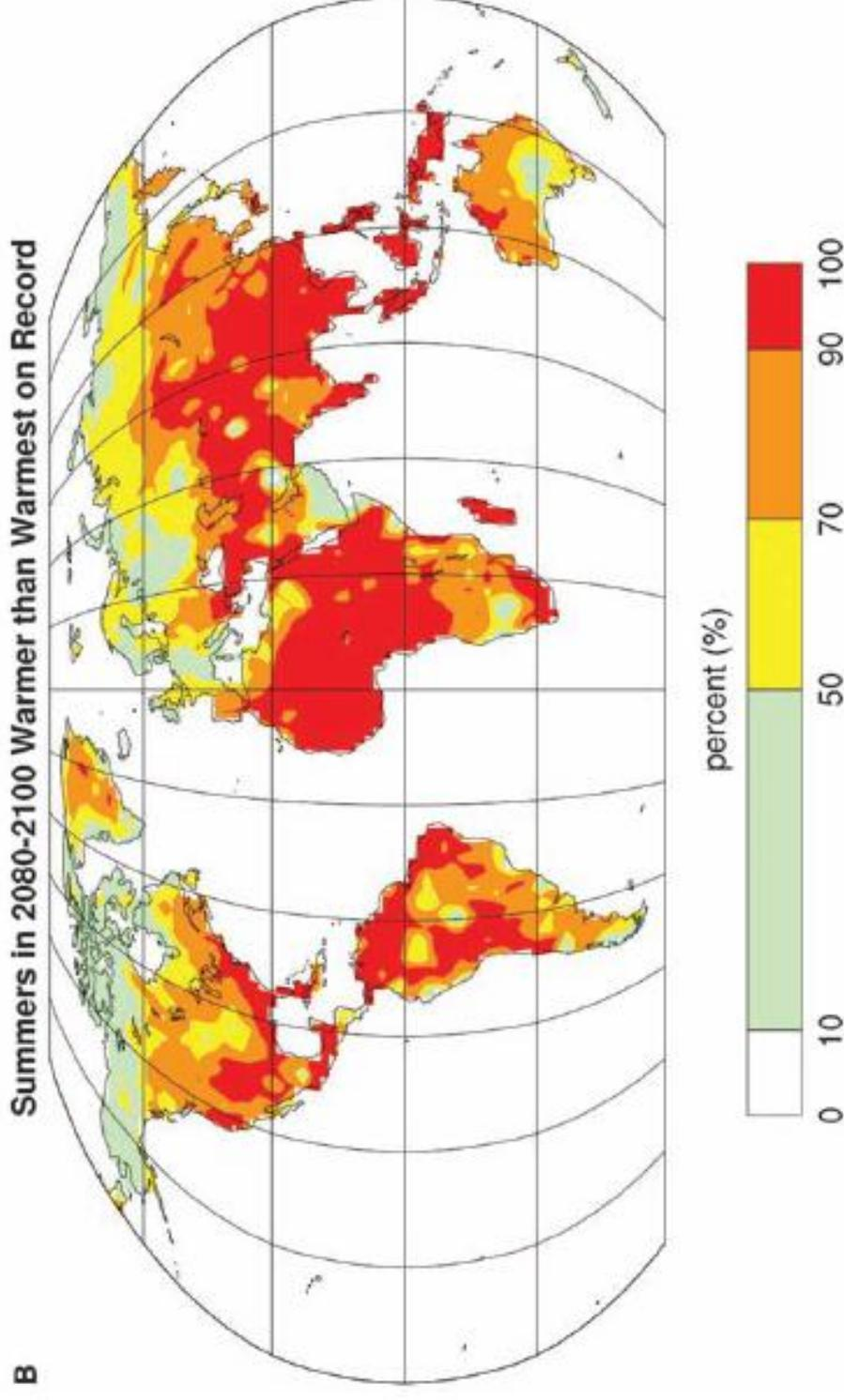

Likelihood in percent of summer average temperature exceeding by 2090 highest observed temperature on record

(Battisti and Naylor, 2009, Science)



# Temperature thresholds in wheat

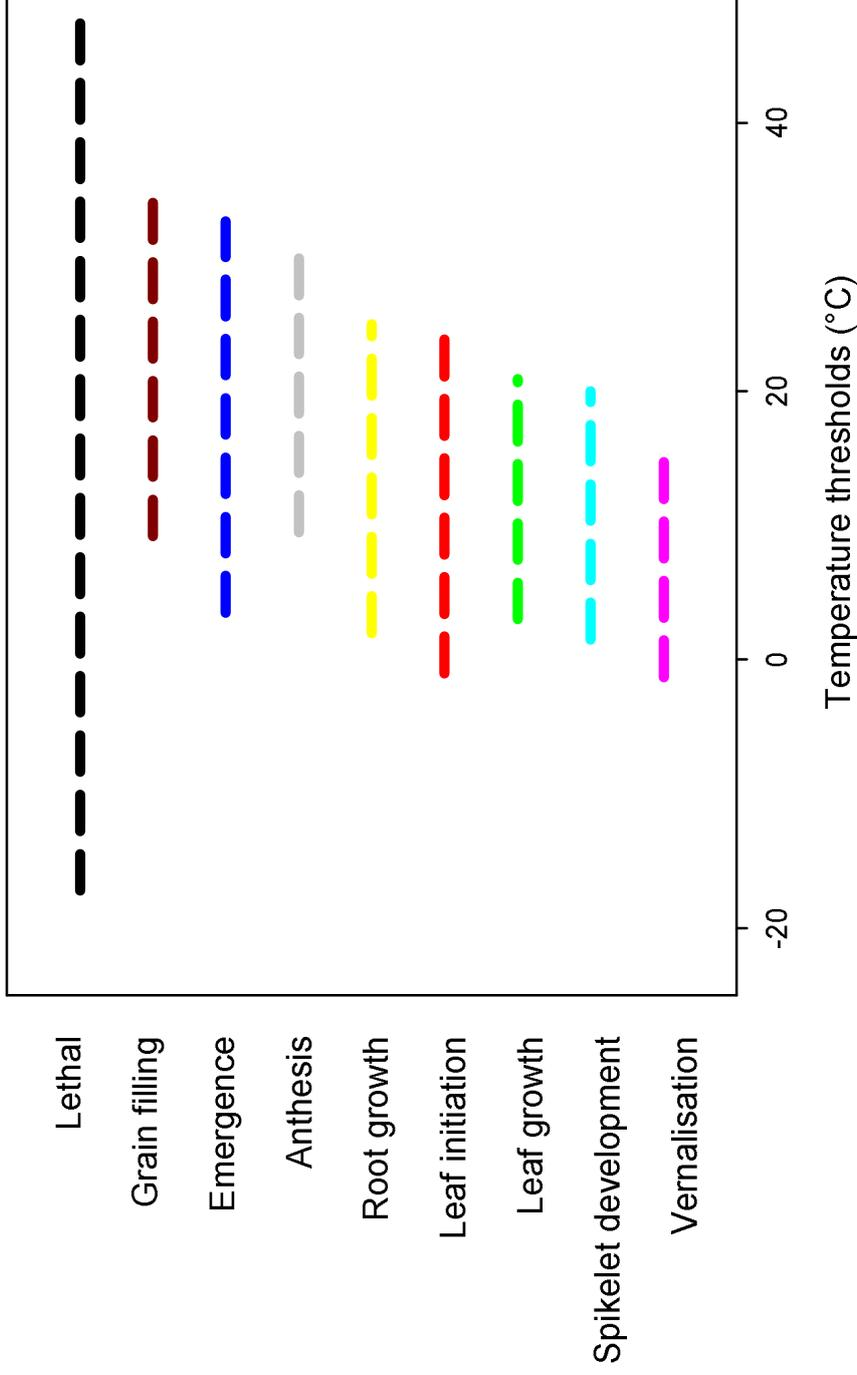

Complex interactions between phenology and warming impacts  
Missing in some crop models

(after Porter and Semenov, 2005)

# Interactions between CO<sub>2</sub> and temperature for spikelets number in paddy rice

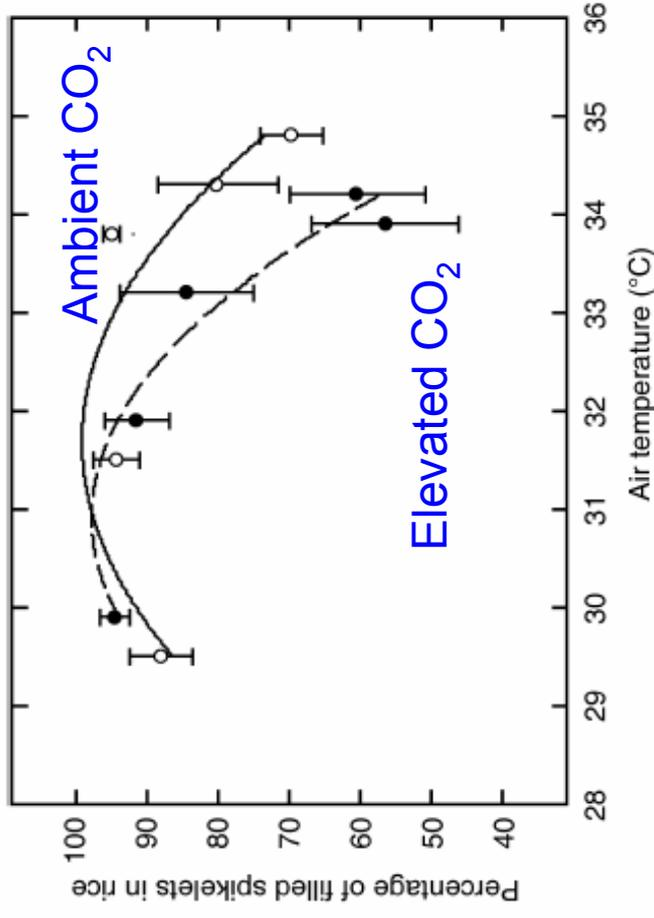

Negative  
interaction  
Modelled?



(Ziska and Bunce, 2007, N Phytol.,  
after Matsui et al., 1997)

# Simulated vs observed effect of a week at +10°C compared to a 28°C control in groundnut

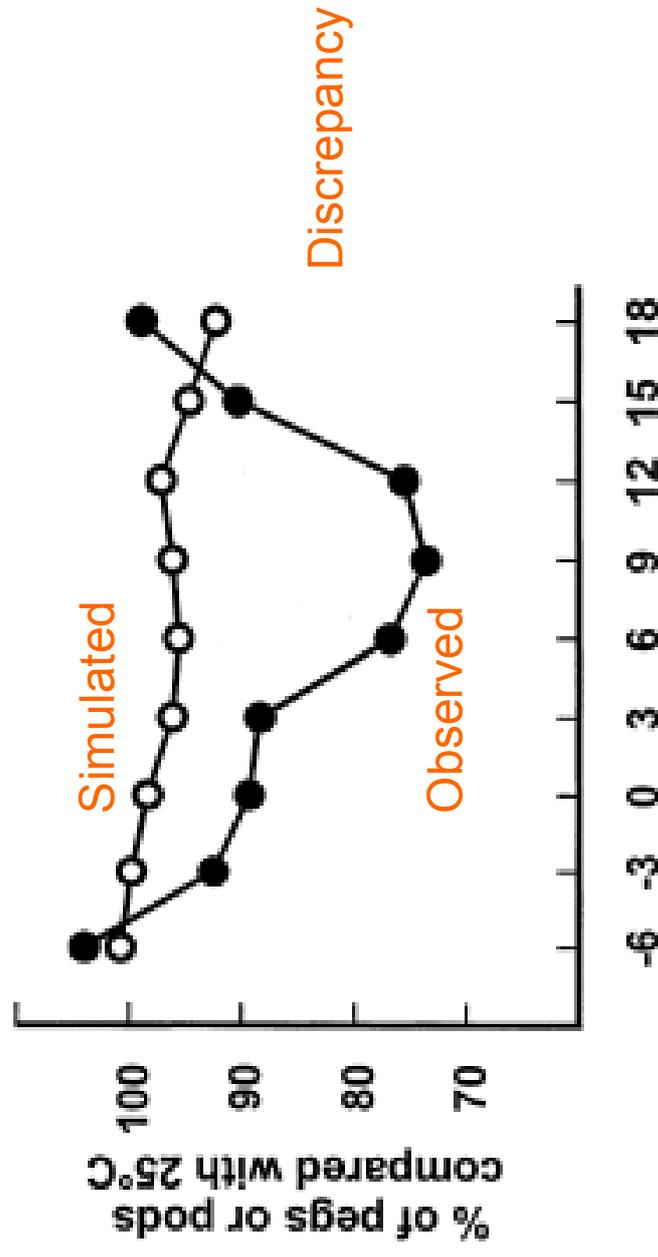

Time of hot temperature episode relative to onset of flowering (d)

(Wheeler et al., 2002)

# Perennial grasses strategies under prolonged droughts

## WHOLE PLANT

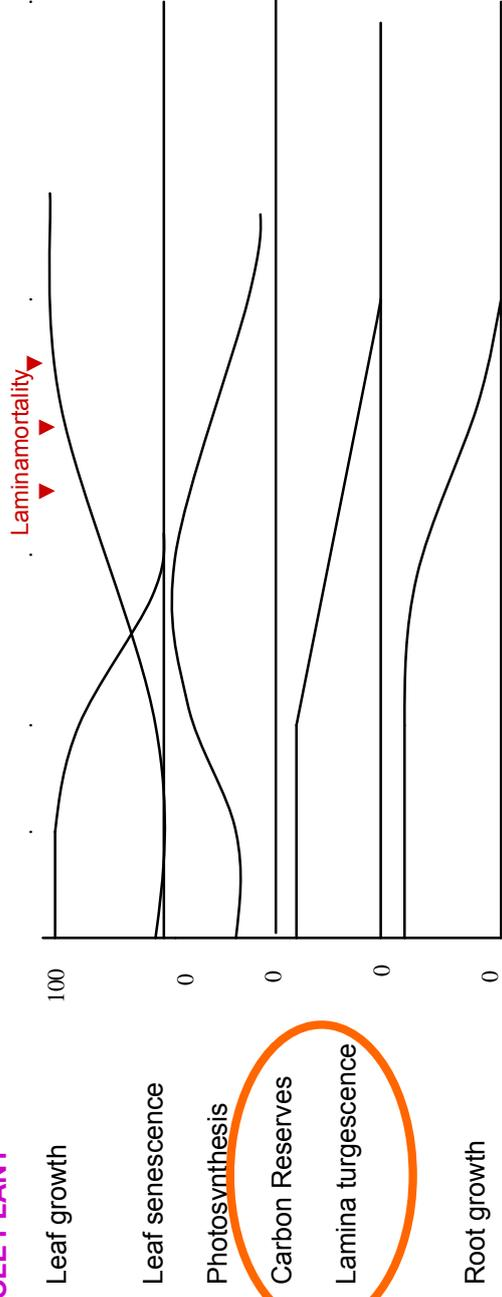

How to model mortality vs reserves?

## MERISTEMS

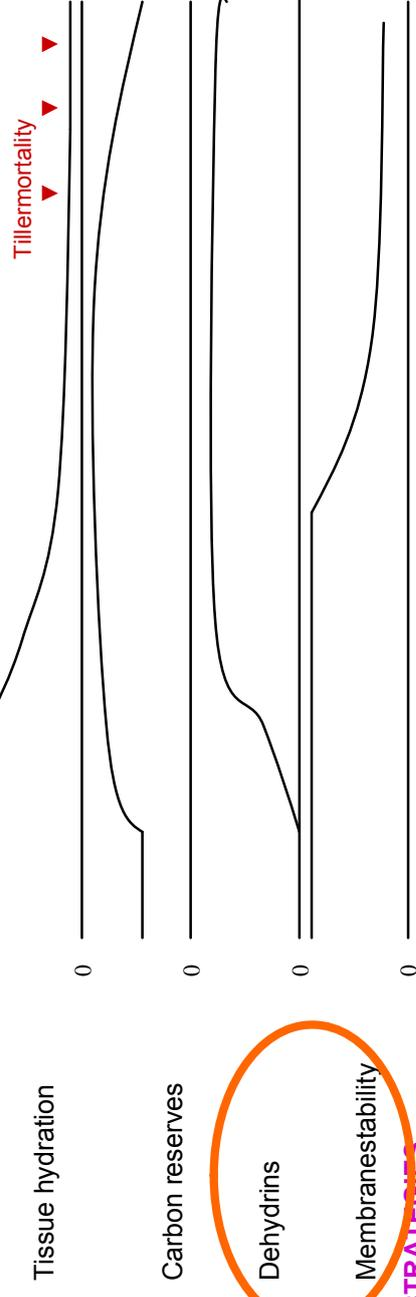

## STRATEGIES

**Growth maintenance**

**Dehydration delay**

**Dehydration tolerance**

Desiccation tolerance

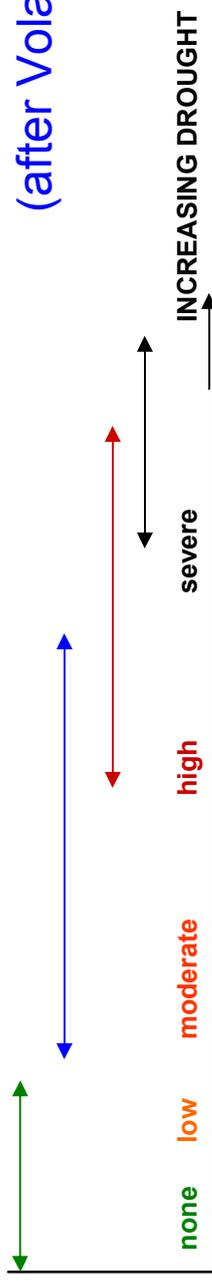

(after Volaire, 2008)

# Drought survival vs. the duration and intensity of water stress

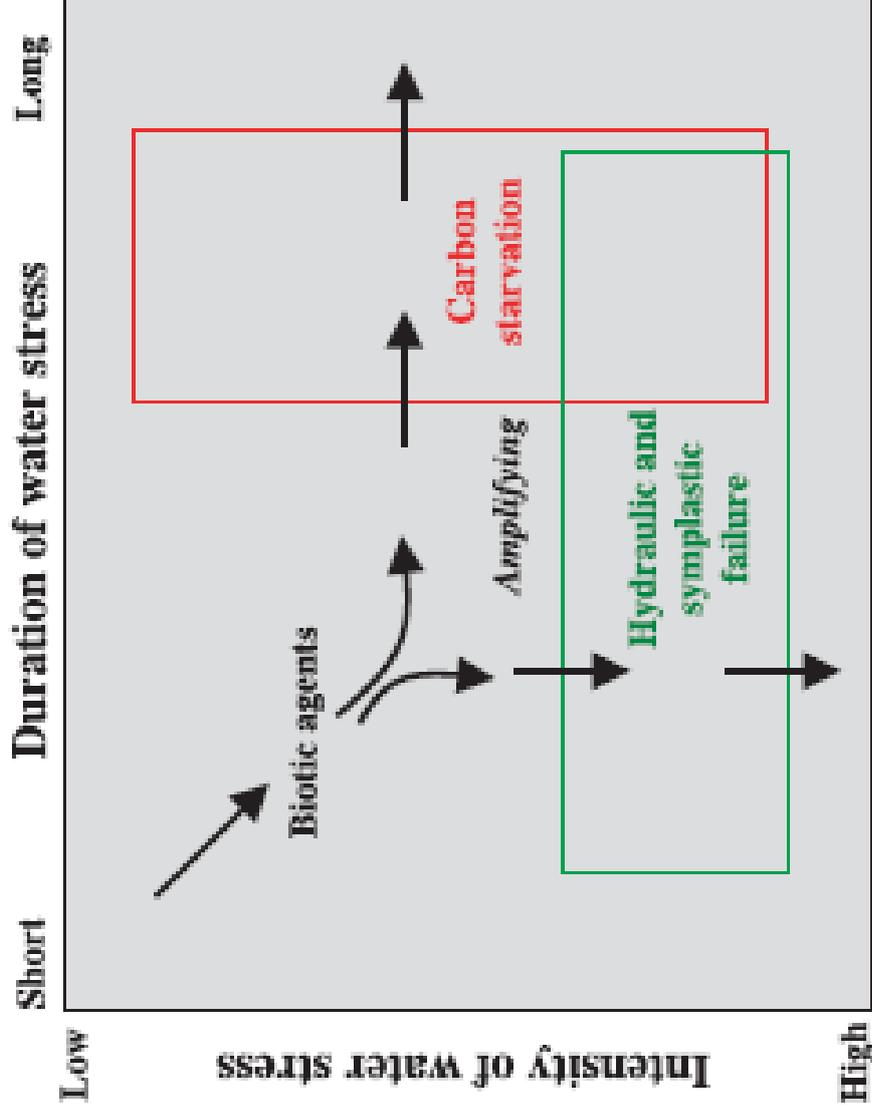

Theoretical relationships based on the hydraulic framework

(Mc Dowell et al., 2008, N Phytol.)

# 4°Modelling the role of biotic interactions and of pollutants

# Role of pests, diseases and pollutants: reducing factors

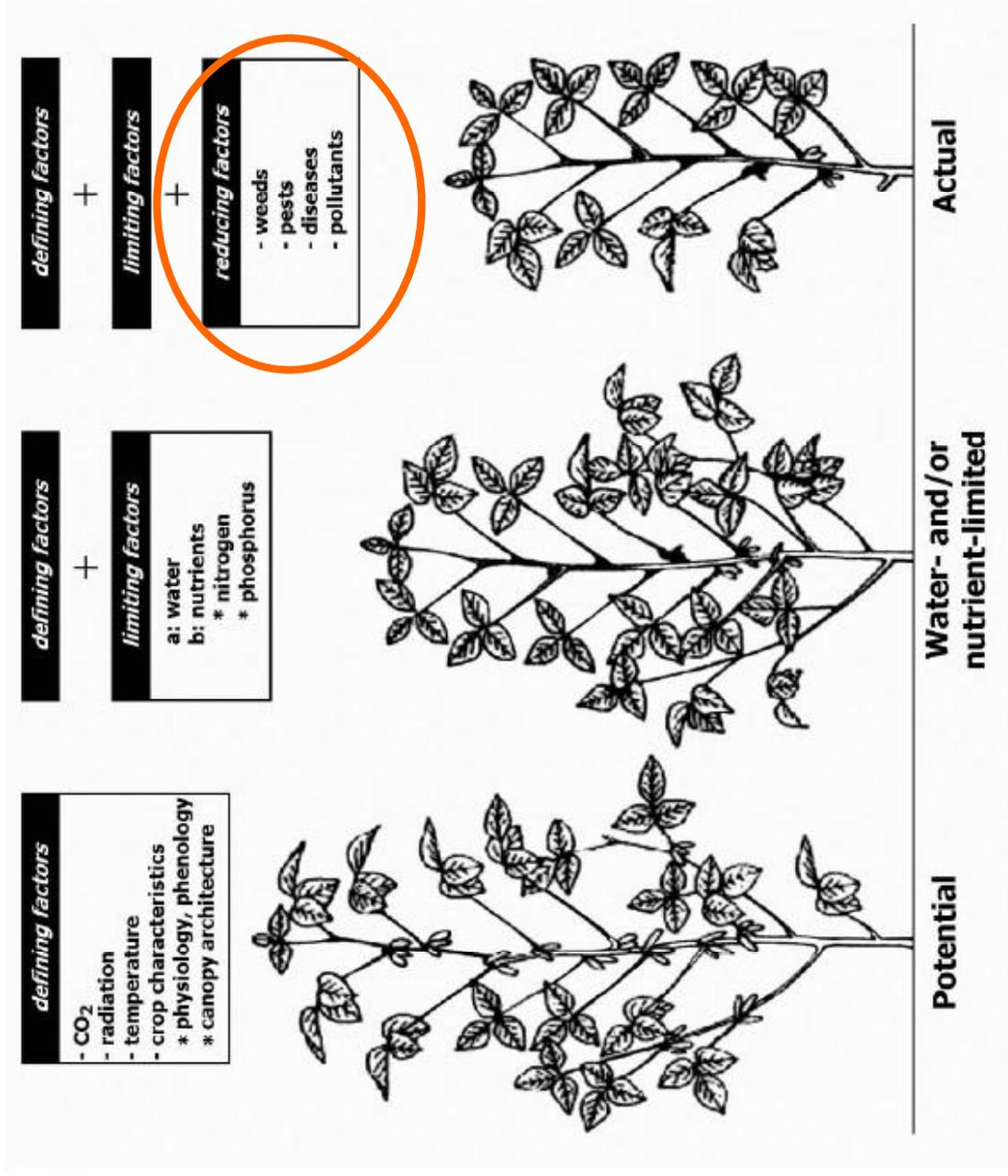

(Van Ittersum et al., 2003, EJA)

# Observed % reduction in seed yield as a function of competition from C<sub>3</sub> and C<sub>4</sub> weeds

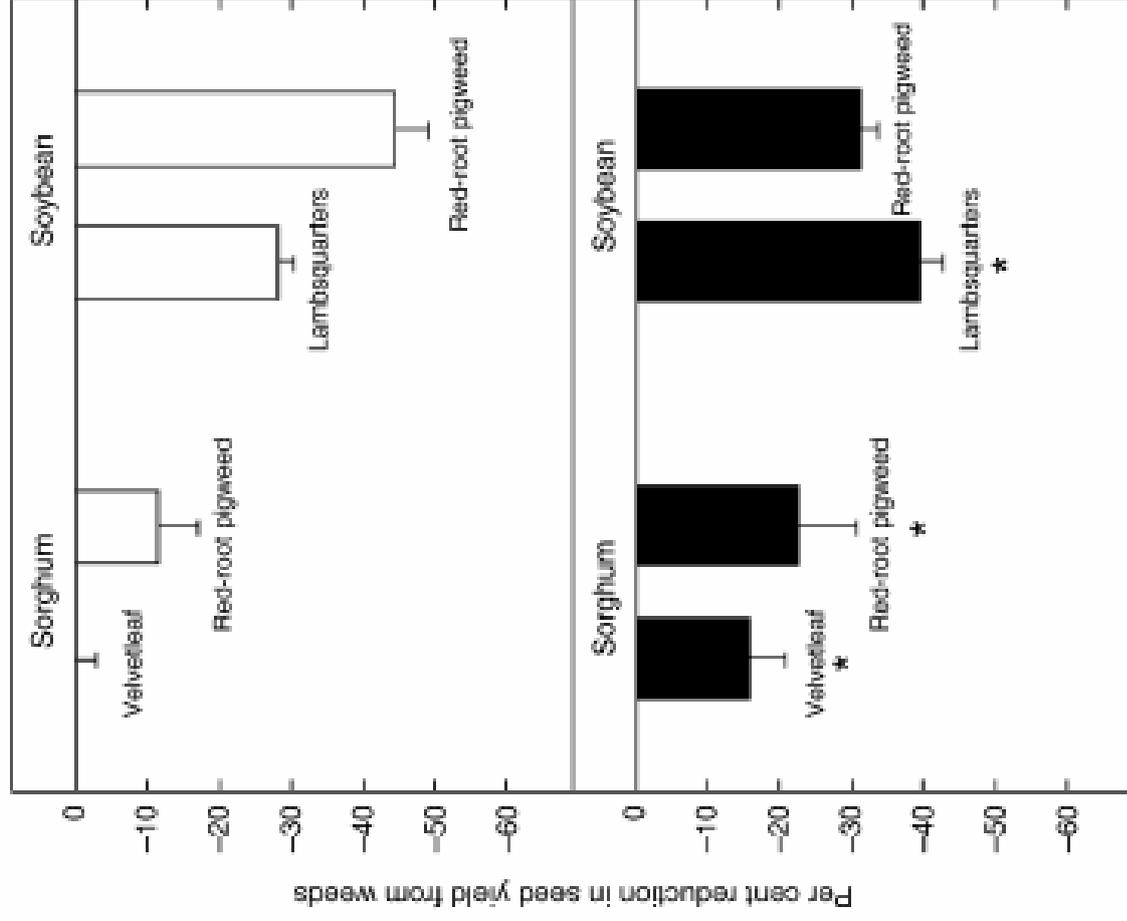

Elevated CO<sub>2</sub>

(\* , interaction with CO<sub>2</sub>)

(Ziska and Bunce, 2007, N Phytol.)

# Response of pathogen growth rate to temperature and 1.5°C warming

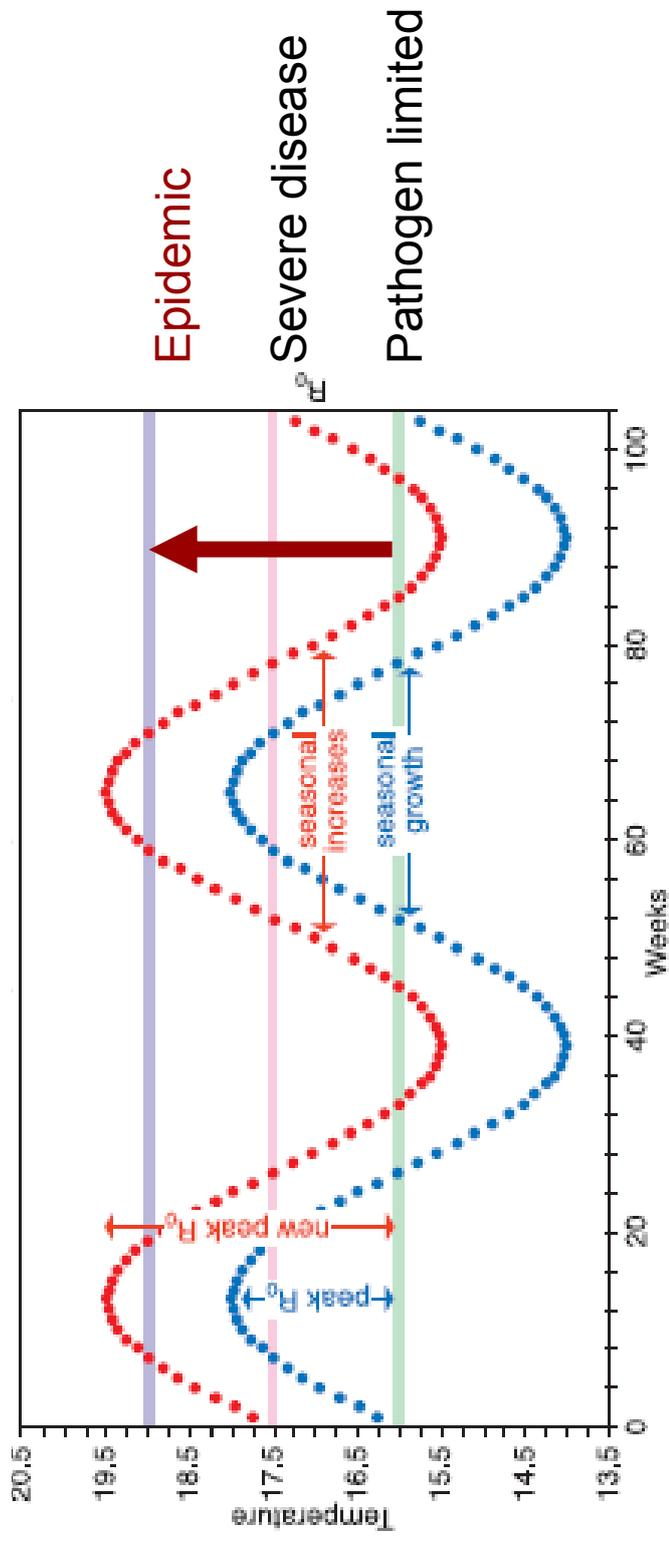

(Harvell et al., 2002, Science)

# Modelling pests and pathogens

- Forecasting models using climate variables can effectively predict outbreaks for some crop diseases.
  - Potato late blight (*Phytophthora infestans*) is correctly forecasted 92% of years on the basis of number of days of rain,
  - Rice blast (*Pyricularia oryzae*) models based on temperature and moisture forecast when an epidemic will start and when to apply fungicide for optimal control.
- Coupling disease forecasting models with models predicting epidemic impacts on crop productivity under climate change is needed.
- The rate of adaptation and evolution is an important unknown in any prediction of climate impacts.

(Harvell et al., Science, 2002)

# Projected increase in surface ozone concentration (ppb) by 2100

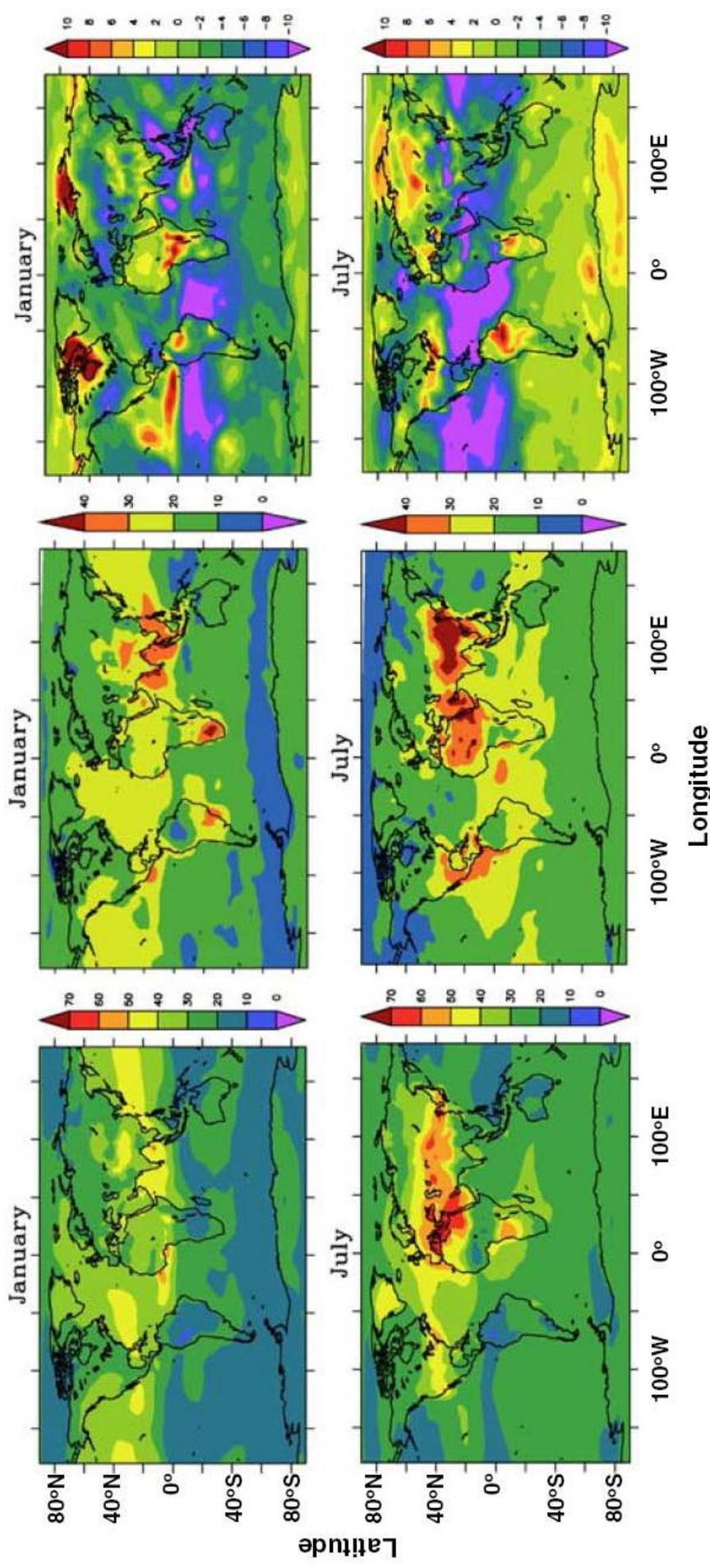

Present day Increased anthropogenic Interactions with climate  
ozone emissions change

(Zheng et al., 2008)

# Scheme of interactions between vegetation, climate and ozone pollution

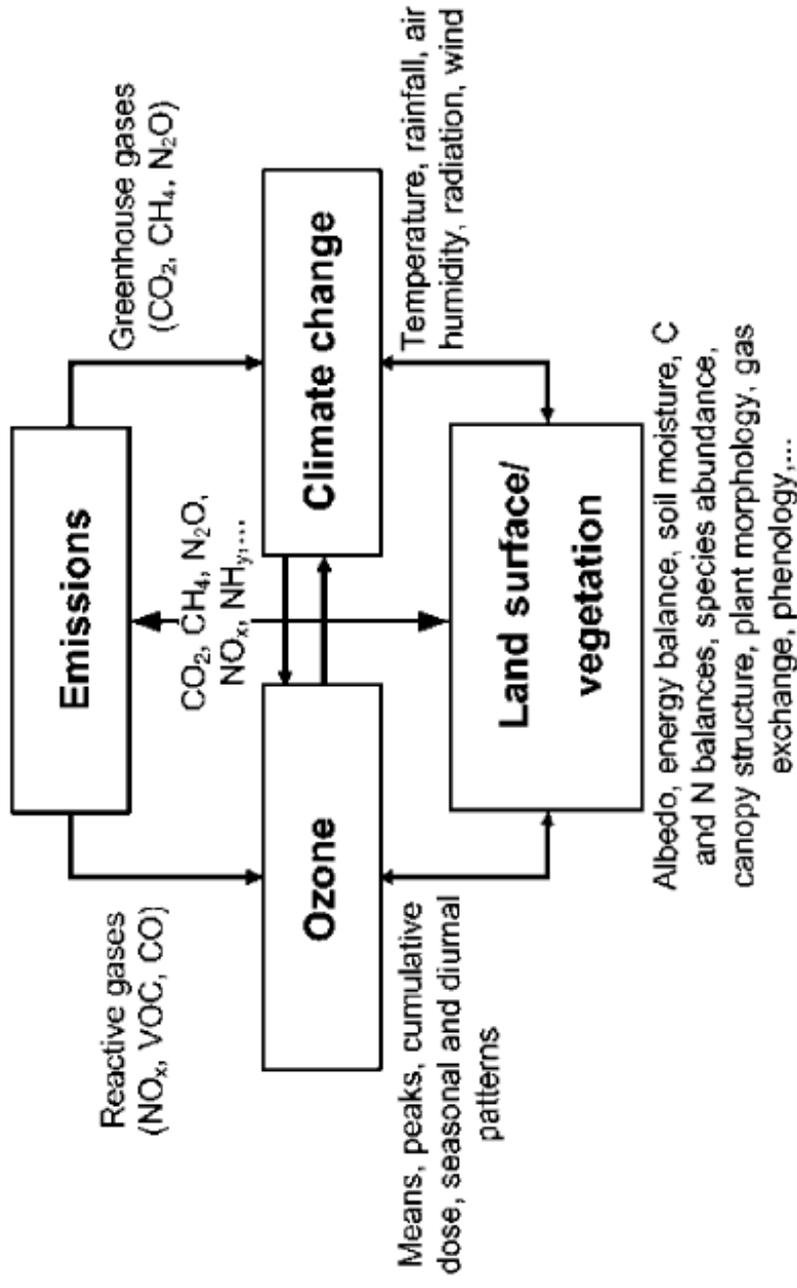

Interactions included in some global biosphere models (e.g. ORCHIDEE)

(Fuhrer, 2009, Naturwissenschaft)

# Perspectives

- Improving climate change impact projections will require a major effort combining:
  - Further crop/pasture model developments
  - Development of international data bases
  - Extensive model-data and model-model intercomparison
  - New generation of CO<sub>2</sub> experiments (Ainsworth et al., 2008) and of climate change experiments
  - Setting quality standards for an ensemble of crop and pasture models used for generating projections
- Bridging contrasted scales (from field to global) implies coupling crop & pasture models with:
  - soil biota models,
  - hydrology models,
  - disease spread, weed dispersion models,
  - Atmospheric pollution models
  - Farm scale adaptation models
  - Socio-economic models



# Thank you

