



**HAL**  
open science

## Determination of fatty acid composition in milk of individual animals by fourier-transform mid-infrared spectrometry

M. Ferrand, V. Huquet, Marie-Rose Aurel, Sarah Barbey, Francis F. Barillet, Frédéric F. Bouvier, P. Brunschwig, K. Duhem, Felicie Faucon, D. Gueldry, et al.

### ► To cite this version:

M. Ferrand, V. Huquet, Marie-Rose Aurel, Sarah Barbey, Francis F. Barillet, et al.. Determination of fatty acid composition in milk of individual animals by fourier-transform mid-infrared spectrometry. 37. ICAR Annual Meeting, May 2010, Riga, Latvia. hal-02756756

**HAL Id: hal-02756756**

**<https://hal.inrae.fr/hal-02756756v1>**

Submitted on 3 Jun 2020

**HAL** is a multi-disciplinary open access archive for the deposit and dissemination of scientific research documents, whether they are published or not. The documents may come from teaching and research institutions in France or abroad, or from public or private research centers.

L'archive ouverte pluridisciplinaire **HAL**, est destinée au dépôt et à la diffusion de documents scientifiques de niveau recherche, publiés ou non, émanant des établissements d'enseignement et de recherche français ou étrangers, des laboratoires publics ou privés.

# ICAR TECHNICAL SERIES NO. 14



## FARM ANIMAL BREEDING, IDENTIFICATION, PRODUCTION RECORDING AND MANAGEMENT

PROCEEDINGS OF THE 37<sup>TH</sup> ICAR BIENNIAL SESSION  
RIGA, LATVIA



*Lettere scritte da Antonio P. Monti, Sommo Ufficiale del Reale Istituto Veneto di Scienze, Lettere ed Arti, in occasione della 37<sup>a</sup> Sessione Biennale dell'ICAR, Riga, 1998. L'opera è pubblicata a cura dell'ICAR, Roma, 1999.*

EDITORS: E. SKUJINA, E. GALVANOSKA, O. LERAY & C. MOSCONI

---

The designations employed and the presentation of material in this publication do not imply the expression of any opinion whatsoever on the part of the Organisation concerning the legal status of any country, territory, city or area or of its authorities, or concerning the delimitation of its frontiers or boundaries.

---

*Cover page: 17<sup>th</sup> century engraving by Pieter Jacobsz van Laer of Haarlem, dit Bamboccio, (1599-1642), representing a livestock farm in the Latium region of Italy*

---

All rights reserved. No part of this publication may be reproduced, stored in a retrieval system, or transmitted in any form or by any means, electronic, mechanical, photocopying or otherwise, without the prior permission of the copyright owner. Applications for such permission, with a statement of the purpose and the extent of the reproduction, should be addressed to the Secretary General of ICAR, Via G. Tomassetti 3, 00161 Rome, Italy [icar@icar.org](mailto:icar@icar.org)

---

Title of the Series: ICAR Technical Series

Title of the Volume: Farm animal breeding, identification, production recording and management

Editors: E. Skujina, E. Galvanoska, O. Leray & C. Mosconi

Publisher: ICAR, Via G. Tomassetti 3, 1/A, 00161 Rome, Italy

Responsible for ICAR Technical Series: Cesare Mosconi

ISSN: 1563-2504

ISBN: 92-95014-10-3

---

All the manuscripts are published under the responsibility of each Author. ICAR is in no way responsible for the opinion expressed by each Author.

---

The International Committee for Animal Recording (ICAR) wishes to express its appreciation to the *Ministero per le Politiche Agricole e Forestali* and to the *Associazione Italiana Allevatori* for their valuable support of its activities.

**ICAR Technical Series no. 14**

**Farm animal breeding, identification,  
production recording and management**

**Proceedings of the 37<sup>th</sup> ICAR Biennial Session  
Riga, Latvia 31 May - 4 June 2010**

**Editors: E. Skujina, E. Galvanoska, O. Leray & C. Mosconi**

**November 2010**

In the same series:

- Identification, breeding, production, health and recording of farm animals. Proceedings of the 36th ICAR Biennial Session held in Niagara Falls, USA, 16-20 June 2008, ICAR T.S. 13
- R. Pauw, A. Speedy & J. Mäki-Hokkonen (Eds), Development of animal identification and recording systems for veterinary surveillance and livestock development in countries of Eastern Europe, Finland, 6 June 2006, I.T.S. no. 12
- R. Cardellino, A. Rosati & C. Mosconi (Eds), Current status of genetic resources, recording and production systems in African, Asian and American Camelids, Sousse, Tunisia, 30 May 2004, I.T.S. no. 11
- V. Tancin, S. Mihina & M. Uhrincat (Eds), Physiological and Technical Aspects of Machine Milking, Nitra, Slovak Rep., 26-28 April 2005, I.T.S. no. 10
- R. Pauw, S. Mack & J. Maki-Hokkonen (Eds), Development of Animal Identification and Recording Systems for Developing Countries, Sousse, Tunisia, 29 May 2004, I.T.S. no. 9
- J. Mäki-Hokkonen, J. Boyazoglu, T. Vares & M. Zjalic (Eds), Development of Successful Animal Recording Systems for Transition and Developing Countries, Interlaken, Switzerland, 27 May 2002, I.T.S. no. 8
- A. Rosati, S. Mihina & C. Mosconi (Eds), Physiological and Technical Aspects of Machine Milking, Nitra, Slovak Republic, 26-27 June 2001, I.T.S. no. 7
- H. Simianer, H. Täubert & K. Küttner (Eds), Beef Recording Guidelines: A Synthesis of an ICAR Survey, I.T.S. no. 6
- T. Vares, F. Habe, M. Klopčič & D. Kompan (Eds), The Role of Breeders' Organisations and State in Animal Identification and Recording in CEE Countries, Bled, Slovenia, 15 May 2000, I.T.S. no. 5
- B. Moioli, J. Mäki-Hokkonen, S. Galal & M. Zjalic (Eds), Animal Recording for Improved Breeding and Management Strategies for Buffaloes, Bled (Slovenia) 16-17 May 2000, I.T.S. no. 4.
- S. Galal, J. Boyazoglu & K. Hammond (Eds), Developing Breeding Strategies for Lower Input Animal Production Environments, Bella (Italy) 22-25 September 1999, I.T.S. no. 3.
- T. Vares, M. Zjalic & C. Mosconi (Eds), Cattle Identification and Milk Recording in Central and Eastern European Countries, Warsaw (Poland), 23 August, 1998, I.T.S. no. 2.
- K.R. Trivedi (Ed.), International Workshop on Animal Recording for Smallholders in Developing Countries, Anand (India) 20-23 October 1997, I.T.S. no. 1.

All the above publications can be freely  
downloaded from the ICAR web site at: [www.icar.org](http://www.icar.org)

**GOVERNMENT SUPPORT**



**Ministry of Agriculture of Latvia**

**ORGANIZER**



**State agency Agriculture Data Centre**

**SPONSORS**

**Platinum level**



**Gold level**



**Bronze level**



**WELCOME COCKTAIL SPONSORS**



**DISTRIBUTORS**



**Saldus**

**pārtikas**

**kombināts**



**SIA PURE FOOD**



The realisation of this publication has been made possible thanks to the efforts of the Local Organising Committee

<b>Organizing Commttee of Latvia</b>	Tatjana Šlapina	<b>IT support</b>
Ivans Vorslovs	Ruta Latkovska	Jeļena Celiševa
Erna Galvanovska	Solvita Jirgensone	Dmitrijs Rassohins
Evija Skujiņa	Baiba Armašēviča	Deniss Marčenko
Dainis Rungulis	Brigita Ozoliņa	Valentīns Kurmangalijevs
Ineta Lavrinoviča	Silvija Čima	Andrejs Sarokins
	Ērika Hatejenkova	Andrejs Vanags
<b>Secretariat</b>	Ingūna Slice	Ruslans Kolosovs
Irina Aleksejeva	Inese Bernere	
Dace Inda	Rita Sarma	
Inga Goldova	Mairita Elbrete	

and the Chairmen of the Sessions who reviewed the single manuscripts

<b>Session</b>	<b>Session Chairman</b>	<b>Country</b>
2.1 Small dairy ruminants	Jean Michel Astruc	France
2.2 Breeding Technologies	Pierre-Luis Gastinel	France
2.3 ID techniques and market requirement	Ole Klejs Hansen	Denmark
3.1 Improving health and fertility in dairy cattle	Erling Strandberg	Sweden
3.2 Beef production and recording	Brian Wickham	Ireland
3.3 Milk recording	Franz Schaller	Austria
4.1 Management of recording and evaluation organisations	Marco Winters	UK
4.3 Southern hemisphere opportunities	Pierre van Rooyen	South Africa
5 New Technologies	Jay Mattison	USA
Manufacturers Showcase	Frank Armitage	UK
SCMA 1 - Subcommittee for Milk Analysis: Reference Laboratory Network	Olivier Leray	France
Use of molecular genomic tools in animal breeding	Reinhard Reents	Germany

## Table of content

### Session 2.1 - Small dairy ruminants session

Chairman: J.-M. Astruc

Evaluating the suitability of milk for cheese making by on-line sensing .....	1
<i>G. Leitner, N. Silanikove &amp; U. Merin</i>	
Analysis of a representative sample of Sarda breed artificial insemination rams with the OvineSNP BeadChip .....	7
<i>M.G. Usai, T. Sechi, S. Salaris, T. Cubeddu, T. Roggio, Sara Casu &amp; A. Carta</i>	
Use of genomic data in French dairy sheep breeding programs: results and prospects .....	11
<i>J.M. Astruc, G. Lagriffoul, H. Larroque, A. Legarra, C. Moreno, R. Rupp, F. Barillet</i>	
Evaluating the accuracy of the genetic ranking of rams in the selected population of the Sarda dairy sheep breed .....	19
<i>S. Salaris, Sara Casu, M.G. Usai, P. Fresi, A. Carta</i>	

### Session 2.2 - Breeding technologies

Chairman: P.L. Gastinel

Implementation of developments of Institute of Animal Science in Dairy Cattle Breeding in Ukraine .....	23
<i>V. Shablia</i>	
Genetic gain in open nucleus breeding scheme to improve milk production in Egyptian buffalo .....	25
<i>S.A. Abdel-Salam, A.I. Sayed, Manal Elsayed &amp; S. Abou-Bakr</i>	
A wide range of tools to improve reproduction in dairy cattle .....	37
<i>C. Ponsart, B. Frappat, H. Seegers, S. Freret, P. Paccard, J. Gatien, P. Salvetti, X. David &amp; P. Humblot</i>	

### Session 2.3 - ID techniques and market requirement

Chairman: O.K. Hansen

Introduction of mandatory electronic identification of cattle in Denmark .....	47
<i>O.K. Hansen</i>	
Current situation of animal identification and recording systems in developing countries and countries with economies in transition.....	53
<i>C.B. Banga, B. Besbes, B. Balvay, L. Chazo, O.M. Jamaa, A. Rozstalnyy, G. Rovere, A. Toto &amp; K.R. Trivedi</i>	
The French bovine identification and traceability system, updated with the technology of RFID .....	61
<i>L. Marguin</i>	

### Session 3.1 - Improving health and fertility in dairy cattle

Chairman: E. Strandberg

Registration of health traits in Austria – Experience review .....	69
<i>C. Egger-Danner, W. Obritzhauser, B. Fuerst-Waltl, B. Grassauer, R. Janacek, F. Schallerl, C. Litzllachner, A. Koeck, M. Mayerhofer, M. Miesenberger, G. Schoder, F. Sturmlechner, A. Wagner &amp; K. Zottl</i>	
Animal Health Data Comparison – two EADGENE sub projects .....	79
<i>A. Neeteson, R. Aumüller, G. Bleriot, S. Hoste, G. Jones, H. Jones, A. Malafosse, M. Neuteboom, P. Oostenbach, E. Rehben, A. van der Sanden</i>	



Real-Time QPCR-based DNA Mastitis Analysis using the preserved DHIA sample .....	93
<i>J. High</i>	
Improving the management of the dairy cow through use of the Herd Companion on line website.....	97
<i>T. Craven</i>	
The use of a new sensor (Behaviour tag) for improving heat detection, health and welfare monitoring in different rearing conditions .....	113
<i>A. Arazi, E. Ishay &amp; E. Aizinbud</i>	

**Session 3.2 - Beef production and recording**  
**Chairman: B. Wickham**

Using integrated solutions to achieve high levels of performance recording in beef herds.....	129
<i>S. Coughlan</i>	
Trends in beef cattle performance record collection and genetic evaluation systems in the United States.....	133
<i>R.L. Weaber</i>	

**Session 3.3 - Milk recording**  
**Chairman: F. Schaller**

Use of the Tru-Test Electronic Milk Meter (EMM) in France .....	145
<i>C. Lhomme &amp; C. Lecomte</i>	
Determination of carry-over in automated milking, recording and sampling systems using fluorescent tracers .....	147
<i>P. Løvendahl, M. Bjerring &amp; T. Larsen</i>	
Health monitoring in Austria – statistical models based on somatic cell count at cow level for early detection of udder health problems developed .....	153
<i>P. Winter, J. Hofrichter, W. Obritzhauser, K. Zottl &amp; C. Egger-Danner</i>	
The role of agricultural recording systems in reducing the global carbon footprint .....	159
<i>P.A. Dukas</i>	

**Session 4.1 - Management of recording and evaluation organisations**  
**Chairman: M. Winters**

Management of the B-system in a small country .....	165
<i>K. Ilves</i>	
Adding value to test-day data by using modified best prediction method.....	171
<i>A. Gillon, S. Abras, P. Mayeres, C. Bertozzi &amp; N. Gengler,</i>	
Improved method for calculating daily yields from alternate testing schemes .....	179
<i>A. Bünger, X. Bourrigan, H. Leclerc, Z. Liu, K. Kuwan &amp; S. Mattalia</i>	
Transitioning milk recording services in changing times.....	185
<i>P. Baier</i>	
Adding value to data emanating from routine animal recording processes .....	189
<i>C. Hunlun</i>	

### Session 4.3 - Southern hemisphere opportunities

Chairman: P. van Rooyen

Opportunities in Southern Africa using animal economic values .....	199
<i>J. van der Westhuizen, R.R. Van der Westhuizen, C B. Banga &amp; H.E. Theron</i>	
Persistency of conjugated linoleic and vaccenic acids in Argentine Tybo and Sardo cheeses produced from natural high CLA milk .....	205
<i>M.A. Rodriguez; V. Cejas, R. Castañeda, G. Gagliostro &amp; M. Balán</i>	
The role of pedigree recording in sustainable animal agriculture with special focus on indigenous breeds .....	209
<i>C. Hunlun &amp; K. Ramsay</i>	
Maximising performance on a typical Southern Hemisphere pasture dairy farm.....	215
<i>N. Lok</i>	
Challenges and opportunities for beef production in developing countries of the southern hemisphere .....	221
<i>M.M. Scholtz, C. McManus, O. Mwai, L. Seixas &amp; H. Louvandini</i>	

### Session 5 - New technologies

Chairman: J. Mattison

Continuous improvement for dairy laboratories through REDELAC.....	233
<i>C. Pecorino, M. Bilotta, M. Murphy, L. Giorgi , P. Labacá &amp; R. Castañeda</i>	
Potential estimation of titratable acidity in cow milk using Mid-Infrared Spectrometry.....	239
<i>F.G. Colinet, H. Soyert,, C. Anceau, A. Vanlierde, N. Keyen, P. Dardenne, N. Gengler, &amp; M. Sindic</i>	
Exchanging data from and into on barn automats and sensors .....	245
<i>R. Rognant</i>	
Experiences with comprehensive herd management of a mega-dairy using RFID, automatic milk recording and multi-client cow-side data entry with reproduction and health protocols .....	249
<i>D.W. Webb</i>	
The new infrastructure for cattle and sheep breeding in Ireland.....	253
<i>B. Wickham</i>	

### Sub-Committee for Milk Analysis: Reference Laboratory Network

Chairman: O. Leray

ICAR Reference Laboratory Network - Objectives and stage of progress in 2010 .....	257
<i>O. Leray</i>	
Analytical precision performance in ICAR proficiency testing programmes .....	263
<i>O. Leray</i>	
International reference system for somatic cell counting in milk. A world wide challenge .....	271
<i>C. Baumgartner &amp; H. van den Bijgaart</i> <i>(and, on behalf of ICAR SC MA, E. Brenne, J. Floor, M. Gips, R. Castaneda, O. Leray, S. Orlandini, G. Psathas, J. Rhoads &amp; G. Scott)</i>	
Latvian milk recording analysis and Dairy Laboratory Ltd. in the ICAR analytical reference system.....	275
<i>D. Ruska</i>	

Determination of fatty acid composition in milk of individual animals by Fourier-Transform Mid-Infrared Spectrometry .....	277
<i>M. Ferrand, V. Huquet, M.R. Aurel, S. Barbey, F. Barillet, F. Bouvier, P. Brunschwig, K. Duhem, F. Faucon, D. Guedry, H. Larroque, G. Lautier, O Leray, S. Leverrier, I. Palhiere, J.L. Peyraud, J.M. Trommenschlager &amp; M. Brochard</i>	
New parameters and analytical challenges for milk recording by Fourier-Transform Mid-Infrared Spectrometry (FTMIR) .....	283
<i>H. Soyeurt</i>	
Herd Navigator or “How to benefit from frequent measurements” .....	291
<i>T. Asmussen</i>	

**Workshop 2 - Manufacturers Showcase**  
**Chairman: Frank Armitage**

The Virtual Cow – A World st from Holstein-UK .....	295
<i>L. Andrews, J. Gribbon, H. Richardson &amp; G. Ward</i>	

**Reports of the ICAR Sub-Committees and Working Group**

Report of the Animal Identification Sub-Committee .....	301
<i>K. Ilves</i>	
Report of Interbull Sub-Committee.....	305
<i>R. Reents</i>	
Report of the Milk Analysis Sub-Committee .....	309
<i>O. Leray</i>	
Report of Recording Devices Sub-Committee .....	313
<i>U. Lauritsen</i>	
Report of the Animal Fibre Working Group.....	315
<i>M. Antonini</i>	
Report of the Animal Recording Data Working Group .....	317
<i>E. Rehben</i>	
Report of Artificial Insemination and Relevant technologies Working Group .....	319
<i>L. Journaux</i>	
Report of Beef and Interbeef Working Group .....	321
<i>B. Wickham</i>	
Report of the Conformation Working Group .....	323
<i>G. De Jong</i>	
Report of the Developing Countries Working Group .....	325
<i>B. Besbes</i>	
Report of the Functional Traits Working Group .....	327
<i>E. Strandberg</i>	
Report of the Genetic Analysis Working Group .....	329
<i>P. Ajmone Marsan</i>	
Report of the Lactation Calculation Methods Working Group .....	331
<i>F. Miglior</i>	

Report of the Milk Recording of Goat Working Group.....	333
<i>Z. Barac</i>	
Report of the Milk Recording of Sheep Working Group.....	335
<i>J.-M. Astruc</i>	
Report of the Parentage Recording Working Group .....	343
<i>S. Harding</i>	

### **Cow and sheep milk enquiries**

Yearly enquiry on the situation of cow milk recording in ICAR member countries - Results for the years 2008 - 2009 .....	345
Yearly enquiry on the situation of sheep milk recording in ICAR member countries - Results for the years 2008 - 2009 .....	379



## Preface

This publication contains the Proceedings of the 37th ICAR Session that was held in Riga, Latvia. Around 400 participants join the meeting whose main topics were the last developments in animal recording, the evaluation of animals and their traits and the last advancement in recent technologies related with the different steps of the milk production chain

These points were debated during the four days Session either by means of technical approaches or as a introductory elements for a wider discussion occurred among the participating experts.

This publication tracks the new tools at the service of the various phases of domestic animal recording at the light of the most recent technologies available to breeders, in order to get an optimal management of herds and increasing the productivity or characteristics closely associated with it.

New strategies for identification and recording were debated during the Session and the most updated technologies are consequently presented to the readers, interconnecting as well the national practices where such technologies have been implemented.

The 37th Session hosted satellite meetings, whose papers are collected in this publication. In particular, the manuscripts from the meeting "ICAR Reference Laboratory Network" arranged by the Sub Committee for Milk Analysis. This section presents the reference systems, the principles and the practices for calibration systems for routine milk testing.

A specific section of the publication presents some of the manuscripts presented during the "Manufacturers' showcase", a specific part of the ICAR Session where some of the most relevant world manufacturers expose their approaches and solutions to cow milking.

Experiences in various countries were presented and examples of potential uses of genomic tools for parentage testing, individual identification, and traceability were discussed. Future challenges and opportunities in this field and the definition of the future developments in the sector were also debated.

The last section of this publication shows the national statistics of the "Yearly enquiry on the situation of cow and sheep milk recording in member countries" for the years 2008 and 2009. A total of 47 useful pages describes the methodologies used at national level for milk recording, the national data for milk production, the costs of recording and the productivity and numbers of recorded cattle and sheep at national level (divided by species and by herdbook).





## Evaluating the suitability of milk for cheese making by on-line sensing

G. Leitner<sup>1</sup>, N. Silanikove<sup>2</sup> & U. Merin<sup>2</sup>

<sup>1</sup>Kimron Veterinary Institute, P.O. Box 12, Bet Dagan 50250, Israel

<sup>2</sup>Agricultural Research Organization, The Volcani Center, P.O. Box 6, Bet Dagan 50250, Israel

### Abstract

In modern dairy farms, cows are milked at different stages of lactation, while a relatively large number of their glands is infected with a variety of bacteria. Thus, bulk milk quality depends on the mixture of the milked quarters. Even though many dairy animals with subclinical chronic infections are not noted because there are no recognizable symptoms and the milk appearance is normal, subclinical mastitis affects milk quality.

In small ruminant's dairy systems, the quality and suitability of milk for cheese making is analyzed by laboratory milk testing. In this research, sheep at mid lactation (90-130 days in milk) and at the end of the lactation (~70 days before next parturition) were studied. Of those, 36 glands were infected with *Staphylococcus epidermidis* and *Staphylococcus chromogenes* and 43 glands were uninfected. Milk yield of uninfected glands was higher than in uninfected ones (2.83 vs. 1.75 L d<sup>-1</sup>) while somatic cell counts was lower (154×10<sup>3</sup> vs. 2,150×10<sup>3</sup>;  $P < 0.001$ ). Percent fat was lower and protein was higher in the milk from the infected glands in comparison to uninfected ones, while percent casein of total protein was significantly higher in milk from the uninfected glands (78.3±0.5 and 67.3±0.6;  $P < 0.001$ ). Lactose concentration was lower in the infected glands than in the uninfected ones (41.1±0.2 g L<sup>-1</sup> vs. 48.1±0.3 g L<sup>-1</sup>;  $P < 0.001$ ). Cheese-making parameters were measured by the Optigraph. Clotting time was significantly longer and curd firmness was significantly lower in milk from the infected glands in comparison to uninfected glands.

Signals obtained by the on-line milk testing device (AfiLab® S.A.E. Afikim, Israel) for cows significantly correlated with measures of milk quality on the animal udder level obtained by the Optigraph i.e., clotting time and curd firmness. Thus, this achievement will allow small ruminant's milk producers to qualify on-line their milk for its potential for cheese production.

*Keywords: small ruminants, subclinical mastitis, milk recording, cheese-making.*

## 1. Introduction

Mammalian species produce milk for their offspring, therefore the quantity and composition depend on the newborn needs and change over time during the lactation. However, the variations in milk quantity and composition are not only among species but also within-species owing to diverse genotypes, management, stage of the lactation and their interactions. Additionally, glands infected with microorganisms, mainly bacteria, have negative effects on milk yield and quality. These effects are primarily localized in the infected glands due to induction of milk-borne negative regulatory signals that lead to changes in the secretory pathways of lactose, lipids, proteins and other components (Silanikove *et al.*, 2006; 2010).

In modern dairy farms, animals are milked at different stages of lactation, with a relatively large number of glands infected with a variety of bacteria. Thus bulk milk quality is the mixture of all the milked quarters. In traditional farming, surplus milk is used for dairy products with an effort to match between milk quality and optimal products yield. Therefore, milk from infected animals is carefully monitored and diverted from entering the bulk milk tank.

Many of the animals with subclinical chronic infection are not detected because there are no recognizable symptoms and the milk appearance is normal. Routine milk testing such as CMT on the animal side or more advanced techniques like the sophisticated cell counters allow the identification of subclinically infected animals close to the occurrence of the infection. However, these methods are laborious and/or require special equipment to perform and in many cases identify the infected animals long after the



infections occurred. On-line computerized milking systems are designed in part to overcome these obstacles and to apply genuine real-time data acquisition on individual animals, including milk yield and conductivity.

Recently, new information collected on-line in the milking parlour facilitated achieving a good correlation between milk quality and its suitability for cheese making. This achievement is of major interest to the small ruminant industry because most of that milk is used for cheese production.

## 2. Materials and Methods

### 2.1. Animals

Assaf dairy sheep in mid-lactation (ML) and at the end of lactation (EL), ~70 days before next parturition entered the study. Prior to the study, sheep were tested for bacterial infection and SCC. Of the ML sheep, 47 glands were free of bacteria (ML-F) and 56 glands were subclinically infected (ML-I) with CNS, mainly *Staphylococcus epidermidis* and *Staphylococcus chromogenes*. In the EL, only the milk of 30 glands free of bacteria was collected for the study. The sheep were kept in 4 m<sup>2</sup> closed sheds with extra 4 m<sup>2</sup> of open yard for each animal. Food was offered in mangers located in free-stall barns.

### 2.2. Milk sampling

Foremilk milk (5 mL) was sampled for testing after cleaning and disinfecting the glands during the morning milking. Bacteriological analysis was performed according to accepted microbiological procedures described by the US National Mastitis Council (Oliver *et al.*, 2004). On the test days, an additional sample (100-300 mL of the whole milk) was taken from each gland for analysis as follows: SCC by the Fossomatic 360 and gross milk composition, i.e., protein, fat and lactose with the Milkoscan FT6000 (Foss Electric, Hillerod, Denmark) at the Israel Cattle Breeders Association Laboratory (Caesarea, Israel). Casein content was determined according to standard methods (Marshall, 1992). Curd firmness (CF) and clotting time (RCT) were determined by the Optigraph (Ysebaert, Repillon, France) as described by Leitner *et al.* (2006).

### 2.3. Statistical analysis

All statistical analyses were carried out with JMP software (SAS Institute, 2000).

## 3. Results

End-lactation sheep were on the average 204 days in milk (DIM) while the ML-F and ML-I were on the average 99 and 119 DIM, respectively (Table 1). Daily milk yields were ~2.3 L day<sup>-1</sup> in ML-F, significantly higher than ML-I (1.57 L d<sup>-1</sup>), whereas both were significantly higher from the EL, which produced 0.99 L d<sup>-1</sup>. SCC was significantly higher ( $P < 0.001$ ) for ML-I than ML-F and EL, with no significance between the latter (7211, 129, 403 × 10<sup>3</sup> cells mL<sup>-1</sup>, respectively). Fat was higher in the EL than ML-F and ML-I but significantly ( $P < 0.05$ ) only from the ML-I. No significant differences were found among the groups in percent protein and casein. However, percent casein of total protein was significantly lower ( $P < 0.001$ ) in ML-I. Lactose was significantly lower ( $P < 0.001$ ) in ML-I than ML-F; the lowest lactose concentration was recorded in EL. RCT was significantly longer ( $P < 0.001$ ) in both ML-I and EL than in ML-F. CF at 40 min after enzyme addition (CF-40) was significantly lower ( $P < 0.001$ ) in ML-I and EL than in ML-F in comparison to ML-F (8.22, 14.54 and 18.27, respectively).

The correlation between protein, casein and Protein + fat and CF was not significant. The correlation between casein or % casein of total protein and CF was positively significant, whereas the correlation between lactose and CF was negative, and highest ( $r = 0.591$ ). SCC and log SCC also correlated negatively, but with lower  $r$ .

Table 1. Mean and SE of days in milk, milk yield, milk composition: fat, protein, casein, % casein, lactose and RCT and CF according to groups of sheep designated: Mid-lactation, bacteria free (ML-F), Mid-lactation-infected (ML-I) and End-lactation, bacteria free (EL).

	ML-F	ML-I	EL	R <sup>2</sup>	P [F]
No. of quarters	41	56	39		
DIM	99±9.2 <sup>b</sup>	119±8.5 <sup>b</sup>	204±4.9 <sup>a</sup>	0.452	P<0.001
Milk (L d <sup>-1</sup> ) <sup>1</sup>	2.28±0.16 <sup>a</sup>	1.57±0.18 <sup>b</sup>	0.99±0.18 <sup>c</sup>	0.333	P<0.001
SCC (×10 <sup>3</sup> )	129±48 <sup>b</sup>	7211±1197 <sup>a</sup>	403±94 <sup>b</sup>	0.299	P<0.001
Fat (g L <sup>-1</sup> )	72.7±0.32 <sup>ab</sup>	68.7±0.32 <sup>b</sup>	76.1±0.34 <sup>a</sup>	0.062	P<0.001
Protein (g L <sup>-1</sup> )	47.74±0.17	50.1±0.17	51.8±0.18	0.059	NS
Casein (g L <sup>-1</sup> )	35.8±0.11	34.1±0.11	36.3±0.16	0.051	NS
% Casein <sup>2</sup>	76.39±1.43 <sup>a</sup>	67.94±1.44 <sup>b</sup>	74.57±0.5 <sup>a</sup>	0.294	P<0.001
Lactose (g L <sup>-1</sup> )	47.9±0.12 <sup>a</sup>	40.5±0.1 <sup>c</sup>	43.8±0.13 <sup>b</sup>	0.205	P<0.001
RCT (sec)	547±22 <sup>c</sup>	1820±205 <sup>a</sup>	802±37 <sup>b</sup>	0.255	P<0.001
CF-40 (V)	18.27±1.10 <sup>a</sup>	8.22±0.98 <sup>c</sup>	14.54±1.27 <sup>b</sup>	0.301	P<0.001

<sup>1</sup>Sheep milk

<sup>2</sup>% Casein = Casein/protein × 100

<sup>a-b</sup>Parameter within row with no common superscript differ significantly (P< 0.05)

Table 2. Correlations and P[r] of protein, casein, protein + fat, percent casein, lactose, SCC and log SCC with CF of milk from all the sheep in the study.

Parameter	R	P[r]
Protein (g L <sup>-1</sup> )	-0.074	NS
Casein (g L <sup>-1</sup> )	0.352	0.002
% Casein <sup>1</sup>	0.222	0.01
Protein + fat	0.141	NS
Lactose	0.591	<0.0001
SCC (×10 <sup>3</sup> )	-0.510	<0.0001
SCC (log)	-0.232	<0.0001

<sup>1</sup>% Casein = Casein/protein × 100

## 4. Discussion

No correlation was found between fat, protein and casein concentrations and CF, while a positive correlation was found between lactose and CF and a negative correlation between % casein and SCC and CF, consistent with previous findings (Leitner *et al.*, 2007; 2008). The study highlighted the effectiveness of measuring lactose content in predicting milk quality, since the correlation between lactose and CF was higher than between % casein and SCC and CF.

Subclinical infection of glands with CNS at mid-lactation simultaneously affected milk yield and milk quality measures, clotting time and curd firmness. Milk yield was least and insignificantly affected, since in sheep it was found that glands infected with CNS compensate their milk yield by the uninfected gland. Consequently, loss of milk yield on the whole animal level is attenuated in sheep (Leitner *et al.*, 2004, 2008). Nevertheless, it should also be noted that deterioration in milk quality is almost certainly associated with loss of curd yield. Moreover, when milk is used for curdling and cheese production, the negative effect of CNS infection, when only one gland is infected, on losses due to reduced curd yield is greater than the contribution of milk yield loss (Leitner *et al.*, 2008).

End of lactation negatively affected milk yield and milk quality. The inflammatory response at the end of lactation may be interpreted as a pre-adaptive response to the forthcoming involution stage, because the acute inflammatory response associated with this adaptation will aid in clearing existing bacterial infection; thus, preventing the transfer of infection from current lactation to the next.

Changes in lactose as an indication of infection and deterioration in milk quality are well-known during clinical (Werner-Misof *et al.*, 2007) and subclinical mastitis (Leitner *et al.*, 2004, 2007). The reduction of lactose concentration in subclinically infected animals in which the tight junction integrity is maintained, indicates that the reduction is related to reduced secretion of lactose by the mammary gland cells. Indeed, it is the milk-borne regulatory element (i.e.,  $\beta$ -CN f(1–28)), which blocks apically located K<sup>+</sup>-channel and affects the secretion of lactose into the milk (Silanikove *et al.*, 2000; 2009). Interestingly,

reduction of lactose to around 4% signifies milk that will not coagulate and thus is of no value for cheese production (Fig. 1), which is also associated with casein degradation and liberation of casein-degradation products that reach a level that would completely impede curdling.

The result of this research provides small dairies that process their own milk to cheese with a new technology that will enable them to separate the milk that will not coagulate. This milk can still meet the criteria for being used for drinking; thus, allowing the farmers to exploit the milk produced more economically. The effectiveness of lactose, % casein and SCC in predicting milk quality for cheese production is lost on the dairy tank level because of its dilution with good quality milk. Nevertheless, the effect of subclinical mastitis on milk quality remained significant (Leitner *et al.*, 2007). Thus, future developments of new techniques for on-line measures of milk quality, particularly the level of lactose, will allow the producers to meet the top dairy price-quality standards by separating milk according to its best properties, cheese production and drinking, thus maximizing their profit from milk selling.

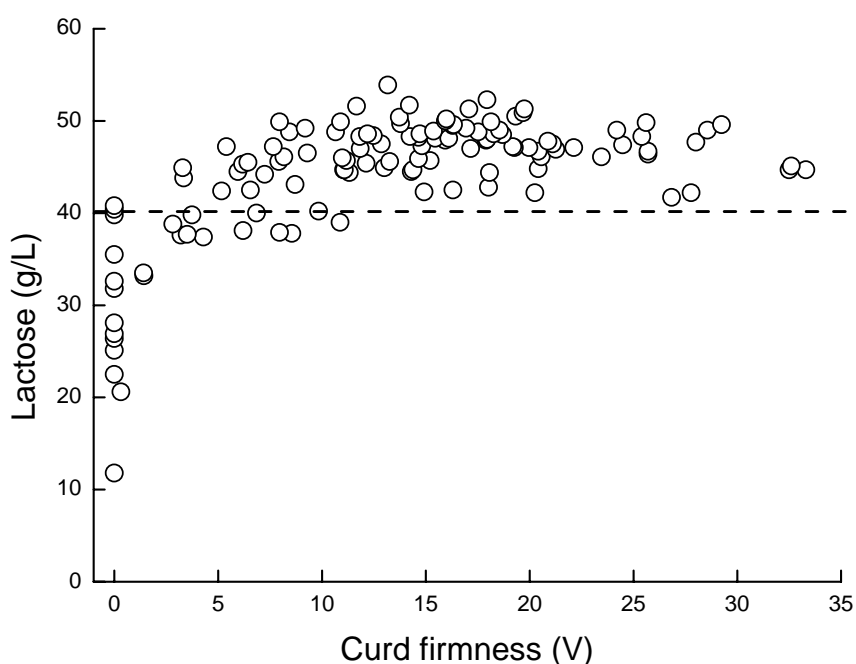

Figure 1. Lactose concentration in milk and its relation to curd firmness as measured by the Optigraph.

## 5. References

- Leitner, G., Chaffer, M., Shamay, A., Shapiro, F., Merin, U., Ezra, E., Saran, A., Silanikove, N. 2004. Changes in milk composition as affected by subclinical mastitis in sheep. *J. Dairy Sci.*, 87:46-52.
- Leitner, G., Kriucks, O., Merin, U., Lavi, Y., Silanikove, N. 2006. Interactions between bacteria type, proteolysis of casein and physico-chemical properties of bovine milk. *Int. Dairy J.*, 16:648-654.
- Leitner, G., Merin, U., Lavi, Y., Egber, A., Silanikove, N. 2007. Aetiology of intramammary infection and its effect on milk composition in goat flocks. *J. Dairy Res.*, 74:186-193.
- Leitner, G., Silanikove, N., Merin, U. 2008. Estimate of milk and curd yield loss of sheep and goats with intramammary infection and its relation to somatic cell count. *Small Rumin. Res.*, 74:221-225.
- Marshall, R. T. (Ed.) 1992. *Standard Methods for the Examination of Dairy Products* (16th ed.), American Public Health Association, Washington DC, USA.

- Oliver S.P., Gonzalez R.N., Hogan J.S., Jayarao B.M., Owens W. E. 2004. Microbiological Procedures for the Diagnosis of Bovine Udder Infection and Determination of Milk Quality, in: The 4<sup>th</sup> ed., National Mastitis Council, Verona, WI, USA.
- SAS Institute, 2000. JMP Statistics and Graphics Guide, Version 5. SAS Institute Inc., Cary, NC, USA.
- Silanikove, N., Shamay, A., Sinder, D., Moran, A. 2000. Stress down regulates milk yield in cows by plasmin induced  $\kappa$ -casein product that blocks  $K^+$  channels on the apical membranes. *Life Sci.* 67:2201-2212.
- Silanikove, N., Merin, U., Leitner, G. 2006. Physiological role of indigenous milk enzymes: An overview of an evolving picture. *Int. Dairy J.*, 16:535-545.
- Silanikove, N., Shapiro, F., Shinder, D. 2009. Acute heat stress brings down milk secretion in dairy cows by up-regulating the activity of the milk-borne negative feedback regulatory system. *BMC Physiol.*, 9:13.
- Silanikove, N., Leitner, G., Merin, U., Prosser, C.G. 2010. Recent advances in exploiting goat's milk: quality, safety and production aspects. *Small Rumin. Res.*, 89:110-124.
- Werner-Misof, C.M., Pfaffl, W., Bruckmaier, R.M. 2007. Dose-dependent immune response in milk cells and mammary tissue after intramammary administration of lipopolysaccharide in dairy cows. *Veterinarni Medicina*, 52:231-244.





## Analysis of a representative sample of Sarda breed artificial insemination rams with the OvineSNP50 BeadChip

M.G. Usai<sup>1</sup>, T. Sechi<sup>1</sup>, S. Salaris<sup>1</sup>, T. Cubeddu<sup>2</sup>, T. Roggio<sup>2</sup>, Sara Casu<sup>1</sup> & A. Carta<sup>1</sup>

<sup>1</sup>Research Unit: Genetics and Biotechnology, DIRPA-AGRIS Sardegna, Loc. Bonassai, 07100 Sassari, Italy

<sup>2</sup>PortoConteRicerche Srl, Loc. Tamariglio, 07041 Alghero, Italy

### Abstract

One hundred eleven artificial insemination rams with a high genetic impact on the Sarda breed selected population were chosen to be analysed with the OvineSNP50 BeadChip produced by Illumina. They had on average 165 lactating daughters in 75 flocks. The average relationship and inbreeding coefficients were  $0.065 \pm 0.102$  and  $0.017 \pm 0.040$  respectively. After editing 41,446 out of 54,241 available SNPs were retained. Reasons of exclusion were: number of no calls over 0 (2,783), unknown chromosome (364), X chromosome (1,341), significant deviation ( $P < 0.05$ ) from the Hardy-Weinberg equilibrium (4,950), minimum allelic frequency (MAF) lower than 2,5 % (3,357). The total length of the explored genome was 2,644,101 Kb ( $\approx 2,644$  cM). The average distance between markers was 63.796 Kb ( $\approx 0.064$  cM). The average MAF was 28%. The expected heterozygosity was on average  $0.37 \pm 0.13$ . The average number of heterozygous SNPs per ram was 15,583. The LD on 1,000 Kb measured as the squared correlation ( $r^2$ ) between pairs of loci was on average 0.07. Moreover, the LASSO-LARS procedure on the de-regressed EBVs for milk yield was performed. Forty five SNPs explaining 72% of the total variance were detected. The average SNP effect was 0.055 standard deviation units ranging from 0.002 to 0.183.

*Keywords: SNP, Sarda dairy sheep, OvineSNP50 Beadchip.*

### 1.0 Introduction

The recent availability of the OvineSNP50 Beadchip (Illumina) opens promising perspectives on using molecular information in the management of breeding schemes of dairy sheep populations. The large amount of information provided by this tool may have a strong impact on studies aimed at verifying the feasibility of Marker (or Gene) Assisted Selection or Genome-Wide Selection programs. The OvineSNP50 Beadchip has been recently used by the International Sheep Genomics Consortium (ISGC; [www.sheepmap.org](http://www.sheepmap.org)) to genotype samples from 64 different sheep breeds. The Sarda dairy sheep breed population may have great advantages by introducing molecular information in the selection scheme. Indeed the possibility to predict breeding values by genomic data might lead to reduce costs of phenotype recording and increase the number of selection objectives. In the present work we analysed a sample of rams with a high genetic impact on the Sarda selected population with the OvineSNP50 Beadchip. Moreover, an association analysis aimed at detecting a set of SNPs affecting milk yield was performed.

### 2.0 Materials and methods

A sample of 111 Sarda rams born from 1985 to 1999 and with a high genetic impact on the selected population was chosen among those involved in the artificial insemination program of the Sarda breed. The lactating daughters per sire were on average 165 ranging from 49 to 938, distributed on average in 75 flocks. The rams were genotyped with the OvineSNP50 BeadChip produced by Illumina. Genotypes were edited to exclude SNPs not suitable for further analyses. The minimum allele frequency (MAF); the expected and observed heterozygosities and the extent of linkage disequilibrium (LD), measured by the squared correlation between pairs of loci ( $r^2$ ; Hill and Robertson, 1968) were calculated. Moreover an association analysis between SNPs and de-regressed estimated breeding values (EBV) for milk yield was performed. In order to select a limited-size subset of SNPs the least absolute shrinkage and selection

operator (LASSO; Tibshirani, 1996) using the least angle regression (LARS; Efron *et al.*, 2004) algorithm, with cross-validations (Usai *et al.*, 2009) was performed. At each cross-validation replicate the rams' population was randomly split into a training (T) and validation (V) sample. The T and V sizes were 75% and 25% respectively. The best constraint per cross-validation replicate was the sum of absolute effects corresponding to the LASSO-LARS step where the correlation between Genomic-EBV (calculated from the effects estimated in T) and phenotypes of V was maximized. One thousand cross-validation replicates were performed. Then the LASSO-LARS procedure was carried out on the whole population until the sum of absolute effects was equal to the mean of the best constraints over all cross-validations. Furthermore the frequency of occurrence was calculated as the number of replicates where a given SNP showed non zero effect.

### 3.0 Results

The average relationship coefficient between pairs of rams was  $0.065 \pm 0.102$  and the average inbreeding coefficient was  $0.017 \pm 0.040$ . The average EBV was  $20.9 \pm 11.8$ . All rams were successfully genotyped. After editing 41,446 SNPs out of the original 54,241 were retained. In particular, reasons for SNP exclusion were: number of no calls higher than 0 (2,783); unknown location (364); chromosome X location (1,341), significant deviation ( $P < 0.05$ ) from the Hardy-Weinberg equilibrium (4,950); MAF lower than 2.5 % (3,357). The number of markers per chromosome ranged from 4,677 for OAR1 to 560 for OAR24.

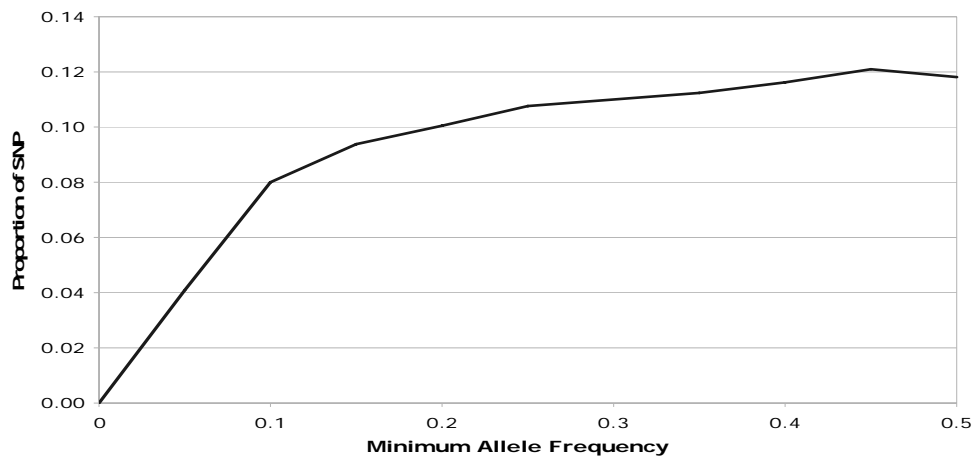

Figure 1. Minimum Allele Frequency (MAF) distribution.

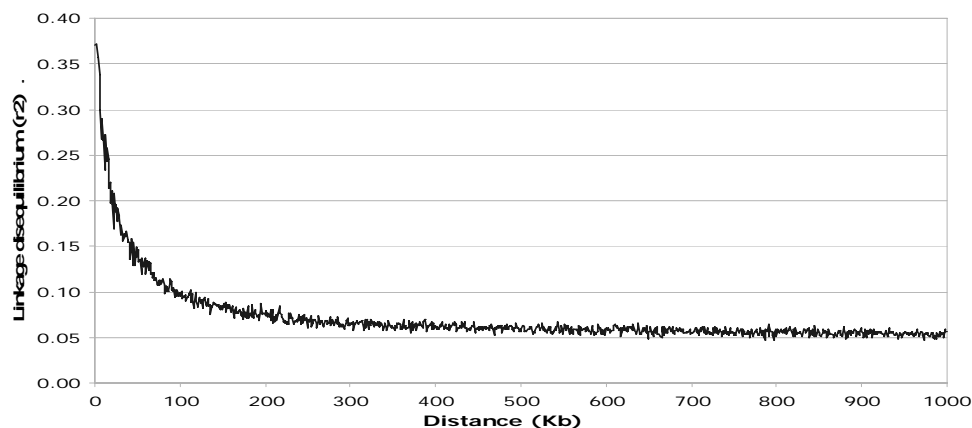

Figure 2. Linkage Disequilibrium ( $r^2$ ) profile.

The total length of the explored genome segment was 2,644,101 Kb ( $\approx 2,644$  cM). The average distance between flanking SNPs was 63.796 Kb ( $\approx 0.064$  cM) with a maximum of 3,571 Kb ( $\approx 3.571$  cM) on OAR10. The expected heterozygosity was  $0.37 \pm 0.13$  on average and slightly lower than the observed one ( $0.38 \pm 0.13$ ). The average number of heterozygous SNPs per ram was 15,583. Figure 1 shows the

distribution of MAF. The mean and the mode (12%) were 0.28 and 0.45 respectively. Figure 2 shows the profile of the average  $r^2$  according to the distance between SNPs. The maximum distance considered was 1000 kb ( $\approx 1$  cM). The average value of  $r^2$  over 1000 kb was 0.072. For a value of  $\approx 64$  Kb (average distance between retained SNPs)  $r^2$  was moderate 0.133

As far as the association analysis is concerned, the overall best constraint estimated by 1000 cross-validations was 28.74 which corresponded according to LASSO-LARS procedure on the whole population, to 45 SNP with non zero effect. These SNPs explained 72% of the total phenotypic variance. Figure 3 shows the effects and the frequency of occurrence of detected SNPs and their location along the genome. The average SNP effect was 0.055 standard deviation units ranging from 0.002 to 0.183. The frequency of occurrence of the selected SNPs was on average 27% and ranged from 6.6% to 70%.

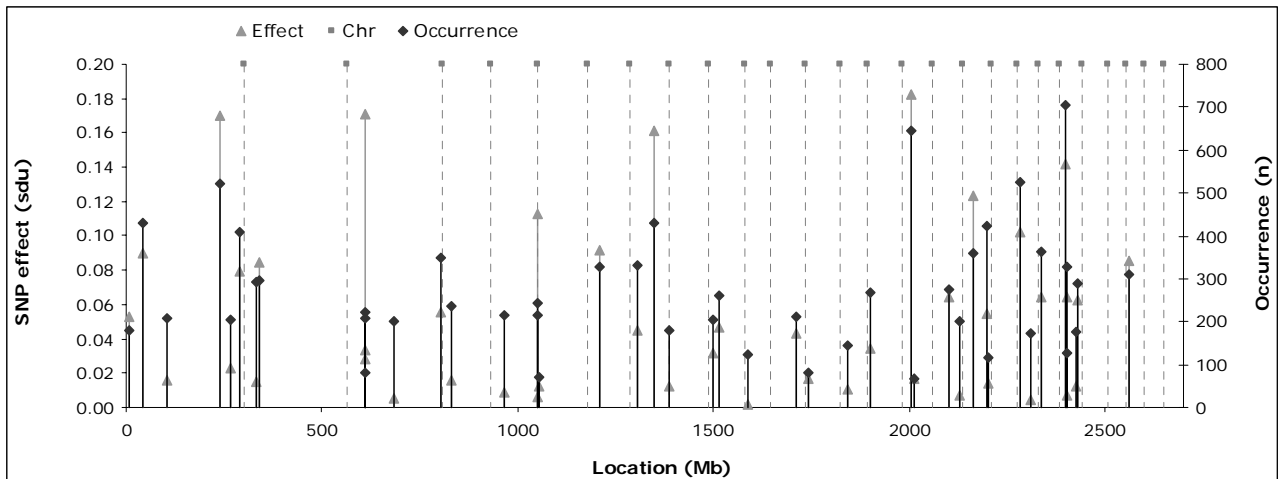

Figure 3. Effects and frequency of occurrence for the SNPs selected by LASSO-LARS procedure

## 4.0 Discussion and conclusion

Our results showed that the OvineSNP50 BeadChip can be successively used on the Sarda sheep breed. Indeed 76% of the original markers resulted suitable for genetic analyses. Furthermore, the MAF distribution and the observed heterozygosity showed a high information content of most markers. The  $r^2$  profile was similar to those observed in other dairy sheep breeds as Churra and Lacaune (Raadsma *et al.*, 2010). In Holstein dairy cattle for distances lower than 100 Kb,  $r^2$  were higher than those estimated here (de Roos, 2008). This difference could be explained by lower selection pressures and larger effective population sizes in dairy sheep breeds. Concerning the association analysis results, even if they are based on a small sample of artificial insemination rams, the amount of explained variance and the frequencies of occurrence of the selected SNPs seem promising for future analysis based on larger samples.

This work was funded by the research program "APQ per la ricerca scientifica e l'innovazione tecnologica, progetto P5a – Attivazione del Centro di biodiversità animale per la valorizzazione del patrimonio animale con riferimento alla produzione e alla ricerca al servizio dell'allevamento" of the regional government of Sardinia.

## 5.0 References

- de Roos, A.P.W., B.J. Hayes, R.J. Spelman, and M.E. Goddard, 2008. Linkage Disequilibrium and Persistence of Phase in Holstein–Friesian, Jersey and Angus Cattle. *Genetics* 179, 1503-1512.
- Efron, B., T. Hastie, I. Johnstone, and R. Tibshirani, 2004. Least angle regression. *Ann. Statist.* 32:407-499.
- Hill, W. G., and A. Robertson, 1968. Linkage disequilibrium in finite populations. *Theor. Appl. Genet.* 38:226-231.
- Raadsma, H., 2010. LD analyses in the sheep HapMap project using an ovine 50K SNP array. <http://www.sheephapmap.org/pag.php>
- Tibshirani, R., 1996. Regression shrinkage and selection via the Lasso. *J. Royal. Stat. Soc. B.* 58:267-288.



Usai, M.G., M.E. Goddard, and B.J. Hayes, 2009. LASSO with cross-validation for genomic selection. *Genet. Res.* 91:427-436.



## Use of genomic data in French dairy sheep breeding programs: results and prospects

J.M. Astruc<sup>1</sup>, G. Lagriffoul<sup>1</sup>, H. Larroque<sup>2</sup>, A. Legarra<sup>2</sup>, C. Moreno<sup>2</sup>, R. Rupp<sup>2</sup>, F. Barillet<sup>2</sup>

<sup>1</sup>Institut de l'Élevage – BP 42118 – F-31321 Castanet-Tolosan Cédex, France

<sup>2</sup>INRA-UR631, Station d'amélioration génétique des animaux, F-31326 Castanet-Tolosan, France

### Abstract

The selection of the 5 French dairy sheep breeds is presently based on the usual quantitative genetics approach, both for milk production and udder functional traits, using pedigree and recorded phenotypes in nucleus flocks. Moreover since 2002 a gene-assisted selection (GAS) has also been implemented to select for scrapie resistance against classical scrapie and BSE strain, based on a large scale PrP gene genotypings. This national scrapie plan was included in the existing breeding schemes : between 2002 and 2009, a total of 160,000 PrP genotypings have been funded and designed, mainly in the nucleus flocks, in the aim to be efficient at the whole population level. As a result in 2009, 95 % of the rams used in the nucleus flocks were homozygous ARR sires, illustrating the efficiency of PrP GAS in French dairy sheep populations. Now a high-density SNP array ( the Illumina Ovine SNP50 BeadChip) available in sheep since January 2009 makes feasible in the future either marker-assisted selection (MAS)/GAS, or genomic selection (GS), at least in the Lacaune and Manech red faced breeds, thanks to the size of the nucleus of the 5 French dairy sheep breeds using extensively AI and to the storage of the DNA/blood of the AI rams since the middle of the 90's. Therefore we present an overview of different genomic on-going projects involving the French dairy sheep breeds.

*Keywords: dairy sheep, genomics, selection, SNP, breeding schemes.*

### 1.0 Introduction

The selection of the 5 French dairy sheep breeds is presently based on the usual quantitative approach, both for milk production and udder functional traits, using pedigree and recorded phenotypes in nucleus flocks. This selection has given sound results, with differences from one breed to another, according to the size of the selected population in nucleus flocks, the starting year of each breeding program, and the more or less extensive use of animal insemination (AI).

Since 2002 a gene-assisted selection (GAS) has also been implemented to select for scrapie resistance against classical scrapie and BSE strain, based on a large scale PrP gene genotypings. This national scrapie plan was included in the existing breeding schemes and has allowed a successfully increase of the frequency of the ARR allele, firstly in the nucleus flocks, then in the commercial flocks. Such a GAS has been made possible through the development of both strategies and tools, which would be useful to any other gene selection.

The Illumina Ovine SNP50 BeadChip, available in sheep since January 2009, opens the door to a more systematic utilization of genomic tools in the future, either by applying marker-assisted selection (MAS)/GAS, or genomic selection (GS) in the French dairy sheep breeds.

In this paper, we first intend to present the breeding programs of the French dairy sheep breeds, in order to bring to light the assets of these programs for a possible use of genomic tools. We describe the main features of the GAS implemented for ovine PrP gene, underlining the organization and tools that have been set up to succeed in spreading the favorable ARR allele as a genomic way to increase scrapie resistance. Finally, we present the different on-going genomics projects in French dairy sheep breeds, whose common applied purpose is to test MAS/GAS, or GS.

## 2.0 The dairy sheep breeding programs in France

Dairy sheep breeding in France is mainly located in 3 mountainous areas of Southern France, in which one or more local breeds are milked to produce high added-value cheese: the Lacaune breed in the Roquefort area (Roquefort cheese), the Manech (red-faced and black-faced) and the Basco-Béarnaise breed in the Western Pyrenean hills and mountains (Ossau-Iraty cheese), the Corsican breed in the Corsica Island (various kinds of cheese, bruciu cheese).

Since the early seventies, breeding programs have been implemented for each breed, based on extensive milk recording, heat synchronization and animal insemination (AI), progeny-test and assortative matings. They are also based on a pyramidal organization of the population with, at the top, breeders of the nucleus flocks, where breeding programs are carried out, and from where the genetic gain is transferred afterwards to the commercial flocks by using natural mating or AI rams born in the nucleus flocks (Barillet, 1997). The table 1 highlights main features of the selection breeding programs, showing differences between breeds.

Table 1. Size of the selection programs in the French dairy sheep breeds (year 2009)

Breed	Total population	Population recorded in nucleus flocks (%)	Number of AI (AI rate within the nucleus flocks)	Progeny-tested AI rams
Lacaune	900,000	173,568 (19%)	395,800 (85%)	445
Red-faced Manech	270,000	70,712 (26%)	56,800 (50%)	151
Black-faced Manech	100,000	14,509 (15%)	7,900 (45%)	36
Basco-Béarnaise	80,000	21,984 (27%)	14,100 (50%)	52
Corsican	95,000	21,050 (23%)	6,300 (30%)	31

For each breed, the selection criteria and the efficiency of the breeding schemes depend on the size of the entire population and the part of population included in nucleus flocks (submitted to official AC milk recording), the impact of AI, the number of AI rams progeny-tested, the history and age of each breeding scheme, according to the organization of the breeders and industry interest. The table 2 summarizes selection criteria as well as indicators illustrating the efficiency of the breeding programs. Among the main features:

The program of the Lacaune breed has included functional traits at a 50% level since 2005 (Barillet *et al.*, 2006; Barillet, 2007). The program of the Pyrenean breeds has included fat and protein, steadily since 2001, up to a 2009 new criterion whose objective is to increase fat and protein yields and contents.

The relationship between the impact of AI and progeny-test and the efficiency of the selection program is high, as shown when looking at tables 1 and 2.

Table 2. Selection criteria and efficiency of the breeding schemes in the French dairy sheep breeds.

Breed	Selection criteria <sup>1</sup>	Annual Genetic gain in MY for rams (1995-2007) (liters)	Average lactation in 2009 in liters (length in days)
Lacaune	1/2 FY+PY+F%+P%) + 1/2 (SCC+U)	6.4 272	(164)
Red-faced Manech	FY+PY+F%+P%	3.8	180 (155)
Black-faced Manech	FY+PY+F%+P%	1.2	134 (139)
Basco-Béarnaise	FY+PY+F%+P%	2.9	164 (146)
Corsican	MY	0.7	133 (182)

MY = milk yield, FY = fat yield, PY = protein yield, F% = fat content, P% = protein content, SCC = somatic cell count, U = udder morphology.

<sup>1</sup>Economic values for each trait included in the subindex for milk production (MY, or FY, PY, F%, P%) and in the subindex for functional traits (SCC, U) are not described in the selection criteria of the table 2.

### 3.0 A large scale gene assisted selection: selecting for scrapie resistance

In addition to the phenotypic selection on quantitative traits, the BSE crisis context has been the starting point, from 2000, of the implementation of a GAS for scrapie resistance, based on PrP gene genotyping. The objective of the program was to eradicate the unfavorable VRQ allele and to select for the favorable ARR allele (Leymarie *et al.*, 2009). Since the breeding programs were efficient and the diffusion AI-oriented, the efforts of genotypings focused first in the nucleus flocks, in the aim to combine selection on the PrP gene and selection on production and functional traits, while maintaining genetic variability of each breed. Regarding initial allelic frequencies, the situation was heterogeneous from one breed to another, from only 17% of favorable ARR allele in the Red-Faced Manech to 55% in the Lacaune breed.

To tackle the issue, from 2000 to 2009, 160,000 genotypings have been carried out. The genotyping strategies were different from one breed to another, depending on the initial ARR allelic frequency of the PrP gene and on the relative part of AI. In the Lacaune breed, the genotypings concerned the young rams candidates to enter the breeding centers, whereas in the other breeds, both candidate rams and elite dams were genotyped, to take into account a more unfavorable initial ARR frequency as well as a less extensive use of AI in the nucleus flocks. The organization of the genotypings were made to allow the young rams be PrP genotyped very early, before entering the breeding center at 1 month-old. To face this constraint a blood sampling is taken at about 10 days-old, sent to an agreed lab, which sends back the result as quickly as possible to allow the program manager to select young rams for the breeding center.

A national molecular information system has been set up to manage and valorize PrP genotypes. The molecular database, when exchanging with the dairy sheep genetic information system (named SIEOL), enables passing on of checked genotypes for selection purposes and computation of genotype predictions on relatives (Astruc *et al.*, 2008 ; Morin *et al.*, 2008).

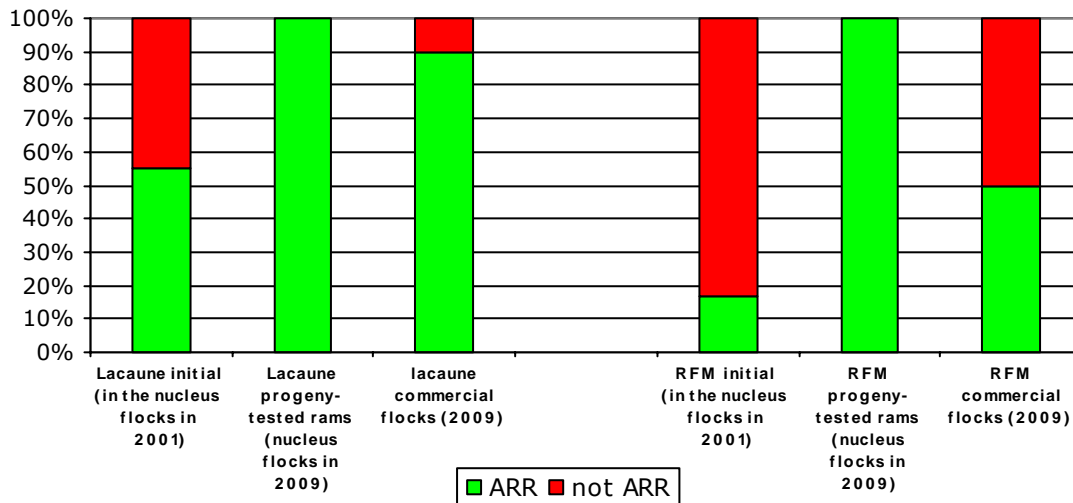

Figure 1. Evolution of the PrP allelic frequencies in the Lacaune and Red-Faced Manech (RFM) breeds between 2001 and 2009.

The increasing number of genotypes and predictions, combined with the use of AI and diffusion of natural mating rams, has allowed a dramatic change in the allelic frequencies. The figure 1 illustrates the results of the PrP breeding plan, within the breeding program (nucleus flocks) and in the whole population (commercial flocks) for the Lacaune and Red-Faced Manech breeds.

## 4.0 Genomics in the French dairy sheep breeds : on-going projects and strategies for using genomic data

Using the opportunity of the PrP scrapie plan as well as research programs for QTL detection in the French dairy sheep breeds, a DNA-bank was constituted, from the middle of the nineties. Blood samples of all the AI rams progeny-tested in the 5 French dairy sheep breeds were systematically collected and sent to the molecular laboratory Labogéna in Jouy-en-Josas. In 2009, the collection of DNA-samplings of AI progeny-tested rams reached 9,100 rams, as shown in the table 3.

Since January 2009, a high-density SNP array (the Illumina Ovine SNP50 BeadChip) has been available in sheep, opening the door in the future to an either marker-assisted selection (MAS)/GAS, or genomic selection (GS).

Table 3. DNA-collection on the French dairy sheep breeds (year 2009).

Breeds	Number of AI progeny-tested rams with storage of DNA	Year of beginning of the DNA-storage
Lacaune	5961	1995
Red-Faced Manech	1940	1995
Black-Faced Manech	436	1995
Basco-Béarnaise	544	1995
Corse	219	2003

Furthermore, the recent developments on genomic selection and their growing applications in bovine have stimulated the breeding organizations involved in dairy sheep in France, alongside with the organizations of research and development (INRA and Institut de l'Élevage) to set up a strategy of utilization of the genomic tools. In this purpose, different projects have been built and are on-going. Thus, several programs have been launched, which are complementary and serve the adopted strategy.

According to the size of the selection programs, which is different from one breed to another (Table 1), the proposed strategy consists in studying and testing the utilization of genomics based either on MAS/GAS, or genomic selection (GS) with the idea to test different methods or procedures to run genomic evaluations (Aguilar *et al.*, 2010). Indeed, the implementation of GS seems feasible at least in the Lacaune and Red-Faced Manech breeds, whose potential training populations, higher than a minimum of 1,000 animals (table 3), could allow genomic estimated breeding value (GEBV) predictions to be accurate enough for further utilization to compute GEBVs for young rams at birth. In the other breeds with smaller training populations, an across-breed genomic selection approach will be tested, particularly for the Manech breeds, whose racial and environmental proximity to the Latxa breeds from Spain might allow to mix all the progeny-tested rams with true proofs in a single training population, which could be sufficient to estimate accurate enough genomic equations. We will check if this across-breed approach, using Illumina ovine SNP50 BeadChip, is relevant.

The strategy lays on the following programs, mainly based on genotyping but also on engineering inputs:

The SheepSNPQTL project (2009-2011) (Moreno *et al.*, 2009), partially founded by research and breeder organizations, besides fine detection of QTL, aims at determining a first set of procedures to calculate genomic breeding value estimates (GEBV) for selected traits in the Lacaune breed, using a thousand of well-known progeny-tested rams.

The European 3SR project (2009-2011) is devoted to major gene and QTL detection in sheep and goats. The final aims are, on the one hand, to provide enhanced insight into mechanisms controlling resistance to mastitis, resistance to gastrointestinal parasites and ovulation rate, and, on the other hand, to provide lists of SNP associated to those traits and that can be used for selection.

One of the goal of the Roquefort'in project (2010-2013) is to test a genomic selection approach in the dairy Lacaune breed with the following tasks : increasing the accuracy of the GS procedures previously estimated in the SheepSNPQTL project, using 2,000 rams more in order to reach a training population of 3,000 rams; experimenting GS, by computing GEBV for a part of two batches of young rams to be progeny-tested in 2011 and 2012, two-third of each batch being chosen classically on EBV ancestor selection, and one-third of each batch being chosen with a

GEBV selection pressure, in the aim to compare EBV or GEBV efficiency with official proofs got in 2013. On the whole, 4,000 rams will be SNP genotyped.

The across-border project Genomia (2010-2012) involves the French Manech and Spanish Latxa breeds. Regarding genomic selection, the purpose is to test GS in Manech red faced breed alone (training population of 1,000 rams); then to test an across-breed GEBV approach, by genotyping 2,600 AI rams, corresponding to the mixing of Red-Faced and Black-Faced Manech, Blond-Faced and Black-Faced Latxa training populations.

The on-going project PhenoFinLait (2008-2013) (Faucon *et al.*, 2009) ([www.phenofinlait.fr](http://www.phenofinlait.fr)), also partially founded by research and breeder organizations, concerns cattle, goats and sheep and aims mainly at searching QTL for milk fatty acid profiles and milk proteins, but will be also useful for fine QTL detection on all the selected traits recorded in the nucleus flocks. In dairy sheep, 2,000 SNP genotypings will be performed in this project, corresponding to a daughter design in Lacaune and Manech red faced breeds.

The Genovicap project (2010-2012), jointly led by INRA and Institut de l'Élevage associated in a partnership unit named UMT GENEPR is devoted to the engineering issues: how to handle genomic data, how to run the breeding schemes using genomic breeding values, how to adapt them, how to organise the genotypings (founding, chip purchase, genotypings).

The challenge and hopes in GS for dairy sheep in France, associated or not with fine QTL detection or knowledge of causal mutations, would be to increase the selection efficiency, by speeding up selection on routinely recorded traits, and/or by implementing selection of new traits expensive or difficult to record. Thus the first step will be to test the accuracy of GEBV prediction for selected milk and functional traits. Assuming that accuracies of GEBV will be sufficient to select elite sires very early, the way(s) towards which the increasing efficiency will have to be used and oriented will be a major concern for the breeding organizations and those who manage the breeding programs:

Reducing costs (removing the progeny test of AI rams and reducing the total number of AI rams). The selection tools are expensive in sheep regarding the gross margin per animal (milk recording, AI). Cutting costs while maintaining the genetic relevance/efficiency has always been a key concern in dairy sheep programs in France.

Increasing genetic gain on actual selected traits. This is of most importance since all breeds have a long generation interval for the sire pathways in present phenotype selection regarding progeny-test of AI rams; this could be dramatically reduced by GS.

Adding new traits in the selection criteria of dairy sheep breeds (Barillet, 2007). The demand of both industry, breeders and consumers is still growing regarding healthy and functional animals and foods; thus encouraging the breed organizations to introduce new traits in the breeding goals: production traits (milk fatty acid profiles, milk persistency and once a day milking ability), functional traits (as milking ability or disease resistance, such as mastitis, nematodes or scrapie resistance) ...

These different ways are all relevant and will probably mix to an expected improvement of the selection efficiency.

At the same time, the breeding organizations will have to think and face evolutions of the breeding schemes:

What new management of the AI livestock without progeny-testing ?

Which size of the open nucleus population, with official animal recording ?

How to re-organize engineering ?

How to take into account genomic data in the information system, as it has been successfully completed for the integration of PrP gene ?

## 5.0 Conclusion

The breeding programs of the French dairy sheep breeds are known to be efficient on a classical phenotypic selection basis. The management of the PrP gene to reinforce scrapie resistance of the entire population, which is the first application of using genomics data on a large scale, was a success story.

Regarding the availability of the Illumina Ovine SNP50 Bead Chips since January 2009 and the recent developments on genomic selection, the French dairy sheep breeding schemes are in a favourable situation to successfully introduce genomic data in their programs: the Lacauine and Red-Faced Manech programs are based on a high number of progeny-tested rams due to an extensive use of AI in their nucleus flocks. Furthermore, the storage of DNA has been implemented for more than a decade. Thus the breeders of the French dairy sheep breeds have decided to test and implement a genomic selection or a marker/gene-assisted selection (both are not antagonistic). Therefore, several genomic projects are ongoing and will output results and answers in the next years, basically on the accuracies of GEBV for the selected traits and then on the cost-effectiveness of such a selection, compared to the actual phenotypic selection. The structuring power of these on-going projects on the breeders, research and development, and the co-operation between all these organizations involved in provide a favourable situation to face this exciting challenge in dairy sheep. Nevertheless unexpected issues arise, among them the legal aspects around the status of the GEBV: shall an individual breeder be authorized to use genomic tools and consequently GEBV from its own within-flock rams, given that the computation of such GEBV has required a huge collective investment? This kind of questions is far from being clearly answered.

## References

- Aguilar, I., Misztal, I., Johnson, D.L., Legarra, A., Tsuruta, S., Lawlor, T.J., 2010. Hot topic: A unified approach to utilize phenotypic, full pedigree, and genomic information for genetic evaluation of Holstein final score. *J. Dairy Sci.* 93: 743-752.
- Astruc, J.M., Lagriffoul, G., Morin, E., Barillet, F., Bonaiti, B., Rehben, E., 2008. SIEOL : implementing a global information system for genetic and techno-economic support in dairy sheep in France. Proc. 36th Session of ICAR, Niagara Falls, USA, 18-20 June 2008, ICAR Technical Series, N° 13, 123-127.
- Barillet, F., 1997. Genetics of milk production, Chap 20. In: Piper, I., Ruvinsky, A. (Eds.), *The Genetics of Sheep*. CAB International, pp. 539-564.
- Barillet, F., Astruc J.M., Lagriffoul, G. 2006. Taking into account functional traits in dairy sheep breeding programs through the French example. 35th ICAR Session, Kuopio, Finland, EAAP publication N° 121, 57-64.
- Barillet, F., 2007. Genetic improvement for dairy production in sheep and goats, chapter of the special issue entitled «The outlook of quantitative and molecular genetics. Application in improving Sheep and Goats», edited by D. Notter, R. L. Baker and N. Cokett. *Small Ruminant Research* 70 (2007) 60–75
- Faucon F., Brochard M., Barillet F., Bollard M., Brunshwig P., Duhem K., Eggen A., Esvan S., Ferrand M., Fritz S., Gastinel P.L., Guerin J.L., Journaux L., Krychowski T., Lagriffoul G., Larroque H., Lecomte C., Leray O., Leveurier S., Martin P., Mattalia S., Miranda G., Palhière I., Peyraud J.L., Boichard D. PhenoFinLait (LactoScan) : French national program for high scale phenotyping and genotyping to detect QTL linked with fine composition of ruminant milk. International Milk Genomics Consortium, Paris, France, 28-30 Septembre 2009.
- Leymarie C, Bouffartigue B, Astruc JM, Bael den M, Barillet F, Bibé B, Bonnot A, Boscher MY, Bouix J, Brochard M, Dion F, François D, Jouhet E, Jullien E, Orlianges M, Moreno C, Palhière I, Perret G, Raoul J, Sidani C, Tiphine L, Raynal A, Bouchel D, Catrou O, Chibon J, Tribon. The national breeding program for scrapie resistance in the French sheep population. *Renc.Rech.Ruminants* 2009, 16. 411-414.
- Moreno C., Servin B., Faraut T., Klopp C., Rupp R., Mulsant P., Robert-Granié C., Barillet F., Delmas C., Bouix J., François D., Allain D., Manfredi E., Bodin L., Elsen J.M., Robelin D., Mangin B., Aurel M.R., Bouvier F., Calavas D., San Cristobal M., Jacquiet P., Foucras G., Boissy A., Legarra A.. SheepSNPQTL : a 60,000 SNP chip to fine map QTL affecting production traits, resistance to diseases and behavior in sheep. *Renc.Rech.Ruminants*, 2009, 16. 420.
- Morin, E., Astruc, J.M., Lagriffoul, G., SIEOL, a new global information system for genetic and techno-economic support for dairy sheep breeders in France. Proceedings of the International Mediterranean Symposium of EAAP in Corte, France, 6-8 November 2008.

## 6.0 Acknowledgements

Financial support of the different projects described in this paper was provided by Apis-Gène, ANR, Casdar, Conseils Généraux de l'Aveyron et du Tarn, Communauté de Communes du Grand Rodez, France Agri-Mer, Feder, FGE, FUI, Ministère de l'Agriculture, Région Aquitaine, Région Midi-Pyrénées.







## Evaluating the accuracy of the genetic ranking of rams in the selected population of the Sarda dairy sheep breed

S. Salaris<sup>1</sup>, Sara Casu<sup>1</sup>, M.G. Usai<sup>1</sup>, P. Fresi<sup>2</sup>, A. Carta<sup>1</sup>

<sup>1</sup>Research Unit: Genetics and Biotechnology, DIRPA-AGRIS Sardegna, S.S. 291 Sassari-Fertilia, Km. 18.6, 07100 - Sassari, Italy

<sup>2</sup>Associazione Nazionale della Pastorizia – ASSONAPA, Via Togliatti 1587, 00155 - Rome, Italy

### **Abstract**

In Sarda breed it is difficult to extend the use of AI to the whole selected population due to specific features of the breeding system. The current rate of AI (8 to 10% of replacement ewes) is not sufficient by itself to assure the genetic connectedness between all selected flocks. However, the breeding scheme is characterized by a large use of the controlled natural mating with an important exchange of rams which may counterbalance the low spread of AI. The aim of this study was to assess the accuracy of the genetic ranking of AI and natural mating rams obtained by BLUP methods. The connectedness correlation ( $r_{ij}$ ) was used to cluster sires of the last generation in connected subpopulations. The iterative process joins at each step the two sires (or clusters) with the highest  $r_{ij}$  in a new cluster. The process stops when the highest  $r_{ij}$  equals a given threshold. At 0.005 threshold, a large subpopulation including 1,236 sires was detected. For higher thresholds, two large sub-populations were identified: the largest including most of AI rams and the smallest rams belonging to few elite farms or flocks where farmers were used to buy males from the elite farms. This study showed that the current breeding management allows to reach a sufficient level of reliability of the genetic ranking of animals for most flocks.

*Keywords: Connectedness correlation, artificial insemination, dairy sheep.*

## **1.0 Introduction**

The main feature of the Sarda breeding program is the large application of the controlled natural mating (CNM) combined with low rates of AI. It is difficult to extend the use of AI to the whole selected population due to specific features of the breeding system. The current rate of AI (8 to 10% of replacement ewes) is not sufficient by itself to assure the genetic connectedness between all selected flocks. However, the large use of CNM with an important exchange of males, mainly sons of AI rams, may counterbalance the low spread of AI. In a previous work, Salaris *et al.* (2008) showed that, although limited by organisational constraints, the combining of CNM with AI allowed to reach a high number of direct genetic links between rams (*i.e.* direct comparisons through lactating daughters in the same management unit). Moreover, the number of completely disconnected flocks have had a strong decrease in the last 20 years. However, the authors concluded that a more precise evaluation of the genetic connectedness of the registered Sarda breed population was needed to assess the accuracy of the genetic ranking of animals. Lewis *et al.* (1999) proposed the correlation of breeding value prediction errors ( $r_{ij}$ ) as a measure of the connectedness between pairs of sires. Khuen *et al.* (2009) used the average  $r_{ij}$  to cluster flocks in different subsets. Salaris *et al.* (2010) proposed to use  $r_{ij}$  as a criterion to assign rams to different genetic subpopulation and the square of the correlation between estimated and true differences between breeding values (CD; Laloe *et al.*, 1993) as a measure of the accuracy of the contrast between EBV. The aim of this study was to assess the accuracy of the genetic ranking of AI and CNM rams obtained by BLUP method in the selected population of the Sarda dairy sheep breed by using objective measures of connectedness.

## **2.0 Material and methods**

A dataset including 308,503 first lactation records of yearlings born from known sires (9,330) between 1995 to 2007 was extracted from the 2008 genetic evaluation database managed by the Italian Association of Sheep Breeders (ASSONAPA). The ewes yielded in 10,034 management units (flock-year of

production combinations). Data were analyzed with a mixed model including the management unit as fixed effect and the random sire effect.

The connectedness correlation ( $r_{ij}$ ) and the coefficient of determination (CD) of the contrast for all possible pairs of 1,404 sires of 21,331 ewes born in 2007 were calculated as:

$$r_{ij} = \frac{PEC(\hat{u}_i, \hat{u}_j)}{\sqrt{PEV(\hat{u}_i)PEV(\hat{u}_j)}}; CD(\mathbf{x}) = \frac{\mathbf{x}'(\mathbf{A} - \lambda\mathbf{C})\mathbf{x}}{\mathbf{x}'\mathbf{A}\mathbf{x}}$$

where PEV is the prediction error variance and PEC is the prediction error covariance of the EBV ( $\hat{u}_i$  and  $\hat{u}_j$ ) of the  $i^{th}$  and  $j^{th}$  sires. PEV and PEC were calculated multiplying the residual variance ( $\sigma_e^2$ ) by the diagonal and the off diagonal elements of  $\mathbf{C}$ , the inverse of the fixed effect absorption matrix,  $[\mathbf{Z}'\mathbf{Z} - \mathbf{Z}'\mathbf{X}(\mathbf{X}'\mathbf{X})^{-1}\mathbf{X}'\mathbf{Z} + \mathbf{A}^{-1}]^{-1}$ , respectively, and  $\mathbf{x}$  is the vector of coefficients defining the contrast.  $\mathbf{X}$  and  $\mathbf{Z}$  are the incidence matrices of the management unit fixed factor and the sire random factor respectively,  $\mathbf{A}$  is the numerator relationship matrix, was calculated as the ratio of  $\sigma_e^2$  and the sire variance ( $\sigma_s^2$ ).  $\sigma_s^2$  and  $\sigma_e^2$  were imposed equal to 80 L<sup>2</sup> and 1,040 L<sup>2</sup>.

A clustering iterative process was used to group sires into connected subpopulations using  $r_{ij}$  as a measure of distance between sires. The process begins setting each sire in a cluster by itself. Then the iterative procedure joins the 2 sires (or clusters) with the highest  $r_{ij}$  in a new cluster. When a cluster includes more than one sire, the average  $r_{ij}$  of the included sires with the sires of other clusters was calculated. The procedure stops when the highest  $r_{ij}$  equals a given threshold. Accordingly to Khuen *et al.* (2009), two thresholds were chosen: 0.010 ("superior" level of connectedness) and 0.005 ("good" level of connectedness). A further intermediate threshold of 0.007 was introduced. At each threshold, the number and the size of identified clusters were calculated. The following parameters were averaged for relevant (more than 50 sires) clusters:  $r_{ij}$ , CD, the total number of daughters per sire (NF); the total number of effective daughters per sire (NFW); the total number of CG in which a sire had daughters (NCG); the total number of directly compared sires per sire (NP); the inbreeding coefficient (IC); the average relationship of a sire within a given CG (PW) calculated as the average relationship coefficient with the other sires in the CG weighted for the effective number of daughters. NF, NFW, NCG and NP affect the accuracy of EBV (Tosh and Wilton, 1994) whereas increasing PW and IC reduce CD of contrast (Kennedy and Trus, 1993).

### 3.0 Results and Discussion

About 61% of the 2008 recorded yearlings were born from known sires. The average PEV of sires' EBV was  $40.8 \pm 15.0$  L<sup>2</sup>. The PEC mean was  $0.3 \pm 0.4$  L<sup>2</sup>. Average additive relationship between sires was  $0.038 \pm 0.055$  and ranged between 0 and 0.898. The average  $r_{ij}$  of all possible comparisons (984,906) between sires were  $0.010 \pm 0.011$  and ranged between 0 and 0.641. Only 3.5% of all possible pairs of sires showed null  $r_{ij}$ .

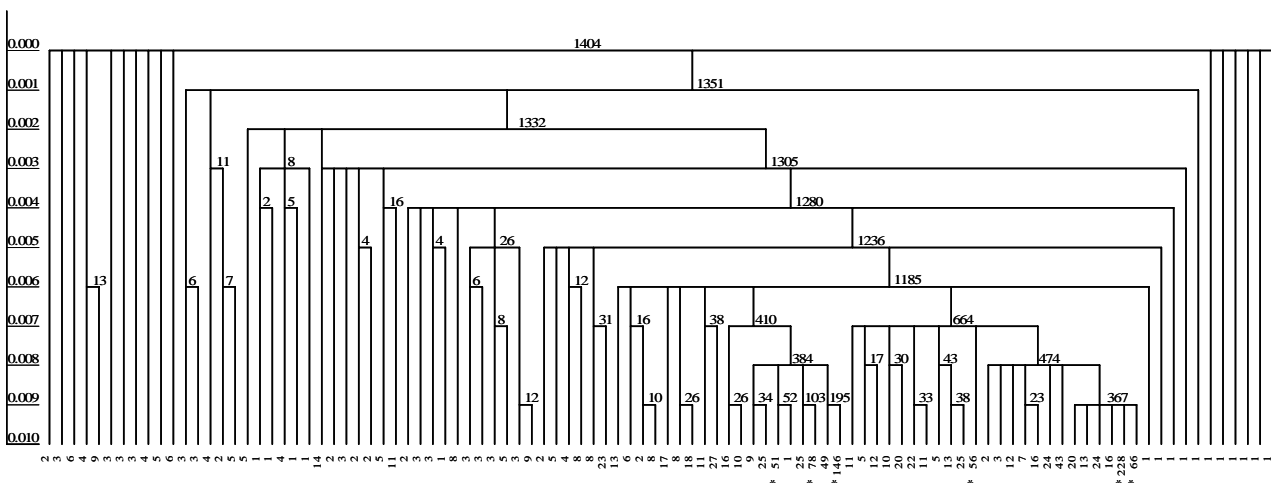

Figure 1. Diagram of clustering procedure results at successively decreasing connectedness correlation ( $r_{ij}$ ) thresholds (from 0.010 to 0 with a step of 0.001). Horizontal axis represents the number of rams grouped in each cluster at 0.010  $r_{ij}$  threshold level (clusters highlighted with asterisk included more than 50 sires). Vertical axis represents  $r_{ij}$  threshold levels. The number of rams grouped in a cluster are reported within the diagram.

The percentage of sires included in the largest cluster increased from 16.2% at 0.010  $r_{ij}$  threshold, to 47.3% at 0.007, and 88.0% at 0.005 (Figure 1). At the 0.010 threshold, 83 different subpopulations including on average  $17 \pm 31$  sires (from 2 to 228 sires) were detected. At 0.005 threshold a large cluster including 1,236 sires and other 26 clusters including more than 2 sires were formed. At 0.007 two large separate subpopulations of rams with 664 and 410 rams respectively were identified. The first included mainly AI sires whereas the second included many rams born in few flocks, located in the central-west part of Sardinia, which represents the historical region where selection of the Sarda breed started. Breeders of these regions usually raise own homebred rams and are the main rams sellers to the registered flocks.

The largest cluster at each threshold included always the largest rate of AI rams and it always showed the higher average CD of contrasts (Table 3). The difference of CD means between the two largest subpopulations at 0.007 threshold was 0.024. The CD mean within the largest cluster at 0.005 threshold was 0.524. This level of connectedness can be ascribed to the strategy of combining a low rate of AI with an important exchange of CNM sires. Actually, Salaris *et al.* (2008) showed that the average number of natural mating groups per flock was 1.9, with 52% of flocks with only 1 sire, 38% with 2 or 3 sires and 10% with more than 3 sires. Over the last twenty years the percentage of CNM sires born by AI increased from 2% to 32%, connecting 19% of flocks not directly involved in the AI program. As far as the genetic links created by CNM rams are concerned, the average annual percentage of sires born in one flock and used in another one was 62% and the average annual percentage of CNM sires with daughters in more than one flock was 23%. Significant higher value of NFW, NCG, and NP and smaller values of PW and IC means were found in clusters with high rate of AI sires. These differences are in the direction of a better accuracy of EBV as confirmed by a significant lower PEV mean.

This study showed that the current breeding management of the Sarda dairy sheep breed allows to reach a sufficient level of accuracy of the genetic ranking of rams involved in the breeding program, including CNM rams which still play a crucial role in the selection program.

Table 1. Number of sires (NS) and AI sires (NAIS) grouped in clusters with more than 50 rams at 0.010, 0.007 and 0.005  $r_{ij}$  threshold levels (TL) and means<sup>1</sup> per cluster of: connectedness correlation ( $r_{ij}$ ), coefficient of determination of the contrast (CD), prediction error variance of EBV (PEV), number of daughters (NF) and number of effective daughters (NFW) per sire, number of management units in which the sire has daughters (NCG), number of other sires directly compared to the considered sire (NP), average additive relationship coefficient within CG (Pw), inbreeding coefficient (IC) per sire.

TL	NS	NAIS	$r_{ij}$	CD	PEV	NF	NFW	NCG	NP	Pw	IC
0.010	51	0	0.028 <sup>a</sup>	0.540 <sup>a</sup>	40.3 <sup>a</sup>	42	17	3 <sup>b</sup>	9 <sup>b</sup>	0.063 <sup>c</sup>	0.158 <sup>b</sup>
	56	1	0.040 <sup>b</sup>	0.502 <sup>b</sup>	39.7 <sup>a</sup>	33	18	3 <sup>b</sup>	9 <sup>b</sup>	0.060 <sup>bc</sup>	0.071 <sup>a</sup>
	66	5	0.021 <sup>c</sup>	0.564 <sup>c</sup>	35.3 <sup>ab</sup>	38	22	5 <sup>b</sup>	24 <sup>b</sup>	0.046 <sup>bc</sup>	0.064 <sup>a</sup>
	78	0	0.024 <sup>d</sup>	0.500 <sup>b</sup>	41.9 <sup>a</sup>	35	15 <sup>b</sup>	2 <sup>b</sup>	5 <sup>b</sup>	0.058 <sup>c</sup>	0.162 <sup>b</sup>
	146	1	0.023 <sup>c</sup>	0.518 <sup>d</sup>	39.3 <sup>a</sup>	38	20	2 <sup>b</sup>	9 <sup>b</sup>	0.106 <sup>a</sup>	0.180 <sup>b</sup>
	228	74	0.016 <sup>e</sup>	0.586 <sup>e</sup>	33.2 <sup>b</sup>	42	25 <sup>a</sup>	11 <sup>a</sup>	64 <sup>a</sup>	0.036 <sup>b</sup>	0.044 <sup>a</sup>
0.007	410	1	0.014 <sup>a</sup>	0.519 <sup>a</sup>	41.1 <sup>a</sup>	39	18 <sup>b</sup>	2 <sup>b</sup>	7 <sup>b</sup>	0.076 <sup>b</sup>	0.166 <sup>b</sup>
	664	119	0.012 <sup>b</sup>	0.543 <sup>b</sup>	37.4	37	21 <sup>a</sup>	7 <sup>a</sup>	39 <sup>a</sup>	0.038 <sup>a</sup>	0.052 <sup>a</sup>
0.005	1236	128	0.010	0.524	39.3	37	19	5	24	0.052	0.089

<sup>1</sup>Means with different upper case letters are significantly different with a  $p < 0.05$ . Test for multiple comparisons are adjusted with Bonferroni test.

This work was funded by the research program "APQ per la ricerca scientifica e l'innovazione tecnologica, progetto P5a – Attivazione del Centro di biodiversità animale per la valorizzazione del patrimonio animale con riferimento alla produzione e alla ricerca al servizio dell'allevamento" of the regional government of Sardinia.

## 4.0 References

- Kennedy, B.W., and D. Trus, 1993. Considerations on genetic connectedness between management units under an animal model. *J. Anim. Sci.*, 71: 2341–2352.
- Kuehn, L.A., R.M. Lewis, and D.R. Notter, 2009. Connectedness in Targhee and Suffolk flocks participating in the U.S. National Sheep Improvement Program. *J. Anim. Sci.*, 87: 507–515.
- Laloë, D., 1993. Precision and information in linear models of genetic evaluation. *Genet. Sel. Evol.*, 25: 557–576.
- Lewis, R.M., R.E. Crump, G. Simm, and R. Thompson, 1999. Assessing connectedness in across-flock genetic evaluations. *Proc. Brit. Soc. Anim. Sci.* 121.

- Salaris, S., Sara Casu, P. Fresi, and A. Carta, 2008. Effect of combining controlled natural mating with artificial insemination on the genetic structure of the flock book of Sardinian breed sheep. In Proc. ICAR 36th Session, Technical Series n. 13, pages 113-121.
- Salaris, S., Sara Casu, M.G. Usai, P. Fresi, and A. Carta, 2010. Evaluating the connectedness of a dairy sheep selected population with low rates of artificial insemination and controlled natural mating. In Proc. 9<sup>th</sup> WGLAP (in press).
- Tosh, J.J., and J.W. Wilton, 1994. Effects of data structure on variance of prediction error and accuracy of genetic evaluation. *J. Anim. Sci.* 72: 2568-2577.



## Implementation of developments of Institute of Animal Science in Dairy Cattle Breeding in Ukraine

V. Shablia

*Institute of Animal Science of National Academy of Agrarian Sciences of Ukraine, Kharkov region, Kharkov district, p/o Kulynychi, 62404, Kharkov, Ukraine*

### **Abstract**

Institute of Animal Science of National Academy of Agrarian Sciences of Ukraine implements its developments in dairy cattle breeding in Ukraine. Breeding centre of the Institute developed some National standards of Ukraine on genetic evaluation of dairy bulls using BLUP and system of organization of selection in order to harmonize Ukrainian legislation with European and international requirements. Breeding centre has developed and implemented on-farm computer programs for dairy cattle recording as well as breeding programs for main dairy breeds in Eastern region of Ukraine. Laboratory of ecological monitoring of the Institute provides testing of milk, meat, food and others samples from the farms of the region using equipment of Bentley Instruments for wide range of traits.

*Keywords: Institute of Animal Science, breeding centre, Ukraine, evaluation, cattle, prediction, ecological.*

### **1.0 Introduction**

Institute of Animal Science of National Academy of Agrarian Sciences of Ukraine (NAASU) is breeding centre for cattle, pigs, sheep, horses and rabbits. The Institute conducts studies on adaptation of animal breeding to European standards. We have developed new methods of evaluation of breeding values of sires and dams.

#### **1.1 Methods**

We have analyzed the status of recording, evaluation, selection and mating in Ukraine. On the basis of comparing current status with requirements of ICAR and INTERBULL we have developed measures to improve system of recording and genetic evaluation in dairy cattle breeding.

#### **1.2 Results**

There are about two and half million cows in Ukraine. Average milk yield of cows is about four thousand kilograms of milk per lactation. We have seven basic dairy breeds. We used a crossing with Holstein and other foreign breeds for obtain Ukrainian breeds.

Genetic trends of milk yield of Ukrainian breeds have increased, but not rather fast.

Institute of Animal Science has developed and implemented "Complex program of development of agrarian sector in Kharkov region". This program includes a set of breeding, technological and management approaches to modernize animal production.

Among others our breeding centre for cattle has developed breeding programs for Simmental, Ukrainian Black-and-White and Red-and-White breeds in the farms of Eastern region of Ukraine. We develop mating plans for farms.

Breeding centre implements the system of computer recording on the farms for cattle. On the basis of the data of recording in these farms the central database of breeding animal was created.

Breeding centre of the Institute developed some National standards of Ukraine on genetic evaluation of dairy bulls using BLUP and system of organization of selection in order to harmonize Ukrainian legislation with European and international requirements.

We have fixed the Multitrait Animal Model for procedure of Genetic evaluation model of dairy cattle in National standards of Ukraine .

Breeding values of 247 sires were evaluated by progeny testing.

Dairy breeding centre of the Institute has developed the methods of early prediction of milk yield, milk fat, milk protein, fat yield, protein yield, reproductive efficiency, calving interval, live weight and other economic-useful traits of cows on the basis of indirect traits of heifers.

We use indices of body measurements, skin histology, selection, blood, reaction on the stress and live weight of heifers as indirect traits for the prediction.

We use procedures of multiple regression, discriminant analysis, general linear model and neural networks for creating of prediction model.

The best models for early prediction of milk yield have high effectiveness for 15% culling at early age according to the predicted milk yield of heifers. The difference between average milk yields of breeding and culled groups was significant and was about 1000 kg.

Laboratory of ecological monitoring of our Institute provides testing of milk, meat, food and others samples from the farms of the region for wide range of traits.

The laboratory has International and Ukrainian certificates of conformity to requirements.

Laboratory of ecological monitoring of the Institute provides testing of milk, meat, food and others samples from the farms of the region using equipment of Bentley Instruments for wide range of traits.

The Institute of Animal Science comprises 157 scientific workers including 20 doctors and 60 candidates of sciences.

The institute consists of 20 laboratories

The institute is the scientific center on technologies of animal product manufacture of Ukraine.

The institute collaborates with the scientific establishments of Ukraine, Russia, Belorussia, Poland, Slovenia, France and the USA.

The institute trains high-qualified personnel at the post-graduate and doctorate courses on the seven professions with the subsequent attestation.

Specialists of the breeding centre take part in work of attestation commission of Ministry of agrarian policy of Ukraine to consider materials of subjects of animal breeding.

Institute of Animal Science of NAASU permanently conducts workshops, training for specialists, competitions etc.

In 2009 there were two workshops: "Basic principles of dairy cattle breeding" and "Testing milk quality using modern instrumental methods", competition of reproduction technicians, training for regional and district specialists on problems of implementing advanced methods of selection. The Institute takes part in international and European scientific grants in animal production, agrarian and ecological areas.

Institute of Animal Science of National Academy of Agrarian Sciences of Ukraine propose a co-operation to all organizations in the areas of researches in breeding, technology, housing, feeding, physiology, ecological monitoring for a stock-raising.

We would like to take part in implementation of the international programs and grants in the animal science.

## 2.0 Conclusions

The Institute of animal Science of NAASU develops and implements modern methods of milk testing, recording, genetic evaluation of dairy cattle and early prediction of performance. This allowed to increase milk production of dairy cattle in Eastern region of Ukraine.



## Genetic gain in open nucleus breeding scheme to improve milk production in Egyptian buffalo

S.A. Abdel-Salam<sup>1</sup>, A.I. Sayed<sup>1</sup>, Manal Elsayed<sup>2</sup> & S. Abou-Bakr<sup>2</sup>

<sup>1</sup>Department of Animal Production, Faculty of Agriculture, Cairo University, Gamaa Street, Giza, Egypt

<sup>2</sup>Department of Animal Production, Faculty of Agriculture, Ain Shams University, Shubra El-Khema, Cairo, Egypt

### Abstract

Populations of buffaloes with one milk record for each buffalo were generated using Monte Carlo simulation with assumed mean (0) and variance (1). Four different of population sizes ( $z$ ): 10000, 25000, 50000 and 100000 animals were obtained. Four generations of progeny were obtained by selection of sires and dams of the next generations. Mating ratio (male: females) were designed to differ from 1:2.5 to 1:100 in natural mating (NM) and from 1:1000 to 1:5000 in artificial insemination (AI). Genetic gain per generation and annual genetic gain were calculated.

Genetic gain increased significantly ( $P < 0.05$ ) with increase in generation number ( $G$ ) being 282, 389, 457 and 488 kg milk per generation for  $G_1$ ,  $G_2$ ,  $G_3$  and  $G_4$ , respectively. The annual genetic gain ranged from 64 kg/yr for  $z=10000$  to 73 kg/yr for  $z=100000$ . Increasing nucleus size ( $p$ ) from 0.05 to 0.10 increased genetic gains significantly ( $P < 0.05$ ) from 390 to 418 kg milk. Non-significant differences in genetic gain among different proportions of males born used as sires ( $a$ ) were observed.

Annual genetic gain ranged from 50 to 66 kg milk/yr in NM and from 80 to 82 kg milk/yr in AI. Applying open nucleus breeding scheme (ONBS) for many generations of selection could accelerate the rate of genetic gain of milk production in Egyptian buffalo and increased the average milk yield from 15% in  $G_1$  to 26% in  $G_4$ .

*Keywords: Open nucleus breeding scheme, genetic gain, simulation, Egyptian buffalo.*

### 1.0 Introduction

According to FAO STAT (2009) the Egyptian buffalo contributes about 2.7% and 8.4% to the world buffalo's milk and meat, respectively. The proportion of Egyptian buffaloes to the world buffalo's milk production decreases year after year. The increase of total milk production of Egyptian buffaloes was due only to increasing buffalo population size. Lack of effective sustainable breeding programs for local breeds in developing countries is a reason that such breeds lose their competitive advantage, especially where production systems or external conditions are subjected to change (Hiemstra *et al.*, 2007).

Livestock production in developing regions is generally characterized by small herd-size (particularly in mixed crop/livestock systems), communally shared grazing, uncontrolled mating, and the absence of pedigree and performance recording. These characteristics limit the implementation of effective genetic improvement programs. To overcome these problems, nucleus breeding schemes have been suggested, in which genetic improvement is centrally organized in a population maintained in research institutes or government farms (Galal, 1986; Terrill, 1986 and Solomon *et al.*, 2009). The open nucleus breeding scheme offers a simpler procedure for producing and disseminating breeding stock of known value (Cunningham, 1979 and 1987; Hinks, 1978 and Jasrowski, 1991). Bondoc and Smith (1993) recommended the establishment of two-tier open nucleus breeding system to maximize genetic improvement, reduce inbreeding rate and reduce the total cost of recording in smallholder systems. Several studies indicated the significance of using open nucleus breeding scheme to improve milk production of buffalo and increase the rate of genetic gain (Dixit and Sadana, 1999, Abdel-Salam *et al.*, 2004 and Nigm *et al.*, 2005).

The purpose of this paper was to use the simulation technique to study the expected genetic gain by changing migration rates and male selection intensity in four generations of applying two-tier open



nucleus breeding scheme to improve milk production of Egyptian buffaloes using different nucleus and population sizes.

## 2.0 Material and methods

### 2.1 Basic parameters

Simulation technique was used to generate population of buffaloes with one milk record for each buffalo. A total number of 3526 lactation records of 2179 buffaloes recorded by Cattle Information Systems/Egypt (CISE, 2007) of the Faculty of Agriculture, Cairo University during the period from 1990 to 2006 were used to estimate various parameters (Table 1) which were used to generate simulated populations.

Table 1. The estimates used in generating the simulated populations.

Parameter	Estimate	Reference
Average total milk yield (TMY)	1884, kg	CISE, 2007
Phenotypic variance for TMY	191845, kg <sup>2</sup>	CISE, 2007
Phenotypic standard deviation for TMY	438, kg	CISE, 2007
Average generation interval	5.78, yr	Mourad, 1990
Heritability estimate	0.17	CISE, 2007

CISE: Cattle Information Systems/Egypt

### 2.2 Generation of the simulated population of buffaloes

Populations were generated using stochastic Monte Carlo simulation procedure of SAS (2004) with assumed mean (0) and variance (1). Simulation was replicated four times to generate four different sizes of populations: 10000, 25000, 50000 and 100000 animals. Four generations were generated by selection of progenies with the highest breeding values for milk production to be sires and dams of the next generation. Selected bulls and heifers were mated at random. Figure (1) shows the structure of designed open nucleus breeding scheme and gene migration from nucleus to base and vice versa.

Genetic gain per generation was estimated as the average genetic selection differentials of animals used in nucleus and base (James, 1977). The rate of progress as response to selection is modified by migration of genes between parts of the population with different mean breeding values, i.e. from the nucleus to the base and vice versa. The best selected males are kept for breeding in the nucleus while other selected males are given to the base herds for breeding. The best selected females are maintained in the nucleus while females disseminated to the base herds are surplus to the nucleus replacement. By this means, improvements are quickly spread throughout the population. The nucleus remains open to animals from the base herds, the best selected females in the base transfer to the nucleus. Thus, the ultimate genetic gain was estimated by a weighted average of the genetic selection differentials in the nucleus and base, the weights being the gene migration rates from each part of the population to the other. Both additive genetic and residual effects were assumed to be distributed normally. This procedure was carried out for four generations. It was assumed that all buffalo females were mated naturally or artificially to bulls coming from the nucleus or base (Figure 1). Mating ratio (male: females) were 1:25, 1:50 and 1:100 in natural mating (NM), and 1:1000, 1:2500 and 1:5000 in artificial insemination (AI). The objective of using different mating ratios was to compare between different selection intensities in males.

The genotypes of animals were simulated by the following formula (1) according to (Meuwissen, 1991):

$$g_i = \frac{1}{2}g_s + \frac{1}{2}g_d + a_i\sqrt{0.5h^2\sigma_p^2} \quad (1)$$

Where  $g_i$ ,  $g_s$ , and  $g_d$  are the additive genetic values of individual  $i$ , its sire ( $s$ ) and its dam ( $d$ ), respectively,  $h^2$  is the heritability in population ( $h^2 = 0.17$ ),  $\sigma_p^2$  is the phenotypic variance,  $a_i$  is the random number from the distribution  $N(0,1)$  and  $\sqrt{0.5h^2\sigma_p^2}$  is the Mendellian sampling term.

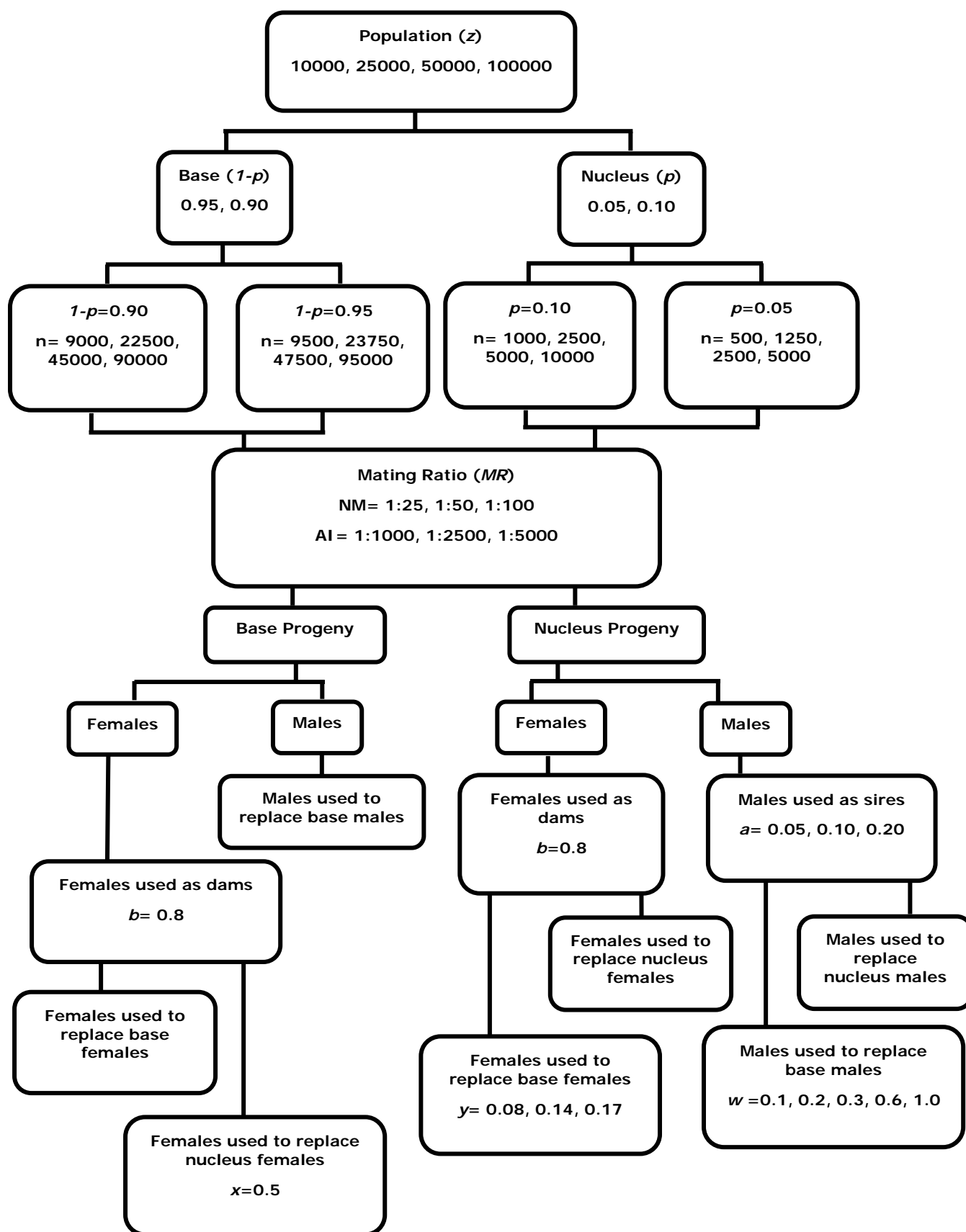

Figure 1. Structure of breeding scheme and gene migration.

The record of buffalo  $i$  was simulated by the following formula (2) according to (Meuwissen, 1991):

$$Y_i = \mu + g_i + E_i \quad (2)$$

Where  $Y_i$  is the lactation of the  $i^{\text{th}}$  buffalo,  $\mu$  is the mean total milk yield,  $g_i$  is the additive genetic value of individual  $i$ ,  $E_i$  is the environmental effect of the  $i^{\text{th}}$  buffalo and assumed to equal  $\sigma_e a_i$ ,  $\sigma_e$  is the square root of the error variance and  $a_i$  is the random number from the distribution  $N(0,1)$ .

### 2.3 Estimation of breeding values

Breeding values were estimated using the Derivative – Free Restricted Maximum Likelihood (DF-REML) procedure (Meyer, 1998).

The linear animal model (3) used for analyzing simulated records was as follows:

$$Y = X\beta + Z_a a + e \quad (3)$$

Where  $Y$  is the vector of observations,  $X$  is the incidence matrix for assumed fixed effect required by software to run distributed to the data at random,  $\beta$  is vector of an overall mean and fixed effect (2 levels) distributed to the data at random,  $Z$  is the incidence matrix for random effects,  $a$  is the vector of direct genetic effects of buffalo and  $e$  is vector of random errors normally and independently distributed with zero mean and variance  $1\sigma_e^2$ .

### 2.4 Calculation of the expected genetic gain in milk yield

Seven schematic variables, namely, number of generations ( $G$ ), population size ( $z$ ), nucleus size ( $p$ ), mating ratio (male: females) ( $MR$ ), proportion of males born used as sires ( $a$ ), fraction of base sires born in nucleus ( $w$ ) and fraction of base dams born in nucleus ( $y$ ) were studied.

The parameters assumed for estimating the genetic gain of the simulated open nucleus breeding scheme and levels of variables are shown in table 2. Genetic gain per generation and annual genetic gain were calculated according to James (1977).

Table 2. Input variables for calculating genetic gain.

Item Description	Symbol	Value
Heritability estimate	$h^2$	0.17
Replacement rate	$r$	0.20
Fraction of total population in nucleus	$p$	0.05, 0.10
Fraction of nucleus dams born in base	$x$	0.50
Fraction of base dams born in nucleus	$y$	0.08, 0.14, 0.17
Fraction of nucleus sires born in base	$v$	0.00
Fraction of base sires born in nucleus	$w$	0.10, 0.20, 0.30, 0.60, 1.00
Proportion of all males born used as sires	$a$	0.05, 0.10, 0.20
Proportion of all females born used as dams	$b$	0.80
Simulated population size (number of breedable females)	$z$	10000, 25000, 50000, 100000
Generations	$G$	1, 2, 3, 4

The effects of the different variables on genetic gain were analyzed according to the following model (4):

$$GG_{ijklmnop} = \mu + G_i + z_j + p_k + a_l + MR_m + w_n + y_o + e_{ijklmnop} \quad (4)$$

where  $GG$  is the genetic gain,  $\mu$  is the average genetic gain,  $G_i$  is the number of generation (4 level),  $z_j$  is the population size (4 level),  $p_k$  is the fraction of total population in nucleus (2 levels),  $a_l$  is the proportion of all males born used as sires (3 levels),  $MR_m$  is the mating ratio (6 levels),  $w_n$  is the fraction of base sires born in nucleus (5 levels),  $y_o$  is the fraction of base dams born in nucleus (3 levels) and  $e_{ijklmnop}$  is the residual term.

Significance of differences among means of genetic gain resulting from applying different input variables was tested using Duncan Test procedure (SAS, 2004).

### 3.0 Results and discussion

#### 3.1 Number of generations (G)

Genetic gain increased significantly ( $P < 0.05$ ) by increasing generation number as shown in figure 2. The genetic gains by generation were 282, 389, 457 and 488 kg of milk for G1, G2, G3 and G4, respectively. The average annual genetic gain ranged from 48 kg for G1 to 83 kg for G4.

The rate of increase of genetic gains decreased by increasing the generation number (Figure 2). The highest rate of increasing genetic gain (38%) was observed between G1 and G2 and the lowest (7%) was observed between G3 and G4. The reason for decreasing rate of genetic gain by increasing the generation number was due to reducing genetic lag between nucleus and base, by advancing generation, which means that the genetic selection differential between nucleus and base decreased by increasing generation of selection.

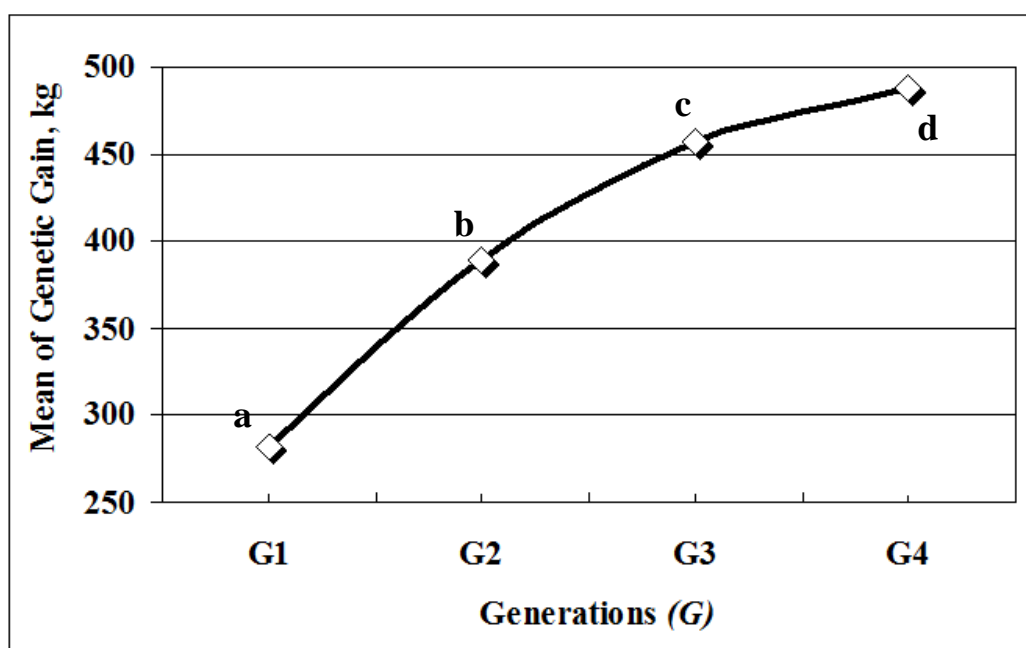

<sup>a,b,c,d</sup>Means with different letters differ significantly ( $P < 0.05$ ).

Figure 2. Change of genetic gain means by generation number.

This result is in agreement with the findings of Mueller and James (1983). They reported that the cumulated gain after 10 generations of selection, in a likely sheep or cattle system, would be overestimated by about 20%. This may be important in economic evaluations of nucleus schemes.

#### 3.2 Population size (z)

Genetic gain increased significantly ( $P < 0.05$ ) by increasing population size ( $z$ ) (Figure 3) due to increasing migration rates in the large populations. Increasing  $z$  from 10000 to 25000 resulted in an increase of 6% in genetic gain. The rate of increase in the genetic gain increased to 27% and 34% when the population size increased from 25000 to 50000 and from 50000 to 100000, respectively. There were significant differences ( $P < 0.05$ ) among all means. The average annual genetic gain ranged from 64 kg for  $z=10000$  to 73 kg for  $z=100000$ . These results are comparable with the results observed by Abdel-Salam *et al.* (2004) and Nigm *et al.* (2005).

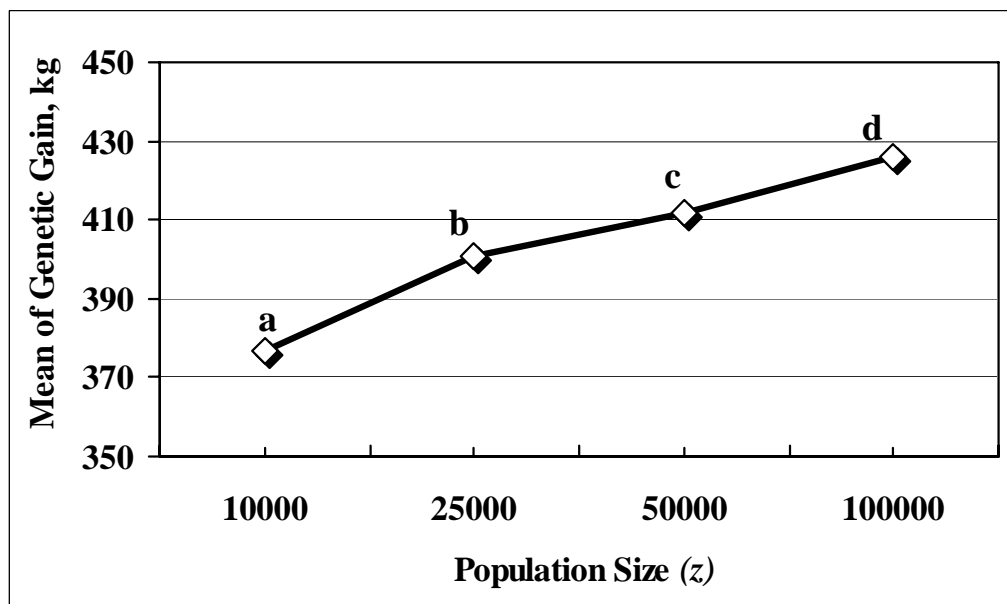

<sup>a,b,c,d</sup>Means with different letters differ significantly ( $P < 0.05$ ).

Figure 3. Change of genetic gain means by changing population size ( $z$ ).

The large population needs large numbers of animals in the nucleus and this situation is difficult in practical application. For avoiding this obstacle it is suggested that the required nucleus size is divided into more than one nucleus (sub-nucleus) working as big nucleus and that depends on the prevailing production systems and population structure.

### 3.3 Nucleus size ( $p$ )

Table 3 shows the change in genetic gain by changing the fraction of total population in nucleus from 0.05 to 0.10. Increasing  $p$  from 0.05 to 0.10 increased genetic gain significantly (4.5%,  $P < 0.05$ ) from 397 to 415 kg milk per generation.

Abdel-Salam *et al.* (2004), however, showed that increasing  $p$  from 0.05 to 0.10 resulted in an insignificant increase of only 0.3% in the genetic gain of milk yield in buffalo for one generation of selection.

The increase of genetic gain by increasing  $p$  was due to increasing migration (fraction of base dams born in nucleus,  $y$ , and fraction of base sires born in nucleus,  $w$ ) rates from nucleus to base in large nucleus size and that led to acceleration genetic change by genetic improvement at both levels of nucleus and base.

Table 3. Least squares mean and standard errors (SE) of genetic gain of milk yield (kg) in simulated buffalo populations of different nucleus sizes ( $p$ ).

$P$	Mean	SE
0.05	397 <sup>a</sup>	7
0.10	415 <sup>b</sup>	6

<sup>a,b</sup>Means with different letters differ significantly ( $P < 0.05$ ).

Phillips (2001) reported that the most important decision in establishing a nucleus breeding operation is to determine its size. There are several tradeoffs. With increasing nucleus size, greater selection pressure can be applied to potential breeding stock resulting in more rapid genetic gains. However, increasing the nucleus size also increases the cost of maintaining it. If replacement females for the nucleus are selected

from the nucleus and the commercial herd, larger nucleus herds are less elite when compared to the commercial herd.

### 3.4 Proportion of all males born used as sires ( $a$ )

Figure (4) shows change of genetic gain by changing proportions of males born used as sires ( $a$ ). Non-significant differences in genetic gain means among different proportions of all males born used as sires were observed. The expected annual genetic gain increased 1.5 % by increasing  $a$  from 0.05 to 0.10. Further increase of annual genetic gain (1.5%) by increasing  $a$  from 0.10 to 0.20. The reason of increasing the genetic gain with increasing  $a$  is mainly due to increasing fraction of base sires born in nucleus ( $w$ ) with increasing  $a$ . However, by increasing  $a$  all replacement sires in the base came from the nucleus ( $w$ ). It was clear that, the genetic improvement of the designed ONBS in the present study depended mainly on migration rate of sires from nucleus to base.

This result is contrary to the result found by Abdel-Salam *et al.* (2004) applying open nucleus breeding scheme for one generation and using different nucleus size (0.01, 0.05 and 0.20), who reported a significant decrease in genetic gain with increasing proportion of selected males ( $a$ ). Decreasing  $a$  from 0.20 to 0.10 resulted in an increase of 1.6% in genetic gain. The increase was enlarged to 3.3% when  $a$  decreased from 0.10 to 0.05.

Often the base is managed for commercial production and the nucleus to breed superior sires. Hopkins (1978) emphasized that using more efficient selection strategies and short generation lengths in the nucleus would increase rates of gain.

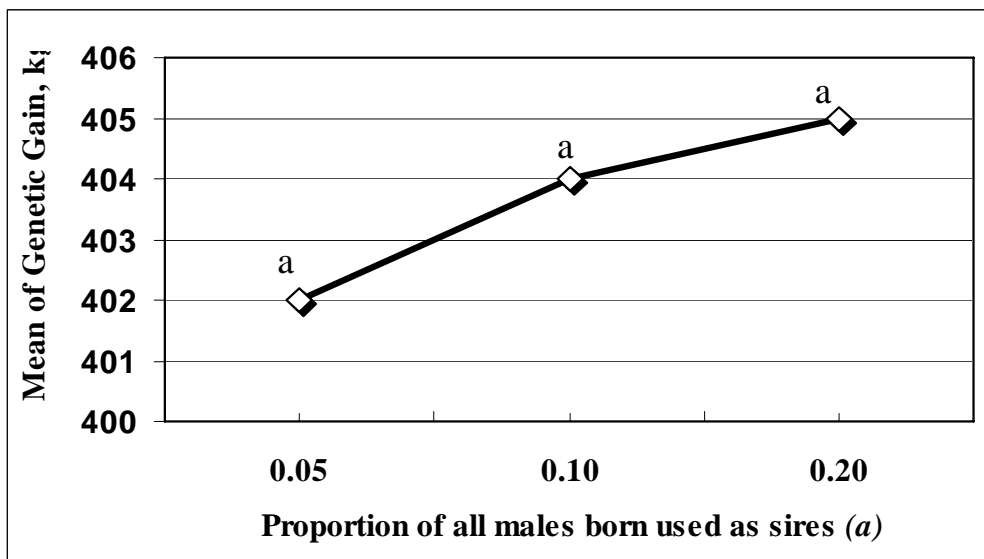

<sup>a</sup>Means with same letters do not differ significantly ( $P>0.05$ ).

Figure 4. Change of genetic gain means by changing proportion of all males born used as sires ( $a$ ).

### 3.5 Fraction of base sires born in nucleus ( $w$ )

The genetic gain ranged from 278 to 435 kg of milk (Figure 5) and the annual genetic gain ranged from 49 to 74 kg of milk at different levels of  $w$ . Genetic gain increased non-significantly by increasing  $w$  from 0.1 to 0.20 and from 0.20 to 0.30. Differences between  $w$  levels were significant ( $P<0.05$ ) when  $w=0.60$  and all sires used in base ( $w=1$ ) came from the sires born in nucleus.

The results of this study indicate that the main variables affecting the fraction of base sires born in nucleus were  $z$ ,  $p$  and  $a$ . The direct relationship was observed between  $z$ ,  $p$  and  $a$  on one hand and  $w$  on the other hand. However, this relationship is not absolute but depends on the different combinations of population size, nucleus size, and selection intensity in males.

The increase of  $w$  led to decreasing genetic lag between nucleus and base. For applying ONBS, it is recommended that all sires used in the base are introduced from sires born in nucleus.

This result is not in line with the result showed by Abdel-Salam *et al.* (2004) who observed that the genetic gain decreased significantly by increasing  $w$  from 0.05 to 0.10 or 0.20 and differences were significant between 0.05 on one hand and 0.10 and 0.20 on the other hand which was applying for one generation and different nucleus size. James (1977) reported that it is, however, of interest to note that the value of  $w$  depends on the nucleus size ( $p$ ) as  $w$  increases with any increase in  $p$ . Also,  $w$  depends on the proportion of males born and used as sires ( $a$ ).

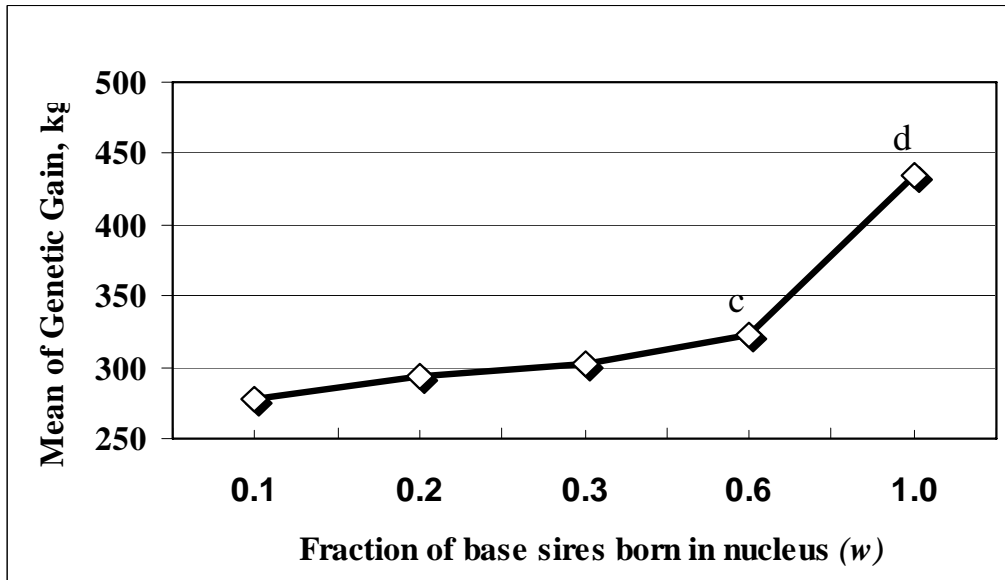

<sup>a,b,c,d</sup>Means with different letters differ significantly ( $P < 0.05$ ).

Figure 5. Change of genetic gain means by changing fraction of base sires born in nucleus ( $w$ ).

### 3.6 Mating ratios, MR, (male: females)

Figure (6) shows the change of genetic gain with mating ratios in natural mating and artificial insemination. Significant differences ( $P < 0.05$ ) were observed between MR within natural mating (NM), and between MR in natural mating and artificial insemination (AI). No significant differences were shown between mating ratios within AI.

Using NM, 14% increase of genetic gain was observed by increasing MR from (1:25) to (1:50) and 16% by increasing MR from (1:50) to (1:100). Increasing MR from (1:100) to (1:1000) by using AI was accompanied with an increase in genetic gain of 22%. Further increase in genetic gain was shown (0.2%) with increasing MR from (1:1000) to (1:2500) and by 1.7% with increasing MR from (1:2500) to (1:5000).

It was concluded that increasing genetic gain by increasing MR is mainly due to increasing the selection intensity in males used as sires and that was clear when comparison between NM and AI. Using small number of males led to reduction in the proportions of males born used as sires ( $a$ ) and increase the fraction of base sires born in nucleus ( $w$ ).

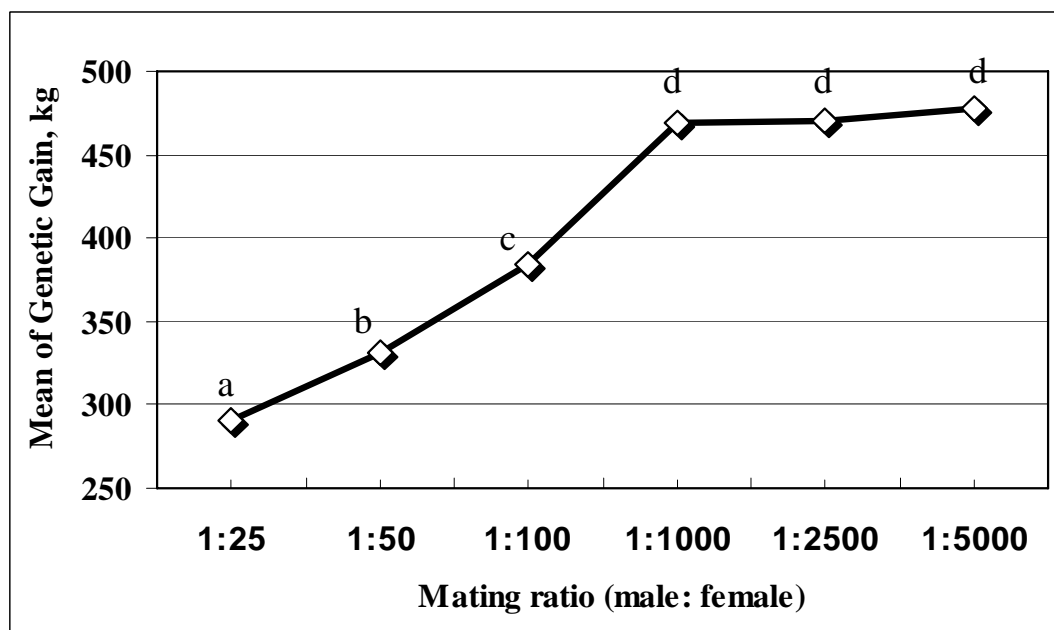

<sup>a,b,c,d</sup>Means with different letters differ significantly ( $P < 0.05$ ).

Figure 6. Change of genetic gain means by changing different mating ratios (MR).

The results agree with those of Ni gm *et al.* (2005) who concluded that the observed increase in genetic gain is mainly due to the higher selection intensity of males used as sires in AI. Also, AI will enable higher selection intensity even in small nucleus size of small populations. From the practical point of view, large number of breedable females could be inseminated by a smaller number of bulls with higher breeding values. In addition, it is recommended to concern about increasing rate of inbreeding and decreasing genetic variation in the population.

### 3.7 Fraction of base dams born in nucleus ( $y$ )

Genetic gain of milk yield change by changing fraction of base dams born in nucleus ( $y$ ) is shown in figure (7). Significant differences ( $P < 0.05$ ) are shown by increasing  $y$  from 0.08 to 0.14 and from 0.14 to 0.17. However, no non-significant differences ( $P < 0.05$ ) were observed by increasing  $y$  from 0.08 to 0.17. Increasing  $y$  from 0.08 to 0.14 increased the genetic gain by 8%. Slight increase of  $y$  from 0.14 to 0.17 resulted in a significant ( $P < 0.05$ ) decrease of 6.7% in genetic gain.

The results presented in this study indicated that, increasing the migration rate of females born in nucleus ( $y$ ) to the base led to lower selection intensity of females selected in nucleus to transfer to the base. This result agreed with the result reported by Abdel-Salam *et al.* (2004) for applying ONBS for one generation to improve milk production in buffalo. James (1977) reported that the low value of  $y$  is caused by the fact that only a small proportion of needed base-breeding females can be supplied from the nucleus. In sheep and cattle then, only a light culling of nucleus-born females would be recommended.



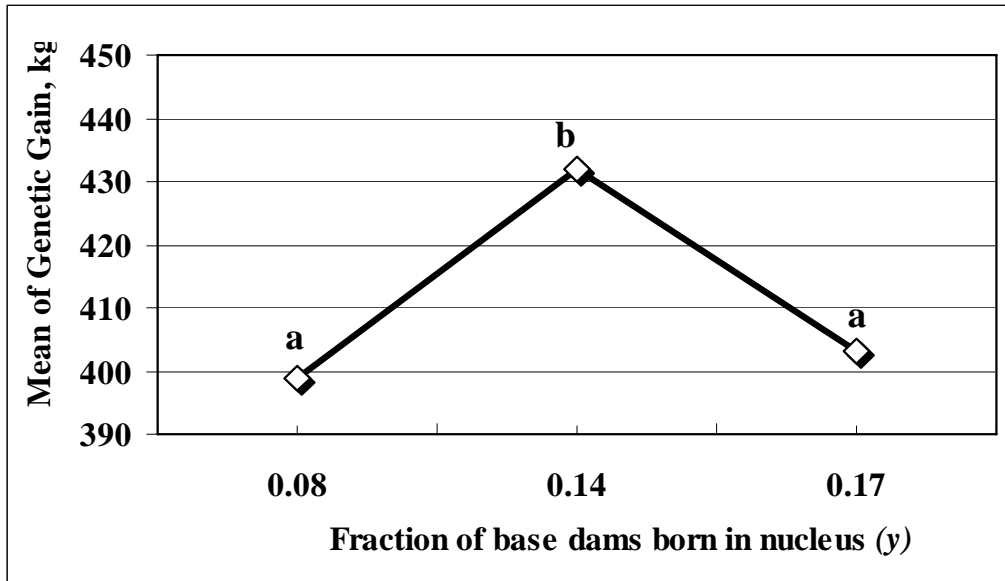

<sup>a,b</sup>Means with different letters differ significantly ( $P < 0.05$ ).

Figure 7. Change of genetic gain means by changing fraction of base dams born in nucleus (y).

## 4.0 Conclusion

The open nucleus breeding scheme offers a suitable practical procedure for producing and disseminating buffalo bulls of known breeding values. Applying ONBS for many generations of selection could accelerate the rate of genetic gain of milk production in buffalo and increase the average milk yield by 15% in  $G_1$  to 26% in  $G_4$ . It is recommended to take into account mating ratios when applying ONBS with the combinations of  $z$  and  $p$  which affect  $a$  and  $w$ .

## 5.0 References

- Abdel-Salam, S.A.M., Nigm, A.A., Manal Elsayed, Sadek, R.R., Abdel-Aziz, A.S. 2004. Genetic gain of milk production in Egyptian buffalo as affected by population size, nucleus size and selection intensity in open nucleus breeding scheme. *Egypt. J. Anim. Prod.* 42:33-42.
- Bondoc, O.L., Smith, C. 1993. Deterministic genetic analysis of open nucleus breeding schemes for dairy cattle in developing countries. *J. Anim. Breed. Genet.* 110: 194-208.
- CISE, 2007. Buffalo herd book 1<sup>st</sup> edition. Cattle Information Systems/Egypt (CISE), Faculty of Agriculture, Cairo University, Egypt.
- Cunningham, E.P. 1979. The importance of continuous genetic progress in adapted breeds. Report of the FAO Expert Consultation on Dairy Cattle Breeding in the Humid Tropics, pp. 35-41. FAO, Rome.
- Cunningham, E.P. 1987. Crossbreeding *Bos Taurus* and *Bos Indicus* for milk production in the tropics. *Animal Production and Health Paper* 68: 15. FAO, Rome.
- Dixit, S.P., Sadana, D.K. 1999. Response of single trait selection in open nucleus schemes for buffalo breeding. *Indian J. Dairy Sci.* 52: 17.
- FAOSTAT. 2009. FAO Statistics Division., FAO, Rome, Italy, [www.fao.org](http://www.fao.org).
- Galal, E. S.E., 1986. Selection for increased production in multi-purpose sheep and goats. *FAO Animal production and health paper*, vol. 58. FAO, Rome.
- Hiemstra, S.J., Drucker, A.G., Tvedt, M.W., Louwaars, N., Oldenbroek, J.K., Awgichew, K., Abegaz Kebede, S., Bhat, P.N., da Silva Mariante, A., 2007. What's on the menu? Options for strengthening

the policy and regulatory framework for the exchange, use and conservation of animal genetic resources. *Anim. Genet. Resour. Inf.* 4, 65–74.

- Hinks, C.J.M. 1978. The use of centralized breeding schemes in dairy cattle improvement. *Animal breeding Abstract* 46: 291.
- Hopkins, I.R. 1978. Some optimum age structures and selection methods in open nucleus breeding schemes with overlapping generations. *Anim. Prod.* 26: 267-276.
- James, J.W. 1977. Open nucleus breeding systems. *Anim. Prod.* 24: 287.
- Jasiorowski, H.A. 1991. European animal husbandry: a model to adopt or reject by developing countries ?. on the eve of the 3rd millennium, the European challenge for animal production, EAAP Publication 48: 127. (CAB Abst.).
- Meuwissen, T.H.E. 1991. The use of increased female reproductive rates in dairy cattle breeding schemes. *Anim. Prod.* 52: 21.
- Meyer, K. 1998. DFREML (Derivative – Free Restricted Maximum Likelihood) package. Version 3.0a. 6th World Cong. Genetic. Appl. Livest. Prod., Armidal.
- Mourad, K.A. 1990. Buffaloes in Egypt. Proceedings of FAO Workshop on Buffalo Open Nucleus Breeding Schemes (ONBS), Shuman, Bulgaria.
- Mueller, J.P., James, J.W. 1983. Effect of reduced variance due to selection in open nucleus breeding systems. *Aust. J. Agric. Res.* 34: 53-62.
- Nigm, A.A., Abdel-Salam, S.A.M., Manal Elsayed, Sadek, R.R., Abdel-Aziz, A.S. 2005. Preliminary results on use of the open nucleus breeding scheme for improving milk production of Egyptian buffalo. *Egypt. J. Anim. Prod.* 42: 1-9.
- Phillips, A. 2001. Nucleus bull-breeding herds. Technote 111: 1-8. [www.primaryindustry.nt.gov.au](http://www.primaryindustry.nt.gov.au).
- SAS Procedures Guide, Version 9. 2004. SAS Inst., Inc., Cary, NC.
- Solomon, G, Komen, H., van Arendonk, J.A.M. 2009. Optimal village breeding schemes under smallholder sheep farming systems. *Livest. Sci.* 124: 82-88.
- Terrill, C.E., 1986. Breeding program to increase production efficiency of small ruminants in developing countries. FAO Animal Production and health paper, vol. 58. FAO, Rome.





## A wide range of tools to improve reproduction in dairy cattle

C. Ponsart<sup>1</sup>, B. Frappat<sup>2</sup>, H. Seegers<sup>3</sup>, S. Freret<sup>4</sup>, P. Paccard<sup>2</sup>, J. Gatien<sup>1</sup>, P. Salvetti<sup>1</sup>, X. David<sup>1</sup> & P. Humblot<sup>5,1</sup>

<sup>1</sup>UNCEIA, Département R et D, 13, rue Jouët, 94704 Maisons-Alfort, France

<sup>2</sup>institute de l'Elevage, Paris, France

<sup>3</sup>UMR INRA-ENVN, Nantes, France

<sup>4</sup>INRA, Nouzilly, France

<sup>5</sup>SLU, Dpt of Clinical Studies, Uppsala, Sweden

### **Abstract**

As most countries where genetic selection for milk production has been conducted, France has been faced a continuous degradation of reproductive performances in dairy cattle especially in the Holstein breed. A research and development programme conducted by UNCEIA and its partners has been proposed to face the decrease in reproductive performances observed in high producing dairy cows. Since 2002 several tools related either to genetics and environmental/management effects on fertility were developed in an attempt to stop this decrease or even improve female fertility.

New genetic tools associated with Marker Assisted Selection (MAS) progressed very rapidly those last years. MAS is based today on sets of thousands of genetic markers. This will result in a more rapid genetic progress, particularly regarding traits with low heritability or reliability, such as fertility. In parallel with those technological evolutions, attempts are made in different countries to strengthen the value of the genomic information by including more and more animals in the evaluation and selection process, as illustrated in 2009 by the creation of Eurogenomics which gathers the main breeding companies in Europe. The consequence of this is the calculation of more reliable estimates for the desired traits together with the preservation and or optimisation of the exploitation of genetic variability.

A second part of this programme was dedicated to farming practices. New field references on heat detection and insemination practices, body condition scoring were obtained from epidemiological trials. Moreover, herd follow-up methods were implemented to investigate reproductive herd management. The current use and impact of these different tools, which were developed with the participation of the local AI centres will be presented.

The first results originating from last years genetic and phenotypic evaluation tend to show positive trends for fertility. The combined use of new genetic evaluation and herd management tools, which were developed with the participation of the local AI centres should contribute to optimize reproductive performances in dairy herds.

*Keywords: Fertility, genetics, breeding management, consultancy on farm, post partum.*

### **1.0 Introduction**

In France, as in many other countries fertility has decreased in the Holstein breed since twenty years. More recently, the data from the national data basis showed a decrease in reproductive performances in the two other main dairy breeds (Montbéliarde and Normande) between 1995 and 2005. Such a decrease was also reported too from heifer data (Barbat *et al.* 2005).

Conception and early pregnancy failures are linked to several management characteristics: feeding (assessed by body condition score), milk production, genetic potential, health state and season of reproduction (Humblot 2001; Grimard *et al.* 2006). Moreover, the sensitivity of the oestrus detection may be estimated to be around 50 % (Grimard *et al.* 2004). Evolutions of farm structures, social demand and perception of farming practices by the breeder may also influence the performances of reproduction.

Since 2002, the management issues have been approached through 3 main axes together with AI centres and "Institut de l'Élevage" (technical support organisation). The first aim is to actualise some references and advises given to farmers to manage reproduction. A second part of this work is dedicated to the methods of herd follow-up and diagnosis of reproductive problems. The aim is to characterise different types of herds with different problems of reproduction and to adapt the advice and the strategy/means to conduct further investigations to those types of herds / situations. This program is elaborated together with the National Veterinary School of Nantes (UMT Santé des Troupeaux bovins). The last part of the management issues is to communicate about reproduction, with documents and forms dedicated to AI centres. A manual describing the quality procedures in AI has been elaborated in 2003 and a guideline for AI technicians and farmers about reproduction and insemination management has been prepared.

These different tools have to be used simultaneously to touch a large number of farmers and technicians and to act in a synergic way to optimize reproduction results in dairy cows.

## 2.0 Genetic tools to improve fertility

Genetic selection in dairy cattle has been evolving considerably within the last years. As an example, the genetic evaluation for the Holstein breed is made in France since 2008 by using several hundreds of markers/character instead of 30 QTL/character in the previous MAS evaluation (Fritz 2010). Recent genomic tools give the possibility to breeding companies to implement Marker Assisted Selection (MAS), which allows to evaluate very young candidates with a good precision: sets of thousands of genetic markers are today available to select animals (Ducrocq 2010, Fritz 2010). The evolution of sequencing techniques as well as the manufacturing of very powerful chips (already used for human research) will probably make available the use of the complete genome information for selection purposes in a few years. Due to those technical evolutions, application to different small breeds should be the next step (Ducrocq 2010). For those breeds, one important point will be to establish a reference basis and to collect appropriate phenotypic characteristics, as they have not been so much intensively studied when compared to Holsteins (Humblot *et al.*, 2010).

Accuracy of genomic indexation has been calculated in comparison to classical selection: estimated breeding values with MAS information in very young animals (few days) are higher than those obtained at birth without MAS and after first lactation (using progeny testing). For some traits, such as fertility the precision associated to genomic indexes is much better than with classical selection (FGE, 2009; Table 1). This enough precision of MAS indexes combined with the high costs of progeny testing should contribute to reduce progressively progeny testing or even to suppress it.

Table 1. Accuracy of Estimated Breeding Value (EBV) of animals at birth, after first lactation and after usual progeny test without MAS, and of animals at birth with MAS information (FGE, 2009).

Animal age →	Sex	Birth	4-5 years	3-4 years	Few days
Trait ↓		EBV (without MAS)	EBV after progeny testing	EBV after first lactation	EBV with MAS information
Milk	Male	0.32	0.70		0.60
	Female	0.32		0.47	0.60
Morphology	Male	0.30	0.70		0.50
	Female	0.30		0.45	0.50
Female fertility	Male	0.22	0.45 (non official)		0.50
	Female	0.22		0.25 (unpublished)	0.50

In parallel with those technological evolutions consortiums are created in different countries to strengthen the value of the genomic information by including more and more animals in the evaluation and selection process (Ducrocq 2010). In autumn 2009, the EuroGenomics partners VikingGenetics (Denmark/Sweden/Finland), UNCEIA (France), DHV and vit (Germany) and CRV (Netherlands/Belgium) agreed on the exchange of genomic SNP marker data (Illumina Bovine SNP50 BeadChip). Each partner contributed the data of 4,000 proven bulls to further improve the reliability of genomic breeding values. Starting March 2010 all partners will extend their reference population to a total of 16,000 bulls. This is

one of the largest reference populations in the world, but more important is its unique quality. Conventional daughter breeding values of the EuroGenomics bulls all result from sophisticated data collection systems and herdbook registration including comprehensive fertility data. Thus, data recording includes not only milk production traits (i.e. 19 million cows as daughters of the EuroGenomics bulls) but also functional traits. The new approach results in reliabilities that exceed current reliabilities of genomic proofs by about 10 %. To optimize use of genomic tools in breeding programs, recent simulations on real data tried to maximize the genetic progress, by running different scenarios of breeding schemes: generating a higher number of candidates (2400 young male calves evaluated by MAS, leading to 80 in use, instead of 800 calves leading to 130 progeny tested and 15 in use under classical selection) seems to maximize genetic progress together with a lower consanguinity (-23 % when compared to the classical evaluation; Colleau, 2010). Moreover, obtaining high number of candidates implicates to adapt the way of using biotechnologies in the breeding programs in order to optimize the genetic variability, to control the interval between generations and to lower the costs (Humblot *et al.*, 2010).

These changes highlight the possibility to select animals for new traits, even with a low heritability. This strengthens the importance of the phenotypic information that must be recorded in a common way from large number of animals and the necessity to ensure the quality of the collected data.

### 3.0 Field to assess environmental and management factors associated with reproductive results

Field studies are very useful to investigate environmental and management factors under farm conditions. Preliminary results retrospectively issued from 309 farm audits indicated that the main sources of low fertility results are related to high energy deficit after calving and to problems around time of breeding (particularly heat detection or expression; table 2).

Table 2. Principal risk factors retrospectively identified in 309 farms audited for reproductive problems by AI and technicians from the milk control association (Ponsart *et al.*, 2005).

Risk Factors	Number of farms	%
High energy deficit after calving	191	61.8 %
Heat detection or management of breeding	190	61.5 %
No principal factor and / or mineral deficit	111	35.9 %
Management of heifers of dried cows	105	34.0 %
Low hygiene at calving	77	24.9 %

Following this, a set of field trials were initiated in 2004 in the Holstein breed aiming to study all the factors that may influence AI results (heat detection, restraining of cows....), during the 3 first months of lactation (regularity of cyclicity in relation to body condition score) and to study management feeding practices before and after calving. The largest trial called FERTILIA was realized in 135 Holstein dairy herds to describe at both individual and herd levels management practices for heat detection, restraining of cows and nutrition. As heat detection practices have been identified as a key point in herd management, the results will be focused on practices related to heat detection and insemination. Moreover, the recent development of new automated tools may change the way of detecting estruses or spotting unhealthy animals and therefore managing reproduction within a herd. Thus, the use of automated heat detection devices has been evaluated under different field conditions.

#### 3.1 FERTILIA: insemination practices

Individual first artificial insemination (AI) conditions were recorded from 135 herds and 4667 1st AI's by AI technicians (Fréret *et al.*, 2006). Progesterone was measured in milk (ELISA) on the day of AI and 21 days later to determine the incidence of non-fertilization or early embryonic death (NF-EED), as described by Humblot (2001). Pregnancy was checked by ultrasonography between 45 and 75 days following first AI, in order to estimate the incidence of late embryonic death (LED) and conception rates following first AI. The effects of individual practices related to heat detection, calving and AI conditions were simultaneously tested with a multivariate mixed logistic model. Cows with a short calving to 1st AI interval (< 60 d), with 3 lactations at least, with difficult calving conditions, without sexual behavioral signs or mounting activity during estrus presented lower conception rates than the other females. On the

contrary, when AI was performed within 18 hours following heat detection and occurred from September to February, higher conception rates were observed (Table 3; Freret *et al.*, 2008).

The frequency of NF-EED was significantly increased when other signs of oestrus than standing heat or mounting activity (alone or in association) were used to call the AI technician. Time of AI (relative to heat detection) as well as restraint quality was associated to NF-EED. Both early (up to 6 hours) and late insemination (later than 24 hours) increased the incidence of NF-EED, but also of LED (Figure 1).

Table 3. Individual factors associated with conception rates (CR) in a multivariate mixed logistic model (Freret *et al.*, 2008).

Variable	Estimated CR (%)	Odds ratio
Class (n)		
<i>Calving to 1rst AI interval (p=0.04)</i>		
<60 d (n=539)	37.4 *	0.79
[60-80[ d (n=1079)	43.1	1
[80-100[ d (n=672)	42.2	0.96
[100-180[ d (n=477)	46.6	1.15
<i>Rank of lactations (p=0.002)</i>		
1rst (n=1126)	47.9	1
2nd (n=760)	43.8	0.85
3rd (n=425)	39.4 *	0.71
≥ 4th (n=456)	38.2 *	0.67
<i>Calving Conditions (p&lt;0.0001)</i>		
Without assistance (n=1820)	50.0	1
With easy assistance (n=739)	44.8 *	0.81
With difficult assistance, caesarian section (n=208)	32.6 *	0.48
<i>Heat Sign(s) leading to call the AI technician (p=0.01)</i>		
Standing heat (n=1095)	42.7	0.88
Mounting (n=539)	44.4	0.95
Sniffing/Licking the vagina of other cows (n=73)	52.8	1.32
Mucus vulvar discharge/ Restlessness/Drop in production/Mooing/Looking to calendar (n=278)	32.3 *	0.56
Several signs including standing heat (n=501)	45.8	1
Several signs including mounting (n=166)	41.9	0.85
Several signs including Sniffing/Licking the vagina (n=43)	44.0	0.93
Other signs (n=72)	35.4	0.65
<i>Interval from the heat detection (sign leading to call the AI technician) and AI (hour) (p=0.01)</i>		
[0-6[ h (n=498)	43.2 *	1.37
[6-12[ h (n=586)	47.4 *	1.62
[12-18[ h (n=767)	44.0 *	1.41
[18-24[ h (n=526)	41.3	1.27
≥24 h (n=390)	35.7	1
<i>Season of AI (p =0.002)</i>		
Sept-Oct 2004 (start of the AI period) (n=553)	45.3 *	1.54
Nov-Dec 2004 (n=1074)	45.1 *	1.53
Jan-Feb 2005 (n=652)	44.0 *	1.47
March-April-May-June 2005 (n=488)	34.9	1

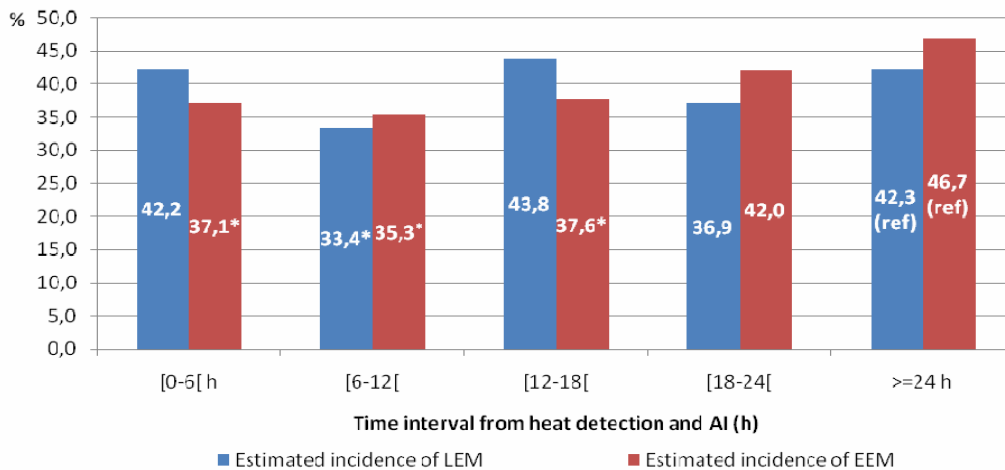

Figure 1. Effects of time interval from heat detection (sign associated with the call of AI technician and first detected sign) to insemination and embryonic mortality (Early = EEM, Late = EEM; \* significantly different from the reference. From "FERTILIA", UNCEIA, Humblot et al., 2009).

### 3.2 FERTILIA: Restraining practices

Places and means of restraint were grouped together according to their effect on NF-EED rate and classified as UFR= unfavourable, IR= intermediate and FR= favourable type of restraint. Unfavourable restraint comprised box with corridor or cubicle without cow being tied-up or cow inseminated in the milking parlour. Intermediate conditions were those in which AI was performed in loose housing conditions or in a box, with head-locking restrainer, or box with a barrier. Favourable restraining conditions were identified as box with head-locking restrainer or corridor with restraining bar or tie stall barn or cubicle with cow being tied-up by the farmer or cow tied-up with a rope or a halter. Lack of fertilization and NF-EED rate was globally 36.8%, and was influenced by the type of restraint: UFR, 40.7% (n=398), IR, 37.1% (n=2961) and FR, 32.2% (n=488), (Figure 2) and by the quality of the restraining method as judged by the technician at time of AI: good, 34.8% (n=2188), nearly good, 38.9% (n=1675), bad/nearly bad, 37.2% (n=277) (Freret et al., 2007).

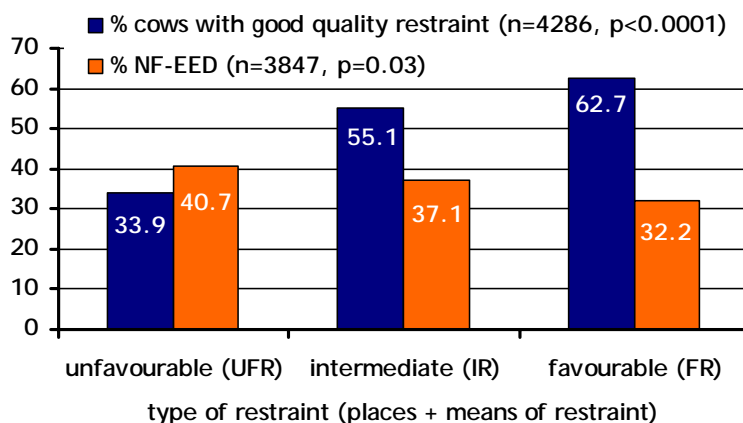

Figure 2. Percentages of cows with a good quality of restraint as judged by the AI technician and effect of the restraining conditions on the frequency of lack of fertilization and early embryonic mortality (NF-EED) (from "FERTILIA": Freret et al., 2007, Ponsart et al., 2007).

Not so much data exists in the literature on the effects of those factors related to AI conditions. It may be speculated that when conditions are unfavorable (i.e. in case of lack of clear signs of estrus, bad



restraining conditions, and bad timing of AI) these different factors may induce a lack of fertilization or fertilization at a time which is not optimum for oocyte quality and subsequent embryo development.

The time of detecting estrus during the day influenced LED. Incidence of LED was increased when detection occurred during feeding compared to a period of inactivity (48 vs 34%,  $p < 0.05$ ). The incidence of LED was increased also when AI was made on induced estrus when compared to natural heat (44 vs 35.5%,  $p < 0.05$ ) (from "FERTILIA", UNCEIA, unpublished data). Despite negative progesterone concentrations at time of AI were measured in those cows, a possible confusion with bad timing of AI and cyclic irregularities may exist for those sources of variation of LED.

## 4.0 Practical tools dedicated to farmers and technicians for reproductive follow up

A first part of this work aimed to develop methods for herd follow-up to diagnose reproductive problems. The strategy consists to characterise different types of herds with different reproductive problems and to give specific advises to modify management and eventually to propose additional investigations in some herds. This program is conducted in partnership with the Livestock Institute (Institut de l'Élevage, Paris) and National Veterinary School of Nantes. The last part of the management issues is to communicate about reproduction, with documents and forms dedicated to the AI centres and/or to farmers.

### 4.1 Practical tools in breeding management: needs and demands

The attitudes and expectations of farmers in terms of technical support or services are ranging from «self-working» farmers "picking" some information on reproduction to farmers expecting assistance from experts or farmers working regularly with AI technicians to follow-up reproductive results (Frappat *et al.* 2005; Magne 2005). Moreover, a large variability has been observed between farmers when considering the concept of « reproductive problems». This is partly explained by their different production and herd management objectives, by differences in the follow-up of reproductive performances and the conditions under which they can compensate low reproductive results (such as culling).

Several factors are combined to interpret the performances of reproduction at a herd level, which may lead to discrepancies between the needs formulated by farmers and those sensed by technicians or veterinarians. Nevertheless, AI cooperatives, technicians or veterinarians should propose a wide range of tools ranging from individual assistance to booklets explaining advantages related to the use of different practices, in order to adapt their services to the different profiles of farmers and to repeat the important messages through different communication channels.

Two qualitative surveys were realized in 2004 and 2005 to investigate the needs and expectations of farmers in terms of reproductive follow-up and learning sessions. About 100 farmers, as well as technicians and veterinarians were individually interviewed for 2 hours with the help of a questionnaire about their needs in terms of reproductive management and the modalities of reproductive follow-up used in their herd. From this study it was shown that most often several sources of information were available for farmers in the field of reproduction, and in that case the different persons involved seemed to fail convincing farmers to change their farming practices.

According to Tancerel (Tancerel 2004), 46 à 91 % of 71 interviewed dairy breeders may use some risk practices in heifer management, calving intervention, heat detection and restraining cows before AI. The use of risk practices seems to be more related to an individual perception of farmers than to a general lack of knowledge in terms of "physiological" processes. This leads to promote tools based on convincing methods, with a personalized approach including psychological barriers and motivations (Dockès *et al.*, 2005). Two different tools seem to correspond to this approach: an individual follow-up (with regular visits, documents and discussion) or a small training group with debates, exchanges between participants (Kling-Eveillard 1996).

As recently described by Mee (2009), technicians and veterinarians cannot simply wait for the farmer to call for this specialized service, it must be promoted. The primary route to this goal remains through opportunities created by the clinical reproductive problems encountered by clients, so-called 'contact moments'. Rather than continuing to focus on problems of the indicator cow, the veterinarian or technician needs to focus on what this cow tells us about the herd, become more 'data-literate' and realize that by repeatedly observing individuals alone they cannot influence the herd performance. Presented with these opportunities, particularly with a receptive client, it is up to the technician to attempt to lever existing relationships to get higher levels of interaction with herd owners. Receptive

clients have been defined as those with larger herds, fertility problems, higher education levels, members of agricultural organizations and farm managers (Mee, 2009).

#### 4.2 REPRO Action: Evaluation of an individual retrospective approach

As the AI cooperatives decided in 2002 to develop new tools to optimize reproductive results in dairy cows, a preliminary study was performed to evaluate some previously existing methods and tools designed to help farmers in the field of reproduction: some positive and negative aspects were pointed out by farmers, technicians and veterinarians during interviews. Three different kind of existing services have been identified: individual approach, small training groups and large plans of communication (Table 4).

When considering the individual approach, the most critical points were related to the implication of different partners (to coordinate the delivered messages), the use of a standardised method (which facilitates audit realization) and the absolute necessity to continue the assistance after a first visit (Table 4). In response to those observations, a standardised method aiming to diagnose reproductive problems "REPRO Action" was developed with a more structured approach (estimation of performances in different groups of cows, herd visit, research of potential sources of reproductive problems, plan of action discussed with farmer, reports) including a precise guideline for technicians and a computer analysis to estimate the existing and future reproductive performances. This approach is in agreement with other methods reported by Mee (2009), describing 3 successive stages of implementing veterinary herd fertility management: 1/establishing current herd fertility performance, 2/ investigating the factors associated with it and 3/ designing a program to improve it.

Table 4. Main tools proposed by the AI cooperatives and the UNCEIA team to help farmers and technicians to better manage reproduction.

Type	Tools existing before 2002 *	New tools developed
Individual approach	16 methods (4 evaluated from 88 individual interviews*)  Important role of partners (technicians, veterinarians) to coordinate the technical messages.  One appreciated method: from a quantitative estimation of reproduction criteria, identification of groups of cows or particular periods related to the reproductive problem.  Use of a standardized method, with a real herd visit and precise documents.  Necessity to implement a follow-up after the first visit to verify the effectuation of the plan and the results.	REPRO Action for dairy (2005) and beef herds (2006)  Standardized method in 6 steps, leading to a plan of action and an evaluation of results.  Dedicated to herds with «low» reproductive results.  With a computer analysis.
Small groups	15 actions (teaching session or information via meetings)  Farmers are not motivated by theoretical meeting.  Practical and concrete approach is needed.	«Succeed AI together» (2007)  Two days of debates/exchanges on reproduction and AI managements.  Dedicated to all farmers.
Large plans of communication	3 kinds of worksheets, 4 guides or books in the field of: heifers management, calving, calving interval, semen production, heat detection, AI and restraining  No exhaustive guide including all aspects	"REPRO Guide" (2005-2006)  Referential on reproduction, including 37 worksheets (physiology, female and herd management, analysis of reproduction parameters,  Dedicated to farmers and technicians,

\* Data from 25 AI cooperatives and 88 individual interviews in 4 AI cooperatives (31 AI technicians, 26 partners and 31 farmers; (Ponsart *et al.*, 2008).

A first technical evaluation has been realized in 2007, indicating that 255 herds took benefit from a first visit in 2006. From 132 herds visited between September 2005 and October 2006, the proposed actions have been retrospectively evaluated from a phone survey (with 105 farmers) and associated with their real application. A large part of the farmers (83 %) were satisfied by this individual approach and 73 % of them considered that the follow-up proposed by the AI technician was sufficient and improved reproductive performances in their herd. A majority of actions were dedicated to dairy cows (61 %). About 60 % of the planned actions have been applied in a rapid and complete manner. It is interesting to note that the most frequent recommendation that aimed to improve heat detection was not adopted in most of the cases (Ponsart *et al.*, 2008).

**4.3 REPRO Pilote: Monitoring reproduction according to preset goals**

Watson (2009) has emphasized the need for this to be a continuous in-going cycle rather than a straight line audit (Figure 3; reported by Mee, 2009). In order to complete the investigative audit, a scheduled monitoring of reproduction may be proposed to farmers. Therefore, REPRO Pilote has been designed as a preventive approach, aiming to monitor reproductive events according to preset goals (Table 5).

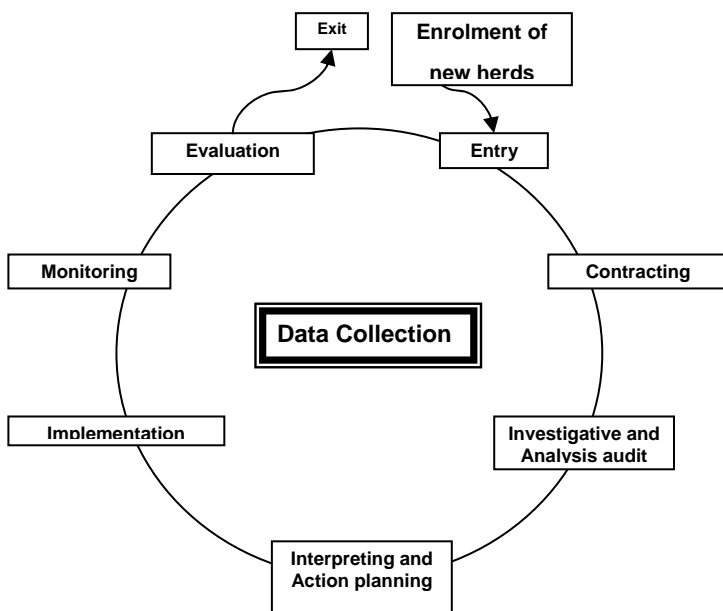

Figure 5. The bovine fertility management cycle (Watson, 2009 reported by Mee, 2009).

Table 5. Description of 2 different individual approaches of herd fertility management.

Retrospective investigation of problems	Scheduled monitoring of reproduction
Aim: identify source of problems	Set goals and assist farmers in reproduction management (according to the management strategy)
Retrospective approach	Preventive approach
Decreased performances of reproduction	All farmers
Complete visit + evaluation of plan (standardized method)	scheduled and frequent visits (standardized method)
Plan of «corrective actions»	Adapted tools to facilitate the monitoring of reproductive events: Pregnancy checks, lists of females...

When using REPRO Pilote, the ultimate goals should be set by the farmer and the role of the technician is to assist the farmer in measuring and achieving these goals. Goals should be SMART (specific, measurable, attainable, relevant and time-limited; Mee, 2009). Four different herd situations have been defined in order to help technicians to focus the monitoring on the more relevant reproductive

performances according to the following “production strategies”: high milk productivity, low cost of milk and work organization.

After having set personalized goals, the technician may propose the most relevant tools to facilitate the herd follow-up such as pregnancy checks, list of females or body condition scoring. Finally, a plan of actions is proposed with intermediate visits, which are scheduled according to the herd situation (production strategy, seasonality of calving). This approach is actually tested in 40 farms, from 5 different AI centres, with standardized documents and a previous training course. This may help AI centres to standardize and implement herd fertility management programs which may be compared a hazards analysis critical control point (HACCP) approach (Lean *et al.*, 2003).

#### **4.5 REPRO Guide: a referential widely diffused to AI technicians and farmers**

All summarized messages from the literature and from previous field experiments were gathered in a guide “REPRO Guide” that contains 37 illustrated worksheets on bovine reproduction. This referential describes the basics in reproductive physiology, AI management and semen production, herd management and the analysis of reproduction criteria. A total of 2090 guides have been diffused to all French AI technicians and engineers involved in reproduction. About 3300 supplementary books have been distributed to farmers, agricultural schools and other partners involved in development activities. Actually, several sets of slides have been prepared to facilitate the utilisation of the REPRO Guide during teaching sessions.

### **5.0 Conclusion**

Several sources of information are available to quantify and qualify reproductive performances at a national level (genetic indexes, detection of genetic markers) and at the herd level (analysis of reproductive performances). The combined use of genetic and practical tools may improve reproductive results in the next years.

At the herd level, it is necessary to convince breeders to modify some of their practices to decrease the impact of detrimental environmental factors such as bad restraining, and bad management of the peri-partum period. When based on precise estimation of the reproductive performances, field trials help to actualize and precise the practices to be recommended under field conditions. Such trials also facilitate the appropriation of the results by breeders and this contributes to increase the application rate. However, some domains remain problematic. Most particularly, heat detection and expression remain one of the most important problems in dairy herds, mainly because in case of bad results, it is difficult to separate properly the detection and expression characteristics within a herd and also because, when formulated, the recommendations are not often applied. New methods of detection (such as automatic methods) and/or new management strategies (in relation with milk production), which could involve economical criteria should be developed to improve heat detection.

Finally, sanitary aspects and the way pathogens interact with reproductive events should be probably more precisely investigated. Additional tools and alternative strategies may be developed especially in the herds where the use of above described tools were not efficient enough to improve reproductive performance despite a good application of recommended measures.

### **6.0 References**

- Barbat A., Druet T., Bonaiti B., Guillaume F., Colleau J.-J., Boichard D., 2005. Bilan phénotypique de la fertilité à l'insémination artificielle dans les trois principales races laitières françaises. *Renc. Rech. Rum.*, 12, 137-140.
- Colleau J.J., 2010. Cited by Fritz 2010
- Ducrocq V., 2010. Le projet AMASGEN vers la sélection génomique du futur. *BTIA*, 135:18-19.
- FGE, 2009. La révolution génomique: une nouveauté pour la sélection des bovins laitiers, la SAM. Editor: France Génétique Elevage, 1-16.
- Frappat B., Dockès A.-C., Lacour C., Souquet C., 2005. Les attentes et besoins des éleveurs de bovins en matière de conseil. *Renc. Rech. Rum.*, 12, 69-72
- Freret S., Ponsart C., Rai D.B., Jeanguyot N., Paccard P., Humblot P., 2006. Facteurs de variation de la fertilité en première insémination et des taux de mortalités embryonnaires en élevages laitiers Prim'Holstein. *Renc. Rech. Rum.*, 13, 281-284.

- Freret S., Ponsart C., Jeanguyot N., Paccard P., Humblot P. Effect of restraint quality during first service on early embryonic death rate in Prim'Holstein dairy herds. In: 11<sup>th</sup> annual conference of the European Society for For Domestic Animal Reproduction (ESDAR), 21-22 septembre 2007, Celle, Allemagne. *Reprod. Dom. Anim.*, Vol. 42, Suppl. 2 (Sept. 2007). p. 125 (abstract P176).
- Freret S., Ponsart C., Paccard P., Jeanguyot N., Humblot P., 2008. Relationships between estrus detection practices, AI conditions, milk production and fertility at first service in Prim'Holstein herds ("FERTILIA" field study). *Renc. Rech. Rum.*, 15.
- Fritz S., 2010. Perspectives d'utilisation de la sélection génomique chez les bovins laitiers. *BTIA*, 135:15-17.
- Grimard B., Fréret S., Chevallier A., Pinto A., Ponsart C., Humblot P., 2006. Genetic and environmental factors influencing first service conception rate and late embryonic/foetal mortality in low fertility dairy herds. *Anim. Reprod. Sci.*, 91, 31-44.
- Humblot P., 2001. Use of pregnancy specific proteins and progesterone assays to monitor pregnancy and determine the timing, frequencies and sources of embryonic mortality in ruminants. *Therio.*, 56, 1417-1433.
- Humblot P., Freret S., Ponsart C., 2009. Epidemiology of Embryonic Mortality in Cattle; practical implications for AI and Embryo production. CETA/ACTE & AETA Joint Scientific Convention, Montréal, Québec, Canada, 17-19 septembre 2009.
- Humblot P., Le Bourhis D., Fritz S., Colleau J.J., Gonzalez, Guyader-Joly C., Malafosse A., Heyman Y., Amigues Y., Tissier M., Ponsart C., 2010. Reproductive technologies and genomic selection in the bovine. In: 26<sup>ème</sup> Colloque de l'A.E.T.E., 10-11 septembre 2010, Kuopio (Finlande) (accepted for publication).
- Kling-Eveillard F., 1994. Etude exploratoire sur la fécondité des cheptels laitiers. 58 p
- Lean I.J., Rabiee A.R. and Moss N., 2003. A hazards analysis critical control point approach to improving reproductive performance in lactating dairy cows. *Proceedings of the Australia and New Zealand Combined Dairy Cattle Vets Conference* 20:419-44.
- Magne M.-A., Couzy C., Cerf M., Ingrand, S., 2007. Analyse des difficultés rencontrées par les conseillers et des façons qu'ont les éleveurs de mobiliser les ressources informationnelles: quelle convergence ? *Renc.Rech. Rum.*, 13,63.
- Magne M.-A., Couzy C., Ingrand, S., 2005. Comprendre comment les éleveurs de bovins allaitants mobilisent des informations pour concevoir et piloter leur activité d'élevage: distinguer le Support, l'Origine et le Contenu (SOC). *Renc.Rech. Rum.*, 12, 65-70.
- Mee J. Bovine fertility management. In: "European Buiatrics Forum (EBF), 1-3 décembre 2009, Marseille (France).
- Ponsart C., Dubois P., Levert J., Fréret S., Jeanguyot N., Charbonnier G., Congnard V., Humblot P., 2005. Influence des profils de notes d'état corporel sur la reprise de cyclicité après vêlage en élevage laitier. *Journée Bovine Nantaise*, 98-101.
- Ponsart C., Frappat B., Le Mezec P., Freret S., Seegers H., Paccard P., Humblot P. Une palette d'outils pour améliorer la reproduction des vaches. In: 14<sup>èmes</sup> Journées 3R (*Renc. Rech. Ruminants*), Paris, 5-6 décembre 2007. p. 351-358.
- Ponsart C., Fréret S., Frappat B., Barbat A., Le Mezec P., Seegers H., paccard P., Humblot P., 2008. Fertility management & consultancy on farm in France. In: 20<sup>th</sup> European AI Vets Meeting, Utrecht (Pays-Bas), 17-20 novembre 2008, p. 47-56
- Tancerel M., 2004. Les pratiques de reproduction en élevage bovin laitier: état des lieux et perspectives d'amélioration, Mémoire de fin d'études d'ingénieur ISAB. 149 p.



## Introduction of mandatory electronic identification of cattle in Denmark

O.K. Hansen

*Danish Cattle Federation, Livestock Registration and Milk Recording, Agro Food Park 15, DK-8200 Aarhus N, Denmark*

### **Abstract**

Electronic identification (EID) of cattle in Denmark is by regulation mandatory as of 1. July 2010. Denmark is the first EU member state to introduce mandatory EID of cattle, but for sheep and goats in EU it has been mandatory as of 1. January 2010. This paper discusses the background and the considerations before this decision was made and describes how it will be implemented.

*Keywords: identification, cattle, EID.*

## **1.0 History**

### **1.1 Identification in general**

Denmark was the first country with regular milk recording schemes starting in 1895. Here of course individual identification of cows is necessary and it was done by ear notching.

This system was used until 1982 when Danish Cattle Federation (DCF) introduced the current numbering system with premises numbers and nationally unique lifetime numbers and lifetime ear tags for animals in milk and beef recording schemes (herdbook animals). At that time the average herd size in milk recording was 40 cows. The change was coordinated with introduction of a cattle database in 1984.

Until 1991 metal ear tags were used. These provided very poor readability. The farmer had to catch the animal and often to clean the metal tag to be able to read the number. As of 1991 plastic ear tags with good readability are used.

In 1995 DCF asked for a national legislation to make identification and registration of all cattle in a central national database mandatory. This was in order to enable control of all movements of cattle in order to help eradication of infectious diseases such as IBR (Infectious Bovine Rhinotracheitis). However, no national legislation was made until EU-legislation was published in June 1997. At that time the numbering system built by DCF was adopted by Danish authorities. The national database already had 70 % of all cattle registered and the remaining 30 % were registered before March 1998. At that time the average herd size in milk recording was 65 cows.

### **1.2 Electronic identification**

In 2001 Danish Meat Board representing slaughterhouses and DCF made a study on feasibility of EID followed by a test in eight herds 2001 – 2003. The test covered aspects from daily farm management to automatic identification when entering the slaughterhouse.

DCF has actively followed experience gathered in Australia, Canada and other countries already implementing mandatory EID in cattle.

In 2007 DCF asked for national legislation mandating EID of cattle.

In 2008 DCF, Veterinary Services of Denmark, and the Department of EU Control made a joint test of transponders and transceivers. The test covered aspects from reading distance to practical use of handheld readers and panel readers. In 2009 DCF finalized a report on technical and economic aspects regarding EID. At the same time the Ministry for Food, Agriculture and Fisheries published a report on possible ease of administrative burdens for farmers. Now the average herd size in milk recording was 135

cows and still increasing. In December 2009 finally the regulation on mandatory EID for all cattle in Denmark was published.

## 2.0 Technical aspects

### 2.1 Selection of devices

When EID is a voluntary solution used only for automating identification of animals for daily management purposes quality issues may be left to the market place. If the user is not satisfied with the product he has to discuss it with the manufacturer or he might choose products from another manufacturer. This is how manufacturers improved the quality of products over time simply to stay in the market.

When EID becomes mandatory by law the situation is different. The competent authority must approve products for the official identification scheme and they must check that the products satisfy relevant quality criteria. Products with bad performance cannot be approved but still there may be options for the farmers to choose among a list of approved products.

Also the competent authority must ensure that the identity of animals moved can be read where the animals arrive. Thus EID products approved must be conforming to general standards for the country and possible even internationally.

ICAR is the Registration Authority of ISO and has for almost 15 years been active in testing and approving conforming devices to ISO 11784/11785. In animal identification these standards are the basic standards. Previous ICAR test protocols have now been transformed into the ISO 24631 standard but ICAR still is the Registration Authority. You can find all ICAR approved devices on the ICAR website.

### 2.1 ISO conformance and performance

#### 2.1.1 Transponders

Transponders approved for official identification of cattle in Denmark have to be ICAR approved for ISO 11784 and ISO 11785 conformance, which means they have to pass the ISO 24631-1 test. In addition they have to be performance tested according to ISO 24631-3.

The test made by DCF in 2008 with six types of tags all tested against five types of readers provided useful information about reading distances, which could later be related to the ISO 24631-3 test when it started in late 2008.

The transponders chosen for cattle in Denmark all have a minimum activation field strength under 0,6 A/m (115,6 dB $\mu$ A/m) and a modulation amplitude higher than the EU requirement for transponders for sheep and goats. Transponders for sheep and goats in EU must have a activation field strength at or under 1,2 A/m (121,6 dB $\mu$ A/m) and a modulation amplitude at or above 10 mV at a field strength 1,2 A/m.

In comparison to all other transponders currently tested by ICAR the cattle transponders chosen in Denmark are in the upper 33% when we talk about expected read range.

#### 2.1.2 Transceivers (readers)

The read distance for a transponder depends on several factors including the transponder (see above section) and the transceiver. The transceiver must deliver sufficient field strength to activate the transponder. When activated the transponder must respond with a signal strong enough to be received by the transceiver. In addition the transmission may be hampered by electronic noise from the environment. Laboratory testing of read distances must be done under controlled and identical conditions, which means actual read distances in practice might be different. These are the reasons why it is not possible to guarantee exact read distances.

In Denmark there are no official requirements on transceivers. The use of transceivers on farms is voluntary so the performance requirements are to be agreed between user and supplier. DCF very strongly advocates the farmers buy "ISO readers" which are readers capable of reading HDX and FDX-B transponders at almost same performance level. This goes for handheld readers and panel readers, bought separately or as built in readers in barn equipment.

### 2.1.3 HDX and FDX-B

Transponders with the same performance test results from ISO 24631-3 test will to the best of our knowledge perform equally independent on HDX or FDX-B technology. The reason for discussions about HDX and FDX-B performance might be a bigger variation in performance among products coming from a big number of manufacturers of FDX-B products compared to a lower number of manufacturers of HDX products.

Transponder performance should never be compared without an ISO 24631-3 test. When you compare tractors from different companies you would always ask how much power each tractor provides. The parallel situation when discussing transponders is to ask for the performance test results on transponders from different technologies and manufacturers.

As for tractors the performance needed from transponders depends on the task to be done. Previously I discussed performance criteria for sheep and goat applications compared to cattle applications. The performance test can only provide performance information. Performance criteria need to be defined for different applications.

## 2.0 Economic aspects

### 1.1 Where EID is useful

The overall goals by introducing mandatory EID are easier everyday herd management, improved data quality in registration, improved food safety, and improved farm economy.

EID is able to ease identification in milking equipment, feed stations, weighing animals, separation gates, surveillance, and moving animals etc. The rapid growth in herd size means that EID solutions are feasible for ever more herds. We have seen already that the number of herds voluntarily using EID is hastily growing.

EID will also be able to ease identification when outside personnel apply services such as milk recording, AI-service, veterinary treatment, hoof trimming, transporting, slaughtering, and rendering. Not only is the identification of animals quicker, it is also more reliable and electronic transfer of the identity read takes out mistakes from misreading and miswriting of data. In order to harvest the advantages at full scale it is important that all animals are electronically tagged as soon as possible. When harvesting the benefits at full scale EID is also economically feasible for smaller herds.

### 1.2 Estimated cost benefit

The following benefits are based on estimated time saving at normal events in herds after EID tagging of all animals, and the economy is estimated as saved working hours at a normal salary for those events:

- |   |                            |
|---|----------------------------|
| 1. Better and more effective herd management and implementation of new technique<br>13 € per cow and year : | <b>Total 6.7 million €</b> |
| 2. Easier identification and registration in AI-service<br>0,25 € per first service:                        | <b>Total 173,000 €</b>     |
| 3. Easier identification and registration in veterinary service<br>1.33 € per visit:                        | <b>Total 800,000 €</b>     |
| 4. Easier identification and registration in milk recording<br>40 € per visit:                              | <b>Total 2.0 million €</b> |
| 5. Easier identification and registration in hoof trimming<br>0,40 € per trimming:                          | <b>Total 240,000 €</b>     |
| 6. Easier identification and registration in transporting<br>0,40 € per moved animal:                       | <b>Total 350,000 €</b>     |
| 7. Easier identification and registration in slaughterhouse<br>1,33 € per slaughtered animal:               | <b>Total 650,000 €</b>     |



8. Easier identification and registration in rendering plant 0,40 € per rendered animal:	<b>Total</b>	<b>40,000 €</b>
9. Easier identification and registration in markets, shows, etc. 0,80 € per animal:	<b>Total</b>	<b>80,000 €</b>
10. Easier identification at authority on farm inspections One working hour per inspection:	<b>Total</b>	<b>67,000 €</b>
<b>Annual savings:</b>		<b>11.1 million €</b>
Estimated extra cost for EID tags:		<b>1.0 million €</b>
Readers etc. for service providers:		<b>670,000 €</b>
<b>Annual costs</b>		<b>1.67 million €</b>

The desire to use automated identification for on farm daily herd management is decided by the farmer himself and so the costs for on farm readers are not considered a part of costs from introducing mandatory EID.

Benefits arise from time savings in registration of animal identities and in handling fewer errors in registries. Some of the time savings are harvested directly by the farmer and have no impact on invoiceable costs. Benefits harvested by service providers should eventually come back to the farmer when service providers invoice their services.

Benefits for the competent authority cannot alone cover the cost of implementing mandatory EID.

Off farm benefits cannot alone cover the cost of implementing mandatory EID.

Benefits for service providers are more than double of the extra costs. This means that even farmers not utilising electronic reading themselves will benefit from the introduction of mandatory electronic identification.

More than 50 percent of possible benefits are directly on farm.

The benefits will not be fully harvested until all animals have been electronically tagged. This is expected by 2015. For the first couple of years after implementing the regulation the investments will be higher than the benefits.

### 3.0 Administrative aspects

The above estimated cost benefit is valid only when all cattle is electronically identified. The interest of service providers to invest in portable transceivers and automated data capture depends on the proportion of animals with EID.

Introduction of EID could be done by three different regimes:

#### 1. Voluntary use of EID

10–15 percent of tags sold in recent years were electronic tags, so the system already exists. Only farmers seeing personal benefits will start using EID. Risk that transponders used in voluntary on farm applications do not follow internationally agreed standards and do not have ID-codes unique outside the specific farm where applied.

Voluntary use means it will take long time before service providers and authority inspection body want to invest in reader equipment and automatic data capture.

#### 2. Use of EID in all animals tagged after fixed date

The system provides gradual implementation so that service providers etc. can incorporate the benefits after a few years.

Farmers and service providers will gradually learn the benefits related to EID, which will improve the interest of voluntary EID tagging of animals born before the start date.

The cost of EID tagging will from the start be at the same level as normal future operating cost.

15 – 18 months after the start date heifers for AI-service, and the AI service might be interested.

At the same time bulls for slaughter will wear EID, and the slaughterhouses might be interested. 27 months after the start date first calves in dairy herds will wear EID and the veterinarians might be interested.

Three years after the start date approx. 15 percent of the Danish cattle population would still not be EID tagged. After four years it would be approx. 10 per cent. At such time the authorities might decide mandatory EID tagging of all animals not yet wearing EID.

### **3. Retagging of the whole population within a short period**

After a very short while (months) everybody (farmer, service provider, authority etc.) will be able to implement all benefits from EID.

However, it would be necessary to retag the full existing cattle population incurring a lot of extra work and extra cost at a time when the benefits of EID have not been evident in practice.

Variations of the three main regimes have been discussed and also questions regarding funding of EID. One variation was to exempt smaller herds from mandatory EID. Another variation was that bigger herds paid a small levy for EID tags. The levies could then have funded the extra cost of EID in smaller herds even if the EID tagging would still be mandatory for all.

By December 2009 option 2 was chosen and a regulation was issued making the use of EID mandatory for all cattle to be tagged after 30. May 2010.

Information letters were sent by Danish Veterinary Services to all keepers of cattle in Denmark in December 2009. DCF has sent further information in its newsletter early March 2010 and by a special letter again reaching all keepers of cattle in Denmark by the end of April 2010.





## Current situation of animal identification and recording systems in developing countries and countries with economies in transition

C.B. Banga<sup>1</sup>, B. Besbes<sup>2</sup>, B. Balvay<sup>3</sup>, L. Chazo<sup>4</sup>, O.M. Jamaa<sup>5</sup>, A. Rozstalnyy<sup>6</sup>, G. Rovere<sup>7</sup>, A. Toto<sup>8</sup> & K.R. Trivedi<sup>9</sup>

<sup>1</sup>Agricultural Research Council, Animal Production Institute, P/Bag X2, Irene 0062, South Africa

<sup>2</sup>FAO Animal Production and Health Division, Viale delle Terme di Caracalla - 00100 Rome, Italy

<sup>3</sup>Institut de l'élevage, 149, rue de Bercy, 75595 Paris, France

<sup>4</sup>Asociación Criadores de Holando Argentino, ACHA Laprida 1818 AR 1425 Buenos Aires, Argentina

<sup>5</sup>Livestock and Pasture Bureau, 30 Rue Alain Savary, Tunis 1002, Tunisia

<sup>6</sup>FAO Sub regional Office for Central and Eastern Europe, Benczúr ut.34, 1068 Budapest Hungary

<sup>7</sup>National Institute for Dairy Herd Improvement, Nueva York 1673, CP 11800 Montevideo Uruguay

<sup>8</sup>Ministry of Agriculture, Water and Forestry, P/Bag 12022, Windhoek, Namibia

<sup>9</sup>National Dairy Development Board, IND 388001 Anand, Gujarat, India

### Abstract

Animal identification and recording have a critical role to play in enhancing food security and rural development, particularly in the poor countries of the world. A survey was conducted to assess the current status of animal identification and recording (AI&R) systems in 23 developing countries and 10 countries with economies in transition. The survey showed wide variation of AI&R systems among countries, within and across regions. Different AI&R systems, addressing various needs, exist in these countries. Most of the countries (87%) indicated that they have animal identification systems in place, which, for the large majority (76%), serve as a means to control animal diseases. Other uses of AI&R are traceability (65.5%) and performance recording (51.7%). The majority of AI&R systems (53.1%) cater for cattle/buffaloes only. In 15.6% of the countries, all livestock are identified and recorded. Most AI&R systems developed for disease control and traceability are fully funded by government, generally with donor support. Government and farmers share the costs of most performance recording systems; also with donor subsidies. Pedigree recording systems are financed by government and breed societies. Most AI&R systems (61.4%) are administered by government; private organisations, research institutions and universities run 20.5%, 9.1% and 6.8%, respectively.

*Keywords: Identification, registration, performance recording, traceability.*

### 1.0 Introduction

The socio-economic importance of livestock in the poor countries of the world cannot be over-emphasised. Globally, the livestock sector contributes 4.0% of agricultural domestic product (GDP), employs 1.3 billion people and creates livelihoods for 1 billion (70%) of the world's poor (Steinfeld *et al.*, 2006). As a result of population growth, urbanization and changing food preferences, the demand for livestock products is increasing rapidly and this trend is expected to continue into the foreseeable future. Whereas only marginal increases in consumption of meat and milk are expected in the developed world, increases of 114% and 133% respectively are projected until the year 2020 for meat and milk consumption in the developing world (Delgado *et al.*, 1999). Furthermore, there is a great challenge to alleviate poverty in developing countries by producing more and safe food, especially of animal origin, against a shrinking animal genetic diversity and increased global trade (Philipsson and Okeyo, 2006).

There is therefore a pressing need for increased output of food of animal origin in the poor countries of the world. In some developing regions, e.g. Sub-Saharan Africa, higher output from livestock production

has been achieved by increases in animal numbers than by improved productivity. However, the increasing trend towards intensification and industrialisation of livestock production occurring in most developing regions (Steinfeld *et al.*, 2006) is placing unprecedented pressure on existing resources; hence future emphasis will have to concentrate on greater efficiency in terms of output per animal and per unit of land. Animal performance recording, monitoring and evaluation are key to better herd and flock management and, thus, to increased efficiency.

Efficient utilisation of animal genetic resources in developing countries is also key to meeting future demands for food to improve the livelihood of poor people. About 70% of the world's livestock breeds are found in the tropical developing world (Philipsson and Okeyo, 2006). It is essential to characterize these breeds so as to develop an awareness of their roles and values, followed by programmes to improve and conserve them. Animal identification and recording systems are vital to the achievement of all this.

Animal identification and recording potentially have a big role to play in preserving the rich animal genetic resources in developing countries through disease control. A sound AI&R system, particularly when linked with a traceability system, helps countries to put in place measures such as surveillance, early detection and notification of outbreaks, rapid response, control of animal movements, and zoning or compartmentalisation. Furthermore, past food scares such as those caused by bovine spongiform encephalopathy (BSE), and foot and mouth disease (FMD) outbreaks, in addition to emerging diseases caused by climate change have heightened concerns about food safety and the need to trace farm products from "farm to fork". Traceability systems used to identify animals, monitor their movements, and trace animal products have evolved considerably, largely due to the requirement by large trading blocks (the EU in particular) to have all animals traceable. Developing countries and countries with economies in transition that are exporting or wish to export animal products to the EU, USA or Japan have no choice but to fulfil these "world market" standards.

In many developing countries, the need to control stock theft has also given motivation to the implementation of AI&R schemes. In some countries in southern Africa, the problem is getting so bad that farmers are no longer willing to take the risk of keeping animals at all.

This paper presents preliminary results of work carried out by the ICAR task force for developing countries to assess the current state of AI&R programmes in developing countries and countries with economies in transition. Such information will allow the establishment of a database of current programmes and monitor them on regular basis, not only to document and learn from successes and failures but also to report on those at risk so that action could be timely taken. This forms part of an ongoing broad effort by ICAR and FAO to promote the establishment of sustainable AI&R systems in these countries.

## 2. Methodology

A survey was conducted, through a questionnaire, in 23 developing countries and 10 countries with economies in transition in Africa, Asia, Central and Eastern Europe and Latin America (see Table 1). The questionnaire was in the form of an excel spreadsheet, in order to facilitate subsequent data management and analysis. Columns in the spreadsheet were filled out for each programme in the country. Questions gathered information such as type of programme, status (running, being implemented/tested or planned), purpose(s), species recorded, participation options, administration and funding mechanisms. Persons involved in AI&R in the various countries were requested to fill out the questionnaires. Responses were received between September and November 2009.

Data were first summarised by using categorical variables (1, 2....) to denote different responses. Counts and percentages of the response variables were subsequently derived and are presented herein graphically.

Table 1. Regions and countries covered by survey.

Region	Countries
Latin America	Paraguay, Chile, Peru, Ecuador, Panama, Mexico, Colombia, Uruguay, Argentina, Costa Rica
Africa	Namibia, South Africa, Zimbabwe, Botswana, Kenya, Tanzania, Malawi, Zambia, Lesotho, Angola, Tunisia
East and Central Europe	Hungary, Serbia, Croatia, Macedonia, Moldova, Ukraine, Belarus, Russia, Armenia, Georgia
Asia	India, Malaysia

### 3. Results and discussion

Figure 1 shows the number of countries with identification, performance recording or traceability systems, as a percentage of the total number of countries surveyed. These are systems that are currently running, are being implemented/tested or have concrete plans for implementation. A large majority of countries (87%) have identification systems. These systems range from simple group/owner identification (e.g. branding) to state-of-the-art electronic systems. A significantly large number of these countries (57.6%) have traceability systems while 45.5% have performance recording systems. There is, therefore, a substantial number of AI&R systems (running, being implemented or planned) in most of these countries.

The purposes for which animal identification systems are put into use are depicted in Figure 2. Some identification systems serve multiple purposes. Most of the identification systems (75.9%) are utilised for the control of animal diseases. Traceability and performance recording utilize a relatively smaller proportion of the existing identification systems (65.5% and 51.7% respectively).

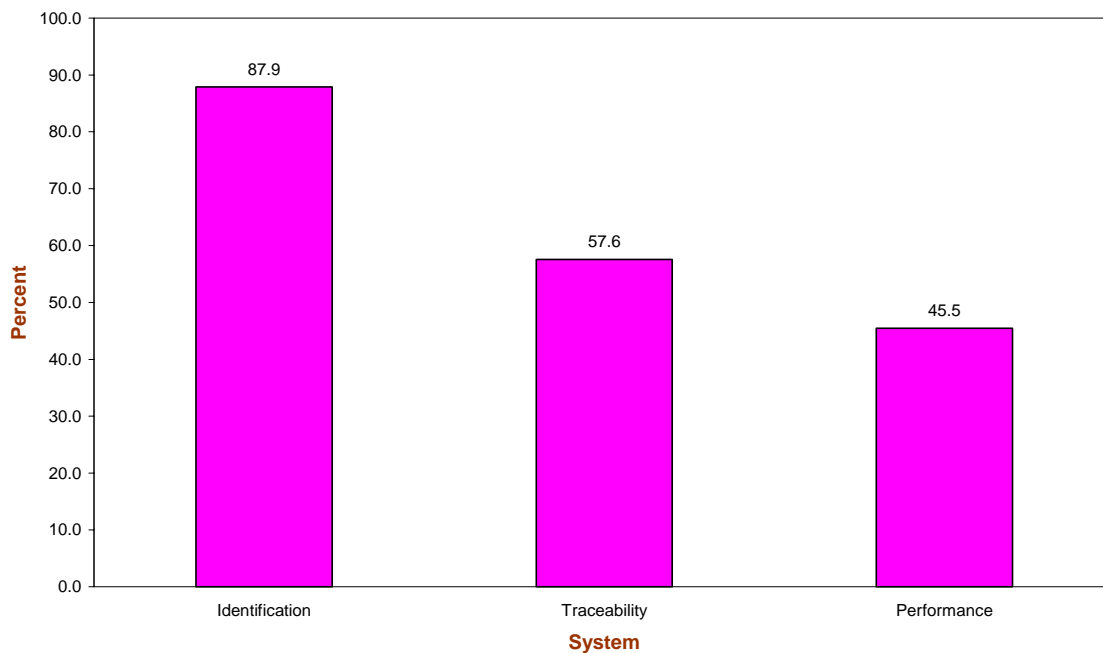

Figure 1. Percentages of countries with Identification, Traceability and Performance Recording Systems.

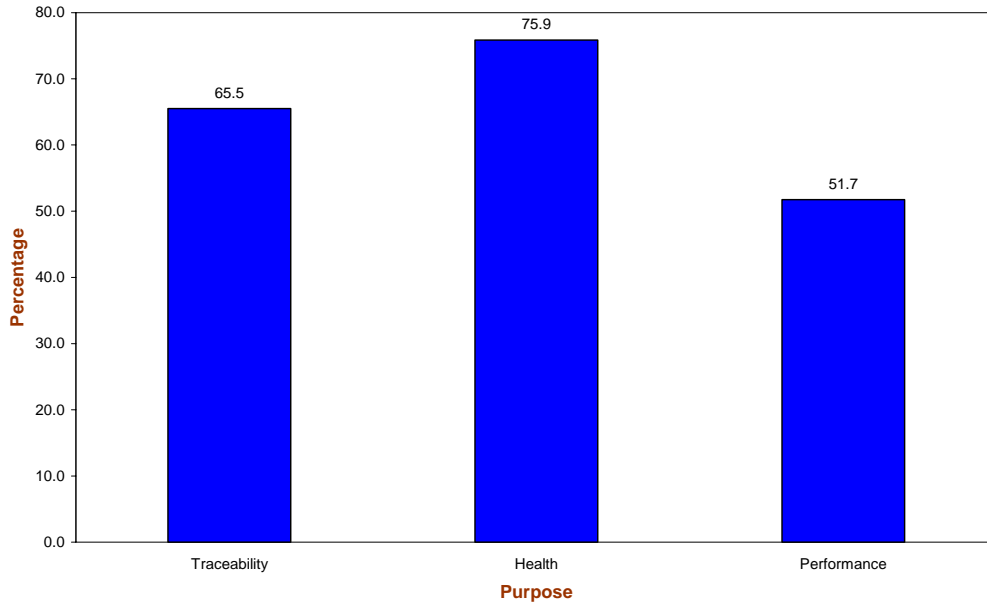

Figure 2. Purposes of Animal Identification Systems.

Subsequent analysis of the data was carried out to get an indication of systems that are currently running, compared to those that are planned and those being implemented. None of the countries surveyed has performance recording or traceability systems that are being implemented. A significant proportion of traceability systems (42.1 %) have however been planned. On the other hand, only 16.7% of performance recording systems are planned for implementation. This shows that there is, presently, much more interest in setting up traceability systems compared to performance recording systems. The non-existence of systems in being implemented may, however, be an indication that many systems get planned but do not get to the implementation stage. There is a need to monitor the planned systems over time to see if they ever get implemented.

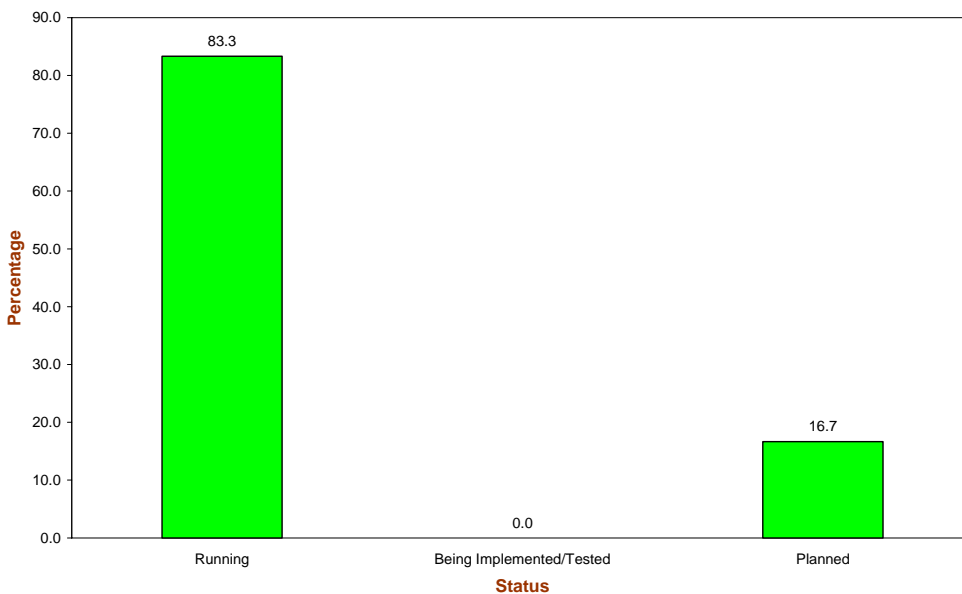

Figure 3. Status of Performance Recording Systems.

Fifty-eight per cent of AI&R systems in the countries surveyed are mandatory; the rest are voluntary. In general, systems developed for traceability or disease control are mandatory while performance recording systems are voluntary. Some countries (e.g. Namibia, Argentina, and Uruguay) have mandatory national identification and traceability systems. Other countries (e.g. Zimbabwe) have voluntary privately-run traceability systems primarily designed to enable market access.

The majority of AI&R systems (53.1%) cater for cattle/buffaloes only. All livestock are identified and recorded under 15.6% of the systems. Dairy cattle AI&R programmes are by far the most popular ones, particularly where improvement of animal performance is the primary goal. There are, however, examples of AI&R programmes aimed at improving the performance of beef cattle (Armenia, Argentina, Botswana, South Africa, Namibia and Uruguay), sheep (Belarus, Croatia, Georgia, Namibia, South Africa, Perú and Uruguay), horses (Argentina, Namibia, Perú and Uruguay), pigs (Argentina, South Africa, and Zimbabwe), buffaloes (India) and camelids (Perú).

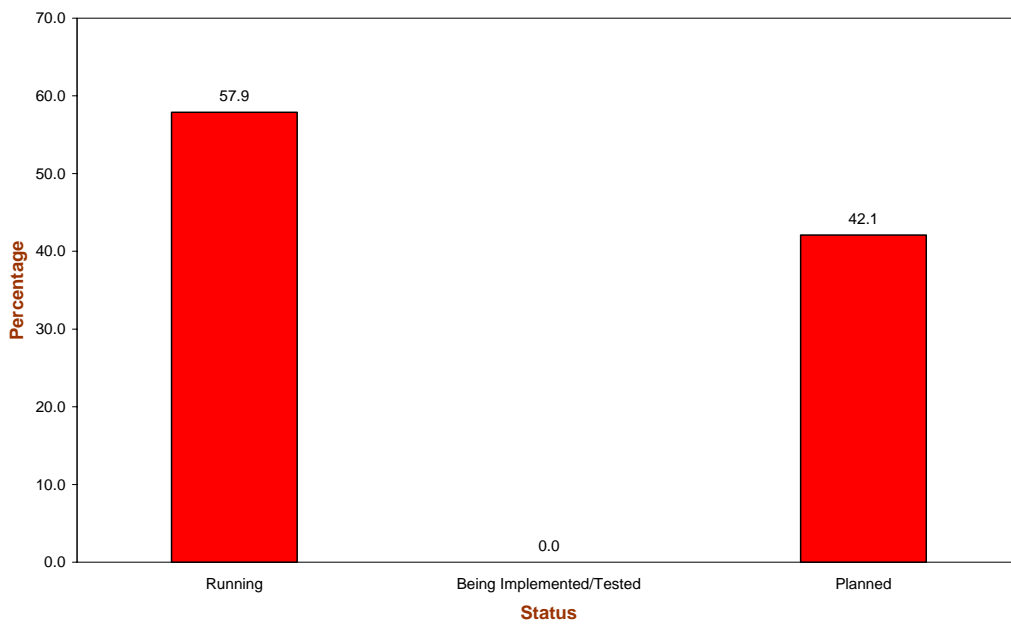

Figure 4. Status of Traceability Systems.

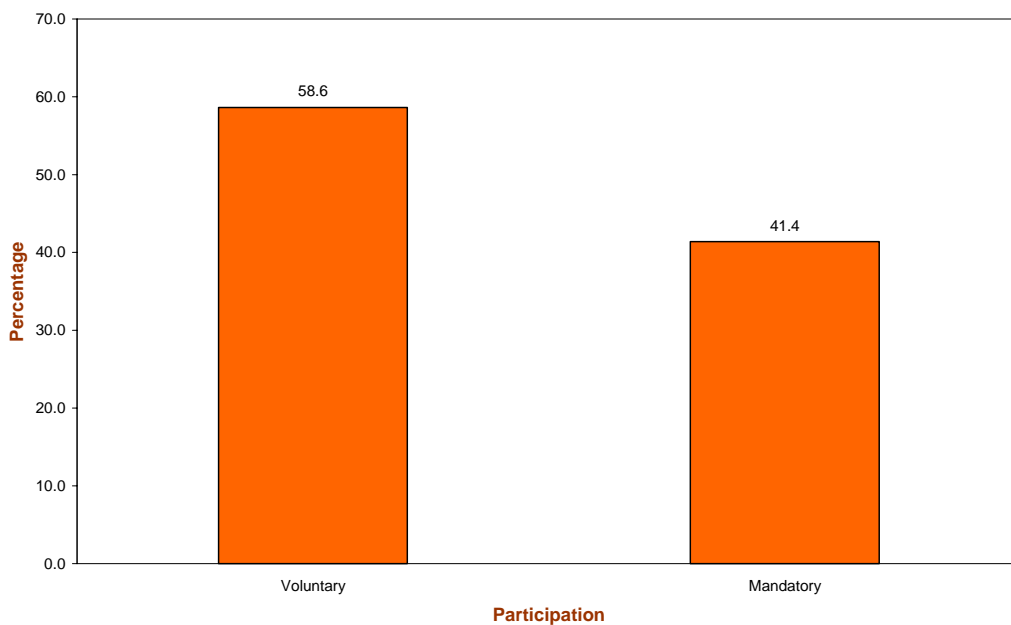

Figure 6. Participation in I&R system.



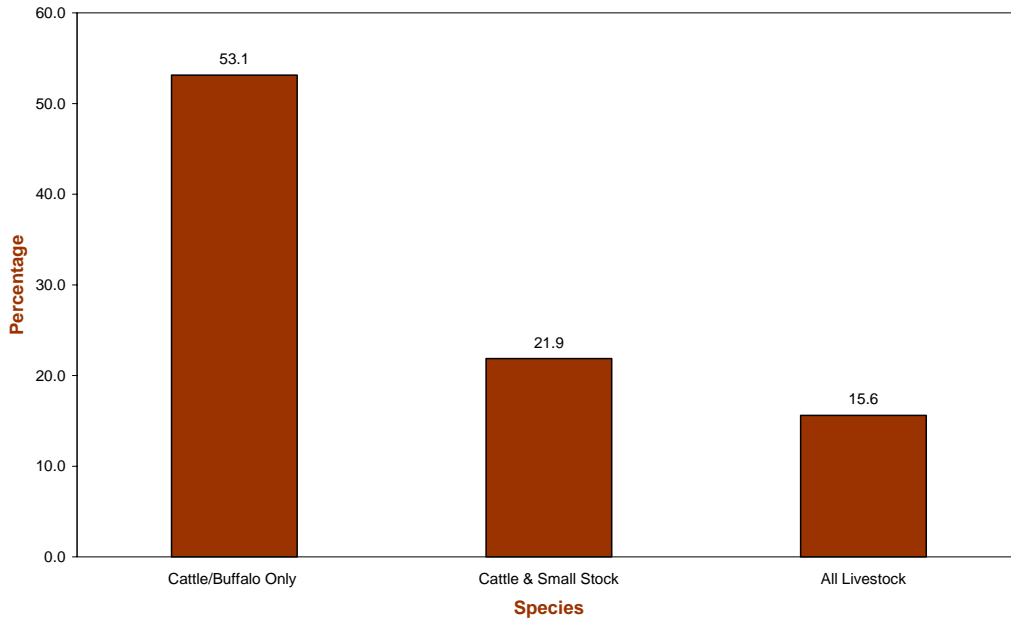

Figure 6. Species participating in I&R systems.

A primary objective of the study was to look at the way the various AI&R systems are administered and funded. These are highly important factors influencing programme sustainability. An understanding of the relationship between these factors and system sustainability may help to develop models for sustainable AI&R systems in developing countries. Government contributes in funding nearly 70% of the systems; it fully pays for 37.1% of these. The latter mainly comprise systems of national importance, such as those developed for traceability and disease control. System users (farmers) pay the full costs in 25.7% of the programmes and these are mainly performance and pedigree recording systems. The contribution of donors is marginal and they mainly provide supplementary funding. Most I&R systems (61.4%) are administered by government; private organisations, research institutions and universities run 20.5%, 9.1% and 6.8%, respectively.

Further surveys will be conducted that will seek to collect information on some sustainability indicators. Analysis and monitoring of these indicators *vis a vis* the different funding and administration methods will help in the development of guidelines for sustainable AI&R systems in developing countries.

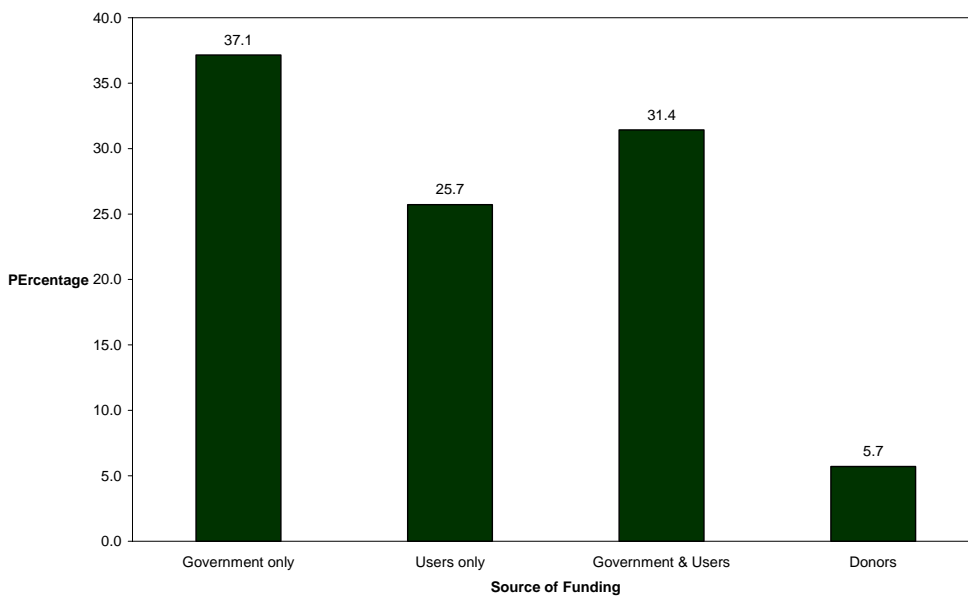

Figure 7. Funding of systems.

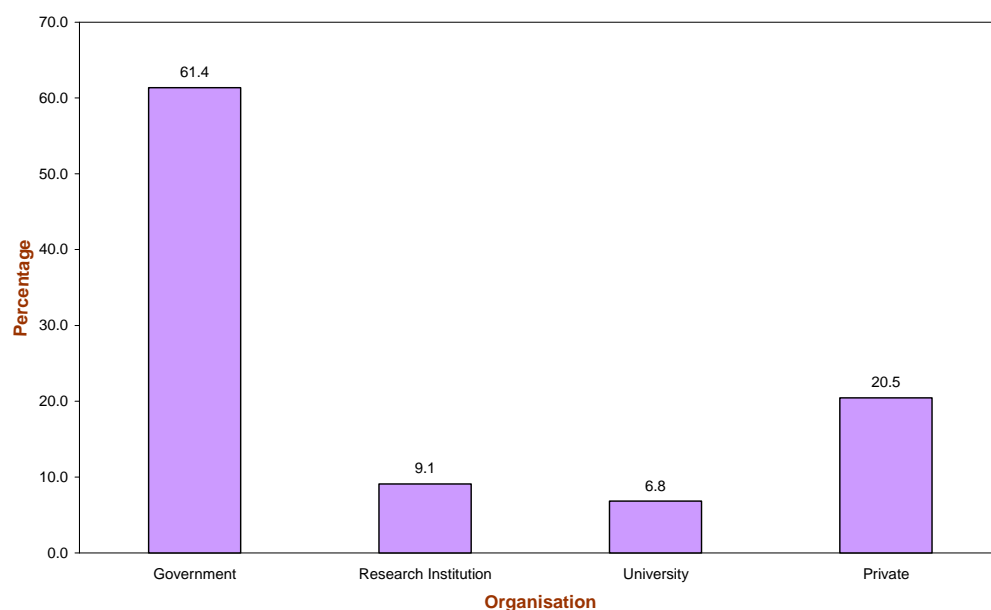

Figure 8. Implementing organisations.

## 4. Conclusions

The study provides a quick picture of the current situation of AI&R systems in developing countries and countries in transition. There are various AI&R systems in the different regions and countries, serving different purposes and funded and administered in different ways. Government, however, plays a central role in the running of most of these systems, particularly those of national importance. There is a growing interest in setting up new AI&R systems as indicated by the high number of systems that have been planned but not yet implemented. Consistent monitoring of existing systems will provide practical lessons on how to implement sustainable AI&R systems in the developing world.

## 5. References

- Delgado C., Rosegrant M., Steinfeld H., Ehui S. and Courbois C. 1999. Livestock to 2020- The next food revolution. Food, Agriculture, and the Environment Discussion Paper 28. IFPRI (International Food Policy Research Institute), Washington, DC, USA. 72 pp.
- Philipsson, J. and Okeyo, A.M. 2006. Global perspectives on animal genetic resources for sustainable agriculture and food production in the tropics. In: Animal Genetics Training Resource, version 2, Ojango, J. M., Malmfors, B. and Okeyo, A.M. (Eds). International Livestock Research Institute, Nairobi, Kenya and Swedish University of Agricultural Sciences, Uppsala, Sweden.
- Steinfeld H, Gerber P, Wassenaar T, Castel V, Rosales M, de Haan C. 2006. In: Livestock's Long Shadow: Environmental Issues and Options. Rome: Food and Agriculture Organization of the United Nations.





## The French bovine identification and traceability system, updated with the technology of RFID

L. Marguin

*Institut de l'Elevage, 23 Rue Baldassini, 69364 Lyon, France*

### **Abstract**

From 1998, individual identification and traceability became essential for major cattle breeding countries.

In France starting in the 70's, all the premises and the cattle were identified as early as 1978. The national system is managed by the Ministry of Agriculture with the responsibilities of the regional farmers' organisations. There are 8 millions of births per year, 25 millions of movements and 6 millions of slaughters for 280 000 bovine farmers.

In the slaughterhouses, an own traceability system is applied, based on an order number of slaughter for each animal, carcass quarters and main cuts of meat. An accurate labelling of each piece of carcass gathers all the information, transferred electronically by the national identification system.

At first the development of software on PDA helped the record and controls of data on the field and now the RFID ear tags on the animals can still improve the quality of data at all levels of the production line : on the farm, on the market, in the slaughterhouse.

The success of such a system depends on technological aspects but also on the organisation of the national system to ensure reliability and efficiency.

*Keywords: Identification, traceability, cattle, RFID.*

### **1.0 Cattle individual identification**

The traceability of beef meat began with the individual identification in many big breeding countries. It has been compulsory in all the European Union since 1998, in Australia and New Zealand one year after, then in Canada, and after Japan, Brazil, Uruguay, Mexico, Argentina, and Chile.

Traceability is a necessity for the reasons developed under.

#### **1.1 To eradicate some animal diseases and to manage sanitary crisis**

For eradication or management plans relative to designed diseases, control veterinarians from the Ministry of Agriculture have to check that all cattle get compulsory vaccinations and regularly realize blood tests.

These tests may give a positive result. In such cases, the veterinarian responsible for the test needs to find very quickly all animals which could have been in contact with the sick one. Indeed, depending on the disease (BSE for example), all these animals will have to be destroyed.

#### **1.2 For herd management**

The same of ficial individual identification has to be used by the farmer and technicians who manage animals of the herd.

### **1.3 For cattle trade**

When some live cattle or carcass are to be sold abroad, importer asks for identification number and data about the animal, to guaranty on the sanitary quality and to get technical data about an animal as breed, birth place and even parentage.

## **2.0 The French system of traceability**

The traceability of beef means that all cattle get a unique official individual identification number just after the birth, and then all the movements of cattle are recorded, so that trace back is possible to find all the animals in contact anytime. And this is anywhere till the slaughterhouse or the natural death.

### **2.1 The French history of identification**

In France the first law on breeding was in 1966. It defined rules of a permanent individual identification for volunteers' breeders who needed it for technical reasons: to select mothers and fathers for genetic improvement, private working number is no more sufficient.

After this genetic purpose, the sanitary crisis pushed the official identification complete itself after 12 years. In 1978, this permanent official identification was widespread and became compulsory for all breeders and all animals, this time on the official purpose of traceability of cattle. At this date, all farms were recorded with a unique number of premises, all births were notified very soon after born with an individual unique number and all movements between premises were also notified and recorded.

This compulsory identification was widespread to the whole European Union by the regulation of 1998 which makes compulsory the traceability of the beef meat till the pieces of meat with a system of labels for the consumers and specifies the necessity of a national database for alive cattle data.

### **2.2 General French organization**

From the beginning of the national system, French Ministry of Agriculture delegates the daily work of identification to local breeders' organizations, named "EDE" which are responsible of defined geographical zones. There are around 70 EDE to manage with 280 000 cattle herds and 20 millions of cattle.

A national technical organization, named Institut de l'Élevage, supports the Ministry to coordinate the implementation of the identification:

- To define methods which have to be the same everywhere.

- To help for the implementation at the level of farmers, EDE and national level.

- To help for the implementation of electronic identification and its different using cases.



## 2.3 Identification from the birth till the slaughtering

### 2.3.1 Identification of the calves

At the beginning a technician from the EDE, applied only one ear tag to the calves, when he passed once each three months on the farm.

In 1998, the European Commission decided that the calves have to be identified before 21 days of age, so the farmers were charged to put the two ear tags themselves. On top the French res possible decided to identify in the 7 days after birth.

The farmer orders to the EDE only the number of ear tags he needs for the calving year: the uniqueness of the numbers granted is the responsibility of the EDE (and the State behind). When some ear tags are not used or damaged, the farmer has to give back to the EDE.

To trace the data of any system (genetic, herd management, trading...) the same unique official identification number has to be used by anybody for the animal.

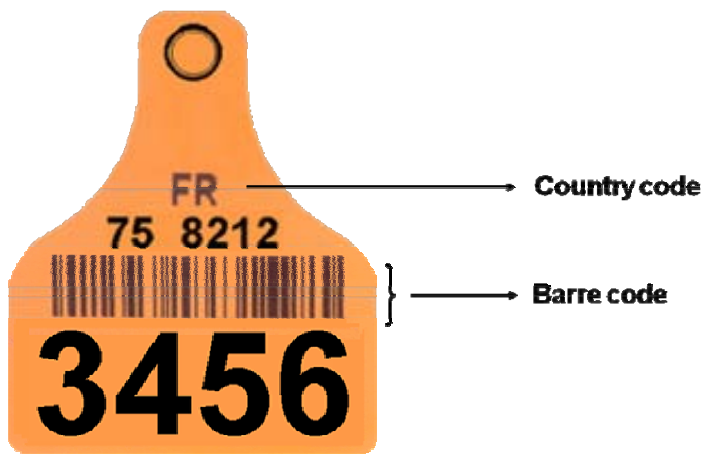

Figure 1. An official French conventional ear tag

Some electronic (Radio Frequency I D) official ear tags can be used since 2008 in France, with the previous identification system just adapted to the new electronic number: the advantage of RFID is an automatic reading with a receiver of the identification number of the animal, which is encoded in the chip of the ear tag.

This avoids involuntary human mistakes (on reading, on writing and on recording) on the identification of the animal concerned, so improve the reliability of the data recorded

### 2.3.2 The notification of all events on the farm

The farmer has to declare all events in the herd:

The birth with a new identification number, birth date, sex...

The entries on the farm, individual identification number of new animals.

The exits from the farm with the date of departure to slaughterhouse, other farms or death.

### 2.3.3 Record of data and controls

The record of all information sent by the farmer is done by the EDE or directly by the farmer with specific software and sent by an electronic net, after some controls on the data in the local database.

### 2.3.4 The French cattle passport

After recording a birth, the data are sent to the national database to check them at this level, and errors or OK are coming down to the EDE before to print the passport. The passport has to follow the animal all his life, till the slaughterhouse and after they are recovered to be destroyed.

### 2.3.5 Controls before slaughtering the animal

Before the animal is slaughtered, the identification number between his passport and his ear tags are checked: if there is not the right passport, the animal is not slaughtered.

If the passport corresponds to the animal at the entry of the slaughterhouse, a unique slaughtering number is associated to the identification number: a number with slaughtering date and an order number on the chain.

This short number is easier to use for the work on the chain, but one ear tag stays on the carcass till the cold chamber, in case of any doubt on the identification number.

### 2.3.6 Controls on the carcasses and pieces of meat

A label is printed and also barcodes to stick on each piece of carcass. On the label you find with the official identification number, all the data from the passport (birth farm, birth date, breed, sex, type of animal) and the slaughtering data (slaughter date, place, and weight).

The European regulations and French specifications ask for 3 types of checking:

Controls from the slaughter.

Controls from private firms agreed for that (EN 45011).

Controls from veterinaries of the Ministry of Agriculture.



Figure 2. The label on the carcass.

## **2.4 The roles of the Ministry of Agriculture**

All the technical work is supported by the Institut de l'Élevage and validated by the Ministry.

That means the Ministry has the responsibility of the EDE and agrees them, the EDE have to help and check the operations of the farmers and other stakeholders. The Ministry agrees the official ear tags on the results of laboratory and field tests and the official documents for them.



The Ministry validates the procedures on the proposal of the Institute, for the data exchanges between agreed computer centers.

The Ministry manages the national database of identification himself.

Identification and genetic data are managed in the same information system.

## **2.5 Adaptation to the electronic identification**

The actual system described over has to adapt to the RFID and his different using cases.

### 2.5.1 Use of RFID on farm

#### From private use to official use of the RFID tag

For the farmers, who already use herd management software and automatic scales or feeding equipments, the specific interests to use RFID are proportional with the number of animals in the herd.

RFID ear tags are not a new way (from more than 10 years in some experimental genetic stations) to benefit of the advantages of the automatic recording of data collected on the farm, like the weights or milk recording.

RFID support was adapted to each situation (necklace for feeding automate, pastern tag for milk goats, ear tag for head lockers...).

The cost of RFID was not so high, because the same RFID part of the ear tags can be used on more than one animal, changing the corresponding with the national animal identification each year.

Herd software assures the corresponding between a private RFID number and the national identification of the animal: identity, parents, treatments...

When RFID becomes an official way for identification, it must respect some new characteristics.

The type of support is not completely free for the European countries: only ear tags, bolus and pastern tag for goats are possible (no injected glasses for cattle and small ruminants).

To be read by anybody with a reader, some technical RFID specifications as transfer protocol, defined frequency and data structure have to be taken in account from two ISO standards 11784 and 11785.

The RFID tag must be applied only once on ONE animal (no recovery after the death to apply again).

These constraints may result in cost increase (even then the necklace with active chip for cows is much more expensive than ear tag transponder) but give new opportunities even on the farm.

The RFID number is unique (in France, the national number is directly coded in the transponder), so that no more correspondence is necessary to link official data to electronic data.

The breeders can change the brand of equipments (readers and automate with readers) or software, which are able to read all the same RFID official tags.

#### For the performances' recording

From very long time some private RFID systems have brought the possibility of automatization of performances recording, in the selection premises or expert farmers.

The easiest automatic recordings are for body weighing, milk recording and individual feeders for calves or cows.

So there is also a transition from private systems to the official RFID system.

To benefit from official RFID interests, farmers need at least minimal of equipment.



What about farmers without any reader and unable to use such equipment surely and well. What about farms without any corridor or handling pen to maintain small groups of animals

Farms with private systems must be adapted.

Animal tags must be replaced by official ones.

Readers must be in compliance with ISO standards 11784 – 11785: you can see the results of tests of devices on the website [www.icar.org](http://www.icar.org)

Technicians' and farmers' software have to be adapted to National RFID number automatically recorded, instead of system with private number, herd number and control

The type of the transponders has to be adapted to the operation concerned: in the milking parlor the best is to read the identification number from down and not at the head with an ear tag. But the pastern tags used on goats for a long time (without RFID) are not adapted for cows and not allowed by the European regulation.

For the feeding automates, the ear tags on the head are well adapted.

### 2.5.2 RFID for sanitary security

The aim of the traceability is to trace back contagious animals and all the animals in contact:

Individual traceability allows reducing the number of animals killed in case of problem on one premises, in comparison of group traceability. The system of individual traceability was also possible without RFID for cattle, because of number of movements of animals to follow (it is not the same with other species like ovine).

Obviously, it must be an official RFID

RFID allows general individual identification, but for trade and traceability, 100 % of animals have to be identified and it is a strong constraint to benefit from RFID interest:

To automate entries and exits recording with RFID 100% animals must be identified by RFID.

Reading ratio, will never be 100 %.

If the cattle is weighed while RFID tag is read, like usually, the door of the pen doesn't open before the official identification number and weight are recorded.

### 2.5.3 RFID for trade

For trade, RFID official numbers will be used by different operators (seller, market, buyer, slaughterhouse...), so it has to respect common characteristics to be read by every reader with fixed antenna or handheld.

The main interests are the better liability of animal numbers recorded and increase of speed of trading operations, only in the case where all animals are RFID tagged.

RFID reading of the tags in a big group of animals is rapid and liable: the main interest of this way to read all of one group is to collect and record common data for all the animals of whole group. The best example is for animals ready to be sold together (or a group of animals which receive a same treatment...).

No RFID reading is possible in a group of animals without a handling pen or a corridor.

### 2.5.4 RFID in slaughterhouse

Individual official identification is already compulsory for the slaughterhouses. The interest of RFID is the automation of arrival recording, on live animals and after on carcasses: the constraint of 100% reading is also extremely strong at the arrival

No organisation was found to benefit from RFID when animals with and without RFID arrives at the entry.



Presently, carcasses are identified with a specific number, different from live animal number: software must be adapted to link RFID official identifier from arrival till the end of the slaughtering chain, and in some cases till the packed meat ready for the supermarkets.

### 3.0 Conclusions

An identification and traceability system like the French one needs many conditions to be reliable.

The main question is to collect the real data on the field and record them under the right identification number for every actor of the chain line from farmer to slaughterhouse.

RFID on farm has existed for a long time with private systems used by few farmers interested in technology. Such private systems present no interest for other actors of animal industry.

Only an official RFID presents a common interest and it supposes a wide use of the RFID by a big majority of farmers.

The challenge is to help non technology farmers to use RFID and also small herds to survive even they don't get any direct benefit from this technology.

### 4.0 References

Council Directive 92/102/EEC of 27 November 1992 on the identification and registration of animals.

Council Directive 97/12/EC of 17 March 1997 amending and updating Directive 64/432/EEC on the health problems affecting intra-Community trade in bovine animals and swine.

Council Directive 98/99/EC of 14 December 1998 amending Directive 97/12/EC amending and updating Directive 64/432/EEC on health problems affecting intra-Community trade in bovine animals and swine.

Regulation (EC) No 1760/2000 of the European Parliament and of the Council of 17 July 2000 establishing a system for the identification and registration of bovine animals and regarding the labelling of beef and beef products and repealing Council Regulation (EC) No 820/97.

COMMISSION REGULATION (EC) No 911/2004 of 29 April 2004 implementing Regulation (EC) No 1760/2000 of the European Parliament and of the Council as regards ear tags, passports and holding registers (Text with EEA relevance).

French decree No 98-764 of 28 August 1998 on identification of bovine animals.

French departmental order of 10 February 2000 creating the national database of identification and traceability of bovine animals and their products.

French decree No 2006-376 of 23 March 2006 on identification of bovine animals and modifying rural code.

French departmental order of 9 May 2006 on identification of bovine animals modalities.

Norm ISO 11784: 1996 Radio frequency identification of animals -- Code structure.

Norm ISO 11785: 1996 Radio frequency identification of animals – Technical concept.





## Registration of health traits in Austria – Experience review

C. Egger-Danner<sup>1</sup>, W. Obritzhauser<sup>2</sup>, B. Fuerst-Waltl<sup>3</sup>, B. Grassauer<sup>2</sup>, R. Janacek<sup>4</sup>, F. Schaller<sup>5</sup>, C. Litzllachner<sup>6</sup>, A. Koeck<sup>3</sup>, M. Mayerhofer<sup>1</sup>, M. Miesenberger<sup>7</sup>, G. Schoder<sup>4</sup>, F. Sturmlechner<sup>1</sup>, A. Wagner<sup>1</sup> & K. Zottl<sup>5</sup>

<sup>1</sup>ZAR/ZuchtData EDV-Dienstleistungen GmbH, Dresdner Str. 89/19, A-1200 Vienna, Austria

<sup>2</sup>Chamber of Veterinaries, Biberstr. 22, A-1010 Vienna, Austria

<sup>3</sup>BOKU - University of Natural Resources and Applied Life Sciences Vienna, Division of Livestock Sciences, Gregor-Mendel-Str. 33, A-1180 Vienna, Austria

<sup>4</sup>Representative of Animal Health Organizations, Landhausplatz 1, A-3109 St. Pölten and Bahnhofplatz 1, A-4021 Linz, Austria

<sup>5</sup>Representative of Performance Recording Organizations, Hammerlinggasse 3, A-8010 Graz and P. Werner Deibl-Straße 4, A-3910 Zwettl, Austria

<sup>6</sup>Representative of Breeding Organizations, Volksfestplatz 1, A-4910 Ried im Innkreis, Austria

<sup>6</sup>Chamber of Agriculture, Schauflergasse 6, A-1014 Vienna, Austria

<sup>7</sup>Representative of Breeding Organizations, Volksfestplatz 1, A-4910 Ried im Innkreis, Austria

### **Abstract**

A project to establish an Austrian wide health monitoring system for cattle started in 2006. Veterinary diagnostic data, which have to be documented by law (law of animal drug control) are standardized, validated and recorded into a central cattle database. This Austrian wide project is a collaboration between agricultural and veterinarian organizations as well as universities and is further supported by the ministries. Beside provision of reports for herd management and preventive measures, breeding values for health traits and monitoring of the health status are project objectives. The precondition for an efficient use of health records are valid data. The challenge hereby is to distinguish between farms with low frequencies of diseases as well as incomplete documentation and recording. Presently 13,150 farms with about 220,000 cows are participating. Significant regional participation discrepancies are observed: from 80% participation in the eastern part of Austria to almost 0 in the very western part of Austria. The project is going to terminate at the end of 2010. Measures are undertaken to establish a routine monitoring system for health traits. The Austrian experiences in setting up a system of health registration with its successes and difficulties are described.

*Keywords: registration, health traits, challenges.*

### **1.0 Introduction**

Improved animal health is gaining in increasing importance worldwide, because of its effect on farm economy and animal welfare but also as food security is of interest from the consumer perspective.

In Scandinavian countries, animal health data have been routinely collected and utilized for decades (Aamand, 2006, Philipsson and Linde, 2003, Nielsen, 2000). Experiences from these countries show that health traits can be successfully improved (Østerås and Sølverød, 2005, Heringstad *et al.*, 2007). The EU Animal Health policy: "Prevention is better than cure" (European Commission, 2007) stresses the importance to register health data and use them for preventive measures.

In Austria, recording of diagnostic data and treatments is obligatory by law since 2002. However, before the project "Health monitoring in cattle" started in Austria, those data were neither standardised, nor routinely collected and stored in a common database and could therefore not be used for breeding and management purposes.

Within the project a health monitoring system for cattle in Austria including all animals under performance recording has been established. The data are primarily used for management and breeding purposes. Operating figures about the cattle health status are another project aim.

The paper describes the concept, measures and experiences gained through four years of implementation of the project.

## 2.0 Aims

The project aims are the increase of animal health in cattle by breeding and management measures resulting in an improved economic sustainability. An overall aim is the increase in food security. By working together within this project, the collaboration between agriculture and veterinarians will be strengthened. The project also is expected to have an impact on the positioning of the Austrian Agriculture.

Main project aims:

- Development and implementation of a system to collect diagnostic data.

- Health reports for farmers and veterinarians as well as the centres of the Animal Health Organizations (TGD).

- Genetic evaluation for health traits.

## 3.0 Methods and measures

### 3.1 Project organization

Under the leadership of the Federation of Austrian Cattle Breeders (ZAR) a health monitoring system has been elaborated and implemented in close cooperation with the organizations involved in animal health issues. These are the Ministry of Agriculture, Forestry, Environment and Water Management, the Ministry of Health, the University of Veterinary Medicine Vienna, the University of Natural Resources and Applied Life Sciences Vienna, the Animal Health Organizations, the Chamber of Agriculture, and the Chamber of Veterinarians. The Federation of Austrian Cattle Breeders, also representing performance recording and breeding organizations is the project executing organization.

The project is managed by a steering committee. Temporary working groups have been set up to elaborate different project aspects (health reports, breeding values, training module,..).

### 3.2 Project history

The project officially started in 2006. The set up of the project and preparation was carried out in 2005 and beginning of 2006. The different measures carried out within the project are listed in table 1. In 2010 the main emphasis is put on the implementation into the routine.

Table 1. Timeframe of implementation of different measures within the project.

	2005		2006		2007		2008		2009		2010	
Preparation												
Elaboration of the project design and financing	x	x	x									
Legal basis for health data recording			x									
Technical aspects of recording implemented			x									
Project implementation												
Motivation and information				x	x	x	x	x	x	x	x	x
Provision of health reports after each milk recording					x	x	x	x	x	x	x	x
Monitoring of recording and data validation			x	x	x	x	x	x	x	x	x	x
Promotional program for direct electronic transmission of diagnoses data by veterinarians					x	x	x	x	x	x	x	x
Web based annual health reports							x	x	x	x	x	x
Educational project based on health reports								x	x			x
Research project to elaborate a genetic evaluation				x	x	x	x	x	x	x	x	x
Publication of first breeding values for Fleckvieh									x	x	x	x
Continuous improvement of health reports						x	x	x	x	x	x	x
Key figures on animal health										x	x	x
Implementation to routine												
TGD-programme health monitoring											x	x
Health traits part of the breeding programme												
Tyrolean Grey						x						
Fleckvieh											x	

### 3.3 Health data registration

#### 3.3.1 Legal framework

Based on the law of drug control 2002/2005, diagnoses have to be documented on the receipt for the documentation of drugs. Due to a by-law on residual control, enacted and realized treatments have to be indicated in a special book at the farm. According to the publication GZ 74 .200/0012 – IV /D/8/2006 published by the Ministry of Health in April 2006, diagnoses have to be specified with a two-digit code. The standardized key of diagnoses was published by the Ministry of Health before the project started.

#### 3.3.2 Data type and standardization

Diagnostic data are standardized by veterinarians using an elaborated key with 65 diagnoses subsumed to 10 groups. This key only includes on-site findings by veterinarians of major diagnoses relevant for breeding purposes but currently no laboratory results. To link more detailed keys of diagnoses used by veterinarians a list of synonyms was provided. The receipt for the documentation of drugs (law of animal drug control) has been extended by the two-digit code for the standardized diagnoses. From this receipt the number of the farm, the ID of the animal, the date of veterinary treatment, and the code of first diagnoses only is recorded. The ID of the veterinarian is no mandatory field. Information on drugs is not recorded.

**Arzneimittelanwendungs-, Arzneimittelabgabe-ur**

<b>Betrieb:</b> (Name und Anschrift)		<b>Legende:</b> B=Behandlt NB=Nachbe A=Abgabe R=Rücknah <b>Tierarten:</b> (T Rd = Rind Schf = Schaf Gfl = Geflüge	
<b>LFBISNr.:</b> <input type="text"/>			
TA	Identität der/s Tiere/s OhrmarkenNr BoxenNr.	Diagnose- schlussel (2-stellig)*	Menge
B O	<input type="text"/>	<input type="text"/>	
A O	<input type="text"/>	<input type="text"/>	
R O	<input type="text"/>	<input type="text"/>	
		NB O	

Figure 1. Excerpt of the receipt for the documentation of drugs with the newly introduced field for the standardized diagnoses.

### 3.3.3 Data collection and data storage

Diagnostic data are registered into the cattle database, where all other data from performance recording are stored.

Data may be transmitted electronically by the veterinarians or recorded by the performance organizations. Supplementary information (observations, hoof trimming) can be registered by farmers. This information is stored separately to distinguish observations from farmers and diagnoses of vets.

### 3.3.4 Data security

Health data are very sensitive and therefore data security for farmers and veterinarians has to be warranted and given high priority. The farmers have to sign an agreement for recording of data explicitly stating the possible use of data. For provision of the health reports to veterinarians an additional agreement has to be signed. It is important that the farmer has only access to the diagnosis registered at his own farm. For the veterinarian it is important that the veterinarian number is only stored in the database without a link to the person. Therefore it is not possible to trace back to the veterinarian.

### 3.3.5 Data validation

Precondition for the benefit of health data is a good data quality. Plausibility checks concerning diagnoses, identification of animal and herd are carried out before the data are stored in the database.

Only data from farms fulfilling criteria concerning continuous and complete registration of diagnoses are included in genetic analyses (Egger-Danner *et al.*, 2009, Koeck *et al.*, 2010). Emphasis is put on defining the observation period. A minimum of 0.1 first diagnoses per cow and year is required.

### 3.3.6 Promotional programme for electronic diagnostic data transmission

To motivate the veterinarians to update their software for direct transmission of the diagnostic data an amount of 200 € was provided once. Additionally 10 cent are paid per electronically transmitted diagnosis during the course of a disease.

## 3.4 Health reports

Optimized herd management is important for an economically successful farming. To recognize problems early additional health information is valuable. Therefore diagnostic data were included to the already

existing reports provided to the farmer after each milk recording. As a consequence of the project the veterinarian can also get this information if the farmer agrees.

Additionally annual reports were elaborated enabling the farmer to compare farm results to the ones of the previous year as well as to the average on district and province level.

Annual reports with comprehensive information on health aspects are provided in a long and short version. A graphical overview will soon be added. These annual reports are also used by the veterinarians for their evaluation of the herd health status of the supervised cattle herds within the Animal Health Organization. An internet based tool provides annual reports with daily updated information.

The use of the health reports by farmers and veterinarians is also an important contribution to data quality as incorrect documentation and recording of diagnostic data may be recognized.

### **3.5 Genetic evaluation**

One major project aim is the provision of breeding values for health traits for sires. Before the project only indirect information as somatic cell count or indirect fertility traits has been used. Koeck *et al.* (2010 a, b) show that heritabilities for reproductive diseases and mastitis are comparable with those from analyses of health data by e.g. Heri ngstad *et al.* (2005) and Zwald *et al.* (2004 a, b). Since April 2009 first breeding values for fertility disorders, clinical mastitis and milk fever are provided to the farmers breeding Fleckvieh. Showing the existing genetic variation between bulls assists in motivation to support the project.

### **3.6 Motivation and information**

To encourage farmers and veterinarians to adopt a new technology, emphasis needs to be put on information and awareness about benefits. At the beginning of the project, when no project results are available this is more difficult. Experiences from the Scandinavian countries are helpful. The employees of performance recording organizations were given the task of convincing farmers to join the project and to collect signed agreements to join the project. The veterinarians were informed by their Chamber and the Animal Health Organization. Before starting the information campaign the employees of the performance recording organizations and representatives from the other partner organizations were trained as disseminators.

Additionally more emphasis should have been put on convincing opinion leaders in advance to the project start and also on including breeding organizations in the motivation of the farmers more intensively. During the project progress reports were provided continuously. Further farmers and veterinarians were asked to share their experience about the use of the project.

#### **3.6.1 Education project on health reports**

For the interpretation of the health reports a special training programme was set up. It was realized that too much information was provided where many farmers were lacking the knowledge to interpret and work with this data. In a participatory way each farmer elaborated his plan of action; 6,500 farmers participated.

### **3.7 Operating figures about health status**

The Ministries and the Animal Health Organizations will be provided with different operation figures on the animal health status and on the development of single diagnosis on regional and national level.

### **3.8 Implementation to the routine**

To ensure that diagnoses are registered further on and used in management and breeding, information has to be adopted officially by the involved organizations in the routine. The following steps have already been achieved.



Animal Health Programme (Ministry of Health, 2010): In March 2010 the Animal Health Organizations have decided that the Health monitoring programme is officially recognised. Information based on performance recording and health monitoring will be part of the evaluation process in supervised herds.

Breeding programme: The Tyrolean Grey Association already decided in 2008 that monitoring of health traits is compulsory for its members. The Austrian Fleckvieh (Simmental) Federation adopted health traits to their breeding programme in April 2010.

Permanent working group within the Federation of the Austrian Cattle Breeders (ZAR) with representatives of the different partner organizations will be set up to ensure that the monitoring of diagnoses is continued and further on developed.

## 4.0 Results and discussion

### 4.1 Participation

In most regions, the project to establish an Austrian wide health monitoring system started between September and December 2006. Table 2 shows the impact of implementation in different regions from 2007 till 2010. In total, 13,150 farms with 220,000 cows are presently participating.

Some regions achieved a very high participation within a few months with slow, but continuously increasing support by the veterinarians. Regions like Lower Austria and Styria have participation close to 80%. Presently about 80 to 90% of these farms are providing veterinary diagnoses, which results in approximately 70% of health registered cows. In the very western part of Austria, the project did not really start yet. The most essential prerequisite is the support of the opinion leaders in both, agricultural and veterinarian organizations. Surveys on farmers about their future breeding emphasis stress the desire to improve especially fertility and udder health. Nevertheless, continuous information is needed to strengthen confidence and to convince of the benefits.

Table 2. Number of dairy farms within the Austrian Dairy Herd Recording System, development of percentage of farms participating in the Health Monitoring (HM) and farms with veterinary diagnoses data in the database (HMVDR).

Regions	Farms	HM farms %				HMVDR farms %			
	Feb.10	Feb.10	Feb.09	Feb.08	Feb.07	Feb.10	Feb.09	Feb.08	Feb.07
Burgenland	136	23	17	13	12	55	54	36	21
Carinthia	1,288	76	76	73	71	64	53	42	14
L. Austria	3,925	78	77	77	76	90	80	64	21
U. Austria	4,864	55	51	33	28	58	49	49	24
Salzburg	2,194	44	44	42	41	65	59	42	11
Styria	3,383	79	66	63	61	85	82	66	37
Tyrol	6,009	36	23	20	7	20	13	3	0
Vorarlberg	1,479	1	1	0	0	58	50	0	0
Austria	23,278	54	48	42	37	66	61	50	23

### 4.2 Important project measures for success

**Participative approach:** For registration of veterinarian diagnoses the cooperation between farmers and veterinarians is needed at the different levels (farm, organizations on different levels). It is important that starting from the project design to the implementation all partners involved in cattle health issues are participating. In this way it can be achieved that the project aims and expectations of all the partners can be achieved. Synergies can be used and different aspects and knowledge can be contributed; e.g. the health reports were elaborated in cooperation of representatives from performance recording organizations, feeding experts, veterinarians and research.

**Benefit for key players.** Farmers and veterinarians are only ready to adopt new technologies and approaches, if they are convinced by the benefit and if the benefit-cost-analysis is to their advantage. Different expectations have to be fulfilled. Farmers and veterinarians are using this information to improve herd management. Ministries and Animal Health Organizations are interested in monitoring of the health status. For consumers, food safety is of importance. For farmers and breeding organizations the use for breeding purposes is the main goal. For motivation, early and continuous information about

the results is essential. To endure the joint benefit and to reduce costs it is important to link and use infrastructure jointly.

**Technical implementation with guaranteed data security.** Before such a project may start, the technical structure has to be elaborated and questions especially concerning data security can be answered in detail for farmers and veterinarians. A key of diagnoses which is accepted by the veterinarians is additionally essential. For genetic evaluation, a less detailed key of diagnoses would be sufficient. For fertility traits Koeck *et al.* (2010) showed that rather high genetic correlations between traits are observed. Due to low frequencies the breeding values can be estimated more reliably for combined traits. However, for veterinarians more detailed information about the diagnoses can be of interest.

**Sustainable high quality data recording and validation.** For opponents of health data recording the main arguments are insufficient data quality and data security. The easiest and best way of data recording is electronic transmission of diagnoses directly by the veterinarians. Once the software products have been adopted, the data can be provided directly to the database without big effort. Veterinarians using electronic devices are normally recording all the measures taken. Analyses show that incidence rates based on diagnoses which are electronically transmitted are slightly higher for traits like (cystic ovarian disease) or metabolic disorders where also drugs without waiting periods are applied. Therefore the farmers were enabled to record additional information as observations themselves.

The data validation for breeding value estimation is very important especially at the beginning of setting up such a system. It cannot be taken for granted that all of the farms start recording diagnoses immediately after joining the projects. The distinction between farms with low frequencies and incomplete recording is a challenge.

**Continuous information and motivation.** To achieve a high participation, which is especially important for breeding purposes due to the rather low heritabilities of the health traits, continuous information, motivation and awareness are important. Farmers as well as veterinarians and especially their opinion leaders need to be convinced by the benefits and encouraged to participate.

**Financing and economic aspects.** It is important, that the project can be established without additional costs for farmers and veterinarians. The additional benefit has to be bigger than the effort involved. Basically the effort to record these diagnoses can be compared with recording of calving ease. On average about 0.7 first diagnoses (per course of a disease) per cow and year need to be registered. On the long term the additional effort has to be paid. An average calving interval of 398 days and an average SCC of 209,000 (ZuchtData, 2009) show the potential of cost saving. An economic study based on Austrian field data show that one month extended calving interval and an average SCC above 250,000 costs 125 and 180 € per cow and year, respectively (Stocker, 2008).

**Legal framework:** A continuous recording of health data based on broad participation is a big challenge. For the sustainability these traits have to be used routinely by the different organizations. Thus, legal frameworks for documentation and use of diagnostic data are very valuable (law of drug control, law of animal breeding). The inclusion of such traits in breeding goals and the use for preventive measures by veterinarians and Animal Health Organizations is especially important. A level has to be reached where health traits are recorded and used like other fitness traits.

## 5.0 Conclusions

The registration and utilization of health data is gaining importance. Measures to monitor and improve animal health and food security are sensible. Therefore the full support of all involved partner organizations is essential. Success depends on the cooperation between farmer and veterinarian on farm level as well as on the collaboration of breeding and performance recording organizations, veterinarians and researchers as well as on the support of the Chambers and Ministries. The cooperation is a challenge but also the chance to establish a joint system to share benefits and to use synergies efficiently. Performance recording data as well as diagnostic data are available for breeding and management purposes by the farmers and breeding organization, but the information can also be used by veterinarians and Animal Health Organizations.

For establishing a system of health monitoring beside a participative approach, an appropriate system of registration and data storage with warranted data security and the provision of benefits for all partners involved are essential. The motivation and information process is to our experience a much bigger challenge than setting up of the technical requirements. It is especially important to convince opinion leaders already at an early stage. Continuous information to build up confidence and to communicate the benefits are key factors for success.

For the sustainability of continuous recording of health data these traits have to be used routinely by the different organizations. Thus, legal frameworks for documentation and use of diagnostic data are very valuable.

## 6.0 Acknowledgements

The collaborative work of the project partners in Austria (Federation of Austrian Cattle Breeders, University of Natural Resources and Applied Life Sciences, University of Veterinary Medicine, Chamber of Agriculture, Chamber of Veterinaries, Animal Health Organizations, Performance Recording Organizations, Breeding Organizations) to establish a "Health monitoring system in cattle" and all dairy farmers and veterinarians participating are gratefully acknowledged. The project has been financed by the Federal Ministry of Agriculture, Forestry, Environment and Water Management (BMLFUW) of Austria, the Ministry of Health and the Federation of Austrian Cattle Breeders (ZAR).

## 7.0 References

- Aamand, G. P., 2006. Data Collection and Genetic Evaluation of Health Traits in the Nordic Countries. British Cattle Conference, Shrewsbury, UK, 2006.
- European Commission, 2007: European Union Animal Health Strategy (2007-2013): prevention is better than cure. [http://ec.europa.eu/food/animal/diseases/strategy/animal\\_health\\_strategy\\_en.pdf](http://ec.europa.eu/food/animal/diseases/strategy/animal_health_strategy_en.pdf).
- Egger-Danner, C., B. Fuerst-Waltl, W. Holzhaecker, R. Janacek, J. Lederer, C. Litzllachner, C. Mader, M. Mayerhofer, J. Miesenberger, W. Obritzhauser, G. Schoder, and A. Wagner, 2007. Establishing a health monitoring for cattle in Austria: first experiences. In: EAAP-Book of Abstracts No 13: 58th Annual Meeting of the EAAP, 26-29.8.2007 Dublin, Ireland, 363.
- Egger-Danner, C., Koeck, A., Obritzhauser, W., Fuerst, C., Fuerst-Waltl, B., 2009. Impact of health data quality on breeding efficiency in Austrian Fleckvieh cows. In: EAAP-Book of Abstracts No 15: 60th Annual Meeting of the EAAP, 24.-27.8.2009, Barcelona, 411.
- Heringstad, B., Rekaya, R., Gianola, D., Klemetsdal, G. and Weigel, K.A., 2003. Genetic Change for Clinical Mastitis in Norwegian Cattle: A Threshold Model Analysis. *J. Dairy Sci.* 86: 369-375.
- Heringstad, B., Chang, Y.M., Gianola, D. and Klemetsdal, G., 2005. Genetic correlations between clinical mastitis, milk fever, ketosis and retained placenta within and between the first three lactations of Norwegian Red (NRF). In: EAAP-Book of Abstracts No 11: 56th Annual Meeting of the EAAP, 3-4.6..2005 Uppsala, Sweden.
- Heringstad, B., Klemetsdal, G. and Steine, T., 2007. Selection responses for disease resistance in two selection experiments with Norwegian red cows. *J. Dairy Sci.* 90: 2419-2426.
- Koeck, A., C. Egger-Danner, C. Fuerst, W. Obritzhauser, und B. Fuerst-Waltl, 2010. Genetic Analysis of Reproductive Disorders and their Relationship to Fertility and Milk Yield in Austrian Fleckvieh Dual Purpose Cows. *J. Dairy Sci.* 93: 2185-2194.
- Koeck, A., B. Heringstad, C. Egger-Danner, C. Fuerst, und B. Fuerst-Waltl, 2010. Comparison of Different Models for Genetic Analysis of Clinical Mastitis in Austrian Fleckvieh Dual Purpose Cows. *J. Dairy Sci.* (in press).
- Ministry of Health, 2010. Kundmachung des TGD-Programms Gesundheitsmonitoring Rind. <http://www.bmg.gv.at/cms/site/standard.html?channel=CH0920&doc=CMS1271936439807>.
- Nielson, U. S., Aamand, G. P. and Mark, T., 2000. National Genetic Evaluation of Udder Health And Other Traits in Denmark. Interbull Open Meeting, Bled, 2000, Interbull Bulletin 25: 143-150.
- Obritzhauser, W., Egger-Danner, C., Grassauer, B., Holzhaecker, W., Winter, P., 2008. Preliminary results of a general health monitoring system for cattle in Austria. XXV. World Buiatrics Congress, Budapest, Hungary, July 7th, 2008.
- Østerås, O. and Sølverød, L., 2005: Mastitis control systems: The Norwegian experience. In: Hogeveen, H. (Ed.), *Mastitis in dairy production: Current knowledge and future solutions*, Wageningen Academic Publishers, Niederlande, 91-101.
- Phillipson, J. and Lindhe, B., 2003. Experiences of including reproduction and health traits in Scandinavian dairy cattle breeding programmes. *Livestock Production Sci.* 83: 99-112.

- Stocker, F. 2008. Fitness – nur ein Schlagwort oder klarer wirtschaftlicher Nutzen? Seminar des Ausschusses für Genetik der ZAR, Zentral e Arbeitsgemeinschaft österreichischer Rinderzüchter (Hrsg).
- Zwald, N. R. , Weigel, K. A ., Chang, Y.M., Welper R. D. and Clay, J. S., 2004a. Genetic Selection for Health Traits Using Producer-Recorded Data. I. Incidence Rates, Heritability Estimates and Sire Breeding Values. J. Dairy Sci. 87: 4287 – 4294.
- Zwald, N. R. , Weigel, K. A ., Chang, Y. M., Welper R. D. and Clay, J. S. , 2004 b. Genetic Selection for Health Traits Using Producer-Recorded Data. II. Genetic Correlations, Disease Probabilities and Relationships with Existing Traits. J. Dairy Sci. 87: 4295 – 4302.
- ZuchtData Jahresbericht, 2009. <http://www.zar.at/article/archive/25>





## Animal Health Data Comparison – two EADGENE sub projects

A. Neeteson<sup>1</sup>, R. Aumüller<sup>2</sup>, G. Bleriot<sup>3</sup>, S. Hoste<sup>4</sup>, G. Jones<sup>5</sup>, H. Jones<sup>6</sup>, A. Malafosse<sup>7</sup>, M. Neuteboom<sup>1</sup>, P. Oostenbach<sup>8</sup>, E. Rehben, A. van der Sanden<sup>1</sup>

<sup>1</sup>European Forum of Farm Animal Breeders (EFFAB), Benedendorpsweg 98, 6862 WL Oosterbeek, The Netherlands

<sup>2</sup>GlobalGap

<sup>3</sup>Institut d'Élevage

<sup>4</sup>Quantech Solutions

<sup>5</sup>Aponi2b

<sup>6</sup>Biosciences Knowledge Transfer Network (BKTN)

<sup>7</sup>Malafosse

<sup>8</sup>Schering Plough

### **Abstract**

Emerging animal health related issues and improved animal health management requires sufficient comparable data. In the EADGENE<sup>a</sup> Health Data Comparison Project a pilot study indicated that, both across Europe and between species, animal health data collection is fragmented and lacks harmonisation. The systems were designed in order to meet the needs of veterinarians authorities. For cattle the requirements from farmers were hardly taken into account. However there are structures and systems in place that contain very valuable information, if it were possible to access and consolidate these data on the European and/or species level. This would create a significant increase in the quantity and quality of the already collected and stored data. At two workshops the knowledge and technical input from experts of different bodies dealing with subjects of animal health data collection on notifiable diseases was brought together. They made clear there is added value for all species to build animal health data systems but with differences between species on implementation and application. Therefore species specific working groups were set-up to define the way forward. For all sectors involved there is an interest in the development of better coordinated systems for animal health related data. This can only be obtained by good involvement of stakeholders from the start with a bottom-up approach. Small pilot studies can show the benefits and can be expanded up to European wide harmonisation of animal health related data – among the key factors of a cattle pilot project is the implication of the most advanced systems in EU.

*Keywords: Data comparability, animal health, disease, standardisation, harmonisation, breeding, research, European Animal Disease Genomics Network of Excellence.*

### **1.0 Introduction**

The international availability and comparability of animal health data is important for various reasons - animal movement and health data are a key source of information in the effective management of disease prevention and outbreaks, but also progress in animal breeding and management, and research related to animal health will depend on the availability and comparability of data.

The impact of epidemic livestock diseases can be devastating on farmers and the economy as a whole – in a specific country, a continent or even globally. In 2007, the European Commission launched the Animal Health Strategy for the European Union (2007-2013) (European Commission, 2007) striving for increased collaboration between EU member states to increase the prevention of animal health related problems before they happen and to be ready to manage outbreaks and crisis more effectively, but also to improve economic growth, cohesion and competitiveness assuring free circulation of goods and appropriate animal movements.

For plans to gradually improve the availability and comparability of animal health data, studies into the feasibility of making the collection of animal health data are therefore of great interest. This paper describes the two pilot projects, that have been undertaken in the framework of the EADGENE Network of

Excellence (EADGENE, 2004-2010), and design the set up of the required / possible follow up phase. In particular, the work of the cattle working group of Phase 2, and the proposals for the future are highlighted. Furthermore, this paper includes examples of similar work undertaken outside the European Union.

## 2.0 Methodology

The first pilot (Phase 1, 2007-2008) has provided an overview on the current status of animal health data collection and recording systems in cattle, pigs and poultry in four EU countries, namely: Denmark, France, Netherlands, United Kingdom. The second pilot (Phase 2, 2009-2010) has included mainly stakeholder consultation in two workshops, the preparation of plans for the next phase (Phase 3), and mapping of animal health data recording in a few extra countries (for cattle: Portugal, Italy, Spain (pilot: Basque Country)).

### 2.1 Phase 1 – Mapping Data Systems in Pilot Countries

A project team has designed a plan for interviewing key persons and mapping of animal health data recording systems on cattle, pig and poultry in four pilot countries: Denmark, France, Netherlands, United Kingdom. They have gathered information on the different animal health data collection and recording systems within each country by means of informal interviewing process. An initial broad overview of the recording systems within each country has been developed through literature searches and preliminary interviews with a small sample of people. Further Interviewees have then been chosen with the aim of gaining more detailed knowledge of recording systems in areas that were identified as being important in the initial overview. Discussions were held with a large number of people including representatives of Government departments, Government agencies, academics, animal scientists, veterinarians and industry organisations. The process conducted concurrently in each country and species by different members of the project team and took place between January and September 2008.

Due to the diverse range of different recording systems being considered, a fixed set of questions for all interviews could not be developed. Instead, a list of important aspects to cover as part of each interview was developed in the preliminary stages of the project and then used as guide by each interviewer.

Following the preliminary interviews, draft overviews of the recording structures within each country were developed. These draft overviews along with the project summary were then circulated to the interviewees prior to the interview being conducted with the aim of aiding the discussion within the interview. A written report was put together after each interview which was then sent to the relevant interviewee for verification. After completion, information from all interviews were compiled in to individual country reports and final diagrammatic overviews of the health recording structures for each species within each country, which provided the information content for the report.

### 2.2 Phase 2 – Stakeholder Consultation and Species Specific Plans

Based on the recommendations of Phase 1, it was decided to base Phase 2 around two workshops with stakeholders. The project team prepared several documents which were used as input for Workshop 1 in Brussels. A broad range of stakeholders was approached to attract interest for this workshop. The Brussels workshop contributed essentially to the project design as it made clear that there is added value for all species to build animal health data systems but with clear differences between species regarding the way of implementation and of application.

Based on this important result of the first workshop, it was decided to set up species specific working groups, guided by the project team experts. These species working groups had numerous telephone conferences where they were brainstorming about possible ways forward. It was also important to get a general national overview for each species. It was decided to propose the participants to voluntarily set up additional country mapping diagrams as in Phase 1. This input plus the results of questionnaires, which were elaborated and sent around amongst participants of the first workshop plus stakeholders, were used to prepare Workshop 2, which was held on 15 October 2009 in Paris. At this workshop the working groups on cattle, pig and poultry presented their outline proposal for the phase after EADGENE funding, Phase 3. This paper highlights the work of the cattle working group.

At the two workshops the knowledge and technical input from experts of different bodies dealing with subjects of animal health data collection on notifiable diseases was communicated in order to create the best information amongst participants on existing schemes, especially on notifiable diseases. Representatives from the following organisations contributed by presentations: DG SANCO, OIE, Copacogeca, ISAH and ICAR.

## 3.0 Results

The first project has allowed to establish a general framework which could be used to describe the different national situations in the same way. It has identified the major data providers and key players in the collection and recording of animal health data in the four pilot countries, and has distilled a general diagram that can be used across species and across countries, to enable comparison of the systems in a bird eye's view. The results of two stakeholder workshops are being described, and the proposal of the cattle working group. The interest for animal health data is not limited to Europe. For instance, in Canada, was implemented a large system which allow dairy farmers to record health data for their own management and for other purposes.

### 3.1 General Description of Data Collection and Recording

The increased risk of epidemic spread of diseases caused by the freedom of livestock movement is acknowledged within the EU. This has led to a number of legislations which have an important bearing on the recording of health traits in animals across all member states within the EU: legislation on identification, tracing of movements, food hygiene and safety, the animal disease notification system, zoonoses control and disease eradication programmes.

EU legislative requirements often differ between species and this can account for important differences between the respective national recording systems. Movement documents, referred to as Passports, which include details such as the animal identification number, owner and mother's identification details, are also required to be issued with the aim of improving traceability. For pigs and poultry individual identification and passports is currently not a legislative requirement.

Given the need to meet the legislative requirements, it is not surprising that in pulling together the overviews it became clear that there are a number of similarities between the recording structures for different species and across the four different countries. A diagram showing the common elements of the different recording structures is shown in Figure 1. Specific diagrams for cattle in each of the four countries plus two extra countries mapped in Phase 2 can be found in Figures 2, 3, 4 and 5.

An overview of the major data collection and recording parties in the four pilot countries and their particularities of Phase 1 is given in chapters 3.1.1., 3.1.2, 3.1.3 and 3.1.4.



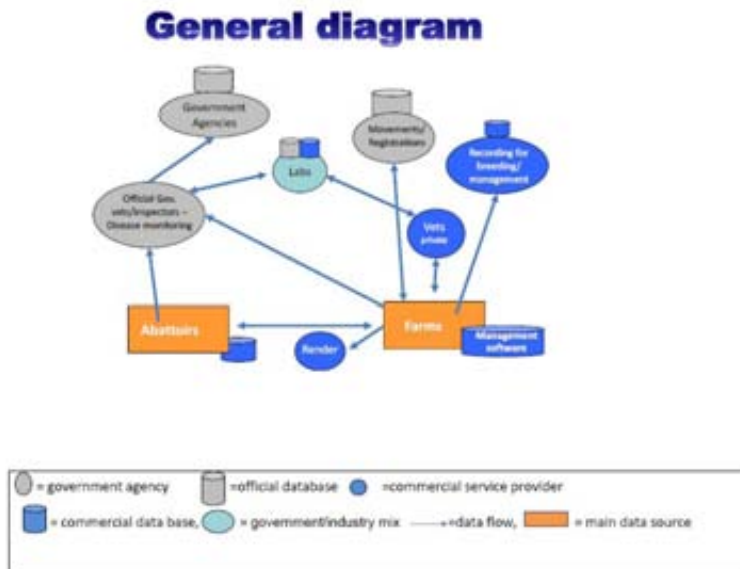

Figure 1. Description of animal health data recording systems

### 3.1.1 Data Collection and Recording Parties

The major Data Collection and Recording Parties in the four pilot countries of Phase 1 are:

#### Farms and Abattoirs.

- Data recording on Farms In all instances, the main sources of data were farms and abattoirs. Other than a health and movement register, any additional recording by producers themselves is done on a voluntary basis and therefore the level differs between specific farms within a country.
- Data transfer between farms and abattoirs The main transfer of animal health data from farms to abattoirs is done to meet EU requirements on Food chain Information (FCI).
- Data recording in abattoirs Much of the health recording in abattoirs is done by outside organisations, primarily associated with government agencies.

Government Agencies – Disease monitoring Within each of the four countries, government agencies play an important role in meeting EU legislative requirements with respect to food safety, disease monitoring and eradication for notifiable and other diseases of interest.

Laboratories Within each country there are two types of laboratory services; those mainly funded from public (government) sources, and others which are mainly funded through the provision of services to private clients.

Private Veterinarians Private vets are those that are generally provide a commercial service farmers or breeding companies. However on some occasions they can also act as official veterinarians being licensed to conduct work on behalf of a government agency.

#### Recording for breeding and management

Other organisations Other organisations involved in recording animal health data are: renderers, inseminators and hoof trimmers, Groupement de Défense Sanitaire (France), Farm Assurance Schemes.

### 3.1.2 Recording for breeding and management

Animal breeding is concerned not only with production characteristics such as growth and number of offspring, but also in structure and conformation of animals and their health to adapt their gene make-up to production constraints and as indicators of longevity. In cattle somatic cells counts (an indication of mastitis) and calving ease are also recorded.

#### Animal Movements and Registrations

- Registration of animal holdings To meet EU regulations, all keepers with stock above a certain number (e.g. with more than 50 birds for poultry in the UK) must register their

holdings with the relevant registration organisation. In all four countries this function is performed either directly by a government department or by a government agency.

- Animal Movement tracking Since 1999, to meet EU regulations, all EU member states are required to have a computerised tracking system for animal movements for cattle.

### ***3.1.3 The Role of Government Departments and Levy Boards***

Within each of the four pilot countries of Phase 1, responsibilities for different recording activities ultimately fall either to government departments, levy boards or commercial organisations.

Governments have adopted a variety of approaches. In Denmark there are relatively few Agencies, whereas in the UK there are a number. In The Netherlands GD is an example of a private company performing a number of roles that in other countries are performed by government Agencies. Levy Boards (termed Product boards in The Netherlands) exist in the UK and The Netherlands, but not in France and Denmark. Their remit is statutory in both countries, however the Product Boards in The Netherlands can also lay down binding regulations that apply to the sector concerned. In both countries the Product Boards are increasingly involved in the management of animal health data, zoonoses recording and reporting and Food Chain Information (FCI).

### ***3.1.4 Data Ownership***

Data ownership generally lies with the provider, however often access to grouped, averaged and trend data to provide benchmarking is agreed to by the data provider. Animal health data is a relatively small subset of the total data in the animal sector. Across countries predominantly in the poultry sector there is data transfer between farm, abattoir and feed mill to optimise economic performance. This data is generally not in the public domain.

## ***3.2 Testing the Waters - Stakeholder Input***

The study on the animal health data systems (Phase 1) indicated that, both across Europe and between species, animal health data collection is fragmented and lacks harmonisation. However the study also indicated that there are structures and systems in place that contain very valuable information, if it were possible to access and consolidate these data on the European and/or species level. This would create a significant increase in the quantity and quality of the already collected and stored data.

Based on the recommendations of Phase 1, it was decided to base this Phase 2 mainly around two workshops with stakeholders. At the two workshops the knowledge and technical input from experts of different bodies dealing with subjects of animal health data collection on notifiable diseases was communicated in order to create best information amongst participants on existing schemes, esp. on notifiable diseases.

The workshops made clear that there is added value for all species to build animal health data systems but with clear differences between species regarding the way of implementation and of application. This means that a common approach for all three species is not feasible. Therefore species specific working groups were set-up with members from several countries and institutes which defined the way forward.

## ***3.3 Cattle Working Group***

The voluntary participants in EADGENE cattle working group had to define, whether it is worth constructing a European project of Health Data Management for the cattle industry. This work made clear that animal health issues, both notifiable as described in the corresponding legislation and non-notifiable, are important and could have real benefits for all stakeholders.

In several EU member states, information systems dealing with notifiable and non-notifiable diseases in cattle do already exist (For examples see Figures 2, 3, 4 and 5).

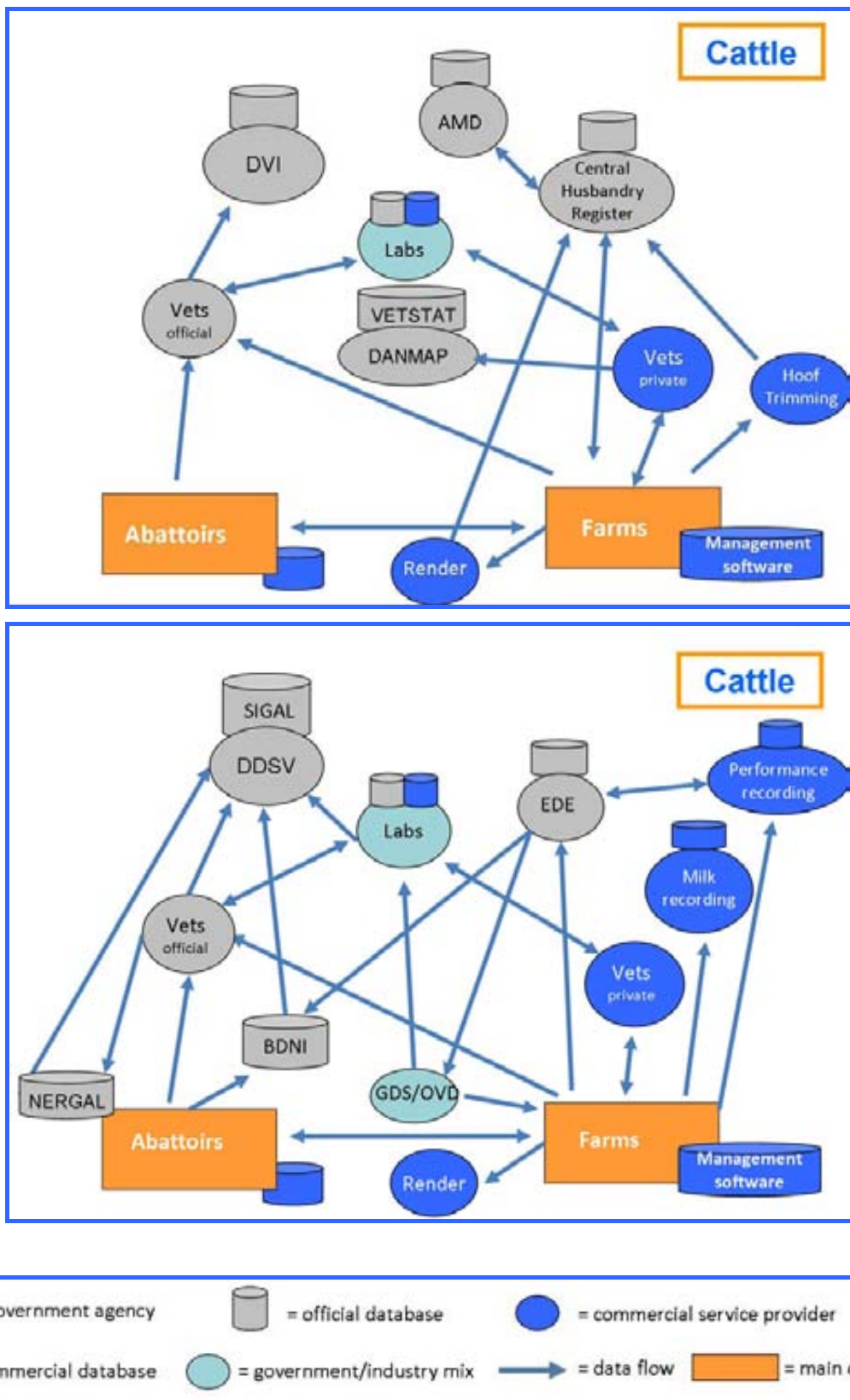

Figure 2. Description of cattle animal health data recording systems for Denmark and France

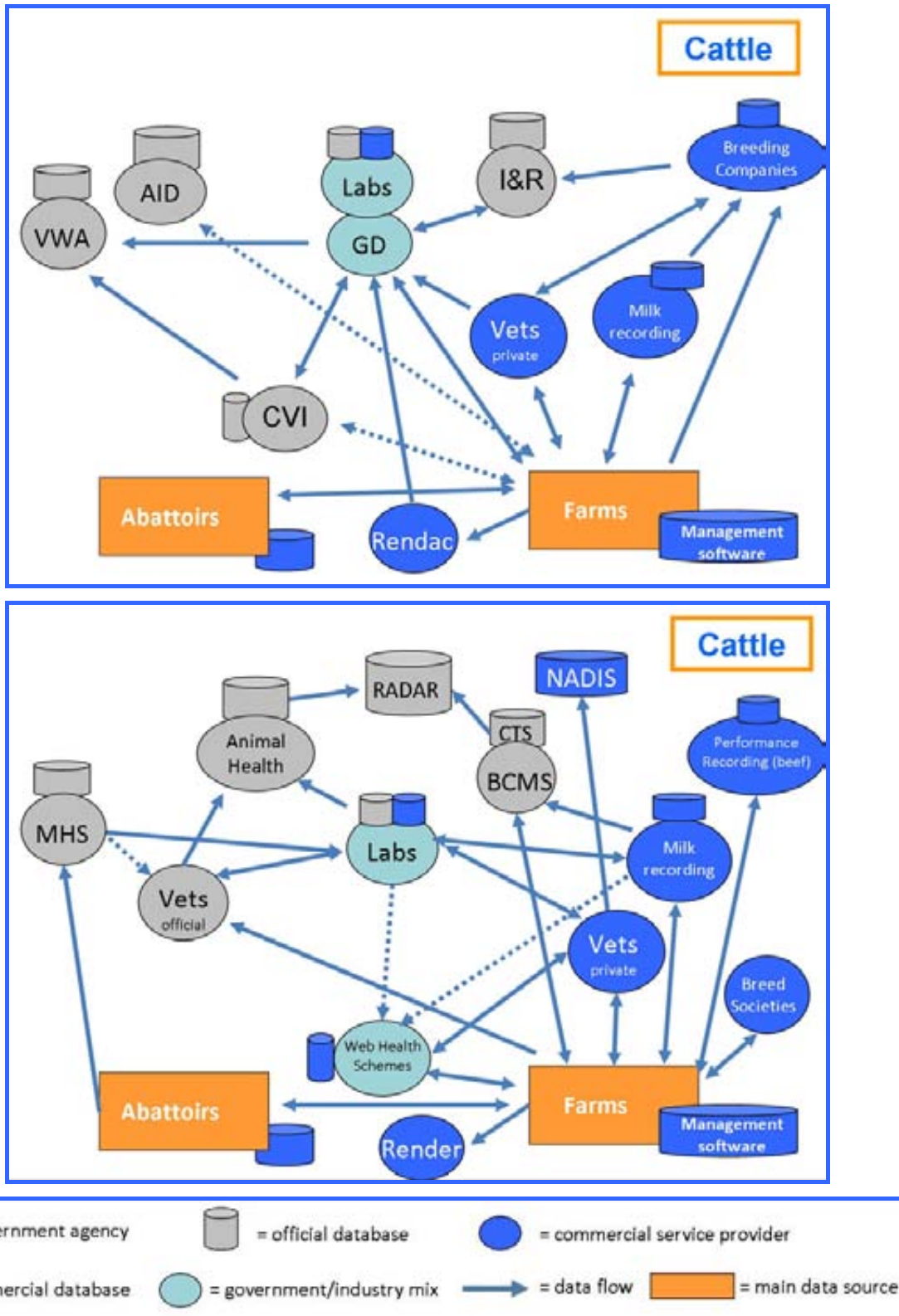

Figure 3. Description of cattle animal health data recording systems for the Netherlands and the United Kingdom

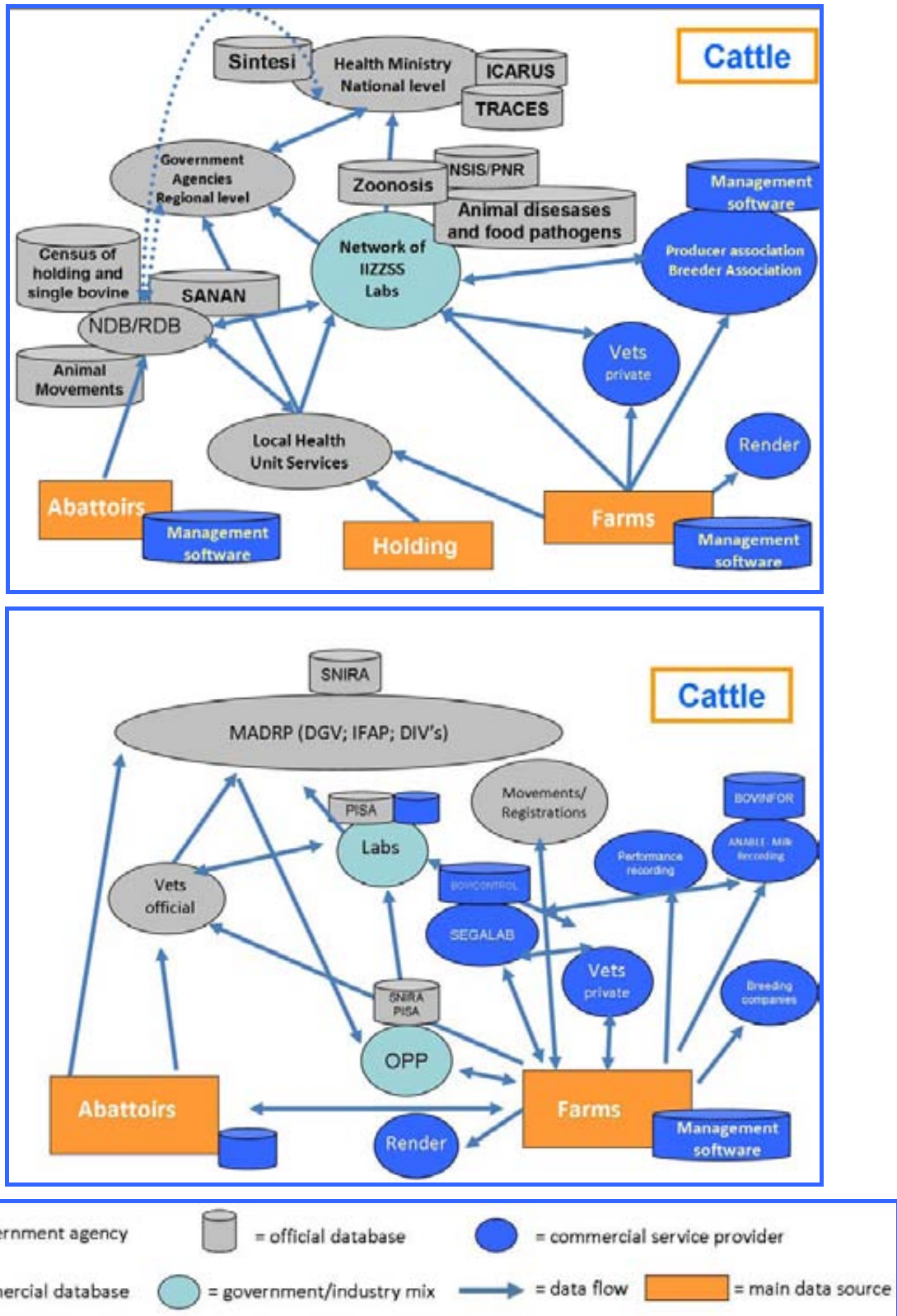

Figure 4. Description of cattle animal health data recording systems for Italy and Portugal.

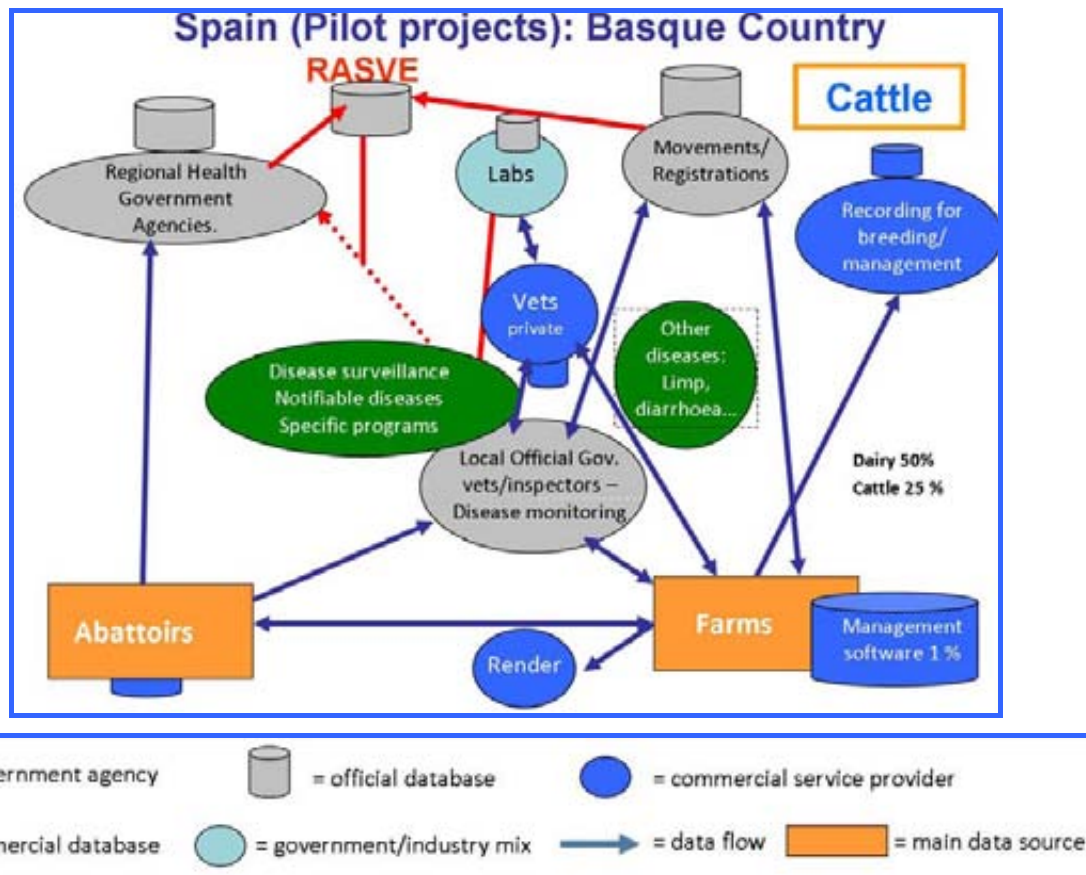

Figure 5. Description of cattle animal health data recording systems for Spain (pilot: Basque Country).

### 3.3.1 Importance of Non-Notifiable Diseases

The government implication is focused on the contagious diseases within animals or between animals and human beings. It results in an obligation to notify these diseases to the public authority. Fortunately, these diseases which have a major economic impact are rare. Besides these notifiable diseases, there are many other non notifiable disease which have real impact for all stakeholders working in cattle production:

On animal production profitability.

Technical-economical results of farms are linked with animal health. It complements the other factors determining animal performance : genetics, feeding, husbandry system or management.

On the amount of work for breeders.

Sanitary problems on farms lead to increased time spent in animal care and vigilance.

On animal welfare, e.g. lameness.

Human health concerns: less disease result in less medicine, and mainly less antibiotics.

There are real needs from the farmers' point of view for:

Advice in health monitoring for a herd or for each animal,

Improvement of sanitary best practices,

Help in reproduction/mating strategy, in linkage with animal selection and genetics,

Alert before the outbreak of diseases.

Non-notifiable diseases could also be a key factor for the discovery of new transmissible factors for genetic evaluation or genomics.

From a veterinary perspective, it will also be possible to make epidemiologic studies in cattle populations.

### 3.3.2 Added Values for All Stakeholders

All partners involved in animal management and husbandry, genetics or animal health can identify real benefits in cattle health data provision, management and analyses:

For farmers, it will contribute to the identifying of potentials for economic improvement,

For veterinarians, it will be a tool which would develop coordinated actions in prevention and treatment of diseases,

For advisory services, breeding or recording organisations, it will be a basic requirement to have information about the health status of farms and animals, to share knowledge between stakeholders and to have a common vocabulary,

For research, there are applications in genomics to explore, especially since there is the existing EADGENE Network, working on links between animal health and genomics.

## 3.4 Global Developments

Agriculture and Agri-Food Canada (AAFC, [http://www.agr.gc.ca/index\\_e.php](http://www.agr.gc.ca/index_e.php)) provides information, research and technology, and policies and programs to achieve security of the food system, health of the environment and innovation for growth. They have undertaken a national animal health project to gather data on eight key diseases to improve the management and economy of the farm level. The partners in animal health improvement, among others the artificial insemination centers, the breed associations, and the veterinarians, have initiated this project in the course of 2006 with the aim to improve the production of selection indexes. The diseases are milk fever, left displaced abomasum, cystic ovarian disease, clinical mastitis, retained placenta, metritis, ketosis, lameness.

AAFC has a history of gathering public animal health data – in poultry already since 1999 animal health data have been gathered on e.g. 32 diseases ([www.agr.gc.ca/poultry/condmn\\_eng.htm#chicken](http://www.agr.gc.ca/poultry/condmn_eng.htm#chicken)). At the Economic and Market Information section, a Poultry Market Place section gives access to all the data that are being delivered in the excel file with data and graphs of Canadian poultry health and production data over time. They have also been made available to the European Food Safety Authority working groups that are looking into the developments of broiler welfare and genetics over time. They show considerable improvement in broiler health over time.

## 4.0 Discussion

The design of animal health data collection, storage in a database and usage has often been designed with a single purpose in mind. In many countries there are separate databases that require multi data entry of the same or similar information. Usage by a variety of audiences has not been taken into account in the design. The connection or links between the various databases have historically not been a priority. Part of this has been lack of foresight and lack of a different perspective and that information has been considered proprietary.

People, organisations, companies and government are realising the benefit of simple single data entry of information, of the benefit of connected data, the benefit of varied usage.

The current technical status of computing and of the technical skills in computer use enable greater benefit than has been possible previously.

The various stakeholders, throughout the food chains in Europe, with their varied needs of animal health data are increasingly aware of the need for accurate, interoperational and accessible information.

The diagrams in the Phase 1 project report indicate substantial variation, both between the countries and the species analysed. This variation can be explained historically to some extent, such as differences in requirements between species and countries and in the structure of the animal production of each country. In addition differences in consolidation between the structure for cattle, pig and poultry have been equally important drivers. It can be expected that the species specific drivers will grow further in dominance over the national drivers.

## 4.1 Cattle

Once having defined all the interests of a European common project, it seems important to discuss the key issues for success.

One of the main factors used to define the scope of the activities included in the project is animal diseases. As described in the previous paragraph, there are a large number of non-notifiable diseases in cattle production. The question arises: which one to start with?

*The idea accepted by the group is to set up a general framework which can be used for any disease. It would allow pro-action when there is a new disease to deal with. There are systems already existing in human health.*

However, it seems important to identify pertinent diseases that could serve as examples to define a common structure of data. The following relevant diseases in cattle were identified: Mastitis / Lameness / Bovine hypodermosis (warble) / BHV1(IBR/IPB) / Paratuberculosis / Pneumonia / Diarrhoea in calves.

The objective of the project would be to facilitate the implementation of:

Harmonised recording systems:

The definition of a precise methodology of data collection, with common procedures to be used by each actor involved – such as farmers, veterinarians or slaughtering houses – has to be given;

Harmonised architecture of data systems:

The aim is to define all the elements, which are necessary for a common structuring of data e.g. data dictionary;

Harmonised guides for best practices:

To enhance commitment of farmers and veterinarians, it is necessary to build a system which is able to identify and share knowledge and best practices amongst the actors in order to improve cattle health at farm level.

The major hurdle for such a project is early and strong involvement of stakeholders.

A return of information to all the stakeholders has to be a priority for success in this project. They must have a clear interest and get practical results in the short as well as in the long term.

A benchmarking tool is envisioned. Pilot farms with effective data collection systems will show the feasibility and continuity, the real interests of the animal health management system for cattle farmers.

The voluntary participants in EADGENE cattle working group had to define, whether it is worth constructing a European project of Health Data Management for the cattle industry.

## 5.0 Conclusions and Recommendations

The motivation for a species specific discussion as given in the previous chapters does also apply to the drawing of conclusions and the formulation of recommendations.

However, this should not be interpreted that those concepts described in one of the following species specific paragraphs cannot be applied to other species. The initial drivers and objectives for this project as described in chapter 3 of this report are identical for all, as illustrated by the similarities of the country/species / disease dimensions of data collection in Figure 6.

There is no doubt, that future successful implementation of inter-operability in the field of animal health data collection and analysis will be dependent on the stakeholders involved. This stakeholder-base should be as comprehensive as possible. Any groups not involved in the preparation of this report and interested in the topic are invited to join.



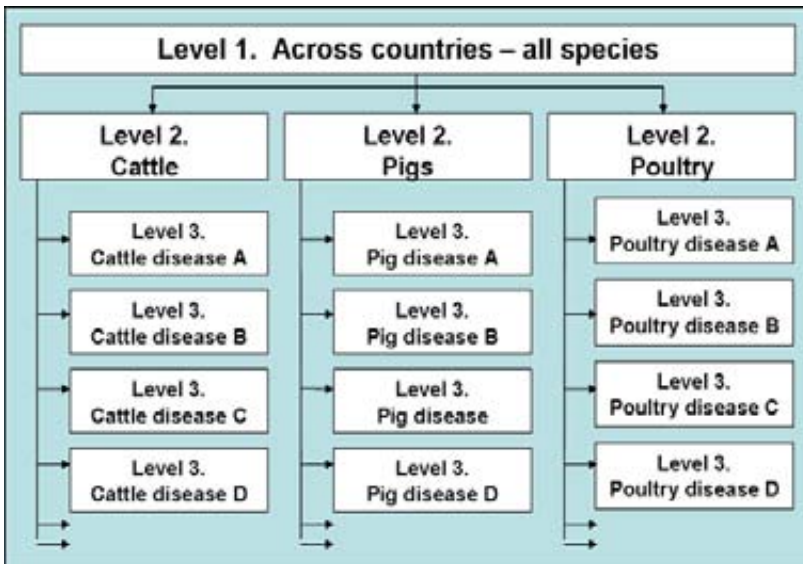

Figure 6. Illustration of the similarity of the country/species/disease dimensions of data collection.

### 5.1 Cattle

Phase 2 of the EA DGENE AHDC project allowed the preparation of a concrete project which will improve the analysis of cattle health data to create more added value for the stakeholders. It was only possible with the input from other countries, with new country mapping realised and a real commitment in the project.

There are several projects that will be launched or are about to be launched in the EU and elsewhere. There is a real interest at international level to deal with this issue.

For cattle, a specific working group was set-up. The conclusion from this was that there are several opportunities existing for European cattle production to share animal health data to improve farming practices. To achieve this, it is necessary to harmonise both recording systems and systems of data analysis.

A general overview of the project could be based on an approach with an existing method schematically represented in Figure 7.

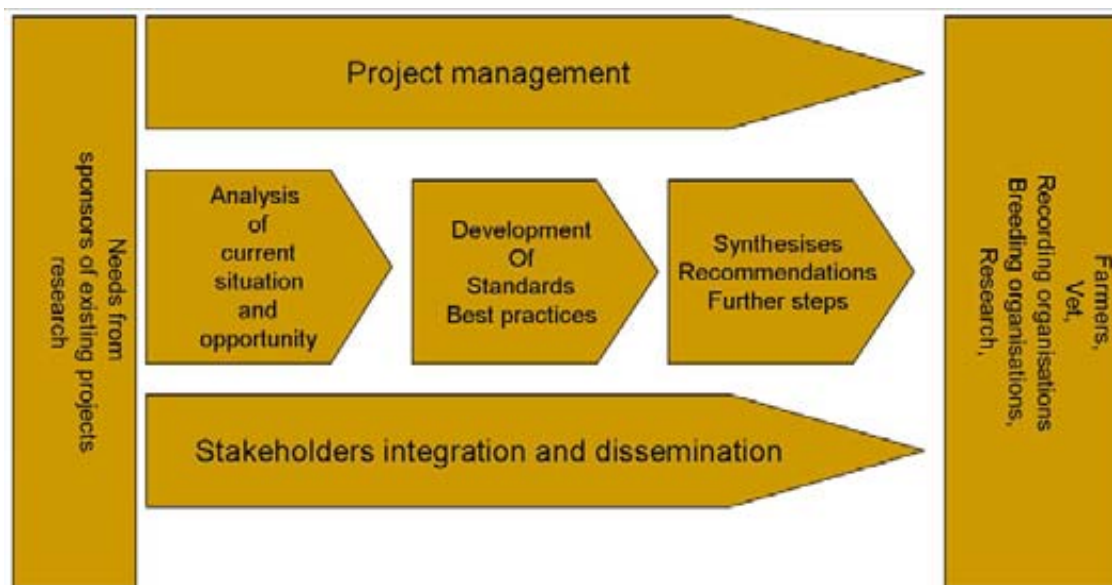

Figure 7. Schematic presentation of a general overview of the project for cattle.

The project concept would be divided in three big steps:

1. Analysis of current situation and opportunity.  
In this step, we have to define precisely the procedure : who and how to get the data.
2. Development of standards and best practices.  
The aim is to deliver a guide of best practices to implement the standards.
3. Provide recommendations and definition of further steps.  
The final work is to get all the elements that ensure the strong involvement of stakeholders.

The realisation of the cattle project could be achieved in two years. Limited objectives, a specific funding, limited number of participants and the implication of the most advanced countries are the key issues for this kind of project.

As a conclusion it may be stated, that a general lay out of a cattle project is progressing. It will require substantial involvement of European and if possible global stakeholders to reach our objective of cattle health data management and exchange. Phase 2 of EADGENE Animal Health Data Comparison (AHDC) has already achieved an important step : to federate a small but motivated group possessing relevant technical elements and ready to proceed. It is time for the next step: preparation and funding of the Phase 3 project – this could be the job for a stakeholder wide dedicated working group. It would be preferable if this working group could work under/with the remit of the major cattle recording body/bodies.

## 6.0 Acknowledgements

We would like to thank all the interviewees in participating and providing relevant information, Garcia Manca, António Ferreira, and Clara Díaz for the overview of Italy, Portugal and Spain (pil ot: Basque Region) respectively.

We acknowledge the European Union European Commission for funding this study by the EADGENE project.

## 7.0 References

- Aumüller, A., Bleriot, G., Neeteson, A.-M., Neuteboom, M., Oostenbach, P., Rehben, E., 2010. Animal Health Data Comparison. Recommendations for the Future. February 2010. 20 + 40 pp. [www.eadgene.org](http://www.eadgene.org)
- EADGENE, 2004-2010. European Animal Disease Genomics Network of Excellence. Network of Excellence supported by funding under the 6th Research Framework Programme (EU Contract No. FOOD-CT-2004-506416) of the European Union European Commission. [www.eadgene.org](http://www.eadgene.org)
- European Commission, 2007. A new Animal Health Strategy for the European Union (2007-2013) where 'Prevention is better than cure'. [http://ec.europa.eu/food/animal/diseases/strategy/animal\\_health\\_strategy\\_en.pdf](http://ec.europa.eu/food/animal/diseases/strategy/animal_health_strategy_en.pdf)
- Malafosse, A., Van der Sanden, A., Jones, G., Jones, H., Hoste, S., 2008. Project Report EADGENE Data Comparison. October 2008. 89pp. [www.eadgene.org](http://www.eadgene.org)





## Real-Time QPCR-based DNA Mastitis Analysis using the preserved DHIA sample

J. High

Lancaster Dairy Herd Improvement Association, 1592 Old Line Road, Manheim, PA 17545, USA

### Abstract

Real-Time PCR has dramatically improved the usefulness of the common preserved DHIA bovine milk sample. It allows for a quicker turn around time while utilizing a high-end technological test. This helps to identify many of the common mastitis causing bacteria without the need for a sterile sample. It dramatically cuts down the wait time from up to 7 days to down to 1 day. The need for better, more accurate results is a welcome change for the dairymen.

*Keywords: preserved DHIA sample, Real-time PCR, mastitis, bacteria.*

### 1.0 Introduction

For decades in the dairy industry producers have strived to supply higher quality milk. Lancaster DHIA has aided in this need by testing for individual somatic cell count through the DHIA samples. Today producers want to perform further testing to identify the source of infection that is contributing to a high SCC. Lancaster DHIA saw the need for this service and opened a culture lab to assist the producer in achieving a higher quality product.

Producers are increasingly aware of management practices, and have used new resources like the culture lab to decrease their average SCC. The average LDHIA rolling herd SCC for 2008 was 306,000; it has decreased in 2010 to an average of 267,000 SCC for 3,000 farms with 210,000 cows. Producers have discovered that by lowering their SCC they have not only increased their milk quality bonus but have also increased milk production. For example, if current SCC were decreased by half, there would be a gain of 1.5 pounds (.68 kilogram) of milk per cow, per day, on average. With an increase in milk production of this magnitude, the potential increased revenue is a welcome reward. In the current economic landscape, maximizing milk production and quality is of utmost importance for success. Lancaster DHIA has made it a priority to help our members, and the agriculture community, prosper while promoting a safe and abundant food supply. We started a new service, PathoProof Real-Time qPCR-based Mastitis Assay, in October 2009, which will provide more accurate test results and the ability to use DHIA preserved milk. This assay is provided by Finzymes Diagnostics of Finland.

### 1.1 Tests Provided

The real-time qPCR-based mastitis assay identifies and quantifies the DNA of 12 mastitis-causing species or groups and the  $\beta$ -lactamase to the producer, as well as their veterinarian. This will show the specific bacterial specie(s) along with semi-quantification. The semi-quantification will show -, +, ++, +++ for all 13 targets. The 12 bacterial targets are *Staphylococcus aureus*, *Staphylococcus sp.* (including all major coagulase-negative staphylococci), *Streptococcus agalactiae*, *Streptococcus dysgalactiae*, *Streptococcus uberis*, *Escherichia coli*, *Enterococcus sp.* (including *E. faecalis* and *E. faecium*), *Klebsiella sp.* (including *K. oxytoca* and *K. pneumoniae*), *Serratia marcescens*, *Corynebacterium bovis*, *Arcanobacter pyogenes* and *Peptoniphilus (Peptostreptococcus) indolicus* and *Mycoplasma bovis*. Approximately 25-40% of conventional milk cultures result in no bacterial growth. The real-time qPCR-based mastitis assay does not rely on bacterial growth, and as a result has 100% sensitivity for bacterial identification. With the ability to test DHIA preserved samples and milk from animals treated with antimicrobials, sample collection is easier and results more reliable. Also, producers can choose to set up regular qPCR testing regimens that utilize DHIA preserved samples.

**1.1.1 How it works**

The first step is taken during the DHIA test day. The producer and field technician fill out the DNA lab form based on the needs of the dairy producer. Producers may specify which cows to test based on somatic cell count and clinical or sub clinical mastitis. Bulk tank analysis is also available as a screening method for contagious and environmental bacteria. The producer can pool samples to screen select groups of cows. Based on the pooled results, producers can determine which cows should be used for individual testing. Using this method, producers will reduce testing costs when trying to detect the contagious bacteria. Then the information is emailed to the veterinarian and a copy sent to the dairy producer. This information is analyzed for proper treatment and potential extended therapy treatment based on individual findings.

**1.1.2 The results**

A dairy producer has the ability to utilize several reports such as the report below showing the results of a sample pool for the Major-3 Contagious Analysis.

Sample	Bacterial finding	Quantity	Proportion
1	Negative	-	-
2	Negative	-	-
3	Negative	-	-
4	Negative	-	-
5	Staph. aureus	+	
6	Negative	-	-
7	Negative	-	-
8	Negative	-	-
9	Staph. aureus	+	
10	Negative	-	-
11	Negative	-	-

628,794,812,470,26
759,349,532,420,707
723,146,865,19,198
832,200,033,1007,566
37,705,547,88,144
4150,335,722,3134,123
589,452,789,668,782
1189,640,1100,97,473
2984,858,2808,701,713
733,074,2416,600,613
10,913,27,938,5

Next is an example of the results of the individual cows from the pool

Sample	Bacterial finding	Quantity	Proportion
37	Negative	-	-
705	Negative	-	-
547	Negative	-	-
88	Negative	-	-
144	Staph. aureus	+	
7984	Negative	-	-
858	Negative	-	-
2808	Negative	-	-
701	Staph. aureus	suspect	-
713	Negative	-	-
685	Negative	-	-
627	Negative	-	-
660	Negative	-	-
760	Staph. aureus	+	
1061	Negative	-	-

This is an example of the results from the Complete-12 Full Panel Analysis for their 10 highest SCC.

Sample	Bacterial finding	Quantity	Proportion
768	Enterococcus sp. (including faecalis and faecium)	++	
	Klebsiella sp. (including oxytoca and pneumonia)	++	
	E. coli	+	
	Staphylococcus sp.	+	
4063	A. pyogenes and P. indolicus	+	
	Enterococcus sp. (including faecalis and faecium)	+	
	Klebsiella sp. (including oxytoca and pneumonia)	+	
	Staphylococcus sp.	+	
410	Staphylococcus sp.	++	> 90%
	Enterococcus sp. (including faecalis and faecium)	+	
596	Enterococcus sp. (including faecalis and faecium)	+	
	Staphylococcus sp.	+	
5307	Staphylococcus sp.	+	
813	Beta-lactamase gene	+	
	Staphylococcus sp.	+	
913	A. pyogenes and P. indolicus	+	
	Enterococcus sp. (including faecalis and faecium)	+	
	Staphylococcus sp.	+	
4521	Beta-lactamase gene	+	
	Enterococcus sp. (including faecalis and faecium)	+	
	Staph. aureus	+	
	Staphylococcus sp.	+	
29	Enterococcus sp. (including faecalis and faecium)	+	
	Staphylococcus sp.	+	
676	Enterococcus sp. (including faecalis and faecium)	+	
	Staphylococcus sp.	+	

**1.1.3 Conclusion**

In conclusion, the real-time qPCR-based mastitis test is fast, reliable and accurate. This allows us to give the results to our dairymen in a timely manner. This allows them to make more effective treatment decisions leading to improvements in milk quality and milk production.

As shown in this example, the dairyman started using the qPCR mastitis at the end of 2009. This allowed him to identify the top cows and has even lowered his already low SCC to an impressive 3 month average of 39,000 for 73 cows.

DATE OF TEST	WT. AVG. ACTUAL SCC
MONTH DROPPED	108
4-23-09	122
6-09-09	195
7-09-09	86
8-27-09	103
10-21-09	72
12-09-09	101
1-22-10	53
2-27-10	25
3-27-10	41
AVERAGES	89





## Improving the management of the dairy cow through use of the Herd Companion on line website

T. Craven

*National Milk Records plc, Fox Talbot House, Bellinger Close, Greenways Business Park, Chippenham, Wiltshire, UK, SN15 1BN*

### **Abstract**

NMR has provided an online application for use by customers since 2005 called Herd Companion - an information management system for customers benefiting from NMR (National Milk Records) and NML (National Milk Laboratories) services. It allows farmers and their advisors to view fertility, health, milk quality and disease information online immediately after the herd records have been processed and updated.

The policy of NMR is to encourage the use of the data within the website by not only the farmer but also the vet and farm advisors. Information such as somatic cell counts, results of disease tests such as BVD, Leptospirosis, IBR, Johnes, results of bulk and individual cow mastitis pathogen tests, (using PCR technology) and bacto breakdown analysis are all available on the website.

The Herd Companion system allows customers to view key parameters which show trends and can highlight where performance of the dairy herd is not meeting expectations. Example areas such as cow health (somatic cell counts % over 200, herd averages), feed monitor (using proteins to look at energy levels in the cow diet) and key performance indicators (of which there are approximately 15, such as milk per cow per year which highlights the importance of fertility management), all help the customer manage their herds and, importantly for NMR, makes the farmer reliant upon his records.

### **1.0 Introduction slide 1**

I would like to present a brief talk on the Herd companion website offered by NMR (National Milk Records)

NMR is the largest milk recording organisation in GB with approx 5,000 regular milk recording customers. Average herd size 150 cows. Approx 11,000 dairy producers in GB.

NMR group also own National Milk Laboratories (NML) who conduct payment testing services for circa 95% of GB dairy farms in addition to offering disease and mastitis pathogen testing.

### **1.1 Introduction NMR locations, slide 2**

NMR owns 3 milk testing laboratories.





One in Harrogate that tests the Dairy Herd Improvement samples and two payment testing labs under the NML banner at Glasgow and Wolverhampton

The red pins in the map indicate the milk haulier transport sample collection points which our vans collect from daily, delivering payment samples to the labs in Glasgow and Wolverhampton.

## 1.2 Introduction NMR website, slide 3

This is a view of the NMR website



## 1.3 Introduction NMR website Herd companion location, slide 4

Herd Companion can be accessed through the NMR website by clicking on the Herd Companion button at the top right of the screen



## 2.0 Herd Companion main menu, slide 5

Once logged in the user has access to a number of areas to help him manage his cows. Areas such as health, fertility, milk quality and disease information are all available, using data that has already been recorded either from milk recording, his milk payment sample or samples sent in for testing.

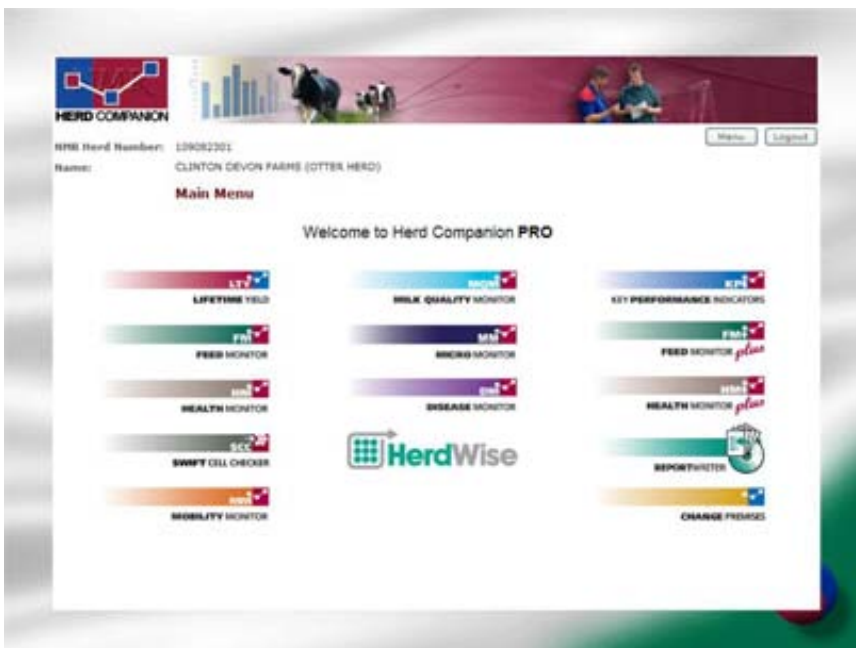

## 2.1 Accessing the system, slide 6

Access is free and users of on farm software can gain free access to further interrogate the data using the Herd Companion Pro functionality

Farm advisors such as vets, consultants or nutritionists can access the data for any of their farms, as long as the farmer gives permission.



### **Accessing the system**

- **Access to Herd Companion is free**
- **Herd Companion Pro is free for InterHerd users**
- **Need for farmer permission for advisors to access farm data**
- **Same permission form used for NMR results, NML milk quality results and for disease and microbiology test results**



## **2.2 Milk quality monitor, slide 7**

Dairy farmers having their bulk samples tested by NML for payment purposes (95% of all GB dairy farmers) can use Herd companion to access their payment results online.

They do not need to be milk recording with NMR, it is free and they can also access their disease and micro test results.



### **MILK QUALITY MONITOR**

- **NML payment test results online**
- **Available for all NML herds using latest NML database**
- **No requirement to be milk recording with NMR**
- **Free to farmers and third parties (if authorised by the farmer)**



## **2.3 Groups of customers, slide 8**

A benefit of a vet, consultant or feed advisor having access to farm records as a third party is that they can set up their own comparison tables to look at the performance of their herds. Indeed one of the main drivers for us to set up the Herd Companion website was to encourage the use of the farm advisors- not only helping their customers to improve efficiency using data that has already been recorded, but the more we can encourage use of the records, the less likely the customer is to leave milk recording.

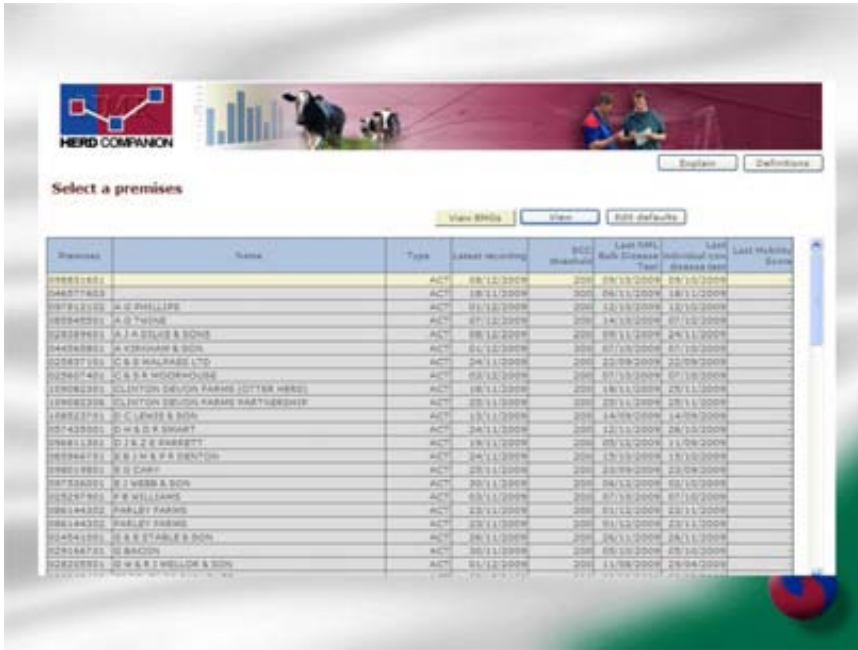

### 3.0 Cell count summary, slide 9

I am going to talk you through a small number of the available reports and functionality to give you a flavour of what sort of information is available.

The cell count summary report lists results for each animal tested, with the animal with the highest cell count at the latest recording at the top of the list. With the latest 4 milk recording results also showing.

One of the most popular figures is the % contribution to the herd, for example here cow line number 2875 produced 13% of the bulk somatic cells at the last recording.



### 3.1 Cell count types, slide 10

Within Herd companion we try to distinguish between 4 types of infection:

- Cows with a first infection over a set cell count limit within the current lactation (new)
- Cows with a mastitis infection at their first recording of a lactation only (first)
- Cows with a cell count over the threshold on more than one occasion in the current lactation (repeat)
- And cows with a high cell count at the current and previous recording (chronic)

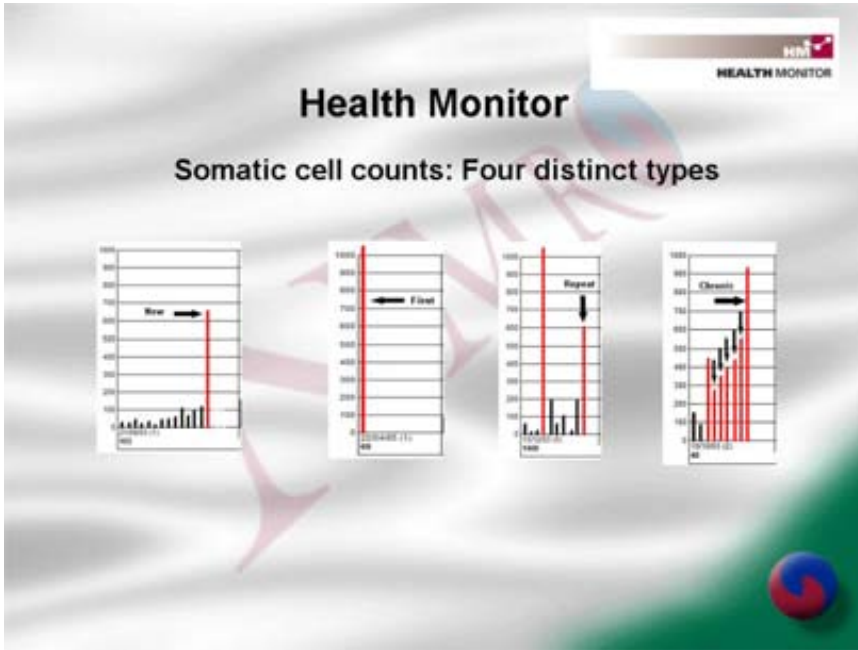

### 3.2 SCC status, slide 11

So- the red section is the chronic cows.

This graph on a live herd shows that roughly 15% of his herd have a chronic mastitic infection and that the trend, if anything over the last 15 months shows chronic infections to be increasing.

In addition- if we look at dry period performance for the same period.....

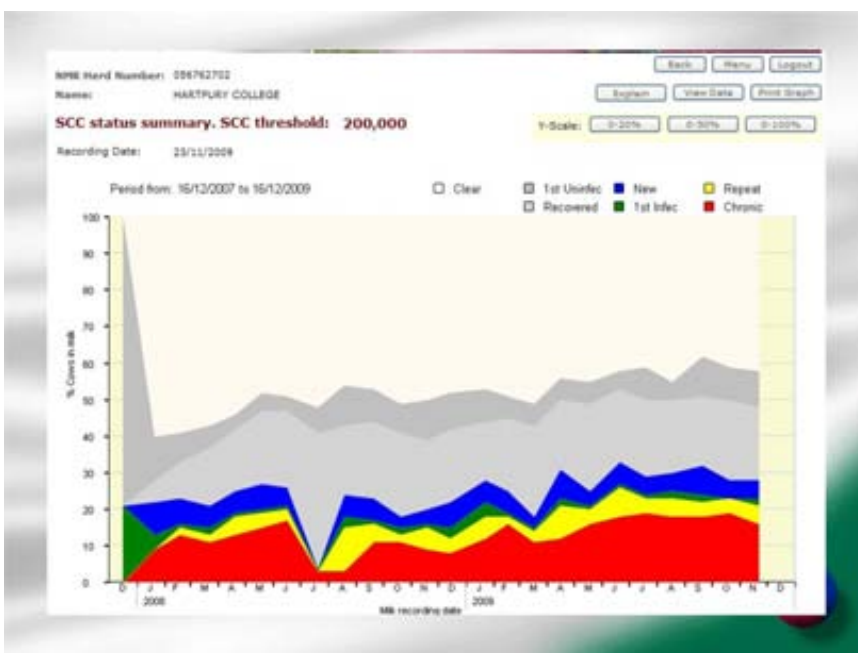

### 3.3 SCC dry period performance, slide 12

Here we are looking at somatic cell counts before and after a cows dry period.

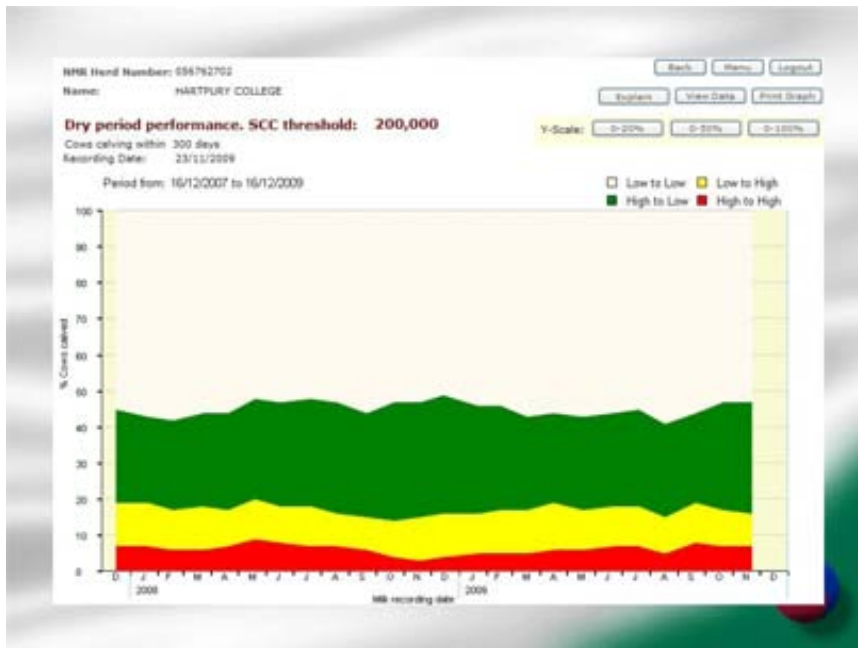

This graph displays trends in the four categories of dry period performance over time and the key at the top indicates the cows which fall into one of the four categories. For example, the cows in the red section ended one lactation and started the next with a high cell count.

The data are limited to cows that calved in the 300 days up to the currently selected recording date and require at least one milk recording in both the new and previous lactation.

On this farm, there is no real deterioration of the cows getting new infections but equally there is no reduction in the cows finishing one lactation with a cell count above the threshold and starting a new one still with a high cell count. He may be well advised to test some of the cows in the red high to high section using the PCR mastitis pathogen testing on offer to try and identify if there is a particular infection affecting the herd.

### 4.0 Feed monitor, slide 13

The bars on the chart represent the average kg milk production of all cows milked on the corresponding recording date. The points show a reference value referred to as the "Protein 3.2% intercept". This is derived from plotting yield against protein for all individual cows milked on the recording date. A best-fit straight line through these gives an intercept at a reference value of 3.2%. This intercept broadly represents the average daily yield at that month above which the protein % of the milk drops below 3.2%. If significant numbers of cows are yielding greater than the intercept level, this may indicate energy deficiency in the cows.

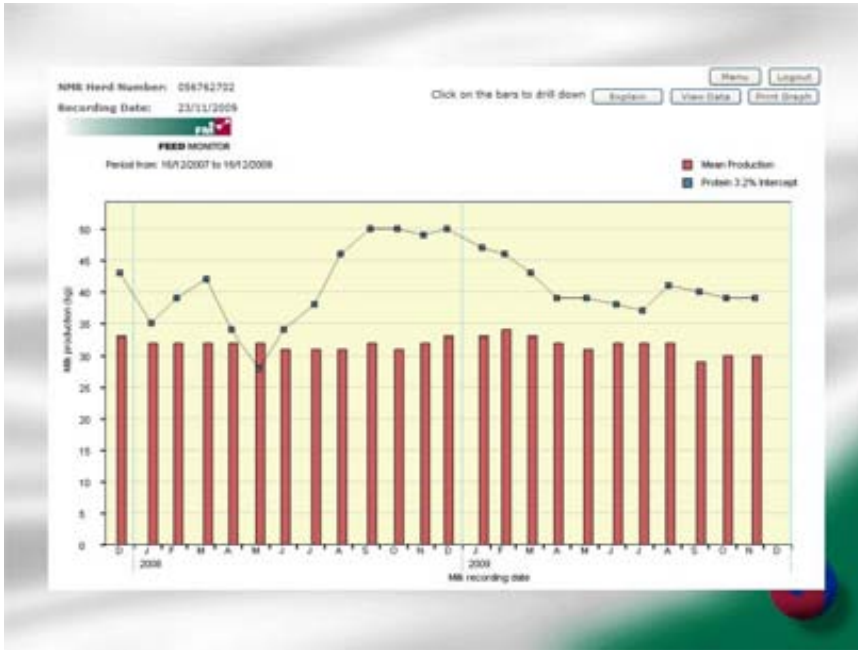

The knock on effect from energy deficiency may well be ketosis which is linked to poor fertility, and I will explain why it is important later.

#### 4.1 Protein vs production slide 14

Each point on this chart represents the protein % against milk yield for a cow milked on the recording date. The colours and shape of the individual points describe the fertility status and stage of lactation respectively of the cow.

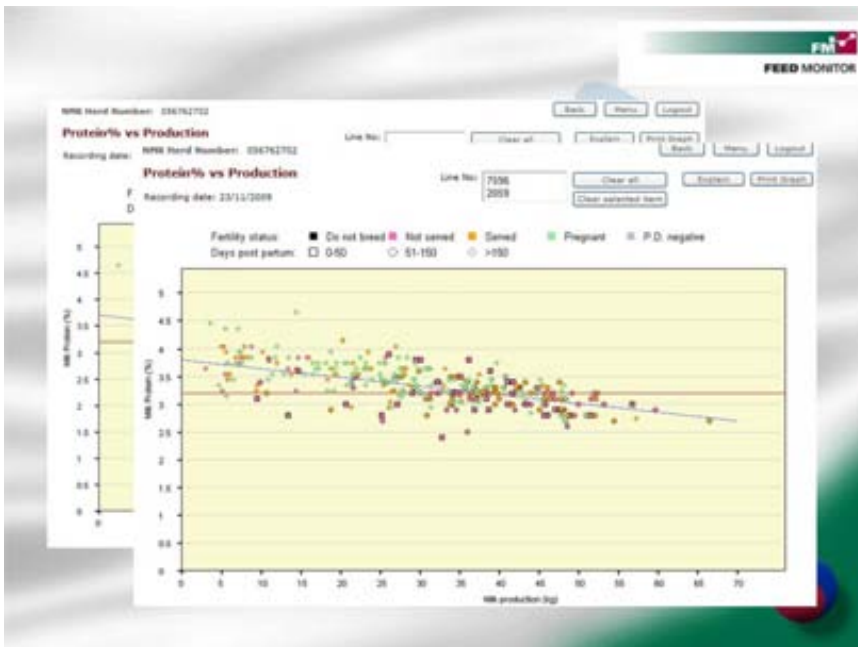

The blue line is a straight line fitted by linear regression through all the points to show the overall relationship between milk quantity and protein %. The red line highlights the 3.2% protein level.

As yield increases the protein % normally declines. In cows with severe energy problems this decline is accentuated. Where the blue "best-fit" line crosses the red 3.2% protein line gives the yield value for the "Protein 3.2% in intercept". It indicates the level of milk production (in kg milk per cow) that can be sustained by the diet, whilst maintaining 3.2% protein in the milk.

In this case, the intercept is at around 25l so the farmer is on average getting 25l per cow on the present diet without protein dropping below the 3.2% level. However, it is clear that a number of the cows in negative balance are in the 0-50 days post partum- exactly the cows he should be trying to get back in calf. It is this graph that feed advisors find particularly useful.

In the next slide you can see that milk yield has risen to 35l with fewer cows below the 3.2% level- knock on benefits of better fertility.

#### 4.2 Average protein % , slide 15

Just to illustrate the point, the graph here is from a live herd averaging 8,500 kg in 305 days.

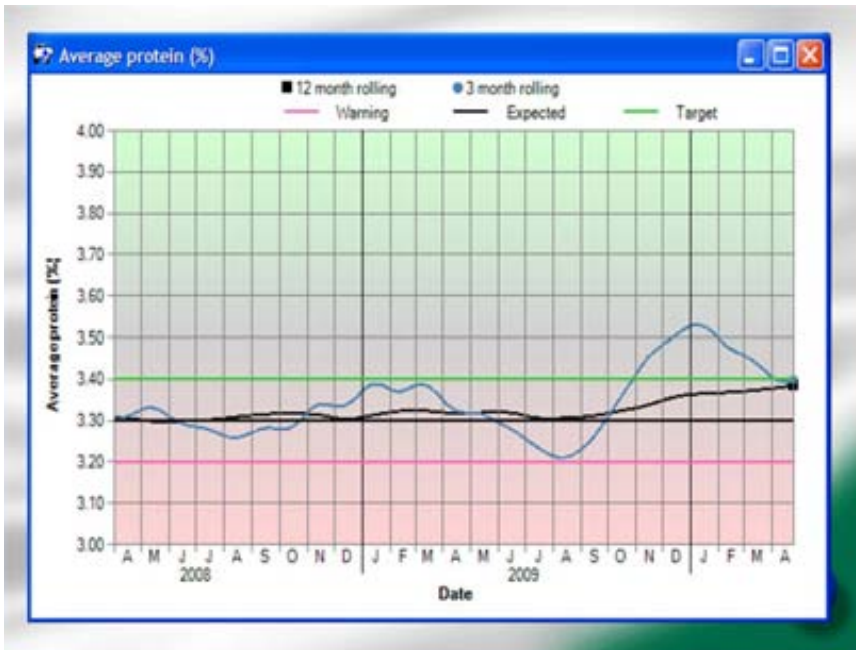

The blue line is a rolling 3 month protein percentage and just at the time when the protein takes a dip in the autumn of last year,.....

#### 4.3 Conception rate, slide 16

There is a corresponding dip in the conception rate and.....



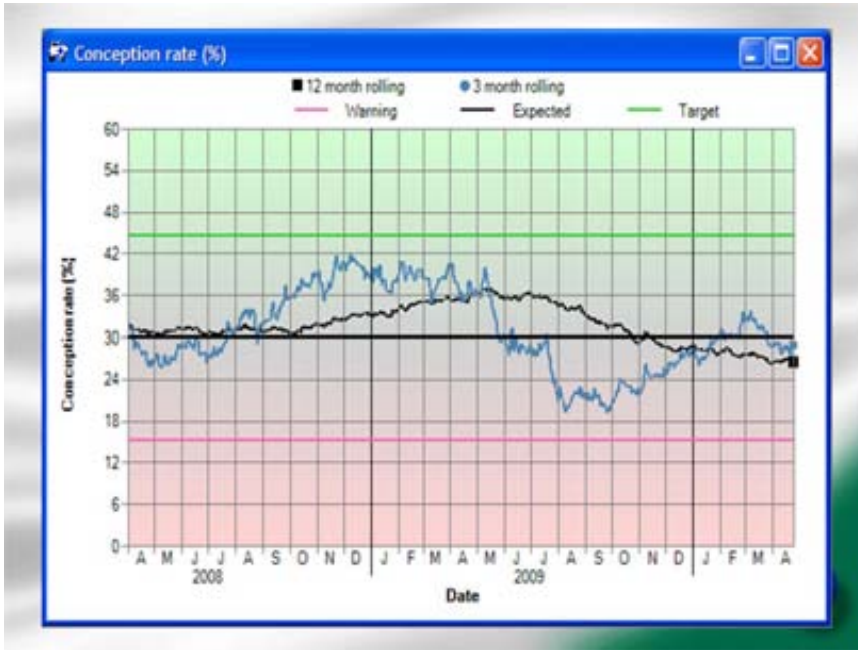

**4.4 Calving- conception, slide 17**

A rise in the calving to conception interval.

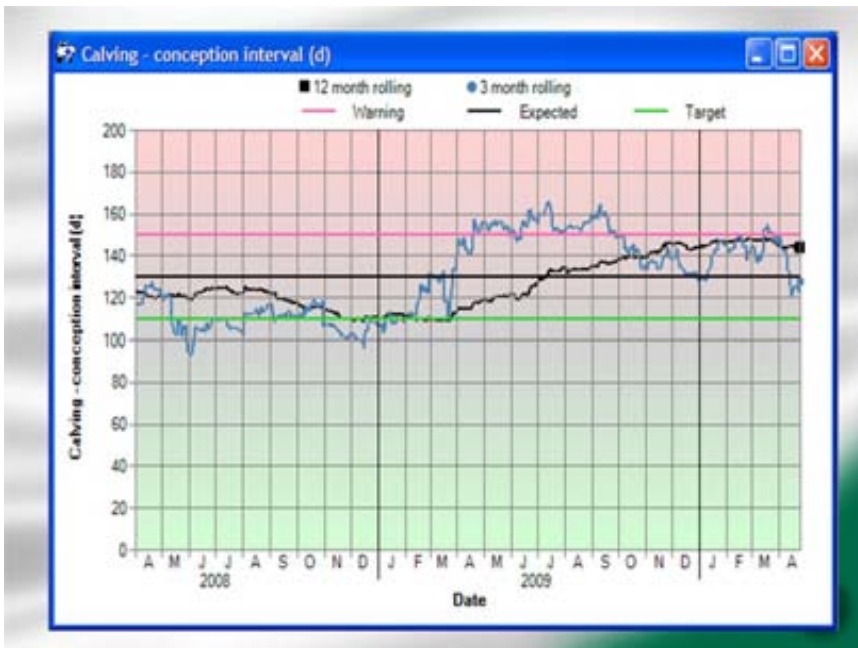

This drop in protein levels indicating a shortfall in the energy requirement in the diet of high yielding herds, with knock on effects to the fertility performance is becoming more common

**5.0 Herdwise, slide 18**

Herdwise is a service we offer to our milk recording customers where we send their samples for Johnes disease testing following every third monthly milk recording. We are testing about 22,000 samples per month currently and obviously, the more we can do with the samples we already have, the better. We introduced mastitis pathogen testing on bulk samples earlier this year and are due to introduce individual cow PCR testing using the NMR samples we already have, later this year.



Results are available via Herd Companion allowing the farmer quick access to the latest results.

### 5.1 Herdwise report , slide 19

The results are grouped into bands, easily identified with a colour, based on their antibody profile.

Line No.	Ear Tag	ELISA 18/08/2009	ELISA 18/11/2009	Days in Milk*	Milk Yield (kg)	Parity	Milk Yield Drop	Predicted Calving Date	Infection Group on 18/11/2009	
7	36617402447	16.78	40.84	123	21.00	1	Likely		J4	Yellow
11	343617300466	27.09	40.65	512	8.30	1	Likely		J4	Yellow
96	366174301886	--	93.69	370	15.10	2	Likely	10/07/2010	J4	Yellow
93	366174601931	--	103.73	14	25.70	2	Likely		J4	Yellow
136	366174602267	--	48.56	392	21.90	1	Likely		J4	Yellow
239	343617300494	2.70	114.57	135	23.10	2	Likely	24/08/2010	J4	Yellow
348	366174201850	27.15	38.95	341	15.50	3	Likely	09/07/2010	J4	Yellow
381	366174501218	36.91	--	601	10.40	2	Likely		J4	Yellow
387	366174502096	7.29	69.69	503	19.60	1	Likely		J4	Yellow
Line No.	Ear Tag	ELISA 18/08/09	ELISA 18/11/09	Days in Milk*	Milk Yield (kg)	Parity	Milk Yield Drop	Predicted Calving Date	Infection Group on 18/11/2009	
1	366174501398	--	19.41	468	29.30	3	Not Likely		J1	Green
8	366174201332	4.40	--	468	14.80	3	Not Likely		J1	Green
13	V00793/02243	--	3.92	556	23.48	8	Not Likely	07/08/2010	J1	Green
15	366174302124	--	0.79	455	25.70	1	Not Likely		J1	Green
22	366174102052	--	0.21	477	20.10	1	Not Likely		J1	Green
30	366174502064	--	2.20	496	26.10	1	Not Likely		J1	Green
39	366174301904	--	0.53	464	24.50	4	Not Likely		J1	Green

Green colours indicate they are non infected and non infectious and yellow colours indicate the cow is controlling the infection but may be in the initial phase of not controlling the infection.

### 5.2 Herdwise report , slide 20

Red cows are no longer controlling the infection.

Results based on cows sampled on: (Only valid up to 4 months from specified sample date)

Line No.	Ear Tag	ELISA 15/12/2009	ELISA 10/09/2010	Days in Milk*	Milk Yield (kg)	Partly	Milk Yield Once	Predicted Calving Date	Infection Group on 10/09/2010
19	186329102496	9.25	11.55	508	31.30	3	Very Likely		J6
64	186329102646	-	68.91	495	52.30	2	Very Likely	05/01/2011	J6
158	186329402039	65.54	52.80	486	31.10	5	Very Likely		J6
248	103941020348	60.64	48.10	428	41.30	4	Very Likely	29/11/2010	J6
11	186548102682	11.54	47.20	666	10.30	2	Likely	14/06/2010	J4
87	186329402687	27.55	33.11	236	26.60	3	Likely		J4
121	83613102433	22.89	52.58	260	8.80	8	Likely	14/07/2010	J4
196	186329402418	12.86	41.82	268	17.90	4	Likely	01/06/2010	J4
286	186329702639	11.40	43.66	343	6.90	3	Likely	21/11/2010	J4
298	186329402680	14.85	38.77	337	21.80	3	Likely		J4
499	26288802687	12.87	70.32	467	48.10	5	Likely	05/12/2010	J4

\*RED\* cows (High-risk cows) potentially culled prior to next calving (start with cows with high values).  
 NO COLOSTRUM/MILK USED FOR CALVES

\*YELLOW\* cows (High-risk cows) require good hygiene around calving. Cull only if few high-risk cows.  
 NO COLOSTRUM/MILK USED FOR CALVES

VET COMMENTS:

The very fact that advisors such as vets can view the farm data means that they can see the results and advise the farmer accordingly.

## 6.0 KPIs, slide 21

Key Performance Indicators are rolling 12 month averages (which remove any seasonal effects) which allow a farmer to see how his farm is performing compared to other similar sized farms.



It also allows farm advisors to compare farms, for example a vet practice could look at performance of the herds at their vets practice, subdividing their customers to groups such as herd size, organic, channel Island breeds etc.

## 6.1 SCC KPI, Slide 22

Farmers can plot their performance on many differing parameters and compare their performance to 50 similar sized other random herds held within the NMR database. The farm performance is indicated in yellow and is plotted against the other farms so that the farmer can see easily how he is performing against other similar farms.

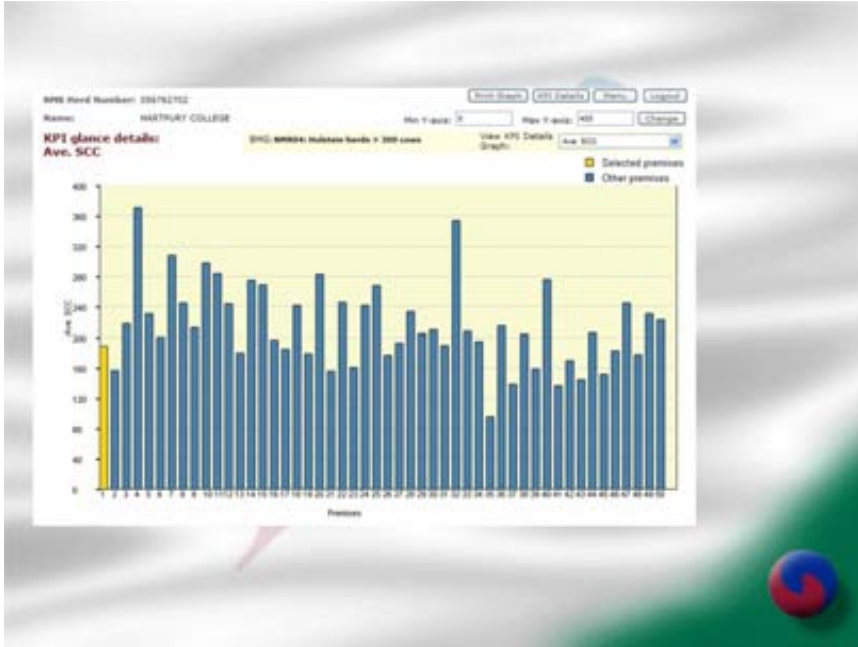

Here for example the herd average somatic cell count was just under 200 compared to a range between 370 and 90 for 50 other farmers with a similar sized herd picked at random

## 6.2 All KPIs, slide 23

Here is a selection of some of the parameters that can be used as Key Performance Indicators.



**7.0 Lifetime Yield, slide 24**

Finally I would like to show you a section about lifetime yield per cow-



This is the true commercial contribution of cows to the total herd performance in terms of milk produced during the cows life.

Here the farmer can see the differences in milk produced by cows in differing lactations over the last 2 years, and also the number of cows in each lactation group- let me explain why this is important

**7.1 Lifetime daily yield, slide 25**

This slide is a little involved but the 3 sections indicate months along the bottom, and the lactation curves we all understand and how the reproductive cycle works in the middle.

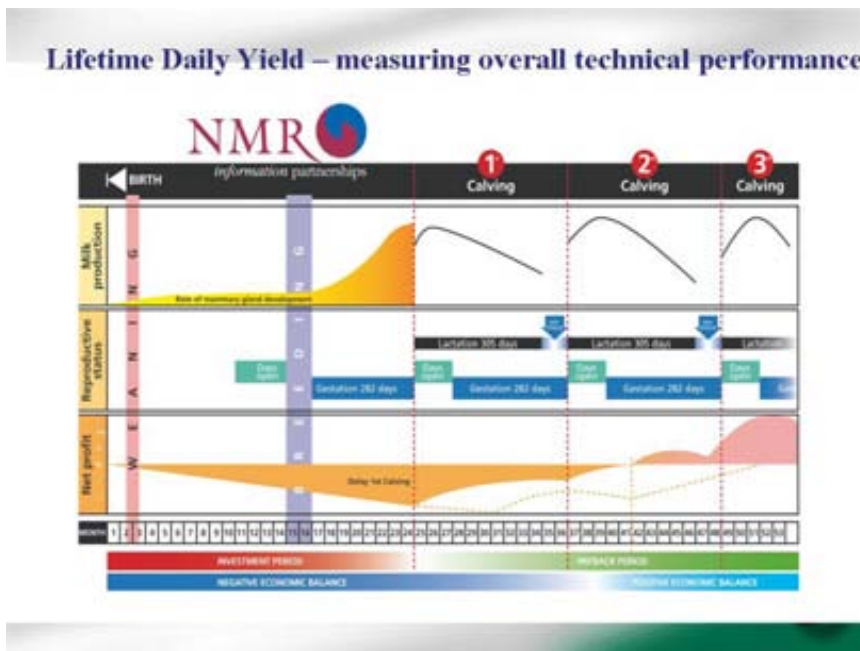

It is the bottom section that is the interesting bit, plotting the net profit of an animal from birth. You can see that as soon as the animal is born, it starts to cost the farmer money, feeding it, housing it and looking after it. He then has to pay for semen and wait until she calves before she starts contributing to

income. However, it is a gradual process for her production to pay for not only her continued upkeep but also the money the farmer has invested in her since birth, and if she is in calf by the time she is 15 or 16 months old it will take until well into her 2nd lactation before she is contributing to the farm profitability. Up until this point, the animal has been a drain on profit.

The effect of not getting her in calf until 21 months, with her calving down at 30 months means that she will be well into her 3rd lactation before she contributes to profit.

### 7.2 Average NMR lactations before leaving the herd, slide 26

In NMR, this is the average lactation number animals reach before leaving the herd- currently averaging almost 2.5 lactations. The graph shows the trend (if any) over the last 10 years.

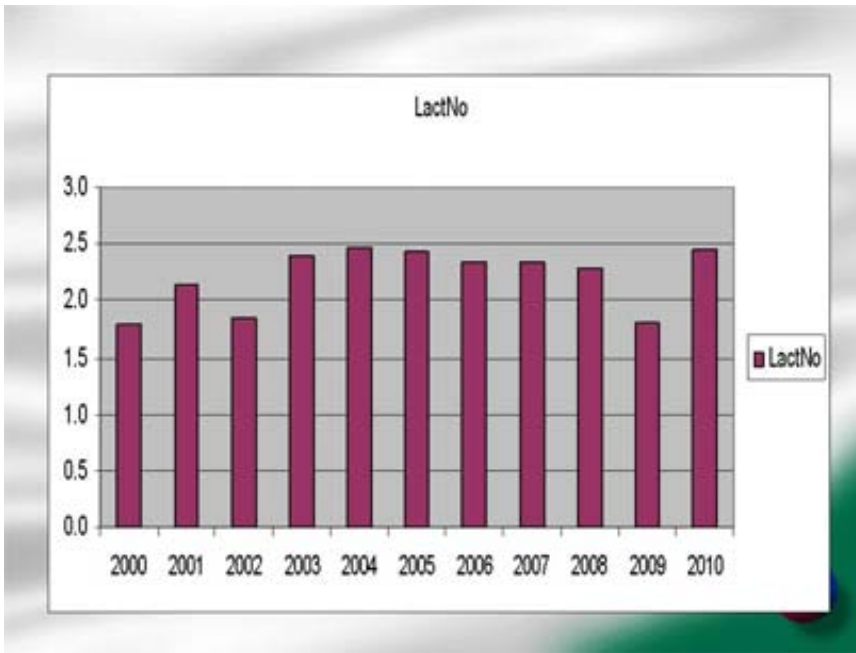

It will be interesting to see if this figure rises now that we have started to point out the financial benefits of keeping fit, fertile and healthy cows for longer.

For information, the average age at leaving the herd in 2010 was 4 years 8 months.

### 7.3 Average age at 1<sup>st</sup> calving, slide 27

We are starting to see a trend in the average age of heifers at first calving coming down so it will be interesting to see if this continues.

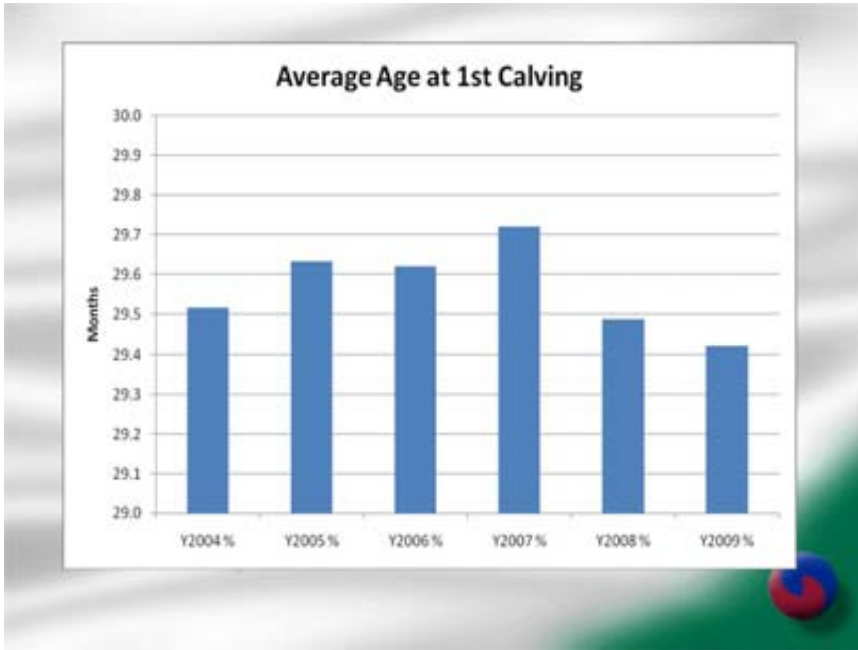

### 7.4 True performers, slide 28

So- with the information available it is easy to see that whereas the traditional thinking of increasing yields was the way to increase profitability, it is becoming clear that a longer lasting well managed cow that does not suffer from poor fertility as a result of an energy deficient diet adds more to farm profit.

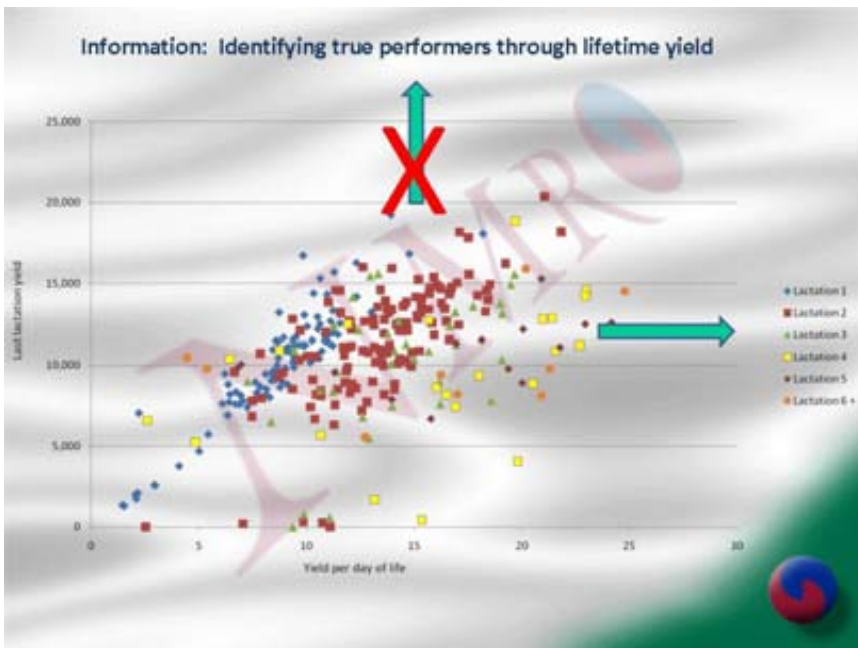

There appears certainly to be the case for, dare I say it some cross breeding bringing hybrid vigour to milk producing cows, leading to a longer productive period, thus making a greater contribution to farm profits

### 8.0 Conclusion, slide 29

In conclusion, in NMR we want to encourage the use of the Herd Companion system by farmers and their advisors in order to help them make the right management decisions.



## The use of a new sensor (Behaviour tag) for improving heat detection, health and welfare monitoring in different rearing conditions

A. Arazi, E. Ishay & E. Aizinbud

*S.A.E. Afikim, Afikim, Israel*

### **Abstract**

The milk production increase of the individual cow and the growth in dairy cow herd size in the last decades are generating new challenges for health and reproduction performance in the modern dairy farms.

Detection of oestrus and early diagnosis of sick cows are important keys in the management of dairy farms. Monitoring the welfare and comfort of the cows is essential for health, reproduction and production of dairy farms and for the profitability of the herd.

A newly developed sensor, a Behaviour tag, which records rest and activity behaviour of cows, is already employed in research and commercial dairy farms. This paper review studies and observations performed in these farms, exploring the applications of the new recorded data.

Our observations support the assumption that incorporating lying behaviour data could improve heat detection under limited conditions such as tie stall barn and heat stress environment. Furthermore, lying behaviour is showing promising possibilities for improving the treatment of health disorders, by both specifying the disorder and reducing time for detection.

In a survey that was performed in 6 Israeli commercial dairy herds (1808 lactating cows), the dynamic of daily rest time versus daily milk production was explored. It was found that the correlation between those two parameters changes along the lactation with correlations of -0.846, 0.628, -0.706, -0.843 and -0.466 for 5-25, 26-50, 51-100, 101-200 and 201-305 DIM, respectively. Under the hot Israeli summer dairy cows spent less time resting compared to winter season (8.7 vs. 10.2 hours/day), this probably due to the heat stress and the intensive cooling procedures during the summer. The changes in rest time routine were found to be a sensitive tool for cow comfort assessment.

Our findings suggest that integrating automatically collected rest behaviour data to computerized herd management systems has high potential to monitor cow welfare and comfort and to improve of heat detection capabilities and early diagnosis of sick cows.

*Keywords: Lying behaviour, cow, welfare, comfort, health, oestrus detection, pedometer.*

### **1.0 Introduction**

Increase of individual cow milk production and the size of the dairy cow herds in the last decades, generate new challenges for health and reproduction performance in the modern dairy farms. Detection of oestrus and early diagnosis of sick cows play an important role in the management of dairy farms.

Monitoring the well being of the cows is essential for health, reproduction and production of dairy farms and for the profitability of the herd.

Poor welfare usually leads to greater susceptibility to disease due to effects on the immune system as a function of having to contend with difficult condition (Broom and Corke, 2002). The OIE, Guiding Principles for Animal Welfare (O.I.E, Terrestrial animal health code, 2006) states that there is a critical relationship between animal health and animal welfare. Improving farm animal welfare can often improve productivity and food safety, hence leading to economic benefits.

Schepers *et al* (2008), have identified stressful condition such as stocking density of breeding or high group pens as a significant negative influence on the overall herd average conception rate (Cited by Cook, 2008).



Furthermore, animal welfare is of considerable and growing importance from the social, political, ethical and scientific viewpoint (Clamari and Bertoni, 2009).

Some authors suggest that among various animals' direct reactions - total lying time and lying synchrony are key factor of cow welfare (Fregonesi and Leaver, 2002). According to Jensen (2005), "dairy cows are highly motivated to lie for 12 -13 h/day". Mostly, authors define the rest target for a dairy cow as 12 -14 hours/day. Erroneous management, climatic factors and health problems often prevent achieving these goals.

In the last years, high efforts were invested in developing systems for evaluating animal welfare. Nevertheless, the current research apparatuses that evaluate animal welfare are expensive and time consuming (Sørensen, 2003 as cited in Ekman and Sandgren, 2006). For evaluating welfare and comfort status in commercial farm the situation is even more challenging. Different indices were developed but they are all subjective and based on visual observations, which require time and skilled labour. Bartussek (1998), stated about the ANI system, which grades important factors in animal rearing, that either no or very few animal based measurements or management variables are used in the currently systems used. Experiences from users indicate good repeatability in measurements at different visits and between different evaluators, but this does not mean that farms with the best or worst welfare are classified in the right category, or in other words, the validity of the index is not satisfactory (Cited in Ekman and Sandgren, 2006).

Tolkamp *et al.* (2010) suggest that information on (changes in) standing and lying behaviour of cows can be used for oestrus detection, early diagnosis of disorders and evaluation of welfare consequences due to change in housing and management.

The usage of time-lapse video-photography to monitor cows' behaviour is expensive, time consuming and inconvenient for commercial farms.

Recently, sensors fitted to cow leg were developed for monitoring activity and lying behaviour of cattle – The IceTag (Ice Robotics, Roslin, UK), ALT-Pedometer (Brehme *et al.*, 2008), and Pedometer Plus™ (S.A.E. Afikim, Israel). The latter is incorporated in the existing Afimilk dairy management system and Afifarm software and serves as a "Behaviour Tag".

The present paper discusses the use of this new tag for improving cow welfare and comfort, fertility (oestrus detection) and health (health problem detection).

This paper focuses mainly on the relevance of lying (rest) behaviour of cows as an indicator for cow welfare assessment. Despite the growing interest this area has for the milk industry (breeders, researcher and consumer), there is still lack of automatic objective tools for monitoring and evaluating the in farm status. The primary interest of the authors is to examine and evaluate the potential use of the Behaviour tag for improving management procedures and facilities at the herd level.

## 2.0 Pedometer Plus™ system – Behaviour Tag

The Pedometer Plus™ system (S.A.E. Afikim, Kibbutz Afikim, Israel) is a novel sensor that supplies three parameters: Activity (steps/hour), Lying Time (minutes) and Lying Bouts (changing position between standing and lying). The tag is fitted to the cow leg (front or rear), the data is accumulated and transmitted to management software (Afifarm™) each time the cow is passing an antenna (which could be located in the milking parlour, walkways or in the barns).The recorded data is analyzed and the information presented for the user. Fertility – improving heat detection

### 2.1. Current reproduction status in dairy cows

Reproductive efficiency in dairy cows is decreasing worldwide. This decrease is contributed mostly to the increase of milk production, but other factors also contributing include; increase in herd size, global warming, diets and others (Lucy, 2001; Sheldon and Dobson 2003). Lucy (2001) reviewed the decline in reproductive performance in many aspects – decline in first conception rate (CR) from approximately 65% in 1951 to 40% in 1996 in New York (U.S.A.) dairy cattle, and decrease of CR from 55% in early sixties to approximately 45% for insemination at spontaneous oestrus and 35% in timed AI in recent publication.

In addition, there is an increase in other reproduction parameters such as service per conception, open days and days to first insemination. The enlarging herds size and the intensive management increase the risk for mammary and uterine infectious which are risk factors for infertility in dairy cows (reviewed by

Lucy, 2001; Lavon, personal communication). The global warming which exposes more cows to heat stress for longer durations also contribute to the decrease of reproduction efficiency (Lucy, 2001).

Furthermore, oestrus behaviour, intensity and duration have reduced in the last decades (Mcdougl, 2006; Seldon *et al.*, 2004). Lucy (2007) stated that anovulatory and behavioural anoestrus is one of the four primary mechanisms that depress fertility in lactating cows. Under limited conditions like heat stress, early period of lactation and tie stall barn oestrus behaviour is even more depressed, increasing the ratio of "silent oestrus".

Nebel *et al.* (1997) (Cited in Hansen and Arechiga, 1999) and DeSilva *et al.* (1981) reported that dairy cows in oestrus during the summer had 4.5-4.7 mounts per oestrus vs. 8.6-11.2 for those in winter, while Thatcher and Collier (1986) reported that the percentage of undetected oestrus periods in commercial dairy farms in Florida were estimated at 76%-82% during the hot season compare to 44%-65% in the cooler season (review by Hansen and Arechiga, 1999).

Heat detection ratio depend on the number of ovulation post partum, with much lower rates in the first ovulation compare to second and third (Peter and Bosu, 1986, cited by Frick *et al.*, 2002). Ranasinghe *et al.* (2010) reported that incidence of silent ovulation was 55.2%, 23.8%, 21.3%, and 10.5% at the first, second, third, and fourth ovulations postpartum, respectively.

## **2.2. The importance of oestrus detection**

Effective oestrus detection is essential for reproduction improvement (Foote, 1974, Frick *et al.*, 2002; Gwazdauskas *et al.*, 1982). Nebel *et al.* (2000) indicate that for the majority of dairy herds where artificial insemination is practiced, the limiting factor toward obtaining efficient reproductive performance is the failure to detect oestrus in a timely and accurate manner. The positive impacts of increased oestrus detection rates are: improved insemination results, controlled calving interval and total pregnancy rate (Stumpfenhausen, 2001 cited by Frick *et al.*, 2002). Frick *et al.* (2002) reviewed studies calculating a cost of 0.59-1.17 Euro per day of prolonged calving intervals and a cost of 1.52 Euro per cow per year for 1% decrease in CR. Annual losses to the U.S.A. dairy industry, due to oestrus detection failure or oestrus misdiagnosis, was estimated in more than US\$300 million (Senger, 1994 cited by Nebel *et al.*, 2000).

## **2.3. Oestrus detection in different rearing conditions**

Frick *et al.* (2002) cited in their review, studies reporting difference in increase of activity during oestrus between cows kept in free stall barn and tied stalls. These studies report 14%-20% activity increase during oestrus in tie stalls compared to 93% of this increase in free stall. Cow in comfort stall housing changed their activity less distinct at the time of oestrus compare to cows in free stall housing (Kiddy, 1976). Studies using activity for oestrus detection in free stalls and loose stall barns were reported detection rate of 72% to 100%, with error rate of 17%-51% and specificity of 96%-98% (review by Frick *et al.*, 2002), while in tie stall barns detection rates using activity behaviour were 59%-80% and high false positive alarms up to 1.2 false positive for every correctly identified oestrus reported (Kennedy and Ingalls, 1995; Redden *et al.*, 1992). In a study conducted in Japan deferent methods (neck pedometer vs. leg pedometers and diverse algorithms for defined activity deviation) in different rearing conditions (pasture grazing, open paddock and tie stall barn) were tested to evaluate efficiency and accuracy of oestrus detection in heifers using activity data. The best results for open paddock were of 92% efficiency and 100% accuracy (hind leg) and results of 87% and 82%, respectively were found for heifers in tie stall (front leg) (Sakaguchi *et al.*, 2007). These results are better than other studies probably due to the fact that heifers are showing enhanced external oestrus behaviour signals compared to cows, and the extenuating of defining correctly identified oestrus used in this study.

## **2.4. Improving oestrus detection by incorporate lying and activity behaviour**

Early in the eighties of the last century it was suggested that measuring standing time and activity could be used for heat detection in tie stall barns. Walton and King (1986) reported that number of changes in postural position during the previous night increased on the day of oestrus, but their results were disappointed with more false positives than true positives events. Lately it was reported that cows in oestrus do not lie down for 6-17 hours and that cycles with weak oestrus intensity or quiet oestrus recognize by the ALT pedometer, very frequently show oestrus symptoms only under measuring parameter "lying time" (Brehme *et al.*, 2008).

Based on these reports and on the authors observations in commercial farms equipped with the Pedometer Plus system (Figure 1) we speculated that the integration of both activity and rest behaviour (rest time and rest bout) could improve oestrus detection in unfavourable condition such as heat stress, tie stall or free stall barns and ovulation in early stage of lactation.

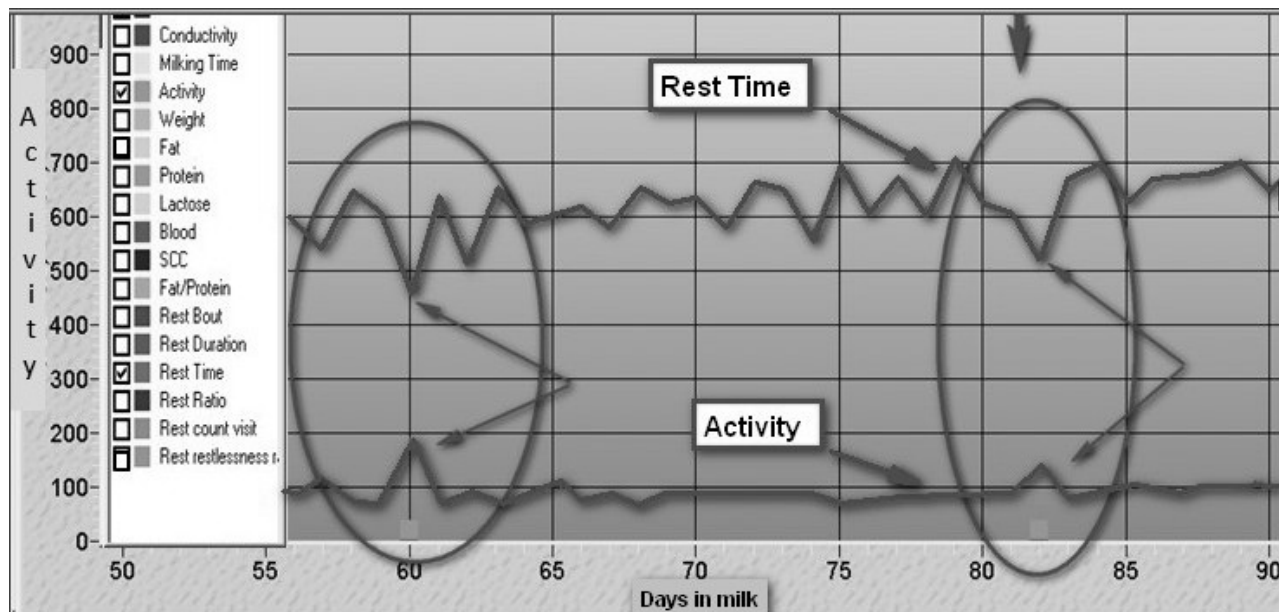

Figure 1. Example for two events (indicated by ellipses) of silent oestrus (low activity), detected based on integration of the slight increase of activity with parallel decrease in rest (lying) time.

Initial results from study conducted in a large commercial Israeli farm (~500 milking cows), containing both free stall and loose stall barns, during the summer of 2009 (Kaim, personal communication), show difference of +5.2% of efficiency oestrus detection rate between cows housed in the loose barn compared to free stall barn when only activity measurements were analyzed.

Currently models for improving efficiency of oestrus detection with respect to cow housing are being constructed. These models are being constructed from the integrated lying and activity data for different housing particularly for tie stalls. Figure 2 illustrates an example of an oestrus event detected for a cow in tie stall housing using integrated data of activity and lying behaviour.

The data presented in Figure 2 are in full agreement with those obtained by Brehme *et al.*, (2008).

### 3.0 Health – early detection and prevention of health problems

#### 3.1. Rest behaviour as a potential tool for early detection of disease and health improvement in dairy cows

There are numerous studies describing the correlation between lying time and health status of the cow, and the importance of adequate rest time for cow health in general and for the hoof health in particular (Broom and Corke, 2002; Cook *et al.*, 2004; Fregonesi *et al.*, 2006, Grant 2005; Grant, 2007; Grant 2008; Jensen *et al.*, 2005).

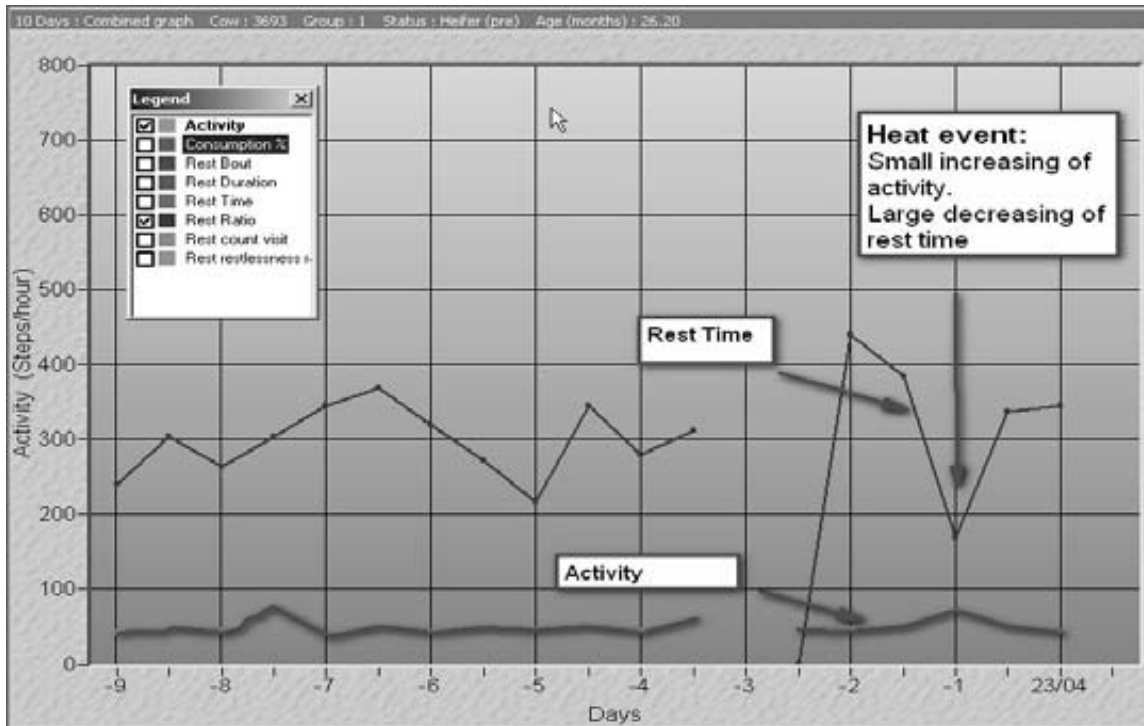

Figure 2. Example of oestrus behaviour (large decrease in rest time with simultaneously small increase in activity) of heifer housed in tie stall barn.

It was suggested that identification of lying and standing bouts may provide information on animal behaviour that may assist in early detection of health problems (Tolkamp *et al.*, 2010). Nevertheless there are limited works studying the use of lying behaviour for health problem detection. This is probably due to the difficulty of continuously measuring and monitoring such behaviour for prolonged time on large number of animals. Niss *et al.* (2009) reported that disease induced by oligofructose overload (i.e. ruminal acidosis and lameness) can effect lying behaviour in heifers. They concluded that both metabolic and leg problems appear to lead to a thwarting of the lying down motivation in cattle and potentially prevent the animals from lying down. Blackie (2008) reported that cows locomotion score 3 (1-5 scale) spent approximately 2 hours/day longer lying time than cows with locomotion score 1 and 2. Juarez *et al.* (2003) reported that the percentage of cow's lying time increased linearly with the increase of cow's locomotion score. Other publications supply the correlation of activity data (not including lying behaviour) with fresh cows disorders and lameness (Edwards and Tozer, 2004; Mazrier *et al.*, 2006).

Veterinary treatments and management changes are generally more effective when initiated at earlier stages in the disease process. Therefore, early identification of sick animal could improve animal welfare and reduce treatment cost (Gonzalez *et al.*, 2008). Gonzales *et al.* (2008) declared that under the intensive condition of the modern dairy farm, tools to monitor the health status of cows can assist breeders to identify sick cow earlier. The implementation of such tools via computer-controlled programs can become valuable instrument for on-farm use.

### 3.2. Using the Pedometer Plus system for early detection of health problems

Our observations in commercial farms show that there is a wide diversity in individual cow response to different disease and painful events. Some disease such as abdominal pain or clinical mastitis can cause an increase in rest bout numbers and a decrease in the duration of each lying event (Figure 3). This is probably due to the pain and discomfort inflicted on the cow placing its body weight on the painful area, belly or udder, respectively. If the cow becomes too exhausted long lying durations are expected even at high pain levels during the recumbence time. Lame cows tend to lie-down for longer periods although in some cases a cow will prefer not to lie-down at all, because of the pain and suffering during the standing up and lying down process. Some of the events can be detected by using integrated data of rest behaviour, activity, milk production, milk conductivity, milk components (namely; fat, protein, lactose and blood) and body weight, measured by the integrated Afimilk system, while other events could be detected only by the changes in the rest behaviour. Figure 4 demonstrate a pre calving heifer diagnosed

by the herdsman as suffering from eye injury, following changes only in lying behaviour, detected by the Pedometer Plus system.

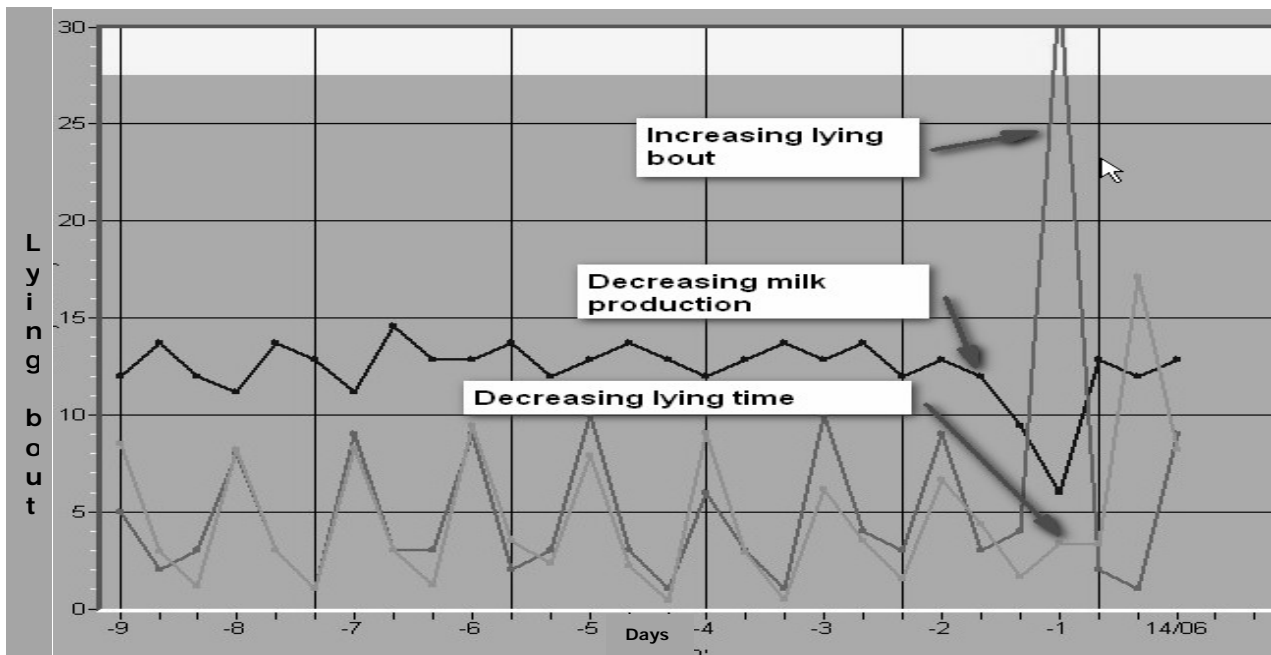

Figure 3. Changes in lying behaviour (lying time and lying bout) and milk production of cow suffering from abdominal pain (high increasing in lying bouts probably due to discomfort and pain during the recumbency).

Several studies, aimed to explore and define the characteristic behaviour of specific diseases (lameness, mastitis, calving disorder, ketosis, acidosis and digestive problems) are currently conducted.

The objective of these studies is to integrate behavioural data with additional parameters (milk quantity, milk conductivity, milk components and body weight) to improve detection of health disorders, and reduce time for detection.

## 4. Welfare - Can cow behaviour be used as an objective measurement for evaluating cow welfare and comfort?

### 4.1 Welfare assessment

Animal welfare is a term that includes many different aspects which cannot be described by one definition. Calamari and Bertoni (2009), based on Fraser and Broom (1990) suggest that "level of welfare is not achieved merely by the absence of difficulties..., but by the herdsman's capacity to overcome them through genetics, **management**, feeding, hygiene, social environment, etc".

Based on Calamari and Bertoni (2009), welfare assessment model for livestock herd can include two types of measures:

1. Environmental parameters - describe the production and management system (e.g. feeding and drinking facilities, housing and bedding condition, etc.) – these parameters are **indirect indicators**, they are relatively easy, quick and reliable to record, nevertheless these indicators leads to "risk assessment", but not to an evaluation of their real effect on welfare status, which can be differ in different systems.
2. Animals' reactions to specific environments - these parameters include behaviour, health and physiology data. Animals' parameters are **direct indicators**, they provide information on current welfare status, but in the other hand they do not point out the cause of impaired welfare.

In this section we examine the relevance of dairy cow behaviour (namely – activity, rest time and rest bout) as an indicator for the cow welfare and comfort status.

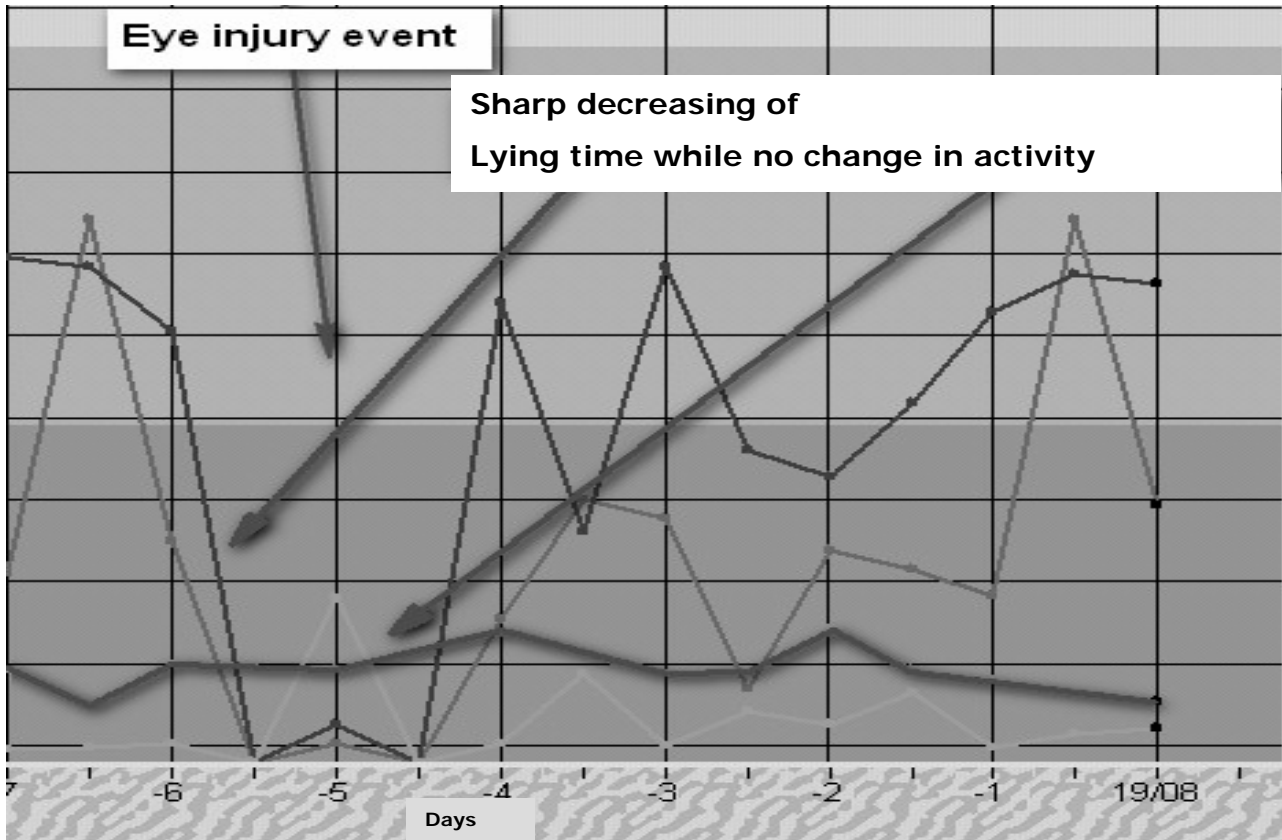

Figure 4. Changes in lying behaviour with no change in activity behaviour of pre calving heifer suffering from injury near her eye (note the recurrence for normal lying behaviour flowing treatment that was performed on day -5).

#### 4.2. Are dairy cows' activity and rest behaviour recordings by the Pedometer Plus™ system suitable indicators for welfare status?

Once a new indicator is explored for its suitability to indicate any phenomena/status it is necessary that two properties are accomplished (Calamari and Bertoni, 2009):

1. Validity – the degree to which measurement actually measures what is supposed to.
2. Reliability – the variance between measurements.

In addition three other properties are desirable:

1. Feasibility – to be easily operated by trained people, to require limited time to be measured and to be cheap (Calamari and Bertoni, 2009).
2. Reduce the effects of mediation or interpretation of the data by people (herdsman, researchers and consultants).
3. Automatic monitoring 24/7.

##### 4.2.1 Do cows' activity and rest behaviour supply information on cow welfare status (Validity)?

Deprivation of lying from cows was associated with increase in cortisol concentrations, reduced responses to ACTH challenges (Fisher *et al.*, 2003; Munksgaard and Lovendal, 1993, both cited by Fregonesi *et al.*, 2007) and increase in ACTH concentrations (Munksgaard and Simonsen, 1996). Cook (2008) summarize that a failure to achieve adequate rest is causing a significant stress response.

There are numerous studies that demonstrate the relationship between rest time and prevalence of lameness and hoof problems in dairy cows (Blackie, 2008; Cook *et al.*, 2004; [Galindo and Broom, 2000;

Hassel *et al.*, 1993; Philips and Schofield, 1994; all cited at Fregonesi *et al.*, 2007]). Other studies indicate that rest time has higher priority for dairy cows when compared to feeding and socializing interactions (Batchelder, 2000; Metz, 1985, both cited by Grant, 2005; Munksgaard *et al.*, 2005).

A study performed using the Pedometer Plus system by Livshin *et al.* (2005), concluded that a lying sensor can serve as indicator for suitability of housing condition and animal comfort. It was also stated that lying behaviour for individual dairy cows can indicate cows comfort in different housing conditions and physiological status. Drissler *et al.* (2005) and Tucker and Weary (2004) measured the effects of different housing and bedding condition on lying behaviour in aim to identify the most comfortable system.

Fregonesi and Leaver (2001) concluded that total lying time, lying synchrony, milk cell count and locomotion score are potential indicators for assessment of dairy cow welfare in different housing environments. Furthermore Weary and Tucker (2003) referred to Healy *et al.*, (2000) work, summarized: "that this study provides some insight into behavioural measures likely to change if cow is uncomfortable, namely, time spent lying and standing, and the number of times she changes position between lying and standing".

#### **4.2.2 Is the Pedometer Plus system a reliable method for recording activity, lying time and bouts?**

Validation study of the system was performed at the University of Guelph, (Guelph, Ontario, Canada), it was concluded that the Pedometer Plus device appears to be a useful tool for the measurement of activity, including steps taken, number of lying bouts, and duration of lying time in dairy cows (Higginson *et al.*, 2009).

The use of Pedometer Plus system allows recording data 24/7 with no time consuming and with minimal interpretation needed.

### **4.3 Review of studies and observations for evaluating dairy cows' welfare and comfort performed by means of the Pedometer plus system**

#### **4.3.1 Survey of dairy cows' rest behaviour in Israel**

A survey of Israeli commercial dairy farms, using the Pedometer Plus system for at least one year, was performed. The aim of the survey was to explore the rest behaviour of high producing dairy cows in the Israeli climate and intensive management conditions. Two aspects were analyzed:

1. The rest behaviour characteristic during the 305 days lactation.
2. The difference of rest behaviour between different times of the year (winter vs. summer) in the Israeli hot summer climate.

##### **4.3.1.1. Characteristic of rest behaviour during the lactation**

Data of daily rest time and milk production was collected from more than 1800 lactating cows in 6 Israeli herds from different geographic locations and varied sizes (range: 87 to 580 milking cows/farm). The average lactation graph of all cows is presented (Graph 1). Typical rest behaviour shows a decrease in rest time during the first 25 DIM, flowing by a sharp increase of daily rest time up to 150 DIM. A continuously yet more moderate increase occurs from 150 DIM and up, with highest rest time of about 10.5 hours/day at 305 DIM.

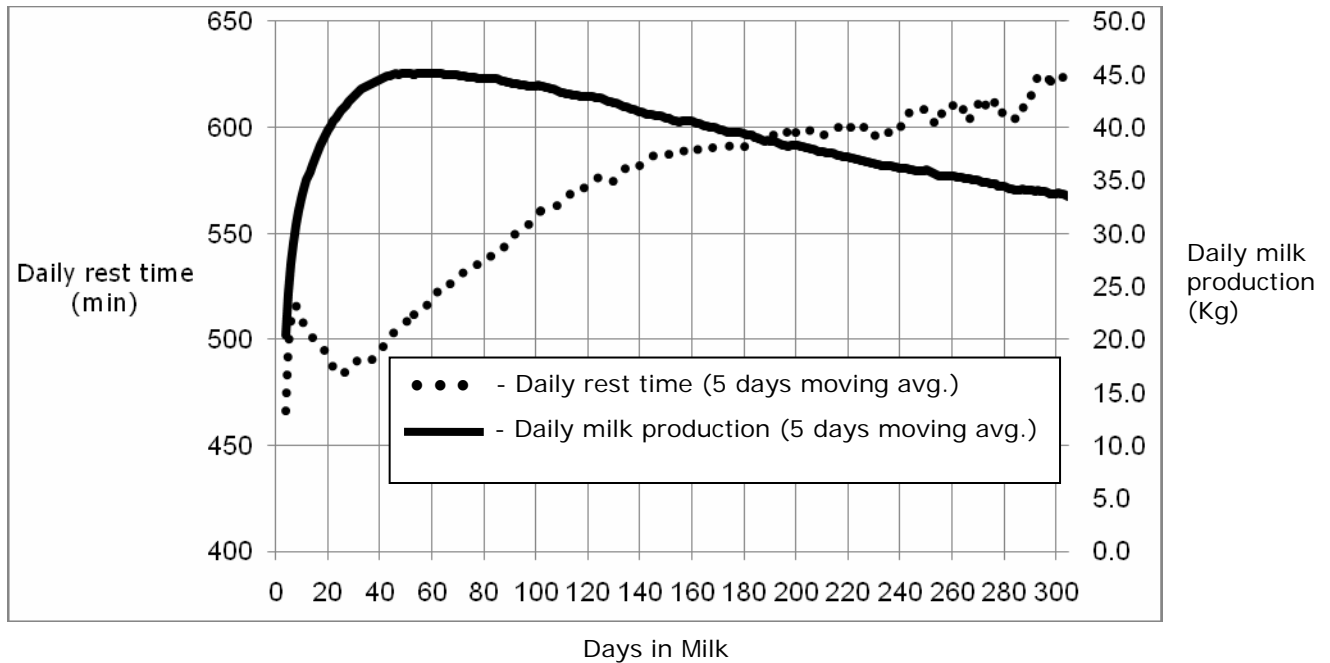

Graph 1. The dynamics of daily rest time (minute) of Israeli-Holstein cows versus daily milk production (Kg) during the lactation. The displayed values represent average data obtained from 1810 lactating cows (from 6 herds) with an average production of 11,832 kg milk /lactation, during 2009-10.

The authors suggest, that the decrease of the daily rest data in early lactation indicates the discomfort of many highly yielding cows during the metabolic stress, accompanied by the sharp increase of milk production during this stage in lactation.

In the aim to explore the relationship between milk yield and rest time and based on our finding regarding the dynamics of rest behaviour during the lactation, the lactation period was divided to five sub-periods; 5-25, 26-50, 51-100, 101-200 and 201-305 DIM. It was found that the correlation between daily milk yield and daily rest time changes along the lactation. The results are presented in Table 1. It can be seen that during the early stage of lactation there is negative correlation. While milk yield is increasing sharply there is a decrease in rest time. As it was described, this may be due to the "metabolic stress" the cows suffer from the high demands of producing milk. In the next period, 26-50 DIM, there is positive correlation were the cows overcome the "metabolic stress" while milk yield is still increasing. From 50 DIM and up to 305 DIM the correlation is inverted again and daily rest time is increasing continuously while milk yield is decreasing. The largest correlation was found to be in the periods of 5-25 DIM and 101-200 DIM (-0.846 and -0.843, respectively). The smallest one was in the period of 201-305 DIM (-0.466). The results were highly significant for most of the periods in all the farms but farm 5 (the smallest farm). The reason for that is not known. Data from this farm was excluded from the average calculations.

Table 1. Pearson correlations between daily lying time and milk yield during different stages of lactation in 6 Israeli dairy farms (range: 87 to 580 milking cows/farm).

DIM	Pearson Correlation						Average <sup>1</sup>
	Farm 1	Farm 2	Farm 3	Farm 4	Farm 5	Farm 6	
5-25	-0.580 <sup>b</sup>	-0.886 <sup>b</sup>	-0.886 <sup>c</sup>	-0.952 <sup>c</sup>	-0.138	-0.924 <sup>c</sup>	-0.846
26-50	0.291	0.677 <sup>c</sup>	0.547 <sup>b</sup>	0.871 <sup>c</sup>	0.231	0.756 <sup>c</sup>	0.628
51-100	-0.652 <sup>c</sup>	-0.707 <sup>c</sup>	-0.827 <sup>c</sup>	-0.536 <sup>c</sup>	-0.237 <sup>a</sup>	-0.807 <sup>c</sup>	-0.706
101-200	-0.726 <sup>c</sup>	-0.795 <sup>c</sup>	-0.898 <sup>c</sup>	-0.948 <sup>c</sup>	0.134	-0.848 <sup>c</sup>	-0.843
201-305	-0.586 <sup>c</sup>	-0.668 <sup>c</sup>	0.041	-0.537 <sup>c</sup>	-0.322 <sup>c</sup>	-0.581 <sup>c</sup>	-0.466

a= $P < 0.1$ , b=  $P < 0.001$ , c=  $P < 0.0001$  <sup>1</sup> – Pearson correlation parameters of farm 5 were excluded.

Our observation is in agreement with other works, which found that lactating cows 6 weeks post parturition spent less time lying compared to 12 weeks post parturition (Blackie *et al.*, 2006) and that cows in early lactation spent significantly less time lying than those in late lactation (Bewley *et al.*, In



press). Nevertheless to the authors' knowledge this is the first work to describe the dynamics of rest behaviour during the entire lactation of such a large population of dairy cows.

#### 4.3.1.2 Characteristics of rest behaviour during different times of the year (winter vs. summer) in high yield cows under the Israeli climates condition (heat stress during the summer)

The rest behaviour and the milk production in 7 Israeli high producing dairy farms were investigated. All farms conduct three milking sessions a day. The farms are located in different geographic regions and climate conditions. Data was collected during three month of winter and three month of summer (January-March 2009 and July-September 2009, respectively) (Table 2). It was found in all farms that during the summer the cows rest less time (in average 88 minutes less) and produced less milk (in average 3.96 kg/day). The reasons for the decrease in rest time is probably mainly due to cooling management which in most of the farms is done before and between milking in the holding pen, restricting the available rest time. However, when comparing between individual farms it seems that some farm overcome this obstacle better than others, suggesting that management procedures are an important factor in increasing rest time. The higher coefficient of variation (CV) of rest time during the summer compared to winter time (6% vs. 4.25%) could be another indication of the influence of different cooling and management strategies treating this phenomena (the reasons for the decrease in milk is not discussed in this paper).

Table 2: Average daily rest time (hours) and milk yield (kg) in 7 Israeli dairy cow herds during winter (January-March, 2009) and summer (July-September, 2009).

	Daily Rest Time (hour)		Daily Milk Yield (kg)		Ratio Summer:Winter* (%)	
	Winter	Summer	Winter	Summer	Rest time	Milk yield
Farm 1	9.53	7.91	39.37	35.65	83	91
Farm 2	10.05	8.86	41.21	37.75	88	92
Farm 3	10.05	7.91	37.41	33.44	79	89
Farm 4	9.85	8.91	36.66	33.84	90	92
Farm 5	10.42	8.94	40.53	37.94	86	94
Farm 6	10.90	9.07	36.82	31.72	83	86
Farm 7	10.05	9.03	38.17	32.13	90	84
Average $\pm$ SD	10.12 $\pm$ 0.43	8.66 $\pm$ 0.52	38.60 $\pm$ 1.81	34.64 $\pm$ 2.53	86 $\pm$ 4.25	90 $\pm$ 3.41
CV (%)	4.25	6.00	4.69	7.30	4.94	3.79

\*Ratio Summer: Winter – the ratio between daily rest time or milk yield in the summer compared to winter, calculated as = (summer parameter/winter parameter)\*100

It was found that in farms under similar heat stress conditions, equal temperature humidity index (THI) levels, there was a significant difference in rest time during the summer (data not presented), this is probably due to differences in cooling strategy and facilities used in the farms.

The reduction of rest time during heat stress is in agreement with other studies (Cook *et al.*, 2007; Lee and Hillman, 2007; [Shultz, 1984 and Zahner *et al.*, 2004 both Cited by Cook *et al.*, 2007]). This reduction was attributed to increase in standing time which provides a thermal advantage, due to increase surface area for cooling while standing (Lee and Hillman, 2007). When the in diurnal rest behaviour of one farm was examined, it was found that during the summer the cows rest less time during the day (light hours) compared to winter (18% of available time vs. 34%), while in the night (dark hours) cows rest for longer time (65% of available time vs. 55%) in the summer. These findings suggest that the reduction of rest time during the summer is due to the large decrease during day time, because of the heat stress and the intensive cooling management. The cows tried to compensate for this reduction by increasing rest time during the cooler and quiet hours at night.

Based on observations in the farms, it was speculated that rest behaviour is a more sensitive indicator for cow welfare and comfort than milk production, and deviations in this behaviour will precede changes in milk production at the herd level. This speculation was confirmed in many events. We explored the time relation between daily milk production (kg/day) and daily rest time in a commercial farm comprising 68 milking cows with an average of 12,708 kg milk/cow/lactation during the summer (2007). The results are presented in Graph 2. It can be seen that under heat stress conditions (indicating by THI data) the negative change rate of lying time was more excessive and appeared earlier to the decrease of milk yield.

With the end of the hot season the lying time increased rapidly to the maximal steady level, followed by the increase of milk yield which took much more time to restore.

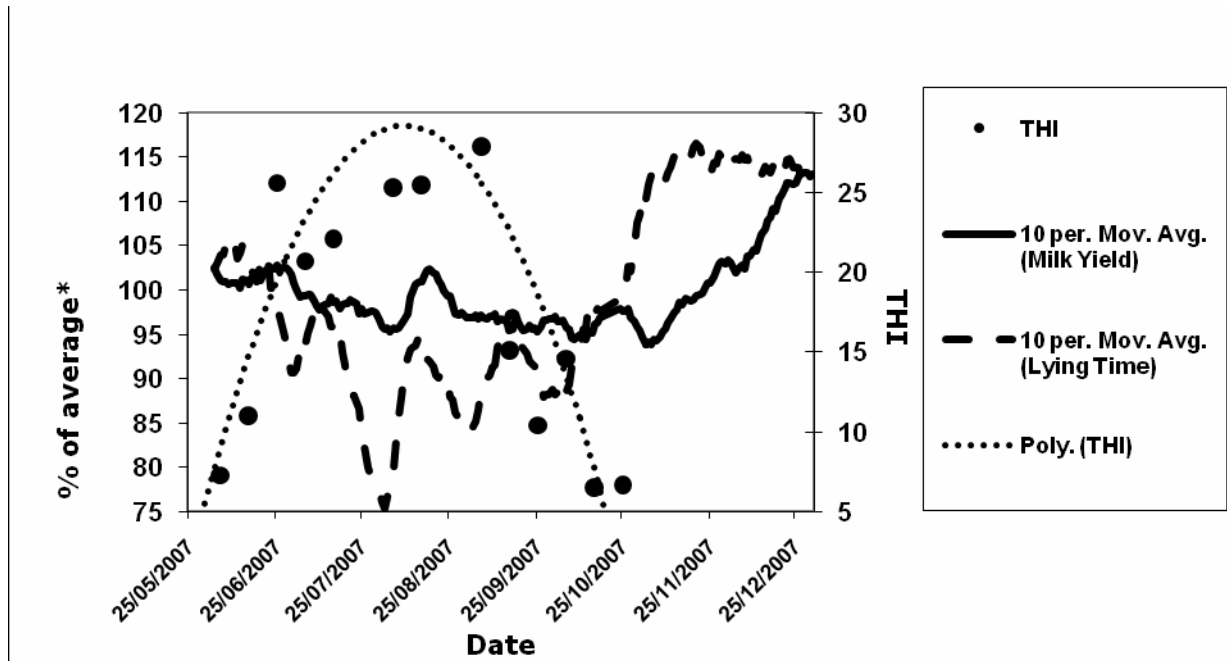

Graph 2. Changes of daily milk yield (kg) and lying time under heat stress conditions (data from 68 milking cows, average milk yield 12,708 kg milk/cow/lactation, May-December, 2007).

\*Data of milk yield and lying time is presented as percentage of ten days average from the average of the entire period.

In future studies, different cooling methods and strategies will be explored using the lying time and rest behaviour as indicative parameter for the comfort of the cows.

#### 4.3.2 Studies and observation for incorporating the Pedometer Plus system as a tool for evaluating cow welfare and comfort

In the last three years the Pedometer Plus system was installed in some research and commercial farm. Some of the studies and observations performed in those farms are reviewed below.

Adin *et al.* (Personal communication) tested the influence of increasing stock density of high yield dairy cow in loose stall barns. Cows in higher density (14.8 m<sup>2</sup>/cow vs. 19.4 m<sup>2</sup>/cow) rest 72 min/day less than the control group. It was also found that there were higher standard deviation (SD) values in the number of rest bout for the cows in the higher density group. It is the authors speculation that these higher SD values could indicate that some cows in that group (sick cows, low hierarchy) are influenced more by the high density than others (sound cow, high hierarchy). This speculation is based on other studies which demonstrate that young cows (primiparous) and lame cows suffer more when overcrowding compared to older cows (multiparous) and healthy cows (Grant, 2007).

Guash and Bach (2009) studied found a decrease of lying time and increase of activity when cows were moved from pens. These changes were more pronounced in primiparous than in multiparous cows and could be observed up to 4 weeks after the move.

Maltz (2006) investigated the effect of twice daily forced cooling (each one for one hour) management on the rest behaviour of milking cows. He reported that forced cooling cows for one hour twice daily during the summer does not impaired quantitatively with normal cow behaviour. These findings support our intuition that incorporating lying behaviour for evaluation of different cooling managements, could lead to a strategy that will improve heat stress relief with minimal interference of cows rest needs.

In one commercial farm using the behaviour tags, it was found that the rest time of three groups of cows housing in a free stall barns was much lower when compared to cows in adjacent loose stall barns. In the same day the bedding in those three barns was treated, and a sharp increase (from 420 minutes/day up to 500 minutes/day) was observed in less than one week (Figure 5).

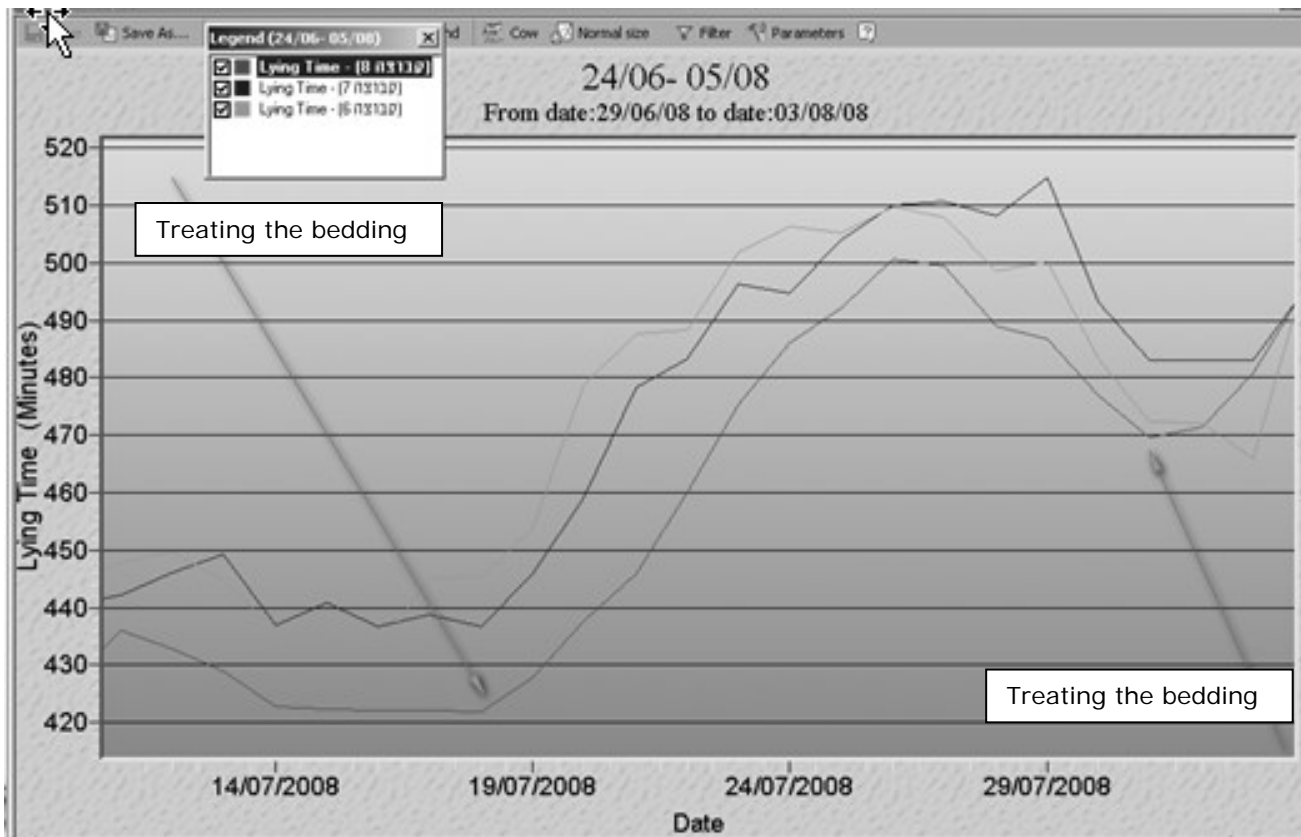

Figure 5. Extensive increase in daily rest time of cows in three free stall barns due to improving of the bedding (~500 milking cows commercial farm, south of Israel, July 2008).

This observation and others (not presented) support the highly potential use of automatic rest behaviour recording as a powerful management tool for monitoring and improving cows comfort and welfare status in commercial farms.

## 5. Discussion

The modern dairy farms introduce new challenges for breeders, veterinarians and consultants in all aspects of the dairy industry (management, housing, nutrition, reproduction and etc.). Reproduction performance and health problem of dairy cows have been two area of high interest for the dairy industry for long time and have been studied for many years. Yet, the results in many farms are not satisfying. Cow welfare and comfort is a relative new area of interest. Significant amount of research performed in the last two decades emphasize the importance of this topic for the productivity, fertility and health of the individual cow and overall herd performance.

Lying behaviour of cows provides valuable information which could be useful for improving oestrus detection in unfavourable conditions. In addition, this data can enable early detection of health problem and diseases, and be applied for monitoring cow comfort as an indicator of the facilities and management procedures in the herd.

The introduction of a new commercial "Behaviour Tag" (Pedometer Plus™, S.A.E. Afikim, Israel) which records activity and the rest behaviour (rest time and rest bouts) of each cow 24 hours/day, and the integration of this newly data in a computerized farm management system open new opportunities for herd managers and researchers.

Data that has been collected in commercial and research farms using the Pedometer Plus system illuminates the high potential of this system to improve oestrus detection performance and early detection of health problems. Furthermore, integrating of activity and lying behaviour data (particularly the latter), could be used for developing objective and automatic parameters for a cow comfort assessment system. This system will comprise the advantages of the automated recording of reliable data 24 hours a day on the overall individuals comprising the herd. Furthermore, the integration with

other data collected by the herd management system (milk quantity, milk conductivity, milk components and body weight) has the potential for improving and fine tuning the assessment system.

The automatic daily monitoring of lying behaviour in 7 Israeli dairy farms enabled us to reveal: 1) the dynamics of cows' lying behaviour in different seasons of the local climatic condition; 2) the dynamics of the cows' lying behaviour along the entire lactation; and 3) the changing relationship between the lying time and milk yield in different stages of lactation. It was found that changes in routine lying behaviour of cows are more sensitive and provide earlier indication of cow welfare disturbance than changes in milk production.

Additional studies are required to develop easily operated models for herd managers and breeders, and to explore methods for optimization of rest behaviour in high producing dairy cows under the intensive conditions of modern farms. This last area of studies, will have to focus on investigating improvement of housing and other facilities conditions as well as management procedures like; cooling, mass treatments, feeding protocols and the timetable of these procedures in the daily farm routine.

## 6. Reference

- Bewley J., R. Boyce, J. Hockin and L. Munksgaard, (In press). An exploratory study of management factors influencing lying time using an automated activity monitoring sensor. *J. Dairy Res.*
- Blackie N., 2008, Relationship between lameness and lying behaviour of zero grazed Holstein dairy cattle recorded using an activity monitor. Third student Animal Welfare conference, Writtle College, 30 April 2008.
- Blackie N., J.R. Scaife and E.C.L. Bleach, 2006. Lying behaviour and activity of early lactation Holstein dairy cattle measured using an activity monitor...
- Brehme U., U. Stollberg and T. Schlesuener, 2008. ALT pedometer-new sensor-aided measurement system for improvement in oestrus detection. *Computeres and Electronics in Agriculture.* 62, 73-80.
- Broom D.M. and Corke M.J., 2002, Effects of diseases on farm animal welfare. *Actv. Vet. Brno.* 71, 133-136.
- Calamari L. and G. Bertoni, 2009. Model for evaluate welfare in dairy cows. *Ital. Anim. Sci.* 8, 301-323.
- Cook N.B. 2008. The budgets for dairy cows: how dose cow comfort influence health, reproduction and productivity Proc. Dairy Cattle Reproduction Council, Omaha, NE. November 7-8, 2008.
- Cook N.B., R.L. Mentink, T.B. Bennett and K. Burgi, 2007. The effect of heat stress and lameness on time budgets of lactating cows. *J. Dairy Sci.* 90, 1674-1682.
- Cook N.B., T.B. Bennett, and K.V. Nordlund, 2004. Using indices of comfort to predict stall use and lameness. Proceedings of 13th International Ruminant Lameness Symposium, Maribor, Slovenia, 2004.
- DeSilva A.W.M.V., G.W. Anderson, F.C. Gwacduskas, M.L. McGilliard AND J.A. Lineweaver, 1981. Interrelationships with oestrus behaviour and conception in dairy cattle. *J. Dairy Sci.* 64, 2409-2418.
- Drissler M., M. Gaworski, C. B. Tucker and D. M. Weary, 2005. Freestall Maintenance: Effects on Lying behaviour of Dairy Cattle. *J. Dairy Sci.* 88, 2381-2387.
- Edwards J.L and P.R. Tozer, 2004. Using activity and milk yield as predictors of fresh cow disorders. *J. Dairy Sci.* 87, 524-531.
- Ekman T. and C. H. Sandgren, 2006. An overview of animal welfare and mastitis. Proceedings of the NMC Annual Meeting (2006).
- Foote R.H., 1974. Oestrus detection and oestrus detection aids. *J. Dairy Sci.* 58, 248-256.
- Fregonesi J.A. and J.D. Leaver, 2001. Behaviour, performance and health indicators of welfare for dairy cows housed in strawyard or cubicle systems. *Livestock Production Science.* 68, 205-216.
- Fregonesi J.A., C.B. Tucker and D.M. Weary, 2007. Overstocking reduced lying time in dairy cows. *J. Dairy Sci.* 90, 3349-3354.
- Frik R., E. Stamer, W. Junge and J. Krieter, 2002. Automation of oestrus detection in dairy cows: a review. *Livestock Production Science.* 75, 219-232.

- González L.A., B. J. Tolkamp, M. P. Coffey, A. Ferret, and I. Kyriazakis, 2008. Changes in feeding behaviour as possible indicators for the automatic monitoring of health disorders in dairy cows. *J. Dairy Sci.* 91, 1017–1028.
- Grant R., 2005. Incorporating dairy cow behaviour into management tools, 2006 Penn State Dairy Cattle Nutrition Workshop.
- Grant R., 2007. Taking advantage of natural behaviour improves dairy cow performance. Western Dairy Management Conference, Reno, NV, March 7-9, 2007.
- Guasch I. and A. Bach, 2009. Effect of group change on lying time and milk yield of dairy cattle. Proceedings of the ADSA-CSAS-ASAS Joint Annual Meeting, Montreal (Canada), 12-16 July, 2009.
- Gwazdauskus F.C., J.A. Lineweaver and M.L. McGilliard, 1983. Environmental and management factors affecting oestrus activity in dairy cattle. *J. Dairy Sci.* 66, 1510-1514.
- Hansen P.J. and C.F. Arechiga, 1999. Strategies for Managing Reproduction in the Heat-Stressed Dairy Cow. *J. Anim. Sci.* 77, 36-50.
- Higginson J.H., K.E. Leslie, S.T. Millman and D.F. Kelton, 2009. Evaluation of the Pedometry Plus system for the detection of pedometric activity and lying behaviour in dairy cattle. Proceedings of the ADSA-CSAS-ASAS Joint Annual Meeting, Montreal (Canada), 12-16 July, 2009.
- Jensen M. B., L. J. Pedersen and L. Munksgaard, 2005. The effect of reward duration on demand functions for rest in dairy heifers and lying requirements as measured by demand functions. *Applied Anim. Behav. Sci.* 207-217.
- Juarez S.T., P.H. Robinson, E.J. DePeters and E.O. Price, 2003. Impact of lameness on behaviour and productivity of lactating Holstein cows. *Applied Animal Behaviour Science.* 83, 1–14
- Kennedy A. D. and J. R. Ingalls, 1995. Oestrus detection with activity tags in dairy cows housed in tie-stalls. *Canadian J. of Anim. Sci.* 633-635.
- Kiddy C.A., 1976. Variation in Physical Activity as an Indication of Oestrus in Dairy Cows. *J. Dairy Sci.* 60, 235-243.
- Lee C.N. and P.E. Hillman, 2007. Thermal responses of Holstein dairy cows on pastures with high solar loads and high winds. Proceeding of the Sixth International Dairy Housing Conference, Minneapolis, Minesota, 16-18 June, 2007.
- Livshin, N., A. Antler, B. Zion, G. Stojanovski, G. Bunevski, and E. Maltz, 2005. Lying behaviour of dairy cows under different housing systems and physiological conditions. In: *Precision Livestock Farming '05*, Edited by S. Cox. pp. 305-311
- Lucy M. C., 2001. Reproductive Loss in High-Producing Dairy Cattle: Where Will It End? *J. Dairy Sci.* 84, 1277–1293
- Lucy M.C., 2007. Fertility in high-producing dairy cows: reasons for decline and corrective strategies for sustainable improvement. *Soc. Reprod. Suppl.* 64, 237-254.
- Maltz, E., 2006. Behaviour sensor for welfare assessment and physiological status of the dairy cow. Forth International Workshop Smart Sensors in Livestock Monitoring, Gargnano (Italy), 22-23 September, 2006.
- Mazrier, H., Tal, S., Aizinbud, E., Bargai, U., 2006. A field investigation of the use of the pedometer for the early detection of lameness in cattle. *Can. Vet. J.* 47, 883–886.
- Munksgaard L. and H.B. Simonsen, 1996. Behavioural and Pituitary adrenal-axis responses of dairy cows to social isolation and deprivation of lying down. *J. Anim. Sci.* 74, 769-778.
- Munksgaard L., M.B. Jensen, L.J. Pedersen, S.W. Hansen and L. Matthews, 2005. Quantifying behavioural priorities-effects of time constraints on behaviour of dairy cows, *Bos Taurus*. *Applied Anim. Behav. Sci.* 92, 3-14.
- Nebel R.L., M.G. Dransfield, S.M. Jobst and J.H. Bame, 2000. Automated electronic systems for the detection of oestrus and timing of AI in cattle. *Animal Reproduction Science.* 60-61, 713-723.
- Niss D. B., M. S. Herskin, A. M. Danscher, and M. B. Thoenfer, 2009. Short communication: Rising and lying behaviour of heifers before and after alimentary oligofructose overload. *J. Dairy Sci.* 92, 617–620.
- O.I.E, Terrestrial animal health code 2006, [http://www.oie.int/eng/norems/mcode/en\\_chapitre\\_3.7.1.htm](http://www.oie.int/eng/norems/mcode/en_chapitre_3.7.1.htm)

- Ranasinghe R.M.S.B.K., T. Nakao, K. Yamada and K. Koike, 2010. Silent ovulation, based on walking activity and milk progesterone concentrations, in Holstein cows housed in a free-stall barn. *Theriogenology*. 73, 942–949.
- Redden K.D., A. D. Kennedy, J. R. Ingalls, and T. L. Gilson, 1993. Detection of Oestrus by Radiotelemetric Monitoring of Vaginal and Ear Skin Temperature and Pedometer Measurements of Activity. *J. Dairy Sci.* 76, 713-721
- Sakaguchi M., R. Fujiki, K. Yabuuchi, Y. Takahashi and M. Aoki, 2007. Reliability of oestrus detection in Holstein heifers using a radiotelemetric pedometer located on the neck or legs under different rearing conditions. *J. of Repro. and Devlop.* 53, 819-828.
- Sheldon I.M. and H. Dobson, 2003. Reproductive challenges facing the cattle industry at the beginning of the 21<sup>st</sup> century. *Reprod. Suppl.* 61, 1-13.
- Tolkamp B.J., M. J. Haskell, F. M. Langford, DJ. Roberts and C A. Morgan, 2010. Are cows more likely to lie down the longer they stand? *Applied Animal Behaviour Science.* 124, 1–10.
- Tucker, C. B., and D. M. Weary. 2004. Sawdust bedding on geotextile mattresses: How much is needed to improve cow comfort? *J. Dairy Sci.* 87, 2889–2895.
- Walton J.S. and G.J. King, 1986. Indicators of oestrus in Holstein cows housed in tie stall. *J. Dairy Sci.* 69, 2966-2973.
- Weary D.M. and C B. Tucker, 2003. The science of cow comfort. Proceedings of the Joint Meeting of the Ontario Agri Business Association and the Ontario Association of Bovine Practitioners, Guelph, Ont., April, 2003.





## Using integrated solutions to achieve high levels of performance recording in beef herds

S. Coughlan

*Irish Cattle Breeding Federation (ICBF) Soc. Ltd, Highfield House, Shinagh, Bandon, Co. Cork Ireland*

### **Abstract**

In 2007, the number of calves registered from beef herds in Ireland with sire details was 168,000. In 2008, it was 741,000. This represents an increase of over 440%. Having an integrated approach to performance recording whereby all data recorded for statutory and non-statutory purposes are utilised in a central cattle breeding database has had a major impact on Ireland's ability to provide genetic evaluations to farmers.

Using a common infrastructure for recording official birth registrations and cattle breeding data has greatly simplified the practical difficulties of obtaining phenotypic performance data on beef cattle. Integrating the capture of the key cattle breeding data into a Suckler Cow Welfare initiative in 2008 has had a dramatic effect on the numbers of animals with genetic evaluations. Many of the key performance measures (e.g. ease of birth, weaning weights, slaughter weights, carcass weight & grade, age at first calving, ease of calving, calving interval, and maternal weaning weight) that are required to carry out effective genetic evaluations using data from commercial beef cattle are already being captured in various systems. The key is to ensure that the sire of the animal is captured at birth so that any performance data subsequently collected on the animal can be used in genetic evaluations.

*Keywords: Performance recording, ICBF, Animal events.*

### **1.0 Background**

The purpose of this paper is to describe the key factors that have contributed to ICBF's ability to deliver dramatic increases in beef performance recording.

In the period leading up to 2002 the infrastructure supporting performance recording in beef herds was on a very small scale, focused only on pedigree animals, and was significantly lacking in integration. The challenge was to (a) achieve the integration and (b) achieve high levels of uptake among beef farmers.

The core elements of the increase in beef performance recording over the past 10 years are:

- A centralised cattle breeding database.
- Department of Agriculture (DAFF) animal registration and movement systems.
- Animal Events recording.
- Animal Welfare, Recording, and Breeding Scheme (AWRBS).
- A culture of sharing and cooperation.

The effective combination of the above elements has allowed Irish beef breeding the opportunity to significantly increase its profitability from breeding through increased genetic gain



## 2.0 A centralised cattle breeding database

Prior to the set-up of ICBF in 1998, and the establishment of its central cattle breeding database, Irish cattle breeding data was spread across some 40 different systems. The establishment of the database began a removal of duplication across the industry and allowed the breeding industry to establish a database of a scale that would allow exponential growth. Web based technology has been employed to provide service providers and herd-owners with direct access to the database to both record data and retrieve information.

## 3.0 Dept of Agriculture Registration and Movement Systems

The 1996 implementation of the EU Directive on the identification of cattle in Ireland preceded the setting up of the ICBF database by some 6 years, but was a critical element in the feasibility of the efficient establishment of that database. In Ireland, we were fortunate that DAFF and its agents were very effective in implementing the new registration and movement systems. DAFF and its agents have been very cooperative in sharing the registration and movement data.

The single biggest impediment to effective integration of data across systems with performance data on beef cattle was the lack of a common identifier for that animal. As part of the migration of data to the cattle breeding database, many different forms of identification had to be managed, with a given animal often having a different identifier in each system in which that animal existed.

The advent of the single lifetime identifier (the official tag) for an animal, which preceded the establishment of the ICBF database, played a key role in helping remove duplication in farm level recording. It also meant that data gathered from marts and slaughter factories was readily usable, as they were using the official tag number to identify all animals.

## 4.0 Animal events recording

Prior to the launch of Animal Events recording in 2002, pedigree breeders were required to record the same data multiple times for different purposes (DAFF calf registration, herd-book registration, calving surveys, etc). The launch of Animal Events recording put in place a robust, easy to use solution, that removed duplication of effort on the part of the farmers, and reduced errors in cattle breeding activities due to inconsistencies arising between systems (e.g. different birth dates on the calf passport to the pedigree certificate).

The critical aspect of Animal Events from a commercial beef herd perspective was that there was now a mechanism by which the sire of a calf could be recorded as a matter of course when completing calf registration activities. In Ireland, the number of sires recorded on beef cattle has risen from 80,000 in 2001 to over 900,000 (90% of the total beef calves born) in 2009.

## 5.0 Animal Welfare, Recording and Breeding Scheme (AWRBS)

While beef cattle breeding in Ireland had an excellent infrastructure with which to work, the number of herds fully engaged with the system was still only 20%-25% of what it potentially could be. In 2008, a visionary initiative by DAFF, and supported by farm representative organisations, was launched. The core aim of the scheme was to improve animal welfare and breeding practices on beef farms.

The key elements of the scheme were:

- a. the recording of the sire and calving ease for each calving in the herd;
- b. the recording of meal feeding at least four weeks prior to weaning, as well as any disbudding or castration information relating to the calf, and
- c. the recording of weaning dates, as well as a calf quality and calf docility score at weaning. Farmers receive a €40/cow annual payment to cover the extra costs associated with compliance with the scheme conditions.

From a cattle breeding perspective, it had two dramatic impacts. Firstly, it got almost all beef breeding herds of significance engaged with the cattle breeding database. Secondly, it resulted in a 100% plus increase in the number of beef calves with recorded sires, and it did so in a manner that could be

sustained over time, via the Animal Events system. This was a critical element to increasing the number of commercial beef cows for which ICBF could generate genetic evaluations.

Once farmers have engaged with the scheme, it is intended that they will see the benefits of the activities associated with the scheme (from a health/welfare and breeding perspective) and will continue to carry out the measures even if a supplementary payment is not forthcoming from the government.

## 6.0 A culture of sharing and cooperation

A first class infrastructure of systems and data bases will struggle to achieve its potential if it is not supported by a culture of sharing of data. This is primarily because the key to effective performance recording is to collect the data once (perhaps to fulfil statutory or regulatory requirements), and then use that data for multiple purposes. Of course, this has to be done with the full consent of those who own the data (DAFF, farmers, slaughter factories, marts, etc). Much of the data is commercially sensitive, so it is critical that it is used appropriately.

In ICBF, as a non-commercial entity, this culture has been core to the organisation, and it has been supported fully by DAFF, farmers, and other cooperatives throughout the Irish agriculture industry. As a result, ICBF has been able to achieve high levels of beef performance recording, which can be used to help maximise the profit from genetic gain for the benefit of Irish beef farmers and the wider industry.

## 7.0 References

ICBF Annual Report 2009. [http://www.icbf.com/publications/files/Annual\\_Report\\_for\\_2009.pdf](http://www.icbf.com/publications/files/Annual_Report_for_2009.pdf)

Animal Welfare, Recording and Breeding Scheme <http://www.icbf.com/services/suckler/index.php>

ICBF Website. [www.icbf.com](http://www.icbf.com) – go to “bull search” and enter “CF52” to access detailed information.





## Trends in beef cattle performance record collection and genetic evaluation systems in the United States

R.L. Weaber

*University of Missouri, S134A ASRC, Columbia, Missouri, United States of America*

### **Abstract**

Beef production remains the single largest segment of American agricultural production and is a geographically dispersed production system with many independent players in each industry segment. Economic signals for changes in genetic merit or product attributes are often not clearly communicated in pricing systems. Seed stock and commercial producers have effectively utilized performance record collection schemes over the past 40 years to make remarkable changes in the genetic merit of beef cattle. Over time, the suite of traits included in genetic evaluation systems continues to evolve and now includes measures of growth, carcass merit, reproduction, survival and temperament among others. Work continues to develop efficient multiple trait selection systems via industry-wide or firm-level customized indexes. Participation in performance record collection systems by seed stock breeders in the US is at unprecedented levels as breeders seek to discover unique genetic combinations among their cattle. Development of effective molecular genetics assays that describe significant portions of additive genetic variation for a number of beef production traits remains a priority for research and development efforts in the US. Industry and academic leaders continue work to realize convergence of molecular and traditional quantitative genetic evaluation systems for efficient delivery of genetic predictions for use in selection by beef cattle breeders. Economic constraints continue to affect both academic and breed focused institutions motivating the privatization of genetic evaluation services in the US. Undoubtedly, selection at the seed stock and commercial levels by US beef producers will continue to adopt new technologies and methods that enhance the value and improve the nutritional benefits of US beef while simultaneously improving animal health and well-being, minimizing environmental impacts and meeting the dietary needs of a hungry world.

*Keywords: beef cattle, performance records, genetic evaluation.*

## **1.0 Introduction**

Beef cattle production represents the largest single segment of American agriculture. In 2007, there were 96.3 million cattle in the United States including 32.8 million beef cows. Producers of beef cattle were responsible for more than \$61 billion in added value to the U. S. economy, as measured by their contribution to the national output. Approximately 765,000 farms or ranches in the United States report raising beef cattle as an economic activity (USDA, 2009a).

## **2.0 US beef industry structure**

The beef industry in the US spans nearly every geographic region. The wide range in environments requires a wide variety of production systems and breed utilization. The geographic dispersion of beef cows, principally in areas where grazing is the preferred land use as the acreage is not suitable for crop production, is in stark contrast with the cattle feeding segment of the industry. Cattle feeding, in confinement facilities, is concentrated in the high plains states (Nebraska, Kansas, Colorado, Oklahoma and Texas) near feed sources. Weather in these states is much more favourable for cattle feeding. Not surprisingly, a majority of the US beef packing capacity is located in this region. Seed-stock production closely mirrors the commercial cow-calf inventory. The US beef industry remains fractured in both capital ownership and structure. Little vertical integration has occurred in the US beef industry due to the large capital costs to enter the business regardless of point of entry. These barriers are enhanced by significant price risks that exist between segments of the beef industry. Beef industry segments are principally defined at market interfaces as illustrated in Figure 1 below.

Since the mid-1990s, value based purchasing systems that price fed cattle at packer level on an individual basis based on carcass merit have been expanding. Now more than 50% of fed cattle are marketed on individual merit based pricing systems (USDA, 2009b; USDA 2009c) with the balance being sold in groups with an average price paid for each animal in the pen. Value base marketing systems have been a vehicle for communicating value in the beef marketing chain. However, unless an individual producer retains some ownership interest in the animal until harvested, it is very difficult to obtain meaningful information on carcass merit. A variety of marketing alliances exist in the US that assist commercial cow-calf producers in managing and marketing their calves through the feeding segment to harvest. Relatively few producers take advantage of this vertical integration system due to price risks associated with feeding cattle. Several systems in the US work to 'informationally' integrate the beef industry by communicating carcass merit data back to cow-calf producers that were responsible for the mating decisions and rearing of the resulting calf. Even less data is returned to seed stock producers regarding the performance of progeny of herd sires they may have bred.

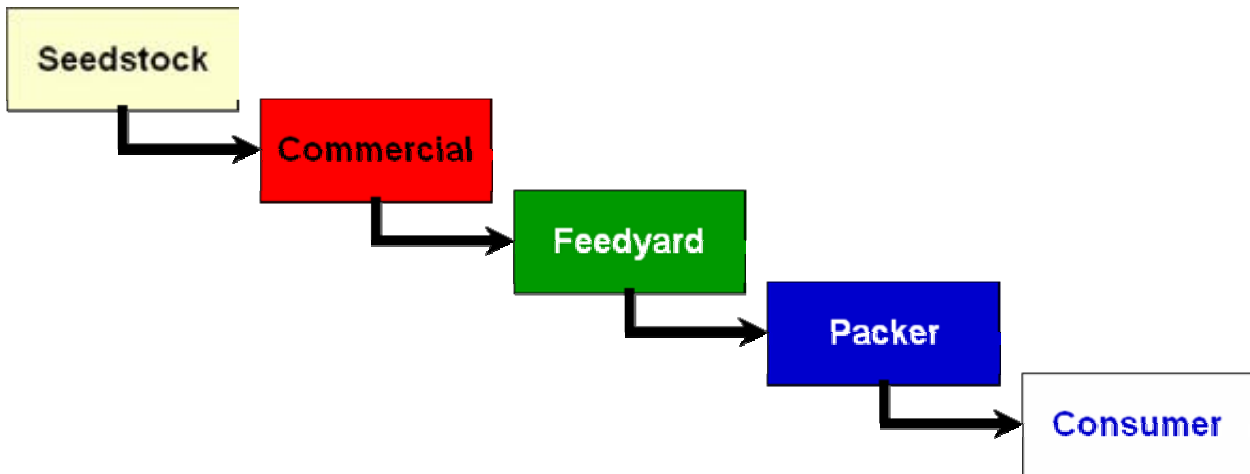

Figure 1. Illustration of germplasm and animal flow in the segmented US beef industry.

The lack of clear market signals between segments of beef industry, especially between the commercial cow-calf producer and feed yard, has resulted in a great deal of heterogeneity in the animals marketed for beef production in the US. Selection decisions at the cow-calf and seed stock levels are then driven by perceived needs of customers. The genetic trends of various breed expected progeny differences (EPD) values for reported traits provide a glimpse into the selection being practiced in these breeds. EPD provide a relative measure of genetic merit for individuals within a pedigree structure and are computed using information from performance records. Figures 2 and 3 illustrate the phenotypic and genetic trends for birth weight (BW) and yearling weight (YW), respectively, for Angus bulls in the US. Regression analysis (data not shown) reveals that changes in BW and YW EPDs explain large portions of the variation (95% and 96%, respectively) in observed BW and YW in Angus bulls. The utility of EPD as a selection tool for genetic change is unparalleled and the technology had been widely adopted across the seed stock and commercial cow-calf sectors. Figures 4-7 illustrate the genetic trends in eight major US beef breeds. The genetic trends illustrate that, generally, seed stock producers have selected to moderate BW, while dramatically improving weaning weight (WW), YW and Milk performance. It is clear that seed stock producers from these breeds are utilizing EPD to change the relative merit of progeny produced in their breeding herds. The changes in merit in these traits are made in response to the purchase demands of commercial cow-calf producers.

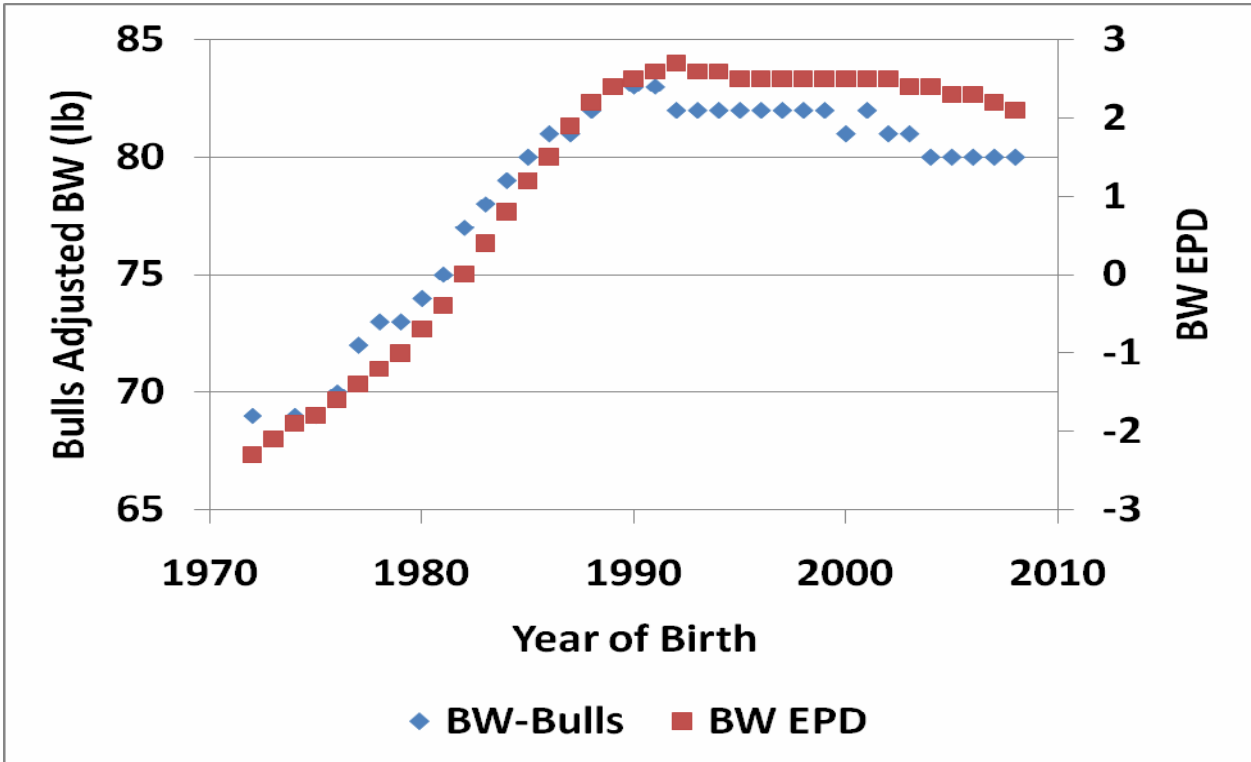

Figure 2. Angus bull birth weight phenotypic and genetic trends. (adapted from Am. Angus Assn., 2010a).

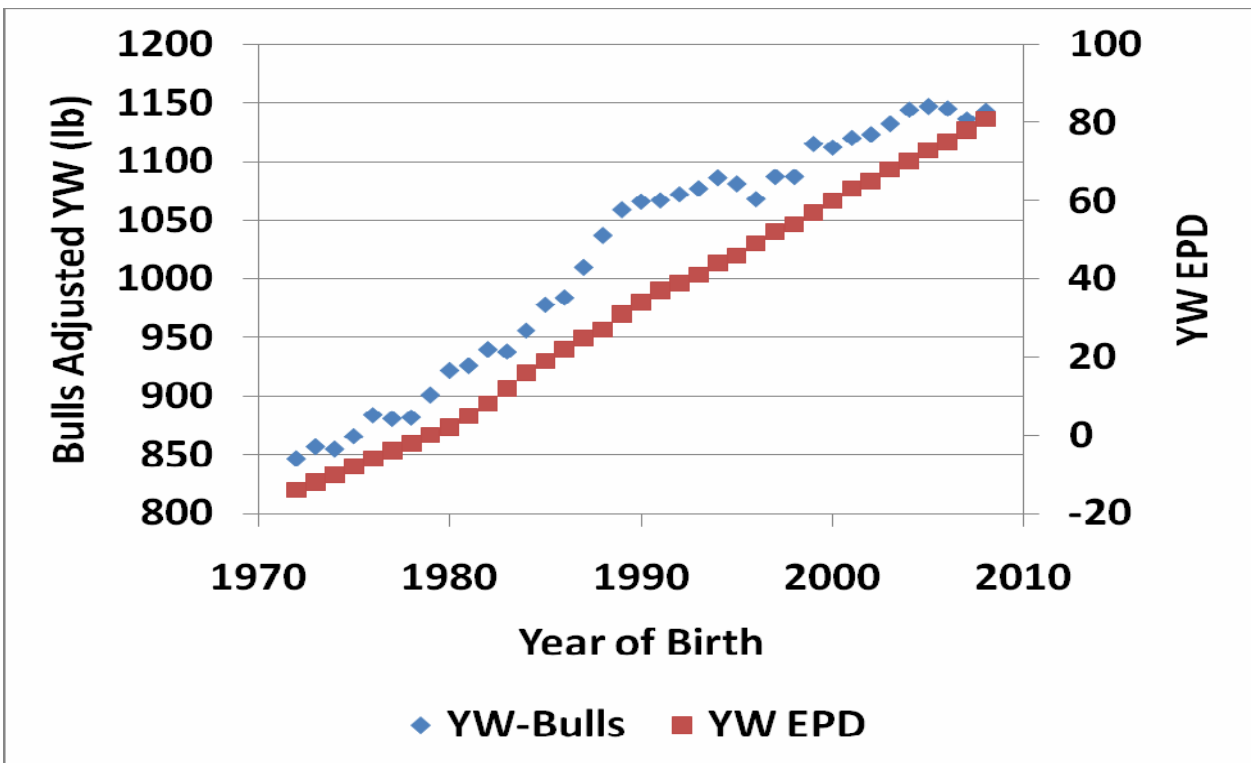

Figure 3. Angus bull yearling weight phenotypic and genetic trends. (adapted from Am. Angus Assn., 2010a).

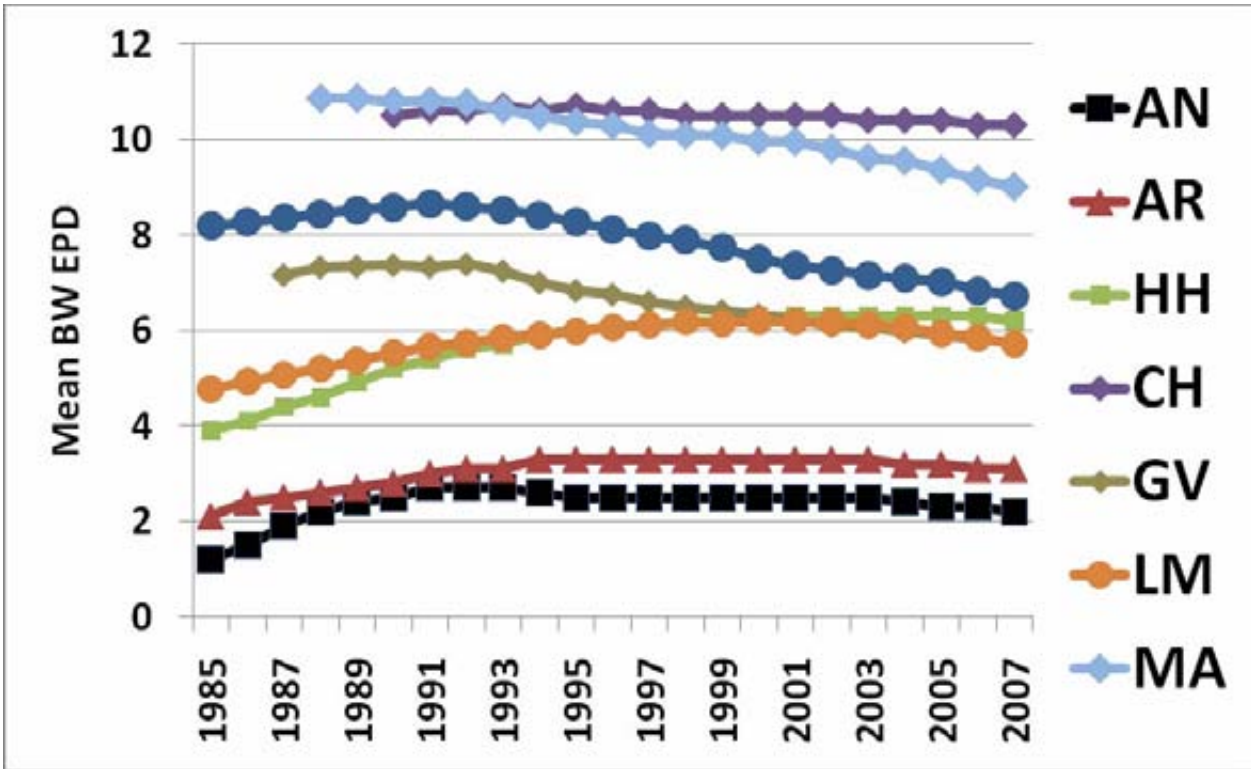

Figure 4. Birth weight EPD genetic trends converted to Angus base using USDA-MARC across breed EPD adjustment factors for eight major US beef breeds where AN=Angus, AR=Red Angus, HH=Hereford, CH=Charolais, GV=Gelbvieh, LM=Limousin, MA=Maine Anjou, SM=Simmental.

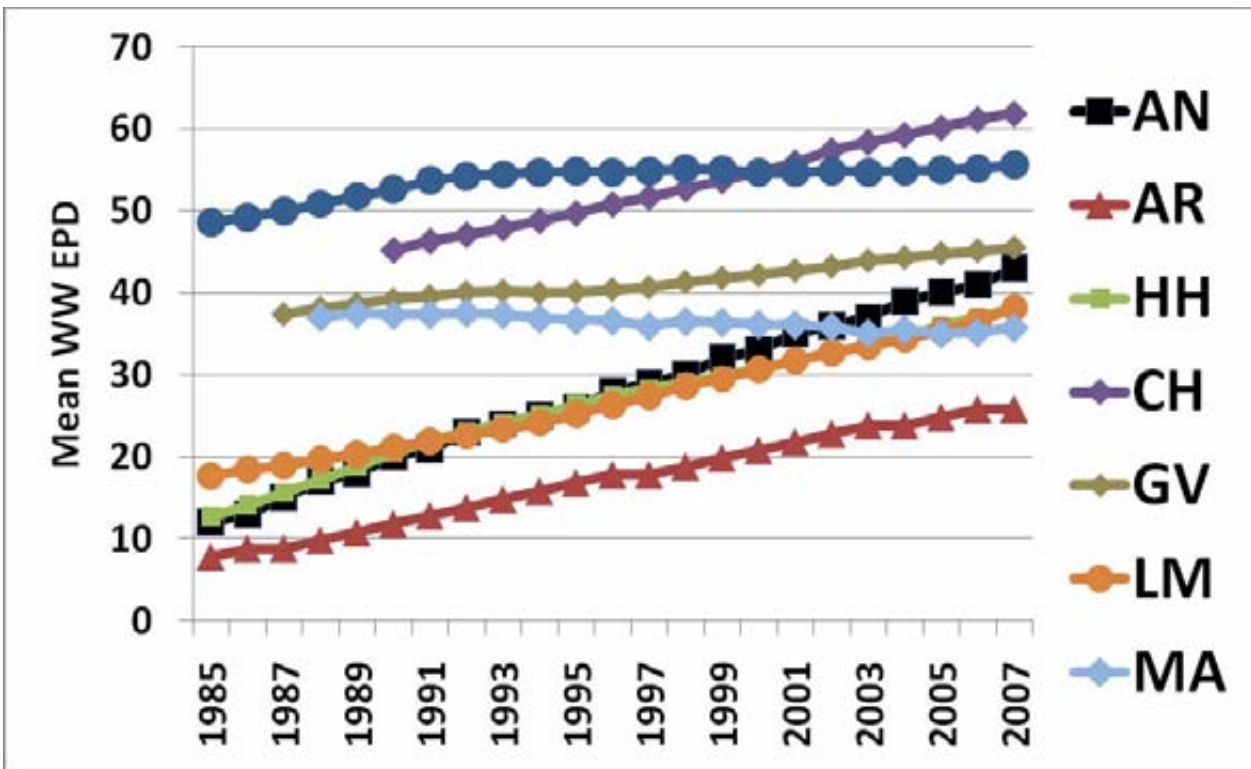

Figure 5. Weaning weight EPD genetic trends converted to Angus base using USDA-MARC across breed EPD adjustment factors for eight major US beef breeds. where AN=Angus, AR=Red Angus, HH=Hereford, CH=Charolais, GV=Gelbvieh, LM=Limousin, MA=Maine Anjou, SM=Simmental.

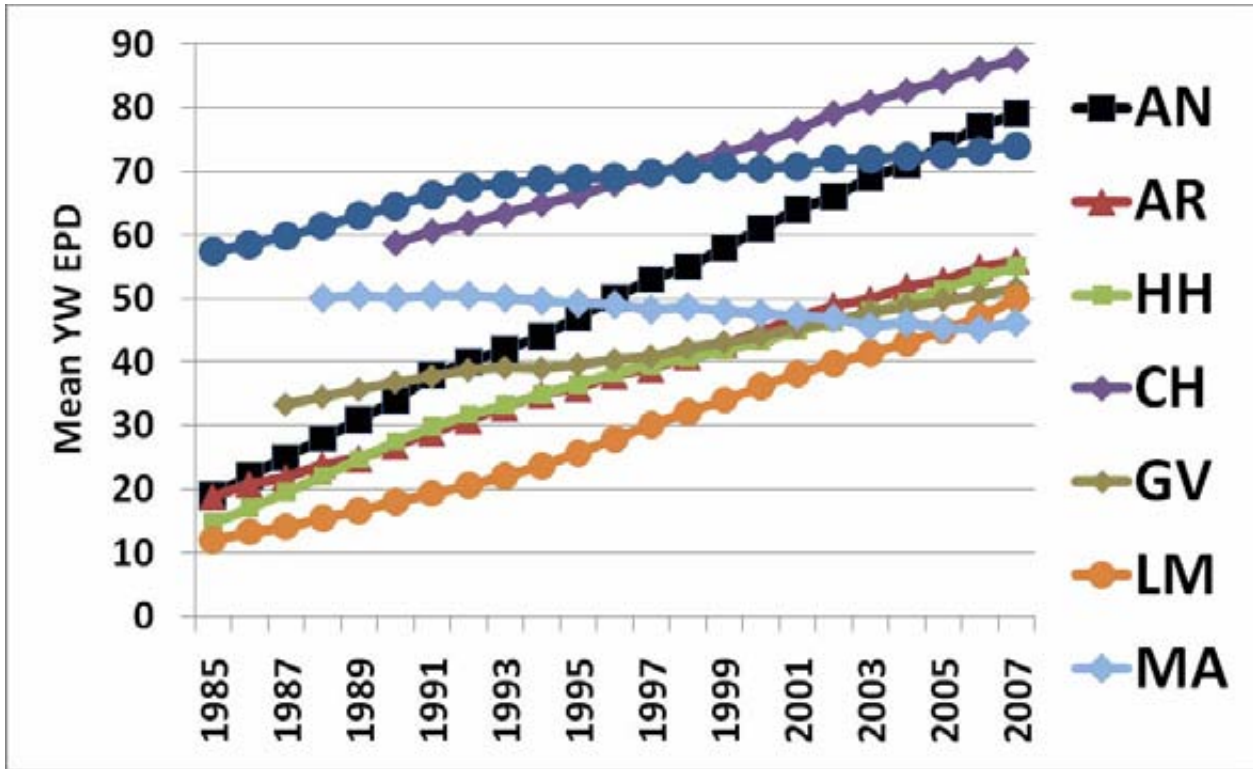

Figure 6. Yearling weight EPD genetic trends converted to Angus base using USDA-MARC across breed EPD adjustment factors for eight major US beef breeds where AN=Angus, AR=Red Angus, HH=Hereford, CH=Charolais, GV=Gelbvieh, LM=Limousin, MA=Maine Anjou, SM=Simmental.

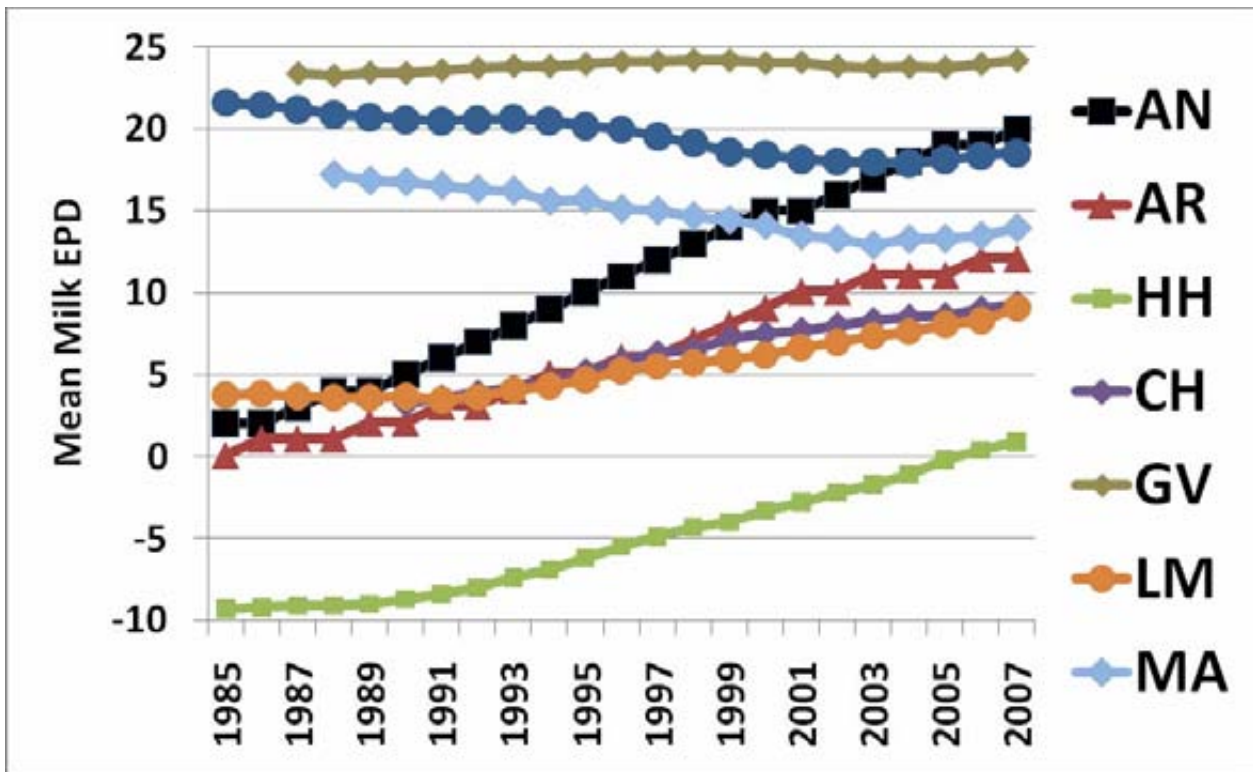

Figure 7. Milk EPD genetic trends converted to Angus base using USDA-MARC across breed EPD adjustment factors for eight major US beef breeds where AN=Angus, AR=Red Angus, HH=Hereford, CH=Charolais, GV=Gelbvieh, LM=Limousin, MA=Maine Anjou, SM=Simmental.



### 3.0 Proliferation of EPDs

As beef cattle breeders became more skilled at phenotype collection and use of EPD, interest in expanding the suite of traits evaluated became strong. At least a portion of the motivation to expand the traits evaluated came from the fact many traits, not just BW, WW, YW and MILK impact the profitability of beef production. In fact, as producers selected for larger weaning and yearling weights the genetic antagonisms became quite obvious (Koots *et al.*, 1994). The correlated responses to selection for improved pre- and post-weaning growth included larger birth weights, increased dystocia, larger mature cow weights, and in some cases lower body condition and reduced reproductive rates. These antagonisms, in conjunction with the concept of economically relevant traits (ERT; Golden *et al.*, 2000), motivated a wave of phenotype collection and genetic evaluation research to produce EPDs for calving ease, gestation length, stayability and heifer pregnancy. ERT are traits that are directly associated with costs or revenues as viewed by the producer in the context of their production/marketing system. Indicator traits, then, are those traits observed in the production system that are genetically correlated with an ERT. In instances where it is cost prohibitive or otherwise difficult to collect phenotypes on an ERT, the indicator trait is utilized in selection thus relying on the correlated response for improvement.

More recently, beef producers have become more concerned with end-product attributes through the proliferation of individual carcass merit based pricing systems, the emergence of branded or specification beef product channels and through campaigns such as the National Beef Quality Audit that highlight the ability of beef products to satisfy domestic consumer demands. The quality shortcomings and defects identified by these industry-wide surveys of carcasses (NCBA, 2000; Roeber *et al.*, 2002; Garcia *et al.*, 2008), products and perceptions of packers/processors/consumers have illuminated the opportunities for improvement in the quality and consistency of beef products through genetic selection and application of best management practices. Starting in the late 1990's, seed stock producers began collecting carcass records on progeny of candidate sires. Sire evaluation was conducted through the collection of both carcass and ultrasound observations on progeny. These performance records have been incorporated into effective EPD. The use of these EPD has enabled the positive genetic trends observed in marbling score and rib eye area as illustrated in Figure 8.

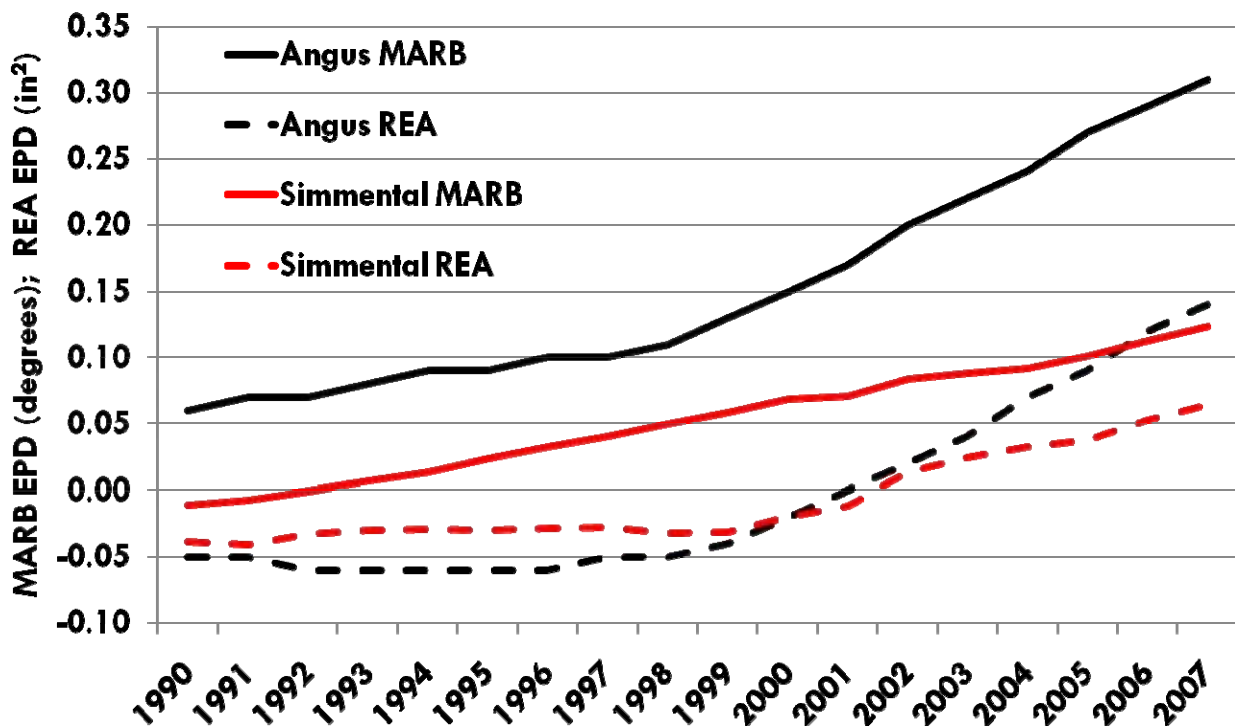

Figure 8. Marbling score (MARB) and rib eye area (REA) EPD genetic trends for Angus and Simmental breeds.

A host of other traits and genetic evaluation model features have been developed by breeds to address specific needs. The current EPD produced by eight major beef breeds for genetic improvement are listed in Table 1. The main categories reported by nearly all breeds are growth, reproduction (calving ease direct (CED) and calving ease maternal (CEM)) and carcass traits. The Angus and Limousin breeds have adopted standards for reporting measures of docility while Red Angus, Angus and Simmental have adopted a heifer pregnancy EPD. Several breeds now report stayability EPD describing differences in the expected longevity of daughters in the herd. In addition to expanding the number of traits offered, several breed associations, led by model developments by the American Simmental Association and Cornell University, have developed multi-breed evaluations. These evaluation systems for growth traits account for breed, direct and maternal heterosis, and heteroscedastic additive and residual variances to more appropriately analyze data structures that include large numbers of animals from different breeds and their respective crosses. A number of breeds continue to work towards implementation of multi-breed genetic evaluations to capitalize on composite and systematic crossbreeding programs.

Table 1. Current EPD available in 2010 from eight major beef breeds in the United States.

Breed	Growth							Reproduction					Carcass					Ultrasound				Other					
	Birth Weight	Weaning Weight	Milk	Yearling Weight	Total Maternal	Yearling Height	Mature Height	Mature Weight	Scrotal Circumference	Gestation Length	Calving Ease Direct	Calving Ease Maternal	Heifer Pregnancy	Carcass Weight	Ribeye Area	Fat Thickness	Marbling	Retail Product	Yield Grade	Tenderness	Percent Intramuscular Fat	Ribeye Area	Fat Thickness	Retail Product	Stayability	Maintenance Energy	Docility
Angus	X	X	X	X	X	X	X	X	X	X	X	X	X	X	X	X	X	X			X	X	X	X			X
Charolais	X	X	X	X	X			X	X	X	X		X	X	X	X											
Gelbvieh	X	X	X	X	X			X	X	X	X		X	X		X									X		
Hereford	X	X	X	X	X			X		X											X	X	X				
Limousin	X	X	X	X				X		X															X		X
Maine Anjou	X	X	X	X	X								X	X	X	X	X										
Red Angus	X	X	X	X	X					X	X	X		X	X	X									X	X	
Simmental	X	X	X	X	X		X	X	X				X	X	X	X			X	X					X		

#### 4.0 Participation in beef cattle performance recording grows

Seed stock breeders continue to see value in performance record collection and EPD generated through national cattle evaluation systems. EPD are used by both seed stock and commercial producers for selection and to some extent in marketing. Commercial cow-calf producers generally expect complete EPD profiles on young sire candidates available for purchase. To that end, seed stock breeders collect and report performance records for a large number of traits (see Table 1 above). Beginning in the late 1960s seed stock breeders began recording growth trait data and performance recording programs were initiated by the major breed associations. From humble beginnings and through structured performance record standards developed by the Beef Improvement Federation, performance recording programs are now at the core of the modern breed association's activities. Growth in the weaning weight performance record collection system at the American Angus Association from 1962 – 2009 is depicted in Figure 9. Since 2001, Angus breeders submit more weaning weight records than animals registered. This is achieved through a fee based performance collection system that operates independent of the registration system. Now, an overwhelming majority of animals are evaluated. The Angus national cattle evaluation system now utilizes more than 6 million on weaning records, 5.5 million birth weights, 3 million yearling weights and over 1 million on ultrasound scan records (Figure 10). While recent years recording of birth weights and weaning weights is equal to or greater than registrations, several traits lag behind in record collection as illustrated in Figure 11. For instance, only about 50% of animals registered have calving ease scores or ultrasound body composition measures reported. Angus breeders would be among the most complete record collectors in the beef business, but many other breeds have large performance record systems that match the saturation level of trait recording. Several breeds have adopted whole herd reporting schemes that make record collection and submission a requirement for registration. In

some cases these systems are breed wide (Red Angus) or may be an alternative method of doing business with an association (Simmental) rather than the traditional pay-as-you-go registration system.

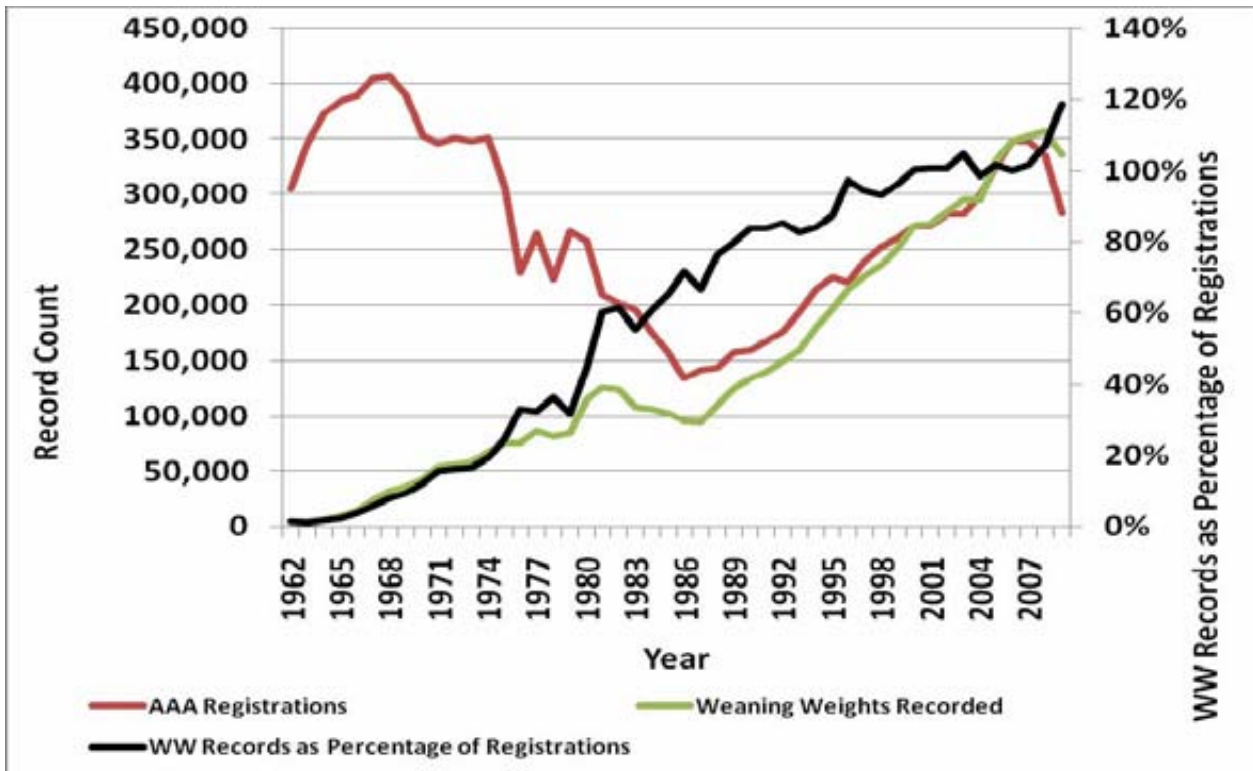

Figure 9. American Angus Association registrations and weaning weight records by year with weaning weight records as a percentage of registrations. (Am. Angus Association, 2010b).

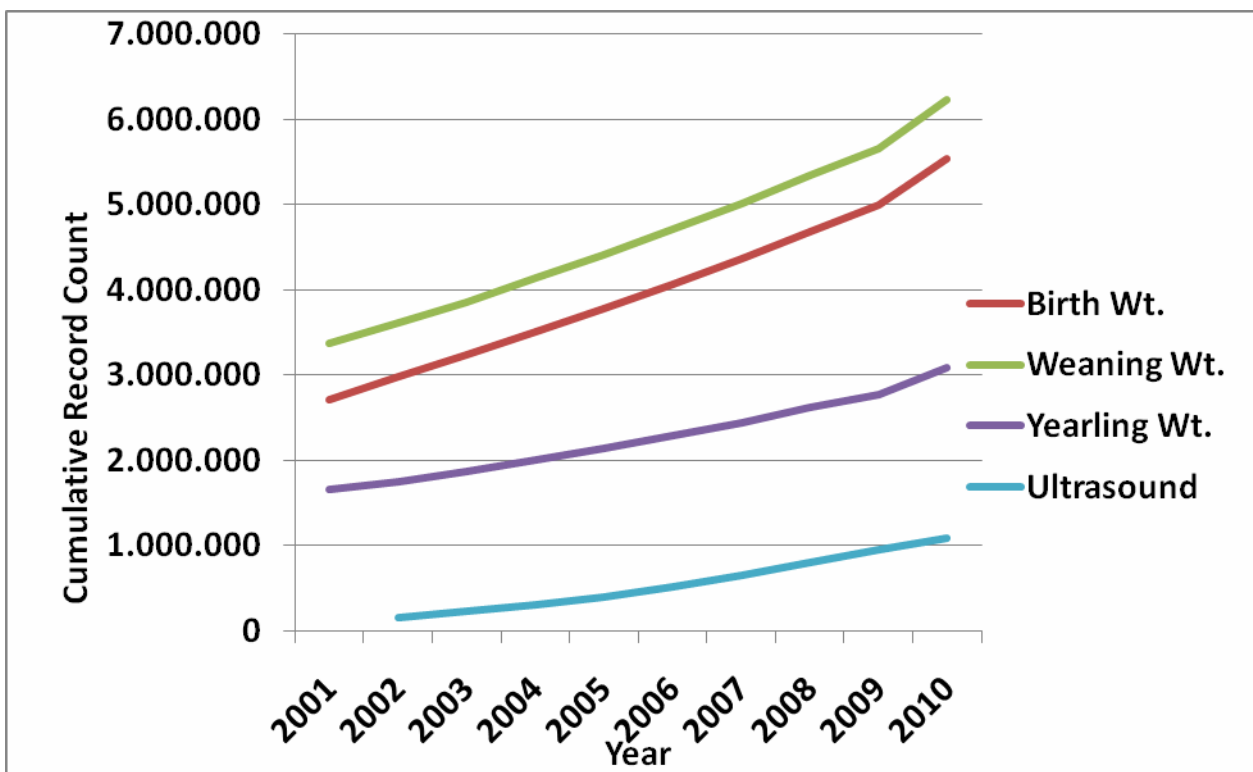

Figure 10. Cumulative performance record counts utilized in Am. Angus Association genetic evaluations. (Am. Angus Association, 2010b).

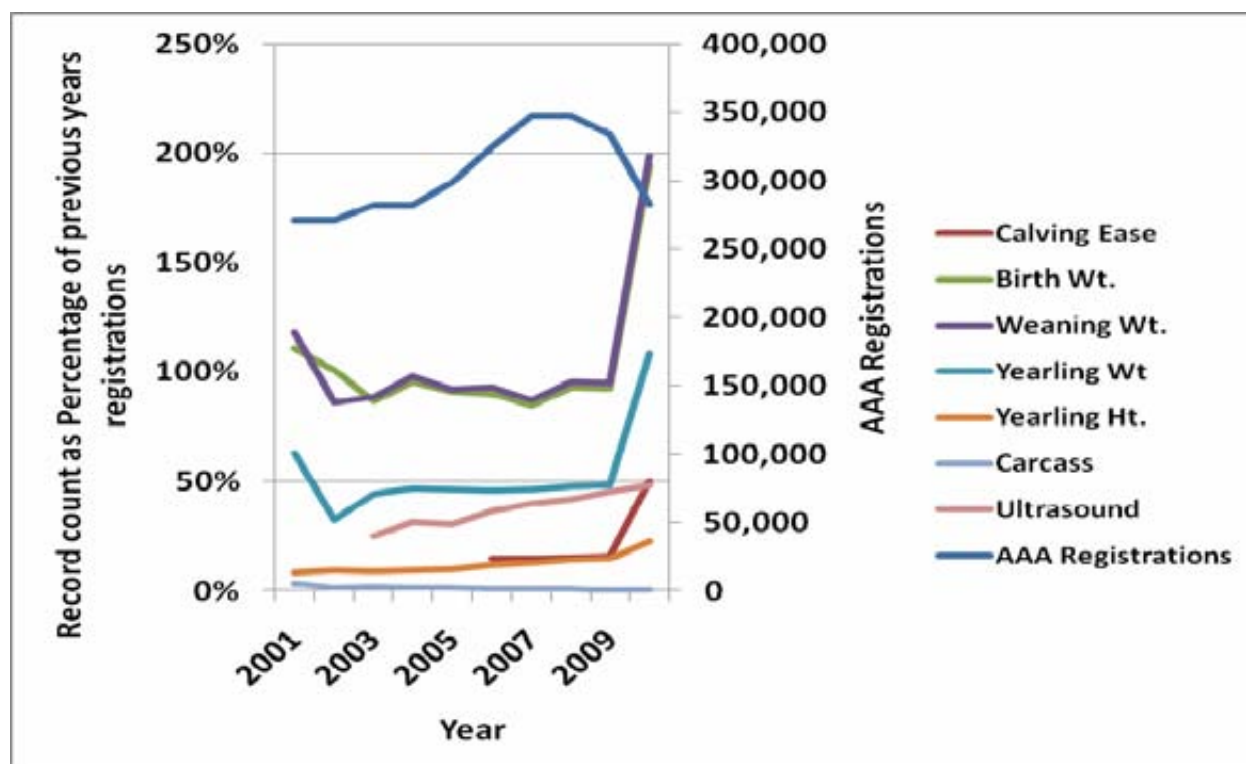

Figure 11. Trends in Am. Angus Association performance data recording as a percentage of prior year's registrations. (Am. Angus Association, 2010b).

## 5.0 Deployment and implementation of selection indexes

While the tools provided by genetic evaluation systems have proven effective for creating change in one or more traits, efficient multiple trait selection has remained challenging. The complications of multiple-trait selection and animal breeding decisions may be best summarized by Dr. Lanoy N. Hazel in the opening paragraph of his landmark paper on the topic of selection indexes published in the journal *Genetics* in 1943:

*The idea of a yardstick or selection index for measuring the net merit of breeding animals is probably almost as old as the art of animal breeding itself. In practice several or many traits influence an animal's practical value, although they do so in varying degrees. The information regarding different traits may vary widely, some coming from an animal's relatives and some from the animal's own performance for traits which are expressed once or repeatedly during its lifetime.... These factors make wise selection a complicated and uncertain procedure; in addition fluctuating, vague, and sometimes erroneous ideals often cause the improvement resulting from selection to be much less than could be achieved if these obstacles were overcome.*

Hazel points to the complexities of selection of individuals when many traits are observed and when the 'information' or performance record of an individual and its ancestors, collateral relatives and progeny may vary considerably. Indeed, the overall net merit of the individual, considering several traits of economic importance, provides a superior selection criterion than other forms of selection including single trait selection and multiple trait selection via independent culling levels (Hazel and Lush, 1943).

Hazel's pioneering work solidified the idea of a breeding objective or goal using a quantitative method. The aggregate genotype described by Hazel was a linear function (selection index) of observations such that the observations of each trait were weighted by the relative economic value of that trait. The result was a single value for each animal that represented an objective valuation of the overall satisfaction with that animal. In production agriculture, our level of satisfaction with an animal or system is generally measured in profit. The selection index provided a natural connection between the net merit of an animal's genotype and its relationship with profit.

As beef producers, we know that more than one trait exhibited by beef cattle contribute to profit at the enterprise level. Clearly, a cow-calf producer that sells calves at weaning depends on more than just the average weaning weight of calves for profitability. Simple ranch accounting suggests that reproduction

rate, calf survivability, cow maintenance feed costs, length of productive life and others influence the total pay weight of weaned calf produced and the cost required to produce that weight. Likewise, the producer that sells calves at harvest relies on more than just marbling score or quality grade to pay the bills. Reproductive rate of the cow herd, maintenance costs, longevity, not to mention carcass weight, are all factors affecting profitability. Thus, breeding objectives should include all the traits that are of economic relevance.

The original work by Hazel and later the work of Henderson (1951), who incorporated the use of EPD into selection indexes, stimulated a great deal of activity in the area of genetic prediction. Significant time and monetary resources have been devoted by producers, breed associations, beef improvement organizations, public sources, and academics to produce the sophisticated genetic predictions at our disposal today. However, comparatively little work has been devoted to full implementation of multiple-trait predictions into the multiple-trait prediction tools (Bourdon, 1998) envisioned by the originators. While the EPD produced today are of sufficient precision and accuracy, they are presented without context. Bourdon goes on to state that, "There is no easily accessible, objective way for breeders, particularly breeders in the beef and sheep industries where ownership is diverse and production environments vary a great deal, to use these predictions intelligently." Academic animal breeders are encouraged to solve this problem. The solution to the problem of intelligent use of multiple-trait EPD is to integrate genetic predictions with multiple-trait selection strategy usable on a large scale (Bourdon, 1998).

During the last decade, animal breeders have developed a series of selection indexes for use by seed stock and commercial producers. These indexes vary considerably in the approach utilized to develop the economic weights. The vast majority of the indexes are endpoint focused and seek to capture important genetic variation related to profit within that industry segment. Dr. Mike McNeil (personal communication) has developed several indexes for the Hereford and Simmental breeds that utilize a bio-economic simulation of individual animals at the herd or farm level to generate economic weight through perturbation of the levels of genetic merit and monitoring effects on profit. Currently, the Angus, Hereford, Simmental, Charolais, Gelbvieh breeds offer selection indexes for multiple trait selection.

## 6.0 Privatization of genetic evaluation systems

With the contraction of federal and state level support of agriculture experiment stations at land grant universities in the US, many animal breeding programs that have historically provided genetic evaluation services are re-tasking scientists to focus on new research developments. As such, the service components that have provided EPDs to many breed associations are being discontinued. Breed associations have responded in a variety of ways to this threat. Angus and Simmental have invested heavily in computing and staff resources to move the evaluations 'in house.' Others have sought the service of these organizations for genetic evaluations. Several independent start-ups have been initiated to license software developed at universities and through the National Beef Cattle Evaluation Consortium to provide genetic evaluations as fee for service. Given the funding trends in land grant universities, it is unlikely that new players will emerge to satisfy the industry needs for genetic evaluation. Breeds will likely need to develop strategies and cooperative relationships to develop economically sustainable genetic evaluations service provider(s) with a robust product offering.

## 7.0 Convergence of molecular and traditional quantitative genetics

Molecular genetics and associated technologies such as marker assisted selection, whole genome selection, genome sequencing, marker assisted management and others provide a great deal of promise to cattle breeders for traits that are difficult and/or expensive to phenotype. Much work has been undertaken in the US to identify DNA markers associated with growth, meat quality and fatty acid composition, female reproductive efficiency, animal health and feed intake/efficiency. Additionally strategies for implementation of genomic selection systems are in development. The ultimate success of many of these tools will be cost effective delivery of selection information and their ability to converge with existing genetic evaluation systems. The American Angus Association has recently deployed genomically enhanced carcass EPDs that leverage information for existing carcass performance records, ultrasound performance records and DNA markers (MacNeil *et al.* 2010). The beauty of the converged systems is that they communicate genetic merit as EPD and index values, selection currency with which producers are already quite familiar. Convergence alleviates the conflicting estimates of merit that exist when disparate sources of information are utilized. Familiarity will ease implementation and speed uptake by producers.

## 8.0 References

- Am. Angus Association. 2010a. 2009 Angus Sire Evaluation report. <http://www.angus.org/Nce/AHIRAvg.aspx>. Accessed May 20, 2010.
- Am. Angus Association. 2010b. Personal communication: Historic performance record and registration counts time series.
- Bourden, R. M. 1998. Shortcomings of current genetic evaluation systems. *J. Anim. Sci.* 76:2308-2323
- Garcia, L. G., K. L. Nicholson, T. W. Hoffman, T. E. Lawrence, D. S. Hale, D. B. Griffin, J. W. Savell, D. L. VanOverbeke, J. B. Morgan, K. E. Belk, T. G. Field, J. A. Scanga, J. D. Tatum, and G. C. Smith. 2008. National Beef Quality Audit–2005: Survey of targeted cattle and carcass characteristics related to quality, quantity, and value of fed steers and heifers. *J. Anim. Sci.* 86:3533-3543.
- Golden, B. L., D. J. Garrick, S. Newman, and R. M. Enns. 2000. Economically Relevant Traits A Framework for the Next Generation of EPDs. Proc. 32nd Annual Research Symposium and Annual Meeting, Beef Improvement Federation, Wichita, Kansas.
- Hazel, L. N. 1943. The genetic basis for constructing selection indexes. *Genetics* 28:476-490.
- Hazel L. N. and J. L. Lush. 1943. The efficiency of three methods of selection. *Journ. Hered.* 33:393-399.
- Henderson, C. R. 1951. Mimeo published by Cornell University. Ithaca, NY.
- Koots, K. R., J. P. Gibson, and J. W. Wilton. 1994. Analyses of published genetic parameter estimates for beef production traits. 2. Phenotypic and genetic correlations. *An Breeding Abstr* 62:825.
- MacNeil, M. D., J. D. Nkrumah, B. W. Woodward, and S. L. Northcutt. 2010. Genetic evaluation of Angus cattle for carcass marbling using ultrasound and genomic indicators. *J Anim Sci* 2010 88: 517-522.
- National Cattlemen’s Beef Association (NCBA). 2000. Executive Summary of the 2000 National Beef Quality Audit. Accessed on May 7, 2007 at: [http://www.texasbeef.org/files/publication\\_4\\_NBQA2000.pdf](http://www.texasbeef.org/files/publication_4_NBQA2000.pdf)
- Roeber, D. L., D. R. McKenna, P. K. Bates, T. B. Schmidt, K. E. Belk, T. G. Field, J. A. Scanga, J. W. Savell, J. B. Morgan, T. H. Montgomery, and G. C. Smith. 2002. The 2000 National Beef Quality Audits: Views of producers, packers, and merchandisers on current quality characteristics of beef. *Prof. An. Sci.* 18:112-119.
- USDA. 2009a. 2007 Census of Agriculture: United States Summary and State Data. Vol. 1, Geographic Series, Part 51, Pages 7,19.
- USDA. 2009b. National Weekly Direct Slaughter Cattle - Formulated and Forward Contract – Domestic. Accessed on 07/08/2009 at: [http://mpr.datamart.ams.usda.gov/menu.do?path=\Species\Cattle\Weekly Cattle\LM\\_CT151](http://mpr.datamart.ams.usda.gov/menu.do?path=\Species\Cattle\Weekly Cattle\LM_CT151) National Weekly Direct Slaughter Cattle - Formulated and Forward Contract - Domestic
- USDA. 2009c. National Weekly Direct Slaughter Cattle - Negotiated Purchases. Accessed on 07/08/2009 at: [http://mpr.datamart.ams.usda.gov/menu.do?path=\Species\Cattle\Weekly Cattle\LM\\_CT154](http://mpr.datamart.ams.usda.gov/menu.do?path=\Species\Cattle\Weekly Cattle\LM_CT154) National Weekly Direct Slaughter Cattle - Negotiated Purchases





## Use of the Tru-Test Electronic Milk Meter (EMM) in France

C. Lhomme<sup>1</sup> & C. Lecomte<sup>2</sup>

*CL62 Controle laitier du Pas Calais, 62161 Maroeuil, France*

*Z.A. Le Brunehaut - 840, rue Curie, 62161 Maroeuil, France*

### **Abstract**

The Tru-Test Electronic Milk Meter (EMM) was updated over 2007 in close association with several French herd testing regions and France Controle Laitier. While the original EMM read bar-coded milk sample vials, this later model EMM uses RFID vials instead. Other new features have also been added including longer battery life, user-friendly menu software and Bluetooth in the Data Handler control unit.

Controle Laitier Du Pas Calais started using the RFID version EMM for commercial herd testing in early 2008. This service is based around the farmers doing their own testing.

EMM's are installed on herd test day, with a milk sample from both the evening and morning milking sessions automatically dispensed into one single RFID vial. The EMM and Data Handler control unit ensure the correct vial is attached.

After the milking, the test data is downloaded from the Data Handler to a PDA and this file is remotely transmitted to the database centre used by Controle Laitier Du Pas Calais. Herd test results are available on-line later the same day after the morning milking.

Trialling of RFID anklets linking the cow numbers wirelessly back to the EMM and Data Handler is underway and will become a standard feature of the herd testing service provided to farmers by Controle Laitier Du Pas Calais.

*Keywords: France, Controle Laitier Du Pas Calais, Tru-Test Electronic Milk Meter, RFID EMM, RFID vials, farmer testing, Bluetooth, PDA, RFID anklets*







## Determination of carry-over in automated milking, recording and sampling systems using fluorescent tracers

P. Løvendahl, M. Bjerring & T. Larsen

*Faculty of Agricultural Sciences, Research Centre Foulum, Aarhus University, Tjele, Denmark*

### **Abstract**

Integration of yield recording and sampling devices with automated milking systems (AMS) make these more complex with more possibilities for milk residues from one milking to be mixed with milk in the following milking thus creating a carry-over problem. Carry-over can be substantial so that test samples may contain up to 10 percent of milk from the previously milked cow. This study describes the application of a tracer based method for fast determination of carry-over in milk recording equipment under farm or bench conditions. The carry-over test is based on sequences of milkings of a "phantom cow". In each sequence the first milking is with milk containing a fluorescent color dye as tracer. The milk volume is fixed and samples are taken. The next milking is with pure "white" milk of the same fixed volume. Again, samples are taken using the sampling equipment. The coloring of the white milk in the second sample shows the degree of carry-over. Equipments from leading manufacturers were tested and results showed that carry-over can be a serious problem if any volume of milk is left in containers or pumps. However, with well maintained and adjusted settings for sampling, carry-over reached acceptable values below 4%. In conclusion, the tracer based detection of carry-over is reliable, relatively fast and applicable under field conditions.

*Keywords: AMS, carry-over, milk sampling.*

### **1.0 Introduction**

The complexity of automated milking systems (AMS) may interfere with recording and sampling units to produce unexpected effects. Rather than testing recorder and sampling units separately these need to be tested as an integral part of the AMS. This has also been the intention with conventional recording and sampling equipment when applying for ICAR approval. However, even devices that have been approved by ICAR may give unacceptable results if used in the complexity of an AMS if not all settings and adjustments are exactly as intended.

One particular problem associated with obtaining milk samples is the carry-over problem where milk from one previously milked cow is mixed with milk from the one currently being milked. The carry-over problem can be rather serious and levels up to 10% were detected by Løvendahl & Bjerring (2006) using a sampler with modifications for scientific purposes.

Methods for detection and estimation of carry-over are not explicitly described in ICAR rules and guidelines. Some indirect measures of carry-over may be the bias and standard deviations but these are not directly interpretable as coefficients of carry-over. Løvendahl & Bjerring (2006) used a statistical approach taking advantage of intensive sampling in a research herd over 14 d periods. The degree of carry-over was estimated as the linear regression of fat percentage in the current sample on the previous sample. Although the method was sensitive it required many samples to become sufficiently powerful, and thereby became expensive.

For purposes of testing newly developed or modified sampling equipment a dedicated carry-over test was developed and validated in the present study. The test is based on use of a fluorescent colour tracer and require approximately 3 hours of down time for running the protocol. Details and validation of the method is reported here.

## 2.0 Materials and Methods

### 2.1 Principle

The fluorescent tracer carry-over test use milkings of a “phantom cow”, first with a fixed volume of coloured milk and follow that with one or two phantom milkings with similar volume of un-coloured white milk. The coefficient of carry-over is estimated from the colouring of the white milk, using fluorometry. We have used 6 to 8 replicate rounds to ensure consistency of results.

### 2.2 Detailed protocol

#### 2.2.1 Milk and Tracers

Approximately 200 L of raw milk was set aside for a complete test. For preparation of tracer 25 kg was weighed out in a container (T) and another 30 kg was kept as white milk (W); both were heated to 39°C using an immersion heater. The tracer was prepared by dissolving 600 mg of A Y73 (Fluorescein Sodium salt, Sigma-Aldrich, Fluka 46960) and 600 mg of 4MeU (4-Methylumbelliferon Sodium salt, Sigma-Aldrich M1508), first in 40 mL of milk and then mixed up in the 25 kg container. The tracer solution was visibly yellow. The chosen tracers are known to mix well with water and lipids, and have no specific affinity towards plastics or other surfaces more than water and fat itself. From both batches of T and W milk a sample of 300 mL was taken to be used for preparation of calibrators in the lab. The milk was kept warm until used mainly by covering containers with lids.

#### 2.2.2 Phantom cows

Two phantom cows were each constructed from containers holding at least 10 L and a set of 4 plastic tubes (i.d. 4 mm, L = 2 m) ending in hard plastic “teats” with 4 mm openings. One cow was the “Yellow” tracer cow and the other the “White” cow.

Each phantom cow was assigned to an ID-tag used by the AMS to identify it and trigger the milking process.

#### 2.2.3 AMS settings

The AMS were set in “recording mode” whatever that involved of mixing and extended pumping time and mounting of T-pipes.

The line leading milk from AMS to bulk tank was dismantled and diverted into a collection container. In some cases diversion of milk to “drain” was used instead, but milk was always collected in a container and weighed.

#### 2.2.4 Samplers

The method was applied to various makes of samplers as delivered or following deliberate modifications for research purposes. Also, a recorder and sampler unit for use in parlours was tested using this method. All samplers were set to give 24 mL standard samples.

The method has been applied to a number of different equipments and some examples were included in the present study (Table 1). It should be noted that the current study was only conducted to validate the method and never for comparisons between specific equipments.

Table 1. Milk sampling equipments tested for carry-over.

Test no.	Type	Modifications
1	AMS	Standard
2	AMS	Standard unadjusted
3	AMS	Standard adjusted
4	AMS	Research modified
5	Manual Parlour	Standard electronic meter and sampler

### 2.2.5 Testing protocol

We have mostly used 6 to 8 replicate runs as that gives sufficient power and fits well with using two batches of tracer. The phantom cow was set to "yield" 5, 6 or 8 kg milk as the carry-over problem gets diluted at higher volumes, and because ICAR states that equipment should reach precision already at low yields.

At each milking, samples (8 mL) for lab-analysis were collected as pre-milking (A) from the phantom cow and following the milking from the sampler-unit (B), and finally from the drain line or bulk line (C). Samples were cooled (4°C) until assayed, usually the day after the test. Bronopol was not avoided nor was it used deliberately, but it had no impact on fluorescence readings in normal, double or triple concentrations (T. Larsen, unpublished). All milk was weighed out and collected milk was weighed. Yield record data from the AMS were collected as supplementary data. The protocol is illustrated in the table below (Table 2).

Table 2 Protocol (example, part) for testing of carry-over in AMS milk sampling. Samples A are pre-test, B is the sampler, C is the end-unit or bulk tank line or waste line.

Replicate	Run	Liquid	Volume (Kg)	Samples
1	1_1	Yellow	5	A B C
	1_2	White	5	A B C
2	2_1	Yellow	5	A B C
	2_2	White	5	A B C
	2_3	White	5	A B C
3	3_1	Yellow	8	A B C
	3_2	White	8	A B C
4	4_1	Yellow	8	A B C
	Wash	No		
	4_2	White	8	A B C

### 2.3 Fluorescence determination and calibration

Fluorescence intensity was measured using excitation filter at 485 nm and emission filter at 520 nm for the AY73 and at 355 / 460 nm for the 4MeU. "White" milk readings were always low, but were included as the 0 (zero) calibrator. The "yellow" sample from each batch was defined as 600 arbitrary units, being equal to 100 % colour saturation. Ten more (10) calibrators were initially made for all intermediate values by mixing white and yellow milk. Calibrators and samples were dispensed into duplicate wells of microtitre plates, so that all readings were in duplicate. All calibrators and samples were heated to 39°C before measurement on a fluorometer. Calibration curves were checked for linearity by back-calculating values derived from a simple 2-point calibration. For routine use a 5 point curve was used (0, 10, 20, 30, 100 %).

In this setup, carry-over is expressed in units of "yellow" which was proportional to percentage by division with 6.0.

### 3.0 Results and discussion

#### 3.1 Linearity of Fluorescence Response

Calibration curves for the two fluorochromes are shown below in figures 1 and 2. The fluorescence readings were directly proportional to the concentrations of each tracer over the range used.

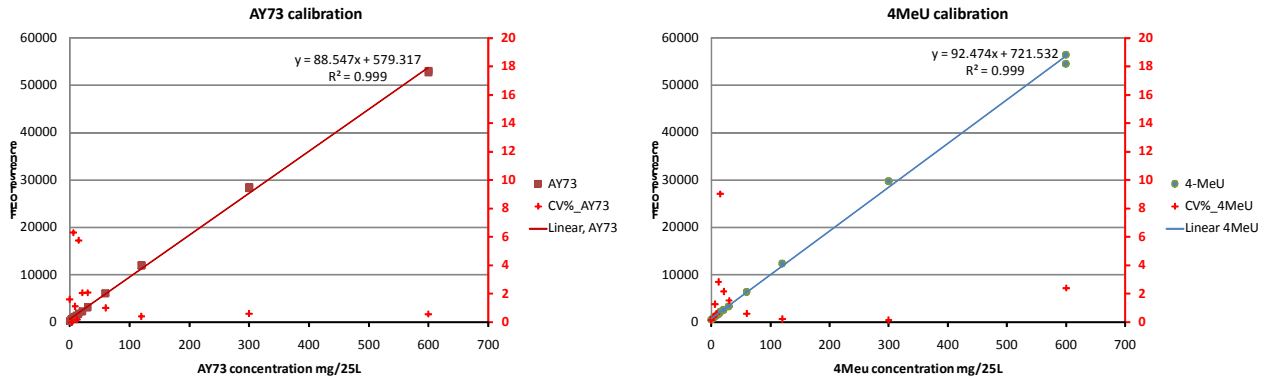

Figures 1 (left) and 2 (right). Calibration curves and precision profiles for two colour tracers. Precision is shown as CV% of duplicates (right red axis, + markers).

The linearity of both colours was almost perfect over the range of concentrations and fluorescence readings. The precision profiles showed that duplicate replication was always better than 10% and typically around 2 to 4% in the range of interest for use, namely between 12 and 120 mg/25L, equal to 2 to 20% carry-over. "White" milk had a baseline reading of 600 to 700 fluorescence counts, which was deducted from calculated concentrations, using the trend-line as calibration formula. Similar new curves were produced for every batch of tracer and white milk, and used for actual concentrations. In effect, a sample containing 60 units, would have a precision of 2 units or less, equal to a carry-over at 10% ± 0.3% units, from a single determination.

#### 3.2 Detailed example results

Results are obtained in the form of concentrations in the arbitrary units. For convenience these were immediately recalculated to a scale of 0 to 100% before being presented in table 3 (below). Otherwise results are aligned with the protocol in table 2.

Table 3. Detailed results from a carry-over test on an AMS system. A second order carry-over is shown in run 2\_3.

Run	Type	Volume	Pre-sample, A		Sampler, B		End unit, C	
			AY73	4MeU	AY73	4MeU	AY73	4MeU
Carry-over in percent								
1_1	Yellow	5	100.0	100.0	95.1	93.3	91.1	91.0
1_2	White	5	0.4	0.3	18.5	18.0	29.2	29.2
2_1	Yellow	5	100.0	100.0	90.2	93.0	94.1	95.4
2_2	White	5	0.9	0.6	15.4	15.8	18.3	18.7
2_3	White	5	0.5	0.4	2.8	2.8	3.1	2.9
3_1	Yellow	8	100.0	100.0	96.4	98.0	97.8	97.6
3_2	White	8	0.7	0.5	20.0	19.7	18.6	18.3
4_1	Yellow	8	100.0	100.0	95.4	97.4	97.4	99.2
<b>WASH !</b>								
4_2	White	8	1.0	0.7	1.7	1.4	1.0	0.6
<b>First order carry-over without wash</b>					<b>18.0</b>	<b>17.8</b>	<b>22.0</b>	<b>22.1</b>

This example comes from an AMS that required some serious adjustments! However, readings of carry-over are simply found in the lines with "white" milk. There is very good agreement between readings of the two tracers. In the case 2\_3 where a second run with white milk was conducted, carry-over was less, but should be seen in relation to the immediate previous sample, and thereby values of around 18% were obtained in B samples. In replicate 4, a short wash cycle interrupted between tracer and white milk. This was clearly effective in removing tracer and residues of milk, leaving practically no signs of carry-over.

### 3.3 Carry-over in various AMS and samplers

Five different equipments were tested on different occasions, using the same basic protocol but with modifications needed for each special case. Weight was put on the 8 kg results as the lead through all tests. Results are presented in table 4, as extracts from the detailed results from each testing round.

Table 4. Carry-over test results from 5 different setups. Carry-over in percent (CO%) as measured in samples taken from the autosampler.

Equipment	Volume (N)	CO%, AY73	CO%, 4MeU	Average
1.A AMS Standard	5 (1)	8.4	8.5	8.5
	8 (3)	3.3	2.8	3.1
1.B	8 (6)	6.7	7.2	7.0
2 AMS Unadjusted	5 (2)	17.0	16.9	17.0
	8 (1)	20.0	19.7	19.9
3 AMS Well adjusted	6 (1)	3.1	4.6	3.9
	8 (6)	2.1	2.5	2.3
4 AMS Modified	6 (2)	10.5	10.0	10.3
	8 (3)	11.2	11.8	11.5
5 Conventional	8 (6)	3.3	3.7	3.5

Good results were obtained from standard equipment but only when this was well adjusted. These were comparable to results from conventional setups. It is less clear if results are affected by volume of milk. Modifications to samplers may increase carry-over.

## 4.0 Discussion and Conclusion

### 4.1 Discussion

This study has presented an effective method of directly detecting carry-over in milk sampling equipment connected to AMS or to conventional parlour milking systems. This method provides fast and precise results and only requires few hours of down-time for the AMS+sampler unit under test. The required chemical tracers are inexpensive and measurements easy to perform in microtitre plates using standard research lab equipment.

Estimates of carry-over based on this method confirmed previous findings of high carry-over in modified samplers for AMS (Løvendahl & Bjerring, 2006).

Visible residues of milk have been detected in AMS units with high carry-over, both in tube connections and in separator and pumping units. Residues of up to 0.5 L were found. These residues were successfully reduced following adjustment of level sensors, and carry-over problems were similarly reduced.

The tests were mostly carried out using 5 to 8 kg of milk in order for the test to be as sensitive as possible, and because sampling should work already from such small volumes. However, most milkings are larger than 10 kg, which will inevitably reduce the problem by simple dilution, as also shown by Løvendahl & Bjerring (2006).

A small degree of carry-over (3.5%) was also detected in the conventional system, and previous findings indicate that around 2% can be found in another conventional system (Løvendahl & Bjerring, 2006), using normal milkings in a tie-barn system. However, milk volumes were in that case larger and may thereby give lower carry-over.

The described method could be the basis for testing carry-over for approval of combinations of AMS and samplers. The method has a dependency on volume and directions are therefore needed as to appropriate testing volumes, and acceptable levels of carry-over at these volumes.

## 4.2 Conclusion

The present study has described an efficient method for assessment of carry-over in combined AMS-sampler equipments. This method should be helpful to the manufacturers and to recording organisations for monitoring and improving sampling equipment, and to provide testable tolerances for approval of new or modified equipment.

## 4.3 Acknowledgements

The authors are grateful to farmers volunteering their AMS and time for carry-over testing. This work was supported by the BIOSENS project portfolio (Ministry of Food, Fisheries and Agriculture; Lattec.com; Danish Cattle; Danish Cattle Research Centre) and the Danish Recording Societies, Skejby Denmark.

## 5.0 Literature

ICAR, 2007. ICAR Recording Guidelines: International Agreement of Recording Practices. ICAR Guidelines approved by the General Assembly held in Kuopio, Finland on 9th June 2006. Available as PDF from [www.icar.org](http://www.icar.org) 474 pp.

Løvendahl, P. and Bjerring M, 2006. Detection of Carry-Over in Automated Milk Sampling Equipment. *Journal of Dairy Science*, 89:3645–3652



## Health monitoring in Austria – statistical models based on somatic cell count at cow level for early detection of udder health problems developed

P. Winter<sup>1</sup>, J. Hofrichter<sup>2</sup>, W. Obritzhauser<sup>4</sup>, K. Zottl<sup>5</sup> & C. Egger-Danner<sup>3</sup>

<sup>1</sup>Department for Farm Animals and Veterinary Public Health, University of Veterinary Medicine Vienna, Austria

<sup>2</sup>Data, Statistics and Risk Assessment, Austrian Agency for Health and Food Safety, Austria

<sup>3</sup>ZuchtData EDV-Services, Vienna, Austria

<sup>4</sup>Chamber of Veterinaries, Vienna, Austria

<sup>5</sup>Performance Recording for Lower Austria, Zwettl, Austria

### **Abstract**

An Austrian wide health monitoring system for cattle has been established since 2006. A monitoring tool based on somatic cell count (SCC) is a further step for early and accurate awareness of subclinical mastitis cases. A logistic regression model based on the Dairy Herd Improvement (DHI) data for the Simmental Fleckvieh breed was developed. For validation cows marked suspicious of suffering from intramammary infections (IMI) were sampled for bacteriological examination twice in a weekly interval. The positive predictive value of the logistic regression model was 96.5% (CI 90.0-99.3). The positive predictive value of cows with two consecutive warnings based on the logistic regression model was 99.0%. Farmers will be able to select cows for further investigations and following treatment protocols more accurately than using the 200.000 cells/ml benchmark. The risk assessment will be implemented in the DHI reports which are sent in a monthly interval to the farmers. Potentially subclinical infected cows will be summarized in the category "cows with high somatic cell counts and mastitis – further investigations are recommended".

*Keywords: Health monitoring, cattle, logistic regression model, somatic cell count.*

### **1.0 Introduction**

A project to establish an Austrian wide health monitoring system for cattle has been established since 2006 (Egger-Danner *et al.*, 2009). Within the project diagnostic data, which have to be documented by law (law of animal drug control) are standardised and recorded into a central database for performance recording and breeding. All farms under performance recording are free to join the project. Presently about 13.100 farms with about 220.000 cows are participating.

One project aim is the provision of breeding values for health traits. To increase the health status of the animals by management measures health reports are provided. One of the most frequent diagnoses are acute and chronic mastitis; 28% of all diagnoses recorded within the Austrian health monitoring project are acute or chronic mastitis. A monitoring tool based on somatic cell count (SCC) is a further step for early and accurate awareness of subclinical mastitis cases.

Somatic cell count has been extensively used as a tool for monitoring mastitis in dairy herds. Monthly SCC values that are routinely measured at cow level are useful figures of prevalence and incidence and are often used to monitor dynamics of IMI within herds. Farm managers use SCC to identify cows requiring interventions such as bacteriological examination, treatment, or removal from the herd (Ruegg 2003). Interpretation of SCC is sometimes difficult, because it is a variable parameter that is influenced by many factors, such as diurnal variation, stage of lactation, parity and intramammary infections (Lam *et al.* 2009). Because of the variability of SCC, for monitoring infections dynamics of longitudinal data are necessary. An operational threshold of practical value with minimal diagnostic error, 200.000 cells/ml, was proposed by Schukken *et al.* (2003). The choice of SCC thresholds depends on the purpose of the test. Lowering the threshold increases the sensitivity and consequently provides minimal false negative results whereas raising the threshold increases the specificity, providing minimal false positive results (Pantoja *et al.* 2009).



The objective of the study was to develop a statistical model assessing the individual dynamics of SCC for identifying uninfected and potentially infected cows instead of using the fixed threshold of 200,000 cells/ml. Therefore, two statistical models based on monthly DHI data were developed. These models are a logistic regression model and a model based on Classification and Regression Trees (CART). Based on the validation results the model, which performs clearly better, will be implemented in the DHI reports.

## 2.0 Materials and methods

### 2.1 Data

For developing and validating the statistical models data sets from the routine bacteriological laboratory at the Clinic for Ruminants from 2000 to 2007 were used. Each data set included the result of a bacteriological examination and the monthly DHI data from the previous 6 months regarding SCC, milk yield, milk contents, breed, age and days in lactation. Bacterial examination was conducted according to NMC (1999) recommendations. A cow was considered infected if a mastitis pathogen was isolated at least in one quarter.

### 2.2 Statistical Analysis

Two different statistical models were used to analyse these data. These models are a logistic regression and a CART model. The logistic regression model yields a prediction for the probability of the presence of IMI based on DHI data. The aim of the CART model was to split the data in several subgroups. Then for each subgroup a specific threshold value for the SCC can be specified.

The response variable of the logistic regression was the bacteriological examination. The explanatory variables are monthly DHI data from the previous 6 months as described above. The considered model was

$$\text{logit}(\pi) = X\beta, \text{ which is } \pi = \frac{\exp(X\beta)}{1 + \exp(X\beta)},$$

where  $\pi$  is the probability of the presence of IMI,  $X$  is the design matrix of the explanatory variables and  $\beta$  is the vector of unknown parameters (Hofrichter *et al.* 2010, Winter *et al.* 2009). The model selection was done by a backward selection using the Analysis of Deviance table. Given an appropriate model, a cutoff value for  $\pi$  must be determined to specify the level at which probability a cow should be considered as infected. This was done using the Receiver Operating Characteristic (ROC) curve. The point with minimal quadratic distance to the point of a sensitivity and specificity of 100% is recommended (Dohoo *et al.* 2003).

For the CART model the DHI data of the previous two months were used. The SCC values were used as response variable to split the data into several subgroups based on the DHI data. An appropriate set of subgroups was found by pruning the tree with respect to a minimal cross validated error. Then for each subgroup a threshold value for the SCC was specified. This was again done by using the ROC curve within each subgroup in the same way as described above.

### 2.3 Implementation - DHI monthly reports

To support management decisions of cattle breeders and herd health management of their veterinarians, health reports are provided for the first time within a health monitoring project in Austria. The health report is available approx. 10 times a year. It combines performance recording data and data from health monitoring to enable early detection of health problems and their therapy. The report is providing relevant information for individual cows in the fields Fertility, Udder health, Metabolism and Digestive tract, Feet and Legs and Miscellaneous (e.g. Diaposals, Calving difficulties). At these reports the SCC information based on the logistic regression model is implemented (Figure 1).

### 3. Results

Initially 7,437 Simmental Fleckvieh (SI) cows were enrolled, with a total of 33.0 % positive diagnosed cows. Combining these data with the DHI data, complete data were available for 5,115 cows. A logistic regression model was fitted. The relevant explanatory variables are SCC of the two previous months, the age in lactation, the days in lactation and the amount of urea in the milk. Sensitivity and specificity of this model are listed in table 1. For the second kind of model based on the CART analysis, the data sets were splitted into two subgroups with respect to the age in lactation. The performance of this model is listed in Table 1, too.

Table 1 shows that the logistic regression performs better in terms of sensitivity and specificity than the model based on CART. Additionally, both models yield to a much better sensitivity, than using a fixed threshold of 200.000 cells/ml.

### 4. Validation of the models

After the two final models (logistic regression and CART) for each breed had been found, these models were validated with additional data from the year 2007. Complete data were available for 206 SI cows. The sensitivity and specificity for these models applied on these validation data sets are listed in table 1.

A comparison of the performance of the CART model applied on the two different data sets shows, that sensitivity and specificity differ more than in the logistic regression approach. This indicates that the CART model has less performance than the logistic regression, and is additionally confirmed by lower values of sensitivity and specificity.

*Table 1. Sensitivity (Se) and specificity (Sp) for a fixed threshold at SCC 200.000, the regression model and the CART model, applied on the model data set (model) and the validation data set (val), for Simmental.*

Breed	SCC >200.000		Logistic regression				CART			
	Se	Sp	Se	Sp		Se	Sp			
	model	model	val	model	val	model	val	model	val	
SI	46.6%	88.7%	72.4%	84.4%	72.6%	71.3%	68.6%	77.5%	70.5%	68.3%

#### Application of the model

The logistic regression model was implemented in the DHI database. For the application a dataset from Simmental Fleckvieh cows in Lower Austria from 2009 was used. Remarkable is the group between 100 and 150,000 cells, in which 4.3% of the cows were considered as potentially infected after two consecutive warnings using the regression model (Table 2).

Table 2. Distribution of suspicious Fleckvieh cows based on the logistic regression formula grouped by SCC categories of SCC of cows of Lower Austria in 2009.

SCC on day of milk recording	Nr MR	% suspicious with one warning	% suspicious with two consecutive warnings
<50	166,012	2.2	1.0
50 < 100	107,859	27.1	14.7
100 < 150	56,127	73.4	43.0
150 < 200	33,473	86.8	54.9
200 < 250	21,537	89.1	59.6
250 < 300	14,585	89.4	60.9
300 < 350	10,293	89.0	61.6
350 < 400	7,656	88.7	60.5
>= 400	45,242	85.8	57.5
Total	462,784	41.1	25.7

Figure 1. The health reports are expanded by the warning cows suspicious for SCC based on the logistic regression formula.

<b>Cows with high somatic cell counts and mastitis – further investigations recommended</b>							
Name	Animal-ID	L.	Days	BE*	21.08.2009 SCC	21.07.2009 SCC	12.06.2009 SCC
LISA	AT 999.444.972	2	283	BE*	568	205	132
SUMSI	AT 999.136.847	4	121		40	D 268	174
BIENE	AT 999.326.745	5	215	BE*	182	108	48
STRAUSSA	AT 999.327.845	4	28		31	T	T
LOLITA	AT 999.857.145	5	11		16	T	T

BE\*: Bacterial examination recommended

As shown in figure 1 for cow „BIENE“ a bacteriological examination is recommended even the SCC is below the threshold of 200.000 cells.

#### 4.1 Dissemination of the reports

The reports are provided electronically to farmers and veterinarians. Most of the information is also available at an internet platform. A future perspective is the implementation of the logistic regression formula within the internet platform.

## 5. Discussion

According to Pantoj *et al.* (2008) cows with SCC > 200.000 cells/ml are 2.7 times more likely to experience a first case of mastitis. Cows with intramammary infections at dry-off can be identified adequately combining information from SCC and clinical mastitis records, but decisions regarding the optimal selection criteria depend on herd characteristics such as prevalence of IMI and type of microorganisms present in the herd (Torres *et al.* 2008).

Using the risk assessment model these cows are detected on a very early stage of infection and no further herd information is necessary. It has to be considered that the sensitivity is 72,4%, which means that 27,6% of the cows are false positive highlighted. Therefore the application of the model should never be the base of a treatment decision or any other decisions like culling. Highlighted cows require further investigations like performing a California Mastitis Test or a bacteriological examination of quarter milk

samples. Normally about 30% of the Austrian dairy cows are subclinically infected, at least in one quarter (Hofrichter *et al.* 2010).

## 6. Conclusion

The design of the DHI reports summarizing the cows in special categories gives the farmers and the veterinarians a precise overview of the health status of the herd. The regular interpretation of the DHI data using the logistic regression model is a potential tool for monitoring udder health in Austria. Potentially subclinically infected cows will be determined as soon as somatic cell counts are exceeding their individual base line.

This risk assessment allows an early detection of IMI and supports the reduction of infection reservoirs and of economic losses. For the correct interpretation and use, continuous information and training for farmers is needed. Support by the veterinarians is recommended.

## 7. Acknowledgements

The study was funded by the Austrian Federal Ministry of Health (BMGF 74020/0034-IV/6/2006; BMGF-70420/0109-IV/6/2006) and the Ministry of Agriculture, Forestry, Environment and Water Management (BMLFUW) of Austria. The authors thank the Austrian Breeding Association (ZuchtData, Mr. Mayerhofer) for the cooperation and assistance.

## References

- Egger-Danner, C., B. Fuest-Waltl, W. Holzhaecker, R. Janacek, J. Lederer, C. Litzllachner, C. Mader, M. Mayerhofer, J. Miesenberger, W. Obritzhauser, G. Schoder, and A. Wagner, 2007. Establishing a health monitoring for cattle in Austria: first experiences. In: EAAP-Book of Abstracts No. 13: 58th Annual Meeting of the EAAP, 26-29.8.2007 Dublin, Ireland, 363.
- Dohoo I, Martin W, Stryhn H (2003) : Veterinary Epidemiologic Research. Atlantic Veterinary College, Charlottetown, PE, Canada.
- Hofrichter, J., Winter, P., Fuchs, K. (2010): Comparison of two statistical models based on Somatic cell count for diagnosis of intramammary infections at cow level. 5th IDF Mastitis Conference, 21.-24.03. 2010, New Zealand, p. 558-561.
- Lam TJGM, Olde Riekerink RGM, Sampimon OC, Smith H (2009): Mastitis diagnostics and performance monitoring: a practical approach. Irish Vet. J. 62, Suppl, 34-39.
- National Mastitis Council (1999): Laboratory Handbook on Bovine Mastitis. Madison WI, USA: NMC.
- Pantoja JCF, Hlland C, Ruegg P. (2009): Dynamics of somatic cell counts and intramammary infections across dry period. Prev. Vet. Med. 90, 43-54.
- Pantoja JCF, Hlland C, Ruegg P. (2009): Somatic cell count status across the dry period as a risk factor for the development of clinical mastitis in the subsequent lactation. J. Dairy Sci. 92, 139-148.
- Schukken YH, Wilson DJ, Welcome F, Garrison-Tikofsky L, Gonzalez RN. (2003): Monitoring udder health and milk quality using somatic cell counts. Vet. Res. 34, 579-596.
- Torres AH, Rajala-Schultz PJ, De Graves FJ, Hoblet KH. (2008) : Using dairy herd improvement records and clinical mastitis history to identify subclinical mastitis infections at dry-off. J. Dairy Res. 75, 240-247.
- Ruegg PL. (2003): Investigations of mastitis problems on farms. Vet. Clin. North Am. Food Anim. Pract. 19 (1), 47-74.
- Winter, P., Hofrichter, J. (2009) : Risk assessment of monthly determined somatic cell counts and cow individual parameters for detecting subclinically intramammary infections at cow level. European Buiatrics Forum, 1.-4. 12. 2009, Marseille, Frankreich, p 85.





## The role of agricultural recording systems in reducing the global carbon footprint

P.A. Dukas

*Dairy Records Management Systems, North Carolina State University, Raleigh, North Carolina, USA*

### **Abstract**

The effective use of a comprehensive recording and benchmarking system is shown to reduce the overall carbon footprint of agricultural production systems. Dairy producers, research institutions, and allied industry partners collaborating in the U.S. herd recording system (DHI) have demonstrated a 13 percent increase in resource utilization (dry matter intake) and a 15 percent reduction in projected methane production compared to herds not involved in herd recording.

The environmental benefits of herd recording are also interpreted in the context of environmental benefit per DHI worker. While the environmental benefit per cow is no longer increasing over the last ten years, the benefit per worker continues to increase, underscoring the value of herd recording organizations to a national environmental strategy.

*Keywords: Herd recording, DHI, carbon, methane, climate change*

### **1.0 Introduction**

The U.S. herd recording system (Dairy Herd Improvement or DHI) has grown steadily over its 105-year history due to a strong focus on genetic improvement, reproductive management, mastitis control, and more recently, health and disease management. DHI continued to evolve as new management tools became available, now reaching almost 50 percent of U.S. dairy cattle. Over the last 30 years, the full cost of herd recording has been borne by the dairy farmer, with no government subsidies, thus underscoring the value of DHI to the participating farmers. (Table 1)

However, DHI's sole orientation to date has been towards the profitability of the dairy farmer. Increasingly, U.S. agriculture, including the dairy industry, is coming under the increased scrutiny of environmental groups and federal and local governmental agencies. Environmental stewardship and management of public perception is becoming an important element in farm management.

DHI can serve an additional societal role in reducing the amount of greenhouse gases released under all forms of dairy production, including high-density, conventional, organic, or grazing operations. This paper provides a preliminary view of production metrics recast in an environmental orientation.

*Table 1. Enrollment in DHI and DRMS Herd Recording Programs.*

Year	All U.S. Cows	DHI Enrollment	DRMS Enrollment
2001	9,102,000 4,	282,206 1,	659,064
2002	9,139,000 4,	226,692 1,	664,236
2003	9,082,000 4,	232,629 1,	864,028
2004	9,011,000 4,	071,099 1,	784,804
2005	9,043,000 4,	121,752 1,	825,864
2006	9,137,000 4,	162,303 1,	811,851
2007	9,189,000 4,	243,205 1,	847,371
2008	9,315,000 4,	414,821 2,	192,080
2009	9,200,000 4,	443,029 2,	201,821
2010	9,085,000 4,	255,950 2,	108,057

## 2.0 U.S. Perspectives on greenhouse gases

The role of greenhouse gases in climate change is controversial in the U.S and other countries. However, the increase in the level of controversy cannot be avoided. The official position of the U.S. Environmental Protection Agency (EPA) identifies methane of greatest concern:

*“Methane (CH<sub>4</sub>) is a greenhouse gas that remains in the atmosphere for approximately 9-15 years. Methane is over 20 times more effective in trapping heat in the atmosphere than carbon dioxide (CO<sub>2</sub>) over a 100-year period and is emitted from a variety of natural and human-influenced sources. Human-influenced sources include landfills, natural gas and petroleum systems, agricultural activities, coal mining, stationary and mobile combustion, wastewater treatment, and certain industrial process.”*

The regulation of carbon dioxide seems less certain than the focus on methane. The U.S. EPA highlights that enteric fermentation and manure management comprised 32.8 percent of methane production in 2008.

## 3.0 Relative methane production of DHI cows

The mean production of dairy cows (9.1m) in the U.S. in 2006 was 9,048 kg of milk (Economic Research Service, 2006). Forty-nine percent of U.S. cows (4.5m) were involved in formal milk recording schemes defined by the National Dairy Herd Improvement Association (DHI). The mean production of these DHI cows in 2006 was 10,101 kg. Therefore, the production of cows not involved in DHI was 7,989 kg, resulting in a production advantage of 26 percent.

Dry matter intake (DMI) is calculated using the National Research Council, 2001 model.

$$\text{DMI (kg/d)} = (0.372 \times \text{FCM} + 0.0968 \times \text{BW}^{0.75})$$

The relationship of methane production to dry matter intake (Ellis, 2007) is:

$$\text{CH}_4 \text{ (Megajoules/d)} = 3.23 + [0.81 \times \text{DMI (in kg/d)}]$$

Applying these DMI and CH<sub>4</sub> models to the DHI production advantage reveals the CH<sub>4</sub> advantage for herds enrolled in milk recording. “Cows Needed” is the number of cows (in millions) required to produce the quantity of milk to meet U.S. consumption and export needs.

Since methane output is derived from dry matter intake, the underlying principle remains the increased production capacity per unit of maintenance. This is clearly demonstrated by the reduced size of the national herd needed as more cows are enrolled in DHI. It should be noted that DHI and non-DHI cows have made significant advances over the last ten years, but the degree of superiority of DHI cows is beginning to shrink.

## 4.0 Contribution of somatic cell testing and genetic progress

Two significant elements in the effectiveness of DHI have been somatic cell testing and genetic evaluations. Progress has been consistent over the last ten years, as shown in Table 3.

While milk production data are available for non-DHI cows, DHI produces the only national summary of farm performance for SCC and genetic data, and includes only cows enrolled in DHI (AIPL, 2010). One of the few available studies in respect of DHI enrollment covered the 14 states that shipped at least 60 percent of milk through the Federal milk order system. While a direct comparison against the DHI database is not possible, the rate of improvement over the six-year period is comparable – approximately 12 percent.

Table 2. Relative methane production of a national herd of DHI vs. Non-DHI cows.

Year	If all cows on DHI recording					If no cows on DHI recording					Relative CH <sub>4</sub> Produced (%)
	Milk (kg)	DMI (kg)	CH <sub>4</sub> /cow MJ/d	Cows(m) Needed	U.S. CH <sub>4</sub> MJ/d (m)	Milk (kg)	DMI (kg)	CH <sub>4</sub> /cow MJ/d	Cows(m) Needed	U.S. CH <sub>4</sub> MJ/d (m)	
1997	24.3	9.75	11.13	7.99	88.92	18.3	8.71	10.28	10.63	109.27	81.37
1998	24.8	9.84	11.20	7.88	88.30	18.4	8.71	10.28	10.64	109.40	80.72
1999	25.4	9.93	11.27	7.95	89.59	19.0	8.80	10.36	10.63	110.05	81.40
2000	25.9	10.02	11.35	8.04	91.21	19.5	8.93	10.47	10.65	111.42	81.86
2001	25.9	10.02	11.35	7.93	90.01	19.5	8.89	10.43	10.55	110.09	81.76
2002	26.4	10.11	11.42	8.02	91.58	20.1	9.02	10.54	10.51	110.80	82.65
2003	26.4	10.11	11.42	8.02	91.65	20.5	9.07	10.58	10.32	109.19	83.94
2004	26.4	10.11	11.42	8.04	91.88	21.0	9.16	10.65	10.09	107.48	85.48
2005	27.2	10.25	11.53	8.10	93.36	21.8	9.30	10.76	10.07	108.37	86.15
2006	27.7	10.34	11.61	8.16	94.71	21.9	9.34	10.80	10.32	111.41	85.01

Table 3. Progress in somatic cell counts and net merit \$.

Year	Somatic Cell Count U.S. DHI Cows	Somatic Cell Count Cows in 14-State Federal Milk Order Study
2000	311,000	--
2001	322,000	--
2002	313,000	291,000
2003	319,000	283,000
2004	295,000	265,000
2005	296,000	257,000
2006	288,000	247,000
2007	276,000	258,000
2008	262,000	--
2009	233,000	--

A literature survey (Hortet, 1998) revealed an average daily loss of 0.4 kg in primiparous and 0.6 kg in multiparous cows for each doubling of somatic cell count. This effect contributes approximately 12 percent of the improvement in DHI cows over the ten-year period.

Genetic progress also contributes a significant portion of the ten-year gain. Using data in table 4, this contribution is estimated to be approximately 30 percent. The advent of genomics evaluations will likely have a significant positive effect on the rate of progress. It is likely that DHI data will continue to play an important role in:

- Validating the base genomics research.

- Continuing to provide evaluation data for traits not summarized in genomics evaluations.

- Most significantly, supporting management decisions as the intensity of the decision process increases due to the increased production levels resulting from genomic evaluations.

## 5.0 Potential contribution of recent developments

Other recent developments are showing strong potential for widespread adoption, and should be evaluated to determine their contribution to the overall effectiveness of the DHI program. These developments include:

- Pathogen testing, including Johne's, leukosis and other pathogens.

- Advanced management-level analysis tools recently released by the DHRMS and AgSource processing centers.

- Gender-selected semen.



Table 4. U.S. genetic progress (Indexed to year 2000).

Year	Service Sire Net Merit \$ DRMS Holsteins	Sire PTA\$ DRMS Holsteins First Lactation	Sire PTA\$ DRMS Holsteins All Lactations
2000	324	212	157
2001	341	240	186
2002	362	261	211
2003	369	280	237
2004	398	309	266
2005	423	334	293
2006	422	332	299
2007	438	354	314
2008	472	385	343
2009	517	414	372

## 6.0 Contribution of DHI organizations and employees

Approximately 800 DHI technicians, field managers, and laboratory staff collect and process data from 14,500 dairy farms enrolled in DHIA Affiliate organizations served by DRMS, at an average monthly cost of EUR 1.42 (US\$1.76). This workforce is responsible for the avoidance of 4.25 million megajoules of methane per day (5,300 MJ/d per person), although some consideration should be given to suppliers of milk meters, analyzers, and other components of the milk recording industry.

Using EPA's coalbed methane calculator, 5,300 MJ/d represents 2.0 metric tons CO<sub>2</sub> equivalent per day, or 730 tons per year. The average U. S. citizen produces a CO<sub>2</sub> equivalent of 27 tons. Therefore, the efforts of each DHI worker offsets the carbon footprint of approximately 26 other citizens.

DHI's environmental efficiencies will continue to increase due to new mobile data collection devices, increased analyzer efficiency, additional analyses from the milk sample, and increases in herd size.

## 6.0 Opportunities

**Organizational perceptions** can be enhanced by communicating the impact of herd recording on the reduction of greenhouse gasses. While this opportunity may not yield a direct economic benefit, it provides the opportunity to convey the contribution to the community in a significant and documented manner.

**Employee relations** and the attraction/retention of employees can also be aided by communicating this impact. For example, many employees at DRMS are motivated by the opportunity to strengthen the lives of over 14,000 dairy farm families. The opportunity to contribute to the quality of the global environment can only deepen this employee commitment.

**Public funding for marketing and enrollment campaigns** may be achieved by providing documented proof of the effectiveness of herd recording.

**Measurement of organizational effectiveness** can be improved by comparing outcomes in farm performance, including environmental impact. While the superiority of production is still significant under U.S. herd recording schemes, the recent narrowing of this superiority should stimulate a realistic assessment of current and future product development and marketing strategies.

## 7.0 References

Economic Research Service, 2006.

Ellis, J.L. and E. Kebreab, N. E. Odongo, B. W. McBride, E. K. Okine and J. France, 2007. Prediction of Methane Production from Dairy and Beef Cattle. J. Dairy Sci. 2007. 90:3456-3466.

Environmental Protection Agency, 2010. Coalbed methane outreach calculator. On-line  
<http://www.epa.gov/cmop/resources/converter.html>

Garcia, A.D. and J.G. Linn, 2008. Dairy Cows and the Environment. Presentation, American Dairy Science Association.

Hortet, P. and H. Seegers, 1998. Calculated milk production losses associated with elevated somatic cell counts in dairy cows: review and critical discussion. *Veterinary Research* 29(6):497-510.

Norman, H.D., 2010. Annual DHI Reports. United States Department of Agriculture Animal Improvement Program Laboratory. On-line: <http://aipl.arsusda.gov/publish/dhi.htm>

Nutrient Requirements of Dairy Cattle, National Research Council, 2001.





## Management of the B-system in a small country

K. Ilves

*Estonian Animal Recording Centre, Kreutzwaldi 48A, Tartu, Estonia*

### **Abstract**

Although 92% of cows in Estonia are in milk recording, the size of population still remains smaller than in most countries. The Animal Recording Centre (Jõudluskontrolli Keskus) is a state agency which offers in addition to milk recording also services to the breeders of other animal species. The possibilities offered by the Internet have been successfully used for over 10 years during the process of animal recording system development in Estonia. Presently, 51% of farmers, who own in total 88% of cows in milk recording, use Internet-based solutions for dairy cattle recording.

*Keywords: Milk recording, management.*

### **1.0 Background**

In Estonia, milk recording has a more than 100 years long history. Throughout the years milk recording has been organised through farmers' organisations, scientific institutions and, for the last seventeen years, an independent state agency.

The number of herds and animals has constantly fluctuated in the last twenty years. After the Republic of

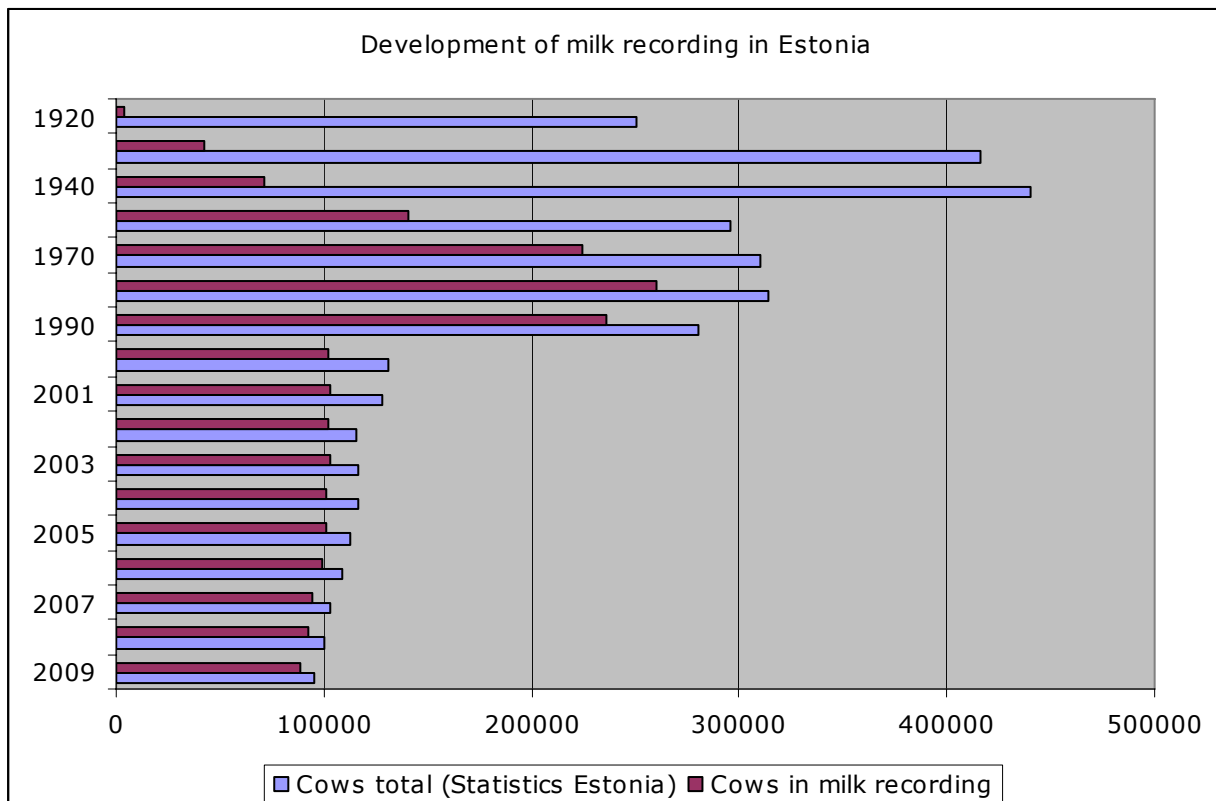

Estonia regained independence, former state companies were liquidated. Instead of former sovhozes and kolhoses cooperatives and numerous small farms were established. Whilst there was a steep rise in the number of herds in milk recording, the number of animals did not change significantly at first. In recent years the total number of herds and animals is declining steadily. A corresponding trend is noted in the number of herds and animals in milk recording. The direct aid scheme for dairy cow breeding had a positive impact on the number of cows in milk recording as milk recording was one of the aid eligibility criteria.

In addition to the fluctuating number of herds and animals, the whole system of animal recording has undergone major changes. Between 1993 and 1998 a complete reform of the animal recording data processing system was undertaken during which a mainframe was replaced by personal computers. In the last 10 years, the dairy farms in Estonia have also undergone large technological changes. Around 50% of dairy cows are kept in farms that have been built or reconstructed in the past 10 years. Although an average size of a herd is 86 cows, the herd structure largely varies in Estonia, from one cow to two thousand cows.

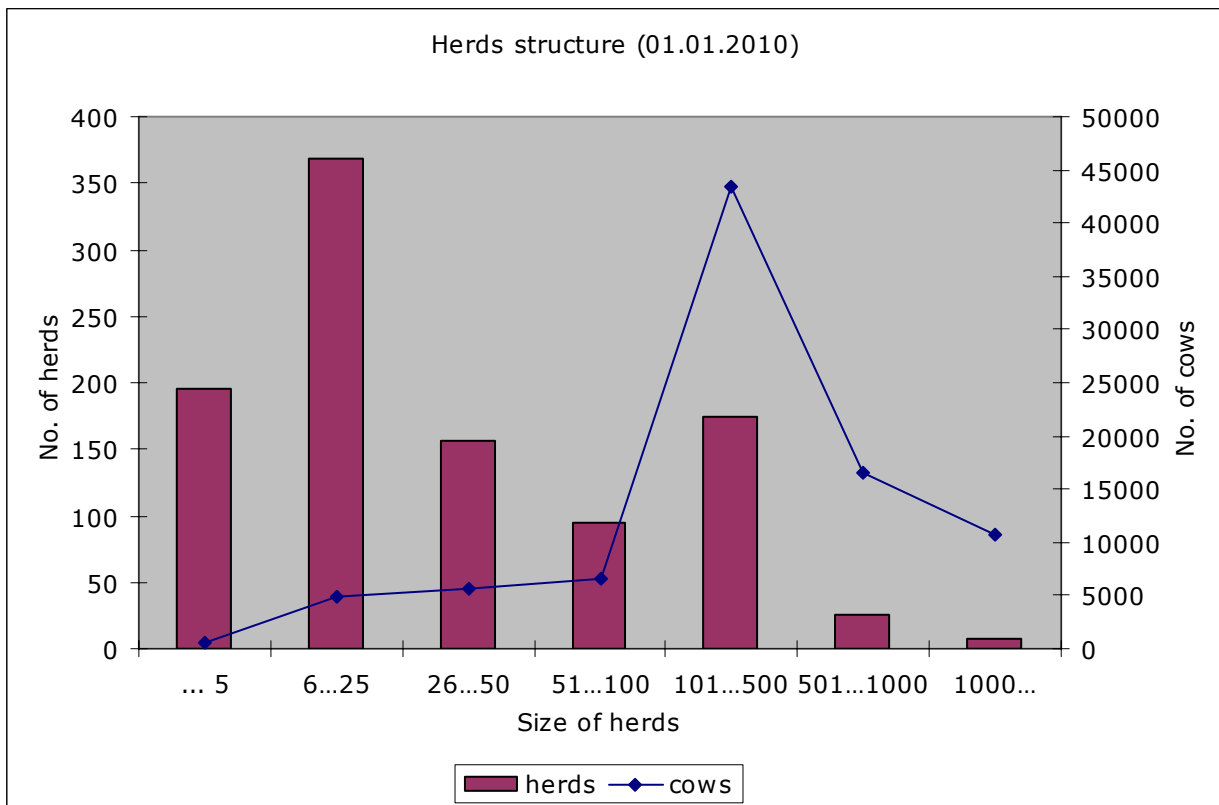

Technological development has influenced every aspect of our life and using different e-services available via the Internet (e-voting, digital signature, Internet-bank, e-school) is very popular in Estonia. In addition to the development of the Internet mobile phones are very widely spread. The Estonians are good users of several innovative mobile services as they are of Internet-based e-services. Most widely used mobile-services are mobile-parking, mobile digital signatures and using mobile phones as identification when using different Internet-software.

## 2.0 Animal recording centre

### 2.1 Management and development of the organisation

In Estonia, milk recording is organised by the Animal Recording Centre. The Animal Recording Centre is a state agency under the supervision of the Ministry of Agriculture. As a state agency the Animal Recording Centre is directly accountable to the Minister of Agriculture. The Centre does not have a board comprising of farmers. The daily management of the organisation is a cooperative effort of the members of the

management. Although the services for dairy cattle are mainly developed in the Animal Recording Centre, farmers, breeding associations belonging to the farmers and Eesti Maaülikool (Estonian University of Life Sciences) are also involved in the process.

There are two distinct periods of development in the past twenty years. From 1993 to 2000 the system of animal recording and applicable technologies were updated. During this period a unified identification system was established, the first agricultural aids were paid out in Estonia and farm animals' registers were established. As milk recording system was very well developed and the majority of milk producers were participating in the system, the milk recording database was used as the base for the establishment of the farm animals register and it was also considered suitable for the initial administration of different agricultural aid schemes. From 2000 until today we have been improving the quality of our services and developing additional services. All our employees can see monthly summaries of how quickly animal recording results are issued, the total amount of invoices issued by each service and also the total receipt of money compared to our expectations. The employees directly communicating with the farmers can also see which services each client uses as well as the amount due from the client.

## **2.2 Other services**

The primary service of the Animal Recording Centre is milk recording and other related services. In addition to milk recording we have made efforts to maximize resource utilisation and we offer IT-related services to the breeders of other animal species.

### 2.2.1 Cooperation with dairy cattle breeding association

In addition to dairy cattle performance data all data on animals used for breeding are collected into the database of the Animal Recording Centre. The Animal Recording Centre has developed several software programmes for the employees of the breeding association to help them in their daily work. Through these programmes insemination data and linear scoring data are entered straight into the database by the breeding association. The animal genetics laboratory of the Institute of Veterinary Medicine and Animal Sciences of the Estonian University of Life Sciences uses the database of the Animal Recording Centre in order to conduct compliance checks on animal data submitted for expertise analysis for genetic identification or verification of parentage data accuracy (suspected ID or HB number or the animal's date of birth is not known).

### 2.2.2 Pig performance recording and maintaining the animal breeding register

Eesti Tõusigade Aretusühistu (Estonian Pig Breeding Association) is the organization responsible for pig performance recording. The Animal Recording Centre has made an agreement with the mentioned association. The tasks of the Animal Recording Centre are to collect performance data, process it and conduct genetic evaluations and train pig farmers. The Animal Recording Centre has designed a PC software programme which is intended for daily farm management and data exchange with the Animal Recording Centre. In addition to breeding farms the fattening pig module of the same software is used by fattening farms to organise their day to day work.

### 2.2.2 Beef animal performance recording and maintaining the herd book

Eesti Tõuloomakasvatajate Ühistu (Animal Breeders Association of Estonia) is the organization responsible for beef animal performance recording. The tasks are divided between the Animal Recording Centre and Eesti Tõuloomakasvatajate Ühistu as follows: daily communication with the animal breeders (training and collecting ideas for development) is the duty of Eesti Tõuloomakasvatajate Ühistu and the Animal Recording Centre is responsible for data collection, processing and publishing. The Animal Recording Centre has also designed Internet-based software that was created for the beef breeders enabling them daily use of relevant data.

### *2.2.3 Sheep and horses performance recording and maintaining the herd book*

The responsibility for organising sheep performance recording and maintaining the herd book lies with Eesti Lambakasvatajate Selts (Estonian Sheep Breeders' Association), Eesti Hobusekasvatajate Selts (Estonian Horse Breeders' Association) and Eesti Sporthobuste Kasvatajate Selts (Estonian Sport Horse Breeders' Association), two breeding organisations uniting horse breeders, are responsible for organising horse performance recording and maintaining the herd book. The underlying principles of the services offered to the sheep and horse breeders' organisations are very similar. The Animal Recording Centre is responsible for processing and maintaining data on sheep and horses. The duty of the respective breeding organisation is to communicate with the sheep/horse breeders and enter relevant data. The Animal Recording Centre has designed an Internet-based software programme for the breeding organisations (including their members) to facilitate their everyday work.

### *2.2.4 Selling ear tags*

Although the Animal Recording Centre was the first organisation that started creating and developing animal identification system in Estonia, the official farm animals register is not presently included in the Animal Recording Centre's database. In 2000, the farm animals' register was given over to the Agricultural Registers and Information Board, a state authority that maintains all official agricultural registers. This state authority administers different aid schemes and the quota system in Estonia. The Animal Recording Centre has retained its intermediary role as the distributor of ear tags in the animal identification system. The Animal Recording Centre acquires the ear tags and sells them to the farmers, the Agricultural Registers and Information Board maintains the farm animals' register. In addition to selling ear tags, the Animal Recording Centre offers its clients registration of animal identification through the animal recording system. The clients of milk recording can also use the vehicle collecting milk samples as a means of transporting ear tags to their farm.

### *2.2.3 Raw milk quality samples for dairy processing industries*

In addition to milk recording samples (fat content, protein content, somatic cell count, urea content) quality samples are analysed in the Animal Recording Centre's laboratory. Fat content, protein content, somatic cell count, urea content, milk freezing point, bacteria count and existence or non-existence of antibiotics are tested for dairy industries. These samples account for around 5% of all samples. The test results are forwarded to the dairy industries. The farmers can see the results via the Internet or order a message through SMS to their mobile phone.

## **3.0 Organisational structure of the animal recording centre/elements of milk recording system**

In Estonia there is only one organisation engaged in milk recording. All elements of this service, starting from field service to genetic evaluation are centrally managed by the Animal Recording Centre.

### **3.1 Field service**

As the B-system is used in Estonia, our field service is not engaged in taking milk samples every day which is why we have a small number of employees in the field service. The people working in the field service act as regional coordinators whose main tasks are to train the farmers and milk recording technicians, conduct herd visits and repeat recordings. In addition to the main tasks their duties also comprise introducing and selling various services (including goods) to our clients. A negative side of their work is that they have to deal with our debtors and follow the terms for checking milk meters (milk meters are the property of the animal farmers).

In order to facilitate the work of the field service and get a general overview, an Internet-based programme, containing all necessary data for routine work and applications for recording information, was developed in cooperation with the IT-department.

### 3.1.1 Certification of technicians

There are altogether more than 600 milk recording technicians in Estonia. As in case of the A-system a technician is a person who services several farms and receives payment for the services from the farmers. In Estonia, a farmer can also be a milk recording technician. In Estonia, a person is allowed to work as a technician after he/she has undergone appropriate training at the Animal Recording Centre and successfully passed the required test. This certification is valid for three years after which the technician will have to renew the certification.

### 3.1.2 Herd visits

One of the weaknesses of the B-system is that the communication with the farmers compared to A-system is less frequent because the farmers arrange test milking themselves. In order to strengthen client relations we have initiated a system in Estonia where our field service supervisor visits each farm at least once in three years. During the visit the field service supervisor will examine the general state of the farm, draw attention to deficiencies, if necessary, help in interpreting milk recording results and introduce additional services which the particular farm does not yet use. A herd visit together with observations will be saved in the database, ensuring thus that current information is available on the farm visits and enabling making various summaries on observations made by field service supervisors.

### 3.1.3 Repeat recordings

In order to avoid errors during test milking, we carry out repeat recordings. Repeat recordings are conducted in at least 5% plus one of herds in each county. Criteria for selecting repeat recordings are following:

- The herds that belong to the best herds by production and where no repeat recording has been conducted in past 3 years.
- The herds the production of which has significantly increased year on year.
- The herds the fat content in milk of which is high.
- The herds submitted for examination by a breeders' association.
- The herds chosen randomly.

In case the analysis of repeat recording shows a deviation from test milking exceeding 7% and the herd's fat content exceeding  $\pm 0.25\%$  or there is a deviation in the recording data of a large number of cows, the reasons behind such deviations will be analysed and a new repeat recording will be carried out within 12 months from the first repeat recording. The results of test milking are replaced with the results of repeat recording.

## **3.2 Milk laboratory**

Milk recording samples and quality samples are analyzed in milk laboratory. The duty of the milk laboratory is also to arrange the collection of milk samples. Sample collection is organised so that the farmers are concurrently informed of test milking results and the next milk samples collection date. Such system ensures that the number of milk samples to be analysed is distributed evenly throughout a month and the period between days of testing falls within established limits. There are around 300 milk samples collection points all over Estonia which are mainly located near larger dairy farms. In addition to the task of collecting milk samples, we also use the samples collection vehicle as a means of transporting ear tags if an animal keeper has subscribed to such service.

In April this year we introduced real-time QPCR-based DNA mastitis analysis.



### 3.3 Data processing

Data is centrally entered and processed in the Animal Recording Centre. The need to forward information on paper has decreased with the advances in technology. The animal keepers forward around 30% of information via the Internet by entering data online or sending a file saved from the farm management software to the Animal Recording Centre. This data is checked when it is entered into the database as well as during data processing. The farmers receive milk recording data via post and they can access the data via the Internet.

### 3.4 Genetic evaluation

Dairy cattle genetic evaluation is conducted three times a year. Characteristics evaluated are:

- Production traits by random regression test day animal model.
- Conformation traits by BLUP animal model ("PEST").
- Udder health trait by random regression test day animal model.
- Fertility traits by BLUP multi-trait animal model ("PEST").
- Longevity trait using "Survival Kit".
- Calving traits by BLUP multi-trait animal model ("PEST").

Estonian Animal Recording Centre is participating in Interbull's evaluation of bulls with the production, udder health and conformation data of the Estonian Holstein breed and with the production and udder health data of the Estonian Red breed.

### 3.5 IT as a developing unit

All computer programmes used in daily work have been designed in the Animal Recording Centre. Software intended for the farmers is developed as Internet-based software. An exception to the rule is the Possu- programme, intended for pig breeders, which is a PC programme. Using Internet-based software ensures that all farmers are at any given time using the most recent version of the particular software and we do not incur costs to deliver programme updates. As all software is created in the Animal Recording Centre we can respond very quickly to programme errors and immediately repair them. We can also promptly deal with the needs of the farmers related to programme improvement. A situation typical for the largest herds in Estonia is that milk is produced on several farms and there are a number of people who enter or look up data. The advantage of Internet-based software is that all these users see the most recent information.

## 4.0 Conclusion

The reasons for the popularity of animal recording in Estonia are long traditions and good cooperation with the farmers and breeding organisations. The most significant shortcoming of an animal recording system in a small country is the continuing decrease in the number of animals, although we are able to provide services for a larger population because of investments made. The wide use of the Internet and innovative attitude of the farmers has supported us in our endeavour to provide an efficient service. The Internet helps us to keep software servicing costs low and the exchange of information between the farmers and the database is conducted quickly which in turn increases the level of satisfaction with the service. Our in-house developing team enables us to respond very rapidly to the needs of the farmers and we can independently develop new services without being hindered by external factors. The services offered to the breeders of other animal species contribute to lower information technology related costs.



## Adding value to test-day data by using modified best prediction method

A. Gillon<sup>1</sup>, S. Abras<sup>2</sup>, P. Mayeres<sup>2</sup>, C. Bertozzi<sup>2</sup> & N. Gengler<sup>1,3</sup>

<sup>1</sup>*Animal Science Unit, Gembloux Agro-Bio Tech, University of Liege, Passage des Déportés 2, 5030 Gembloux, Belgium*

<sup>2</sup>*Walloon Breeding Association, Rue des Champs Elysées 4, 5590 Ciney, Belgium*

<sup>3</sup>*National Fund for Scientific Research, Rue d'Egmont 5, 1000 Brussels, Belgium*

### Abstract

Computation of lactation yields from test-day data has lost much of its importance for genetic evaluations as the use of test-day models is currently quite widespread. In the other hand its interest for intra-farm management is increasing as a base for advanced management tools. The first and principal aim of this study was to develop a method which takes into account advantages and disadvantages of existing methods, and to test its potential to provide useful management tools to dairy farmers. A test-day model with modifications to be able daily run and management tools was developed. Because of its similarities with best prediction, the method developed here was called modified best prediction. The second objective was to compare the accuracy of this new method with best prediction and test interval methods. Modified best prediction showed good results for predicting daily yields and was slightly better than best prediction for lactation yields prediction. Management tools obtained with modified best prediction are explained.

*Keywords: Lactation yields computation, modified best prediction, test-day model, management tools.*

### 1.0 Introduction

Milk performance recording and computing of lactation yields from test-day yield data had historically two main purposes: intra herd management and genetic evaluation. The last one is often the main reason to do milk recording, however the desire of assessing precisely phenotypic performances of dairy cows was at the origin of milk recording. As the use of test-day models is currently quite widespread, lactation yields computation for genetic evaluations has lost much of its importance. At the same time, its interest for intra-farm management has increased because farms are getting larger and economic sustainability is more and more difficult to achieve.

The official method recommended by ICAR (2009) to compute lactation yields is the test interval method (**TIM**). This method connects test-day data using linear interpolation between them. Over the years, alternative methods for computing cumulated productions were developed and approved by ICAR. These methods are interpolation using standard lactation curves (Wilkinson, 1987), multiple trait prediction (**MTP**, Schaeffer and Jamrozik, 1996) and best prediction (**BP**; VanRaden, 1997). MTP combines, using a Bayesian method, the a priori knowledge on standard lactation curve and the observed data. BP combines recorded yields into a lactation record using selection index procedures, therefore it has best linear prediction properties. BP is more accurate than TIM but less accurate than the simultaneously equations as provided by BLUP (Pool and Meuwissen, 1999).

Furthermore, several authors have shown the potential for calculating cumulated production with test-day models (**TDM**). Pool and Meuwissen (1999), Mayeres *et al.* (2004), and Vasconcelos *et al.* (2004) reported the ability of a TDM to predict daily and lactation yields. Mayeres *et al.* (2004), Koivula *et al.* (2007), and Caccamo *et al.* (2008) showed the interest of using a TDM to bring useful management tools to dairy farmers. However full, population wide TDM require important computations resources. They are therefore performed on schedules, e. g., three times a year for the INTERBULL international genetic evaluations. This reduces their direct usefulness as farmers need lactation yields and other management results a few days after milk recording.

The aim of this study was first to develop a new method which takes into account advantages and disadvantages of existing methods, is applicable on the field, and brings useful management tools. The

second objective was to test the ability of this new method to describe and predict daily and lactation yields.

## 2.0 Materials and Methods

### 2.1 Data

Data available in this study were 21, 839,073 test-day data (milk, fat, protein, and somatic cell count) coming from milk recording in Walloon region of Belgium and collected between January 1980 and March 2010. These data included all lactations and all dairy breeds, including dual purpose breeds. Pedigree and lactation data were also provided.

Additional data consisting in daily individual milk yields were collected in 8 herds. After editing, 132,607 daily production records, from 562 lactations, 312 cows and 4 herds were kept.

### 2.2 Model

Because of its similarities with BP, the method developed here was called modified-BP (**mBP**). However, some elements of others methods have been included.

The mBP method has the following properties:

- multiple-trait computation (milk, fat and protein yields, somatic cell score);

- (co)variances are supposed to be known and constant;

- standard lactation curves account for general pattern of lactation curve within breed and age at calving classes, year of production within herd, season of production within herd, herd deviation from general pattern of lactation curve, and genetic value of the cow.

The main differences between mBP and BP are the definition of the standard lactation curves and the inclusion of individual genetic value. In order to minimize bias, components of standard lactation curves specific to the herd are computed jointly with random individual effect. Components of standard lactation curves obtained using the whole population (i.e. genetic values and general pattern of lactation within breed, age at calving and parity) are not recomputed each time but extracted from databases. If a cow moves from one herd to another during its lactation, standard lactation curves components specific to the herd are changed at the time of transfer. The inclusion of genetic effects is important for predicting daily yields when lactation is in progress if a cow is genetically more or less persistent than population average.

Among possible implementations of this method, we choose to use a multi-trait multi-lactation random regression TDM that allowed direct joint estimation of fixed and random effects. Data were pre-corrected for population level effects in order to make possible a daily run at herd level. Therefore, mBP could be located between BP and population-wide TDM with BLUP properties integrating ideas about distributed computing and sequential solving (Gengler *et al.*, 2000). Classical fixed herd x test-day effect was replaced by three herd effects to enable herd-management prediction following Mayeres *et al.* (2004). These three effects are a fixed herd x test year effect, a fixed herd x test month x period of 5 years effect, and a random herd x test-day effect. These three herd effects reflect evolution of herd management level, corrected for lactation stage, age at calving, parity, and genetics.

The global model could be written as follows:

$$\mathbf{y} = \mathbf{X}\boldsymbol{\beta} + \mathbf{Tt} + \mathbf{Wh} + \mathbf{Zp} + \mathbf{Za} + \mathbf{e}$$

Where:

- $\mathbf{y}$  is the vector of observations (milk, fat and protein yields, somatic cell score);

- $\boldsymbol{\beta}$  is the vector of fixed effects:

- class of 5 DIM x class of breed x class of age at calving (data are pre-corrected for this effect),
- herd x test year,
- herd x test month x 5 year period;

- $\mathbf{t}$  is the vector of random herd x test-day effect;
- $\mathbf{h}$  is the vector of herd x year of calving random regression coefficients;
- $\mathbf{p}$  is the vector of permanent environmental random regression coefficients;
- $\mathbf{a}$  is the vector of genetic additive random regression coefficients (data are pre-corrected for this effect);
- $\mathbf{e}$  is the vector of residuals;
- $\mathbf{X}$ ,  $\mathbf{T}$ ,  $\mathbf{W}$  and  $\mathbf{Z}$  are incidence matrices assigning observations to effects.

Herd x year of calving random regression effect was not used for somatic cell score modelling.

Finally a variant of this method was tested. This variant contains integration of expectations of constant animal effects to observed average values using a Bayesian prediction approach. The Bayesian method is similar to the MTP method, only avoiding expectations about lactation shape curves. This approach was called **mBPb**. Using this variant, the expected value of the residuals in a given lactation for a given animal was forced to be zero. The reason for the development of this alternative method was that with standard mBP, expected value of the residuals is only zero by herd. The consequence is that predicted curves could not reflect the observed records of extreme cows compared to the average animal in this herd.

(Co)variances estimations were obtained from REML and Gibbs sampling (Misztal, 2009).

## 2.3 Validation

In order to validate mBP, adjustment quality and prediction ability were studied. Adjustment quality is the difference between observed records used for solving the model and predicted values for these test-days. Prediction ability is the ability of the model to predict values of the following test-day. mBP and mBPb were run for 400 herds. Data of last available test-day were set to zero. All records needed for running mBP and mBPb were used to assess the adjustment quality of the model; and daily predictions for the last available test-date were used to assess the prediction ability of the model. Mean error, mean square error and correlations were computed for these two parameters.

Lactation yields prediction was also estimated. To match as much as possible to the reality, official test-day records were simulated, using actual daily production and respecting the schedule of conditions and the characteristics of the Walloon situation:

each herd had the probability of 87 percent to be simulated in a A4 test plan and 13 percent to be simulated in a A6 plan;

time between two tests was between 22 and 37 days (A4) or between 38 and 53 days (A6). To make test interval longer, each test-day had also 1 percent of probability to be cancelled;

corresponding to the current practice, tests were not done in July for A4 plan;

first test of the lactation had to be performed after the fourth day in milk.

A total of 200 simulations were done. Using these simulated test-day data, mBP, mBPb, BP and TIM lactations yields were computed and compared to the real ones. When real daily milk yields were missing, predictions for these days were not taken into account for mBP, mBPb, BP and TIM lactation yields calculation. For each method, mean, standard deviation, relative bias and correlation with actual lactation yields were computed on overall data set, by parity, and by test plan.

BP method was official best prediction program downloaded on AIPL website. To allow comparison with mBP, data were pre-corrected for parity x age at calving x breed, and standard lactation curves accounted for herd x season of calving.

Lactation yields prediction when lactation is in progress was also studied. The method was similar but only 25 simulations were done. For each simulation, 11 data sets were created: the first one contained only first test-day records; the second one contained only first and second test-day records, and so on. Each 305-d lactation yields prediction was compared to the real one for each data set.

### 3.0 Results and discussion

#### 3.1 Lactation curve modelling and herd means

As described before mBP is a method to compute daily and lactation yields, but it also can compute management tools such as evolution of herd effects, peak yield and persistency. This method can be run daily herd by herd, and farmers can receive results a few days after milk recording. Figure 1 shows milk yields modelled with mBP method from an ended lactation. Prediction of entire lactation with four test-day records is shown on Figure 2. The inclusion of genetic effects in lactation curve allows to take into account genetic persistency of a cow, in addition to average persistency of the herd (explained by herd x year of calving effect) and of the breed (explained by class of 5 DIM x class of breed x class of age at calving effect).

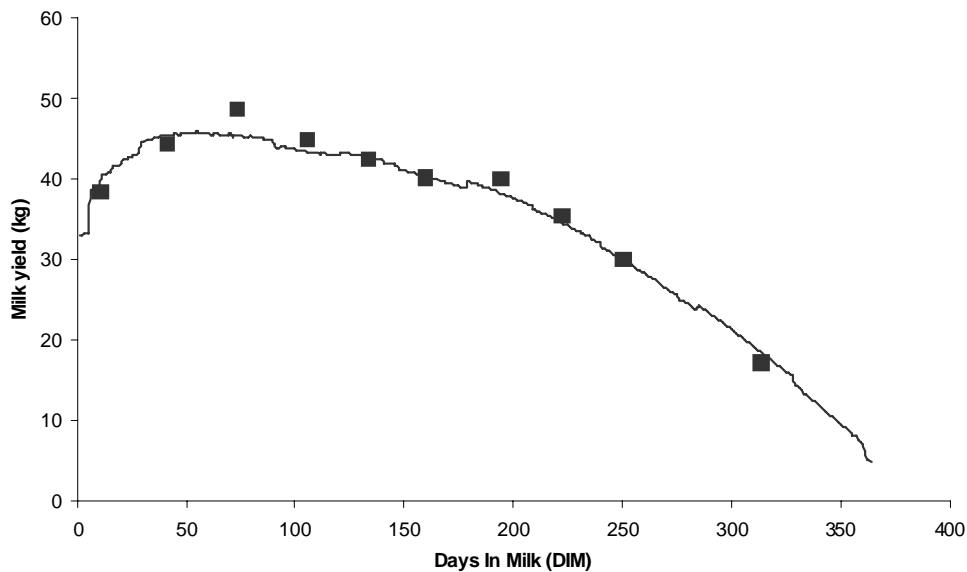

Figure 1. Illustration of the modelling of a lactation by modified-best prediction (mBP) method. (■ test day record; —mBP modelling).

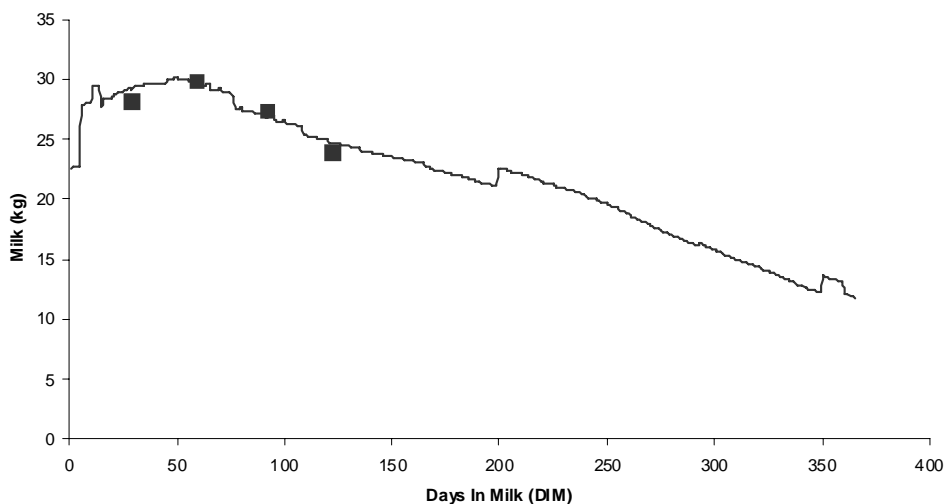

Figure 2. Prediction of the entire lactation with four test day records by modified-best prediction (mBP) method. (■ test day record; — mBP modelling).

As in Mayeres *et al.* (2004) a modification of classical fixed herd x test-date effect was done in order to predict herd effects for each day of the lactation. Figure 3 shows evolution of these three effects for a particular herd. Herd x test year effect shows a regular decrease of management level over the years. Herd x test month x period of 5 years effect shows seasonal variation of management level inside years. And herd x test-day effect includes the part of the herd variation that is not explained by the two previous effects. Sum of these three effects shows the general evolution of herd management, which is decreasing in this particular herd. General decrease can be explained by an extension of farming practices and seasonal variation by period of grazing or seasonal feeding. But if these variations can not be explained, results indicate management problems that need to be identified and solved. These herd management level indicators are corrected for lactation stage, breed, age at calving, and genetic, so interpretation of these values is more accurate than interpretation of raw yields. Similarly to Koi vula *et al.* (2007), values of random herd x test day effect reflects difference between predicted and observed values for herd management. No thresholds to detect management problems have been tested so far. Herd x calving year random regression could also be plotted as done by Caccamo *et al.* (2008).

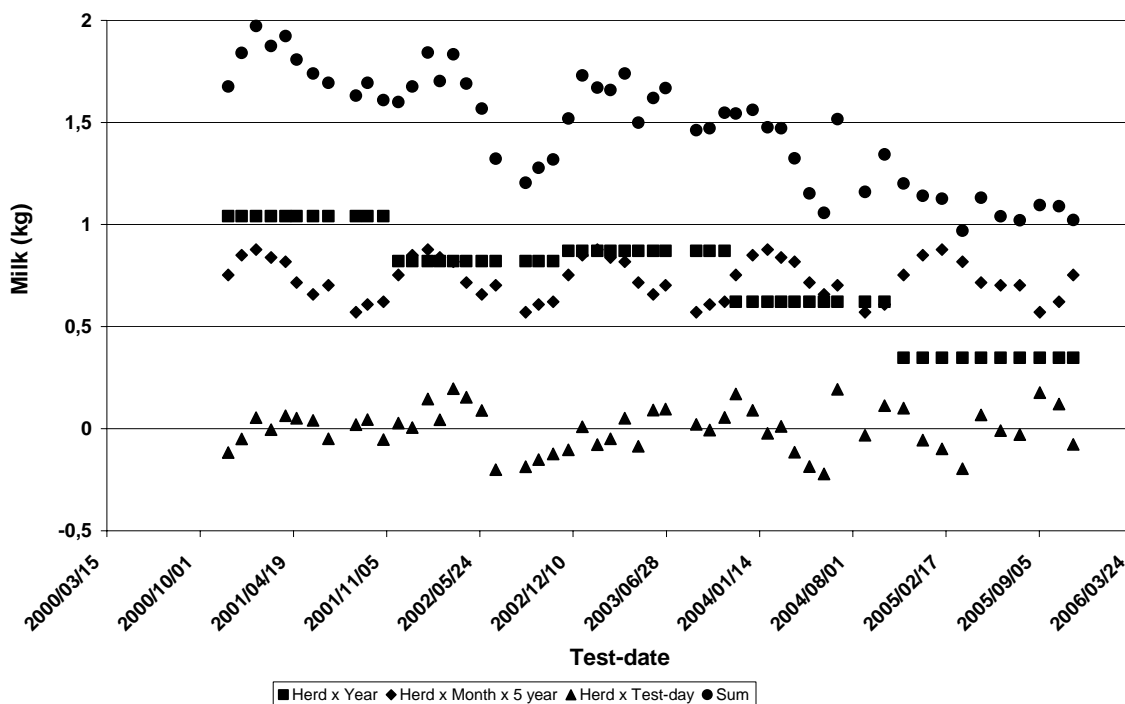

Figure 3. Evolution of herd solutions for a particular herd.

### 3.2 Validation

Adjustment quality was analyzed for mBP and mBPb methods. Table 1 shows results for parity one. Results were similar for other parities. Adjustment quality is the difference between available records and predicted values for these test-days. As shown in Table 1 mean error is null, mean square error is small and correlations are high, ranging from 0.85 for somatic cell score to 0.95 for milk yields. The two methods showed similar results. Prediction ability is shown in Table 2 for first parity. Prediction ability is the ability to predict values of the following test-day. The mBPb method was inferior to mBP in its ability to predict yields of following test-day. This result was not unexpected as in mBPb the prediction is centred on the already observed values for a given cow. Further results given in Table 3 will show that this issue disappears when more test-days become available.

Table 1. Adjustment quality for mBP and mBPb methods in first parity.

Trait	N	mBP			mBPb		
		ME <sup>1</sup>	MSE <sup>2</sup>	Corr. <sup>3</sup>	ME <sup>1</sup>	MSE <sup>2</sup>	Corr. <sup>3</sup>
Milk (kg)	651,266	0.00	4.28	0.95	0.00	4.17	0.95
Fat (kg)	651,266	0.00	0.01	0.92	0.00	0.01	0.92
Protein (kg)	651,266	0.00	0.01	0.93	0.00	0.01	0.94
SCS	556,791	0.00	0.70	0.85	0.00	0.68	0.85

<sup>1</sup> ME: mean error.<sup>2</sup> MSE: mean square error.<sup>3</sup> Corr.: correlation between observation and prediction.

Table 2. Prediction ability for mBP and mBPb methods in first parity.

Trait	N	mBP			mBPb		
		ME <sup>1</sup>	MSE <sup>2</sup>	Corr. <sup>3</sup>	ME <sup>1</sup>	MSE <sup>2</sup>	Corr. <sup>3</sup>
Milk (kg)	7,368	-0.09	12.37	.87	-1.73	29.47	.75
Fat (kg)	7,368	0.00	0.03	.83	-0.06	0.06	.69
Protein (kg)	7,368	0.01	0.01	.85	-0.07	0.03	.72
SCS	6,233	0.00	1.70	.57	-0.22	2.31	.49

<sup>1</sup> ME: mean error<sup>2</sup> MSE: mean square error<sup>3</sup> Corr.: correlation between observation and prediction

Simulation of fictive test-day yields was done with real daily milk yields in order to maximize situations that can be present in reality. Lactations yields were computed using 5 methods: real yields, mBP, mBPb, BP, and TIM. For each method, mean and standard deviation were reported. Relative bias and correlation with real productions were also computed. For lactation yields description (when lactation is finished), analyse was done per parity and per data collecting plan. For lactation yields prediction (when lactation is in progress), analyse was done by number of available tests. Table 3 shows that mBP method was the best method even if differences were quite small. BP had higher relative bias for first parity. Additional study has to be made to see if it can be explained by production level. After 3 tests, lactation yields were predicted with high precision: relative bias was smaller than 1 percent and correlations were higher than .90 with mBP and mBPb methods. With BP, this level of precision was reached after 5 available tests.

## 4.0 Conclusions

The new proposed method called mBP is a daily and lactation yields computation method based on TDM that can bring management tools such as evolution of management level, peak yield and persistency. This method can be run daily herd by herd, and farmers can receive results a few days after milk recording. Validation showed that mBP was better than mBPb, that was developed to solve issues with extreme cows, and BP but differences were small. Possible management tools can be directly deduced from results that are potentially very useful tools to dairy farmers.

Table 3. Lactation yields prediction when lactation is terminated (description) and when lactation is in progress (prediction) for 4 methods: mBP, mBPb, BP, and TIM, compared with real lactation yields.

DESCRIPTION	N	305-d lactation yields																		
		Real		mBP				mBPb				BESTPRED				TIM				
		Mean	std	Mean	std	r.bias <sup>1</sup>	Corr. <sup>2</sup>	Mean	std	r.bias <sup>1</sup>	Corr. <sup>2</sup>	Mean	std	r.bias <sup>1</sup>	Corr. <sup>2</sup>	Mean	std	r.bias <sup>1</sup>	Corr. <sup>2</sup>	
all	80200	7230	1930	7227	1917	-0.04	0.991	7235	1949	0.07	0.990	7077	1927	-2.12	0.985	7254	1951	0.33	0.990	
by parity																				
lact=1	26600	6361	1352	6361	1364	0.00	0.985	6369	1383	0.13	0.985	6012	1200	-5.49	0.979	6376	1382	0.24	0.984	
lact=2	17600	7348	1853	7356	1849	0.11	0.990	7363	1880	0.20	0.990	7217	1775	-1.78	0.987	7385	1883	0.50	0.990	
lact=3	15600	7986	2182	7962	2176	-0.30	0.991	7974	2217	-0.15	0.991	7946	2177	-0.50	0.991	8000	2205	0.18	0.990	
lact=4	10000	8036	1999	8029	1970	-0.09	0.990	8050	2000	0.17	0.989	8045	1993	0.11	0.989	8086	2004	0.62	0.988	
lact=5	4800	8157	1877	8128	1823	-0.36	0.986	8148	1878	-0.11	0.987	8137	1865	-0.25	0.988	8176	1890	0.23	0.987	
lact=6 +	5600	6643	1730	6677	1673	0.51	0.988	6644	1717	0.02	0.988	6631	1673	-0.18	0.987	6655	1718	0.18	0.988	
by data collection plan																				
A4	69774	7230	1930	7229	1917	-0.01	0.991	7236	1948	0.08	0.991	7080	1928	-2.07	0.986	7253	1950	0.32	0.991	
A6	10426	7230	1930	7213	1912	-0.24	0.988	7225	1955	-0.07	0.987	7054	1924	-2.43	0.982	7256	1958	0.36	0.987	
<b>PREDICTION</b>																				
number of available tests																				
1	3179	7716	1833	7489	1670	-2.94	0.907	7373	2343	-4.45	0.811	7731	1954	0.19	0.838	-	-	-	-	
2	5638	7556	1889	7449	1800	-1.42	0.934	7466	2308	-1.19	0.884	7786	2030	3.04	0.896	-	-	-	-	
3	6271	7473	1861	7438	1852	-0.50	0.948	7509	2216	0.48	0.920	7653	1989	2.41	0.923	-	-	-	-	
4	6695	7292	1867	7272	1877	-0.27	0.960	7345	2136	0.73	0.943	7368	1962	1.04	0.942	-	-	-	-	
5	7603	7117	1904	7101	1910	-0.22	0.974	7160	2085	0.60	0.966	7114	1976	-0.04	0.962	-	-	-	-	
6	7211	7272	1878	7248	1863	-0.33	0.979	7299	1989	0.37	0.975	7213	1919	-0.81	0.968	-	-	-	-	
7	6842	7462	1958	7438	1936	-0.32	0.985	7482	2033	0.27	0.983	7376	1989	-1.15	0.977	-	-	-	-	
8	6066	7602	1908	7566	1882	-0.47	0.988	7595	1947	-0.09	0.987	7484	1919	-1.55	0.981	-	-	-	-	
9	5267	7745	2082	7720	2067	-0.32	0.992	7742	2122	-0.04	0.991	7610	2114	-1.74	0.986	-	-	-	-	
10	3701	7639	2024	7613	2006	-0.34	0.992	7626	2042	-0.17	0.992	7455	2024	-2.41	0.987	-	-	-	-	
11	2656	7816	2110	7786	2083	-0.38	0.993	7803	2116	-0.17	0.992	7624	2135	-2.46	0.988	-	-	-	-	

<sup>1</sup>Relative bias (%) = (mean - real mean)\*100 / real mean

<sup>2</sup>Correlations between real and predicted lactation yields

## 5.0 Acknowledgments

The authors gratefully acknowledge financial support of the Ministry of Agriculture of the Walloon Region of Belgium [Service Public de Wallonie, Direction générale opérationnelle "Agriculture, Ressources naturelles et Environnement", projets 2732, 2733 et D31-1207], help from John Cole (AIPL-ARS-USDA) in the installation and parameterisation of best prediction, and manuscript review by Catherine Bastin (Gembloux Agro-Bio Tech, University of Liege, Belgium). The first author and Nicolas Gengler, research associate at the National Fund for Scientific Research (Brussels, Belgium), acknowledge the financial support provided by the National Fund for Scientific Research through grants F.4552.05 and 2.4507.02 F for processing facilities.

## 6.0 References

- Caccamo M., Veerkamp R. F., de Jong G., Pool M. H., Petri glieri R., and Licitra G.. 2008. Variance components for test-day milk, fat, and protein yield, and somatic cell score for analyzing management information. *J. Dairy Sci.* 91:3268-3276.
- Gengler N., Tijani A., and Wiggans G. R. 2000. Use of sequential estimation of regressions and effects on regressions to solve large multivariate test-day models. *J. Dairy Sci.* 83: 369 (online-only: <http://jds.fass.org/cgi/data/83/2/369/DC1/1>).
- ICAR. 2009. International agreement of recording practices. Available at [www.icar.org](http://www.icar.org)
- Koivula M., Nousiainen J. I., Nousiainen J., and Mäntysaari E. A.. 2007. Use of herd solutions from a random regression test-day model for diagnostic dairy herd management. *J. Dairy Sci.* 90:2563-2568.
- Mayeres P., Stoll J., Bor mann J., Re ents R., and Gengler N.. 2004. Prediction of daily milk, fat, and protein production by a random regression test-day model. *J. Dairy Sci.* 87:1925-1933.



- Misztal, I. 2009. BLUPF90 family of programs. University of Georgia.  
<http://nce.ads.uga.edu/~ignacy/numpub/blupf90>
- Pool M. H. and Meuwissen T. H. E.. 1999. Prediction of daily milk yields from a limited number of test days using test day models. *J. Dairy Sci* 82:1555-1564.
- Schaeffer L. R. and Jamrozik J.. 1996. Multiple-trait prediction of lactation yields for dairy cows. *J. Dairy Sci.* 79:2044-2055.
- VanRaden P. M.. 1997. Lactation yields and accuracies computed from test day yields and (co)variances by best prediction. *J. Dairy Sci.* 80:3015-3022.
- Vasconcelos J. , Martins A. , Petim-Batista M. F. , Colaço J. , Blake R. W. , and Carneira J. . 2004. Prediction of Daily and lactation yields of milk of milk, fat, and protein using an autoregressive repeatability test day model. *J. Dairy Sci.* 87:2591-2498.
- Wilmink J. B. M.. 1987. Comparison of different methods of predicting 305-day milk yield using means calculated from within-herd lactation curves. *Livest. Prod. Sci.* 17:1-17.



## Improved method for calculating daily yields from alternate testing schemes

A. Bünger<sup>1</sup>, X. Bourrigan<sup>2</sup>, H. Leclerc<sup>2</sup>, Z. Liu<sup>1</sup>, K. Kuwan<sup>1</sup> & S. Mattalia<sup>1</sup>

<sup>1</sup>VIT, Heideweg 1, Verden, Germany

<sup>2</sup>Institut de l'Élevage, Paris, France

### **Abstract**

The alternating morning and evening testing scheme, even though it is less accurate than a standard supervised milk recording programme, is more and more implemented on the farm level to reduce costs. In France, this scheme is widely used with Lactocorders. As this technique provides milk yields from both morning and evening milkings ("Z" testing schemes), a new approach was developed to improve estimated 24-hour daily fat and protein yields, by extending the current German model to estimate daily yields in alternate testing schemes. In the new model, the other milk yield of a test-day was considered as an additional covariate. Separate regressions for 96 combinations of parity, milking interval class and lactation stage were fitted as in the current model. The new extended model was applied to a French data set for deriving regression factors, which were subsequently validated using an independent, later recorded French data set. Comparing the results of the extended to the current model, remarkable improvement in accuracy of 24-hour daily yield estimates can be seen, especially for extremely unbalanced milkings with large differences between morning and evening yields. With the new model, errors estimated for fat and protein yields were significantly reduced. Correlations between true and estimated daily fat yields derived from morning (evening) milkings increased from 0.923 to 0.952 (from 0.914 to 0.935) for first lactation and from 0.927 to 0.959 (from 0.923 to 0.947) for later lactation, respectively. The correlations of the new model exceeded 0.982 for protein yield. The newly developed model was proven to be more suited for estimating daily yields with Z schemes.

*Keywords: alternate testing scheme, Lactocorder technique*

## **1.0 Introduction**

Presently in France, the use of EMM is increasing, particularly with Lactocorders. This technique is well adapted to alternating morning and evening testing schemes, in which both milk yields of a test-day are available, whereas only one sample is taken to estimate the daily fat and protein yields ("Z" testing schemes, Leclerc *et al.*, 2004). Therefore, the milk yield of the other milking of the test-day can be used as an additional covariate to increase the accuracy of estimated daily fat and protein yields. This can be done by extending the German model (Liu *et al.*, 2000), which considers parity, milking interval and lactation stage for estimating daily yields from single milkings. The objective of this study is to apply the new, extended model to real data and compare the results to the basic model. The intention is to implement the new model in practice and this study can be considered as a validation of the model.

## **2.0 Material and methods**

For this joint project, two data sets were provided by French milk recording organisations. The first one consisted of 24,491 test-day records of 8,655 cows. It was used for deriving new regression factors. The second data set with 22,407 test-day records of 8,190 cows was used for the validation. The data structure for both data sets is described in table 1. Only milkings from Holstein cows were considered. Correlations among morning, evening and daily yields are shown for both data sets in tables 2 and 3, respectively. Morning milkings have higher correlations with daily milkings than evening milkings. Rather low correlations between single and daily milkings are found for fat content, whereas correlations for protein yield and protein content are higher than 0.90. For means, standard deviations, minima and maxima, there are nearly no differences between both data sets (Table 4).

Table 1. Description of data sets.

	Data set(I) for deriving regression factors	Data set (II) for validation
No. test-day records	24,491	22,407
No. cows	8,655	8,190
No. herds	169	156
No. milkings per cow	2.8	2.7
Recording period	January 2008 - November 2009	November 2008 - March 2010

Table 2. Data set (I). Correlations among morning, evening and daily yields (24,491 milkings).

Trait	AM - PM	AM - DMY	PM - DMY
Milk, kg	0.844	0.967	0.952
Fat, kg	0.707	0.925	0.923
Protein, kg	0.829	0.963	0.949
Fat, %	0.521	0.887	0.851
Protein, %	0.903	0.980	0.970

Table 3. Data set (II) Correlations among morning, evening and daily yields (22,407 milkings).

Trait	AM - PM	AM - DMY	PM - DMY
Milk, kg	0.821	0.961	0.947
Fat, kg	0.697	0.921	0.921
Protein, kg	0.781	0.951	0.931
Fat, %	0.552	0.901	0.854
Protein, %	0.919	0.984	0.973

Table 4: Means, Standard Deviation, Minimum and Maximum of variables of both data sets (N = 46,898 milkings).

	Mean	Std. Dev.	Minimum	Maximum
Daily Milk-kg	28.3	8.15	2.3	67.02
Milk-kg (AM)	15.7	4.62	1.1	48.6
Milk-kg (PM)	12.6	3.89	1.2	45.8
Fat-% (AM)	3.78	0.74	1.50	8.94
Fat-% (PM)	4.24	0.79	1.50	9.00
Daily Fat-kg	1.11	0.31	0.07	2.97
Fat-kg (AM)	0.58	0.17	0.03	1.89
Fat-kg (PM)	0.53	0.17	0.03	2.04
Protein-% (AM)	3.19	0.36	1.92	5.65
Protein-% (PM)	3.25	0.37	1.55	5.62
Daily Protein-kg	0.90	0.23	0.11	1.99
Protein-kg (AM)	0.49	0.13	0.04	1.54
Protein-kg (PM)	0.40	0.11	0.03	1.42
Milking interval (AM)	13.3	0.71	9.7	17.1
Milking interval (PM)	10.7	0.71	6.9	14.4
Parity*	2.4	1.5	1.0	9.0
Lactation stage (DIM)	165	96.4	7.0	360.0

The German model (Liu *et al.*, 2000) for estimating daily yields from single morning or evening milkings considers separate regressions for every combination of parity  $i$ , milking interval  $j$ , and lactation stage  $k$ :

$$y_{A4}^{[ijk]} = b_0^{[ijk]} + b_1^{[ijk]} y_{AT}^{[ijk]}$$

The effects considered in the model as well as the definition of effect classes are described in table 5.

Table 5. Definition of effect classes considered in the model.

Trait	No. classes	Class definition
Parity	2	1 <sup>st</sup> lactation, 2 <sup>nd</sup> and later lactations
Milking interval	4	AM: < 13h; 13h-13.5h; 13.5 h-14h; ≥14h
Stage of lactation	12	PM : ≥ 11h; 10.5h-11h; 10 h-10.5h; < 10h
		30 days per class

The new approach which is presented here also considers the milk yield of the other milking of a test-day. This means that the milk yield of the morning milking is used as a covariate when the evening milking is taken for analysing the contents – and vice versa.

$$\text{Morning milking: } y_{A4}^{[ijk]} = b_0^{[ijk]} + b_1^{[ijk]} y_{AT-am}^{[ijk]} + b_2^{[ijk]} \text{Milk}_{-pm}^{[ijk]}$$

$$\text{Evening milking: } y_{A4}^{[ijk]} = b_0^{[ijk]} + b_1^{[ijk]} y_{AT-pm}^{[ijk]} + b_2^{[ijk]} \text{Milk}_{-am}^{[ijk]}$$

### 3.0 Results

Table 6 shows correlations between true and estimated daily yields. Higher correlations obtained with morning milkings indicate that daily yields estimated from morning milkings are more accurate than those from evening milkings, and thus for all traits. Compared to first parities, later parities lead to slightly better estimates for daily yields. In general correlations between true and estimated daily fat yield are considerably lower than those for milk and protein yields. Correlations from the extended model are remarkably higher than those from the current model both for fat and protein yields, which confirms that the new approach can increase accuracy of estimated daily yields from alternating testing schemes. Table 7 shows that residual standard deviations also decrease with the extended model.

Table 6: Correlations between daily and estimated yields by lactation.

Trait	Lactation	Factors from current model		Factors from extended model	
		AM-DMY	PM-DMY	AM-DMY	PM-DMY
M-kg	1	0.964	0.949	1.00 <sup>1</sup>	1.00 <sup>1</sup>
	2+	0.973	0.961	1.00 <sup>1</sup>	1.00 <sup>1</sup>
F-kg	1	0.923	0.914	0.952	0.935
	2+	0.927	0.923	0.959	0.947
P-kg	1	0.959	0.944	0.988	0.982
	2+	0.965	0.951	0.990	0.985

AM = Morning milking, PM = Evening milking, DMY = Daily milking

<sup>1</sup> 1.00 since both milk yields of a test-day are known when Lactocorder technique is used.

Table 7. Standard deviation of residuals.

Trait	Lactation	Current model		Extended model	
		AM-DMY	PM-DMY	AM-DMY	PM-DMY
F-kg	1	0.09000	0.09485	0.07164	0.08243
	2+	0.12596	0.12962	0.09489	0.10794
P-kg	1	0.05274	0.06173	0.02899	0.03527
	2+	0.06382	0.07469	0.03423	0.04196

In tables 8a and 8b, differences between true and estimated daily fat and protein yields are shown for both approaches. Differences are expressed in percentage of true daily yield. For all traits, the percentage of extreme differences is higher for pm-milkings than for am-milkings, which confirms the lower accuracy of yields derived from the evening milkings.

Again, the lowest accuracy is found for fat yield: the differences between the true and estimated daily yields greater than 10% of daily yield represent more than 24% of the cases for fat (am or pm milkings) instead of 18.1% for protein with pm milkings and 10.7% with am milkings. With the extended model, only 15% of the milkings result in a difference of higher than 10% for fat, and 3% for protein.

Table 8a. Percentage of milkings with absolute difference between true and estimated daily fat yield (in %).

Trait	Difference	Current model		Extended model	
		AM milking	PM milking	AM milking	PM milking
F-kg	< 1%	10.1	10.1	12.9	10.5
	1-5%	37.1	36.1	44.8	38.9
	5-10 %	28.5	28.6	28.2	30.6
	10-20 %	18.1	18.1	12.0	16.4
	≥ 20 %	6.2	7.1	2.2	3.6

Table 8b. Percentage of milkings with absolute difference between true and estimated daily protein yield (in %).

Trait	Difference	Current model		Extended model	
		AM milking	PM milking	AM milking	PM milking
P-kg	< 1%	14.8	11.7	22.8	19.2
	1-5%	48.0	41.0	61.7	57.5
	5-10 %	26.6	29.2	14.3	20.5
	10-20 %	9.2	14.9	1.1	2.7
	≥ 20 %	1.5	3.2	0.1	0.1

Table 9 shows that differences between true and estimated daily yields increase with increasing differences between morning and evening milk yields. With the extended model, these differences are reduced, especially for very unbalanced milkings. This confirms that accuracy of estimates for fat and protein yield can be remarkably improved with the extended model.

Table 9. Mean differences between true and estimated daily yield depending on proportion of milk yield AM to milk yield PM.

AM / PM <sup>1</sup>	No.	Current model		Extended model		Current model		Extended model	
		F-kg		F-kg		P-kg		P-kg	
		AM	PM	AM	PM	AM	PM	AM	PM
0 -	3	-0.77	0.73	-0.35	0.29	-0.58	0.63	-0.17	0.18
0.25 -	29	-0.27	0.36	-0.09	0.12	-0.31	0.38	-0.12	0.11
0.50 -	132	-0.19	0.23	-0.10	0.07	-0.18	0.22	-0.08	0.05
0.75 -	1830	-0.09	0.08	-0.05	0.02	-0.08	0.08	-0.04	0.01
1.00 -	9371	-0.02	0.01	-0.03	-0.01	-0.01	0.01	-0.01	-0.01
1.25 -	8048	0.02	-0.03	-0.01	-0.03	0.02	-0.03	0.00	-0.02
1.50 -	2256	0.07	-0.08	0.01	-0.05	0.06	-0.07	0.01	-0.03
1.75 -	536	0.14	-0.12	0.03	-0.08	0.10	-0.12	0.02	-0.05
2.00 -	202	0.25	-0.22	0.08	-0.12	0.18	-0.21	0.05	-0.09

<sup>1</sup>Proportion of milk yield AM to milk yield PM.

## 4.0 Conclusions

For all traits, higher accuracy can be achieved with morning milkings. Comparing the three traits, milk, fat and protein yields, the lowest accuracy is found for fat yield. The extended model, which considers the milk yield of the other milking of a test-day, leads to more accurate estimated fat and protein yields, and thus it should be highly recommended to estimate fat and protein yields with "Z" testing schemes. With this testing scheme both milk yields are known anyway and therefore there is no disadvantage when compared with classical schemes.

For all regions or farms that use an alternating testing scheme but do not work with EMM (such as Lactocorders), daily milk yield still has to be estimated ("T" schemes, according to the ICAR nomenclature). In these cases the German approach (model 6, Liu *et al.*, 2000) should be applied.

Finally, it is recommended to derive regression factors from a data set representative of the situation of the country and which includes milkings of at least a whole year, to obtain complete lactations and to remove potential seasonal effects or the impact of short lactations.

In conclusion, the new model reduces disadvantages of alternating testing schemes. Accuracy of estimates for daily fat and protein yields from am or pm milkings is improved. This is especially true for very unbalanced milkings with large differences between morning and evening milk yield which very often lead to large estimation errors.

## 5.0 Acknowledgements

We thank the French Regional Milk Recording Organizations of Alsace, CAIAC and OPTIVAL for having provided the data used in this study.

## 6.0 References

- Leclerc H, Delacroix J., Larroque H., Gallard Y. and Mattalia S., 2004: Milk recording: a comparison of the T, Z and standard methods (Z=milk recording on 2 milkings and the contents on one alternate milking) – Biennial Session of ICAR, May 28 – June 4, 2004, Sousse, Tunisia.
- Liu Z., R. Reents, F. Reinhardt and K. Kuwan. 2000. Approaches to Estimating Daily Yield from Single Milk Testing Schemes and Use of a.m.-p.m. Records in Test-Day Model Genetic Evaluation in Dairy Cattle. *J. Dairy Sci.* 83: 2672-2682.





## Transitioning milk recording services in changing times

P. Baier

*AgSource Cooperative Services, 135 Enterprise Drive, Verona, Wisconsin 53593 USA; a subsidiary of Cooperative Resources International, Shawano, Wisconsin, USA*

### **Abstract**

AgSource recognized the need to drive change rather than follow change. This was a necessary step to remain a strong and viable option for our current and prospective customers. New milking parlor technologies mixed with the introduction of sexed semen and genomics have and will continue to change the daily information available to dairy owners within the AgSource service area. Use of these technologies has the ability to adjust management decisions made on dairy operations. It was also recognized that some of these technologies will avail the dairy farmer of tomorrow to increase leisure and family time spent away from the dairy. All of these adjustments lead to AgSource changing the style of reports and summaries produced for customers. The product target has been twofold; first, assisting the speed and accuracy of the on farm decision process; the second, benchmarking the results of each dairy's management activities against a peer group of like dairies. The program has made great strides in how customers view AgSource products and has brought a new respect from customers to AgSource employees. This has improved employee morale and increased the desire to better serve customers. The end result has been a growth of cows on test with AgSource along with a higher percentage of animals sampled on a monthly basis. The adjustment of product offerings has been an ongoing project over the last five years. To verify program success comparisons of annualized individual cow milk recordings over different time periods were analyzed. In May 2004, AgSource had 350,000 fewer individual cow milk recordings than the previous year. While in contrast, May 2010 had annualized recordings that had increased over the previous year by nearly 100,000 cow milk recordings. This marks the fourth straight year of increases in this area.

*Key words: trend lines, benchmarks, management information.*

### **1.0 Determining areas in need of management time**

AgSource serves a diverse population of dairy producers. Herds range in size from 30 to over 10,000 cows. Management styles vary from free stall, to stall barn, to grazing herds. The one common factor amongst these operations is the need to obtain data and information relevant to improving individual decisions. Data is collected on monthly visits in order to gather herd management information through one sample of milk per cow. Using data collected from our monthly testing visiting, AgSource develops the necessary management tools. These tools or products need to assist customers in making informed decisions without having to sift through piles of data. The products developed need to quickly point to areas where management decisions and/or the implementation of these management decisions needs to improve. Customers and consultants have busy schedules; the best service that AgSource can provide is creating the analysis that allows decisions to be made and not just create data points that need to be sorted through to create management information. By saving this step there is immediate efficiency and satisfaction for the end user. As a final step, monetary measures have been linked to products and reports. Informing customers of the hidden income losses associated by not acting to improve deficient management has been an eye opening experience for customers. Once management changes are made the hidden income starts to appear. This new found income improves the overall financial standing of an operation and customer satisfaction with AgSource.

In order to serve the needs of customers, AgSource has created several new products to assist customers in spending their valuable management time making decisions rather than sorting through pages of data.

One of the first steps in the plan was developing products which are visual in nature and quickly show an area of need. A good example of how this was accomplished is the Profit Opportunity Analyzer®. Figure 1 demonstrates the simplicity of use in the easy to read bar graphs that demonstrate areas of management concern to customers. Customers and consultants have used this report to stay focused on the areas



needing management attention rather than leaning toward human nature and concentrating on areas as they prefer to spend time. In the given example, transition and dry period and turnover are the areas with the greatest need for adjustments with udder health following behind.



Figure 1. Profit Opportunity Analyzer.

## 2.0 Development of trend lines

Another important development in the program was the implementation of trend line reports and summaries. Trend lines allow customers to visualize the direction a herd is moving in several management areas or seasonal management struggles experienced each year. They also serve as important tools for customers to track the management direction and assistance in determining what management actions were successful. Often trend lines make directional changes that can be traced back to a specific action taken just before the trend line moves in an up or down direction. Trend lines are great tools for measuring past management decisions and giving guidance of when it is time to look at specific areas of current management due to a trend line downturn. Figure 2 demonstrates the use of trend lines to create a quick view picture of direction of rolling herd average for milk alongside the ME trend lines for first lactation cows versus the same trend line for second and greater lactation animals.

## 3.0 Benchmarks

The use of benchmarks has been an outstanding way to measure the results of one dairy in comparison to similar dairies of the same size or management style. Customers have found this to be a great tool in demonstrating what levels of production or productive efficiency can be obtained.

AgSource benchmarks have been produced for herds at different levels. The 80th percentile level is the level of performance of the top 20 percent of herds being ranked in an individual management area. This level of performance has been set as the goal area by AgSource. Once a herd has reached the 80th percentile rank in a given management area it is assumed to be more financially beneficial to concentrate time improving other areas below the 80th percentile mark. Moving to levels higher than the 80th percentile encourages unrealistic management goals. Levels lower than this may be allowing customers

to overlook management areas that should be given some level of concentration. Guidance is provided to customers when introducing the benchmarking tools. The development of plans to improve management needs to be realistic. If a customer is in the 20th percentile range for an area of management results, it is necessary to develop a plan to reach the 50th percentile range and then continue working toward the 80th percentile range. If expectations are set too high for improvement in too short of time, the customer may become discouraged with the plan and slip backwards due to frustration.

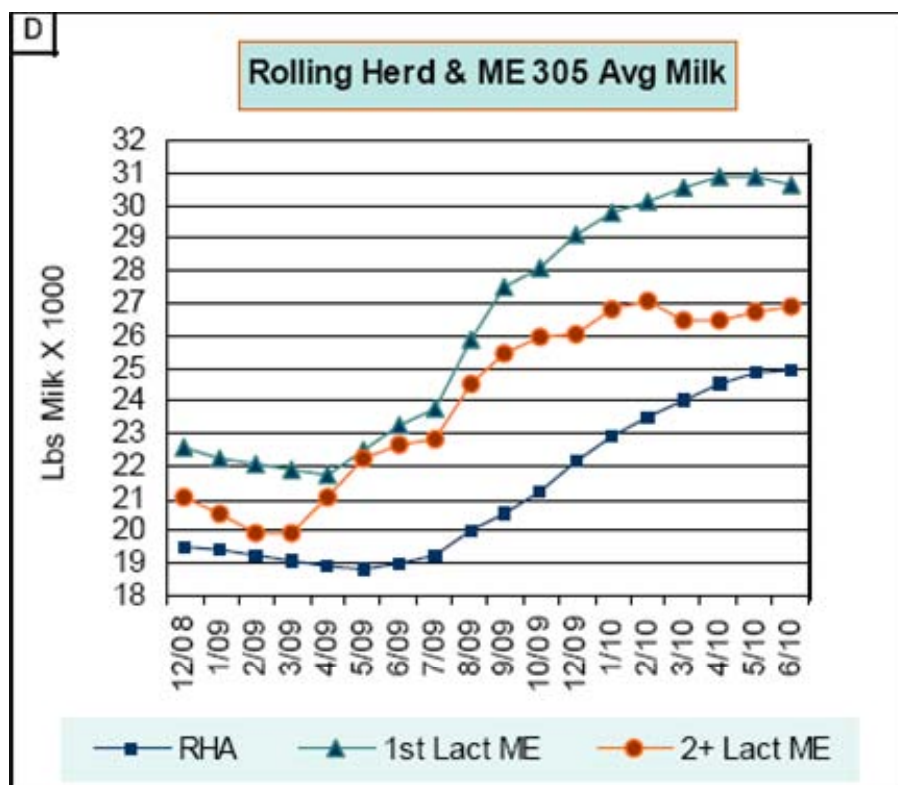

Figure 2. Rolling herd and & ME 305 average milk.

## 4.0 Research and development of products

The development of new products is essential to the future of AgSource. It is important to develop products capable of filling the needs of the customer. It is also important these products have been properly researched and the end product is supported by science.

Product development and marketing costs are the same whether a product has been successful or a total failure. The difference often is that the successful product meets the needs of a customer's specific management.

AgSource staff has stayed in touch with potential needs by attending meetings, trade shows and other opportunities to listen to the most progressive producers and consultants. AgSource relies heavily on the University of Wisconsin School of Veterinary Medicine staff and the University of Wisconsin Dairy Science Department for product development. Price points and anticipated sales volumes have been developed.

New products must have the following characteristics:

- Quantitative/measurable.
- Repeatable.
- Limited lag time.
- Unbiased.
- Decision can be made from the data.

After a prototype has been developed, customer and consultant focus groups are used for fine tuning changes. Before release, the field and internal staff are trained about how the product adds value to

customers, how to interpret results and how to sell the product. Marketing and educational materials are developed for both hard copy and website.

## 5.0 Monitoring results

Adjusting the way services are provided to customers is important for the cooperative to stay on target with their needs. However, monitoring is also needed to be sure the changes that are being made result in satisfied customers. One of the best monitoring tools can be seen in figure 3. This graph demonstrates growth not only in active cows or herds, but also in individual cow milk recordings. An increase in these numbers represents customer satisfaction.

This graph demonstrates growth in the area on a rolling twelve month basis. Each line represents the growth in cow tests on a rolling year basis. The effectiveness of our marketing plan can also be seen in these numbers. The lines above zero represent growth. Lines below zero represent decreases in cow tests. Previous to current plan introduction, all numbers were headed in a negative direction. Dramatic gains were seen in 2007 and 2008. While 2009 and 2010 have had less dramatic gains, numbers are still increasing above previous years. Economic swings have played a factor in the numbers as well. However, the current marketing program has heightened the lines in the upswings of the economy and countered the full effect of downturns in the economy.

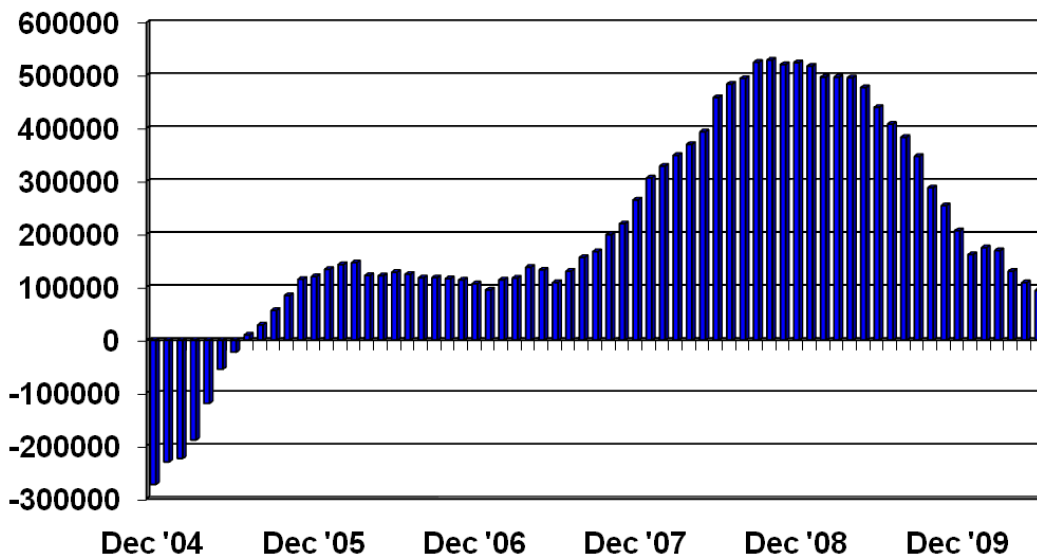

Figure 3. Individual milk recordings.

AgSource considers the entire process of product development as part of the value added program. The goal the program is to provide services and products so valuable to customers they cannot see operating their business without AgSource. AgSource employees have spent time with customers, consultants, veterinarians and financial institution representatives explaining products such as the Profit Opportunity Analyzer. Good open discussions have resulted and these discussions are held using AgSource reports. This has put AgSource employees in the room with a team of decision makers asking questions and learning about AgSource products, earning responsibility that AgSource employees may not have had the opportunity to hold on dairy farms in the past. This has taken training and commitment from AgSource and employees. However, the outcome has been a new level of respect for AgSource and employees. Customers now look forward to the next information collection date with enthusiasm because they understand how test date links to the delivery of management products which can have a positive effect on the improved financial performance of their operation. This in turn has improved AgSource employee career satisfaction and renewed their commitment to improving performance.



## Adding value to data emanating from routine animal recording processes

C. Hunlun

*SA Stud Book and Animal Improvement Association, Bloemfontein, South Africa*

### **Abstract**

Animal breeders, like any other entrepreneurs, operate in a dynamic and competitive industry. Reliable and applicable information forms the core of good management and strategic decisions. By utilising existing records of origin, parentage, ownership and other features of recorded animals, breeders and breeders' organisations can improve the quality of the decisions they have to make. Breeders' organisations are generally in a good position to provide a value-adding service to their breeders and in the process make basic animal recording more cost-effective.

Some examples of value-adding to basic animal recording data and processes are given and discussed.

*Keywords: animal recording, value adding, demography, pedigree analysis, breeding structure, Bonsmara*

## **1. Introduction**

The global community, in all its spheres, finds itself in the midst of an information revolution. Applicable and reliable information forms the basis of almost all processes and is at the core of any good management or strategic decision. It is almost inconceivable that any project or business can succeed without good management decisions. It is the business of animal breeders and breeders' organisations to constantly improve their animals genetically in order to meet the demands of their markets. To achieve this, information generated from basic routine animal recording processes can play a vital role, whether it is origin-, ownership- or pedigree information.

Generally, significant amounts of time, effort and money are spent on the collection, processing and storage of data that is used for the primary purposes of animal- and herd identification, parentage recording and herdbook registration. By utilising the same data to generate additional information, breeders and breeders' organisations can improve the quality of the decisions they have to make and in the process improve their competitive edge in the industry. The processes that drive genetic change in animal populations depend largely on the analytical use of pedigree and ownership information as recorded by breeders, breeders' organisations and recording authorities. Breeders' organisations and recording authorities are generally in a good position to provide a value-adding service to their customers and in the process make basic animal recording more cost-effective.

Demographic parameters and genetic analyses using pedigree information have been used extensively to assess the genetic structure of livestock populations. Some examples of such analyses may be found for horses (Moureaux *et al.*, 1996), dairy cattle (Maignel *et al.*, 1996; Sölkner *et al.*, 1998), beef cattle (Gutiérrez *et al.*, 2003) and sheep (Huby *et al.*, 2003). De Rochambeau *et al.* (2000) give an overview of some of the applicable methodology. The information that emanates from these kinds of analyses does not only have academic value but could also play a major role in the animal improvement efforts of breeders and breeders' organisations. The use of some of these parameters may give significant insight into the status of herds or breeds regarding the size of breeding populations, breeding practices, genetic variability and effective population sizes.

## **2. Demography**

In the context of livestock populations, demographic analysis uses administrative records to develop an estimate of the relevant population(s), whether it is on a herd or breed level, in terms of the size, composition and spatial distribution of the populations and how these features change over time. Data is

generally obtained from a census of the population (herd / breed count) that is derived from registry records of events like births, deaths, cancellations and migrations (transfers of ownership).

Elements of demography are used to assist breeders to predict the demand for their animals and to analyse the demands on a breeder or a breeders' organisation's capacity in terms of products and services. It can also be used as an interpretive and analytic tool for the comparison of different markets and trends within a herd or breed. Breeders' organisations have an interest in the number and characteristics of their breeders and the animals in their possession so they can optimize their service to their breeders and focus the promotion of the breed and the sale of animals on behalf of the breeders. Demographic analysis is also used to reveal some of the consequences of the genetic management of herds and breeds and to contribute to the interpretation and understanding of genetic results.

A demographic analysis was done for the Bonsmara, a South African beef cattle breed (Hunlun *et al.*, 2009), and some of the results from that study will be used to illustrate the possible uses of these statistics.

## 2.1 Population Change

Livestock populations are inherently dynamic and continue to change. Changes in numbers of animals and herds have a wide application and can, amongst others, be used to describe the developmental history of a population and to make certain predictions about the future development of a population. The evolution of the number of herds and animals in the Bonsmara breed since its foundation is depicted in Figure 1.

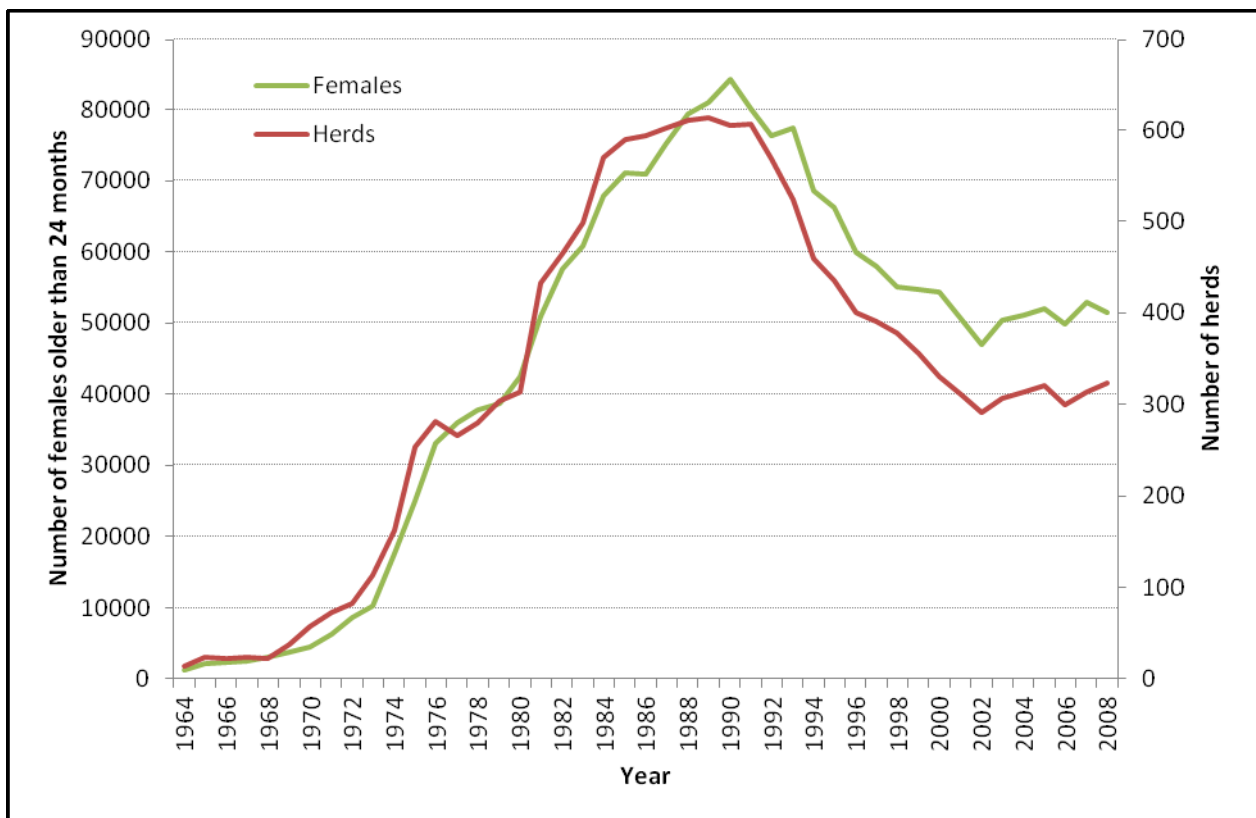

Figure 1. Number of herds and female animals older than 24 months in the Bonsmara breed (Hunlun *et al.*, 2009).

From Figure 1 several phases can be identified in the history of the breed, each phase having its own causes and consequences. Some interesting and important information can be learned about the evolution of average herd size over time and the effect of important events in the history of the breed on the average herd size, like the secession of the Namibian Bonsmara breeders to form their own breeders' society in 1993/94 and two periods of rather widespread drought in the summers of 1991/92 and 1994/95.

## 2.2 Population Composition

Population composition is the description of a population in terms of characteristics such as age, breed / line, gender or recording / registration status. These descriptions are sometimes necessary for understanding the dynamics of a breed from a historical perspective, for comparative research and to provide perspective on the capacity of the breed for future growth and, to some extent, genetic change. The characteristics of a herd or breed in terms of age and gender is often presented and compared by using a population pyramid (Figure 2).

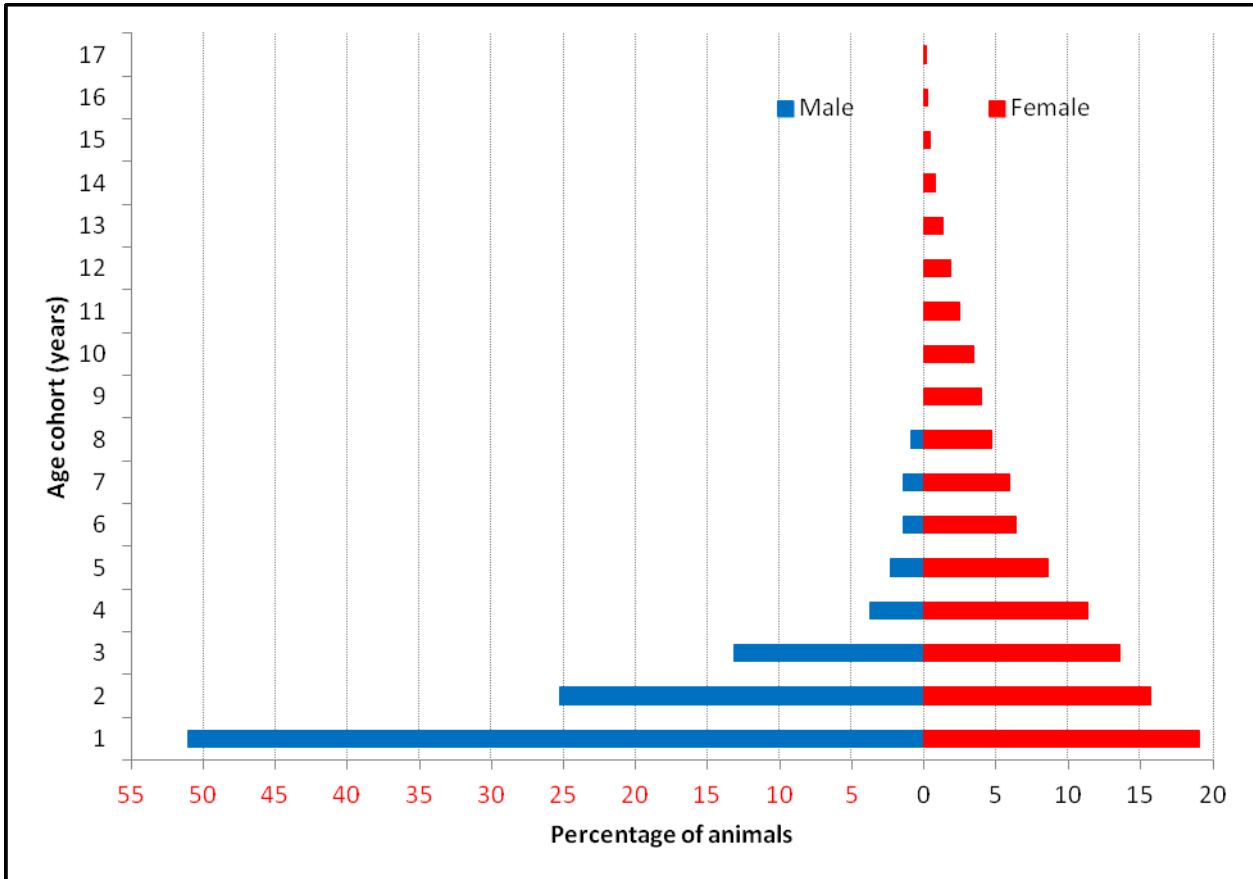

Figure 2. Age and gender distribution in the Bonsmara breed, as in July 2008 (Hunlun et al., 2009).

In July 2008 the Bonsmara breed consisted of 26% male animals and 74% female animals of all ages. The age distribution of these animals is very typical and shows a healthy age structure in the population with a noticeable degree of momentum for future growth appearing in the younger female age categories – the higher proportions of females in the categories 2-3 years and 3-4 years old (new entrants into the breeding population) bodes well for future growth in the breed.

The age distribution (Figure 2) follows a typical negative growth function which has very high predictive properties. In the case of Bonsmara females in 2008 –

$$y = 20.047 - 7.14 \ln(x) \quad (R^2 = 0.9706)$$

where  $y$  – the percentage of female animals in an age cohort

$a$  – intercept with the horizontal ( $y$ -) axis, the percentage females in the first age cohort

$b$  – logarithmic regression coefficient

$x$  – age cohort

From this equation the annual erosion rates can be calculated between different age cohorts – in 2008 the erosion rate for Bonsmara heifers was *ca.* 25% between the groups 0-1 to 1-2 years of age and *ca.* 20% between the groups 1-2 to 2-3 years of age. The erosion rate for cows starts at *ca.* 17% for first calvers and decreases to *ca.* 15% between the cohorts 5-6 to 6-7 years of age but then increases steadily to *ca.* 30% between the age groups 12-13 to 13-14 years of age. The regression coefficients and

intercepts show a very high repeatability within breeds over years and are generally statistically significant.

The distribution of recording status in the breed, across the two genders is reflected in Table 1.

Table 1. Distribution of recording status of Bonsmara animals as in July 2008 (Hunlun *et al.*, 2009).

	Male	Female
Number of animals	27 319	77 320
Registration Pending (%)	14.12	3.50
Foundation (%)	-	4.90
Appendix A (%)	-	14.38
Appendix B (%)	11.61	12.11
Studbook Proper (%)	74.24	65.11

The majority of active animals in the breed are fully registered animals (SP). The high proportion of male SP animals is to be expected because only SP bulls can be used to beget registrable progeny. The proportion of Appendix A females is higher than that of the Appendix B females, which is an indication that there is a renewed interest in the upgrading programme of the breed and that the breed is bound to display positive growth in the future.

### 2.3 Generation interval

Generation interval is defined as the average age of parents when their 'useful' progeny are born – an offspring is considered to be useful if it, in turn, left at least one further offspring (Gutiérrez *et al.*, 2003). The evolution of the realised average generation interval (L) of the Bonsmara is shown in Table 2 and to some extent reflects the developmental history of the breed – a shorter generation interval during the formative years, gradually increasing as the breed established itself, with a slight decrease during the period when the breed experienced its highest census. The latest realised average generation interval for the breed (2007/2008) is 5.61 years, which is comparable to that of other beef breeds in South Africa. The average dam component (5.79 years) of the latest generation interval was slightly higher than the corresponding sire component (5.42 years).

### 2.4 Effective population size

Demographic parameters can also be used to infer the evolution of genetic variability in a breed by estimating the effective population size,  $N_e$ , from the numbers of parents in the breed (Gandini *et al.*, 2004). Although the use of Wright's well known equation for the effective population size (Wright, 1931),

$$N_e = 4MF/(M+F)$$

where M and F are numbers of reproducing males and females respectively, yields a gross overestimate of the true effective population size, it serves as a convenient descriptive measure. When used over time in the same population, it gives a fair indication of the relative changes in the genetic variability and genetic drift that may have occurred in the population.

The number of calves born per year, the number of sires and dams with progeny born in a particular year and the effective population size for the Bonsmara breed is also presented in Table 2.

Table 2. Number of Bonsmara herds, calves born per year, number of parents, effective population size ( $N_e$ ) and average generation interval (L) (Hunlun *et al.*, 2009).

Year	Herds	Calves born	Male calves	Female calves	Dams	Sires	$N_e$	L
1972/73	42	551	152	399	281	92	277	4.34
1977/78	213	4881	794	4087	3662	572	1979	5.01
1982/83	405	17608	3604	14004	17244	1313	4880	5.67
1987/88	514	30332	9109	21223	30024	1848	6963	5.65
1992/93	462	35288	13476	21812	34892	1958	7416	5.57
1997/98	353	32149	13792	18357	31411	1742	6602	5.67
2002/03	296	28476	13119	15357	27861	1577	5970	5.61
2007/08	282	25138	12156	12982	24859	1433	5420	-

The realised effective population size can be estimated from the rate of inbreeding in a population ( $\Delta F$ ), which can be calculated from the existing parentage records in breed's registry (see § 3.3).

### **2.5 Proportion Retained**

On average 43.63% of the female Bonsmara calves born eventually became mothers of Bonsmara calves and 5.65% of the male calves born eventually sired a Bonsmara calf (Hunlun *et al.*, 2009). These figures, also referred to as the 'Proportion Retained' (PR), can be readily calculated from registry records and give an indication of the selection intensity in the breed. The PR differs somewhat between calf crops and also reflects the dynamics of the breed in terms of the length of the productive life of animals and selection intensity. The PR tends to be somewhat higher during times when the breed is growing positively.

## **3. Pedigree analysis**

It has long been established that selection changes the relationships between reproducing animals (Lush, 1946; Robertson, 1961) and that the inbreeding in the progeny of selected parents is higher than under pure genetic drift. Some simple demographic parameters have a large impact on the evolution of the genetic variability within a population and the effects of these depend largely on the management of the population in terms of the number of male and female parents, (dis)equilibrium of progeny size and length of reproductive life.

The genetic variability in a population can be studied through the analysis of the pedigree data of a breed and focuses mainly on the evolution of a population's gene pool. The fact that almost all the South African beef cattle breeds have initiated breed improvement programmes utilizing BLUP methodology necessitates periodic investigations of this kind. Verrier *et al.* (1991) have argued that the use of BLUP-derived selection parameters in populations of limited effective size leads to profound changes in the structure of the populations and that these measures could probably not be considered to be the optimum selection criterion in terms of the cumulated genetic progress or the maintenance of genetic variability.

The genetic structure of the Bonsmara breed was analysed recently (Hunlun, 2009; Van der Westhuizen, 2009) and some of the results of those studies will be used to demonstrate the possible use of information emanating from pedigree analyses to support the decision making processes of breeders and breeders' organisations.

### **3.1 Important ancestors**

In most practical animal breeding situations it is important to know which ancestors are the most influential in a given population or sub-population. Several methods exist by which the contributions of ancestors to the genetic make-up of individual animals, herds or even whole breeds can be calculated. These methods vary in sophistication from mere summaries of numbers of progenies born per ancestor to the calculation of the relative contributions of ancestors to a specific cohort or generation of progeny, taking the numbers of effective progeny and the numbers of generations separating ancestors and progeny into account. Methods using the theory of gene origin to estimate the effective number of founders and ancestors in a population (Boichard *et al.*, 1997) can also yield information about the relative contribution of ancestors. Even more important is the fact that the parameters emanating from this analysis are considered to be very good indicators of genetic variation in the population analysed and it is less sensitive to the completeness of the pedigree data in the population. Parameters derived from probabilities of gene origin are especially useful in small populations and in populations where the genetic management is divided amongst several smaller units (herds).

Information about the relative importance of ancestors can be used with coefficients of additive genetic relationships (§ 3.2) to establish and manage breeding lines and to limit the effects of inbreeding in future generations.



### 3.2 Pedigree completeness

An in-depth analysis of the pedigree completeness level of a population is important since all results in terms of inbreeding and relationships are dependent upon it. Van der Westhuizen (2009) demonstrated the evolution of the average completeness of 2-, 3- and 5-generation pedigrees of the Bonsmara breed over a period of 45 years (Figure 3) and reported an average completeness of 85% for the 3-generation pedigrees of Bonsmara animals born between 2000 and 2007.

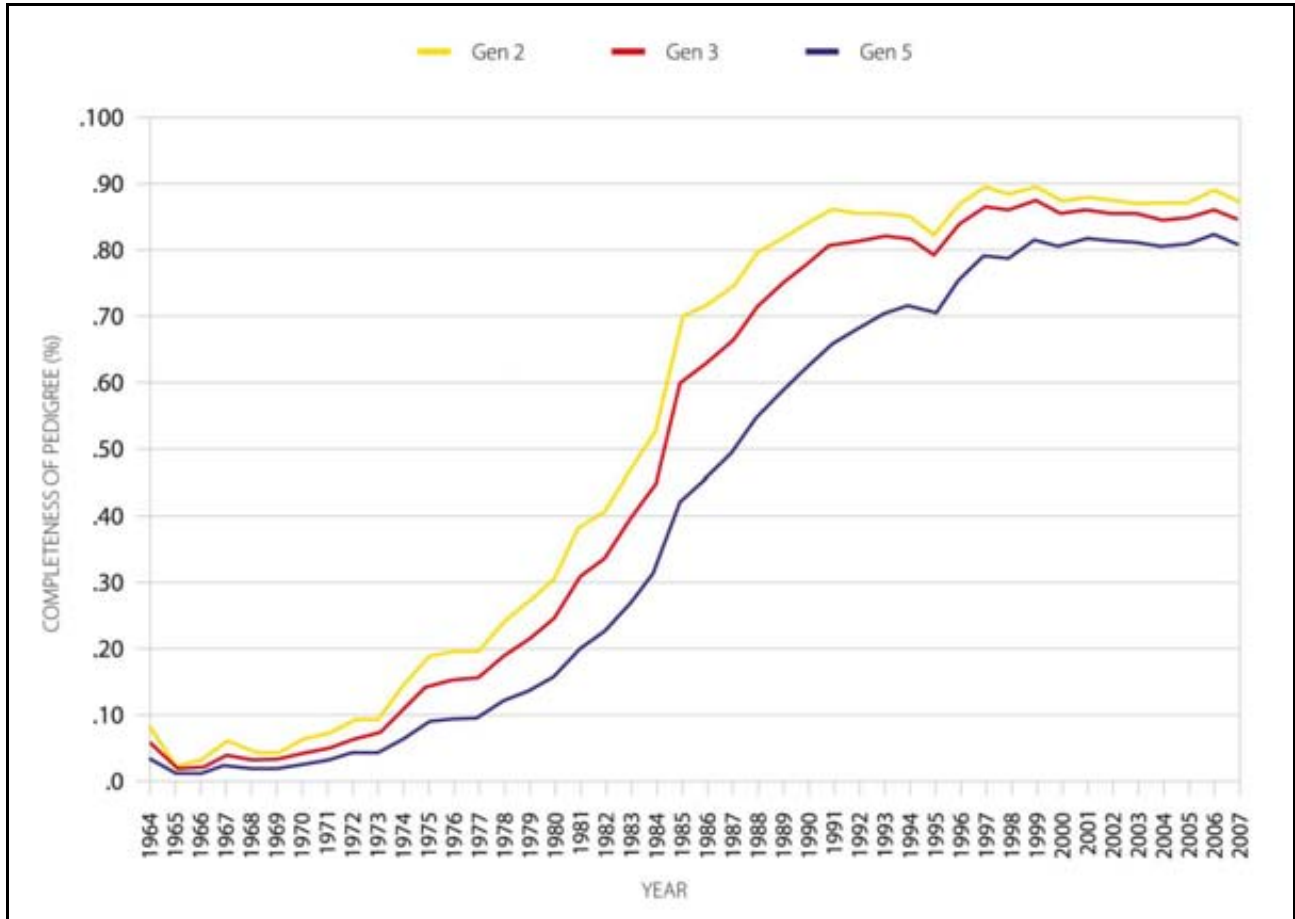

Figure 3. Percentage of pedigree completeness for a two, three and five generation deep pedigree in Bonsmara cattle (Van der Westhuizen, 2009).

Hunlun (2009) reported that 98.2% of the parents of Bonsmara animals born in the period July 2006 to June 2008 were known and recorded.

### 3.3 Inbreeding and relationships

The trend in inbreeding in a population is the method most frequently used to quantify the rate of change in genetic variability and is calculated from the pedigree records of a population. Several software packages exist to perform the necessary analyses (eg Minbreed (Gandini *et al.*, 1998), Pedig (Boichard, 2002) and ENDOG (Gutiérrez *et al.*, 2005)) and the inbreeding coefficients of animals in a population is also available as a by-product of a BLUP-analysis of the population.

Van der Westhuizen (2009) described the evolution of the average inbreeding coefficients, the additive genetic relationships and the percentage of inbred Bonsmara animals for the period 1964 to 2007 (Figure 4) and estimated a rate of inbreeding of 0.29% per generation.

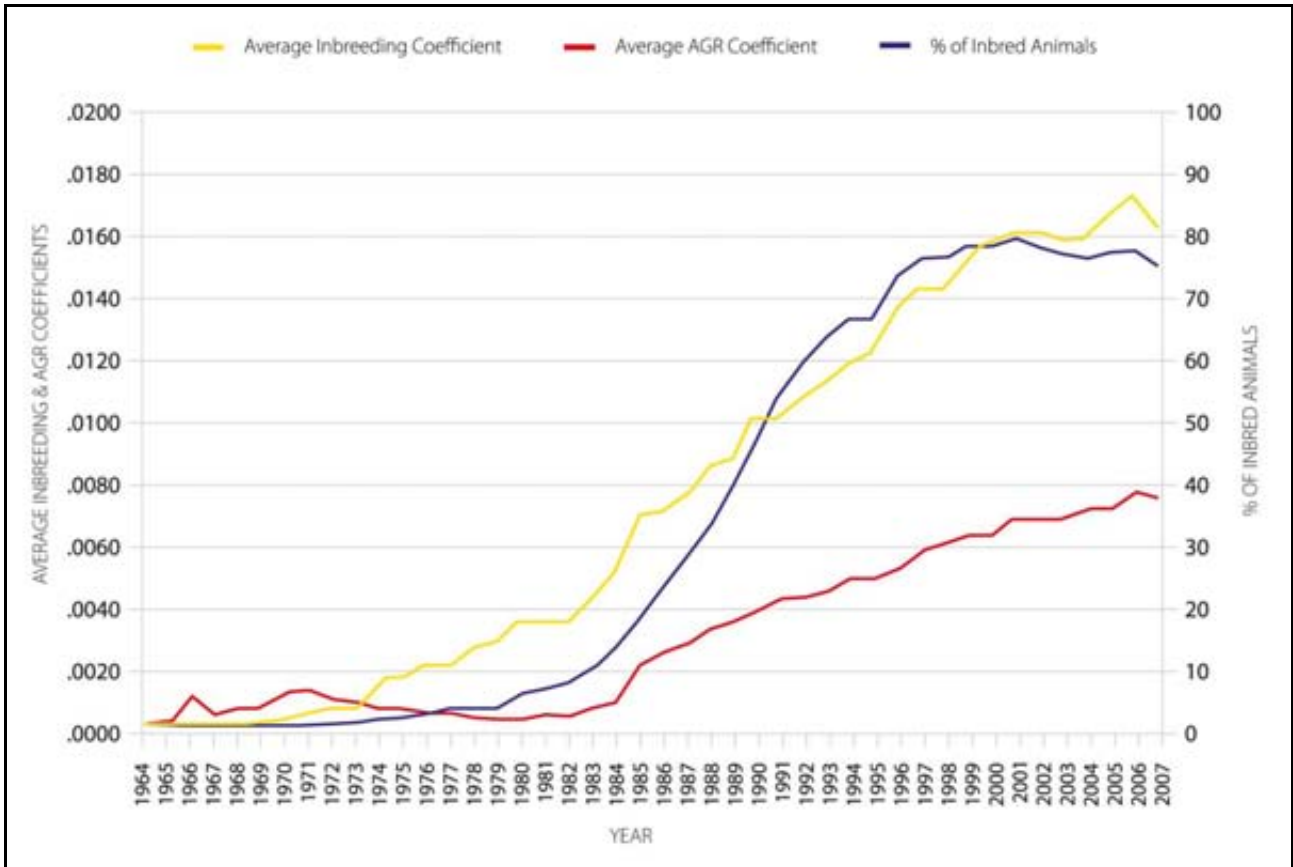

Figure 4. Average inbreeding coefficients, additive genetic relationships and the percentage of inbred Bonsmara calves born per year (Van der Westhuizen, 2009).

In many instances the inbreeding and relationships in sub-populations (herds) are more useful than the average inbreeding in whole populations as it is much easier to identify possible problem areas and to devise proper strategies to address these problems. The additive genetic relationships between animals can become available from the analysis of inbreeding, depending on the routine or calculation method used. These can be used to help a breeder plan future matings in order to avoid inbreeding in the herd.

### 3.4 Effective population size

The effective size of a population ( $N_e$ ) is defined as the size of an idealized population which would give rise to the same rate of inbreeding ( $\Delta F$ ) as that experienced in the population. The rate of inbreeding per generation can be calculated from the inbreeding analysis (§ 3.2) and the generation interval (§ 2.3), and the effective population size can be derived as described by De Rochambeau *et al.* (2000) –

$$N_e = 1/(2 \Delta F)$$

The rate of inbreeding for the Bonsmara relates to a realised effective population size of 172.

### 3.5 Analysis of breeding structure

The analysis of the breeding structure of a breed (Robertson, 1953) provides vital information about where in the breed genetic change is being derived from and what the perceptions of the breeders are about where the most eligible genetics in the breed are to be found. Periodic analysis of the breeding structure of a breed also provides useful information about the development and evolution of a breed and about important herds that played a significant role in the genetic history of the breed. All this information is vital in the formulation of effective mating systems.

The breeding structure of the Bonsmara breed was analysed (Hunlun, 2009) in seven two-year periods, each five years apart, between 1976/77 and 2007/08.

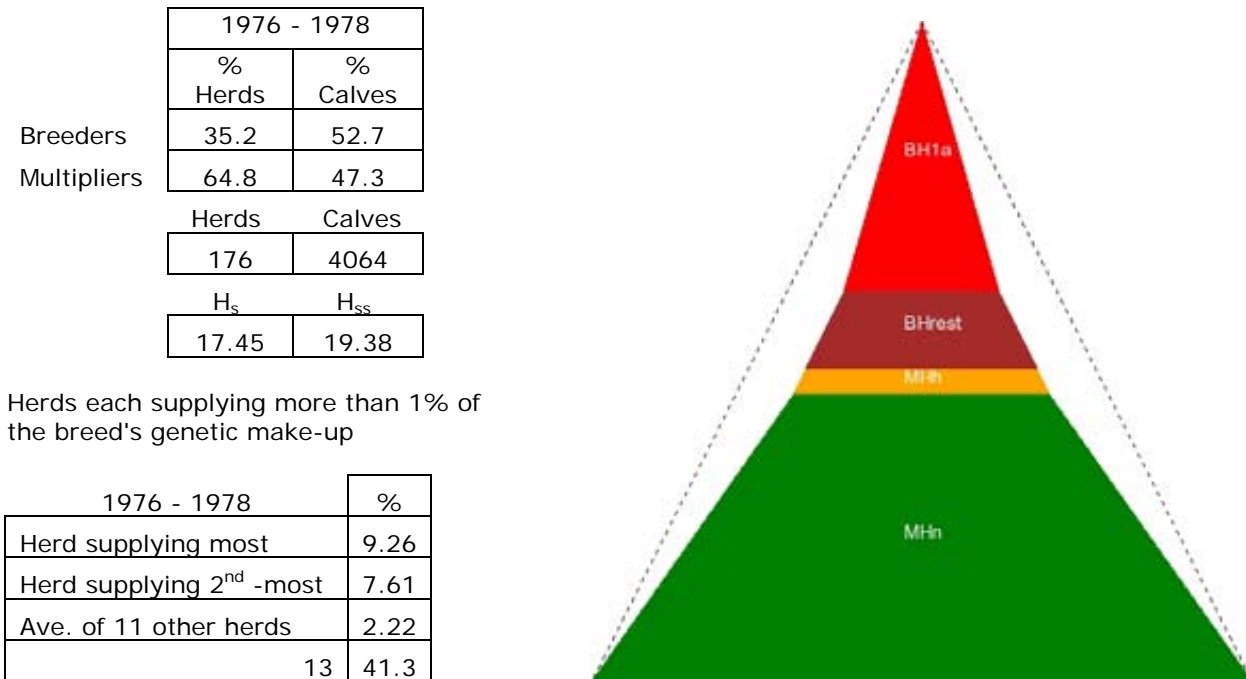

Figure 5: Breeding structure for the Bonsmara breed – 1976-1978 (Hunlun, 2009).

In the period 1976-1978 the Bonsmara breed displayed a typical breeding structure (Figure 5) with 35% of the 176 Bonsmara herds that recorded births being classified as 'Breeder Herds' (BH1a and BHrest)) and almost 65% of the herds being classified as 'Multiplier Herds' (MHh and MHn). Breeder Herds usually comprise an 'elite' minority with the majority of the herds in a breed being Multipliers. The distribution of cows amongst the two groups was somewhat skewed with 52.7% of the calves born in the Breeder Herds and 47.3% born in the Multiplier Herds – BH-herds on average having twice as many births per herd than MH-herds.

During this period, 13 herds (7.4% of the active herds) each supplied more than 1% of the breed's genetic make-up and together these 13 herds contributed more than 41% to the genetic composition of the breed. The effective number of herds supplying sires (H<sub>s</sub>) and grandsires (H<sub>ss</sub>) to the breed (Robertson, 1953; Gutiérrez *et al.*, 2003), an indication of the levels of within-breed genetic diversity, were 17.45 and 19.38 respectively. The herd with the highest genetic contribution supplied 9.26% of the breed's sires and dams. The next most important herd contributed 7.61% to the breed's genetic make-up.

On average, 40% of the calves born annually during this period were fully registered calves and 161 of the 176 (91.5%) herds recorded calves in the appendixes to the Herdbook. A high percentage of both BH and MH made use of the appendixes although the MH (especially MHn) had higher percentages of appendix calves. The genetic origins of 77% of the two calf crops could be accounted for.

Only 17% of the calves recorded in the two years were male calves and 82.7% of the recorded male calves were born in Breeder Herds. In general, breeding herds were small (average size *ca.* 23 cows – foundation females excluded) but the average size for BH was almost twice that of MH.

During the period 2006-2008 (Figure 6) the births of 24 844 Bonsmara calves were recorded by 250 active herds.

Almost 50% of the herds were classified as BH and these herds recorded almost 65% of the births. The overall average number of births recorded per herd per year was 99 with the averages for BH 131 births per year and for MH 68 births per year.

Sixteen herds (6.4% of all herds) each supplied more than 1% of the genetic make-up of the breed and the combined genetic contribution of these herds was 30.4%. The two herds supplying the most breeding animals to the breed had contributions of 5.37% and 3.07% respectively.

The effective numbers of herds supplying sires ( $H_s$ ) and grandsires ( $H_{ss}$ ) to the breed rose to 52.63 and 22.37 respectively. The proportion of herds recording animals in the appendixes to the Herdbook was 86% but the proportion of animals born in the appendix sections was only 22% of all recorded animals. The overall proportion of male calves being recorded rose to 48% with more than 67% of the recorded bull calves emanating from Breeder Herds.

		2006 - 2008	
		%	%
		Herds	Calves
Breeders		49.2	64.9
Multipliers		50.8	35.1
		Herds	Calves
		250	24844
		$H_s$	$H_{ss}$
		52.63	22.37

Herds each supplying more than 1% of the breed's genetic make-up

2006 - 2008		%
Herd supplying most		5.37
Herd supplying 2 <sup>nd</sup> -most		3.07
Ave. of 14 other herds		1.57
16		30.4

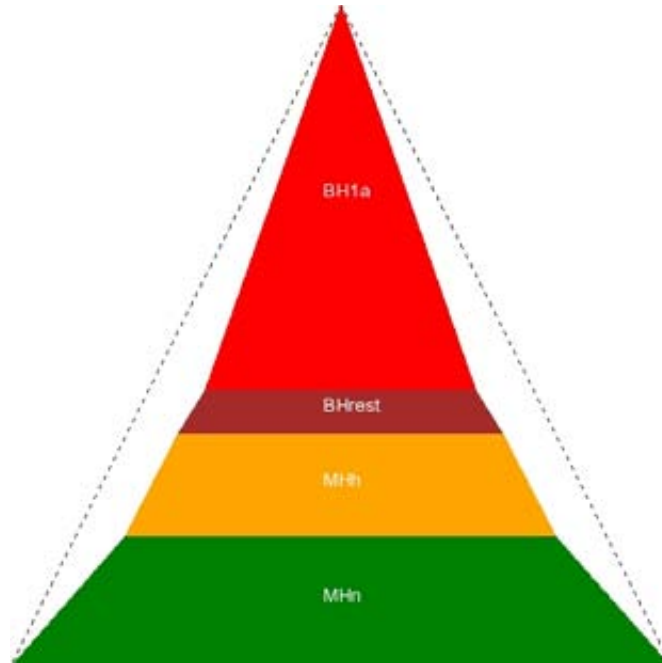

Figure 6: Breeding structure for the Bonsmara breed – 2006-2008 (Hunlun, 2009).

#### 4. Conclusive remarks

Genetic improvement depends largely on the availability of genetic variability in the population under selection. The genetic variability in a population can be assessed from demographic and pedigree analyses, yielding various complementary criteria. In a population that undergoes selection, the roles of the breeders' organisation and the collective decisions taken by the breeders are crucial for creating and disseminating genetic gain. Too intense selection will reduce within-population genetic variability and hamper genetic gain. Breeders' organisations need to constantly monitor the use of animals as donors of embryos and semen through appropriate methodologies and parameters, as the over-use of animals may have detrimental effects on the genetic variability of the breed.

Each breed differs in terms of developmental history, state of genetic variability in the breed and levels of genetic gain achieved and desired in the breed. Consequently, every breed needs a different strategy to achieve its goals. These strategies can only be formulated accurately after an in depth analysis of the pedigrees and some demographic parameters of the breed. The improvement in the capacity and computing power of computers and the availability of computerised databases with the pedigree and ownership information of the animals in the breed puts recording authorities and breeders' organisations in a good position to render a service in this regard to their customers. In the process, they improve their ability to make better decision in terms of improving their herds and breeds.

#### 5. References

- Boichard, D., Maignel, L. & Verrier, É., 1997. The value of using probabilities of gene origin to measure genetic variability in a population. *Genet. Sel. Evol.* 29, 5-23.
- Boichard, D., 2002. Pedig: a Fortran package for pedigree analysis suited for large populations. Proc. of the 7<sup>th</sup> World Congr. Genet. Appl. Livest. Prod., Montpellier, France.
- De Rochambeau, H., Fournet-Hanocq, F. & Vu Tien Khang, J., 2000. Measuring and managing genetic variability in small populations. *Ann. Zootech.* 49, 77-93.

- Gutiérrez, J.P., Altarriba, J., Díaz, C., Quintanilla, R., Cañón, J. & Piedrafita, J., 2003. Pedigree analysis of eight Spanish beef cattle breeds. *Genet. Sel. Evol.* 35, 43-63.
- Gutiérrez, J.P. & Goyache, F., 2005. A note on ENDOG: a computer program for analysing pedigree information. *J. Anim. Breeding and Genetics*, 122, 172-176.
- Gandini, G.C. & De Filippi, P., 1998. Minbreed – Software package for the genetic management of small breeds. *Proc. of the 6<sup>th</sup> World Congr. Genet. Appl. Livest. Prod.*, Armidale, Australia.
- Gandini, G.C., Ollivier, L., Danell, B., Distl, O., Georgoudis, A., Groeneveld, E., Martyniuk, E., van Arendonk, J.A.M. & Wooliams, J.A., 2004. Criteria to assess the degree of endangerment of livestock breeds in Europe. *Livest. Prod. Sci.* 91, 173-182.
- Huby, M., Griffon, L., Moureaux, S., de Rochambeau, H., Danchin-Burge, C. & Verrier, E., 2003. Genetic variability of six French meat sheep breeds in relation to their genetic management. *Genet. Sel. Evol.* 35, 637-655.
- Hunlun, C., 2009. The breeding structure of the Bonsmara breed. In: Ferreira, P. & Webb, E. (editors). *Bonsmara: Born to breed – born to lead*. Bonsmara SA. Bloemfontein, 2009, 229 – 234.
- Hunlun, C. & Ferreira, P., 2009. A demographic overview of the Bonsmara cattle breed. In: Ferreira, P. & Webb, E. (editors). *Bonsmara: Born to breed – born to lead*. Bonsmara SA. Bloemfontein, 2009, 65 – 68.
- Lush, J.L., 1946. Chance as a cause of changes in gene frequency within pure breeds of livestock. *Am. Nat.* 80, 318-342.
- Maignel, L., Boichard, D. & Verrier, E., 1996. Genetic variability of French dairy breeds estimated from pedigree information. *Interbull Bull.* 14, 49-54.
- Moureaux, S., Verrier, E., Ricard, A. & Mériaux, J.C., 1996. Genetic variability within French race and riding horse breeds from genealogical data and blood marker polymorphisms. *Genet. Sel. Evol.* 28, 83-102.
- Robertson, A., 1953. A numerical description of breed structure. *J. Agric. Sci.* 43, 334 – 336.
- Robertson, A., 1961. Inbreeding in selection programmes. *Genet. Res.* 189-194.
- Sölkner, J., Filipčić, L. & Hampshire, N., 1998. Genetic variability of populations and similarities between subpopulations in Austrian cattle breeds determined by pedigree analysis. *Anim. Sci.* 67, 249-256.
- Van der Westhuizen, B., 2009. Population history and genetic variability in Bonsmara beef cattle via a pedigree analysis. In: Ferreira, P. & Webb, E. (editors). *Bonsmara: Born to breed – born to lead*. Bonsmara SA. Bloemfontein, 2009, 258 – 268.
- Verrier, E., Colleau, J.J. & Foulley, J.L., 1991. Methods for predicting response to selection in small populations under additive genetic models: a review. *Livest. Prod. Sci.* 29, 93-114.
- Wright, S., 1931. Evolution in Mendelian populations. *Genetics* 16, 97-159.



## Opportunities in Southern Africa using animal economic values

J. van der Westhuizen, R.R. Van der Westhuizen, C B. Banga & H.E. Theron

ARC Animal Production Institute, Private Bag X2 Irene 0062, South Africa

### **Abstract**

Comprehensive new selection indices have been developed for Holstein, Jersey (Dairy) and Bonsmara (Beef) breeds in South Africa. In all cases the developments were based on the common practices followed in local production systems, biological knowledge, prices realised for the products, costs of inputs and the genetic (co)variances among the recorded traits. Although selection indices are in use with Holstein (BVI) and Jersey (SA-Index) the application in beef cattle, based on cow profitability, will be new. The proper use of a monetary genetic value therefore heralds new opportunities for Bonsmara breeders, as the breed dominates beef cattle breeding in Southern Africa.

Measured traits included in the Beef Index are: Birth Weight (direct and maternal), Weaning Weight (direct and maternal), Post Wean Weight (at about 540 days of age), Mature (Cow) Weight, Age at first calving and Calving interval. B-values are positive for the growth traits (and wean maternal) and negative for birth (direct and maternal), mature weight and the reproduction traits. This index will also supplement the current "Feedlot Profit Index" that has been available for some time. Measured traits included in the Dairy index are: Milk, Protein, Butterfat, Longevity, Somatic Cell Score, Calving Interval and Live Weight. B-values differ between the two breeds and among four different payment systems.

*Keywords: Selection index, beef cattle, dairy cattle, cow profitability.*

## 1. Introduction

Livestock production is the most important agricultural activity in South Africa and accounts for more than 40% of the total value of the agricultural output. This is a reflection of the environmental constraints as 80% of the agricultural land is suitable only for animal husbandry. Livestock production is therefore largely natural resource based. The only way that rangeland and (grassland ecosystems) can be used for food production is through herbivores. Therefore, rangeland with its wide diversity of vegetation types, is the major natural resource that provides the main source of fodder for the 12,4 million beef cattle, 1,6 million dairy cattle, 29 million sheep and 7 million goats within South Africa. With regard to herbivores, beef cattle accounts for 45% of the gross value of herbivore products while livestock earnings amount to about 10% of agricultural export and through import plays a significant role in stabilizing the economies of SADC countries (Source: South Africa National Beef Cattle Strategy).

Of the 1 39 000 dairy cows (accounting for a approximately 22% of the national dairy cow population) in the South African National Milk Recording Scheme, respectively 65 000 (47%) and 60 000 (43%) represent Holstein and Jersey cows (2009 Annual Report: National Milk Recording and Improvement Scheme). Of the 135 000 beef cows from participating farmers in the National Beef Recording and Improvement Scheme, 56 000 (41%) are from the Bonsmara breed (2009 Annual Report: National Beef Recording and Improvement Scheme).

Two projects, one aimed at adjusting the selection indices for dairy cattle and the other to develop a new index for beef cattle have recently been undertaken. Appropriately the Holstein and Jersey breeds were used for the dairy cattle index and the Bonsmara breed for the beef breed.

## 2. Methodology and results

### 2.1 Dairy Index methodology

A bio-economic herd model simulating an average farm, for each breed in each production system, was developed. Data collected through the National Dairy Animal Improvement Scheme (NDAIS) were used

to derive base herd parameters. Farm economic data and information on milk pricing were obtained from the Milk Producers' Organisation (MPO) of South Africa. Two of the milk buyers, Parmalat SA and Clover SA, also provided information on their milk payment schemes.

The partial budget approach was used to compute economic values by simulating the marginal change in profit resulting from a unit increase in the trait of interest, while all other traits remained constant. Profit was expressed per cow in the herd per year and its marginal change was calculated as the difference between marginal change in revenue and marginal change in costs. Economic values obtained this way can be converted so that they are expressed according to selection goals.

The herd model simulated typical breeding and management practices in the two major production systems in South Africa (pasture and concentrate-based system). Breeding and calving took place all year round, with constant herd size being assumed. Replacement rate was therefore equal to death plus culling rate. All replacement heifers were raised on the farm. It was assumed that 55% of calves born were male and they were all sold at a fixed price, within one week of birth. All heifer calves were retained until culling took place at 12 months of age and 3 months after reaching breeding age (for failure to conceive). Conception rate and mortality rate were assumed to be 85% and 5% respectively, across breed and production system. Surplus heifers were sold for slaughter, with the price per animal being based on carcass weight. Cull ed cows were disposed of at the end of a 305-day lactation and their slaughter price was determined by carcass weight. Carcass weight was calculated as 49% of live weight for both heifers and cows.

Calf rearing was the same in both production systems. After receiving 3 or 4 litres of colostrum a day (respectively for Jersey or Holstein) in the first 3 days of life, Jersey calves were fed 3 litres and Holstein calves 4 litres of whole milk a day until weaning at 8 weeks of age. In addition, Jersey and Holstein calves were given, respectively, 2 kg and 3 kg of calf meal a day from day 3 of age. Average weaning weight was 50 kg and 60 kg respectively for the Jersey and Holstein.

Cows in the pasture-based production system were grazed on pasture, comprising predominantly Kikuyu grass, and given 6 to 10 kg (as fed) of concentrate per cow per day during lactation. In winter (June-July), 10 kg (as fed) of maize silage were provided per cow per day as supplementary feed. Cows in the concentrate based production system were fed a total mixed ration (TMR), with quantities being based on production. The average energy content of feed (MJ ME/kg DM) was 9.0, 9.5, 11.0 and 14.0 respectively for pasture, silage, TMR and concentrate.

Base herd parameters used to simulate the average performance level of each breed in each production system. These values were derived from data recorded under the NDAIS on cows that calved between 1 January and 31 December 2006. It was assumed that all Jersey cows remaining in the herd were culled after completing their tenth lactation. There were however extremely few (less than 1%) Holstein cows calving after the eighth lactation, therefore it was assumed that all Holstein cows were only allowed to last in the herd for up to 8 lactations.

Live weight (LW) of animals at each month of age was predicted from the first month after weaning (month 3), using the von Bertalanffy growth function

## 2.1 Beef Index methodology

In order to derive relative economic values for traits included in a selection objective, the first step was to identify all traits with a direct economical impact on a typical beef enterprise and could be quantified. A simulation program had to be developed that will included all the traits of relative economical value. The aim of the simulation program is to determine what the change in income or profit is with a one unit of change in such a relative economical trait while the rest of these traits' magnitude in the simulation program stays constant.

Qualifying traits identified as those of relative economic value for typical extensive South-African beef cattle farm were: survival percentage (from birth to weaning age), calving interval, weaning weight (wean direct), milk production (wean maternal), 18 months weight, mature weight and average daily gain (post wean).

In order to achieve the objective calculations were based on yearly gross income per hectare given the availability of a fixed amount of energy. This simulation is therefore based on farm size and grazing capacity (large stock units/hectare). The program require the averages (the national averages for the Bonsmara used) for weaning weight (228.5 kg), 18 months weight (371 kg), mature weight of cows and bulls (510 kg and 800 kg), milk production (14 kg/day), daily gain post wean (300 g), average fluctuations in daily gain for growing bulls during an average year (200 g per day), calving interval

(416 days), calf and wean percentages, replacement percentage (10%), herd age structure as well as the weaner (R14.50/kg) and slaughter (R18.50/kg) price per kilogram. Furthermore the program assumes an extensive beef production system where input costs are limited.

Based on this information the simulation program calculates (based on feed requirement specifications from the National Research Council) the number of animals that can be kept on a standard farm, according to the herd age structure presented. By using the given weaning percentage, replacement percentage, mature and weaning weights, the program calculates a total farm income. It is assumed that young animals are sold at weaning and replacement breeding stock are all sold to an abattoir. Because of the unavailability of slaughter data, it was furthermore assumed that all animals sold to the abattoir, obtained the same classification and therefore the same price per kilogram with a dressing percentage of 55%.

Herd profitability values were simulated for every unit change within biological levels for weaning survival percentage, weaning weight, milk production, 18-months weight, mature weight, average daily gain and calving interval.

To include the traits indicated, it was furthermore decided to fit newly developed models and re-estimate the genetic variances and co-variances for these traits. Two multi trait genetic analyses were done. The first analysis was a multi trait including all weight related traits where all the direct and maternal components were considered. The second genetic analyses was also a multi trait including heifer and cow fertility traits namely, age at first calving and calving intervals between the 1st and 2nd calf, 2nd and 3rd calf and between the 3rd and 4th calf. The resultant genetic variances and co-variances from the analyses were used in the development of the cow profitability index.

### 2.3 Dairy Index results

Tables 1 and 2 depict the resultant b-values for the two dairy breeds, production systems and the different payment systems.

Table 1. Economic values<sup>1</sup> (ZAR per unit) for concentrate-fed production system.

Breed	Trait	Payment System			
		A	B	C	D
Jersey & Holstein	Fat (kg)	1.21	5.81	2.47	4.21
	Protein (kg)	7.62	21.88	19.88	20.21
	Milk (l)	0.28	-0.49	-0.49	0.28
Jersey	Longevity (days)	1.15	1.11	1.09	1.23
	Live weight (kg)	-7.49	-7.49	-7.49	-7.49
	Calving interval (days)	-4.19	-4.19	-4.19	-4.19
	Somatic cell score	-433.87	-912.90		
Holstein	Longevity (days)	3.68	3.59	3.59	3.67
	Live weight (kg)	-6.62	-6.62	-6.62	-6.62
	Calving interval (days)	-5.75	-5.75	-5.75	-5.75
	Somatic cell score	-949.26	-1795.57		

<sup>1</sup>Economic values of milk production traits (fat, protein and volume) the same for both breeds.



Table 2. Economic values (ZAR per unit) for pasture-based production system.

Breed	Trait	Payment System			
		A	B	C	D
Jersey	Fat (kg)	6.26	10.91	8.59	6.51
	Protein (kg)	10.48	24.77	23.35	21.42
	Milk (l)	0.45	-0.32	-0.28	0.36
	Longevity (days)	1.77	1.73	1.54	2.29
	Live weight (kg)	-4.63	-4.60	-3.93	-6.46
	Calving interval (days)	-2.47	-2.45	-2.19	-3.18
	Somatic cell score	-178.65	-367.37		
Holstein	Fat (kg)	6.36	11.52	9.10	6.76
	Protein (kg)	10.54	25.11	23.63	21.56
	Milk (l)	0.45	-0.30	-0.27	0.37
	Longevity (days)	3.68	3.59	3.59	3.67
	Live weight (kg)	-4.12	-3.78	-3.22	-5.71
	Calving interval (days)	-3.19	-3.00	-2.68	-4.05
	Somatic cell score	-491.48	-938.00		

## 2.4 Beef Index results

Table 3 depicts the b-values for the selection index for the Bonsmara beef breed.

Table 3. Economic values (ZAR per unit) for the Bonsmara beef breed on an extensive farming system.

Trait	Economic value (South African Rand)
Birth Direct	-1.82437
Birth Maternal	-1.05686
Weaning weight Direct	+3.31048
Weaning weight Maternal	+4.56219
Eighteen months old weight (Direct)	+0.42546
Mature weight (Direct)	-0.42666
Age at first calving	-0.02954
Calving Interval ((Interval 1*0.44)+(Interval 2*0.33)+(Interval 3*0.23))	-4.26335

Figure 1 depicts the genetic change in the Bonsmara breed, based on the economic selection index Farm profitability).

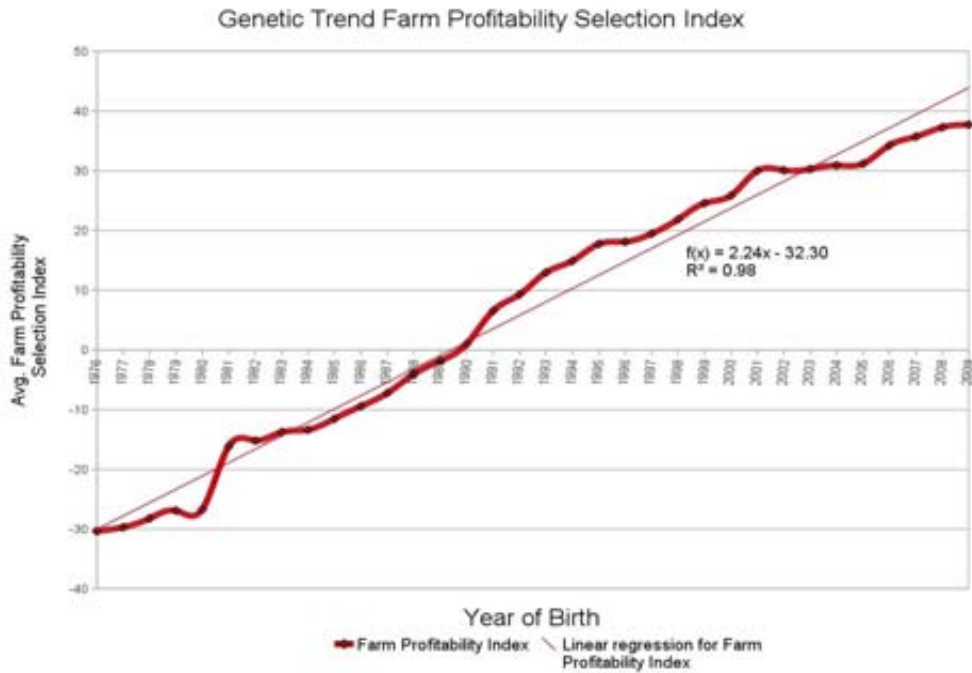

Figure 1. Genetic change in cow profitability index in Bonsmara cattle.

### 3. Future prospects and opportunities

Figure 2 depicts the gene-flow structure for beef (and dual purpose) cattle in South Africa (from the National Beef Cattle Strategy for South Africa).

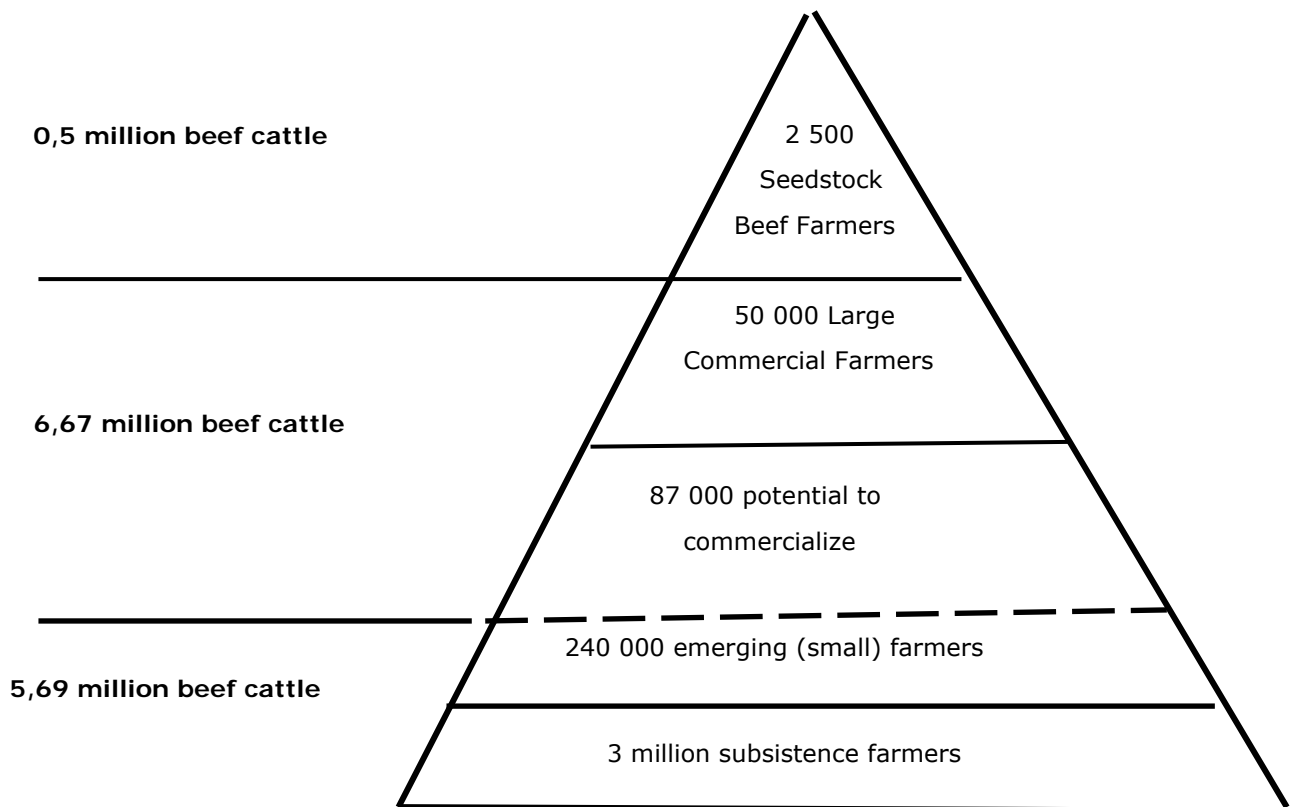

Figure 2. Gene flow pyramid for beef and dual purpose cattle in South Africa.

From the gene flow pyramid (Figure 2) it is clear that it is possible to impact a large number of cattle if positive genetic change based on cow profitability or dairy economic values are possible. If the trend in the most prominent beef breed, the Bonsmara can be achieved, given the genetic lag and “gene dilution” in the commercial cattle population, positive genetic change in the profitability of beef cattle is possible.

The use of selection indices has been practice in the dairy industry (SAINET for Jersey and BVI for Holstein) for some time, although the underlying principles in drafting these values were not based on the same sound principles as the currently proposed economic values. The beef industry, on the other hand, has been used to selection based on independent culling levels. The reduction of the current number of traits, presented on a typical sale catalogue, from more than 13 traits to a single monetary genetic value will simplify selection plans while also ensuring change in the desirable direction.



## Persistency of conjugated linoleic and vaccenic acids in Argentine Tybo and Sarado cheeses produced from natural high CLA milk

M.A. Rodriguez<sup>1</sup>, V. Cejas<sup>1</sup>, R. Castañeda<sup>1</sup>, G. Gagliostro<sup>2</sup> & M. Balán<sup>3</sup>

<sup>1</sup>INTI. National Institute of Industrial Technology. Dairy Industry Technological Research Centre. Av General Paz 5445. (1650) San Martín. Buenos Aires, Argentina

<sup>2</sup>INTA. National Institute for Agricultural Technology. EEA Balcarce. Animal Production Area. CC 276 (7620) Balcarce. Buenos Aires, Argentina

<sup>3</sup>PRODEO SRL. Parque Industrial Chivilcoy. Km 160, RN 5 (6620) Chivilcoy. Buenos Aires, Argentina

### Abstract

Sardo and Tybo cheeses were elaborated from milk with high conjugated linoleic acid (CLA) and Vaccenic Acid (VA) contents and they were tested to evaluate the persistency of 9- cis 11-trans C 18:2, trans-11 C18:1 and other fatty acids (FA). The natural high CLA milk was obtained from 8 Holstein cows from middle lactation (109 ± 26 days post partum), supplemented with sludge soybean oil (SSO) with 55.5% of C18: 2n 6 and fish oil (FO) as an inhibitor of ruminal biohydrogenation. After 25 days of adaptation, milk was collected and transformed into Tybo and Sarado Argentine cheeses reproducing industrial conditions. Milk and cheeses FA composition was analyzed by GLC and differences in FA content were stated using the T-test for paired observations.

Intake of SSO and FO reduced the atherogenicity index of milk from pre supplementation basal value of 2.06 to 1.16, decreasing the concentration of atherogenic FA (C12:0; C14:0; and C16:0). After supplementation the milk CLA content increased from a basal value of 1.42 to 3.58 g/100g and VA from 2.56 to 3.58 g/100g FA.

The atherogenicity index of high CLA Sarado and Tybo cheeses were 1.22 and 1.29 respectively. There was a high transference rate of CLA 9 cis 11 trans: 95% for Tybo cheese and 97% for Sarado cheese. Assuming that the cheese fat contains 95% FA, an intake of 90 g/day of Sarado and 143 g/day of Tybo high CLA cheeses may allow achieving cardiovascular protection (800 mg) to the consumer of CLA. The beneficial effect of functional foods may be effective only within a comprehensive nutrition and healthy lifestyle.

*Keywords: Sarado, Tybo, Argentine cheese, conjugated linoleic acid; atherogenicity index.*

### 1. Introduction

The health quality of fat present in the dairy products depends on its composition of fatty acids (FA). Conjugated linoleic acid (CLA) is a group of positional and geometric isomers of conjugated dienoic derivatives of linoleic acid. The major dietary source of CLA for humans is ruminant fat contained in meats, (beef and lamb), but mainly in dairy products, such as milk, butter and cheese. The major isomer of CLA in milk is cis-9, trans-11 (C18:2), also called rumenic acid. It is produced in part in the rumen from linoleic FA together with vaccenic acid (trans-11 C18:1, VA) but mainly by the conversion of VA into CLA by the enzyme delta 9 desaturase in the mammary gland. Both, VA and CLA showed cholesterol-lowering, antiatherogenic; anti-diabetic and anti-carcinogenic effects demonstrated in experimental models.

Our preliminary results showed that the transfers rate of CLA from milk to yogurt, soft-cream cheese and pasteurized milk was very effective. We focused now on hard and semi-soft cheeses to extend other possibilities of inclusion of CLA in the daily intake. The objective was to determine if the transformation of natural milk containing high CLA and VA contents into Tybo and Sarado cheeses induces significant changes in the concentration of these bioactive molecules in the final product. This may contribute to generate dairy functional foods.

Tybo is a semi-soft cheese of great popular consumption, usually used in fast food, while Sardo cheese is a hard variety, usually used during consumption of pasta or stuffed. The daily intake of these high-CLA cheeses can help to increase the incorporation in the human diet of these bioactive molecules. The study represents a joint work between INTI-LACTEOS, the Experimental Station of INTA Barcarce and the company Prodeco SRL, award winner of "La Mirada Larga" INTI competition.

## 2. Materials and methods

Natural high CLA milk was obtained from 8 Holando-Argentina cows in mid lactation ( $109 \pm 26$  days postpartum) supplemented with sludge soybean oil (64% oil, 55.5% of C18: 2n6) and fish oil (FO) as an inhibitor of ruminal biohydrogenation. Prior to start the lipid supplementation period, milk from each cow were sampled to determine the baseline profile of FA.

At day 25<sup>th</sup> after lipid feeding milk was collected to be processed into cheese. An aliquot of milk was used to determine FA profile and the rest of the milk was pasteurized and transformed into Tybo and Sardo argentine cheeses according to industrial processes.

Fatty acid composition in milk and cheese were analyzed by gas-liquid chromatography using an Agilent GC 6890 Serie Plus fitted with a FID detector and auto-sampler. The column used was W-COT 100 m. Oven conditions were: 70°C, 1 min, increased 5°C/min to 100 °C, hold 2 min, increased 10°C/min to 160 °C hold for 5.2 min and increased 5 °C/min to 225 °C hold for 15 min. Injection volume : 1 µl. The gas carrier used was hydrogen.

Atherogenicity index AI was calculated as  $C12:0 + 4C14:0 + C16 / \text{total unsaturated fatty acids}$ .

The difference of each FA concentration between milk and cheese was analyzed using the Student t test for paired observations.

## 3. Results

Milk and standardized 4% fat milk yields were 23.4 and 18.6 kg per cow per day respectively.

Fat, protein and lactose content in Tybo cheese milk were 2.42, 3.45 and 4.66 g/100g respectively with a fat/protein ratio of 0.70. Same compositions for Sardo cheese milk were 2.30, 3.51 and 4.71 g/100g respectively with a fat/protein ratio of 0.65. Moisture content in Tybo and Sardo cheese were 47.46 ( $\pm 1.26$ ) and 34.84 ( $\pm 2.58$ ) g/100g. Fat content were 21.67 ( $\pm 1.26$ ) and 26.73 ( $\pm 4.03$ ) g/100g respectively. And total protein content were 26.84 ( $\pm 1.46$ ) and 31.23 ( $\pm 2.89$ ) g/100g respectively.

A high transference of CLA from milk to cheese was observed averaging 95% for Tybo and 97% for Sardo cheeses (Table 1)

Table 1. Main fatty acid composition in milk (M-CLA) and its transfer to Tybo (Tybo C-CLA) and Sardo cheeses (Sardo C-CLA).

Fatty acids (g/100 g total FA)	M-CLA	Sardo C-CLA	SC-CLA/M-CLA x 100	M-CLA	Tybo C-CLA	C-CLA/M-CLA x 100
C12:0	2.38	2.33	98	2.2	2.54	115
C14:0	9.04	9.27	103	8.88	9.73	110
C16:0	24.27	24.95	103	25.87	25.9	100
C18:1t10	4.22	5.95	141	5	3.89	78
C18:1t11 (AV)	5.43	5.89	109	3.55	4.48	126
CLA c9t11	3.58	3.51	98	2.86	2.72	95
CLA c12t10	0.02	0.03	144	0.04	0.05	115
C <sub>20:5 n3</sub> (EPA)	0.05	0.04	77	--	--	--
C <sub>22:6 n3</sub> (DHA)	0.03	0.03	100	0.04	0.04	100
AI	1.16	1.22		1.16	1.29	

The Atherogenicity Index (AI) of milk in pre-supplementation was 2.06 ( $\pm 0.24$ ) and concentration of potentially atherogenic fatty acids (g/100 g) were 4.04% ( $\pm 0.65$ ) for C12:0, 12.52% ( $\pm 1.37$ ) for C16:0 and 29.16% ( $\pm 2.38$ ) for C14:0.

The AI of high CLA milk and high CLA Tybo and Sarde cheeses were 1.16, 1.29 and 1.22 respectively and are shown in Figure 1.

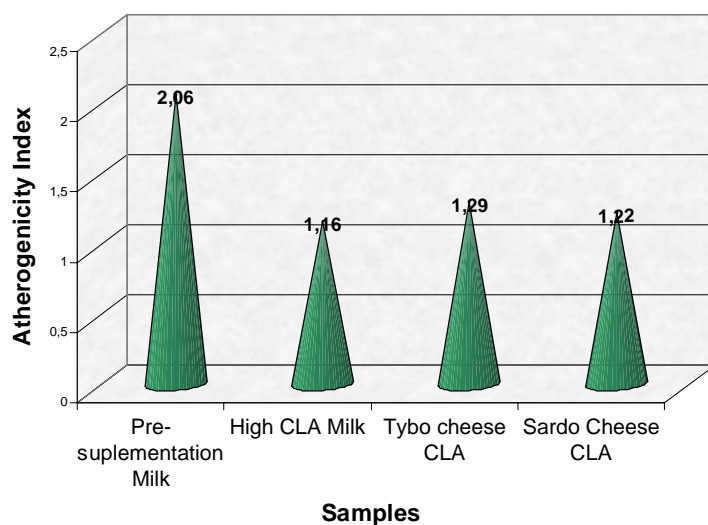

Figure 1. Atherogenicity Index from high CLA cheeses.

## 4. Conclusions

Intake of SSO and FO reduced the atherogenicity index of milk from pre supplementation basal value of 2.06 to 1.16, decreasing the concentration of atherogenic FA (C12:0; C14:0; and C16:0). After supplementation the milk CLA content increased from a basal value of 1.42 to 3.58 g/100g and VA from 2.56 to 3.58 g/100g FA.

The cheese-making process did not alter the fatty acid profile observed in the original milk.

A high transference rate of 9cis-11trans CLA and VA was observed in both cheeses. Lipid supplementation reduced the atherogenicity index in milk and this property was maintained in cheeses.

Assuming that the cheese fat contains 95% FA, intake of 90 g/day of Sarde or 140 g/day of Tybo cheeses rich in CLA, may allow obtain the suggested anticancer dose (800 mg) of CLA.

The beneficial effect of functional foods may be effective only within a comprehensive nutrition and healthy lifestyle.

Successful transfer of this research to cheese industry was done. Support from INTI Dairy Industry Research Centre was doing to develop more healthy cheeses. Nowadays, these healthy cheeses are being commercialising in the Argentine market.

## 5.0 References.

- Gagliostro G, Rodríguez MA, Pellegrini P, Muset G, Gatti P, Garciarena C and Castañeda R. (2008) "Persistency of Conjugated Linoleic Acid (CLA) in White Cheese from High CLA Milk." 5<sup>th</sup> IDF Symposium on Cheese Ripening. Mars 9-13. Bern. Switzerland.
- Gagliostro G. A., M. Martínez, V. I. Cejas, M. A. Rodríguez, and M. Balán. (2009). Persistency of conjugated linoleic acid and vaccenic acid on Sarde cow cheese. J. Anim. Sci. Vol. 87, E-Suppl. 2/J. Dairy Sci. Vol. 92, E-Suppl. 1. Pag. 572- 2009 Joint ADSA-CSAS-ASAS Annual Meeting.
- Gagliostro G.A., M. Martínez, V. I. Cejas, M. A. Rodríguez, and M. Balán. 2009. Persistency of conjugated linoleic acid and vaccenic acid on Tybo cow cheese. J. Anim. Sci. Vol. 87, E-Suppl. 2/J. Dairy Sci. Vol. 92, E-Suppl. 1. Pag. 22-23. 2009 Joint ADSA-CSAS-ASAS Annual Meeting.
- F. Luparia, P. Pellegrini, A. Rodríguez, D.A. Garciarena, G.A. Gagliostro; Effects of high oil corn (HOC) on milk fatty acid composition in grazing dairy cows in early lactation. 2008 Joint ADSA-CSAS-ASAS Annual Meeting.

- G.A. Gagliostro, M. A. Rodríguez, P. Pellegrini, P. Gatti, G. Muset, D. Garciarena, A. Ferlay, Y. Chilliard<sup>3</sup>; Effect of supplementation with sunflower oil (SO) or seeds (SS) combined or not with fish oil (FO) on conjugated linoleic acid (CLA) in milk from grazing dairy cows. . 2008 Joint ADSA-CSAS-ASAS Annual Meeting.
- Gagliostro, Rodríguez M.A, et al. "Effects of ruminal infusión of sunflower oil (SO) or seeds (SS) combined or not with fish oil (FO) on conjugated linoleic acid (CLA) in milk" . ADSA PSA AMPA ASAS : Presentacion de 3 Abstracts : del 8 al 12 de Julio de 2007
- Gagliostro, Rodríguez M. A. , et al. "Persistence of conjugated linoleic acid (CLA) on three dairy products". ADSA PSA AMPA ASAS : Presentacion de 3 Abstracts : del 8 al 12 de Julio de 2007
- Gagliostro, Rodríguez M.A., et al. "Effects of high oil corn grain supplementation on milk yield and composition and milk fatty acids profile in grazing dairy cows in early lactation" ADSA PSA AMPA ASAS : Presentacion de 3 Abstracts : del 8 al 12 de Julio de 2007
- Gagliostro G, Rodríguez A, Pellegrini, P., Gatti, P., Muset, G., Castañeda, R.A., Oporto, M.I. y Colombo, D. (2005) "Efectos del suministro de aceite de pescado y aceite de girasol sobre las concentraciones de ácido linoleico conjugado (CLA) y omega tres (n3) en leche de cabra." R.A.P.A. Vol 25 (Suplem.1): NA 31. Diciembre 2005
- Gagliostro, Schroeder, Gatti, Rodríguez. (2004) "Reemplazo parcial del grano de maíz por lípidos en vacas lecheras primiparas y multíparas en pastoreo. Composición en ácidos grasos de la leche y metabolitos plasmáticos". (AAPA Oct 04)
- Rodríguez, M.A., Pellegrini, P., Gagliostro, G., Gatti, P., Castañeda, R., Muset, G. (2007). "Persistencia de CLA en yogurt, queso blanco y leche." Póster en Jornadas 50º Aniversario INTI, Buenos Aires, 20-21/11/2007.



# The role of pedigree recording in sustainable animal agriculture with special focus on indigenous breeds

C. Hunlun<sup>1</sup> & K. Ramsay<sup>2</sup>

<sup>1</sup>SA Stud Book and Animal Improvement Association, Bloemfontein, South Africa

<sup>2</sup>Department of Agriculture, Forestry and Fisheries, Pretoria, South Africa

## **Abstract**

The realities of global warming and climate change pose new challenges to livestock producers in terms of the harsh environments in which they will have to produce in future. The challenge for animal breeders is to maintain or improve the specific adaptation of their animals to the changing environmental conditions while improving the productivity and efficiency of their breeds. The recording of origin, parentage and ownership of animals is a fundamental and indispensable part of the conservation and genetic improvement of animal populations.

It has been well established that local and indigenous breeds are indispensable for global animal genetic diversity, providing the world with a greater range of options to meet future challenges in terms of animal production. Most indigenous and local breeds, however, are not part of formal animal recording programmes.

Some of the problems relating to this situation are discussed and examples of how various recording processes can be used to address these problems are given.

*Keywords: pedigree recording, indigenous breeds, farm animal genetic bio-diversity, population statistics*

## **1. Introduction**

Livestock has played a very important role in the history and development of sub-equatorial Africa and it will undoubtedly continue to do so. This region harbours the full spectrum of livestock breeds - from highly productive modern and global breeds of cattle, sheep, pigs and horses, well adapted to the demands of modern production practices, to a rich complement of truly local and indigenous breeds of farm livestock which have sustained pastoral communities through many years.

The livestock industry in its entirety is faced by very real challenges:

- Land use for agriculture, and livestock production in particular, will have to be planned with greater discernment than before.
- The realities of global warming and climate change will pose new challenges to livestock producers in terms of the harsh environments in which they will have to produce.

The challenge then for animal breeders is to maintain or improve the specific adaptation of their animals to the changing environmental conditions while improving the productivity and efficiency of their breeds. It has been well established (FAO, 2007) that local and indigenous breeds greatly contribute to global animal genetic diversity, providing the world with a greater range of options to meet future challenges in terms of sustainable animal production.

## **2. Sub-equatorial Africa**

Animal agriculture in sub-equatorial Africa can be typified as dualistic: On the one hand there is a 'commercial' sector focused on the production of marketable commodities. On the other, there is a rather large 'informal' sector that does not participate in the 'normal' processes found in a typical production environment.



The dynamics of the commercial livestock industry indicate that purebred breeding and formal animal recording are vitally linked to the production sector. There is a healthy interdependence between these two segments. Cost effective and sustainable production in commercial herds and the constant improvement of the genetic components thereof, are to a large extent dependent on the genetic improvement of the relevant traits in the purebred herds – the source of their breeding material. The recording of origin, parentage and ownership of purebred animals, as performed by registering authorities and breeders' societies, is an indispensable part of this segment of the industry. The cost of animal recording – and animal improvement in general – is largely borne by the purebred breeders themselves, with government assistance in some cases.

Due to many factors the livestock owners and breeders in the informal sector of the livestock industry can be termed as resource-poor. To some extent they lack or have limited access to basic resources in the production processes such as land, capital, knowledge and institutional support. In most instances livestock forms the backbone of the wealth and production of resource-poor farming communities. Invariably these livestock are well adapted, indigenous breeds with appropriate productive capabilities for the circumstances under which they are managed.

The biggest problems facing livestock production under resource-poor circumstances are rangeland management and the control of communal land. The cultural relationship between farmers and their livestock, which to a large extent dictates the eventual application of the production that may occur from these animals, is another factor – in many cases the perceived wealth in animal numbers seldom leads to financial emancipation. To some extent these factors are all interrelated and limit the ability of the farmer to be a productive and efficient producer, regardless of the eventual product. In terms of the possible future use of livestock from this sector, the almost total lack of formal identification and recording of the animals is a very big challenge.

The dilemma that faces the industry is rather intricate:

- Sub-equatorial Africa has a rich heritage of locally adapted indigenous breeds and landraces that have evolved under the harsh local conditions and are well suited to these conditions.
- These breeds possess special qualities – some of which may not yet have been recognised. Indeed, some of the owners and breeders of these breeds may not be aware of the potential value of these animals.
- The need for the sustainable conservation and utilisation of these populations is well established but not always well accepted. The concepts of biodiversity and conservation of indigenous breeds must become part of the policies and aid programmes not only of governments but also of the management ethos of the producers of these breeds.
- Breeders and owners of these local and indigenous breeds need to be made aware of the benefits of conserving and / or improving their livestock and these owners / breeders need to derive rewards commensurate to their efforts.
- Breed characterisation, improvement and conservation are costly processes. For instance: Proper identification and recording of animals is a basic requirement of any improvement or conservation project. All other actions like descriptive processes, genetic management etc. are dependent on proper identification and efficient recording. The identification of livestock will require resources like capital, labour, management, time and skill – from a farmer who can already be described as 'resource-poor'.
- Governments need to realise the importance of actions like basic animal identification and recording and the use of such information for the benefit of the owners and breeders and their broader communities. They need to get actively involved in programmes that support animal improvement in rural and developing communities.
- Established breeders and breeders' organisations need to reach out to breeders of local and indigenous breeds that are not yet participating in the formal processes of animal recording. Through active involvement, and by example, they need to demonstrate the rewards of the various processes of formal animal recording.

In the past, the ability to respond to environmental and market changes was achieved readily, even without the use of modern evaluation techniques. This was mainly because breeders had access to a larger gene pool spread over a number of diverse ecosystems. But these reservoirs of genetic insurance policies have, for many reasons – of which indiscriminate crossbreeding is not the least – dwindled noticeably over the past few decades.

In the absence of direct measures of genetic diversity, the identification, characterization and recording of indigenous breeds provide the best indication of total farm animal genetic diversity. In the short to

medium term, the management activities of previously unrecorded local and indigenous breeds will, to a large degree, determine the future role and contribution of any breed to farm animal genetic diversity and towards global food security.

Selection is the only practical tool at the disposal of animal breeders to face the challenges of changing environmental and consumer needs. Within breeds, selection response depends on five factors – variation in breeding worth, generation interval, intensity of selection, effective population size and the accuracy of selection, all of which depend heavily on the extent and accuracy of basic animal recording in the relevant populations. The first logical step in meeting the challenges is to embark on a formal process of census and recording of genealogical and distribution information to facilitate the evaluation of salient population structure parameters and to quantify and monitor in breeding in the breed and its sub-populations. The information gained in this way forms the basis of virtually all other efforts that are needed to ensure the future existence and application of the breed.

### 3. Possible use of pedigree information

Some examples of the use of formal recording processes in indigenous and local breeds exist in South Africa and may be used to demonstrate some of the benefits that can be derived from the use of these processes. Data pertaining to four indigenous beef cattle breeds is used for this purpose.

Summaries of the histories of the Afrikaner (AFR), Bonsmara (BON), Drakensberger (DRB) and Nguni (NGI) cattle breeders' societies and the basic characteristics and performance profiles of each of the breeds are well documented (FACT (2000); SA Stud Book (2004); ARC-AII (2001)).

The Afrikaner is one of South Africa's oldest recorded breeds. Formal recording of this breed commenced in 1907 and a breeders' society was established for this breed in 1912. The Afrikaner was once the most numerous cattle breed in South Africa.

Of all livestock breeds in South Africa (and possibly the world) the Bonsmara is probably the most widely researched and documented. While formal recording of animals in the breed commenced in the early 1940s the Bonsmara Cattle Breeders' Society was established only in 1964. The Bonsmara is currently the most numerous cattle breed in South Africa and has breeders and breeders' societies in several other countries.

Development of the Drakensberger breed of cattle probably started as early as 1800, but formal recording of the breed started with the establishment of a breeders' society for the breed in 1947.

The Nguni is, like the Afrikaner, one of South Africa's oldest cattle breeds, but formal recording commenced on a very limited scale only in the late 1940s. The Nguni Cattle Breeder's Society was established in 1986. The Nguni shows the highest increase in terms of numbers of formal breeders and formally recorded breeding animals in South Africa.

The comparative census statistics for the four breeds in July 2008 (N extGenSA, 2010) are shown in Table 1. The average recorded performances of the four breeds for 2007/2008 (ARC-API, 2009) are shown in Table 2.

Table 1. Census statistics for four beef cattle breeds, as in July 2008.

Breed	Registered herds	Perf. Rec. herds	Registered animals	Perf. Rec. animals
AFR	74	52	11 885	10 505
BON	350	332	99 642	97 235
DRB	73	71	13 538	13 355
NGI	441	95	53 265	19 307

The data in Table 1 provide some context for the comparison of the four breeds: The Bonsmara is numerically the biggest breed with almost 100 000 registered animals. The Nguni has the most breeders but shows the lowest participation in performance recording – only 22.3% of the herds with only 33.2% of animals participate in the South African National Beef Recording and Improvement Scheme. The levels of performance recording is very high and similar for the Bonsmara and the Drakensberger breeds and slightly lower for the Afrikaner.

Table 2. Average performance of animals of four beef cattle breeds, as in 2007/2008.

Breed	Birth weight (kg)	Weaning weight (kg)	Cow weight at weaning (kg)	Weaning weight ratio
AFR	31.3	195	478	43.2
BON	35.3	218	508	44.1
DRB	34.6	204	499	43.3
NGI	25.1	158	366	44.9

The average performances of the four breeds vary very much typify the breeds – the BON and DRB on average being medium-framed, medium-maturing breeds, the AFR is a small- to medium-framed early-maturing breed and the NGI is a small-framed early-maturing breed.

An analysis of the breeding structures (Robertson, 1953) of the four breeds was performed on the data of the progeny born in the 24-month period 1 July 2006 to 30 June 2008. An analysis of the breeding structure of a breed yields very pertinent information about the functional stratification and several population statistics of a breed and is dependant on pedigree and ownership data of the breed being analysed. The four breeds show very similar breeding structures with an average of 50.7% of the herds being classified as 'breeder herds' – herds supplying breeding animals to other herds. On average the 'breeder herds' bred 69.3% of the progeny that was recorded for these breeds. Compared to the same parameters for six other numerically significant beef breeds in South Africa, these statistics are of more or less the same magnitude. The four indigenous breeds, however, display less variation amongst them than the other breeds.

The number of active herds, the number of progeny born in the 24-month period and the average number of births recorded per herd per year for each of the four breeds are shown in Table 3.

The data in Table 3 serves to support the data in Table 1. The numbers of herds in Table 3, however, are slightly lower, as the data in Table 3 reflects only the number of herds that actually recorded births of qualifying progeny in the relevant period.

Table 3. Number of animals born, number of active herds and average number of births recorded per herd per year for four beef cattle breeds.

Breed	Number of animals born	Number of herds	Average births / year
AFR	4 999	52	48.07
BON	49 688	250	99.38
DRB	7 232	64	56.50
NGI	26 447	259	51.06

From this data it can be established that, on average, only 72% of all herds actually contribute to the breeding of animals in the breeds, with DRB-herds being above average (87.73%) and NGI-herds below average (58.7%) in this regard. The situation for the other six numerically significant beef breeds in South Africa in this respect is on average somewhat lower (66%) but variable – some breeds have levels of recording as high as that of the DRB and some have levels lower than that of the NGI.

The BON has an appreciably higher average herd size than the other three breeds. The average herd size for six other numerically significant beef cattle breeds in South Africa is of the same magnitude as that of the AFR, DRB and NGI breeds, except for one other breed, which has an even higher average number of births per year (127.57) than the BON. The size of breeding units within a breed has a significant effect on the rate and extent of genetic gain that can be achieved within a breed.

The effective number of herds supplying sires ( $H_s$ ), grandsires ( $H_{ss}$ ) and great-grandsires ( $H_{sss}$ ) to the respective breeds (Robertson, 1953; Gutiérrez *et al.*, 2003), an indication of the levels of within-breed genetic diversity, is shown in Table 4.

The data in Table 4 indicates that the BON and NGI had the highest number of effective herds supplying sires to the breed and that the AFR and DRB had substantially lower  $H_s$ -values. The data is, however, skewed due to the differences in the number of progeny born for each of the breeds. If the  $H_s$ -value for each breed is weighted for the number of progeny born, it becomes clear that the AFR actually had the highest levels of genetic diversity (3.33 herds supplying sires per 1 000 calves born), followed by the DRB (2.07), the NGI (1.60) and the BON (1.06). These figures are slightly lower for the four indigenous breeds when compared to some numerically significant international beef cattle breeds in South Africa. This is probably to be expected if the worldwide genetic base of these breeds is taken into account.

Table 4. The effective number of herds supplying male ancestors for four beef cattle breeds.

Breed	$H_s$	$H_{ss}$	$H_{sss}$
AFR	16.64	11.14	15.04
BON	52.63	22.37	20.12
DRB	14.95	13.83	14.43
NGI	42.19	42.37	49.02

The standardised effective number of herds supplying male ancestors to a breed also serves as an indication of the average relatedness of male ancestors within a breed and may be used as an indicator of whether a more extensive analysis of the relationships within a breed needs to be performed – another analysis that depends on the pedigree and ownership data of a breed.

The average completeness of the pedigree information in the parental generation of the animals born in the period under investigation is shown in Table 5.

The average completeness of pedigrees of a breed also serves as an indication of the reliability of parameters that are calculated from the pedigree- and relationship data of the breed like inbreeding coefficients and breeding values and, in some cases, may indicate potential problems with the recording processes that are used for the breed or with the integrity of the database.

Table 5. Average completeness of pedigree information in the parental generation for four beef cattle breeds.

Breed	Average completeness of pedigrees (%)
AFR	99.95
BON	98.23
DRB	97.44
NGI	89.12

The data in Table 5 reflects the extent to which a breed has an 'open studbook' with an active upgrading programme. The data in Table 5 is comparable to that of the six other numerically significant beef cattle breeds in South Africa. Only one other breed has an appreciably lower value for the average completeness of its parental pedigrees (79.3%) – a recently introduced synthetic breed with an open studbook and a very active upgrading programme.

Several comprehensive analyses of the basic animal recording data of the Bonsmara breed were recently done as part of a publication commemorating 45 years of the breeders' society. The changes in the breeding structure of the breed over its history were described (Hunlun, 2009), a demographic description of the breed over time was given (Hunlun *et al.*, 2009) and the developmental history and evolution of the genetic variability of the breed were described (Van der Westhuizen, 2009). All these analyses depend largely on the recorded ownership and pedigree data of the breed.

## 4. Conclusive remarks

To be able to reach selection goals, modern techniques of animal- and performance recording and breeding value estimation should be employed and used judiciously. To safeguard populations against the detrimental effects of inbreeding and to help preserve genetic variation, a system of exchange of genetic material between sub-populations within breeds must be established. No efforts should be spared to increase the effective population size, both on a regional and on a global level.

Most of these factors are interrelated and have marked effects on each other and all of these actions require thorough recording of pedigree and ownership. Animal breeders today are in the fortunate position that excellent scientific and institutional support is readily accessible and affordable. There are no technical reasons that will prohibit breeders of local and indigenous breeds from positively meeting the challenges that face them and the broader livestock industry. The first steps towards this goal are animal identification and the recording of origin and descent.

## 5. References

- ARC-AII, 2001. *Beef Breeding in South Africa*. Scholtz, M.M., Bergh, L. & Bosman D.J. (editors). CPS-Publishers. Brandfort, 2001, 220 pp.
- ARC-API, 2009. National Beef Recording and Improvement Scheme: Annual Report - 2008/2009. Bergh, L., Gerhard, R.G. & Havenga, N. (editors). ARC-Animal Production Institute, Irene, 2009, 20 pp.
- FACT, 2000. *Landrace breeds: South Africa's indigenous and locally developed farm animals*. Ramsay, K., Harris, L. & Kotzé, A. (Editors). Farm Animal Conservation Trust. Pretoria, 2000, 112 pp.
- FAO, 2007. *The State of the World's Animal Genetic Resources for Food and Agriculture*. Rischkowsky, B. & Pilling, D. (Editors). Commission on Genetic Resources for Food and Agriculture: Food and Agriculture Organization of the United Nations. Rome, 2007, 511 pp.
- Gutiérrez, J.P., Altarriba, J., Diaz, C., Quintanilla, R., Cañón, J. & Piedrafita, J., 2003. Pedigree analysis of eight Spanish beef cattle breeds. *Genet. Sel. Evol.* 35, 43-63.
- Hunlun, C., 2009. The breeding structure of the Bonsmara breed. In: Ferreira, P. & Webb, E. (Editors). *Bonsmara: Born to breed – born to lead*. Bonsmara SA. Bloemfontein, 2009, 229 – 234.
- Hunlun, C. & Ferreira, P., 2009. A demographic overview of the Bonsmara cattle breed. In: Ferreira, P. & Webb, E. (Editors). *Bonsmara: Born to breed – born to lead*. Bonsmara SA. Bloemfontein, 2009, 65-68.
- NextGenSA, 2010. NextGenSA – A statistical and analytical service by S A S tud Book – Table S 2. <http://www.nextgensa.co.za>
- Robertson, A., 1953. A numerical description of breed structure. *J. Agric. Sci.* 43, 334 – 336.
- SA S tud Book, 2004. *South African Livestock Breeding – 2004*. De Kock, T. & Hunlun, C. (Editors). Picasso Headline. Cape Town, 2004, 160 pp.
- Van der We sthuizen, B., 2009. Population history and genetic variability in Bonsmara beef cattle via a pedigree analysis. In: Ferreira, P. & Webb, E. (Editors). *Bonsmara: Born to breed – born to lead*. Bonsmara SA. Bloemfontein, 2009, 258 – 268.



# Maximising performance on a typical Southern Hemisphere pasture dairy farm

N. Lok

*Dairy Farmer, South Africa*

## Abstract

Managing large herds successfully on pastures presents a myriad of ever mutating challenges. In this period of extreme climatic conditions (droughts and floods) constant monitoring of many variables is essential. In spite of supplementary irrigation, grass growth can vary by as much as 300% from one annual period to the next. To overcome the challenges, grass measurement (quantity & quality) is essential to correctly supplement forages. Concentrates are best fed in parlour according to individual cow requirements and genetic potential. Management systems which can measure body weight & height, milk yield, and milk constituents automatically at every milking are essential aids in determining the exact concentrates (eg maize, soya, minerals) each cow requires during the different stages of lactation. Rations are then automatically recalculated daily, based on a rolling average. Individual cow performance and response can then be automatically monitored and adjusted to achieve ideal body condition scores.

By adopting the above practices whole farm performance is maximised which is essential in a scenario of pasture land prices doubling every 4 to 5 years.

*Keywords: Pasture, individual cow, supplementation, management systems.*

## South Africa cow concentration

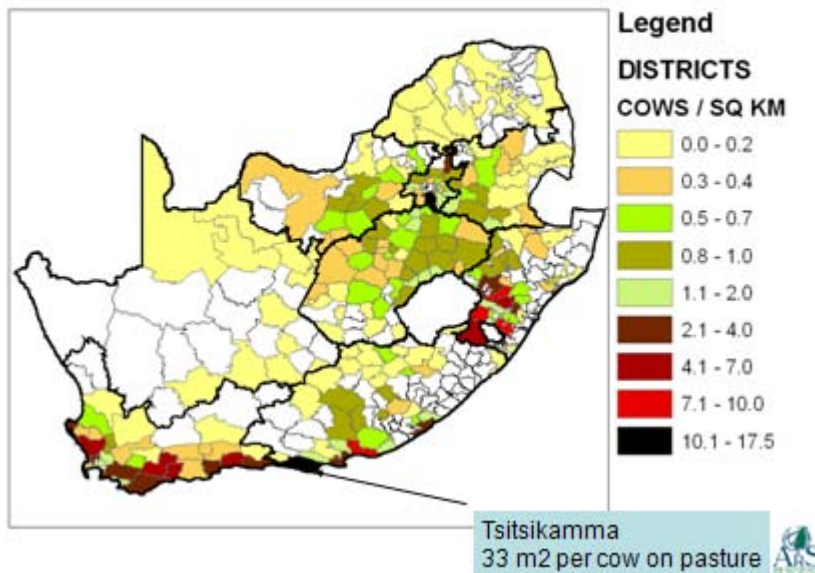

## 1.0 Laws of dairying

- Feed your cows properly and individually to manage milk condition and fertility.
- Body condition is king
- The dry period and transition is crucial
- Grow your heifers out to their genetic potential

### 1.1 Lessons learnt

- Individual cow management is the best way to increase efficiencies and maximise sustainable profits.
- Management systems should collect and utilize data such as milk, butterfat, protein, lactose, SCC, body weight, height, activity, conductivity, SCC daily to be effective.
- Only with comprehensive data collected at every milking can we make informed decisions.
- Principles of feeding roughage and supplementing cows to optimise production and BCS

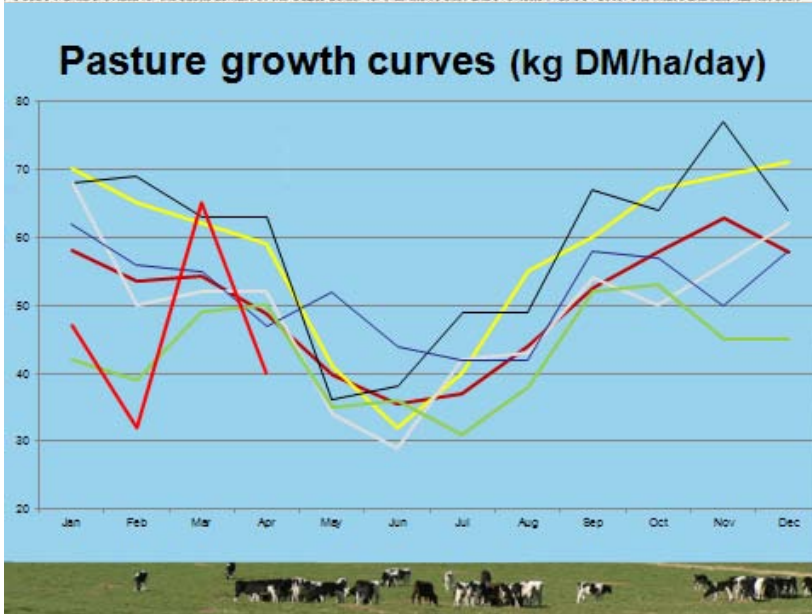
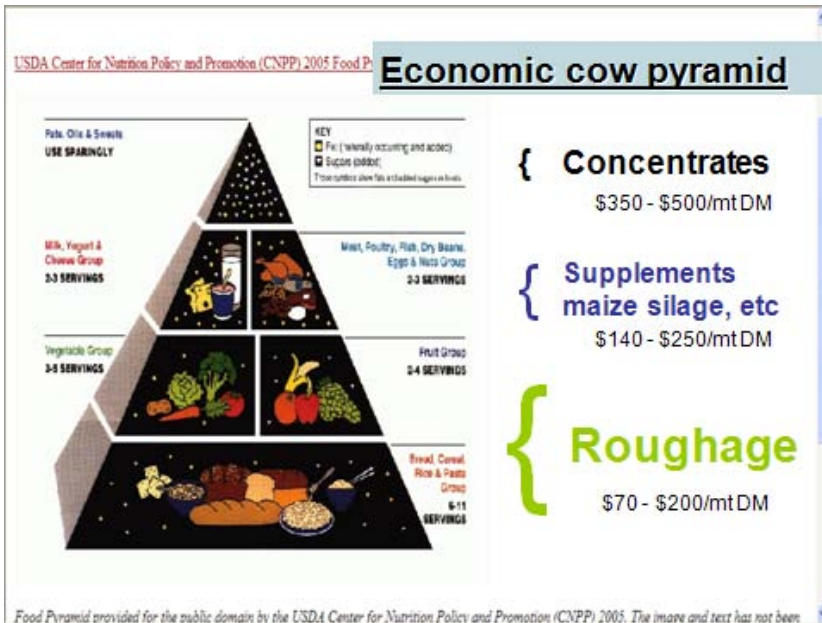



### Supply to meet demand Mar 2009 – Feb 2010

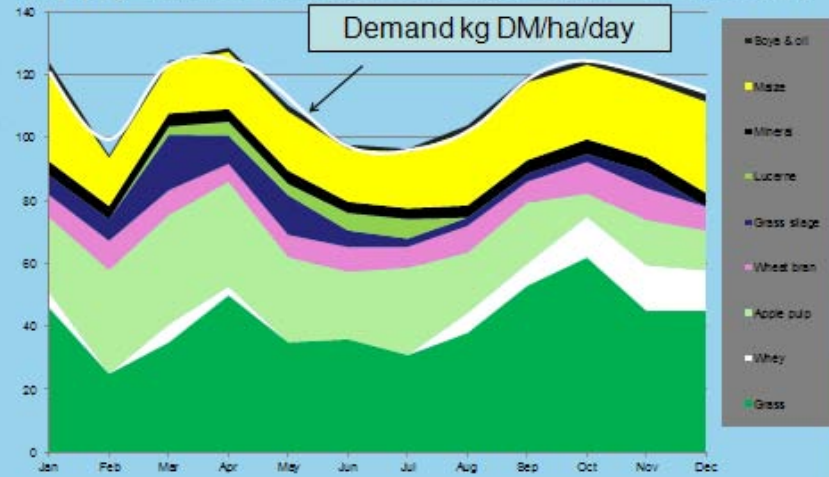

### Effect of feeding concentrates individually to manage BCS and production

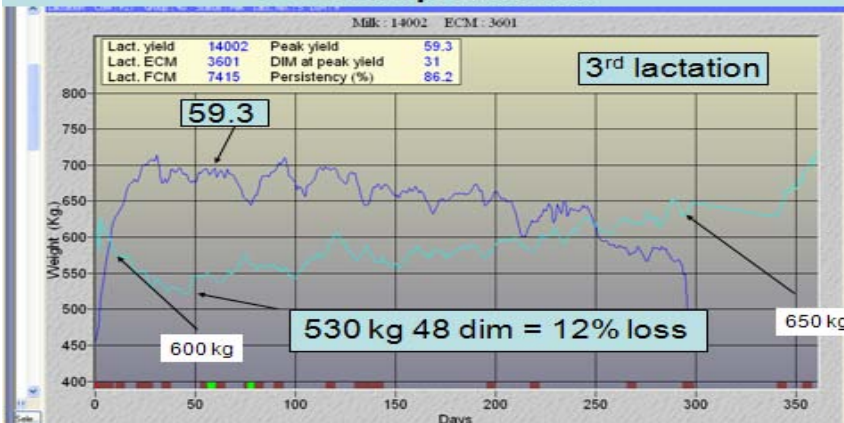

## Parameter ranges

Daily avg. yield	Avg. fat	Daily avg. FCM	Avg. fat	Lact. no.	DIM	Avg. weight	Weight in calf	Index now
9.4	5.12	11.0	3.24	2	132	334	335	82
41.2	4.14	42.1	6.44	1	341	711	578	125
--	--	--	--	--	--	--	--	207
--	--	--	--	--	--	--	--	103

Calving exp. date	Lact. no.	DIM	Gyn. status
04/05/2009	1	1	Calving
26/10/2009	8	712	Heat
--	--	--	Insemination
--	--	--	Not for Insemination
--	--	--	Pregnant



Index	Co	Size (wt & ht)	Daily avg. yield	% FCM from weight	Avg. fat	Alloc. (today)	bcs last before c	index now	current BW/ht inde	Days to calving	Not for insemin. date
1	T47	20 203 557	4 23.7	26.4	4.7	4.78	4.7	3.50	100	107	132
2	T49	40 223 507	4 19.6	19.8	3.9	4.07	2.9	3.25	100	102	200
3	T79	40 215 498	4 28.3	30.9	6.2	4.60	9.0	3.25	99	93	--
4	U160	20 51 510	3 28.4	29.5	5.8	4.26	8.1	3.50	94	92	--
5	U178	40 54 487	3 27.4	28.5	5.9	4.27	7.8	3.00	98	97	--
6	U263	20 49 491	3 27.3	25.7	5.2	3.59	6.5	3.25	95	95	--
7	V24	40 355 473	2 23.3	23.9	5.0	4.16	4.7	3.25	99	99	--
8	V109	20 205 460	2 23.3	24.9	5.4	4.44	5.9	3.25	97	93	196
9	V187	40 199 453	2 23.6	26.8	5.9	4.90	5.9	3.50	99	99	27/01/2009
10	V195	20 179 481	2 19.7	22.6	4.7	4.97	4.7	3.25	97	93	196
Total	--	--	--	--	--	--	--	60.3	33.50	981	977

Automatic feed allocation for



## Afilab

Milk Component (Day) (03/02/2009 - 12/02/2009) (12/02/2009 09:27:58)

Index	Date	Total yield	Avg. yield per milk. cow	Total milk cows	Total cows	Avg. yield per cow	Daily ECM	Daily FCM	Fat %	Protein %
1	03/02/2009	9750	19.7	495	636	15.3	58.0	19.8	4.39	3.39
2	04/02/2009	10177	20.6	495	636	16.0	62.2	21.1	4.27	3.34
3	05/02/2009	10210	20.5	499	637	16.0	62.0	21.1	4.31	3.36
4	06/02/2009	10181	20.3	501	637	16.0	61.8	20.8	4.33	3.45
5										
6										
7										
8										
9										
10										
Total										
Avg										

Bulk tank sample  
 Butterfat 4.34%; Protein 3.4% SCC 242  
 (Afi day report = 230 for that day)



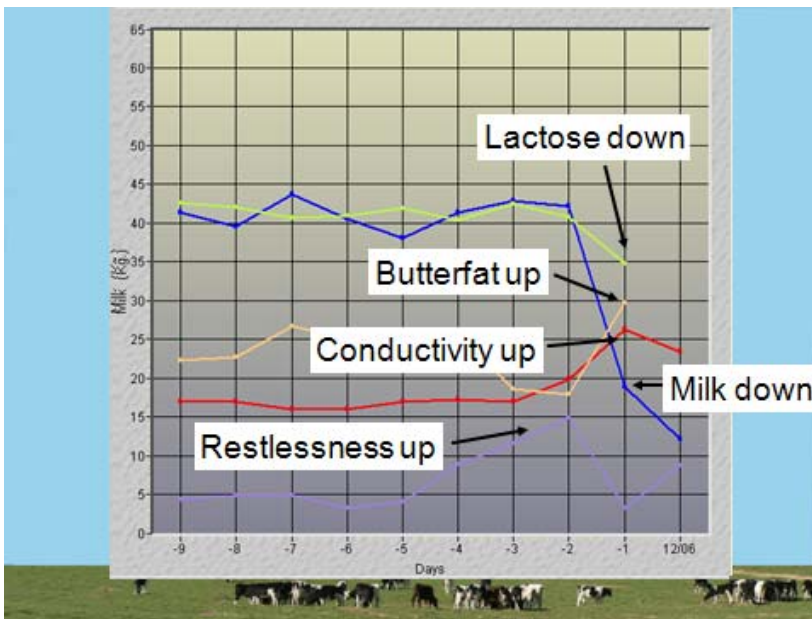

## Sub acute acidosis

Index	Cow	Grp.	Lact. no.	DIM	Daily avg. yield	Avg. fat	Fat %	Avg. protein	Protein %	/ 1 Avg. Fat/ Protein	Fat/ protein
1	7003	20	1	36	29.2	3.32	2.44	3.34	3.11	1.00	0.79
2	R41	40	5	290	21.3	3.48	3.94	3.43	3.41	1.01	1.15
3	Q141	40	7	43	28.4	3.72	3.31	3.65	3.64	1.02	0.91
4	U240	40	3	186	19.9	4.05	3.84	3.89	3.93	1.04	0.98
5	6236	20	1	171	22.0	3.54	3.16	3.39	3.03	1.04	1.04
6	V293	40	2	47	30.6	4.06	3.03	3.76	3.70	1.08	0.82
7	R162	40	6	168	18.1	4.50	3.44	4.07	3.88	1.11	0.89
8	U3	40	3	39	22.2	4.03	3.09	3.58	3.58	1.13	0.86

Concentrates allocated as a percentage of body weight and the limitation is as a maximum percentage of BW  
This severely limits acidosis and promotes rumen health

### 1.2 Results

- Our average fat corrected milk yield is 45% higher than our district.
- Kilograms FCM per hectare is 45% higher.
- Concentrates fed per kg FCM is 30% less
- Nitrogen used is 30% less
- Intercalving period is 380 days – only AI, no bulls.
- At calving average Body condition score is 3.45



## Challenges and opportunities for beef production in developing countries of the southern hemisphere

M.M. Scholtz<sup>1</sup>, C. McManus<sup>2</sup>, O. Mwai<sup>3</sup>, L. Seixas<sup>2</sup> & H. Louvandini<sup>2</sup>

<sup>1</sup>ARC-Animal Production Institute, Private Bag X2 Irene 0062, South Africa

<sup>2</sup>Universidade de Brasília, Fac de Agronomia e Medicina Veterinária, Caixa Postal 04508, CEP 70910-9000, Brasília, DF, Brazil

<sup>3</sup>ILRI, P.O. Box 30709, 00100, Nairobi, Kenya

<sup>4</sup>Instituto Nacional de Ciência e Tecnologia- Informação Genético-Sanitária da Pecuária Brasileira, Brazil

### Abstract

Livestock production faces specific challenges due to a rise in population numbers, urbanization and economic development in the developing world. A substantial increase in demand for meat in these countries will offer larger market opportunities for livestock producers. Developing countries from the southern hemisphere are characterized by a highly dualistic beef cattle sector with communal, subsistence or small scale farmers and large commercial farmers co-existing. Whereas the off-take from the commercial sector is high, the off-take from the other sectors is still low in certain regions. Global warming is expected to have a negative effect on the beef production environments of these countries. By describing production environments it will be possible to identify genotypes that are adapted to the environment. Tools are needed to overlay geo-referenced data sets onto the different environments in order to quantify them. Gene or marker assisted selection may play an important role in selection for disease and parasite resistance or tolerance, since it is difficult to measure these traits directly. Strategies that utilize EBVs derived from genomic analyses (genomic EBVs), together with conventional mixed model methodology, may speed up the process of breeding animals with higher and more efficient production. Research into methane production will also have to be stimulated.

*Keywords: Adaptation, animal improvement, animal recording, genomics, global warming, landscape genetics, methane production, production environment.*

### 1.0 Introduction

Livestock production faces specific challenges due to increasing population, urbanization and economic development, especially in developing countries. These developments are expected to lead to a significant rise in demand for livestock products, referred to as the *Livestock Revolution* (Delgado *et al.*, 1999). The world demand for meat is expected to rise by more than 200% from 229 million ton in 1999 to 465 million ton in 2050 (Steinfeld *et al.*, 2006), with global numbers of meat animals that will have to increase to respond to the demand, which in turn will increase methane production from livestock. This substantial increase in demand for livestock products in developing countries (Delgado *et al.*, 1999), partly due to population increase and improved incomes, will offer much larger market opportunities for the livestock producers in these countries.

There is growing evidence that improving the productivity of farmers that are not currently operating on a commercialized level (subsistence, smallholder, emerging, etc.) has the potential to address poverty in agriculturally based economies (Hazell *et al.*, 2007) of developing countries in the southern hemisphere, while the more commercialized (industrialized) production systems remain in balance with the natural environment (Comprehensive Assessment of Water Management in Agriculture, 2007; UNEP, 2007).

Cattle are the most important livestock species in Africa and Latin America; the difference being that Africa is one of the centres of domestication (Bruford *et al.*, 2003; Hanotte *et al.*, 2002) and is richly endowed with a large number of indigenous breeds that have adapted to the continent's prevailing conditions (Scholtz, 1988, 2005; Scholtz and Theunissen, 2010), whereas the only domestic animals in Latin America at the time of the discovery of the Americas in 1492 were camelids such as llamas, alpacas, guinea pigs, etc. All other animals were imported, mainly from the Iberian Peninsula and North Africa and underwent approximately 500 years of natural selection in the diverse environments. From the end of the 19<sup>th</sup> century there were other imports from mainland Europe and zebu cattle from India (Primo, 2004).

The type of production strategy to be followed in these countries depends primarily on the environment and level of management (Scholtz and Theunissen, 2010). There is a need to match the environment with the correct genotype to ensure increased and sustainable production (McManus *et al.*, 2009). While beef production in Brazil is based primarily on *Bos indicus* (Zebu) breeds, Uruguay and Argentina base their beef cattle industry on traditional British breeds (Mariane *et al.*, 2008). Southern hemisphere Africa is dominated by indigenous Sanga breeds with some influence of Zebu, British and European breeds.

Major beef production in Latin America comes from Brazil, Argentina, and Uruguay, which are large net exporters of beef (over 35% of world trade in 2005 – Steiger, 2006), whereas southern hemisphere African countries, with the exception of Botswana and Namibia, are all net importers of beef, despite the huge and untapped potential of exceptionally good indigenous beef cattle breeds (Demeke, *et al.*, 2004; Scholtz and Theunissen, 2010; Rewe *et al.*, 2010 Wasike *et al.*, 2006).

This paper aims to discuss the challenges and opportunities for beef production in the developing countries of the southern hemisphere in relation to beef production levels, the challenges posed by global warming, enteric methane production, the role of recording and quantitative breeding technology, and genomics.

## 2.0 Discussion

### 2.1 Production levels

Cognisance should be taken of the fact that the cattle sector in these countries is highly dualistic with communal, subsistence or small scale farmers and large commercial farmers all co-existing. Whereas the off-take from the commercial sector is high, the off-take from the other sectors is still low in certain countries as a result of low fertility, high mortality, etc.

A survey undertaken in South Africa (Scholtz and Bester, 2009) demonstrated major differences in the different sectors regarding production levels (Table 1).

Table 1. Beef production information on the different sectors in South Africa.

Trait	Commercial sector	Emerging sector	Communal sector
% Adult females in herd	52	49	25
Calving percentage	62	48	35
Pre-weaning mortality (%)	3.1	3.3	30.7
Post weaning mortality (%)	2.7	2.2	4.7
% Off-take	32	25	6

Major discrepancies in production and throughput between the commercial, emerging and communal sectors in South Africa are demonstrated by Table 1, and clearly indicate that aspects such as pre-weaning mortality, herd composition and calving percentage in the communal sector should be urgently addressed to improve production from this sector.

Similar discrepancies in production were demonstrated in the Brazilian Pantanal (freshwater wetland). Table 2 demonstrates the effect of a four year monitoring period on production in the Pantanal (Abreu *et al.*, 2010). In harsh environments such as the Pantanal in Brazil, it had been shown that while Nelore cattle have a calving interval of almost two years the naturalized breeds such as Pantaneiro or Curraleiro calve once a year (McManus *et al.*, 2002).

Table 2. Beef cattle production in the Brazilian Pantanal following four years of monitoring.

Trait	Start of monitoring	After four years monitoring
Calving percentage	45-56	65-70
Pre-weaning mortality (%)	18-25	5-10
Post weaning mortality (%)	5	3

These examples illustrate the opportunities for increasing beef production in these regions, but specific actions need to be taken for this to happen. Farmers tend to be reluctant to address specific management problems, such as soil erosion, pasture quality or animal growth rates, preferring to open virgin forest to create temporary pastures, which are abandoned after use for a few years

The poor use of technology is emphasized when it is noted that meat off-take in Brazil is 22% and in the communal sector in South Africa 6%; compared to 26% in Argentina, 30% in Uruguay and 32% in the South African commercial sector. The United States have an off-take of up to 37%.

## 2.2 Global warming

Tropical and subtropical climates have both direct and indirect effects on livestock. Factors such as temperature, solar radiation, humidity and wind all have direct effects on animals, whereas factors such as digestibility of feed, intake, quality and quantity of grazing, pests and diseases, all have indirect effects on animals (Linington, 1990). It is predicted that climate change will have a more extreme effect on southern hemisphere continents than on other continents. Reports indicate that temperatures will rise by a minimum of 2.5°C in large parts of southern Africa, while the grazing capacity is expected to decline by more than 30% (Furstenburg and Scholtz, 2009). Romanini *et al.* (2008) predict that an increase of 5°C in air temperatures in Brazil may lead to a decrease in pasture capacity of up to approximately 50%. These changes in grazing capacity are substantial.

Ambient temperature is the factor that has the largest direct effect on livestock production. Most livestock performs at their best at temperatures between 4 and 24°C (McDowall, 1972). In the tropics and subtropics temperatures frequently rise above this comfort zone and it is therefore important that livestock are adapted to these higher temperatures (Linington, 1990). Maximum daily temperature is not the biggest problem, but if the minimum night temperature does not drop to below 20°C, unadapted cattle will suffer from tropical degeneration (Bonsma, 1980). High temperatures and solar radiation decreases intake in order to reduce digestive heat production, and reduce grazing time (animals do not graze in hot midday hours), whereas sweating and water intake increases. Other factors involved in thermal comfort include the external coat of the animal (thickness, structure, thermal insulation, absorption and reflectivity) and body traits (shape, size and superficial area) (Bonsma, 1983; Silva, 2000).

Nutritional stress has the largest indirect effect on the grazing animal in the tropics and subtropics. In these environments, natural pasture has both lower nutritional value and lower tiller density than in temperate regions (Linington, 1990). These tropical grasses (C<sub>4</sub>) have developed a different photosynthetic pathway to adapt to the climate. The C<sub>4</sub> refers to a 4 carbon compound compared to a 3 carbon compound (C<sub>3</sub>) in temperate grasses. C<sub>4</sub> plants have a higher photosynthetic rate, which results in high fibre content, low stem to leaf ratio, reduced digestibility and intake (Leng, 1984). C<sub>4</sub> grasses also result in higher enteric methane production during fermentation than C<sub>3</sub> grasses.

Another consequence of climate change is altered patterns of diseases in animals, which may include the emergence of new disease syndromes and a change in the prevalence of existing diseases, particularly those spread by biting insects. Animals will therefore be exposed to different parasites and diseases (IPCC, 2007) as indicated from the predicted change in the distribution of, for example, Tsetse in Africa (Herrero, *et al.*, 2008); putting an even greater pressure on production and the survival of livestock breeds. Rift Valley Fever and East Coast fever are other diseases whose distribution may be effected.

Climate also plays a vital part in determining distribution of ticks, which are responsible for diseases such as Red Water, Gall Sickness, Heartwater, Corridor disease, and East Coast fever.

As a result of global warming, livestock in the developing countries of the southern hemisphere, will need to adapt to higher ambient temperatures, lower nutritional value of the grass in some cases, and expansion of diseases, especially ticks and tick borne diseases in Africa (Scholtz, *et al.*, 2009). Under such challenges balancing genotypes with production environments will become a crucial element requiring the utilization of diverse genetic resources with the appropriate genetic potential for growth, milk production, resistance to disease and prolificacy (Blackburn and Mezzadra, 2006). The question is how to measure adaptation and how to select for it.

## 2.3 Adaptation

Adaptability of an animal can be defined as the ability to survive and reproduce within a defined environment (Prayaga and Henshall, 2005) or the degree to which an organism, population or species can remain/become adapted to a wide range of environments by physiological or genetic means (Barker, 2009). An improved understanding of the adaptation of livestock to their production environments is important, but adaptation is complex and thus difficult to measure (Scholtz, *et al.* 2009). Extensive research has been conducted on the direct measurement of adaptation. This included direct

measurements on the animal such as rectal body temperature, respiration rate, heart (pulse) rate, sweating rate (water loss), skin thickness and hair per cm<sup>2</sup>. In addition, more sophisticated measurements investigated, included the heat tolerance test where the difference in body temperature was measured before and after exposure to extreme heat, and temperature change associated with exercising the animals (Bonsma, 1980; 1983; McManus, *et al.* 2009).

Several proxy-indicators for adaptation are available and have also been used (McManus, *et al.*, 2008). These include reproductive traits such as fertility, survival, birth rate and peri-natal mortality; production traits such as growth rate, milk production, low mortality and longevity; and health traits such as faecal egg counts and number of external parasites (Bonsma, 1980, 1983; Spickett *et al.*, 1989; Scholtz *et al.*, 1991; McManus *et al.*, 2008).

## 2.4 Description of production environments

Adaptation can also be characterized indirectly by describing the production environment in which a breed or population has been kept over a period of time and to which it has become adapted (Scholtz *et al.*, 2009). By describing production environments in more detail it would be possible to identify breeds or genotypes that may be adapted to the changed environment of an area (FAO/WAAP, 2008). It will thus be necessary to link animal performance with the production environment. Such information can then be factored during genetic evaluations either as part of the predictive model or as a "post breeding value prediction" calculation. This will require further research to identify and prioritize variables that can describe the genetics, management and climate of each herd more accurately.

Good quality environmental data describing production environments already exists (FAO/WAAP, 2008). Variables on temperature, relative humidity, precipitation (including variation in rainfall), day length and radiation are available through Geo-referenced Information Systems (GIS) layers. It is therefore important that GPS waypoints are recorded with the animal performance information. Likewise, levels of toxins (e.g. aflatoxins, phyto-toxins, excesses of some minerals, salts and tannins) can also be related to specific geo-morphological formations and geographical positions thus can be easily linked to the relative performance of animals.

## 2.5 Methane production

Methane makes up 16 % of total world gas emissions and is therefore the second most important greenhouse gas (GHG) (US-EPA, 2006). Despite the highest concentration being carbon dioxide (CO<sub>2</sub>), methane (CH<sub>4</sub>) and nitrous oxide (N<sub>2</sub>O) have a heating potential 23 and 296 times higher than CO<sub>2</sub>, respectively, due to the higher atmospheric warming activity of these compounds (Clark *et al.*, 2001).

Human-related activities producing methane include fossil fuel production, animal husbandry (enteric fermentation in livestock and manure management), rice cultivation, biomass burning, and waste management. Natural sources of methane include wetlands, gas hydrates, permafrost, termites, oceans, freshwater bodies, non-wetland soils, wild ruminants (game) and other sources such as wild fires. It is estimated that more than 60 percent of global methane emissions are related to human activities (IPCC, 2007).

Enteric fermentation (animal digestive tract) is the main source of methane and is responsible for 28% of global CH<sub>4</sub> emissions, followed by natural gas (15%), waste management (13%) and rice cultivation (11%) (US-EPA, 2006). Factors that influence enteric methane production in livestock are level of feed intake, diet composition, digestibility and quality of roughage, forage or cultivar species, C<sub>3</sub> versus C<sub>4</sub> grasses, and variation between animals.

In ruminants, CH<sub>4</sub> is produced by a specific group of bacteria called methanogenics, (Moss, 1993), whereas CH<sub>4</sub> may also be produced by protozoa's, which may account for up to 20% of methanogenic microorganisms. As CH<sub>4</sub> cannot be metabolized by the animal or microorganisms, it is partly absorbed by the rumen wall and enters in the blood stream where it is eliminated in respiration. However, most is eliminated by eructation with CO<sub>2</sub> (Kozloski, 2002). From a nutritional point of view, methane represents a loss of energy by the animal of between 6 and 10% which is not converted to a product (meat, milk, wool, etc).

Greenhouse gas (GHG) emission from livestock is measured either in terms of kg CO<sub>2</sub> equivalent per kg of meat or milk available for consumption, or per area of land used. In the case of ruminants extensive systems are usually found to have a lower per-area footprint than intensive grain-fed systems but a higher footprint if expressed in terms of kg/product (Garnett, 2010).

Some studies have shown that the use of tanniferous legumes alone or in combination with grasses in pastures for ruminants, may reduce enteric methane emissions per unit of dry matter consumed (g CH<sub>4</sub>/Kg DMC) without affecting production performance (Pinares-Patino *et al.*, 2003). However, most research has focused on manipulating animal diet in an effort to create a rumen environment unfavorable for methane production. Other options to combat enteric fermentation such as genetic engineering and the use of additives may be options (Beauchemin *et al.*, 2008), but further research and development is needed before such options can be employed.

A very important aspect is that the genetic improvement of livestock results in permanent and cumulative changes in animal performance (Wall *et al.*, 2009). Selection for productivity and efficiency will mitigate greenhouse gases in two ways: firstly, higher productivity leads to higher gross efficiency as a result of diluting the maintenance cost of animals; and secondly, a given level of production can be achieved with fewer higher yielding animals. Wall *et al.* (2009) reported variations between animals, between breeds, and across time, providing the potential for improvement through selection.

Nkrumah *et al.* (2006) reported that beef cattle with low residual feed intake produced up to 28% less methane than those with high residual feed intake. Residual feed intake is calculated as the difference between actual feed intake and the expected feed requirements for maintenance of body weight and a certain level of production (Hegarty *et al.*, 2007). The lower methane production was attributed to differences in rumen microbial population and Nkrumah *et al.* (2006) stated that the differences could be heritable.

Goopy and Hegarty (2004) found large variations in methane emissions between animals (Friesian Jersey crossbreds) at the same level of production and fed the same diet. "High" and "low" methane emitters were identified on identical feed and feed intakes. The reason for the reported differences is unclear, but they assumed that factors such as the rate of passage, microbial activity, fermentation conditions and grazing behavior could play a role.

## 2.6 Recording and improvement

Animal recording forms the backbone of any improvement programme. If traits are not measured and recorded no improvement is possible. Countries such as Argentina, Brazil, Namibia and South Africa have very well organized recording and improvement programmes in place. In South Africa the major improvement programme is the National Beef Recording and Improvement Scheme supported by government and managed by the ARC (Agricultural Research Council), whereas in Brazil, successful beef breeding schemes are run by private companies, together with universities and EMBRAPA (Brazilian Corporation for Agricultural Research).

However, performance recording in many developing countries is difficult since the breeding objective may include many traits, some of which can not be easily measured or quantified. Furthermore, organizational and institutional bottlenecks, including inadequate funding and staffing lead to inconsistencies in systems where governments are in charge of official performance and pedigree recording. Uganda and Kenya offer good, yet contrasting examples of where the public sector support livestock recording, but with little success or impact being realized to the former (personal observation). Through private farmer initiatives and building of strategic partnership with international organizations such as ILRI, Kenya's beef recording is now picked up from a near collapse a few years ago. Although data can easily be recorded at ranch or farm levels, adequate computing/processing facilities are not always available leading to delays or total lack of feedbacks to the farmers, thus rendering such recording exercises almost useless (Kosgey *et al.*, 2010).

Opportunities of using the modern information technologies such as mobile phones, to relay raw data to central data processing centres exist, but are yet exploited. Other constraints include rigid rules on recording, even when such rules do not add much value. For example, in some countries, breed societies, which are may be exclusive clubs actually hinder livestock recording, by not accepting own recorded farm data, and insisting on some form of inspection, and by-laws on breed standards and registration. By insisting that only officially registered animals can be recorded, opportunities to exploit the huge genetic variation in the population are lost.

Wurzinger *et al.* (2009) and Kugonza (2009) examined the ranking or scoring of animals for a trait rather than measuring the trait directly, even for traits that are easy to measure. They concluded that if animals can be ranked reasonable accurately for a trait of economic value, direct measurements may not be necessary. It also appeared that ranking is more accurate than scoring.

There are large differences between breeding cattle for the subtropics / tropics and temperate areas, the main difference being in trait definition. Cattle in subtropical and tropical environments are subjected to



numerous stressors (Prayaga *et al.*, 2006), e. g. parasites (tick and tick borne diseases, internal parasites, flies), seasonally poor nutrition, high temperatures or high daily temperature variation, humidity (both high and low) and temperament (exaggerated by extensive production systems).

In these cases management interventions may be possible, but they are difficult and expensive to implement, particularly in poorly adapted cattle. The best method of ameliorating the effects of these environmental stressors to improve productivity and animal welfare is to breed cattle that are productive in their presence, without the need of managerial interventions.

Statistical science continues to support animal breeding and improvement, and very sophisticated, high-dimensional, models have been applied in this field (Gianola, 2006). The challenge now is to identify fixed and random effects, in respect of quantitative breeding technology, that account for spatial and temporal variation in production environments for use in genetic evaluations (Scholtz, *et al.*, 2009). Further research is needed to identify and prioritize variables that can describe the genetics and management levels of each herd more accurately (Neser *et al.*, 2008). The estimation of separate breeding values (EBV's) for different production environments may even be necessary in extreme cases.

As mentioned earlier, proxy-indicators are available to use in selection for adaptation. Unfortunately it is only in the case of growth traits that quantitative breeding technology has succeeded in the prediction of breeding values that are not problematic. Traits linked to fertility and/or survival (days to calving, calving interval, stayability, calving tempo) are all influenced significantly by management or arbitrary decisions taken by breeders or scientists (Scholtz, *et al.*, 2009). The appropriate quantitative breeding technology to properly handle these traits still needs to be developed.

With respect to parasite resistance adequate quantitative breeding technology exists and heritability for such resistance seems to be high (Scholtz *et al.*, 1989). Parameters such as levels of parasites in the blood etc. are additional information that can easily be measured and included in evaluation programs.

Efficient recording is also necessary to keep inbreeding under control. Globalization of breeding programs and semen sales have led to a limited number of elite sires being used for insemination, leading to increased inbreeding with a reduction in fitness (Falconer and Mackay, 1996), and a decrease in survival and reproductive performance in cows (Smith *et al.*, 1998). A classical example is the Holstein-Friesian which represents more than 90% of all dairy cattle in USA and more than 60% in Europe. The effective population size for the Holstein-Friesian breed has been estimated at only 60 animals (Hansen, 2006).

Computer programs that enable assigning of breeding mates in such a way that inbreeding is minimized without compromising on the expected genetic gains have been developed (Bergh, 2010; Kinghorn and Kinghorn, 2009), however, for such programs to be useful, accurate pedigree records must be kept and used.

## 2.7 Genomics

Twenty years ago the first studies to identify, characterize and use molecular markers to characterize genetic resources and generate tools for animal breeding and management were carried out. Over the last 20 years the technologies to generate molecular data went through several innovation cycles, including Restriction Fragment Length Polymorphisms (RFLP) and Single Sequence Repeats (SSR). The first genome wide genetic maps in domestic animals were built using microsatellite markers (Guerin *et al.*, 2003).

With respect to gene or marker assisted selection beef cattle breeders have been promised for years that it will change the way they breed livestock. However, currently only a few of such tests are available for production traits.

Recent research has indicated that the inclusion of information from DNA analysis in the genetic evaluations or estimation of breeding values may result in substantial increases in genetic gain at reduced cost (Meuwissen *et al.*, 2001; VanRaden, 2008; VanRaden *et al.*, 2009). Strategies that utilize EBVs derived from DNA information (genomic EBVs), together with conventional mixed model methodology, may speed up the process of breeding animals that are adapted to the newly created environment as a result of climate change.

The developments in Quantitative Trait Loci (QTL) (Williams, 2005), and high-throughput SNP's or gene chips (genomic selection based on Single Nucleotide Polymorphisms) may enhance the detection and fine mapping of many genes and QTLs, that for example affect tick resistance. It is foreseen that the utilization of marker assisted selection will play a major role in selection for disease and parasite resistance or tolerance.

Marker assisted selection and proteomics may also be valuable in selection for secondary traits linked to adaptation, such as the gene(s) for high levels of blood urea (N) and ruminal NH<sub>3</sub> in certain genotypes, associated with adaptation to low quality C<sub>4</sub> grasses (Scholtz, *et al.*, 2009).

The most recent innovations include methods to identify and genotype SNP (Single Nucleotide Polymorphism) markers in large scale. High density DNA chips were generated to genotype from tens of thousands to hundreds of thousands of SNPs in a single assay. These new technologies will lead to the development of new applications such as methods to genetically evaluate and select animals (Hayes *et al.*, 2009) based on their Genomic Estimated Breeding Value (GEBV). The first bull summary for the Holstein breed with GEBVs for milk production and quality traits was released in January 2009.

The development of a high-throughput SNP or gene chip may enhance the implementation of marker assisted and genomic selection. A 50k SNP chip is currently on the market for bovines and can make a major contribution towards selection for adaptability. An important prerequisite is the establishment of resource (reference) populations (Meuwissen *et al.*, 2001; VanRaden, 2008; VanRaden *et al.*, 2009) for different environments, which may be costly.

Landscape genomics is also a new field and is a combination of landscape ecology and population genetics aiming at providing information about the interaction between landscape features and micro-evolutionary processes, such as gene flow, genetic drift and selection (Manel *et al.*, 2003). The development of landscape genomics is based on the integration between landscape ecology [such as high-quality remote sensing techniques and geographical information systems (GIS)] and molecular data, as well as spatial statistics designed to detect discontinuities in geographical space (Guillot *et al.*, 2005; Kidd & Ritchie, 2006).

Sub-Saharan Africa is characterized by extremely variable environments and is home to many indigenous cattle breeds and combinations of breeds; the latter as a result of both planned and unplanned crossbreeding with exotic beef breeds. The application of landscape genomics offer tremendous opportunities for the better understanding of the different types and complex nature of gene actions and interactions. If properly analyzed, the results can reveal attributes such as genetic adaptation to specific environmental stress causing factors such as diseases, parasites and extreme heat, humidity or lack of water or combinations of thereof.

### 3.0 Conclusion

Challenges facing beef production in the developing countries of the southern hemisphere include variable and low production levels, the effect of climate change, enteric methane production and low levels of animal recording.

Several new technologies offer opportunities for beef production in developing countries in next few years. These include genomic evaluation methods, together with the development of statistical, bio-informatics, computational and geographical information system techniques.

There is a demand for overlapping research programmes that use molecular tools to empirically evaluate the geographical context of biodiversity patterns by linking genetics, environment and biogeography. In this way, developing countries can be prepared for challenges and make optimum use of the opportunities as they materialize with changes in environmental and political status in regions and countries. To fully benefit from these technologies, performance and pedigree recorded herds of local breeds in developing countries, especially sub-Saharan Africa countries have to participate in on-going SNP genotyping and sequencing so as to allow for appropriate calibration and development of the appropriate chips that contain adequate information for the local breeds, breed combinations and production systems.

### 4.0 References

- Abreu, U. G. P., McManus, C. & Santos, S A., 2010. Cattle Ranching, Conservation and Transhumance in the Brazilian Pantanal. In: Pastoralism - Research, Policy and Practice. 1.
- Barker, J.S.F., 2009. Defining fitness in natural and domesticated population. In: Adaptation and Fitness in Animal Populations. Evolutionary and Breeding Perspectives on Genetic Resource Management. Eds. van der Werf, J.H.J., Graser, H.-U., Frankham, R., Gondoro, C., Springer, The Netherlands
- Beauchemin, K. A., Kreuzer, M., O'Mara, F. & McAllister, T. A. 2008. Nutritional management for enteric methane abatement: A review. Aust. J. Exp. Agric. 48:21–27

- Bergh, L., 2010. The national beef recording and improvement scheme. In: Beef breeding in South Africa, 2<sup>nd</sup> Edition. Ed. Scholtz., M. M.: 57 – 72
- Blackburn, H. & Mezzadra, C., 2006. Policies for the management of animal genetic resources. Proc. 8<sup>th</sup> Wrl. Cong. Genet. Applied Livest. Prod. August 13-18, 2006, Belo Horizonte, MG, Brasil. [www.wcgalp8.org.br/wcgalp8/articles](http://www.wcgalp8.org.br/wcgalp8/articles).
- Bonsma, J.C., 1980. Livestock production: a global approach. Cape Town, South Africa, Tafelberg Publishers.
- Bonsma, J.C., 1983. Man must measure: livestock production. Cody, WY, USA, Agi Books.
- Bruford, M.W., Bradley, D.G. & Luikart, G., 2003. DNA markers reveal the complexity of livestock domestication. Nature Reviews Genetics 4: 900 – 910.
- Clark, H., Klein, C., Newton, P., 2001. Potential management practices and technologies to reduce nitrous oxide, methane and carbon dioxide emissions from New Zealand Agriculture. Ngaherehere, NZ: Ministry of Agriculture and Forestry, 2001. Available in: <<http://www.maf.govt.nz/mafnet/rural-nz/sustainable-resource-use/climate/green-house-gas-migration/ghg-mitigation.htm>>. Accessed in 30<sup>th</sup> May 2005.
- Delgado, C.M., Rosegrant, H., Steinfeld, S., Ehui, & Courbois, C., 1999. Livestock to 2020: the next food revolution. IFPRI, FAO, and ILRI, Washington, D.C., USA.
- Demeke, S., Nesor, F. W. C., & Schoeman, S. J., 2004. Estimates of genetic parameters for Boran, Friesian and crosses of Friesian and Jerseys with the Boran cattle in the tropical highlands of Ethiopia: milk production traits and cow weight. Journal of Animal Breeding and Genetics 121: 163-175.
- Falconer, D.S., & Mackay, T.F.C., 1996. Introduction to Quantitative Genetics. Longman, Essex, U.K., 4th ed. edition.
- FAO/WAAP, 2008. Report of the FAO/WAAP Workshop on Production Environment Descriptors for Animal Genetic Resources. Caprarola, Italy, 6 – 8 May 2008. Eds Pilling, D., Rischowski, B. & Scherf, B. D.
- Furstenburg, D. & Scholtz, M. M., 2009. Global climate change and animal production in southern Africa: a short review. Poster presented at 10th Wrl. Cong. Anim. Prod. Cape Town, South Africa.
- Garnett, T., 2010. Intensive versus extensive livestock systems and greenhouse gas emissions. Food Climate Research Network briefing paper, January 2010.
- Gianola, D., 2006. Statistics in animal breeding: Angels and demons. Proc. 8<sup>th</sup> Wrl. Cong. Genet. Applied Livest. Prod. August 13-18, 2006, Belo Horizonte, MG, Brasil. [www.wcgalp8.org.br/wcgalp8/articles](http://www.wcgalp8.org.br/wcgalp8/articles).
- Goopy, J.P. and Hegarty, R.S., 2004. Repeatability of methane production in cattle fed concentrate and forage diets. J. Anim. Feed Sci. 13: 75 – 78.
- Guérin, G.; Bailey, E.; Bernoco, D., Anderson, I.; Antczak, D.F.; Bell, K.; Biros, I.; Bjørnstad, G.; Bowling, A.T.; Brandon, R.; Caetano, A.R.; Cholewinski, G.; Colling, D.; Eggleson, M.; Ellis, N.; Flynn, J.; Gralak, B.; Hasegawa, T.; Ketchum, M.; Lindgren, G.; Lyons, L.A.; Millon, L.V.; Mariat, D.; Murray, J.; Neau, A.; Røed, K.; Sandberg, K.; Skow, L.C.; Tammen, I.; Tozaki, T.; VanDyk, E.; Weiss, B.; Young, A.; Ziegler, J. 2003. The second generation of the International Equine Gene Mapping Workshop half-sibling linkage map. Animal Genetics, 34: 161-168.
- Guillot, G., Estoup, A., Mortier, F. & Cosson, J.F., 2005. A spatial statistical model for landscape genetics. Genetics, 170: 1261–1280.
- Hanotte, O., Bradley, D.G., Ochieng, Y.V., Hill, E.W. & Rege, J.E.O., 2002. African pastoralism: Genetic imprints of origins and migrations. Sci. 296: 336 – 339.
- Hansen, L.B., 2006. Monitoring the worldwide genetic supply for dairy cattle with emphasis on managing crossbreeding and inbreeding. Proc 8th Wrl. Cong. Genet. Applied Livest. Prod. August 13-18, 2006, Belo Horizonte, MG, Brasil. [www.wcgalp8.org.br/wcgalp8/articles](http://www.wcgalp8.org.br/wcgalp8/articles).
- Hayes, B.J.; Bowman, P.J.; Chamberlain, A.J., & Goddard M.E. 2009. Invited review: genomic selection in dairy cattle: progress and challenges. Journal of Dairy Science, 92: 433-43.
- Hazell P., Poulton C., Wiggins S. & Dorward A., 2007. The future of small farms for poverty reduction and growth. IFPRI Discussion paper 42. <http://www.ifpri.org/2020/dp/vp42.asp>

- Hegarty, S.R., Goopy, J.P., Herd, R.M., & McCorkell, B., 2007. Cattle selected for lower residual feed intake have reduced daily methane production. *J. Anim. Sci.* 85: 1479 – 1486.
- Herrero, M., Hanotte, O., Notenbaert, A. & Thornton, P.K., 2008. Potential of modelling animal genetic resources data in relation to other existing data sets. In: Report on the FAO/WAAP workshop on production environment descriptors for animal genetic resources report. Eds. Pilling, D., Rischkowsky, B. & Scherf, B., Caprarola, Italy, 6 – 8 May, 2008, Annexure 2.9.
- IPCC, 2007. Climate change 2007: Synthesis report. Contribution of working groups I, II and III to the fourth assessment report of the Intergovernmental Panel on Climate Change [Core writing team, Pachauri, R.K and Reisinger, A. (eds.)]. IPCC, Geneva, Switzerland, 104 pp.
- Kidd, D.M. & Ritchie, M.G., 2006. Phylogeographic information systems: putting the geography into phylogeography. *J. Biogeogr.* 33: 1851–1865.
- Kinghorn B. and Kinghorn S. 2009. Pedigree viewer. <http://www-personal.une.edu.au/~bkinghor/pedigree.htm>
- Kosgey, I.S., Mbuku, S. M., Okeyo, A. M., Amimo, J., Philipsson J. & Ojango J. M., 2010. Institutional and organizational frameworks for dairy and beef recording in Kenya: A review and opportunities for improvement. *Agricultural Systems* (Submitted)
- Kozloski, G.V., 2002. *Bioquímica dos ruminantes*. Santa Maria: Editora UFSM, 140p.
- Kugonza, D., 2009. Genetic diversity, selection criteria and verification of kinship assignment based on oral indigenous knowledge of Ankole cattle. PhD Thesis, Department of Animal Science, Makerere University, Uganda.
- Leng, R.A., 1984. Supplementation of tropical and subtropical pastures for ruminant production. In: *Herbivore nutrition in the tropics and subtropics*. Eds Gilchrist, F. M. C. & Macki, R. I. pp 129 – 144.
- Linington, M.J., 1990. The use of Sanga cattle in beef production. In: Technical communication No 223, pp 31 – 37. Department of Agriculture
- Manel S., Schwartz M. K., Luikart G. & Taberlet P., 2003. Landscape genetics: combining landscape ecology and population genetics. *Trends Ecol. Evol.* 18: 189–197.
- Mariante, A.S., & McManus, C., 2008, The role of the Southern Cone of Latin America in World Beef Production. *WAAP Book of the Year 2007*.
- McDowell, R.E., 1972. Improvement of livestock production in warm climates. In: *WH Freeman & Co, San Francisco*.
- McManus, C., Louvandini, H. & Paiva S., 2008. Examples of different aspects of adaptive fitness, how they can be measured and possible proxy-indicators. In: Report on the FAO/WAAP workshop on production environment descriptors for animal genetic resources report. Eds. Pilling, D., Rischkowsky, B. & Scherf, B., Caprarola, Italy, 6 – 8 May, 2008.
- McManus, C., Prescott, E., Paludo, G. R., Bianchini, E., Louvandini, H. & Mariante, A. S., 2009. Heat tolerance in naturalized Brazilian cattle. *Livest. Sci.* 120: 156 – 264.
- Meuwissen, T.H., Hayes, B.J. & Goddard., M.E., 2001. Prediction of total genetic value using genome-wide dense marker maps. *Genet* 157: 1819 – 1829.
- Moss, R. A., 1993. *Methane: Global warming and production by animals*. Canterbury: Chalcombe Publications, 1993. 105p.
- Neser, F.W.C., Erasmus, G.J. & Scholtz, M.M., 2008. The use of a cluster analysis in across herd genetic evaluation for beef cattle. *S.A. J. Anim. Sci.* 38: 51 – 57.
- Nkrumah, J.D., Okine, E.K., Mathison, G.W., Schmid, K., Li, C., Basarab, J. A., Price, M. A., Wang, Z. & Moore, S. S., 2006. Relationships of feedlot efficiency, performance and feeding behaviour with metabolic rate, methane production, and energy partitioning in beef cattle. *J. Anim. Sci* 84: 145 - 153.
- Pinares-Patino, C. S., Baumont, R. & Martin, C., 2003. Methane emissions by Charolais cows grazing a monospecific pasture of timothy at four stages of maturity. *Can. J. Anim. Sci.* 83: 769.
- Prayaga, K. C., Barendse, W. & Burrow, H. M., 2006. Genetics of tropical adaptation. *Proc 8<sup>th</sup> Wrld Congr. Genet. Appl. Livest. Prod.* August 13-18, 2006, Belo Horizonte, MG, Brasil. [www.wcgalp8.org.br/wcgalp8/articles](http://www.wcgalp8.org.br/wcgalp8/articles).

- Prayaga, K.C., & Henshall, J.M., 2005. Adaptability in tropical beef cattle: genetic parameters of growth, adaptive and temperament traits in a crossbred population. *Aust. J Exp. Agri.*, 45: 971-983.
- Primo, A. 2004. América: conquista e colonização: a fantástica história dos conquistadores ibéricos e seus animais na era dos descobrimentos. Porto Alegre : Movimento, 183p.
- Rewe, T. O, Herold, P., Piepho, H. P, Kahi, A. K. & Valle Zarate, A., 2010. Genetic and economic evaluation of basic breeding programme for Kenya Boran cattle. *Trop. Anim. Hlth and Prod.* 42: 327-340
- Romanini, C. E. B., Nääs, I. D. A., D'Alessandro Salgado, D., Lima, K. A. O., do Valle, M. M., Labigalini, M. R., de Souza, S. R. L., Menezes, A. G. & de Moura D. J., 2008. Impact of Global Warming on Brazilian Beef Production, Livestock Environment VIII, 31 August – 4 September 2008, Iguassu Falls, Brazil 701P0408
- Scholtz, M.M. & Bester, J., 2009. Off-take and production statistics in the different South African cattle sectors: Results of a structured survey. *S. Afr. J. Anim. Sci.* (In press)
- Scholtz, M.M. & Theunissen, A., 2010. The use of indigenous cattle in terminal cross-breeding to improve beef cattle production in Sub-Saharan Africa. *Anim. Genet. Res. Inf.* 46: 33–39.
- Scholtz, M.M., 1988. Selection possibilities for hardy beef breeds in Africa: The Nguni example. *Proc. 3<sup>rd</sup> World Cong. Sheep and Beef Cattle Breed.* 2: 303-319.
- Scholtz, M.M., 2005. The role of research and the seed stock industry in the *in situ* conservation of livestock genetic resources. *Proc. 4th All Africa Conf. Anim. Agric. Arusha, Tanzania:* 311 - 316.
- Scholtz, M.M., Furstenburg, D., Maiwashe, A., Makgahlela, M.L., Theron, H.E. & van der Westhuizen, J., 2009. Environmental-genotype responses in livestock to global warming: A Southern African perspective. *S. Afr. J. Anim. Sci.* (In press)
- Scholtz, M.M., Lombard P.E., de Bruin, D.S. & Enslin, C.B., 1989. Eenvoudige metode vir die beraming van bosluisbestandheid by beeste. *S. Afr. Tydskrif. Veek.* 19: 121 - 123.
- Scholtz, M.M., Spickett, A.M., Lombard, P.E. & Enslin, C.B., 1991. The effect of tick infestation on the productivity of cows of three breeds of cattle. *Onderstepoort J. Vet. Res.*, 58: 71 - 74.
- Silva, R.G., 2000. Introducao a bioclimatologia animal. Sao Paulo, Brazil, Ed. Nobel
- Smith, L. A., Cassell, B. G., & Pearson, R. E., 1998. The Effects of Inbreeding on the Lifetime Performance of Dairy Cattle. *J. Dairy Sci.*, 81(10): 2729–2737.
- Spickett, A. M., de Klerk, D., Enslin, C. B. & Scholtz, M. M., 1989. Resistance of Nguni, Bonsmara and Hereford cattle to ticks in a bushveld region of South Africa. *Onderstepoort J. Vet. Res.* 56: 245 251.
- Steiger, C., 2006. Modern Beef Production in Brazil and Argentina. *Choices.* 21: 105-110.
- Steinfeld, H., Gerber, P., Wassenaar, T., Castel, V., Rosales, M., & de Haan C., 2006. Livestock's long shadow: Environmental issues and options. Rome, FAO, pp 390.
- UNEP, 2007. GEO4 Global Environment Outlook., Environment for development. United Nations Environment Programme, Nairobi, Kenya, pp 540.
- US-EPA. United States Environmental Protection Agency. 2006. International analyses. Washington: EPA,. Available in: <<http://www.epa.gov/methane/intlanalyses.html>>. 03 April 2007.
- VanRaden, P. M., 2008. Efficient methods to compute genomic predictions. *J. Dairy Sci.* 91: 4414 - 4423.
- VanRaden, P. M., Van Tassell, C. P., Wiggans, G. R., Sonstegard, T. S., Schnabel, R. D., Taylor, J. F., & Schenkel, F. S., 2009. Invited Review: Reliability of genomic predictions for North American Holstein bulls. *J. Dairy Sci.* 92: 16 – 24.
- Wall, E., Simm, G. & Moran, D., 2009. Developing breeding schemes to assist mitigation of greenhouse gas emissions. *Animal* : 1 – 11.
- Wasike, C. B., Ilatsia, E. D., Ojango, J. M. K. & Kahi, A. K., 2006. Genetic parameters for weaning weight of Kenyan Boran cattle accounting for direct-maternal genetic covariances. *S. Afr. J. Anim. Sci.* 36: 275-281.
- Williams, J. L., 2005. The use of molecular marker-assisted selection in animal breeding and biotechnology. *Rev. Sci. Tech. Off. Int. Epiz.*, 24, 379 - 391.

Wurzinger, M., Ndumu, D. B., Baumung, R., Drucker, A. G., Okeyo, A. M., Semambo, D. K. & Sölkner, J., 2009. A comparative analysis of alternative methods for capturing indigenous selection criteria. *Anim. Breed. Genet.* (Accepted).





## Continuous improvement for dairy laboratories through REDELAC

C. Pecorino, M. Bilotta, M. Murphy, L. Giorgi, P. Labacá & R. Castañeda

*INTI, National Institute of Industrial Technology. Dairy Industry Technological Research Centre. Av. General Paz 5445, (1650) San Martín, Buenos Aires, Argentina*

### **Abstract**

Since 1991, REDELAC, the Argentine dairy laboratory network, has been an important tool for quality assurance of the laboratories. It provides them different proficiency testing schemes, reference materials from SICECAL, the Argentine centralized calibration system, and specific technical assistance. All focused on the optimization of the accuracy of laboratories results, and the improvement of their analytical performances. Since 2009, technical assistance has been mainly oriented to continuous improvement, detecting potential deviations and finding improvement opportunities of laboratories participating in the Network. Specific indicators were defined and several quality tools were selected, and a survey of all participants was carried out. Then, we made a segmentation using selected indicators, and finally we defined five groups, depending on the technical assistance required. Consequently, an Alarm System has been implemented from the laboratories results of proficiency testing schemes related to raw milk quality. Based on the results, INTI-Lácteos provides recommendations to correct occurred deviations, as well as to prevent potential ones. With the implementation of this Alarm System, we have obtained good results, indicating the effectiveness and consolidation of REDELAC-SICECAL, as an integrated system for quality assurance laboratories.

*Keywords: Milk, dairy national reference laboratory, continuous improvement, technical assistance, integrated system, centralized calibration system, proficiency tests.*

## 1.0 Introduction

REDELAC, the Argentine Dairy Laboratory Network, was created in 1991 by INTI-Lácteos, which is one of the 32 centres of INTI, National Institute of Industrial Technology. The objective of the network is to harmonize dairy laboratory practices, help implementation of international standards, and ensure traceability to national and international laboratories. Nowadays, REDELAC, with more than 40 partners and 100 national and international participating laboratories, has become a "complete integrated system", which offers different proficiency testing schemes, centralized calibrations and a monitoring and alarm system based on the results of this PT schemes.

INTI-Lácteos is the Reference National Laboratory of Argentina and has been the first accredited proficiency testing provider in Latin America in 2004. Different proficiency testing schemes are supplied on a variety of matrices and for different compositional, microbiological and chemical parameters. SICECAL is a Centralized Calibration System, widely recognized in Argentina and provides reference materials in dairy matrices for calibration and control of their equipment to dairy industry and laboratories. Since 2009, technical assistance has been mainly oriented to continuous improvement, detecting potential deviations and finding improvement opportunities of laboratories participating in the Network.

## 2.0 Methodology

Technical assistance has been mainly focused on continuous improvement of participant laboratories in PTs schemes related to raw milk quality: *Monthly Raw Milk Control* and *Instrumental Equipment Control*. Both proficiency testing are mandatory requirements for independent laboratories which are members of the government system for milk payment. Laboratories receive blind samples to analyze fat, total protein, total solids, lactose, ash, presence of antibiotics, freezing point, enumeration of microorganisms at 30 °C and somatic cells counts. In the first stage, a survey of all participants and the different routine methodology used by them was carried out.



Then, specific indicators were defined and several quality tools were selected. The unsatisfactory results of a proficiency testing round were considered as a deviation from a requirement, and these were evaluated as nonconforming work (NC).

The indicators and quality tools were:

Index	1: ratio NC / total tests 2: ratio NC / total participant laboratories. 3: ratio NC / each parameters
Tools	Final reports of each round, where the historical performance for each parameter is included (Annex 1) Monthly table of NC of all laboratories (Annex 2) Annual table of NC of each laboratory (Annex 3) Monthly graphic of NC of all the parameters (Annex 4) Annual graphic of NC of each parameter (Annex 5, example fat content) Annual graphic of Index 1 for each laboratory (Annex 6)
Ishi	Ishikawa diagrams Check lists of each parameter (Annex 9)

Using the first index mentioned, in order to plan work throughout the year, segmentation was made from the laboratories performances, to determine and evaluate the several degrees of technical assistance required. Five groups were defined; one of them was the SIGALEC group, the laboratories of the government system for milk payment.

Group	Indicator 1 Value
Group 1	0,00 – 0,10
Group 2	0,1 – 0,20
Group 3	0,21 – 0,25
Group 4	> 0,25
SIGALEC	0,08 – 0,12
Group	Indicator 1 Value

Finally, in accordance with the segmentation, annual aims were proposed.

From the results of each round, we monitored laboratories' continuing performance, using the selected indicators and quality tools, mentioned above. The value of those indicators and the trends showed in graphics, alert us when a punctual technical assistance is detected. In this situation, participant to these PT programmes were contacted to provide help and try to correct or avoid deviations in future rounds. Consequently, corrective or preventive recommendations were provided by telephone or e-mail. All possible root causes were considered, bearing in mind the Ishikawa diagrams. In order to prevent non conformities works, detected trends were taken into account from graphics. Records of all communications were preserved.

### 3.0 Results and discussion

With the implementation of this Alarm System in rounds of *Monthly Raw Milk Control* and *Instrumental Equipment Control*, at the end of 2009 was achieved:

1. Less number of laboratories with indicator N°1 greater than 0, 21.
2. Improving significantly the performance of some laboratories from Group N°4. 2 laboratories moved to Group 3, and 1 laboratory moved to Group 2. (Annex 6).
3. Remarkable tendency to decrease the ratio of NC to the total tests, throughout the year. (Annex 7).
4. Decrease the number of NC in three parameters with the highest percentage of NC. Fat content decrease from 35% in January to 18% in December; total protein content decrease from 39% in January to 12% in December, and total solids content decrease from 50 % in January to 7% in December.

5. Identification for the near future (Annex 8), tests and laboratories which will require special emphasis to help.

We recommended implementing corrective or preventing actions first, and then monitoring the results associated to ensure that those actions have been effective. Furthermore, being willing to cooperate with participants to improve their performance, designing check lists for each test and offered it laboratories when lacks of knowledge about official methodology are detected. Answers and feedback may be carefully evaluated and, when it is necessary, subsequent communications must be done until feasible solution. This Alarm System allowed us distinguishes in following rounds if actions taken have been effective.

## 4.0 Conclusions

With the implementation of this Alarm System INTI-Lácteos has established a new tool for continuous improvement for dairy laboratories, indicating the effectiveness and consolidation of REDELAC-SICECAL, as an integrated system to improve the quality assurance of dairy laboratories.

## 5.0 Annexes

### Annex 1

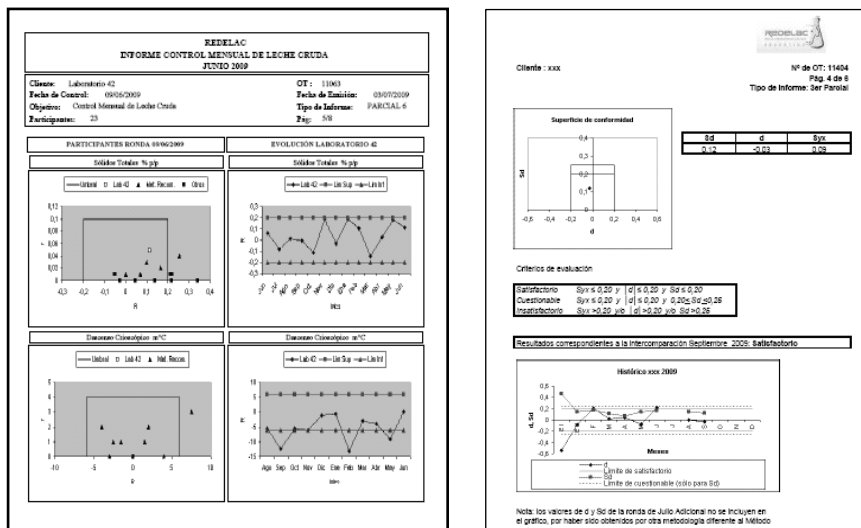

**Annex 2**

**Monthly table of NC of all laboratories ( July 2009)**

ITEM	Registration N°	Laboratory name	tests N°	FC	TP	TS	L	A	FP	ESC	EM 30°C	DI	NC
	A	O											0
	B	8	1	1	1		1	1	1	1	1	1	1
	C	9	1	1	1	1	1	1	1	1	1	1	3
	D	1									1		1
	E	7	1	1	1		1	1			1	1	2
	F	7	1	1	1		1			1	1	1	0
	G	1									1		0
	H	0											0
	I	8	1	1	1	1		1	1	1	1	1	0
			FC	TP	TS	L	A	FP	ESC	EM 30°C	DI	NC	
Total tests			123	17	18	15	9	6	11	17	16	14	Total
%NC			11,8	22,2	0,0	0,0	0,0	9,1	5,9	25,0	0,0	9,8	

Indice 1 = NC/N° de ensayos totales: 0,10  
 Indice 2 = NC/N° total de laboratorios: 0,57

FC: Fat Content - TP: Total Protein - TS: Total solid - L: lactose - A: ash - FP: Freezing Point - ESC: Enumeration of somatic cells - EM 30°C: Enumeration of microorganisms 30°C - DI: Detection of inhibitors.

**Annex 3**

**Annual table of NonConformities - Laboratory X**

Month	test N°	FC	TP	TS	L	A	FP	ESC	EM 30°C	DI	NC / month
Janus ry	7	1	1	1		1		1	1	1	1
Feb	7	1	1	1		1		1	1	1	0
March	0										0
Apr	7	1	1	1		1		1	1	1	0
May	7	1	1	1		1		1	1	1	2
June	7	1	1	1		1		1	1	1	0
July	7	1	1	1		1		1	1	1	0
Ag	7	1	1	1		1		1	1	1	0
Sept	7	1	1	1		1		1	1	1	0
56		8	8	8	0	8	0	8	8	8	
2		1	0	0	0	0	0	0	0	0	3
%		25,0	12,5								5,4

Index 1 = NC/N° total tests: 0,05

**Annex 4**

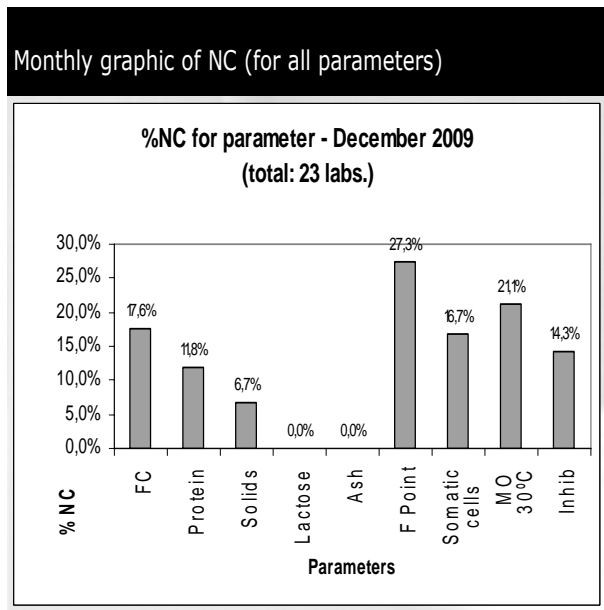

**Annex 5**

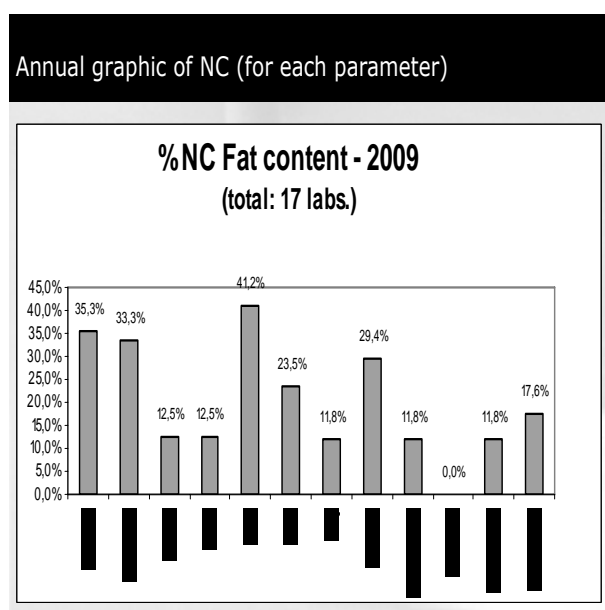

**Annex 6**

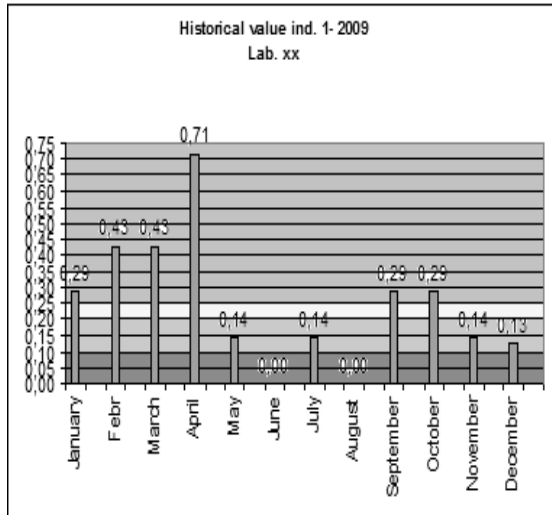

**Annex 7**

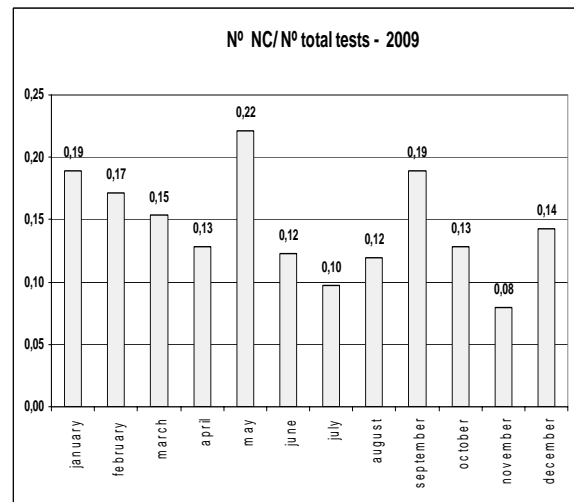

**Annex 8**

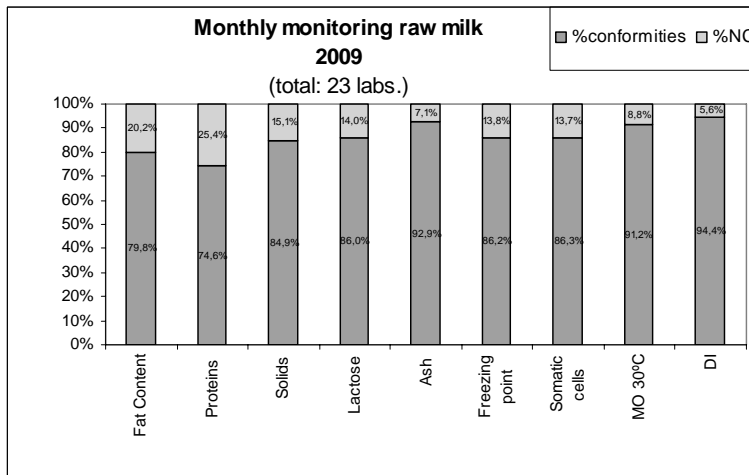

**Annex 9**

Check-list de la determinación de composición de leche por IR (FIL IDF 141C:2000) Versión 12.04.2010		SI	NO	OBSERVACIONES
<b>1. Recepción muestra</b>				
¿Es adecuada la temperatura de recepción de la muestra? (menor a 12°C)				
¿Se encuentra en buen estado? (no está cortada, derramada, etc.)				
¿Esta cerrado herméticamente el envase?				
Conservantes	¿Se utilizan?			
	¿Dicromato de potasio (0,1% p/p)?			
	¿Azida sódica (0,03% p/p)?			
	¿Bronopol (entre 0,02 y 0,06% p/p)?			
	El equipo utilizado, ¿se ve influenciado por el agregado de conservante? ¿Está validado?			
<b>2. Almacenamiento de la muestra</b>				
¿Se almacenan las muestras refrigeradas hasta que se realiza el análisis?				
¿Se establecen tiempos máximos de almacenamiento hasta realizar el ensayo? ¿Se respetan?				
<b>3. Condiciones ambientales</b>				
¿Están establecidas las condiciones ambientales para la realización del ensayo?				
¿Se miden y controlan las condiciones establecidas? (temperatura, humedad, etc)				
<b>4. Equipos y material de laboratorio</b>				
¿Se cuenta con el equipamiento necesario de acuerdo a la norma? ¿Alcanza la exactitud requerida por el método?				
¿Está identificado unívocamente?				
¿El laboratorio cuenta con instructivos para el uso y mantenimiento de los equipos?				
Soluciones de limpieza	¿Se chequea su vencimiento?			
	¿Es capaz de ser mantenido a (40 ± 1°C)?			
Baño de agua	¿Se lo mantiene con agua destilada, limpio?			
	Calibración termómetro	¿Está calibrado?		
		¿Se cumple el plan de calibraciones?		
		¿Se utiliza la corrección especificada en el informe de calibración?		
		¿Se verifica que cumpla con la tolerancia de la norma?		
¿Se utilizan la corrección y la incertidumbre, especificadas en el informe de calibración, para calcular el rango de trabajo del termómetro?				

**6.0 References**

R. Ca stañeda. "R eference Sys tem an d Ce ntralized Ca libration fo r mi lking r ecording in Ar gentina". Proceedings of the 36th ICAR Session Niagara Falls USA 2008.

M. Murphy et al. "REDEL AC. ARGENTINE DAIRY LA BORATORY NETWORK". The S econd Internati onal Proficiency Testing Conference. Sibiu, Rumania. Septiembre 2009.

P. Labacá et al. "Sistema externo de aseguramiento de la calidad a través de la REDELAC". Encuentro de Primavera, INTI. Argentina. Noviembre 2009.





## Potential estimation of titratable acidity in cow milk using Mid-Infrared Spectrometry

F.G. Colinet<sup>1</sup>, H. Soyeurt<sup>1,2</sup>, C. Anceau<sup>3</sup>, A. Vanlierde<sup>1</sup>, N. Keyen<sup>3</sup>, P. Dardenne<sup>4</sup>, N. Gengler<sup>1,2</sup> & M. Sindic<sup>3</sup>

<sup>1</sup>Animal Science Unit, Gembloux Agro-Bio Tech, University of Liege, Passage des Deportés 2, B-5030 Gembloux, Belgium

<sup>2</sup>National Fund for Scientific Research, Rue d'Egmont 5, B-1000 Brussels, Belgium

<sup>3</sup>Food Technology Unit, Gembloux Agro-Bio Tech, University of Liege, Passage des Deportés 2, B-5030 Gembloux, Belgium

<sup>4</sup>Walloon Agricultural Research Center, Valorisation of Agricultural Products Department, Chaussee de Namur 24, B-5030 Gembloux, Belgium

### Abstract

Milk coagulation has a direct effect on cheese yield. Several factors influence the milk coagulation kinetics. In addition to calcium and milk protein concentrations, titratable acidity influences all the phases of milk coagulation. The objective of this research was to study the feasibility of prediction of titratable acidity directly in bovine milk using mid-infrared (MIR) spectrometry. In order to maximize the variability in the measurements of titratable acidity, milk samples were collected on basis of several criteria (e.g. breeds, time of sampling...). The titratable acidity was recorded as Dornic degree. All samples were also analyzed by MIR spectrometry. Using partial least squares regressions and first derivative pretreatment of spectral data, a calibration equation was built to predict the Dornic degree in cow milk. First results were promising and showed the potentiality of this calibration. The calibration and cross-validation coefficients of determination were 92.25 and 89.88 %, respectively. Moreover, the ratio of standard error of prediction to standard deviation was 3.13 and permits us to consider the calibration equation as usable in most application such as scientific researches and the screening of the Walloon dairy herd particularly in order to improve the milk coagulation properties.

*Keywords: Milk, titratable acidity, mid-infrared spectrometry.*

## 1. Introduction

Finer and more accurate estimations of technological abilities of individual milk to be transformed in dairy products (cheese, cream, ice cream, yogurt...) would provide better support of farmers/producers and finer management of the herd, and thereby improve transformation yields in connection with the valuation of milk as dairy products in short circuit. Moreover, Glantz *et al.* (2009) showed the possibility to use milk composition and processing characteristics to adjust farming practices in order to improve the quality and the stability of milk and dairy products.

Cheese making process is generally evaluated by the global cheese yield but milk coagulation properties (MCP) influence also the efficiency of cheese production. These MCP can vary greatly among cows, up to 40 % of this variation could be explained by genetic differences (Ikonen *et al.*, 2004; Cassandro *et al.*, 2008). The milk coagulation kinetics could be influenced by several factors: nature and concentration of the coagulation enzyme, the protein and calcium contents in milk, the temperature and the acidity (O'Callaghan *et al.*, 2001). The titratable acidity (TA) influences all phases of milk coagulation, e.g. the aggregation of para-casein micelles.

The developed acidity of milk results from bacterial activity producing lactic acid during milk collection, transportation, and transformation. Even if TA is considered as a measure of lactic acid, TA determined on fresh milk is more a measure of the buffer action of milk. Indeed, acidity of fresh milk is mainly due to some components of milk such as carbon dioxide, citrates, casein, albumin/globulin and phosphates.

Given the important role played by acidity during milk coagulation, the objective of this study was to investigate the potential use of MIR spectrometry (currently used for routine predictions of major milk components) to predict TA of individual milk samples from Walloon dairy cattle.

## 2. Material and methods

### 2.1 Sampling

A large variability of milk composition is required for the development of calibration equations. Therefore, different criteria were taken into account during sampling: the milk sampling (individual or bulk milk samples), the breeds (Dual Purpose Belgian Blue, Holstein, Red-Holstein, Montbeliarde, and Jersey), and the time of sampling (morning milking, evening milking, or a mix of 50% of morning and 50% of evening milk samples). All samples (225) were collected in the Walloon Region of Belgium. An aliquot of each sample (30 ml) was analyzed by MIR spectrometry using a Foss MilkoScan FT6000 spectrometer (Foss, Hillerød, Denmark) at the milk lab used for routine milk infrared analysis (Comité du Lait, Battice, Belgium). Analysed traits were the content of fat, protein, free fatty acid (FFA), urea, lactose, and dry matter (DM), the somatic cell count (SCC), and the pH. SCC was transformed into somatic cell score (SCS) by the following formula:  $SCS = 3 + [\log_2(SCC/100000)]$ . Furthermore, all generated spectra were recorded in a database.

The titratable acidity was expressed as Dornic degree ( $D^\circ$ ). This acidity was measured by titration of 10 ml of milk with a 0.1 N NaOH solution. The consumption of NaOH necessary to shift the pH value from  $6.6 \pm 0.1$  (corresponding to fresh milk) to a pH value of 8.4 (in presence of phenolphthalein) was measured. The  $D^\circ$  value was equal to the number of ml of NaOH used multiplied by ten.

### 2.2 Calibration procedure

The spectral data were converted into absorbance in order to linearize the spectra. The formula used for converting was:  $\text{absorbance} = \log(\text{transmittance}^{-1})$ . Based on these spectra and  $D^\circ$  values, a calibration equation was computed using partial least squares (PLS) regressions and first derivative pretreatment of spectral data. The calibration was performed using a specific program for multivariate calibration (WINISI III, <http://www.winisi.com>). The use of PLS regressions was preferred because it limits the presence of noise in the calibration equations when a limited number of samples are used.

During the development of the calibration equation, 22 outliers were detected based on predicted TA value and deleted from the used dataset. The mean and the standard deviation (SD) were calculated from the reference  $D^\circ$  values. Moreover, two statistical parameters were calculated to assess the accuracy of the prediction given by the developed equation: the standard error of calibration (SEC) and the calibration coefficient of determination ( $R^2_c$ ).

The regression technique used requires a cross-validation to determine the optimal number of factors for the equation in order to prevent over-fitting. Moreover, the cross-validation permits also to assess the accuracy of the prediction. The cross-validation estimates validation errors by the random partitioning of the calibration set into 102 groups. The validation errors were combined into a standard error of cross-validation (SECV). Two additional statistical parameters were calculated to assess the proficiency of the calibration equation: the cross-validation coefficient of determination ( $R^2_{cv}$ ) and the ratio of SECV to standard deviation (RPD) (Williams, 2007).

## 3. Results and discussion

### 3.1 Characterization of the samples

The descriptive statistics of the infrared predicted traits and the measured TA are shown in Table 1. The degree of variability of TA measurements was relatively high. The coefficient of variation of TA expressed in  $D^\circ$  was 14 %. This value was similar to that reported by De Marchi *et al.* (2009) in Brown Swiss in Northern Italy, in that case the TA was recorded as Soxhlet-Henkel degree and the coefficient of variation was 13 %.

Table 1. Mean and standard deviation (SD) for each analyzed component of milk of the 225 studied milk samples.

Trait <sup>1</sup>	Mean	SD
Fat (%)	3.88	1.03
Protein (%)	3.49	0.52
FFA (mmol/100g of Fat)	5.63	8.62
Urea (g/100 mL)	0.023	0.011
Lactose (g/100 mL)	4.85	0.35
DM (%)	12.66	1.25
SCS	3.31	1.90
pH	6.69	0.09
TA (D°)	16.27	2.27

<sup>1</sup>FFA = Free Fatty Acid; DM = Dry matter; SCS = somatic cell score; D° = Dornic degrees

The observed correlations among infrared predicted traits and measured TA recorded as Dornic degree are shown in Table 2. The correlations among milk components were some times relatively high. It was expected, for instance, between protein content and DM and between fat content and DM. A similar phenotypic correlation between fat and protein contents was also observed by Cassandro *et al.* (2008). Surprisingly, our correlation between SCS and pH was exactly the opposite of that presented by Cassandro *et al.* (2008).

Table 2. Observed correlations among the traits.

	Fat	FFA	Protein	Urea	Lactose	DM	SCS	pH
TA (D°)	0.04 <sup>NS</sup>	0.13 <sup>*</sup>	0.39 <sup>***</sup>	0.18 <sup>**</sup>	0.21 <sup>**</sup>	0.26 <sup>***</sup>	-0.16 <sup>*</sup>	-0.32 <sup>***</sup>
Fat	-	0.41 <sup>***</sup>	0.42 <sup>***</sup>	0.13 <sup>*</sup>	-0.19 <sup>**</sup>	0.89 <sup>***</sup>	0.18 <sup>**</sup>	-0.18 <sup>**</sup>
FFA		-	0.68 <sup>***</sup>	0.41 <sup>***</sup>	-0.17 <sup>**</sup>	0.50 <sup>***</sup>	0.04 <sup>NS</sup>	-0.38 <sup>***</sup>
Protein			-	0.30 <sup>***</sup>	-0.07 <sup>NS</sup>	0.69 <sup>***</sup>	0.10 <sup>NS</sup>	-0.26 <sup>***</sup>
Urea				-	0.18 <sup>**</sup>	0.25 <sup>***</sup>	-0.18 <sup>**</sup>	-0.01 <sup>NS</sup>
Lactose					-	0.11 <sup>NS</sup>	-0.40 <sup>***</sup>	0.66 <sup>***</sup>
DM						-	0.07 <sup>NS</sup>	-0.06 <sup>NS</sup>
SCS							-	-0.19 <sup>**</sup>

FFA = Free Fatty Acid; DM = Dry matter; SCS = somatic cell score; D° = Dornic degrees

\* = P-value < 0.05; \*\* = P-value < 0.01; \*\*\* = P-value < 0.001; NS = non significant

Concerning the correlation of the infrared predicted traits with the titratable acidity, the correlation with the protein content was high (0.39). Indeed, the TA in fresh milk is mainly due to, among other things, casein and albumin/globulin, this could explain the buffer action of milk (if the protein content increases, more NaOH would be needed for the titration). This positive correlation was also observed by Cassandro *et al.* (2008). Contrary to that study, a correlation between TA and fat content was not observed. The present study shows the same trend between TA and SCS but other study presented a correlation value between TA and pH twice our correlation (-0.70 vs. -0.32).

### 3.2 Calibration

The means of samples used for the calibration (n = 203) was 16.22 D° (SD = 2.01 D°). Ten factors were used. The SEC and R<sup>2</sup><sub>C</sub> estimated for the calibration procedure were 0.56 D° and 92.25 %, respectively. The SECV and R<sup>2</sup><sub>CV</sub> estimated during the cross-validation were 0.64 D° and 89.88 %, respectively. Thus, the RPD was equal to 3.13. De Marchi *et al.* (2009) built a calibration equation for TA with R<sup>2</sup><sub>CV</sub> of 66 %.

Based on the high coefficients of determination, the calibration equation could be considered as usable in most application, including research (Williams, 2007). Because the RPD was higher than 2, the result given by the calibration equation could be considered as good predictor of the titratable acidity in bovine milk. The cross-validation results from 203 milk samples are presented in Figure 1 and show the ability of the calibration equation to predict titratable acidity.



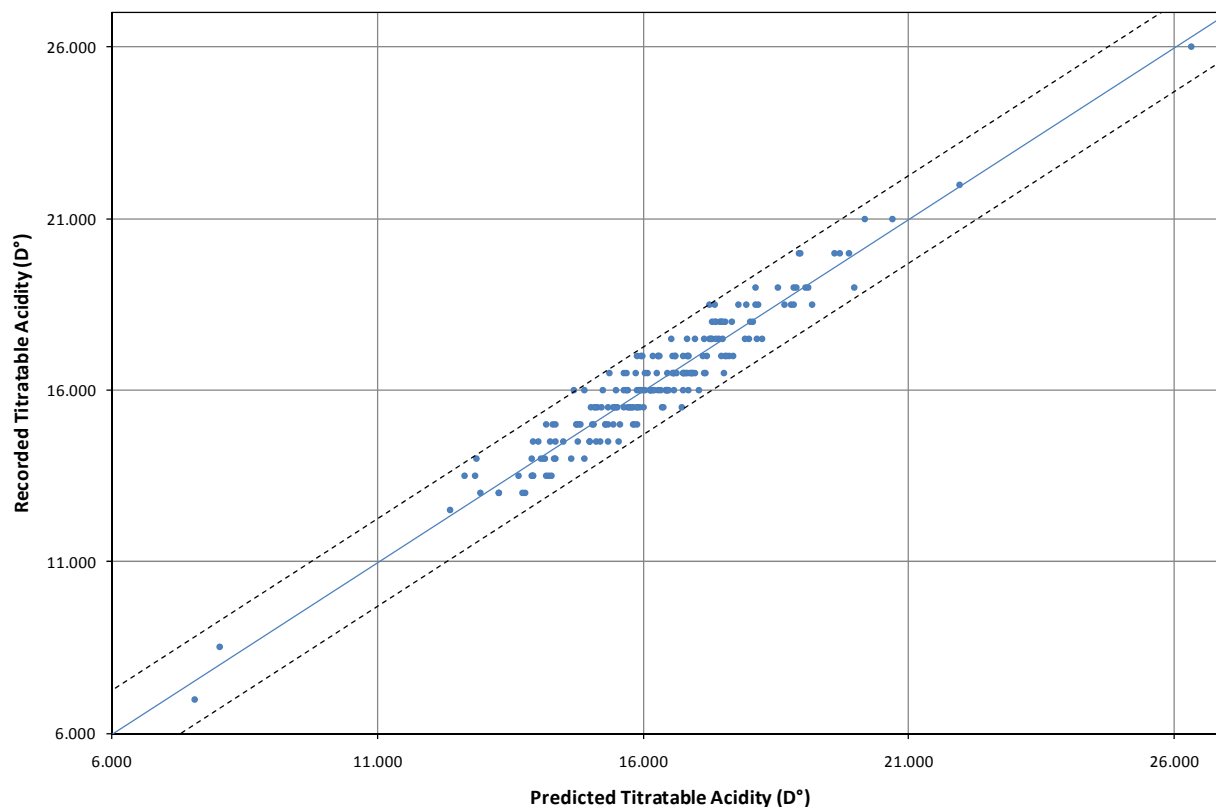

Figure 1. Cross-validation results from 203 milk samples (dotted lines: twice standard error of cross-validation; solid line: perfect prediction where recorded titratable acidity ( $D^{\circ}$ ) = titratable acidity ( $D^{\circ}$ ) predicted by infrared analysis).

The maximum value of correlations between infrared predicted traits and TA shown in Table 2 was 0.39. Consequently, this value is inferior to the squared root of the obtained coefficients of determination for TA equation. Therefore, the use of the developed equation to predict TA in bovine milk is interesting because it is not possible to have the same accuracy by using only the relationships among infrared studied traits and TA.

## 4. Conclusion

The prediction of the titratable acidity in milk by MIR spectrometry investigated in the current study provided promising first results. The calibration and cross-validation coefficients of determination were higher than or close to 90%. Furthermore, the RPD value was 3.13. These first results showed the feasibility of TA MIR prediction in bovine milk. The obtained calibration equation gave a good predictor and could be used in most applications (including research).

In a near future, this equation will be implemented to estimate milk titratable acidity of Walloon dairy cows that take part in milk recording programs. This will permit to study TA variability in the Walloon dairy cattle and to detect potential effects of breed, season, lactation number, days in milk ... on TA. Finally, based on these results, the development of a genetic evaluation could be considered and these TA breeding values in association with other traits could be incorporated into a new economic index for cheese making abilities.

## 5. Acknowledgements

The authors gratefully acknowledge the financial support of the Ministry of Agriculture of the Walloon Region of Belgium and the European Commission through the INTERREG I Va project named BlueSel. Nicolas Genlér, research associate, and Hélène Soyeurt, post-doctoral researcher, acknowledge the

financial support provided by the National Fund for Scientific Research (Brussels, Belgium) through their positions and grants F.4552.05 and 2.4507.02F(2) for processing facilities.

## 6. References

- Cassandro M., A. Comin, M. Ojala, R. Dal Zotto, M. De Marchi, L. Gallo, P. Carnier and G. Bittante, 2008. Genetic parameters of milk coagulation properties and their relationships with milk yield and quality traits in Italian Holstein cows. *J. Dairy Sci.* 91: 371-376.
- De Marchi M., Fagan C.C., O'Donnell C.P., A. Cecchinato, R. Dal Zotto, M. Cassandro, M. Penasa and G. Bittante, 2009. Prediction of coagulation properties, titratable acidity, and pH of bovine milk using mid-infrared spectroscopy. *J. Dairy Sci.* 92: 423-432.
- Glantz M., Lindmark Mannsson H., Stalhammar H., Barström L.-O., Fröjelin, Knutsson A., Teluk C. & Paulsson M., 2009. Effects of animal selection on milk composition and processability. *Journal of Dairy Science* 92: 4589-4603.
- Ikonen T., A. Morri, A.M. Tyrisevä, O. Ruottinen and M. Ojala, 2004. Genetic and phenotypic correlations between milk coagulation properties, milk production traits, somatic cell count, casein content and pH of milk. *J. Dairy Sci.* 87: 458-467.
- O'Callaghan D.J., E.P. Mulholland, A.P. Duffy, C.P. O'Donnell and F.A. Payne, 2001. Evaluation of hot wire and optical sensors for on-line monitoring of curd firmness during milk coagulation. *Ir. J. Agric. Food Res.* 40: 227-238.
- Williams, P., 2007. *Near-infrared technology – Getting the best out of light*. PDK Grain, Namaimo, Canada.





## Exchanging data from and into on barn automats and sensors

R. Rognant

*FIEA, 149 rue de Bercy, 75595 Paris Cedex 12, France, rrognant@fie-arsoe.com*

Computerized procedures are progressively getting in farm business as any other business

As size of herds increases, use of on farm automated cattle husbandry monitoring is developing. The number of computerized farm equipments, such as automatic feeders, milking robots, sensors, etc. is quickly increasing (for instance 10 000 milking robots in the world, on 2010, in quick progression). These devices produce many recorded data. Some of them are only useful to control the working automated system. But others can inform about the hard management status of each animal, his feed consumption, his body weight or milk production....

Manufacturers have made their own herd management software and sell it to farmers. But many of them have already implemented data import-export procedures to exchange some available data with other systems, among them milk recording organization central data bases.

Retrieving these data is for cattle organizations a challenge to succeed in order to be able to continue providing renewed relevant services to farmers. It is also a challenge for farmers and their software providers in order to make interoperate the different parts of their information system.

This paper talks about some lists questions that are raised by this challenge. It describes an import-export module developed to facilitate data exchanges with 3d party software.

*Keywords: Computerized procedures, automated systems, data exchange, multi system data import, sensors.*

### 1.0 Issues about data exchange

#### 1.1 Which data should be exchangeable ?

Automated systems may produce some data that are not relevant for use by a 3d party software. But every produced data related to the farm producing system, characterizing the cattle and individuals flock, should be available for the farmer, and reusable on any other electronic system for his own purposes. Farms are organizations. Automated machines are parts of their facilities and have to be able to share data with the farm information system. These data, some of them are phenotypes relevant for genomic evaluation, should also be easily (electronically) transmittable, under the control of the farmer, to milk recording and breeding organizations.

In the other direction, farmer may want to enter herd data that are also useful for the working of the automated system, on a specific medium, rather than directly on the software linked to the automated system. He may use for data entering, another device such as a handheld computer, or a terminal linked to the cattle organizations data base. The software of the automated system must then be able to introduce them in its database.

#### 1.2 Semantic definition and codification of exchanged data

The information extracted from automated systems must be interpretable. In practice, different farmers may be equipped with several kinds of automated systems (e.g. milking systems) and several kinds of external software. So, a specific type of software that would be implemented in several farms may have to exchange the same type of information issued from different brands of automated devices.

Therefore it is useful that a standardized conceptual data model defines animal event types to be exported. And that it is implemented by automated system manufacturer in their import-export module. The data model should allow to include the way this event has been captured : by which device, the

devices being registered elsewhere, in order to let the user decide whether data from different origins have really the same meaning.

Example of events: Animal milking, feed intake, artificial insemination, dry off, ...

Such an international data dictionary (ISO 11788) exists already. It should be updated to take into account new registered events and new captured data.

### 1.3 Physical level interchange protocols

The protocols to be used include different layers

- Type of medium : USB keys, Local network, hertzian way, Wi-fi, ...
- The file and message formats : Adis files (ISO 11787), XML files, ...
- The transport protocol. Ex : FTP or HTTP + WEB service (SOAP), ...

ISO has published Standard ISO 17532 which defines way to electronically exchange in real time data between on farm devices and partially with far external systems, and to add plug and play new devices to an existing local network.

The usable Physical level interchange protocols supported by commercial automated system are evolving. So, actually the farm management software has to adapt itself to the available protocols.

## 2.0 Example of one farm multi system data import – export tool

French and Quebec organizations (France Conseil Elevage and Valacta) have realized the importance of data exchanging with automated systems. They have built up a common project to develop an internationally reusable import-export tool with on farm computerized system.

They worked with the 5 most important companies, leader players on the market of dairy cattle automated systems.

The import – export module may be interfaced with the respective automated system from these companies. This module is installed on the farmer's computer in a specific folder. It dialogues at the initiative of the milk recording field staff, or at automatically scheduled times, with the executable program installed by the automated machine manufacturer. It may exchange data in both directions. The data exchanged at this level are formatted in ISO ADIS standard.

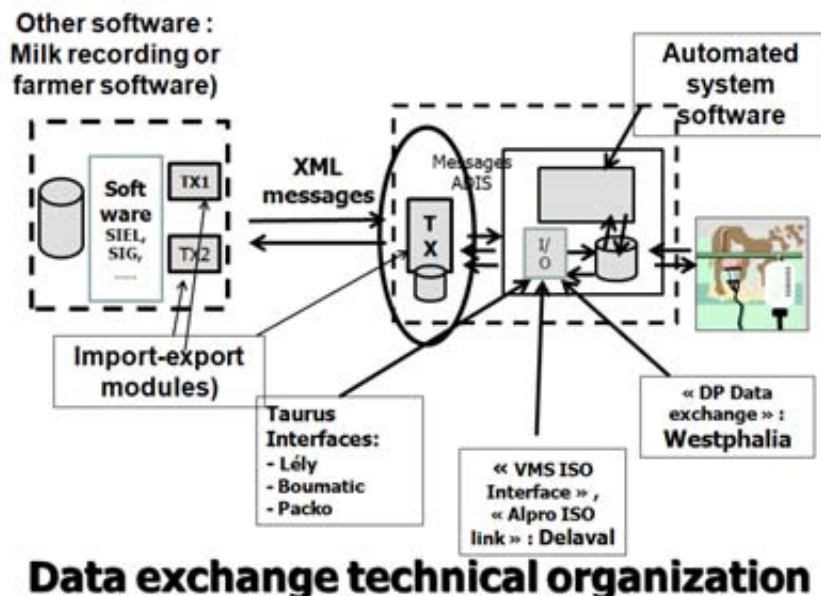

An XML message has been designed to be exchanged with any 3d party systems. It is based on ISO data definition and codification. It lets transmit any animal event type. In the first release the set of

exchangeable event types are limited. The module can also export ADIS formatted message for milking organizations that use this format message.

The farmer may decide which kind of event data he wants to submit automatically to the automated system. For data to be input, the farmer may view, check and validate them before they are submitted to the software of the automated. So it is an appreciated help for the farmer who has not to key again already recorded data.

This portable module makes up for the incomplete standardization of import export modules on the automated systems. It permits the farmer to have his data at his disposal and to send them electronically easily to recording and breeding organizations. The next releases will add new types of events to be exchangeable, and new types of automated systems and sensors to take in account to exchange with them.





## **Experiences with comprehensive herd management of a mega-dairy using RFID, automatic milk recording and multi-client cow-side data entry with reproduction and health protocols**

**D.W. Webb**

*Southeast DHIA, Inc. and University of Florida, P.O. Box 142460, Gainesville, FL 32614, USA*

### **Abstract**

A comprehensive data base system, integrated with DHIA and automatic milk recording has been used for total management of a herd with 7600 female animals located in Florida. Cow identity is provided by Allflex RFID tags. The herd's primary data resides in PCDART along with real-time milk weights and parlour performance collected by Boumatic. The milking parlour is a double-40, rapid exit system with dual sort-gates at each of two exits. Computer work stations, networked to PCDART are present at three cow-side locations for entry and look up of breeding, health and group data. The adult cow herd of 3800 milking is milked three times per day. Cows are sorted for diagnosis, treatment and breeding on each of two milkings, 7 days per week. The herd uses extensive estrus synchronization, embryo transfer and aggressive sire selection programs. PCDART's protocol system allows for generation of to-do lists and signals for cows to be sorted for attention.

*Keywords: DHIA, RFID, sort gate, data management system.*

### **1.0 Introduction**

Large herds in the U.S. have implemented varying strategies to accomplish day-to-day management routines. Some herds have unique barn configurations, designed to manage cow location in order to have similar cows housed together. Others use lock-up stanchions for breeding, vet check and treatment.

The herd in this study depends on cow-sorting after milking to allow breeders and other personnel access to cows needing various kinds of attention. Cows are managed in groups ranging from 100 to 500 cows. Each cow passes a dual sort gate as she exits the double-40 milking parlour. Cows may be sorted automatically based on algorithms in the parlour software or by the PCDART program's schedule of chores to be done that day. Additionally, farm personnel can enter sort requests based on observation or knowledge of a particular cow's history or need. Networked PC's, located at cow-side allow for immediate access to and input of breeding and health information. PCDART, QUICKCOW and BOUMETRIX software programs are used for individual cow information in the parlour office. A second parlour, double-12 is used for cows in the hospital area.

Located in the agricultural community of Bell, Florida, 30 miles west of Gainesville and the University of Florida, North Florida Holsteins is home to 6400 head of Holsteins on 1250 acres. Managing partner Don Bennink and the entire management team are committed to producing quality milk from comfortable cows. Priorities for this herd are breeding, performance, herd health and environmental stewardship. Management depends heavily on digital information for everyday operation.

North Florida Holsteins practices an intensive embryo transfer program with a professional veterinarian performing the flush while in-house herd health technicians implant the embryos. This procedure is used both for genetic improvement, and to maximize conception rates during the extreme summer heat. Approximately 20% of the herd is bred to young sires, including homebred sires from well-respected cow families.



More than 70 employees are organized into seven departments, including: parlour, herd health, calf, hospital, heifers and feed, farm maintenance-crops, and administration. Among these employees at any given time one will find 8-10 international students, most of whom have veterinary or four year agriculture degrees, participating in a highly successful program where both the students and the farm benefit.

## 2.0 Description of Data Management System

The observations of this study began with the transition from a previous system in June of 2009. The new system consists of two BM2060 controllers from Boumatic, each connected to an individual PC on the parlour office network. There are a total of 13 PC's, 2 for Boumatic, 3 at cow-side stations, 6 in the office, 1 as server for PCDART and 1 for data backup.

Cows are identified with RFID. Current tags are all Allflex HD button tags. Numbering is coordinated with Holstein USA for registration and pedigrees.

Cow identification, milk weight assignment and automation control are managed by software from BouMatic, called the *SmartEID™/ISO Ear Tag ID System*, specifically SmartEID™ and BouMetrix. These programs interface with PCDART (pcdnet version) for acquisition of data entered by the farm staff and delivery of milk weights and other data collected at milking. BouMetrix receives cow-sort requests from PCDART and generates parlor sorts based on real-time observation at milking. Both are transmitted to the sort gate controllers such that cows can be sorted for action as they exit the parlor.

PCDART serves as the primary database combining data from Boumatic, cow-side, office entries, DHIA, USDA AIPL genetic evaluations, USA Holstein pedigrees and physical traits. Health and status events are stored for lifetime. Individual milk weights are maintained for 400 days. PCDART provides a system of *protocols and chores* to assist in organization of actions needed for all cows on a daily basis. Once cows are entered into a protocol, they will be included in the work list and cow-sort requests for the appropriate day according to the schedule for that protocol.

Quickcow is a PCDART dependent application that is used to view individual cow's most current data at cow-side. It can be configured to display user-selected data in an abbreviated format to make use more convenient. Quickcow consolidates the most recent parlor data including milk weight, deviation and parlor sorts.

## 3.0 Experience and observations

Parlour data for all milking cows have been collected successfully for both the double-40 and double-12 parlors. PCDART communicates routinely with both BM2060 controllers and successfully collates data from both. Early in the observation period, data were transferred at the close of each milking. Currently, parlour data are being pulled at 10-minute intervals. Data entered at cow-side are transmitted immediately.

Sort gates are operating fully and provide cows for breeding, treatments, vaccinations and reproductive evaluations for all cows. Sort gates run during first and second shift (0700 -2300 hr) every day.

In the first weeks of observation, there were significant issues with EID tags not being read. These problems were found to be due to significant electrical noise emitted by motors, lights and other devices. Once these were cleared, identity has been satisfactory with 94-96% complete on most days.

Herd management personnel have defined 77 different protocols using 146 chores for routine herd management. (Protocols = schedules. Chores = actions, drugs or observations scheduled.) These protocols have been used heavily. For example, for 8 months

(September - April) 2355 cows were enrolled on the primary synchronizing protocol (SYP); 1807 cows were on the foot management protocol (LAMECHK); and 3087 animals were on the primary vaccination protocol.

On the most recent herd test 3774 milking cows averaged: 35.3 kg milk, 3.7% fat, 2.8% protein, 178 thousand scc.





## The new infrastructure for cattle and sheep breeding in Ireland

**B. Wickham**

*Irish Cattle Breeding Federation Soc. Ltd, Highfield House, Shinagh, Bandon, Co. Cork Ireland*

### **Abstract**

Over the last twelve years ICBF has established a new technical infrastructure for cattle and sheep breeding in Ireland. This involved:

Establishing a philosophy and agreement for the sharing of data and information between a large number of cattle breeding industry stakeholders including AI Companies, Herd Books, Milk Recording Organisation, Research Organisations, Farm Advisor and the Department of Agriculture.

The building of a tightly integrated national cattle breeding data base that utilises a number of technologies for data collection, data storage and information provision.

Developing a shared breeding objective and associated genetic evaluation system for dairy, beef and sheep breeding. Most recent developments are in the use of genomic data in dairy genetic evaluations.

Identifying the optimal breeding scheme design for each breed and implementing a number of novel approaches for achieving more rapid rates of genetic gain.

Farmer participation in beef and dairy cattle recording breeding has increased dramatically.

*Keywords: cattle, sheep, database, genetic evaluation, genomics, recording, infrastructure*

### **1.0 Background**

The purpose of this paper is to describe the technical infrastructure established over the last twelve years for cattle and sheep breeding in Ireland. The main focus is on cattle breeding although, commencing in 2008, the infrastructure established for cattle is being extended to sheep.

In the period leading up to 1998 the infrastructure supporting Irish cattle breeding comprised two main elements. Firstly, multiple milk recording, artificial insemination and herd book organisations providing specialist breeding services to farmers. Secondly, central Government through its Department of Agriculture (DAF) providing within breed genetic evaluations for a limited range of traits. Each organisation maintained its own stand-alone information system with associated data collection and reporting facilities. There were some 40 computer systems providing cattle breeding information to Irish farmers in 1997. The Irish cattle breeding industry, with strong support from DAF, decided to establish a new information infrastructure in 1997 and this gave rise to the formation of the Irish Cattle Breeding Federation Society Limited (ICBF) which commenced operations in 1998.

The mission of ICBF (ICBF Annual Report 2009) is to "*achieve the greatest possible genetic improvement in the national cattle herd - Dairy and Beef*". It was not until June 2000 that agreement was reached on the current structure for ICBF. Shareholding in ICBF is split between milk recording (MR), artificial insemination (AI) and herd books (HB) each holding 18% and the farm organisations (FO) who hold 46%. The sixteen member Board of ICBF comprises three from each of the service providing member groups (MR, AI, HB), six from the FO and one from DAF. The Board of ICBF sets policy for cattle breeding in Ireland.

ICBF has established a new technical infrastructure for Irish cattle breeding by establishing a basis for sharing a unique database and utilising a number of new and emerging technologies.

## 2.0 Data and information sharing agreement

A single shared database has been established to support the information needs of Irish cattle breeders. The key principles which have enabled the database to be established and to operate are:

- Organisations contributing data to the database, either for its initial creation or as a result of routine operations, retain "ownership" of that data. At any time they can cease participation and receive an electronic copy of all their data.
- ICBF have established an "animal events" data recording service which it provides to herd owners. This service removes duplication in data collection from farms and provides data that is incorporated into a wide range of information services provided by multiple service providers.
- ICBF have electronic data sharing arrangements with organisations that collect data of relevance to cattle breeding as part of their routine operations. Examples include DAF's calf registration and animal movement system, factories where animals are slaughtered for meat, and milk processors.
- All data held in the database is available for use in approved research and in genetic evaluations.
- All genetic evaluation results are stored in the database and all bull proofs are publicly accessible through the ICBF website (ICBF Website).
- The herd owner controls which service providers can have electronic access to information for their herd.
- A range of specific information services have been developed, and are being continually improved, by ICBF for service providers. These include milk recording, herd book and artificial insemination services.
- ICBF provides the HerdPlus<sup>®</sup> service (ICBF HerdPlus) to herd owners. This service is focused on genetic evaluations and breeding. It compliments information services provided service providers and gives the herd owner a consolidated view, across all service providers, of all data for the herd.
- All services are provided on the basis of "user-pays" and "full cost recovery" by ICBF.

## 3.0 ICBF's national database

Initially, commencing in 1999, ICBF utilised the NRS developed IRIS database system. This runs on Oracle<sup>®</sup> using Hewlett Packard<sup>®</sup> servers. A group of six software developers is employed by ICBF to develop database inputs and outputs. Over time this group have maintained a steady level of innovation both taking advantage of new technologies and providing improved services for farmers. As a result the original IRIS system has been replaced.

Web based technology has been employed to provide herd owners with facilities to directly access the database to record data and to access a comprehensive range of reports and interactive facilities. The move to web based systems has also reduced network costs and enabled provision of ever more valuable information and facilities to service providers.

The current focus of database developments is its extension to support animal health initiatives, genomic selection for both dairy and beef, and sheep breeding.

## 4.0 Genetic evaluation system

The first step taken by ICBF was to establish a breeding objective philosophy. While this was not a technically difficult task, the implications have been far reaching and dramatic. The philosophy is simple "*to breed cattle that maximise farm profitability*". The emphasis immediately moved from just a consideration of outputs to a consideration of the balance between inputs and output. Establishing a genetic evaluation system that can rank animals on their genetic merit for profitability required a great deal of research involving collaborators and contractors from many countries. It also required very effective and convincing demonstrations and farmer education.

Overall indexes, expressed in euro and comparable across breeds have been developed for dairy, the EBI (economic breeding index), and beef, the SBV (suckler beef value). The EBI is now widely accepted in the dairy industry and has resulted in a reversal of the decline in fertility which had come close to causing a

major loss of confidence in the Irish dairy industry. The SBV was introduced more recently and is rapidly gaining acceptance in the beef industry. Both indexes, and their component traits are reviewed annually an enhancements are being introduced on a regular basis. The main sources of improvements are: improvements in data quality, availability of new data, increased volumes of data and new technology. Genomic technologies are currently delivering dramatic improvements in the accuracy of genetic evaluations for dairy cattle and are the subject of a major research effort for beef.

## 5.0 Breeding Schemes

Achieving the mission of ICBF is dependent on the Irish cattle breeding industry achieving an optimal breeding scheme design. Our initial focus was on research to establish the optimal design for dairy and beef. It turned out that the optimal design, prior to the advent of genomic technologies was remarkably similar. For dairy and beef some 100 bulls should be progeny tested annually on the basis of 100 daughters completing a first lactation. For dairy, utilising genomic technology, the optimum is very similar but much heavier use is made of the young bulls to breed female replacements. Research for beef is still underway.

GENE IRELAND<sup>®</sup> is a bull progeny testing service (ICBF Gene Ireland) that has been launched by ICBF. This service facilitates the progeny testing of dairy and beef bulls from competing AI companies in a group of collaborating herds. This facility will be required into the future as the on-going exploitation of whole genome selection requires frequent re-estimation and a supply of high quality phenotype data.

## 6.0 Funding

A substantial financial investment has been made to establish Ireland's new cattle breeding infrastructure. Funding has come from three sources: DAF, farmers and services. ICBF was established with an initial share capital of €2 million. This capital has been supplemented with National Development Plan (NDP) structural funds covering 70% of eligible costs and a farmer contribution, collected on ear tag sales of €0.42 per animal born giving some €0.8 million annually. Service income was initially very low but has now grown to some €1.5 million per year.

## 7.0 Benefits

The new infrastructure is now providing demonstrable benefits to the stakeholders in Irish cattle breeding.

For Government & the wider community these include: cost savings through not having to provide services, increased tax income from a more profitable industry, more effective research investments primarily due to the availability of ICBF database, and better quality cattle for future farmers.

For the cattle breeding industry and service providers: increased uptake of services, better quality services, improved export potential, and cost savings.

For farmers and breeders: more rapid genetic gain worth some €20 million per year cumulative for dairy and some €5 million per year cumulative for beef, better quality information for decision making, and more rapid availability of the benefits of new technologies (eg genomics).

Currently 90% of the 1.1 million dairy calves and 1.0 million beef calves born annually in Ireland are participating in the new Irish cattle breeding infrastructure.

## 8. References

ICBF Annual Report 2009. [http://www.icbf.com/publications/files/Annual\\_Report\\_for\\_2009.pdf](http://www.icbf.com/publications/files/Annual_Report_for_2009.pdf)

ICBF Gene Ireland. <http://www.icbf.com/services/geneireland/index.php>

ICBF HerdPlus. <http://www.icbf.com/services/herdplus/index.php>

ICBF Website. [www.icbf.com](http://www.icbf.com) – go to “bull search” and enter “GMI” for dairy bull or “CF52” for beef bull to access detailed information.





## ICAR Reference Laboratory Network - Objectives and stage of progress in 2010

O. Leray

*Actilait/Cecalait, Rue de Versailles, BP 70129, F-39802 Poligny Cédex, France*

### **Abstract**

A policy for quality assurance on milk recording analysis has been developed from sixteen years by ICAR according to the orientation proposed in Ottawa in 1994. So called analytical quality assurance system has been based on the adoption and use by laboratories of same technical guidelines produced by ICAR and a structuring model based on national networks for laboratory monitoring at country levels and an international network of reference laboratories. The latter network is the corner stone of the system as it allows to anchor countries to common reference values defined internationally through proficiency testing programmes and offer a adequate framework to characterize reference materials well made to distribute analytical trueness. The efficiency of the system, as depending on general recognition, requires the largest participation of member organisation of ICAR.

*Keywords: Milk analysis, reference laboratories, network, proficiency testing, analytical harmonisation.*

## **1.0 History**

A policy for analytical quality assurance (AQA) was introduced at the 29<sup>th</sup> ICAR Session in Ottawa in 1994 so as, with covering every aspect of milk recording analysis, provide confidence to stakeholders, ensure equivalence of genetic evaluation and enable analytical system recognition between countries.

That policy was implemented and handled by the Working Group on Milk Testing Laboratories of ICAR until 2006. then was continued by the enlarged permanent working party, the Sub-Committee on Milk Analysis.

From 1994 the working group has defined essential guidelines in order to assure the minimum needed precision in milk recording analysis and in 1996 created a network of expert laboratories expected to become the basis of an international analytical quality assurance system for milk recording, the ICAR Reference Laboratory Network.

The international reference laboratory network has become an essential piece of the AQA system aiming at analytical harmonisation as its members are entrusted to be intermediaries between national levels and the international level where optimum methods and practices are defined (IDF/ISO guides and standards, ICAR guidelines) to transmit adequate information to milk testing laboratories.

## **2.0 Structure and architecture**

The network is built on a hierarchical centralized model for the sake of vertical forth and back communication for harmonisation and provision of standard technical information and offers of services from the coordinating committee, the ICAR MA SC. Horizontal communication and collaboration between laboratories is encouraged and made possible thanks to a member list regularly updated. This is an organisation in two (possibly three) levels of network implementation as national (or regional) and international.

A third layer can exist for instance in federal countries where as well regions can organise labs in network or be a prospective challenge for the future to monitor on-farm analysis from regional laboratories.

### **2.1 National level**

National networks gather the milk recording laboratories of the country (or the organisation) and establish a national (or local) coordination based on international standards and guidelines, Good Laboratory Practices, as mentioned in the ICAR guidelines. It is expected the coordination is made by a



laboratory with high competence in every aspects of milk analysis, so-called "reference laboratory", so as to be able to run the missions needed to assure analytical quality. This is to monitor routine laboratories, teach and train lab technicians, evaluate and implement new techniques, methods or instruments, advise laboratories as well as milk recording organisations by which it is commissioned.

The reference laboratory is also requested to establish concrete tools to assess laboratory performances so as to assure confidence nationally to stakeholders. This is mostly attained by the organisation of national proficiency testing schemes. Beside the provision of technical tools in the form of reference materials to check reference methods or calibrate routine methods is highly recommended by ICAR for the ease in the laboratory work and analytical result security every day.

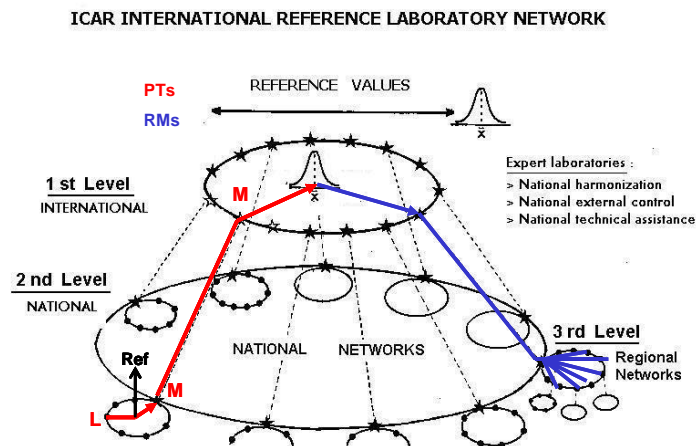

Figure 1. Structure of ICAR networking model with bottom-to-top/top-to-bottom circulation of information.

## 2.2 International level

The reference laboratories are invited in an international coordination by ICAR and can become member of the ICAR Reference Laboratory Network. This is made through the nomination of the national ICAR member organisation and under the condition the candidate laboratory and the national organisation adopt the model of functioning, as far as the local situation permits so, and comply to the ICAR guidelines. Such reference laboratories may have been existing for other purposes prior to the ICAR Reference Laboratory Network implementation but however in a number of case the reference laboratory must have been created and competence acquired so as to cover the largest panel as promoted by ICAR.

## 3.0 Roles

### 3.1 Analytical traceability and anchorage

The international network constitutes a structure through which, thanks to interlaboratory studies, it becomes possible to provide an international anchorage to routine laboratories and estimating overall accuracy of milk recording measurement and absolute measurement uncertainty in individual laboratories.

The national reference laboratories operate as bridges to transmit the precision traceability from the international level to national levels thanks to interlaboratory studies carried out regularly at both national and international levels. Interlaboratory studies allow to measure laboratory bias to the reference laboratory which relays to the international absolute reference through its own bias to the international reference values. Elements of trials reports allow laboratories to calculate the uncertainty related to its practice with the method.

Beside every member of the reference laboratory network can be invited to participate in international collaborative studies to characterize certified reference materials (golden standard) and establish reference values for every reference laboratory of the network therefore can contribute to provide tools to routine laboratories to measure the trueness of results and perform adjustment according to their needs.

### 3.2 Interlaboratory proficiency studies

Since 1996 an annual interlaboratory proficiency scheme has been regularly run twice a year for methods used as reference to calibrate routine methods for fat, protein and lactose in cow milk. It was complemented from 1999 with methods for urea and somatic cell counting. From 2009 participant number has significantly decreased and in the first round of 2010 it is 15 for fat, 16 for protein, 14 for lactose, 13 for urea and 16 for SCC.

However significant improvement of analytical performances was noted throughout years and today the overall precision observed within the network appears fit to standard precision values stated in respective international method standards.

## 4.0 Membership

Any laboratory commissioned to monitor routine testing laboratories should be invited by their national organisation to join the network. Competence and expertise requested as eligibility criteria to belong to the network are one or more of the followings :

- |   |   |
|---|---|
| 1- National ring test organizer                   | 5- Information on analytical methods            |
| 2- Reference Material supplier                    | 6- Evaluation of analytical methods/instruments |
| 3- Master laboratory for centralized calibration  | 7- Research on analytical methods               |
| 4- Teaching and training in laboratory techniques | 8- National regulatory control of DHI analyses  |

and the ideal situation is where the reference laboratory covers every competence item and therefore can ensure consistency and continuity in missions to routine laboratories. In some situation competence and expertise may be in several laboratories which may allows more laboratories per country.

For specific situation where only few laboratories with no national co-ordination, individual routine laboratories may also join the network so as to benefit to a direct anchorage to the international level whereas, in well structured local situations, so-called reference laboratories can establish the junction between routine labs and the international level.

## 5.0 Stage of progress

from 1996 to 2003 and moved to stabilisation attained in 2007 (Figure 2). In mid 2010 there are 38 of 32 countries involved in cow milk analysis, of which as well 17 work for goat milk and 14 for sheep milk.

Table 1. Worldwide representative-ness and of member number per country in 2010.

Argentina	(1)	Austria	(1)	Belgium	(2)	Canada	(1)
Cyprus	(1)	Czech Republic	(1)	Denmark	(1)	Estonia	(1)
Finland	(1)	France	(1)	Germany	(1)	Hungary	(1)
Ireland	(1)	Israel	(1)	Italy	(1)	Korea	(1)
Latvia	(2)	Lithuania	(1)	Netherlands	(1)	New Zealand	(1)
Norway	(1)	Poland	(1)	Slovakia	(1)	Slovenia	(1)
South Africa	(3)	Spain	(1)	Sweden	(1)	Switzerland	(1)
Tunisia	(2)	UK	(1)	U.S.A.	(2)	Zimbabwe	(1)

(n) : number of member(s).

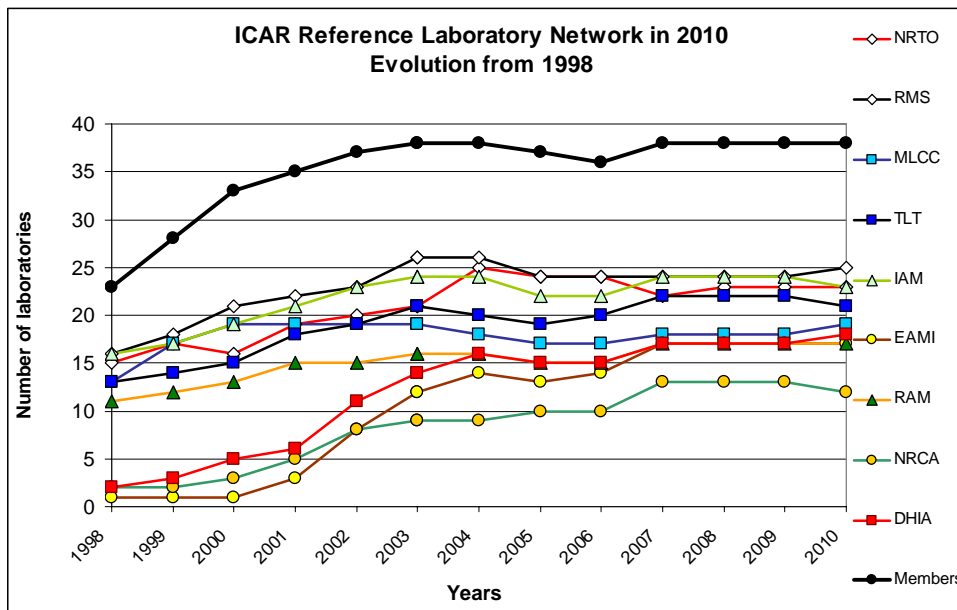

Figure 2. Evolution of membership and expertise in ICAR Reference Laboratory Network from 1998 to 2010.

In 2010, with regard to the number of eligibility criteria declared by laboratories 75% of competence items are realized by 39% of members, and 50% by 63% (Table 2).

Table 2. Numbers and proportions of eligibility criteria of network members in 2010.

Criteria number N	Proportion (%)	Lab number with N	Lab % with N	Lab number with at least N	Lab % with at least N
8	100%	5	13%	5	13%
7	88%	5	13%	10	26%
6	75%	5	13%	15	39%
5	63%	3	8%	18	47%
4	50%	6	16%	24	63%
3	38%	3	8%	27	71%
2	25%	2	5%	29	76%
1	13%	4	11%	33	87%
0	0%	5	13%	38	100%

## 6.0 Conclusion

A stable membership of the ICAR Reference Laboratory Network is observed from 2003 but in parallel it is noted the progressive increase of the number of individual members competence. Such increase improve the potential efficiency of the AQA system developed by ICAR from 1996 through more AQA services and expertise proposed to routine testing laboratories in ICAR countries. Nevertheless participation in international proficiency testing schemes organized by ICAR is only the fact of about a half of the network members with a decrease from 2009.

Promotion of the PT programme and technical improvement in the organizing should help to reverse that trend as all the members should be convinced that the most numerous participation in ICAR PTs, the best the quality of performance estimates then the highest the confidence in testing results used to harmonise laboratories and calibration in ICAR member organisations.

## 7.0References

- Leray, O. , 2008. Update on ICAR Reference Laboratory Network. Fourth ICAR Reference Laboratory Network Meeting. Proceedings of the 36<sup>th</sup> ICAR Biennial Session, Niagara Falls (USA) , 16-20 June 2008. ICAR technical Series No.13. 291-293.
- Leray, O., 2008. ICAR AQA strategy – International anchorage and harmonisation. Fourth ICAR Reference Laboratory Network Meeting. Proceedings of the 36<sup>th</sup> ICAR Biennial Session, Niagara Falls (USA), 16-20 June 2008. ICAR technical Series No.13. 295-300.





## Analytical precision performance in ICAR proficiency testing programmes

O. Leray

*Actilait, BP 70129, 39800 Poligny, France*

### **Abstract**

The increased development of international trade in animal genetic has made worldwide comparability and equivalence recognition for animal performance measurement a topical issue. This is especially the case for milk recording where milk analysis is a major issue.

To assure a harmonised analytical quality among member organisations, ICAR has built up since 1996 an international reference system based on an international network of dairy reference laboratories. Beside a number of recommendation set in guidelines, ICAR organises annually international proficiency testing schemes to help laboratory members of the network to evaluate their analytical performance and, through continuous improving, upgrade the overall analytical precision in the ICAR world and lead to form a consistent group of expert laboratories capable to establish trusty reference values.

Proficiency testing studies are organised twice a year for cow milk and involve reference methods for fat, protein, any methods lactose, urea and somatic cell counting.

A first review of laboratory performances and precision figures for fat, protein and somatic cell counting between 1996 and 2003 were presented in ICAR Session 2004 (Sousse, Tunisia) and showed unsatisfactory precision performances for the group as not conforming to IDF-ISO standard precision values, with unequal individual laboratory performances.

The compared review for the six last year (until 2009) illustrates a significant improvement with precision figures of the group converging onto or below standard precision values. The number of regular good performing laboratories appears significantly increasing compared to the picture made in 2004.

Nevertheless particular care must maintain and especially be given to somatic cell counting where last trials show a trend to higher precision values.

This work undertaken within ICAR serves as a basis for further undergoing development in the joint IDF-ICAR project "Reference system for somatic cell counting" where qualifying and selecting expert laboratories has become a major issue.

*Keywords: milk analysis, dairy laboratories, laboratory network, proficiency.*

### **1.0 Introduction**

For the two last decades, the increased development of international trade in animal genetic has made worldwide comparability and equivalence of animal performance measurement a topical issue. This is especially the case for milk recording, being for genetic trade (animals, semen, embryo) or the international evaluation of animal genetic index (Interbull).

To cope with that issue, ICAR set up in 1996 an international network of dairy reference laboratories so as to implement progressively a harmonised international quality assurance system for milk recording analysis worldwide. The reference laboratories are expected to acquire a high expertise in the analytical methods, either standardised or validated, used in milk recording so that they can provide routine laboratories with good reference values through adequate monitoring, anchoring (reference material) and good analytical practices. Harmonising analytical performances within the network is the first major step.

From 1996, ICAR has organised twice a year international proficiency studies for the benefit of the laboratory network members. Those studies were carried out mainly for cow milk and the reference methods for fat, protein, lactose, urea and routine methods for somatic cell counting.

A first review of laboratory performances and the precision figures shown for the methods by the group of laboratories was made in ICAR Session 2004 in Sousse (Tunisia) covering the period from 1996 to 2003 (13 trials). It was the occasion to illustrate how collaborative trials like proficiency studies could be used to strengthen analytical system through measuring analytical performance quality.

Six years later a new review appears necessary to update the knowledge on laboratory performance precision. Indeed, from 2004 and the experience acquired in ICAR, the concept of reference system, including the various uses of laboratory networks, was developed and evolved into the joint IDF-ICAR project "Reference system for somatic cell counting". Qualifying and selecting expert laboratories to provide suitable reference values for somatic cell counting has become a major issue whereas need is still to evaluate the current state of the Art for the main milk components, fat and protein.

## 2.0 Material and methods

### 2.1 Protocol of the PT scheme organisation

At every end of year the programme of ICAR proficiency testing scheme for the forthcoming year is addressed to the members of the ICAR Reference Laboratory Network and national member organisations of ICAR. The yearly scheme is organised in two rounds, the first in March and the second in September and is applied on cow milk for the component of interest for milk recording and dairy herd management. They are fat and protein by the relevant reference methods, somatic cell counting, lactose and urea by any validated methods excluding infrared. Indeed infrared is marked by significant interferences related to milk composition that makes so-obtained results irrelevant to assess lab performance quality.

Only results for fat, protein and somatic cell counting are reported here as main components used for the genetic evaluation.

#### 2.1.1 Samples

Sets of samples used are made of 10 samples preserved with bronopol at a concentration of 0.02% in milk, covering evenly the range of concentration usually met in routine testing that is

- 10 whole milk samples regularly ranging from 1.5 % to 4.9 % fat.
- 10 whole milk samples regularly ranging from 2.5 % to 4.0 % crude protein.
- 10 whole milk samples regularly ranging from 4.6 % to 5.1 % lactose.
- 10 whole milk samples regularly ranging from 50 to 1600 x10<sup>3</sup> cells/ml.
- 10 whole milk samples regularly ranging from 10 to 70 mg urea /100 ml.

Sample containers are 65 ml or 35 ml polyethylene screw-capped vials with airtight joints to prevent breaking and leakage, and sample temperature before and during shipment to laboratories is +4°C. Possible storage prior analysis is required to be +4°C whereas analysis is to be performed within 5 days for somatic cell counting and 10 days for chemical analysis after the dispatch date.

#### 2.1.2 Milk testing, statistical analysis and assessment parameters

Milk testing is required to be performed in duplicate and according to the current version of the relevant international standard. Cautions for sample preparation before analysis are reminded in an advisory technical note appended to samples. The order of analysis is to be better than one indicated in the numbering in order to avoid errors and reporting is made through adequate tables.

Statistical analysis is performed according to the model developed by the Institut de l'Élevage then used by Cevalait as described in the IDF Bulletin n°342:1999, annexe 3. Assigned values used as reference are calculated according to ISO 13528.

Each sample corresponds to a different concentration level. Assessment is made through dedicated tables allowing the evaluation of lab performance in lines and group performance in columns, for repeatability (ranges of duplicates and standard deviation of labs or samples, accuracy (means of duplicates, assigned reference per level, differences to assigned reference values, lab scores made of the mean,  $\bar{d}$ , and the standard deviation of the differences,  $sd$ ). A synthesis table with lab ranking according to the Euclidian

distance  $D$  (as the geometric mean of the two latter parameters,  $D = \sqrt{d^2 + sd^2}$ ) provides indications of the range of analytical performances and a figure illustrates the related location of each lab vs an indicative conformity target (Figure 1).

For somatic cell counting an table for calibration equation estimates is given as an additional information.

## 2.2 Meta-analysis for a global evaluation

### 2.2.1 Meta-analysis and group performance evaluation

Meta-analysis consists in gathering individual lab performances in a single large table per criterion - repeatability, mean of bias, standard deviation of difference, distance  $D$  - and to present such results in figures in a form of control chart with values in ordinate and trial number in abscissis.

This is done at first with raw data as including all the methods and abnormal scores for a first visual scrutiny and evaluation of the evolution of performance throughout time, then after discarding not expected methods (e.g. Gerber, infrared methods) and outlier laboratories.

If the source of outliers are evident and reflects on only a basic error of unit or disorder than can be repaired, correction and recalculation of scores are made since they would be detected in lab situation when calibrating routine analysers. Otherwise outlier are detected then discarded through a Cochran test applied on the distance  $D$  with a risk of error of 1% and in the limit of 20% max which was attained or passed but occasionally.

As well the geometric averaging per trials of all the participant values serve to evaluate the precision figures for each trial and the similar integration of the individual trial precision figures for a defined period of time allow to measure the overall precision improvement of the group of laboratories (Table 1).

### 2.2.2 Meta-analysis and lab performance evaluation

Individual lab control chart can be built up to assess each lab over a period of time and the calculation of an average score for the defined period (for instance the four last trials) becomes possible for a defined period of time to apply a suitable selection of laboratories for a defined purpose according to their performances (Table 2). Additional selection criterion can be the frequency of each lab participation.

Similarly as well as shown in Sousse (2004), such individual score merging allow to calculate a robust true individual uncertainty for the measurement applied for a given representative period.

## 3.0 Results

### 3.1 Overall scrutiny of individual scores

Compared to the period of 1996 to 2003, the control charts have shown in general a lower frequency of outliers with lower upper values for the period of 2004 to 2009, can this be for repeatability standard deviation, mean bias, standard deviation of bias or Euclidian distance  $D$ .

The outlier discarding suppressed less scores and rarely reached the percentage limit for deletion of 20%.

### 3.2 Repeatability and reproducibility figures (precision)

#### 3.2.1 Fat measurement

Repeatability standard deviation values,  $s_r$ , were higher than 0.10 g/kg from 1996 to 1999 then decreased to keep almost stable from 2000 to 2006 just above the standard limit of 0.07 g/kg of IDF 1 / ISO 1211. From 2007, in conjunction with the implementation of ICAR Quality Certificate, the values dropped below the limit. Referring to new standard value 0.15 g/kg implemented with the recent revision of IDF 1 / ISO 1211 the group shows good compliance from 1996.

A similar trend is observed for reproducibility standard deviation,  $s_R$ , although the group never passed through the standard reproducibility limit of 0.14 g/kg. Referring to new standard value 0.20 g/kg



implemented with the recent revision of IDF 1 / ISO 1211 the group shows however frequent compliance from 2000 (Figure 2).

### 3.2.2 Protein measurement

From 1996 to 1999 repeatability standard deviation values are mostly lower than the standard limit of 0.14 g/kg of IDF 20 / ISO 8968 with only two trials outside. However stabilization around 0.10 g/kg from 2006 is observed.

Reproducibility standard deviation was significantly higher than the standard limit of 0.18 g/kg of IDF 20 / ISO 8968 but from 2003 have decreased to a regular fitting onto the limit (Figure 3).

### 3.2.3 Somatic cell counting

From 1996 to 1999 repeatability standard deviation values are mostly significantly lower than the standard limit of 20 000 cells/ml of IDF 148-2 / ISO 13366-2 with only one trial outside in 2000. However after an optimal performance period between 2005 and 2007 irregular discrepancy is observed.

Besides, whereas reproducibility standard deviation was at the level or higher than the standard limit of 45 000 cells/ml of IDF 148-2 / ISO 13366-2 until 2003, they have been reduced significantly around a level of 30 000 cells/ml from 2004 to 2008. Since a deterioration of the global performance is observed and the limit is passed through in 2009 (Figure 4).

## **3.3 Individual lab performances and reference lab group selection**

Individual performances whatever the component - fat, protein or somatic cells - have shown significant progress as illustrated through the improvement of the overall precision of the group of participants.

Selection of group of reference lab for a defined purpose such as assigning reference values for reference material should be made from the more recent lab performances measured hence to define the last necessary period. Then to rank laboratories according to the overall precision shown by a significant statistical parameter, for instance sRL which covers all the sources of errors of the laboratory.

Table shows a case example dealing with fat for the four last trials (2008-2009) and yellow highlighting indicates prior defined limits are passed. On such a basis, as an example, one could assume to retain 19 labs of 21 for fat, 17 of 20 for protein and 12 of 18 in somatic cell counting.

Nevertheless not all participated at the same time in the same trials and the observed participation frequency (re Total% in Table 2) indicates regularity of the feedback information and possible corrective actions. So ranking according to the frequency can be associated to the ranking on scores thus introduced a weighting.

## **4. Conclusion**

Findings of the first review and their presentation in Sousse 2004 permitted to inform laboratory network for the need to improve testing practices and invited them to review own ways of work. This has resulted in an effective improvement at individual lab levels and consequently at the level of the whole group of participants. The efficiency of the ICAR reference system is demonstrated there.

Year 2006 saw the implementation of the ICAR Quality Certificate to replace the Special Stamps and broaden the scope of ICAR quality assurance system to all the parts of its expertise and among them milk analysis. Correlatively tighter regularity and compliance took place for fat and protein, at a lower extent for somatic cell count, demonstrating the efficiency of ICAR quality policy.

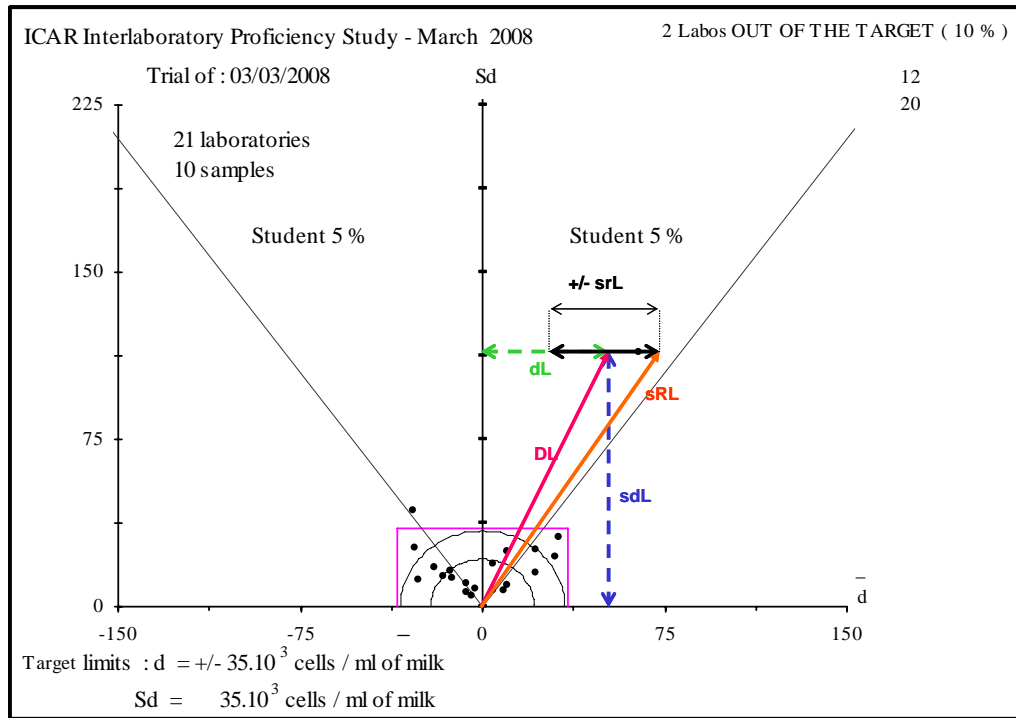

Figure 1. Statistical parameters for individual lab performance evaluation - Example of ICAR trial of March 2008

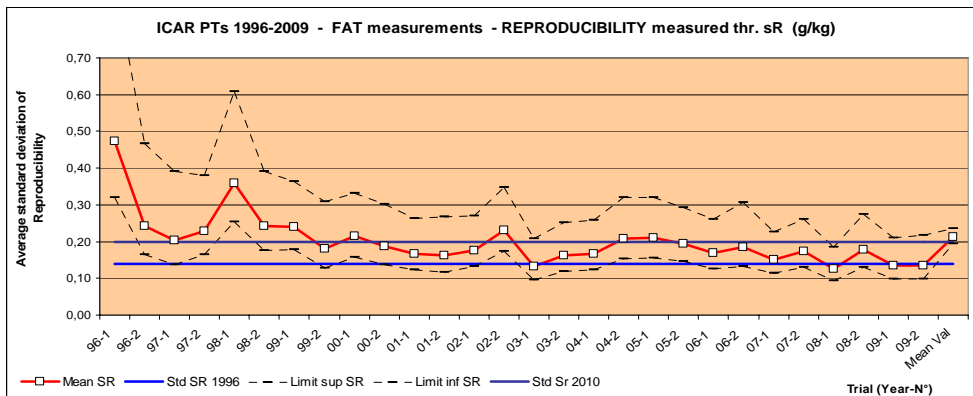
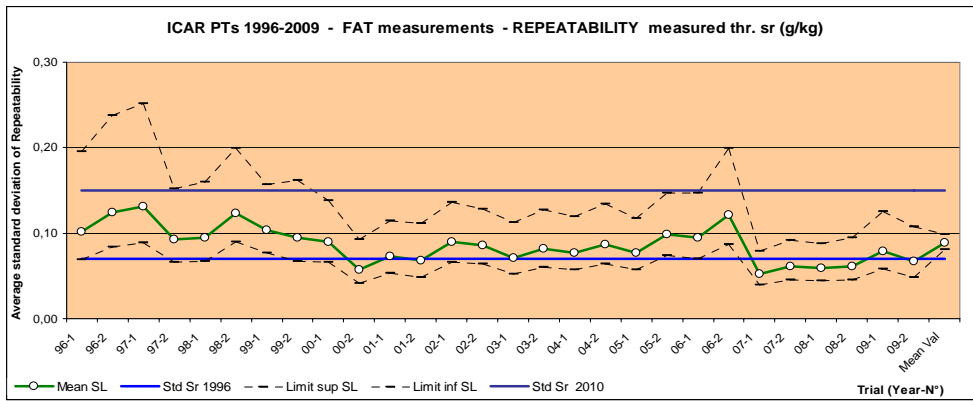

Figure 2. Precision figures in ICAR trials in fat analysis between 1996 and 2009

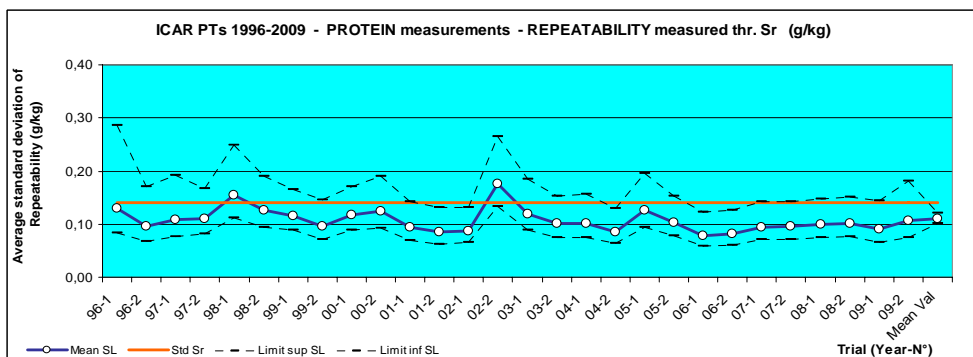
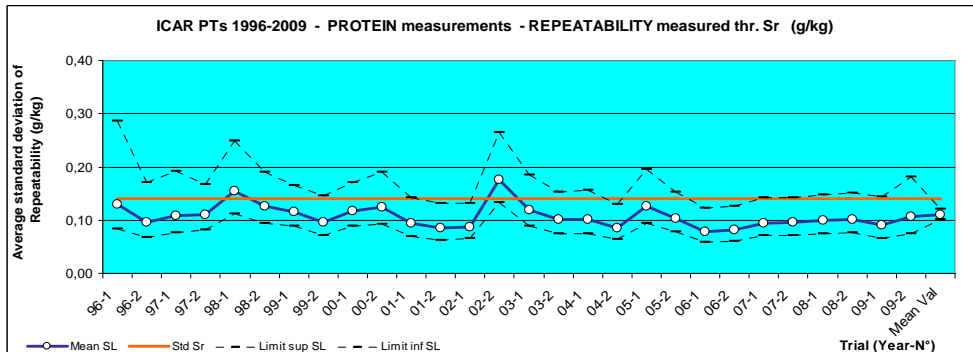

Figure 3. Precision figures in ICAR trials in protein analysis between 1996 and 2009

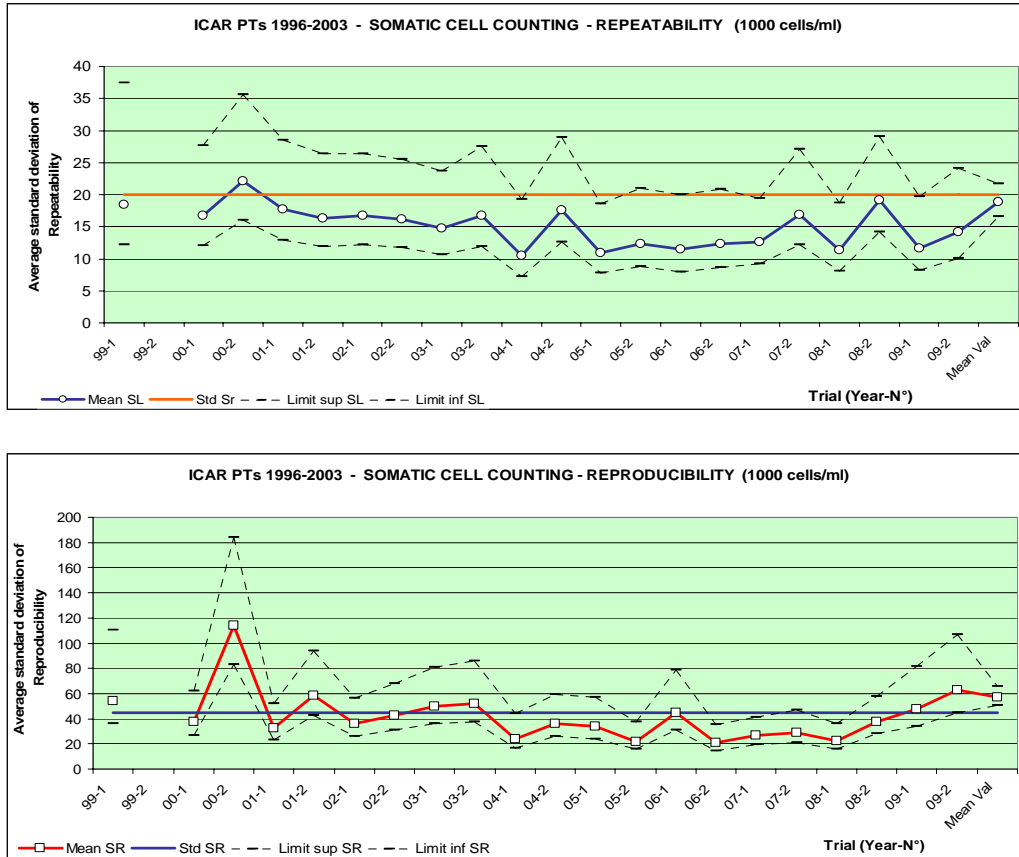

Figure 4. Precision figures in ICAR trials in somatic cell counting between 1996 and 2009

Table 1. Robust estimates of precision and accuracy parameters in fat by meta-analysis for the group of participant in ICAR trials

Fat (g/kg)						
N° ICAR	1996 - 2009	1996 - 2003	2004 - 2009	2008 - 2009	Limits	Standard
Mean SL	0,09	0,09	0,08	0,07	0,10	0,07
Mean d	-0,01	-0,01	-0,01	0,00	0,20	
Mean Sd	0,16	0,18	0,13	0,13	0,30	
Mean D	0,20	0,23	0,18	0,18	0,36	
Mean SR	0,21	0,24	0,20	0,19	0,37	0,14
Number N	387	203	184	60		

Table 2. Example of laboratory ranking according to reproducibility (srL) performances in ICAR trials (last four trials in fat)

**Fat : Ranking to select lab candidate pool to assign reference value (4 last trials)**

RANK	Lab ID	TOTAL %	Mean SL	Mean d	S mean d	Mean Sd	Mean D	Mean SRL
1		100%	0,04	0,02	0,09	0,05	0,06	0,07
2		75%	0,04	0,05	0,06	0,04	0,06	0,07
3		75%	0,04	0,02	0,08	0,06	0,07	0,07
4		100%	0,04	0,04	0,07	0,05	0,07	0,07
5		50%	0,07	0,01	0,12	0,06	0,07	0,08
6		50%	0,04	0,04	0,05	0,07	0,10	0,10
7		100%	0,07	-0,03	0,06	0,07	0,09	0,10
8		100%	0,07	-0,01	0,06	0,06	0,09	0,10
9		100%	0,05	0,07	0,31	0,08	0,12	0,12
10		50%	0,04	0,11	0,05	0,08	0,14	0,14
11		100%	0,07	-0,11	0,18	0,08	0,15	0,15
12		100%	0,06	-0,05	0,61	0,14	0,16	0,17
13		100%	0,06	0,01	0,18	0,09	0,17	0,18
14		100%	0,12	0,01	0,19	0,16	0,17	0,19
15		25%	0,16	0,18	0,14	0,06	0,19	0,22
16		50%	0,07	-0,09	0,08	0,21	0,23	0,23
17		100%	0,07	-0,16	0,10	0,16	0,24	0,24
18		75%	0,09	0,01	0,18	0,28	0,35	0,36
19		50%	0,11	0,04	0,21	0,35	0,36	0,37
20		100%	0,05	-0,13	0,24	0,12	0,38	0,38
21		25%	2,28	-1,16	0,78	1,81	2,15	2,69



## International reference system for somatic cell counting in milk - A world wide challenge

C. Baumgartner<sup>1</sup> & H. van den Bijgaart<sup>2</sup>

(on behalf of ICAR SC MA, E. Brenne, J. Floor, M. Gips, R. Castaneda, O. Leray, S. Orlandini, G. Psathas, J. Rhoads & G. Scott)

<sup>1</sup>Milchprüfing Bayern e.V., Hochstatt, 2, 85283 Wolnzach, Germany

<sup>2</sup>Qlip NV, Oostzeestraat 2a, P.O. Box 119, 7200 AC Zutphen, The Netherlands

### **Abstract**

In a globalizing world analytical results play a major role in free and fair trade. However, worldwide equivalence of analytical results can not be ensured by "only" producing standardized analytical methods. For some parameters standardized reference materials are lacking and the reference method shows limited performance. It is there that a reference system should serve to optimally safeguard equivalence.

In this paper it is explained what a reference system is and why Somatic Cell Counting (SCC) was chosen as a first example for implementation. An outline of a reference system for SCC is drawn and the time plan and the next actions of the joint IDF / ICAR project group are described.

*Keywords: Reference system, raw milk analysis, somatic cell count, SCC, relation between reference and routine method, joint IDF / ICAR project group.*

## **1.0 What is a reference system?**

A reference system is a systematically developed anchoring system that is fed by different types of information from various sources in a laboratory network structure:

Reference method results.

Routine method results.

Results from proficiency testing.

Joint recognition by regulatory bodies, competent authorities and other stakeholders is essential for an effective functioning. A more extensive explanation on the background and aims as well as on the elements of reference systems was published in the Bulletin of the IDF 427/2008.

## **2.0 Why somatic cell counting as a first example?**

SCC is one of the most frequently performed tests worldwide, estimated at over 500.000.000 tests/year.

SCC – as an indicator for udder health status – is relevant in food legislation, payment of raw milk and also has a major impact on farm management and breeding programs.

SCC data are obtained almost exclusively by automated high-throughput fluoro-opto-electronic counting instruments, which are calibrated and controlled with more or less defined milk samples giving a "reference level" for counting. This reference level derives in many cases from the application of the reference method, a direct microscopic cell counting according to ISO 13366-1|IDF 148-1.

### **2.1 Somatic cell counting as a typical problem**

Traditional calibration schemes are especially problematic with SCC, because several preconditions are only poorly met. It is necessary to repeat the reference method in more than one lab to arrive at an acceptable precision and accuracy of resulting reference values. Results from a collaborative study carried

out in October 2005 show that repeatability  $r$  and reproducibility  $R$  is rather limited (see also table below). The recently revised ISO 13366-1|IDF 148-1 on the microscopic reference method provides a better description on "what to count and not to count". Still, the reference method is tedious and cumbersome and requires experience and frequent execution in order to safeguard adequate competence of the analyst and a proper counting of the "analyte".



Certified reference material ("golden standard") is not available. Secondary reference materials have problems with shelf life and batch homogeneity during storage. Different matrices and cell types are used for the preparation of these secondary reference materials.

In routinely exercised somatic cell counting, well functioning automated fluoro-opto-electronic methods are used. However, the target analyte of these actual routine methods is not commonly accepted as "reference" basis.

Therefore, a true common basis for the calibration of routine instruments is in fact lacking. As a consequence, several routine laboratories have put their own 'reference system' in place in order to anchor their counting level.

For all these reasons, SCC serves as illustration of a typical problem and makes it into a true candidate parameter for implementing a world wide adopted reference system approach.

ISO 13366|IDF 148, part 1 vs. part 2 (all values in '000/ml)

	Mean	$s_r$	$s_R$	$r$	$R$
Reference	245	38.41	107		114
	679	69.79	192		218
Routine	245	13	20	36	57
	679	21.40		59	112

### 3.0 Outline of reference system for somatic cell counting

A reference system is regarded as a tool to provide a commonly acknowledged reference level for a given analytical parameter. It is characterized as a systematically developed anchoring system that is fed by different types of information from various sources, i.e. from reference materials, reference method analysis, routine method results and proficiency testing in a laboratory network structure. Joint recognition by regulatory bodies, competent authorities and other stakeholders is essential for an effective functioning.

A joint project group of IDF and ICAR has recently outlined a reference system for SCC and aims for its implementation during the next years. The system will be fed by routine and reference laboratories to characterize one or more (secondary) reference materials and systematically assign a "true" value to each material. This "assigned value" will represent the anchor level to which local routine laboratories can relate to. A system, well structured and anchored means avoiding fluctuations between different batches of RMs and subsequent calibrations.

The following scheme shows the principle.

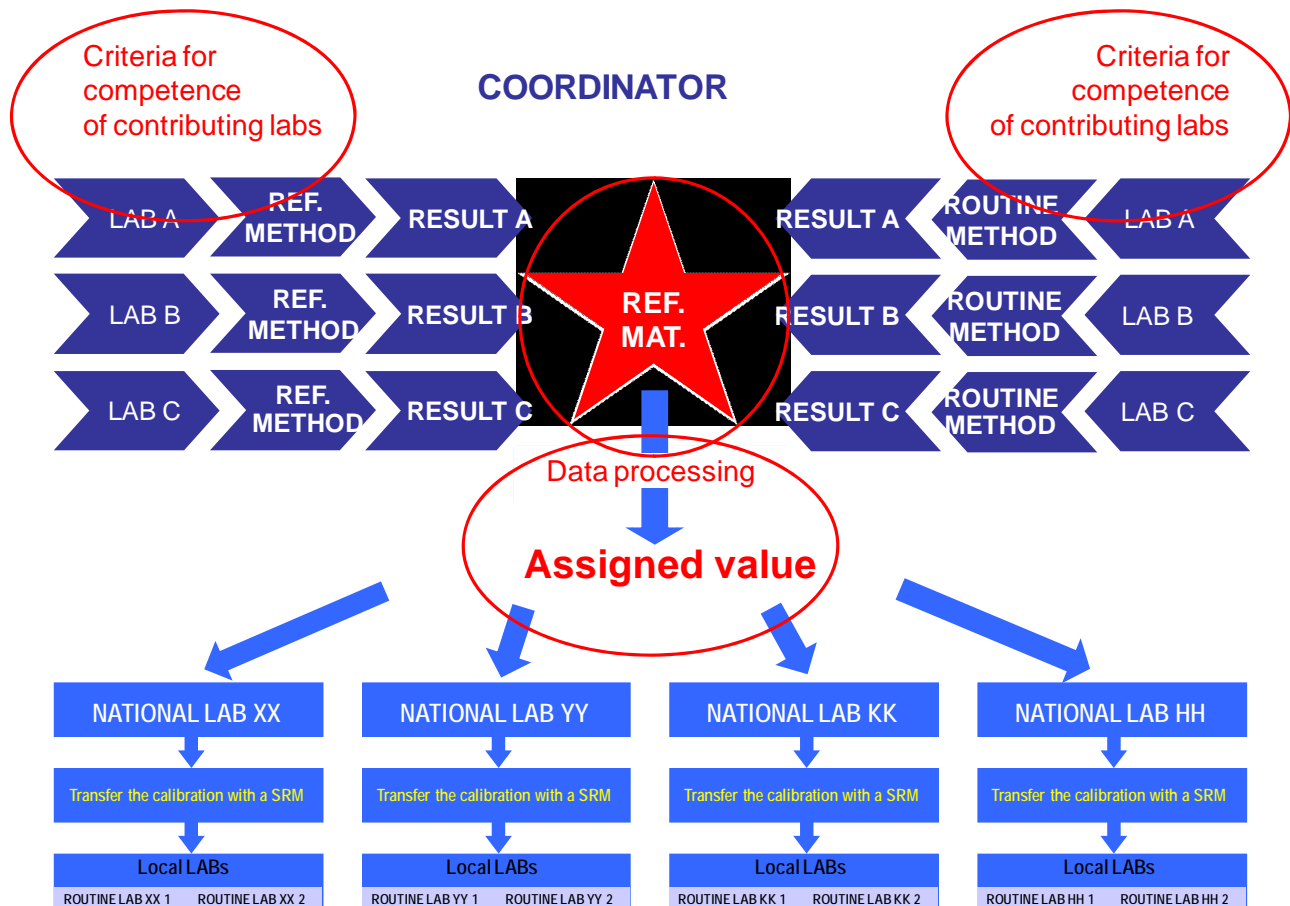

#### 4.0 What has the project achieved yet ?

In the joint IDF / ICAR project group now 4 continents and 16 countries are represented.

A strategic aspect is to communicate the aim of the project in the right way. This is achieved through meetings, by publishing papers, by publication of a newsletter and creating visibility on the ICAR and IDF websites. The communication will be oriented towards both the analytical stakeholders (labs, RM providers) as well as others (animal health bodies, authorities).

Questionnaires for reference material providers and routine laboratories bring information on how available reference materials produced in several continents and more than 15 countries are used. This information will be useful to draft guidelines for reference materials and to draw a picture of the interlinkages between the different existing local analytical systems.

The first calculation models for assessing both proficiency testing schemes and the performance therein of laboratories involved with the assignment of reference values are under development within a group of statistical experts.

#### 5.0 Next actions

The project group has identified the important parts to come to a reference system and is working out the details of a pilot model, which is to be evaluated in practise.

Crucial parts of this pilot model will be (amongst others):

- A suitable reference material (representative and stable).
- A laboratory database with a system for competence scoring.
- A calculation model for determining optimized assigned values.



The project group follows a bottom-up approach. This means to collect and make use of existing and functioning local structures.

Of course some organizational matters and financial issues have to be addressed in the near future, too.

## 6.0 Time plan

### Time Plan

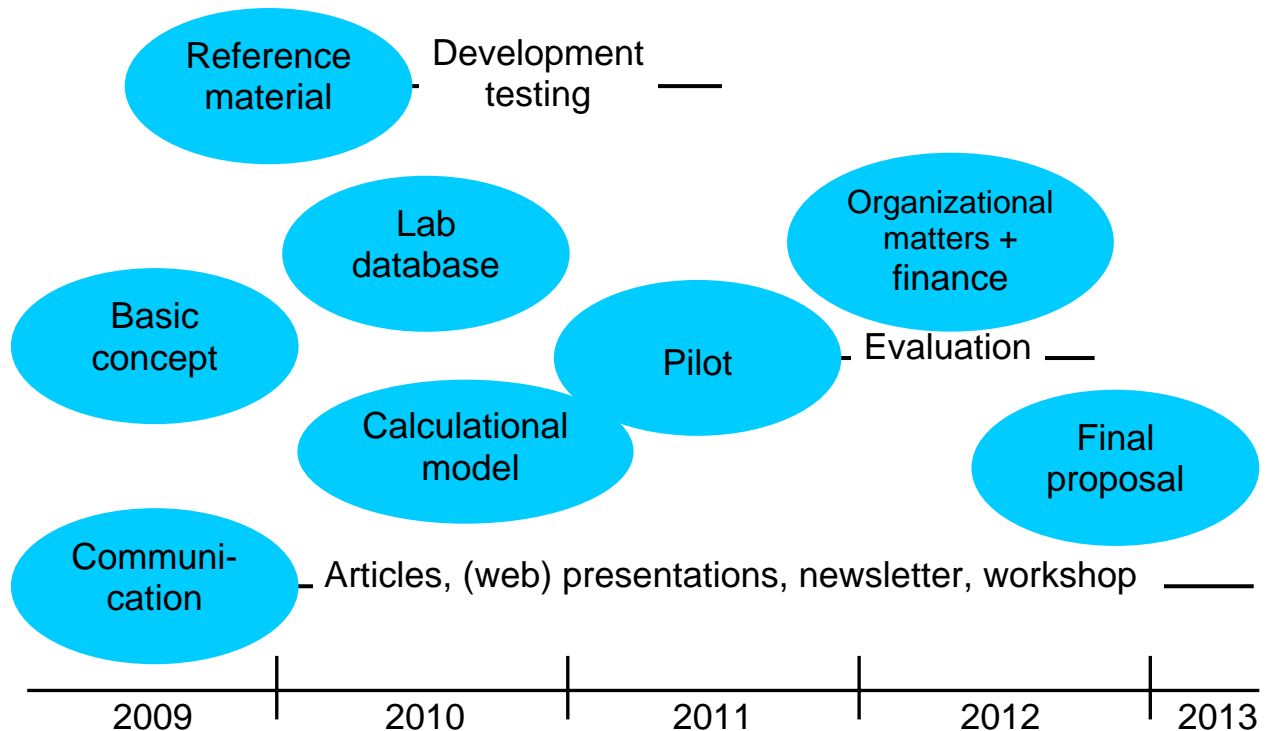

## 7.0 Conclusions

Somatic cell count in milk is an excellent parameter to explore the feasibility of a reference system approach. It is a very relevant parameter in food legislation, in farm management and in animal breeding and the reference method has distinct drawbacks.

The world wide challenge of this innovative analytical approach is to create mutual trust between the actors involved and to share useful data and experience which are obtained in daily analytical life.

A collaborative atmosphere at the national and international levels will help – and will be needed – to complete the puzzle of this sophisticated but also more robust analytical approach that is focussed at obtaining better analytical equivalence.

A robust reference system should produce results, which are valid in a three-dimensional scale: worldwide, over time and between different methods. ICAR and IDF as dedicated international organisations have taken up the glove to develop and implement this innovative and valuable approach.



## Latvian milk recording analysis and Dairy Laboratory Ltd. in the ICAR analytical reference system

D. Ruska

*SIA Piensaimnieku laboratorija, (Dairy Laboratory Ltd.), Instituta str. 1, Ulbroka, Latvia*

### **Abstract**

Dairy farming is one of the basic agricultural sectors in Latvia. Therefore milk recording system is very important for our farmers and it has very old history. Initially in Latvia farmers could test milk recording analyses in every milk laboratory. Later when centralisation of milk recording system started farmers could do milk recording analyses only in laboratory of the Breeding station. Now we are working with Agricultural Data Centre program for milk recording and farmers can do these analyses only in the accredited laboratory. Breeding system in Latvia is regulated by the government. The state reference laboratory is the supervisor of all of Latvian milk control laboratories. The reference laboratory organizes proficiency testing and prepares reference materials for fat, protein content and somatic cells count.

Dairy Laboratory Ltd. works in the both fields of milk analysing, such as milk recording analysis and payment analysis. The quality system in the laboratory is very strictly determined according ISO 17025 standard. We are working with ISO, IDF and validated methods. Scopes of accreditation are raw milk physical - chemical testing and milk, milk products and water microbiology. We work with instrumental methods and reference methods for milk microbiology and for determinate freezing point in milk. Our laboratory takes part in the different proficiency testing in Latvia and in the reference laboratories of European countries. Operation with different reference materials gives reliable, traceable and very precise results of analyses.

Staffs of the laboratory for a whole time get new experience and knowledge in the testing field. As well as we organise training for our customers in milk sampling system, transporting and milk recording system.

*Keywords: national regulation, sampling, accreditation*

## **1. Milk recording in Latvia**

First information about milk recording analyses for milk fat content and milk yield in Latvia we can find in beginning of 20th century. Total protein for milk recording start analysed in 1980, for somatic cells count in 1998. In 1997 was founded State Agency Agricultural Data Centre (S/A ADC) and was started digital era of milk recording.

Now under milk recording are 120 800 cows in 8062 farms. Every year from 1991 we observe decreasing in number of cows and herds. Situation with milk yield is different and we see increasing in milk recording results and in statistical every year.

## **2. Latvian milk recording analysis**

Latvian milk recording system is voluntary, but we have strong National regulation and support from government for this system. In National regulation are defined requirements for milk testing laboratory, milk sampling, milk analysing and analysed results recording.

The herd owners in whose herd's milk monitoring is being carried out shall receive control forms and reporting lists. All the cows and heifers of the herd, which are older than 24 months, must be indicated in the control forms. Taking milk samples for analysis, controller or the herd owner fills in the control list and sends it together with the milk samples to the Laboratory for processing.

Milk testing laboratory need to have Quality Assurance System according to standard LVS EN ISO/IEC 17025:2005. Accredited at Latvian National Accreditation Bureau (LA TAK), Member of European Cooperation of Accreditation.

Milk laboratory for milk recording analysing provide milk samples containers with samples vials volume up to 45 ml, accompanying document for samples, milk samples preservative (BSM II) and transportation of samples.

After testing Laboratory send samples testing results to central data base in Agricultural Data Centre. From data base farmers and breeding specialists take all milk recording information and analyses results.

### 3. National reference laboratory

The reference laboratory perform following tasks: co-ordinating of activities of the laboratories whose task is to conduct analyses to check the chemical and bacteriological standards; supervision and control of laboratories involved in raw milk control; preparation of calibration samples using reference methods, twice per month (fat, protein, dry matter, somatic cells count); preparation and implementation of proficiency tests four times per year.

In Latvia are 6 accredited raw milk routine laboratories. Three of them are Milk factory laboratories, they work only for payment testing. Two laboratories are DHI (Dairy Herd Improvement) laboratories in the Breeding and Artificial Insemination Station. One is independent laboratory - Dairy laboratory Ltd. it works to both systems - payment and DHI testing.

### 4. Dairy laboratory Ltd.

Dairy Laboratory place in milk recording system are in third place. First level is legalisation level from Government and according ICAR Guidelines. Second level are audit level from Food and Veterinary service, National reference laboratory, Accreditation bureau – LATAK, Agricultural data centre. Third level is Laboratory and basic of this system are Farmers and Dairies.

Dairy Laboratory is a private company. Our owners are non governmental organisations, stock companies and State. It represents three big groups of interest Farmers, Dairies and Breeding organisations.

Organization structure of Laboratory is following: board (5), administration (2), head of Laboratory and quality system (1), technical manager, chemist (1), microbiologist (1), instrumental equipment operators (2), data operators (2) and samples collection (2).

Staff of Laboratory every time renew skills and competence in testing field. Participation in specialised course for staff, study in High school. Technical tours in other testing laboratories (The Netherlands, Germany, Cyprus, Estonia, Lithuania).

For equipment calibration in laboratory are used Reference materials RM from different producers: Latvia, France, Germany, Denmark, Italy and USA.

Laboratory regular take part in several International Proficiency Testing schemes in Latvia and in Europe countries for each parameter at least one time per year. In Latvia – 4 times per year, in Germany – 5 times per year and France, Italy, England – 1 times per year.

Our Laboratory has following testing scope for milk compounds (Fat, Protein, Lactose, Casein, Urea content and Total solids), milk quality (Somatic cells count, Total bacteria count, pH) and milk falsification (Inhibitor, Freezing point).

All testing methods, what we use in Laboratory are based on National, international and in house validate methods. For milk compound we work with Infra red testing methods.

In Laboratory we have two reference methods for bacteria counting and freezing point.

Basic place of our works is precision of testing results, therefore important to give testing knowledge for our customers. For them we organise education courses and giving individual consulting in milk recording system, milk sampling for milk recording, milk sampling for payment analyzing and consulting about calibration of equipment.

We active take part in several work groups and projects in testing field and we have very close relationship with Ministry of Agriculture, Agricultural Data Centre, Food and Veterinary department, Latvian University of Agriculture, International Dairy Federation (National secretary) and ICAR.

Dairy laboratory represents: Quality, Speed and Customer service.



## Determination of fatty acid composition in milk of individual animals by Fourier-Transform Mid-Infrared Spectrometry

M. Ferrand<sup>1</sup>, V. Huquet<sup>1</sup>, M.R. Aurel<sup>2</sup>, S. Barbey<sup>3</sup>, F. Barillet<sup>4</sup>, F. Bouvier<sup>5</sup>, P. Brunschwigg<sup>1</sup>, K. Duhem<sup>7</sup>, F. Faucon<sup>1</sup>, D. Gueldry<sup>8</sup>, H. Larroque<sup>6</sup>, G. Lautier<sup>9</sup>, O Leray<sup>10</sup>, S. Leverrier<sup>11</sup>, I. Palhiere<sup>4</sup>, J.L. Peyraud<sup>12</sup>, J.M. Trommenschlager<sup>13</sup> & M. Brochard<sup>1</sup>

<sup>1</sup>Institut de l'Élevage, 149 rue de Bercy, 75595 Paris cedex 12, France

<sup>2</sup>UE INRA La Fage

<sup>3</sup>UE INRA du Pin-Au-Haras

<sup>4</sup>INRA-SAGA

<sup>5</sup>UE INRA de Bourges

<sup>6</sup>INRA-GABI

<sup>7</sup>CNIEL, 42 rue de Châteaudun, 75314 Paris cedex 09, France

<sup>8</sup>LIAL MC Aurillac

<sup>9</sup>LILCO Surgères

<sup>10</sup>Actilait, <sup>11</sup>LiLano

<sup>12</sup>INRA UMR-PL

<sup>13</sup>UR-ASTER INRA Mirecourt

### **Abstract**

The increasing social demand for healthy products leads more and more dairy companies to select collected herd milks according to the fine milkfat composition and could also lead to the introduction of the composition in fatty acid (FA) as a criterion for milk payment. However, today, there is neither rapid method officially validated in France to determine milk fatty acid composition in routine analysis nor tools to allow adaptation of the fine milkfat composition to the evolving consumers demand.

Consequently it has become today of a major interest to define technical levers that will allow milk producers to orient milk fatty acid profiles as soon as the production stage on-farm. Since then the objectives to measure elementary milk components with sufficient accuracy and to identify the genetic and environmental factors affecting the composition are being pursued through a R&D project, initiated in France in 2008, called PhenoFinLait.

The first step was to develop a cheap and large scale phenotyping system for determination of FA individual milk content. A set of equations was developed to estimate fine FA milk composition from MIR (Mid Infra-Red) spectra usually obtained by milk recording laboratory. For several FA, a variable selection was applied to improve the equations. In the end, 15 to 20 FA are well estimated in the three ruminant species (cow, sheep and goat). Statistical research is ongoing to improve estimation for other FA and normalize this method.

This study is part of PhenoFinLait project funded by Apis-Gène, CASDAR, CNIEL, FranceAgriMer, France Génétique Elevage, French Ministry of Agriculture and French Ministry of Research.

*Keywords: cow, ewe, goat, milk, fatty acid, mid-infrared (MIR) spectrometry, genetic algorithms, Partial Least Squares (PLS) regression*

## **1.0 Materiel and methods**

### **1.1 Milk samples**

#### **1.1.1 Cow milk samples**

First, 154 milk samples from 77 crossbred Holstein X Normande dairy cows were collected in 2008 at the experimental Pin-Au-Haras INRA farm. The cows were a part of a QTL (Quantitative Trait Loci) detection

experiment, and they arose from a cross over two generations (F2) between Normande and Holstein breeds that display numerous differences in particular for milk fat and protein contents.

Milk samples were collected twice, in winter and in summer to take into account the possible effect of feed. Cows were in an average stage of lactation of 160 days (77-235) in winter, and 209 days (126-284) in summer. Each time and for each cow, two milk samples were realized during the morning milking. One was analyzed freshly using MIR spectrometry, the other was frozen at -20°C and analyzed using gas chromatography. Finally, on 154 samples, 150 milks were kept in the study due to missing data.

Secondly, 153 milk samples from 54 Montbéliarde and 42 Prim'Holstein were collected in 2009 at the experimental Mi-recourt INRA farm. Depending on calving date, the cows belong either to a grazing system or to a mixed crop dairy system. Milk samples were collected using the same protocol as above, but only a part of the cows were present at both sampling. On 153 samples, 100 milks were analysed by gas chromatography.

### 1.1.2 Goat milk samples

705 milk samples from 235 Alpine dairy goats were collected in 2008 at the INRA experimental farm of Bourges at three stages of lactation (about 40, 150 and 240 days). The goats' diet was almost similar throughout lactation and was based on grass hay offered *ad libitum* and a commercial concentrate mixture. These samples were collected in tubes containing a preservative (Bronopol).

For each goat, one sample was analysed by MIR spectrometry, and one other was frozen at -20°C. Among them, 149 samples (about 50 per stage of lactation) with a large variability of spectra were selected to be analysed for milk fatty acid composition by the referenced method.

### 1.1.3 Ewe milk samples

A first sampling was carried out twice in 2008 in the experimental La Fage INRA farm: milk samples were collected from Lacaune dairy ewes, respectively on March 2008 at 80 days in milk (DIM) for 490 ewes in winter diet (hay, silage and concentrates), and on May 2008 at 152 DIM on average for 493 ewes in spring diet including pastures. At each sampling carried out at the morning milking, 2 milk samples were collected, the first fresh one to be analyzed without delay to provide MIR spectra and the second one to be frozen at -20°C for a possible reference gas chromatography carried out later.

Accounting for somatic cell count, fat content and milk spectra, 75 milk samples were chosen within each sampling period, i.e. a total of 150 frozen milk samples to be analyzed by gas chromatography.

A second sampling, using the same design described above, was performed in 2009 in 3 private flocks, the first one composed of Basco-Bearnaise (BB) ewes, and the two others of Manech red faced (MRF) ewes: a total of 103 milk samples, respectively 35 from BB ewes and 78 from MRF ewes, were collected by the end of April 2009 at 120 DIM on average in pasture diet condition. Accounting for fat content, milk spectra and breed, 50 milk samples were chosen to be analyzed by gas chromatography (respectively 20 and 30 for BB and MRF breed).

Finally 200 milks from Lacaune ewes (150 samplings) or from BB or MRF ewes (50 samplings) with both milk spectra and gas chromatography results were included in the present analysis carried out in dairy sheep.

## 1.2 MIR spectra

After a transport at 4°C to the laboratory (LILANO of St Lo, LILCO of Surgères and LIAL of Aurillac), fresh milk samples were analyzed for milk spectra extraction using MIR spectrometry with defined routine FT-MIR analyzers (Milkoscan FT6000, Foss and Bentley FTS). Spectra have been recorded from 5012 to 926 cm<sup>-1</sup>. According to Foss (1998), only informative wave length bands, i.e. bands not spoiled by water molecule, were kept (representing a total of 446 wavelengths). No pre-treatments were applied as suggested by Soyeurt *et al.* (2006).

### 1.3 Fatty acid composition

Frozen milk samples were analyzed for milk fatty acid composition using gas chromatography according to ISO standards (Kramer, 1997). Quantities of 64 fatty acids were expressed in g/100mL. Outliers were removed by Grubb's test as indicated in the norm ISO 8196.

### 1.4 Calculation of calibration equations

MIR spectra and milk fatty acid composition of samples presenting a large variability in their composition were retained to calculate the equations. For cow and ewe milk, the samples were divided into calibration and validation sets (cow milk:  $n_{\text{calibration}}=175$  and  $n_{\text{validation}}=75$ , ewe milk:  $n_{\text{calibration}}=140$  and  $n_{\text{validation}}=60$ ).

The equations were developed by univariate and multivariate PLS regression (Tennehaus, 2002), data being centered but not reduced according to Bertrand *et al.* (2006). For each equation, optimal number of latent variables was chosen according to root mean square error of cross-validation ( $RMSEP_{cv}$ ). To improve equations and quality of estimation, a selection of wavelengths by genetic algorithm was performed before PLS regression in cow and goat milk (Ferrand, 2010). The genetic algorithm used is the algorithm developed by Leardi (1998) which is specific to wavelengths selection. Mutation rate, initial population, and number of variables selected in the solution of initial population were fixed to 1%, 30 and 5 respectively.

GA were performed with MATLAB 7.8 and PLS regressions were performed with the package PLS in R 2.8.1.

To compare and assess the equations, several statistical parameters were computed: mean, standard deviation (Sd), standard error of validation ( $SE_{\text{validation}}$ ), validation coefficient of determination ( $R^2_{\text{validation}}$ ) and the relative error ( $SE_{\text{validation}}/\text{Mean}$ ).

$$SE_{\text{validation}} \text{ is defined as } \sqrt{\frac{\sum_{i=1}^N (\hat{y}_i - y_i)^2}{N - k - 1}}$$

with N the number of samples and k the number of latent variables introduced in PLS regression.

We considered that estimation was accurate enough and robust to be applied in routine, when the relative error was under 8%. For relative error in the range of 8 to 12 %, we advise to using the equations with caution. We chose to use this parameter rather than the  $R^2_{\text{validation}}$  because this latter depends on the standard deviation of our population.

## 2.0 Results and discussion

The calibrations were validated through the accuracy values obtained by validation on a new dataset in cow and ewe milk and by cross-validation in goat milk (Table 1 to 3). About 10 to 20 fatty acids (depending on the species) of 60 have a relative error below 10%. The estimations are better for the FA present in medium or high concentration, i.e. for the saturated fatty acid (C4:0 to C16:0) and for some monounsaturated fatty acids (cis or trans isomers of C18:1). It is worth noting that in the three species, the relative error for the stearic fatty acid (C18:0) is important

The results are comparable in ewe and cow milk. The estimation of lauric acid (C12) is however better in ewe milk. The accuracy is lower in goat milk. This is certainly linked to the lower level of fat in goat milk. But even for the caprylic (C8:0), capric (C10:0), and lauric fatty (C12:0) acids, whose the contents are more important than in ewe and cow milk, the relative error is important (R.E. >12%). New samples in goat milk are intended in the next weeks to improve the accuracy.

Table 1. Statistical parameters for cow milk validation set (PLS regression only or genetic algorithm (GA) + PLS regression).

	N	Mean	Sd	Relative error (%)	R <sup>2</sup>
Fat content	70	3.816	0.637	0.32	1.00
C4:0	72	0.149	0.025	5.71	0.88
C6:0	70	0.087	0.015	3.97	0.95
C8:0	70	0.050	0.010	5.00	0.94
C10:0	71	0.111	0.029	6.92	0.93
C12:0	71	0.126	0.037	11.12	0.86
C14:0	72	0.435	0.088	6.10	0.91
C16:0	71	1.271	0.282	6.41	0.92
C18:0	71	0.342	0.099	12.58	0.81
Total 18:1	69	0.780	0.203	6.70	0.93
Saturated	72	2.766	0.510	2.09	0.99
Monounsaturated	69	0.889	0.220	5.80	0.95
Polyunsaturated	69	0.107	0.019	8.06	0.80
Omega 3	70	0.029	0.010	16.24	0.77
Omega 6	70	0.075	0.016	11.23	0.72

Table 2. Statistical parameters for ewe milk validation set (PLS regression).

	N	Mean	Sd	Relative error (%)	R <sup>2</sup>
Fat content	54	6.802	1.398	0.40	1.00
C4:0	52	0.233	0.035	5.88	0.85
C6:0	54	0.177	0.033	4.21	0.95
C8:0	54	0.175	0.037	4.83	0.95
C10:0	54	0.574	0.147	5.90	0.95
C12:0	54	0.339	0.103	8.57	0.92
C14:0	54	0.821	0.214	6.98	0.93
C16:0	54	1.650	0.345	6.70	0.90
C18:0	55	0.511	0.143	12.62	0.80
Total 18:1	54	1.276	0.414	4.40	0.98
Saturated	54	4.825	0.994	2.31	0.99
Monounsaturated	54	1.389	0.443	3.83	0.99
Polyunsaturated	55	0.238	0.075	7.03	0.95
Omega 3	52	0.069	0.016	13.65	0.66
Omega 6	55	0.137	0.036	12.13	0.79

Table 3. Statistical parameters for goat milk, cross-validation results (PLS regression only or genetic algorithm (GA) + PLS regression).

	N	Mean	Sd	Relative error (%)	R <sup>2</sup>
Fat content	150	3.310	0.666	0.48	1.00
C4:0	150	0.092	0.025	9.23	0.87
C6:0	150	0.078	0.020	8.97	0.87
C8:0	150	0.080	0.022	12.36	0.78
C10:0	150	0.264	0.071	12.48	0.77
C12:0	150	0.134	0.041	13.36	0.79
C14:0	150	0.307	0.077	9.17	0.85
C16:0	150	0.996	0.197	5.14	0.93
C18:0	150	0.282	0.099	18.14	0.73
Total 18:1	150	0.756	0.176	8.84	0.85
Saturated	150	2.351	0.485	3.55	0.97
Monounsaturated	150	0.798	0.184	8.92	0.84
Polyunsaturated	150	0.128	0.028	12.47	0.65
Omega 3	150	0.018	0.005	19.58	0.44
Omega 6	150	0.109	0.027	13.71	0.65

### 3.0 Conclusion

These first results show it is possible to obtain accurate estimations for the main fatty acids in individual milk samples of the three species. It was observed that performing a selection of variables prior to the PLS regression permitted to improve accuracy and stabilize equations over the time.

Future researches will focus on other spectrum data pre-treatment procedures, while increasing simultaneously the initial sampling size to get more accurate estimation equations of milk fatty profile.

The advancements of the *PhenoFinLait* program are available on <http://www.phenofinlait.fr/>.

### 4.0 References

- Bertrand D. and Dufour E., 2006. La spectrométrie infrarouge et ses applications analytiques, Second ed., Tec&Doc Lavoisier, Paris.
- Foss, 1998. Reference Manual of Milkoscan FT120 (Type 71200), Denmark.
- Kramer J.K.G., Fellner V., Dugan M.E.R., Sauer F.D., Mossoba M. M., Yurawecz M. P., 1997. Evaluating acid and base catalysts in the methylation of milk and rumen fatty acids with special emphasis on conjugated dienes and total trans fatty acids. *Lipids* 32, 1219-1228.
- Ferrand M., Huquet B., Barbey S., Barillet F., Fauchon F., Larroque H., Leray O., Trommschlag J.M. and Brochard M., 2010. Determination of fatty acid profile in cow's milk using mid-infrared spectrometry: Interest of applying a variable selection by genetic algorithms before a PLS regression. *Chemometrics and Intelligent Laboratory Systems*, Article in Press.
- Leardi R. and Lupiañez G., 2002. Genetic algorithms applied to feature selection in PLS regression: how and when to use them. *Anal.Chim. Acta.* 461, 189-200.
- Soyeurt H., Dardenne P, Dehareng F., Lognay G., Veselko G., Marlier M., Bertozzi C., Mayeres P., Gengler N., 2006. Estimating Fatty Acid Content in Cow Milk Using Mid-Infrared Spectrometry. *J. Dairy Sci.* 89, 3690-3695.
- Tenenhaus M., 2002. La regression PLS, Technip, Lassay-les\_Chateaux.







## New parameters and analytical challenges for milk recording by Fourier-Transform Mid-Infrared Spectrometry (FTMIR)

H. Soyeurt<sup>1,2</sup>

<sup>1</sup>*Animal Science Unit, Gembloux Agro-Bio Tech, University of Liege, Passage des Deportés 2, B-5030 Gembloux, Belgium*

<sup>2</sup>*National Fund for Scientific Research, Rue d'Egmont 5, B-1000 Brussels, Belgium*

### **Abstract**

The increasing consumer concern over the relationship between food and human health requires to consider the analysis of new characteristics of milk composition. Due to the large number of analyzed samples, the technology used by the milk recording organizations must be fast and cheap. For these reasons, the Fourier Transform mid-infrared spectrometry (FTMIR) is largely used to quantify major milk components. The recent literature reveals that FTMIR is currently under-used in practice.

Currently, only fat and protein contents are routinely quantified by FTMIR and sometimes the concentrations of urea, lactose, and casein. Recent studies showed the potentiality of FTMIR to quantify new milk components or to predict indicators related to specific milk properties. With the condition of good analytical practices during the calibration and the use of these new equations, some of them can be implemented in milk labs. These FTMIR predictions can be executed internally in the spectrometer software or externally based on recorded spectral data.

Moreover, the FTMIR predictions can be used for additional valorisations by combining information recorded by milk recording structures and the FTMIR predictions. For instance, by using models to explain the observed variability of the studied traits, it is possible to extend the number of possible valorisations such as useful tools for herd management and breeding purposes.

Consequently, FTMIR becomes a powerful technology to quantify milk components and/or to permit a screening of the dairy cattle population based on different milk characteristics interesting for different purposes: nutritional quality (e.g. fatty acid, minerals), hygienic quality (e.g. antibiotics, somatic cells), technological quality (e.g. cheese-making), environment (e.g. methane), herd management (e.g. urea), animal health (e.g. lactoferrin, acetone), and biodiversity. The large number of FTMIR predictions will involve the development of methodologies to resume the most interesting information for the development of specific dairy products and to help farmers in their daily decisions. FTMIR still has a bright future.

*Keywords: Mid-infrared, milk, FTMIR spectrometry, selection tools.*

### **1. Introduction**

The consumer is more and more conscious that the diversity, the quantity, as well as the quality of the ingested foods influence his health. This situation is reinforced by the attitude of many dieticians and nutritionists who recommend to their patients to limit drastically their consumption of dairy products due to notably the large amount of saturated fatty acids present in bovine milk fat (70% on average). It involves a truncated view in the interest of dairy products. Therefore, to promote the healthiness of dairy products, the dairy sector should take into account the detailed milk composition. Consequently, milk labs and also milk recording organizations should think about the analysis of new characteristics of milk composition showing a potential economic interest.

Traditionally, the assessment of a detailed milk composition is expensive because it requires a lot of different chemical steps and analyses such as the separation of studied constituents from the milk matrix, the use of gas chromatography or other analyses... Moreover, all of these analyses require a lot of time, skilled staff, and use often polluting products. For many years, FTMIR spectrometry has been used to quantify the major components of milk such as fat and protein contents used for the milk payment. Thanks to its fast and non-destructive advantages, this technology could be a good alternative to the traditional chemical analysis.

## 2. FT-MIR Spectrometry

There are 3 different infrared regions (near, medium, and far infrared) with their own specificities. The analysis of milk can be realised by using near or mid-infrared. The mid-infrared has a high sensitivity to the chemical environment due to the fundamental absorptions of molecular vibrations (Belton, 1997). Mid-infrared spectrum represents the absorptions of mid-infrared ray at frequencies correlated to the vibrations of specific chemical bonds (Figure 1). Therefore, the mid-infrared spectrum reflects the global chemical composition. The near infrared gives a much more complex structural information related to the vibration behaviour of combination bonds (Cen and He, 2007). In this review, it was decided to discuss about the potentialities of FT-MIR spectrometry for milk analysis because this technology is largely used by milk labs all around the world to quantify major milk components used for the milk payment or by the milk recording organizations to develop management and selection tools to help farmers in their daily decisions.

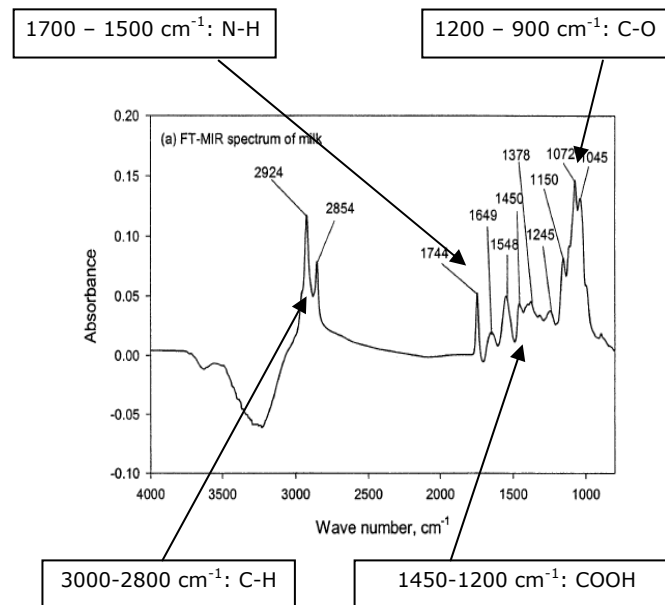

Figure 1. MIR spectrum of milk (Sivakesava and Irudayaraj, 2002).

FTMIR spectrometry is not only routinely used to quantify the contents of fat and protein in milk, but also the contents of urea, lactose, casein, and free fatty acids. Nevertheless, the recent literature reveals that FTMIR is currently under-used in practice.

## 3. FT-MIR and milk recording

### 3.1 Introduction

The main objective of milk recording organizations is to develop management and selection tools useful for the dairy sector including dairy farmers and dairy industry in the current economic context. Two ways are possible to achieve this aim: first, a direct use of the FTMIR predictions of specific milk components and second, the milk recording organization can put together all available information (FTMIR predictions but also animal, lactation, and environmental information) necessary to take into account the natural variation of the considered traits in order to extend the number of potential valorisations.

### 3.2 Direct use of FTMIR data

The principle to obtain milk FTMIR predictions is resumed in Figure 2. The collected samples are analyzed by FTMIR spectrometry and raw data (commonly named spectral data) are generated. The number of datapoints depends on manufacturers. Finally, a specific equation is applied to the spectral data to

provide the measurement of the studied trait (e.g., fat, protein...). Therefore, if you want to analyze new components in milk, you need to develop new equations.

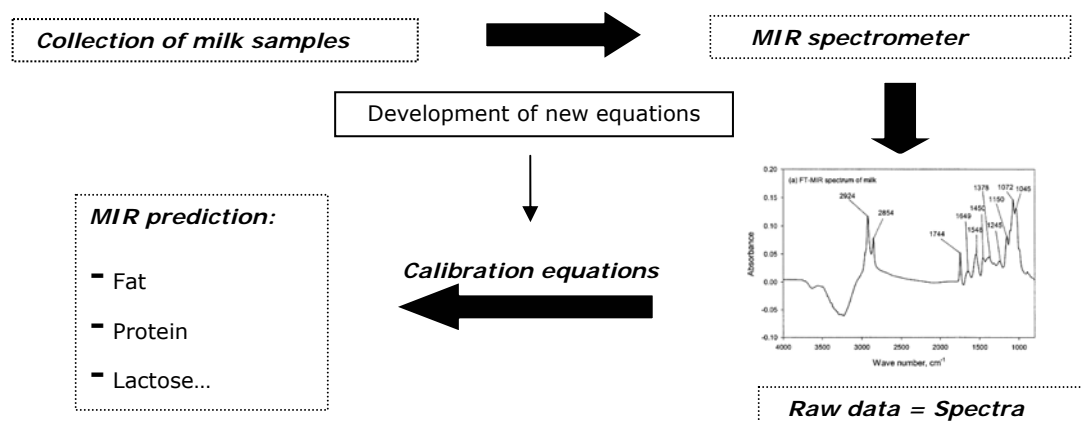

Figure 2. Principle of FTMIR prediction of milk components

Several authors have realized different research studies to extend the number of milk constituents predictable by FTMIR, which showed an interest in different fields such as the nutritional quality (e.g., fatty acid, minerals, lactoferrin), hygienic quality (e.g., antibiotics, somatic cells), technological quality (e.g., cheese-making properties of milk (e.g., casein, titratable acidity, coagulation time...), environment (e.g. urea, fatty acids, methane emissions through fatty acid predictions (Chilliard *et al.*, 2009), herd management (e.g., urea, fat, protein, lactose), animal health (e.g., fatty acids, minerals, lactoferrin,  $\beta$ -hydroxybutyrate, acetone), and biodiversity (e.g., by studying the changes in milk composition). This review presents some examples potentially interesting for milk recording organizations.

Recently, several authors showed the potentiality of FTMIR spectrometry to quantify the fatty acid contents directly on bovine milk (Rutten *et al.*, 2009; Soyeurt *et al.*, 2006, 2008a, 2008b, and 2010). The prediction of fatty acid in milk (g/dl of milk) is more accurate if the content of considered fatty acid is high in milk. The FTMIR prediction of fatty acid in fat is less accurate because the variability of fatty acids in milk fat is lower than the one observed in milk. Table 1 describes the results obtained by Soyeurt *et al.* (2010) from a multiple breeds, multiple countries, and multiple production systems approach for major groups of fatty acids in bovine milk. RPD calculated, as the ratio of the standard deviation of reference value to the standard error of cross-validation, is a parameter assessing the robustness of a calibration equation. If this ratio for a considered equation is greater than 2, it involves a potential use of this equation for breeding and animal purposes. Therefore, all fatty acids shown in Table 1 could be used in practise to assess the nutritional quality of bovine milk fat.

Table 1. Descriptive statistics of the calibration equations for the quantification fatty acids in milk developed by Soyeurt *et al.* (2010).

Constituent (g/dl of milk)	N	Mean	SD	RPD	SECV
Saturated FA	496	2.40	0.80	15.7	0.0513
Monounsaturated FA	491	1.06	0.37	8.9	0.0411
Polyunsaturated FA	499	0.16	0.05	2.6	0.0204
Unsaturated FA	492	1.22	0.41	9.6	0.0428
Short chain FA	486	0.31	0.11	6.7	0.0165
Medium chain FA	496	1.78	0.60	6.5	0.0928
Long chain FA	495	1.52	0.57	6.5	0.0875

Based on Soyeurt *et al.* (2009), other traits potentially predictable by FTMIR spectrometry are the calcium, sodium, and phosphorus contents in milk as shown in Table 2. Even if this publication considered a low number of samples, the results for Ca and P were recently confirmed by using 100 additional milk samples (data not shown).

Table 2. Descriptive statistics of the calibration equations measuring minerals in milk developed by Soyeurt *et al.* (2009).

Mg/l of milk	N	Mean	SD	SECV	RPD
Ca 87		1333	260	95	2.74
K	61	,336	168	136	1.24
Mg	61	110	18	11	1.68
Na	87	403	107	64	1.68
P	87	1093	127	50	2.54

Interesting traits for milk recording organizations to check animal health status are ketone bodies. Hansen (1999) and Heuer *et al.* (2001) developed the first calibration equations to quantify acetone content in bovine milk. More recently, De Ross *et al.* (2007) has also developed with a relatively good success calibration equations for acetone and  $\beta$ -hydroxybutyrate in milk (Table 3).

Table 3. Descriptive statistics of the calibration equations for ketone bodies in milk developed by De Ross *et al.* (2007).

mMol	N	Mean	SECV	R <sup>2</sup> c
Acetone 1063		0.146	0.184	0.72
$\beta$ -hydroxybutyrate 1069		0.078	0.065	0.62

The improvement of milk nutritional quality is desired. However, it is necessary to know if these changes are positively related to the technological properties of milk. In this context, several authors have developed calibration equations permitting to assess the cheese-making properties of milk through the quantification of specific traits such as titrable acidity, rennet coagulation time... Based on these results (Table 4), it appears that the cheese-making properties of milk could be assessed by relatively good FTMIR predictions of titrable acidity and rennet coagulation time.

Table 4. Descriptive statistics of the calibration equations for traits related to cheese-making properties of milk.

		N	Mean	SD	R <sup>2</sup> cv	SECV
Titrable acidity (SH°/50ml)	De Marchi <i>et al.</i> , 2009	1063	3.26 0.	43 0.	66 0.	25
Rennet coagulation time (min)	De Marchi <i>et al.</i> , 2009	1049	14.96 3.	84 0.	62 2.	36
	Dal Zotto <i>et al.</i> , 2008	74	15.05 3.	78 0.	73 0.	80
pH	De Marchi <i>et al.</i> , 2009	1064	6.69	0.12	0.59	0.07
Titrable acidity (D°)	Colinet <i>et al.</i> , 2010	203	16.22 2.	01 0.	90 0.	64
Curd firmness (mm)	Dal Zotto <i>et al.</i> , 2008	74	32.43	7.95	0.45	5.49

Another interesting trait is a glycoprotein present naturally in milk and entitled lactoferrin because this molecule is involved in the immune system. Soyeurt *et al.* in 2007 developed a preliminary calibration equation for the measurement this milk component. This first equation was built with 57 reference samples and the obtained RPD was equal to 2.39 with a SECV equal to 86 mg/l of milk.

### 3.3 Models based on FTMIR data

The milk recording organizations have an access to the animal, lactation and environmental data (pedigree, lactation stage, breed, number of lactation...). Merging these data with the FTMIR prediction permits to investigate the potential for using specific models that take into account the natural variability of these FTMIR values and therefore to extend the number of possible valorisations. To illustrate this application, two examples are presented.

Bastin *et al.* (2009) showed the possibility to model the level of milk urea in a specific herd by using a random regression test-day model. From the results given by the model, it is possible to estimate an expected value of milk urea content in a specific herd at specific test date. Based on that, it is possible to compare the expected value obtained by the model to the observed one. If the difference is too big, it can be assumed that the studied herd has a management problem (Figure 3).

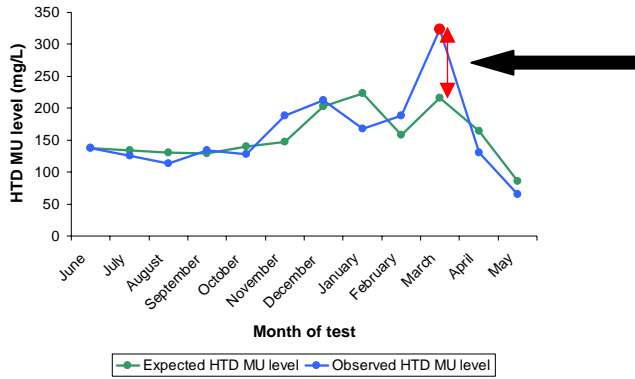

Figure 3. Evolution of observed and expected urea content (MU) in a specific herd (Bastin *et al.*, 2009)

Another very interesting application for milk recording organizations (because the structures have individual values for cows) could be to model the contents of a specific FT MIR prediction in order to give to the farmers sufficient information to discard the less interesting cows and/or to develop an animal selection programs.

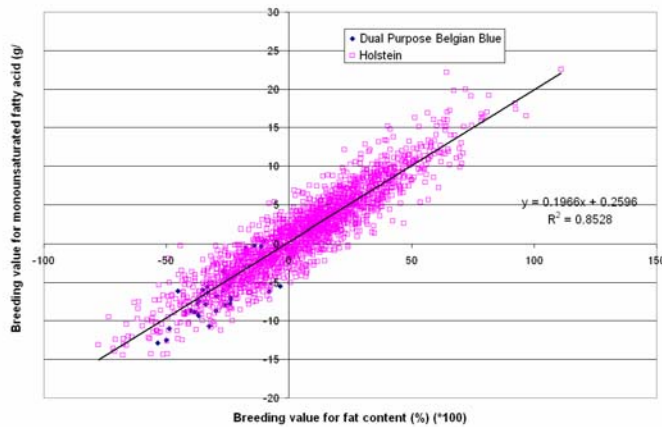

Figure 4. Relationship between the estimated breeding value for monounsaturated fatty acid in milk and the estimated breeding value for fat content.

One interest of an animal selection program is to have information for foreign bulls based on data collected from their daughters present in a country where the FT MIR analysis of a specific trait is done. For instance, through the European project RobustMilk ([www.robustmilk.eu](http://www.robustmilk.eu)), the tools needed to implement an animal selection programs for fatty acid contents in bovine milk are developed. The contents of fatty acids in milk are heritable. The lactation heritabilities for saturated and monounsaturated FA were 44% and 22%, respectively. The first results were obtained from data collected from first parity cows. Figure 4 shows the results of the genetic evaluation for 1,993 bulls with a sufficient number of Walloon daughters with known fatty acid data. High variability of breeding values (parameters estimated to assess the individual variability of studied animals) for monounsaturated fatty acid content was observed for a considered estimated breeding value of fat content (Figure 4). Consequently, a sufficient variability of fatty acid traits exists to investigate the development of an animal selection based on the improvement of the nutritional quality of milk.

This kind of researches can be extended to all FT MIR predictions.

## 4. Conclusion

In conclusion, the FT MIR spectrometry is currently under-used in practice even if new traits predictable by MIR exist. A lot of work should be done by the milk recording organizations to include these new traits showing a potential economic interest in their services given to their members. Two ways will be possible to achieve this objective: a direct use of FT MIR predictions given by milk labs and/or the developments of specific models taking into account the natural variability of the studied infrared traits in order to develop specific valorisations for dairy sector including farmers, dairy companies, breeding associations...

However, this introduction of new traits in the routine milk recording will involve new challenges. The first challenge will be an analytical challenge. To avoid high bias, the FT MIR equation should be validated on the considered cow population. Indeed, breed differences or differences in the milk samples (e.g., the composition of bulk milk is less variable than the composition of milk samples collected from individual cows) used to develop the calibration equation could involve a bias. Moreover, it is currently possible to implement externally new equations thanks to the recording of spectral data. However, to use this approach successfully, it will be needed that the variability of the spectral data used for the prediction by the milk recording organization was taken into account in the calibration set used to build the used FT MIR equation. Finally, the accuracy of the FT MIR prediction should be tested regularly by the use of reference samples to correct if needed the bias and the slope of the calibration equation. Since January 2008, FT MIR fatty acid predictions is implemented in the Walloon milk lab (Battice, Belgium) and a maintenance is realized using milk samples with known contents of fatty acid (these samples are produced by Walloon Agricultural Research Centre – Valorisation of Agricultural Products Department (Gembloux, Belgium).

The second challenge will be a computational challenge. The number of studied traits by milk recording organizations will increase. Consequently, it will be necessary to study some traits simultaneously because some of them (the majority of them) will be correlated. It will be also important to know the natural variability of the studied FT MIR trait for a specific cow because the optimum of content for a studied trait can be different according to the considered aim. For instance, high lactoferrin content in milk is interesting for human health but sick cows can also produce milk samples with high content of lactoferrin. This kind of applications will require the use of multiple traits models, which need high computational cost.

In conclusion, a lot of work to do to improve the services given to the dairy farmers thanks to the extension of FT MIR possibilities.

## 5. Acknowledgements

Hélène Soyeurt, post-doctoral researcher at the National Fund for Scientific Research (Brussels, Belgium), acknowledges the financial support provided by the National Fund for Scientific Research for her position and for the additional grants 2.4507.02F (2) and F.4552.05 (2.4.623.08.F). Some of the results shown in this review were obtained through the financial support from the European Commission, Directorate-General for Agriculture and Rural Development, under Grant Agreement 211708 and from the Commission of the European Communities, FP7, KBBE-2007-1. This paper does not necessarily reflect the view of these institutions and in no way anticipates the Commission's future policy in this area. Moreover, the Ministry of Agriculture of the Walloon Region of Belgium [Service Public de Wallonie, Direction Générale Opérationnelle de l'Agriculture, des Ressources Naturelles et de l'Environnement, Direction de la Recherche] is also acknowledged for their financial support allocated to obtain some of the results shown in this paper through the projects D31-1207 and D31-1224/S1.

## 6. References

- Bastin, C., L. Laloux, A. Gillon, F. Miglior, H. Soyeurt, H. Hammami, C. Bertozzi, and N. Gengler. 2009. Modeling milk urea of Walloon dairy cows in management perspectives. *J. Dairy Sci.* 92:3529-3540.
- Belton, P. S. 1997. Spectroscopic approaches to the measurement of food quality. *Pure Appl. Chem.* 69(1):47-50.
- Cen, H., and Y. He. 2007. Theory and application of near infrared spectroscopy in determination of food quality. *Trends Food Sci. Technol.* 18(2):72-83.
- Chilliard, Y., C. Martin, J. Rouel, and M. Doreau. 2009. Milk fatty acids in dairy cows fed whole crude linseed, extruded linseed, or linseed oil, and their relationship with methane output. *J. Dairy Sci.* 92:5199-5211.

- Colinet, F.G., H. Soyeurt, C. Anceau, A. Vanlierde, N. Keyen, P. Dardenne, N. Gengler, and M. Sinding. 2010. Potential estimation of titratable acidity in cow milk using mid-infrared spectrometry. Proc. 37<sup>th</sup> ICAR annual meeting, 31 May – 4 June 2010, Riga, Latvia.
- Dal Zotto, R., M. De Marchi, A. Cecchinato, M. Penasa, M. Cassandro, P. Carnier, L. Gallo, and G. Bittante. 2008. Reproducibility and repeatability of measures of milk coagulation properties and predictive ability of mid-infrared reflectance spectroscopy. *J. Dairy Sci.* 91:4103-4112.
- De Marchi, M., C.C. Fagan, C.P. O'Donnell, A. Cecchinato, R. Dal Zotto, M. Cassandro, M. Penasa and G. Bittante. 2009. Prediction of coagulation properties, titratable acidity, and pH of bovine milk using mid-infrared spectroscopy. *J. Dairy Sci.* 92: 423-432.
- Hansen, P.W. 1999. Screening of dairy cows for ketosis by use of infrared spectroscopy and multivariate calibration. *J. Dairy Sci.* 82:2005-2010.
- Heuer, C., H.J. Luinge, E.T.G. Lutz, Y.H. Schukken, J.H. van der Maas, H. Wilmink, and J. P.T.M. Noordhuizen. 2001. Determination of acetone in cow milk by Fourier transform infrared spectroscopy for the detection of subclinical ketosis. *J. Dairy Sci.* 84:575-582.
- de Roos, A.P.W., H.J.C.M. van den Bijsgaart, J. Horlyk, and G. De Jong. 2007. Screening for subclinical ketosis in dairy cattle by Fourier transform infrared spectrometry. *J. Dairy Sci.* 90:1761-1766.
- Rutten, M.J.M., H. Bovenhuis, K.A. Hettinga, H.J.F. van Valenberg, and J.A.M. van Arendonk. 2009. Predicting bovine milk fat composition using infrared spectroscopy based on milk samples collected in winter and summer. *J. Dairy Sci.* 92:6202-6209.
- Sivakesava, S., and J. Irudayaraj. 2002. Rapid determination of tetracycline in milk by FT-MIR and FT-NIR spectroscopy. *J. Dairy Sci.* 85(3):487-493.
- Soyeurt, H., P. Dardenne, F. Dehareng, G. Lognay, D. Veselko, M. Marlier, C. Bertozzi, P. Mayeres, and N. Gengler. 2006. Estimating fatty acid content in cow milk using mid-infrared spectrometry. *J. Dairy Sci.* 89(9):3690-3695.
- Soyeurt, H., F.G. Colinet, V.M.-R. Arnould, P. Dardenne, C. Bertozzi, R. Renaville, D. Portetelle, and N. Gengler. 2007. Genetic variability of lactoferrin content estimated by mid-infrared spectrometry in bovine milk. *J. Dairy Sci.* 90(9):4443-4450.
- Soyeurt, H., F. Dehareng, P. Mayeres, C. Bertozzi, and N. Gengler. 2008a. Variation of delta9-desaturase activity in dairy cattle. *J. Dairy Sci.* 91:3211-3224.
- Soyeurt, H., P. Dardenne, F. Dehareng, C. Bastin, and N. Gengler. 2008b. Genetic parameters of saturated and monounsaturated fatty acid content and the ratio of saturated to unsaturated fatty acids in bovine milk. *J. Dairy Sci.* 91:3611-3626.
- Soyeurt, H., D. Bruwier, J.-M. Rommée, N. Gengler, C. Bertozzi, D. Veselko, and P. Dardenne. 2009. Potential estimation of major mineral contents in cow milk using mid-infrared spectrometry. *J. Dairy Sci.* 92:2444-2454.
- Soyeurt, H., F. Dehareng, N. Gengler, S. McParland, E. Wall, D.P. Berry, M. Coffey, and P. Dardenne. 2010. *J. Dairy Sci.* Submitted.





## Herd Navigator or “How to benefit from frequent measurements”

T. Asmussen

FOSS A/S, Hillerød, Denmark

### **Abstract**

With Herd Navigator frequent measurements ensures close monitoring of the herd to allow proactive action on a number of parameters such as reproduction parameters, mastitis, ketosis and urea.

It is evident that alerts informing the herd manager about need for insemination or other immediate actions are of big value, - however it is also important to take advantage of the frequent measurements for more proactive activities on group or herd level.

This presentation will give examples on such possibilities.

*Keywords: herd monitoring, milk, analysis, health, reproduction, mastitis, ketosis.*

## 1.0 Introduction to Herd Navigator

The solution works by taking a representative milk sample of individual cows during milking. The milk is taken at the milk samplers connected at each individual milking point or milking robot.

### Herd Navigator systematic procedure

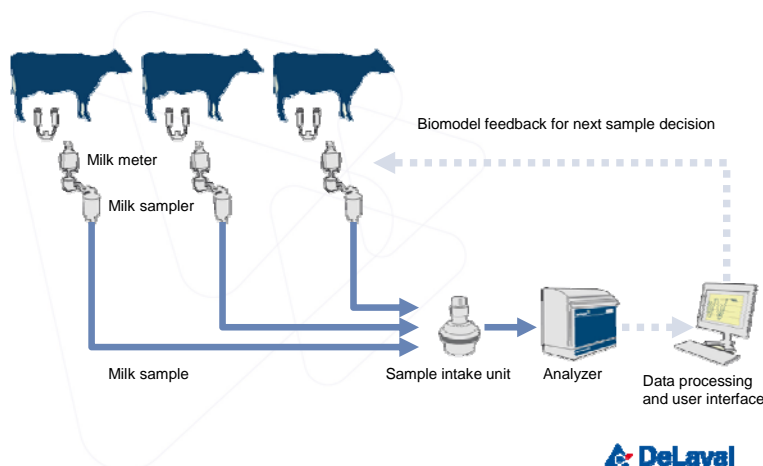

When the cow is being milked the sampler delivers its milk to the sample intake unit (SI) located at the end of the milking pit. This device holds the samples and sends them one by one to the Analyzer Instrument (AI) located in the milk room.

The Analyser Unit is temperature and humidity constant and uses dry stick technology to perform the analysis. Each parameter has its own stick and those are stored in cartridges inside the AI. The parameters measured are:

Focus area	Parameter analyzed in milk	Early/on time detection
Reproduction	Progesterone	Heat Silent heat Pregnancy Abortion Cysts Anoestrus
Udder health	LDH – lactate dehydrogenase	Mastitis Subclinical mastitis
Feeding and energy balance	Urea BHB – beta hydroxybutyrate	Feed ration – protein Ketosis Subclinical ketosis Secondary metabolic disorders

The technique used for LDH, urea and BHB is colorimetric and for progesterone it is lateral flow assay.

The values are captured by the biological model which calculates the risk of any of the above diseases or physiological statuses and at the same time decides when each parameter will be measured again next time for the cow in question.

The complete system gets cleaned automatically together with the milking machine equipment.

## 2.0 How to maximize the benefit of frequent measurements

Herd Navigator impacts on the most important factors on milk production, reproduction, mastitis and feeding. All information from Herd Navigator can, one way or the other, be combined with information already present in the on farm cattle database and the central cattle database.

Herd Navigator detects consistently above 95% of all heats of the herd (including silent ones) and is able to pinpoint the time of the heat, the likelihood of success of a prospective insemination as well as the system is able to detect post partum anoestrus, pregnancy and both types of ovarian cysts. This has resulted in a significant reduction on open days at most farms running a Herd Navigator.

Herd Navigator is able to detect clinical and sub-clinical mastitis up to 3 to 4 days before clinical signs are shown in the animals affected. The sensitivity of the system reaches more than 80%.

Herd Navigator is able to detect all cases of clinical and subclinical ketosis, and normally it detects 50% more ketotic cows than do the farmers/herd manager.

For an average European herd the data shows that Herd Navigator can bring profit improvement potentials for farmers from 250 to 350 € per cow per year.

Benefiting to this extent from running Herd Navigator requires optimum use of results from the Herd Navigator. Herd Navigator both provides new information and more frequent information than most dairy farmers have been used to previously. All this information is combined with the already existing information in the farms herd management system, - but to benefit further from all the acquired information a more advanced tool is under development.

In the following a few examples will be presented.

### 2.1 Ketosis

The level of BHB in milk is monitored from calving until 60 days after calving.

The incidence of ketosis varies significantly from herd to herd and from one period to another.

In general we have seen that the frequency is significantly higher than registered by the herd manager before Herd Navigator is introduced. Though all present Herd Navigator users have doubts about the correctness of the alerts issued there are big differences in the way they act upon the alerts and thereby on the effect on performance in the herd.

By monitoring the lactation cumulated lactation curve of all cows having a ketosis alert in different herds it is clearly seen that the yield loss in some herds are almost avoided whereas it is very big over the entire lactation in other herds.

## 2.2 Reproduction

The progesterone level is monitored frequently from 15 days after calving until 60 days after the last heat. At this stage the cow is considered pregnant, and the risk of abortion limited.

This allows monitoring for prolonged anoestrus, heat, follicular and luteal cysts, pregnancy, early foetus loss (day 24-35) and abortion (>day 35).

On average this has allowed the HN test farms to reduce number of empty days by 22 days, - though reduction in number of empty days has not been main targets in all herds.

However an additional benefit of the Herd Navigator, besides informing about when to inseminate which cow, is to display why cows are not getting pregnant.

Is it because inseminations are badly timed? Do cows become pregnant, - but suffer from early foetus loss? Or do they abort more than 35 days after insemination.

These questions can be answered by examining the progesterone curves of the cows.

Doing so in different test herds has revealed big differences in the reasons behind reproduction problems. Knowing the reason for a problem can eventually lead to solving the problem by changes in management procedures, feeding or other measures.

## 3.0 Conclusion

Above two examples illustrates that frequent analyses of management parameters give access to further information about the reasons behind potential problems in a herd.

It is important to reveal such information to the herd manager and the information may also be important to other parties.

It can therefore be concluded that:

- It is important to use the new information available to develop new parameters to be monitored in order to optimize the production and economy in the herd.

- It is important to use the new information available to monitor the breeding goals in new ways.



## The Virtual Cow – A World 1<sup>st</sup> from Holstein-UK

L. Andrews, J. Gribbon, H. Richardson & G. Ward

*Holstein-UK, Scotsbridge House, Scots Hill, Rickmansworth, Hertfordshire, United Kingdom*

### **Abstract**

As the farming industry focuses ever closer on health and welfare, it is fitting that Holstein-UK has launched an innovative educational and breeding tool which has the potential to transform understanding of the form, movement and condition of the milking cow.

The Virtual Cow is the first fully interactive, three-dimensional, computer-generated model of the dairy cow, available through a web-based interface. It demonstrates graphically the differences in conformation between animals with various classification scores. Allowing the impact on conformation to be visualised and so helping breeders and students understand what they are looking for in the optimum cow for their system and circumstances.

The model can be viewed from any angle and rotated through 360° on any axis. Each of 18 linear type traits can be viewed individually and is accompanied by a written description of how it is measured. As a slider is moved through each of the trait scores from 1-9, the appropriate section of the cow's anatomy adapts before your eyes, showing the degree and effect that trait has on the animal. The Virtual Cow also illustrates a range of full-animal, three-dimensional body condition scores, and demonstrates locomotion scores from 1 to 9 by video clips of real cows in motion.

For farmers interested in bull selection, it has the added benefit of relating each trait to the linear profile of a bull (commonly expressed as a bar chart), so aiding breeding decisions and overall breed improvement.

When learning about dairy cow conformation, there is no substitute for having a real animal in front of you. But the number of animals that would need to be assembled to illustrate every score for every trait makes this practically impossible. However, with the Virtual Cow, this can be done consistently, reliably and with pin-point accuracy.

*Keywords: Dairy cow, model, three-dimensional, interactive, computer-generated, web-based, linear-type, conformation, locomotion, condition, breeding, education.*

## 1.0 Holstein-UK – 100 years of innovation

Holstein-UK is Europe's largest independent breed society, with around 8000 members and registering over 200,000 animals per year. It acts as the single herd book provider for both Holstein and British Friesian cattle in the United Kingdom, and also provides additional registration services to some eight other, independent UK breed societies, including Ayrshires, British Blue, Brown Swiss, European Angus, English Guernsey, Island Jersey, Montbeliarde and UK Jerseys.

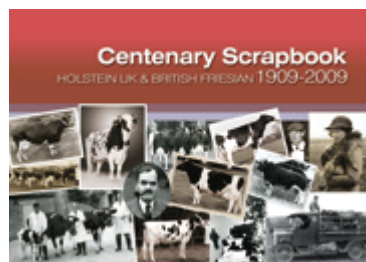

Alongside its herdbook function of registering births and ancestry, the Society aims to promote and improve the breed, helping to increase the value of UK livestock overall, a long with extending herd life and the profitability of its members herds. It is the principle provider of Type classification services in the UK through its Centre for Dairy Information subsidiary business, which also provides database and data access services to most of the societies mentioned, along with full genetic evaluation of both Holstein and Friesian Type results.

In 2009 the Society celebrated the 100<sup>th</sup> anniversary of its foundation with a series of special events, product launches and a hard-backed "scrapbook" of people, scenes and animals from all periods of its history.

## 1.1 Innovative products and services



Throughout its history, the society has supported, researched, and developed new techniques and services for dairy breeders and herd owners. It pioneered the use of telephone registration services for members and more recently, the use of a web-based registration system "WebReg", available to all partner societies. For many years it has supported and encouraged younger members to develop their skills of stock judging, cattle showmanship and husbandry, through its Holstein Young Breeders programme. A section that now has its own dedicated web site at [www.thehyb.co.uk](http://www.thehyb.co.uk), detailing field and social events at both regional and national level, contacts and a series of "how to" guides for all members.



The **Cattle Information Service** provides integrated milk recording, herd health and herd management support to herd owners throughout the UK, whether breed society members or not. In 2008 CIS won the Queen's Award for Enterprise for the continuous development of its web-based service 'Your Herd', which enables dairy farmers to easily access all the vital information to manage their herds more efficiently. This was rapidly followed by the award for 'Top Livestock Supplier of the Year' from the Royal Highland Agricultural Society, based on excellent levels of customer service, satisfaction, value for money and innovation. For clients who register their cattle, the CIS and HUK offer the 'Holstein Complete' service to further reduce the duplication and cost of integrated, multi-organisation data recording, bringing the benefits of the latest technology within reach of every dairy farmer in the simplest way possible.



The **Centre for Dairy Information** maintains a single, integrated database for all registration, production, classification and genetic evaluation data for all its partner breed societies. With a web site devoted to easy access to that data for information ranging from individual animals, bull and cow evaluations, production trends and statistics, health and welfare guides, through to innovative tools to take the hassle out of bull selection and cow mating decisions through its **Bull Selector** and **WebMate** user-friendly decision-aid tools.



As the whole farming industry focuses ever closer on dairy cow health and welfare therefore, it is entirely fitting that Holstein UK has launched a new innovative breeding tool that has the potential to transform understanding of the form, movement and condition of milking cow – the 'Virtual Cow'.

## 2.0 The Virtual Cow development

The Virtual Cow is the first computer-generated, three-dimensional model of a dairy cow. It has been said to be a "fully interactive, adjustable version of the traditional Model Cow - much loved by breed societies and breeders throughout the world". Developed with education firmly in mind, it graphically illustrates the differences in conformation between cows and traits at all the various classification scores.



The impetus to develop a 21<sup>st</sup> century cow model came from several directions. The traditional ceramic or plastic composite cast model, whilst often a collectable object of art in its own right, has several limitations that restrict its usefulness. At its best, it is a static image of the perception of desirable characteristics at a single point in time. The process and expense of creating a new master, casting and reproducing multiple copies has always made it difficult to adapt the ideal model as perceptions and breeding objectives change over time. Furthermore, it has always been a valid question to ask: "Is there only one 'ideal cow'?" Or do different breed societies, or even sections within a society, have different and equally valid views on what constitutes the "ideal"?

Educators, advisors, classifiers, breeders and students have frequently asked for posters and graphical examples of differing classifications scores, particularly since the advent of linear type scoring techniques. Whilst this has frequently been possible, these media have always had the limitation of being two-dimensional views of a three-dimensional real cow. When learning about dairy cow conformation there is

no substitute for having a real animal in front of you, preferably several, that illustrate differing score values. It has been calculated that to assemble a group of cows that might illustrate every possible combination of the 16 core linear trait scores would require over 140 animals! Something that would be practically impossible, particularly in the classroom situation.

The best aspect of the cast model for these purposes was that it can be picked up and rotated, or viewed from any angle, to give a perspective on how the trait looks. The judge can move around the real animal, provided she stays still for long enough, to gain the required view of each body or mammary trait he or she needs to view.

Software applications that can project three-dimensional images of an object onto a computer screen were developed originally in the building and engineering industries, particularly for Computer Aided Design and the like. The originals of these however, required near super-computer levels of processing power to operate them. So were available only to relatively few. As techniques developed the costs were gradually reduced. But it was the explosive growth of the computer gaming market that generated the vast sales that in turn allowed software engineers to turn their attention to models of animals (or even homo sapiens!) that could be viewed in 3-D and more importantly moved. Even then renditions tended to look like either cartoon characters or angular stick-models of the animal concerned. Still not very useful to project the sometimes fine and subtle differences in dairy cow conformation score.

A UK-based software company was discovered, who had begun work on interactive models of a lamb and a steer to demonstrate meat animal carcass classification scores for the English Beef and Lamb Executive ("EBLEX"). Work began in 2007 to adapt this technology to the wide number of conformation traits required for a dairy cow. After much painstaking development effort, the Virtual Cow was given its first public demonstration at the Dairy Farming Event in September 2009.

## 2.1 Understanding the functional dairy cow

The Virtual Cow can currently be reached from two websites: [www.holstein-uk.org](http://www.holstein-uk.org) and [www.thehyb.co.uk](http://www.thehyb.co.uk). During the initial 12-month launch period, the program is available through a PIN-protected login screen.

There are two main sections to the Cow model: The '**Ideal Cow**' dealing with the current view of the model Holstein animal and '**Individual Scoring Traits**' where the user can examine how each linear trait score looks on the model cow.

### 2.1.1 The Ideal cow

The **Ideal Cow** section depicts a series of fixed settings for the current consensus view of the cow breeders should be striving to achieve.

The linear scores for this ideal are listed on the left.

This 3D view can be rotated any way the user chooses, plus enlarged or shrunk in size using the computer's pointing device (mouse or touchpad) to give an ideal perspective view of any part of the body or trait area.

One frequent question is "Why is the cow not black and white?" During the two-year development period it was found that areas of dark colour in particular tended to hide features of the cow. Flesh tones in the udder area for example, also failed to generate sufficient contrast between shade and light to reveal differences in full detail. The silver tone adopted gave the best combination of effects to portray the full 3D image when rotated. This also means the Virtual Cow can be more easily adapted to other preferences, and is not dependent on specific colour combinations or pattern of markings.

The trait scores used to create this image can easily be adapted to suit any alternative consensus or to create the ideal conformation model for other breeds or groups.

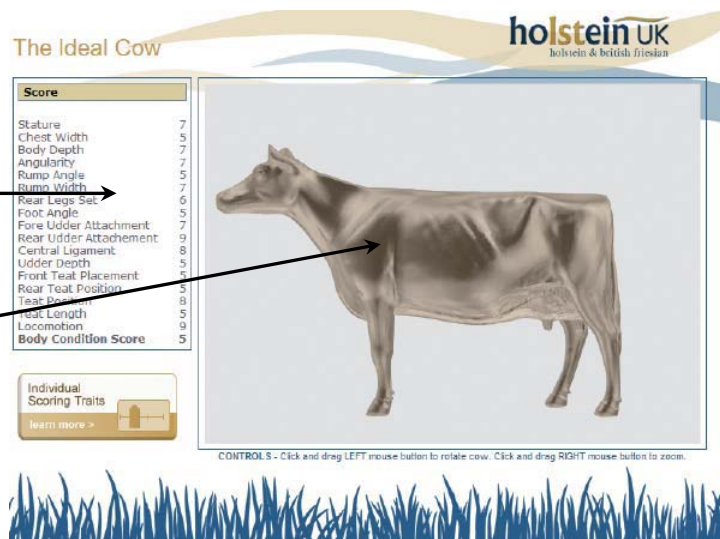



2.1.2 Individual scoring traits

Switching to **Individual Scoring Traits** means the user can select any on the 16 key linear scoring traits, plus Locomotion and Body Condition for individual focus.

Choosing any one trait moves to a high-resolution view of that area of the cow's anatomy.

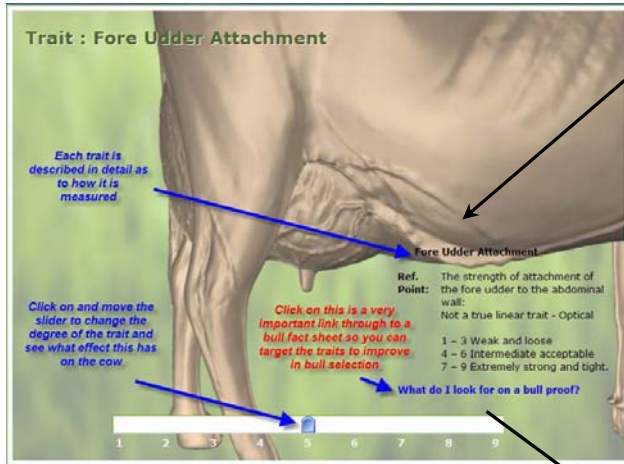

Each trait is described in detail with an explanation of its own linear scores.

Moving the slider up or down its linear scale adapts the feature immediately to the morphology appropriate to the score. The user can see the effects of any change in the degree of the trait see what impact this has on the cow.

Direct links to a bull's Fact Sheet, showing linear scores in graphical format, allow the user relate any trait to the bull's linear type profile, helping to visualise that score and see the impact of a breeding decision on the structure of the animal. So aiding bull selection and ultimately, breed improvement across the national dairy herd.

Type Proof		DTAT2010 (4/10)						1477 Dhrs(UK)	492 Hds(UK)	95% Rel	Value
UK Type Proof		-3	-2	-1	0	+1	+2	+3			
Type Merit	Poor								Excellent	3.09	
Hannings	Poor								Excellent	2.33	
Legs & feet	Poor								Excellent	3.12	
Stature	130 cm								154 cm	2.78	
Chest width	Narrow								Wide	-1.35	
Body depth	Shallow								Deep	0.87	
Angularity	Coarse								Open Rib	1.92	
Rump angle	High pins								Low pins	0.15	
Rump width	Narrow								Wide	0.42	
Rear leg side	Straight								Sickled	-1.16	
Foot angle	Low								Steep	1.56	
Fore udd att	Loose								Tight	2.08	
Rear udder ht	Very low								Very high	2.72	
Udder supp	Broken								Strong	2.02	
Udder depth	Below hook								20cm above	1.71	
Front test pl	Outside								Close	0.00	
Teat length	Short								Long	0.78	
Rear test pl	Apart								Close	0.60	
Teat pos side	Close								Apart	-0.2	
Temperament	Poor								Good	0.57	
Base of milk	Slow								Fast	1.94	
Locomotion	Poor								Excellent	3.65	
Cond Score	Low								High	-1.49	

**Locomotion** is by definition a dynamic action. This presents the problem of depicting the movement adequately for viewers to understand each score.



**17 Locomotion**  
**Ref. Point:** The use of legs and feet, length and direction of the step  
 1-3 = Severe Abduction - Short Stride  
 4-6 = Slight Abduction - Medium Stride  
 7-9 = No Abduction - long stride

The Virtual Cow overcomes this by embedding video clips of real cows into the model.

There is a separate, 30-second sequence, for each locomotion score from 1 to 9 (with the median scores 5 & 6 combined). The viewer can select any score and play, pause or repeat the video.

Each video is complete with its own audio commentary explaining the features of the cow's gait and why she achieves that score. Complementing the written description of the scores.

This helps improve the understanding and importance of locomotion scores, leading to a long term reduction in lameness.

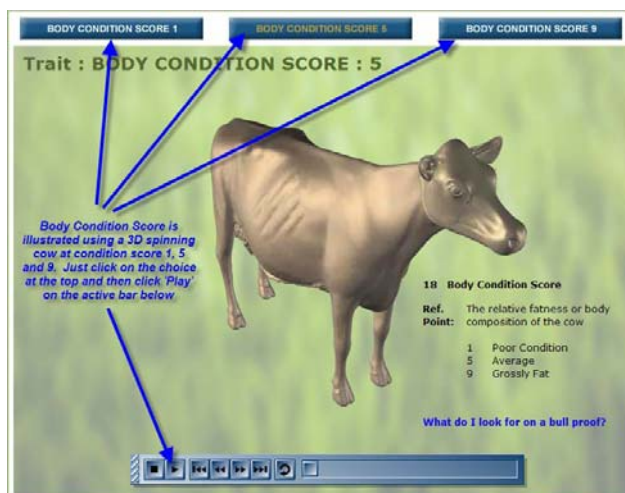

**Body Condition Score** is illustrated to a series of 3D animations, each similar to the Ideal Cow. Three scores are available, at the extremes and centre of the 1-9 scoring range.

As the cow rotates to view all areas of her conformation at the chosen score, the animation can be paused or re-started, so the impact of the score value can be absorbed more easily.

## 2.2 Further developments

Feedback from early users is already leading to a series of valuable suggestions for the further enhancement of the Virtual Cow's functionality.

Items such as the ability to build a user's own view of an Ideal Cow have been requested, or perhaps store the model showing all the linear scores for a particular bull the breeder is considering?

Plans are already underway to incorporate recent results from the CDI on the effect that any trait score has on the typical herd life achieved by animals who were first classified as heifers.

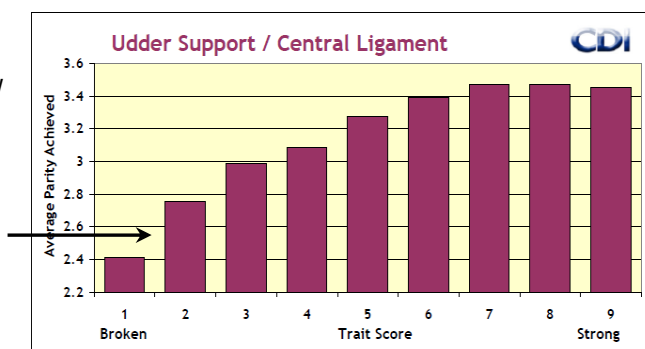

## 3.0 Benefits summary

**Existing and Potential Users** include a number of UK agricultural colleges and universities, individual breeders and students, breeding advisors, breed associations, AI companies and Milk Records Organisations.

Several key benefits of the Virtual Cow have been mentioned already. In summary these include:

- Can be used in a wide variety of locations from classroom and lecture theatre to home and office. (With a laptop even car, cowshed or field?)
- Removes the need for a large number of live cows to be assembled to illustrate each score value.
- Enables numeric scores to be visualised interactively.
- Promotes better understanding of linear scores and classification.
- Breeders can assess a bull by viewing the likely impact of each trait on his daughters.
- Changes in trait scores are easy to follow.
- Promotes breed improvement through enhanced understanding of those traits which need to be carried forward.
- Adapts to all preferences and can cater for different breeds.

The shape and conformation of the dairy cow has changed dramatically over the last 100 years, thanks to the concerted efforts of breeders, associations, societies, advisors and breeding organisations of all types. The Virtual Cow can help to ensure that the dairy animal of the future has the constitution to lead a long, comfortable, and trouble free productive life in any herd or situation.



## Report of Animal Identification Sub-Committee

<b>Chair</b>	In transition from Ole Klejs Hansen to Kaivo Ilves	
<b>Members</b>	<ol style="list-style-type: none"> <li>1. Kaivo Ilves, Estonian Animal Recording Centre, Estonia Joined 2010, Chair 2010; Confirmation 2014 kaivo.ilves@ikkeskus.ee</li> <li>2. Erik Rehben, France Genetique Elevage, France Joined 2010 Confirmation due 2014 Erik.Rehben@inst-elevage.asso.fra</li> <li>3. Ken Evers, Department of Primary Industries, Australia Joined 2009 Confirmation due 2013 ken. Evers@nre.vic.gov.au</li> <li>4. Jay Mattison, National Dairy Herd Improvement Association, USA Joined 2004, Confirmed due 2012 imattison@requestltd.com</li> <li>5. Henry Richardson, The Centre for Dairy Information, United Kingdom Joined: 2002, Confirmation due 2010 henryrichardson@thecdi.co.uk</li> <li>6. Folkert Onken, Arbeitsgemeinschaft Deutscher Rinderzuchter, Germany Joined 2007 Confirmation due 2011 folkert.onken@adt.de</li> <li>7. Ole Klejs Hansen, Danish Cattle Federation, Denmark, Joined 1994, Chair 2006, Resigning 2010 okh@landscentret.dk</li> </ol>	
<b>Members left</b>	Louise Marguin, louise.marguin@inst-elevage.asso.fr	
<b>Meetings</b>	Last: 17. - 19. November 2009, Paris	Next: ICAR Conference 2010, Riga
<b>Participation P</b>	<p>Participants:</p> <p>Ole Klejs Hansen Jay Mattison Folkert Onken Henry Richardson Louise Marguin</p>	<p>Absence:</p> <p>Ken Evers</p>
<b>Key Agenda Issues</b>	<p>At or after the SC meeting in Paris the following issues have come up:</p> <ol style="list-style-type: none"> <li>1. The ISO 24631-3 performance test of transponders has been much used probably for manufacturers to qualify themselves for the EU market for electronic tags to be used in sheep and goats. The original performance criteria, which were published as an ISO TWG document on the ICAR website, seems to have been used as intended by manufacturers and competent authorities.</li> <li>2. The chairman attended a meeting with the EU Commission early November to discuss a review of the EU documents to adapt to the situation now the ISO standard has been published. ISO and ICAR had the opinion that EU should for transponders make reference to the full ISO 24631, parts 1 and 3. This would close a gap for countries to approve products which might not be ICAR approved. However, this did not happen. EU in its decision still makes reference to the test procedures of the ISO tests but does not include demands for approval by the ISO Registration Authority (which is ICAR). The current situation is exactly as before the ISO standard when EU made reference to the test procedures of the ICAR test protocols. Also EU stepped up the approval criteria requiring a minimum activation field strength of maximum 1.2 A/m where the ISO TWG had suggested 1.2 A/m with a latitude of 0.3, effectively setting the requirement at 1.5 A/m.</li> <li>3. The field test of conventional plastic tags finally got started in USA in May 2010. The ICAR secretariat and the SC chairman have set up contracts with manufacturers and the ICAR member organisations performing the field tests. A contract has also been set up for the data centre to do the</li> </ol>	

calculation of the test results. This means that the rest of the first round of field tests should now be on the right track.

The second round of testing should be starting as soon as possible and the delays seen in the first round should be avoided so that the full test procedure could be finished within about 24 months. This requires strict time limits for all parties involved in the testing.

At the November 2009 SC Meeting we visited the CETIM test centre in Nantes, France, which has made the laboratory testing of plastic ear tags. The test centre indicated that they might propose some amendments in the testing and the SC invited such proposals. However we did not receive any proposals, even after asking again for proposals in due time before the upcoming SC meeting.

4. The role of ICAR as Registration Authority of ISO for 11784/11785 conforming devices is under discussion in the ISO groups. The subcommittee has presented a draft for a new administrative option where manufacturers can contract approved test centres themselves and where economic transactions regarding the testing itself are handled directly between manufacturer and test centre without Service-ICAR involvement.

The proposal was well received in the ISO TWG and has been forwarded by ICAR to the ISO Central Secretariat in order that it can be part of the renegotiating of the ISO - ICAR agreement. The proposal ensures ICAR's ability to

- a. Check that the manufacturer asks, for the relevant test
- b. Securing the tested devices for ICAR collection
- c. Securing that ICAR is formed in case of any problems with tests and that ICAR has the right at any time to inspect the testing even if ICAR is not the contractor.

In case the proposal is accepted the conditions for ICAR approval of test centres has to be amended also. Proposal for this has been prepared.

5. A discussion about retesting of electronic ID devices has started in the ISO groups. The main points are if all products must be periodically retested (e.g. every 5 years) or retesting should be made on indication of problems or maybe just randomly with at certain percentage of tags per year. ICAR agrees that retesting to some extent is needed but that the financing of retesting has to be agreed also. ICAR currently has no reserve funds that could be used for that purpose.
6. A discussion about how to monitor that manufacturers keep required databases and how to follow up on alleged duplicate codes has started after cases found in the market. The manufacturers ask that the Registration Authority (ICAR) takes a more active role and that sanctions could be administered by ICAR.
7. A wish that the ICAR website could provide links to databases with ID codes not only for farm animals but also for pets.
8. 2009 was the busiest year ever for conformance testing. 45 transponders were conformance tested during 2009. During the last four calendar years (2006-2009) ICAR conformance tested more than half of all the transponders tested during the 15 year period with conformance testing available. By mid May 2010 another 23 new transponders had been tested and approved. By the end of 2009 ICAR had conformance tested and approved 243 transponders from 100 manufacturers. In 2009 performance tests had a very high priority for ISO -ICAR, for manufacturers and for competent authorities. During 2009 ICAR performance tested 26 products. By mid May 2010 another 15 transponders had been performance tested, bringing the total number of performance tested transponders to 41.
9. SC members visited in January 2010 the DLG Testzentrum, Gross Umstadt, Germany, to discuss ICAR approval of this centre. DLG has been preparing for approval over the last couple of years and were very active in seeking approval in late 2009. SC members found the test facilities valid for approval and first documents from the ISO certification and auditing were presented by DLG. The DLG centre is able to make

	<p>both the ISO 24631 tests and the ICAR laboratory tests on plastic ear tags.</p> <p>A draft contract was discussed at the January visit and DLG was invited to amendments if needed. By mid May we have not received the response expected, and so we have not yet been able to use the test centre.</p> <p>10. By the end of April 2010 all administrative work regarding test applications and approvals of devices was moved to the Service-ICAR Secretariat in Rome. The secretariat already had taken over the contracting and economic transactions, so by now all the administrative tasks are in the secretariat. The Secretariat is taking over also the contact with manufacturers asking technical questions and the task to follow up on cases when there is doubt if standards are not followed, duplicate numbers are found, etc etc. This takes a big workload from the SC Chair, who can then concentrate on policy matters. This new split of work makes it necessary that the secretariat is represented at the SC meetings and presents a report on activities (number of tests and activities regarding cases).</p>
<b>Important Decisions</b>	
<b>Cooperation and links to other WG/TF/SC</b>	
<b>Issues to be handled by the Board &amp; Deadlines</b>	<ol style="list-style-type: none"> <li>1. Discuss with the ISO Central Secretariat about new administrative routines and the impact on the ICAR-ISO agreement. This should be done as soon as possible to avoid useless discussions for the SC chair attending meetings in ISO Working Group and Technical Working Group. Discuss with ISO Central Secretariat about copyright issues and ICAR's possibilities to make ISO standards available to ICAR members. It was OK to publish ICAR test procedures after the ICAR Conference in 2008 because at that time the ISO 24631 was not published as international standard. Now we are no longer using ICAR test protocols but ISO standards for testing of EID-devices.</li> <li>2. ISO has a very strict regime on copyright for ISO Documents whereby copies of ISO standards are only available for purchase,,- not for free. This means that ICAR needs consent from ISO before making ISO standards freely available</li> </ol>
<b>Top 5 Issues for WG/TF/SC</b>	<ol style="list-style-type: none"> <li>1. Implementing the new work structure of Sub-Committee chair and Secretariat</li> <li>2. Test of tissue sampling tags of test of conventional plastic tags</li> <li>3. Progress on the field test</li> <li>4. Retesting of previously approved EID devices</li> <li>5. Review of test protocol for laboratory test of plastic tags (including preliminary assessment to be made at test centres)</li> </ol>



## Report of Interbull Sub-Committee

<b>Chair</b>	Reinhard Reents	
<b>Members</b>	<ol style="list-style-type: none"> <li>1. <b>Reinhard Reents</b> (Chairman) rreents@vit.de Vereinigte Informationssysteme Tierhaltung w.V. Heideweg 1, 27283 Verden / Aller, Germany</li> <li>2. <b>Brian Van Doormaal</b> vandoorm@cdn.ca Canadian Dairy Network 150 Research Lane, Suite 307, Guelph, N1G4T2, Ontario, Canada</li> <li>3. <b>Gert Pedersen Aamand</b> GAP@landscentret.dk Nordisk Avelsvårdering Udkærsvvej 15, Skejby, DK-8200 Århus N, Denmark</li> <li>4. <b>Bevin Harris</b> bevinharris@me.com Animal Evaluation Unit, Private Bag 3016, Hamilton, New Zealand</li> <li>5. <b>Marjorie Faust</b> MFaust@absglobal.com ABS Global, Inc. P.O. Box 459, 1525 River Rd., DeForest, WI 53532, USA</li> <li>6. <b>Sophie Mattalia</b> sophie.mattalia@jouy.inra.fr France Génétique Élevage INRA-SGQA Domaine de Vilvert, 78352 JOUY en JOSAS cedex, France</li> <li>7. <b>Enrico Santus</b> enrico.santus@anarb.it Assoc. nazionale allev. bovini razza Bruna Loc. Ferlina, 204, 37012 Bussolengo (Verona), Italy</li> <li>8. <b>Hans Wilmink</b> Wilmink.H@cr-delta.nl NRS PO Box 454, 6800 AL Arnhem, The Netherlands</li> <li>9. <b>Juraj Candrák</b> Slovak University of Agriculture in Nitra Juraj.candrak@uniag.sk 956 13 Korniarovce 153, Slovak Republic</li> <li>10. <b>Jan Philipsson</b> (Secretary) Jan.philipsson@hgen.slu.se SLU – Department of Animal Breeding and Genetics SE-750 07 Uppsala, Sweden</li> </ol>	
<b>Members left</b>	Paul Van Raden (USA), Bill Montgomerie (NZL)	
<b>Meetings</b>	<u>Last:</u> Riga, Latvia, May 31-June 4, 2010	<u>Next:</u> Guelph, Canada, February 27-March 2, 2011
<b>Participation</b>	Full +: all members attended	



<b>Key Agenda Issues</b>	<ol style="list-style-type: none"> <li>1. Interbull Centre report</li> <li>2. Nomination of new Steering Committee members</li> <li>3. Discussion with North American Consortium</li> <li>4. Interbull strategic plan</li> <li>5. Interbull Scientific Advisory Committee report</li> <li>6. Nomination of a new SACmember</li> <li>7. Future fee structure including new services</li> <li>8. Interbull Technical Committee report</li> <li>9. Developments on genomic analyses</li> <li>10. Future events</li> <li>11. Patents</li> </ol>
<b>Important Decisions</b>	<ol style="list-style-type: none"> <li>1. The strategic plan for future activities was discussed to give priority to the urgent developments in the area of international genomic evaluations.</li> <li>2. It was decided to revise the fee structure for the Interbull services to accommodate also for inclusion of genomic information in future international genetic evaluations.</li> <li>3. A joint session of ICAR and Interbull on genomics applied in livestock showed that genomic information is rapidly introduced into systems used for selection in dairy cattle.</li> <li>4. Chairman Reinhard Reents had asked A. Eggen from Illumina to inform about latest developments in SNP chip technology. Paul van Raden, USA, reported about the implications of using chips with different marker densities for genomic evaluation and Theo Meuwissen, Norway, reported about the impact of using genomic information on genetic gain and inbreeding for breeding programs. Interbull Centre Director João Dürr summarised the ongoing genomic developments within Interbull.</li> <li>5. Implementation of genomic information in the Interbull portfolio got a large attention. As a first step, the Interbull Centre will offer a test for validation of protein yield effective August 9, 2010. Two research runs on a validation procedure have been conducted in early 2010 and the necessary refinements are incorporated in a final version that will be distributed from Interbull to national genetic evaluation centres on June 14. Results can then be sent back until July 5 and will be analysed by Interbull until August 9, 2010. The genomic evaluation systems that pass the test will then be displayed on the ICAR webpage in order to fulfil the requirements of the EC regulation 427/2006 for wide use of semen also from young sires.</li> <li>6. Validation of all other traits of the Interbull portfolio will be added for a research later in the year 2010 for a review of the technical bodies and the Interbull steering committee in early 2011. It is intended to offer a validation test for all traits in the future and the results will then be made public for general information.</li> </ol>

	<ol style="list-style-type: none"> <li>7. The research runs for GMACE (MACE including genomic information) showed larger challenges than expected. It was therefore decided to first proceed with a simplified version of GMACE and test its properties, until the technical issues with the full GMACE system are solved.</li> <li>8. The research and development work on genomics at the Interbull Centre has been facilitated by support from EU and in collaboration with scientists of a number of countries. New methods are tested in a collaborative project involving Brown Swiss breed data from seven countries around the world.</li> <li>9. It was also agreed that Interbull facilitates the exchange of genotyping information via a list of bulls, that displays in which location data on a given bull is stored. Through this list, bilateral exchange of DNA data is facilitated in order to avoid multiple genotyping of the same bull.</li> <li>10. In conjunction with these development an urgent need for standardisation of genotypic data formats was identified and Interbull / ICAR will work on standardised protocols in agreement with the providers of genotyping systems.</li> <li>11. At the meeting results of a pilot project on international evaluations of beef cattle, Interbeef, were discussed. This project has primarily been sponsored by organizations in Ireland, France, UK and the Nordic countries and is driven by the beef working group of ICAR. A business plan for the future research and possible services is under development.</li> <li>12. Due to the rapid developments in genomic evaluation and the applications in practical breeding programs the next meeting of Interbull will be organized as a workshop end of February 2011 in Guelph, Ontario, Canada.</li> </ol>
<b>Cooperation and links to other WG/TF/SC</b>	Interbull Centre has been asked to provide the pertinent documentation whenever there is a ICAR member requesting the certificate of quality in genetic evaluation. The interaction has been smooth.
<b>Issues to be handled by the Board &amp; Deadline</b>	<ol style="list-style-type: none"> <li>1. Nomination of new Interbull Steering Committee members</li> </ol>
<b>Top 5 Issues for WG/TF/SC</b>	<ol style="list-style-type: none"> <li>1. Improve international genetic evaluations of cattle (MACE)</li> <li>2. Develop national and international methods for genomic evaluation of cattle</li> <li>3. Improve communication with members and final beneficiaries</li> <li>4. Provide harmonization, monitoring and quality assurance</li> <li>5. Provide services that are accurate, independent, timely, transparent, unbiased and cost effective</li> </ol>



## Report of the Milk Analysis Sub-Committee

### Introduction

The terms of reference for the sub-committee include every aspect related to milk analysis. This covers analytical methods, devices and systems for application to the every animal species of interest to ICAR whatever the location analyses are performed.

At the date of the present report the sub-committee is composed of 11 members:

1. Christian Baumgartner (Germany)
2. Egil Brenne (Norway)
3. Roberto Castañeda (Argentina)
4. Jan Floor (South Africa)
5. Marina Gips (Israel)
6. Olivier Leray (France), Chair
7. Silvia Orlandini (Italy)
8. George Psathas (Cyprus)
9. John Rhoads (United States)
10. Gavin Scott (New Zealand)
11. Harrie Van den Bijgaart (The Netherlands)

From the last ICAR session the foreseen extension of the membership to the African area was concretised with Jan Floor's nomination (manager of LactoLab, ZA) as a new member. Further membership extensions to Asia is still underconsideration to enlarge worldwide representation in MA SC. The activities were carried out thanks to email communication and regular meetings either of the whole sub-committee or of part of it (project groups) as follows:

#### Milk Analysis Sub-Committee:

1. Niagara Falls (USA), 17 June 2008, 36<sup>th</sup> Biennial ICAR Session
2. Sochi (Russia), 17 May 2009, IDF/ISO Analytical Week 2009
3. Montreal (Canada), 16 May 2010, IDF/ISO Analytical Week 2010
4. Riga (Latvia), 2 June 2010, 37<sup>th</sup> Biennial ICAR Session

#### Joint IDF-ICAR project on Reference system on SCC:

1. Paris (FR): 9 April 2009
2. Sochi (RU): 22 May 2009
3. Berlin (DE): 22 September 2009 (IDF World Dairy Summit: communication and poster)
4. Montreal (CA): 18 May 2010

#### Meetings on On-farm Milk Analysis:

1. Niagara Falls (USA), 17 June 2008 (Working Party on OMA)
2. Paris (FR), 21 April 2009
3. Riga (LV), 1 June 2010

#### ICAR promotion: (Chair and ICAR General Secretary)

1. Moscow (RU), 18 March 2010: Russian Dairy Union,
2. Moscow (RU), 18 March 2010: Russian Federation of Milk Producers (Soyuz Moloko)
3. Moscow (RU), 19 March 2010: Laboratory of All-Union Dairy Research & Design Institute

### Working programme and current activities

The status of current activities and progress are reported in the minutes of MA SC meeting in Sochi (RU) 2009 and Montreal (CA) 2010.

#### Key issues - Milk Analysis on-farm

An horizontal working group called Working Party on On-farm Milk Analysis (OMA WP) worked out guidelines suitable for milk analysers installed on-farm from 2007 till 2010.

A draft guidelines document was presented and discussed in Niagara Falls 2008. It was upgraded and completed till the end 2009. Between 2008 and 2009 two meetings were held to consider the comments

received from the manufacturers. The document was proposed for scrutiny to ICAR member organisation before their approval in the General Assembly of 4 June 2010 in Riga.

### **Key issues - Milk analyser approval by ICAR**

Launching of the process was made in July 2006.

Since 2003 a new international standard, ISO 8196-3 | IDF 128-3, based on the ICAR evaluation protocol has been prepared by IDF/ISO from the ICAR protocol and was published in end 2009. In 2010 MA SC hold it and approved the replacement of the former ICAR protocol of 2002 by that new international standard. Besides, specific adaptations have been agreed upon for manual instruments that may serve as master instrument for calibration and for instrument deriving closely from a former approved instrument of the same manufacturer. This will be stated in an updated approval procedure (under preparation).

### **Key issues - International reference systems**

The ICAR analytical quality assurance system involving the ICAR Reference Laboratory Network has shown evidence for a strong potential in the harmonisation of analytical results through international reference materials. Such an approach is being thought through and developed jointly by ICAR and IDF in an IDF project on somatic cell counting. Five experts of MA SC participate tightly in the project as project leaders. The aim will be to provide reference materials for SCC internationally recognised and used for both regulatory and private purposes in a sustainable way. Launching of the project was made in 2009 and an IDF-ICAR Project Group was created. Since then four meetings were held. A communication plan is being run with already a newsletter regularly circulated, communication in every possible event (e.g. World Dairy Summit 2009, ICAR Session 2010) whereas technical development are carried out with significant inputs from the outcomes of ICAR Reference Laboratory Network meeting of Niagara Falls 2008.

### **Key issues - Annual international proficiency testing programme :**

It was renewed in 2009 and 2010 for cow milk with no change and renewal for 2011 was approved in Montreal. The convention between Service-ICAR and the organiser (Actilait/Cecalait, France) will be updated and the new proposals for 2011 dispatched with the usual annual information/announcement letter in December.

Proficiency studies in sheep and goat milk analysis are still not proposed in 2008 but the possibility is maintained if sufficient number of laboratories expressed such a need for 2011.

An update of the Laboratory network situation and proficiency study activities was made in Riga during the meeting of ICAR Reference Laboratory Network and are reported in the proceedings. A decrease in participation occurred in 2009 and the need was stressed to promote these trials and their technical and political interest for the international milk recording data equivalence recognition. A review of analytical performances and overall precision measured within the network through ICAR trials showed continuous improvement along time and compliance with standard precision figures thus bringing proof of the efficiency of the system and work done.

### **Key issues - Education and training**

This is one of major importance in analytical harmonisation. Today it is developed mainly through communication in dedicated workshops as for instance the regular meetings of ICAR Reference Laboratory Network during biennial ICAR sessions.

Basically, the international level cannot provide education and training directly to testing laboratories in ICAR countries for evident reason of workload and language, what necessitates relays. So the principle lies in education and training actions to be made through lab network members. The international level, ICAR MA SC, should promote regular realisation of national/local action, guidance for essential items, standard documents or tools. A harmonised training programme could be drafted.

The possibility to develop video clips as supports to analytical method standards keeps being under consideration by both ICAR MA SC and IDF.

## Information to ICAR and ICAR members

Regular information is given by e-mail through the annual letter on reference laboratory network activities and the updates of the list of network members, through the website of ICAR where report, survey results, protocol, procedures, etc are posted, and thanks to open meetings of MA SC and ICAR Reference Laboratory Network held during international events such as ICAR sessions and IDF/ISO analytical weeks. As an example, the last laboratory workshop held in Riga was made to promote the international reference systems and inform on new analytical developments of interest for milk recording and farmers.

Presentations and findings will be all reported and posted on the website of ICAR.

Development of tools to improve the access to information is underway (on-line questionnaire on laboratory situation) or under consideration (ICAR laboratory data base in milk recording).

## Co-operation and links to other WG/TF/SC

MA SC is connected to other expert groups of ICAR but also technical bodies or working groups of IDF-ISO for joint actions:

1. Working Party on On-farm Milk Analysis (WP OMA) and RD SC
2. Regular activity through participation as experts in IDF/ISO project groups ( e.g. WDS Berlin 2009, IDF-ISO analytical week)
3. Liaison to IDF Method Standard Steering Group
4. ICAR contribution in IDF/ISO symposium in Sochi (RU) in 2009 and Montreal (CA) in 2010
5. Joint IDF/ICAR new work item on an international reference system for somatic cell counting (SCCRS) launched and presented during the World Dairy Summit in Berlin on 23/09/2009.

## Key points to address

- 1- As worldwide recognition is a general issue, it is expected that every ICAR dairy organisation has an expert laboratory nominated as member of ICAR Reference Laboratory Network and that every network member can participate in ICAR PT schemes. Entering in the system is indeed a individual voluntary demarche from which each member organisation can then get much benefit in return together with ICAR community. In a global worldwide economy the international anchorage so provided is an additional assurance for compliance and recognition of analytical equivalence worldwide.
- 2- For the evaluation and approval of new milk analysers by member organisations it must be taken care that the ICAR protocol should be used as a minimum requirement since it is a piece of ICAR guidelines. Indeed the protocol makes evaluations comparable worldwide, everywhere, every time, with same degrees of confidence in the outcomes which is the only condition that ICAR could grant an international approval.
- 3- Provision of knowledge and service development. The development of international reference system requires to acquire further knowledge on the precision of methods of milk analysis used within ICAR. FTMIR has brought larger variety of possible compounds to be measured and potentially significant improvement for classical compounds like fat and protein. Fat and protein fine compositions were sources of discrepancy in precision and accuracy for milk analysers with limited filter numbers. Large spectrum analysis brought good promises to optimise centralised calibration. Till now this have still not been evaluated at the international level. An experiment to evaluate worldwide regional effect on MIR calibration within ICAR is foreseen for 2011-2012, which would require a financial support.

## Next meetings

The next meetings will be organised during the next IDF and ICAR international events as follows

1. Lyon (FR), 23-27 May 2011, IDF/ISO Analytical Week 2011
2. Bourg-en-Bresse (FR), 20-24 June 2011, ICAR Technical Session
3. Parma (IT), 15-19 October 2011, IDF World Dairy Summit

## Conclusion

MA SC is in expansion for worldwide representativeness (regions, sectors), carry on its regular activities (work programme), consolidate existing ICAR AQA system and broaden its recognition, strengthen IDF/ICAR collaboration for common interests, broaden focus onto milk analysis out of laboratories (with other ICAR technical bodies), aim to develop adequate tools and future services for laboratories

### Four Yearly Programme of Sub-Committee on Milk Analysis (MA SC) 2007-2010

Work item	1 2	3 4	5 6	7 8	9	10	11				
Theme Analytical QA (toolbox)	Analytical QA (toolbox)	Analytical QA (toolbox)	Analytical QA (toolbox)	Analytical QA (toolbox)	Laboratory network & harmonisation	Laboratory network & harmonisation	Laboratory network & harmonisation				
Title Guidelines on organising proficiency study	Guidelines on organising centralised calibration	Guidelines on on-farm analytical devices	Reference materials Reference systems	ICAR approval of new milk analysers	On-line questionnaire on laboratory situation within ICAR	Website data base on laboratories of ICAR countries	International proficiency studies	Reference Laboratory Network meeting	Education & training on analytical matters	Liaison to other (international) groups of experts	
Experts	<i>O Leray G Psathas S Orlandini</i>	<i>C Baumgartner O Leray S Orlandini</i>	<i>C Baumgartner H v d Bijgaart M Gips O Leray E Brenne</i>	<i>C Baumgartner H v d Bijgaart O Leray S Orlandini</i>	<i>3 examiners + All</i>	<i>G Psathas G Scott + ICAR HO</i>	<i>O Leray G Psathas + ICAR HO</i>	<i>O Leray S Orlandini</i>	<i>All</i>	<i>C Baumgartner S Orlandini + ICAR HO</i>	<i>H v d Bijgaart O Leray</i>
Objectives	ICAR guidelines and IDF/ISO IS	ICAR guidelines and IDF/ISO IS	ICAR guidelines	To be considered	Eval. report examination / advising ICAR	Two-yearly information	Regular updated information	Evaluation services	Two-yearly information	Improving laboratory testing performances	Information and feed-back / Horizontal work
2007	- Introduction - Outlines	- Introduction - Outlines	- Introduction - Outlines	Consideration for interest : - Provision of information - Guidelines on RM Qualification - Qualifying RMs	On-going process			Annual Programme	Programming	Elaboration of supports for teaching/training (movies on methods)	Setting up of a horizontal ICAR working party on on-farm testing (composition, work programme, meeting) Liaison persons with IDF MCM & QASADS SC
2008	Working draft	Working draft	Working draft	SCC reference system	On-going process	Definition of content, structure, reporting	Content & design definition IDF completed ICAR	Annual Programme	Organising	On-going process Video clip project	OMA WP meeting MSSG/ICAR SCC reference system
2009 Del	Delayed (ref system)	Delayed (ref system)	- Reviewed draft - MO draft	SCC reference system	On-going process	Implementation delayed	delayed	Annual Programme	Programming	On-going process Video clip project	OMA WP meeting MSSG/ICAR SCC reference system
2010 Del	Delayed (ref system)	Delayed (ref system)	Final draft: - G.A. approval - Inclusion in ICAR guidelines	SCC reference system	On-going process Process update Protocol update	Implementation delayed	delayed	Annual Programme	Organising	On-going process Video clip project	OMA WP work (MASC & RDSC) MSSG/ICAR SCC reference system

## Report of Recording Devices Sub-Committee

<b>Chair</b>	Uffe Lauritsen ufl@landscentret.dk	
<b>Members</b>	<p>1. Mark Adam (USA) adamm@northstarcooperative.com</p> <p>2. Martin Burke (Ireland) mburke@icbf.com</p> <p>3. Allain Clement (France) Allain.Clement@inst-elevage.asso.fr</p> <p>4. Andrew Fear (New Zealand) afear@liv.co.nz</p> <p>5. Manfred Hammel (Germany) dr.hammel@lkvbb.de</p> <p>6. Pascal Savary, pascal.savary@art.admin.ch</p> <p>7. Vladimir Tancin (Slovak Republic) tancin@scpv.sk</p>	
<b>Members left</b>		
<b>Meetings</b>	<u>Last:</u> 16-17.02 2010	<u>Next:</u> June 01 2010
<b>Participation</b>	Full + TC directors and P. Huijsmans and G.van Logtenstij, The Netherlands	Absence:
<b>Key Agenda Issues</b>	Guideline revisions for 2010 (buffalo and SR); draft new protocols for testing of in-line analysers, device approvals and devices in test; improvements in SC presentation on web; coding of multi-species meters' SW; relations SC and ISO, on-farm test day procedures	
<b>Important Decisions</b>	<ol style="list-style-type: none"> <li>1. Revision of Guideline Section 11 circulated for member comments and for presentation to ICAR GA for endorsement in Riga.</li> <li>2. SC decided to hold a WS in Riga open to manufacturers to discuss "Milk recording systems and services in the 21st century"</li> </ol>	
<b>Cooperation and links to other WG/TF/SC</b>	Close collaboration with SC for Milk Analysis in finalization of new protocols for testing of in-line analysers.	
<b>Issues to be handled by the Board &amp; Deadline</b>	Routine endorsement of meter approvals: MDS Saccomatic IDC 3 (done)	
<b>Top 5 Issues for SC</b>	<ol style="list-style-type: none"> <li>1. In-line analyser pre-test with Afilab system;</li> <li>2. System testing</li> <li>3. ICAR - MF agreement on sampling in automatic milking systems</li> <li>4. Carry-over in sampling</li> <li>5. Review of guidelines link to ISO and IDF</li> </ol>	





## Report of the Animal Fibre Working Group

<b>Chair</b>	Marco Antonini	
<b>Members</b>	<ol style="list-style-type: none"> <li>1. Marco ANTONINI (Italy) ENEA / University of Camerino - 2007 - marco.antonini@enea.it</li> <li>2. LOU Yujie (China) Jilin Agricultural University – 2007 - louyujie2003@yahoo.com.cn</li> <li>3. Claudio TONIN (Italy) CNR Italian National Research Council – 2007 - c.tonin@bi.ismac.cnr.it</li> <li>4. Hugh GALBRAITH (United Kingdom) University of Aberdeen – 2007 - h.galbraith@abdn.ac.uk</li> <li>5. Oscar TORO (Peru) Ong DESCO – 2007 otoro@descosur.org.pe (cpachecomg@gmail.com )</li> <li>6. Eduardo FRANK (Argentina) Catholic University of Cordoba – 2007 - frank@uccor.edu.ar</li> <li>7. Moises ASPARIN (Peru) Michell Group – 2008 - masparrint@hotmail.com / mallkini@michell.com.pe</li> <li>8. Malcolm FLEET (Australia) SARDI Research Scientist (Wool) – 2007 - Fleet.Malcolm@saugov.sa.gov.au</li> <li>9. Fabrizio CASTAGNETTI (Italy) Ermenegildo Zegna Group – 2008 - Fabrizio.Castagnetti@zegna.com</li> <li>10. David Barboza (USA) Alpaca Owners and Breeders Association (AOBA) – 2009 - Ranchonc@hughes.net</li> <li>11. Ian Davison Australian Alpaca Association Ltd. – 2010 - ian@illawarraalpacas.com</li> </ol>	
<b>Members left</b>	Malcolm FLEET (Australia)- SARDI Research Scientist (Wool) – 2007 (Changed company)	
<b>Meetings</b>	<u>Last:</u>	<u>Next:</u>
<b>Participation</b>	Full +:	Absence: Mone
<b>Important Decisions</b>	<ol style="list-style-type: none"> <li>1. ICAR Animal Fibre Working Group in Riga has been deleted because it was decided that it was much more useful to meet in a meeting more visited by Animal fibre experts. It was decided so to disseminate the ICAR activities to those who, although might be interested, are not really aware of ICAR. For Riga we received 4 papers on Alpaca and one on Chinese Cashmere.</li> <li>2. For Riga we received 4 papers on Alpaca and one on Chinese Cashmere even if in the same time of Icar Riga Event the International Alpaca Congress will be held in Madrid from 4th to 6th of June 2010</li> </ol>	
<b>Cooperation and links to other WG/TF/SC</b>		
<b>Issues to be handled by the Board &amp; Deadline</b>	Agree with the Icar Board, we decided to move cancel the session in Riga to the III SIMPOSIUM INTERNACIONAL DE INVESTIGACIONES SOBRE CAMELIDOS SUDAMERICANOS ( <a href="http://simposiumcamelidos.wordpress.com/">http://simposiumcamelidos.wordpress.com/</a> ) to be held in Arequipa 8 – 10 September 2010.	
<b>Top 5 Issues for WG/TF/SC</b>	In Arequipa will be discussed all the main parameter to define objectively the Alpaca Huacaya and Suri differences in animal characteristics and in fibre production.	



## Report of the Animal Data Recording Working Group

<b>Chair</b>	Erik Rehben	
<b>Members</b>	Suzanne Harding – Holstein UK – UK – 2007	
<b>Members left</b>	Dick Koorn – NRS – The Netherlands – 2010 (Change of position) Norbert Wirtz – VIT – Germany – 2009 (Change of position)	
<b>Meetings</b>	<u>Last: Porec May 2009</u>	<u>Next: not yet planned</u>
<b>Participation</b>	Full	Absence: none
<b>Key Agenda Issues</b>	<p>The following items are the major results of the task force whose terms of reference are very wide.</p> <p>The activity of the task force was focused on a strategic approach of the standardisation of animal data including a beginning of implementation of this strategy.</p> <p>Animal data recording is in relation with increasing challenges and more and more complexity mainly due to technological innovation: captor, RFID... Beside classical issues of data exchange between breeding organisations, data standardisation should now be considered as a global issue from the animal to the data base of breeding organisations. Beside classical pedigrees, records and breeding values, many non conventional data should be considered: health data, data from captors, new technologies for milk analysis...</p> <p>The driving ideas of this strategic approach are:</p> <ol style="list-style-type: none"> <li>1. The mission of ICAR with regard of data standardisation is to act in order to create conditions which allow its members to provide the farmers with efficient and relevant services. Not necessarily to establish standards which is only one of the possible means to reach this objective.</li> <li>2. Needs for data standardisation are increasing, too much bodies are in charge of data standardisation with poor results and a waste of time for the limited number of experts who could contribute in this activity</li> <li>3. A better coordination between the key players, ICAR, ISO, Interbull Center, World Holstein Federation is a pre requisite to any efficient animal data standardisation.</li> <li>4. International Animal Data standardisation is the final stage of a process, not the starting point.</li> <li>5. The process for international data standardisation should start with limited projects involving only the stakeholders who have an interest in the project and who will invest in the implementation of the standards. The sponsors of these projects could commit with ICAR to produce their standards in order to meet some requirements, for instance ISO-ADED compatible, make the results available for an international body, ICAR, ISO and ICAR or ISO... and communicate through ICAR web site.</li> </ol>	
<b>Important Decisions</b>	<ol style="list-style-type: none"> <li>1. Changes in the ICAR web site are planned in june 2010 for:</li> <li>2. Periodical survey about the state of art for animal data exchange among ICAR members.</li> <li>3. Interoperability of codification for breeds and coat colours.</li> <li>4. Meeting with CEN / UNCEFACT in Brussels in September 2009.</li> <li>5. Meeting in March 2010 with the World Holstein Frisean Federation.</li> <li>6. Strategy implementation:</li> <li>7. Cooperation with World Holstein Frisean Federation according to the draft for discussion from Suzanne Harding.</li> <li>8. In collaboration with animal recording devices an initiative for a project with a limited number of manufacturers of milking equipment.</li> <li>9. In collaboration with EFFAB an initiative for animal Health Data Management.</li> <li>10. Proposal from the EU / AgriXchange project led by the University of Wageningen (NL) for ICAR to become member of the advisory committee. The objective of this project is to establish a network about data exchange in agriculture and to provide the payers with a frame work relevant for these problems.</li> </ol>	

<p><b>Issues to be handled by the Board &amp; Deadline</b></p>	<ol style="list-style-type: none"> <li>11. Recording devices Sub Committee.</li> <li>12. To be established with the Interbull Center.</li> <li>13. Endorse the strategy of the task force.</li> <li>14. Endorse the proposal to transform the task force in a network with a large number of people and with non ICAR participants such as WHHF, ISO or UNCEFACT as a result of this strategy.</li> <li>15. Endorse the common WHFF initiative as a beginning of implementation of this strategy.</li> <li>16. Endorse the initiative for a common project with a limited number of milk equipment manufacturers and ICAR members (Danish Catlle Federation and France Génétique Elevage at the moment)</li> <li>17. Endorse the ICAR participation in the AgriXchange project in the advisory committee and appoint a representative in order to increase the size .</li> </ol>
<p><b>Top 5 Issues for WG/TF/SC</b></p>	<ol style="list-style-type: none"> <li>1. ICAR strategy for animal data records in order to meet its member requirements.</li> <li>2. Coordination of international animal standards players.</li> <li>3. Through the web site share information with its members about the state of art and the current initiatives in regards with animal data standardisation.</li> <li>4. Through the website provide ICAR members with material for international data communication.</li> </ol>

## Report of Artificial Insemination and Relevant technologies Working Group

<b>WG/TF/SC name</b>	Artificial Insemination and Relevant technologies	
<b>Chair</b>	Laurent Journaux, UNCEIA, France, 2008, Laurent.journaux@unceia.fr	
<b>Members</b>	<ol style="list-style-type: none"> <li>1. Dario Pasetti, ANAFI, Italy, 2008 dariopas@tin.it</li> <li>2. Ulrich Witschi, Swissgenetics, Swizerland uwi@swissgenetics.ch</li> <li>3. Gerben De Jong, CR Delta, The Netherlands jong.g@cr-delta.n</li> <li>4. Gordon Doak, NAAB, USA gdoak@naab-css.org</li> <li>5. Ulrich Janowitz, RUWEG, Germany ujanowitz@ruweg.de</li> <li>6. Jan-Ake Erikson, Svenskmjolk, Sweden jan-ake.eriksson@svenskmjolk.se</li> </ol>	
<b>Members left</b>		
<b>Meetings</b>	<u>Last:</u> Niagara Falls, 17 <sup>th</sup> of June 2008	<u>Next:</u> (dates and location here)
<b>Participation</b>	<p>Mr. Laurent Journaux <i>UNCEIA</i> (Chairman)</p> <p>Gordon Doak Jan-Ake Eriksson Ulrich Janowitz U.Witschi G.De Jong</p> <p>Invited : Alain Malafosse <i>UNCEIA</i></p>	Absence:
<b>Key Agenda Issues</b>	<ol style="list-style-type: none"> <li>1. Semen traceability developments in bar-code: proposal of the AI vets group</li> <li>2. Other development in straw labelling and /or automatic reading systems (chips...)</li> <li>3. Organisation of a technical session on AI matters during the ICAR congress in Niagara Falls</li> </ol>	
<b>Important Decisions</b>	<ol style="list-style-type: none"> <li>1. Adoption of recommendation for bar code</li> </ol>	
<b>Cooperation and links to other WG/TF/SC</b>		
<b>Issues to be handled by the Board &amp; Deadline</b>	<ol style="list-style-type: none"> <li>1. Continue it's activities</li> <li>2. Reflexion about sexed semen (identification, tracability)</li> </ol>	
<b>Top 5 Issues for WG/TF/SC</b>	<ol style="list-style-type: none"> <li>1. Develop necessary tools (SCC registration) for use of international bar-code in accordance with ICAR recommendation</li> <li>2. To keep watch new development in straw labelling and / or automatic reading systems</li> <li>3. To update existing recommendation</li> </ol>	



## Report of Interbeef Working Group

<b>Chair</b>	Brian Wickham, Ireland	
<b>Members</b>	<p><b>Working Group:</b></p> <ol style="list-style-type: none"> <li>1. Interbull Centre - Joao Durr (Joao.DurrLhgen.slu.se)</li> <li>2. Beef Working Group - Clara Diaz (cdiazginia.es)</li> <li>3. France - Laurent Griffon (Laurent.Griffonginst-elevaee.asso.fr)</li> <li>4. UK - Mike Coffey (mike.coffeygsac.ac.uk)</li> <li>5. Nordic Countries - Anders Fogh (ADF@landscentret.dk)</li> <li>6. Ireland-Brian Wickham bwickham@icbfcom</li> </ol> <p><b>Scientific Advisory Committee:</b></p> <ol style="list-style-type: none"> <li>1. Roel Veerkamp - Wageningen (Roel.Veerkamp@wur.nl)</li> <li>2. Dorian Garrick - Iowa State University (dorian@iastate.edu)</li> </ol> <p><b>Research Team</b></p> <ol style="list-style-type: none"> <li>1. INRA - Eric Venot (eric.venotgjut@inra.fr), Denis Laloe (laloe@dga2.jouy.inra.fr ga2.jouy.inra.fr)</li> <li>2. ICBF - Thierry Pabiou (tpabiou @icbfcom), Andrew Cromie (acromie@icbf.com)</li> <li>3. Interbull Centre - Flavio Forabosco (Flavio.Forabosco @hgen.slu.se)</li> </ol> <p><b>New Members from merging with ICAR Beef WG:</b></p> <ol style="list-style-type: none"> <li>1. Australia - Hans Graser (hgraser@une.edu.au)</li> <li>2. Italy - Mauro Fioretti (fioretti.m@aia.it)</li> <li>3. Germany -Friedrich Reinhardt (friedrich.reinhardt@vit.de)</li> <li>4. Austria –Birgit-Furst-Waltl (birgit.fuerst-waltl@boku.ac.at)</li> <li>5. South Africa -Japie Van der Westhuizen (japie@arc.agric.za)</li> <li>6. USA - Darrh Bullock(dbullock@uky.edu)</li> </ol>	
<b>Members left</b>	Isabelle Boulesteix, France	
<b>Meetings</b>	Last: January in Telford, UK- Monda 25`" January, 2010.	Next: June in Riga, Latvia-Tuesday 1 <sup>st</sup> June 2010
<b>Participation</b>	Full +: All members participating.	
<b>Key Agenda Issues</b> (as contained in Interbeef Strategic Plan developed during meetings in Barcelona)	<ol style="list-style-type: none"> <li>1. Extend time period &amp; review Governance - see draft report to ICAR Board dated 10th Feb 2010.</li> <li>2. Resolve integration with national evaluations - progressed at Telford</li> <li>3. meeting - ideally all data is assembled at the Interbull Centre.</li> <li>4. Finalize and launch the service - transfer from INRA nearing completion.</li> <li>5. Extend range of traits - calving and carcass have been chosen.</li> <li>6. Extend to use data on cross bred animals - database to be extended to record breed composition.</li> <li>7. Support genomics research</li> <li>8. Funding - approach to DG Sanco being made for funding to Interbull Centre as reference laboratory</li> </ol>	
<b>Important Decisions</b>	<ol style="list-style-type: none"> <li>1. Review of governance &amp; integration with Beef WG - final report with recommendations attached for ICAR Board decision.</li> <li>2. Business plan -to be considered further in Riga WG meeting.</li> <li>3. Funding - seeking development funding from EU.</li> <li>4. Recommendations from Scientific Advisory Committee - considered at Telford meeting and actions decided.</li> </ol>	
<b>Cooperation and links to other WG/TF/SC</b>	1. Interbull Sub Committee provided by Interbull Centre and joint activities.	
<b>Issues to be handled b the Board &amp; Deadline</b>	<ol style="list-style-type: none"> <li>1. Extension of term - May 2010</li> <li>2. Review of Governance - Ma 2010.</li> </ol>	
<b>Top 5 Issues for WG/TF/SC</b>	<ol style="list-style-type: none"> <li>1. Development of service for international evaluations of beef breeds and traits.</li> <li>2. Continue research on method development for international beef evaluations.</li> <li>3. Collaboration to facilitate use of genomic data in national and international beef evaluations.</li> <li>4. International survey of beef recording.</li> </ol>	





## Report of the Conformation Recording Working Group

<b>Chair</b>	Gerben de Jong, Netherlands, Gerben.de.Jong@crv4all.com		
<b>Members</b> <i>Name, organization, country and year joined, email contact</i>	László Bognár	Hungary	bognar@holstein.hu
	Gabriel Blanco	Spain	gabriel.blanco@conafe.es
	Lucy Andrews	UK	lucyandrews@holstein-uk.org
	Bethany Muir	Canada	bmuir@holstein.ca
<b>Meetings</b>	<u>Last:</u> 10 December 2009 3 March 2010	<u>Next:</u> October 2010 (skype)	
<b>Participation</b>	Full +:	Absence	
<b>Key Agenda Issues</b>	<ol style="list-style-type: none"> <li>1. Update of recommendations on 18 standard traits.</li> <li>2. Survey among non HF dairy/dual purpose breeds -&gt; adding 5 new traits to document with recommendations to improve further harmonisation.</li> <li>3. Description on how to improve data quality and transparency.</li> </ol>		
<b>Important Decisions</b>	<ol style="list-style-type: none"> <li>1. New document with recommendations.</li> </ol>		
<b>Cooperation and links to other WG/TF/SC</b>			
<b>Issues to be handled by the Board &amp; Deadline</b>	<ol style="list-style-type: none"> <li>1. Approval of the new recommendations.</li> </ol>		
<b>Top 5 Issues for WG/TF/SC</b>	<ol style="list-style-type: none"> <li>1. Survey among beef breeds and come up with list of standard traits for beef breeds.</li> <li>2. Extend group with people from beef breed societies.</li> </ol>		



## Report of Developing Countries Working Group

The Task Force for Developing Countries (TF-DC) was launched in March 2008. Its overall objective is to assist developing countries in planning and implementing sound and sustainable animal Identification and Recording systems.

The task force is composed of 8 members from (Namibia, South Africa, Argentina, Uruguay, India, Hungary and France) and is chaired by Badi Besbes (FAO). Only one member (Alexander Toto, Namibia) is from an organization which is not an ICAR member. The composition of the TF has changed over time. Gyula Meszaros (LPT, Hungary) did not contribute at all and was replaced by Mr Ben Jamaa (OEP, Tunisia). On his request, Mr Jean Noel Bonnet (IE, France) was replaced by his colleague Beatrice Balvay.

The task force combined e-mail discussions and physical meetings. Two meetings were organized in Budapest (Hungary, 2008) and in Porec (Croatia, 2009). The TF conducted a survey to assess the current status of animal identification and recording (AI&R) systems in 33 developing countries. Some of the results will be presented in Riga. A background paper was also prepared and will be submitted to ANG (previously AGRI). Outlines of decision-support guidelines for animal identification and recording in low and medium input production systems were discussed and drafted.

Despite these achievements, the chairman would like to express his concerns about the future of the TF. Despite all the efforts, the group suffers from a lack of motivation of some members. The attempt to attract new ones has not been successful so far. However, the major concern is the lack of financial resources. Most of the members would not have come to the meetings without financial support. Unfortunately, FAO will not be able to continue such a support.

The chairman of the TF-DC presents his apologies for not being able to participate to the board meeting and kindly seeks advice from the members of the board on how to sustain the activities of this TF.



**Report of the Recording, Evaluation and Genetic Improvement  
of Functional Traits in Dairy Cattle Working Group**

<b>Chair</b>	Erling Strandberg, Dept of Animal Breeding & Genetics, SLU, Sweden. Erling.Strandberg@hgen.slu.se	
<b>Members</b> <i>Name, organization, country and year joined, email contact</i>	<ol style="list-style-type: none"> <li>4. Lucy Andrews, Holstein UK, Scotsbridge House Rickmansworth, Herts, WD3 3BB (joined 2006) lucyandrews@holstein-uk.org</li> <li>5. Christa Egger-Danner, ZuchtData EDV-Dienstleistungen GmbH, Vienna, Austria (joined 2006) egger-danner@zuchtdata.at</li> <li>6. Nicholas Gengler, Gembloux Agricultural University, Belgium (original member) gengler.n@fsagx.ac.be</li> <li>7. Jennie Pryce, Dr Jennie Pryce, Senior Research Scientist, Biosciences Research Division, Department of Primary Industries, Victorian AgriBiosciences Centre, 1 Park Drive, Bundoora Victoria 3083, Australia (joined 2006) jennie.pryce@dpi.vic.gov.au</li> <li>8. Kathrin Friederike Stock VIT, Vereinigte Informationssysteme Tierhaltung w.V. Heideweg 1, 27283 Verden (Germany) Joined 2010. friederike.katharina.stock@vit.de</li> <li>9. Dr. John B. Cole, Research Geneticist Animal Improvement Programs Laboratory 10300 Baltimore Avenue BARC-West, Building 005, Room 306 Beltsville, Maryland 20705-2350. Joined 2010. john.cole@ars.usda.gov</li> <li>10. Andrew John Bradley; Stoke House, Stoke Street, Rodney Stoke, Cheddar, Somerset. BS27 3UP A.J.Bradley@bris.ac.uk</li> </ol>	
<b>Members left</b>	Ab Groen (original chairman); Johann Sölkner (original member)	
<b>Meetings</b>	<u>Last:</u> ICAR meeting Kuopio 2006	<u>Next:</u> part of group: in Riga 2010
<b>Participation</b>	Full +:	Absence: None
<b>Key Agenda Issues</b>	<ol style="list-style-type: none"> <li>11. Status of female fertility guidelines.</li> <li>12. Plan for feet and legs guidelines.</li> </ol>	
<b>Important Decisions</b>		
<b>Cooperation and links to other WG/TF/SC</b>	None	
<b>Issues to be handled by the Board &amp; Deadline</b>		
<b>Top 5 Issues for WG/TF/SC</b>	<ol style="list-style-type: none"> <li>13. Circulating female fertility guidelines and getting them approved</li> <li>14. Writing feet and legs guidelines (FLG)</li> <li>15. Circulating FLG and getting them approved</li> <li>16. Writing calving ease and stillbirth guidelines (CESG)</li> <li>17. Circulating CESG and getting them approved</li> </ol>	



## Report of Genetic Analysis Working Group

<b>Chair</b>	Paolo Ajmone Marsan (IT; chair)
<b>Members</b>	<ol style="list-style-type: none"> <li>1. Marie-Yvonne Boscher (FR)</li> <li>2. Brent Woodward (US)</li> <li>3. Elena Genzini (IT)</li> <li>4. Wim Van Haeringen (NL)</li> <li>5. Marco Winters (UK)</li> <li>6. Bianca Lind (DE)</li> <li>7. Kevin Lang (CA)</li> </ol>
<b>Activity 2009-2010</b>	<p>Below are schematically described news and activities of the WG in 2009 and 2010</p> <ol style="list-style-type: none"> <li>1. Bianca Lind from FBF, DE has joined the Working Group</li> <li>2. Applications for ICAR accreditation of laboratories running parentage testing in cattle with microsatellites have been evaluated. In total 10 applications were examined and 10 positively evaluated. These laboratories have ICAR accreditation for years 2009 and 2010</li> <li>3. Questionnaires and Instructions for application have been revised and updated. New versions have been uploaded on the web site. Starting from 2010 call for application lab certification is considered a minimum requirement.</li> <li>4. The call for application for year 2010 has been launched on 24/2/2010. Nine applications have been received and are to be evaluated.</li> <li>5. The use of SNP in paternity test has been discussed. The ISAG SNP ring test is under constant monitoring and proposals on how ICAR will accreditate the use of SNPs in paternity testing will be formulated after the presentation of the ring test results at the next ISAG conference in Edinburgh (July 26-30, 2010).</li> <li>6. Contact has been maintained by conference call and by mail. A meeting is now planned during the Edinburgh ISAG meeting, after the presentation of the results of the ISAG SNP ring test.</li> <li>7. A proposal under discussion is to have ICAR set up an on-line database for SSR marker profile and data storage and exchange between accredited labs. Input and output of data should be allowed in different formats. Access to profiles and data should be regulated in agreement with data owners. The initiative is in line with ICAR mission of facilitating the exchange of information around the world.</li> </ol>





## Report of the Lactation Calculation Methods Working Group

<b>Chair</b>	Filippo Miglior, Agriculture and Agri-Food Canada, miglior@cdn.ca, since 1998	
<b>Members</b> <i>Name, organization, country and year joined, email contact</i>	<ol style="list-style-type: none"> <li>1. Zengting Liu, VIT, Germany, zliu@vit.de</li> <li>2. Sophie Mattalia, Institute de l'Elevage, France, sophie.mattalia@dga.jouy.inra.fr, since 2004</li> <li>3. Larry Schaeffer, University of Guelph, Canada, lrs@uoguelph.ca</li> <li>4. Mauro Fioretti, AIA, Italy, fioretti.m@aia.it, since 2010</li> <li>5. Paul VanRaden, AIPL - USDA, United States, paul@aipl.arsusda.gov, since 1998</li> <li>6. Gerben de Jong, NRS, The Netherlands, Jong.G@nrs.nl, since 2008</li> </ol>	
<b>Members left</b>	Alessia Tondo, AIA, Italy, tondo.a@aia.it, 2004-2009, replaced by Mauro Fioretti, AIA, Italy, fioretti.m@aia.it, since 2010	
<b>Meetings</b>	Last: June 2008, Niagara Falls, US	Next June 2010, Latvia
<b>Participation</b>	Full +:	All present
<b>Key Agenda Issues</b>	<ol style="list-style-type: none"> <li>1. Development of guidelines for milk recording from on-line sampling at farm</li> <li>2. Development of guidelines for milk recording from Electronic Milk Meters</li> <li>3. Update of guidelines for milk recording from alternate milk recording from regular milking parlors and from robotic systems</li> </ol>	
<b>Important Decisions</b>	<ol style="list-style-type: none"> <li>1. To perform additional research using data from Electronic Milk Meters</li> <li>2. Obtain data from herds where Afilab has been installed</li> </ol>	
<b>Cooperation and links to other WG/TF/SC</b>	Full cooperation with Sub-committee of recording device and with newly formed Working Party on On-Farm Milk Analysis	
<b>Issues to be handled by the Board &amp; Deadline</b>		
<b>Top 5 Issues for WG/TF/SC</b>	Analyze data from on-farm analyzers in order to draft guidelines for milk recording in farms with daily milkings and analysis	



## Report of Goat Milk Recording Working Group

<b>Chair</b>	Zdravko Barac, Croatian Agriculture Agency, Croatia	
<b>Members</b>	<ol style="list-style-type: none"> <li>1. Drago Kompan, University of Ljubljana (2004); Drago.Kompan@bfro.uni-lj.si</li> <li>2. Jean-Michel Astruc, Institut de l'Elevage - INRA-SAGA (France, 2004); astruc@germinal.toulouse.inra.fr</li> <li>3. Christina Ligda, National Agricultural Research Foundation (N.AG.RE.F.) (Greece, 2004); chligda.arsc@nagref.gr</li> </ol>	
<b>Members left</b>		
<b>Meetings</b>	<u>Last:</u> (dates & location here) 17. June, Niagara Falls, 16.00-18.00	<u>Next:</u> (dates and location here) June, 2. 2010, Riga
<b>Participation</b>	Full +: Marija KLOPCIC+ Andreas GEORGOUDIS + Klemen POTOČNIK	Absence: Christina LIGDA
<b>Key Agenda Issues</b>	<ol style="list-style-type: none"> <li>1. To prepare "on line" database to fill in his own results for each countries</li> <li>2. To promote information on goat milk recording practice</li> <li>3. To continue harmonize the milk recording method</li> <li>4. To include other characteristic, like litter size, management</li> <li>5. To include non milked goat breed for meat production</li> <li>6. To establish the standards for meat recording in goat breed?</li> </ol>	
<b>Important Decisions</b>	<p>We are discussing all topics.</p> <p><b>1. On-line data collection the Tables proposed on WG meeting 17. June was:</b></p> <ol style="list-style-type: none"> <li>1. Total number of population and recorded population by breed in country</li> <li>2. Recording methods</li> <li>3. Methods of lactation calculation and milk yield by breeds</li> <li>4. Recording of non-milking traits</li> <li>5. Equipment for recording</li> <li>6. Type of production (organic, conventional) and type of milking (machine, by hand)</li> <li>7. Traits, which are included in breeding goals</li> </ol> <p><b>Conclusions</b></p> <p>Increasing importance of simplification of milk recording was discussed and the great diversity in lactation calculation between the countries Big differences in milk yield between breeds and countries The development of optional recordings: milk composition and non-3. milking traits are important It is necessary closely cooperation with other ICAR WG We are proposed to include of meat traits (daily gain, classification by slaughtering or some other meat traits and preparing some draft guidelines for meat traits by meat goats Discussion was to include the fertility and health traits in data sets and some other traits (morphology, functional traits...)? To establish Inter-goat centre for EBW of bucks (for example Boer breed) was proposed?</p>	
<b>Cooperation and links to other WG/TF/SC</b>	Collaboration with WG Milk recording on sheep and Working group on AI and other relevant technologies	
<b>Issues to be handled by the Board &amp; Deadline</b>	<ol style="list-style-type: none"> <li>1. To help secretariat on establish goat database for country/breed data on milk recording and milk quality</li> <li>2. To manage the database with restricted online data management</li> </ol>	
<b>Top 5 Issues for WG/TF/SC</b>	<ol style="list-style-type: none"> <li>1. Changes in the constitution of the working group - Renewal of the members of the group.</li> <li>2. Discussion about preparing "on line" database to fill in his own results for each countries</li> <li>3. Enhance members' interest to the yearly enquiry</li> <li>4. Tackle the problem of some point of the guidelines</li> <li>5. To establish the standards for meat recording in goat breed?</li> </ol>	



## Report of Milk Recording in Sheep Working Group

J.M. Astruc<sup>1</sup>, F. Barillet, A. Carta, E. Gootwine, D. Kompan, F.J. Romberg, A. Tondo, E. Ugarte

<sup>1</sup>Institut de l'Élevage, BP 27, 31326 Castanet-Tolosan, France

*Working group members: Jean-Michel Astruc (France-chairman), Francis Barillet (France), Antonello Carta (Italy), Alessia Tondo (Italy), Elisha Gootwine (Israel), Drago Kompan (Slovenia), Franz-Josef Romberg (Germany), Eva Ugarte (Spain)*

### **Abstract**

The report of the working group on milk recording in sheep presents an overlook of its activities over the last two years, in relation with the terms of reference of the group. The main activities have concerned the on-line enquiry, which is open to every ICAR members which would like to enter data. The report focuses on the valorization of the data base, using data from 11 countries. Emphasis is given on the increasing use of simplified methods of quantitative and qualitative recording. Another important activity is the cooperation with other bodies of ICAR, especially in relation with recording devices, about the requirements of the accuracy of the devices. New prospects are on-going, related to the guidelines (relevance of the guidelines in some situations, inclusion of udder morphology in the guidelines).

*Keywords : dairy sheep, milk sheep, milk recording, guidelines, ICAR.*

## **1.0 Introduction**

The terms of reference of the Working Group on Milk Recording in Sheep (MRSWG) may be synthesized in four main items: evolution of the guidelines, cooperation with relevant bodies of ICAR, dairy sheep enquiry, contact with non-ICAR organizations in the dairy sheep field. The main activities of the MRSWG during the last 2 years have focused, firstly on the cooperation within ICAR, especially with the sub-committee involved in recording devices, secondly on the on-line enquiry implemented since May 2006, and thirdly on the perspectives of work. A valorization of the on-line enquiry is presented in this report, permitting to establish the state of the art on different topics related to the terms of reference of the working group. Basically, a key objective of the group is to spread simplified methods of recording, especially qualitative recording, while keeping the relevance of the measures for genetic purposes. The objective is also to cope with new traits, such as udder morphology.

## **2.0 Main activities of the working group during the last two years**

### **2.1 Constitution of the Working Group**

We started 2 years ago a process for renewing the members of the Working Group, after some "historical" members have retired or left the group. In this context, Antonello Carta and Eva Ugarte entered the group in 2008. In 2010, Alessia Tondo from AIA is proposed to replace Mauro Fioretti. Moreover, as the chair of the Goats Working Group has changed (Zdravko Barac from Croatia has replaced Drago Kompan from Slovenia), Zdravko Barac naturally should become member. Finally, discussions are on-going to introduce a Greek member, in order to have a representative of the larger European country regarding the dairy sheep population. The actual members are:

- -Jean-Michel Astruc, Institut de l'Élevage, France
- -Zdravko Barac, Croatian Agricultural Agency, Croatia

- -Francis Barillet, INRA, France
- -Antonello Carta, AGRIS Sardinia, Italy
- -Alessia Tondo, AIA, Italy
- -Elisha Gootwine, Volcani Center, Israel
- -Drago Kompan, University of Ljubljana, Slovenia
- -Franz-Josef Romberg, Dienstleistungszentrum Ländlicher Raum Westpfalz, Germany
- -Eva Ugarte, Neiker, Spain

## ***2.2 Meetings involving the Working Group of Milk Recording in Sheep***

Meetings of the Working Group - The last meeting of the MRS WG was held in Niagara Falls (USA) on 17th of June 2008 with 5 attending participants. The main issues of the agenda were the changes in the constitution of the Working Group, the overview of the main activities of the group over the last 2 years, the presentation of the results of the on-line dairy sheep enquiry, the co-operation with other ICAR bodies (recording device, milk analysis, recording of goats), the perspectives of work.

The next meeting will be held in Riga on the 1st of June 2010. Between two biennial sessions, the exchanges are mainly done by e-mail.

Meeting of the ICAR Board with Chairperson in Porec (Croatia) on 11th May 2009 – The chairman of the Working Group did not attend this meeting. A synthesis of the work of the group had been sent before.

## ***2.3 Updating the ICAR Guidelines of sheep milk recording***

The last evolutions date back to 2005 and are reported in the guidelines published in the booklet "International Agreement of Recording Practices" (ICAR guidelines, 2008), in the section 2.2.

A new issue was raised at Niagara Falls by Antonello Carta, about difficulties to meet the guidelines in some conditions: (a) due to difficulties in organizing the milk recording and reproduction activities for a large number of ewes, some large size flocks have a part of the ewes which are registered and another part non-registered (there is no evidence of preferential treatments of the registered part of the flock); (b) some farmers are used to milking part of the flock twice and another part only once; this practice is particularly spread at the end of the milking period (May-June-July) when pre-milking ewes are always milked twice while adult ewes are often progressively dried-off by decreasing the milking frequency.

These two points make the AC recording difficult to implement and might exist in other situations/countries and must therefore be tackled by the MRS WG. To go further, it has been demanded to Antonello Carta a short report to present the problem at the meeting of Riga, in order to propose if necessary emendations of the guidelines, or at least recommendations or experimentations/studies to face this situation.

In addition, it was intended to develop a glossary of the main terms specifically related to dairy sheep. This task has not yet been completed.

## ***2.4 Co-operation with the relevant Sub-Committees and Working Groups of ICAR***

The MRS WG co-operated over the last 2 years with the following bodies of ICAR:

-Cross-participation with the Working Group on Milk Recording in Goats, the chairman of each group participating at the work of the other group.

Co-operation with the Sub-Committee on Milk Recording Devices about the requirements for sheep. As the requirements in cattle has been relaxed, the concern is about the opportunity to relax or not the requirements of the meters in sheep as well. Up to now, and regarding the fact that two meters

have been agreed for sheep over the last 4 years, the group considers the guidelines as relevant. Nevertheless, this issue must be discussed at the next meeting of the group in Riga.

## **2.5 Dairy sheep enquiry on-line**

Since May 2006, the on-line database has been ready to accept submission of data. The database has been developed with the help of ICAR Secretariat. The purpose was to get data about the situation of milk recording in sheep, and related connected issues such as breeding schemes, selection criteria, molecular information in sheep, recording devices. This annual survey constitutes one of the main terms of reference of the MRS WG.

The dairy sheep enquiry is divided in 7 tables, representing 7 different topics.

- -Basic information on population, recording methods and percentages
- -Milk yield: type of lactation calculation + milk yield results
- -Optional test for milk composition
- -Recording of non-milking traits
- -Milk recording equipment used in case of machine milking
- -Breeding programs using insemination (AI)
- -Molecular information

The raw data of the survey will be put on the ICAR Website.

The first results of the on-line enquiry were presented at the Niagara Falls Session: general presentation at the Technical Session on Sub-Committees, Task Forces and Working Groups, detailed presentation at the meeting of the WG. Moreover, the slides synthesizing the data are available on the ICAR website, in the page dedicated to the Milk Recording of Sheep WG ([http://www.icar.org/pages/working\\_groups/wg\\_sheep\\_milk.html](http://www.icar.org/pages/working_groups/wg_sheep_milk.html)).

Basically, all ICAR members should have answered the enquiry, even to declare no dairy sheep breeding. Finally, members with no dairy sheep milk recording do not answered the enquiry. More disappointing, some countries with substantial population of dairy sheep do not answer the questionnaire, despite sometimes several recalls.

On the whole, since 2008, 10 countries have answered the on-line enquiry at least once, a 11th country sending information without using the ICAR site. We acknowledge these countries for this co-operation and for their help to have an updated overview of the situation of dairy sheep milk recording.

The main results of the on-line enquiry are described below. Additional tables which could not be included in this report are available on the ICAR website.

## **3.0 Dairy sheep enquiry on-line: situation of milk recording in dairy sheep**

### **3.1 Situation of milk recording in dairy sheep**

The table 1 summarizes the impact of milk recording in the countries having answered the on-line enquiry over the last 3 years.

Official milk recording is carried out in every country and represents on the whole 1,209,305 ewes. If we look at the countries with the largest dairy sheep population, situated in the Mediterranean area (Greece, Italy, Spain, France), the impact of milk recording is quite different: high in France (57.6% on the whole, 20.9% when considering only official milk recording), medium in Spain and Italy (respectively 10.0% and 8.5%), low in Greece (1.3%). Italy has the highest recorded population (480,000 ewes). Italy, France and Spain represent 89% of all sheep in official milk recording.

In the other countries, with smaller population, milk recording represents few flocks and ewes, from 488 ewes in Belgium to 18,600 ewes in Israel. The other countries are (ordered by ascending number of recorded ewes): Germany, Czech Republic, Slovenia, Croatia, Slovak Republic.



Table 1. Size of population of dairy sheep, impact of quantitative recording and recording designs in ICAR member countries.

Countries Year	Size of population	Quantitative recording (official milk recording)		Methods used
		Number of recorded ewes	% recorded ewes	
Belgium 2009	593	488	82.0	AT
Croatia 2009	34,500	7,770	22.5	AT
Czech Rep. 2009		821	-	AT (part), E (part)
France 2009	1,445,000	301,823 <sup>1</sup>	20.9	AC
Germany 2009	8,204	638	7.8	A4 (34%), AT (29%), E (37%)
Greece 2007	7,034,000 <sup>2</sup>	90,834	1.3	A4
Israel 2007	35,000	18,600	53.1	On-farm, daily basis
Italy 2009	5,617,000 <sup>2</sup>	479,897	8.5	AT, AC
Slovak Rep. 2009	220,000 <sup>2</sup>	17,884	8.1	AC
Slovenia 2009	4,900	3,749	76.5	AT
Spain 2008	3,064,000	305,402	10.0	AT (77%), A C (18%), A4 (5%)

<sup>1</sup> In addition, 531,299 ewes are recorded with D method (non official milk recording) without qualitative recording

<sup>2</sup> Figure from <http://faostat.fao.org/>

The table 2 illustrates the increasing impact of official milk recording in most of the countries over the last 20 years. This growth has been favored by the steadily increasing adoption of simplified design of official milk recording, such as AT or AC method. Whereas in 1988, 2 countries only used simplified method (France with AC method, Spain with AT method in Latxa breed), this number reached up to 6 countries in 1998, and 8 countries in 2009. Promoting simplified methods of milk recording has been a leitmotiv of the Working Group since it has been created in the eighties, with the aim to compensate as far as possible the high cost of recording in small ruminants by reducing the number of measures.

The use of the D method, which is a non-official and "free-of-rules" milk recording, is described only in France. In France, this very simplified method consisting in 2 to 4 flock-visits per year, whatever the visit intervals (monthly to bimonthly), is implemented out of the nucleus scheme and is mainly devoted to a within-flocks valorization to help the breeder to optimize culling and replacement. D method is a quantitative recording.

The additional tables, available on the ICAR website, show that three breeds are up to 100,000 recorded ewes: Sarda and Valle de Bèlice (Italy), Lacaune (France). Sarda breed has the more important population with nearby 250,000 recorded ewes.

Table 2. Evolution of official milk recording over the last 20 years in ICAR member countries.

1988				1998				2010			
Record	ed ewes (official)	% Method		Recorded ewes (official)	% Method		Recorded ewes (official)	% Method			
Italy	140,000	2.8	A4	331,024	5.0	A4	479,897	7.8	AT /AC		
France	202,000	16.8	AC	281,070	20.9	AC	301,823	20.9	AC		
Spain	110,000	2.8	AT	141,044	6.2	AT	305,402	10.0	AT/AC/A4		
Greece	37,000	0.5	A4	26,600	0.3	A4	90,834	0.8	A4		
Portugal	7,600	1.5	A4	38,571	15.2	A4/AT	-	-	-		
Croatia	-	-	-	-	-	-	7,770	22.5	AT		
Israel	-	-	-	6,200	12.4	B4/AC	18,600	53.1	-		
Slovak R.	-	-	-	5,100	2.3	A4/AC/AT	17,883	8.3	AC		
Slovenia	-	-	-	1,474	19.8	A4	3,749	76.5	AT		
Germany	356	2.2	A4	836	3.3	A4/B4	638	7.8	A4/AT/E		
Czech R.	-	-	-	177	35.0	AT	821		AT/E		
<b>Total</b>	<b>496,956</b>			<b>832,096</b>			<b>1,227,417</b>				

Table 3. Qualitative recording in ICAR member countries.

Q	Qualitative recording				
	Countries Yes/Not	Recorded ewes	% of the recorded ewes	Method used	Categories of ewes (lactation)
Belgium	No	-	-	-	-
Croatia	Yes	4,619	59%	AT	
Czech Republic	Yes	821	100%	AT/E	
France	Yes	84,166	28%	Part-lactation sampling (AC)	Lacaune : L1/L2 Pyrenean breeds : L1
Germany	Yes	602	100%	A4/AT/E	
Greece	Yes	?	?		
Israel	No	-	-	-	-
Italy	Yes	25,108	5%	Part-lactation sampling (AC)	Sarda : L1
Slovak Republic	Yes	17,883	100%	AC	L1/L2/L3
Slovenia	Yes	3,749	100%	AT	
Spain	Yes	?	?	AT,AC	

### 3.2 Simplification of qualitative recording in dairy sheep

Conversely to dairy cattle, qualitative milk recording is optional in official milk recording in sheep, as established in the ICAR guidelines (ICAR guidelines, 2008), considering that the cost of qualitative milk recording may be crippling and that qualitative recording becomes useful and necessary only when selection on milk yield is efficient. Simplified designs are strongly recommended to reach some cost-effectiveness. The main features of the table 3 can be summarized as following:

- The impact of qualitative recording among the recorded population is high only in countries with a quite small population (from 59% in Croatia to 100% in Czech Republic, Germany, Slovak Republic and Slovenia).
- In countries with a large population, the impact reaches 41% in Spain, 28% in France and 6% in Italy. Qualitative recording concerns only some breeds, some parities (lactation 1 or lactation 1 and 2). It is implemented within a simplified design of milk recording, with one sample per test-day (AC or AT method).

### 3.3 Definition of milk traits (see additional table on [www.icar.org](http://www.icar.org))

Regarding the diversity in the exploitation of the lactation through milking ([a] milking-only period preceded by a 1-2 month suckling period before the weaning of the lamb(s) in most breeding systems; [b] milking from lambing in some other systems as in Germany, Israel, and more and more in Spain), the guidelines have precisely described the different terms of lactation calculation according to the system. Moreover, without ruling out any type of calculation, ICAR has recommended to compute the lactation at the milking-only period (TMM = total milked milk) in the system [a] and the total milk yield (TMY) in the system [b].

Actually, the yields given in the enquiry still show a large diversity in the methods of computation, preventing from any comparison between breeds/countries.

### 3.4 Milk recording equipment (see additional table on [www.icar.org](http://www.icar.org))

ICAR has recently agreed two on-farm milk meters for sheep. No portable meter has been agreed until now. The enquiry underlines wide variety of devices (jars or meters, measuring volume or weight, with or without sampler, from local or multinational manufacturers) used in the different countries. The questionnaire should be adapted, at least to enhance the impact of these newly agreed meters that cannot be detected with the current answers.

### 3.5 Breeding schemes, objective and selection criteria

Breeding programs based on progeny-test of rams by AI or by combining AI and controlled natural mating are implemented in a few breeds, in France, Italy and Spain (table 4). AI is not widespread (at the exception of France) and is mostly realized in fresh semen. 573,570 AI are realized in France, Italy and Spain, 84% of them in France. AI is practiced with a low dilution and with synchronization of the heat (one AI per ewe, whatever the result, return being realized by natural mating). The selection criteria are still based on milk yield on most situations, with, in addition, fat, protein (Churra), udder morphology (Sarda). Only the Lacaune breed has included in its selection criteria somatic cell count (SCC) and udder morphology in addition to the production traits, giving the same weight on the one hand to production traits and on the other hand to udder functional traits (SCC and udder morphology).

The strategy of implementing efficient breeding program for local breeds seems to have had different kind of achievements, according to the countries / breeds. Indeed, some "foreign" breeds are more and more spread in more and more countries: East Friesian in the northern and central European countries, Assaf particularly in Spain, Lacaune everywhere. Both Lacaune and East Friesian are mentioned as recorded in Spain, Italy, Slovak Rep., Germany, Czech Rep. For the first time in 2008, recording of Assaf and Lacaune breeds are reported in Spain, with a quite important recorded population of 76,000 ewes (one fourth of all recorded ewes in Spain).

### 3.6 Other topics

Other additional tables ([www.icar.org](http://www.icar.org)) present information about the following topics: molecular information in sheep and recording of other traits.

Table 4. Importance of breeding programs and selection criteria <sup>1</sup>.

Country	Breed	AI progeny-tested rams	AI	Selection criteria <sup>2</sup>
France (2009)	Lacaune	445	395,812	(FY+PY+F%+P%) + .5 SCC + .5 Udder
	Manech Red face	151	56,760	FY+PY+F%+P%
	Manech Black face	36	7,869	FY+PY+F%+P%
	Basco-Béarnaise	52	14,128	FY+PY+F%+P%
	Corse	31	6,336	MY
Italy (2007)	Sarda	60	13,500	MY + Udder
Spain (2008)	Latxa blond faced	30	9,210	MY
	Latxa black faced	50	15,103	MY
	Karrantzana	2	300	MY
	Manchega	150/175	35,764	MY
	Churra	51	12,300	MY + P%
	Assaf	60	6,488	

<sup>1</sup> MY=milk yield, FY=fat yield, PY=protein yield, F%=fat content, P%=protein content, SCC=somatic cell count, Udder=udder morphology

<sup>2</sup> most of the breeding schemes include selection for scrapie resistance (PrP gene)

## 4.0 Conclusion

Over the last two years, the Milk Recording of Sheep WG has mainly focused, a part the on-line enquiry and its valorization, on starting new topics and maintaining co-operation with other bodies of ICAR, especially in the field of recording devices. Among the new topics, the group must cope with the specific situation where meeting the guidelines is difficult. It should be proposed emendations of the guidelines in the next few years. Moreover, it is intended to prepare a glossary of the main specific terms of the guidelines for sheep, to describe in the guidelines the scoring of udder morphology made by different countries. The issue of the requirements about the agreement of recording devices is recurrent and is still discussed. Relaxing the requirements is not relevant with the challenge of the group which encourages simplified methods of recording, especially for qualitative recording, while keeping enough relevance to each individual measure. Finally, the

on-line enquiry is a useful and collective tool that should be filled in by all the countries with dairy sheep population.

## 5.0 References

FAOSTAT. <http://faostat.fao.org/>

ICAR guidelines, 2008. International Agreement of Recording Practices. Guidelines approved by the General Assembly held in Niagara Falls, USA. 18 June 2008. Section 2.2, pp.57-67.

[http://www.icar.org/Documents/Rules%20and%20regulations/Guidelines/Guidelines\\_2009.pdf](http://www.icar.org/Documents/Rules%20and%20regulations/Guidelines/Guidelines_2009.pdf)

ICAR website. [www.icar.org](http://www.icar.org)



## Report of the Parentage Recording Working Group

<b>Members</b>	<ol style="list-style-type: none"> <li>1. Gerard van Logtestijn, CRV , NL, 2010, Gerard.van.Logtestijn@crv4all.com</li> <li>2. Jean Marc Vacelet, Organisme de selection de la race Montbeliarde, FR, 2007, Vacelet@montbeliarde.org</li> <li>3. Juergen Duda, LKV Munchen, DE, 2007, Juergen.duda@lkv.bayern.de</li> <li>4. Suzanne Harding, Holstein UK, UK, 2008, Suzanne@holstein-uk.org</li> <li>5. Suzan Tellez, Resource Computing, US, sztellez@aol.com</li> </ol>	
<b>Members left</b>	Dick Koorn, CRV, NL, 2007, Koorn.d@nrs.nl	
<b>Meetings</b>	<u>Last:</u> June 17th, Niagara Falls	<u>Next:</u> 1 <sup>st</sup> June, Riga
<b>Participation</b>	Absent: Juergen Duda	Absent:
<b>Key Agenda Issues</b>	<ol style="list-style-type: none"> <li>1. Review TOR</li> <li>2. Parentage Survey Results</li> <li>3. Update on Genetic Analysis WG</li> <li>4. Update on Genomics</li> <li>5. SNP Parentage Verification</li> <li>6. Working plan</li> <li>7. AOB</li> </ol>	
<b>Important Decisions</b>	<ol style="list-style-type: none"> <li>1. Publish survey results</li> <li>2. SNP Parentage Verification Timeline</li> </ol>	
<b>Cooperation and links to other WG/TF/SC</b>	<ol style="list-style-type: none"> <li>1. Genetic Analysis WG</li> <li>2. AI WG</li> </ol>	
<b>Issues to be handled by the Board &amp; Deadline</b>		
<b>Top 5 Issues for WG</b>	<ol style="list-style-type: none"> <li>1. SNP Parentage Verification Timeline</li> <li>2. Survey results</li> <li>3. Working Plan</li> </ol>	



Cow milk enquiry 2008-2009

Table 1 - National milk production



Year	Country	Total number of dairy cows	Total number of dairy herds	Average of cows per herd	Average milk production per cow per year (kg)	Percent of fat production per cow per year (%)	Percent of protein production per cow per year (%)
2008	Australia	1,700,000	7,953	214	5,414	4.10	3.32
2008	Austria	530,221	48,362	11.0	6,059	4.10	3.35
2009	Austria	532,976	47,499	11.2			
2008	Belgium (Wallonia Region)	217,716	5,150	42.3	5,905	4.00	3.09
2009	Belgium (Wallonia Region)	218,920					
2008	Canada	988,500	13,587	72.8	8,456	3.84	3.24
2009	Canada	978,400	13,214	74.0	8,458	3.85	3.23
2008	Chile	483,041	18,900	26	5,306	3.59	3.35
2009	Chile	476,077	18,522	26	4,845	3.91	3.36
2008	Croatia	202,920	27,632	7.3	3,950	4.09	3.32
2008	Czech Republic	403,638			6,959	3.86	3.35
2009	Czech Republic	394,122			7,055	3.85	3.33
2008	Denmark	555,000	4,600	120	8,200	4.26	3.41
2009	Denmark	560,000	4,300	130	8,700	4.29	3.44
2008	England	174,055	1,077	161	7,733	4.07	3.33
2009	England	185,000	1,158	159	7,876	4.10	3.30
2008	Estonia	103,000	5,621	18.3	6,765	4.00	3.30
2009	Estonia	99,617	4,781	20.8	6,849	4.10	3.30
2008	Finland	288,800	12,270	23.5	8,185	4.20	3.44
2008	France	3,758,600	92,000	40.1	6,105	4.14	3.49
2009	France	3,793,600	86,000	44.1			
2008	Germany <sup>1</sup>	4,229,138	99,431	42.3	6,827	4.14	3.39
2009	Germany <sup>2</sup>	4,169,349	95,766	43.5	6,900	4.13	3.40
2008	Hungary	264,000	188,00	14.0	6,788	3.68	3.24
2009	Hungary	249,000	175,00	14.5	6,920	3.67	3.29
2008	Iran <sup>3</sup>	450,000	77,273	6		3.61	3.25
2008	Ireland	1,104,800	22,010	50.2	4,720	3.81	3.34
2008	Israel <sup>4</sup>	103,895	689	151	11,461	3.62	3.20
2009	Israel <sup>5</sup>	97,921	675	145	11,653	3.60	3.20

<sup>1</sup> Number of dairy cows out of the national database; modified method of counting

<sup>2</sup> Production estimated

<sup>3</sup> Cross-bred mainly native x holstein

<sup>4</sup> Cows in herdbook

<sup>5</sup> Cows in herdbook



Cow milk enquiry 2008-2009

Table 1 - National milk production



Year	Country	Total number of dairy cows	Total number of dairy herds	Average of cows per herd	Average milk production per cow per year (kg)	Percent of fat production per cow per year (%)	Percent of protein production per cow per year (%)
2008	Italy <sup>6</sup>	1,831,000	40,207	45.5			
2008	Japan	985,200	22,300	44.2			
2008	Latvia	170,361	35,739	4.7	4,822		
2008	Lithuania	392,897	111,668	3.5			
2009	Lithuania	367,449	102,260	3.6			
2008	New Zealand	4,252,881	11,618	366	3,829	4.87	3.64
2008	Norway	249,000	12,244	20	6,921	4.19	3.39
2009	Norway	249,080	12,270	20.3	7,057	4.22	3.37
2008	Poland	2,696,934			4,621	3.97	3.23
2009	Poland	2,606,094	486,470	5.4	4,714	4.02	3.23
2008	Slovak Republic	172,300	1,039	166	6,025	3.74	3.29
2009	Slovak Republic	162,485	1,236	131	5,770	3.73	3.33
2008	Slovenia	107,239	8,608	12.5	4,985	4.08	3.33
2009	Slovenia	106,500	8,565	12.4	4,955	4.07	3.31
2008	South Africa	521,750	3,665	142	4,964	4.18	3.33
2009	South Africa	535,500	3,458	155	4,975	4.05	3.28
2008	Spain	888,286	38,900	22.8	6,644	3.72	3.22
2009	Spain	838,000	36,700	22.8			
2008	Sweden	365,561	6,562	54.4	8,372	4.21	3.28
2009	Sweden	356,776	6,137	58.1	8,321	4.24	3.40
2008	Switzerland	726,875	39,564	18.4	5,717	3.97	3.29
2008	The Netherlands	1,466,134	20,746	71	7,926	4.37	3.50
2008	Turkey	4,080,243	2,074,439	2	2,679		
2008	UK (England & Wales)	774,493	5,306	146	9,010	4.03	3.21
2009	UK (England & Wales)	716,107	4,782	150	9,090	4.00	3.30
2009	UK Jersey Island	2,996	29	103	4,311	5.22	3.90
2008	UK Northern Ireland	101,679	790	128	6,764	4.02	3.32
2009	UK Northern Ireland	92,285	722	127	6,570	4.15	3.34
2008	UK Scotland (by Holstein UK)	104,555	626	167	7,451	3.93	3.31
2009	UK Scotland (by Holstein UK)	104,287	619	168	7,563	3.99	3.29
2008	UK Wales	19,586	148	132	7,263	4.21	3.35
2009	UK Wales	21,928	156	140	7,517	4.22	3.33

<sup>6</sup> Total number of dairy herds: data from BDN (National Bovine Data Bank)

Cow milk enquiry 2008-2009



Table 1 - National milk production

Year	Country	Total number of dairy cows	Total number of dairy herds	Average of cows per herd	Average milk production per cow per year (kg)	Percent of fat production per cow per year (%)	Percent of protein production per cow per year (%)
2009	USA (by AgSource)	610,307	4,319	141	10,744	3.70	3.10
2009	USA (by NDHIA)	9,201,000	54,942		9,353		
2008	USA (by NDHIA)	9,315,000	57,127		9,271	3.68	

Cow milk enquiry 2008-2009



Table 2 - Position of milk recording (Methods and Organisations)

Year	Country	Number of recorded cows	Percent of recorded cows	Number of recorded herds	Percent of recorded herds	Average number of cows per recorded herd	Percent of recorded herds per method A3	Percent of recorded herds per method A4	Percent of recorded herds per method A6	Percent of recorded herds per method AT	Percent of recorded herds per method B	Notes
2008	Australia	785,462	46	3,966	50	198						
2008	Austria	385,411	72.7	23,991	49.6	16.1				100		
2009	Austria	390,031	73.2	23,676	49.8	16.5				100		
2008	Belgium (Wallonia Region)	76,460	35.1	1,263	24.5	60.5	0			0		
2009	Belgium (Wallonia Region)	71,042	32.5	1,138		62.4	0					
2008	Canada	706,957	71.5	10,025	7.38	70.5						
2009	Canada	711,810	72.8	9,859	74.6	72.4						
2008	Chile	127,224	26.3	535	2.8	237		94.8				5.2
2009	Chile	125,452	26.4	595	3.2	211		40.6		33.3		26.1
2008	Croatia	120,001	59.1	9,122	33.0	7.6				60.5		39.5
2008	Czech Republic	390,129	96.7	2,181		179		99.3		0.7		
2009	Czech Republic	373,199	94.7	2,039		183		99.3		0.7		
2008	Denmark	525,000	94	4,000	92	127		10				90
2009	Denmark	516,441	92	3,817	89	135	0	10		0		100
2008	Estonia	94,671	91.9	1,276	22.7	74.2						100
2009	Estonia	92,282	92.6	1,136	23.8	81.2						100
2008	Finland	227,876	78.9	8,725	71.1	26.1		0				97.3
2008	France	2,665,684	71	58,409	63	45.6		44.7	6.9	AT4=10% AT5=5% AT6=1.8%	B4-5-6-7=3% BT4-5-6=0.1% BR4-5-6-7=1.1% BZ4-5-6=0.2%	A5=20.9% A7=3.7 AR4-5-6-7=0.7% CZ4-5-6=2%
2009	France	2,561,748	68	55,621	65	46.1		42.6	7.2	AT4=10.6% AT5=5.1% AT6=2%	B4-5-6-7=3.6% BT4-5-6=0.1% BR4-5-6-7=1.9% BZ4-5-6=0.2%	A5=19.4% A7=4% AR4-5-6-7=1% CZ4-5-6=2.3%
2008	Germany	3,534,548	83.6	64,524	64.9	54.8		44.2		26.5		28.2
2009	Germany	3,492,652	83.8	62,017	64.8	56.3		42.4		26.4		29.3

Cow milk enquiry 2008-2009



Table 2 - Position of milk recording (Methods and Organisations)

Year	Country	Number of recorded cows	Percent of recorded cows	Number of recorded herds	Percent of recorded herds	Average number of cows per recorded herd	Percent of recorded herds per method A3	Percent of recorded herds per method A4	Percent of recorded herds per method A6	Percent of recorded herds per method AT	Percent of recorded herds per method B	Notes
2008	Hungary <sup>1</sup>	1,923,666	72.8	566	3.1	340		100				
2009	Hungary <sup>2</sup>	181,085	72.7	515	3.0	352		100				
2008	Iran	160,000	40	2,000	19	80	0	100	0	0	0	
2008	Ireland	467,029	42.3	6,567	29.8	71.1	0	16	54		30% EDIY	
2008	Italy	1,337,872	73.06	20,970	52.2	63.8						
2009	Italy	1,344,733		20,606		65.3						
2008	Japan	569,782	57.8	10,142	45.5	56.2		61.5		37.5	1.0	B=B4
2009	Jersey Island	2,996	29	103				79	0	21		
2008	Latvia	121,549	71.3	8,659	24.2	14.0						
2008	Lithuania	183,406	48	8,495	7.6	21.5						
2009	Lithuania	156,773	43	6,245	6	25		9		91		
2008	Luxembourg	33,215	83	678	78	49.0		17.7		27.3	50.4	4.6
2009	Luxembourg	33,968	82.6	678	79	50.1		17.4		27.1	48.6	6.9
2008	New Zealand	3,039,850	71.5	8,589	73.9	354	null	null	null	null	77	23
2008	Northern Ireland	101,679		790		128		44	5	23	16	11
2009	Northern Ireland	92,285		722		127		46	5	24	15	10
2008	Norway	233,187	97	11,794	97	20					100	
2009	Norway	206,223	98	10,067	98	20					100	

<sup>1</sup> December 2008

<sup>2</sup> December 2009

Cow milk enquiry 2008-2009



Table 2 - Position of milk recording (Methods and Organisations)

Year	Country	Number of recorded cows	Percent of recorded cows	Number of recorded herds	Percent of recorded herds	Average number of cows per recorded herd	Percent of recorded herds per method A3	Percent of recorded herds per method A4	Percent of recorded herds per method A6	Percent of recorded herds per method AT	Percent of recorded herds per method B	Notes
2008	Poland	567,477	21.3	19,090		29.73		18.1		66.5		Percent of recorded herds per method A8=15.34; Percent of recorded cow per method: A4=31.02; AT4=59.54. A8=9.44
2009	Poland	579,910	22.4	19,299	4.0	30.05		16.60		70.6		Percent of recorded herds per method A8=12.78; Percent of recorded cow per method: A4=29.14; AT4=62.92. A8=7.94
2008	Scotland	104,555		626		167		65	8	9	14	4
2009	Scotland	104,287		619		168		65	6	11	14	4
2008	Slovak Republic	148,124	86	717		207		4.0		96		
2009	Slovak Republic	133,668	84.5	587		228		4.1		95.9		
2008	Slovenia	82,875	77.3	4,864	56.5	17.0				100		AT4 method
2009	Slovenia	85,000	79.9	4,800	55.5	17.7				100		AT4method
2008	South Africa	128,894	25	658	18	196					100	
2009	South Africa	118,140	22	627	18	188					100	
2008	Spain	524,318	59	8,731	30.7	59.6		69		31		
2009	Spain	520,981	62.1	8,508	23.1	60		59.3		40.5		0.1
2008	Sweden	305,957	86	5,020	80	58.2						B4=100
2009	Sweden	300,935	86	4,622	80	61.7						B4=100
2008	Switzerland	436,804	100	25,440	100	17.2	0	52.5	0	47.5		0
2009	Switzerland	451,389	100	24,680	100	18.3	0	50.9	0	49.1		0
2008	The Netherlands	1,284,231	87.6	17,103	82.4	75.1	1.8	55.4	36.7			

Cow milk enquiry 2008-2009



Table 2 - Position of milk recording (Methods and Organisations)

Year	Country	Number of recorded cows	Percent of recorded cows	Number of recorded herds	Percent of recorded herds	Average number of cows per recorded herd	Percent of recorded herds per method A3	Percent of recorded herds per method A4	Percent of recorded herds per method A6	Percent of recorded herds per method AT	Percent of recorded herds per method B	Notes
2008	Turkey	819,825	17.4	78,349	3.8	10.5	0	0	0	0	100	
2009	Turkey	974,133	23.9	84,915	4.1	11.5	0	0	0	0	100	
2008	UK (England & Wales)	501,345	64	5,243		148	0.04	81.8	2.3		13.0	2.1
2009	UK (England & Wales)	475,303	66.3	4,970		150	0.04	79.8	2.2		15.0	
2008	UK England	174,055		1,077		161		32	11	19	37	1
2009	UK England	185,000		1,158		159		32	10	20	37	1
2008	UK Wales	19,586		148		132		26	6	16	52	0
2009	UK Wales	21,928		156		140		24	4	21	50	1
2009	USA (by AgSource)	610,307		4,319		141	12.4	34	0	83.7	37.5	
2008	USA (by NDHIA)	4,414,821		23,005		192						
2009	USA (by NDHIA)	4,478,447		23,013		195						

## Cow milk enquiry 2008-2009

Table 3 - Costs and financing



Year	Country	Cost price of milk recording per cow and per year - A4	Cost price of milk recording per cow and per year - A6	Cost price of milk recording per cow and per year - AT	Cost price of milk recording per cow and per year - B	Part of the cost price paid by the producer % - A4	Part of the cost price paid by the producer % - A6	Part of the cost price paid by the producer % - AT	Part of the cost price paid by the producer % - B
2008	Austria			52.9€				58.3	
2008	Belgium (Wallonia Region) <sup>1</sup>								
2009	Chile	12.3€		9.7€	9.0€	100		100	40
2008	Croatia			35	30			50	50
2008	Czech Republic	46.2		38.0		86		100	
2009	Czech Republic	57.7		42.0		88		100	
2008	Denmark	70			50	100			100
2009	Denmark	75			55	100			100
2008	Estonia				20.0				62.0
2009	Estonia				27.3				75.0
2008	France	45.6 €		38.9 €	35 €	100		100	100
2008	Hungary	37.4				100			
2009	Hungary <sup>2</sup>	50.5							
2008	Iran	6US\$				80			
2008	Ireland <sup>3</sup>	16.5€	14€		10€				100
2008	Italy	n.a. <sup>4</sup>	n.a.	n.a.	n.a.	n.a.	n.a.	n.a.	n.a.
2009	Italy	n.a.	n.a.	n.a.	n.a.	n.a.	n.a.	n.a.	n.a.
2008	Latvia	6.36			6.36	0		-	0
2009	Latvia	6.24			6.24	0			0
2008	Lithuania	33.3		33.3		33		31	
2009	Lithuania	38		34		39		32	
2008	New Zealand <sup>5</sup>				16.4				
2008	Norway				70				100
2009	Norway				70				100
2008	Slovak Republic	55.00		43.00		67		67	
2009	Slovak Republic	37.57		36.7		36.7		36.7	

<sup>1</sup> All methods: depends on many factors: time on farm, tru-tests or not, number of samples etc..., if interested please contact: [jf.duckerts@mrw.wallonie.be](mailto:jf.duckerts@mrw.wallonie.be)

<sup>2</sup> low milk price

<sup>3</sup> A8 - €12, A8 Compact Spring - €10

<sup>4</sup> Not available

<sup>5</sup> NZ has no subsidies 100% cost price paid by producer

Cow milk enquiry 2008-2009



Table 3 - Costs and financing

Year	Country	Cost price of milk recording per cow and per year - A4	Cost price of milk recording per cow and per year - A6	Cost price of milk recording per cow and per year - AT	Cost price of milk recording per cow and per year - B	Part of the cost price paid by the producer % - A4	Part of the cost price paid by the producer % - A6	Part of the cost price paid by the producer % - AT	Part of the cost price paid by the producer % - B
2008	Slovenia <sup>6</sup>			120				15 - 20	
2009	Slovenia <sup>6</sup>			120				15 - 20	
2008	Spain	117.93 (milk kg)		117.93 (milk kg)		70		70	
2009	Spain	119.11 (milk kg) - 35.74€		119.11 (milk kg) - 35.74€		70		70	
2008	Sweden				B4: 43 kg milk				100
2009	Sweden				B4: 50 liters of milk				100
2008	Switzerland	66	-	45.75	-	31.8	-	31.8	
2009	Switzerland	66	-	45.75	-	31.8	-	31.8	-
2008	Turkey	0	0	0	13.98€	0	0	0	100
2009	Turkey	0	0	0	17.38€	0	0	0	100
2008	UK (England & Wales)					100	100	100	100
2009	UK (England & Wales)					100	100	100	100
2008	UK England								
2009	UK England								
2008	UK Northern Ireland					100	100	100	100
2009	UK Northern Ireland					100	100	100	100
2008	UK Scotland (by Holstein UK)					100	100	100	100
2009	UK Scotland (by Holstein UK)					100	100	100	100
2008	UK Wales								
2009	UK Wales								
2009	USA (by AgSource)					100	100	100	100
2008	USA (by NDHIA)					100		100	100
2009	USA (by NDHIA)					100		100	100

<sup>6</sup> Costs for AT4 method are mention in kg of milk (average milk price on the national level)



Cow milk enquiry 2008-2009



Table 4.1 - All breeds together - All recorded cows

Year	Country	Number of lactations	Length of the lactations (days)	Milk yield per recorded cow (kg)	Milk per cow in 305 days (kg)	Percent fat content (%)	Percent protein content (%)	Calving interval (days)
2008	Australia	578,263	321	6,827	6,827	4.00	3.30	
2008	Austria	320,707	299		6,830	4.15	3.40	
2009	Austria	325,738	299		6,828	4.13	3.38	
2008	Belgium (Wallonia Region)	53,662	360	8,238		3.98	3.36	
2008	Canada	295,275	305		9,642	3.78	3.23	432
2009	Canada	305,746	305		9,592	3.81	3.22	433
2008	Chile	83,714	345	8,236	8,810	3.99	3.36	400
2009	Chile	82,481	344	8,013	8,504	3.91	3.36	402
2008	Croatia	72,598			5,164	4.09	3.32	422
2008	Czech Republic	313,366	297	7,537	7,689	3.88	3.33	412
2009	Czech Republic	305,378	297	7,659	7,813	3.87	3.32	411
2008	Denmark <sup>1</sup>	507,000	365	8,922		4.26	3.41	
2009	Denmark <sup>1</sup>	516,441	365	9,022		4.29	3.44	
2008	Estonia	92,698	337	7,390	7,378	4.07	3.31	422
2009	Estonia	89,389	338	7,447	7,570	4.07	3.33	421
2008	Finland	227,876	305	8,755	8,802	4.22	3.45	410
2008	France	2,665,684	340	8,185	7,129	3.99	3.39	412
2009	France	2,561,748	338	8,109	7,131	3.99	3.38	416
2008	Germany	3,496,257	321	7,879	7,812	4.13	3.43	406
2009	Germany	3,508,798	319	7,974	7,883	4.13	3.43	405
2008	Hungary	146,516	299	8,554		3.60	3.21	441
2009	Hungary	140,462	298	8,622		3.58	3.28	442
2008	Iran	26	345	10,000	9,100	3.30	3.10	422
2008	Ireland	455,129	302	6,695		3.85	3.41	383
2008	Israel	69,524	358	12,782	11,302	3.62	3.20	421
2009	Israel	68,620	354	12,874	11,484	3.61	3.21	416
2008	Italy	838,369	305	8,579	8,579	3.67	3.32	
2009	Italy	838,341	305	8,423	8,423	3.67	3.34	

<sup>1</sup> 365 days rolling average

Cow milk enquiry 2008-2009



Table 4.1 - All breeds together - All recorded cows

Year	Country	Number of lactations	Length of the lactations (days)	Milk yield per recorded cow (kg)	Milk per cow in 305 days (kg)	Percent fat content (%)	Percent protein content (%)	Calving interval (days)
2008	Latvia	94,067	365	5,487	5,520	4.32	3.30	
2009	Latvia	93,781	365	5,785	5,704	4.34	3.30	
2008	Lithuania	149,528	305	5,900	5,796	4.29	3.35	412
2009	Lithuania	130,312	305	6,119	6,049	4.36	3.35	415
2008	Luxembourg	33,215		7,353		4.22	3.41	425
2009	Luxembourg	33,968		7,451		4.17	3.40	422
2008	New Zealand	2,203,560	216	3,936	4,970	4.61	3.63	370
2008	Norway	158,556	300	6,921	6,428	4.19	3.37	382
2009	Norway	152,405	299	7,057	6,731	4.19	3.38	382
2008	Poland	567,477	305	6,817	6,817	4.14	3.34	429
2009	Poland	579,910	305	6,935	6,935	4.17	3.33	427
2008	Portugal	80,009	365	10,330	8,920	3.66	3.27	436
2008	Slovak Republic	109,556	296	6,759	6,913	4.13	3.23	428
2009	Slovak Republic	99,122	296	6,858	7,014	4.09	3.24	428
2008	Slovenia	80,669	361	6,826	6,043	4.05	3.26	415
2009	Slovenia	81,117	362	6,789	6,012	4.00	3.31	416
2008	South Africa	128,894	321	6,730	6,730	4.16	3.42	424
2009	South Africa	138,887	330	6,790	6,790	4.13	3.42	421
2008	Spain	349,578	369	10,588	9,092	3.68	3.21	405
2009	Spain	351,218	369	10,590	9,061	3.70	3.23	405
2008	Sweden <sup>2</sup>	305,957	365	9,162		4.15	3.40	407
2009	Sweden	300,935	365	9,285		4.16	3.43	407
2008	Switzerland	338,793	316	7,261	7,066	3.97	3.29	400
2009	Switzerland	353,183	317	7,337	7,124	4.03	3.32	400
2008	The Netherlands	831,959	356	9,358	8,574	4.30	3.45	422

<sup>2</sup> 365 days rolling average

Cow milk enquiry 2008-2009



Table 4.1 - All breeds together - All recorded cows

Year	Country	Number of lactations	Length of the lactations (days)	Milk yield per recorded cow (kg)	Milk per cow in 305 days (kg)	Percent fat content (%)	Percent protein content (%)	Calving interval (days)
2008	UK (England & Wales)	510,110	361	9,010	7,990	4.03	3.31	423
2009	UK (England & Wales)	482,415	361	9,090	8,100	4.00	3.30	423
2008	UK England	183,347	341	9,223	8,014	4.01	3.21	434
2009	UK England	200,833	338	9,132	7,964	3.99	3.23	432
2009	UK Jersey Island	3,190	326	4,780	4,345	5.22	3.77	413
2008	UK Northern Ireland	99,071	327	8,128	7,170	3.92	3.22	416
2009	UK Northern Ireland	94,695	327	8,051	7,130	4.00	3.25	420
2008	UK Scotland (by Holstein UK)	113,161	335	8,741	7,698	3.88	3.21	429
2009	UK Scotland (by Holstein UK)	112,951	336	8,756	7,710	3.85	3.22	427
2008	UK Wales	20,048	341	8,628	7,490	4.18	3.24	435
2009	UK Wales	22,968	343	8,907	7,582	4.13	3.24	432
2009	USA (by AgSource)	337,556	372	12,532	10,865	3.71	3.05	
2008	USA (by NDHIA) <sup>3</sup>	4,478,447	305	10,088	10,088	3.70	3.10	
2009	USA (by NDHIA) <sup>3</sup>	4,469,906	305	10,125	10,125	3.69	3.09	

<sup>3</sup> NDHIA herd averages

Cow milk enquiry 2008-2009



Table 4.2 - All breeds together - Cows in herdbook

Year	Country	Number of lactations	Length of the lactations (days)	Milk yield per recorded cow (kg)	Milk per cow in 305 days (kg)	Percent fat content (%)	Percent protein content (%)	Calving interval (days)
2008	Australia	87,558	342	7,630	7,630	3.98	3.32	
2008	Austria	311,927	299		6,848	4.15	3.40	
2009	Austria	316,021	299		6,849	4.13	3.39	
	Belgium (Wallonia Region) <sup>1</sup>							
2008	Czech Republic	296,772	297	7,632	7,786	3.88	3.34	412
2009	Czech Republic	287,559	297	7,752	7,908	3.88	3.33	411
2008	Denmark <sup>2</sup>	507,000	365	8,922		4.26	3.41	
2009	Denmark <sup>2</sup>	516,441	365	9,022		4.29	3.44	
2008	Estonia	78,640	342	7,587	7,563	4.06	3.32	423
2009	Estonia	76,117	343	7,635	7,755	4.06	3.33	422
2008	Finland	36,401	305		9,758	4.07	3.40	
2008	France	2,665,684	340	8,185	7,129	3.99	3.39	412
2009	France	2,561,748	338	8,109	7,131	3.99	3.38	416
2008	Germany	2,529,502	321	8,154	8,056	4.12	3.44	402
2009	Germany	2,555,854	320	8,255	8,129	4.11	3.43	408
2008	Hungary	138,227	299	8,609		3.59	3.2	441
2008	Italy	838,369	305	8,579	8,579	3.67	3.32	
2009	Italy	838,341	305	8,423	8,423	3.67	3.34	
2008	Latvia	18,203	355		6,540	4.40	3.33	
2009	Latvia	24,276	358		6,667	4.39	3.32	
2008	New Zealand	(na) <sup>3</sup>	(na)	(na)	(na)	(n.a.)	(n.a.)	(n.a.)
	Norway <sup>4</sup>							
2008	Poland	428,721	305	6,802	6,802	4.12	3.27	
2009	Poland	448,693	305	6,988	6,988	4.10	3.28	
2008	Portugal	46,528	367	10,658	9,180	3.67	3.28	
2008	Slovak Republic	29,029	296	6,754	6,908	4.14	3.27	420
2009	Slovak Republic	61,102	297	7,375	7,524	4.11	3.26	425
2008	Slovenia	80,669	361	6,826	6,043	4.05	3.26	415
2009	Slovenia	81,117	362	6,789	6,012	4.00	3.31	416

<sup>1</sup> All cows in milk recording = All cows in herdbook

<sup>2</sup> 365 days rolling average

<sup>3</sup> Information not available

<sup>4</sup> The National Member does not have any special statistics for Cows in Herdbook. The herdbook is incorporated with cows in milk recording

Cow milk enquiry 2008-2009



Table 4.2 - All breeds together - Cows in herdbook

Year	Country	Number of lactations	Length of the lactations (days)	Milk yield per recorded cow (kg)	Milk per cow in 305 days (kg)	Percent fat content (%)	Percent protein content (%)	Calving interval (days)
2008	South Africa	71,294		7,025	7,025	4.19	3.42	423
2009	South Africa	77,366		7,194	7,194	4.14	3.42	
2008	Spain	349,578	368	10,588	90,92	3.68	3.21	404
2009	Spain	351,874	370	10,590	9,061	3.70	3.23	405
2008	Switzerland	338,793	316	7,261	7,066	3.97	3.29	400
2009	Switzerland	353,183	317	7,337	7,124	4.03	3.32	401
2008	The Netherlands	737,979	357	9,480	9,480	4.36	3.51	
2008	Turkey	193,077	342	6,559	5,766			411
2008	UK (England & Wales)	253,061	364	9,410	8,310	4.06	3.31	426
2009	UK (England & Wales)	235,299	363	9,490	8,430	4.03	3.29	426
2008	UK England	152,223	344	9,451	8,192	4.00	3.2	434
2009	UK England	160,076	340	9,377	8,159	4.00	3.21	434
2009	UK Jersey Island	3,190	326	4,780	4,345	5.22	3.77	413
2008	UK Northern Ireland	51,842	337	8,795	7,697	3.92	3.21	424
2009	UK Northern Ireland	50,322	333	8,655	7,615	4.01	3.24	429
2008	UK Scotland (by Holstein UK)	66,498	342	9,295	8,118	3.93	3.22	435
2009	UK Scotland (by Holstein UK)	65,310	342	9,315	8,134	3.88	3.21	434
2008	UK Wales	17,614	345	8,779	7,604	4.18	3.24	436
2009	UK Wales	19,970	347	8,908	7,730	4.15	3.23	435

Cow milk enquiry 2008-2009



Table 4.3 - Main breeds - All recorded cows

Year	Country	Breed	Number of lactations	Length of the lactations (days)	Milk yield per recorded cow (kg)	Milk per cow in 305 days (kg)	Percent of fat content (%)	Percent of protein content (%)	Calving interval (days)
2008	Australia	Australian Red Breed	6,263	310	5,838	5,838	4.09	3.47	
2008	Australia	Ayrshire	2,710	311	5,524	5,524	4.06	3.34	
2008	Australia	Brown Swiss	3,301	326	6,207	6,207	4.15	3.49	
2008	Australia	Holstein	392,581	325	7,280	7,280	3.87	3.28	
2008	Australia	Illawarra	5,414	313	5,983	5,983	3.97	3.39	
2008	Australia	Jersey	64,289	310	5,247	5,247	4.83	3.72	
2008	Austria	Braunvieh	48,255	301		6,817	4.14	3.41	
2009	Austria	Braunvieh	47,531	301		6,856	4.11	3.41	
2008	Austria	Fleckvieh	227,666	298		6,702	4.17	3.43	
2009	Austria	Fleckvieh	232,632	298		6,687	4.14	3.41	
2008	Austria	Grauvieh	2,959	294		4,792	3.95	3.27	
2009	Austria	Grauvieh	3,111	294		4,817	3.92	3.25	
2008	Austria	Holstein	34,105	301		8,212	4.13	3.25	
2009	Austria	Holstein	34,875	300		8,223	4.11	3.25	
2008	Austria	Pinzgauer	6,811	297		5,441	3.90	3.26	
2009	Austria	Pinzgauer	6,677	298		5,478	3.87	3.25	
2008	Belgium (Wallonia Region)	Blanc-Bleu Belge	2,575	297	4,132	3,982	3.50	3.24	
2008	Belgium (Wallonia Region)	Holstein	42,705	366	8,670	7,603	3.97	3.35	
2008	Belgium (Wallonia Region)	Montbéliarde	817	343	7,049	6,422	3.92	3.44	
2008	Belgium (Wallonia Region)	Normande	420	340	6,149	5,608	4.22	3.54	
2008	Belgium (Wallonia Region)	Red Holstein	7,145	353	7,394	6,676	4.15	3.42	
2008	Canada	Ayrshire	8,830	305		7,561	3.99	3.36	
2009	Canada	Ayrshire	9,205	305		7,468	4.04	3.35	
2008	Canada	Brown Swiss	1,661	305		8,366	4.04	3.48	
2009	Canada	Brown Swiss	1,974	305		8,127	4.08	3.35	
2008	Canada	Canadienne	190	305		5,415	4.25	3.59	
2009	Canada	Canadienne	187	305		5,761	4.32	3.56	

Cow milk enquiry 2008-2009



Table 4.3 - Main breeds - All recorded cows

Year	Country	Breed	Number of lactations	Length of the lactations (days)	Milk yield per recorded cow (kg)	Milk per cow in 305 days (kg)	Percent of fat content (%)	Percent of protein content (%)	Calving interval (days)
2008	Canada	Guernsey	415	305		6,820	4.51	3.45	
2009	Canada	Guernsey	419	305		6,812	4.56	3.43	
2008	Canada	Holstein	274,581	305		9,836	3.74	3.20	
2009	Canada	Holstein	283,762	305		9,793	3.76	3.19	
2008	Canada	Jersey	9,301	305		6,435	4.84	3.81	
2009	Canada	Jersey	9,874	305		6,371	4.87	3.81	
2008	Canada	Milking shorthorn	297	305		6,656	3.62	3.32	
2009	Canada	Milking shorthorn	325	305		6,566	4.87	3.81	
2008	Croatia	Brown	1,680			5,376	4.07	3.40	436
2008	Croatia	Holstein	23,039			6,405	4.05	3.27	453
2008	Croatia	Simmental	47,879			4,559	4.11	3.34	407
2008	Czech Republic	Fleckvieh	137,892	295	6,466	6,630	4.02	3.43	401
2009	Czech Republic	Fleckvieh	120,609	294	6,457	6,637	4.02	3.43	399
2008	Czech Republic	Holstein	158,277	299	8,561	8,690	3.77	3.26	423
2009	Czech Republic	Holstein	171,936	299	8,586	8,715	3.78	3.26	421
2008	Czech Republic	Montbéliarde	1,252	295	7,758	7,954	3.72	3.39	396
2009	Czech Republic	Montbéliarde	1,206	295	7,785	7,982	3.74	3.40	399
2008	Denmark <sup>1</sup>	Ayrshire	230	365	7,897		4.18	3.36	
2009	Denmark <sup>1</sup>	Ayrshire	246	365	9,084		4.22	3.46	
2008	Denmark <sup>1</sup>	Danish Holstein	367,875	365	9,379		4.07	3.33	
2009	Denmark <sup>1</sup>	Danish Holstein	373,333	365	9,504		4.10	3.36	
2008	Denmark <sup>1</sup>	Jersey	60,833	365	6,603		5.85	4.01	
2009	Denmark <sup>1</sup>	Jersey	63,421	365	6,623		5.90	4.06	
2008	Denmark <sup>1</sup>	Red Danish	40,053	365	8,668		4.21	3.46	
2009	Denmark <sup>1</sup>	Red Danish	39,851	365	8,750		4.27	3.49	
2008	Denmark <sup>1</sup>	Red Holstein	5,660	365	8,358		4.28	3.42	
2009	Denmark <sup>1</sup>	Red Holstein	5,801	365	8,442		4.31	3.44	
2008	Estonia	Estonian Holstein	69,599	341	7,582	7,577	4.03	3.28	426
2009	Estonia	Estonian Holstein	68,059	341	7,615	7,755	4.03	3.30	427
2008	Estonia	Estonian Red	22,357	329	6,891	6,855	4.22	3.40	410
2009	Estonia	Estonian Red	20,577	328	6,995	7,057	4.23	3.40	407

<sup>1</sup> 365 days rolling average

Cow milk enquiry 2008-2009

Table 4.3 - Main breeds - All recorded cows



Year	Country	Breed	Number of lactations	Length of the lactations (days)	Milk yield per recorded cow (kg)	Milk per cow in 305 days (kg)	Percent of fat content (%)	Percent of protein content (%)	Calving interval (days)
2008	Finland	Finnish Ayrshire	152,416	305	8,564	8,609	4.33	3.48	411
2008	Finland	Finnish Cattle	2,602	305	6,223	6,422	4.38	3.50	400
2008	Finland	Holstein Friesian	72,728	305	9,251	9,290	3.99	3.40	407
2008	Finland	Jersey	22	305	7,922	7,401	5.16	3.90	389
2008	France	Abondance	21,528	295	5,129	4,872	3.69	3.47	395
2009	France	Abondance	22,031	298	5,152	4,872	3.68	3.97	397
2008	France	Brune	17,803	338	7,003	6,115	4.16	3.57	415
2009	France	Brune	17,606	335	6,938	6,113	4.18	3.57	420
2008	France	Montbéliarde	404,874	307	6,541	6,083	3.89	3.42	390
2009	France	Montbéliarde	407,223	310	6,575	6,103	3.89	3.43	392
2008	France	Normande	268,612	317	6,201	5,626	4.28	3.62	396
2009	France	Normande	247,200	319	6,203	5,655	4.28	3.61	398
2008	France	Pie Rouge des Plaines	10,308	322	7,365	6,707	4.23	3.45	397
2009	France	Pie Rouge des Plaines	9,915	323	7,303	6,697	4.25	3.45	403
2008	France	Prim'Holstein	1,847,614	353	8,993	7,695	3.98	33.6	420
2009	France	Prim'Holstein	1,758,394	349	8,894	7,700	3.97	3.35	425
2008	France	Simmental Française	14,971	302	5,756	5,400	4.01	3.50	387
2009	France	Simmental Française	15,308	305	5,789	5,436	4.00	3.50	390
2008	Germany	Braunvieh	178,358	324	6,824	6,770	4.23	3.59	416
2009	Germany	Braunvieh	175,635	324	7,040	6,931	4.23	3.59	416
2008	Germany	Fleckvieh	882,737	317	6,806	6,678	4.14	3.48	394
2009	Germany	Fleckvieh	882,205	316	6,881	6,716	4.14	3.47	395
2008	Germany	Holstein B&W	2,030,077	323	8,538	8,504	4.10	3.39	412
2009	Germany	Holstein B&W	2,042,989	321	8,641	8,573	4.09	3.40	414
2008	Germany	Holstein R&W	251,609	320	7,556	7,559	4.23	3.41	404
2009	Germany	Holstein R&W	248,359	317	7,672	7,649	4.24	3.42	408
2008	Hungary	Hungarian Holstein Friesian	134,726	299	8,692		3.58	3.2	442
2008	Hungary	Hungarian Red Spotted	3,503	294	5,412		3.86	3.38	410



Cow milk enquiry 2008-2009

Table 4.3 - Main breeds - All recorded cows



Year	Country	Breed	Number of lactations	Length of the lactations (days)	Milk yield per recorded cow (kg)	Milk per cow in 305 days (kg)	Percent of fat content (%)	Percent of protein content (%)	Calving interval (days)
2008	Italy	Castana	2,559	305	2,906	2,906	3.50	3.41	
2008	Italy	Grey of Alps (Grigio Alpina, Grauvieh)	5,590	305	4,908	4,908	3.71	3.35	
2009	Italy	Grey of Alps (Grigio Alpina, Grauvieh)	6,388	305	4,745	4,745	3.68	3.45	
2008	Italy	Italian Brown (Bruna Italiana)	65,964	305	6,837	6,837	3.95	3.50	
2009	Italy	Italian Brown (Bruna Italiana)	64,814	305	6,739	6,739	3.93	3.51	
2008	Italy	Italian Friesian (Frisona Italiana)	690,680	305	9,079	9,079	3.64	3.30	
2008	Italy	Italian Red Spotted (Pezzata Rossa Italiana)	33,401	305	6,472	6,472	3.89	3.43	
2009	Italy	Italian Red Spotted (Pezzata Rossa Italiana)	35,781	305	6,330	6,330	3.86	3.43	
2008	Italy	Jersey	4,501	305	5,933	5,933	5.14	3.98	
2009	Italy	Rendena	3,055	305	4,858	4,858	3.42	3.28	
2008	Italy	Valdostana Red Spotted (Valdostana Pezzata Rossa)	7,110	305	3,838	3,838	3.52	3.28	
2009	Italy	Valdostana Red Spotted (Valdostana Pezzata Rossa)	10,003	305	3,821	3,821	3.46	3.32	
2008	Latvia	Holstein Black and White	32,093	373		6,269	4.19	3.23	
2009	Latvia	Holstein Black and White	33,321	373		4,307	4.19	3.23	
2008	Latvia	Latvian Blue	467	330		4,292	4.40	3.37	
2009	Latvia	Latvian Blue	554	335		4,307	4.39	3.36	
2008	Latvia	Latvian Brown	58,536	349		5,103	4.44	3.26	
2009	Latvia	Latvian Brown	53,930	350		5,233	4.48	3.35	

Cow milk enquiry 2008-2009

Table 4.3 - Main breeds - All recorded cows



Year	Country	Breed	Number of lactations	Length of the lactations (days)	Milk yield per recorded cow (kg)	Milk per cow in 305 days (kg)	Percent of fat content (%)	Percent of protein content (%)	Calving interval (days)
2008	Lithuania	Angler	442	305	6,052	5,908	4.62	3.61	430
2008	Lithuania	Ayrshire	927	305	6,754	6,433	4.30	3.40	435
2009	Lithuania	Ayrshire	1,489	305	6,462	6,505	4.29	3.43	435
2008	Lithuania	Danish Black & White	261	305	7,300	6,973	4.50	3.38	446
2008	Lithuania	Danish Red	452	305	6,312	6,188	4.49	3.61	433
2008	Lithuania	Dutch Black & White	120	305	6,376	7,075	4.28	3.50	483
2008	Lithuania	German Black & white	1,058	305	6,255	6,386	4.33	3.33	437
2008	Lithuania	German Red & White	330	305	6,110	6,239	4.32	3.34	417
2008	Lithuania	Holstein	2,843	305	6,736	6,801	4.28	3.39	455
2009	Lithuania	Holstein	3,229	305	6,981	7,138	4.33	3.38	453
2009	Lithuania	Holstein R&W	6,865	305	6,657	6,865	4.28	3.38	436
2008	Lithuania	Lithuanian Black & White	108,716	305	5,878	5,779	4.25	3.32	411
2009	Lithuania	Lithuanian Black & White	91,912	305	6,125	6,022	4.33	3.31	414
2009	Lithuania	Lithuanian Native Ash-grey	387	305	5,533	5,376	4.26	3.31	402
2009	Lithuania	Lithuanian R&W	28,087	305	5,935	5,927	4.46	3.44	409
2008	Lithuania	Lithuanian Red	31,972	305	5,768	5,659	4.39	3.47	409
2008	Lithuania	Native Ash - grey	375	305	5,522	5,281	4.14	3.30	407
2008	Lithuania	Native White-backed	331	305	5,494	5,407	4.24	3.33	403
2008	Lithuania	Swedish Black & White	190	305	7,405	8,172	4.42	3.34	494
2008	Lithuania	Swedish Red & White	598	305	6,893	6,750	4.42	3.50	418
2008	Luxembourg	Holstein-RBT	5,995		6,588		4.37	3.46	419
2009	Luxembourg	Holstein-RBT	5,669		6,752		4.34	3.44	416
2008	Luxembourg	Holstein-SBT	26,039		7,591		4.18	3.41	427
2009	Luxembourg	Holstein-SBT	26,951		7,657		4.14	3.38	424

Cow milk enquiry 2008-2009



Table 4.3 - Main breeds - All recorded cows

Year	Country	Breed	Number of lactations	Length of the lactations (days)	Milk yield per recorded cow (kg)	Milk per cow in 305 days (kg)	Percent of fat content (%)	Percent of protein content (%)	Calving interval (days)
2008	New Zealand	Ayrshire	20,108	223	3,813	4,781	4.25	3.49	371
2008	New Zealand	Friesian	954,031	214	4,302	5,549	4.18	3.46	370
2008	New Zealand	Friesian/Jersey	871,930	217	3,893	4,975	4.74	3.70	370
2008	New Zealand	Jersey	357,491	217	3,070	3,923	5.51	3.98	370
2008	Norway	Jersey	1,047	297		4,971	6.00	3.90	391
2009	Norway	Jersey	1,006	305		5,290	5.96	3.92	392
2008	Norway	Norwegian Red	150,536	300		6,620	4.17	3.37	381
2009	Norway	Norwegian Red	144,825	299		6,756	4.17	3.38	382
2008	Poland	Jersey	1,020	305	5,347	5,347	5.29	3.89	403
2009	Poland	Jersey	1,054	305	5,426	5,426	5.26	3.81	422
2009	Poland	Montbeliarde	1,312	305	7,125	7,125	4.12	3.49	407
2008	Poland	Polish Black-White	1,502	305	4,894	4,894	4.12	3.27	404
2009	Poland	Polish Black-White	2,353	305	4,732	4,732	4.13	3.25	397
2008	Poland	Polish Holstein-Friesian (HO)	525,280	305	6,903	6,903	4.14	3.33	431
2009	Poland	Polish Holstein-Friesian (HO)	530,721	305	7,041	7,041	4.16	3.32	428
2008	Poland	Polish Holstein-Friesian (RW)	16,694	305	6,345	6,345	4.15	3.34	420
2009	Poland	Polish Holstein-Friesian (RW)	16,716	305	6,465	6,465	4.17	3.35	418
2008	Poland	Polish Red	2,030	305	3,927	3,927	4.25	3.35	394
2009	Poland	Polish Red	2,342	305	3,913	3,913	4.26	3.34	401
2008	Poland	Polish Red-White	2,406	305	4,911	4,911	4.05	3.27	404
2009	Poland	Polish Red-White	3,102	305	4,735	4,735	4.05	3.24	403
2009	Poland	Simmental	8,904	305	5,254	5,254	4.10	3.41	406
2008	Poland	Simmental	8,298	305	5,190	5,190	4.06	3.41	400
2008	Portugal	Holstein Frisia	80,089	365	10,330	8,920	3.66	3.27	436
2008	Slovak Republic	Cross breeds	68,264	295	6,505	6,670	4.15	3.24	427
2009	Slovak Republic	Cross breeds	58,245	295	6,576	6,742	4.12	3.25	422
2008	Slovak Republic	Holstein	27,542	299	8,109	8,231	4.04	3.18	442
2009	Slovak Republic	Holstein	27,578	298	8,169	8,313	4.02	3.20	435
2008	Slovak Republic	Slovak Pinzgauer	930	290	4,387	4,556	4.02	3.36	400
2009	Slovak Republic	Slovak Pinzgauer	1,035	289	4,545	4,732	4.07	3.37	414

Cow milk enquiry 2008-2009



Table 4.3 - Main breeds - All recorded cows

Year	Country	Breed	Number of lactations	Length of the lactations (days)	Milk yield per recorded cow (kg)	Milk per cow in 305 days (kg)	Percent of fat content (%)	Percent of protein content (%)	Calving interval (days)
2008	Slovak Republic	Slovak Simmental	12,820	294	5,377	5,527	4.25	3.30	415
2009	Slovak Republic	Slovak Simmental	12,264	294	5,395	5,546	4.16	3.34	414
2008	Slovenia	Brown	13,191	361	6,251	5,521	4.09	3.33	418
2009	Slovenia	Brown	12,740	365	6,249	5,476	4.06	3.38	419
2008	Slovenia	Holstein	30,048	377	8,385	7,247	3.98	3.21	426
2009	Slovenia	Holstein	30,575	376	8,295	7,188	3.93	3.25	425
2008	Slovenia	Simmental	34,907	349	5,812	5,238	4.11	3.31	408
2009	Slovenia	Simmental	32,928	350	5,707	5,156	4.07	3.35	409
2008	South Africa	Ayrshire	6,873		6,873	6,079	4.03	3.34	418
2009	South Africa	Ayrshire	6,695	326	6,273	6,273	4.02	3.34	422
2008	South Africa	Guernsey	1,227		1,227	5,936	4.29	3.47	413
2009	South Africa	Guernsey	1,062	320	6,099	6,099	4.22	3.44	413
2008	South Africa	Holstein	59,412		8,210	8,210	3.85	3.21	442
2009	South Africa	Holstein	64,761	349	8,277	8,277	3.83	3.22	450
2008	South Africa	Jersey	56,600		5,411	5,411	4.66	3.75	422
2009	South Africa	Jersey	60,330	349	5,392	5,392	4.66	3.75	412
2008	Spain	Frisona	348,573	369	10,601	9,102	3.68	3.21	
2009	Spain	Frisona	350,656	370	10,590	9,061	3.70	3.23	403
2008	Spain	Parda Alpina	1,005	312	6,892	6,372	3.76	3.53	403
2009	Spain	Parda Alpina	1,218	314	6,892	6,384	3.70	3.54	398
2008	Sweden	Swedish Red	131,958	365	8,730		4.30	3.49	398
2008	Sweden	Swedish Holstein	154,065	365	9,648		4.01	3.32	413
2009	Sweden	Swedish Holstein	144,365	365	9,778		4.02	3.35	413
2008	Sweden	Swedish Jersey	2,080	365	6,472		5.76	3.94	407
2009	Sweden	Swedish Jersey	1,904	365	6,758		5.77	3.96	407
2008	Sweden	Swedish Polled	1,330	365	5,590		4.45	3.54	410
2009	Sweden	Swedish Polled	1,254	365	5,420		4.39	3.53	407
2009	Sweden	Swedish Red	122,192	365	8,844		4.32	3.52	398
2008	Switzerland	Braunvieh	135,205	300	6,735	6,819	3.97	3.35	408
2009	Switzerland	Braunvieh	139,686	300	6,819	6,904	4.04	3.38	411
2008	Switzerland	Eringer	646	269	3,100	3,180	3.67	3.40	406
2009	Switzerland	Eringer	745	270	3,095	3,123	3.65	3.38	406
2008	Switzerland	Fleckvieh	160,548	334	7,561	7,054	3.97	3.26	390
2009	Switzerland	Fleckvieh	168,177	335	7,613	7,086	4.03	3.29	391

Cow milk enquiry 2008-2009



Table 4.3 - Main breeds - All recorded cows

Year	Country	Breed	Number of lactations	Length of the lactations (days)	Milk yield per recorded cow (kg)	Milk per cow in 305 days (kg)	Percent of fat content (%)	Percent of protein content (%)	Calving interval (days)
2008	Switzerland	Grauvieh	177	295	4,041	4,143	3.74	3.23	391
2009	Switzerland	Grauvieh	204	296	4,057	4,149	3.71	3.23	391
2008	Switzerland	Hinterwalder	107	297	3,983	4,063	3.93	3.38	374
2009	Switzerland	Hinterwalder	97	297	3,987	4,067	4.00	3.38	374
2008	Switzerland	Holstein	40,471	301	8,056	8,095	3.94	3.22	410
2009	Switzerland	Holstein	42,477	301	8,166	8,170	3.99	3.26	409
2008	Switzerland	Jersey	1,639	299	5,107	5,184	5.36	3.87	389
2009	Switzerland	Jersey	1,797	299	5,222	5,301	5.45	3.90	389
2008	Tunisia	Brown Swiss	576	341	4,817	4,647			438
2008	Tunisia	Holstein	18,595	346	5,733	5,581			443
2008	Tunisia	Tarantaise	143	284	3,453	3,939			415
2008	UK (England & UK)	Jersey	17,621	229	5,887	5,404	5.34	3.89	404
2008	UK (England & Wales)	Ayrshire	7,664	336	6,858	6,349	4.08	3.28	412
2009	UK (England & Wales)	Ayrshire	7,459	334	6,886	6,470	4.09	3.37	413
2008	UK (England & Wales)	British Friesian	5,679	336	7,193	6,695	4.12	3.40	404
2009	UK (England & Wales)	British Friesian	6,368	339	7,298	6,776	4.07	3.36	400
2008	UK (England & Wales)	Guernsey	5,246	350	6,189	5,540	4.74	3.61	418
2009	UK (England & Wales)	Guernsey	4,516	353	6,280	5,653	4.77	4.78	420
2008	UK (England & Wales)	Holstein	461,716	363	9,289	8,206	3.97	3.28	425
2009	UK (England & Wales)	Holstein	435,872	363	9,364	8,316	3.95	3.27	424
2009	UK (England & Wales)	Jersey	15,329	339	6,065	5,617	5.31	3.88	406
2008	UK (England & Wales)	Shorthorn	4,650	323	6,297	5,956	3.80	3.33	402
2009	UK (England & Wales)	Shorthorn	4,615	323	6,328	5,996	3.78	3.32	399

Cow milk enquiry 2008-2009



Table 4.3 - Main breeds - All recorded cows

Year	Country	Breed	Number of lactations	Length of the lactations (days)	Milk yield per recorded cow (kg)	Milk per cow in 305 days (kg)	Percent of fat content (%)	Percent of protein content (%)	Calving interval (days)
2008	UK England	Ayrshire	1,451	294	6,440	5,944	4.12	3.33	419
2009	UK England	Ayrshire	1,449	315	7,032	6,468	4.19	3.37	416
2008	UK England	Brown Swiss	492	318	6,940	6,237	4.10	3.45	433
2009	UK England	Brown Swiss	578	315	6,926	6,227	4.00	3.45	422
2008	UK England	Friesian	2,349	316	6,736	6,142	4.12	3.35	419
2009	UK England	Friesian	2,876	319	6,684	6,129	4.11	3.39	409
2008	UK England	Guernsey	630	342	5,961	5,186	4.90	3.59	439
2009	UK England	Guernsey	828	328	5,952	5,240	4.90	3.61	430
2008	UK England	Holstein	171,174	343	9,449	8,192	3.97	3.19	435
2009	UK England	Holstein	186,573	340	9,360	8,145	3.95	3.20	434
2008	UK England	Jersey	6,100	307	5,579	5,086	5.47	3.87	406
2009	UK England	Jersey	7,198	313	5,691	5,157	5.49	3.92	406
2008	UK England	Montebeliarde	158	328	7,286	6,540	4.05	3.36	402
2009	UK England	Montebeliarde	291	301	6,625	6,036	4.04	3.41	409
2009	UK England	Shorthorn	549	308	6,267	5,795	3.74	3.31	398
2009	UK Jersey Island	Jersey	3,190	326	4,780	4,345	5.22	3.77	413
2008	UK Northern Ireland	Ayrshire	1,982	301	6,116	5,693	4.06	3.30	406
2009	UK Northern Ireland	Ayrshire	2,057	299	6,140	5,725	4.16	3.34	413
2008	UK Northern Ireland	Friesian	645	295	6,151	5,675	4.05	3.31	441
2009	UK Northern Ireland	Friesian	864	307	6,468	5,889	4.11	3.33	399
2008	UK Northern Ireland	Holstein	93,814	329	8,239	7,255	3.90	3.21	416
2009	UK Northern Ireland	Holstein	89,001	328	8,167	7,218	3.99	3.26	421
2008	UK Northern Ireland	Jersey	1,100	312	5,544	4,932	5.01	3.79	399
2009	UK Northern Ireland	Jersey	1,033	311	5,441	4,855	5.07	3.81	414
2009	UK Northern Ireland	Montbeliarde	380	315	6,421	5,944	3.82	3.35	383
2008	UK Northern Ireland	Montebeliarde	348	296	6,081	5,735	3.80	3.37	382
2009	UK Northern Ireland	Other Breeds	362	297	6,313	5,934	3.99	3.40	391
2008	UK Northern Ireland	Shorthorn	698	313	7,228	6,644	3.87	3.27	407
2009	UK Northern Ireland	Shorthorn	942	303	6,974	6,448	3.95	3.32	409

Cow milk enquiry 2008-2009

Table 4.3 - Main breeds - All recorded cows



Year	Country	Breed	Number of lactations	Length of the lactations (days)	Milk yield per recorded cow (kg)	Milk per cow in 305 days (kg)	Percent of fat content (%)	Percent of protein content (%)	Calving interval (days)
2008	UK Scotland (by Holstein UK)	Ayrshire	9,974	318	7,269	6,675	4.07	3.34	422
2009	UK Scotland (by Holstein UK)	Ayrshire	9,717	323	7,391	6,748	4.05	3.36	418
2008	UK Scotland (by Holstein UK)	Brown Swiss	281	355	7,874	6,840	4.08	3.46	435
2009	UK Scotland (by Holstein UK)	Brown Swiss	291	326	7,301	6,301	3.94	3.51	430
2008	UK Scotland (by Holstein UK)	Friesian	1,536	301	6,383	5,876	4.02	3.34	412
2009	UK Scotland (by Holstein UK)	Friesian	1,866	322	6,763	6,175	4.08	3.4	400
2008	UK Scotland (by Holstein UK)	Holstein	98,873	338	9,003	7,895	3.85	3.18	430
2009	UK Scotland (by Holstein UK)	Holstein	98,718	338	8,992	7,888	3.83	3.18	429
2008	UK Scotland (by Holstein UK)	Jersey	1,692	309	5,610	4,943	5.42	3.99	427
2009	UK Scotland (by Holstein UK)	Jersey	1,383	322	6,091	5,370	5.29	3.97	419
2009	UK Scotland (by Holstein UK)	Montbeliarde	414	322	6,941	6,236	3.90	3.32	406
2008	UK Scotland (by Holstein UK)	Montebeliarde	249	292	6,221	5,808	3.93	3.34	400
2009	UK Scotland (by Holstein UK)	Other Breeds	346	317	6,730	6,248	3.99	3.33	406
2008	UK Scotland (by Holstein UK)	Shorthorn	190	291	5,634	5,312	3.75	3.48	395
2009	UK Scotland (by Holstein UK)	Shorthorn	199	280	5,311	5,056	3.88	3.46	389

Cow milk enquiry 2008-2009



Table 4.3 - Main breeds - All recorded cows

Year	Country	Breed	Number of lactations	Length of the lactations (days)	Milk yield per recorded cow (kg)	Milk per cow in 305 days (kg)	Percent of fat content (%)	Percent of protein content (%)	Calving interval (days)
2008	UK Wales	Ayrshire	148	311	7,116	6,513	4.73	3.38	416
2008	UK Wales	Brown Swiss	123	291	5,523	4,769	4.70	3.67	593
2008	UK Wales	Friesian	228	331	6,807	6,240	4.01	3.32	413
2009	UK Wales	Friesian	268	324	6,714	6,067	4.17	3.36	365
2008	UK Wales	Holstein	18,892	343	8,774	7,603	4.14	3.22	435
2009	UK Wales	Holstein	21,650	344	8,849	7,694	4.11	3.22	434
2008	UK Wales	Jersey	531	311	5,812	5,271	5.37	3.89	421
2009	UK Wales	Jersey	593	310	5,862	5,438	5.28	3.88	409
2008	USA (by NDHIA) <sup>2</sup>	Ayrshire	5,622	305	7,027	7,027	3.89	3.18	
2009	USA (by NDHIA) <sup>2</sup>	Ayrshire	5,108	305	6,942	6,942	3.94	3.17	
2009	USA (by NDHIA) <sup>2</sup>	Ayrshire	585	371	8,748	7,744	3.93	3.17	
2008	USA (by NDHIA) <sup>2</sup>	Brown Swiss	14,353	305	8,281	8,281	4.08	3.39	
2009	USA (by NDHIA) <sup>2</sup>	Brown Swiss	3,158	381	10,465	8,863	4.09	3.36	
2009	USA (by NDHIA) <sup>2</sup>	Brown Swiss	13,089		8,323	8,323	4.09	3.39	
2008	USA (by NDHIA) <sup>2</sup>	Guernsey	7,220	305	6,962	6,962	4.52	3.37	
2009	USA (by NDHIA) <sup>2</sup>	Guernsey	1,222	378	8,699	7,467	4.59	3.36	
2009	USA (by NDHIA) <sup>2</sup>	Guernsey	6,184	305	6,891	6,891	4.56	3.37	
2008	USA (by NDHIA) <sup>2</sup>	Holstein	4,027,514	305	10,336	10,336	3.65	3.07	
2009	USA (by NDHIA) <sup>2</sup>	Holstein	312,928	373	12,760	11,059	3.68	3.03	
2009	USA (by NDHIA) <sup>2</sup>	Holstein	3,938,546	305	10,403	10,403	3.64	3.06	
2008	USA (by NDHIA) <sup>2</sup>	Jersey	208,251	305	7,451	7,451	4.62	3.60	
2009	USA (by NDHIA) <sup>2</sup>	Jersey	12,225	364	8,933	7,815	4.65	3.60	
2009	USA (by NDHIA) <sup>2</sup>	Jersey	204,826	305	7,419	7,419	4.64	3.61	
2008	USA (by NDHIA) <sup>2</sup>	Milking Shorthorn	2,109	305	5,980	5,980	3.56	3.10	
2009	USA (by NDHIA) <sup>2</sup>	Milking Shorthorn	339	359	8,109	7,298	3.93	3.11	
2009	USA (by NDHIA) <sup>2</sup>	Milking Shorthorn	1,972	305	6,001	6,001	3.52	3.10	

<sup>2</sup> NDHIA Herd Averages



Cow milk enquiry 2008-2009



Table 4.4 - Main breeds - Cows in herdbook

Year	Country	Breed	Number of lactations	Length of the lactations (days)	Milk yield per recorded cow (kg)	Milk per cow in 305 days (kg)	Percent of fat content (%)	Percent of protein content (%)	Calving interval (days)
2008	Australia	Australian Red Breeds	793	341	7,480	7,480	3.86	3.55	
2008	Australia	Ayrshire	700	332	5,908	5,908	4.05	3.29	
2008	Australia	Brown Swiss	950	341	6,689	6,689	4.05	3.45	
2008	Australia	Holstein	67,178	347	8,158	8,158	3.77	3.21	
2008	Australia	Illawarra	2,179	313	6,237	6,237	3.89	3.34	
2008	Australia	Jersey	15,377	323	5,716	5,716	4.89	3.73	
2008	Austria	Braunvieh	47,346	301		6,834	4.14	3.41	
2009	Austria	Braunvieh	46,608	301		6,874	4.11	3.41	
2008	Austria	Fleckvieh	223,113	299		6,722	4.17	3.43	
2009	Austria	Fleckvieh	227,196	298		6,710	4.14	3.41	
2008	Austria	Grauvieh	2,897	295		4,803	3.96	3.27	
2009	Austria	Grauvieh	3,054	294		4,820	3.92	3.25	
2008	Austria	Holstein	31,114	301		8,312	4.13	3.26	
2009	Austria	Holstein	31,852	300		8,328	4.10	3.25	
2008	Austria	Pinzgauer	6,636	297		5,447	3.89	3.26	
2009	Austria	Pinzgauer	6,486	298		5,481	3.87	3.25	
	Belgium (Wallonia Region)	All breeds	All cows in milk recording = All cows in herdbook						
2008	Czech Republic	Fleckvieh	132,889	295	6,438	6,601	4.02	3.43	400
2009	Czech Republic	Fleckvieh	126,475	294	6,519	6,701	4.01	3.43	399
2008	Czech Republic	Holstein	163,883	299	8,601	8,730	3.77	3.26	422
2009	Czech Republic	Holstein	161,084	299	8,720	8,851	3.77	3.25	421
2008	Denmark <sup>1</sup>	Ayrshire	230	365	7,897		4.18	3.36	
2009	Denmark <sup>1</sup>	Ayrshire	246	365	9,084		4.22	3.46	
2008	Denmark <sup>1</sup>	Danish Holstein	367,875	365	9,379		4.07	3.33	
2009	Denmark <sup>1</sup>	Danish Holstein	373,333		9,504		4.10	3.36	
2008	Denmark <sup>1</sup>	Jersey	60,833	365	6,603		5.85	4.01	
2009	Denmark <sup>1</sup>	Jersey	63,421	365	6,623		5.90	4.06	
2008	Denmark <sup>1</sup>	Red Danish	40,053		8,668		4.21	3.46	
2009	Denmark <sup>1</sup>	Red Danish	39,851	365	8,750		4.27	3.49	
2008	Denmark <sup>1</sup>	Red Holstein	5,660	365	8,358		4.28	3.42	
2009	Denmark <sup>1</sup>	Red Holstein	5,801	365	8,442		4.31	3.44	

<sup>1</sup> 365 days rolling average

Cow milk enquiry 2008-2009



Table 4.4 - Main breeds - Cows in herdbook

Year	Country	Breed	Number of lactations	Length of the lactations (days)	Milk yield per recorded cow (kg)	Milk per cow in 305 days (kg)	Percent of fat content (%)	Percent of protein content (%)	Calving interval (days)
2008	Estonia	Estonian Holstein	58,839	347	7,778	7,774	4.01	3.29	428
2009	Estonia	Estonian Holstein	57,803	348	7,798	7,948	4.01	3.31	428
2008	Estonia	Estonian Red	19,399	330	7,068	7,007	4.21	3.32	410
2009	Estonia	Estonian Red	17,943	330	7,173	7,218	4.23	3.41	406
2008	Finland	Finnish Ayrshire	22,204	305		9,569	4.20	3.43	
2008	Finland	Finnish Cattle	1,222	305		6,349	4.35	3.48	
2008	Finland	Holstein Friesian	12,962	305		10,407	3.86	3.35	
2008	France	Abondance	21,528	295	5,129	4,872	3.69	3.47	395
2009	France	Abondance	22,031	298	5,152	4,872	3.68	3.47	397
2008	France	Brune	17,803	338	7,003	6,115	4.16	3.57	415
2009	France	Brune	17,606	335	6,938	6,113	4.18	3.57	420
2008	France	Montbéliarde	404,874	307	6,541	6,083	3.89	3.42	390
2009	France	Montbéliarde	407,223	310	6,575	6,103	3.89	3.43	392
2008	France	Normande	268,612	317	6,201	5,626	4.28	3.62	396
2009	France	Normande	247,200	319	6,203	5,655	4.28	3.61	398
2008	France	Pie Rouge des Plaines	10,308	322	7,365	6,707	4.23	3.45	397
2009	France	Pie Rouge des Plaines	9,915	323	7,303	6,697	4.25	3.45	403
2008	France	Prim'Holstein	1,847,614	353	8,993	7,695	3.98	3.36	420
2009	France	Prim'Holstein	1,758,394	349	8,894	7,700	3.97	3.35	425
2008	France	Simmental Française	14,971	302	5,756	5,400	4.01	3.50	387
2009	France	Simmental Française	15,308	305	5,789	5,436	4.00	3.50	390
2008	Germany	Braunvieh	143,780	319	7,015	6,938	4.23	3.60	415
2009	Germany	Braunvieh	142,767	319	7,228	7,095	4.23	3.60	415
2008	Germany	Fleckvieh	645,124	317	7,020	6,864	4.13	3.49	393
2009	Germany	Fleckvieh	650,063	316	7,096	6,903	4.13	3.48	393
2008	Germany	Holstein B&W	1,549,431	324	8,783	8,724	4.09	3.39	405
2009	Germany	Holstein B&W	1,569,468	322	8,887	8,794	4.07	3.40	415
2008	Germany	Holstein R&W	149,627	322	7,979	7,927	4.22	3.42	403
2009	Germany	Holstein R&W	149,592	320	8,107	8,013	4.21	3.42	409

Cow milk enquiry 2008-2009



Table 4.4 - Main breeds - Cows in herdbook

Year	Country	Breed	Number of lactations	Length of the lactations (days)	Milk yield per recorded cow (kg)	Milk per cow in 305 days (kg)	Percent of fat content (%)	Percent of protein content (%)	Calving interval (days)
2008	Hungary	Hungarian Holstein Friesian	134,724	299	8,692		3.58	3.2	442
2008	Hungary	Hungarian Red Spotted	3,503	294	5,412		3.86	3.38	410
2008	Italy	Castana	2,559	305	2,906	2,906	3.50	3.41	
2008	Italy	Grey of Alps (Grigio Alpina, Grauvieh)	5,590	305	4,908	4,908	3.71	3.35	
2009	Italy	Grey of Alps (Grigio Alpina, Grauvieh)	6,388	305	4,745	4,745	3.68	3.45	
2008	Italy	Italian Brown (Bruna Italiana)	65,964	305	6,837	6,837	3.95	3.50	
2009	Italy	Italian Brown (Bruna Italiana)	64,814	305	6,739	6,739	3.93	3.51	
2008	Italy	Italian Friesian (Frisona Italiana)	690,680	305	9,079	9,079	3.64	3.30	
2009	Italy	Italian Friesian (Frisona Italiana)	681,098	305	8,965	8,965	3.63	3.31	
2008	Italy	Italian Red Spotted (Pezzata Rossa Italiana)	33,401	305	6,472	6,472	3.89	3.43	
2009	Italy	Italian Red Spotted (Pezzata Rossa Italiana)	35,781	305	6,330	6,330	3.86	3.43	
2008	Italy	Jersey	4,501	305	5,933	5,933	5.14	3.98	
2009	Italy	Rendena	3,055	305	4,858	4,858	3.42	3.28	

Cow milk enquiry 2008-2009



Table 4.4 - Main breeds - Cows in herdbook

Year	Country	Breed	Number of lactations	Length of the lactations (days)	Milk yield per recorded cow (kg)	Milk per cow in 305 days (kg)	Percent of fat content (%)	Percent of protein content (%)	Calving interval (days)
2008	Italy	Valdostana Red Spotted (Valdostana Pezzata Rossa)	7,110	305	3,838	3,838	3.52	3.28	
2009	Italy	Valdostana Red Spotted (Valdostana Pezzata Rossa)	10,003	305	3,821	3,821	3.46	3.32	
2008	Latvia	Holstein B&W	6,098	372		7,440	4.19	3.23	
2009	Latvia	Holstein B&W	8,892	373		7,550	4.18	3.25	
2008	Latvia	Latvian Brown	10,932	346		6,034	4.51	3.38	
2009	Latvia	Latvian Brown	13,479	348		6,093	4.52	3.37	
2008	New Zealand	Ayrshire	16,509	246	4,244	4,968	4.27	3.50	(n.a.)
2008	New Zealand	Friesian	(n.a.) <sup>2</sup>	(n.a.)	(n.a.)	(n.a.)	(n.a.)	(n.a.)	(n.a.)
2008	New Zealand	Jersey	(n.a.)	(n.a.)	(n.a.)	(n.a.)	(n.a.)	(n.a.)	(n.a.)
	Norway	The National Member does not have any statistics for Cows in Herdbook. The Herdbook is incorporated with cows in milk recording							
2009	Poland	Polish Black-White	1,603	305	4,904	4,904	4.12	3.24	
2008	Poland	Polish Holstein-Friesian (Ho)	397,108	305	6,897	6,897	4.11	3.26	
2009	Poland	Polish Holstein-Friesian (Ho)	411,441	305	7,101	7,101	4.09	3.27	
2008	Poland	Polish Holstein-Friesian (RW)	12,708	305	6,292	6,292	4.17	3.29	
2009	Poland	Polish Holstein-Friesian (RW)	13,028	305	6,526	6,526	4.10	3.30	
2008	Poland	Polish Red	1,619	305	3,926	3,926	4.24	3.31	
2009	Poland	Polish Red	1,863	305	3,916	3,916	4.26	3.34	
2009	Poland	Polish Red-White	2,229	305	4,937	4,937	4.01	3.22	
2008	Poland	Simmental	6,284	305	4,944	4,944	4.04	3.38	
2009	Poland	Simmental	6,932	305	5,208	5,208	4.08	3.40	
2008	Portugal	Holstein Friesian	46,528	367	10,658	9,180	3.67	3.28	

<sup>2</sup> Not available

Cow milk enquiry 2008-2009



Table 4.4 - Main breeds - Cows in herdbook

Year	Country	Breed	Number of lactations	Length of the lactations (days)	Milk yield per recorded cow (kg)	Milk per cow in 305 days (kg)	Percent of fat content (%)	Percent of protein content (%)	Calving interval (days)
2008	Slovak Republic	Holstein	7,559	299	8,541	8,669	4.00	3.19	437
2009	Slovak Republic	Holstein	23,065	299	8,312	8,437	4.05	3.22	433
2008	Slovak Republic	Slovak Pinzgauer	1,112	289	4,631	4,821	4.00	3.35	400
2009	Slovak Republic	Slovak Pinzgauer	918	289	4,574	4,762	4.02	3.38	406
2008	Slovak Republic	Slovak Simmental	2,448	295	5,917	6,067	4.20	3.34	407
2009	Slovak Republic	Slovak Simmental	1,831	293	5,797	5,974	4.14	3.35	405
2008	Slovenia	Brown	13,191	361	6,251	5,521	4.09	3.33	418
2009	Slovenia	Brown	12,740	365	6,249	5,476	4.06	3.38	419
2008	Slovenia	Holstein	30,048	377	8,385	7,247	3.98	3.21	426
2009	Slovenia	Holstein	30,575	376	8,295	7,188	3.93	3.25	425
2008	Slovenia	Simmental	34,907	349	5,812	5,238	4.11	3.31	408
2009	Slovenia	Simmental	32,928	350	5,707	5,156	4.07	3.35	409
2008	South Africa	Ayrshire	6,240		6,578	6,578	3.97	3.30	418
2009	South Africa	Ayrshire	6,299		6,836	6,836	3.92	3.31	
2008	South Africa	Guernsey	438		6,449	6,449	4.32	3.47	424
2009	South Africa	Guernsey	406		6,697	6,697	4.21	3.45	
2008	South Africa	Holstein	29,091		9,331	9,331	3.81	3.18	440
2009	South Africa	Holstein	33,654		9,508	9,508	3.78	3.19	
2008	South Africa	Jersey	35,525		5,745	5,745	4.66	3.74	411
2009	South Africa	Jersey	37,007		5,738	5,738	4.64	3.73	
2008	Spain	Frisona	348,573	369	10,601	9,102	3.68	3.21	
2009	Spain	Frisona	350,656	370	10,590	9,061	3.70	3.23	403
2008	Spain	Parda Alpina	1,005	312	6,892	6,372	3.76	3.53	403
2009	Spain	Parda Alpina	1,218	314	6,892	6,384	3.70	3.52	398
	Sweden	The National Member does not have any special statistics for Cows in Herdbook. The herdbook is incorporated with cows in milk recording							
2008	Switzerland	Braunvieh	135,205	300	6,735	6,819	3.97	3.35	408
2009	Switzerland	Braunvieh	139,686	300	6,819	6,904	4.04	3.38	411
2008	Switzerland	Eringer	646	269	3,100	3,180	3.67	3.40	406
2009	Switzerland	Eringer	745	270	3,095	3,123	3.65	3.38	406
2008	Switzerland	Fleckvieh	160,548	334	7,561	7,054	3.97	3.26	390
2009	Switzerland	Fleckvieh	168,177	335	7,613	7,086	4.03	3.29	391

Cow milk enquiry 2008-2009



Table 4.4 - Main breeds - Cows in herdbook

Year	Country	Breed	Number of lactations	Length of the lactations (days)	Milk yield per recorded cow (kg)	Milk per cow in 305 days (kg)	Percent of fat content (%)	Percent of protein content (%)	Calving interval (days)
2008	Switzerland	Grauvieh	177	295	4,041	4,043	3.74	3.23	391
2009	Switzerland	Grauvieh	204	296	4,057	4,149	3.71	3.23	391
2008	Switzerland	Hinterwälder	107	297	3,983	4,063	3.93	3.38	374
2009	Switzerland	Hinterwälder	97	297	3,987	4,067	4.00	3.38	374
2008	Switzerland	Holstein	40,471	301	8,056	8,095	3.94	3.22	410
2009	Switzerland	Holstein	42,477	301	8,166	8,170	3.99	3.26	409
2008	Switzerland	Jersey	1,639	299	5,107	5,184	5.36	3.87	389
2009	Switzerland	Jersey	1,797	299	5,222	5,301	5.45	3.90	389
2008	Turkey	Brown Swiss	7,695	330	4,996	4,476	n.a.	n.a.	405
2008	Turkey	Holstein Friesian (Black and White)	179,445	343	6,670	5,858	n.a.	n.a.	412
2008	Turkey	Holstein Friesian (Red and White)	383	342	6,620	5,828	n.a.	n.a.	411
2008	Turkey	Simmental	5,554	329	5,115	4,593	n.a.	n.a.	410
2008	UK (England & Wales)	Ayrshire	4,812	335	7,025	6,514	4.09	3.38	414
2009	UK (England & Wales)	Ayrshire	4,812	335	7,011	6,588	4.41	3.37	414
2009	UK (England & Wales)	British Friesian	2,892	335	7,271	6,804	4.08	3.35	402
2008	UK (England & Wales)	Guernsey	4,253	351	6,323	6,151	3.79	3.32	407
2009	UK (England & Wales)	Guernsey	3,629	352	6,373	5,747	4.81	3.63	420
2008	UK (England & Wales)	Holstein	223,374	367	9,818	8,628	3.97	3.26	428
2009	UK (England & Wales)	Holstein	208,620	366	9,868	8,732	3.94	3.25	428
2008	UK (England & Wales)	Jersey	13,258	339	5,905	5,409	5.40	3.90	405
2009	UK (England & Wales)	Jersey	11,266	340	6,169	5,657	5.43	3.91	408
2008	UK (England & Wales)	Shorthorn	2,752	320	6,492	6,151	3.79	3.32	407
2009	UK (England & Wales)	Shorthorn	2,528	323	6,492	6,098	3.77	3.31	402
2008	UK (England & Wales)	British Friesian	3,056	334	7,319	6,842	4.22	3.39	410
2008	UK England	Ayrshires	1,163	296	6,559	6,063	4.07	3.32	420
2009	UK England	Ayrshires	1,083	316	7,004	6,429	4.17	3.36	418
2008	UK England	Brown Swiss	239	316	6,995	6,246	4.15	3.46	447
2009	UK England	Brown Swiss	313	315	7,071	6,358	4.04	3.48	426
2008	UK England	Friesian	1,737	324	6,857	6,333	4.11	3.36	412
2009	UK England	Friesian	1,947	322	6,849	6,323	4.11	3.38	410

Cow milk enquiry 2008-2009



Table 4.4 - Main breeds - Cows in herdbook

Year	Country	Breed	Number of lactations	Length of the lactations (days)	Milk yield per recorded cow (kg)	Milk per cow in 305 days (kg)	Percent of fat content (%)	Percent of protein content (%)	Calving interval (days)
2008	UK England	Guernsey	560	344	6,005	5,226	4.88	3.58	441
2009	UK England	Guernsey	692	331	6,083	5,346	4.86	3.59	435
2008	UK England	Holstein	142,904	346	9,678	8,371	3.97	3.18	435
2009	UK England	Holstein	149,745	342	9,603	8,339	3.95	3.19	436
2008	UK England	Jersey	5,548	307	5,518	5,026	5.51	3.90	407
2009	UK England	Jersey	6,198	314	5,657	5,126	5.56	3.94	407
2009	UK Jersey Island	Jersey	3,190	326	4,780	4,345	5.22	3.77	413
2008	UK Northern Ireland	Ayrshire	1,553	300	6,093	5,682	4.08	3.31	408
2009	UK Northern Ireland	Ayrshires	1,577	301	6,148	5,757	4.17	3.34	417
2008	UK Northern Ireland	Friesian	394	322	6,724	6,233	4.19	3.35	391
2009	UK Northern Ireland	Friesian	355	314	7,046	6,608	4.25	3.39	398
2008	UK Northern Ireland	Holstein	49,218	338	8,940	7,811	3.90	3.2	425
2009	UK Northern Ireland	Holstein	47,771	334	8,792	7,720	3.99	3.24	430
2008	UK Northern Ireland	Jersey	649	320	5,585	4,865	5.10	3.84	408
2009	UK Northern Ireland	Jersey	600	314	5,357	4,707	5.16	3.87	421
2008	UK Scotland (by Holstein UK)	Ayrshires	6,666	321	7,528	6,905	4.10	3.33	423
2009	UK Scotland (by Holstein UK)	Ayrshires	6,520	322	7,532	6,881	4.05	3.36	420
2008	UK Scotland (by Holstein UK)	Brown Swiss	177	352	7,959	6,934	4.04	3.49	440
2009	UK Scotland (by Holstein UK)	Brown Swiss	196	331	7,463	6,368	3.86	3.53	444
2008	UK Scotland (by Holstein UK)	Friesian	710	287	6,296	5,835	4.11	3.43	412
2009	UK Scotland (by Holstein UK)	Friesian	514	319	7,062	6,563	4.14	3.41	401
2008	UK Scotland (by Holstein UK)	Holstein	57,764	346	9,606	8,347	3.89	3.19	437
2009	UK Scotland (by Holstein UK)	Holstein	57,162	345	9,592	8,339	3.86	3.19	436

Cow milk enquiry 2008-2009



Table 4.4 - Main breeds - Cows in herdbook

Year	Country	Breed	Number of lactations	Length of the lactations (days)	Milk yield per recorded cow (kg)	Milk per cow in 305 days (kg)	Percent of fat content (%)	Percent of protein content (%)	Calving interval (days)
2008	UK Scotland (by Holstein UK)	Jersey	1,122	327	6,057	5,287	5.56	4/03	428
2009	UK Scotland (by Holstein UK)	Jersey	855	335	6,364	5,522	5.45	4.00	429
2008	UK Wales	Ayrshires	144	311	7,159	6,542	4.74	3.38	418
2009	UK Wales	Ayrshires	151	342	8,115	7,013	4.72	3.39	408
2009	UK Wales	Brown Swiss	118	363	7,404	5,644	4.68	3.61	393
2008	UK Wales	Friesian	217	334	6,840	6,266	4.02	3.32	415
2009	UK Wales	Friesian	213	330	6,885	6,276	4.22	3.36	398
2008	UK Wales	Holstein	16,650	346	8,921	7,712	4.15	3.22	437
2009	UK Wales	Holstein	18,970	348	9,028	7,829	4.11	3.22	436
2008	UK Wales	Jersey	507	312	5,841	5,294	5.38	3.91	422
2009	UK Wales	Jersey	446	317	6,064	5,535	5.42	3.94	421



## Cow milk enquiry 2008-2009 – Responsible for the National submission

The following, are the accounts of the National Responsibles for the submission to the cow on-line database.

Country	E-mail account
Australia	dabernethy@adhis.com.au
Austria	rehling@zuchtdata.at
Belgium (Wallonia Region)	JeanFrancois.Duckerts@pw.wallonie.be
Canada	slafontaine@valacta.com
Chile	clo@cooprinsem.cl
Croatia	hpa@hpa.hr
Czech Republic	bucpav@centrum.cz
Denmark	UFL@landscentret.dk
Estonia	aire.pentjarv@jkkeskus.ee
Finland	sanna.nokka@proagria.fi
France	michel.douguet@inst-elevage.asso.fr
Germany	folkert.onken@adt.de
Hungary	gymeszaros@atkft.hu
Iran	abci@abc.org.ir
Ireland	mburke@icbf.com
Israel	hmb-efraim@icba.org.il
Italy	fioretti.m@aia.it
Japan	webmaster@liaj.or.jp
Latvia	ldc@ldc.gov.lv
Lithuania	egidijusz@zum.lt
Luxembourg	armand.braun@convis.lu
New Zealand	nwilson@lic.co.nz
Norway	per.sigve.lien@tine.no
Poland	d.radzio@pfb.pl
Portugal	jaimemachado2007@gmail.com
Scotland	suzanne@holstein-uk.org
Slovak Republic	stefanryba@pssr.sk
Slovenia	Marija.Klopčič@bfro.uni-lj.si
South Africa	jill@arc.agric.za
Spain	amartinr@mapa.es
Sweden	Nils-Erik.Larsson@svenskmjolk.se
Switzerland	info@asrbern.ch
The Netherlands	w.koops@pz.agro.nl
Tunisia	dg.oep@email.ati.tn
Turkey	onur@dsymb.org.tr
UK (England and Wales by NMR)	Richardn@nmr.co.uk
UK England, Jersey Island, Northern Ireland, Scotland, Wales	suzanne@holstein-uk.org
USA (by AgSource)	jmarshall@agsource.com
USA (by NDHIA)	melvin.tooker@ars.usda.gov



Table 1 - Basic information on population, recording methods and percentages

Year	Country	Breed or population (Name)	Dairy sheep breeds or populations recorded in ICAR member countries				Milk yield: methods and recording intervals (according to international regulations for milk recording in sheep)				Information on the management of the flocks subject to official milk recording			Breeds or populations recorded in ICAR member countries in other type of milk recording <sup>4</sup>			
			Size of the population (Estimation)		Recorded population		Percentage of A4, A5, A6, B4, B5, B6, C4, C5, C6 (precise if necessary) <sup>2</sup>	Percentage of AT, BT, CT (precise if necessary) <sup>2</sup>	Percentage of AC, BC, CC (precise if necessary) <sup>2</sup>	Percentage of E4, E5, E6, ET, EC (precise if necessary) <sup>2</sup>	Breeding system <sup>3</sup> (1) Milking from lambing (2) Milking after a suckling period	If system 2). Average length of the suckling period (in days)	Percentage of official recorded flocks in machine milking	Size of the population (Estimates)		Recorded population (Estimation)	
			Number of flocks	Number of ewes <sup>1</sup>	Number of flocks	Number of ewes <sup>1</sup>								Number of flocks	Number of ewes <sup>5</sup>	Number of flocks	Number of ewes <sup>5</sup>
2008 - 2009	Belgium (Wallonia Region) <sup>1</sup>	Sheep Mouton Laitier Belge	21	593	19	488											
2008	Croatia	East Friesian	50	2000	34	1490		100% AT		2	47						
2009	Croatia	East Friesian	50	2000	32	1375		100% AT		2	61						
2008	Croatia	Istrian sheep	40	2500	34	2261		100% AT		2	53						
2009	Croatia	Istrian sheep	40	2500	39	2142		100% AT		2	62						
2008	Croatia	Paska sheep	600	30000	30	2390		100% AT		1	31						
2009	Croatia	Paska sheep	600	30000	55	4253		100% AT		2	32						
2008	Czech Rep.	All breeds			22	549		AT		ET	1 and 2	40					
2009	Czech Rep.	All breeds			23	821		AT		ET	1 and 2	40					
2008	Czech Rep.	Bohemian Forest sheep			1	39											
2009	Czech Rep.	Bohemian Forest sheep			1	68											
2009	Czech Rep.	East Friesian			18	350											
2008	Czech Rep.	East Friesian			18	318											
2009	Czech Rep.	Improved Valachian			1	1											
2008	Czech Rep.	Lacaune			3	192											
2009	Czech Rep.	Lacaune			3	402											
2008	France	Basco-Béarnaise	420	80000	76	21434			AC	2	35	90%	420	80000	24	6534	
2009	France	Basco-Béarnaise	420	80000	78	21984			AC	2	35	90%	420	80000	23	5427	
2008	France	Corse	420	95000	71	21087			AC	2	35	85%	420	95000	9	1829	
2009	France	Corse	420	95000	72	21050			AC	2	35	80%	420	95000	10	1982	
2008	France	Lacaune	2600	900000	383	171211			AC	2	25	100%	2600	900000	1322	508235	
2009	France	Lacaune	2600	900000	376	173568			AC	2	25	100%	2600	900000	1268	504081	
2008	France	Manech Tête Noire	500	100000	54	15424			AC	2	35	85%	500	100000	7	1496	
2009	France	Manech Tête Noire	500	100000	52	14509			AC	2	35	85%	500	100000	4	881	
2008	France	Manech Tête Rousse	1150	270000	210	71900			AC	2	35	90%	1150	270000	73	28461	
2009	France	Manech Tête Rousse	1150	270000	203	70712			AC	2	35	90%	1150	270000	64	18928	
2008	Germany	Lacaune	1	118	1	39				100	1	100					
2009	Germany	Lacaune	1	104	1	36				100	1	100					
2008	Germany	Ostfriesisches Milchschaaf	530	8300	57	686	54	14		32	(1) 90% (2) 10%	50-70	39				
2009	Germany	Ostfriesisches Milchschaaf	510	8100	53	602	34	29		37	(1) 88% (2) 12%	50-70	46				
2008	Italy	Altamura			1	34			AT	AC	2	30					
2009	Italy	Altamura			2	92			AT	AC	2	30					
2008	Italy	Barbaresca			16	1.335			AT	AC	2	30					
2009	Italy	Barbaresca			16	1162			AT	AC	2	30					
2009	Italy	Brigasca			8	1421			AT	AC	2	30					
2008	Italy	Comisana			579	54.931			AT	AC	2	30					
2009	Italy	Comisana			581	50505			AT	AC	2	30					
2008	Italy	Delle Langhe			90	3.154			AT	AC	2	30					
2009	Italy	delle Langhe			86	2661			AT	AC	2	30					
2009	Italy	Frisona			4	41			AT	AC	2	30					
2009	Italy	Lacaune			10	1365			AT	AC	2	30					

<sup>1</sup> Detailed information on demand

Year	Country	Breed or population (Name)	Dairy sheep breeds or populations recorded in ICAR member countries				Milk yield: methods and recording intervals (according to international regulations for milk recording in sheep)				Information on the management of the flocks subject to official milk recording			Breeds or populations recorded in ICAR member countries in other type of milk recording <sup>4</sup>			
			Size of the population (Estimation)		Recorded population		Percentage of A4, A5, A6, B4, B5, B6, C4, C5, C6 (precise if necessary) <sup>2</sup>	Percentage of AT, BT, CT (precise if necessary) <sup>2</sup>	Percentage of AC, BC, CC (precise if necessary) <sup>2</sup>	Percentage of E4, E5, E6, ET, EC (precise if necessary) <sup>2</sup>	Breeding system <sup>3</sup> (1) Milking from lambing (2) Milking after a suckling period	If system 2). Average length of the suckling period (in days)	Percentage of official recorded flocks in machine milking	Size of the population (Estimates)		Recorded population (Estimation)	
			Number of flocks	Number of ewes <sup>1</sup>	Number of flocks	Number of ewes <sup>1</sup>								Number of flocks	Number of ewes <sup>5</sup>	Number of flocks	Number of ewes <sup>5</sup>
2008	Italy	Massese			60	4.473		AT	AC		2	30					
2009	Italy	Massese			59	4764		AT	AC		2	30					
2008	Italy	Moscia Leccese			9	651		AT	AC		2	30					
2009	Italy	Moscia Leccese			8	618		AT	AC		2	30					
2009	Italy	Nera di Arbus			2	22		AT	AC		2	30					
2008	Italy	Pinzirita			302	41.895		AT	AC		2	30					
2009	Italy	Pinzirita			234	30051		AT	AC		2	30					
2008	Italy	Sarda			1.126	260.098		AT	AC		2	30					
2009	Italy	Sarda			1095	249072		AT	AC		2	30					
2008	Italy	Valle del Belice			884	127.110		AT	AC		2	30					
2009	Italy	Valle del Belice			970	138123		AT	AC		2	30					
2008	Slovak Rep.	East Friesian			5	65			AC		2	51	-				
2009	Slovak Rep.	East Friesian			5	76			100% AC		2	547	53				
2008	Slovak Rep.	Hybrids			13	1 595			AC		2	49	7 %				
2009	Slovak Rep.	Hybrids			19	2676			100% AC		2	568	39				
2008	Slovak Rep.	Improved Valachian			44	8 008			AC		2	60	20 %				
2009	Slovak Rep.	Improved Valachian			46	8497			100% AC		2	526	45%				
2008	Slovak Rep.	Lacaune			9	545			AC		2	49	-				
2009	Slovak Rep.	Lacaune			13	714			100% AC		2	622	98				
2008	Slovak Rep.	Tsigai			30	5 059			AC		2	41	17 %				
2009	Slovak Rep.	Tsigai			36	5920			100% AC		2	511	524				
2008	Slovenia	Bovec sheep	75	2700	27	2178		100			1 and 2	41	100				
2009	Slovenia	Bovec sheep	75	2700	26	2292		100			1 and 2	42	100				
2008	Slovenia	Improved Bovec sheep	25	1100	10	552		100			1 and 2	48	100				
2009	Slovenia	Improved Bovec sheep	25	1100	10	556		100			1 and 2	42	100				
2008	Slovenia	Istrian Pramenka	15	1100	5	935		100			1 and 2	67	100				
2009	Slovenia	Istrian Pramenka	15	1100	5	901		100			1 and 2	/	100				
2008	Spain	Assaf		592949	126	66500		AT4-100%			1)-60%; (2)-40%	28	100%				
2008	Spain	Carranzana	696	12401	7	3424		AT-100%			2) Milking after a suckling period	30					
2008	Spain	Churra	950	480000	85	40010		100%AT			2) Milking after a suckling period	25	98				
2008	Spain	Colmenareña	10	2810	3	2085	A4-100%	AT-100%			1) Milking from lambing		33%				
2009	Spain	Colmenareña	11	3039	4	2231	A4-100%	AT-100%			1) Milking from lambing		25%				



Table 1 - Basic information on population, recording methods and percentages

Year	Country	Breed or population (Name)	airy sheep breeds or populations recorded in ICAR member countries				Milk yield: methods and recording intervals (according to international regulations for milk recording in sheep)				Information on the management of the flocks subject to official milk recording			Breeds or populations recorded in ICAR member countries in other type of milk recording <sup>4</sup>			
			Size of the population (Estimation)		Recorded population		Percentage of A4, A5, A6, B4, B5, B6, C4, C5, C6 (precise if necessary) <sup>2</sup>	Percentage of AT, BT, CT (precise if necessary) <sup>2</sup>	Percentage of AC, BC, CC (precise if necessary) <sup>2</sup>	Percentage of E4, E5, E6, ET, EC (precise if necessary) <sup>2</sup>	Breeding system <sup>3</sup> (1) Milking from lambing (2) Milking after a suckling period	If system 2). Average length of the suckling period (in days)	Percentage of official recorded flocks in machine milking	Size of the population (Estimates)		Recorded population (Estimation)	
			Number of flocks	Number of ewes <sup>1</sup>	Number of flocks	Number of ewes <sup>1</sup>								Number of flocks	Number of ewes <sup>5</sup>	Number of flocks	Number of ewes <sup>5</sup>
2008	Spain	Lacaune	52	46751	9	9500	100%A4				1) Milking from lambing	100%					
2008	Spain	Latxa Cara Negra	4146	173237	123	59279		AT-47%	AC-53%		2) Milking after a suckling period	30	72.5%				
2008	Spain	Latxa Cara Rubia	4266	217165	67	32964		AT-46%	AC-54%		2) Milking after a suckling period	30	88%				
2008	Spain	Manchega	1025	600000	111	90000		100% AT			2) Milking after a suckling period	30	99%				
2008	Spain	Merina de Grazalema	36	4690	9	1092	100%A4	AT-100%			(1)-5%; (2)-95%	56	77.77%				
2009	Spain	Merina de Grazalema	34	4673	8	983	100%A4	AT-100%			(1)-5%; (2)-95%	55	75%				
2008	Spain	Rubia del Molar	10	1305	3	519		AT-100%			2) Milking after a suckling period	35					
2009	Spain	Rubia del Molar	11	1267	3	511		AT-100%			AT-100%	35	0%				

Table 2 - Milk yield: type of lactation calculation (quantity of milk) and Milk yield: results (quantity of milk)

Year	Country	Breed or population (Name)	Milk yield: type of lactation calculation (quantity of milk)						Milk yield: results (quantity of milk)		
			Lactation calculation <sup>1</sup>			Production of reference (for lactation)			Average milk yield per recorded ewe (length)		
			TSMM <sup>2</sup> (Yes/No)	TMM <sup>3</sup> (Yes/No)	TMY <sup>4</sup> (Yes/No)	TSMM <sup>1</sup> (Yes/No)	TMM <sup>2</sup> (Yes/No) If yes, standard length (days)	TMY <sup>3</sup> (Yes/No) If yes, standard length (days)	Yearlings (12-18 months)	Adults (> 18 months)	All ewes
2008	Croatia	East Friesian	Yes	Yes	No	No	No	No	14193	21303	19219
2009	Croatia	East Friesian	Yes	Yes	No	No	No	No	15238	17513	16755
2008	Croatia	Istrian Sheep	Yes	Yes	No	No	No	No	13749	13603	13617
2009	Croatia	Istrian sheep	Yes	Yes	No	No	No	No	11038	13801	13229
2008	Croatia	Paska Sheep	Yes	Yes	No	No	No	No	8733	10468	10511
2009	Croatia	Paska sheep	Yes	Yes	No	No	No	No	8471	10002	10027
2008	Czech Rep.	All breeds									213
2009	Czech Rep.	All breeds									263
2008	France	Basco-Béarnaise	No	Yes	No	No	No	No			161 litres (146 days)
2009	France	Basco-Béarnaise	No	Yes	No	No	No	No			164 (146)
2008	France	Corse	No	Yes	No	No	No	No			140 litres (183 days)
2009	France	Corse	No	Yes	No	No	No	No			133 (182)
2008	France	Lacaune	No	Yes	No	No	No	No			269 litres (165 days)
2009	France	Lacaune	No	Yes	No	No	No	No			272 (164)
2008	France	Manech Tête Noire	No	Yes	No	No	No	No			133 litres (140 days)
2009	France	Manech Tête Noire	No	Yes	No	No	No	No			134 (139)
2008	France	Manech Tête Rousse	No	Yes	No	No	No	No			176 litres (151 days)
2009	France	Manech Tête Rousse	No	Yes	No	No	No	No			180 (155)
2008	Germany	Lacaune			100 %			Yes 150 d			300
2009	Germany	Lacaune			100 %			Yes 150 d			283
2008	Germany	Ostfriesisches Milchschaaf		10 %	90 %			Yes 150 d			313
2009	Germany	Ostfriesisches Milchschaaf		12 %	88 %			Yes 150 d			283
2009	Italy	Altamura <sup>1</sup>	Yes	Yes	No	No		No			38
2009	Italy	Barbaresca <sup>1</sup>	Yes	Yes	No	No		No	99	166	161
2009	Italy	Brigasca <sup>1</sup>	Yes	Yes	No	No		No	72	93	93
2009	Italy	Comisana <sup>1</sup>	Yes	Yes	No	No		No	97	187	182
2009	Italy	delle Langhe <sup>1</sup>	Yes	Yes	No	No		No	113	161	157
2009	Italy	Frisona <sup>1</sup>	Yes	Yes	No	No		No	162	213	172
2009	Italy	Massese <sup>1</sup>	Yes	Yes	No	No		No	112	132	131
2009	Italy	Moscia Leccese <sup>1</sup>	Yes	Yes	No	No		No	84	128	127
2009	Italy	Nera di Arbus <sup>1</sup>	Yes	Yes	No	No		No		156	156
2009	Italy	Pinzirita <sup>1</sup>	Yes	Yes	No	No		No	67	118	115
2009	Italy	Sarda <sup>1</sup>	Yes	Yes	No	No		No	191	196	188
2009	Italy	Valle del Belice <sup>1</sup>	Yes	Yes	No	No		No	119	209	202

<sup>1</sup> From day 30 from lambing to reference length

Table 2 - Milk yield: type of lactation calculation (quantity of milk) + Milk yield: results (quantity of milk)

Year	Country	Breed or population (Name)	Milk yield: type of lactation calculation (quantity of milk)	Milk yield: results (quantity of milk)	Year	Country	Breed or population (Name)	Milk yield: type of lactation calculation (quantity of milk)	Milk yield: results (quantity of milk)	Year	Country
2008	Slovak Rep.	East Friesian	No	Yes	No	No	Yes 160	No			19615
2009	Slovak Rep.	East Friesian	No	Yes	No	No	Yes 160	No			18303
2008	Slovak Rep.	Hybrids	No	Yes	No	No	Yes 150	No			15243
2009	Slovak Rep.	Hybrids	No	Yes	No	No	Yes 150	No			13792
2008	Slovak Rep.	Improved Valachian	No	Yes	No	No	Yes 150	No			10401
2009	Slovak Rep.	Improved Valachian	No	Yes	No	No	Yes 150	No			10726
2008	Slovak Rep.	Lacaune	No	Yes	No	No	Yes 150	No			20988
2009	Slovak Rep.	Lacaune	No	Yes	No	No	Yes 150	No			20463
2008	Slovak Rep.	Tsigai	No	Yes	No	No	Yes 150	No			10303
2009	Slovak Rep.	Tsigai	No	Yes	No	No	Yes 150	No			9774
2008	Slovenia	Bovec sheep	Yes	Yes	Yes	No	No	No			TSMM 238 kg, TMM 175 kg, suckled 63 kg, lactation length 214 days
2009	Slovenia	Bovec sheep	Yes	Yes	Yes	No	No	No			TSMM 237 kg, TMM 183 kg, suckled 55 kg, lactation length 215 days
2008	Slovenia	Improved Bovec sheep	Yes	Yes	Yes	No	No	No			TSMM 261 kg, TMM 198 kg, suckled 64 kg, lactation length 208 days
2009	Slovenia	Improved Bovec sheep	Yes	Yes	Yes	No	No	No			TSMM 279 kg, TMM 219 kg, suckled 60 kg, lactation length 217 days
2008	Slovenia	Istrian Pramenka	Yes	Yes	Yes	No	No	No			TSMM 142 kg, TMM 87 kg, suckled 56 kg, lactation length 202 days
2009	Slovenia	Istrian Pramenka	Yes	Yes	Yes	No	No	No			TSMM 137 kg, TMM 87 kg, suckled cca. 50 kg, lactation length 198 days



Table 2 - Milk yield: type of lactation calculation (quantity of milk) and Milk yield: results (quantity of milk)

Year	Country	Breed or population (Name)	Milk yield: type of lactation calculation (quantity of milk)	Milk yield: results (quantity of milk)	Year	Country	Breed or population (Name)	Milk yield: type of lactation calculation (quantity of milk)	Milk yield: results (quantity of milk)	Year	Country
2008	Spain	Assaf	No	No	Yes			150-210	370	420	400
2008	Spain	Carranzana	Yes	Yes	Yes	Yes	120		148	175	
2008	Spain	Churra	Yes	Yes	No	No	Yes (30-120 DAYS)	No	85	91	90
2008	Spain	Colmenareña	No	No	Yes	No	No	Yes/120	73.1	72.98	72.9
2008	Spain	Colmenareña	No	No	Yes	No	No	Yes/120	65.5	63.7	64.0
2008	Spain	Lacaune	No	No	Yes	No	No	Yes/200	287	399	361
2008	Spain	Latxa Cara Negra	Yes	Yes	Yes	Yes	120		131	158	
2008	Spain	Latxa Cara Rubia	Yes	Yes	Yes	Yes	120		144	152	
2008	Spain	Manchega	Yes	Yes	No	Yes	120	No	150	160	154
2008	Spain	Merina De Grazalema	No	Yes	No	No	Yes/150	No	75.310	126.297	122.769
2009	Spain	Merina De Grazalema	No	Yes	No	No	Yes/155	No	68.999	124.755	122.595
2008	Spain	Rubia del Molar	Yes	Yes	N	Yes	Yes/120	No		84	84



Table 3 - Optional tests for milk composition

Year	Country	Breed or population (Name)	Categories or classes of age or parity concerned (number of ewes in the reference year)	Method used for recording milk composition <sup>1</sup>	Milk analysis in laboratory Fat content (Yes/No) Protein content (Yes/No) Somatic Cells Counts (Yes/No) Other analysis (Lactose... Describe it)
2008-2009	Belgium (Wallonia Region)	Mouton Laitier Belge (Belgian Dairy Sheep)	Detailed information on demand		
2008	Croatia	East Friesian	747	AT	Fat content (Yes) 5,760%, Protein content (Yes) 4,96%, Somatic Cells Counts (Yes), Lactose(Yes) 4,46%
2009	Croatia	East Friesian	621	AT	Fat content (Yes)5,35%, Protein content (Yes)5,09%, Somatic Cells Counts (Yes), Lactose(Yes) 4,49%
2008	Croatia	Istrian sheep	1157	AT	Fat content (Yes) 7,44%, Protein content (Yes) 6,04%, Somatic Cells Counts (Yes), Lactose(Yes) 4,22%
2009	Croatia	Istrian sheep	1298	AT	Fat content (Yes) 7,18%, Protein content (Yes)6,04%, Somatic Cells Counts (Yes), Lactose(Yes) 4,59%
2008	Croatia	Paska sheep	1645	AT	Fat content (Yes) 7,83%, Protein content (Yes) 6,00%, Somatic Cells Counts (Yes), Lactose(Yes) 4,58%
2009	Croatia	Paska sheep	2700	AT	Fat content (Yes) 7,35%, Protein content (Yes) 6,03%, Somatic Cells Counts (Yes), Lactose(Yes) 4,39%
2008	Czech Rep.	All breeds		AT, E	Fat, Protein, SC, Lactose
2009	Czech Rep.	All breeds		AT, E	Fat, Protein, SC, Lactose
2008	France	Basco-Béarnaise, Manech Tête Noire, Manech Tête Rousse	Parity 1 (18,571)	part-lactation sampling	Fat, Protein, SCC
2009	France	Basco-Béarnaise, Manech Tête Noire, Manech Tête Rousse	Parity 1 (19,269)	part-lactation sampling	Fat, Protein, SCC
2008	France	Lacaune	Parities 1 & 2 (63,420)	part-lactation sampling	Fat, Protein, SCC
2009	France	Lacaune	Parities 1 & 2 (64,897)	part-lactation sampling	Fat, Protein, SCC
2008	Germany	Ostfriesisches Milchschaft	686	A4, B4, AT4, E4	Fat content, Protein content, Somatic Cells, Lactose content, Urea
2009	Germany	Ostfriesisches Milchschaft	602	A4, B4, AT4, E4	Fat content, Protein content, Somatic Cells, Lactose content, Urea
2009	Italy <sup>1</sup>	Sarda	Primiparous - 25108 Lactations	Fat-Protein	
2008	Italy <sup>1</sup>	Sarda	Primiparous (27.476 lactations)		Fat - Protein
2008	Slovak Rep.	East Friesian	Parity 1 to 3, 65 ewes	AC	Fat content Yes, Protein content Yes, Somatic Cells No, Other analysis (Lactose)
2009	Slovak Rep.	East Friesian	Parity 1 to 3, 76 ewes	AC	Fat content Yes, Protein content Yes, Somatic Cells No, Other analysis (Lactose)
2008	Slovak Rep.	Hybrids	Parity 1 to 3, 1595 ewes	AC	Fat content Yes, Protein content Yes, Somatic Cells No, Other analysis (Lactose)
2009	Slovak Rep.	Hybrids	Parity 1 to 3, 2676 ewes	AC	Fat content Yes, Protein content Yes, Somatic Cells No, Other analysis (Lactose)
2008	Slovak Rep.	Improved Valachian	Parity 1 to 3, 8008 ewes	AC	Fat content Yes, Protein content Yes, Somatic Cells No, Other analysis (Lactose)
2009	Slovak Rep.	Improved Valachian	Parity 1 to 3, 8497 ewes	AC	Fat content Yes, Protein content Yes, Somatic Cells No, Other analysis (Lactose)
2008	Slovak Rep.	Lacaune	Parity 1 to 3, 545 ewes	AC	Fat content Yes, Protein content Yes, Somatic Cells No, Other analysis (Lactose)
2009	Slovak Rep.	Lacaune	Parity 1 to 3, 714 ewes	AC	Fat content Yes, Protein content Yes, Somatic Cells No, Other analysis (Lactose)
2008	Slovak Rep.	Tsigai	Parity 1 to 3, 5059 ewes	AC	Fat content Yes, Protein content Yes, Somatic Cells No, Other analysis (Lactose)
2009	Slovak Rep.	Tsigai	Parity 1 to 3, 5920 ewes	AC	Fat content Yes, Protein content Yes, Somatic Cells No, Other analysis (Lactose)

<sup>1</sup> Numbers referred to lactations, not ewes





Table 3 - Optional tests for milk composition

Year	Country	Breed or population (Name)	Categories or classes of age or parity concerned (number of ewes in the reference year)	Method used for recording milk composition <sup>1</sup>	Milk analysis in laboratory Fat content (Yes/No) Protein content (Yes/No) Somatic Cells Counts (Yes/No) Other analysis (Lactose... Describe it)
2008	Slovenia	All milk breeds	All milk ewes under control	AT	Fat content (Yes), Protein content (Yes), Lactose (Yes), Somatic Cell Count (Yes)
2009	Slovenia	All milk breeds	All milk ewes under control	AT	Fat content (Yes), Protein content (Yes), Lactose (Yes), Somatic Cell Count (Yes)
2008	Spain	Assaf		AT4	Fat, Protein, Somatic Cells, Lactose
2008	Spain	Carranzana		AC	Fat, Protein, Dry Matter, Somatic Cells, Lactose
2008	Spain	Churra		AT	Fat, Protein, Somatic Cells, Lactose
2008	Spain	Colmenareña		A4	Fat, Protein, Dry Matter, Somatic Cells, Lactose
2009	Spain	Colmenareña		A4	Fat, Protein, Dry Matter, Somatic Cells, Lactose
2008	Spain	Lacaune		A4	Fat, protein, somatic cells
2008	Spain	Latxa Cara Negra		AC	Fat, Protein, Dry Matter, Somatic Cells, Lactose
2008	Spain	Latxa Cara Rubia		AC	Fat, Protein, Dry Matter, Somatic Cells, Lactose
2008	Spain	Manchega		AT	Fat, Protein, Dry Matter, Somatic Cells
2008	Spain	Merina De Grazalema		AT4	Fat, Protein, Dry Matter, Somatic Cells, Lactose
2009	Spain	Merina De Grazalema		AT4	Fat, Protein, Dry Matter, Lactose
2008	Spain	Rubia del Molar		AT4	Fat, Protein, Dry Matter, Somatic Cells, Lactose
2008	Spain	Rubia del Molar		AT4	Fat, Protein, Dry Matter, Somatic Cells, Lactose

Table 4 - Recording of non-milking traits

Year	Country	Breed or population	Reproductive traits, weights & growths, udder score, longevity			
			Traits	On-farm recording (Yes/No)	Breeding evaluation (Yes/No)	Use in selection (Yes/No)
2008	Croatia	East Friesian	Reproductive traits and birth weight (10 years, number of controlled ewes in 2008:990)	Yes	No	Yes
2009	Croatia	East Friesian	Reproductive traits and birth weight (10 years, number of controlled ewes in 2009:931)	Yes	No	Yes
2008	Croatia	Istrian sheep	Reproductive traits and birth weight (10 years, number of controlled ewes in 2008:1775)	Yes	No	Yes
2009	Croatia	Istrian sheep	Reproductive traits and birth weight (10 years, number of controlled ewes in 2009:1768)	Yes	No	Y
2008	Croatia	Paska sheep	Reproductive traits and birth weight (10 years, number of controlled ewes in 2008:1919)	Yes	No	Yes
2009	Croatia	Paska sheep	Reproductive traits and birth weight (10 years, number of controlled ewes in 2009:3518)	Yes	No	Yes
2008	Czech Republic	All breeds	weight, reproductive traits	Yes		
2009	Czech Republic	All breeds	weight, reproductive traits	Yes	Yes	Yes
2008	France	all breeds	reproductive traits, udder score (Lacaune only), longevity	Yes	Udder score (Lacaune only)	udder score (Lacaune only)
2009	France	all breeds	reproductive traits, udder score (Lacaune only), longevity	Yes	Udder score (Lacaune only)	udder score (Lacaune only)
2008	Germany	Ostfriesisches Milchscharf	Reproductive traits, longevity, weights, appearance and udder score, wool quality	Yes	Some	Yes
2009	Germany	Ostfriesisches Milchscharf	Reproductive traits, longevity, weights, appearance and udder score, wool quality	Yes	Some	Yes
2008	Italy	All breeds reported in year 2008	Udder score, morphological evaluation	yes	No	No
2009	Italy	All breeds reported in year 2009	Udder score, morphological evaluation	yes	no	no
2008	Slovak Rep.	all breeds	Reproductive traits, weight	Yes	Yes	Yes
2009	Slovak Rep.	all breeds	Reproductive traits, weight	Yes	Yes	Yes
2008	Slovenia	All breeds	Litter size and other data on reproductive cycle, daily gain to weaning (on farm), daily gain to puberty (test station)	Yes	No	Yes
2009	Slovenia	All breeds	Litter size and other data on reproductive cycle, daily gain to weaning (on farm), daily gain to puberty (test station)	yes	no	yes
2008	Spain	Assaf	Reproductive traits; weights and growths); udder score, longevity,	No (except reproductive traits)	No	No
2008	Spain	Carranzana	Udder score, longevity, prolificity, mortality, weights and growths	Yes (except weights and growths)	No (except udder score)	
2008	Spain	Churra	Udder score	Yes	Yes	Yes
2008	Spain	Lacaune	Udder score, morphology	No	SI	SI
2008	Spain	Latxa Cara Negra	Udder score, longevity, prolificity, mortality	Yes (except weights and growths)	No (except udder score)	
2008	Spain	Latxa Cara Rubia	Udder score, longevity, prolificity, mortality, weights and growths	Yes (except weights and growths)	No (except udder score)	
2008	Spain	Manchega	Udder score	Yes	Yes	Yes
2008	Spain	Merina de Grazalema	Weights and growths; resistance scrapie	Yes	No	Yes (except weights and growths)
2009	Spain	Merina de Grazalema	Resistance scrapie	Yes	No	Yes



Table 5 - Milk recording equipment used in case of machine milking

Year	Country	Breed or population (Name)	Use of jars			Use of milk meters		
			Name of the manufacturer	Measurement (weight/volume) Sampler (yes/no)	Approximate number in use	Name of the manufacturer	Measurement (weight/volume) Sampler (yes/no)	Approximate number in use
2008	Croatia	East Friesian	Cartel Germany	Measurement - volume, Sampler - no	4			
2009	Croatia	East Friesian	Cartel Germany	Measurement - volume, Sampler - no	6			
2008	Croatia	Istrian Sheep	Cartel Germany	Measurement - volume, Sampler - no	9			
2009	Croatia	Istrian Sheep	Cartel Germany	Measurement - volume, Sampler - no	12			
2008	Croatia	Paska Sheep	Cartel Germany	Measurement - volume, Sampler - no	10			
2009	Croatia	Paska Sheep	Cartel Germany	Measurement - volume, Sampler - no	15			
2009	France	All breeds	Établissements Gély (ex. Dintilhac)	Volume - Sampler	,000			
2008	Germany	Ostfriesisches Milchschaaf				TruTest		
2009	Germany	Ostfriesisches Milchschaaf				TruTest		
2008	Slovak Rep.	All breeds		Volume	20	Berango, Milkovis	Volume, sampler no	Berango 251, Milkovis 84
2009	Slovak Rep.	All breeds	Fisher Slovakia	Volume	20	Berango, Milkovis	volume, sampler no	Berango 226, Milkovis 144
2008	Slovenia	All milk breeds		Volume/Yes	2	True test, Girotech	Weight/Yes	45
2009	Slovenia	All milk breeds		Volume/Yes	2	True test, Girotech	Weight/Yes	45
2008	Spain	Assaf				Esneder	Volume/Yes	425
2008	Spain	Carranzana				Mibo	Volume/Yes	50
2008	Spain	Churra				Berango	Volume/Yes	150
2008	Spain	Lacaune				Westfalia	Volume/Yes	25
2008	Spain	Latxa Cara Negra				Mibo	Volume/Yes	216
2008	Spain	Latxa Cara Rubia				Mibo	Volume/Yes	166
2008	Spain	Manchega		Volume/Yes	1	DeLaval, Westfalia, Flaco	Volume/Yes	820
2008	Spain	Merina de Grazalema				ref:EE 120416	Volume/Yes	3
2009	Spain	Merina de Grazalema				ref:EE 120416	Volume/Yes	4

Table 6 - Breeding program using artificial insemination

Year	Country	Breed or population (Name)	AI		Selection criteria	Progeny test	
			Fresh semen	Frozen semen		AI progeny-tested rams per year	Number of AI per progeny-tested ram
2008	France	Basco-Béarnaise	14464		Milk yield, fat and protein	49	
2009	France	Basco-Béarnaise	14128		Milk yield, fat and protein	52	
2008	France	Corse	7097		Milk yield	30	
2009	France	Corse	6336		Milk yield	31	
2008	France	Lacaune	399885		Milk yield, fat and protein; SCC and udder score	445	120
2009	France	Lacaune	395812		Milk yield, fat and protein; SCC and udder score	445	
2009	France	Manech Tête Noire	7869		Milk yield, fat and protein	36	
2008	France	Manech Tête Rousse	59221		Milk yield, fat and protein	158	
2009	France	Manech Tête Rousse	56,760		Milk yield, fat and protein	151	
2008	France	ManechnTête Noire	9440		Milk yield, fat and protein	40	
2009	Italy	All <sup>1</sup>	15000				
2008	Slovenia <sup>2</sup>		No	No	No	No	No
2009	Slovenia <sup>2</sup>		No	No	No	No	No
2008	Spain	Assaf	6488	160		60	200
2008	Spain	Carranzana	300	0	Morphology	2	120
2008	Spain	Churra	8850	3454	Milk Production, Fat, Protein, Lactose, SCS, Tse Resistance, Udder Score	51	170
2008	Spain	Latxa Cara Negra	15103	0	Fat, Protein, Lactose, SCS, Dry Matter, Udder Score, Morphology	50	120
2008	Spain	Latxa Cara Rubia	9210		Fat, Protein, Lactose, SCS, Dry Matter, Udder Score, Morphology	30	120
2008	Spain	Manchega	35764		Milk Production, Tse Resistance, Udder Score	150/175	200/250

<sup>1</sup> Not available if fresh or frozen semen - mainly on Sarda sheep

<sup>2</sup> Slovenia do not use AI

Table 7 – Molecular information

Year	Country	Breed or population	Type of genotyping <sup>1</sup>	Number of analysis, Number of flocks involved	Use in experimental program	Effective use in selection program
2008	Belgium (Wallonia Region)	Sheep (all breeds)	PrP	185 an.		185
2009	Belgium (Wallonia Region) <sup>1</sup>	Sheep (all breeds)	Filiation tests	673 an. (A, F, M)		2
2009	Belgium (Wallonia Region)	Sheep (all breeds)	PrP	206 an.		206
2008	Belgium (Wallonia Region)	Sheep (Belgian Milk Sheep)	Microsatellite markers for genetic diversity studies	121 / 12	Cryo-preservation program	
2008	Belgium (Wallonia Region) <sup>2</sup>	Sheep (all breeds)	Filiation tests	977 an. (A,F,M)		252
2008	Croatia					
2009	Croatia					
2008	Czech Rep.	All breeds	PrP			Yes
2009	Czech Rep.	All breeds	PrP			Yes
2008	France	all breeds	Filiation tests	1473 animals (all rams progeny-tested and some ewes)		Yes
2009	France	all breeds	Filiation tests	1466 animals (all rams progeny-tested and some ewes)		Yes
2009	France	all breeds	Filiation tests	1466 animals (all rams progeny-tested and some ewes)		Yes
2008	France	Basco-Béarnaise	PrP	1688		Yes
2009	France	Basco-Béarnaise	PrP	1461		Yes
2008	France	Corse	PrP	1950		Yes
2009	France	Corse	PrP	2016		Yes
2008	France	Lacaune	PrP	6704		Yes
2009	France	Lacaune	PrP	6337		Yes
2008	France	Manech Tête Noire	PrP	648		Yes
2009	France	Manech Tête Noire	PrP	745		Yes
2008	France	Manech Tête Rousse	PrP	5943		Yes
2009	France	Manech Tête Rousse	PrP	4348		Yes
2009	Italy	all	Scrapie	20000 analysis (estimated)		
2008	Slovak Rep.	all breeds	PrP genotyping	2251 analysis		Yes
2009	Slovak Rep.	all breeds	PrP genotyping	2246 analysis		Yes
2008	Slovenia	All breeds	PrP genotyping	5623 analyses, 410 flocks		Yes
2009	Slovenia	All breeds	PrP genotyping	2255 analyses, 253 flocks		Yes
2008	Spain	Assaf	Filiation test, GEN PNRP	Filiation test: 23000/60; PNRP: 25468/127	No	Yes
2008	Spain	Carranzana	Filiation test (9), PNRP	Filiation test: 4/2, PNRP: 415/7	No	Yes
2008	Spain	Churra	PNRP	33435/170		Yes
2008	Spain	Colmenareña	Filiation test; PNRP	Filiation test: 753; PNRP: 6		
2009	Spain	Colmenareña	Filiation test; PNRP	Filiation test: 502; PNRP: 6		
2008	Spain	Lacaune	PNRP	PNRP:34000/29		Yes
2008	Spain	Latxa Cara Negra	Filiation test (9), PNRP	Filiation test: 103/54; PNRP: 9841/114	No	Yes
2008	Spain	Latxa Cara Rubia	Filiation test (9), PNRP	Filiation test: 77/22, PNRP:8171/59	No	Yes
2008	Spain	Manchega	Filiation test (9-12), PNRP	Filiation test: 8200/90; PNRP: 40739/139		Yes
2008	Spain	Merina de Grazalema	Filiation test (11), PNRP	Filiation test: 225/6; PNRP: 1632/35		Yes
2009	Spain	Merina de Grazalema	Filiation test (11), PNRP	Filiation test: 640/30; PNRP: 650/30		Yes
2008	Spain	Rubia del Molar	PNRP; Filiation test	PNRP: 176/10; Filiation test: 112/6		Yes

<sup>1</sup> Most of the samples are collected but analyzed only if needed; more analysis in 2008 so very few in 2009

<sup>2</sup> Most of the samples are collected but analyzed only if needed

The following, are the accounts of the National Responsibles for the submission to the sheep on-line database.

<b>Country</b>	<b>E-mail</b>
Belgium (Wallonia region)	jeanfrancois.duckerts@spw.wallonie.be
Czeck rep.	bucek@cmsch.cz
France	Jean-michel.astruc@toulouse.inra.fr
Germany	franz-josef.romberg@dlr.rlp.de
Greece	ve46u013@minagric.gr
Hungary	zbarac@hpa.hr
Slovak Rep.	martinarafajova@pssr.sk
Slovenia	drago.kompan@bfro.uni-lj.si
Spain	amartinr@mapya.es