



**HAL**  
open science

## The condensed tannins in sainfoin cause digestive synergy on in vitro rumen fermentation of cocksfoot

Vincent Niderkorn, Aline Le Morvan, René Baumont

### ► To cite this version:

Vincent Niderkorn, Aline Le Morvan, René Baumont. The condensed tannins in sainfoin cause digestive synergy on in vitro rumen fermentation of cocksfoot. 23. General Meeting of the European Grassland Federation, Aug 2010, Kiel, Germany. hal-02757875

**HAL Id: hal-02757875**

**<https://hal.inrae.fr/hal-02757875v1>**

Submitted on 4 Jun 2020

**HAL** is a multi-disciplinary open access archive for the deposit and dissemination of scientific research documents, whether they are published or not. The documents may come from teaching and research institutions in France or abroad, or from public or private research centers.

L'archive ouverte pluridisciplinaire **HAL**, est destinée au dépôt et à la diffusion de documents scientifiques de niveau recherche, publiés ou non, émanant des établissements d'enseignement et de recherche français ou étrangers, des laboratoires publics ou privés.



EGF 2010  
Kiel Germany

# *Grassland in a changing world*

*Edited by*

**H. Schnyder  
J. Isselstein  
F. Taube  
K. Auerswald  
J. Schellberg  
M. Wachendorf  
A. Herrmann  
M. Gierus  
N. Wrage  
A. Hopkins**



**VOLUME 15  
GRASSLAND SCIENCE IN EUROPE**

# *Grassland in a changing world*

Proceedings of the 23<sup>th</sup> General Meeting  
of the European Grassland Federation  
Kiel, Germany  
August 29<sup>th</sup> - September 2<sup>nd</sup> 2010

*Edited by*

H. Schnyder  
J. Isselstein  
F. Taube  
K. Auerswald  
J. Schellberg  
M. Wachendorf  
A. Herrmann  
M. Gierus  
N. Wrage  
A. Hopkins

Mecke Druck und Verlag  
Duderstadt 2010

Published by

Organising Committee of the 23<sup>th</sup> General  
Meeting of the European Grassland Federation  
and  
Arbeitsgemeinschaft Grünland und Futterbau der  
Gesellschaft für Pflanzenbauwissenschaften

Copyright © 2010 Universität Göttingen

All rights reserved. Nothing from this  
publication may be reproduced, stored  
in computerised systems or published  
in any form or any manner, including  
electronic, mechanical, reprographic  
or photographic, without prior written  
permission from the publisher Universität Göttingen.

The individual contributions in this  
publication and any liabilities arising  
from them remain the responsibility of  
the authors.

ISBN 978-3-86944-021-7

*Printed by*

MECKE DRUCK UND VERLAG  
Christian-Blank-Straße 3  
37115 Duderstadt Germany

*Distributed by*

European Grassland Federation EGF  
W. Kessler · Federation Secretary  
c/o Agroscope Reckenholz-Tänikon Research Station ART  
Reckenholzstrasse 191  
CH-8046 Zürich, Switzerland  
E-mail [fedsecretary@europeangrassland.org](mailto:fedsecretary@europeangrassland.org)





EGF 2010  
Kiel Germany



### Organising Committee

President	Johannes Isselstein	Georg-August-Universität Göttingen
Local Organizer	Friedhelm Taube	Christian-Albrechts-Universität Kiel
General Secretary	Antje Herrmann	Christian-Albrechts-Universität Kiel
Members	Sigmone Hoffmann	Christian-Albrechts-Universität Kiel
	Karin Rahn	Christian-Albrechts-Universität Kiel
	Mirja Kämper	Christian-Albrechts-Universität Kiel
	Martin Elsässer	Bildungs- und Wissenszentrum Aulendorf
	Jürgen Pickert	Ministerium für Ländliche Entwicklung, Umwelt und Verbraucherschutz, Brandenburg
	Gerhard Riehl	Sächsische Landesanstalt für Landwirtschaft
	Hans Schnyder	Technische Universität München

### Scientific Committee

Chairman	Hans Schnyder	Technische Universität München
Members	Johannes Isselstein	Georg-August-Universität Göttingen
	Nicole Wrage	Georg-August-Universität Göttingen
	Friedhelm Taube	Christian-Albrechts-Universität Kiel
	Antje Herrmann	Christian-Albrechts-Universität Kiel
	Michael Wachendorf	Universität Kassel
	Jürgen Schellberg	Universität Bonn
	Martin Gierus	Christian-Albrechts-Universität Kiel
	Karl Auerswald	Technische Universität München
	Alan Hopkins	University of Exeter

## External reviewers and anglicisers

K. Auerswald	B. Frankow-Lindberg	F.A. Lattanzi	D. Rosellini
J. Aufrere	M. Ghesquiere	E. Lewis	E. Salomon
L. Bach Jensen	P. Golinski	V. Lind	R. Schäufele
R. Baumont	A. Gonzalez-Rodriguez	R. Loges	A. Schiborra
G. Belanger	J.-M. Greef	A. Luescher	R. Schils
R. Blank	A.-M. Gustavsson	R. Luick	E. Schlecht
B. Boller	A. B. Hald	V. Maire	H. Schnyder
C. Brophy	M. Halling	M. McGee	J. Schrautzer
M. Collomb	D. Hatch	A. Moloney	J. Sehested
J. Cone	M. Hejcman	R.M. Mosquera-Losada	K. Soegaard
J. Connolly	A. Helgadottir	A. Münger	U. Soelzer
P. Crosson	D. Hennessy	L. Nesheim	H. Steinshamn
A. De Vlieghe	M. Hetta	H.J. Neumann	A. Steinwider
C. Deblitz	M. Hofmann	H.-J. Nussbaum	D. Stilmant
R. Delagarde	A. Hopkins	O. Oenema	M. Suter
J. Dijkstra	O. Huegenin-Elie	P. O'Kiely	S. Tamminga
I. Dufresne	M. Humphreys	A. Pacholski	U. Thumm
B. Dumont	J. Humphreys	G. Pahlow	K. Topp
J.-L. Durand	C. Huyghe	S. Plantureux	A. van den Pol- van Dasselaar
B. Durgiai	S. Jaakkola	E. Poetsch	E. van Santen
M. Duru	S. K. Jensen	M. Potthoff	F. Vertes
L. Eckstein	A. Johansen	S. Prache	P. Virkajärvi
M. Elsässer	M. Kayser	A. Prochnow	M. Wachendorf
A. Farruggia	B. Keogh	A. Randby	R. Wulfes
A. Ferlay	R. Kölliker	O.A. Rogli	U. Wyss
U. Feuerstein	B. Kramberger	I. Roldan-Ruiz	

## Supporters and sponsors

Bundesministerium für Ernährung, Landwirtschaft und Verbraucherschutz  
Norddeutsche Pflanzenzucht, Hans-Georg Lembke KG  
Euro Grass B.B., International Marketing Department  
Bernard Krone Holding GmbH und Co. KG  
Deutsches Maiskomitee e.V. (DMK)  
Vereinigte Hagelversicherung VVaG  
The Stapledon Memorial Trust, UK  
KWS Saat AG, Einbeck  
K+S Kali GmbH  
Hansa-Milch AG  
E.ON AG

## Foreword

Grassland is the major resource to sustain the living of about one billion people worldwide. In industrialized Europe, grassland covers some 30 % of the agricultural area and forms the basis of a strong ruminant livestock sector. Grassland also provides a broad range of services that are beneficial for man. In addition to the production of herbage for livestock, grassland plays a major role in, for example, the maintenance of biodiversity, carbon sequestration into soils, clean surface and ground water, and the provision of an attractive environment for recreation and leisure activities. The way grassland provides these services is increasingly being affected by large scale processes that are commonly summarized as "global change". Grassland farming, the intensity of management and utilization, and the production of goods and environmental services at a given site are strongly affected by global markets for tradable goods, by international societal developments, by worldwide and realtime information exchange, and, most importantly, by climate change. These factors are seriously challenging the functioning of grassland and there is a great uncertainty as to how grassland will maintain its importance. Grassland researchers have realized this challenge and they have responded with in depth research in the various aspects of grassland farming and global change.

This was the background for the organizers of the EGF 2010 General Meeting to select 'Grassland in a Changing World' as the general topic of the conference. It is the first time that this topic has been addressed as the major theme for an EGF conference. Within this theme, five sections have been identified, ranging from 'grassland, climate and socio-economic change', over 'the future of grassland production systems', 'from grass to milk and meat', 'grassland ecosystem services', to 'pastoral systems'. Peer reviewed papers have been included in the present conference proceedings that are published in the EGF book series 'Grassland Science in Europe' as volume 15. Each section is introduced by a pair of review-papers from experienced scientists, followed by a set of voluntary submissions that had been presented at the conference as either oral or paper contributions. The book is an excellent source for up-to-date research in the field of grassland science and global change.

We wish to express our gratitude to the many people who have contributed to the conference. First of all we thank the 400 delegates from more than 40 countries all over the world for their scientific contributions as lectures, papers, posters and in the discussions. We particularly thank the numerous people that actively supported the planning and preparation of the conference: the members of the Organizing and the Scientific Committees, the many external reviewers, Alan Hopkins for the anglicizing of the manuscripts, Karl Auerswald for revising, formatting and proofreading of the whole book, and Melitta Sternkopf for managing the correspondence with the authors. Special thanks go to the members of the organizing group at Kiel University, Antje Herrmann as the Conference Secretary, Sigmone Hoffmann, Karin Rahn and the many 'helping hands' in the conference office, and the technical support team. Many thanks also to Martin Elsässer and his team for organizing the most attractive pre-conference tour. They were all very dedicated to the conference and it was a pleasure to share the experience of organizing a General Meeting with them. The European Grassland Federation Secretary Willy Kessler was very helpful in giving sound advice throughout the four years of conference preparations.

The conference was supported by many sponsors whose contributions are gratefully acknowledged.

Hans Schnyder  
Chairman of the  
Scientific Committee

Friedhelm Taube  
Chairman of the  
Organizing Committee

Johannes Isselstein  
President of the  
European Grassland Federation



## Contents

### Session 1. Grassland and Global Change

#### *Invited Papers*

C3/C4 grasslands and climate change <i>Lattanzi F.A.</i> .....	3
Impact of economic and political drivers on the grassland use in the EU <i>Osterburg B., Isermeyer F., Lassen B. and N. Röder</i> .....	14

### Session 1.1 Grassland and climate change

#### *Oral presentations*

Changes in soil organic matter content of grassland and maize land in the Netherlands between 1970 and 2009 <i>Reijneveld J.A., Kuikman P.J. and Oenema O.</i> .....	30
Changes in abundance and diversity of wild species in grass fields in Denmark <i>Andreasen C., Stryhn H. and Andresen L.C.</i> .....	33
Impacts of climate change on the grazing period, and the conserved feeding costs of grazing systems in the UK <i>Topp C.F.E., Wreford A., Tolkamp B.J., Wu L. and Moran D.</i> .....	36

#### *Poster presentations*

Effect of crude protein intake on CH <sub>4</sub> concentration in a dairy stall <i>Arriaga H., Blanco F., Salcedo G., Martínez-Suller L. and Merino P.</i> .....	39
Quantification of ley yield increase by climate change in mountainous regions of southern Norway <i>Baadshaug O.H., Haugen L.E. and Skjelvåg A.O.</i> .....	42
Evaluation of greenhouse gas emissions from fertilized grassland <i>Balezentiene L., Klimas E. and Bleizgys R.</i> .....	45
Carbon gain of C3 and C4 grasses in a dense canopy in the field <i>Berone G.D., Lattanzi F.A. and Schnyder H.</i> .....	48
AFLP analysis of genetic differentiation in legume germplasm in contrasting environments <i>Collins R.P., Frankow-Lindberg B.E., Helgadóttir Á., Skøt L., Jones C. and Skøt K.P.</i> ..	51
Greenhouse gas inventory for grasslands in the Basque Country in 1990 and 2008 <i>del Hierro O., Artetxe A. and Pinto M.</i> .....	54
Fertiliser value and environmental impact of digestate application on permanent grassland <i>Dieterich B., Finnan J., Hepp S., Hochstrasser T. and Müller C.</i> .....	57
Change in carbon balance of a dry calcareous grassland caused by spontaneous afforestation <i>Ferlan M., Eler K., Alberti G., Vodnik D., Peressotti A., Miglietta F., Simončič P. and Batič F.</i> .....	60
Using a dynamic system simulation model to assess the effects of climate change on grass-based dairy systems in Ireland <i>Fitzgerald J.B., Holden N.M. and Breerton A.J.</i> .....	63
Reduction of N <sub>2</sub> O emissions from grasslands under Atlantic conditions with the use of inhibitors (Basque Country, northern Spain) <i>Menéndez S., Merino P., Pinto M., González-Murua C. and Estavillo J.M.</i> .....	66
Evapotranspiration from grassland with contact to groundwater <i>Misztal A. and Zarzycki J.</i> .....	69
Climate change mitigation in European grasslands <i>Peeters A. and Hopkins A.</i> .....	72

Effect of climate change on grassland production for herbivorous livestock systems in France	
<i>Ruget F., Moreau J.-C., Cloppet E. and Souverain F.</i> .....	75
Surface Runoff Simulator (SIMU) hastens the research on phosphorus losses from grassland	
<i>Saarijärvi K. and Virkajärvi P.</i> .....	78
Fertilising practices to reduce nitrous oxide emissions from managed grasslands	
<i>Schils R.L.M., Van Groenigen J.W., Velthof G.L. and Kuikman P.J.</i> .....	81
Nitrous oxide emissions from highly productive grassland as a function of soil compaction and nitrogen fertilization	
<i>Schmeer M., Dittert K., Loges R., Senbayram M. and Taube F.</i> .....	84
Grazing intensity and precipitation affects herbage accumulation, herbage quality and animal performance in semi-arid grassland	
<i>Schönbach P., Wan H., Gierus M., Müller K., Lin L., Susenbeth A. and Taube F.</i> .....	87
Effect of precipitation on dry matter production of a meadow with varied cutting frequency	
<i>Thumm U. and Tonn B.</i> .....	90

## Session 1.2 Grassland and socio-economic change

### Oral presentations

Case-control studies for risk-assessment in ecology and agriculture	
<i>Suter M. and Lüscher A.</i> .....	94
Extensive grasslands beyond the year 2013 – present situation and options for the future?	
<i>Luick R. and Schrode S.</i> .....	97
Simulation of the effect of grass intake on the farmer's income	
<i>Van den Pol-van Dasselaar A., De Haan M., Evers A. and Philipsen A.P.</i> .....	100

### Poster presentations

Socio-economic changes and their effects on agro-pastoral goat husbandry systems in semi-arid, sub-tropical mountain regions	
<i>Dickhoefer U. and Schlecht E.</i> .....	103
Management and legislation affecting the conservation of mountain grasslands subjected to common use in Central Apennine	
<i>D'Ottavio P., Trobbiani P., Rismondo M., Iezzi G., Piergiovanni R., Sargenti P., Santilocchi R. and Roggero P.P.</i> .....	106
Structural analysis of the dairy industry and its evolution in Central Switzerland	
<i>Hofstetter P.</i> .....	109
Grassland management on the 'Low Cost Farm': an overview of an eight-year period	
<i>Holshof G. and de Haan M.H.A.</i> .....	112
Global economic crisis impacts on dairy cattle in the Czech Republic	
<i>Kvapilík J., Kohoutek A. and Komárek P.</i> .....	115
Values and image of pasture-based milk production systems	
<i>Lobsiger M., Wyss U., Réviron S. and Stoll W.</i> .....	118
Assessment of energy consumption pattern in a sample of Walloon livestock farming systems	
<i>Rabier F., Mignon C., Lejeune L. and Stilmant D.</i> .....	121
The role of agri-environmental programmes in grassland conservation and environmental protection	
<i>Stypiński P.</i> .....	124

Threats to grassland plant diversity in Transylvania, Romania <i>Larkham K.S. and Sutcliffe L.M.E.</i> .....	127
Environmental aspects of grazing animals in a European context <i>Van der Hoek K.W.</i> .....	130
Abandonment of farming practices: impact on vegetation <i>Zarzycki J. and Misztal A.</i> .....	133

## **Session 2. The Future of Grassland Productions Systems**

### ***Invited papers***

Grass biomethane: A sustainable alternative industry for grassland <i>Singh A., Korres N.E., Murphy J.D.</i> .....	139
The role of genetic resources for sustainable and productive grassland agriculture <i>Kölliker R. and Boller B.</i> .....	149

## **Session 2.1 Grassland systems and technology**

### ***Oral presentations***

Dry matter and protein yields of red clover, Italian ryegrass and their mixtures <i>Alibegovic-Grbic S., Bezdrob M. and Civic H.</i> .....	160
Analysis of hyperspectral data to estimate forage quality in legume-grass mixtures <i>Biewer S., Fricke T. and Wachendorf M.</i> .....	163
Modelling ammonia emissions after field application of biogas slurries on grassland sites <i>Pacholski A., Gericke D., Ni K. and Kage H.</i> .....	166
Microwave for dock control on grassland <i>Latsch R. and Sauter J.</i> .....	169
Influence of cutting date and pre-conditioning on the energy production from grassland through the integrated generation of solid fuel and biogas from biomass (IFBB) <i>Richter F., Fricke T. and Wachendorf M.</i> .....	172
Grassland yield response to knife/tine slurry injection equipment – benefit or crop damage? <i>Halling M.A. and Rodhe L.</i> .....	175
Better grazing opportunities with a mobile milking robot <i>Haan M.H.A. de, Philipsen A.P., Van den Pol-van Dasselaar A., Holshof G., Lenssinck F.A.J. and Koning C.J.A.M. de</i> .....	178
Slurry seeding in grassland in Norway <i>Nesheim L.</i> .....	181
Continuous and rotational grazing system with horses: effects on gorse production understorey developed under <i>Pinus radiata</i> stand <i>Mosquera-Losada M.R., Mouhbi R., González-Hernández M.P., Boubaker A. and Rigueiro-Rodríguez A.</i> .....	184

### ***Poster presentations***

Productivity and yield quality of white clover-grass mixed swards depending on cutting frequency <i>Adamovics A. and Adamovica O.</i> .....	187
Comparison of three traditional uses of forage production of mountain meadows in western Azerbaijan, Iran <i>Akbarlou M., Mesdaghi M. and Sepehry A.</i> .....	190
Pastures feeding value response to humic fertilizers <i>Klimas E. and Balezentiene L.</i> .....	193

Soil fertility and forage yield in a maize-Italian ryegrass rotation fertilized with pelletized broiler litter <i>Bande-Castro M.J., Gómez-Sánchez R., Sainz M.J. and López-Mosquera M.E.</i> .....	196
Natural lucerne populations of Estonia: yielding ability, herbage quality and prospective ways of use <i>Bender A. and Tamm S.</i> .....	199
A preliminary study on new biodegradable films to cover silages <i>Borreani G., Chion A.R., Piano S., Ranghino F. and Tabacco E.</i> .....	202
Utilisation of clover-grass silage of different cutting dates for solid fuel production <i>Bühle L., Richter F., Perbandt D., Stoll S. and Wachendorf M.</i> .....	205
PROGRASS – A mobile plant to produce solid fuel from grass harvested in the NATURA grassland habitats <i>Bühle L., Donnison I., Heinsoo K., Südekum K.-H. and Wachendorf M.</i> .....	208
White clover effect on yield and quality of a <i>Lolium perenne</i> sward under cutting conditions <i>De Vliegher A.</i> .....	211
Crop-livestock system: Influence of different sward heights in cattle performance <i>Carvalho P.C. de F., Wesp C. de L., Conte O., Machado A.P., Oliveira E.V. and Bremm C.</i> .....	214
Grazing with a mobile milking robot <i>DufRASNE I., Robaye V., Istasse L. and Hornick J. L.</i> .....	217
Fermentation residues of biogas co-fermentation and their effects on grassland <i>Elsaesser M.</i> .....	220
Forage yield and N <sub>2</sub> fixation of <i>Trifolium alexandrinum</i> in pure stand and in mixture with <i>Lolium multiflorum</i> <i>Giambalvo D., Amato G., Di Miceli G., Frenda A.S., Ruisi P. and Stringi L.</i> .....	223
Effect of different methods of sward renovation on selected physical and chemical soil properties <i>Zajac M., Szychalski W. and Goliński P.</i> .....	226
Biogas-Expert: grassland methane yield and short-term N efficiency of biogas residues <i>Wienforth B., Herrmann A., Sieling K., Ohl S., Hartung E., Taube F. and Kage H.</i> ....	229
Using digital image analysis to estimate legume contents in legume-grass swards <i>Himstedt M., Fricke T. and Wachendorf M.</i> .....	232
Grassland potassium balance in a pot experiment using soils with different management histories <i>Seidel M., Kayser M., Moir J.L. and Isselstein J.</i> .....	235
The intensity of grassland management on farms in the north-eastern part of Lublin province <i>Jankowski K., Jodelka J., Kolczarek J. and Sosnowski J.</i> .....	238
Effects of <i>Trifolium incarnatum</i> proportion in binary mixtures with <i>Lolium multiflorum</i> on the soil N <sub>min</sub> content and the amount of symbiotically fixed N <i>Kramberger B., Gselman A. and Podvrsnik M.</i> .....	241
Use of portable NIRS equipment in field conditions to determine the nutritional value of mountain pastures <i>Mendarte S., Ibarra A., Garbisu C., Besga G. and Albizu I.</i> .....	244
Dairy soiled water as an organic fertilizer for perennial ryegrass pasture <i>Minogue D., Murphy P., French P., Coughlan F. and Bolger T.</i> .....	247
Fertilisation with different types of sewage sludge on pasture production and protein concentration in a silvopastoral system developed under <i>Fraxinus excelsior</i> L <i>Mosquera-Losada M.R., Ferreiro-Domínguez N. and Rigueiro-Rodríguez A.</i> .....	250



Impact of different levels of inorganic and organic fertilizers on sward production <i>Rigueiro-Rodríguez A., García-Fernández M. and Mosquera-Losada M.R.</i> .....	253
Effect of frost on regrowth ability and frost tolerance of rush ( <i>Juncus</i> spp.) <i>Folkestad J., Østrem L. and Netland J.</i> .....	256
Hyperspectral measurements in maize ( <i>Zea mays</i> L.) for silage <i>Perbandt D., Fricke T. and Wachendorf M.</i> .....	259
Effects of additional illumination under changing simulated sky cover on field spectroscopic measurements in clover-grass swards <i>Perbandt D., Fricke T. and Wachendorf M.</i> .....	262
Analysis of land utilisation by red deer in the Apennine Mountains <i>Crocetti C., Ponzetta M.P., Minder I., Messeri A., Cervasio F., Argenti G. and Maccelli S.</i> .....	265
Ammonia volatilization after application of biogas slurries in a coastal marsh region of Northern Germany <i>Quakernack R., Techow A., Herrmann A., Taube F., Kage H. and Pacholski A.</i> .....	268
Changes in soil P status of grassland in the Netherlands between 1971 and 2009 <i>Reijneveld J.A., Ehler P.A.I., Schoumans O.F., Termorshuizen A.J and Oenema O.</i> ..	271
A comparison of different conversion techniques for the production of energy from permanent grasslands <i>Richter F. and Wachendorf M.</i> .....	274
Improvement of permanent grasslands in NE Romania <i>Samuil C., Vintu V., Iacob T. and Popovici I.C.</i> .....	277
Effects of different methods of meadow maintenance and non-tillage seeding on yield and plant composition <i>Sauter J. and Latsch R.</i> .....	280
Suitability of perennial grasses and legume-grass-mixtures for methane production <i>Schmalzer K., Weiß K. and Krause R.</i> .....	283
Defining optimum practices for Italian ryegrass seed production in Serbia <i>Simić A., Vučković S., Petrović S. and Sokolović D.</i> .....	286
Influence of sod seeding grassland on the quality of the first cut <i>Skládanka, J., Mikyska F., Doležal P., Šeda J. and Rosická L.</i> .....	289
The benefits of long-term legume swards in an organic farming system <i>Slepetys J. and Slepetiene A.</i> .....	292
Grass and grass-legume mixtures for methane production <i>Sölter U., Höppner F., Luesink W., Ingwersen B., Feuerstein U. and Greef J.M.</i> .....	295
Biogas-Expert: Sustainable biomethane production in northern Germany - Nitrogen leaching after application of biogas residue <i>Svoboda N., Wienforth B., Sieling K., Kage H., Taube F. and Herrmann A.</i> .....	298
Biogas-Expert: Nitrous oxide emission from biogas production systems on a coastal marsh soil <i>Techow A., Dittert K., Senbayram M., Quakernack R., Pacholski A., Kage H., Taube F. and Herrmann A.</i> .....	301
The evaluation of tall fescue, cocksfoot and reed canary grass as energy crops for biogas production <i>Tilvikienė V., Kadžiulienė Z. and Dabkevičius Z.</i> .....	304
Potential of leaching to optimise fuel quality of semi-natural grassland biomass <i>Tonn B., Thumm U. and Claupein W.</i> .....	307
Improving grasslands of <i>Agrostis capillaris</i> and <i>Festuca rubra</i> in the Carpathian Mountains of Romania by organic fertilization <i>Vintu V., Samuil C., Popovici I.C. and Saghin G.</i> .....	310

## Session 2.2 The role of genetic resources

### Oral presentations

The effect of evaluation protocol on the dry matter yield performance of *Lolium perenne* varieties

McEvoy M., O'Donovan M., Wims C. and Kennedy E. .... 314

A system to optimize forage crop variety trials for regionalized Recommended Lists in Germany

Hartmann S. .... 317

Genetic shift in white clover (*Trifolium repens* L.) after natural selection in a marginal area

Göransson M. and Helgadóttir Á. .... 320

### Poster presentations

Some plant characteristics of accessions of fescue species (*Festuca* sp.) collected from the Central-Black Sea Region of Turkey

Acar Z., Ayan I., Basaran U., Mut H. and Asci O. .... 323

White clover (*Trifolium repens* L.) germplasm evaluation under two levels of soil phosphorus: growth and phosphorus absorption

Acuña H., Inostroza L. and Sánchez M.P. .... 326

Influence of the cutting regime on sainfoin yield (*Onobrychis viciifolia* Scop.)

Demdoum S., Delgado I. and Muñoz F. .... 329

Morphogenetic and structural characterization of seven tropical forage grasses

Nascimento Jr. D., Rodrigues C.S., Da Silva S.C., Silveira M.C.T., Sousa B.M.L., Detmann E., Sbrissia A.F., Silva W.L., Pena K.S., Monteiro H.C.F. and Vilela H.H. .... 332

Morphogenetic and structural characteristics of *Andropogon gayanus* cut to different heights over seasons

Nascimento Jr. D., Sousa B.M.L., Da Silva S.C., Monteiro H.C.F., Rodrigues C.S., Souza Jr. S.J., Sbrissia A.F. and Ramos R.S. .... 335

Legumes increase forage *Brassica* yield in low-input systems

Fustec J., Cortés-Mora F.A., Piva G., Oury V., Pineau S. and Renaud S. .... 338

Influence of 1000-grain weight on predicted density of selected varieties of pasture grass species

Harkot W., Czarnecki Z. and Gawryluk A. .... 341

Genetic diversity of red clover varieties listed in Germany concerning the resistance to Southern Anthracnose

Jacob I., Hartmann S., Schubiger F.X. and Struck C. .... 344

Osmotic adjustment and water use efficiency of seven cultivars of *Lotus corniculatus* L.

Inostroza L., Acuña H. and Rivera H. .... 347

Root system development of *Lolium perenne* under different management

Straková M., Janků L. and Straka J. .... 350

Genotypic differences in maize phenology, growth and biomass in response to different N fertilizer sources applied at variable rates

Amanullah..... 353

Conservation characteristics of maize cultivars ensiled as whole-crop, cob or stover at sequential stages of maturity

Lynch J.P., O'Kieily P. and Doyle E.M. .... 356

Response of *Dactylis glomerata* to low temperature stress

Borowska-Jarmulowicz B., Mastalerczuk G. and Kalaji M.H. .... 359

Apex development and stem morphology of vernalized and regrowing tillers of timothy <i>Seppänen M., Pakarinen K., Jokela V., Andersen J.R., Fiil A., Santanen A. and Virkajärvi P.</i> .....	362
Lifespan of white clover ( <i>Trifolium repens</i> L.) plant organs under northern temperate climatic conditions <i>Sturite I., Henriksen T.M. and Breland T.A.</i> .....	365
Effects of fungal endophyte infection in the grass <i>Festuca rubra</i> on germination and growth of four legume species <i>Vázquez-de-Aldana B.R., Romo M., García-Ciudad A., Petisco C. and García-Criado B.</i> .....	365
Cytoplasmic genetic diversity in molecular markers within and between <i>Lolium</i> cultivars <i>Wallace M.D., Provan J. and Gilliland T.J.</i> .....	371
Effect of maturity type of <i>Lolium perenne</i> cultivars on performance of grass-clover mixtures under frequent cutting <i>Wulfes R. and Taube F.</i> .....	374

### Session 3. From Grass to Milk and Meat

#### Invited papers

Forage conservation, feeding value and milk quality <i>Huhtanen P., Südekum K.-H., Nousiainen J. and Shingfield K.J.</i> .....	379
Authenticity and traceability of grassland production and products <i>Monahan F.J., Moloney A.P., Downey G., Dunne P.G., Schmidt O. and Harrison S.M.</i> .....	401

#### Session 3.1 Forage conservation, feeding value and product quality

##### Oral presentations

Harvest dates affect fungal counts and fungal composition of baled haylage <i>Schenck J.A. and Müller C.E.</i> .....	416
Influence of genotype and mechanical stress on the specific polyphenol oxidase activity in pure red clover swards <i>Weiber N., Krawutschke M., Gierus M. and Taube F.</i> .....	419
Variation of fatty acid content in grass and milk during the grazing season <i>Wyss U., Münger A. and Collomb M.</i> .....	422
Effect of pasture botanical composition on milk composition in organic production <i>Adler S., Dahl A.V., Vae A.H., Thuen E., Garmo T., Krogh-Jensen S., Hansen-Møller J. and Steinshamm H.</i> .....	425
Top losses in maize silage sealed with different plastic films <i>Bernardes T.F., Nussio L.G. and Amaral R.C.</i> .....	428
Comparison of grazed grass and a TMR diet on early lactation milk production performance <i>Kennedy E., Lewis E., Murphy J.P. and O'Donovan M.</i> .....	431
Influence of tree and shrub presence on plant nutrient content of pasture in dehesa system <i>López-Díaz M.L., Moreno Marcos G. and Rolo Romero V.</i> .....	434
Enrichment of C in <i>Medicago sativa</i> and <i>Lolium multiflorum</i> n-alkanes <i>Bulang M., Boguhn J. and Rodehutschord M.</i> .....	437
The condensed tannins in sainfoin cause digestive synergy on <i>in vitro</i> rumen fermentation of cocksfoot <i>Niderkorn V., Le Morvan A. and Baumont R.</i> .....	440

A scheduling model for forage harvesting <i>Sørensen C.G., Bochtis D.D., Green O. and Oudshoorn F.W.</i> .....	443
<b>Poster presentations</b>	
Forage botanical and chemical composition on dairy farms with different grassland systems and production systems <i>Adler S. and Steinshamn H.</i> .....	446
Using NIR spectroscopy to determine cow diet and geographical origin from milk samples <i>Andueza D., Coppa M., Agabriel C., Constant I., Lombardi G. and Martin B.</i> .....	449
Development and nutritive value of three varieties of sainfoin compared to lucerne during primary growth <i>Theodoridou K., Aufrère J., Andueza D., Pourrat J. and Baumont R.</i> .....	452
Quality of grass silages wilted as swathed or wide-spread crop <i>Bakken A.K., Johansen A. and Synnes O.M.</i> .....	455
Top losses of corn silage sealed with oxygen barrier film <i>Basso F.C., Reis R.A., Nogueira M., Bernardes T.F. and Roth A.P.T.P.</i> .....	458
<i>Propionibacterium acidipropionici</i> , <i>Lactobacillus plantarum</i> or its combination on the aerobic stability and microbial dynamics of corn silage <i>Basso F.C., Reis R.A., Assis F.B., Lara E.C. and Rodrigues J.F.H.</i> .....	461
<i>Lactobacillus buchneri</i> , <i>Lactobacillus plantarum</i> or their combination effects on aerobic stability and microbial dynamics of corn silage <i>Basso F.C., Reis R.A., Nogueira M., Assis F.B. and Roth A.P.T.P.</i> .....	464
The effect of forage species on kinetics of large and small particles in dairy cows <i>Bayat A.R., Rinne M., Ahvenjärvi S. and Huhtanen P.</i> .....	467
Forage species effects on particle digestion kinetics estimated by rumen evacuation or gas production technique <i>Bayat A.R., Rinne M., Seppälä, A., Ahvenjärvi S. and Huhtanen P.</i> .....	470
Non structural carbohydrate concentration of AM and PM-cut forage species <i>Bélanger G., Pelletier S., Tremblay G.F., Bertrand A., Drapeau R., Castonguay Y. and Pageau D.</i> .....	473
Characterization of forages produced and used in the production area of Parmigiano-Reggiano cheese <i>Bortolazzo E., Ligabue M. and Pacchioli M.T.</i> .....	476
Variability in composition of grass samples in a national testing system for <i>Lolium perenne</i> L. <i>Burns G.A., Gilliland T.J., McGilloway D.A., Lewis E., O'Donovan M. and O'Kiely P.</i> .....	479
Aerobic deterioration in maize silages under different covering methods of the plastic film <i>Amaral R.C., Queiroz B.C., Garcia E.H.C., Sá Neto A., Bernardes T.F. and Nussio L.G.</i> .....	482
Description and prediction of multi-species pasture nutritive value across the grazing season <i>Delaby L., Baumont R., Peccatte J.R., Aufrère J. and Peyraud J.L.</i> .....	485
Physico-chemical characterisation of forage fibre from different C <sub>3</sub> -grasses in South Brazil <i>Eggers M., Bockor J., Oliveira Júnior J.M., Warpechowski M.B., Dittrich J. and Gierus M.</i> .....	488

Fatty acid composition of forage herb species <i>Warner D., Jensen S.K., Cone J.W. and Elgersma A.</i> .....	491
Effects of row spacing and seeding rate on sorghum whole crop yield and quality <i>Emile J.C., Bolaños-Aguilar E.D., Le Roy P. and Audebert G.</i> .....	494
Yields and contents of condensed tannins of some forage legumes and herbs <i>Goeritz M., Loges R. and Taube F.</i> .....	497
Effects of dry matter and additive on wilted bale silage quality and milk production <i>Heikkilä T., Saarisalo E., Taimisto A.-M. and Jaakkola S.</i> .....	500
Aerobic stability and fermentation quality of round bale silage treated with inoculants or propionic acid <i>Jaakkola S., Saarisalo E. and Heikkilä T.</i> .....	503
Effects of a combination of selected lactic acid bacteria strains on the fermentation quality and aerobic deterioration of maize silage <i>Jatkauskas J. and Vrotniakienė V.</i> .....	506
Evaluation and performance of five maize hybrids for silage cut at different cutting heights <i>Jobim C.C., Oliveira F.C.L., Branco A.F. and Santos G.T.</i> .....	509
Characterisation of the fibre composition of fresh and ensiled herbage species under varying management conditions <i>King C., McEniry J., Richardson M. and O’Kiely P.</i> .....	512
Silage fermentation characteristics as influenced by red clover/ryegrass-mixing ratio, degree of wilting and silage inoculants <i>Krawutschke M., Thaysen J., Weiher N., Gierus M. and Taube F.</i> .....	515
The effect of different fodder galega-grass mixtures and nitrogen fertilization on forage yield and chemical composition <i>Lättemäe P., Meripõld H., Tamm U. and Tamm S.</i> .....	518
Insights into carbohydrate and protein fractionation in perennial ryegrass ( <i>Lolium perenne</i> L.) genotypes using the Cornell Net Carbohydrate and Protein System. 1. Carbohydrate and protein fractionation <i>Lösche M., Salama H., Gierus M., Herrmann A. and Taube F.</i> .....	521
Performance of ewes fed long or chopped grass silage using different feeding strategies <i>Helander C., Eilersen R., Nørgaard P., Arnesson A. and Nadeau E.</i> .....	524
Volatile fraction from sugarcane silage and forage proportion on the ingestive behaviour of beef steers <i>Daniel J.L.P., Nussio L.G., Zopollatto M., Goulart R.S., Santos V.P. and Toledo Filho S.G.</i> .....	527
Effect of additive treatment on fermentation quality and ruminal degradability of red clover-timothy silage <i>Olt A., Kaldmäe H., Ots M., Kärt O. and Songisepp E.</i> .....	530
Effect of fungicidal control of Chewing’s fescue ( <i>Festuca rubra</i> L. ssp. <i>commutata</i> ) and strong creeping red fescue ( <i>F. rubra</i> L. ssp. <i>rubra</i> ) on seed infection with fungi <i>Panka D., Jeske M. and Szczepanek M.</i> .....	533
Suitability of seed mixtures for intensively farmed permanent meadows in a mountain environment <i>Peratoner G., Gottardi S., Werth E., Figl U., Bodner A. and Kasal A.</i> .....	536
A simple model for the estimation of protein content of first-cut meadow forage <i>Peratoner G., Bodner A., Stimpfl E., Werth E., Schaumberger A. and Kasal A.</i> .....	539
A test of sampling methods for the investigation of forage quality in permanent meadows <i>Kasal A., Stimpfl E. and Peratoner G.</i> .....	542

The effect of Na-buffered acid-based additives on wilted roundbale grass silage <i>Randby Å.T.</i> .....	545
Relationships between dry matter yield, forage nutritive value, and some canopy parameters of alfalfa crop <i>Rimi F., Macolino S. and Ziliotto U.</i> .....	548
Insights into carbohydrate and protein fractionation in perennial ryegrass ( <i>Lolium perenne</i> L.) genotypes using the Cornell Net Carbohydrate and Protein System. 2. Ruminant kinetics <i>Salama H., Lösche M., Gierus M., Herrmann A. and Taube F.</i> .....	551
Floristic composition and herbage quality changes with tree cover in NW Patagonia, Chile <i>Sánchez-Jardón L., Acosta B., Elizalde H.F., del Pozo A., Casado M.A., Ovalle C., Hepp C. and de Miguel J.M.</i> .....	554
Aerobic stability evaluation by carbon dioxide (CO <sub>2</sub> ) production on corn silages using Infrared Gas Analyzer <i>Schmidt P., Junges D., Campos G.P. and Marques R.</i> .....	557
Hygiene is crucial in controlling the heating of total mixed ration <i>Seppälä A., Heikkilä T., Miettinen H. and Rinne M.</i> .....	560
The effect of climate, clover species and swath management on pre-wilting of a mixture of grass and clover <i>Søgaard K.</i> .....	563
Micro-mineral profile in different grassland species <i>Søgaard K., Sehested J. and Jensen S.K.</i> .....	566
Yields of forage crops in Schleswig-Holstein 1985-2008 under farm-scale and trial conditions <i>Thaysen J., Dreyer H., Sierts H.-P. and Thomsen J.</i> .....	569
Does tiller type distribution explain the differences in yield and nutritive value of timothy genotypes? <i>VirkJärvi P., Pakarinen K., Hyrkäs M., Savolainen J. and Isoahti M.</i> .....	572
Fermentation quality and dry matter losses of grass-legume silage treated with lactic acid bacteria mixture <i>Vrotmiakiene V. and Jatkauskas J.</i> .....	575
A comparison between cut and intensively grazed swards on dry matter yield of perennial ryegrass <i>Wims C., McEvoy M., Boland T. and O'Donovan M.</i> .....	578
The influence of natural fertilisation on quality and nutritive value of grass silage <i>Wróbel B. and Jankowska-Huflejt H.</i> .....	581

### **Session 3.2 Authenticity and traceability of grassland production and products**

#### **Oral presentations**

The effect of allocation frequency in rotational grazing systems on the fatty acid profile in milk fat of dairy cows <i>Vlaeminck B., Abrahamse P.A., Fievez V., Lourenço M., Dijkstra J. and Tamminga S.</i> .....	586
Influence of the botanical diversity and development stage of mountain pastures on milk fatty acid composition, carotenoids, fat-soluble vitamins and sensory properties <i>Tornambé G., Ferlay A., Farruggia A., Chilliard Y., Loiseau P., Pradel P., Graulet B., Chauveau-Duriot B. and Martin B.</i> .....	589

Meat quality of Norwegian lambs finished on semi-natural pastures, concentrate or ryegrass pastures <i>Lind V., Berg J., Eik L.O., Eilertsen S.M., Hersleth M. and Haugland E.</i> .....	592
<b>Poster presentations</b>	
Variation of fatty acid profile during the grazing season in cows' milk from mountain permanent meadows <i>Coppa M., Lonati M., Gorlier A., Falchero L., Cugno D., Lombardi G. and Cavallero A.</i> .....	595
Milk fatty acids and cheese from hay based diet and continuous or rotational grazing <i>Coppa M., Ferlay A., Monsallier F., Farruggia A., Pradel P. and Martin B.</i> .....	598
Milk production and composition of day and night grazing of cows fed a total mixed ration <i>Hernández-Ortega M., Morales-Almaráz E., Martínez-Fernández A., de la Roza-Delgado B. and Vicente F.</i> .....	601
Fatty acids and antioxidant profiles in summer milk from different biodynamic and conventional systems in Southern Germany <i>Kusche D., Ruebesam K. and Baars T.</i> .....	604
Effect of the reduction of indoor supplementation on grazing time and sheep milk quality <i>Mandaluniz N. Barrón L.J.R., Amores G., Arranz J., Virto M., Abilleira J.E., Aldezabal A., Ruiz de Gordo J.C., Nájera A.I., Ruiz R., Albisu M., Pérez-Elortondo F.J. and de Renobales M.</i> .....	607
Ability of visible spectroscopy to authenticate pasture-fed lambs in three breeds <i>Prache S., Larue A., Ballet J., Jailler R., Coustet C., Teuma J.B., Pourrat J. and Andueza D.</i> .....	610
Seasonal variation of fatty acid in milk of intensive and extensive dairy systems in Northern Italy <i>Revello Chion A., Battelli G., Giaccone D., Peiretti P.G., Tabacco E. and Borreani G.</i> .....	613
Composition and fatty acids profile of bovine milk after supplementation with barley and cottonseed <i>Roca-Fernández A.I., González-Rodríguez A., Vázquez-Yáñez O.P. and Fernández-Casado J.A.</i> .....	616
Influence of French dairy feeding systems on cow milk fatty acid composition <i>Rouillé B. and Montourcy M.</i> .....	619
Seasonal variation in the fatty acid composition of cow milk in the mountain regions of the Czech Republic <i>Frelich J., Šlachta M., Hanuš O., Špička J., Samková E. and Kobes M.</i> .....	622
Diversity of vascular plants and ground beetles (Coleoptera: Carabidae) in mountain cattle pastures <i>Šlachta M., Frelich J., Tonka T., Hakrová P. and Sýkorová Z.</i> .....	625
The maturity stage of the grass affects milk fatty acids of cows grazing a mountain grassland. <i>Tornambé G., Martin B., Pradel P., Di Grigoli A., Bonanno A., Chilliard Y. and Ferlay A.</i> .....	628
Fatty acid composition of different grassland species <i>Wyss U. and Collomb M.</i> .....	631
Seasonal variation in fatty acid contents of cow milk from indoor and pasture-based feeding <i>Wyss U., Collomb M., Frey H.J. and Hofstetter P.</i> .....	634



## Session 4. Grassland Ecosystem Services

### Invited papers

- Balancing trade-offs in ecosystem functions and services in grassland management  
*Sanderson M.A. and Wätzold F.* ..... 639
- Ecosystem services and functions of biodiversity in grasslands  
*Weigelt A., Vogel A. and Scherer-Lorenzen M.* ..... 649

### Session 4.1 Balancing tradeoffs between functions

#### Oral presentations

- Plant functional strategies from 13 co-occurring grass species explain the productivity and abundance in productive grasslands  
*Pontes L. da S., Maire V., Gross N., Proulx R., Louault F., Carrère P. and Soussana J.F.* ..... 654
- Distinct response of two wet grassland communities to different management regimes  
*Čop J., Eler K. and Vidrih M.* ..... 657
- Regulation of meadow saffron (*Colchicum autumnale* L.) in extensively managed grasslands  
*Jung L.S., Winter S., Kriechbaum M., Eckstein R.L., Donath T.W. and Otte A.* ..... 660
- Winter resistance of pasture weeds *Rumex obtusifolius* L. and *R. crispus* L.  
*Křišťálová V., Hejman M. and Červená K.* ..... 663
- Evaluation of the agronomical and environmental relevance of the CAP measure ‘flowering grassland’  
*Plantureux S., Ney A. and Amiaud B.* ..... 666

#### Poster presentations

- Pyrrrolizidine alkaloid level in *Senecio jacobaea* and *Senecio erraticus* – the effect of plant organ and forage conservation  
*Berendonk C., Cerff D., Hünting K., Wiedenfeld H., Becerra J. and Kuschak M.* ..... 669
- Yield evolution from pastures on the Po Valley plain during the growing season  
*Da Ronch F. and Ziliotto U.* ..... 672
- Pasture characteristics on a Venetian prealps *malga* where the animals’ diet is supplemented by concentrates  
*Da Ronch F. and Ziliotto U.* ..... 675
- Speed of reduction of the specific biodiversity in abandoned meadows when they are re-colonized by woodland  
*Da Ronch F., Macolino S. and Ziliotto U.* ..... 678
- Effects of the management techniques on the specific and coenotic biodiversity in three meadows of the Venetian plain (NE Italy)  
*Da Ronch F., Bonifazzi B. and Ziliotto U.* ..... 681
- Construction of a simplified method based on the functional composition of the vegetation for characterizing the agricultural services provided by species-rich grasslands  
*Duru M., Cruz P., Jouany C. and Theau J.P.* ..... 684
- Survival of *Rumex* seedlings under different management in upland grassland  
*Gaisler J., Pavlů V. and Pavlů L.* ..... 687
- Increasing the milk quality with grazing feeding in humid Spain grassland  
*Gonzalez Rodriguez A., Roca-Fernandez A.I., Vazquez-Yañez O. and Fernandez-Casado J.* ..... 690
- Grassland in Pays de Caux (France): balancing trade-off between livestock feeding and decreasing runoff  
*Faure J., Havet A., Remy B. and Barrier C.* ..... 693



Secondary dry grassland management by frequent mowing in the Western-Cserhát, Hungary	
<i>Házi J., Bartha S., Szentes S., Malatinszky Á. and Penksza K.</i> .....	696
Agronomic characteristics of a lowland and a mountain hay meadow under different cutting regimes	
<i>Hofmann M., Kirschig J. and Riehl G.</i> .....	699
The effect of different grazing systems on botanical composition, diversity and productivity of permanent pasture	
<i>Kobes M., Suchý K., Voženílková B. and Frelich J.</i> .....	702
The impact of <i>Deschampsia caespitosa</i> (L.) P. Beauv (tufted hairgrass) on the floristic composition of meadow communities	
<i>Kryszak A., Strychalska A., Kryszak J. and Klarzyńska A.</i> .....	705
Effect of cutting frequency of a meadow sward on the bulk density of a peat-muck soil	
<i>Kulik M.</i> .....	708
Protecting Aquatic Warblers ( <i>Acrocephalus paludicola</i> ) through a landscape-scale solution for the management of fen peat meadows in Poland	
<i>Lachmann L., Marczakiewicz P. and Grzywaczewski G.</i> .....	711
Practices and motivations of farmers who sign contracts to preserve grassland biodiversity	
<i>Nettier B., Dobremez L., Orsini M. and Fleury P.</i> .....	714
Phenolic compounds in sustainable grassland production: availability of nitrogen to plants	
<i>Oreja A., San Emeterio L., Villanueva E. And Canals R.M.</i> .....	717
Could the grassland production costs be an argument for biodiversity?	
<i>Orth D., Begon M. and Sabatier J.</i> .....	720
Multidimensional scaling for describing the risks for grasslands ecosystems located in the Polish Landscape Parks	
<i>Paderewski J. and Sienkiewicz-Paderewska D.</i> .....	723
Changes in plant C-S-R strategy after 10 years of different management of a mountain hay meadow	
<i>Pavlu L., Pavlu V. and Gaisler J.</i> .....	726
Incidence of <i>Epichloë festucae</i> in <i>Festuca rubra</i> plants of natural grasslands and presence of double-stranded RNA fungal viruses	
<i>Petisco C., García-Ciudad A., Vázquez-de-Aldana B.R., García-Criado B. and Zabalgoeazcoa I.</i> .....	729
e-FLORA-sys, a website tool to evaluate the agronomical and environmental value of grasslands	
<i>Plantureux S. and Amiaud B.</i> .....	732
Effects of extensive year-round grazing on breeding bird communities in Northern Germany	
<i>Ruf M., Neumann H. and Reck H.</i> .....	735
Mechanical weeding of <i>Rumex obtusifolius</i> in grasslands	
<i>Srnad L., Hejzman M., Křišťálová V. and Fričová K.</i> .....	738
Effect of different management on the yields, forage quality and botanical composition of permanent grassland	
<i>Štýbnarová M., Svozilová M., Hakl J., Karabcová H., Pozdišek J. and Otrhálková P.</i> ..	741
Fertilization as a factor of plant community change, higher productivity and water percolation on a mountain meadow	
<i>Szewczyk W. and Kasperczyk M.</i> .....	744

Minimum management intensity for maintaining and improving biodiversity of a mesotrophic semi-natural grassland <i>Tonn B. and Briemle G.</i> .....	747
--	-----

## Session 4.2 Functions of biodiversity

### Oral presentations

Paths of nitrogen transfer from <i>Trifolium repens</i> to non-legume plants in unfertilised pastures <i>Auerswald K., Schäufele R. and Schnyder H.</i> .....	752
Effect of mono- and mixed grazing of cattle and sheep on grassland diversity patterns <i>Seither M., Petersen U., Wrage N. and Isselstein J.</i> .....	755
Anecic earthworms and associated ecosystem services under pressure in a ley-arable crop rotation <i>van Eekeren N., Bommelé L., Bokhorst J., Schouten A.J., Reheul D. and Brussaard L.</i> .....	758
Agronomically improved grass-legume mixtures: higher dry matter yields and more persistent legume proportions <i>Suter D., Huguenin-Elie O., Nyfeler D. and Lüscher A.</i> .....	761
Grass root turn-over for improved soil hydrology to combat flooding <i>Humphreys M.W., Turner L.B., O'Donovan S.A., Macleod C.J.A., King I.P., Whalley W.R. and Haygarth P.M.</i> .....	764

### Poster presentations

Habitat improvements with agronomic treatments for ungulates in an area of central Italy <i>Messeri A., Ponzetta M., Cervasio F., Crocetti C., Gori L. and Argenti G.</i> .....	767
Plant communities and soil groups in mountain pastures of the Central Pyrenees <i>Ascaso J., Alcubilla M., Broca A. and Ferrer C.</i> .....	770
Quality of food products from species-rich alpine pastures <i>Bele B., Østerlie M. and Norderhaug A.</i> .....	773
Halting the loss of biodiversity: Endemic vascular plants in grasslands of Europe <i>Bruchmann I. and Hobohm C.</i> .....	776
Diversity of weed spectrum in grasses grown for seed in the Czech Republic <i>Cagaš B., Macháč J., Frydrych J. and Macháč R.</i> .....	779
Multi-species mixtures - new perspectives on models and mechanisms <i>Connolly J., Bell T., Brophy C., Carnus T., Finn J., Kirwan L., Luscher A., Sebastia M.T. and Weigelt A.</i> .....	782
Study of the earthworm population ( <i>Lumbricus terrestris</i> ) in grassland differing in management <i>Daugėlienė N., Žekonienė V., Bartkevičius E. and Gavenauskas A.</i> .....	785
A method to assess the management of permanent grasslands at farm level <i>Duru M., Cruz P., Martin G. and Theau J.P.</i> .....	788
Influence of management and environmental factors on species composition and species richness in semi-arid rangeland in western Iran <i>Faramarzi M., Kesting S., Wrage N. and Isselstein J.</i> .....	791
Richness of unsown plant species in a sown ley crop <i>Frankow-Lindberg B.E.</i> .....	794
Carbon isotope composition ( $\delta^{13}\text{C}$ ) in <i>Dactylis glomerata</i> and its relationship with water use efficiency at plant and leaf level <i>Gulías J., Ribas-Carbó M., Moreno M.T., Conesa M.A. and Cifre J.</i> .....	797

Management strategies to increase botanical diversity at grassland with a history of intensive agricultural management <i>Hald A.B. and Nielsen A.L.</i> .....	800
How can <i>Trifolium repens</i> patches simultaneously expand and persist? <i>Johansen L.</i> .....	803
Restoration of species-rich grasslands: reduction in nutrient availability slightly improved forb species' establishment <i>Huguenin-Elie O., Stutz C.J., Gago R. and Lüscher A.</i> .....	806
Differences in plant species diversity between managed and abandoned semi-natural meadows <i>Kaçki Z.</i> .....	809
Diversity–ecosystem function relationship in mixed forage crops <i>Lurba R., Ribas A., Ventura D., Connolly J. and Sebastià M.T.</i> .....	812
Plant strategies in relation to different grazing intensities <i>Ludviková V. and Pavlů V.</i> .....	815
Grass-legume mixtures can fix more N <sub>2</sub> from the atmosphere than legume pure stands <i>Lüscher A., Nyfeler D., Suter M., Suter D. and Huguenin-Elie O.</i> .....	818
The effect of manipulated plant species diversity of semi-natural permanent grassland on forage production and quality <i>Petersen U., Isselstein J. and Wrage N.</i> .....	821
Manipulating species richness of permanent grasslands - a new approach to biodiversity experiments <i>Petersen U., Wrage N., Köhler L., Leuschner C. and Isselstein J.</i> .....	824
Diversity and stability in experimental grassland communities <i>Picasso V.D., Brummer E.C. and Liebman M.</i> .....	827
<sup>15</sup> Nitrogen uptake from shallow- versus deep-rooted plants in multi-species and monoculture grassland <i>Pirhofer-Walzl K., Høgh-Jensen H., Rasmussen J., Rasmussen J., Søgaard K. and Eriksen J.</i> .....	830
Use of species number, Shannon index and Sorensen index for the evaluation of biodiversity in different types of pasture <i>Pornaro C., Munari N. and Ziliotto U.</i> .....	833
Influence of afforestation on forage value and plant diversity in the Mediterranean <i>Susan F., Pornaro C., Migliorini S. and Ziliotto U.</i> .....	836
Changes in biodiversity composition and soil nutrient content with management in a Pyrenean grassland community <i>Ribas A., Lurba R., Ventura D., Hodge A. and Sebastià M.-T.</i> .....	839
Effects of arbuscular mycorrhizal symbiosis on growth and N <sub>2</sub> fixation of <i>Trifolium alexandrinum</i> under late drought stress conditions <i>Saia S., Ruisi P., Amato G. and Giambalvo D.</i> .....	842
Plant functional trait expression in the Rengen Grassland Experiment <i>Schellberg J., Brüne K. and Hejcman M.</i> .....	845
Long-term effects of large-scale, moderate grazing on the vegetation of a river valley <i>Schrautzer J., Jensen K., Breuer V. and Breuer M.</i> .....	848
Assessing the environmental qualities of permanent grassland <i>Hasund K.P., Holgersson T., Norell B. and Ståhlberg D.</i> .....	851
Roots and earthworms under grass, clover and a grass-clover mixture <i>van Eekeren N., Bokhorst J. and Brussaard L.</i> .....	854

<sup>13</sup> Carbon allocated to the leaf growth zone of <i>Poa pratensis</i> reflects soil water and vapour pressure deficit <i>Auerswald K., Landinger C., Wittmer M. and Schnyder H.</i> .....	857
Influence of drought stress and fertilisation on carbon isotopes as indicators of water use of grassland differing in diversity <i>Wrage N., Gauckler L., Steep E., Küchenmeister F., Küchenmeister K. and Isselstein J.</i> .....	860

## **Session 5. Pastoral/Grazing Systems**

### ***Invited papers***

Producing milk from grazing to reconcile economic and environmental performances <i>Peyraud J.L., Van den Pol-van Dasselaar A., Dillon P. and Delaby L.</i> .....	865
Environmental impacts of grazed pastures <i>Eriksen J., Ledgard S., Luo J., Schils R. and Rasmussen J.</i> .....	880

## **Session 5.1 Pasture management and production**

### ***Oral presentations***

Utilisation of cut and grazed fields is linked to their geographical characteristics in mountainous bovine systems <i>Garcia-Launay F., Sibra C., Molénat H., Agabriel C. and Brunschwig G.</i> .....	892
Grazing behaviour and intake of two Holstein cow types in a pasture-based production system <i>Schori F. and Münger A.</i> .....	895
Comparison of methods to quantify bite rate in calves grazing winter oats with different structures <i>Nadin L.B., Sánchez Chopa F., Trindade J.K., Amaral G., Milano G.D., Moreno L.S. and Gonda H.L.</i> .....	898
Increasing concentrate levels during the grazing season – effects on yield and behaviour of dairy cows <i>Alvåsen K. and Spörndly E.</i> .....	901
The effect of sward <i>Lolium perenne</i> content and defoliation method on seasonal and total dry matter production <i>Creighton P., Kennedy E., Gilliland T., Boland T.M. and O'Donovan M.</i> .....	904
The effect of organic management strategies on dairy production in clover-based grassland <i>Keogh B., Humphreys J., Phelan P., Necpalova M., Casey I.A. and Fitzgerald E.</i> .....	907
Feeding behaviour of sheep on shrubs ( <i>Cytisus scoparius</i> L.) in response to contrasting herbaceous cover <i>Pontes L. da S., Magda D., Agreil C. and Gleizes B.</i> .....	910

### ***Poster presentations***

Modelling the dynamics of biomass production and herbage quality of grasslands according to functional groups composition <i>Baumont R., Andueza D., Vuattoux J., Picard F. and Michaud A.</i> .....	913
The quest for persistent green in outdoor chicken runs – an investigation on fourteen grassland species <i>Breitsameter L., Wrage N. and Isselstein J.</i> .....	916

Dietary selection of heifers in natural grasslands: effect of time of day and phenological stage	
<i>Carvalho P.C.F., Bremm C., Gibb M.J., Perez N., Fonseca L. and Amaral G.A.</i> .....	919
Intake choices of cattle and sheep grazing alone or together on grass swards differing in plant species diversity	
<i>Cuchillo H.M. and Isselstein J.</i> .....	922
Relationship between herbaceous productivity and species richness in grazed areas on La Palma (Canary Islands)	
<i>de Nascimento L., Bermejo L.A., Saro I., Fernández-Lugo S. and Mata J.</i> .....	925
Are high genetic merit dairy cows compatible with low input grazing systems?	
<i>Delaby L., Horan B., O'Donovan M., Gallard Y. and Peyraud J.L.</i> .....	928
Daily pattern of feeding activities of dairy cows in an 8-d rotational grazing system	
<i>Delagarde R., Peyraud J.L. and Wade M.H.</i> .....	931
Tillering dynamics in <i>Brachiaria decumbens</i> pastures under continuous stocking	
<i>Santos M.E.R., Fonseca D.M., Nascimento Júnior D., Gomide C.A.M., Gomes V.M. and Sbrissia A.F.</i> .....	934
Selective grazing, patch stability and vegetation dynamics in a rotationally-grazed pasture	
<i>Dumont B., Carrère P., Rossignol N., Chadoeuf J., Farruggia A., Ginane C. and Louault F.</i> .....	937
Balance between production and biodiversity in two upland dairy grazing systems	
<i>Farruggia A., Pomiès D., Bethier A., Troquier O., Le Bec G., Paccard P., Baumont B. and Pradel P.</i> .....	940
Long term performance of an artificial pasture vegetation under Mediterranean conditions in Turkey	
<i>Geren H., Avcioglu R., Soya H., Kir B., Demiroglu G. and Kavut Y.T.</i> .....	943
The effect of nitrogen on yield and composition of grass clover swards at three sites in Ireland: a comparison of six commonly grown species	
<i>Gilliland T.J., Farrell A.D., McGilloway D. and Grogan D.</i> .....	946
Evaluation of leaf tensile strength of selected grass genotypes	
<i>Goliński P., Golińska B. and Zajac M.</i> .....	949
Performance of <i>Lolium perenne</i> with <i>Trifolium repens</i> , and spontaneous grasses with <i>Trifolium repens</i> , in Azores	
<i>Gomes A.</i> .....	952
Comparison of methods for estimating forage mass in grazing systems of the south Brazilian Pampas	
<i>Grün A., Gierus M., Carvalho P.F.C., Pinto C. E. and Brambilla D.</i> .....	955
Post-grazing height and productivity of white clover-based systems of dairy production	
<i>Humphreys J., Keogh B., Phelan P. and Casey I.A.</i> .....	958
Growth and quality of multispecies pastures harvested at a fixed sward height	
<i>Johansen A.</i> .....	961
The use of grazing in intensive dairy production and assessment of farmers' attitude towards grazing	
<i>Kristensen T., Madsen M.L. and Noe E.</i> .....	964
Herbage productivity and quality of mountain grassland under different forage management systems	
<i>Leto J., Bošnjak K., Perčulija G., Kutnjak H. and Vranić M.</i> .....	967
The effect of pasture herbage mass on dairy cow ruminal pH	
<i>Lewis E., Coughlan F., O'Donovan M. and Wims C.</i> .....	970

Patterns of sward height reduction in a tropical pasture grazed by dairy cows <i>Mezzalana J.C., Carvalho P.C.F., Amaral M.F., Bremm C., Da Trindade J.K., Gonçalves E.N., Martins R. S. and Genro T.C.M.</i> .....	973
Beef fattening on grazed leys: interest of tall fescue <i>Mosimann E., Schmied R. and Thomet P.</i> .....	976
The effects of the nitrification inhibitor dicyandiamide (DCD) on herbage production when applied at different times and rates in the autumn and spring <i>O'Connor P.J., Hennessy D., O'Donovan M. and Lynch B.</i> .....	979
Substitution rate and milk response to maize silage supplementation of dairy cows grazing low-mass pastures <i>Pérez-Prieto L.A., Peyraud J.L. and Delagarde R.</i> .....	982
Impacts of autumn cutting height and interval on annual productivity of a white clover-grass sward. <i>Phelan P., Keogh B., Casey I.A., Fitzgerald E. and Humphreys J.</i> .....	985
Productivity and floristic diversity of a continuous grazing system on short swards in mountainous regions of Austria <i>Poetsch E.M., Resch R., Haeusler J. and Steinwidder A.</i> .....	988
Voluntary intake of forages from permanent grasslands with different quality in suckler cows <i>Pozdišek J., Látal O. and Štýbnarová M.</i> .....	991
Effect of two pre-grazing herbage masses and daily herbage allowances on perennial ryegrass sward characteristics <i>Roca-Fernández A.I., O'Donovan M., Curran J. and González-Rodríguez A.</i> .....	994
Effect of entry time to a daily strip on daily weight gain and nitrogen balance <i>Sánchez Chopa F., Nadin L.B., Trindade J.K., Amaral G. and Gonda H.L.</i> .....	997
Suitability of grass species on equine pasture: water soluble carbohydrates and grass preferences by horses <i>Särkijärvi S., Niemeläinen O., Sormunen-Cristian R. and Saastamoinen M.</i> .....	1000
Potassium effect on pasture yield and its composition in management of an old permanent pasture <i>Sarunaite L. and Kadziuliene Z.</i> .....	1003
Morphological characteristics and tiller population density of aruana guineagrass subjected to frequencies and severities of grazing by sheep <i>Zanini G.D., Santos G.T., Padilha D.A., Cizinande S., Silva D., Borges J.A.S., Silva M.C., Freitas R.C., Arruda J.C.A., Almeida G., Nascimento-Junior D., Da Silva S.C. and Sbrissia A.F.</i> .....	1006
Continuous grazing in comparison to cutting management on an organic meadow in the eastern Alps <i>Starz W., Steinwidder W., Pfister R. and Rohrer H.</i> .....	1009
Changing towards a seasonal low-input pastoral dairy production system in mountainous regions of Austria – results from pilot farms during reorganisation <i>Steinwidder A., Starz W., Podstatzky L., Kirner L., Pötsch E.M., Pfister R. and M. Gallnböck</i> .....	1012
Impact of grazing intensity on performance of sheep in the Inner Mongolian steppe, China <i>Müller K., Lin L., Glindemann T., Wang C., Schiborra A., Schönbach P., Wan H.W., Tas B.M., Dickhöfer U., Gierus M., Taube F. and Susenbeth A.</i> .....	1015
Efficiency of Swiss and New Zealand dairy breeds under grazing conditions on Swiss dairy farms <i>Thomet P., Piccand V., Schori F., Troxler J., Wanner M. and Kunz P.</i> .....	1018

Dry matter production of perennial ryegrass swards following poaching damage on a free-draining brown earth soil <i>Tuñon G., O'Donovan M., Hennessy D., Kemp P., Lopez Villalobos N. and Kennedy E.</i> .....	1021
The grazing selectivity of Konik horses on grasslands located in Biebrza National Park <i>Chodkiewicz A. and Stypiński P.</i> .....	1024

## Session 5.2 Environmental benefits and risks

### Oral presentations

The contribution of grass and clover root turnover to N leaching <i>Rasmussen J., Helgadóttir Á., Frankow-Lindberg B., Loges R., and Eriksen J.</i> .....	1028
Winter grazing of grass-clover swards grown as green manure under the maritime climatic conditions of Northern Germany <i>Loges R., Westphal D. and Taube F.</i> .....	1031
Nitrogen excretions in dairy cows on a rotational grazing system: effects of fertilization type, days in the paddock and time period <i>Dufresne I., Robaye V., Istasse L. and Hornick J.-L.</i> .....	1034

### Poster presentations

Water quality and the environmental use of livestock ponds <i>Canals R.M., Ferrer V., San Emeterio L., Iriarte A. and Villanueva E.</i> .....	1037
Residual effects of cutting and grazing on grass-clover growth <i>Eriksen, J., Søegaard K. and Askegaard M.</i> .....	1040
How does stocking rate influence biodiversity in a hill-range pasture continuously grazed by horses? <i>Fleurance G., Dumont B. and Farruggia A.</i> .....	1043
Silage maize in crop rotations with different grass mixtures – N balances and N leaching <i>Kalmage T., Kayser M. and Isselstein J.</i> .....	1046
Soil nitrogen, phosphorus and potassium contents on a dairy cattle pasture <i>Kryszak J. and Musiał M.</i> .....	1049
Shortcut strategies to improve plant species richness after years of intensive management in moist grassland <i>Nielsen A.L. and Hald A.B.</i> .....	1052
Cattle grazing on Swedish semi-natural pastures – how behaviour effects nutrient transport in the grazing area <i>Pelve M.E., Glimskär A. and Spörndly E.</i> .....	1055
Nitrogen and potassium leaching from grassland soil depending on applied fertilizer type and rate and sward botanical composition <i>Raave H., Kauer K., Noormets M., Selge A. and Viiralt R.</i> .....	1058
Behaviour of two cow genotypes within a low input grazing system and a high input total confinement system <i>Roca-Fernández A.I., Ferris C.P., Vance E.R. and González-Rodríguez A.</i> .....	1061
Effect of Scottish Highland cattle grazing on plant communities with <i>Phalaris arundinacea</i> <i>Rogalski M. and Pławska-Olejniczak J.</i> .....	1064
Nitrogen balances for three strains of dairy cows and contrasting intensive grassland systems <i>Ryan W., Hennessy D., Boland T. and Shalloo L.</i> .....	1067

Flows of nitrogen and phosphorus on large dairy farms with different grazing systems – a model study <i>Salomon E., Spörndly E., Sundberg M. and Wahlund L.</i> .....	1070
<b>Addendum</b>	
<b>Session 4.1</b>	
Concepts for nutrient management in nature conservation areas on organic soils <i>Müller J., Kayser M. and Belting H.</i> .....	1075
<b>Index of Authors</b> .....	1079



# Session 1

## Grassland and global change



## C3/C4 grasslands and climate change

Lattanzi F.A.

*Lehrstuhl für Grünlandlehre, Technische Universität München, Am Hochanger 1 D-85350 Freising-Weihenstephan, Germany.*

Corresponding author: lattanzi@wzw.tum.de

### Abstract

Species with the C3 and C4 modes of photosynthesis coexist in grasslands of North and South America, Central Asia, South Africa, Australia and New Zealand. In these ecosystems, the balance between C3 and C4 vegetation affects many functional aspects, including total and seasonal primary productivity and water use, the digestibility of herbage available to grazing animals, and the decomposability of litter and roots. Therefore, changes in the C3/C4 balance strongly influence the biogeochemistry and agronomic performance of these ecosystems, with potential impacts on animal productivity, carbon storage and nitrogen cycling. This review first presents the primary difference between the C3 and C4 photosynthetic pathways, and its consequences for plant carbon, water and nitrogen economies. Then, it explores how these physiological differences would influence the response of the C3/C4 balance to elevated CO<sub>2</sub> and global warming. Finally, expected responses are contrasted to the available evidence (from present-day and past-climate/vegetation studies, from analysis of recent regional changes, and from manipulative experiments) to verify their actual role in observed C3/C4 responses, and to identify gaps in our understanding of the mechanisms controlling the C3/C4 balance of grasslands.

Keywords: natural grasslands, elevated CO<sub>2</sub>, global warming, ecophysiological mechanisms, light use efficiency, maximum quantum yield, water use efficiency, nitrogen use efficiency

Abbreviations: CO<sub>2</sub> partial pressure ( $p\text{CO}_2$ ), Phospho-*enol*-pyruvate carboxylase (PEPCase), photosynthetic water use efficiency (PWUE), photosynthetic nitrogen use efficiency (PNUE), light-saturated photosynthetic rate ( $A_{\text{sat}}$ ), free-air CO<sub>2</sub> enrichment (FACE)

### Introduction

A unique difference between the C3 and C4 modes of photosynthesis determines contrasting photosynthetic responses to CO<sub>2</sub> and temperature in C3 vs. C4 plants, which in turn have consequences for plant's light, water and nitrogen use efficiencies, and for the digestibility and decomposability of plant biomass. As a result, the balance between C3 and C4 vegetation is believed to be potentially very responsive to climate change, and ecosystem function, potentially very responsive to changes in the C3/C4 balance.

Major C3/C4 ecosystems include savannas, in which a more or less dense population of C3 trees co-occur with a largely C4 herbaceous stratum, and grasslands, in which C3 grasses and forbs co-occur with C4 herbaceous plants, mostly grasses (Sage *et al.*, 1999). C3/C4 savannas occur in relatively hot, humid or subhumid climates (e.g. Brazilian *cerrado*, Argentinean *chaco*, tropical savannas in Africa and Northern Australia). C3/C4 grasslands occur either in temperate or subtropical climates with humid to subhumid conditions (e.g. *prairies* of North America, *pampas* and *campos* of South America, *grassvelds* of South Africa). A C4 component can also be present in grasslands of cooler and drier climates (e.g. *prairies* of North America, Mongolian *steppe*). Thus, even though the C4 flora comprises a relatively small number of species, mostly in the *Poaceae*, C3/C4 ecosystems include a substantial part

of global vegetation, and account for a relevant portion of its primary productivity (Lloyd and Farquhar, 1994).

Almost all C3/C4 grasslands and savannas operate as agroecosystems, supporting variable populations of grazing animals, typically sheep and/or cattle herds, managed rather extensively. Therefore, a better understanding of the mechanisms controlling C3/C4 interactions is important for the design and management of agroecosystems able to provide a seasonally stable supply of quality forage, and efficient at recycling nitrogen and storing carbon. Such agroecosystems exert a substantial influence on global biogeochemical cycles (Lloyd *et al.*, 1994), particularly in regard to the coupling of carbon and nitrogen cycles. Further, a better understanding of the controls of the C3/C4 balance in grasslands would improve our knowledge on the ecophysiological basis of species coexistence (Anten and Hirose, 2003), and hence of the controls of (functional) biodiversity. Moreover, because of the variable isotopic composition of CO<sub>2</sub> exchanged by mixed C3/C4 vegetation, a better understanding of the controls of the C3/C4 balance in grasslands will also contribute to a more accurate estimation of the isotopic signature of carbon fluxes required to constrain the partition of global carbon fluxes into terrestrial vs. oceanic components (Lloyd *et al.*, 1994; Randerson *et al.*, 2002).

This review focuses on C3/C4 grasslands, because this allows a more straightforward analysis of the influence of photosynthetic mode on the interaction between plants of similar morphology. Climate-change effects on C3 tree–C4 grass interactions have been reviewed elsewhere (e.g. Polley *et al.*, 1997; Scheiter and Higgins, 2009). Here, the intrinsic difference between the C3 and C4 photosynthetic modes is first presented, and its consequences for plants' carbon, water and nitrogen economies are described. Then, how such physiological differences could influence the balance between C3 and C4 species in response to increased levels of CO<sub>2</sub> and temperature is explored. Finally, expected responses are contrasted with available evidence (from present-day and past-climate/vegetation studies, from analysis of recent regional changes, and from controlled experiments) to verify their actual role in observed C3/C4 changes, and to identify gaps in our understanding of the mechanisms controlling the C3/C4 balance of grasslands.

### **Primary differences between C3 and C4 species: photosynthetic responses to temperature and CO<sub>2</sub> partial pressure**

The essential difference between the C3 and C4 modes of photosynthesis is that CO<sub>2</sub> partial pressure ( $p\text{CO}_2$ ) at the site of Rubisco is 5 to 10 times higher in C4 than in C3 photosynthesis. This effectively prevents photorespiration by suppressing O<sub>2</sub> competition, and also saturates Rubisco carboxylase activity. Since photorespiration is a temperature- and CO<sub>2</sub>-dependent process (Brooks and Farquhar, 1985), photosynthesis is higher in C4 than C3 plants at high temperature and low  $p\text{CO}_2$ .

C4 plants accomplish this *via* (i) a biochemical CO<sub>2</sub>-pump that involves Phospho-*enol*-pyruvate carboxylase (PEPCase), an enzyme with high affinity for CO<sub>2</sub> and no oxygenase function located in the mesophyll, and (ii) by concentrating Rubisco in bundle-sheath cells (Kranz anatomy; Hatch, 1987). Thus, PEPCase fixes CO<sub>2</sub> in mesophyll cells producing a four-carbon acid (hence the name). Fixed carbon is then translocated to bundle-sheath cells as malate or aspartate, where it is decarboxylated and the resulting CO<sub>2</sub> assimilated by Rubisco. Bundle-sheath cells have a low conductance for CO<sub>2</sub> diffusivity in C4 leaves. The reason is unclear, and may involve engrossed cell walls and/or lower membrane permeability to CO<sub>2</sub> (von Caemmerer and Furbank, 2003).

Pumping CO<sub>2</sub> is costly: each pumped molecule of CO<sub>2</sub> requires 2 ATP, produced by photophosphorylation at a rate of ~ 8 photons per ATP (Furbank *et al.*, 1990). The total cost of CO<sub>2</sub> pumping per unit fixed CO<sub>2</sub> is further increased by the fact that some of the pumped CO<sub>2</sub>

leaks back to mesophyll cells (Farquhar, 1983). Therefore, maximum quantum yield (moles of CO<sub>2</sub> fixed per mol of absorbed quanta at very low irradiance) is greater in C<sub>4</sub> than C<sub>3</sub> plants at high temperature or low intercellular  $p\text{CO}_2$ , when photorespiration more than offsets ATP consumption by the C<sub>4</sub> pump. But the opposite becomes true at low temperature or high intercellular  $p\text{CO}_2$  (Ehleringer and Pearcy, 1983).

The same interaction between photosynthetic mode and temperature is observed at high irradiances. This is because at high temperature light-saturated photosynthetic rate ( $A_{\text{sat}}$ ) is higher in C<sub>4</sub> than C<sub>3</sub> plants due to the photorespiratory load in C<sub>3</sub> photosynthesis, and to C<sub>3</sub> photosynthesis being progressively CO<sub>2</sub>-limited at increasing irradiance. Both these effects are avoided in C<sub>4</sub> plants because Rubisco operates at (near) saturating levels of CO<sub>2</sub>. At low temperature, Rubisco levels increase in C<sub>3</sub> plants and help maintain  $A_{\text{sat}}$  high. In C<sub>4</sub> plants  $A_{\text{sat}}$  decreases dramatically at low temperature, apparently because of a physical limit to the ability of C<sub>4</sub> leaves to increase Rubisco imposed by bundle-sheath cell space (Sage and Kubien, 2007), which leads to higher leakiness (Kubásek *et al.*, 2007).

### **Secondary differences between C<sub>3</sub> and C<sub>4</sub> species: nitrogen and water use efficiency**

The photosynthetic use efficiency of nitrogen (PNUE) is often higher in C<sub>4</sub> plants; that is, more CO<sub>2</sub> is assimilated per unit leaf nitrogen. This is because Rubisco, which accounts for a substantial part of leaf nitrogen, is fully engaged in CO<sub>2</sub> assimilation (as opposed to photorespiration) and operates (nearly) saturated by CO<sub>2</sub> (Bolton and Brown, 1980; Sage and Pearcy, 1987b). Moreover, the particular (Kranz) anatomy associated with the C<sub>4</sub> syndrome implies that C<sub>4</sub> leaves not only have less Rubisco (Ku, Schmitt and Edwards, 1979; Sage *et al.*, 1987) but also more lignified tissue (Dengler *et al.*, 1994). This is reflected in an inherently lower nitrogen concentration in C<sub>4</sub> than C<sub>3</sub> plants (Greenwood *et al.*, 1990), although Taylor *et al.* (2010) have argued this may be more related to phylogeny than to an inherent C<sub>3</sub> vs. C<sub>4</sub> difference.

The C<sub>4</sub> mode of photosynthesis also has indirect consequences for the use of water. The lack of oxygenase function and high affinity of PEPCase for CO<sub>2</sub> determines that C<sub>4</sub> photosynthesis saturates at intercellular  $p\text{CO}_2$  as low as 150  $\mu\text{bar}$ . As a result, low stomatal conductance, and thus low transpiration rates, do not affect C<sub>4</sub> photosynthetic rate (Ghannoum, 2009). Consequently, photosynthetic use efficiency of water (PWUE) is often higher in C<sub>4</sub> plants, that is, more carbon is fixed per unit transpired water (Ghannoum, 2009; Taylor *et al.*, 2010). Lower transpiration rates can lead to increases in leaf temperature (Ghannoum *et al.*, 2000), further improving the performance of C<sub>4</sub> relative to C<sub>3</sub> photosynthesis.

Comparative studies routinely report higher PNUE and PWUE in C<sub>4</sub> plants (e.g. Taylor *et al.*, 2010 and references therein). However, it is important to note that, first, such advantages are less, and eventually disappear, under severe stress (e.g. nitrogen: Sage and Pearcy, 1987a; water: Ghannoum, 2009), perhaps due to increased CO<sub>2</sub> leakage (Buchmann *et al.*, 1996; Meinzer and Zhu, 1998). Second, at low temperature PNUE and PWUE become lower than in C<sub>3</sub> plants because the lesser nitrogen content and stomatal conductance of C<sub>4</sub> plants do not compensate for their low photosynthesis rates (Schmitt and Edwards, 1981; Christie and Detling, 1982; Long, 1983; Sage *et al.*, 1987; von Caemmerer *et al.*, 2001). And third, saturating CO<sub>2</sub> increases both PNUE and PWUE in C<sub>3</sub> plants (Wand *et al.*, 1999), diminishing (even offsetting) the advantage of C<sub>4</sub> plants. Therefore, the actual relevance of secondary differences as determinants of the C<sub>3</sub>/C<sub>4</sub> balance depends, perhaps largely, on the primary difference between C<sub>3</sub> and C<sub>4</sub> plants in the response of carbon assimilation to temperature and CO<sub>2</sub>.

Quantum yield, PNUE and PWUE all measure the efficiency with which a resource is used during carbon assimilation. Of course, these are not the only mechanisms determining the

outcome of competition; the ability for resource acquisition is also important. Whether having the C3 or C4 mode of photosynthesis has specific consequences for plant morphogenesis and architecture that, in turn, affect the ability to capture light, nitrogen or water has been little studied, although improved PNUe has been suggested to allow C4 plants to develop a higher leaf area index in fertile sites and to partition more carbon towards roots in nitrogen-limited situations (Wedin and Tilman, 1996; Long, 1999). An isolated but revealing study by Werger *et al.* (2002) showed that excluding grazing from a C3/C4 grassland induced a change in species (tall grasses replaced short ones), but all stages of the succession were dominated by C4s –from the short *Zoysia japonica*, to the intermediate *Brachypodium sylvaticum* to the tall *Miscanthus sinensis*. Thus, at least in this subtropical site, any constraints on above-ground architecture causing species replacement were not C3- or C4-specific. Other outcomes may be the case when grass/forbs interactions are involved: because of the relatively minor number of C4 dicots, most forbs are in fact C3 species, and therefore factors influencing the forbs/grass composition of grasslands may also indirectly affect their C3/C4 balance.

### **Putative mechanisms controlling the response to climate change of the C3/C4 balance: comparison against the available evidence**

The two major trends associated with climate change, elevated CO<sub>2</sub> and global warming, have opposite effects on the quantum yield of C3 and C4 photosynthesis. Elevated CO<sub>2</sub> improves little photosynthesis in most C4 plants, but leads to higher quantum yield in C3 plants. Conversely, warming decreases the quantum yield of C3 plants. Ehleringer (1978) proposed that temperature plays a major role in determining the C3/C4 balance of grasslands because it affects light use efficiency in C3 species but not in C4 species. This hypothesis, hereafter the *quantum yield hypothesis*, is explicit in Ehleringer *et al.* (1997) and Collatz *et al.* (1998), who estimated the temperature at which the extra quanta required by C4 photosynthesis equals photorespiratory costs for a range of atmospheric pCO<sub>2</sub>. Thus, scenarios below such cross-over temperature are expected to be dominated by C3 species, and those above, by C4 species.

The photosynthetic responses behind the *quantum yield hypothesis* form the ecophysiological basis of the expected response of the C3/C4 balance to increased CO<sub>2</sub> and temperature (e.g. Long, 1999; Sage *et al.*, 1999; Wand *et al.*, 1999). Still *et al.* (2003) further extended it, arguing that the same interaction observed in quantum yield also occurs under light-saturated conditions: elevated CO<sub>2</sub> increases A<sub>sat</sub> much more in C3 plants than in C4 plants, and higher temperature increases A<sub>sat</sub> more on C4 than in C3 plants (A<sub>sat</sub> response to high temperature in C3 plants depends on the magnitude of CO<sub>2</sub>-diffusion limitation (Sage *et al.*, 2007)). Implicit in this view is that carbon gain is the main determinant of competitive outcome, which, of course, is a simplification of reality. But, as in the use of optimization theory in canopy models, it can be a null hypothesis to analyse the adaptive significance of photosynthesis-related characteristics of plants (Anten, 2005).

There has been considerable discussion about the actual value of cross-over temperatures. Although knowing the exact number may be of limited relevance for the interpretation of changes in the C3/C4 balance at regional or global scale, it is important to note that, actually, it is pCO<sub>2</sub> at the Rubisco site and leaf temperature, averaged over daytime hours of highest photosynthetic rates, that determine plant carbon assimilation. These quantities, often difficult to estimate, usually do not vary in the same magnitude than available proxies, typically atmospheric pCO<sub>2</sub> and mean air temperature. In what follows, the predictions of the *quantum yield hypothesis* are contrasted against available evidence from present-day and past-climate/vegetation relationships, from recorded modern (i.e. last 50 years) changes in C3/C4 balance of grassland ecosystems, and from results of elevated CO<sub>2</sub> manipulative experiments.

## Present-day climate/vegetation relationships

Variation in the C3/C4 balance of grasslands is often associated with some measure of temperature, which is typically taken as evidence of an overriding importance of the photosynthetic response to temperature (e.g. Long, 1999; Sage *et al.*, 1999). It also supports the idea of a seasonal niche separation for C3 and C4 species (Kemp and Williams, 1980), although strict separations seem rare (Turner and Knapp, 1996). Modelling of the *quantum yield hypothesis* have shown a reasonably good agreement between predicted and observed latitudinal, altitudinal and seasonal patterns of present-day ‘pure C3’, ‘mixed C3/C4’ and ‘pure C4’ vegetation (Ehleringer *et al.*, 1997; Collatz *et al.*, 1998; Still *et al.*, 2003), lending support to the view that the interaction photosynthetic mode  $\times$  temperature in carbon gain is a major determinant of the C3/C4 balance.

Exactly how good is ‘reasonably good’ has not been rigorously tested (Winslow *et al.*, 2003). In fact, the primary control of temperature and CO<sub>2</sub> is challenged by several authors, who usually claim a larger role for soil moisture in controlling the C3/C4 balance. Indeed, aridity is highly correlated with C4 abundance (Sage *et al.*, 1999 and references therein). However, it seems to act as a secondary control: C4 plants dominate grasslands in hot climates, either arid or humid, and the opposite is true in cold climates. However, in temperate climates, aridity does seem to help C4 vegetation to persist at temperatures that would otherwise have led to C3 dominance (Sage *et al.*, 1999; Cabido *et al.*, 2008). Why this is so is not completely clear. A cause put forward often is their higher PWUE. Another reason may be indirect effects on leaf temperature. Stomatal conductance is lower in arid than in humid environments, and irradiance and thermal amplitude, often higher, due to low cloudiness. This leads to higher daytime leaf temperatures (Ghannoum *et al.*, 2000), and could thus explain part of the effect of aridity on the C3/C4 balance. Cabido *et al.* (2008) suggested phylogenetic effects may also be involved.

A convincing case for the role of precipitation in controlling the C3/C4 balance was made by Winslow *et al.* (2003), who proposed that an inherent difference between C3 and C4 growing seasons is modulated by soil available water, and showed that, under such an assumption, the distribution of present-day C3/C4 biomass is closely related to the seasonality of rain. This is intuitively sound, since summer precipitation would favour the growth of C4 vegetation and thus increase its relative contribution to standing biomass and annual productivity. However, it can still be argued that it is temperature, not rain, which primarily determines the length and timing of C3 and C4 growing seasons. This contrast clearly shows the importance of distinguishing the time scale in discussing the factors controlling the C3/C4 balance of grasslands. Annual averages are always weighed by seasonal productivity and would thus be influenced by the seasonality of precipitation (or, for that matter, irradiance), while more instantaneous (i.e. monthly) averages would reflect more the temperature effect. An integrative model –conceptual or explicit– to interpret annual values would include a temperature function predicting the instantaneous C3/C4 balance, modulated by precipitation.

## Past climate/vegetation relationships

A primary role for temperature and CO<sub>2</sub> in determining the C3/C4 balance has also been argued in analyses of past climates. C4 vegetation underwent an abrupt expansion 6 to 8 million years ago, first in tropical climates and then in more temperate areas. Cerling *et al.* (1997) documented in detail this change in the diet of herbivores of Asia, Africa and North and South America, and associated such widespread process with atmospheric *p*CO<sub>2</sub> decreasing below 400 - 600  $\mu$ bar, arguing that a progressive CO<sub>2</sub>-starvation of C3 plants would also explain why the transition from C3 to C4 diet occurred first in hot climates (higher cross-over temperature).



This interpretation, consistent with the *quantum yield hypothesis*, is not, however, universally accepted. First, it is disputed that atmospheric  $p\text{CO}_2$  decreased during the expansion of C4 vegetation observed by Cerling *et al.* (1997) (Pagani *et al.*, 1999), since it seems it occurred much earlier (Pagani *et al.*, 2005). Second, it is claimed that such expansion was a transition from C3-forests to C4-savanna/grasslands ecosystems, driven by aspects regulating tree/grass interactions. Thus, in a phylogenetic analysis, Edwards and Smith (2010) propose that rain levels decreased below a threshold required to support rainforests, leading to the development of more open (well-lit, less shaded) canopies. In turn, Beerling and Osborne (2006) point out an increase in charcoal in sediments of more or less the same age as the C4 expansion, and suggest a feedback mechanism by which fires fuelled by accumulating C4 dead biomass enhanced the opening process. Thus, in a sense, Cerling *et al.* (1997) propose that grasslands expanded because they included C4 species, while Edwards *et al.* (2010), and to a lesser extent Beerling *et al.* (2006), suggest that C4 vegetation expanded because grasslands expanded.

While low-precipitation-plus-fire, rather than  $\text{CO}_2$  starvation, may indeed be the main cause of decreasing C3 forests, this does not explain why C4 rather than C3 grasses dominated the expanding grasslands and savannas. Temperature and  $p\text{CO}_2$  would still be the main determinants of the C3/C4 balance of these emerging ecosystems. Of course, both factors could have interacted: aridity would affect more and more quickly carbon-starved trees, because, for instance, their root mass ratio would have been lower, and their ability to reduce transpiration, limited by low  $p\text{CO}_2$ . An interesting question arise from these considerations: is low  $p\text{CO}_2$  more detrimental for the growth of C3-grasses than C3-trees?

A major role for temperature and  $\text{CO}_2$  in determining the C3/C4 balance is supported by analyses of more recent changes in Earth's climate. Atmospheric  $p\text{CO}_2$  has oscillated over the last half-a-million years, from 180 – 210  $\mu\text{bar}$  minima at glacial maxima to 280 – 300  $\mu\text{bar}$  during warmer interglacial periods. Modelling changes in C3/C4 vegetation following the last glacial maximum 15000 years ago for two sites that showed contrasting trends (increasing C3 forests in intertropical Africa vs. increasing C4 grasses in the steppes of central China), Flores *et al.* (2009) concluded that the C3/C4 balance was primarily sensitive to temperature and atmospheric  $p\text{CO}_2$ , and thus support the *quantum yield hypothesis*. Boom *et al.* (2002) went a step further and used the model behind the *quantum yield hypothesis* to actually infer past  $\text{CO}_2$  atmospheric pressure from C3/C4 data in Andean grasslands. This is a particularly interesting site because the lack of trees prevents confounding effects derived from tree/grass interactions.

### **C3/C4 changes modern grasslands**

Atmospheric  $p\text{CO}_2$  has risen steadily from *ca.* 280  $\mu\text{bar}$  in pre-industrial times (~1830) to *ca.* 390  $\mu\text{bar}$  today. This change is substantial enough as to make an impact on C3 vs. C4 growth, even if temperatures increased as much as 4 °C to 5 °C. In fact, temperature increases over the past century have been of lesser magnitude, and with a more restricted, regional scale. Similarly, precipitation changes differed in magnitude (and even direction) depending on the region. As a result, over the last hundred years or so, C3/C4 ecosystems experienced a uniform increase in  $\text{CO}_2$  availability but may have been exposed to distinct changes in temperature and precipitation. In spite of this apparently rich experimental material, few studies have analysed the recent evolution of the C3/C4 balance in modern grasslands.

This may be related to the fact that grasslands are poor at archiving, as compared for instance to forests. Comparing past C3/C4 composition of the Mongolian steppe inferred from soil organic carbon vs. present-day composition inferred from sheep hair (i.e. diet), Wittmer *et al.* (2010) found that specific areas of this region have become more rich in C4 vegetation. They ruled out potential effects of grazing and precipitation on this response, and concluded that it



was triggered by increases in summer temperature that overrode the advantage given to C3 plants by elevated CO<sub>2</sub>. Such a response, they argue, agrees with predictions from models based on the *quantum yield hypothesis*.

### Manipulative experiments

Atmospheric  $p\text{CO}_2$  is predicted to increase continuously to reach ~ 600  $\mu\text{bar}$  at the end of the present century. Experiments carried out in controlled environments indicate that such elevated level of CO<sub>2</sub> would favour plant growth more in C3 than C4 species, although the magnitude of the response is less than that predicted from leaf photosynthesis, and it is heavily modulated by nitrogen and water availability (Poorter, 1993; Wand *et al.*, 1999). Analysis of C3/C4 competition in mixed stands (well watered and fertilized) supports the view that the C3 component will increase under elevated CO<sub>2</sub> (Poorter and Navas, 2003). For instance, exposing turves of a New Zealand C3/C4 community in a growth room to a  $p\text{CO}_2$  of 700  $\mu\text{bar}$  for almost a year promoted a large increase of a C3 legume at the expense of the contribution of the dominant C3 grass and of *Paspalum dilatatum*, the only C4 grass (Newton *et al.*, 1995). Water stress, however, reduced the magnitude of this response (Clark *et al.*, 1999).

A few natural C3/C4 communities have been exposed to elevated CO<sub>2</sub>, for a number of years, using either field chambers or free-air CO<sub>2</sub> enrichment (FACE) set ups. Some of these studies would support the *quantum yield hypothesis*, but others would not. Thus, the aforementioned decline in *P. dilatatum* in New Zealand was apparent (albeit less marked) in a FACE experiment set up on essentially the same community (Newton *et al.*, unpublished). Further, in the North American Great Plains, elevated CO<sub>2</sub> accelerated the replacement of *Bothriochloa ischaemum*, a short C4 grass by several tall C3 forbs after exclusion of grazing in a humid site (range 200 to 560  $\mu\text{bar}$ ; Polley *et al.*, 2003). Likewise, in a semiarid shortgrass steppe, it increased the contribution of *Stipa comata*, a C3 grass, and of a C3 shrub (720  $\mu\text{bar}$ ; Morgan *et al.*, 2004a; 2007). But, on the contrary, elevated CO<sub>2</sub> decreased the presence of *Poa pratensis*, a C3 grass, in a C4-dominated humid tallgrass prairie (Owensby *et al.*, 1993), and enhanced more C4 than C3 growth in an Australian FACE experiment (Hovenden *et al.*, unpublished).

The reason for such a diversity of responses is not clear. In some cases, the expected increase in C3 photosynthesis was only transient (e.g. von Caemmerer *et al.*, 2001; Morgan *et al.*, 2001), a phenomenon usually referred to as ‘acclimation’. Interestingly, most of these studies ascribed the observed responses to an elevated CO<sub>2</sub>-mediated enhancement of leaf water status rather than of photosynthesis itself. Indeed, a review of grasslands responses to elevated CO<sub>2</sub> concluded that *increasing atmospheric CO<sub>2</sub> induces water relations responses which in many situations dominate the system biomass and species responses to CO<sub>2</sub>, and could possibly be induced by moisture treatments alone* (Morgan *et al.*, 2004b).

That elevated CO<sub>2</sub> can improve soil water content has been demonstrated in several C3/C4 grasslands (Owensby *et al.*, 1997; Owensby *et al.*, 1999; Polley *et al.*, 2002; Lecain *et al.*, 2003). But why would improved water status benefit C3 species in some studies and C4 species in others? The results from this reduced set of studies suggest that, in humid environments, plant height can be important. In the tallgrass prairie, the C3 grass *P. pratensis* could not cope with increased canopy mass and height under elevated CO<sub>2</sub> in a grassland that was becoming less water-limited and in consequence more light-limited. In agreement, tall C3 forbs actually increased their contribution in this study (Owensby *et al.*, 1993). Paradoxically enough, in the short-C4 grass/tall-C3 forbs grassland, elevated CO<sub>2</sub> favoured C3 vegetation (Polley *et al.*, 2003). Naturally, this suggests that elevated CO<sub>2</sub> would strongly interact with grazing regime in these grasslands.

## Concluding remarks

The basic interaction in carbon gain between photosynthetic mode (C3 vs. C4) and  $p\text{CO}_2$  and temperature, as depicted in the *quantum yield hypothesis*, provides a baseline, a null hypothesis against which responses of the C3/C4 balance of grasslands can be contrasted. This hypothesis, which seems to adequately explain changes in the balance in C3 vs. C4 vegetation at geological time-scales, predicts that the C3/C4 balance should have moved during the last 50 years, and would continue to do so in the next 50 years, for grasslands in climates close to cross-over temperatures. More data recording the C3/C4 balance over the last 50 years of grassland ecosystems that experienced different (contrasting, if possible) changes in temperature and precipitation patterns should be useful to test these predictions.

The actual relevance of the mechanisms proposed by the *quantum yield hypothesis* is not universally accepted. Scepticism about the role of 'pure' photosynthetic responses in determining the C3/C4 balance is supported by recent results from elevated- $\text{CO}_2$  experiments carried out in natural grasslands. These suggest that improved water status, product of the reduced stomatal conductance observed in both C3 and C4 plants, and humid and semiarid ecosystems, plays a decisive role in determining the response of the C3/C4 balance to changes in  $p\text{CO}_2$  in the range 400 to 700  $\mu\text{bar}$ . This has two interesting consequences. First, if elevated  $\text{CO}_2$  does not generally promote C3 species, then it is likely that the C4 component of (some) C3/C4 grasslands will actually increase, driven by global warming. Second, it is not clear that the same relevance of water-mediated responses should not be apparent at lower  $p\text{CO}_2$ , say in the range 200 – 300  $\mu\text{bar}$ . If so, this would force a reinterpretation of the validity of the *quantum yield hypothesis* in explaining paleo-changes of the C3/C4 balance.

Finally, grazing is a factor that should be included in future studies (and interpretations) of climate change effects on the C3/C4 balance. It is a ubiquitous force that shapes grasslands through defoliation and nutrient cycling effects. For instance, in grasslands grazed at optimal or above-optimal stocking rates, and thus with a reduced scope for active selection by herbivores (Agnusdei and Mazzanti, 2001), any growth advantage given by  $p\text{CO}_2$ , temperature or water status to a particular functional group would be minimized by a correlative increased grazing pressure on it (Lemaire *et al.*, 2009). Up to now, only one experiment has explicitly analysed elevated  $\text{CO}_2$  effects on a grazed C3/C4 community (von Caemmerer *et al.*, 2001).

## References

- Agnusdei M.G. and Mazzanti A. (2001) Frequency of defoliation of native and naturalized species of the Flooding Pampas (Argentina). *Grass and Forage Science* 56, 344-351.
- Anten N.P.R. (2005) Optimal photosynthetic characteristics of individual plants in vegetation stands and implications for species coexistence. *Annals of Botany* 95, 495-506.
- Anten N.P.R. and Hirose T. (2003) Shoot structure, leaf physiology, and daily carbon gain of plant species in a tallgrass meadow. *Ecology* 84, 955-968.
- Beerling D.J. and Osborne C.P. (2006) The origin of the savanna biome. *Global Change Biology* 12, 2023-2031.
- Bolton J.K. and Brown R.H. (1980) Photosynthesis of grass species differing in carbon dioxide fixation pathways. 5. Response of *Panicum maximum*, *Panicum milioides* and tall fescue (*Festuca arundinacea*) to nitrogen nutrition. *Plant Physiology* 66, 97-100.
- Boom A., Marchant R., Hooghiemstra H. and Damste J.S.S. (2002)  $\text{CO}_2$ - and temperature controlled altitudinal shifts of C4- and C3-dominated grasslands allow reconstruction of palaeoatmospheric  $p\text{CO}_2$ . *Palaeogeography, Palaeoclimatology, Palaeoecology* 177, 151-168.
- Brooks A. and Farquhar G.D. (1985) Effect of temperature on the  $\text{CO}_2/\text{O}_2$  specificity of ribulose-1,5-bisphosphate carboxylase/oxygenase and the rate of respiration in the light. *Planta* 165, 397-406.
- Buchmann N., Brooks J.R., Rapp K.D. and Ehleringer J.R. (1996) Carbon isotope composition of C4 grasses is influenced by light and water supply. *Plant, Cell and Environment* 19, 392-402.
- Cabido M., Pons E., Cantero J.J., Lewis J.P. and Anton A. (2008) Photosynthetic pathway variation among C4 grasses along a precipitation gradient in Argentina. *Journal of Biogeography* 35, 131-140.
- Cerling T.E., Harris J.M., MacFadden B.J., Leakey M.G., Quade J., Eisenmann V. and Ehleringer J.R.

(1997) Global vegetation change through the Miocene/Pliocene boundary. *Nature* 389, 153-158.

Christie E.K. and Detling J.K. (1982) Analysis of interference between C<sub>3</sub> and C<sub>4</sub> grasses in relation to temperature and soil-nitrogen supply. *Ecology* 63, 1277-1284.

Clark H., Newton P.C.D. and Barker D.J. (1999) Physiological and morphological responses to elevated CO<sub>2</sub> and a soil moisture deficit of temperate pasture species growing in an established plant community. *Journal of Experimental Botany* 50, 233-242.

Collatz G.J., Berry J.A. and Clark J.S. (1998) Effects of climate and atmospheric CO<sub>2</sub> partial pressure on the global distribution of C<sub>4</sub> grasses: present, past and future. *Oecologia* 114, 441-454.

Dengler N.G., Dengler R.E., Donnelly P.M. and Hattersley P.W. (1994) Quantitative leaf anatomy of C<sub>3</sub> and C<sub>4</sub> grasses (*Poaceae*) - Bundle-sheath and mesophyll surface-area relationships. *Annals of Botany* 73, 241-255.

Edwards E.J. and Smith S.A. (2010) Phylogenetic analyses reveal the shady history of C-4 grasses. *Proceedings of the National Academy of Sciences of the United States of America* 107, 2532-2537.

Ehleringer J.R. (1978) Implications of quantum yield differences on the distributions of C<sub>3</sub> and C<sub>4</sub> grasses. *Oecologia* 31, 255-267.

Ehleringer J.R., Cerling T.E. and Helliker B.R. (1997) C<sub>4</sub> photosynthesis, atmospheric CO<sub>2</sub>, and climate. *Oecologia* 112, 285-299.

Ehleringer J.R. and Pearcy R.W. (1983) Variation in quantum yield for CO<sub>2</sub> uptake among C<sub>3</sub> and C<sub>4</sub> plants. *Plant Physiology* 73, 555-559.

Farquhar G.D. (1983) On the nature of carbon isotope discrimination in C<sub>4</sub> species. *Australian Journal of Plant Physiology* 10, 205-226.

Flores O., Gritti E.S. and Jolly D. (2009) Climate and CO<sub>2</sub> modulate the C-3/C-4 balance and delta C-13 signal in simulated vegetation. *Climate of the Past* 5, 431-440.

Furbank R.T., Jenkins C.L.D. and Hatch M.D. (1990) C<sub>4</sub> photosynthesis: quantum requirement, C<sub>4</sub> acid overcycling and Q-cycle involvement. *Australian Journal of Plant Physiology* 17, 1-7.

Ghannoum O. (2009) C-4 photosynthesis and water stress. *Annals of Botany* 103, 635-644.

Ghannoum O., Von Caemmerer S., Ziska L.H. and Conroy J.P. (2000) The growth response of C<sub>4</sub> plants to rising atmospheric CO<sub>2</sub> partial pressure: A reassessment. *Plant, Cell and Environment* 23, 931-942.

Greenwood D.J., Lemaire G., Gosse G., Cruz P., Draycott A., Neeteson J.J. (2009) Decline in percentage N of C<sub>3</sub> and C<sub>4</sub> crops with increasing plant mass. *Annals of Botany* 66, 425-436.

Hatch M.D. (1987) C<sub>4</sub> photosynthesis, a unique blend of modified biochemistry, anatomy and ultrastructure. *Biochimica et Biophysica Acta* 895, 81-106.

Kemp P.R. and Williams G.L. (1980) A physiological basis for niche separation between *Agropyron smithii* (C<sub>3</sub>) and *Bouteloua gracilis* (C<sub>4</sub>). *Ecology* 61, 846-858.

Ku M.S.B., Schmitt M.R. and Edwards G.E. (1979) Quantitative determination of RuBP carboxylase-oxygenase protein in leaves of several C<sub>3</sub> and C<sub>4</sub> plants. *Journal of Experimental Botany* 30, 89-98.

Kubásek J., Setlik J., Dwyer S. and Santrucek J. (2007) Light and growth temperature alter carbon isotope discrimination and estimated bundle sheath leakiness in C<sub>4</sub> grasses and dicots. *Photosynthesis Research* 91, 47-58.

Lecain D.R., Morgan J.A., Mosier A.R. and Nelson J.A. (2003) Soil and plant water relations determine photosynthetic responses of C-3 and C-4 grasses in a semi-arid ecosystem under elevated CO<sub>2</sub>. *Annals of Botany* 92, 41-52.

Lemaire G., Da Silva S.C., Agnusdei M, Wade M. and Hodgson J. (2009) Interactions between leaf lifespan and defoliation frequency in temperate and tropical pastures: a review. *Grass and Forage Science* 64, 341-353.

Lloyd J. and Farquhar G.D. (1994) d<sup>13</sup>C discrimination during CO<sub>2</sub> assimilation by the terrestrial biosphere. *Oecologia* 99, 201-215.

Long S.P. (1983) C<sub>4</sub> photosynthesis at low temperature. *Plant, Cell and Environment* 6, 345-363.

Long S.P. (1999) Environmental responses. In: Sage R.F. and Monson R.K. (eds.) *C<sub>4</sub> Plant Biology*. Academic Press, San Diego, USA, pp. 215-249.

Meinzer F.C. and Zhu J. (1998) Nitrogen stress reduces the efficiency of the C<sub>4</sub> CO<sub>2</sub> concentrating system, and therefore quantum yield, in *Saccharum* (sugarcane) species. *Journal of Experimental Botany* 49, 1227-1234.

Morgan J.A., LeCain D.R., Mosier A.R. and Milchunas D.G. (2001) Elevated CO<sub>2</sub> enhances water relations and productivity and affects gas exchange in C<sub>3</sub> and C<sub>4</sub> grasses of the Colorado shortgrass steppe. *Global Change Biology* 7, 451-466.

Morgan J.A., Milchunas D.G., LeCain D.R., West M. and Mosier A.R. (2007) Carbon dioxide enrichment alters plant community structure and accelerates shrub growth in the shortgrass steppe. *Proceedings of the National Academy of Sciences of the United States of America* 104, 14724-14729.

Morgan J.A., Mosier A.R., Milchunas D.G., LeCain D.R., Nelson J.A. and Parton W.J. (2004a) CO<sub>2</sub> enhances productivity, alters species composition, and reduces digestibility of shortgrass steppe vegetation. *Ecological Applications* 14, 208-219.

- Morgan J.A., Pataki D.E., Korner C., Clark H., Del Grosso S.J., Grunzweig J.M., Knapp A.K., Mosier A.R., Newton P.C.D., Niklaus P.A., Nippert J.B., Nowak R.S., Parton W.J., Polley H.W. and Shaw M.R. (2004b) Water relations in grassland and desert ecosystems exposed to elevated atmospheric CO<sub>2</sub>. *Oecologia* 140, 11-25.
- Newton P.C.D., Clark H., Bell C.C., Glasgow E.M., Tate K.R., Ross D.J., Yeates G.W. and Sagar S. (1995) Plant growth and soil processes in temperate grassland communities at elevated CO<sub>2</sub>. *Journal of Biogeography* 22, 235-240.
- Owensby C.E., Coyne P.I., Ham J.M., Auen L.M. and Knapp A.K. (1993) Biomass production in a tallgrass prairie ecosystem exposed to ambient and elevated CO<sub>2</sub>. *Ecological Applications* 3, 644-653.
- Owensby C.E., Ham J.M., Knapp A.K. and Auen L.M. (1999) Biomass production and species composition change in a tallgrass prairie ecosystem after long-term exposure to elevated atmospheric CO<sub>2</sub>. *Global Change Biology* 5, 497-506.
- Owensby C.E., Ham J.M., Knapp A.K., Bremer D. and Auen L.M. (1997) Water vapour fluxes and their impact under elevated CO<sub>2</sub> in a C4-tallgrass prairie. *Global Change Biology* 3, 189-195.
- Pagani M., Freeman K.H. and Arthur M.A. (1999) Late Miocene atmospheric CO<sub>2</sub> concentrations and the expansion of C4 grasses. *Science* 285, 876-879.
- Pagani M., Zachos J.C., Freeman K.H., Tipler B. and Bohaty S. (2005) Marked decline in atmospheric carbon dioxide concentrations during the Paleogene. *Science* 309, 600-603.
- Polley H.W., Johnson H.B. and Derner J.D. (2002) Soil- and plant-water dynamics in a C3/C4 grassland exposed to a subambient to superambient CO<sub>2</sub> gradient. *Global Change Biology* 8, 1118-1129.
- Polley H.W., Johnson H.B. and Derner J.D. (2003) Increasing CO<sub>2</sub> from subambient to superambient concentrations alters species composition and increases above-ground biomass in a C3/C4 grassland. *New Phytologist* 160, 319-327.
- Polley H.W., Mayeux H.S., Johnson H.B. and Tischler C.R. (1997) Viewpoint: Atmospheric CO<sub>2</sub>, soil water, and shrub/grass ratios on rangelands. *Journal of Range Management* 50, 278-284.
- Poorter H. (1993) Interspecific variation in the growth response of plants to an elevated ambient CO<sub>2</sub> concentration. *Plant Ecology* 104/105, 77-97.
- Poorter H. and Navas M.L. (2003) Plant growth and competition at elevated CO<sub>2</sub>: On winners, losers and functional groups. *New Phytologist* 157, 175-198.
- Randerson J.T., Collatz G.J., Fessenden J.E., Munoz A.D., Still C.J., *et al.* (2002) A possible global covariance between terrestrial gross primary production and <sup>13</sup>C discrimination: Consequences for the atmospheric <sup>13</sup>C budget and its response to ENSO. *Global Biogeochemical Cycles* 15, 83-1-83-16.
- Sage R.F. and Kubien D.S. (2007) The temperature response of C3 and C4 photosynthesis. *Plant, Cell and Environment* 30, 1086-1106.
- Sage R.F. and Pearcy R.W. (1987a) The nitrogen use efficiency of C3 and C4 plants. 1. Leaf nitrogen, growth, and biomass partitioning in *Chenopodium album* (L.) and *Amaranthus retroflexus* (L.). *Plant Physiology* 84, 954-958.
- Sage R.F. and Pearcy R.W. (1987b) The nitrogen use efficiency of C3 and C4 plants. 2. Leaf nitrogen effects on the gas exchange characteristics of *Chenopodium album* (L.) and *Amaranthus retroflexus* (L.). *Plant Physiology* 84, 959-963.
- Sage R.F., Pearcy R.W. and Seeman J.R. (1987) The nitrogen use efficiency of C3 and C4 plants. 3. Leaf nitrogen effects on the activity of carboxylating enzymes in *Chenopodium album* (L.) and *Amaranthus retroflexus* (L.). *Plant Physiology* 85, 355-359.
- Sage R.F., Wedin D.A. and Li M. (1999) The biogeography of C4 photosynthesis: patterns and controlling factors. In: *C4 Plant Biology* (eds R.F.Sage and R.K.Monson), pp. 313-373. Academic Press, San Diego, USA.
- Scheiter S. and Higgins S.I. (2009) Impacts of climate change on the vegetation of Africa: an adaptive dynamic vegetation modelling approach. *Global Change Biology* 15, 2224-2246.
- Schmitt M.R. and Edwards G.E. (1981) Photosynthetic capacity and nitrogen use efficiency of maize, wheat and rice: a comparison between C<sub>3</sub> and C<sub>4</sub> photosynthesis. *Journal of Experimental Botany* 32, 459-466.
- Still C.J., Berry J.A., Collatz G.J. and DeFries R.S. (2003) Global distribution of C<sub>3</sub> and C<sub>4</sub> vegetation: carbon cycle implications. *Global Biogeochemical Cycles* 17, (1) article no 1006.
- Taylor S.H., Hulme S.P., Rees M.E., Ripley B.S., Woodward F. I. and Osborne C.P. (2009) Ecophysiological traits in C3 and C4 grasses: a phylogenetically controlled screening experiment. *New Phytologist* 185, 780-791.
- Turner C.L. and Knapp A.K. (1996) Responses of a C4 grass and three C3 forbs to variation in nitrogen and light in tallgrass prairie. *Ecology* 77, 1738-1749.
- von Caemmerer S. and Furbank R.T. (2003) The C4 pathway: an efficient CO<sub>2</sub> pump. *Photosynthesis Research* 77, 191-207.
- von Caemmerer S., Ghannoum O., Conroy J.P., Clark H. and Newton P.C.D. (2001) Photosynthetic responses of temperate species to free air CO<sub>2</sub> enrichment (FACE) in a grazed New Zealand pasture. *Australian Journal of Plant Physiology* 28, 439-450.

- Ward S.J.E., Midgley G.F., Jones M.H. and Curtis P.S. (1999) Responses of wild C3 and C4 grasses (Poaceae) to elevated atmospheric CO<sub>2</sub> concentration: a meta-analytic test of current theories and perceptions. *Climate Change Biology* 5, 723-741.
- Wedin D.A. and Tilman D. (1996) Influence of nitrogen loading and species composition on the carbon balance of grasslands. *Science* 274, 1720-1723.
- Werger M.J.A., Hirose T., Doring H.J., Heil G.W., Hikosaka K., Ito T., Nachinshonhor U.G., Nagamatsu D., Shibasaki K., Takatsuki S., van Rheenen J.W. and Anten N.P.R. (2002) Light partitioning among species and species replacement in early successional grasslands. *Journal of Vegetation Science* 13, 615-626.
- Winslow J.C., Hunt E.R. and Piper S.C. (2003) The influence of seasonal water availability on global C3 versus C4 grassland biomass and its implications for climate change research. *Ecological Modelling* 163, 153-173.
- Wittmer M.H.O.M., Auerswald K., Bai Y.F., Schauffele R. and Schnyder H. (2010) Changes in the abundance of C3/C4 species of Inner Mongolia grassland: evidence from isotopic composition of soil and vegetation. *Global Change Biology* 16, 605-616.

# Impact of economic and political drivers on grassland use in the EU

Osterburg B., Isermeyer F., Lassen B. and Röder N.

*Johann Heinrich von Thünen-Institute, Bundesallee 50, D-38116 Braunschweig, Germany*

Corresponding author: [bernhard.osterburg@vti.bund.de](mailto:bernhard.osterburg@vti.bund.de)

## Abstract

The paper provides an insight into structures and recent trends of grazing livestock production (cattle, sheep, goats and equines) and their relation to forage area. Dairy production and grassland use are the focus of the study. The differing land use and farming conditions throughout the EU are briefly addressed as well as farm structural change. The dairy, beef and sheep sectors are highly dependent on policy interventions implemented as part of the EU Common Agricultural Policy (CAP). These policies have been subject to fundamental reforms during the last years. Expected short-term impacts of these agricultural policy changes on livestock production and land use are discussed and, as far as is possible, compared to recent empirical data. The influence of environmental policies is considered. Building on this analysis, the future prospects of grazing livestock and grassland use in the EU are examined and, finally, challenges for research are discussed.

Key words: Grassland use, farm structures, CAP reform, milk quota.

## 1. Introduction

Grassland and forage crops on arable land account for a large proportion of the utilized agricultural area (UAA) of the EU. In 2007, about 33 % of total UAA in the EU-27 were used as permanent grassland, and 11 % of UAA were cultivated with forage crops such as temporary grass and green maize (see Table 1). Grassland serves as forage area for cattle, sheep, goats and equines; therefore, we subsume these livestock categories as ‘grazing livestock’ in this paper. Beef and dairy production contribute significantly to EU agricultural income. According to the Economic Accounts for Agriculture of the EU-27 in the year 2007, beef and veal, sheep and goat meat amounted to 11 % and milk to 14 % of the total agricultural production value (values at factor prices, this means that taxes and subsidies related to production are not considered). Farms specialised in dairy, cattle-rearing and fattening, sheep, goats and other grazing livestock employed about 21 % of total EU-27 agricultural labour force in 2007 (Eurostat, 2010, in annual working units).

Beyond its contribution to meat and milk production, permanent grassland provides a number of environmental and social benefits. Compared to arable land, grassland is associated with a better conservation of soil against erosion, a reduced runoff and leaching of nutrients into surface and ground water (Briemle and Elsässer, 1997), and contributes to flood control. In the debate on climate change caused by anthropogenic greenhouse gas emissions, grassland is classified as an important carbon sink, due to higher organic matter contents compared to arable land use (IPCC, 2000). Further, grassland constitutes a characteristic element of European cultural landscapes, and the maintenance of semi-natural grassland habitats through traditional agricultural use is vital for the protection of biodiversity (Briemle *et al.*, 1999; Zdanowicz *et al.*, 2005). Within the Natura 2000 network established according to the Birds and Habitats Directives (79/409/EEC, 92/43/EEC), grassland constitutes the dominant type of agricultural land use. More than 18 % of EU’s total grassland is located within designated Natura 2000 sites (Cooper *et al.*,



2009). Several types of semi-natural grassland habitats, which are of community interest according to Habitats Directive Annex I, are threatened either by agricultural intensification or farmland abandonment (Ostermann, 1998). Most of the beneficial environmental impacts of grassland are highly site- and management-specific. Also, long-term continuity of grassland use is of importance, especially regarding objectives related to biodiversity and storage of soil carbon. Temporary grassland contributes to environmental objectives such as soil and water protection, but regular ploughing and conversion to arable crops might be critical due to potential discharge of carbon and nitrogen, and is detrimental for biodiversity objectives.

Dairy, beef and sheep production as the main sectors sustaining Europe's grassland are associated with negative environmental impacts, such as water pollution due to nitrogen leaching, air pollution through ammonia emissions, soil degradation, e.g. due to overgrazing or maize cultivation, and on landscape and biodiversity, e.g. due to high intensity of grazing or mowing regimes (CEAS *et al.*, 2000; IEEP, 2007). Grazing livestock is causing a considerable share of agricultural greenhouse gas emissions, with methane emissions from enteric fermentation of cattle, sheep and goats accounting for about 30 % of direct emissions from agriculture in 2007. This is equivalent to 3 % of the EU-27's total greenhouse gas emissions (EEA, 2009). Additional greenhouse gas emissions related to cattle and sheep occur from manure management, nitrogen fertilisation of fodder crops, and agricultural land use of organic soils such as bogs and fens.

Statistics on grassland and other forage areas should be interpreted with caution, as not all types of grazed areas are reported and some areas reported as forage crops are not used by grazing livestock. EU statistics distinguish permanent grassland, rough grazing, temporary grassland and various arable forage crops (e.g. green maize). In EU statistical surveys, permanent grassland is defined as not being part of crop rotations for more than five consecutive years. It is used to grow herbaceous forage crops, either sown or natural (self-seeded), as pasture for grazing or for mowing in order to provide fresh forage for livestock kept indoors, or to produce hay or silage. Also, areas for rough grazing, e.g. semi-natural, low-yielding pastures, are permanent grassland. In contrast to permanent grassland, temporary grassland is part of arable crop rotations and thus it is seeded and regularly ploughed a few years later in order to establish other arable crops.

In statistical surveys, a proportion of permanent grassland might not be recorded, e.g. because parts of grassland are common land which does not directly belong to a particular farm, some areas are not continuously farmed but are used only in years of forage shortage, or areas used for pasture may serve mainly for other purposes (airports, military training areas, dikes). For instance, in France common lands and grasslands not managed by farmers were estimated at 1.5 million ha (Pointereau *et al.*, 2008), an area equivalent to almost 20 % of the permanent grassland reported in the Farm Structural Survey 2007. Other semi-natural vegetation types serving for rough grazing, such as heather, are not accounted for as grassland (Röder *et al.*, 2007). In recent years, production of energy crops has emerged as a new agricultural activity, e.g. in Germany (Taube *et al.*, 2007). Green maize and grassland for biogas production are still not reflected in official statistics, but influence the trends of the forage area reported. Further, statistical time series on grassland throughout the EU are incomplete and suffer from changing survey methods, e.g. regarding the minimum farm size included in the statistics.

In the following section, we analyse the utilisation of grassland in the EU and, in particular, its connection to dairy production. Subsequently, we focus on the implications of the EU's Common Agricultural Policy in the recent past. The paper closes with a brief

outlook on the future use of grassland in the EU and highlights some challenges for future research.

## 2. Spatial distribution, state and trends of grassland use

The statistical basis for the following analysis comprises EUROSTAT data, provided through the internet database (Eurostat, 2010), as well as a more disaggregated data set based on the 2007 Farm Structural Survey for the CAPRI model system (Common Agricultural Policy Regional Impact, see <http://www.capri-model.org/>). Cropper and Del Pozo-Ramos (2006) describe the long-term developments of livestock numbers in the EU. Declining dairy cow numbers have been the dominant trend since introduction of milk quota in 1984, which is often associated with losses of grassland area (Pointereau *et al.*, 2008). In middle and eastern Europe, grazing livestock herds diminished sharply in the 1990s during transition towards market economies (Röder *et al.*, 2007).

Table 1: Distribution of grassland and forage crops by EU Member States, and intensity indicators in 2007. Source: Eurostat 2010 (Farm Structural Survey 2007), Lutter (2009), own calculations.

EU member state	Code	perm. grassland Share of UAA (%)	forage crops (%)	forage area share of EU-27 total (%)	grazing livestock per forage area LU ha <sup>-1</sup>	cow milk production kg ha <sup>-1</sup>
<b>EU-15</b>						
Austria	AT	54	8	2.6	0.77	1568
Belgium	BE	37	18	1.0	2.63	3911
Germany	DE	29	12	9.2	1.41	4087
Denmark	DK	8	18	0.9	1.75	6751
Spain	ES	35	3	12.4	0.71	698
Finland	FI	2	29	0.9	0.97	3172
France	FR	29	17	16.8	1.26	1918
Greece	GR	20	6	1.4	1.79	744
Ireland	IE	76	17	5.1	1.43	1344
Italy	IT	27	14	6.9	1.06	2161
Luxemburg	LU	52	18	0.1	1.61	2834
The Netherlands	NL	43	22	1.6	2.25	9301
Portugal	PT	51	10	2.8	0.61	747
Sweden	SE	16	36	2.1	0.77	1885
United Kingdom	UK	62	8	15.1	0.91	1228
<b>EU-12</b>						
Cyprus	CY	1	29	0.1	2.04	3175
Czech Republic	CZ	26	12	1.7	0.82	2138
Estonia	EE	30	24	0.7	0.42	1356
Hungary	HU	12	6	1.0	0.95	2390
Lithuania	LT	31	15	1.6	0.55	1645
Latvia	LV	36	22	1.4	0.31	829
Malta	MT	0	45	0.0	3.50	8655
Poland	PL	21	5	5.4	1.17	3004
Slovenia	SI	59	11	0.4	1.07	1561
Slovakia	SK	28	13	1.1	0.51	1225
Bulgaria	BG	9	3	0.5	2.11	3359
Romania	RO	33	6	7.0	0.75	992
<b>EU-15</b>		36	12	79	1.11	2005
<b>EU-12</b>		25	8	21	0.85	1780
<b>EU-27</b>		33	11	100	1.06	1958



The EU-27 dairy herd was decreasing between 2003 and 2007 at a rate of -1.6 % per year, due to increasing milk yield per cow and the administrative limitations on milk production (Cropper and Del Pozo-Ramos, 2006). Although most EU Member States have decoupled direct payments for suckler cows from production (Röder *et al.*, 2007), which were formerly paid per head, the herd size of other cows even slightly increased between 2003 and 2007 in the EU-27, and the effect was more pronounced in several EU-12 Member States.

The relative distribution of total forage area in the EU (Table 1) indicates that about 80 % of this area can be found in Germany, Spain, France, Ireland, Italy, United Kingdom, Poland and Romania. Between Member States, average stocking density of grazing livestock and milk production intensity differ within a wide range. The highest intensity is found in The Netherlands, Belgium and Denmark, whereas Austria, Spain, Portugal, United Kingdom and most of the EU-12 Member States are located at the opposite end of the gradient.

More than 80 % of the grazing livestock units in the EU-27 are cattle (Fig. 1), with dairy cows accounting for 30 % and ‘other cows’ (mainly suckler cows) for another 15 %. Suckler cows are of special importance in some EU-15 Member States, e.g. Spain, France, Ireland and United Kingdom, and also in the Czech Republic, while in most of the other EU-12 Member States, ‘other cows’ are of minor relevance. Sheep and goats represent about 12 % of the grazing livestock herd in EU-27, with shares above average in Mediterranean countries, United Kingdom and Romania. Equines contribute to less than 5 %, but are still more frequent in some EU-12 Member States.

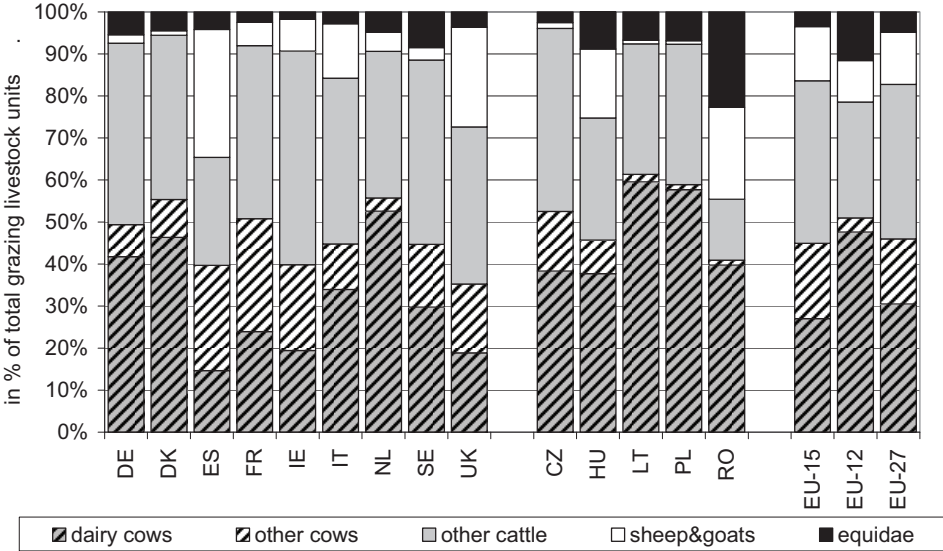

Figure 1: Composition of the grazing livestock herds in EU Member States. Source: Eurostat 2010 (Farm Structural Survey 2007), own calculations. Abbreviations see Table 1.

Fig. 2 depicts the average herd size of dairy and of other cows per farm, in combination with relative development of farms keeping dairy or other cows, respectively. Between 2003 and 2007, for the EU-27, on average each year about 6 % of dairy farms ceased milk production. This is a highly accelerated structural change, compared to the sectoral average of about 2.3 % of farms leaving the EU agricultural sector. Denmark, United

Kingdom and Czech Republic have the largest average dairy herds per holding. In spite of favourable structural conditions, we observe even in Denmark and Czech Republic a pronounced farm structural change. In these countries about 9 % of dairy farms ceased milk production per year between 2003 and 2007. In most other Member States, dairy farms terminated business at an elevated rate compared to the respective sectoral average. In most of the Member States, farms keeping other cows have markedly smaller herd sizes per farm compared to dairy herds. The number of farms keeping other cows is more stable compared to dairy farms. This number is even increasing in the EU-12, especially in countries with the smallest farm structures. This leads to the conclusion that there is a broad, ongoing structural change of the dairy sector, with many smaller dairy farms changing to beef production based on suckler cows while ceasing milk production. In some EU-12 Member States, the category ‘other cows’ possibly still includes some subsistence production of milk. Through this process, forage area is kept under management, although in small farm structures.

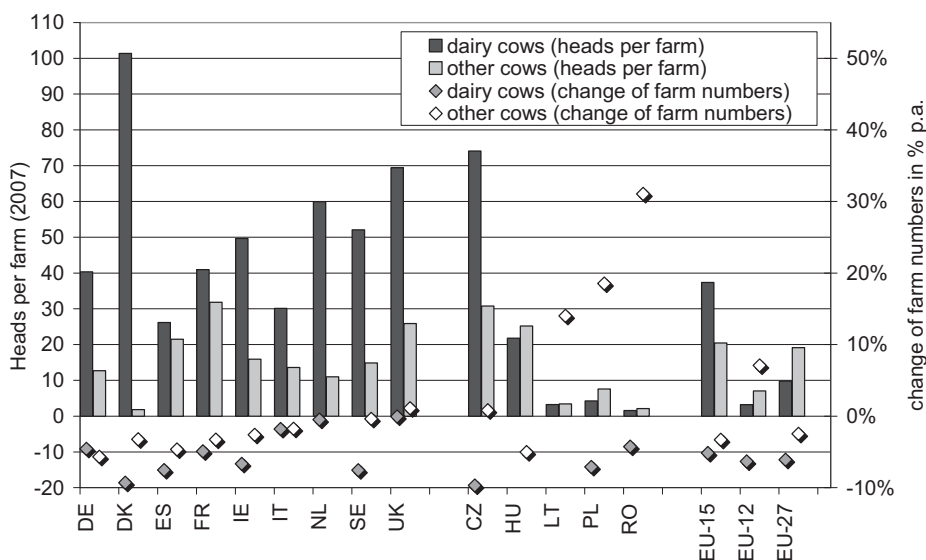

Figure 2: Average heads of dairy and other cows per farm in 2007, and change of farm numbers keeping dairy or other cows between 2003 and 2007. Source: Eurostat 2010 (Farm Structural Survey 2003, 2007), own calculations. Abbreviations see Table 1.

In the following, structures of specialised dairy farms and their relative importance for grassland use are investigated. Specialisation of farms according to the Community typology is measured in economic terms on the basis of the contribution of different production lines to the total potential gross value added (standard gross margin). In Fig. 3, specialised dairy farms (farm type FT41) are compared to the rest of farms keeping grazing livestock. Dairy farms are characterised by higher stocking densities per hectare forage area. On EU average, the difference is almost one livestock unit per hectare.

In several Member States, the structure of the forage area in dairy farms differs from other farms, notably in Denmark, Spain, France and United Kingdom. In these countries, specialised dairy farms cultivate more green maize and temporary grass and use less permanent pasture or meadows and rough grazing. In Fig. 4, the proportion of dairy cows kept in specialised dairy farms is presented as well as the relevance of these farms for use

of permanent grassland. In the EU-15, specialised dairy farms keep almost 80 % of all dairy cows, but utilize less than 20 % of the total permanent grassland. Only in Germany and The Netherlands, specialised dairy farms have a higher importance for grassland use. In some German regions more specialised in dairy production, such as Lower Saxony and Bavaria, the share of grassland in specialised dairy farms accounts for 50 % to 60 % of the total. Compared to the EU-15 in the EU-12, specialised dairy farms keep a smaller proportion of the dairy herd, as there exist more mixed farming systems.

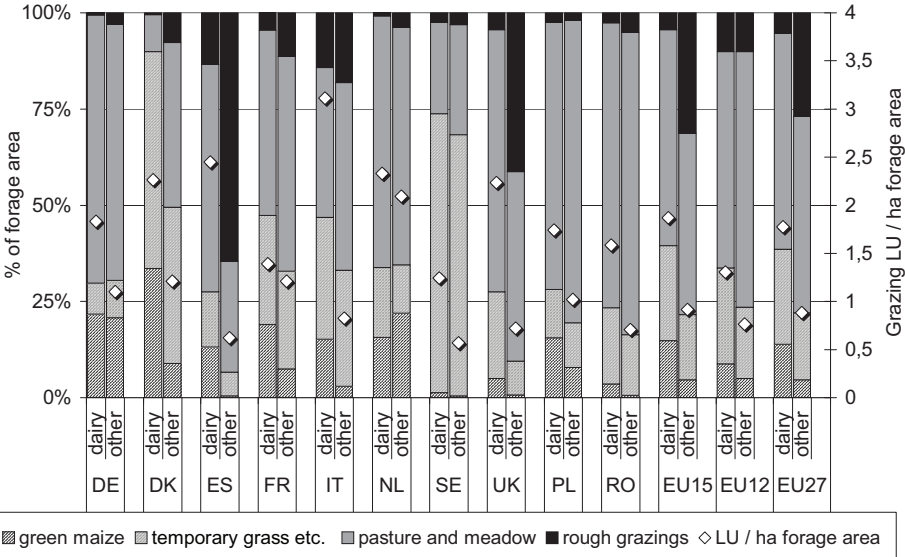

Figure 3: Composition of the forage area and stocking densities of grazing livestock in specialised dairy farms and all other farms in 2007. Source: Eurostat 2009 (Farm Structural Survey 2007, disaggregated data set for the CAPRI model system), own calculations. Abbreviations see Table 1.

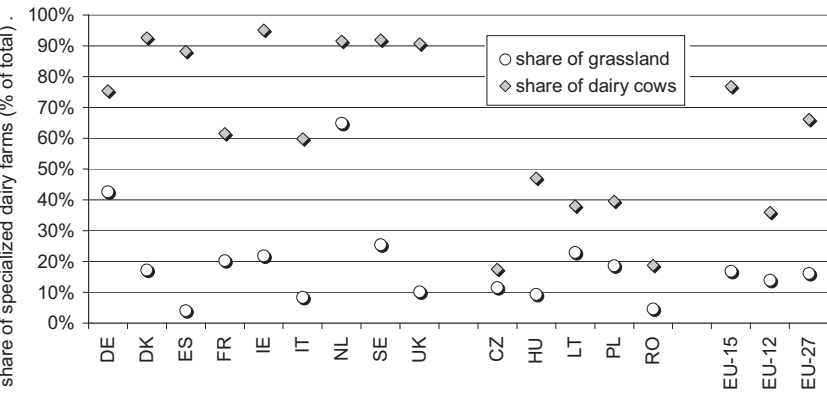

Figure 4: Dairy cows and permanent grassland in specialised dairy farms as a percentage of the sectoral total. Source: Eurostat 2009 (Farm Structural Survey 2007, disaggregated data set for the CAPRI model system), own calculations. Abbreviations see Table 1.

At the EU-27 level, about 66 % of total dairy cows, and about 33 % of total grazing livestock units, are kept in specialised dairy farms which manage about 16 % of EU's permanent grassland. The relatively low proportion of grassland in specialised dairy farms is explained through the high livestock densities on these farms, which are concentrated in the more productive grassland areas. Also, permanent grassland is less relevant because of the higher importance of green maize and temporary grassland as forage crops.

According to Alliance Environnement (2008), in larger dairy farms production intensity is higher in terms of livestock stocking density, milk production per cow and of mineral fertiliser purchase. Higher stocking densities and higher shares of green maize could also be found in larger farms of the Farm Structural Survey data set for Germany in 2007, when comparing dairy farms of different sizes at the regional level. Between 1999 and 2007, the average stocking density in German dairy farms remained stable. However, if the increasing milk yield per cow is considered, the nutrient turnover per hectare increases. During the same period of time, in all other farms in Germany average grazing livestock density per hectare of forage area decreased by about 20 %. This indicates a trend towards more pronounced structural differences between livestock farms.

National statistics do not reflect regional differences and spatial allocation of land use and livestock. As an example, Fig. 5 depicts the distribution of grassland in Germany, and the allocation of milk quota per hectare UAA at the level of municipalities (see also Lassen *et al.*, 2008 and 2009). Obviously, dairy production is concentrated in regions with high grassland shares, e. g. in lowlands and marshes of north-western Germany, low mountain ranges in the western and central regions, and in the pre-alps and low mountain ranges in the south of Germany. In eastern Germany, apart from mountain ranges in the south, there is less regional concentration of grassland and dairy production. In some grassland areas, e. g. the Black Forest in the south-west, and low mountain ranges of Thuringia in the centre of Germany, the incidence of dairy production is rather low. These are regions with structural difficulties or low grassland productivity, where grassland is mainly managed through suckler cows at low stocking densities.

Between 1975 and 2001, permanent grassland decreased by about 17 % in the EU-15; this is a rate of -0.7 % per year (Gobin *et al.*, 2006). Apart from the loss of agricultural land due to urbanisation, both conversion into arable land and afforestation or abandonment of farming contributed to this development (EEA, 2005).

In recent years, the trend of grassland losses has been halted or even reversed in several European regions. An analysis of grassland areas at national level between 2003 and 2007 shows that in Belgium and Germany the area of permanent grassland declined, while the area of arable land increased, indicating a conversion of grassland. However, net changes at the EU level were negligible in this period of time.

In Germany, the grassland area decreased at an annual rate of -0.8 % between 1990 and 2006, while arable land decreased at a rate of -0.05 % per year. Obviously, the overall loss of UAA due to urbanisation occurred mainly at the expense of grassland, due to parallel conversions of grassland into arable land. However, these net figures at national level mask the fact that there have been regions with increasing grassland area, especially in hilly and mountainous areas of western Germany (Gay *et al.*, 2004). In eastern Germany, the area of permanent grassland dropped after German unification by more than 20 % between 1990 and 1992, and increased again during the process of restructuring. This is an example for grassland areas remaining for a time outside the farm sector and agricultural statistics. Later, such 'land reserves' can be included into the farms again. Such aspects complicate the interpretation of net statistics of land use and call for more detailed analysis of net flows and gross changes (Gobin *et al.*, 2006, Pointereau *et al.*, 2008).

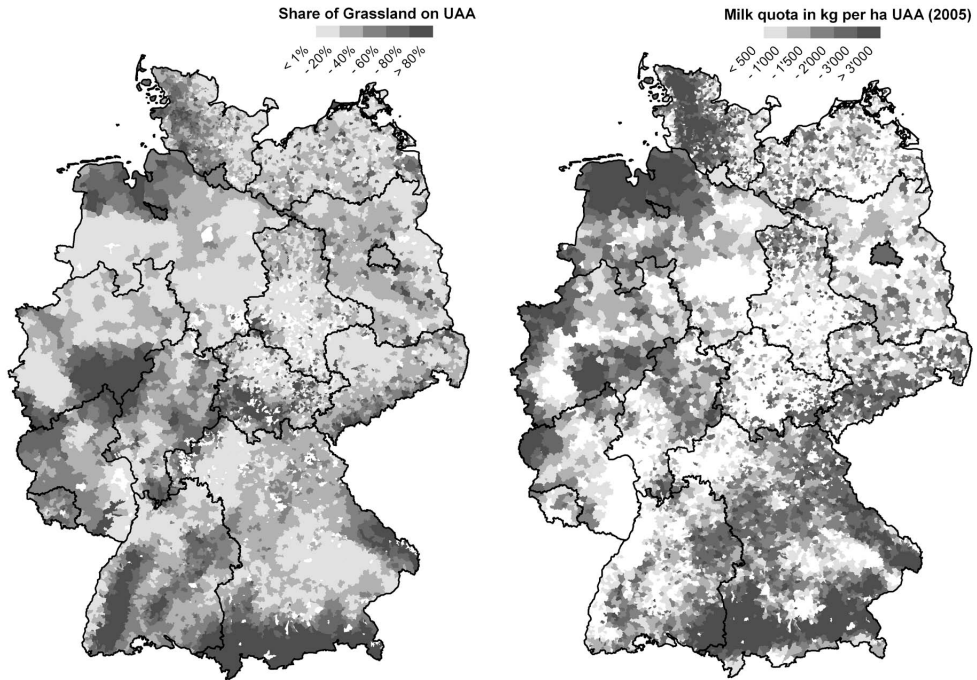

Figure 5: Distribution of permanent grassland in 2007, and milk quota per hectare UAA in 2005. Source: Forschungsdatenzentrum der Statistischen Ämter des Bundes und der Länder, Farm Structural Survey, 2007, data analysis based on Salhofer *et al.*, 2010, own calculations.

With regard to farmland abandonment, Pointereau *et al.* (2008) show that the risk of abandonment is higher on marginal grasslands, e.g. on slopes, poor or wet soils. Farmland abandonment is also influenced through small parcel sizes and poor transport infrastructure, and farm structural change with a decrease of mixed traditional farms. Based on Corine Land Cover data for 1990 and 2000, Osterburg *et al.* (2008) found general trends throughout the EU of arable land expansion in lowlands at the expense of pasture, and pasture expansion as well as set-aside on slightly sloped land and at higher altitudes. Due to afforestation and transitional woodland creation, forest area increased on marginal, less productive land at altitudes and on more inclined terrain, mainly used as pasture beforehand. Over longer periods, farmland abandonment can reach relevant shares of UAA. Pointereau *et al.* (2008) identified 3.3 million hectares of abandoned areas in three EU Member States, equivalent to 2% of the total French UAA (1988-2000), 4% in Poland (1996-2002) and 8% in Spain (1989-1999).

### 3. Influence of policy measures and market forces on the grassland use

Farm structures, production activities and agricultural land use are subject to market and policy influences, of which the CAP plays a central role. For the use of grassland, several CAP instruments are relevant, namely the direct payments, milk quota, rural development measures of the so called Pillar 2, such as investment aid, agri-environmental measures (AEM) and Less Favoured Area (LFA) allowances. Further, the CAP has established rules for

the maintenance of permanent grassland through eligibility rules and minimum requirements as precondition for the receipt of direct payments.

First, we will look at direct payments and milk quota. The recent CAP reform (Mid Term Review reform, based of the Luxembourg decisions of 2003 and Regulation 1782/2003) has initiated a fundamental change of agricultural policies (see also Osterburg and von Horn, 2006; Röder *et al.*, 2007), comprising the introduction of a largely area-based ‘single farm payment’ (SFP) for EU farmers, decoupled from production, and cross compliance (CC). This means the linkage of direct payments to compliance with environmental, food safety, animal and plant health and animal welfare standards (‘statutory management requirements’, SMR), as well as the requirement to keep all farmland in ‘good agricultural and environmental condition’ (GAEC). Further elements were reduced intervention prices for milk products, with a partial compensation through decoupled payments, and options to maintain a proportion of direct payments coupled at Member State level, especially for arable crops, cattle and sheep. Member States were allowed to choose a historic SFP model, with individual payment entitlements based on historic farm production activities in 2000-2002, or regional flat rate payments. Several Member States decided to introduce hybrid systems, with elements of both payment models, and dynamic elements, i.e. a transition towards regionally harmonised payment levels. In the EU-12 Member States a fully decoupled single area payment was introduced, and only Malta and Slovenia opted for the SFP model. Especially in the EU-12, payment entitlements may not cover the total of the potentially eligible land. This implies that there is scope for farmland abandonment, or land abandoned during the transition period may not be activated (Osterburg *et al.*, 2008). Historic SFP models allocate a larger part of direct payments towards more intensive farms. Due to the newly introduced, decoupled milk premia, specialised dairy farms benefit from this distribution through payment levels above average. On the other hand, regional flat rate models tend to relocate payment to the advantage of more extensive farms, e.g. livestock farms with low stocking densities, and give incentives to declare agricultural land which has not been included in the support system previously. In all schemes, a payment entitlement can be ‘activated’ with one hectare of arable or grassland managed subject to cross compliance minimum standards, regardless whether this land is used for production or not.

Several Member States retained coupled payments, e.g. for suckler cows, sheep and goats. Calculated on the basis of animal numbers in the year 2003, a significant share of the EU-15 livestock herd benefits from coupled payments (Röder *et al.*, 2007), e.g. about 60 % of the suckler cow herd of EU-15 (Osterburg *et al.*, 2008). However, according to the last changes of the CAP (‘Health Check’, Regulation 73/2009) special beef and slaughter payments shall be fully decoupled until 2011, while coupled payments for suckler cows, sheep and goats may be retained. This exemption takes into account the potential problems of decoupling: decreasing grazing livestock herds and resulting changes of land management. However, up to now even in Members States with fully decoupled payments, such as Germany, the suckler cow herds remained stable, while sheep numbers have declined by a few percent.

The milk quota introduced in 1984 has limited the expansion of dairy production in the EU and, depending on the national and regional rules for quota transfers, the quota regime has contributed in some Member States, such as France and Italy, to maintain dairy production in less favoured areas (Alliance Environnement, 2008). In Germany, quota transfers were restricted to 27 trading regions, thus ‘ring-fencing’ regional dairy production. By summer 2007, trading regions have been merged into a western and an eastern German region. Quota transfers in 2008 within the western region show a clear concentration of dairy production in regions with a high share of grassland. Increase of quota due to transfers in 2008 only reached



about 2 % of the 2006 level in the *Laender* Lower Saxony and Schleswig-Holstein (Lassen *et al.*, 2009).

The Health Check reform determined the expiry of the milk quota by 31 March 2015, with a ‘soft landing’ through a stepwise increase of the quota by 1% per year between 2009 and 2013. Due to the worldwide economic crisis starting in late 2008, farm commodity prices dropped sharply. Especially the dairy sector was affected. The production value for milk of EU-27 decreased by more than 20 % in 2009 compared to 2008, or by 10 % compared to 2005 (EUROSTAT, data of the economic accounts for agriculture), calling the concept of ‘soft landing’ into question. For comparison, production values for beef decreased only by about 5 % from 2008 to 2009. In Germany, as also in other Member States, flanking measures such as additional investment aid and animal welfare measures for dairy cows are planned as a response to the increased pressure on the dairy market. Also, marketing strategies for premium products, e.g. according to rules for protected denomination of origin (PDO), Protected Geographical Identification (PGI), or organic farming, are of increasing importance for sustaining dairy and cattle farms in less productive areas (Cropper and Del Pozo-Ramos, 2006).

In Fig. 6, support levels per hectare UAA are presented for German farms in 2006. Decoupled direct payments have been still partly dependent on the historical model and thus were much higher in more intensive dairy and cattle farms. Harmonisation of direct payments started in 2009 and will converge at the average level depicted at the left side of the figure by 2013. We stratify farms into a low (ext), medium (med) and high (int) intensity level. Low-intensity farms represent “high nature value” (HNV) farms (see Osterburg *et al.*, 2008, for more details). These farms are most dependent on additional Pillar 2 support. While investment aid supports individual, expanding farms, AEM and LFA payments can reach significantly higher support levels especially in low-input regions and farm groups. Fig. 6 illustrates the high dependency of the income (profit) plus wages for external labour of dairy and cattle farm on transfer payments.

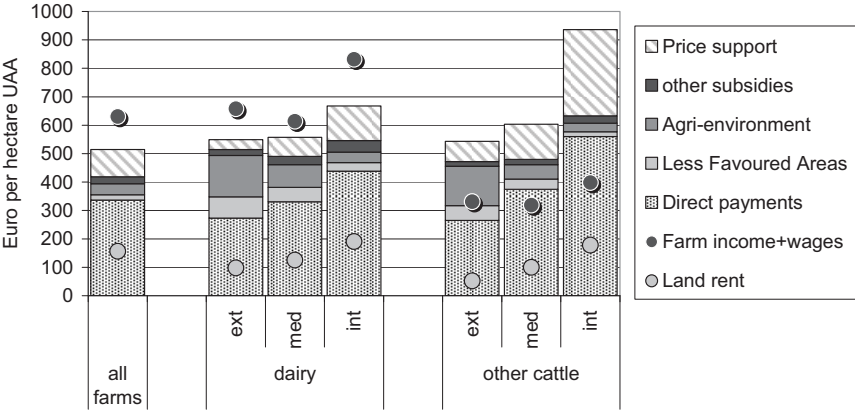

Figure 6: Support payments in German dairy and cattle farms in 2006. Source: German FADN (Farm Accountancy Data Network), price support for beef according to OECD (2009), own calculations.

In the following we describe requirements attached to EU support policies influencing the maintenance of grassland. The EU Member States have determined cross compliance conditions for keeping eligible land free of shrubs and other invasive plants. The cost incurred for minimum land maintenance according to GAEC standards can be understood

as the 're-coupled part' of the decoupled, area related payments. On plane land maintenance costs e.g. through mulching are comparatively low, while for pastures in mountainous areas there might be no alternative for extensive grazing in order to keep the land open. Thus, in such areas a higher effect of 're-coupling' to livestock production occurs. In addition, several Member States (e.g. Austria, France, Ireland, Lithuania, Poland, Spain, Sweden) have defined additional requirements in order to keep grassland in productive use, such as minimum stocking levels of grazing livestock, or the removal of forage after cutting. These rules intend to ascertain a minimum livestock density and avoid farmland abandonment.

Prior to 2005, permanent grassland converted into arable land after 1992 was not eligible for arable crop payments. This rule intended to avoid an expansion of arable production and certainly has decelerated conversions into arable land. However, ploughing of grassland was allowed to compensate for losses of arable land due to urbanisation (Gay *et al.*, 2004). In 2005, this area-specific disincentive for conversion of grassland was removed, as the SFP entitlements can be activated on any eligible land. In order to restrict larger conversions of grassland, Regulation 1782/2003, Article 5 (2), required the EU Member States to prevent a significant decrease of the share of 'permanent pasture' as percentage of agricultural land, compared to the 2003 level. The new Regulation 73/2009 contains equivalent requirements. Permanent pasture is used synonymously with permanent grassland. Most Member States require an authorisation even before the maximum reduction of the grassland ratio (10%) is reached (Alliance Environnement, 2007). In Portugal, authorisation is needed for all grassland conversions. Italy and Spain implemented a general prohibition of conversion of permanent pasture, mainly for reasons of erosion control, and in Belgium (Flanders), Greece and Poland grassland area has to be maintained at the farm level. In Austria, conversion on steep hills and along water courses is banned, and in UK the conversion of semi-natural grassland. In other Member States, the ratio of permanent grassland may decrease by up to 10 % between 2005 and 2013; this is a rate of -1.3 %, exceeding historic average loss rate. Obviously, restrictions on grassland conversion can be seen as another form of 're-coupling' of direct payments, as grazing livestock systems are benefiting from these rules.

The grassland ratio is calculated at regional or national level. Within larger, non-homogeneous regions, significant land use changes may occur without meeting the Cross Compliance threshold level for the grassland ratio, as marginal arable land might be converted into grassland. This allows for more area being converted into arable use on sites more suitable for cropping. Through an analysis based on spatially disaggregated parcel data of the Integrated Administration and Control System (IACS) of four German *Laender*, flows of land use change were traced back in order to identify grassland losses between 2005 and 2007 (Osterburg *et al.*, 2009). Losses of grassland through conversion into arable land occurred at a rate of -1.3 % per year, in parallel to conversions of arable land into grassland at a rate of +0.5 %. In three German *Laender*, the grassland ratio had dropped by more than 5 % until 2009. Obviously, the cross compliance rules have been an incentive for a rapid conversion of grassland before restrictions at the farm level are implemented. Also, the rules allow for further spatial segregation of grassland use, as long as there are no site-specific restrictions.

Environmental mandatory standards according to regional, national and EU legislation restrict the conversion of grassland in designated areas, e.g. of the Natura 2000 network. Restrictions according to the Birds and Habitats Directive are connected to the Cross Compliance rules for permanent pasture. Regionally defined, area or site-specific restrictions may go beyond Cross Compliance, but are not always consistently enforced (Osterburg *et al.*, 2009).

In addition, there are mandatory rules for the control of emissions from livestock production. EU Nitrates Directive defines limits on manure spreading per hectare, and thus puts restrictions on the expansion of dairy production in intensive, specialised farms (Lassen *et al.*,



2009). ‘Derogations’ (exemption from the limit of 170 kg N from animal excretion per hectare) have been implemented in several Member States such as The Netherlands, Denmark, and Germany, allowing for higher manure application rates on intensive grassland. These rules fuel further concentration in the dairy sector, as the limit of 170 kg ha<sup>-1</sup> N according to Nitrates Directive is alleviated.

#### **4. Prospects of grassland use in the EU**

The abolition of milk quota in 2015 will affect land use and farm structures. In spite of expected pressure on milk prices, most model based scenario analyses expect an increase of dairy production in the EU by 2020, as well as a significant relocation of production capacities (Gömann *et al.*, 2009; IPTS *et al.*, 2009). However, exact forecasts for dairy production are problematic, as the sector has been strongly regulated for a long period. For suckler cows and sheep, declines due to decoupling are expected (Röder *et al.*, 2007; Gömann *et al.*, 2009), although in the short term, decoupling has not shown severe impacts on the suckler cow and sheep herds. Considering the relevance of direct payments and Pillar 2 support for dairy, beef and sheep farms, especially those with lower intensity levels, future CAP budgets and support measures are key factors determining the future of grassland use.

With regards to the future development of dairy production, Lassen *et al.* (2009) and Lutter (2009) use a mixed methodology comprising analysis of market shares, of local production factors, of production costs, and farm interviews in order to complement and verify outcomes of economic modelling. They expect a further concentration of dairy production in productive grassland areas. Increasing competition on arable land, due to favourable developments of crop prices and promotion of energy crops, will negatively affect production conditions for milk in arable areas.

The following results are based on a farm survey conducted in the first quarter of 2010 by the international networks EDF (European Dairy Farmers) and agri benchmark dairy. The analysis is based on a sample of 1453 German dairy farmers. Data of farms with farmers older than 55 years and without successor, and of farms which will quit dairy production due to recent market developments were removed from the analysis. Based on the farmers’ expectations about the future development of dairy production in their region the regions were grouped into regions of growth and regions of reduction. To characterise a region appropriately, a minimum of five farms are required per county. Only regions where more than 50% of the participating farmers stated that they expect an increase or decrease in dairy production in their region are taken into account. Regions with expected increases of production are concentrated in marsh areas at the coast of Lower Saxony. Regions with expected reduction are mainly located in Lower Bavaria and southern parts of Lower Saxony. The average milk yield of the surveyed farmers is about 8900 kg per cow and year in growing regions, and the average amount of milk produced per hectare of land used for the dairy is about 11700 kg. These figures do not differ much from the production intensity in regions with expected decline. Farmers in growing regions on average have larger herds of more than 100 cows per farm, and use more grassland on their farm compared to those in regions of reduction. Milk production is already the predominant form of agricultural activity in these regions. The results indicate that current centres of milk production in Germany remain important dairy producing regions and one can expect even a further concentration.

In the past, dairy farmers in both regions grew at the same pace. Until 2015, dairy farmers in growing regions plan on average to increase the number of cows by 12 cows per farm and year, while farmers in the other regions intend to grow by six cows. Land rental payments are expected to increase by 22 % or 16 % in regions of growth or reduction,

respectively. The survey also shows that farmers in all regions intend to increase the annual milk yield per cow. With only little increase in farm land, this implies that the intensity of milk production per hectare will further increase. The survey data suggests that the increase of intensity will be higher in regions with expected growth (+ 2800 kg ha<sup>-1</sup>) compared to regions of reduction (+ 1600 kg ha<sup>-1</sup>). These results imply that grassland will most probably be used even more intensively than today on specialised dairy farms. This coincides with the results of the *ex-post* analysis in chapter 3. On the background of ongoing farm specialisation, intensification and spatial concentration in the dairy sector, the fate of grassland that is not needed anymore for milk production remains open.

The Uruguay Round Agreement on Agriculture has been a key factor for market liberalisation in the EU in the 1990s, both regarding the reduction of tariff protection, domestic support and export subsidies. A future agreement of the World Trade Organisation (WTO) according to the current state of negotiations would result in major changes concerning market access for agricultural commodities: Tariff cuts of 48% to 73% (for sensitive products, such as beef, tariff cuts would be roughly half as high), and the abolition of export subsidies (Brockmeier and Pelikan, 2008). Beef, veal and sheep meat prices would come under pressure due to the high market prices support of 35 % as percentage of commodity gross farm receipts (OECD, 2009), while dairy products would be affected by the abolishment of export subsidies. Thus, lower prices and a higher price volatility are expected. For arable crops, more positive price developments are predicted, so that pressure on forage production on arable land would increase (OECD-FAO, 2009). The further expansion of energy crops on arable land will increase the competitive pressure on the land market. In 2008, German UAA used for biogas production alone was estimated to be around 0.5 million hectare (DBFZ, 2009), and a further increase is expected; thus strong incentives for additional grassland conversion will prevail.

Finally, environmental policies will continue to influence the developments in the dairy, beef and sheep sector, both through regulation, e.g. regulation Nitrates Directive or for controlling ammonia emissions, and through incentive payments in order to keep valuable grassland sites under management. Farming systems based on ruminant livestock will be increasingly in the focus of climate protection policies, although their role is ambiguous. Livestock farms are key sources of emission, but also preserve grassland as an important carbon sink. On the other side, preservation of grassland can not be proclaimed as an invariable objective, as there are other use opportunities which should be weighted against environmental benefits of grassland conservation. For instance, due to raising biomass demand, competition between traditional grassland, its use for biomass, and afforestation or short rotation coppice will increase. Discussions may challenge CAP payments which support livestock production systems identified as key emitters of greenhouse gases, while oppressing larger land use shifts towards more environmental-friendly biomass production.

## **5. Conclusions and challenges for research**

The dairy sector of the EU is passing through an accelerated structural change which is heading towards larger, more specialised and, in terms of milk production per hectare forage area, more intensive farms. Structures of farms keeping suckler cows or sheep remained comparatively more stable during the recent past, in spite of the decoupling of direct payments. However, there is an ongoing trend towards lower livestock densities in the less intensive farming systems, thus absorbing parts of grasslands not used anymore by dairy production. Several challenges arise for policy-oriented research: What will be the competitiveness of the dairy, beef and sheep sector in future, as dependency on CAP support is still high, and markets will be further deregulated? How to improve resource

efficiency and decrease detrimental external effects of intensive dairy production systems? How far there is scope to integrate these systems into a concept of grassland conservation and more extensive management of valuable sites, e.g. using grazing heifers? How far and where should extensive grazing livestock systems be maintained through public intervention and new marketing concepts, considering objectives related to climate protection and biomass demand? Last but not least, a more coherent concept is needed how to steer land use in the EU in particular regarding the preservation of ecologically valuable grassland.

## 6. References

- Alliance Environnement (2007) *Evaluation of the application of cross compliance as foreseen under Regulation 1782/2003. Part II: Replies to Evaluation Questions.* [http://ec.europa.eu/agriculture/eval/reports/cross\\_compliance/index\\_en.htm](http://ec.europa.eu/agriculture/eval/reports/cross_compliance/index_en.htm)
- Alliance Environnement (2008) *Evaluation of the environmental impact of milk quotas.* Deliverable prepared for DG Agriculture, July 2008.
- Briemle G., Eckert G. and Nussbaum H. (1999): Wiesen und Weiden. in: Konold / Böcker / Hampicke: *Handbuch Naturschutz und Landschaftspflege.* Teil "Biototypen" S. 1-58; Teil "Landschaftspflege" S. 1-52. - Ecomed-Verlag Landsberg.
- Briemle G. and Elsässer M. (1997) Die Funktion des Grünlandes. *Berichte über Landwirtschaft* 75, 272–290.
- Brockmeier M. and Pelikan J. (2008) Agricultural market access: A moving target in the WTO negotiations? *Food Policy* 33 250-259.
- CEAS Consultants (Wye) Ltd and European Forum on Nature Conservation and Pastoralism. (2000): *The Environmental Impact of Dairy Production in the EU: Practical Options for the Improvement of the Environmental Impact.* Report for DG Environment, European Commission.
- Cooper T., Hart K. and Baldock D. (2009) *The Provision of Public Goods Through Agriculture in the European Union, Report Prepared for DG Agriculture and Rural Development,* Contract No 30-CE-0233091/00-28, Institute for European Environmental Policy: London.
- Cropper M.R. and Del Pozo-Ramos M. (2006) Impacts of CAP reforms on animal production systems. *Grassland Science in Europe* 11, 615-623.
- DBFZ (Deutsches Biomasse-Forschungszentrum (2009): *Monitoring zur Wirkung des Erneuerbare-Energien-Gesetzes (EEG) auf die Entwicklung der Stromerzeugung aus Biomasse.* [http://www.bmu.de/files/pdfs/allgemein/application/pdf/zwischenber\\_mon\\_bio.pdf](http://www.bmu.de/files/pdfs/allgemein/application/pdf/zwischenber_mon_bio.pdf)
- EEA (European Environment Agency) (2005) *The European Environment — State and Outlook 2005.* Copenhagen.
- EEA (European Environmental Agency) (2009) *Annual European Community greenhouse gas inventory 1990–2007 and inventory report 2009.* Annex 2b CRF tables of EU 27.zip <http://www.eea.europa.eu/publications/european-community-greenhouse-gas-inventory-2009>
- Eurostat (2010) *Database of public data available at Eurostat.* <http://epp.eurostat.ec.europa.eu/portal/page/portal/agriculture/data/database>
- Gay S.H., Osterburg B. and Schmidt T. (2004) *Szenarien der Agrarpolitik: Untersuchungen möglicher agrarstruktureller und ökonomischer Effekte unter Berücksichtigung umweltpolitischer Zielsetzungen;* Berlin : SRU.
- Gobin B., Brodsky L., Tychon B., Andersen E., Campling P. and Van Orshoven J. (2006) Protection and maintenance of permanent pastures. In: Kay S., Sima A. and P. Loudjani (eds) (2006) *Geographical Information in support of the Common Agricultural Policy. Proceedings of the 12th MARS PAC Annual Conference,* 2006. JRC Scientific and Technical Reports.
- Gömann H., Kleinhanß W., Kreins P., von Ledebur O., Offermann F., Osterburg B. and Salamon P. (2009) *Health Check der EU-Agrarpolitik – Auswirkungen der Beschlüsse.* Arbeitsberichte aus der vTI-Agrarökonomie 1/2009.
- IEEP (Institute of European Environmental Policy) (2007) *Evaluation of the environmental impacts of CAP (Common Agricultural Policy) measures related to the beef and veal sector and the milk sector.* Report prepared for DG Agriculture, December 2007.
- IPCC (Intergovernmental Panel on Climate Change) (2000). *Land Use, Land-Use Change, and Forestry.* Robert T. Watson, Ian R. Noble, Bert Bolin, N. H. Ravindranath, David J. Verardo and David J. Dokken (eds). Cambridge University Press, UK.

- IPTS (2009) *Economic Impact of the Abolition of the Milk Quota Regime – Regional Analysis of the Milk Production in the EU*. IPTS with the collaboration of EuroCARE GmbH, Bonn
- Isermeyer F. (2009) *Wohin wandert die Milch? Methoden, Ergebnisse, Belastbarkeit*. PowerPoint presentation, <http://www.vti.bund.de/de/institute/bw/publikationen/default.htm>
- Lassen B., Friedrich C. and Prüße H. (2008) *Statistische Analysen zur Milchproduktion in Deutschland – Geographische Darstellung*. Arbeitsberichte aus der vTI-Agrarökonomie 2/2008.
- Lassen B., Isermeyer F. and Friedrich C. (2009) Regionaler Strukturwandel in der deutschen Milchproduktion. *Agrarwirtschaft* 58 (5/6), 238-247.
- Lutter M. (2009) Strukturwandel in der europäischen Milchviehhaltung: Ergebnisse einer regionalen differenzierten Befragung. *Arbeitsberichte aus der vTI-Agrarökonomie* 5/2009.
- McCracken D., Klockenbring C., Zdanowicz A. and Baldock D. (2006) *Agricultural biodiversity – issues to be aware of within MEACAP*. MEACAP project, MEACAP WP5 ND1, Report Prepared for DG Research: Brussels.
- OECD (2009): *Agricultural policies in OECD countries: Monitoring and Evaluation 2009. Part II. Country Focus*. Working Party on Agricultural Policies and Markets. TAD/CA/APM/WP(2009)/13/FINAL
- OECD-FAO (2009): *Agricultural Outlook 2009-2018*, Highlights published in June 2009, [www.agri-outlook.org](http://www.agri-outlook.org)
- Osterburg B. (2005) Assessing long-term impacts of agri-environmental measures in Germany. In: OECD (eds) *Evaluating agri-environmental policies : design, practice and results*. Paris: OECD, 187-205.
- Osterburg B. and Horn von L. (2006) Assessing the impacts of decoupling EU direct payments from agricultural production and the potential for 're-coupling'. *Outlook on Agriculture* 35(2), 107-113.
- Osterburg B., Nitsch H., Laggner B., Roggendorf W. (2009) *Auswertung von Daten des Integrierten Verwaltungs- und Kontrollsystems zur Abschätzung der EU-Agrarreform auf Umwelt und Landschaft*. Arbeitsber. vTI-Agrarökonomie 2009/07.
- Osterburg B., Nitsch H., Laggner A. and Wagner S. (2008) *Analysis of policy measures for greenhouse gas abatement and compliance with the convention on biodiversity*, MEACAP project, WP6 D16a, Report Prepared for DG Research: Brussels.
- Ostermann O.P. (1998) The need for management of nature conservation sites designated under Natura 2000. *Journal of Applied Ecology* 35, 968-973
- Pointereau P., Coulon F., Girard P., Lambotte M., Stuczynski T., Sanchez Ortega V. and Del Rio A.; Editors: Anguiano E., Bamps C. and Terres J-M. (2008) *Analysis of Farmland Abandonment and the Extent and Location of Agricultural Areas that are Actually Abandoned or are in Risk to be Abandoned*, Institute for Environment and Sustainability, Joint Research Centre, EC
- Röder N., Hennessy T. and Stiltmant D. (2007) Impact of the CAP-reform on the use of pastoral land in Europe. *Grassland Science in Europe* 12, 445-462.
- Salhofer K., Röder N., Kilian S., Henter S. and Zirnbauser M. (2009) *Märkte für Zahlungsansprüche*. Endbericht zum Forschungsauftrag 05HS041, Lehrstuhl für Volkswirtschaftslehre – Umweltökonomie und Agrarpolitik, TU München-Weihenstephan, Freising, den 15.01.2009.
- Taube F., Hermann A. and Pötsch E. M. (2007) What are the consequences of producing energy crops in the European Union for grassland renovation and new forage production systems. *Grassland Science in Europe* 12, 445-462.
- Zdanowicz A., Miller C. and Baldock D. (2005) *The Convention on Biodiversity and Its Potential Implications for the Agricultural Sector in Europe*. MEACAP project, MEACAP WP5 D2, Report Prepared for DG Research: Brussels.

## **Session 1.1**

### **Grassland and climate change**

*Editor: Hans Schnyder*

# Changes in soil organic matter content of grassland and maize land in the Netherlands between 1970 and 2009

Reijneveld J.A.<sup>1</sup>, Kuikman P.J.<sup>2</sup> and Oenema O.<sup>2</sup>

<sup>1</sup>BLGG AgroXpertus, P.O. Box 115, NL-6860 AC Oosterbeek, The Netherlands

<sup>2</sup>Wageningen UR, Alterra, P.O. Box 47, NL-6700 AA Wageningen, The Netherlands

Corresponding author: AR@Blgg.nl

## Abstract

Soil organic matter (SOM) content is of prime importance for sustained levels of agricultural production. Reports indicate that SOM levels have decreased in, e.g., England, Wales and Belgium. Farmers in the Netherlands are concerned that introduction of more strict legislation on manure application will decrease SOM content in the Netherlands too. Here, we report on changes in SOM contents of grasslands and maize lands using a database with more than 2.5 million records of SOM determinations from farmers' fields. SOM content of grassland on mineral soils remained stable or tended to increase on average by  $0.097 \text{ g kg}^{-1} \text{ yr}^{-1} \text{ C}$  during the period 1984-2000. However, there were considerable differences between soil types and regions. Areas with relatively low SOM contents showed increasing SOM contents, while areas with relatively high SOMC (e.g., peaty clays) showed decreasing SOM contents.

Keywords: carbon sequestration, grassland, soil organic carbon, soil organic matter, changes, land use change

## Introduction

Soils contain vast amounts of organic carbon (C). On a global scale, it has been estimated that about  $1.5 \times 10^{18} \text{ g}$  is stored in the upper meter of the soil, which is about three times the amount of C in the aboveground biomass and twice the amount of C as  $\text{CO}_2$  in the atmosphere (e.g. Batjes, 1997). Sequestration of C in soils has been promoted as a strategy to mitigate the emissions of greenhouse gases in the atmosphere (Lal *et al.*, 2004). However, Janzen (2004) questioned this strategy, as it seems not effective in all cases and even counter effective in the case that the mineralization of organic nitrogen has to sustain high crop production levels.

In general, increasing soil organic matter (SOM) content is considered desirable as it improves, among other things, soil structure, Cation Exchange Capacity, water retention and disease suppressiveness. Some recent studies suggest, however, that mean SOM content decreases as a consequence of land and soil management practices, climate change and drainage (Sleutel *et al.*, 2003; Bellamy *et al.*, 2005; Davidson and Janssens, 2006).

Here, we report on changes in mean SOM content of grassland and maize land in the Netherlands during the period 1970-2009, using a database with more than 2.5 million records of soil analyses from farmers' fields. The objective was to relate possible changes in median SOM content to changes in agricultural practices.

## Materials and methods

The soil samples were taken and analysed by BLGG AgroXpertus (BLGG.AgroXpertus.nl) at farmers' requests. From 1984 onwards the soil data were stored digitally and available for statistical analyses. For the period 1970-1984, means and frequency distributions per soil type, land use type and year were available as described in annual reports but, unfortunately, the underlying, original data were not archived. Standard soil sampling depth for grassland was 0-5 cm until 2000 and 0-10 cm thereafter. Sampling depth for maize land depended on

ploughing depth, and ranged between 0-20 and 0-25 cm in 1984, but after the year 2000 >99% of the soil samples were taken from the layer 0-25 cm. Both maize land and grassland may be part of rotational systems. The analytical procedures until 2004 are described in Reijneveld *et al.* (2009). From 2004 onwards the Near Infra Red (NIR) method (e.g. Malley *et al.*, 1999) is used for SOM determinations.

We used simple regression analyses to detect changes in means and medians over time. We checked for homogeneity of variance of the mean SOM content between years.

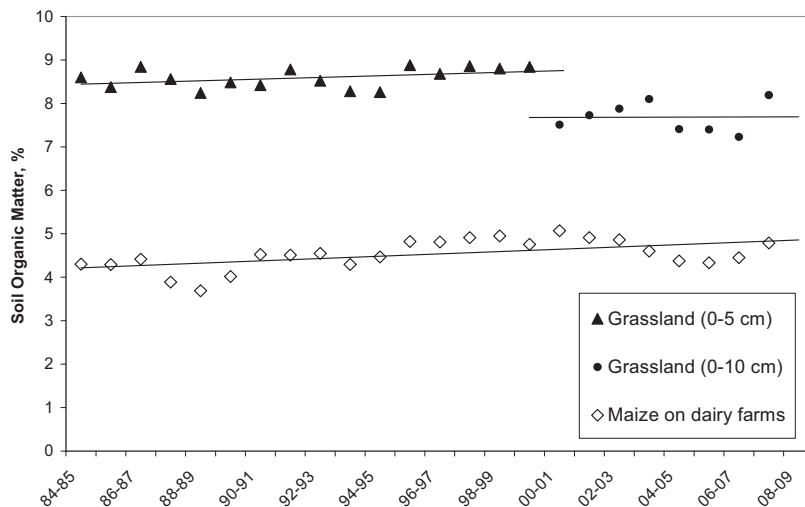

Figure 1. Changes in mean soil organic matter content of grassland and maize land in the Netherlands.

## Results and discussion

Mean SOM contents of mineral soils (soils with <25% SOM) under grassland and maize land tended to increase by 0.097 and 0.081 g C per kg soil per year for grassland and maize land, respectively, during the period 1984-2004 (Figure 1). The suggested trends over time are complicated by the facts that both soil sampling depth and the method of carbon analysis changed during the reporting period. The effect of the first complication is shown in Figure 1 for grassland; the effect of the second complication is nullified by the inclusion of standards.

Our result contrasts with reports from the United Kingdom, Belgium and Brittany, which indicate decreasing SOM contents. Further, our results do not confirm concerns of farmers about a possible rapid decline in SOM contents, because of the manure policy. Our results do support the conclusion of Velthof (2005) that the input of organic matter via crop residues and animal manure has been rather constant over the reporting period.

Regional differences in annual mean changes in SOM under grassland were relatively large and related to soil type. Sandy soils, loess soils, and fluvial soils increased in SOM content. Peaty clay soils and marine clay soils high in SOM content showed decreases in SOM content during the period 1984-2004. For example, a significant ( $P < 0.001$ ) decrease in SOM was found in the north of the Netherlands (Figure 2); this may be related to temporary changes in land use, agricultural practices, groundwater level, or combinations of these aspects.

The increase in mean SOM content of maize land (Figure 1) is related to the increased acreage of maize land. Silage maize was introduced in the late 1960s, starting on sandy soils in the southern half, but from the 1980s onwards silage maize has been grown throughout the country at the expense of grassland. As a consequence, the mean SOM content of maize land



increased over time, as the sample population included an increasing proportion of former grasslands. In addition, maize land has received relatively large amounts of animal manure, which also will have contributed to sustaining levels of SOM in maize land.

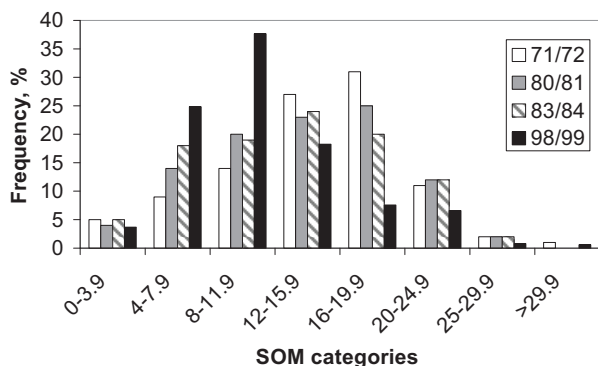

Figure 2. Frequency distribution of SOM content classes of grassland on marine clay soils in the north of the Netherlands in 1971, 1980, 1983, and 1998 (each year contains of >1000 records of soil analysis, the region has an area of ~40500 ha)

Despite the large number of records used in this study (>2.5 million), there remains uncertainty about the significance of the estimated trends in SOM. The uncertainty emanates from the uncertainty in land use changes in practice. It is indicated that land use change has a huge effect on SOM contents (e.g. Vellinga *et al.*, 2004). Reseeding grassland may also have an influence; the grassland area ploughed and reseeded ranges between 5 and 10% of the total grassland area, and seems to remain rather constant.

## Conclusion

Our data suggest that SOM content of mineral grassland soils in the Netherlands remains stable or increased slightly though there are large regional differences. A limitation in the current data base is the uncertainties about previous land use of the sampling locations. A monitoring programme would overcome this uncertainty.

## References

- Bellamy P.H., Loveland P.J., Bradley R.I., Lark R.M. and Kirk G.J.D. (2005) Carbon losses from all soils across England and Wales 1978- 2003. *Nature* 937, 245 – 248.
- Davidson E.A. and Janssens I.A. (2006) Temperature sensitivity of soil carbon decomposition and feedbacks to climate change. *Nature* 440, 165 – 173.
- Batjes N.H. (1997) A world data set of derived soil properties by FAO-UNESCO soil unit for global modelling. *Soil Use and Management* 13, 9-16.
- Janzen H.H. (2004) Carbon cycling in earth systems – a soil science perspective. *Agriculture, Ecosystems and Environment* 104, 399 – 417.
- Lal R., Apt M., Grave L. and Morgan M.G. (2004) Managing soil carbon. *Science* 304, 393.
- Malley D.F., Yesmin L., Wray D. and Edwards S. (1999) Application of near-infrared spectroscopy in analysis of soil mineral nutrients. *Communications in soil science and plant analysis* 30 (7-8), 999-1012.
- Sleutel S., Neve S., Hofman G., Boeckx P., Beheydt D., Van Cleemput O., Mestdagh L., Lootens P., Carlier L., Van Camp N., Verbeeck H., Van De Walle I., Samson R., Lust N. and Lemeur R. (2003) Carbon stock changes and carbon sequestration potential of Flemish cropland soils. *Global Changes Biology* 9, 1193 – 2103.
- Soon Y.K. and Abboud S. (1991) A comparison of some methods for soil organic carbon determination. *Commun. Soil Sci. Plant Anal.* 22, 943 – 954.
- Vellinga Th.V., Van den Pol – Van Dasselaaar A. and Kuikman P.J. (2004) The impact of grassland ploughing on CO<sub>2</sub> and N<sub>2</sub>O emissions in the Netherlands. *Nutrient Cycling in Agroecosystems* 70, 33 – 45.
- Velthof G.L. (2005) Input of organic matter to agricultural soils (in Dutch). *Bodem* 1, 11 – 13
- Reijneveld, J.A., Van Wensem, J. and Oenema, O. (2009) Soil organic carbon contents of agricultural land in the Netherlands between 1984 and 2004. *Geoderma* 152, 231 – 238.



# Changes in abundance and diversity of wild species in grass fields in Denmark

Andreasen C.<sup>1</sup>, Stryhn H.<sup>2</sup> and Andresen L.C.<sup>1</sup>

<sup>1</sup>*Department of Agriculture and Ecology, Faculty of Life Science, University of Copenhagen, Højbakkegaard Allé 13, DK 2630 Taastrup*

<sup>2</sup>*Department of Health Management, Atlantic Veterinary College, University of P.E.I., Charlottetown, Prince Edwards Island, Canada*

Corresponding author: can@life.ku.dk

## Abstract

There has been growing concern about the declining species diversity and abundance in agroecosystems caused by the intensification of land use practice during the last 50 years. Danish surveys in grass leys show that the frequency of many common species declined significantly between 1967-70 and 1987-89. From 1987-89 to 2001-04 the decline continued for a few species (*Matricaria discoidea*, *Plantago major*, *Ranunculus repens*, *Tripleurospermum inodorum* and *Viola arvensis*), while the frequency of the grass weeds *Elytrigia repens* and *Poa annua* increased significantly.

Keywords: Biodiversity, flora, Raunkiær analysis, weeds

## Introduction

During the past 50 years the grassland area has declined in Denmark due to conversion of grassland to crop land and a lower proportion of leys in arable rotation. Whereas previously it was common practice to let the stock graze large areas of grassland, it has now become much more common to keep the stock in the cow house all year. Grass and clover from well fertilized leys are used for ensilage, and swards are harvested several times during the season. This affects the flora and results in relatively low abundance and diversity of wild species. Sown grasses and clovers are very competitive at high fertilizer levels and, since the fields are cut frequently, many wild species do not reach flowering and seed setting. Here we present data on flora from the last 50 years which show how the diversity and abundance of wild species of grasslands has changed during this period.

## Material and methods

In the years 1967-70, 1987-89, and 2001-10, thirty, forty-four and forty-eight grass leys were surveyed, respectively. The surveys were made in June or July. All grass leys were two years old (fields analysed in 2001 were undersown with cereals in 1999) and visited once. The spectrum of sown species in the grass leys has been relatively constant and has consisted of combinations of the following species: *Dactylis glomerata* L., *Festuca pratensis* Hud., *Phleum pratensis* L., *Lolium perenne*, *L. multiflorum* L., *Poa pratensis* L., *P. trivialis* L., *Trifolium pratense* L., and *T. repens* L.. The surveyed fields were selected randomly according to a scheme ensuring approximately equal geographical distribution in Denmark. The number of fields in each county was related to the relative area of grass leys at a national scale. The fields were not the same in the three surveys due to many reasons, e.g. other crops were grown on the fields, some fields were in set-aside, some were used for other purposes (e.g. golf courses, lawn and roads etc). The samples may be regarded as fairly representative for the flora of grass fields in the country. All fields were in conventional agricultural use (no

organic farms), but were not sprayed with herbicides in the sampling years; hence the weeds have been affected by the respective crops throughout the growing season.

In the 1964-70 and 1987-89 surveys, the frequency of weed species in a field was recorded by listing the presence or absence of each species in 10 randomly selected, circular sample plots of 0.1 m<sup>2</sup> within a field. Accordingly, each species was recorded in frequency classes of 0, 10, 20, 30, 40, 50, 60, 70, 80, 90, and 100%. In the 2001-04 surveys we increased the number of sample plots to 20 in order to improve the estimates of the frequencies within a field. The plots were selected by walking across the fields and randomly throwing a ring of sample size in different directions, but avoiding closely located samples. The plots were never located in the headland because that area often differs from the rest. The advantages and disadvantages of the method, and reasons for choosing it in three major Danish surveys were discussed by Andreasen *et al.* (1996). The method gives only a rough estimate of weed frequencies in each field, but variation between fields is much larger than that within a field. Thus, to get a reasonable estimate of the countrywide occurrence of weed species in a crop, one should include more fields rather than investigate more plots within a field. Data for different species were analysed separately, using the same statistical methods. The number of occurrences of a weed species among  $n_f$  (10 or 20) random samples in a field  $f$  was assumed to follow a beta-binomial distribution (Agresti, 2002) with index  $n_f$ , probability  $P_f$  and correlation parameter  $\rho_f$ . The beta-binomial distribution allows for within-field clustering (or correlation) of weed occurrence among the Raunkiær samples, and thereby accounts for any extra-binomial variation in the field counts. The probability  $P_f$  was modelled on a logistic scale, i.e.  $\text{logit}(P_f) = \ln[P_f/(1-P_f)]$ , by effects corresponding to survey period (e.g. 1987-89 versus 2001-04). Previous surveys have shown that crop type accounts for the major part of the variability among fields, although other variables can be shown to have significant influence on the incidence of weeds (e.g. soil factor, crop rotation, agriculture management, landscape heterogeneity (e.g. Andreasen and Skovgaard, 2009). Their exclusion from the present analysis implied some loss of prediction, and generally our analysis gave rather cautious and conservative statements about differences between surveys.

The initial statistical models allowed for separate parameters of  $P_f$  and  $\rho_f$  for each combination of sampling decade, except where weeds were found in one survey only and the same correlation across surveys was assumed. Statistical hypotheses were tested by Likelihood Ratio (LR)-tests, at a significance level of 0.05. For further details about the statistical method see Andreasen and Stryhn (2008).

## Results and discussion

Frequency of 67 common weed species was investigated. Significant changes were found for 32 species (Table 1). From 1967-70 to 1987-89 the frequency of 21 species declined significantly, whilst only *Stellaria media* (L.) Vill. became more common. *S. media* is a nitrophilous and shade tolerant species with a short life cycle and a rapid germination, which enables it to fill any bare spots in the field. Previously common species such as *Cerastium fontanum* Baumg., *Plantago major* L. *Prunella vulgaris* L. *Ranunculus repens* L. and *Viola arvensis* Murray declined substantially or were absent in 1987-89. From 1987-89 to 2001-2004 only minor changes occurred. The grass weeds *Elytrigia repens* (L.) Desv. ex Nevski and *Poa annua* L. became more common, while other species seemed to decline. The frequency of *P. annua* increased immensely in all common crops from 1987-89 to 2001-2004. In general, propagation of grass weeds in crop rotation systems seemed to be favoured by an increasing area of winter cereals in Denmark (Andreasen and Stryhn, 2008). Most farmers do not spray second-year grass leys with herbicides because it is not necessary. Sown grass species are very competitive to wild species because large amounts of slurry are often spread and several cuts during the season prevent weed plants from setting seeds. On many

conventional farms, cows stay indoors and the fodder is transported to the cow house. Grazing, which is common on organic farms, creates a more open canopy with bare spots where the wild flora has better conditions for establishment and can compete with the crop.

Table 1. Observed frequencies (%) of wild species as recorded in surveys in 1967-70, 1987-89 and 2001-04 together with significant indications for statistical test of equal weed incidence in two following surveys.

	1967-70	1987-89	P level	2001-04	P level
<i>Achillea millefolium</i> L.	4.3	0.2	*	0.1	
<i>Aphanes arvensis</i> L.	3.0	0	**	0.1	
<i>Arenaria serpyllifolia</i> L.	2.7	0	*	0.2	
<i>Cerastium fontanum</i> Baumg.	22.3	0.9	***	1.0	
<i>Elytrigia repens</i> (L.) Desv. ex Nevski	8.0	0	***	2.8	**
<i>Galium aparine</i> L.	7.0	0	**	0	
<i>Geranium pusillum</i> L.	2.0	0.2	**	0.8	
<i>Mentha arvensis</i> L.	9.0	0	**	0.3	
<i>Matricaria discoidea</i> DC	2.3	2.5		0.6	*
<i>Myosotis arvensis</i> (L.) Hill.	10.0	0.7	**	2.2	
<i>Plantago major</i> L.	35.7	7.3	***	2.0	**
<i>Poa annua</i> L.	67.3	46.8	**	60.2	*
<i>Polygonum aviculare</i> L.	10.7	6.1	**	5.2	
<i>Prunella vulgaris</i> L.	9.3	0	***	0	
<i>Ranunculus repens</i> L.	13.7	3.0	**	0.8	*
<i>Rumex acetosella</i> L.	8.0	0	***	0.1	
<i>Scleranthus annuus</i> L. ssp. <i>annuus</i>	3.3	0.2	*	0.1	
<i>Senecio vulgaris</i> L.	3.0	0.2	*	0.4	
<i>Spergula arvensis</i> L.	2.3	0	*	1.0	*
<i>Stellaria media</i> (L.) Vill.	14.7	29.1	**	21.6	
<i>Tripleurospermum inodorum</i> (L.) Sch. Bip.	1.7	5.0		0.6	**
<i>Veronica agrestis</i> L.	2.3	0	*	0	
<i>Veronica persica</i> Poir.	7.0	2.5	**	1.6	
<i>Viola arvensis</i> Murray	8.3	1.8	*	0.8	
<i>Viola tricolor</i> L. ssp. <i>tricolor</i>	1.3	0.7		0	*

\* $P < 0.05$ ; \*\* $P < 0.01$ ; \*\*\* $P < 0.001$

## References

- Agresti A. (2002) *Categorical Data Analysis* 2<sup>nd</sup> ed. Section 13.3, pp. 553-559. J Wiley & Sons. Inc, New York.
- Andreasen C., Stryhn H. and Streibig J.C. (1996) Decline of the flora in Danish arable fields. *Journal of Applied Ecology* 33, 619-626.
- Andreasen C. and Stryhn H. (2008) Increasing weed flora in Danish arable fields and its importance for biodiversity. *Weed Research* 48, 1- 9.
- Andreasen C. and Skovgaard I.M. (2009) Crop and soil factors of importance for the distribution of plant species on arable fields in Denmark. *Agriculture, Ecosystems and Environment* 133, 61- 67.

# Impacts of climate change on the grazing period, and the conserved feeding costs of grazing systems in the UK

Topp C.F.E.<sup>1</sup>, Wreford A.<sup>1</sup>, Tolkamp B.J.<sup>1</sup>, Wu L.<sup>1,2</sup> and Moran D.<sup>1</sup>

<sup>1</sup>SAC Research, West Mains Road, Kings Buildings, Edinburgh, EH9 3JG

<sup>2</sup>current address: North Wyke Research, Okehampton EX20 2SB

Corresponding author: Kairsty.Topp@sac.ac.uk

## Abstract

Grassland is the main driver of ruminant systems and its productivity is sensitive to climate. This study explores the response of ruminant production within the UK to climate change. Using climate predictions and grass productivity and animal nutrition models, the impacts are explored for 2020, 2050 and 2080 in ten regions. The associated costs of the predicted changes are assessed using the changes in the ratio of grass to other forage feed and estimating the financial impact. In pastoral systems, climate change is likely to increase grass production. Increased forage availability could increase the annual grazing period by a maximum of five weeks for cattle systems, and seven weeks for sheep systems. In most regions, this will allow animals to be kept outdoors for longer, and could mean a potential reduction in the proportion of the year that animals require housing and/or access to conserved forages. The changes in length of the grass growth season are generally more substantial in northerly than in southerly regions. The results indicate that a changing climate may actually lead to a saving in forage costs to the dairy, beef and sheep sectors of £42m, £5m and £90m respectively by 2080.

Keywords: Climate change, Ruminant systems, Grassland

## Introduction

Grassland production is an important driver in determining the productivity of ruminant systems. Expected climate change will have consequences for the productive potential of grassland systems in the future. These changes will impact of the distribution and production of ruminant livestock. The effects of climate change on grassland systems are potentially complex with effects on forage yields and quality, which may affect the relative suitability of grasses and legumes for grazing and fodder and thus their utilisation. Climate change is likely to have impacts on the length of the growing and grazing seasons and, therefore, animal production. The objective of this contribution is to explore the impact of climate change on the length of grazing period and the associated savings in winter forage costs for different regions within the UK. The impacts are explored for 2020, 2050 and 2080.

## Materials and methods

An assessment of the impact of climate change on livestock systems has been carried out by, firstly, assessing the likely impact of climate change scenarios on grassland production. The SAC grassland systems model (Molle *et al.*, 2006, Moran *et al.*, 2009) was used to predict the changes in forage production and length of grazing season for dairy, beef and sheep systems in the UK. Predictions included days of the year when grass would be cut, the dry matter yield (DMY) of the grass, the grass quality characteristics digestibility (D) and crude protein (CP) content and the variation in these characteristics as indicated by their standard deviations. This model required daily climate data as a driver for these predictions. These were developed using the UKCIP02 medium-high scenario and the weather generator Earwig (Kilsby *et al.*,

2007) for each of the livestock type (i.e. dairy, beef and sheep) zones within each of the eight Rural Development Programme (RDP) regions in the England, plus Scotland and Wales. A total of 50 one-year runs were generated for each production system in all RDPs and for each of the climate change time slices (i.e. baseline 1961-1990, 2020, 2050 and 2080). The means of 50 simulations per system per time point for each RDP were used as inputs into the dairy, beef and sheep farm system models, the characteristics of which are described by Moran *et al.* (2009). The changes in the ratio of grass to other forage fed (mostly silage) in 2020, 2050, and 2080 compared with the baseline were used to estimate the financial impact of climate change on ruminant production systems. A representative system for each of the three analysed production systems was identified in SAC's Farm Management Handbook (2007) and used to determine current volumes of grass and silage required per animal and current prices. To enable comparison between a scenario in which no climate change occurred, the cumulative discounted costs assuming the current ratio between grass and silage continued was calculated for each time point.

Table 1. The percentage change in annual average monthly precipitation and the increase in annual average daily mean temperature from baseline conditions for each of the ten regions.

Regions	annual average monthly precipitation			annual average daily mean temperature		
	(% change)			(°C)		
	2020	2050	2080	2020	2050	2080
Scotland	-0.8	-1.7	-2.9	0.7	1.5	2.7
Wales	-2.7	-5.7	-10.1	0.9	1.8	3.2
East Midlands	-2.3	-4.8	-8.4	0.9	1.9	3.4
East of England	-2.3	-4.9	-8.6	0.9	2.0	3.5
North East	-1.7	-3.6	-6.3	0.8	1.7	3.0
North West	-1.9	-4.0	-7.0	0.8	1.7	3.1
South East	-2.5	-5.4	-9.5	1.0	2.1	3.6
South West	-2.8	-6.0	-10.5	0.9	2.0	3.5
West Midlands	-2.8	-6.0	-10.5	0.9	1.9	3.4
Yorkshire & Humber	-2.1	-4.5	-7.8	0.8	1.8	3.1

## Results and discussion

The predicted changes in temperature and precipitation for each of the time-slices, and for each of the regions modelled are shown in Table 1. The effects of climate change on farms that rely on grass production will, in almost all systems and regions, lead to a potentially longer grazing period. The predicted increase in annual grazing period between the baseline and 2080 differs between regions and varies from 3.2 weeks on dairy farms (range: 1 to 5 weeks), to 1.8 weeks on beef farms (range: -2 to +5 weeks) and 2.9 weeks on sheep farms (range: 1 to 7 weeks) through earlier grazing. In most regions this will allow animals to be kept outdoors for longer, and it means there is a potential reduction in the proportion of the year that animals require housing and/or access to conserved forages. Proportionally, the changes in length of the grazing season are generally more substantial in northerly than in southerly regions.

Climate change is also predicted to lead to increased grass growth per hectare. The predicted increase in annual usable grass DMY per hectare between the baseline and 2080 differs between regions and varies from +1.2 t on dairy farms (range: 0.4 t to 2.4 t), to 1.5 t on beef farms (range: 1.0 t to 2.3 t) and 2.3 t on sheep farms (range: 1.7 t to 2.9 t). Proportionately, the increase is predicted to be strongest on sheep farms, and the increase tends to be higher in northerly compared to southerly regions on all farm types. The cost benefit results indicate

that a changing climate may actually lead to a saving in forage costs to the dairy, beef and sheep sectors of £42m, £5m and £90m respectively by 2080. This is, however, less than a one percent change from base situation for the dairy and beef systems and three percent for the sheep systems, which are clearly not significant over a 70-year period.

To show effects of climate change, as opposed to adaptation to climate change, the models used to predict grass growth and farm outcomes were based on constant other characteristics. For the interpretation of the results presented above it is, however, important to keep in mind that other changes are expected to occur in the considered time span that will affect the magnitude or even the direction of the changes that were predicted. These include the application rate of fertilisers and productivity of the livestock, as well as livestock numbers remaining at the predicted 2020 levels until 2080. An increase in fertiliser application is, therefore, expected to magnify the changes in length of the grazing season, grass yield, stocking rate, grass as a proportion of forage consumed in the direction as predicted by our current models. Proportionally, the changes in length of the grazing season are generally more substantial in northerly than in southerly regions. In addition, other forages (notably forage maize) is expected to play an increasing role at the expense of grass in farming systems where at present these are not favoured because of climatic conditions (especially temperature limitations).

## **Conclusion**

UKCIP02 does not describe extreme events in any detail, although it is projected that extreme flooding events, heat waves and storm conditions are more likely to occur in the future. It is these extreme events that are likely to have a greater impact on livestock production systems than the gradual change in climate described in the UKCIP02 data series. Nevertheless, the study does highlight that the impacts of climate change, particularly in the UK, are not all likely to be negative.

## **Acknowledgements**

The authors wish to acknowledge the financial support of the UK Department for Environment and Rural Affairs (Defra) for funding this work.

## **References**

- Kilsby C.G., Jones P.D., Burton A., Ford A.C., Fowler H.J., Harpham C., James P., Smith A. and Wilby R.L. (2007) A daily weather generator for use in climate change studies. *Environmental Modelling and Software* 22, 1705-1719.
- Molle G. *et al.* (2006) *Low input animal production based on forage legumes for grazing systems (LEGGRAZE)*. Final Report for the EU (Contract No. QLK5-CT-2001-02328).
- Moran D., Topp K., Wall E. and Wreford A. (2009) *Climate Change Impacts on the Livestock Sector AC0307*, Report to DEFRA, <http://randd.defra.gov.uk/Default.aspx?Menu=Menu&Module=More&Location=None&Completed=0&ProjectID=14978>
- SAC Farm Management Handbook (2007) *The Farm Management Handbook 2007/08*. 28th Edition. SAC, Edinburgh.

## Effect of crude protein intake on CH<sub>4</sub> concentration in a dairy stall

Arriaga H.<sup>1</sup>, Blanco F.<sup>1</sup>, Salcedo G.<sup>2</sup>, Martínez-Suller L.<sup>3</sup> and Merino P.<sup>1</sup>

<sup>1</sup>NEIKER-Tecnalia, Berreaga, 1 48160 Derio (the Basque Country, Spain)

<sup>2</sup>I.E.S. La Granja, 39792 Heras (Cantabria, Spain)

<sup>3</sup>University of Cantabria, 39316 Tanos-Torrelavega (Cantabria, Spain)

Corresponding author: harriaga@neiker.net

### Abstract

Grasslands have historically constituted the main source of forages for dairy cattle in the Basque Country. However, the intensification of dairy production has minimized the use of grass-based feedstuffs on commercial farms. Rations are currently formulated on crude protein (CP) content basis, with a high use of concentrates. The use of concentrates is related to increasing ammonia (NH<sub>3</sub>) accumulation in stalls, but little is known on how CP content may affect methane (CH<sub>4</sub>) concentration. The aim of this study was to relate the protein nutrition of lactating dairy cows and the CH<sub>4</sub> concentration in dairy stalls. Three total-mixed-ration diets were formulated whose CP contents were 14.1%, 15.9% and 16.9% for low (LP), medium (MP) and high protein (HP) treatments, respectively. Three Holstein cows were confined to metabolic tie-stalls for individual control and CH<sub>4</sub> monitoring. Methane measurements were made either *in situ* in the stall or in the laboratory through slurry incubations at different temperatures. CH<sub>4</sub> concentration in the stall was measured using a photoacoustic gas analyser. Results showed no effect of dietary CP content on the CH<sub>4</sub> concentration in tie stalls whereas CH<sub>4</sub> concentration increased with increasing temperatures in the laboratory. Dietary protein manipulation was not a successful strategy to alter CH<sub>4</sub> accumulation in stalls in our conditions.

Keywords: dairy cow, methane, nutrition, protein, stall

### Introduction

Grasslands have historically constituted the main source of forages for dairy cattle in the Basque Country (northern Spain). However, the intensification of dairying activity has minimized the use of grass-based forages (silages and hays) on commercial farms (Arriaga *et al.*, 2009). As a consequence, concentrates are being largely used as energy and N sources in dairy cattle nutrition. From an energetic point of view, the amount and type of concentrate used for cow nutrition is related to enteric methane (CH<sub>4</sub>) formation (Johnson and Johnson, 1995). However, rations are more usually formulated on a crude protein (CP) content basis, with concentrates of varying N contents. In this sense, little is known on how CP nutrition may affect CH<sub>4</sub> concentration, directly or indirectly. The aim of this study was to relate the protein nutrition of dairy cows to the CH<sub>4</sub> concentration in dairy stalls.

### Materials and methods

Three first-lactation Holstein cows (210 ± 12 days in milk, 644 ± 8 kg body weight) were randomly assigned to three diets in a 3 by 3 Latin Square design. Cows were held in separated metabolic tie-stalls. Stalls were slatted floor, and a slurry store was placed under each metabolic unit (0.51m<sup>3</sup>). Total mixed rations were formulated to be isoenergetic and contain three levels of CP (low, medium and high) on a DM basis (LP: 14%; MP: 16%; HP: 17%). Maize silage and alfalfa hay were used as forage sources and concentrates were formulated with varying amounts of soybean meal to fit the CP content of diets. Feedstuffs were analysed



for dry matter content, ash, fat, CP and neutral detergent fibre (NDF). Non fibrous carbohydrates were estimated as  $100 - (\text{fat} + \text{CP} + \text{ash} + \text{NDF})$  (Table 1).

Table 1. Chemical composition of dry matter (DM) in low (LP), medium (MP) and high (HP) crude protein diets.

Temperature	LP	MP	HP
CP in DM, g kg <sup>-1</sup>	141	159	169
NDF in DM, g kg <sup>-1</sup>	377	373	368
ADF in DM, g kg <sup>-1</sup>	206	208	211
Fat in DM, g kg <sup>-1</sup>	37	39	39
NFC in DM, g kg <sup>-1</sup>	346	335	343
Ash in DM, g kg <sup>-1</sup>	99	94	79

The stall (30 m<sup>2</sup>) was naturally ventilated, where air flow was passing from an air opening on the western wall (2 m<sup>2</sup>) to the stall access door (5 m<sup>2</sup>) located on the eastern wall. However, when gases were measured the door was always closed to avoid the lateral air flow through metabolic tie-stalls. Metabolic tie-stalls were physically separated by 1 m high cemented walls. Concentrations of CH<sub>4</sub> were measured using a photoacoustic infrared gas analyser (Brüel and Kjaer 1302, detection limit 1.5 ppm). Gases were measured through a Teflon tube at 15 cm distance over the barn floor. The teflon tube was repositioned 30-50 cm behind each cow until a steady-state value was reached.

In order to simulate the effect of temperature on CH<sub>4</sub> production from different CP diet-derived slurries, a slurry incubation experiment was carried out in the laboratory at 3 temperatures (4 °C, 19 °C and 29 °C) for 40 minutes. The minimum temperature represented the mean temperature in winter in the Basque Country, 19 °C the mean temperature in summer period, and 29 °C a typical hot summer day in the territory. Incubations were carried out inside a plant growth chamber (Sanyo MLR-351H Plant Growth Chamber). Slurry was created mixing 60 g of fresh faecal samples and 30 mL of non-acidified urinary samples (2:1 ratio) into a 1-L glass jar. The jars were sealed with lids fitted with rubber stoppers in which one Teflon tube was inserted and connected to a photoacoustic infrared gas analyser (Brüel and Kjaer 1302).

On-farm and laboratory datasets were analysed by SAS 8.0 (SAS Inst., Inc., Cary, NC, 1999), using the PROC MIXED procedure. Data were previously analysed for normality by the Shapiro Wilk test to ascertain the equal variances assumption. Data from manure incubation were base-10 log transformed to fit the normality test. Two model sets were used for statistical analysis. First, a model was carried out to test the effect of the diets on on-farm CH<sub>4</sub> concentrations. In this model, diet was the fixed effect and animal was used as a random effect. The interaction of diet and animal was studied. The second model was used for laboratory CH<sub>4</sub> concentrations and included diet and temperature as fixed effects, and animal as a random effect. The interaction between diet and temperature was also analysed. Differences were analysed by least squares means, and if differences were relevant, the LSD test was used to determine significant differences among treatments. Differences among treatments were considered significant at  $P < 0.05$ .

## Results and discussion

Feed DM intake did not differ among treatments and averaged 19.4 kg d<sup>-1</sup>. Forage:concentrate ratio was established around 50:50 for all diets. As expected, CP intake differed between treatments ( $P < 0.05$ ) and ranged between 438.6 and 522.8 g d<sup>-1</sup> N. Milk yield increased with a higher CP content of the rations ( $P < 0.05$ ) and averaged 24.2 kg d<sup>-1</sup> in HP, 23.7 kg d<sup>-1</sup> in MP diet and 22.1 kg d<sup>-1</sup> in LP diet. On-farm CH<sub>4</sub> concentrations did not respond to the different dietary CP levels ( $P > 0.05$ ). LP treatment averaged 63.5 ppm (SD 19.0), MP 66.0



ppm (SD 21.3) in the MP and 53.3 ppm (SD 8.3) in the HP diet. These concentrations spanned the range of gas concentrations expected for a typical dairy barn, which may vary from 15 ppm to 500 ppm of CH<sub>4</sub> (Kinsman *et al.*, 1995). Methanogenesis and subsequent CH<sub>4</sub> production and emissions in slurry depend strongly on temperature (Husted, 1994). However, no relationship was established between air temperature and CH<sub>4</sub> concentration in the current study ( $P > 0.05$ ). Mean temperature in the stall was 14.6 °C, ranging from 12.6 °C to 18.0 °C, and this range might have limited a likely positive effect. Nevertheless, when slurry was incubated at different temperatures in the laboratory, CH<sub>4</sub> concentration increased with increasing temperatures (Table 2). On average, CH<sub>4</sub> concentration increased 3.5 ppm by increasing temperature unit for all diets. As mentioned above, dietary treatments did not affect CH<sub>4</sub> concentration at laboratory level.

Table 2. Effect of temperature on CH<sub>4</sub> concentration (ppm) in incubated jars (mean and s.d.)

Temperature	LP	MP	HP
4 °C	56.9 <sup>a</sup> (14.3)	52.7 <sup>a</sup> (21.8)	46.0 <sup>a</sup> (6.9)
19 °C	82.8 <sup>b</sup> (22.1)	69.7 <sup>a</sup> (27.9)	73.7 <sup>a</sup> (24.8)
29 °C	131.0 <sup>c</sup> (48.6)	154.1 <sup>b</sup> (101.1)	130.0 <sup>b</sup> (106.5)

<sup>a,b,c</sup>Different superscripts within the same column indicate significant differences ( $P < 0.05$ ).

LP, MP, HP: see Table 1

## Conclusion

Based on the current results, it may be concluded that dietary protein manipulation did not have effect on CH<sub>4</sub> accumulation in stalls. Temperature was found to increase CH<sub>4</sub> concentration by 3.5 ppm per temperature unit in laboratory incubations.

## References

- Arriaga H., Pinto M., Calsamiglia S. and Merino P. (2009) Nutritional and management strategies on nitrogen and phosphorus use efficiency of lactating dairy cattle on commercial farms: an environmental perspective. *Journal of Dairy Science* 92, 204-215.
- Husted S. (1994) Seasonal variation in methane emission from stored slurry and solid manures. *Journal of Environmental Quality* 23, 585-592.
- Johnson K.A. and Johnson D.E. (1995) Methane emission from cattle. *Journal of Animal Science* 73, 2483-2492.
- Kinsman R., Sauer F.D., Jackson H.A. and Wolynez M.S. (1995) Methane and carbon dioxide emissions from dairy cows in full lactation monitored over a six-month period. *Journal of Dairy Science* 78, 2760-2766.

# Quantification of ley yield increase by climate change in mountainous regions of southern Norway

Baadshaug O.H.<sup>1</sup>, Haugen L.E.<sup>2</sup> and Skjelvåg A.O.<sup>1</sup>

<sup>1</sup> *Department of Plant and Environmental Sciences, Norwegian University of Life Sciences, P.O. Box 5003, N-1432 Ås, Norway*

<sup>2</sup> *Department of Hydrology, Norwegian Water Resources and Energy Directorate, P.O. Box 5091 Majorstua, N-0301 Oslo, Norway*

Corresponding author: ole.baadshaug@umb.no

## Abstract

The COUP – ENGNOR ley crop model for calculating fodder dry matter (DM) production was calibrated on data from field trials in southern Norway. By including a function for herbage net energy contents, in feed units lactation, the net energy production was estimated. Potential ley production at Fokstua (62° N, 970 m a.s.l.) for the period 1961-1990 was compared with that of a Hadley A2 climatic scenario for this site during the period 2071-2100. The scenario projects a temperature increase of 2-3 °C, and a lengthening of the growing season by approximately 1½ months, implying an appreciable increase in DM and fodder net energy production potential. The change would allow a new harvesting regime, with a relatively early first cut and two seasonal cuts. Impacts of the increased production potential in the mountainous districts of southern Norway towards the end of this century are considered. The value of ley plant breeding towards optimal combination of late seasonal growth with maximum winter hardiness will still be imperative.

Key words: Climatic change, crop model, feed net energy, ley, regrowth, timothy.

## Introduction

A large part of the Norwegian land reserves that are classified as reclaimable, i.e. with soil of depth and quality suitable for cultivation, lies in the mountainous regions of the south-eastern parts of the country at altitudes of 600-1100 m a.s.l (Grønlund, 1990). As the future temperature increases, as most relevant climatic scenarios indicate, cultivation at higher altitudes will be feasible and more profitable than today. Thus, considerable areas in south-east Norway may be available for increased food production. We have explored potentials and possible challenges encountered when extending fodder production to higher altitudes under a future climate.

## Materials and methods

The analytical tool of this work has been the COUP – ENGNOR crop modelling system, in which the COUP model (Jansson and Karlberg, 2001) simulates soil moisture and crop water uptake based on daily values of global radiation, temperature, precipitation, relative air humidity, and wind speed. These data were the inputs to simulations of plant production by the ENGNOR model (Baadshaug and Lantinga, 2002), which calculates total and harvestable ley yield from temperature, radiation, and soil moisture supply. The present model has been calibrated to weekly observations of growth rates of first and second growths of the two Norwegian timothy cultivars Grindstad and Engmo at the Norwegian University of Life Sciences' experimental farm (59.7° N, 80 m a.s.l.). Results from recent Norwegian field experiments allow calculation of herbage net energy concentration in milk production (FEM kg<sup>-1</sup> DM) (Bakken *et al.*, 2009). The projected future climate of the site Fokstua (62° N, 970

m a.s.l.) in this study is from downscaling the atmosphere-ocean general circulation model HadCM3H (from the Hadley Centre) with emission scenario A2 (Engen-Skaugen, 2007).

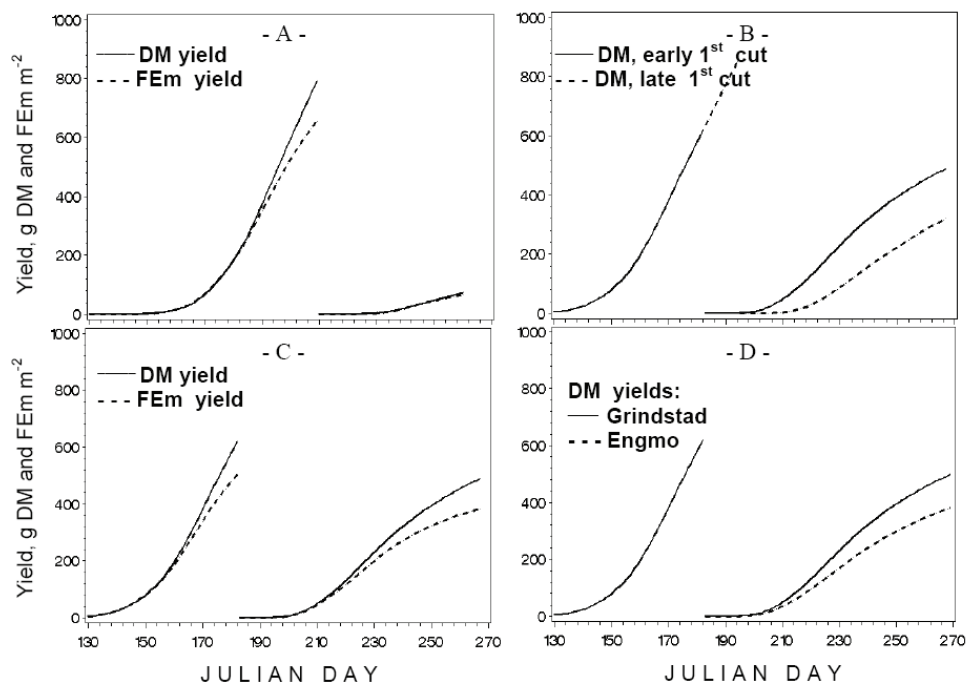

Figure 1. Estimated yields of DM and net energy units (FEm) by the ENGNOR crop growth model: (A) Spring growth and regrowth of a timothy ley at Fokstua (62°N, 970 m a.s.l) for the period 1961-1990. (B) DM yields of a two cutting regime for the scenario period 2071-2100. (C) DM and FEm yields for the period 2071-2100 by an early first harvest. (D) Early cutting regime comparison of regrowth DM yields between the common Norwegian timothy cultivar Grindstad and the extremely hardy one, Engmo.

## Results and discussion

The Hadley A2 scenario indicates only minor changes in precipitation, whereas the air temperature will increase by 2-3 °C, implying a lengthening of the growing season by approximately 1½ months. The appreciable effect of this change on the DM yield potential is seen from Fig. 1 A and B. The total yearly DM yield gains in the "new" climate were 41 and 49 % for early and late first-harvest, respectively. Thus, the DM yield loss by an early first cut, was not fully compensated by a better second growth. Due to the relatively low rating of net energy content in the second growth, the corresponding gains in total yearly FEm yield (not shown in the Fig 1B) were somewhat lower than for DM, 37 and 32 %. So, the superior quality obtained by an early first cut more than outweighed the loss in DM yield. In modern milk production practice, an early cut is most important to meet the high net energy concentration demand of a high yielding dairy cow. In addition, an early first harvest favours a maximum yield of protein, the concentration of which will decrease rapidly with developmental stage of the ley crop. The yields of DM and FEm for the early cut alternative (Fig. 1B) are shown in Fig. 1C.

The results in Fig. 1 A-C are relevant for the timothy cv. Grindstad, which, however, is usually not considered sufficiently winter-hardy for the highest altitudes. When choosing Engmo, a very hardy cultivar, to secure maximum winter survival, the yield gain from the warmer climate was somewhat reduced due to the less vigorous second growth of this far-north adapted cultivar (Fig. 1D). The gain in yearly DM yield when choosing this cultivar, was reduced from Grindstad's 41 to 26 percent, and that of FEm yield (not shown in Fig. 1D) from 37 to 23 percent. Such a choice can be necessary even in the future, since the climatic change may lead to impaired wintering conditions for perennial ley crops. The main problem will probably be warm spells during the winter, which may occur in the more variable climate that is also expected, and imply risk for ice crust formation on the grass fields. Therefore, in the case of timothy ley culture, hardy cultivars will probably still be highly relevant, to the cost of reduced seasonal yield whenever more than one harvest is practised.

## Conclusions

Our predictions suggest that the projected climatic change will strongly increase the agricultural production potential of the mountainous areas of Norway. However, combining vigorous regrowth and sufficient winter hardiness is also likely to remain a challenge under the projected climate change.

## References

- Baadshaug O.H. and Lantinga E. A. (2002) *ENGNOR, a Grassland Crop Growth Model for High Latitudes. Documentations*. Report no 2/2002, Reports from UMB. Dept of Plant and Environmental Sciences, Norwegian University of Life Sciences. 18 pp.
- Bakken A.K., Lunnan T., Höglind M., Harbo O., Langerud A., Rogne T.E. and Ekker A.S. (2009) Mer og bedre grovfôr som basis for norsk kjøtt- og mjølkeproduksjon. *Bioforsk Rapport 4 (38)*, 95 pp.
- Engen-Skaugen T. (2007). Refinement of dynamically downscaled precipitation and temperature scenarios. *Climate Change 84*, 365-382.
- Grønland A. (1990) *Fordeling av jordbruksarealer i ulike klimasoner*. In: Haglerød A. (ed.) *Konsekvenser for jordbruksproduksjonen av økte kliagassutslipp*. The Norwegian Agricultural Economics Research Institute, Report no. C-005-90, 21-25.
- Jansson P.-E. and Karlberg L. (2001) *Coupled Heat and Mass Transfer Model for Soil-plant-atmosphere Systems*. Royal Institute of Technology, Dept of Civil and Environmental Engineering, Stockholm, 325 pp.

# Evaluation of greenhouse gas emissions from fertilized grassland

Balezientiene L., Klimas E. and Bleizgys R.

Lithuanian University of Agriculture (LUA), Studentu 11, LT-53361, Akademija, Kaunas distr., Lithuania

Corresponding author: ligita.balezientiene@lzuu.lt

## Abstract

Since the Climate Change Convention (UNFCCC, 1994) and the Kyoto Protocol (1997) intergovernmental mitigation of climate change has become an increasing concern for scientists, public opinion and policy makers. We investigated biosphere-atmosphere interactions on a light loam soil (*Calc(ar)i-Endohypogleyic Luvisol*) in different managed grassland ecosystems of the training farm of the Lithuanian University of Agriculture in 2009, within the frame of a European COST Project. The objective of this investigation was to determine the impact of fertilizers, their rates and combinations on GHG emissions and productivity of natural and sown grassland.

GHG emission measurements were run in June-September, when meteorological conditions were optimal for intensive plant and soil biota physiological processes, in the absence of frost stress. In this study we compared fertilized natural and sown grasslands by using GHG emissions as indicator. This revealed stronger positive correlation ( $r = 0.8$ ) between applied monomial  $N_{60-240}$  fertilizers on GHG fluxes than of complex NPK fertilizers ( $r = 0.7$ ) in both natural and sown grasslands. Our results imply that  $N_2O$  emissions ( $0.02 \text{ mg h}^{-1} \text{ m}^{-2}$ ) were the same in natural and sown grasslands. Nonetheless,  $CO_2$  and  $CH_4$  emissions were less by  $3.09 \text{ mg h}^{-1} \text{ m}^{-2}$  and  $0.01 \text{ } \mu\text{g h}^{-1} \text{ m}^{-2}$ , respectively, in sown grassland, when the same fertilizer rate ( $N_{180}P_{41}K_{125}$ ) was applied.

Keywords: GHG emission, grassland, fertilization

## Introduction

Change of land management and intensification of agricultural production contribute significantly to anthropogenic greenhouse gas (GHG) emissions, accounting for a global flux of  $6.1 \text{ Pg yr}^{-1} \text{ CO}_2\text{-eq}$  which represent 10-12% of the total anthropogenic emissions (Smith *et al.*, 2007). The main emissions of GHG by agro-ecosystems are  $N_2O$  and  $CO_2$  fluxes between soil-plant systems and the atmosphere, and methane exchanges, mainly in animal husbandry. Depending on N fertilization, arable soils are responsible of producing 60%, or  $2.8 \text{ Pg yr}^{-1} \text{ CO}_2\text{-eq}$ , of the global anthropogenic emissions of  $N_2O$ . Agriculture contributes 9% GHG emissions in EU.

Grasslands and fertilized areas occupy about 20% of the Earth's land surface, generating considerable GHG emissions and increasing global climate change. Grasslands also form a significant part ( $1.2 \times 10^6 \text{ ha}$ , or 50%) of agricultural lands in Lithuania. Abandoned grasslands comprise over 40% of total grasslands in Lithuania, and these territories should be preserved from degradation. Fertilization conserves soil fertility, thereby allowing extensive use, which in turn prevents re-forestation. The objective of this investigation was to determine the impact of single and complex fertilizers, their rates and combinations on GHG emissions of natural and sown grasslands.

## Materials and methods

Field experiments were carried out on fertilized natural and sown grasslands at the training farm of the Lithuanian University of Agriculture (54.52 N, 23.50 E), Kaunas district. The soil

was *Calc(ar)i-Endohypogleyic Luvisol*), light clay loam topsoil over silt loam (artificial drainage). The humus horizon was 25 cm deep, soil pH was 6.97, humus content was 2.51%, P 105.6 mg kg<sup>-1</sup>, and K 103.3 mg kg<sup>-1</sup>. Soil samples were taken from 0-10 cm depth layer in triplicate with an auger. Soil pH was recorded potentiometrically using 1 N KCl extraction, mobile P and K (mg kg<sup>-1</sup> of soil) by the Egner-Riem-Domingo method. The N and NPK (synthetic fertilizer) application scheme with 4 replications (each plot 10 m<sup>2</sup>) in the natural sward was: Control (0); N<sub>60</sub>; N<sub>120</sub>; N<sub>180</sub>; N<sub>240</sub>; N<sub>180</sub>P<sub>41</sub>; N<sub>180</sub>K<sub>125</sub>; N<sub>60</sub>P<sub>14</sub>K<sub>42</sub>; N<sub>180</sub>P<sub>41</sub>K<sub>125</sub>. The sown grassland was fertilized with N<sub>180</sub>P<sub>41</sub>K<sub>125</sub>. P and K were applied before the vegetation period in early spring; N fertilizer was applied at two times: end of April and after 1<sup>st</sup> cut (beginning of July). Grassland productivity (g m<sup>-2</sup>) was determined by weighing (g m<sup>-2</sup> per treatment) fresh mass yield (in June and August) and obtaining dry matter yields (DM) after drying (105 °C). GHG emissions were monitored by a static chamber method using circular chambers (radius = 0.43 m, 0.05 m<sup>3</sup>) that were placed on permanently installed collars (10 cm deep), with 6 replicates per treatment (Breuer *et al.*, 2000). On each sampling date, the chambers were closed with an airtight lid, and the head space was sampled 3 times over a period of 2 hours. The measurements were done every 1-3 weeks between July and September in the absence of frost stress. The gas samples were analysed in the laboratory by an infrared gas analyzer (MGA3000). Daily net ecosystem CO<sub>2</sub>, CH<sub>4</sub> and N<sub>2</sub>O exchange (mg h<sup>-1</sup> m<sup>-2</sup>) were calculated by integrating the 60-minute fluxes determined by the meteorological measurements over each day.

Thermal and irrigation conditions during vegetation were characterized by the sum of monthly precipitation and active air temperature (>10 °C), accordingly to G. Selianinov (1928) hydrothermal coefficient (HTC). HTC was high in June and August (HTC = 2.0 and 4.0), indicating moisture abundance, optimal in July (HTC = 1.6), and low (HTK = 0.9) in September 2009, indicating dry conditions.

Results were evaluated by ANOVA using the Statistica package. The confidence limits of the data were based on Student's theoretical criterion. Standard error (SE) was calculated at the level of statistical significance  $P < 0.05$ .

## Results and discussion

Observed GHG emissions decreased during the vegetation period from June till September in parallel with decreasing soil moisture (HTK decreased from 2.0 to 0.9 and the lowest HTK was recorded in September in natural and cultural grasslands (Fig. 1). The highest monthly mean CO<sub>2</sub> emission (2.17 (Control)–11.04 (N<sub>180</sub>P<sub>41</sub>K<sub>125</sub>) mg h<sup>-1</sup> m<sup>-2</sup>) was induced presumably due to an ample C content in the soil and microbial activity stimulated by fertilizing. CH<sub>4</sub> emission was negligible during measurement periods possibly due to good drainage. Strong and medium cross correlation confirmed the response of CO<sub>2</sub>, N<sub>2</sub>O and CH<sub>4</sub> emission to soil pH ( $r = 0.6$ ; 0.7 and 0.4 respectively) and soil moisture ( $r = 0.5$ ; 0.7; 0.4 respectively).

Anthropogenic GHG fluxes from grasslands also significantly corresponded to inputs and forms of applied fertilizers. Impact of applied monomial N<sub>60-240</sub> fertilizers on increase of all GHG fluxes was higher ( $r = 0.8$ ) than that of complex NPK fertilizers ( $r = 0.7$ ). Mean emissions of productive (14.7 t ha<sup>-1</sup>) and intensively fertilized (N<sub>180</sub>P<sub>41</sub>K<sub>125</sub>) cultural grassland did not exceed emissions of fertilized natural swards. Though fertilizing increased grass yield (190.2 and 767.3 g m<sup>-2</sup> in Control and N<sub>180</sub>P<sub>41</sub>K<sub>125</sub>, respectively), it decreased the share of legumes and augmented emissions in natural grassland. In order to mitigate emissions, appropriate fertilizer rates should not exceed N<sub>60</sub>P<sub>14</sub>K<sub>42</sub>. Such fertilization conserves soil fertility, thereby allowing extensive use by grazing using undemanding cattle (or sheep or goats), which in turn prevents establishment of the climatic cenosis (i.e. forest) in natural grassland.

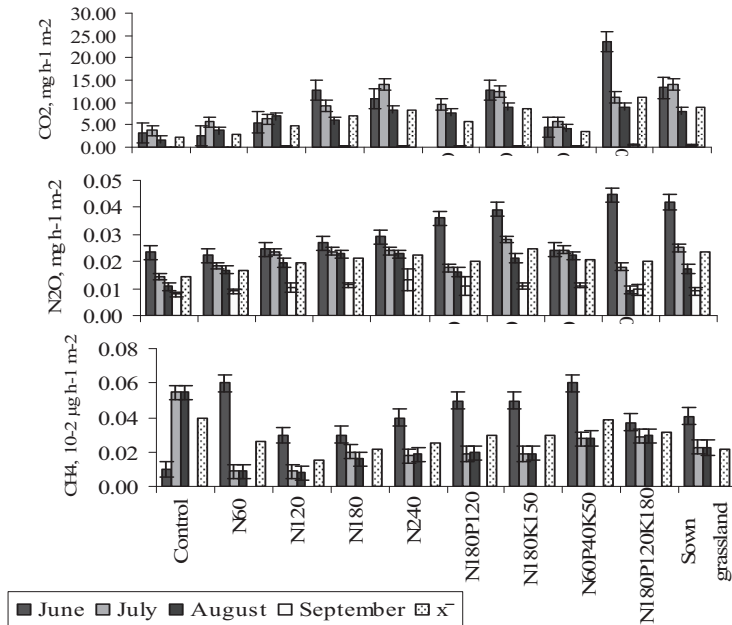

Figure 1. CO<sub>2</sub>, N<sub>2</sub>O and CH<sub>4</sub> exchange between crops and atmosphere in natural (Control - N<sub>180</sub>P<sub>41</sub>K<sub>125</sub>) and sown grasslands (N<sub>180</sub>P<sub>41</sub>K<sub>125</sub>) (mean ± SE)

## Conclusions

CO<sub>2</sub>, N<sub>2</sub>O and CH<sub>4</sub> mean emissions were nearly the same in natural and sown grasslands when the same fertilizers rate (N<sub>180</sub>P<sub>41</sub>K<sub>125</sub>) was applied. Emissions depended on nitrogen ( $r = 0.8$ ) and NPK ( $r = 0.7$ ) fertilizer rates and were influenced by abiotic environmental factors (soil pH and moisture, rainfall, mean day temperature). Therefore, fertilizer rates should not exceed N<sub>60</sub>P<sub>14</sub>K<sub>42</sub> in order to mitigate emissions from natural grassland and to conserve soil fertility.

## Acknowledgements

Research was carried in cooperation with ES COST ES0804 activity and supported by the Agency for International Science and Technology Development Programmes in Lithuania during 2009.

## References

- Smith P., Martino D., Cai Z., Gwary D., Janzen H., Kumar P., McCarl B., Ogle S., O'Mara F., Rice C., Scholes B. and Sirotenko O. (2007) *Agriculture. Climate Change 2007: Mitigation*. Contribution of WG3 to the FAR of the IPCC. Cambridge.
- Breuer L., Papen H. and Butterbach-Bahl K. (2000) N<sub>2</sub>O emission from tropical forest soils of Australia. *Journal of Geophysical Research* 105(D21), 26, 353–367.



## Carbon gain of C3 and C4 grasses in a dense canopy in the field

Berone G.D.<sup>1,2</sup>, Lattanzi F.A.<sup>1</sup> and Schnyder H<sup>1</sup>.

<sup>1</sup>Lehrstuhl für Grünlandlehre, Technische Universität München, Am Hochanger 1 D-85350 Freising-Weihenstephan, Germany.

<sup>2</sup>Estación Experimental Agropecuaria Rafaela, Instituto Nacional de Tecnología Agropecuaria, CC 22, (2300), Rafaela, Argentina.

Corresponding author: berone@wzw.tum.de

### Abstract

Daily carbon gain of a C3 (*Lolium perenne* L.) and a C4 (*Paspalum dilatatum* Poir.) species growing in a mixed dense canopy was assessed at the end of summer, in Argentina. Chambers of transparent acrylic glass received <sup>13</sup>C-enriched CO<sub>2</sub> continuously from 12:00 to 19:00 on a given day. Immediately after labelling, samples were harvested and carbon gain was estimated as plant carbon mass times the proportion of newly assimilated carbon. *P. dilatatum* contributed more than *L. perenne* to both canopy standing biomass (164 vs. 22 g per m<sup>2</sup> ground) and canopy carbon gain (830 vs. 120 mg C per m<sup>2</sup> and per h). Both species showed a similar ability to capture carbon per unit canopy mass (*P. dilatatum*=5.1; *L. perenne*=5.5 mg C per g C and h), which suggested that the C3/C4-grasses composition of the canopy was not changing. Tiller-level analysis revealed that in both species big tillers captured more carbon per unit mass than small tillers (asymmetric competition), and that the C3 and C4 grass species achieved a similar relative photosynthesis rate (mg C per g C and h) in different ways: high gross assimilation rate (mg C per m<sup>2</sup> and h) in *P. dilatatum*, and high leaf area ratio (m<sup>2</sup> per g C) in *L. perenne*.

Key words: C3 and C4 grasses, <sup>13</sup>C-labelling, carbon gain, competition.

### Introduction

Understanding the competition between C3 and C4 grasses is important because of the strong influence that the balance between these two functional groups has on ecosystem function (Wedin and Tilman, 1996). Understanding of the mechanisms determining the C3/C4 balance of dense canopies is emerging from studies of carbon gain based on leaf level photosynthesis models (e.g. Anten and Hirose, 2003). In this study, daily carbon gain of C3 (*Lolium perenne* L.) and C4 (*Paspalum dilatatum* Poir.) plants growing in a mixed dense canopy was measured with a novel approach based on <sup>13</sup>C-labelling. The aim was to analyse the partitioning of canopy carbon gain between the two species, and the role of the amount of leaf area per unit mass (LAR) and of carbon gain per unit leaf area (GAR) in determining the relative photosynthesis rate (RPR) of individual tillers in the canopy.

### Materials and methods

The experiment was carried out in the southeast of the *Pampas* region, in Argentina (37°45'S, 58°18'W), at the end of summer (15/03/08). The soil was a loam Mesic Fine Typical Argiudol, with an A horizon of 25 cm, 62 g kg<sup>-1</sup> organic matter, and pH 6.2, a textural B horizon, which presented no impediments to plant growth. Nutrients and water availability were high. Four chambers of transparent acrylic glass (0.3 x 0.6 x 0.3 m) were placed on a dense canopy (leaf area index=4.0; canopy height=28 cm) composed largely of a mixture of *L. perenne* (a C3 grass) and *P. dilatatum* (a C4 grass). The chambers received <sup>13</sup>C-enriched CO<sub>2</sub> (δ<sup>13</sup>C=398‰) at 380 μmol mol<sup>-1</sup>, during a 7-h labelling period (from 12:00 to 19:00 h). Air temperature during labelling averaged 25 °C, incident photosynthetically active photon

flux density averaged  $1326 \mu\text{mol m}^{-2} \text{s}^{-1}$ . Immediately after labelling, 30 individual tillers per species were harvested and photographed. Further, total aerial biomass was sampled in two quadrats ( $0.2 \times 0.2 \text{ m}$ ) and *L. perenne* and *P. dilatatum* plants were separated. Tillers harvested outside the labelling chambers served as unlabeled reference material for  $^{13}\text{C}$  content. Immediately after harvest, samples were dried at  $60^\circ\text{C}$  for 72 h, milled, weighed into tin cups and analysed by isotope ratio mass spectrometry to obtain carbon content and  $^{13}\text{C}/^{12}\text{C}$  isotope ratio. Blade area and extended height (length of the pseudostem + length of the youngest fully expanded blade) of each tiller were estimated by image analysis. The proportion of newly captured carbon per unit carbon mass ( $f_{\text{lab}}$ ) was estimated as,  $f_{\text{lab}} = (L - U)/(N - U)$ , where  $L$  and  $U$  are the  $^{13}\text{C}$  content of labelled and unlabelled plants, respectively, and  $N$  is the  $^{13}\text{C}$  content of plants grown continuously with the  $^{13}\text{C}$ -enriched  $\text{CO}_2$ . The latter was estimated assuming invariant discrimination between plants growing outside and inside the chambers (Schnyder *et al.*, 2003).  $f_{\text{lab}}$  is closely related to gross photosynthesis rate (RPR), as little tracer was respired and transferred belowground during the labelling period. Thus we equated  $f_{\text{lab}}$  with RPR. The allometric relationship between blade area ( $A$ ) and tiller carbon mass ( $M$ ),  $A = \alpha M^\beta$ , fitted by standardised major axis regression of  $\log(A) = \log \alpha + \beta \log(M)$ , served to derive leaf area ratio (LAR,  $\text{m}^2$  per g C) as  $\alpha M^{\beta-1}$ . Gross assimilation rate (GAR,  $\text{mg per m}^2$  and h) was then estimated as  $f_{\text{lab}}/\text{LAR}$ .

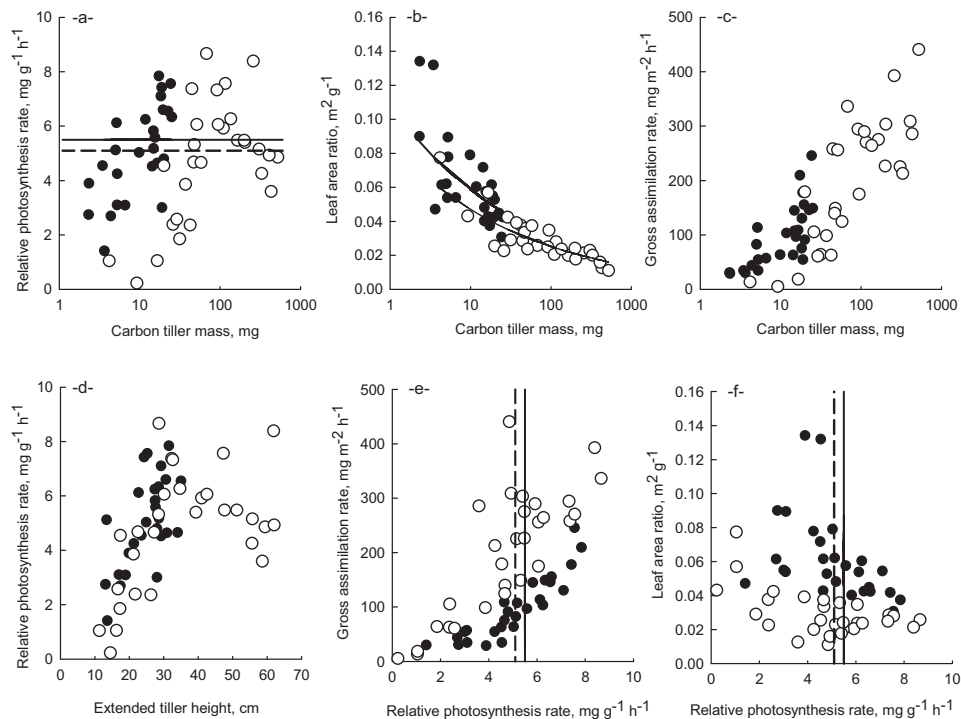

Figure 1. Relationships between tiller size and (a) relative photosynthesis rate, (b) leaf area ratio, (c) gross assimilation rate; (d) relationship between extended tiller height and relative photosynthesis rate; and relationships between relative photosynthesis rate and (e) gross assimilation rate and (f) leaf area ratio of individual *L. perenne* (filled circles) and *P. dilatatum* (open circles) tillers. Lines in (a), (e) and (f), indicate the relative photosynthesis rate of total aerial biomass of *L. perenne* (continuous) and *P. dilatatum* (dotted) in the canopy.

## Results and discussion

*P. dilatatum* (C4) contributed more than *L. perenne* (C3) to both standing biomass (164 vs. 22 g C per m<sup>2</sup> ground) and canopy carbon gain (830 vs. 120 mg C per m<sup>2</sup> ground and h). However, both species showed a similar ability to capture carbon per unit mass (RPR, *P. dilatatum*=5.1; *L. perenne*=5.5 mg C per g C and per h). This relationship, referred to as symmetric competition because species accumulated resources in direct proportion to their size (Weiner, 1990), means the balance between C3 and C4 species did not change.

In both species, smaller tillers had a lower RPR than bigger tillers due to very low GAR not fully compensated by increased LAR (Fig. 1a,b,c). This probably resulted from their short stature and consequent subordinate (i.e. shaded) position within the canopy (Fig. 1d). This situation of asymmetric competition (cf. Weiner, 1990) implied that the difference in size among individuals was increasing, meaning that in both species the smaller tillers were being self-thinned. In agreement, in both species the canopy-level RPR was slightly higher (1.1 times) than the RPR of the average tiller (Fig. 1a).

In *P. dilatatum*, RPR increased up to a tiller size of ~70 mg C per tiller (~30 cm extended tiller height). Above that it was stable or even decreased (Fig. 1a,d). This was due to a decreasing LAR (a consequence of the increased size) and to a stabilisation, or slightly decrease, of GAR (Figs. 1b,c). The latter response may reflect a stabilisation in light interception per unit area, suggesting that increments beyond this extended height either led to minor improvements in the light environment. In fact biggest tillers of *P. dilatatum*, had an increasingly extended height, but they were not taller than canopy height (28 cm).

Contrasting mechanisms explained the similar canopy-level RPR of these two competing species: *P. dilatatum* showed higher GAR and *L. perenne* higher LAR (Figs. 1e,f). Higher GAR in the C4 species may be due to the higher photosynthetic capacity of C4 plants at 27°C (Long, 1999). Higher LAR in *L. perenne* than in *P. dilatatum* tillers was due in part to an intrinsically higher blade area per unit mass (scaling coefficient  $\alpha = 1.13$  vs. 0.91, respectively), but mainly to their smaller size, as in both species, as tillers grew bigger less blade area was produced per unit tiller carbon mass (scaling exponent  $\beta = 0.721$ ).

In conclusion, combining carbon gain data at canopy- and at tiller-level indicated that a presumably stable C3/C4-grasses composition of the canopy can be achieved through different mechanisms: less carbon investment per unit leaf area in *L. perenne*, and higher carbon gain per unit leaf area in *P. dilatatum*.

## References

- Anten N.P.R. and Hirose T. (2003) Shoot structure, leaf physiology and daily carbon gain of species in a tall-grass meadow. *Ecology* 84, 955-968.
- Long S.T. (1999) Environmental Responses. In: R.F. Sage R.F., and Monson R.K.(eds) *C<sub>4</sub> Plant Biology*, Academic Press, Toronto Canada, pp. 215-249.
- Schnyder H., Schäufele R., Löttscher M. and Gebbing T. (2003) Disentangling CO<sub>2</sub> fluxes: direct measurements of mesocosm-scale natural abundance <sup>13</sup>CO<sub>2</sub>/<sup>12</sup>CO<sub>2</sub> gas exchange, <sup>13</sup>C discrimination, and labeling of CO<sub>2</sub> exchange flux components in controlled environments. *Plant, Cell and Environment* 26, 1863-1874.
- Wedin D.A. and Tilman D. (1996) Influence of nitrogen loading and species composition on the carbon balance of grasslands. *Science* 274, 1720-1723.
- Weiner J. (1990) Asymmetric competition in plants. *Trends in Ecology and Evolution* 5, 360-364.

# **AFLP analysis of genetic differentiation in legume germplasm in contrasting environments**

Collins R.P.<sup>1</sup>, Frankow-Lindberg B.E.<sup>2</sup>, Helgadóttir Á.<sup>3</sup>, Skøt L.<sup>1</sup>, Jones C.<sup>1</sup> and Skøt K.P.<sup>1</sup>

<sup>1</sup>*IBERS, Aberystwyth University, Plas Gogerddan, Aberystwyth SY23 3EB, Wales (UK)*

<sup>2</sup>*SLU, Dept. of Crop Production Ecology, SE-750 07 Uppsala, Sweden*

<sup>3</sup>*Agricultural University of Iceland, Keldnaholti, 112 Reykjavík, Iceland*

Corresponding author: rpc@aber.ac.uk

## **Abstract**

We used AFLP (amplified fragment length polymorphism) markers to analyse changes in population genetic differentiation ('genetic shift') over time in red and white clover germplasm, and to assess the effect of contrasting sites (Iceland, Sweden and the UK) on the magnitude of these changes. The AFLP technique successfully identified populations in which genetic shift had occurred. The clearest evidence of this was in Sweden within the short time span of three years. This site showed the greatest annual amplitude in temperature during the experiment and was also the driest, and one or both of these factors may have exerted strong directional selective pressure on the populations grown there.

Keywords: AFLP markers, forage legumes, genetic shift

## **Introduction**

Extending the use of forage legumes through plant breeding requires not only the exploitation of a wider range of genetic diversity but also information about the rate and direction of genetic change within populations being cultivated at the margin of their natural species distribution, e.g. in the cold regions of Northern Europe. The process of adaptation in plant populations implies changes in allele frequency in response to environmental changes (Pérez de la Vega, 1997), and this is commonly referred to as 'genetic shift'. Environment plays a major role in determining the genetic structure of populations, and it appears that the outbreeding propensity and generally high levels of genetic heterogeneity found in red and white clover favour the occurrence of genetic shift in morpho-physiological traits in response to environmental factors. However, genetic diversity within populations of cultivated crops is often reduced in variety breeding programmes due to strong selection for phenotypic uniformity (Hagen and Hamrick, 1998) and this could affect their adaptive capacity. The creation of forage legume populations in which morphological diversity has been greatly increased is a strategy that could be used to improve yield stability in environments that are prone to periods of biotic or abiotic stress (Annicchiarico and Piano, 1997). In this project we used AFLP markers to analyse population genetic structure in red and white clover germplasm differing in morphological diversity, and to assess whether cultivation of this germplasm in contrasting sites over a number of years produced genetic shift.

## **Materials and methods**

AFLP markers were used to assess the genetic diversity within and between red and white clover populations grown at three sites: Iceland (IS) (Korpa: 64°09'N, 21°44'W; 30 m a.s.l.), Sweden (SE) (Svalöv: 56°55'N, 13°07'E; 55 m a.s.l.) and UK (AB) (Aberystwyth: 52°26'N, 4°01'W; 30 m a.s.l.). Meteorological data for each site were recorded over the duration of the experiment. Average daily values for rainfall, minimum, mean and maximum air temperatures, and daily growing degree days (DGDD; base temperature = 5 °C) were

obtained for winter, spring, summer and autumn. At each site monoculture plots of red and white clover were established from seed of (i) one single variety of each species; (ii) wide genetic base (WGB) composite populations of each species, comprising 'Central European' (WGB-C) and 'Northern European' (WGB-N) populations (Frankow-Lindberg *et al.*, 2009). The four WGB populations were constructed at IBERS, Aberystwyth (UK) from a mixture of commercial cultivars and gene pool material and were thus morphologically diverse. The 'WGB-N' populations of both species were sown in IS, 'WGB-C' in the UK and all four composite populations in SE. After three to five years, depending on site, leaf samples were collected from random survivor genotypes within a subset of the sown populations. In IS samples were collected from the white and red clover WGB-N populations, and from the white clover variety Norstar (N). At this site samples were also collected from a 'wild' population of white clover adapted to local conditions (W). In SE samples from red clover, survivors were collected from the populations WGB-C and WGB-N and from the variety Fanny (F); samples from white clover survivors were collected from the populations WGB-C and WGB-N and from the variety Ramona (R). In AB survivor samples were collected from the red clover variety Merviot (M). The number of survivor genotypes sampled in each population ranged from 31-96. 'Original' populations (O) within both species were created by growing plants from seed in a glasshouse in IBERS, Aberystwyth, from the same seed-lots used to sow the initial populations. All the 'WGB original' (WGB-O) populations comprised 96 genotypes; the single variety original populations comprised 31-48 genotypes. In each population, samples of approximately 50 mg fresh weight were collected from one actively expanding leaf per plant and total genomic DNA was extracted from this. Fluorescent AFLP analysis was carried out on 100 ng of DNA from each sample using the procedures described by Skøt *et al.* (2005). The presence or absence of amplified bands was transformed into a data matrix and analysed using the program AFLP-SURV, which estimated a number of population genetic diversity and structure parameters. Here we focus on the proportion of the total gene diversity occurring between, compared to within populations, (*Fst*), calculated according to the method of Lynch and Milligan (1994). A value of 1 indicates no alleles in common between populations; zero indicates that they are identical.

## Results and discussion

The three sites differed substantially in terms of climate. The magnitude of temperature differences between sites was maximised using the parameter DGDD. The largest seasonal fluctuations in DGDD were recorded in SE, which was also substantially drier than the other sites. In red clover (Table 1a) the environment in SE produced convergence in AFLP markers in both the WGB populations sampled at this site i.e. *Fst* between the WGB original populations (0.039) was greater than that between the SE survivors (0.029). Similarly, in the SE environment the genetic distance between the survivor population of variety Fanny and both WGB survivor populations was reduced compared to the distance between the corresponding original populations. However, the red clover WGB-N population sampled in IS was more genetically different from that sampled in SE (0.087) than it was from the original germplasm (0.076), indicating that there were different selection pressures acting on it at these two sites. The red clover varieties Merviot and Fanny were clearly distinct both before (0.092) and after (0.090) selection at their respective sites (AB and SE). A similar pattern of genetic differentiation emerged in white clover (Table 1b): in both WGB populations the survivors sampled in SE were more similar (0.037) than were the original populations (0.047), whereas the WGB-N survivors from IS were genetically much closer to their original population (0.03) than to the WGB-N survivors from SE (0.115). There was evidence of genetic convergence between the survivor population of variety Ramona and the two WGB survivor populations in SE. Survivor populations of the white clover varieties

Ramona and Norstar, selected in SE and IS respectively, were more genetically different from each other (0.215) than were their original populations (0.189). The ‘wild’ white clover sampled in IS was genetically very different from all other white clover populations. Many red and white clover populations cultivated in SE responded to this environment by converging genetically. Cultivation in IS imposed selection pressure in a different direction to SE. In general, WGB populations were more prone to genetic shift than were single varieties.

Table 1. Pairwise genetic differentiation ( $F_{st}$ ) between (a) red and (b) white clover original (O) and survivor populations of varieties and WGB composite populations.

(a) Red clover									
	WGB-N-O	WGB-N-IS	WGB-N-SE	WGB-C-O	WGB-C-SE	M-O	M-AB	F-O	
WGB-N-IS	0.076								
WGB-N-SE	0.077	0.087							
WGB-C-O	0.039	0.042	0.058						
WGB-C-SE	0.099	0.087	0.029	0.058					
M-O	0.109	0.127	0.082	0.072	0.069				
M-AB	0.096	0.099	0.064	0.066	0.063	0.016			
F-O	0.108	0.138	0.074	0.082	0.090	0.092	0.086		
F-SE	0.105	0.137	0.037	0.083	0.062	0.096	0.090	0.036	

(b) White clover									
	WGB-N-O	WGB-N-IS	WGB-N-SE	WGB-C-O	WGB-C-SE	R-O	R-SE	N-O	N-IS
WGB-N-IS	0.030								
WGB-N-SE	0.106	0.115							
WGB-C-O	0.047	0.052	0.085						
WGB-C-SE	0.099	0.093	0.037	0.052					
R-O	0.155	0.174	0.196	0.146	0.197				
R-SE	0.155	0.174	0.057	0.132	0.089	0.172			
N-O	0.071	0.065	0.127	0.095	0.127	0.189	0.195		
N-IS	0.095	0.087	0.153	0.116	0.154	0.202	0.215	0.022	
W-IS	0.210	0.208	0.248	0.213	0.260	0.305	0.301	0.169	0.136

## References

- Annicchiarico P. and Piano E. (1997) Response of white clover genotypes to intergenotypic and interspecific interference. *Journal of Agricultural Science, Cambridge* 128, 431-437.
- Frankow-Lindberg B.E., Brophy C., Collins R.P. and Connolly J. (2009) Biodiversity effects on yield and unsown species invasion in a temperate forage ecosystem. *Annals of Botany* 103, 913-921.
- Hagen M.J. and Hamrick J.L. (1998) Genetic variation and population genetic structure in *Trifolium pratense*. *The Journal of Heredity* 89, 178-181.
- Lynch M. and Milligan B.G. (1994) Analysis of population genetic structure with RAPD markers. *Molecular Ecology* 3, 91-99.
- Pérez de la Vega M. (1997) Plant genetic adaptedness to climatic and edaphic environment. In: Tigerstedt P.M.A. (ed.) *Adaptation in plant breeding*. Proceedings of the XIV EUCARPIA Congress, Jyväskylä, Sweden, 27-38.
- Skot L., Humphreys M.O., Armstead I., Heywood S., Skot K.P., Sanderson R., Thomas I., Chorlton K.H. and Sackville Hamilton N.R. (2005) An association mapping approach to identify flowering time genes in natural populations of *Lolium perenne* (L.). *Molecular Breeding* 15, 233-245.



# Greenhouse gas inventory for grasslands in the Basque Country in 1990 and 2008

del Hierro O., Artetxe A. and Pinto M.

*NEIKER-Tecnalia. Berreaga, 1. 48160 Derio (Basque Country, Spain).*

Corresponding author: odelhierro@neiker.net

## Abstract

The countries that have ratified the United Nations Framework Convention on Climate Change have the obligation to report their greenhouse gas (GHG) inventories. Grasslands cover about 30% of the area of the Basque Country, so the objective of this study was to calculate, according to IPCC guidelines, emissions and removals in 1990 and 2008 concerning grasslands, that are included in the Agriculture and LULUCF (Land Use, Land-Use Change and Forestry) sectors of GHG inventories, in order to provide valuable information for developing research strategies and management practices to enhance C sequestration in grasslands of the Basque Country. A total of 513 Gg CO<sub>2</sub>-eq was emitted from the Agriculture sector related to grasslands in 2008 (31% lower than in 1990). Total removals from the LULUCF sector related to grasslands in 2008 were 289 Gg CO<sub>2</sub>-eq (42% lower than in 1990). Thus, considering Agriculture and LULUCF sectors together, grasslands were an emission source of GHG, emitting 224 Gg CO<sub>2</sub>-eq in 2008 (6% lower than in 1990). Although not calculated, uncertainties were high, indicating the need for more research on monitoring of land-use changes in grassland area (e.g. through remote sensing technology) and on improving emission factors (particularly those related to organic carbon contents in grasslands and to enteric fermentation).

Keywords: CO<sub>2</sub>, grassland, LULUCF, Basque Country, emission, removal

## Introduction

The countries that have ratified the United Nations Framework Convention on Climate Change (UNFCCC) have the obligation to report their GHG inventories, according to IPCC guidelines, to the Secretariat of UNFCCC. These inventories must cover all the UNFCCC sectors, including emissions from the energy, industrial processes, solvent and other product use, agriculture and waste sectors and emissions and removals from the LULUCF sector. Grasslands occupy around 220000 ha of the Basque Country (about 30% of the total area). They may represent a major carbon (C) stock which can be increased by appropriate management. The objective of this work was to estimate the emissions and removals related to grasslands, because this could provide valuable insight for developing research strategies and management practices in order to enhance C sequestration in grasslands and mitigate GHG emissions in the Basque Country.

## Material and methods

GHG emissions and removals related to grasslands were collected from the latest IPCC guidelines prepared for Agriculture and LULUCF sectors (volume 4 from IPCC, 2006). To provide a direct comparison of the effects of the non-CO<sub>2</sub> greenhouse gases relative to CO<sub>2</sub> (CO<sub>2</sub>-eq), each gas mass was multiplied by the Global Warming Potential (GWP<sub>100</sub> of 1, 25 and 298 for CO<sub>2</sub>, CH<sub>4</sub> and N<sub>2</sub>O, respectively).



### *Agriculture sector*

Emissions of methane from enteric fermentation in livestock, and methane (CH<sub>4</sub>) and nitrous oxide (N<sub>2</sub>O) emissions from manure management were estimated according to the IPCC 2006 methodology. The methods for estimating CH<sub>4</sub> and N<sub>2</sub>O emissions from livestock require data on livestock subcategories and annual populations, which were obtained from annual census. However, only cattle, horses, goats and sheep were considered, because other livestock do not graze and their manure is not applied to grasslands. Based on statistical information, an average mineral N fertilization of 60 and 10 kg ha<sup>-1</sup> y<sup>-1</sup> was considered for grasslands in 1990 and 2008, respectively.

### *LULUCF sector*

Area data were multiplied by a carbon stock coefficient or 'emission factor' (default data from IPCC, 2006) to provide the source or sink estimates. Based on information about land area derived from agricultural census and forest inventories, areas of grassland remaining grassland, and changes in land-uses categories concerning grassland, were obtained for 1990 and 2008. These areas were divided into three grassland classes (permanent grassland, scrubland and other pastures) and into two climatic zones (warm temperate wet or dry); it was assumed the same soil type (soils with high activity clay minerals, dominated by 2:1 minerals).

Grassland remaining as grassland includes managed pastures which have been under grassland vegetation for 20 or more years. Land conversions include cropland or land-use categories converted to grassland -or the inverse- within the last 20 years. In both cases the GHG inventory involved estimation of changes in C stock from five carbon pools (above-ground biomass, below-ground biomass, dead wood, litter and soil organic matter). Emissions of non-CO<sub>2</sub> gases from grassland burning were not included.

Table 1. GHG emission and removal estimates (in annual CO<sub>2</sub>-equivalents) related to grasslands. Removals with negative (-) sign and emissions with positive (+).

Source	CO <sub>2</sub> -eq (Gg y <sup>-1</sup> )	
	1990	2008
CH <sub>4</sub> from enteric fermentation	461	336
CH <sub>4</sub> from manure management	74	36
N <sub>2</sub> O from manure management	23	19
N <sub>2</sub> O from direct soil emissions (DSE): synthetic fertilizers	29	5
N <sub>2</sub> O from DSE: manure applied to soils	36	27
N <sub>2</sub> O from DSE: N in residues returned to soils	13	10
N <sub>2</sub> O from indirect soil emissions (ISE): N excretion on pasture	42	39
N <sub>2</sub> O from ISE: atmospheric deposition, leaching and run-off	61	41
Total emissions of Agriculture sector derived from grassland	739	513
CO <sub>2</sub> from grassland remaining grassland (GG)	0	- 120
CO <sub>2</sub> from forest land converted to grassland (FG)	14	10
CO <sub>2</sub> from cropland converted to grassland (CG)	- 513	- 51
CO <sub>2</sub> from grassland converted to forest land (GF)	0	- 135
CO <sub>2</sub> from grassland converted to settlements (GS)	0	9
Total emissions/removals of LULUCF sector derived from grassland	- 499	- 288
TOTAL	239	224

## **Results and discussion**

In 1990 and 2008, 68% and 56% respectively, of the emissions derived from the Agriculture sector were removed by the LULUCF sector. Considering the Agriculture and LULUCF sectors together, grasslands emitted 239 Gg CO<sub>2</sub>-eq in 1990; emissions were about 6% lower in 2008 (Table 1).

Regarding the Agriculture sector, a total of 739 Gg CO<sub>2</sub>-eq was emitted in 1990 from enteric fermentation, manure management, and direct and indirect soil emissions derived from grasslands. These emissions decreased by 31% in 2008, mostly due to the reduction of emissions from enteric fermentation because there were fewer dairy cows in 2008. In both years, enteric fermentation was responsible for more than 60% of the emissions and enteric fermentation plus manure management accounted for more than 75% of the total emissions. About 72% of emissions from grassland were in the form of CH<sub>4</sub>.

Total removals related to LULUCF sector in 1990 were nearly 500 Gg CO<sub>2</sub>-eq and decreased by 42% in 2008, mainly due to a reduction of the cropland area converted to grassland, but grassland continued being net sink. In 1990, conversion CG removed 513 Gg CO<sub>2</sub>-eq from the atmosphere, but this removal decreased to 51 Gg CO<sub>2</sub>-eq in 2008. In 2008, conversion GF was the most relevant activity for fixing CO<sub>2</sub> (135 Gg CO<sub>2</sub>-eq), followed by changes in the proportions of permanent grassland, scrubland and other pastures (120 Gg CO<sub>2</sub>-eq from GG). Therefore, in addition to changes between land-uses, changes in grassland management were also important in 2008.

The influence of changes in grassland management could not be evaluated in 1990, due to a lack of data. Hence it was assumed that proportions of permanent grassland, scrubland and other pastures remained constant from 1971 to 1990 and, thus, the balance of emissions and removals equalled zero for GG in 1990. Although not calculated, uncertainties of changes in grassland area were very high, particularly in 1990. In fact, the role of technology like remote sensing is under scrutiny given its potential for systematic observations and for the provision of data extending back over several decades. The emission factors - mainly those related to soil - were a second source of uncertainty that should be improved.

## **Conclusion**

In the Basque country, grasslands were a net source of GHG because the net emissions of the Agriculture sector were higher than the net removals of the LULUCF sector. Considering the extent of grassland in the Basque Country and its potential as C sink, research efforts should firstly improve estimates of land-use changes particularly for 1990 and, secondly, get better emission factors (particularly those related to organic carbon contents in grasslands and to the enteric fermentation).

## **Acknowledgement**

This study was supported by IHOBE (Environment Department of the Basque Country).

## **References**

IPCC (2006) *IPCC Guidelines for National Greenhouse Gas Inventories, prepared by the National Greenhouse Gas Inventories Programme*. Eggleston H.S., Buendia L., Miwa K., Ngara T., and Tanabe K. (eds.), IGES; Japan.

# Fertiliser value and environmental impact of digestate application on permanent grassland

Dieterich B.<sup>1</sup>, Finnan J.<sup>2</sup>, Hepp S.<sup>1</sup>, Hochstrasser T.<sup>1</sup> and Müller C.<sup>1,3</sup>

<sup>1</sup>*School of Biology and Environmental Science, University College Dublin, Ireland*

<sup>2</sup>*Teagasc, Oak Park, Carlow, Ireland*

<sup>3</sup>*Institute of Plant Ecology, University of Gießen, Germany*

Corresponding author: Burkart.Dieterich@web.de

## Abstract

Fertiliser value and trace gas emissions after application (CH<sub>4</sub>, N<sub>2</sub>O) of digestate are evaluated. Biomass yields and trace gas emissions were measured at four levels of mineral N addition over one growing season. Our results suggest that the mineral N in digestate is less efficient for the support of plant growth than chemical fertiliser. However, digestate may have environmental advantages, as total specific trace gas emissions were found to be lower.

Keywords: biogas, digestate, fertiliser, grassland, methane, nitrogen, nitrous oxide

## Introduction

Digestate from biogas production could be used as a fertiliser (Braun, 2007), but may lead to methane (CH<sub>4</sub>) emissions due to its population of methanogenic micro-organisms. The objectives of our study are to establish the fertiliser value and trace gas emissions (N<sub>2</sub>O, CH<sub>4</sub>) from digestate applied to permanent grassland in the Republic of Ireland. Results from the first year are presented.

## Materials and methods

The trial was laid out with four replicates on long-term set-aside grassland on sandy soil at Oak Park near Carlow, a Teagasc research station. Mean annual temperature is 9.4 °C and mean rainfall is 785 mm. Treatments consisted of four levels of mineral nitrogen (N) application (equivalent to about 60, 120, 200 and 320 kg ha<sup>-1</sup>), applied either as chemical fertiliser (calcium ammonium nitrate, CAN) or as digestate, one combined treatment (320 kg ha<sup>-1</sup> N) and a control receiving no N fertiliser. The volume of digestate was based on its concentration of mineral N (2.8 g l<sup>-1</sup> on average) rather than total N (5.4 g l<sup>-1</sup>). Digestate was applied manually to the soil surface by a trailing shoe attached to a watering can. The combined treatment received digestate on the first and third fertilisation and CAN on the second fertilisation. Fertilisation was carried out in April, May and July in line with common practice for a three-cut system in Ireland. P and K were added such as to be non-limiting.

For sampling of trace gases (CH<sub>4</sub>, N<sub>2</sub>O), closed chambers were installed in the 0N, 120N and 320N plots of both fertilisers and the combined treatment. Gas samples were usually withdrawn 3 times after chamber closure, the first sample was taken immediately and subsequent samples usually after 30 and 60 min. All samples were analysed as soon as possible on a gas chromatographer (Shimadzu GC-2014). Gas sampling was concentrated around the dates of fertiliser application and sampling was continued until the fluxes had ebbed down to background. There was a total of 29 sampling occasions after the three fertiliser applications. Trace gas fluxes were calculated for each plot and fertiliser application by linear interpolation between the measured values to determine emissions per fertiliser application. Global warming potentials were derived by converting these emissions into CO<sub>2eq</sub>. (Forster *et al.*, 2007). Annual CO<sub>2eq</sub> emissions were calculated by adding emissions

from the three fertiliser applications. Specific emissions ( $\text{kg t}^{-1}$ ) were then calculated by division by the respective annual dry matter (DM) yield.

## Results and discussion

DM response to applied mineral N ( $N_{\text{min}}$ ) was steeper for CAN than for digestate, but it levelled off at the highest application rates (Figure 1).

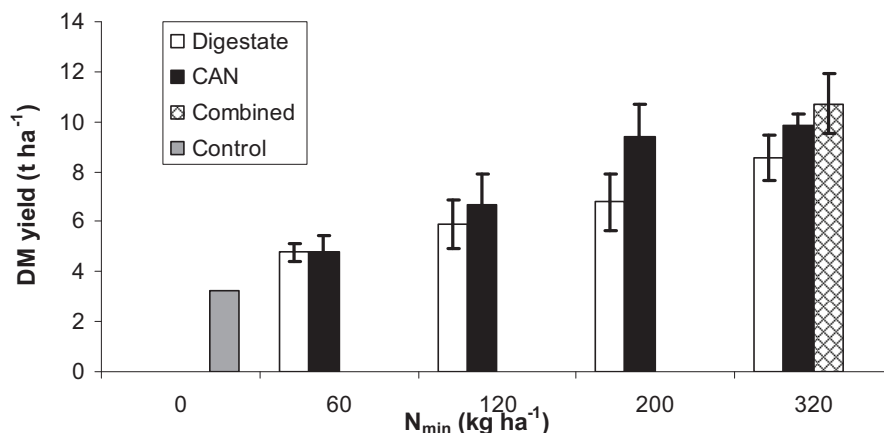

Figure 1. Dry matter yields ( $\text{t ha}^{-1}$ ). Error bars show one standard deviation.

A possible explanation is volatilisation of ammonia ( $\text{NH}_3$ ) from digestate, which is an important pathway of N loss from organic fertilisers (Wulf *et al.*, 2002). However,  $\text{NH}_3$  volatilisation was not measured in this study. The highest yield was achieved from the combined treatment. A possible explanation for the performance of the combined treatment is improved N retention due to the organic carbon in digestate.

A steep increase in the environmental impact per tonne of biomass produced was observed with increasing fertilisation (Table 1).  $\text{CH}_4$  peaks after digestate application were short-lived, so the contribution of  $\text{CH}_4$  to total emissions was negligible. In the 0 N and 120 kg CAN treatment, specific emissions from  $\text{N}_2\text{O}$  alone are higher than from  $\text{N}_2\text{O}$  and  $\text{CH}_4$  together. This is due to a net uptake of  $\text{CH}_4$  in these treatments.  $\text{N}_2\text{O}$  emissions did not follow a clear pattern. They were especially high after the first application of CAN. Plots fertilised with digestate showed lower release of  $\text{N}_2\text{O}$ , which resulted in lower specific emissions of greenhouse gases (Table 1). Rainfall in 2009 was high at 1124 mm, which may have affected emissions of  $\text{N}_2\text{O}$  via high soil water contents (Granli and Bockman, 1994).

Even though emissions from digestate application appear smaller than from CAN, one has to keep in mind that the full greenhouse gas balance was not measured in this experiment. First, linear interpolation between the samplings after fertiliser application probably represents an underestimate of total fluxes because some peaks in emissions may have gone undetected. Moreover, emissions were only recorded after fertilisation events. Second, the more vigorous growth of grass under high fertilisation may have led to higher sequestration of C, thus offsetting some of the emissions. Third,  $\text{NH}_3$  can contribute to indirect  $\text{N}_2\text{O}$  formation (Mosier *et al.*, 1998) but was not measured. Therefore, there are unknown factors in the greenhouse gas balance.

While the agronomic importance of early fertilisation of grassland in spring is stressed in standard books (e.g. Finch *et al.*, 2002), our observation of large  $\text{N}_2\text{O}$  emissions after the first

fertilisation indicated that there may be environmental benefits to delay the first fertilisation until the plants can efficiently take up the available N. Overall, it seems that digestate may have good potential as a fertiliser on grassland, possibly in combination with chemical fertiliser, but further research is required.

Table 1. Specific CO<sub>2eq</sub> emissions per tonne of dry biomass +/- standard deviation. Numbers for the treatments indicate annual application of mineral N in kg. CAN chemical fertiliser treatment, DIGESTATE digestate treatment, COMBINED combined digestate/CAN treatment.

Treatment	Specific emission from N <sub>2</sub> O alone (kg t <sup>-1</sup> )	Specific emission from N <sub>2</sub> O and CH <sub>4</sub> together (kg t <sup>-1</sup> )
Control (0 N)	4.8 ± 5.9	4.7 ± 5.8
120 CAN	114.5 ± 57.3	114.3 ± 57.3
320 CAN	351.4 ± 147.2	351.6 ± 147.5
120 DIGESTATE	12.3 ± 4.6	12.6 ± 4.6
320 DIGESTATE	64.1 ± 24.3	66.4 ± 23.7
320 COMBINED	50.4 ± 9.4	51.7 ± 9.8

## Acknowledgements

This investigation is part of a larger project financed by the Department of Agriculture, Fisheries and Food of the Republic of Ireland (Research Stimulus Programme, RSF 07-506).

## References

- Braun R. (2007) Anaerobic digestion: a multi-faceted process for energy, environmental management and rural development. In: Ranalli P. (ed.) *Improvement of crop plants for industrial end-uses*, Springer, Berlin, pp. 335-416.
- Finch H.J.S., Samuel A.M. and Lane G.P.F. (2002) *Lockhart and Wiseman's crop husbandry*. 8ed: Woodhead Publishing, Cambridge. Establishing and improving grassland, pp. 420-434.
- Forster P., Ramaswamy V., Artaxo P., Bernsten T., Betts R., Fahey D.W., Haywood J., Lean J., Lowe D.C., Myhre G., Nganga J., Prinn R., Raga G., Schulz M. and Van Dorland R. (2007) Changes in atmospheric constituents and in radiative forcing. In: Solomon S., Qin D., Manning M., Chen Z., Marquis M., Averyt K.B., Tignor M. and Miller H.L. (eds.) *Climate change 2007: The physical science basis*. Cambridge, Cambridge University Press, pp. 129-234. [http://ipcc-wg1.ucar.edu/wg1/Report/AR4WG1\\_Pub\\_Ch02.pdf](http://ipcc-wg1.ucar.edu/wg1/Report/AR4WG1_Pub_Ch02.pdf).
- Granli T. and Bockman O.C. (1994) Nitrous oxide from agriculture. *Norwegian Journal of Agriculture*, Supplement 12.
- Mosier A., Kroeze C., Nevison C., Oenema O., Seitzinger S. and van Cleemput O. (1998) Closing the global N<sub>2</sub>O budget: nitrous oxide emissions through the agricultural nitrogen cycle. *Nutrient Cycling in Agroecosystems* 52, 225-248.
- Wulf S., Maeting M. and Clemens J. (2002) Application technique and slurry co-fermentation effects on ammonia, nitrous oxide, and methane emissions after spreading: I. Ammonia volatilization. *Journal of Environmental Quality* 31, 1789-1794.

# Change in carbon balance of a dry calcareous grassland caused by spontaneous afforestation

Ferlan M.<sup>1,2</sup>, Eler K.<sup>1</sup>, Alberti G.<sup>3</sup>, Vodnik D.<sup>1</sup>, Peressotti A.<sup>3</sup>, Miglietta F.<sup>4</sup>, Simončič P.<sup>2</sup> and Batič F.<sup>1</sup>

<sup>1</sup> *University of Ljubljana, Biotechnical faculty, Ljubljana, Slovenia*

<sup>2</sup> *Slovenian Forestry Institute, Ljubljana, Slovenia*

<sup>3</sup> *DISA - University of Udine, Italy*

<sup>4</sup> *CNR-IBIMET – Firenze, Italy*

Corresponding author: mitja.ferlan@gozdis.si

## Abstract

Changes in land use represent one of the most important components of global environmental change. An experimental site has been established in the Slovenian Karst (Submediterranean climate region) with the aim to investigate the effects of land use change on ecosystem carbon cycling. Paired eddy flux measurement design was used in order to assess net ecosystem exchange (NEE) of two ecosystems: extensively used dry grassland and abandoned grassland invaded by woody plants. The use of two eddy towers allowed us to detect the influence of land use change on C fluxes. In this work we present one year of measurements with the emphasis on distinct responses of NEE of both ecosystems to short term effects such as rain pulses.

Keywords: calcareous grassland, eddy covariance, NEE, woody plant encroachment.

## Introduction

The proliferation of woody plants in grasslands has the potential to profoundly influence hydrology, biogeochemistry, biodiversity, and future land use options in the affected areas. Many studies propose that it can lead to carbon storage in these ecosystems, but there are also reports (Jackson *et al.*, 2002) that woody plant encroachment into grasslands has resulted in ecosystem carbon loss. There are limited reports on net ecosystem exchange (NEE) in transitional areas where there is plant conversion from grasslands to woodlands (e.g. Scott *et al.* 2006) which indicate the potential for increased carbon sequestration. However, in dry regions this potential is very dependent on precipitation patterns (Potts *et al.* 2006). The aim of our study was to estimate the net CO<sub>2</sub> exchange for extensively used dry calcareous grassland in a Submediterranean climate region that is invaded by woody plants.

## Materials and methods

In August 2008 micrometeorological and meteorological measurements were applied over two sites located at Podgorski kras plateau in South West Slovenia (45°33' N, 13°55' E, 400-430 m a.s.l.). Rendzina soil developed on the paleogenic limestone bedrock prevails. Soil depth is very uneven ranging from 0 cm (rocky outcrops) to several decimeters in soil pockets between rocks. The area was subjected to widespread land-use changes in the last decades. The previously (over)grazed pastures were largely abandoned and are being slowly overgrown by shrubs and trees. Within the study area two study sites were chosen on the basis of current and historic land use. The grassland site has been used more or less permanently as a low intensity pasture in the last decades. The succession site which is abandoned for at least three decades is covered by small trees and shrubs occupying 40% of the surface. The average height of the tree layer, which is mostly represented by *Quercus*

*pubescens*, is 7 m. Above-ground woody biomass is around  $100 \text{ m}^3 \text{ ha}^{-1}$ . The slope of the sites does not exceed 3 degrees.

Eddy covariance systems and other meteorological measurements were installed on both research sites. The instruments were installed at 15 m and 2 m height at the succession and grassland site, respectively. The applied methodology for eddy covariance flux data evaluation followed the Euroflux protocol with the Webb Pearman Leuning correction.

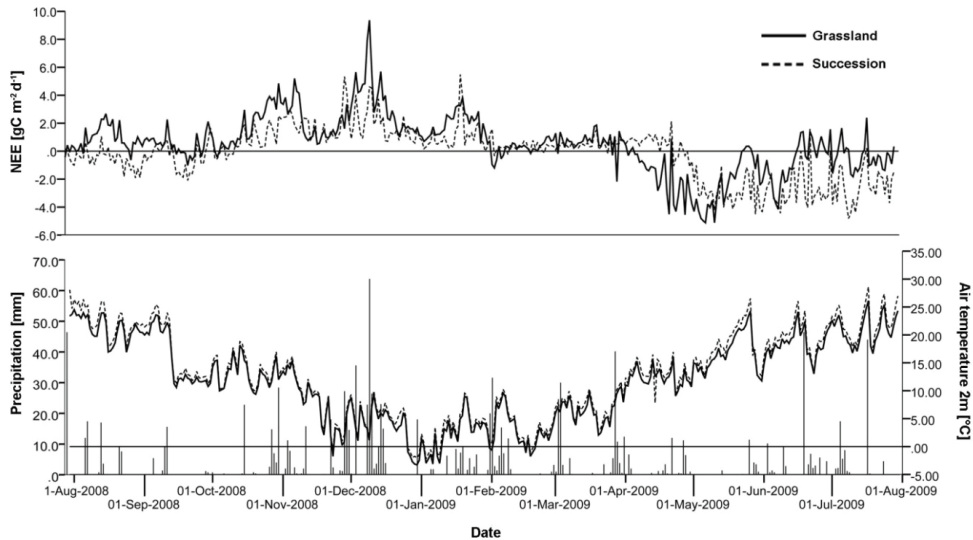

Figure 1: Daily values of eddy covariance based net ecosystem exchange, precipitation and air temperature for grassland and succession ecosystem for the period August 2008 – August 2009.

## Results and discussion

In the first year of carbon exchange measurements (1 August 2008 – 1 August 2009) the grassland was a net carbon source, emitting  $195 \text{ g m}^{-2} \text{ C}$  and the succession site was a weak carbon sink sequestering of  $-63 \text{ g m}^{-2} \text{ C}$ . Despite the difficulty of inference from one year of measurements, the GPP of the investigated ecosystems were quite low, indicating generally low productivity of the investigated ecosystems. However, paired measurements allow us to compare the responses of both ecosystems to some environmental factors. There is apparently an almost one-month lag of the succession site before it becomes a net sink for carbon. The onset of negative NEE on the succession site matches the burst of leaves of the trees. Since both sites are similar in composition of their herbaceous layer, in phenological development of its main species and in peak biomass ( $244 \pm 60 \text{ g of dry mass m}^{-2}$  on grassland vs.  $227 \pm 80 \text{ g m}^{-2}$  on the succession site), it can be concluded that the shifts of the C balance are mainly governed by the activity of forest fragments. There is no indication of higher losses of carbon on the succession site in the period before the start of the vegetation period, which might theoretically decrease the net sink capacity of the ecosystem. Evidently the grassland was a net sink for carbon for a brief period of time. After roughly 4 months the daily carbon balance was again positive, indicating the specific phenology of grassland species which is a well known adaptation to frequent summer droughts in Mediterranean ecosystems. The succession site remained a net sink for much of the summer, which is again mostly attributed to the invaded trees and shrubs and to a lesser degree to more green herbaceous vegetation under



the trees. Carbon fixation of forest fragments ceased in mid October 2009. In the winter period, when gross primary production (GPP) is absent or negligible, the grassland site had larger carbon losses than the succession site. There is no clear explanation for this phenomenon since the grassland site had much less dead plant biomass prone to decomposition and smaller living plant biomass performing respiration. Additionally, there is a difference in the response of both ecosystems to drought and high temperature. In the grassland there was an apparent halt of GPP at the end of May 2009 (in the period of the most intensive growth) which is attributed to a short drought episode with high temperatures. The response of the succession site to these conditions is not perceivable, indicating generally a larger buffer capacity of the succession site to drought stress.

There was a strong and instantaneous increase in CO<sub>2</sub> emissions during rainfall events. The increase is especially profound in autumn and winter period and less so in spring, suggesting that the availability of fresh litter might contribute significantly. It is not clear yet if this increase is solely the effect of increased litter decomposition and soil respiration as suggested by Inglima *et al.* (2009) or whether water induced displacement of CO<sub>2</sub> enriched soil air.

## Conclusions

We observed that woody plant encroachment can significantly shift the C-balance of the ecosystem. Despite undefined contributions of limestone weathering and the fact that eddy covariance measurements could be influenced by spatial heterogeneity of the karstic ecosystem, we estimate that the yearly difference of NEE between the grassland and invaded sites can be largely attributed to the length of the growth season. This study also suggests some possible benefits of silvopastoral systems in semi-arid climates, where scattered trees and shrubs may decrease the sensitivity to environmental perturbation and increase ecosystem carbon sequestration.

## References

- Inglima I., Alberti G., Bertolini T, Vaccari F. P., Gioli B., Miglietta F., Cotrufo M. F. and Peressotti A. (2009) Precipitation pulses enhance respiration of Mediterranean ecosystems: the balance between organic and inorganic components of increased soil CO<sub>2</sub> efflux. *Global Change Biology* 15, 1289–1301.
- Jackson R.B., Banner J.L., Jobbágy E.G. Pockman W.T. and Wall D.H. (2002) Ecosystem carbon loss with woody plant invasion of grasslands. *Nature* 418, 623-626.
- Potts D.L., Huxman T.E., Scott R.L., Williams D.G. and Goodrich D.C. (2006) The sensitivity of ecosystem carbon exchange to seasonal precipitation and woody plant encroachment. *Oecologia* 150, 453-463.
- Scott R.L., Huxman T.E., Williams D.G. and Goodrich D.C. (2006) Ecohydrological impacts of woody-plant encroachment: seasonal patterns of water and carbon dioxide exchange within a semiarid riparian environment. *Global Change Biology* 12, 311-324.

# Using a dynamic system simulation model to assess the effects of climate change on grass-based dairy systems in Ireland

Fitzgerald J.B.<sup>1</sup>, Holden N.M.<sup>2</sup> and Brereton A.J.<sup>2</sup>

<sup>1</sup>*Crops Research Centre, Teagasc, Oak Park, Carlow, Ireland*

<sup>2</sup>*UCD Bioresources Research Centre/Biosystems Engineering, UCD School of Agriculture, Food Science and Veterinary Medicine, University College Dublin, Belfield, Dublin 4, Ireland*

Corresponding author: Joanne.Fitzgerald@ucd.ie

## Abstract

Ireland has experienced a rise of 0.7 °C in mean temperature over the last century and this trend is predicted to continue and accelerate. Dairy production is an important mainstream agricultural enterprise in Ireland and it is important to evaluate if current systems can adapt to climate change. A dairy system simulator, Dairy\_sim, was designed for assessing the interaction of climate and management on grass-based systems. Two scenarios were defined as a basis for evaluation. The first, a maximised production scenario assumed the greatest output on a given land area. It was found that dairy production under this scenario should readily adapt to climate change and production will increase by 2080 when compared with the baseline (1961-1990). The second scenario was based on current environmental legislation with limited stocking rates and N and was known as the minimum input scenario. Dairy\_sim indicated that grass production would exceed animal demand for minimum input systems by 2080, on both well- and poorly-drained soils. It is predicted that this increase in production will require adaptation of the current low-input dairy system to the altered atmosphere and climate.

Keywords: Grass-based, dairy, climate change, model, simulation

## Introduction

Dairying has been the most profitable farming enterprise in Ireland in recent years. The most common system is a spring-calving system which utilises grazed grass as the main feed source during lactation. Approximately 90% of feed consumed is grazed grass or silage produced on-farm. Climate is an important element to consider in the management system and, therefore, it is important to evaluate the potential effects of climate change on dairying in Ireland. In Ireland it is predicted that winters will be milder and wetter, and summers will be warmer and dryer by 2100.

## Materials and methods

A dairy system simulator, Dairy\_sim, was developed in order to assess the interactions between climate and management in grass-based dairy production (Fitzgerald *et al.*, 2005). The simulator contains several components including a grass-growth model (incorporating CO<sub>2</sub> response), an intake/grazing model, an energy demand model and a soil model (Fitzgerald *et al.*, 2008). In order to assess climate change impacts on dairy systems, two context scenarios were defined. The first was a maximised production scenario, whereby the greatest output of milk (within the confines of the grass-based system) for a given land area was evaluated. If a workable system, based on current management principles could be found, then the system would be regarded as capable of adaptation. A second context scenario, whereby production was limited by environmental and husbandry legislation, was also

defined. This was known as the minimum input scenario. Climate change impact was evaluated by looking at changes in system properties such as stocking rate, grass yield and silage supply following simulations for baseline 1970 (1961-1990), 2020 (2010-2039) and 2080 (2070-2099) climates (Fitzgerald *et al.*, 2009). The climate data used came from an Ensemble Mean (EnsM) dataset derived by statistical downscaling by Fealy and Sweeney (2008).

## Results and discussion

For the maximised production scenario, results indicated that farms on both well- and poorly-drained soils would become more productive per hectare in 2080 than for the baseline period (Figure 1). Greatest productivity increases were seen in the North-Eastern part of Ireland. This pattern can largely be attributed to the effects of earlier spring growth on the system. In baseline years, it was the later arrival of spring and associated higher temperatures which affected productivity in these locations (Fitzgerald *et al.*, 2005).

The low-cost, low-input system in the minimum input scenario experienced significant impacts due to climate change. When CO<sub>2</sub> enrichment was accounted for, there was quite a significant increase in DM production at each of the four locations examined. This varied from a fractional increase of 0.27 to 0.32 in DM production when compared with baseline years (Table 1). This means that there was an excess of DM production when compared with animal demand. This means that low-cost low-input systems will need to diversify and adapt but it is not envisaged that climate change will affect the profitability of these systems in a negative manner.

Table 1. The fractional change in DM production, silage excess and change in housing days in 2020 and 2080 with a CO<sub>2</sub> response as compared with the baseline period for well-drained (WD) and poorly drained (PD) soils (1961-1990) for the minimum input scenario.

Location		DM Production		Silage Excess		Housing Days	
		(fraction)		(fraction)		(days)	
		WD	PD	WD	PD	WD	PD
Claremorris	2020	0.00	0.06	-0.01	0.38	0.03	-5.50
	2080	0.32	0.34	4.35	2.23	-40.17	-23.00
Kilkenny	2020	0.02	0.00	0.44	0.03	-5.93	-1.63
	2080	0.27	0.20	9.13	2.64	-38.23	-8.87
Mullingar	2020	0.03	0.01	0.70	0.06	-6.03	1.83
	2080	0.30	0.20	7.84	1.31	-39.18	-2.83
Valentia	2020	0.02	0.02	0.15	0.12	n/a	-7.27
	2080	0.27	0.23	1.95	1.40	n/a	-17.87

Figure 1. The fractional change in stocking rate in 2080 as compared with baseline period (1961-1990) for well drained and poorly drained soils.

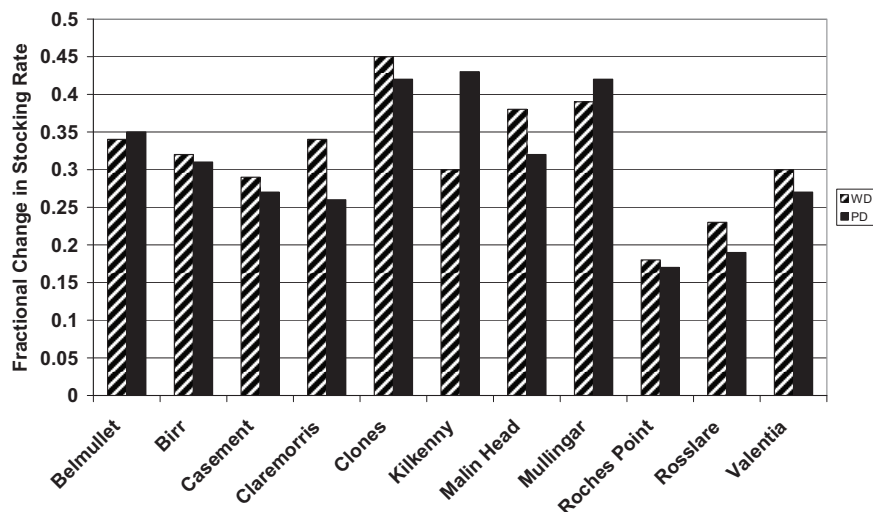

## Conclusion

For the maximum production scenario it was predicted that low-cost, grass-based dairy production could achieve sufficient adaptations for agrometeorological conditions forecast for 2080 to remain a viable system of production. For the minimum input scenario, simulations using Dairy\_sim suggested that it will not be possible to maintain the current low-input dairy system as it currently stands with climate change and CO<sub>2</sub> enrichment into the future.

## References

- Fealy R. and Sweeney J. (2008) Statistical downscaling of temperature, radiation and potential evapotranspiration to produce a multiple GCM ensemble mean for a selection of sites in Ireland. *Irish Geography* 41 (1) 1-27.
- Fitzgerald J. B., Brereton A. J. and Holden N. M. (2005) Assessment of regional climate variation effects on the management of dairy cow systems in Ireland using a simulation model. *Grass and Forage Science* 60 (3), 283-296.
- Fitzgerald J. B., Brereton A. J. and Holden N. M. (2008) Simulation of the influence of poor soil drainage on grass-based dairy production systems in Ireland. *Grass and Forage Science* 63 (3), 380-389.
- Fitzgerald J. B., Brereton A. J. and Holden N. M. (2009) Assessment of the adaptation potential of low-cost grass-based dairy systems to climate change in Ireland – the maximised production scenario. *Journal of Agriculture and Forest Meteorology* 149 (2), 244-255.

# Reduction of N<sub>2</sub>O emissions from grasslands under Atlantic conditions with the use of inhibitors (Basque Country, northern Spain)

Menéndez S.<sup>1</sup>, Merino P.<sup>2</sup>, Pinto M.<sup>2</sup>, González-Murua C.<sup>1</sup> and Estavillo J.M.<sup>1</sup>

<sup>1</sup>*Department of Plant Biology and Ecology. University of the Basque Country, Apdo. 644. E-48080 Bilbao, Spain.*

<sup>2</sup>*NEIKER, B<sup>o</sup> Berreaga, 1. E-48160 Derio. Bizkaia. Spain.*

Corresponding author: sergio.menendez@ehu.es

## Abstract

Intensively managed grasslands are a potentially large source of N<sub>2</sub>O emissions because of the total input of nitrogen fertilizers. Addition of nitrification inhibitors (NI) or urease activity inhibitors to fertilizers could reduce these losses to the atmosphere. In our studies N<sub>2</sub>O losses were evaluated as well as the effect of the nitrification inhibitors dicyandiamide (DCD) and 3,4-dimethylpyrazol phosphate (DMPP) and the urease activity inhibitor N-(n-butyl) thiophosphoric triamide (NBPT) on N<sub>2</sub>O emissions. The study was carried out after the application of ammonium sulphate nitrate, urea or cattle slurry to a mixed clover-ryegrass sward in the edafoclimatic conditions of the Basque Country (northern Spain). Results showed that efficiency of inhibitors in reducing N<sub>2</sub>O emissions varied according to environmental conditions. DMPP reduced losses up to 42% in ammonium sulphate nitrate fertiliser and 69% in slurry. NBPT showed reduction efficiencies of 8% with urea fertiliser and 13% with slurry.

Keywords: DCD, denitrification, DMPP, NBPT, nitrification

## Introduction

The inefficient use of nitrogen fertilizers can lead to large N losses which, apart from economic loss, can lead to undesirable ecological problems such as nitrate leaching or hazardous gas emissions such as nitrous oxide (N<sub>2</sub>O). In the European Union (EU-15), 40% of the direct soil emissions are attributed to fertilizer application; similarly another 21% is related to manure application (EEA 2006).

Previous studies in the Basque Country of Spain (Estavillo *et al.*, 1994 and 1996), which were carried out with soil incubations, determined that denitrification was the main N loss in grassland. It was found that the greatest losses were in spring and autumn following fertilisation events. Annual denitrification losses (N<sub>2</sub>O + N<sub>2</sub>) were about 10-15% of the applied N, and in some periods after fertilization a peak of 20-37% was reached (Estavillo *et al.*, 1994). In order to reduce gaseous emissions to the atmosphere, nitrification inhibitors, such as dicyandiamide (DCD) or 3,4-dimethylpyrazole phosphate (DMPP), and the inhibitor of the urease activity N-(n-butyl) thiophosphoric triamide (NBPT) have been developed.

Over the last years the efficiency of different mitigation strategies has been assessed under the edafoclimatic conditions of the Basque Country (Macadam *et al.*, 2003; Merino *et al.*, 2005; Menéndez *et al.*, 2006; Menéndez *et al.*, 2009). This manuscript is a review of those findings.

## Materials and methods

All the experiments were carried out in a cut grassland in the Basque Country (northern Spain) in which a randomized complete block design with four replicates was established. Each experimental plot covered an area of 12 m<sup>2</sup> (4 × 3 m). The meteorological conditions of the location during the different assays are described in Table 1.

Three different fertilizers were applied: ammonium sulphate nitrate (M), cattle slurry (S) and urea (U). Application rates are detailed in Table 2. DCD and DMPP were applied at a rate of 25 kg ha<sup>-1</sup> and 1 kg ha<sup>-1</sup> respectively. NBPT was applied at a rate of 0.076 mL per liter of slurry. In the case of urea NBPT was applied at a rate of 0.2%.

N<sub>2</sub>O emissions after fertilizer application were measured using a closed air circulation technique in conjunction with a photoacoustic infrared gas analyser (Brüel and Kjaer 1302 Multi-Gas Monitor) for 40 minutes after chamber placing (Menéndez *et al.*, 2006). Cumulative gas emissions during the sampling period were estimated using the average flux in two successive determinations, multiplying it by the length of the period between the measurements, and adding that amount to the previous cumulative total. Percentages of N<sub>2</sub>O emissions reduction by inhibitors were subjected to statistical analysis (ANOVA,  $P \leq 0.05$ ).

Table 1. Climatic characteristic during the different trials (WFPS: soil water content expressed as percentage of water filled pore space).

Experiment	Date	Mean Air Temperature (°C)	Mean Soil Temperature (°C)	Total Rainfall (mm)	Mean WFPS (%)
1	Autumn 1998	14.7	14.2	337.8	79.7
2	Autumn 2001	8.0	6.5	170.6	75.9
3	Autumn 2002	15.8	14.3	112.6	75.7
4	Spring 2003	19.6	17.8	114.4	60.9
5	Spring 2005	15.2	13.6	214.8	71.1

Table 2. Nitrogen application rates, length of experiment, cumulative N<sub>2</sub>O emissions (%) and efficiency of different nitrification inhibitors and urease activity inhibitors in the five experiments.

Experiment	Treatment†	Rate (ha <sup>-1</sup> )	Date	Length (day)	% of applied N without inhibitor	% of applied N with inhibitor	% of reduction with inhibitor
1	M (DCD)	80 kg N	Autumn 1998	20	1.55	0.90	41.9
	S (DCD)	85 kg NH <sub>4</sub> <sup>+</sup> -N	Autumn 1998	20	1.45	0.58	60.2
2	M (DMPP)	125 kg N	Autumn 2001	60	6.02	2.54	57.8
	S (DMPP)	125 kg NH <sub>4</sub> <sup>+</sup> -N	Autumn 2001	60	2.35	0.91	61.2
3	S (DMPP)	135 kg NH <sub>4</sub> <sup>+</sup> -N	Autumn 2002	22	8.52	2.67	68.7
4	M (DMPP)	97 kg N ha <sup>-1</sup>	Spring 2003	59	4.58	4.17	8.9
	S (DMPP)	97 kg NH <sub>4</sub> <sup>+</sup> -N	Spring 2003	59	15.97	11.32	29.1
	U (NBPT)	70 kg N	Spring 2005	29	3.46	3.17	8.4
5	S (DMPP)	70 kg NH <sub>4</sub> <sup>+</sup> -N	Spring 2005	29	3.26	3.00	8.0
	S (NBPT)	70 kg NH <sub>4</sub> <sup>+</sup> -N	Spring 2005	29	3.26	2.83	13.2

† M, ammonium nitrate sulphate; DCD, dicyandiamide; S, slurry; DMPP, 3,4-dimethylpyrazole phosphate; U, Urea; NBPT, N-(*n*-butyl) thiophosphoric triamide.

## Results and discussion

Results show that N<sub>2</sub>O-N emission rates from non fertilized grasslands were usually below 0.1 kg ha<sup>-1</sup> day<sup>-1</sup>; even so, occasionally they reached 0.17 kg ha<sup>-1</sup> day<sup>-1</sup>. When plots were fertilised, N<sub>2</sub>O-N losses increased to 1.3 kg ha<sup>-1</sup> day<sup>-1</sup> when soil and weather conditions were suitable for denitrification processes (data not shown). Cumulative losses reached up to 16% of the applied N, depending on the type of fertiliser and weather conditions. These losses took place in experiment 4 where soil water content, expressed as Water Filled Pore Space (WFPS), was 60% (field capacity) and both nitrification and denitrification occurred at the same time (Table 1). Moreover, it is known that denitrification is highly correlated to carbon availability (Reddy *et al.*, 1982), with low soil organic matter content (<1.8%) being the limiting factor for denitrification. Results suggested that the slurry would provide soil

microorganisms with easily available carbon that is a source of energy for denitrification in the presence of nitrate. This would lead as well to the creation of anaerobic micro-sites in the soil during microbial respiration, hence increasing the denitrification rates. Based on this, the highest losses occurred when the conditions were optimal.

Furthermore, when WFPS was above 70%, denitrification was the main observed process, finding losses in the form of  $N_2$  instead of  $N_2O$ . This would explain the lower percentage of losses in other experiments compared to experiment 4. The inhibitor's efficiency was different in each experiment (Table 2). In autumn, DCD reduced losses by up to 42% and 60% in mineral and slurry fertilizers, respectively, while DMPP reduced them up to 58% and 69%, respectively. In the experiments carried out during spring (experiments 4 and 5), the efficiency of DMPP was lower, reducing losses by 9% and 30% when it was applied to both mineral and slurry fertilizers. With respect to NBPT, which was only tested in experiment 5, an inhibition efficiency lower than 14% was observed. If we compared it with DMPP, NBPT was more efficient than DMPP when it was applied to slurry. DMPP efficiency varied between autumn and spring, thus suggesting that environmental conditions constrained inhibition effectiveness (Table 1). The conditions found in experiment 5, high rainfall and warm temperature, could lead to a faster degradation or leaching of both inhibitors.

## Conclusions

Maximum losses depended on the fertilizer type as well as the weather conditions and soil water content, as these conditions can affect soil mineralization, nitrification or denitrification rates. The efficiency of inhibitors was also affected by these conditions. DMPP reduced losses by up to 42% and 69% when it was applied to mineral fertilizer and slurry, respectively. Meanwhile NBPT should be tested under different conditions in order to observe its maximum efficiency.

## Acknowledgements

This project was funded by the Ministry of Science and Innovation (AGL2009-13339-CO2-01) and (SUM2006-00017-CO3-02) and by the Basque Government (ETORTEK, K-EGOKITZEN).

## References

- EEA (2006) *Annual European Community greenhouse gas inventory 1990-2004 and inventory report 2006*. European Environment Agency, Copenhagen.
- Estavillo J.M., Rodriguez M., Domingo M., Muñoz-Rueda A. and González-Murua C. (1994) Denitrification losses from a natural grassland in the Basque Country under organic and inorganic fertilization. *Plant and Soil* 162, 19-29.
- Estavillo J.M., Rodriguez M. and González-Murua C. (1996) Nitrogen losses by denitrification and leaching in grassland. *Fertilizer Research* 43, 197-201.
- Macadam X.M.B., del Prado A., Merino P., Estavillo J.M., Pinto M. and González-Murua C. (2003) Dicyandiamide and 3,4-dimethyl pyrazole phosphate decrease  $N_2O$  emissions from grassland but dicyandiamide produces deleterious effects in clover. *Journal of Plant Physiology* 160, 1517-1523.
- Menéndez S., Merino P., Pinto M., González-Murua C. and Estavillo J.M. (2006) 3,4-Dimethylpyrazole phosphate effect on nitrous oxide, nitric oxide, ammonia, and carbon dioxide emissions from grasslands. *Journal of Environmental Quality* 35, 973-981.
- Menéndez S., Merino P., Pinto M., González-Murua C. and Estavillo J.M. (2009) Effect of N-(n-butyl) thiophosphoric triamide and 3,4 dimethylpyrazole phosphate on gaseous emissions from grasslands under different soil water contents. *Journal of Environmental Quality* 38, 1-9.
- Merino P., Menéndez S., Pinto M., González-Murua C. and Estavillo J.M. (2005) DMPP reduces nitrous oxide emissions from grassland after slurry application. *Soil Use and Management* 21, 53-57.
- Reddy K.R., Rao P.S.C. and Jessup R.E. (1982). The effect of carbon mineralization on denitrification kinetics in mineral and organic soils. *Soil Science Society of American Journal* 46, 62-68.



# Evapotranspiration from grassland with contact to groundwater

Misztal A. and Zarzycki J.

*University of Agriculture in Kraków, Kraków, Poland*

Corresponding author: rmmiszta@cyf-kr.edu.pl

## Abstract

The paper presents the results of lysimetric analysis of actual evapotranspiration and water use efficiency from grass communities. The study was carried out in the Małe Pieniny mountain area on brown soils (about 600 m above sea-level). The actual evapotranspiration of grasslands correlated with their yield. The highest evapotranspiration (over 550 mm) was found on a 3-cut meadow, which was also characterized by the highest yield. Pasture yield was 20-30% less than meadow yield, which also reduced the amount of water lost through evapotranspiration by 15-20%. For lawns (cut every 10 days) the amount of water lost through evapotranspiration did not exceed 350 mm. The lowest water use efficiency ( $1.4 \text{ g dm}^{-3}$ ) was found for low-yielding unfertilized meadow. The fertilization increased DM yield and improved water use efficiency, which under the high fertilization level exceeded  $3.3 \text{ g dm}^{-3}$ . It was found that evapotranspiration was significantly correlated with dry matter yield and in the case of 3-cut meadow also with contact to groundwater.

Keywords: grasslands, actual evapotranspiration, water use efficiency

## Introduction

Evaporation has a profound effect on the water cycle and energy flow in nature. Water use during biomass production is one of the major uses of water resources in agricultural catchments and impacts water runoff. In turn, the extent and temporal distribution of evapotranspiration depends on many correlated parameters that characterize the state of atmosphere, plant cover, yield level and soil moisture.

## Materials and methods

This study is based on lysimeter measurements taken during 1974-1999 at the Institute for Land Reclamation and Grassland Farming in Jaworki (Małe Pieniny range) at about 600 m above sea level. Twenty-four lysimeters with an area of  $1 \text{ m}^2$  and 20 lysimeters with an area of  $0.2 \text{ m}^2$  contained brown soil. The experiment consisted of three management treatments: meadow (3 cuts in vegetation period), simulated pasture (6 cuts in vegetation period) and lawn (cuts every 10 days), different fertilization levels, with or without contact to groundwater. During the growth period, measurements at the lysimetric station were taken of daily amounts of water added to and drained from lysimeters to maintain the desired level (0.6 m), changes in soil retention every 10 days (by weighing lysimeters or using a soil moisture gauge), daily precipitation in a rain gauge of  $0.2 \text{ m}^2$  area located at ground level, and yield of grass. The data were used to calculate values of actual evapotranspiration for 10 day-periods using the formula:

$$ET = P + WRB - WRE + WA - WD$$

where: ET – actual evapotranspiration (mm), P – precipitation measured in rain gauge located at ground level (mm), WRB – water reserve in lysimeter at the beginning of the balance period (mm), WRE – water reserve in lysimeter at the end of the balance period (mm), WA – amount of water added (in lysimeters with constant groundwater level, in mm), WD – amount of drained water (in lysimeters with constant groundwater level, in mm).

## Results and discussion

The yield was significantly correlated with the management method (meadow, pasture, lawn). Increased cutting frequency was paralleled by a decrease in the yield of sward regrowth under similar conditions of supply from groundwater and fertilization level. The dry matter yield mainly depended on fertilization level. Under the study conditions, highest yields were obtained for a fertilized 3-cut meadow (16 t ha<sup>-1</sup>). Pasture yield (6 cuts) was generally about 30% lower than meadow yield. The lowest yield (5 t ha<sup>-1</sup>) was obtained from the lawn treatment. No effect of contact with groundwater on yield was found (Table 1).

Table 1. Dry matter yield (DM), actual evapotranspiration (ET) and water use efficiency (WUE) for grasslands in the Małe Pieniny.

Management method	Groundwater level [m]	N Fertilization [kg ha <sup>-1</sup> ]	DM [t ha <sup>-1</sup> ]	ET [mm]	WUE [g dm <sup>-3</sup> ]
Meadow	0.6	120	9	443	2.0
Meadow	0.6	240	12	505	2.4
Meadow	0.6	360	16	554	2.9
Meadow	without	0	6	404	1.4
Meadow	without	120	9	434	2.0
Meadow	without	240	12	456	2.6
Meadow	without	360	16	482	3.3
Pasture	without	360	13	414	3.2
lawn	0.6	120	6	347	1.8
lawn	without	120	5	329	1.6
LSD <sub>0.01</sub>			0.92	24.83	0.26

Note: LSD<sub>0.01</sub> – significant difference (for significance level  $\alpha = 0.01$ )

In the study period, it was found that evapotranspiration was significantly affected by management method (meadow, pasture, lawn) and yield level resulting from differences in fertilization. The mean actual evapotranspiration for the meadow fertilized with N (360 kg N ha<sup>-1</sup>) was 553.6 mm when supplied with groundwater, and 482 mm when supplied with no groundwater. During the same period, evapotranspiration was 414 mm for pasture and 329-347 mm for lawn (Table 1). The data on ET and DM yield, obtained during the research period in the Małe Pieniny, were used to derive a regression equation between evapotranspiration and yield. This function took the form:

$$ET = 283 + 13.8 DM \quad (r = 0.84; n = 171)$$

where: ET – actual evapotranspiration (mm), DM – dry matter yield (t ha<sup>-1</sup>),  $r$  – coefficient of correlation.

The coefficient of determination ( $r^2$ ) shows that about 70% of variation in overall grassland evapotranspiration was correlated with differences in yield. Water use efficiency EUW (g dm<sup>-3</sup>) which is the ratio between yield DM (kg ha<sup>-1</sup>) and the amount of water lost through actual evapotranspiration ET (mm) can be assumed after Wolters and Bose (1989), Piekut (1997) and Łabędzki (1997) as a criterion for optimization of water use for biomass production. Water use efficiency for grasslands from the Małe Pieniny region varied. During the study period, it ranged in the growth period from an average of 1.4 g dm<sup>-3</sup> on unfertilized meadow without a constant groundwater level to 3.3 g dm<sup>-3</sup> on a no-groundwater meadow fertilized with 360 kg N ha<sup>-1</sup>. Water use efficiency was 3.2 g dm<sup>-3</sup> for pasture and 1.6-1.8 g

dm<sup>-3</sup> for lawn (Table 1). Evapotranspiration of a 3-cut meadow was higher in the treatment with contact to groundwater (0.6 m) and could be expressed by regression equations:

$$ET_{0.6} = 1.17 \cdot ET_w \quad (r = 0.86; n = 99)$$

where:  $ET_{0.6}$  – evapotranspiration of meadow with groundwater contact (mm),  $ET_w$  – evapotranspiration of meadow without contact to groundwater (mm),  $r$  – coefficient of correlation.

The regression shows that the presence of groundwater level at 0.6 m caused a 17% increase of DM yield in comparison with the meadow without groundwater contact. This is in accordance with the results of other authors (Klimova *et al.*, 1990; Kaca *et al.*, 1998).

## Conclusions

1. The climatic conditions of the Małe Pieniny area favour the high productivity of grass communities, as evidenced by the DM yield of a 3-cut meadow that often exceeded 15 t ha<sup>-1</sup>.
2. The actual evapotranspiration of grasslands depends largely on their yield. Water consumption of a highly productive 3-cut meadow was about 550 mm. Evapotranspiration of pasture was 15% lower, and that of lawns 25% lower, than that of 3-cut meadow.
3. Water use efficiency during biomass production depends on yield level. The lowest efficiency was noted for low-yielding unfertilized meadow (1.4 g dm<sup>-3</sup>). The increase in crop yield helped to improve water use efficiency, which under extreme conditions exceeded 3.3 g dm<sup>-3</sup>.
4. Evapotranspiration was significantly correlated with dry matter yield and in the case of 3-cut meadow also with contact to groundwater.

## References

- Kaca E., Martyniak L. and Szymczak E. (1998) Ewapotranspiracja i plonowanie runi łąkowej na glebie mineralnej w warunkach nawodnień podsiąkowych. *Wiadomości IMUZ* t. 19 z. 3 s. 83-103.
- Klimova P., Haken D. and Kvitek T., (1990) Evapotranspiration from grassland and its relation to the groundwater table. *Rostl. Vyroba* 36 s. 451-462
- Łabędzki L. (1997) Potrzeby nawadniania użytków zielonych-uwarunkowania przyrodnicze i prognozowanie. *Rozprawy Habilitacyjne Fałenty*: Wydaw. IMUZ ss.121
- Piekut K. (1997) Stan zrównoważenia ekosystemów łąkowych w warunkach zróżnicowanej gospodarki wodno-pokarmowej. *Rozprawy Naukowe i Monografie*. Warszawa: Wydaw. SGGW ss. 120.
- Wolters W. and Bos M.G. (1989) Irrigation performance assessment and irrigation efficiency. *Annual Report ILRI* s.

## Climate change mitigation in European grasslands

Peeters A.<sup>1</sup> and Hopkins A.<sup>2</sup>

<sup>1</sup> RHEA, rue des Anciens Combattants 13, 1450 Gentinnes, Belgium

<sup>2</sup> GES Consulting, 27 Brownings Mead, Dunsford, Exeter EX6 7JJ, United Kingdom

Corresponding author: alain.peeters@rhea-environment.org

### Abstract

Grasslands are both a source and a sink of greenhouse gases (GHG). Techniques and production systems can be developed for reducing GHG emissions from agricultural and upstream activities and thus for mitigating agriculture's contribution to anthropogenic climate change. These include i) production of second-generation biofuels; ii) nitrogen fixation by legumes; iii) carbon storage in grassland soils and vegetation, and iv) changes in farming systems to reduce emissions of CO<sub>2</sub> and other GHGs.

Keywords: biofuel, C storage, farming system, GHG emission, mitigation, N fixation

### Introduction

Ruminant agriculture based on forage has been highlighted as a significant contributor to anthropogenic climate change linked to emissions of methane (CH<sub>4</sub>) and nitrous oxide (N<sub>2</sub>O), and through its recent global impact on land use change and its reliance on carbon-intensive processes (FAO, 2006). Although grasslands are a source of greenhouse gases (GHG), their soils and associated vegetation are also an important carbon sink, particularly as soil organic carbon (SOC). Techniques are being developed for shifting the GHG emission balance through the use of grassland for biomass to substitute for fossil fuels, and through improvements in the nitrogen use efficiency and reduced CH<sub>4</sub> emissions in grassland farming systems. Thus, although grassland agriculture has been presented as part of the climate change problem, it is also part of the solution. In this paper, a range of mitigation opportunities and their potential in the context of European grassland systems are considered.

### Production of second-generation biofuels or biomass

First generation bio-fuels synthesized from annual crops are criticized for several reasons. Second generation agro-fuels from ligno-cellulosic biomass, produced by species such as *Miscanthus x giganteus* and very Short Rotation Coppice (vSRC) of *Salix* or *Populus* spp., are characterized by much better GHG emissions savings. They require much lower amounts of fertilizers and pesticides and could have a better impact on biodiversity (Peeters *et al.*, 2009). They can be planted in strips around grassland plots. Grasslands could theoretically also be used as rough material for the production of agro-fuel. Compared to *Miscanthus* and vSRC harvested in autumn or winter by a single cut at a relatively high dry matter content, cut grasslands including lucerne must be harvested in several cuts and wilted, requiring more energy. Lucerne could be managed in double-goals systems: the first cut harvested late in June for biomass production ('energy-lucerne') and the following cuts harvested at an earlier physiological stage for forage production. Studies have shown that *Miscanthus*, vSRC and energy-lucerne could have a beneficial effect on farmland bird populations (Peeters *et al.*, 2009). That would justify the use of lucerne for the production of biofuels and biomass. SOC content increases after *Miscanthus* or vSRC plantations on arable fields (Peeters *et al.*, 2009). The average annual increase would be about 2 to 3 t CO<sub>2</sub> ha<sup>-1</sup> for both crops. This increase would not be indefinite, it would stabilize after a certain time but the period for reaching this new equilibrium is not known. When these crops are established on permanent grassland, the

SOC content would not increase (King *et al.*, 2004). Equilibrium SOC contents are probably similar for *Miscanthus*, vSRC and permanent grasslands on a given soil. The estimation of GHG emission reductions of *Miscanthus* and vSRC on the basis of life-cycle analyses is very complex. For instance, Styles and Jones (2008) recorded net GHG emission reductions ranging from 7.7 t ha<sup>-1</sup> y<sup>-1</sup> CO<sub>2</sub> where vSRC (*Salix* spp.) displaced grassland and gas, to 34 t ha<sup>-1</sup> y<sup>-1</sup> CO<sub>2</sub> where *Miscanthus* displaced set-aside and electric heat. GHG saving estimation for energy-lucerne has also to take into account the beneficial effect of biological nitrogen fixation.

### **Nitrogen fixation by legumes**

The temperate forage legumes *Trifolium pratense* and *Medicago sativa* can typically fix 200-400 kg ha<sup>-1</sup> y<sup>-1</sup> N and *T. repens* 100-300 kg ha<sup>-1</sup> y<sup>-1</sup>. The manufacture of N fertilizers represents the largest single energy input in all crop production systems (about 40% in developed countries). Currently, 1-2% of the global fossil fuel consumption is used for this purpose. Estimations of CO<sub>2</sub> eq. emissions for the synthesis of NH<sub>4</sub>NO<sub>3</sub> (CO<sub>2</sub> emitted when natural gas is combusted and N<sub>2</sub>O emitted during nitric acid production) varies from 3 (modern technologies) to 7 (average) kg of CO<sub>2</sub> eq. per kg N (Wood and Cowie, 2004). On the basis of an annual biological N fixation of 200 kg ha<sup>-1</sup> y<sup>-1</sup> and 7 kg CO<sub>2</sub> eq. emitted per kg N, legumes could theoretically prevent the emission of about 1.4 t ha<sup>-1</sup> y<sup>-1</sup> CO<sub>2</sub>. This rough estimation must be considered as a minimum since this estimation does not take into account the transport of fuel and fertilizers, the spreading of fertilizers, the transfer of nitrogen from grassland to arable land through manure and/or conversion of leys into annual crops. More researches are needed on this important topic.

### **Carbon storage in grassland soils and vegetation**

Grassland soils are important carbon sinks, although estimates of their C storage capacity, rates of SOC accumulation and the potential for further C sequestration vary greatly. According to Soussana *et al.* (2009), average on-site grassland C sequestration reaches 623 kg ha<sup>-1</sup> y<sup>-1</sup> CO<sub>2</sub> for European grasslands (SOC stock changes), both on- site and off-site C sequestrations reach 4.7, 3.6 and 2.7 t ha<sup>-1</sup> y<sup>-1</sup> CO<sub>2</sub> for grazed, cut and mixed European grasslands on mineral soils; however, with high uncertainty. Measures to increase C sequestration include: i) a moderate intensification of nutrient-poor permanent grasslands; ii) a reduction of grazing intensity; iii) an increase of the duration of leys; iv) the conversion of pure grass leys to grass-legume mixtures and especially to permanent grasslands; v) a reduction of N fertilizer inputs in highly intensive grass leys (Soussana *et al.*, 2009); vi) the maintenance or raising of water tables on peaty soils; vii) an improvement of the use of animal manures; viii) an increased use of some organic farming practices and reduced cultivations in ley-crop rotations (Freibauer *et al.*, 2004). However, despite the importance of grasslands as an existing C store, further C sequestration in most European grasslands is seen as providing a relatively modest contribution to mitigating GHG emissions and is a temporary measure. Several estimates suggest a mitigation potential of 3-6% of total fossil CO<sub>2</sub> emissions, though this is accompanied by further soil quality benefits. In a policy context, maintaining existing SOC accumulations through managing permanent grassland and wetland vegetation is a high priority. The integration of non-grass vegetation into grassland landscapes can increase C storage potential (e.g. trees and shrubs) and avoiding the release of CO<sub>2</sub> through wildfires is essential. Harvesting of such material and its pyrolysis to produce biochar (*terra preta*) is a potential technique for longer term C sequestration, and could theoretically greatly reduce global atmospheric CO<sub>2</sub> with possible soil improvement in addition.

## Changes in farming systems

Agriculture is a major contributor of CH<sub>4</sub> and N<sub>2</sub>O emissions. Most CH<sub>4</sub> is emitted from ruminants and manure. CH<sub>4</sub> mitigation options from ruminants focus on increasing production per animal and reducing livestock numbers (Monteny *et al.*, 2006). They also include: i) improved slurry and manure storage, and also using slurry for anaerobic digestion and energy production; ii) ruminant dietary changes or supplements (e.g. ionophores) to reduce enteric fermentation and improve rumen N efficiency; iii) manipulation of rumen flora; iv) farming-system changes to improve the ratio of product (meat/milk) to CH<sub>4</sub> emissions. Many of the measures listed under i) and iv) have recently been implemented in response to economic drivers, and European livestock farms compare very favourably with international competitors in terms of CH<sub>4</sub>, although further research challenges remain especially for ii) and iii). N<sub>2</sub>O is mainly emitted from fertilized land. Mitigation measures include: i) improving fertilizer N efficiency (timing, precision application, type of fertilizer, use of nitrification inhibitors); ii) improving soil structure to reduce compaction and poor drainage; iii) minimizing length of grazing and providing efficient use of slurry from housed livestock. Mitigation measures for N<sub>2</sub>O interact with other important environmental issues like the control of CH<sub>4</sub> and NH<sub>3</sub> emissions, and NO<sub>3</sub> leaching (Monteny *et al.*, 2006).

## Discussion

There are important interactions between mitigation measures for gaseous emissions and between gaseous emissions and NO<sub>3</sub> leaching. It is thus essential to evaluate mitigation practices at the system level (Monteny *et al.*, 2006). Good agricultural and environmental practices need to be improved and to include measures that lead to GHG mitigation, solve the conflicts and improve the synergies of management in order that a better ‘multifunctionality’ of grassland-based systems is achieved to deliver on all aspects of environmental quality (biodiversity, water quality, landscape, GHG reduction, product quality, animal welfare) and meet the challenges of producing adequate amounts of quality food for an expanding population.

## References

- FAO (2006) *Livestock's Long Shadow: environmental issues and options*. FAO – LEAD, Rome, Italy, 390 pp.
- Freibauer A., Rounsevell M.D.A., Smith P. and Verhagen J. (2004) Carbon sequestration in the agricultural soils of Europe. *Geoderma* 122, 1-23.
- King J.A., Bradley R.I., Harrison R. and Carter A.D. (2004) Carbon sequestration and saving potential associated with changes to the management of agricultural soils in England. *Soil Use and Management* 20, 394-402.
- Monteny G.-J., Bannink A. and Chadwick D. (2006) Greenhouse gas abatement strategies for animal husbandry. *Agriculture, Ecosystems and Environment* 112, 163-170.
- Peeters A., Lafontaine R.M., Beudels R., Devillers P., Nolte S., Buysse J. and Van Huylenbroeck G. (2009) *Evaluation of the impact of biofuel crop development, including GMO, on biodiversity in Belgium*. FPS-Environment, Brussels, Belgium, 136 pp.
- Prince A. (2007) *Initiating New Projects in the Ammonia Sector*. IFA Workshop on Energy Efficiency and CO<sub>2</sub> Reduction Prospects in Ammonia Production. Published online at [www.fertilizer.org](http://www.fertilizer.org).
- Singh B.R. (2008) Carbon sequestration in cool temperate regions. *Nutrient Cycling in Agroecosystems* 112, 107-112.
- Soussana J.F., Tallec T. and Blanfort V. (2009) Mitigating the greenhouse gas balance of ruminant production systems through carbon sequestration in grasslands. *Animal*, 1-17.
- Styles D. and Jones M.B. (2008) *Miscanthus* and willow heat production - An effective land-use strategy for greenhouse gas emission avoidance in Ireland? *Energy Policy* 36, 1, 97-107.
- Wood S. and Cowie A. (2004) A review of greenhouse gas emission factors for fertiliser production. *IEA Bioenergy Task* 38, 20 pp.



# Effect of climate change on grassland production for herbivorous livestock systems in France

Ruget F.<sup>1</sup>, Moreau J.-C.<sup>2</sup>, Cloppet E.<sup>3</sup> and Souverain F.<sup>3</sup>

<sup>1</sup>UMR 1114 EMMAH INRA 84914 AVIGNON cedex 9

<sup>2</sup>Institut de l'Élevage, Auzeville 31326 CASTANET -TOLOSAN

<sup>3</sup>42 Av G Coriolis 31000 Toulouse

Corresponding author: ruget@avignon.inra.fr

## Abstract

We used estimations of climate change from a GCM as inputs of a crop model to study the behaviour of grass and alfalfa in the future. We adapted the crop model to account for negative effects of high temperatures and positive effects of CO<sub>2</sub> on plant growth and transpiration. The main results concern crop phenology and yield. Annual yields were generally predicted to increase in the near future, but decrease sometimes in the distant future, despite the positive effect of CO<sub>2</sub>. We predict marked differences between regions in France as a consequence of the variability of climate changes with the region. The distribution of production will probably change over the course of the year and lead to new organization of livestock feeding. Likely, alfalfa yields will not be decreased by climate change, unlike grass yields.

Keywords: climate change, alfalfa, grass, yield

## Introduction

The effects of atmospheric changes on climate were assessed using a GCM (General Circulation Model). We used the results of two scenarios of economic, technical and socio-economic development (GIEC4): the A2 scenario, in which little attention is paid to GHG emissions leading to a high CO<sub>2</sub> concentration in the atmosphere at the end of this century (800 ppm), and the B1 scenario, a moderate scenario in which it is assumed the CO<sub>2</sub> concentration is controlled and only reaches 550 ppm by the end of the century. The study concerned two periods, one in the near future (2020-2049) and one in the distant future (2070-2099). We have previously described climate change (Collectif, 2009; Ruget *et al.*, 2009) based on climatic analyses of present and future climate data and built agrometeorological indices. In this climate analysis, the main result was that warming varied considerably between scenarios in the distant future, and that the main changes will be in summer. Precipitation will decrease mainly in summer too, but the magnitude of the changes will differ in different regions of France. In this paper, we focus on the forecasted effects of climate change on forage production because changes in the production schedule may affect livestock systems.

## Material and methods

To assess the effect of climate change, we used the crop model STICS (Brisson *et al.*, 1998), that was previously evaluated under a range of climates for grass and alfalfa (Ruget *et al.* 2006, Collectif, 2009). The present climate is represented by the observed climate for the period 1980-2006. For future climate, we used results obtained by Déqué (2007), from the ARPEGE model, developed by the CNRM (Météo-France). Downscaling of the GCM results were made using a RCM model (Déqué, 2007) and a fit of the future climate on the present, adding the true present climate value and the difference between simulated present and future climates (or multiplying the rain by the ratio of future to present rain). This method improved the quality of regional estimations, avoiding inaccuracies in the climate estimated for the present period. Besides, we used the mean value of changes for each day of the year – preventing the



representation of evolution within each period – for two scenarios (A2 and B1) and two periods (near and distant future). Here, in the near future, we only present the results of the scenario A2 because the climates for the two scenarios are similar in the near future.

The model takes into account the effect of CO<sub>2</sub>, i.e. an increase in yield and a decrease in transpiration (with parameters depending only on the photosynthetic type). The model is run for two different soils with contrasted water reserves (66 and 208 mm) and several different management practices (number of uses (cuts or grazings), fertilization). The intervals between uses were expressed as heat sums, so uses became more frequent when the weather was warmer, provided that the yield was higher than a harvest threshold. Here, we present only the results for the deep soil, and for uses each 500 °C.day (above a 0°C threshold) for both crops, because the trends were similar to the other soil and other management practices.

Pau (Lon 00° 21', lat 43° 17', altitude 183 m; South-west France)

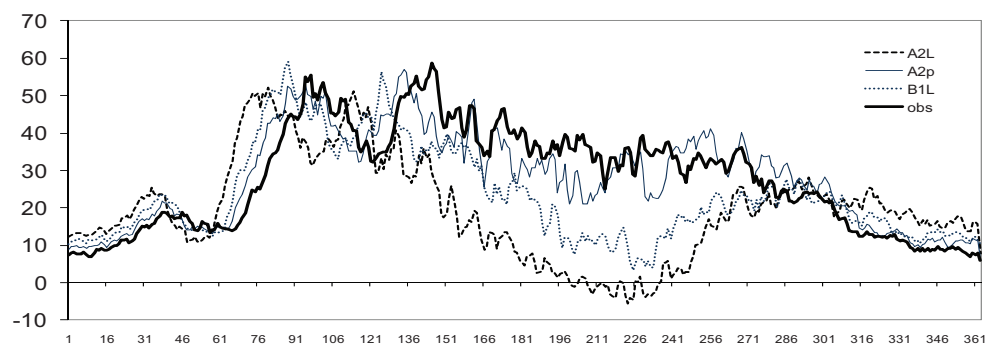

Figure 1. Daily balance of production (difference between new and senescent biomass), calculated as the mean of moving mean of three days over the 27 years of the period.

## Results and discussion

Figure 1 presents the pattern of production over the year for one location. The drop in summer production due to water stress is emphasized especially in the distant future and in the A2 scenario, as one effect of increasing water stress. Moreover, spring production will be earlier than now, and winter production will be enhanced in all the 34 locations studied throughout France. The maps (Figure 2 a, b) show the spatial distribution of the changes. In all the situations (locations and plants), in the near future, production first appears to be enhanced. In the distant future, the results are more varied between crops: for grasses, there are four different zones, with a marked increase in the north, a slow increase in the south-east, no changes in the middle north-west and a significant decrease in the south-west of France. For alfalfa, the results show an increase in yields in all the locations and for all the time periods and scenarios. The difference in behaviour between crops could be due to alfalfa's rooting depth and nitrogen fixing ability. Analyses of water and nitrogen stresses show that these stresses differ between the two crops: in alfalfa, there is currently low water stress and no increase in the future: alfalfa's deep rooting system is its main strength.

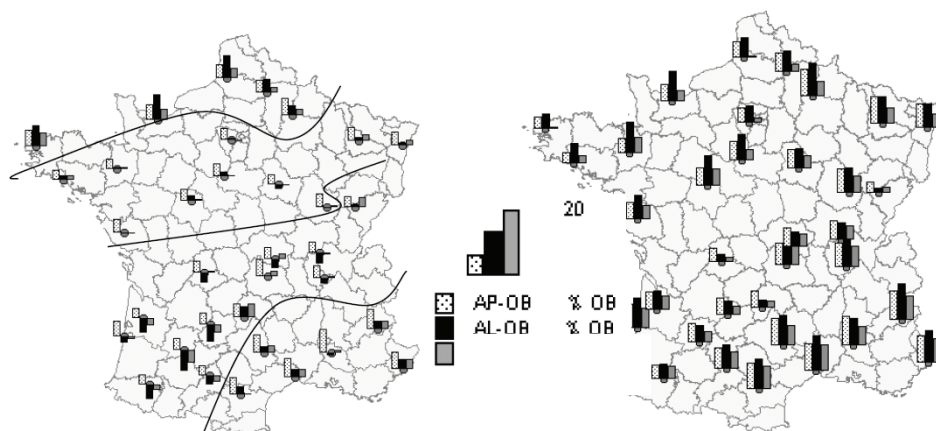

Figure 2 a, b. Evolution of the production of grass (left map) and alfalfa (right map) in the future, related to the present production. Each bar is the percentage of increase (up the zero small black line) or decrease (below the zero line) of production, for near future (A2), distant future (A2 and B1) from left to right for each group of bars.

## Conclusion

In this study, we characterized some effects of climate change on forage production. The main effects we show are changes in the dates of forage availability: earlier in spring, more in winter, less in summer. The effects on yields are different among regions in France and among scenarios and time in the future. An important result is the advantage of alfalfa over grass, because of its deep rooting system, which avoids serious water problems, allowing the use of the whole water reserve even in deep soils.

## References

- Brisson N., Mary B., Ripoche D., Jeuffroy M.H., Ruget F., Nicoullaud B., Gate P., Devienne-Barret F., Antonioletti R., Durr C., Richard G., Beaudoin N., Recous S., Tayot X., Plenet D., Cellier P., Machet J.-M., Meynard J.M., Delécolle R. (1998) STICS: a generic model for the simulation of crops and their water and nitrogen balances. I. Theory and parametrization applied to wheat and corn. *Agronomie* 18, 311-346.
- Collectif (2009) Impact du changement climatique sur la luzerne et la prairie, disparités régionales. In: ACTA-Institut de l'Élevage-Arvalis (ed.) *Changement climatique, Conséquences et enseignements pour les grandes cultures et l'élevage herbivore*. 22 oct. 2009, Paris.
- Déqué M. (2007) Frequency of precipitation and temperature extremes over France in an anthropogenic scenario: model results and statistical correction according to observed values. *Global and Planetary Change* 57, 16-26.
- Ruget F., Novak S. and Granger S. (2006): Du modèle STICS au système ISOP pour estimer la production fourragère. Adaptation à la prairie, application spatialisée. *Fourrages* 186, 241-256.
- Ruget F., Moreau J.-C., Ferrand M., Poisson S., Gate P., Lacroix B., Lorgeou J., Cloppet E. and Souverain F. (2009) Effect of climate change in herbivorous livestock systems, including arable crops, in the French area., *EMS Annual Meeting Abstracts Vol. 6, EMS2009-592, 2009, 9th EMS / 9th ECAM*, Toulouse 28 Sept.-2 Oct. 2009.

## Surface Runoff Simulator (SIMU) hastens the research on phosphorus losses from grassland

Saarijärvi K. and Virkajärvi P.

*MTT AgriFood Research Finland, Halolantie 31A, 71750 Maaninka, Finland*

Corresponding author: [kirsi.saarijarvi@mtt.fi](mailto:kirsi.saarijarvi@mtt.fi)

### Abstract

In Finland the most important grass production areas are located on areas with severe winter conditions, soil frost and snow cover that affect the runoff patterns. To study the effects of changing winter conditions on surface runoff, we developed a surface runoff simulator device (SIMU). With the SIMU it is possible to simultaneously test several methods to reduce phosphorus losses from grassland in artificial winter/spring conditions. The aims of this study were to determine the accuracy of the device and to evaluate its practical value in surface runoff research. The treatments were: control, 20 t and 40 t slurry per ha, 20 t slurry + 3 t of fine lime, and 40 t slurry + 3 t of fine lime per ha. The SIMU detected differences in runoff total P and dissolved Ca concentrations and tendency in dissolved P concentration, although soil water extractable P was the same for all treatments. The results are not straightforwardly transferable on a field scale due to small size, but SIMU is useful in studying the differences between the treatments. SIMU is a useful tool when estimating the P losses from grassland as it is economical, easy to use, fast and adjustable.

Keywords: climate change, eutrophication, grass, phosphorus, snow, surface runoff

### Introduction

In Finland most important grass production areas are located on areas that have severe winter conditions, soil frost and snow cover that affect the runoff patterns. Surface waters of these areas suffer from dissolved phosphorus pollution originated from intensive dairy farming. Due to surface applications of slurry and artificial fertilizers, soil surface layer have higher phosphorus (P) concentration than deeper layers (Saarela and Vuorinen, 2009). Freezing and thawing cycles also extract P from above-ground vegetation (Uusi-kämpä, 2005) and during the runoff events dissolved P is transported to rivers and lakes. Soil frost enhances surface runoff as it prevents most of the water infiltrating through to soil. Climate is changing and, according to the scenarios, this will most likely increase the amount of runoff events during winter and increase the risk of eutrophication (Jylhä *et al.*, 2004). Even though there is an urgent need to find solutions to these problems, measuring the effects of different methods on a field scale is slow and expensive as the spring occurs only once a year. Unfortunately, the years differ from each other and this causes more problems in interpreting the results from the experiments. To study the effects of different treatments and changing winter conditions on surface runoff, we developed a device called Surface runoff Simulator (SIMU). The aim of this study was to determine the accuracy of the device and to evaluate its practical value in surface runoff research.

### Materials and methods

With the SIMU (Figure 1) device it is possible to simultaneously test several different methods to reduce phosphorus losses from grassland. The treatments were randomized on grass plots during growing season. At the end of the growing season, the top layers of the plots were lifted by a turf grass cutter, covered with plastic sheet and stored at outside temperatures until the beginning of the experiment. At the beginning of the melting

experiment in January, the frozen grass mats were placed individually on the sloping SIMU devices and covered with the chosen amount of snow. Infrared heaters were used to melt the snow and the melt water was collected at the lower edge of the slope. Many factors were completely adjustable: the treatments on the field, the slope of the grass mat, the duration of melting period and the amount of snow that produced the surface runoff.

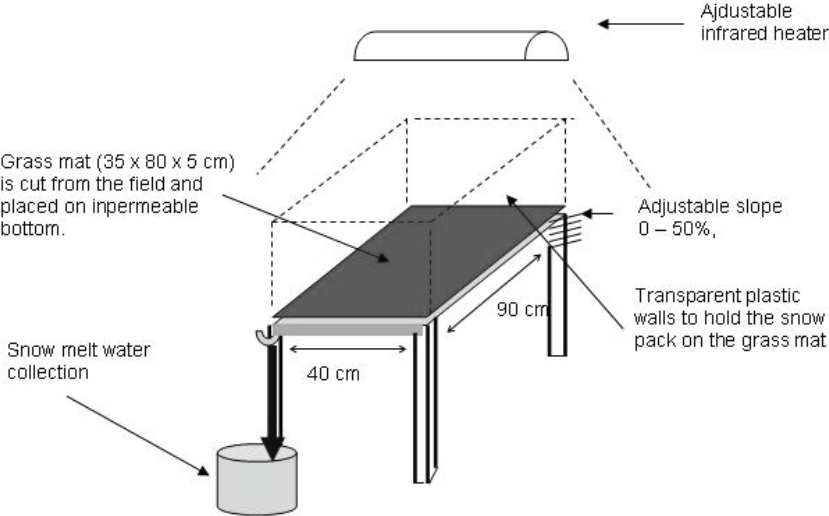

Figure 1. Illustration of the surface runoff simulator (SIMU).

The treatments in the experiment were: control, 20 t of slurry per ha, 40 t slurry per ha, 20 t slurry + 3 t of fine lime per ha, and 40t slurry + 3 t of fine lime per ha, each with four replicates. Soil samples (0-5 cm) from each plot were taken at the same time when the grass mats were lifted and analysed for water extractable P (1:60). Each melting period lasted for 7 days. The amount of melted snow was 25 kg per grass mat, which equals 71 mm of water. Approximately 3 kg (9 mm) melt water infiltrated into the grass mats. The amount of recovered melt water was 20 kg (57 mm). The water sample was taken from the whole runoff amount and analysed for total P (SFS 3026), dissolved P (SFS 3025) and dissolved calcium (Ca) (ICP).

**Results and discussion**

The results from the experiment were realistic and comparable to results from experiments at field scale (Turtola and Kemppainen, 1998) (Table 1). Even though measuring the runoff of dissolved P seemed to be quite scale independent, the processes operating on small scales are generally still different from those at the field scale (Cornish *et al.*, 2002). Thus the results should not be considered as true representatives of field runoff concentrations. The SIMU is more reliable measuring the differences between the treatments. The standard errors (*SE*) of treatment means were 8.0, 10.4 and 13.0% of corresponding treatment means for total P, dissolved P and dissolved Ca, respectively.

The procedure found differences in total P and dissolved Ca concentrations and tendency in dissolved P concentration although soil water extractable P was the same for all treatments. Thus the SIMU was more sensitive than soil sampling in detecting the differences between the treatments. It seemed that 20 t slurry per ha had no effect on concentration of total or

dissolved P but 40 t slurry per ha increased clearly the concentration of total P (Table 2). Adding small amounts of Ca had no effect on run off water P concentrations, but increased the concentration of dissolved Ca. In conclusion, SIMU seems to be accurate enough for testing the effects of different measures to diminish P concentration in surface runoff.

Table 1. The soil and the runoff water concentrations in SIMU experiment.

	Soil of the grass mats	Runoff water from the grass mats					
	Water extractable P mg l <sup>-1</sup> (1:60)	Total P mg l <sup>-1</sup>	SE	Dissolved P mg l <sup>-1</sup>	SE	Dissolved Ca mg l <sup>-1</sup>	SE
Untreated	11.0	0.38	0.045	0.26	0.049	11.3	1.41
Slurry 20 t	10.6	0.36	0.021	0.27	0.021	14.2	1.96
Slurry 40 t	11.7	0.45	0.034	0.32	0.038	10.3	1.41
Slurry 20 t + Ca 3 t	11.7	0.35	0.034	0.26	0.031	15.6	1.61
Slurry 40 t + Ca 3 t	11.1	0.48	0.024	0.37	0.005	15.0	2.19
tr P values	0.52	0.005		0.078		0.005	

Table 2. The contrasts of differences in runoff water concentrations between the treatments in SIMU experiment.

Contrasts	Total P mg l <sup>-1</sup>		Dissolved P mg l <sup>-1</sup>		Dissolved Ca mg l <sup>-1</sup>	
	Difference estimate	P value	Difference estimate	P value	Difference estimate	P value
Untreated vs slurry 20 t	-0.013	0.70	0.008	0.86	2.92	0.045
Untreated vs slurry 40 t	0.075	0.037	0.063	0.16	-0.945	0.48
No Ca vs 3 t Ca	0.015	0.75	0.043	0.48	6.130	0.061

## Conclusion

SIMU was a reliable and accurate device in studying different measures to diminish P concentration in surface runoff. However, the results were not straightforwardly transferable to field size plots, as the surface area of the single grass mat was only 0.3 m<sup>2</sup>. SIMU is a useful tool when estimating the P losses from grassland as it is economical, easy to use, fast and adjustable.

## References

- Cornish P.S., Hallissey R. and Hollinger E. (2002) Is rainfall simulator useful for estimating phosphorus runoff from pastures – a question of scale dependency? *Australian Journal of Experimental Agriculture* 42, 953-959.
- Jylhä K., Tuomenvirta H. and Ruosteenoja K. (2004) Climate change projections for Finland during the 21st century. *Boreal Environmental Research* 9, 127-152.
- Saarela I. and Vuorinen M. (2009) Stratification of soil phosphorus, pH and macro cations under intensively cropped grass ley. *Nutrient Cycling in Agroecosystems* (In press) DOI 10.1007/s10705-009-9298-z
- Turtola E. and Kemppainen E. (1998) Nitrogen and phosphorus losses in surface runoff and drainage water after application of slurry and mineral fertilizer to perennial grass ley. *Agricultural and Food Science in Finland* 7, 569-581.
- Uusi-Kämpä J. (2005) Phosphorus purification in buffer zones in cold climates. *Ecological Engineering* 24, 491-502.

# Fertilising practices to reduce nitrous oxide emissions from managed grasslands

Schils R.L.M.<sup>1</sup>, Van Groenigen J.W.<sup>2</sup>, Velthof G.L.<sup>1</sup> and Kuikman P.J.<sup>1</sup>

<sup>1</sup>*Alterra, Wageningen University and Research Centre, P.O. Box 47, 6700 AA Wageningen, the Netherlands*

<sup>2</sup>*Department of Soil Quality, Wageningen University and Research Centre, P.O. Box 47, 6700 AA Wageningen, the Netherlands*

Corresponding author: rene.schils@wur.nl

## Abstract

Fertiliser and manure applications on grassland are important sources of nitrous oxide (N<sub>2</sub>O) emissions. This paper assesses strategies to reduce N<sub>2</sub>O emissions from fertiliser and manure application on grassland, either by reducing the amounts of applied nitrogen and carbon, or by preventing the simultaneous availability of fertiliser nitrate and manure carbon to prevent detrimental interactions. Three mitigation options were tested in three consecutive years on a sandy soil in the Netherlands: (i) application of ammonium based fertilisers, (ii) split fertiliser applications and (iii) separate application of fertiliser and manure. The observed N<sub>2</sub>O emission factors for the calcium ammonium nitrate were rather low: 0.52%, 0.17% and 0.12% of applied N, in the three consecutive years. Application of ammonium sulphate and split application of calcium ammonium nitrate resulted in a significant reduction of emissions in the first year. In the second and third year however, none of the mitigation strategies resulted in a lower emission. It is concluded that choice of fertiliser type and timing can reduce N<sub>2</sub>O emissions, but solid recommendations on when to apply these strategies are still lacking.

Keywords: ammonium, carbon, fertiliser, manure, nitrate, nitrous oxide

## Introduction

Fertiliser and manure applications on grassland are important sources of nitrous oxide (N<sub>2</sub>O) emissions. Agriculture in the Netherlands has high animal stocking rates, high fertiliser inputs and relies only marginally on legumes as a source of N input. As a consequence, fertiliser and manure applications together are responsible for 75% of the direct soil emissions. Therefore, it is evident that any reduction of emission of greenhouse gases (GHG) from the agricultural sector will hinge on the reduction of N<sub>2</sub>O emissions from fertiliser and manure application.

Factors controlling the release of N<sub>2</sub>O from soils are (1) availability of inorganic nitrogen (N) and (2) easily degradable carbon (C), but also (3) soil aeration, moisture, temperature and pH. Fertiliser and manure application on grassland contain all components for potentially high N<sub>2</sub>O losses, as fertiliser is a source of nitrate (NO<sub>3</sub>) and ammonium (NH<sub>4</sub>), manure provides both NH<sub>4</sub> and C, and grassland generally contains relatively high levels of easy degradable C. The emission of N<sub>2</sub>O is usually calculated from a default IPCC emission value, which for all types of fertiliser and manure is 1.0% of applied N. This restricts the mitigation options to a reduced input of fertiliser and manure. Although easy and effective, these default values for emissions rule out potential mitigation options that reduce the N<sub>2</sub>O emission per kg of applied N. Such mitigation options are crucial for acceptability by farmers in areas with intensive farming, where economic penalties on reduced N inputs and yield losses may be high.

The objective of this paper is to assess strategies to reduce N<sub>2</sub>O emissions from fertiliser and manure application on grassland, either by reducing the amounts of available NO<sub>3</sub> and C, or by preventing the simultaneous availability of fertiliser NO<sub>3</sub> and manure C and provide experimental evidence for their effectiveness. These strategies were elaborated into three

specific mitigation options, (i) application of NH<sub>4</sub> based fertilisers, (ii) split fertiliser applications and (iii) separate application of fertiliser and manure.

## Materials and methods

The experiment was carried out on a sandy soil at the Droevendaal experimental farm in Wageningen, the Netherlands. The experimental field was ploughed and reseeded in the autumn of 1999 with a 100% perennial ryegrass (*Lolium perenne* L.) seed mixture. Treatments in 2000 consisted of an unfertilised control, calcium ammonium nitrate (CAN, 13.5% NH<sub>4</sub>-N and 13.5% NO<sub>3</sub>-N), ammonium sulphate (AS, 21% NH<sub>4</sub>-N), and a split application of CAN (Table 1). In the second (2001) and third (2002) year, the treatment with split application was substituted with two treatments that compared simultaneous application of CAN and cattle slurry (CS) with separate application of CAN and cattle slurry (CS\_late). The cattle slurry was liquid slurry with an average total N content of 4.17 and 4.93 g kg<sup>-1</sup> in the second and third year, respectively. The cattle slurry was applied with a shallow injection technique. The treatments were laid out in a randomised block design with three replicates. The annual N application rate on the fertiliser-only treatments (CAN, CAN split, AS) was 320 to 330 kg ha<sup>-1</sup>. The treatments with combined fertiliser and cattle slurry application received 90 t ha<sup>-1</sup> year<sup>-1</sup> of cattle slurry, supplemented with 180 kg N ha<sup>-1</sup> from fertiliser. In treatment CS50, fertiliser and cattle slurry were applied on the same day, whereas on CS50-late, fertiliser was applied seven days after cattle slurry was applied. All plots were harvested five times between May and October of each year with a Haldrup plot harvester. Daily rainfall and average temperature were collected from a weather station at a distance of 1 km of the experimental field.

The nitrous oxide measuring frequency was up to three times a week after fertiliser and manure application, and two to four times a month in the remainder of the growing season. The N<sub>2</sub>O concentrations were measured in the headspace of vented closed PVC flux chambers, with a diameter of 16 cm and a height of 15 cm, using a Brüel and Kjær photoacoustic spectroscopic infrared gas analyser. Further details on the measurements are described in Schils *et al.* (2008). The emission factor (EF) is calculated from the N<sub>2</sub>O emission of fertilised and/or manured plots (N<sub>2</sub>O<sub>fert</sub>), the N<sub>2</sub>O emission of control plots (N<sub>2</sub>O<sub>zero</sub>) and the amount of total N applied, all expressed in kg N ha<sup>-1</sup>: EF [%] = (N<sub>2</sub>O<sub>fert</sub> - N<sub>2</sub>O<sub>zero</sub>) \* 100 / N applied.

## Results and discussion

The observed N<sub>2</sub>O emission levels in this experiment were rather low compared to the IPCC default emission factor of 1.00%. For CAN, the emission factor in the first year (0.52%) is comparable to earlier results on sandy soil (Velthof and Oenema, 1995), but the emission in the second (0.17%) and third year (0.12%) was extremely low. Analysis of temperature and precipitation patterns did not show any conclusive explanation for the observed differences.

Similarly, the tested strategies only showed a reduction of emissions in the first year when application of AS reduced the N<sub>2</sub>O emissions by 40%, and split application of CAN reduced the N<sub>2</sub>O emission by 35%. However, in the second and third year, none of the three mitigation strategies resulted in a lower emission.

Similar mitigation strategies have also been studied in several other experiments in different countries (e.g. Clayton *et al.*, 1997 and Stevens & Laughlin, 2002). Most studies report fertiliser and slurry based mitigation strategies as being feasible and attractive. However, they also note a high variability of the observed effects on N<sub>2</sub>O. The challenge for the future is to develop sound recommendations on the soil and weather conditions under which these strategies indeed do work and when their application is likely to be not effective or, worse, to



even fail. This is illustrated in our experimental results where application of AS either increased (year 1), did not affect (year 2), or even reduced DM yields (year 3).

Table 1. Annual nitrogen application rates from fertiliser and manure, dry matter yields, nitrous oxide emissions and emission factor (EF) for all treatments in three consecutive years.

Year	Treatment	Fertiliser N (kg ha <sup>-1</sup> )	Manure N <sub>tot</sub> (kg ha <sup>-1</sup> )	DM yield (t ha <sup>-1</sup> )	N <sub>2</sub> O-N (kg ha <sup>-1</sup> )	EF (%)
2000	Control	0	0	1.83	0.01	-
	CAN	320	0	11.40	1.66	0.52
	CAN-split	320	0	11.12	1.09	0.34
	AS	320	0	12.20	1.02	0.32
	LSD ( $P < 0.05$ )			0.64	0.50	
2001	Control	0	0	3.20	0.04	-
	CAN	330	0	10.24	0.6	0.17
	AS	330	0	10.32	0.53	0.15
	CS	180	375	11.42	1.02	0.18
	CS-late	180	375	11.33	1.35	0.24
	LSD ( $P < 0.05$ )			0.58	0.37	
2002	Control	0	0	3.70	0.13	-
	CAN	330	0	7.96	0.53	0.12
	AS	330	0	6.77	0.59	0.14
	CS	180	444	10.39	0.73	0.10
	CS_late	180	444	10.45	0.89	0.12
	LSD ( $P < 0.05$ )			1.16	0.39	

## Conclusion

Choice of fertiliser type and timing can reduce N<sub>2</sub>O emissions, but solid recommendations on when to apply these strategies are still lacking.

## Acknowledgement

Funding for this study was provided by the Reduction Programme Non-CO<sub>2</sub> Greenhouse Gases and the Programme Climate changes Spatial Planning (Project ME1).

## References

- Clayton H., McTaggart I.P., Parker J., Swan L. and Smith K.A. (1997) Nitrous oxide emissions from fertilised grassland: a 2-year study of the effects of N fertiliser form and environmental conditions. *Biology and Fertility of Soils* 25, 252-260.
- Schils R.L.M., Van Groenigen J.W., Velthof G.L. and Kuikman P.J. (2008) Nitrous oxide emissions from multiple combined applications of fertiliser and cattle slurry to grassland. *Plant and Soil* 310, 89-101.
- Stevens R.J. and Laughlin R.J. (2002) Cattle slurry applied before fertilizer nitrate lowers nitrous oxide and dinitrogen emissions. *Soil Science Society of America Journal* 66, 647-652.
- Velthof G.L. and Oenema O. (1995) Nitrous oxide fluxes from grassland in the Netherlands 2. Effects of soil type, nitrogen fertilizer application and grazing. *European Journal of Soil Science* 46, 541-549.

# Nitrous oxide emissions from highly productive grassland as a function of soil compaction and nitrogen fertilization

Schmeer M.<sup>1</sup>, Dittert K.<sup>2</sup>, Loges R.<sup>1</sup>, Senbayram M.<sup>2</sup> and Taube F.<sup>1</sup>

*Christian-Albrechts-University of Kiel, D-24118 Kiel*

<sup>1</sup>*Institute for Crop Science and Plant Breeding, Grass and Forage Science/Organic Agriculture*

<sup>2</sup>*Institute for Plant Nutrition and Soil Science*

Corresponding author: mschmeer@email.uni-kiel.de

## Abstract

Emissions of the greenhouse gas nitrous oxide (N<sub>2</sub>O) that are contributed by agricultural systems represent 50% of the world's N<sub>2</sub>O emissions. This can significantly be attributed to the intensification of modern agriculture, which includes increased nitrogen fertilization and the employment of larger and heavier machines. Heavier machines cause an increase in soil compaction and a reduction in the consistent soil pore system, which often results in more anaerobic conditions in the upper soil layers. In combination with intensive nitrogen fertilization these contribute to an undesirable increase of N<sub>2</sub>O emissions.

Our main aim was to study the interaction between soil compaction and nitrogen fertilization and its impact on N<sub>2</sub>O emissions of highly productive grassland. A three-year (2006-2008) field trial was carried out at Hohenschulen experimental station in Northern Germany. Soil compaction (228 kPa contact area pressure) was applied at the beginning of vegetation in early April. Before applying compaction, the plots had been treated with either 0 or 360 kg ha<sup>-1</sup> of N as calcium ammonium nitrate resulting in grass-legume mixtures and pure grass swards, respectively. Both experimental factors, as well as their interaction, caused significant effects on N<sub>2</sub>O emissions. The magnitude of treatment effects was dependent on soil moisture.

Keywords: Nitrous oxide emission, soil compaction, grassland, calcium ammonium nitrate

## Introduction

The proportion of the climate-relevant N<sub>2</sub>O emissions contributed by agriculture amounts to approximately 50% of the world's N<sub>2</sub>O emissions. In Germany, the agricultural emissions of N<sub>2</sub>O in 2006 were comparable to 41 million t CO<sub>2</sub>-equivalent (UBA, 2007).

During the last decades, an intensification of agriculture has occurred which affects grassland as well as arable land. This development includes an increased use of large and heavy machines, which increases soil compaction. Due to multiple traffics with slurry tankers and forage wagons more passes with heavy machines occur under forage production on grassland related to arable land. In general, soil compaction causes a reduction of the pore system and enhances denitrification, which can lead to increasing N<sub>2</sub>O emissions (Yamulki and Jarvis, 2002). Increased N<sub>2</sub>O emissions are due to anaerobic conditions in the upper soil layers as well as high nitrogen fertilization (Velthof *et al.*, 1997).

Despite the relevance of soil compaction on grassland there is a lack of studies dealing with the simultaneous analysis of soil compaction and high N-input on N<sub>2</sub>O emissions.

## Materials and methods

The field experiment was set up on the experimental station Hohenschulen in Northern Germany (54°18'49"N; 9°57'56"E; mean annual temperature 8.3 °C, and mean annual

precipitation 777 mm; soil: sandy loam) on a uniform grassland with three cuts per year. The experiment comprised the following factors (treatments):

- Controlled soil compaction (control, contact area pressure of 228 kPa) in early April
- N fertilization with calcium ammonium nitrate (0 and 360 kg ha<sup>-1</sup> N)
- Year of first controlled soil compaction (2006, 2007 and 2008)

The experiment was established in a split-plot factorial design with three replicates. The soil compaction was achieved by a single pass of a tractor with a slurry tanker (total weight 22 t/ contact area pressure 228 kPa) at the beginning of the vegetation period. N<sub>2</sub>O emissions were determined with the ‘close-chamber’-method (Hutchinson and Mosier, 1981). The chambers had a diameter of 60 cm and a height of 35 cm. The N<sub>2</sub>O concentration in the headspace was measured immediately after closing the chamber, after 30 min and after 60 min. The flux was calculated based on the increase in concentration within 60 min. Cumulative fluxes were estimated by linear interpolation between daily fluxes. Subsequent to compaction and fertilization, gas samples were taken daily. After two weeks sampling intervals were extended to once a week. Soil water content in 30 cm depth at the time of compaction treatment was measured gravimetrically. The experimental year, nitrogen fertilization and soil compaction as well as their interactions, were tested for significance using PROC MIXED of SAS 9.1. Means were compared with the PDIFF option. Significance was declared at  $P < 0.05$  and adjusted using the Bonferroni-Holm test.

## Results and discussion

N<sub>2</sub>O emission rates were strongly driven by the tested treatments indicating a significant threefold interaction (experimental year x compaction x fertilization (Tab. 1)). N<sub>2</sub>O emissions plotted against time showed a distinct response to soil compaction in the N-fertilized treatment during the 2008 measuring period, while the non-fertilized treatment did not show any response (Fig. 1). In 2006, the N<sub>2</sub>O emission rates were similar to 2008 (Data not shown), which corresponds with similar soil water conditions at the time of soil compaction in both years (2006: 22 Vol.-%, 2008: 20 Vol.-%) whereas in 2007 the soils were drier at the time of soil compaction (16 Vol.-%). Due to the dry soil conditions the compaction showed no effect on N<sub>2</sub>O emissions. The emission peak at the middle of June 2007 was attributable to high precipitation (200 mm during 15 June-7 July) following a very dry period (Fig. 1). The interaction between N-fertilization and soil compaction became evident in the cumulative annual N<sub>2</sub>O emissions (Fig. 2). No compaction-induced effects were perceptible on the unfertilized treatments. In 2006 and 2008, the compaction led to a sharp increase of N<sub>2</sub>O emissions on highly fertilized plots.

Table 1:  $P$ -value of the analysis of variance of the parameter N<sub>2</sub>O-emission (cumulative N<sub>2</sub>O-N, kg ha<sup>-1</sup>) (y = year, comp = compaction, N = N-fertilization)

	y	comp	N	y*comp	y*N	comp*N	y*comp*N
N <sub>2</sub> O	0.0953	0.0587	<0.0001	0.3861	0.2618	0.0270	0.0084

In 2007, the average of all treatments exceeded that of 2006 and 2008. In contrast to 2006 and 2008, high N<sub>2</sub>O emissions occurred in both the compacted and the non-compact highly fertilized treatments. Cumulative N<sub>2</sub>O emissions increased in the fertilized treatments when the soil compaction was carried out under moist soil conditions (2006 and 2008). In 2007, the soil compaction was performed in a dry spring; consequently no effect on N<sub>2</sub>O emissions was detected. In the legume dominated high yielding zero-fertilized treatment, soil compaction had no influence on N<sub>2</sub>O emissions in spring. The increase in emissions in early summer of 2007 for the fertilized treatment can be explained by high precipitation following a long dry period. Owing to a high proportion of alfalfa (67% of DM), the DM-yields of the non-N-

fertilised plots amounted to  $16.2 \text{ t ha}^{-1}$ , which was not statistically different from the yields of the fertilised treatments.

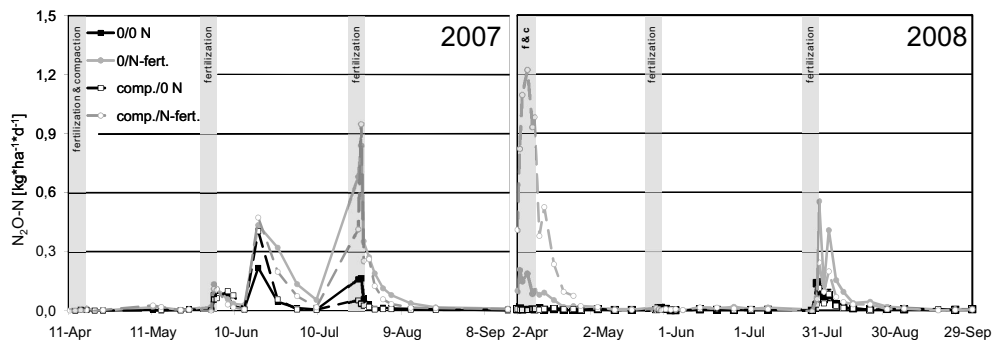

Figure 1:  $\text{N}_2\text{O}$ -flux during the measuring period (Apr. to Sept.); the vertical bars represent treatments

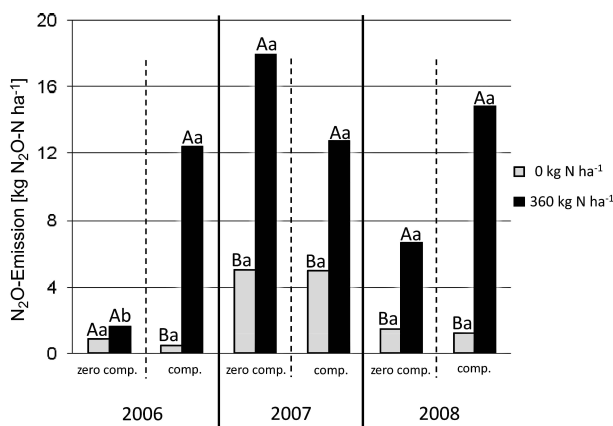

Figure 2: Cumulative nitrous oxide emissions for soil compaction and N-fertilization treatments in 2006–2008. (Capital letters indicate a significant difference due to the fertilization, lower case indicate a significant difference due to the soil compaction)

## Conclusions

Soil compaction on grassland should be avoided because of its effect on  $\text{N}_2\text{O}$  emissions, especially under wet soil conditions and simultaneous high N-application.

## References

- Hutchinson G.L. and Mosier A.R. (1981) Improved soil cover method for field measurement of nitrous oxide fluxes. *Soil Science Society of America* 45, 311-316.
- UBA (2007) Nationaler Inventarbericht zum Deutschen Treibhausgasinventar 1990-2005. *Climate Change* 04/07.
- Velthof G.L. Oenema O.P., Postma R., Van Beusichem M.L. (1997) Effects of type and amount of applied nitrogen fertilizer on nitrous oxide fluxes from intensively managed grassland. *Nutrient Cycling in Agroecosystems* 46, 257-267.
- Yamulki S. and Jarvis S.C. (2002) Short-term effects of tillage and compaction on nitrous oxide, nitric oxide, nitrogen dioxide, methane and carbon dioxide fluxes from grassland. *Biology and Fertility of Soils* 36, 224-231.

## Grazing intensity and precipitation affects herbage accumulation, herbage quality and animal performance in semi-arid grassland

Schönbach P.<sup>1</sup>, Wan H.<sup>1</sup>, Gierus M.<sup>1</sup>, Müller K.<sup>2</sup>, Lin L.<sup>2</sup>, Susenbeth A.<sup>2</sup> and Taube F.<sup>1</sup>

<sup>1</sup>*Institute of Crop Science and Plant Breeding - Grass and Forage Science/Organic Agriculture, Christian-Albrechts-University, Hermann-Rodewald-Str. 9, 24118 Kiel, Germany*

<sup>2</sup>*Institute of Animal Nutrition and Physiology, Christian-Albrechts-University, Hermann-Rodewald-Str. 9, 24118 Kiel, Germany*

### Abstract

The present experiment was performed during four grazing seasons (2005-2008) in semi-arid grassland of Inner Mongolia to gain information on grazing-induced grassland degradation. Effects of sheep stocking rate and precipitation on end-of-season herbage mass, herbage accumulation, herbage quality, and animal performance were analysed along a gradient of seven grazing intensities (ranging from ungrazed to very heavily grazed). End-of-season herbage mass, herbage accumulation, and herbage quality varied greatly between years ( $P < 0.001$ ), correlating with inter-annual variation in precipitation. The accumulation and quality of herbage were inversely affected by grazing intensity. While herbage accumulation decreased ( $P < 0.001$ ) herbage quality increased ( $P < 0.001$ ) with increasing grazing intensity. The relationship between animal performance and grazing intensity were expressed by quadratic functions. Highest live weight gains per sheep and per ha were achieved at light (3 sheep ha<sup>-1</sup>) and very heavy (13 sheep ha<sup>-1</sup>) grazing, respectively. Precipitation appeared to be the factor most crucial for determining accumulation and quality of herbage, while grazing intensity was the key factor determining animal performance.

Keywords: grazing experiment, nutritive value, sheep production, typical steppe

### Introduction

Within the last decades sharply increasing stocking rates have imposed enormous pressure on natural grassland resources in Inner Mongolia leading to overgrazing and degradation. Grazing not only alters the ecological functionality of the grassland but also its value for livestock farming. The present study aimed to analyse grazing-induced changes in productivity and herbage quality as well as its effect on animal performance.

### Materials and methods

This experiment was conducted in semi-arid grassland of Inner Mongolia, P.R. China. A randomized complete block design was chosen to analyse effects of different grazing intensities, i.e. ungrazed (GI0), very-light (GI1), light (GI2), light-moderate (GI3), moderate (GI4), heavy (GI5), and very-heavy (GI6), on end-of-season herbage mass (HM), herbage accumulation (HA), herbage quality, and the live weight gain (LWG) per animal and per ha. Herbage quality analysis comprised organic matter (OM), crude protein (CP), neutral detergent fibre (NDF), acid detergent fibre (ADF), acid detergent lignin (ADL), cellulase digestible organic matter (CDOM), and metabolizable energy (ME). The Near-Infrared-Spectroscopy (NIRS) technique was used to estimate the quality variables. From the pool of herbage samples, calibration (2005: n = 138, 2006: n = 44, 2007: n = 31, 2008: n = 25) and validation (2005: n = 25, 2006: n = 10, 2007: n = 15, 2008: n = 15) subsets were chosen for

the chemical laboratory analysis. Data were analysed by ANOVA, using the Mixed Model, and by simple regression analysis in SAS version 9.1.

## Results and discussion

The factor year strongly affected end-of-season HM ( $P < 0.001$ ), HA ( $P < 0.001$ ), herbage quality ( $P < 0.001$ ), and LWG sheep<sup>-1</sup> ( $P < 0.05$ ) and ha<sup>-1</sup> ( $P < 0.001$ ) (Table 1). Precipitation was the main factor explaining year effects on the accumulation (HA) and the quality of the analysed herbage material. While HA ( $P < 0.01$ ,  $R^2 = 0.2$ ), CP ( $P < 0.01$ ,  $R^2 = 0.3$ ), and CDOM ( $P < 0.05$ ,  $R^2 = 0.2$ ) were positively correlated with precipitation, NDF ( $P < 0.001$ ,  $R^2 = 0.6$ ) decreased with increasing annual precipitation, highlighting the positive effect of precipitation on productivity and quality in semiarid grasslands. Most of the between-year variation in the accumulation and quality of herbage was due to the high inter-annual variability of precipitation.

Grazing intensity considerably influenced most of the studied herbage variables and was the most important treatment factor determining animal performance (Table 1). Compared to GI0, the end-of-season HM on GI1, GI2, GI3, GI4, GI5, and GI6 was 0, 26, 62, 55, 80, and 92%, respectively. HA was also reduced by grazing intensity and decreased from 195 g m<sup>-2</sup> on GI0 to 106 g m<sup>-2</sup> on GI6 ( $P = 0.091$ ). All herbage quality variables were affected by grazing intensity. In general, herbage quality increased with increasing grazing intensity (Table 1). The strong positive effect of grazing intensity was partly caused by decreasing accumulation of senescent material (Schönbach *et al.*, 2009). The mean age of plant tissue is commonly lower under heavy as compared to light grazing, suggesting that younger (regrown) plant material contains higher CP. Furthermore, mineralisation rates are accelerated when herbivore excreta rather than senescent plant material are deposited on the soil surface, thereby increasing availability of mineral nitrogen to plants and increasing plant CP concentrations. Further potential reasons for grazing-induced increases in plant CP concentration are discussed by Schönbach *et al.* (2009).

The LWG sheep<sup>-1</sup> reached its peak at GI3 and its minimum at GI6, whereas, the LWG ha<sup>-1</sup> increased continuously from GI1 to GI6 (Table 1). LWG in g sheep<sup>-1</sup> d<sup>-1</sup> ( $y = -0.6x^2 + 3.8x + 84.5$ ,  $R^2 = 0.3^{**}$ ) and ha<sup>-1</sup> d<sup>-1</sup> ( $y = -4.3x^2 + 109.6x - 25.8$ ,  $R^2 = 0.8^{***}$ ) showed significant quadratic correlations with stocking rate. The LWG sheep<sup>-1</sup> reached its peak at 3 sheep ha<sup>-1</sup>, i.e. the equivalent of light grazing (GI1-GI2), whereas, the LWG ha<sup>-1</sup> reached its peak at 13 sheep ha<sup>-1</sup>, i.e. the equivalent of very-heavy grazing (GI6). Accordingly, LWG sheep<sup>-1</sup> did not benefit from better herbage quality at high grazing intensities. Indeed, high grazing intensities exhibited best herbage quality, but HM was limiting.

## Conclusion

Precipitation appeared to be the crucial factor determining accumulation and quality of herbage, while grazing intensity played the key role in determining animal performance. Increasing grazing intensity decreased HA but increased herbage quality. However, animal performance in this rangeland was primarily influenced by herbage quantity. There were no benefits of grazing-induced increases in herbage quality on LWG.

## References

Schönbach P., Wan H., Schiborra A., Gierus M., Bai Y., Müller K., Glindemann T., Wang C., Susenbeth A. and Taube F. (2009) Short-term management and stocking rate effects of grazing sheep on herbage quality and productivity of Inner Mongolia steppe. *Crop & Pasture Science* 60, 963-974.

Table 1. Effects of grazing intensity on end-of-season herbage mass (HM), herbage accumulation (HA), crude protein (CP), neutral detergent fibre (NDF), acid detergent fibre (ADF), acid detergent lignin (ADL), cellulase digestible organic matter (CDOM), metabolizable energy (ME), and live weight gain (LWG) per sheep and per ha.

Variables	Grazing intensity†						P-values of variables*						
	0	1	2	3	4	5	6	S.E.	Y	B	GI	Y×GI	Y×B
D.F.									3	1	6	18	3
HM (g m <sup>-2</sup> )	165.9a	178.6a	122.3ab	62.8ab	75.2ab	32.5b	13.9b	25.00	<0.01	0.028	0.019	0.306	0.099
HA (g m <sup>-2</sup> )	195.4	210.6	188.6	146.9	179.9	133.2	105.7	22.61	<0.01	0.012	0.091	0.106	0.236
CP (g kg <sup>-1</sup> )	103.8c	98.0c	111.6c	121.2bc	106.4c	137.0ab	153.0a	5.07	<0.01	<0.01	<0.01	0.104	0.136
NDF(g kg <sup>-1</sup> )	689.2ab	696.8a	695.9a	697.2a	703.8a	690.7ab	678.4b	3.71	<0.01	<0.01	0.009	0.273	0.151
ADF (g kg <sup>-1</sup> )	334.1abc	345.3a	334.8abc	325.4bcd	342.7ab	322.1cd	315.0d	3.37	<0.01	<0.01	<0.01	0.044	0.211
ADL(g kg <sup>-1</sup> )	47.9a	47.1a	45.8a	43.9ab	45.0a	41.9bc	40.2c	0.58	<0.01	0.009	<0.01	0.080	0.131
CDOM(g kg <sup>-1</sup> )	607.4c	602.3c	606.6c	615.0bc	601.2c	629.0ab	646.1a	5.33	<0.01	<0.01	0.001	0.126	0.210
ME (MJ kg <sup>-1</sup> )	8.4b	8.3b	8.4b	8.5ab	8.2b	8.7ab	8.9a	0.09	<0.01	<0.01	0.004	0.189	0.259
LWG (g sheep <sup>-1</sup> d <sup>-1</sup> )	-	81.9bc	94.8ab	99.2a	75.7cd	74.0cd	64.6d	3.13	0.017	0.020	<0.01	0.002	0.317
LWG (g ha <sup>-1</sup> d <sup>-1</sup> )	-	170.9d	284.5d	460.4c	469.1bc	582.0ab	602.6a	25.63	<0.01	0.038	<0.01	0.092	0.009

a, b, c, d Within rows, means followed by the same small letters are not significantly different ( $P < 0.05$ ).

\*Y, year; B, block; GI, grazing intensity.

†Grazing intensities 0, 1, 2, 3, 4, 5, and 6 represent grazing scenarios of ungrazed, very light, light, light-moderate, moderate, heavy, and very heavy, respectively (see Materials and Methods).



# Effect of precipitation on dry matter production of a meadow with varied cutting frequency

Thumm U. and Tonn B.

*University of Hohenheim, Institute of Crop Science, 70593 Stuttgart, Germany*

Corresponding author: thumm@uni-hohenheim.de

## Abstract

Grassland dry matter yield was investigated at a site where plant growth is temporarily restricted by inadequate water supply. In a field experiment defoliation frequency was varied from two to five cuts per year at two nitrogen levels over 13 years. Under low nitrogen fertilization maximum yield was obtained at two cuts per year in most years. Under higher nitrogen input, the highest yield was obtained at a cutting frequency of three. Positive relationships between precipitation and biomass production were only observed occasionally. It seems that the impact of restricted water supply was often negligible compared to other factors like botanical composition and soil conditions at this site. Additionally, the effect of rainfall deficiency will vary strongly depending on season and growth stage of the grassland sward.

Keywords: long-term field experiment, cutting frequency, yield, precipitation

## Introduction

Even under constant management, year-to-year variation of grassland dry matter (DM) production is common. In most cases this finding is traced back to variability in weather conditions. Water supply is well known as a main growth factor for grassland in most site conditions. Therefore rainfall is often considered as being responsible for yield variation. Käding *et al.* (2003) found no significant correlation between precipitation and DM yield in a long-term experiment. In contrast, Jo and Schechtner (1991) observed the highest yields in dry seasons in a 4- and 6-cut system. Combining soil and weather data with characteristics of grassland management in a simple model (Trnka *et al.*, 2006) allowed a better prediction of herbage production.

The objective of this study was to investigate, in a long-term experiment, the influence of varied cutting frequency and two levels of nitrogen fertilization on botanical composition and DM yield and assess the influence of precipitation variability.

## Material and methods

A field experiment was started in 1994 after sowing a species-rich mixture on an arable field in the preceding year. The diversity of the mixture (23 species) allowed the establishment of different plant communities under the influence of diversified management. Cutting frequencies of 2, 3, 4 or 5 cuts per year and nitrogen fertilizer rates of 30 (low) or 60 kg ha<sup>-1</sup> cut<sup>-1</sup> N (high) were applied. Thus, annual nitrogen fertilizer rates were 60 or 120 kg ha<sup>-1</sup> with 2 cuts per year and 150 or 300 kg ha<sup>-1</sup> with 5 cuts per year. The experiment was arranged in a split-plot design with 4 replications and a plot size of 39 m<sup>2</sup>. The site was located at Stuttgart-Hohenheim (48.7137 °N, 9.2122 °E, altitude 400 m a.s.l., mean annual rainfall 698 mm, mean daily temperature 8.8 °C) on a silty loam soil. Water-limited conditions for grassland are common at this site. Plant species were recorded and their proportion of biomass was estimated in all plots before the harvest of the first cut. DM yield was quantified by cutting a sample (8 m<sup>2</sup>) in every plot. Precipitation data were assigned to DM yield for every single cut

by adding rainfall of the days between defoliations, respectively rainfall after 15 March until first cut in spring. Statistical analysis of DM data was performed by ANOVA. Linear regressions between DM yield per cut and rainfall sums during the respective growth intervals were calculated additionally. If there was a significant slope of the regression line ( $P < 0.05$ ) in Table 2 fields were marked by an asterisk.

## Results and discussion

After 13 years of differential management typical botanical compositions had developed. The higher fertilization rate resulted in a higher proportion of grasses and fewer legumes and herbs. Tall grasses and legumes (*Arrhenatherum elatius*, *Trifolium pratense*) had high abundances at lower cutting frequency, while species like *Lolium perenne* and *Poa pratensis* had a higher yield percentage under frequent cutting (Table 1). At a few years after establishment of the experiment the influence of the original seed mixture on community composition seemed marginal.

Table 1: Percentage of dry matter yield of grasses, legumes and herbs after 13 years of different management (totals and amount of some selected species)

Species	Low nitrogen fertilization				High nitrogen fertilization			
	Cutting frequency				Cutting frequency			
	2	3	4	5	2	3	4	5
Grasses (total)	76	47	51	62	94	91	78	87
<i>Alopecurus pratensis</i>	18	15	10	15	32	24	18	20
<i>Arrhenatherum elatius</i>	21	13	5	3	28	31	7	3
<i>Dactylis glomerata</i>	5	5	6	5	6	9	12	11
<i>Lolium perenne</i>	-	3	10	18	-	4	15	19
<i>Poa pratensis</i>	-	3	6	6	-	6	10	13
Legumes (total)	19	33	18	13	2	3	4	3
<i>Trifolium pratense</i>	16	28	13	8	2	3	1	1
<i>Trifolium repens</i>	1	5	5	5	< 1	< 1	3	2
Herbs (total)	5	20	31	25	4	6	18	10
<i>Plantago lanceolata</i>	1	3	10	6	< 1	1	6	3
<i>Taraxacum officinale</i>	1	9	16	13	1	1	7	5

Maximum DM yield was mostly obtained with 2 cuts per year at low nitrogen fertilization and with 3 cuts per year at high nitrogen fertilization (Figure 1). The decrease of yield at higher cutting frequencies was more pronounced under low than under high nitrogen fertilization. A tendency for declining yields over the years was also evident. This may indicate a diminishing productivity of the grassland swards at this site due to an increasing proportion of less productive species. Precipitation during the growing period did not influence yield consistently. Yield depression caused by extreme water limitation, however, was evident in the low yields of the year 2003, which was marked by a long drought period in summer. It is probable that the water supply in different periods of the growing season exerted a stronger influence. Therefore the quotient of DM and rainfall was calculated for every separate cut. Highest DM yields per mm rainfall were obtained for the first or sometimes for the second cut. In regression analysis a significant slope, indicating a direct influence of rainfall on yield, was detected only in a few cases (Table 2). A closer relationship between rainfall and biomass production might be detected by considering carry-over effects of soil moisture between regrowth periods in a soil moisture model. There was no evidence for long term trends over years.

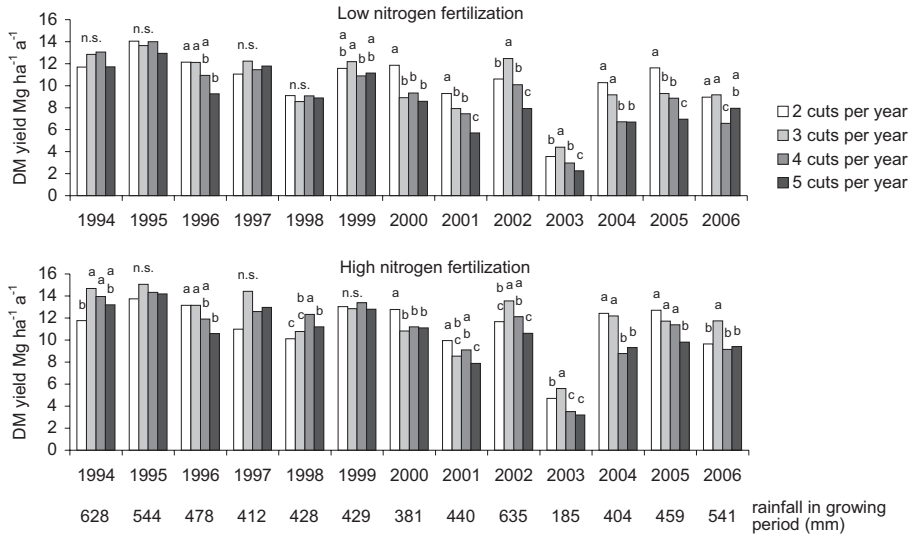

Figure 1. Annual dry matter (DM) yield and rainfall during the (re-)growth period. Different letters indicate significant differences between treatments ( $P < 0.05$ ), n.s. not significant.

Table 2. Quotient of dry matter yield per cut and amount of rainfall during the respective growth period ( $\text{kg ha}^{-1} \text{mm}^{-1}$ ). Mean of annual data from 13 years. A significant ( $P < 0.05$ ) slope of the regression line (not presented in detail here) is marked by \*.

	Low nitrogen fertilization				High nitrogen fertilization			
	Cutting frequency				Cutting frequency			
	2	3	4	5	2	3	4	5
first cut	29	31*	26	23	31	36	30	26
second cut	17	19*	26	25*	18	22*	30	30*
third cut	-	15	16	16*	-	19	19	19*
fourth cut	-	-	15	18	-	-	18*	20
fifth cut	-	-	-	12	-	-	-	16
total	23	22	20	19	25	26	24	23

## Conclusions

A typical adaptation of grassland composition and yield to modified cutting and fertilization regimes was found. Simple basic relationships between DM yield and rainfall were not evident. Under conditions pertaining at this site a simple and reliable yield estimation using only rainfall data was not practicable. There are more factors which influence the harvested DM of a meadow and which have to be considered, such as water storage capacity of the soil, rain distribution and water availability at different growth stages of the sward. In a next step the data will be used for modelling DM accumulation as a function of soil water availability.

## References

- Jo I.H. and Schechtner G. (1991) Efficiency of mineral nitrogen fertilization on yield and botanical composition of grassland. VII. Estimation of economical way of mineral nitrogen application depending on difference of annual precipitations in permanent grassland. *Journal of the Korean Society of Grassland Science* 11, 182-188.
- Käding H., Werner A. and Schälitz G. (2003) Consequences of long term nitrogen fertilization on site-condition, yield, nutrients and vegetation-composition of the peat grassland. *Pflanzenbauwissenschaften* 7, 13-20.
- Trnka M., Eitzinger J., Gruszczynski G., Buchgraber K., Resch R. and Schaumberger A. (2006) A simple statistical model for predicting herbage production from permanent grassland. *Grass and Forage Science* 61, 253-271.

## **Session 1.2**

### **Grassland and socio-economic change**

*Editor: Jürgen Schellberg*

# Case-control studies for risk-assessment in ecology and agriculture

Suter M.<sup>1,2</sup> and Lüscher A.<sup>3</sup>

<sup>1</sup>Swiss Grassland Society, 8046 Zurich, Switzerland

<sup>2</sup>Institute of Integrative Biology, ETH Zürich, 8092 Zürich, Switzerland

<sup>3</sup>Agroscope Reckenholz-Tänikon Research Station ART, 8046 Zürich, Switzerland

Corresponding author: matthias.suter@art.admin.ch

## Abstract

This paper introduces the principles of case-control studies to investigate complex research questions that cannot be easily unravelled by experimentation. Case-control designs were originally developed in human health research but can also be applied to agronomy and ecology. They allow for the inclusion of many different management, ecological, and social factors and for thorough statistical testing using generalised linear models.

The principle of case-control studies is demonstrated by a study assessing the risk for the occurrence of the poisonous *Senecio jacobaea* in agricultural grassland, an increasing problem in Central Europe. Based on this example, we demonstrate that case-control studies provide reliable results in a relatively short timeframe. Effects can be assigned to factors that have acted over the long term, under real and natural conditions, and may have manifold influence on targets. We conclude that case-control studies offer a great opportunity in surveys and on-farm research and can be applied to a wide range of research topics in agronomy and ecology.

Keywords: case-control study, relative risk, generalised linear model, on-farm research, *Senecio jacobaea*

## Introduction

When complex research questions involving ecological, economical, and social aspects are investigated, the set-up of detailed experiments is often inappropriate or even impossible, because the great number of factors with potential influence makes it hard to establish experimental protocols that can lead to relevant conclusions. Moreover, if factors exert their influence over long timeframes and/or low intensity levels, experimentation will become extremely time-consuming and expensive. In such situations, an approach that investigates established structures under given natural or cultural conditions, combined with a sophisticated design that allows for thorough statistical testing would be extremely beneficial. We suggest that case-control studies can fill this gap and demonstrate how they can be applied to agronomy and ecology.

## Materials and methods

Up to this point, case-control studies have been performed regularly in human health research, where experimentation is often restricted due to ethical reasons. A well-known example is the investigation of lung cancer as related to smoking behaviour (Peto *et al.*, 2000). As the name implies, cases (e.g. persons with a disease) are compared with controls (persons without this particular disease). It is decisive that objects can be clearly assigned to be a case or not, which is generally possible with diseases and in many other situations; moreover, cases and controls should be similar in other traits than the one under observation (here: disease) as far as possible. Factors that have caused an object to become a case need not be known beforehand and can have acted over long time.

Factors that potentially influence cases and controls are then recorded for both groups (e.g. age, gender, nutrition, smoking). The influence of these explanatory factors is analysed with generalised linear models (GLMs), the response variable being the objects assigned to one of the two groups. Finally, the method estimates the relative risk, the ratio of the probability for the occurrence of cases (e.g. persons with cancer) for two levels of an explanatory variable (e.g. for smokers *versus* non-smokers) (Agresti, 2002, p. 47). Following Agresti (2002), this is possible with GLMs whenever the probability of the outcome of interest (e.g. cancer in large populations) is close to zero or at least very low.

The principles of case-control designs are demonstrated by a study assessing the risk for the occurrence of the toxic *Senecio jacobaea* in agricultural grassland (Elcock and Oehme, 1982). Following a case-control design, 62 on-farm plots were evaluated, *S. jacobaea* occurring in 32. Plots with *S. jacobaea* (cases) and plots without *S. jacobaea* (controls) were selected in pairs adjacent to each other and had, as far as possible, similar environmental conditions; however, the management practice between them may have differed. The botanical composition of all plots was recorded and samples of the topsoil were taken for the analysis of soil nutrients and soil texture. The farmers provided data on the type of grassland management (mowing, rotational grazing, continuous grazing) and on applied mineral and organic fertilisers (slurry, solid manure). Further details on design and analysis are provided in Suter *et al.* (2007).

## Results and discussion

The highest risk for the occurrence of *S. jacobaea* was found with low nitrogen fertilisation, a very open sward, and continuous-extensive grazing (set stocking; Table 1). Doubling the application of nitrogen from 50 to 100 kg ha<sup>-1</sup> yr<sup>-1</sup> reduced the risk for the occurrence of *S. jacobaea* approximately five-fold, meaning that the species occurred less frequently on intensively fertilised grasslands. Swards with a high percentage of uncovered soil (> 25%) had a forty-fold greater risk for the occurrence of *S. jacobaea* than swards with less than 25% bare ground. Finally, plots that were under continuous-extensive grazing (set stocking) had an approximately eleven-fold greater risk for the occurrence of *S. jacobaea* compared to mown grassland, while rotational grazing did not show significant differences in risks compared to mowing. We conclude that a long-term control of *S. jacobaea* can best be achieved by avoiding sward damage, by replacing continuous-extensive grazing with rotational grazing, and by preventing the species' seed formation in the pasture and local environment (Suter *et al.*, 2007).

Table 1. Variables with significant effects on the occurrence of *S. jacobaea*. The table is adapted from Suter *et al.* (2007).

Variable <sup>†</sup>	Relative risk	P-value
Nitrogen-applied	0.2 <sup>‡</sup>	0.008
Openness: High (> 25%)	40.3	0.005
Rotational grazing vs mowing	0.9	0.953
Continuous grazing vs mowing	11.6	0.017

<sup>†</sup> To calculate the relative risk, the conditions represented by the variables were compared to grassland that was mown, received available nitrogen of 50 kg ha<sup>-1</sup> yr<sup>-1</sup>, and had a low openness of sward (≤ 25%)

<sup>‡</sup> Relative risk for applied nitrogen of 100 kg ha<sup>-1</sup> yr<sup>-1</sup>

This example illustrates well the benefits of case-control studies. (i) Given careful planning and selection of factors to be recorded, the actual field work can last for only a short time, in our case one summer. (ii) More importantly, it is possible to record factors, such as grazing systems, that could not be easily established with acceptable replication in an experimental set-up. (iii) There can be influences with a very broad range or composed of several

components, such as soil conditions. Given that influences are often unknown beforehand, it would be difficult to select the relevant factors and the range in which they could influence experimentation. (iv) If an experiment is performed with a selection of factors, conclusions to be drawn are valid only for the particular conditions, whereas case-control studies allow for conclusions over their investigated range, which is generally broad. (v) At the time of investigation, factors such as soil conditions or grazing systems may have exerted their influence on targets over a very long time. (vi) Case-control studies scrutinise their objects under real or natural conditions (on-farm, in our example), which makes it more feasible to draw conclusions relevant to application. While very beneficial, there are also drawbacks to case control designs: variables recorded are not independent from each other and can be correlated, which limits, to some extent, their interpretation. Various methods have been suggested to face this challenge (Graham, 2003), the most accurate of which performs a detailed experiment that highlights a causal relationship. This can be very insightful once a relevant factor has come up based on a case-control study.

It is clear that case-control studies could be applied to various fields in agronomy and ecology. Possible research questions may cover topics from economy, social background, crop production, or biodiversity in grassland. For example, the design might be used to evaluate the success of farmers in achieving high-quality standards for particular products, to assess the risk of fields to be attacked by wild boars, or to evaluate the establishment of field margin strips from seeds. In particular, for investigations taking place under everyday conditions and providing answers for application, case-control studies offer a great opportunity to improve current methods.

## Conclusions

We demonstrate that case-control studies provide reliable information that is based on established natural or cultural conditions. Effects can be assigned to factors that have acted over a long timeframe and have manifold influence on targets. We are convinced that case-control studies have a great potential in surveys and on-farm research and can be applied to a wide range of research topics.

## Acknowledgments

The project was supported by the Swiss Federal Office for Agriculture FOAG.

## References

- Agresti A. (2002) *Categorical data analysis*. 2nd edn, Wiley, New York, US, 710 pp.
- Elcock L. and Oehme F.W. (1982) *Senecio* poisoning in horses: a summary. *Veterinary and Human Toxicology* 24, 122-123.
- Graham M.H. (2003) Confronting multicollinearity in ecological multiple regression. *Ecology* 84, 2809-2815.
- Peto R., Darby S., Deo H., Silcocks P., Whitley E. and Doll R. (2000) Smoking, smoking cessation, and lung cancer in the UK since 1950: combination of national statistics with two case-control studies. *British Medical Journal* 321, 323-329.
- Suter M., Siegrist-Maag S., Connolly J. and Lüscher A. (2007) Can the occurrence of *Senecio jacobaea* be influenced by management practice? *Weed Research* 47, 262-269.



## **Extensive grasslands beyond the year 2013 – present situation and options for the future?**

Luick R.<sup>1</sup> and Schrode S.<sup>1</sup>

<sup>1</sup>*University of Rottenburg (HFR), Schadenweilerhof, D-72108 Rottenburg*

Corresponding author: luick@hs-rottenburg.de

### **Abstract**

Extensive high nature value (HNV) grasslands belong to the most threatened anthropogenic ecosystems in Europe. In a recent research study, the status of extensive grasslands (and associated agricultural systems) in the South-West of Germany were found to be representative of many other less favoured rural areas in Europe. Major interest was given to the socio-economic situation of related agricultural systems. The present economic situation of farming with extensive grasslands and policy obstacles are depicted from the farmers' perspectives. There is a clear outcome of the study that grasslands with high biodiversity and importance for conservation are declining dramatically. The reasons are mainly qualitative losses due to intensification processes of various reasons. If HNV grasslands are to survive the common agricultural policy reforms following 2013, new land-use systems have to be developed.

Key words: extensive grassland, agricultural policy, dairy production, extensive grazings

### **Introduction**

Extensive high nature value (HNV) grasslands (including meadows as well as pastures) belong to the most threatened anthropogenic ecosystems in Europe. They also provide a major contribution to the world heritage of biodiversity (Oppermann and Gujer, 2003; BMU, 2007; Venn *et al.*, 2010). In Germany, their main distribution, in terms of quantity and quality, is in southern Germany. In a current project financially supported by the Ministry of Rural Affairs of the state of Baden-Wuerttemberg the status of extensive grasslands and associated agricultural systems was examined. Of major interest are the socio-economic situations of farmers and their perceptions of agricultural policy. In this context benefits as well as shortcomings from an economic and environmental point of view were focused. Stakeholders in conservation, and also farmers, who are still dedicated to continue with management of extensive grassland systems, express considerable concern of what will happen after the year 2013 (EC and EEN, 2009). First concepts of a new common agricultural policy (CAP) have already been presented and controversial debates about future perspectives for extensive grassland management strategies in Europe have been started ([www.reformthecap.eu](http://www.reformthecap.eu)).

### **Study area and methods**

The study focuses on 7 regions in Baden-Wuerttemberg with documented distribution of HNV grassland. The empirical basis was developed alongside socio-economic investigations of various types of livestock-keeping farms, which had been chosen because of their importance in terms of distribution, size and ecological quality of HNV-grasslands. The typology follows the nomenclature of the European Habitats Directive (Table 1).

### **Results and discussion**

Of crucial concern for the continuation of extensive grassland management is the situation of the dairy sector in less favoured areas. Using the dairy cow census of the state of Baden-

Wuerttemberg as an indicator, the average number of cows dropped from 874453 to 358136 between 1960 and 2009 (decline of ~ 60 %, Figure 1). There are dramatic losses of up to 95% in certain districts. The decline of cows is not linked to reduced milk production, as progress in breeding and new forms of feeding have more than equalled declining cow numbers. A detailed analysis unveils that the most dramatic changes have happened in grassland-dominated mountainous regions often associated with small-scale farming structures, in (previous) grassland regions which had been turned into maize fields, and in regions with a socio-economic pull of adjacent urban agglomerations. Thus, dairy farms are increasingly concentrated in regions where there is the possibility of intensive silage production and with suitable conditions for supplement maize production. In general, it can be observed that even dairy farms in low productive grassland regions are about to abolish pasturing entirely.

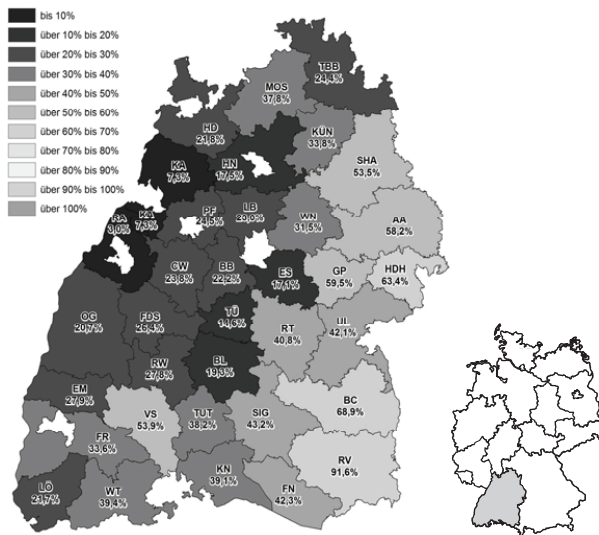

Figure 1: Decline of dairy cows from 1960 to 2009 in the districts within the state of Baden-Wuerttemberg. Cow numbers in 1960 are set as 100% for each district. White spaces represent urban areas.

Table 1: List of Natura 2000 biotopes, which result or which depend on low intensity agricultural systems for the federal state of Baden-Wuerttemberg.

Type and Natura 2000-Code	Related agricultural system
Dry heathland (4030)	Extensive livestock with sheep (grazing)
Formations with <i>Juniperus communis</i> on calcareous heaths or grassland (5130)	Extensive livestock with sheep/cattle (grazing)
Karstic calcareous grasslands (6110)	Extensive livestock with sheep (grazing)
Xeric sand calcareous grasslands (6120)	Extensive livestock with sheep (grazing)
Formations on calcareous substrates (6210)	Extensive livestock with sheep (grazing and hay-making)
Formation with <i>Nardus stricta</i> on silicious substrates in mountain areas (6230)	Extensive livestock with cattle/dairy (grazing and hay-making), suckler cow systems
<i>Molinia</i> meadows on chalk or clay (6410)	Extensive livestock with cattle/dairy (special uses for bedding and hay-making)
Lowland hay-meadows (6510)	Traditional livestock with cattle/dairy, suckler cow systems
Mountain hay meadows (6520)	Traditional livestock with cattle/dairy, suckler cow systems
Alkaline fens (7330)	Extensive livestock with cattle/dairy (special uses for bedding and hay-making)

In association with the present detrimental economy of dairy farms, and also paralleled with a continuous reduction of CAP support, an accelerated structural change was introduced with the revision of the milk quota stock in 2007. Large quantities of quota have left states with significant shares of low intensity dairy systems such as Baden-Wuerttemberg and Hesse, and

were transferred to intensive production regions in Northern Germany including the states of Lower Saxony and Schleswig-Holstein (Table 2). Disparities also exist at the state level and quotas always tend to go to the favoured regions, which allow arable systems.

Farmers also expressed severe concern that constantly rising rents for grassland, which previously was considered as being marginal, are challenging the economy of extensive grazing systems that have suckler cows or/and sheep. This development is mainly driven by the growing importance of biomass production. This in turn leads to significant losses of grassland by ploughing and conversion to energy crops (Lind *et al.*, 2009).

Table 2: Results of milk quota trading in 10<sup>6</sup> kg according to the German stock region West since the introduction in 2007 (plus numbers stand for gains, minus numbers express losses of milk quotas in the according states).

Trading regions	Jul 07	Nov 07	Apr 08	Jul 08	Nov 08	Apr 09	Jul 09	Nov 09	Σ since 2007
BW <sup>4</sup>	-37.620	-9.606	-16.377	-7.819	+0.822	-2.468	+0.134	-5.083	-78.016
Bavaria	-22.900	+22.319	-9.689	-11.083	+1.309	+9.248	-5.894	-7.364	-24.054
Lower Saxony <sup>1</sup>	+88.900	+0.749	+35.874	+27.619	+1.413	-17.096	-7.992	+4.355	+133.822
NRW <sup>3</sup>	-3.050	-5.617	+0.639	+2.364	+0.688	+6.750	+16.591	+13.671	+32.704
Hesse	-13.820	-5.809	-5.644	-6.480	-3.120	+0.112	-5.188	-4.166	-44.114
RP <sup>2</sup>	-11.500	-2.036	-4.803	-4.602	-1.113	+3.453	+2.349	-0.514	-18.766

<sup>1</sup> responsible for the states of Lower Saxony, Schleswig-Holstein, Hamburg und Bremen, <sup>2</sup> Rhineland-Palatinate, responsible for the states of Rhineland Palatinate and Saarland <sup>3</sup> Nordrhein-Westfalia <sup>4</sup> Baden-Wuerttemberg

## Conclusion

The investigations express a clear picture of the dramatic loss of extensive grasslands as unique agricultural ecosystems. It is estimated that species-rich grasslands in the South-West of Germany have diminished by 85% in the last four decades (from 300000 hectares to less than 40000 hectares). Even in designated conservation areas, like Natura 2000-sites, severe quantitative and qualitative losses of high-nature value grasslands are being observed. Long-term discussions and repeated demands for strategies have not yet resulted in sustainable management concepts. It has to be concluded that market-orientated dairy production cannot be followed as a mainstream approach to support the survival of HNV grassland in general. More emphasis should be given to the development of tailored and economically vital extensive grazing systems. Such systems can be realised with the few farmers remaining in less favoured areas, with reasonable demand for capital, best linkages to ecosystem service approaches and regional marketing initiatives (Luick *et al.*, 2009).

## References

- European Commission (EC) and European Evaluation Network (EEN) (2009) *The application of the High Nature Value Impact Indicator - Guidance document*, Brussels, 37pp.
- Federal Ministry for the Environment, Nature Conservation and Nuclear Safety (BMU) (2007): *National strategy on biological diversity*, Berlin 180 pp.
- Lind B., Stein S., Kaercher A. and Klein M. (2009) *Where have all the flowers gone? Grünland im Umbruch*. Hintergrundpapier und Empfehlungen des Bundesamt für Naturschutz (BfN), Bonn, 18 pp.
- Luick R., Muhar A., Wrбка T. and McCracken D. (2009) Perspectives of sustainable development of cultural landscapes ecosystems in Europe. In: Krzywinski K., O'Connell M. and Küster H.-J., 67 (eds.) *Cultural Landscapes of Europe – Fields of Demeter – Haunts of Pan*. Aschenbeck Media, Bremen.
- Oppermann R. and Gujer H. U. (2003) *Artenreiches Grünland bewerten und fördern – MEKA und ÖQV in der Praxis*. Eugen Ulmer Verlag, Stuttgart, 196 pp.
- Veen P., Jefferson R., DeSmidt J. and Van Der Straaten J. (2009) *Grasslands in Europe of High Nature Value*. KNNV Publishing, Zeist, The Netherlands, 320 pp.

## Simulation of the effect of grass intake on the farmer's income

Van den Pol-van Dasselaar A., De Haan M., Evers A. and Philippsen A.P.  
*Wageningen UR Livestock Research, P.O. Box 65, 8200 AB Lelystad, the Netherlands*  
Corresponding author: agnes.vandenpol@wur.nl

### Abstract

Grazing affects people, planet and profit. In general, the farmer's income will be higher when grazing of dairy cows is applied. We studied the economic effects of grazing for situations where we expect that grazing is difficult to apply. These situations could result in lower incomes for grazing. Farms with automatic milking systems, a small grazing surface, a large herd and/or a high milk yield per cow were studied. For the situations with automatic milking systems, large herds and high milk yields per cow, the farmer's income remained the highest for grazing. The difference between grazing and zero-grazing, however, was smaller than for farm situations without restrictions. In situations with more than 10 dairy cows ha<sup>-1</sup> grazing surface, zero-grazing was more profitable than grazing. There was a strong relationship between intake of grass in pasture, on a typical farm, and the difference in income between grazing and zero-grazing. The more grass the cows eat in the pasture, the larger the income profit from grazing compared to zero-grazing.

Key words: economy, grass intake, grazing, income

### Introduction

In northwest Europe, grazing is a matter of public concern (Van den Pol-van Dasselaar *et al.*, 2008). Main reasons for this are animal welfare, biodiversity and the positive image of grazing. Grazing has both positive and negative effects on the environment, the most obvious being nutrient loss. In the end, personal motivations and habits of the farmer will be decisive in the choice between grazing and zero-grazing. Next to labour input, economy is thought to be one of the most important components of these personal motivations. In general, grazing is more economic for farmers than zero-grazing (Kennedy *et al.*, 2005; Van den Pol-van Dasselaar *et al.*, 2008). However, an average situation will not be applicable to all farms. Certain conditions may be less favourable for grazing.

The current trends in livestock farming in northwest Europe may have caused a shift from economic advantage of grazing to economic advantage of zero-grazing. Average herd sizes increased during the last years and the number of automatic milking systems increased. Grazing of large herds is difficult to manage. Even though grazing in combination with an automatic milking system is possible, it is experienced as difficult. The average milk production per cow has increased, and farmers with high yielding cattle like to control rations. Again, control of rations is more difficult in grazing situations. Finally, reasons for zero-grazing may be better grassland utilisation, the need to reduce mineral losses and labour efficiency. In northwest Europe the popularity of grazing is declining. Even though the number of grazing cattle is still relatively high (80-90%), it is decreasing.

### Materials and methods

We studied the economy of farms in the Netherlands with less favourable conditions for grazing. We used the model DairyWise (Schils *et al.*, 2007). The DairyWise model is an empirical model that simulates technical, environmental, and financial processes on a dairy farm. The central component is the FeedSupply model that balances the herd requirements, as

generated by the DairyHerd model, and the supply of homegrown feeds, as generated by the crop models for grassland and corn silage. The GrassGrowth model predicts the daily rate of dry matter accumulation of grass, including several feed quality parameters. The final output is a farm plan describing all material and nutrient flows and the consequences on the environment and economy.

First, the economy of average farms on sand and clay soil with 15000 kg milk ha<sup>-1</sup> and 20000 kg milk ha<sup>-1</sup> was calculated for grazing and zero-grazing. Second, the economy of grazing and zero-grazing was calculated for non-average farms with less favourable conditions for grazing:

1. Automatic milking (including additional selection equipment prior to grazing for € 7000),
2. Small grazing surface (25% of total farm area instead of 75%),
3. A large herd (150 animals instead of 75),
4. A high milk yield per cow (9500 instead of 8000 kg cow<sup>-1</sup> yr<sup>-1</sup>).

Finally, the difference, in economical performances, between grazing and zero-grazing was calculated.

## Results and discussion

In situations without restrictions, the farmer's income was higher for grazing than for zero-grazing (Figure 1). However, the difference varied between 0 and 2.5 € per 100 kg milk produced. For grazing, the costs of e.g. concentrates, contract work for harvesting grass and feed, and feed storage remain low, leading to a higher income per kg milk produced. The range in farm income can be explained by variation in individual farm situations.

For the situations with automatic milking systems, large herds and high milk yields per cow, the farmer's income is also on average highest for grazing. However, the average profit of grazing was smaller than for situations without restrictions.

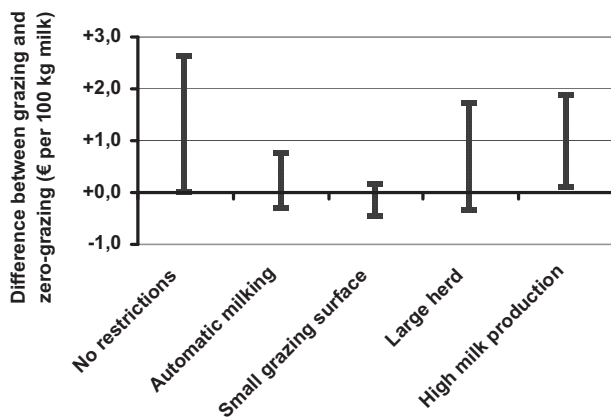

Figure 1. Range in effect of grazing on the farmer's income. Positive numbers indicate an economical advantage for grazing.

The above implies that for most farm situations, grazing is economically attractive. There is one exception, however. If the area available for grazing becomes too small, the grass intake will be limited. If the grass intake is too low, the economical profit of grazing will disappear. Figure 2 shows the strong relationship between intake of grass in pasture, on a typical farm, and the difference in income between grazing and zero-grazing. The break-even point is at a dry matter grass intake of approximately 600 kg cow<sup>-1</sup> yr<sup>-1</sup>. This translates to situations with

approximately 10 dairy cows ha<sup>-1</sup> grazing surface. In situations with more than 10 dairy cows ha<sup>-1</sup>, zero-grazing becomes more profitable than grazing.

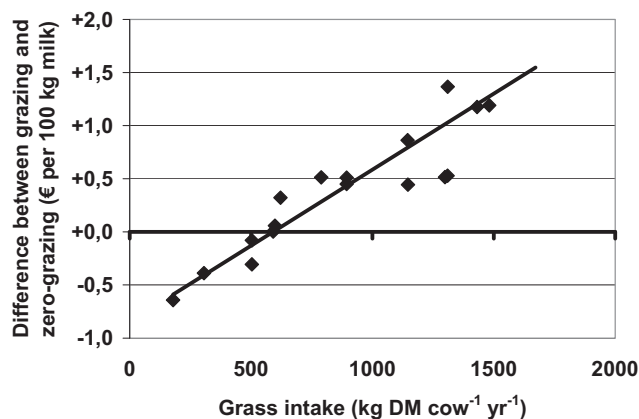

Figure 2. Effect of grass intake on the farmer's income at an average milk production of 8000 kg cow<sup>-1</sup> yr<sup>-1</sup>. Positive numbers indicate an economical advantage for grazing.

## Conclusions

Model simulations showed that in general grazing is economically more attractive than zero-grazing, even under unfavourable conditions. The only exception is when the available grazing area is too small in relation to the number of animals in the field. Increasing the grass intake can enlarge profits. It was shown that the more grass the cows eat in the pasture, the larger the income profit from grazing compared to zero-grazing. These results were confirmed by on-farm participatory research on 60 dairy farms in the Netherlands with less favourable conditions for grazing ([www.koenwijn.nl](http://www.koenwijn.nl)). We conclude that economy is not the most important influencing factor for grazing in northwest Europe.

## Acknowledgements

The Ministry of Agriculture, Nature and Food Quality in the Netherlands sponsored this study.

## References

- Kennedy E., O'Donovan M., Murphy J.P., Delaby L. and O'Mara F.P. (2005) Effects of grass pasture and concentrate-based feeding systems for spring-calving dairy cows in early spring on performance during lactation. *Grass and Forage Science* 60, 310 – 318.
- Schils R.L.M., de Haan M.H.A., Hemmer J.G.A., van den Pol-van Dasselaar A., de Boer J.A., Evers A.G., Holshof G., van Middelkoop J.C. and Zom R.L.G. (2007) DairyWise, A Whole-Farm Dairy Model. *Journal of Dairy Science* 90, 5334-5346.
- Van den Pol-van Dasselaar A., Vellinga T.V., Johansen A. and Kennedy E. (2008) To graze or not to graze, that's the question. *Grassland Science in Europe* 13, 706-716.

# Socio-economic changes and their effects on agro-pastoral goat husbandry systems in semi-arid, sub-tropical mountain regions

Dickhoefer U.\* and Schlecht E.

*Animal Husbandry in the Tropics and Subtropics, Universities of Kassel and Göttingen, 37213 Witzenhausen, Germany*

*\*Current address: Institute of Animal Nutrition and Physiology, Christian-Albrechts-University, 24098 Kiel, Germany.*

Corresponding author: tropanimals@uni-kassel.de

## Abstract

In Oman's mountain regions, lifestyles and infrastructure in rural communities are rapidly modernizing. To determine the effects on the agro-pastoral goat husbandry, activities and herd sizes of goat-keeping households (HH) in three Al-Jabal-al-Akhdar oases were assessed by semi-quantitative interviews (n=28) in autumn 2006. Labour input into goat husbandry was quantified in 15 HH. Map-based interviews (n=10) were used to identify village pastures and to calculate stocking rates. In September 2007, herbaceous ground cover and biomass yields were estimated in 10x10m<sup>2</sup> plots at grazed (n=14) and ungrazed (n=11) sites. At 18±16.3 goats HH<sup>-1</sup>, daily labour input was 13±8.3 min goat<sup>-1</sup>. Livestock herding additionally required ≤8 h d<sup>-1</sup>, but since 6±4.8 persons HH<sup>-1</sup> pursue an off-farm activity, farmers increasingly abandon this practice. Stocking rates on village pastures were ≤0.29 goats ha<sup>-1</sup>, but housing construction continuously decreases the available grazing area and village pastures overlap, so that >0.8 goats ha<sup>-1</sup> graze near settlements. Ground cover (%) and dry mass (kg ha<sup>-1</sup>) of the herbaceous vegetation were strongly reduced at grazed (45±10.1; 20±8.2) compared to ungrazed sites (82±11.7; 573±179; P<0.01). Modernization processes in Oman's mountain communities thus amplify the degradation of the natural vegetation and threaten the future of the agro-pastoral goat husbandry.

Keywords: Goat; Modernization; Oman; Overgrazing; Pastoralism

## Introduction

In Oman's semi-arid highland regions traditional goat production is based on irrigated fodder cultivation and homestead feeding of small amounts of purchased concentrate feeds in addition to grazing the natural rangeland vegetation. The input of family labour and its knowledge on traditional feeding and grazing practices allowed for an age-long use of the natural fodder resources (Dickhoefer, 2009). However, infrastructure and lifestyles in rural communities are rapidly modernizing, thereby initiating profound changes in the local husbandry system (Zaibet *et al.*, 2004). The aim of this study was therefore to analyse the effects of recent socio-economic changes on the traditional goat husbandry, farmers' pasture management practices and thus on rangeland vegetation.

## Materials and methods

In autumn 2006, semi-quantitative interviews were conducted with one adult of all goat-keeping households (HH) in Masayrat ar Ruwajah (n=12), Qasha' (n=6) and Ash Sharayjah (n=10) in the central Al-Jabal-al-Akhdar region (57°40'E, 23°04'N, 1000-2000 m a.s.l.). HH composition, activities and goat herd sizes were quantified. Labour input into goat husbandry was enquired in 15 HH. Map-based key informant interviews (n=10) were used to identify village pastures and to calculate stocking rates. Herbaceous ground cover was visually



estimated in 10x10m<sup>2</sup> plots along 700-1400 m long transects at grazed (n=14) and ungrazed (n=11) plateau sites of similar altitude and geographical setting at the end of the warm and rainy season in September 2007. Herbaceous biomass was quantified in each plot according to Schlecht *et al.* (2009). Dry matter (DM) concentrations were determined in two pooled samples per site (Naumann *et al.*, 2004).

## Results and discussion

In autumn 2006, HH comprised on average 12±6.4 persons (Table 1). While at least one person obtained a non-farm income in every HH, only 10 HH regularly sell animals despite the high prices for live goats at local markets (Dickhoefer, 2009). Because food and fertilizers are cheap at local markets, the supply of meat and milk as well as of manure for crop fertilization depreciates. Hence, farmers claimed that they keep fewer animals than in the past, reflecting the decreasing importance of goat husbandry for farm HH and the ongoing socio-economic changes in the livestock system.

At 18±16.3 goats HH<sup>-1</sup>, the feeding, milking and cleaning of the stables, the harvest of fodder and the collection of tree leaves in the mountains daily required 13±8.3 min goat<sup>-1</sup>. While seven farmers did not perceive any problems related to goat production, the depletion of the pasture vegetation, the high expenses for purchased feedstuffs and, in particular, the lack of irrigation water for the cultivation of fodder and the high labour demand were constraints mentioned by farmers (Fig. 1a). Livestock herding required ≤8 h d<sup>-1</sup> (n=14). However, since 6±4.8 persons HH<sup>-1</sup> pursued an off-farm activity (employment, professional training, school or university attendance), family labour force is largely withdrawn from agriculture. Hence, farmers increasingly abandon this practice, leading to locally very high grazing pressure (Turner *et al.*, 2005).

Calculated stocking rates on village pastures of ≤0.29 goats ha<sup>-1</sup> were low. Road and housing construction as well as the exclusion of large plateau areas for public and military purposes continuously decrease the area available for goat grazing. Moreover, due to the abandonment of the traditional coordination of pasture use among villages, village pastures overlap nowadays, so that >0.8 goats ha<sup>-1</sup> graze near settlements. Hence, vegetation cover (%) and herbaceous biomass (kg ha<sup>-1</sup> DM) were much lower at grazed (45±10.1; 20±8.2) than at ungrazed plateau sites (82±11.7; 573±179; *P*<0.01; Fig. 1b), showing the severe effect of livestock grazing on the natural vegetation and confirming earlier reports of overgrazing in the region (Schlecht *et al.*, 2009). However, goat keeping is an important asset to religious and traditional custom and as a major tourist attraction essential for the regional development (Dickhoefer, 2009). While grazing reduces feeding costs for farmers and renders goat keeping profitable, increased roughage feeding at the homestead reduces the animals' feed intake during grazing (Dickhoefer, 2009).

Table 1. Herd sizes of goat-keeping households (HH) and sizes and stocking rates of village pastures of three oases villages in the central Al-Jabal-al-Akhdar Mountains, Oman.

Village	HH		Goats (n)	Herd sizes Mean±SD	Village pasture (ha)	Stocking rate (goat ha <sup>-1</sup> )
	Total	Goat-keeping				
Ash Sharayjah	12	10	74	6.4±3.2	7.1	0.10
Qasha'	10	6	126	21.0±22.7	11.4	0.11
Masayrat ar Ruwajah	16	12	306	25.5±15.6	10.5	0.29

SD = standard deviation

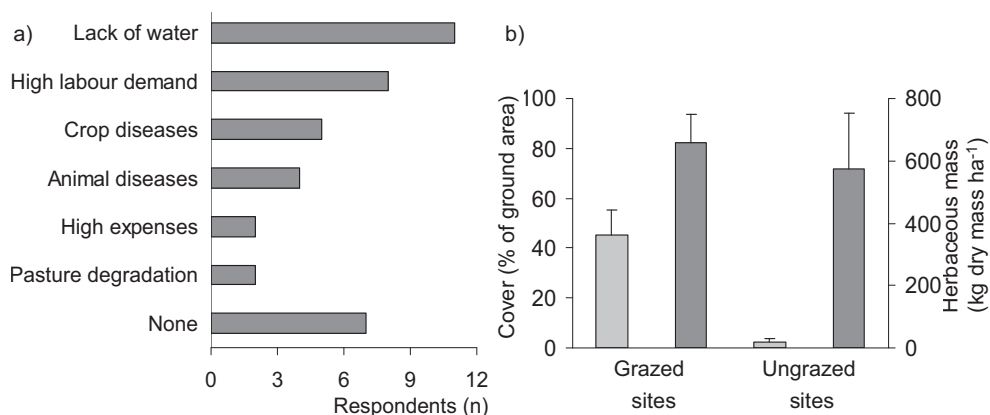

Fig. 1. a) Problems in crop and livestock husbandry perceived by interviewed farmers (n=28) in three villages (multiple answers were possible); and b) the ground cover (primary y-axis) and mass (secondary y-axis) of the herbaceous vegetation at grazed (light grey, n=14) and ungrazed (dark grey; n=11) sites in the central Al-Jabal-al-Akhdar region, Oman (means, error bars indicate one standard deviation).

## Conclusions

Recent modernization processes in Oman's mountain communities have profoundly altered traditional goat husbandry practices, amplifying the degradation of the natural pasture vegetation and threatening the future of the agro-pastoral goat system. An adapted homestead feeding of goats in combination with farmers' traditional grazing practices may allow for an economically viable goat production and reduce grazing pressure on the natural vegetation.

## Acknowledgements

We thank Dr. O. Mahgoub, Dr. A. Palfreman and Dr. S. Al Khanjari of the College of Agricultural and Marine Sciences, Sultan Qaboos University, and the Ministry of Agriculture and Fisheries, Oman, for their valuable collaboration. We acknowledge the funding by the German Research Foundation (BU 1308) and are grateful to Dr. M. Nagieb and to families on Al-Jabal-al-Akhdar for substantial support and continued hospitality.

## References

- Dickhoefer U. (2009) *Tradition and transformation- Steps towards a sustainable goat husbandry in mountain oases of Oman*. PhD thesis, University of Kassel, Germany.
- Naumann K., Bassler R., Seibold R. and Barth K. (2004) *Die chemische Untersuchung von Futtermitteln*. Methodenbuch Band III, Loseblattausgabe mit Ergänzungen 1983, 1988, 1993, 1997 and 2004. VDLUFA-Verlag Darmstadt, Germany.
- Schlecht E., Dickhoefer U., Gumpertsberger E. and Buerkert A. (2009) Grazing itineraries and forage selection of goats in the Jabal al Akhdar mountain range of northern Oman. *Journal of Arid Environments* 73, 355-363.
- Turner M.D., Hiernaux P. and Schlecht E. (2005) The distribution of grazing pressure in relation to vegetation resources in semi-arid West Africa: The role of herding. *Ecosystems* 8, 668-681.
- Zaibet L., Dharmapala P.S., Boughanmi H., Mahgoub O. and Al-Marshudi A. (2004) Social changes, economic performance and development: the case of goat production in Oman. *Small Ruminant Research* 54, 131-140.

# Management and legislation affecting the conservation of mountain grasslands subjected to common use in Central Apennine

D'Ottavio P.<sup>1</sup>, Trobbiani P.<sup>1</sup>, Rismondo M.<sup>1</sup>, Iezzi G.<sup>1</sup>, Piergiovanni R.<sup>1</sup>, Sargenti P.<sup>2</sup>, Santilocchi R.<sup>1</sup> and Roggero P.P.<sup>3</sup>

<sup>1</sup>*Dep. of Environmental and Crop Science, Marche Polytechnic University, I-60131 Ancona*

<sup>2</sup>*Servizio Agricoltura, Forestazione e Pesca, Regione Marche, I-60125 Ancona*

<sup>3</sup>*Dip. di Scienze Agronomiche e Genetica Vegetale Agraria, Università degli Studi di Sassari, I-07100 Sassari*

Corresponding author: p.dottavio@univpm.it

## Abstract

This paper presents a survey on long-term effects of management and socio-economic factors on the evolution of mountain grasslands in Central Apennine. The grasslands are subjected to common use, and we aimed to identify sustainable measures for their conservation. Recording of the vegetation and land use changes over the last fifty years highlighted the abandonment of arable land and a strong decrease of stocking rates. The associated increase of the surface area of open grasslands was followed by shrub encroachment. It is argued that the legislation and the public administration may have influenced the observed patterns. Management strategies are discussed to conciliate grassland production and conservation according to the need for direct financial supports to collective bodies.

Keywords: grasslands, shrubs encroachment, management, legislation, collective property.

## Introduction

Over the last decades most of the territories of Central Apennine were affected by strong changes of the historical conditions of settlement and management (D'Ottavio *et al.*, 2008). The changing management and abandonment was demonstrated to have a strong effect on the conservation of grasslands and shrublands of community interest (Directive 92/43/EC, i.e. habitats 6210 and 5130) (Caballero *et al.*, 2010). At the same time, a reduction in herbage production and in nutritive value is found as a result of shrub encroachment in grasslands (Zarovali *et al.*, 2007). The paper presents a survey on long-term effects of management and socio-economic factors on the evolution of grasslands in a case study. We aimed at identifying sustainable measures for the conservation of grasslands subjected to common use.

## Materials and methods

The research was performed at 'Piano di Macereto' (Macerata province, latitude: 42°57'N, longitude: 13°06'E) on grasslands of about 600 ha (at 900-1300 m a.s.l.) with a prevalent N exposure and calcareous-loamy bedrock, mean annual 7.6°C of temperature and 1246 mm of precipitation. Grasslands are subjected to common use by the residents of Visso and Ussita municipalities. Aerial photography and orthoimages from 1955, 1978, 1998 and 2005 were processed in a geographic information system (Plieninger, 2006) using software ArcGIS (ESRI). Vegetation and land use changes over a 50-year period were identified and quantified in terms of the arable land, open grassland, shrub-dominated surfaces and woodlands (Burkinshaw and Bork, 2009). Land management was analysed (i) by aerial photographs, (ii) by interviews to local shepherds and farmers on cropping, grazing and grassland management, and (iii) by the consultation of documents kept into the Historical Archive of Visso recording

detailed data on grazing management from XV century. Socio-economic factors took into account demography, legislation and administrative system connected to land management.

**Results and discussion**

Subsequent to 1955, the arable land of the study area declined from 70% to 5% of the total surface, while at the same time a progressive increase of open grasslands was observed (Fig. 1). Between 1955 and 1978, this increasing surface of grassland has been used by a raising number of grazing animals (Fig. 2) and for hay production. Periodic tillage and cut of the more fertile and productive areas until the 1970s prevented the spread of shrubs, which in other cases was considerable and not restrained. From 1978 to 2005, the open grasslands declined by 30% and the encroachment by shrubs (mainly *Juniperus communis* and *J. oxycedrus*) increased at the same rate. These trends were related to the abandonment of grassland management and to the decreased stocking rates (Fig. 3). This process is still active and favoured by the understocking conditions. A mean stocking density, calculated on the open grasslands, of 55.5% of the potential carrying capacity was recorded (unpublished data).

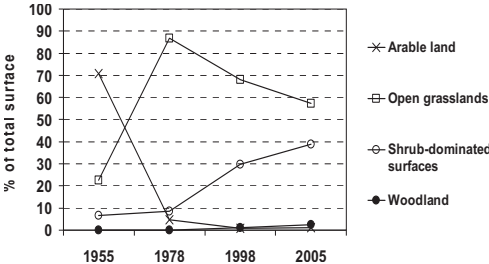

Figure 1. Evolution of different land uses surfaces (% of total surface) in the study area.

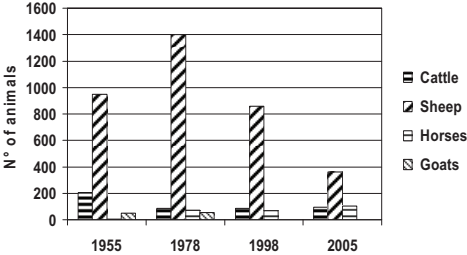

Figure 2. Evolution of the number of the different grazing animals in the study area.

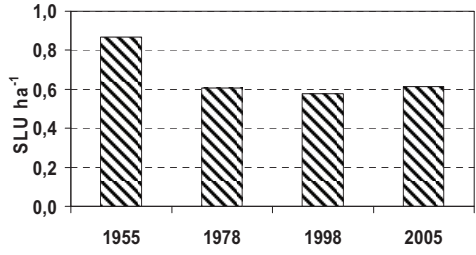

Figure 3. Evolution of the stocking rates (SLU: Standard Livestock Units) on the open grasslands in the study area.

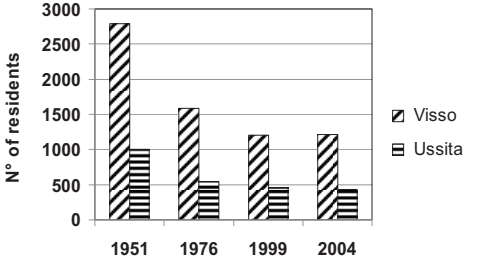

Figure 4. Evolution of the residents in Visso and Ussita municipalities.

The crisis of the traditional breeding (Santilocchi and D’Ottavio, 2005) and the abandonment of the grazing by most of the local and transhumant farmers occurred in concomitance with the high demographic decrease recorded from the seventies in the territory (Fig. 4). From the 1980s, legislation and the public administration may have influenced the observed patterns increasing the problematic conservation of the grasslands. The measures adopted by Marche Region for the protection of juniper seem emblematic. RL 7/1985 listed the protected species, in which juniper was not included (Table 1). But it defined *de facto* the lands with

minimum shrub coverage of 50% and an extension of 5000 m<sup>2</sup> as woods. In any case, it provided for felling authorisation where this aimed to provide land-improvements.

Table 1. Regional Legislation (RL) affecting the protection of Juniper species and formations.

RL		7/1985	8/1987	6/2005
Juniper protection	as species	No	Yes	No
	as formation	Yes	Yes	No
Juniper clearing		Yes	Yes	Yes

From 1987 RL n. 8 added *J. communis* among the protected plants as a single species (Table 1). *J. oxycedrus*, which is the most abundant in the study area, was not included but often confused with the first and subjected to protection.

From 2005 RL n. 6 ‘Regional Forestry Law’ does not anymore protect any juniper species. At the same time, according to national legislation, it provides a new definition of wood in which the shrub-dominated grasslands are not included. In the meantime, over a 20-year period of intensive vegetation dynamics, some shrub-dominated surfaces turned into woodlands. Surface reductions of woods for land-improvements are not authorised by the law.

Common Agricultural Policy 2010 and Rural Development Programme 2007-2013 adopted by Marche Region provide payments to remove shrubs from grasslands when their encroachment is not prevented by the animals. But they are addressed to single farmers and not to public or collective bodies to which the studied grasslands belong or are administrated.

## Conclusions

Changed management and abandonment in addition to legislation restrictions were demonstrated to make difficult the long-term conservation of the grasslands of the study area. Different actions could be undertaken to conciliate grassland production, as reclaimed by local populations, with conservation aims. Normative adjustments for providing direct financial supports to collective bodies are advisable. Target-oriented grassland rehabilitations should be based on sustainable management. Among all, it should include (i) the application of stocking density according to the carrying capacity of the pastures, (ii) the control of the invading shrubs, and (iii) the adoption of a rotational stocking. On this matter, to implement more effective intermittent grazing by different animals (cattle, horses and sheep) fencing and drinking-troughs should be provided (D’Ottavio *et al.*, 2008).

## References

- Burkinshaw A.M. and Bork E.W. (2009) Shrub encroachment impacts the potential for multiple use conflicts on public land. *Environmental Management* 44, 493-504.
- D’Ottavio P., Trobbiani P. and Santilocchi R. (2008) The breeding and the feeding. In: Regione Marche (Eds.) *Marchal Project: The marchigiana: a breed to be exported*. Regione Marche, Ancona, 61-85.
- Caballero R., Fernández-González F., Pérez Badia R., Molle G., Roggero P. P., Bagella S., D’Ottavio P. Papanastasis V.P., Fotiadis G., Sidiropoulou A. and Ipikoudis I. (2009) Grazing systems and biodiversity in Mediterranean areas: Spain, Italy and Greece. *Pastos* XXXIX (1), 7-152.
- Plieninger T. (2006) Habitat loss, fragmentation, and alteration – Quantifying the impact of land-use changes on a Spanish dehesa landscape by use of aerial photography and GIS. *Landscape Ecology* 21, 91-105.
- Santilocchi R. and D’Ottavio P. (2005) The evolution of cattle and sheep breeding systems in Central Italy over the past two centuries. *EAAP Publication* 115, 15-18.
- Zarovali M.P., Yiakoulaki M.D. and Papanastasis V.P. (2007) Effects of shrub encroachment on herbage production and nutritive value in semi-arid Mediterranean grasslands. *Grass and Forage Science* 62, 355-363.

# Structural analysis of the dairy industry and its evolution in Central Switzerland

Hofstetter P.

*Schuepfheim Vocational School and Extension Centre for Nature and Food (BBZN), CH-6170 Schuepfheim, Switzerland*

Corresponding author: pius.hofstetter@edulu.ch

## Abstract

Since Switzerland is not a member of the European Community, EU, it pursues its own agricultural policy, which imposes increased competition and an incremental approach to European conditions. In Central-Switzerland, situated in the northern foothills of the Alps, there are grassland areas as well as mountain areas of high natural value with particularly unfavourable topographical and climatic conditions. In 2008, the average agricultural area of the 3817 Central-Swiss dairy farms was 16.8 ha with a milk supply on contract of 106366 kg per year. Full costs analysis shows that farms in the lowland areas are more productive than mountain farms. The dairy industry, especially the cheese factories, which process 49% of the total milk production, plays an important role in adding value in remote valleys. A promising prospect under these challenging conditions, (e.g. free cheese trade with the EU and the abandoning of milk quotas) is the processing of niche products including specialities and brand merchandising.

Keywords: Swiss agricultural policy, dairy industry, productivity, cheese, value added chain, sustainable development

## Introduction

Central-Switzerland (C-CH) consists of six cantons; Lucerne (LU), Nidwalden (NW), Obwalden (OW), Schwyz (SZ), Uri (UR) and Zug (ZG). Forest accounts for 29.1% of the total C-CH area of 4484 km<sup>2</sup>, 41.3% is agricultural area, 5.6% is occupied by settlements, and 24% is denoted as 'unproductive land' (LUSTAT, 2009). In 2005, 7.9% of the total working population (367306) of C-CH was engaged in the primary sector (agriculture, forestry, fishery), 28% in the secondary sector (industry, handicraft), and 64.1% in the tertiary sector (services). There are significant differences between the cantons, e.g. in OW 12.7% of the working population worked in the primary sector, but only 3% did so in ZG. Also, in ZG, 70.3% are engaged in the tertiary sector (services). The aim of this study was to investigate the evolution of the dairy industry from 1996 to 2008 and especially the production costs of dairy farms in C-CH under different geo-economical and political conditions (Swiss Federal Office for Agriculture (FOAG), 2009).

## Materials and methods

Data on agriculture, dairy farms and factories, milk processing, consumption of cheese and food were taken from FOAG (2010), TSM Treuhand GmbH (2010), Central Switzerland dairy farmers' association (ZMP, 2010), Swiss Milk Producer (SMP, 2009) and GOTTLIEB DUTTWEILER INSTITUTE (GDI, 2008). Full cost accounting data based on the analysis by Höltschi *et al.* (2009) and full cost accounting was performed according to VOKO-Milch + Schweine by AGRIDEA (2009).

## Results and discussion

*Analysis of the farm size structure:* Table 1 shows the evolution of farm size structure in C-CH and CH from 1996 to 2008. During this time the share of full-time farms was reduced by 5.5% in C-CH, whereas their share slightly increased all over CH.

With regard to farm size structure there are considerable differences between mountain and valley regions. In 2008, full-time farms made up 81% of all farms in ZG and consisted of 20 ha agriculture area, in LU 78% and 17.3 ha, and in UR 52% and 13.4 ha. OW and NW were similar to UR. In 2008, 51.8% of all C-CH farms were in mountain areas (34% in LU, 87.5% in UR, 71.1% in SZ, in OW 76.6% in OW, 79.1% in NW and 52.9% in ZG). 8.9% of all C-CH farms were organic farms (25.1% in OW, 13.1% in NW, 12.4% in ZG and 5.7% in LU). In general, the reduction in the number of farms in C-CH was similar to that in Austria and France, but lower than in Germany and Italy.

Table 1. Farms size structure in Central-Switzerland in comparison to Switzerland from 1996 to 2008.

Region and year	Farms		Cultivable area			
	Total	full-time farms, %	Open arable land, %	Main forage area, %	farm area, ha	full-time farm area, ha
Central-Switzerland 1996	11475	79.9	11.2	89.7	12.1	13.9
Switzerland 1996	79479	70.4	28.5	72.7	13.6	17.4
Central-Switzerland 2008	9467	74.4	10.9	90.1	14.4	16.7
Switzerland 2008	60894	72.2	26.3	74.7	17.4	21.2

*Dairy farms:* From 1999 to 2008, the milk quota (since 2006 by private regulation the milk supply has been on contract with the ZMP) rose by 44.6% to an average of 106366 kg milk per farm and per year, which was very similar to the total Swiss average. The number of dairy farms decreased by 34.5% to 3817 and milk delivery per ha increased by 24% to 6331 kg per ha. The average area per dairy farm also increased by 16.7% to 16.8 ha. In 2008, Swiss average milk delivery per ha was 21% lower than in C-CH, because the average farm area was 31.5% greater than the C-CH average. This demonstrates the high intensity of C-CH dairy farms.

*Full costs accounting:* Table 2 shows that the agricultural incomes of an average dairy farm in valley and hill regions were similar. More direct payments compensated for higher direct costs in hill regions. However, the average direct costs per kg of milk for average mountain farms (26.7 ha agricultural area, milk supply on contract 106880 kg y<sup>-1</sup>, 19.5 dairy cows) were essentially higher compared with average valley region farms (26.9 ha agriculture area, milk supply on contract 203067 kg y<sup>-1</sup>, 30.7 dairy cows) due to higher costs for forage (concentrate included, +27%), overhead costs (machinery +91%, buildings and equipment +33%) and internal overhead costs (wage entitlement +92%). The average productivity of labour (kg milk per working hour) was 68 on a lowland farm compared to 43 on a mountain farm.

Full-time grazing systems in the valley region showed a 27% higher labour income (€ h<sup>-1</sup>) than half-time pasture based systems. Organic farms showed a 39% higher labour income (€ h<sup>-1</sup>) than usual farms (e.g. with an ecological performance certificate) and farms with hay conservation systems 24% higher than farms with silage.

In mountain regions, only full-time grazing systems generated a better labour income while farms with hay conservation systems and organic farms had a lower labour income.

*Milk processing and cheese factories:* In 2008, within C-CH, 49% of the total amount of milk was processed to cheese, 37% to milk preserves, 8% to yoghurt, 2% to cream, 4% to market milk and other products. In 2008, within C-CH, there were 34 Emmental cheese factories



(70% fewer than in 1999), 16 Sbrinz cheese factories (45% fewer than 1999), 3 Le Gruyère cheese factories (as in 1999) and 8 semi-hard and soft cheese factories (11% fewer than in 1999). This immense decrease of hard cheese factories (Emmental, Sbrinz AOC) was due to changes in eating and consumption behaviour towards soft and semi-hard cheese, to abandonment or merger of uncompetitive small units, and to the farmers changing their conservation system from hay to silage or abandoning milk production in favour of beef production.

*Limitations:* The farms for the full costs analysis were not randomly selected. These data were recorded from farms whose manager was attending further vocational training in dairy farming. We suspect that these farms have a higher performance than average ones.

Table 2. Full costs analysis of dairy farms (mean  $\pm$  SD) in valley, hill and mountain regions in Central-Switzerland.

Bookkeeping data from 2005 - 2008 Costs and income are per kg milk.	Valley region			Hill region			Mountain region		
	223 dairy farms			121 dairy farms			56 dairy farms		
Direct costs (Cent kg <sup>-1</sup> )	-18.8	$\pm$ 5.4	a*	-18.2	$\pm$ 5.0	a	-22.4	$\pm$ 8.3	b
Overhead costs (Cent kg <sup>-1</sup> )	-27.8	$\pm$ 7.6	a	-30.8	$\pm$ 10.9	b	-40.2	$\pm$ 15.6	c
Internal overhead costs (Cent kg <sup>-1</sup> )	-24.5	$\pm$ 10.6	a	-32.2	$\pm$ 13.9	b	-45.8	$\pm$ 18.8	c
Full costs (Cent kg <sup>-1</sup> )	-71.1	$\pm$ 12.0	a	-81.1	$\pm$ 16.5	b	-108.4	$\pm$ 27.8	c
Milk price (Cent kg <sup>-1</sup> )	49.5	$\pm$ 3.6		49	$\pm$ 4.7		49.7	$\pm$ 7.9	
Direct payment (Cent kg <sup>-1</sup> )	11.6	$\pm$ 4.0	a	18.4	$\pm$ 7.8	b	36.3	$\pm$ 15.2	c
Profit/loss (Cent kg <sup>-1</sup> )	-10.0	$\pm$ 12.2	a	-13.7	$\pm$ 11.2	b	-22.3	$\pm$ 16.9	c
Labour income (€ h <sup>-1</sup> )	11.2	$\pm$ 6.3	A	11.1	$\pm$ 4.8	A	9.3	$\pm$ 4.3	B
Agriculture income (€)	27636	$\pm$ 21702		27194	$\pm$ 20024		22690	$\pm$ 14000	

\* Different lower-case letters indicate significant differences in mean values:  $P < 0.01$  %, different capital letters:  $P < 0.05$  %.

## Conclusions

In C-CH, the share of full-time farms mainly decreased in mountain regions. Therefore, jobs providing additional income are essential in such fringe areas.

With regard to the high production costs of the dairy farms and the agricultural policy, small to medium sized farms, especially, are under considerable strain, which will increase in the future. The productivity of the dairy farms in all regions must improve due to rising competition, e.g. co-operation, particularly with respect to farm mechanisation, becomes very important.

In mountain regions, cheese factories maintain added value. If cheese factories can be developed, apart from improving their efficiency, they may also generate a higher-than-average milk price through milk-based specialities and the merchandising of these products (e.g. cave-aged Emmental cheese) in the European marketplace. Such a milk price would partially compensate for higher production costs in mountain areas.

## References

- AGRIDEA (2009) *VOKO Milch + Schweine*, Eschikon 28, CH-8315 Lindau.  
 FOAG (2009, 2010) <http://www.blw.admin.ch/themen/00005/00044/index.html?lang=de>, CH-3003 Bern.  
 GDI (2008) *European Food Trends Report*. Bossart D. and Hauser M., CH-8803 Rüslikon /ZH.  
 Höltschi M., Meyer A., Sutter F. and Meier H. (2009) *VOKO-Milch+Schweine*. BBZN, CH-6276 Hohenrain.  
 LUSTAT (2009) Statistik Luzern. *Jahrbuch Kanton Luzern*, 2009. Burgerstrasse 22, CH-6002 Luzern.  
 SMP (2009) *Annual Report and Personal Information*. Weststrasse 10, CH-3000 Bern 6.  
 TSM Treuhand GmbH (2010) <http://www.tsm-gmbh.ch/deutsch.htm>, Westerstr. 10, CH-3000 Bern 6.  
 ZMP (2010) *Personal Information*. Zentralschweizer Milchproduzenten, Friedentalstr. 43, CH-6002 Luzern.

## Grassland management on the ‘Low Cost Farm’: an overview of an eight-year period

Holshof G. and de Haan M.H.A.

*Wageningen UR Livestock Research, PO Box 65, 8200 AB Lelystad, the Netherlands*

Corresponding author: Gertjan.Holshof@wur.nl

### Abstract

From 1998 to 2006 grassland management has been monitored on the Low Cost research farm in Flevoland, the Netherlands, on young marine clay. Targets for the costs of grassland management on this farm were: low input of mineral fertilizers (N, P), minimal use of herbicides, long grazing season, efficient use of labour and minimal grassland renewal. Rotational grazing and permanent grazing were successively implemented and monitored. The type of management that matched the targets closest, turned out to be a system of continuous grazing. Nitrogen (N) fertilization was reduced from 275 kg ha<sup>-1</sup> in 1998 to 145 kg ha<sup>-1</sup> in 2003 (including N from slurry). The net average grassland dry matter yield was 11.5 t ha<sup>-1</sup>. The N and phosphorus (P) content of manure strongly decreased over the years. Permanent grazing reduced labour, improved efficiency of fodder production with lower costs, but lowered the yield.

Keywords: grassland management, low cost farm, permanent grazing, low mineral input

### Introduction

In the Netherlands the production factors of soil, labour and buildings are expensive factors and the milk price is relatively low. For Dutch farmers it is important to control the costs for production. From 1998 to 2006 a research farm, called the ‘Low Cost Farm’ was founded on the Waiboerhoeve in Flevoland, the Netherlands, on young marine clay. The purpose of the project was to develop a system (case study) and advice for farmers on how to produce milk at maximum costs of €0.35 kg<sup>-1</sup>. An efficient use of grassland is important to reach those targets. However, direct contribution of grassland management to the costs is difficult to measure. Therefore derived targets were set for grassland management that contributed directly or indirectly to the total costs: low input of N and P mineral fertilizers, minimal use of herbicides, long grazing season, efficient use of labour and minimal grassland renewal and contract work.

### Material and methods

The ‘Low Cost Farm’ had a milk quota of 400000 kg until 2003 and 450000 kg from 2003 on. During the first period the herd consisted of 55 Holstein Friesian (HF) cows, and from 2003 of 30 Montbéliarde and 30 HF cows. The average annual milk production was 8200 kg per cow. The rate of young stock was kept low, matching a replacement of 20%.

During the whole period the length of the grazing season, milk production, concentrate use (maximized to 1600 kg per cow, including young stock), mowing percentage, total N and P fertilization and grass silage yield (fodder supply) were registered. The fresh grass uptake by the cattle was estimated or calculated. During the first period (1998-2002) a rotational grazing system was used. The total grassland area was subdivided into 21 small (1.2 ha) paddocks. During the first two days dairy cows grazed a fresh paddock, which were in turn followed by young stock grazing on the same paddock for the next two days. Most years, the grazing season for young stock started after the first cut to make it possible to use a greater area for

the first cut. During the whole grazing season, calves grazed on aftermath. After 2002, the rotational grazing system was changed to a continuous grazing system. The dairy cows grazed about one month at a time on a large area (8-10 ha), while the young stock grazed in a different plot. The annual net dry matter (DM) grass yield ( $\text{kg ha}^{-1}$ ) was calculated as the sum of animal intake of silage and fresh (grazed) grass (Fig. 1). Intake of fresh grass was predicted from energy intake, intake capacity and milk production.

To reduce the phosphorus (P) input, P was only supplied in slurry after 2003. A grass-clover mix was introduced in 1998 in order to compensate for low N input. As average Dutch dairy farms expand every year, the 'Low Cost Farm,' as a representative farm, was expanded as well, both in herd size and area (from 32 to 33.45 ha).

Because the 'Low Cost Farm' was used to develop a system statistical tests were not applicable.

Table 1. N and P applied as mineral fertilizer and manure during 1998–2005 (in  $\text{kg ha}^{-1}$ )

Year	N mineral fert.	Manure N	Total N	P mineral fert.	P Manure	P Total
1998	225	53	278	11	15	26
1999	186	82	268	14	15	29
2000	127	73	200	11	7	18
2001	136	51	186	10	17	27
2002	119	66	185	9	15	24
2003	53	79	132	0	24	24
2004	89	160	249	0	46	46
2005	182	59	241	0	24	24

## Results and discussion

In the period 1998-2003, N application decreased below  $150 \text{ kg ha}^{-1}$ . This low application level was made possible by the existing stocking rate and the use of white clover (*Trifolium repens*). After 2003, N application increased again, while the stocking rate increased (Table 1) and silage yield decreased. The average P application was about  $26 \text{ kg ha}^{-1} \text{ yr}^{-1}$ , mainly in the form of slurry. Without grassland renewal, manure P could cover the requirements. The highest silage DM yields were reached in 2001 and 2002 (nearly  $200 \text{ t}$  for the whole area) as a result of a higher mowing percentage (Evers *et al.*, 2002-2006). The lower silage yield of the previous three years reduced contract work costs. In 2003 the whole first cut was mowed for silage, because the new expanded herd arrived in June. The average net DM grass yield in the period 1998-2005 was  $11.5 \text{ t ha}^{-1}$ , which is  $1 \text{ t ha}^{-1}$  higher than on average Dutch farms (Aarts *et al.*, 2008). The highest DM yield (almost  $14 \text{ t ha}^{-1}$ ) was estimated in 2002. In 2003, the estimated yield was hardly  $10 \text{ t ha}^{-1}$ , as a result of a relatively very dry summer. Total grass production appears to be lower from 2003 onwards. It turned out to be very difficult on this particular farm to maintain the clover content of the sward at an optimum level (30-40%) contrary to research results from other farms on the same soil type (Schils, 2002). An increase of dandelion (*Taraxum officinale*) and two types of meadow grass (*Poa annua* and *Poa trivialis*) to the detriment of ryegrass (*Lolium perenne*) lowered the total grass production considerably (Bonthuis *et al.*, 2004). Because of the presence of white clover, it was impossible to use herbicides. Therefore, 2 or 3 ha had to be renewed each year. In order to grow a protein-rich mixture, red and white clovers in combination with fodder peas and ryegrass were used for plot renewal. In addition to its effects on grass species composition, continuous grazing reduced yield and grass intake. Efficiency of the applied N appears to be lower in the last two years. This effect was caused by the increase in the proportion of renewed grassland. N application for the first cut was increased in the last two years, in an attempt to obtain a higher protein content of this cut. Although N-input was very low for

several years, the total N content of the manure decreased drastically to a content of 1.2 kg ton<sup>-1</sup>. The equivalent fertilizer N from manure in 2005 was at the same level as in 1998, despite an increase in stocking rate from 1.40 to 1.76 cows ha<sup>-1</sup> (Table 1).

The advantages of permanent grazing were a lower input of labour (1%), a reduction in fencing and a larger area which could be cut or manured in a single operation. Consequently, a reduction in costs was reached. The total feeding costs for milk were 0.044 € kg<sup>-1</sup>, whereas the average feeding costs of comparable farms were €0.072 kg<sup>-1</sup> (Doornewaard *et al.*, 2007).

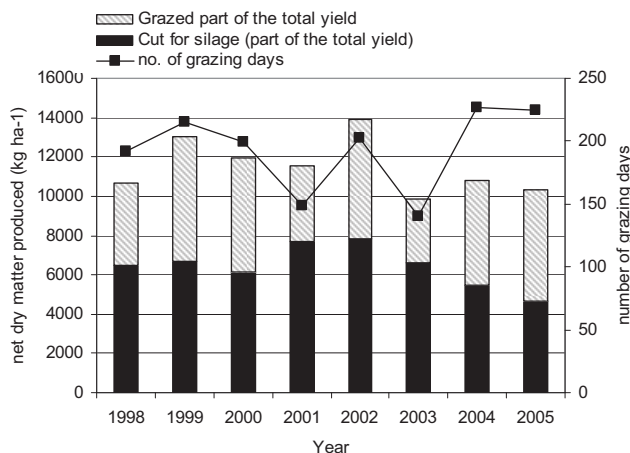

Figure 1. Net dry matter grass yield (calculated from sum of animal intake of fresh grass and silage) and number of grazing days in period 1998-2005

## Conclusions

On the Low Cost Farm specific grassland management could contribute to a reduction in costs. Permanent grazing reduced labour, improved efficiency of fodder production but lowered the yield. Lengthening of the grazing season and minimizing the mowing percentage reduced contract work costs. The N and P input was low (Aarts *et al.*, 2009), but resulted in a downwards spiral to a low N and P content of manure. White clover was difficult to manage on this farm. The total average milk costs on the Low Cost Farm were € 0.34 kg<sup>-1</sup>, equal to the costs of EDF farmers (Lassen *et al.*, 2009) but much lower than on comparable farms in the Netherlands, where the average milk costs were € 0.45 kg<sup>-1</sup> (Doornewaard *et al.*, 2007).

## References

- Aarts H.F.M., Daatselaar C.H.G. and Holshof G. (2009) Bemesting, meststofbenutting en opbrengst van productiegroenland en snijmaïs op melkveebedrijven. *Plant Research International rapport* 208.
- Bonthuis H., Donner D. A. and Vliegen A. van. (2004) 79<sup>th</sup> *Rassenlijst landbouwgewassen (79<sup>th</sup> List of Varieties of field crops 2004)*. 89 pp.
- Doornewaard G.J., Daatselaar C.G.H. and Beldman A.C.G. (2007) Toekomstrichting van veehouders in een veranderende omgeving (in Dutch, summary in English). *K&K rapport* 39, *LEI rapport* 2.
- Evers A.G., Haan M.H.A. de, Hemmer J.G.A., Holshof G., Ouweltjes W., Hollander C.J., Blanken K. and Brandsma E.M. (Praktijkonderzoek Veehouderij (PV)) (2004-2007). Resultaat Lgekostenbedrijf 2002-2005 Operating results for the low-cost farm in 2002-2005. *Praktijk Rapport. Rundvee (Ext. rep. 53,55,96)*. Lelystad: Animal Sciences Group. (Annual reports in Dutch; summary in English).
- Lassen B., Kathes F., Verdenal J. F., Mirbach D. and Busch G. (2009) EDF Congress 2009: Grasping the opportunities. Available at: [http://www.dairyfarmer.net/uploads/media/09\\_EDFCongress\\_Summary\\_01.pdf](http://www.dairyfarmer.net/uploads/media/09_EDFCongress_Summary_01.pdf), 6 pp.
- Schils R.L.M. (2002) *White clover utilization on dairy farms in The Netherlands*. PhD Thesis Wageningen University, 2002. Chapter 6 and 7.

# Global economic crisis impacts on dairy cattle in the Czech Republic

Kvapilík J.<sup>1</sup>, Kohoutek A.<sup>2</sup> and Komárek P.<sup>2</sup>

<sup>1</sup>*Institute of Animal Science, Prague-Uhřetěves, the Czech Republic;*

<sup>2</sup>*Crop Research Institute Prague-Ruzyně, Research Station Jevíčko, the Czech Republic;*

Corresponding author: kvapilik@vuzv.cz

## Abstract

In the Czech Republic (CR) dairy cow numbers fell from 1.248 million in 1989 to 384000 in 2009, which negatively influences the utilization of permanent grasslands (about 975,000 ha and 22.8% of agricultural land). Due to the global economic crisis the farmers' milk price in the CR, as well as in other countries, dropped by 20-30% to 0.18-0.20 € kg<sup>-1</sup>. This is about 0.10-0.15 € kg<sup>-1</sup> below production costs. The considerable economic loss is the main reason why many Czech farms ceased milk production. This situation is unfavourable in the light of production (milk, live and beef cattle) and non-productive functions (landscape maintenance, soil erosion protection etc.) and the observance of the common agricultural policy rules.

Keywords: dairy cows, milk, production, prices, permanent grassland, agricultural policy

## Introduction

In spite of a distinctive decrease in dairy cow numbers (by about 864000 and 69%) and milk production (by 2075 thousand litres and 43%) since 1990, milk production is still a significant source of income for farmers in the Czech Republic (CR). In 2008 its share of gross animal production was 41%. The 'Milk crisis' caused by a sharp decrease in the price of milk has resulted, among other effects, in the decrease of farm incomes. The decrease in dairy cow numbers and cattle in general has had a negative impact on the utilisation of permanent grasslands, execution of non-productive functions and other indicators. The aim of this contribution is an analysis of the development of milk production and prices in the CR and EU in the recent period and possible improvements to the current situation in milk production.

## Material and methods

The data of dairy cow numbers, milk production and prices, permanent grassland area and other indicators are taken from statistical reports of the CR, Eurostat and other sources. Selected Czech indicators are compared with the EU-15 countries average. Statistical processing of data is based on common methods and procedures. Prices per litre are converted to kg with a 0.974 coefficient and from Czech crowns to Euro according to the monthly referential exchange rates published by the European Central Bank, respectively, at an exchange rate of 1€ = 26.50 Czech crowns. Due to differences in milk price setting in different countries and conversion of prices to unified currency, some indicators must be regarded as approximate.

## Results and discussion

According to Kennedy (2009) in 2006/2007 the global demand for milk and dairy products grew by 2.9%, whereas the supply only by 1.5%. This resulted in stock clearance, distinctive increase of milk and dairy products prices worldwide and an increase of milk production in the USA, New Zealand and partly in EU. The growing demand was interrupted in 2008 by an economic crisis. The milk purchase prices fall from the beginning of 2008 to about mid-2009. With the price difference per 100 kg of milk between 2007 and 2009 of 6.94 € in the CR, the

annual loss caused by the crisis can be estimated at 1.24 € cow<sup>-1</sup> d<sup>-1</sup>, 450 € cow<sup>-1</sup> y<sup>-1</sup>, 76300 € y<sup>-1</sup> per average holding (170 dairy cows) and 180.3 10<sup>6</sup> € y<sup>-1</sup> for CR.

In comparison with 2007 this sum represents a decrease of gross animal production by 8.9%. Fig. 1 and Table No. 1 show lower prices in the CR and their slower return to the level of 2006 than in the EU-15 countries. In the CR the average monthly milk prices in the period from 2007 to October 2009 were about 0.0475 € kg<sup>-1</sup> and 308 € cow<sup>-1</sup> y<sup>-1</sup> (sale of 6 500 kg y<sup>-1</sup>) lower than in the EU-15; in October 2009 milk prices in the CR reached 0.2325 € kg<sup>-1</sup> which was 80% of EU-15 prices (0.2902 € kg<sup>-1</sup>). This means that the crisis in the milk sector has caused greater losses in the CR, and together with lower direct payments per ha of arable land (Table 2) results in a distinctly worse economic situation for Czech milk producers compared with those in the EU-15 countries.

The decrease of milk production capacity and cattle numbers demonstrates a certain delay after the start of the crisis; therefore it is more distinctive in the last months of 2009. In the CR the decrease of dairy cow numbers can be estimated at 17000 head (4.5%), and the decrease of milk sales from July to November 2009 in comparison with the same period in 2008 is estimated at 33000 tonnes (3%). In addition to the negative impact on economic indicators of milk production, the milk crisis also results in the loss of jobs and the decrease of cattle numbers utilizing permanent grasslands. The decrease of cow numbers by 17000 means job cuts for about 500 people (milkers, tenders of other cattle, service experts and others), which represents c. 4.5 % of the staff working in the sector of milk production in the CR.

According to data by Kohoutek *et al.* (2009) the current numbers of ruminants in the CR are not sufficient for utilization of about 17 to 33% (160 to 300 10<sup>3</sup> ha) of permanent grasslands. Further decrease in the currently small dairy cow proportion utilizing grazing and conserved fodder from permanent meadows and pastures cannot be excluded due to economic problems. Without efficient measures the situation in this ecologically sensitive area will deteriorate further as a result of the decline of numbers of dairy cows and other cattle.

Table 1. Farmer milk prices development since 2006

Region	Indicator	2006	2007	2008	2009 <sup>1)</sup>	2007 to 2009 <sup>2)</sup>	2009 October
EU 15	€ (100 kg) <sup>-1</sup>	29.46	33.78	37.06	28.21	33.30	29.02
	%	100	100	100	100	100	100
CZ	€ (100 kg) <sup>-1</sup>	26.83	29.47	32.91	22.42	28.57	23.25
	%	91	87	89	79	86	80

Source: Ministry of Agriculture of the CR; DairyCo; European Central Bank.

1) January to November, Germany January to October.

2) Average of "monthly" milk prices from 2007 until October 2009.

Table 2. European Agricultural Guarantee Fund Payments (EAGF, 2008)

Payments	Indicator	EU-15	EU-12	Germany	Austria	CZ
in total	10 <sup>6</sup> € <sup>1)</sup>	39205.5	3753.5	5704.0	745.5	445.6
	%	100.0	9.6	14.5	1.9	1.1
per ha arable land <sup>2)</sup>	€	283.4	69.7	334.9	228.5	104.6
	%	100.0	24.6	118.2	80.6	36.9

1) Source: BMELV (2009); Kvapilík (2009).

2) Approximate data.

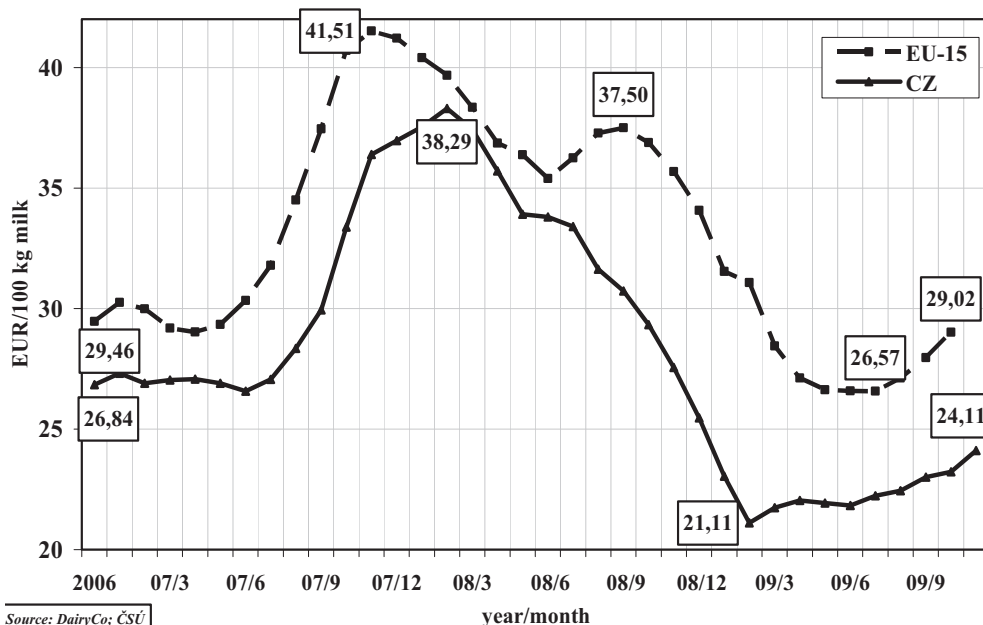

Figure 1. Farmer milk prices development ( $\text{€ (100 kg)}^{-1}$ )

## Conclusions

The milk crisis in the CR in the last two years resulted in the reduction of dairy cow numbers and milk production, high economic losses to the farmers and a setback in the utilization of permanent grasslands. The main solutions for overcoming this current unfavourable situation are an increase in milk prices at least to the level of its production costs, removal of differences in direct payments (Kvapilík, 2009) and equal application of the principles of the common agricultural policy in all EU countries.

## Acknowledgements

This article is based upon work supported by the National Agency of Agricultural Research (Project QH 81280).

## References

- ECB reference exchange rate, Czech crown/Euro, 2:15 pm (C.E.T.) (<http://search.seznam.cz/svet?q=ECB>).
- Einzahlungen der EU-Mitgliedstaaten zum EGFL - Rückflüsse und Saldo 2008. Ausgewählte Daten und Fakten der Agrarwirtschaft 2009. BMELV ([www.bv-agrar.de/bvagrar/agrarwelt/daten/bmelv/agrarwirtschaft\\_2009.pdf](http://www.bv-agrar.de/bvagrar/agrarwelt/daten/bmelv/agrarwirtschaft_2009.pdf)).
- DairyCo Library and Resources. EU Milk Prices - DG Agri (<http://www.dairyco.org.uk>).
- Informace o plnění kvót mléka (Information regarding the milk quotas fulfilment). SZIF, (<http://www.szif.cz/>).
- Kennedy R. Milk Price Outlook 2009/2010. Farm Forum - National Dairy Show. Millstreet ([www.ifa.ie](http://www.ifa.ie)).
- Kohoutek A., Kvapilík J., Čagaš, B. *et al.* (2009) Selected indicators of productive and extraproductual management of grasslands in the CR. In: *Proceedings of the 15<sup>th</sup> of the EGF Symposium*, Brno, CR, pp. 11-24.
- Kvapilík J. (2009) Zemědělská produkce a přímé platby v unii a v ČR (Agricultural production and direct payments in EU and in the CR). *Náš chov* No. 4, 10-12.
- Měsíční výkaz o nákupu mléka (Monthly return of milk delivery) (MZe) 6-12 (<http://eagri.cz/public/eagri/>).
- Number of cattle by age as at 31.12.2009. Czech Statistical Office (<http://www.czso.cz/>).



## Values and image of pasture-based milk production systems

Lobsiger M.<sup>1</sup>, Wyss U.<sup>1</sup>, Réviron S.<sup>2</sup> and Stoll W.<sup>1</sup>

<sup>1</sup> *Agroscope Liebefeld-Posieux Research Station ALP, Posieux, Switzerland,*

<sup>2</sup> *AGRIDEA, Swiss Association for the Development of Agriculture and Rural Areas, Lausanne, Switzerland*

Corresponding author: martin.lobsiger@alp.admin.ch

### Abstract

In a series of scientific presentations in the years 2007-2009 on the topic of 'values and image of pasture-based milk production systems', the current state of knowledge on the special characteristics of this milk production system and the dairy products derived from it were gathered and the market potential for dairy products from pasture-based production systems was described. Compared to milk from cows fed with mainly maize silage and concentrate supplements, milk from pasture-based production systems has higher levels of nutrient contents that are important for human health (e.g. poly-unsaturated fatty acids). Furthermore, pasture-based milk production plays an important role for agriculture in fulfilling the various multifunctional tasks as required by the Swiss Constitution. Consequently, pasture-based dairy products have a very positive image. Furthermore, studies show that actual consumer behaviour is favouring naturally produced domestic products. Thus pasture-based milk products, even though sold at a higher price, do have a market potential.

Keywords: milk production, market potential, fatty acid, multifunctionality

### Introduction

The Swiss dairy farmers face a more expensive production environment compared to their competitors abroad. Higher salaries and small-scale topographic conditions are two major reasons for this. To cover the additional expenses, they must sell their products at a higher price, which can be justified by the quality of products and production. In Switzerland, the dairy cows are fed to about 2/3 with grass, grass silage and hay. This is the one major distinctive feature of grassland- and pasture-based milk production systems, compared to most other production systems worldwide, in which cows are fed primarily with corn-based feed and concentrate supplements. 'Values and image of pasture-based milk production systems in Switzerland' was the title of a joint action in 2007-2009 to point out the special qualities of this production system and the dairy products derived from it. The action was supported by the Federation of Swiss Milk Producers SMP, the agricultural research facilities, the agricultural advisory centres and the Swiss network for milk production Profi-Lait. In a series of conferences, experts summarised the current state of knowledge on the following topics:

- the special qualities of milk from pasture-based production and its components (e.g. fatty acids) (Stoll *et al.*, 2007)
- the importance of pasture-based milk production for agriculture in fulfilling the various multifunctional tasks as required by the Swiss Constitution (Lobsiger and Albisser, 2007)
- the market potential of the dairy products derived from pasture-based production systems

The key messages of the lectures and papers presented in those conferences are summarized below.

### **A) Special characteristics of pasture-based milk and dairy products**

In a scientific conference held in November 2007 at the Swiss Federal Research Station Agroscope Liebefeld-Posieux ALP, the special characteristics of pasture-based milk were discussed. In particular, influence of grass-based diets on milk fatty acid (FA) composition and eventual benefits for human health were reviewed. Martin *et al.* (2007) summarised that different feeding strategies do have a significant effect on FA composition in the milk. E.g. he showed that milk fat from grass-based diets is poorer in short-chain FA and linoleic acid and richer in  $\alpha$ -linolenic acid when compared to corn silage diets. The FA composition and the n-6 and n-3 fatty acids ratio in milk derived from grass-based milk production are consistent with current nutritional principles and recommendations. However, it could not be answered conclusively to what extent the differences found are relevant to human health. It is likely, that with a normal consumption of dairy products, the intake of n-3 and other poly-unsaturated FA in Switzerland is not high enough to have a preventive or even curative effect (Stehle, 2007).

### **B) Added values or public and ecological services**

Based on the Swiss Constitution, which describes the multifunctional tasks of agriculture in Switzerland, the government promotes methods of production that are close to nature, environmentally acceptable and animal-friendly, encouraging them through economic incentives. Grass-based production systems meet those requirements in an ideal manner. This has been shown in a series of colloquiums at the Swiss Federal Institute of Technology ETH in Zurich 2007 (Lobsiger and Albisser, 2007, presentations see [www.profi-lait.ch](http://www.profi-lait.ch) > Dokumentation). Some key-messages from the presentations are summarised in this chapter: Grassland management is indispensable for maintaining an attractive landscape in Switzerland, which again is one of the main arguments for the local tourism industry. Furthermore, the intensity of production plays a crucial role for the biodiversity in grassland regions: the abandonment of farming and thus the reforestation of grassland as an extreme form of extensification has a negative impact on biodiversity, just as a strong intensification. In terms of animal welfare, pasture-based milk production systems provide especially animal-friendly conditions for livestock. Grass is the original feed of ruminants. Those public services, referred to as *added values* of milk production in Switzerland, contribute to a large extent to the positive image of local milk production.

### **C) Consumer preference and willingness to pay for pasture-based domestic dairy products**

The commercial value of 'swissness' has become a crucial question, as EU and Switzerland are negotiating a free-trade agreement. The issue of the Swiss consumers' preference and willingness to pay for Swiss fresh food products has been studied in-depth since 2008 (Bolliger and Reviron, 2008). Studying the Swiss consumers' attitude and buying behaviour regarding 'pasture-based milk production systems' is a tricky exercise, because the comparison point with milk products obtained using other kinds of production practices is missing. To evaluate the commercial value of 'swissness' of dairy products it is, however, possible to extend results that have been obtained for other products (poultry, fruits, apple juices, meat) for which choice between EU products and Swiss products is effective and acknowledged by consumers. Results show strong common features and lessons (Reviron and Thevenod-Mottet, 2009): if sold at the same price as the EU competing product, more than 80% of the interviewed persons prefer the Swiss product. Two kinds of reasons are given spontaneously by the interviewed persons for explaining their preference: 'ethno-centric' reasons (linked to general expected benefits: to support the Swiss economy, to support Swiss

agriculture; ecological reasons such as short transport...) and – less pronounced – 'egocentric' reasons (linked to the concerned product: method of production, product quality, taste, safety (controls)...). A second important result is the willingness to pay a higher price for domestic products: although stated preferences may vary from real customer behaviour in the shops, remarkably, 80% of the consumers interviewed in a representative survey are ready to pay more for Swiss products, of which more than half will pay more than 10% higher prices. Furthermore, the studies revealed that 'egocentric' expected benefits and willingness to pay increase sharply when the consumer perceives that the quality of the Swiss product is better, in comparison with the imported product. In this way, the image of Swiss products, i.e. the 'swissness' becomes a strong argument for product placement and advertising (Feige *et al.*, 2008). That is why it is important to get reliable information on the difference of quality of milk products according to the feeding strategy and to repeat that milk quality differs according to the production process. The production system, its influence on quality and the image of products are crucial elements of differentiation that will become a commercial argument in liberalised markets.

## Conclusions

The action 'Values and image of pasture-based milk production systems in Switzerland' has shown that the local grassland-based milk production system does have verifiable positive impacts on the quality of milk and dairy products. Thus it stands out from milk from cows mainly fed with corn and concentrate supplements. Furthermore, grassland-based and, in particular, pasture-based milk production systems are indispensable to maintain the typical Swiss landscape, to ensure biodiversity and to fulfil the various multifunctional tasks as required by the Swiss Constitution. Swiss dairy products benefit from a positive image based on these findings. The commercial value of 'swissness' has been described for other products. Swiss consumers prefer domestic products and are willing to pay higher prices. The more consumers perceive product differences, the more accentuated this preference is. Thus it is important to document and to communicate the special values and image of pasture-based milk production systems in Switzerland.

## References

- Bolliger C. and Reviron S. (2008) *Preference and WTP-estimates for Swiss chicken using double-bounded dichotomous choice model*. Paper presented at the EAAE congress, Ghent (B), 26-29 August. <http://econpapers.repec.org/paper/agseaae08/44155.htm>
- Feige S., Brockdorff B., Sausen K., Fischer P., Jaemann U. and Reinecke S. (2008) *Swissness worldwide – Internationale Studie zur Wahrnehmung der Marke Schweiz*, Institut für Marketing und Handel an der Universität St-Gallen. [www.hfp-sg.ch](http://www.hfp-sg.ch)
- Lobsiger M. and Albisser G. (2007) *Werte und Image der raufutterbasierten Milchproduktion in der Schweiz – Identifikation nicht marktfähiger Güter*. 13. Alpenländisches Expertenforum, Raumberg-Gumpenstein, Österreich, Proceedings. S.38-41.
- Martin B., Ferlay A., Graulet B., Nozière P. and Chilliard Y. (2007) Influence de l'alimentation de la vache laitière sur la composition en acides gras et en vitamines du lait. In: Stoll W., Frioud E. and Lobsiger M. (eds.) Der besondere Wert graslandbasierter Milch. Forschungsanstalt Agroscope Liebefeld-Posieux, 8. November 2007: *Tagungsband*, Agroscope Liebefeld-Posieux, Posieux.
- Reviron S. and Thevenod-Mottet E. (2009) *'Swissness' des produits des filières agricoles: valeur et consentement à payer des consommateurs*. Mémento agricole, AGRIDEA, 2009.
- Stehle P. (2007) Ernährungsphysiologischer Wert von Fettsäuren in der Humanernährung. In: Stoll W., Frioud E. and Lobsiger M. (eds.) Der besondere Wert graslandbasierter Milch. Forschungsanstalt Agroscope Liebefeld-Posieux, 8. November 2007: *Tagungsband*, Agroscope Liebefeld-Posieux, Posieux.
- Stoll W., Frioud E. and Lobsiger M. (eds.) Der besondere Wert graslandbasierter Milch. Forschungsanstalt Agroscope Liebefeld-Posieux, 8. November 2007: *Tagungsband*, Agroscope Liebefeld-Posieux, Posieux.

# Assessment of energy consumption pattern in a sample of Walloon livestock farming systems

Rabier F.<sup>1</sup>, Mignon C.<sup>2</sup>, Lejeune L.<sup>1</sup> and Stilmant D.<sup>1</sup>

<sup>1</sup>Walloon agricultural Research Centre, Gembloux, Belgium

<sup>2</sup>ValBiom - Biomass use association, Gembloux, Belgium

Corresponding author: rabier@cra.wallonie.be

## Abstract

In order to have a better understanding of the energy consumption pattern in Walloon farms, energy consumption assessments were made for different farm types. Results showed the important variability that exists between and within farm types and the importance of direct energies (fuel and electricity), fertilizers and animal feed on the total energy consumption.

Keywords: energy consumption, direct and indirect energy, Walloon farm, breeding systems

## Introduction

Farming systems have to face the increase in energy prices. In 2003, Walloon farming systems consumed an equivalent of 40 millions Euros of fuel and electricity (Bouquiaux, 2003). At farm level, energy expenditure can be divided into two parts: the direct energy used on the farm (e.g. tractor fuel) and the indirect energy used to produce and transport inputs like feedstuffs, fertilizers, etc. It is important to have a better understanding of the diversity of energy consumption patterns (Meuls *et al.*, 2007) in Walloon farming systems in order to identify the leeway of progress and to advise farmers on how to improve their energy-use efficiency (Institut de l'élevage, 2008).

## Materials and methods

Energy consumption was assessed on 20 Walloon farms. Only the results concerning the dairy and beef farming systems are discussed in this paper (12 farms). The energy balance of the different farms was calculated using a specific tool called PLANETE (Bochu, 2007). This tool is based on a life cycle analysis, meaning that for all inputs used on the farm, the total energy to manufacture, transport and recycle them, are included. All direct energies are taken into account (fuel and other by-products, electricity, lubricants) as well as all inputs purchased. The result of the assessment is an energy profile expressed in litres of fuel equivalent (LFE = 35.8 MJ) per year that can be also expressed per ha, per litre of milk, or per kg of liveweight.

## Results and discussion

There is a great variability among farms in total energy expenditure, ranging between 627 and 2098 litres of fuel equivalent (LFE) per ha ( $898.4 \pm 120.18$  LFE ha<sup>-1</sup> on average). The energy consumed by different items also varies a lot, since the energy used on a farm depends strongly on the farm type and its main products and the farmer's management practices. The direct energy (electricity and fuel/by-products), fertilizers and animal feed together represent 83% (between 74 and 90%) of the total energy expenditure. In order to analyse variations, the results are presented for the different productions: milk, beef and crops (Tables 1 to 3). To account for differences in productivity between farms, for milk production the results are presented in LFE per 1000 litres of milk sold, and for beef production as LFE per 100 kg of liveweight sold.

Table 1: Energy consumption in dairy systems, in litres of fuel equivalent per 1000 litres of milk and per year. Dairy and dairy/beef farms are included.

	Dairy farms (n=3)		Dairy/beef farms (n=4)	
	Mean $\pm$ std <sup>(*)</sup> [min-max]	%	Mean $\pm$ std [min-max]	%
Fuel and by-products	28.4 $\pm$ 2.68 [23.2-32.1]	24%	25.5 $\pm$ 7.29 [8.4-42.2]	16%
Electricity	19.8 $\pm$ 3.32 [15.5-26.3]	17%	26.1 $\pm$ 7.40 [10.5-45.4]	17%
Feedstuff	19.9 $\pm$ 1.42 [18.3-22.7]	17%	59.8 $\pm$ 22.28 [23.4-115.3]	38%
Fertilizer	27.6 $\pm$ 8.04 [14.4-42.1]	23%	25.0 $\pm$ 2.80 [18.8-30.4]	16%
Agricultural equipment and buildings	15.1 $\pm$ 6.23 [2.9-23.6]	13%	9.3 $\pm$ 1.58 [6.8-13.9]	6%
Young animals, plastic for silage and veterinary products	7.0 $\pm$ 1.32 [4.4-8.7]	6%	10.2 $\pm$ 0.93 [8.7-12.8]	6%
Total	119.7 $\pm$ 17.43 [99.4-154.4]	100%	157.2 $\pm$ 29.79 [103.9-242.5]	100%

<sup>(\*)</sup> Standard deviation of the mean

For both farms types, the main inputs are similar (fuel, electricity, animal feed and fertilizer) representing 81% and 87% of the total energy consumption for dairy and dairy/beef farms, respectively. The difference between dairy and dairy/beef farms is on average 37.5 LFE per 1000 litres of milk. The main difference is due to input of animal feed (19.9 $\pm$ 1.42 for dairy farms against 59.8 $\pm$ 22.28 LFE per 1000 l of milk for dairy/beef farms). With an average value of 2.39 Livestock Unit (LU) per ha of fodder crops the dairy farms need less external feedstuff than the dairy/beef farms (3.50 LU per ha fodder crops). In our small sample, the electricity consumption also seems to be negatively correlated to cow productivity; this can be explained by the fact that the same amount of milk is produced by more cows in the dairy/beef farms, meaning an increase of milking time as cow productivity decreases. This difference is observed in the electricity item between both samples: 19.8 $\pm$  3.32 LFE per 1000 litres of milk with an average productivity of 5267 litres of milk/dairy cow in dairy farms and, for dairy/beef farms, an average consumption of 26.1 $\pm$  7.40 LFE per 1000 litres of milk with a production of 4783 litres of milk/dairy cow.

Table 2: Energy consumption for beef production, in litres of fuel equivalent per 100 kg liveweight sold per year. Beef and dairy/beef farms are included

	Beef farms (n=5)		Dairy/beef farms (n=4)	
	Mean $\pm$ std <sup>(*)</sup> [min-max]	%	Mean $\pm$ std [min-max]	%
Fuel and by-products	24.2 $\pm$ 5.48 [9.3-37.1]	21%	24.8 $\pm$ 8.34 [9.1-48.4]	20%
Electricity	8.8 $\pm$ 2.29 [2.5-15.5]	8%	1.5 $\pm$ 0.56 [0.3-2.5]	1%
Feedstuff	43.7 $\pm$ 10.51 [25.8-84.5]	37%	52.8 $\pm$ 15.48 [25.3-82.9]	43%
Fertilizer	17.8 $\pm$ 4.06 [6.2-29.6]	15%	24.3 $\pm$ 3.62 [19.1-34.9]	20%
Agricultural equipment and buildings	11.6 $\pm$ 3.64 [0.4-23.3]	10%	9.4 $\pm$ 2.14 [5.3-15.1]	8%
Young animals and others purchasings	9.0 $\pm$ 2.06 [3.3-13.7]	8%	9.8 $\pm$ 0.53 [8.5-10.8]	8%
Total	116.8 $\pm$ 17.27 [68.7-162.5]	100%	123.8 $\pm$ 11.17 [90.6-138.1]	100%

<sup>(\*)</sup> Standard deviation of the mean

The average energy consumption per 100 kg of liveweight sold is quite similar for both samples (116.8 and 123.8 LFE (100 kg)<sup>-1</sup>). The items fuel, feedstuff and fertilizer represent 73% and 83% of the total energy consumption for beef and dairy/beef farms, respectively. Compared with milk production, the electricity item is less important as the electricity used by the milking machine is attributed to the milk production. The difference observed for the

fertilizer items is probably linked to the higher stocking rate in the dairy/beef farms (3.50 LU per ha fodder crops) than in the beef farms (2.56 LU per ha fodder crops). The dairy/beef farms need to produce more with the same area and for that reason use more fertilizers.

Table 3: Energy consumption for crop production, in litres of fuel equivalent per hectare of purchased crops and per year in dairy, beef and dairy/beef farms

	Dairy farms (n=3)		Dairy/beef farms (n=4)		Beef farms (n=5)	
	Mean±std <sup>(*)</sup> [min-max]	%	Mean±std [min-max]	%	Mean±std [min-max]	%
Fuel and by-products	111.5 ± 29.05 [57.2-156.6]	19%	145.1 ± 23.68 [79.0-191.7]	26%	231.3 ± 58.64 [143.8-460.4]	34%
Fertilizer	229.0 ± 24.23 [183.4-266.0]	38%	233.2 ± 33.03 [142.0-298.5]	42%	322.3 ± 121.30 [172.0-802.5]	48%
Pesticides	83.3 ± 48.02 [35.0-179.4]	14%	61.8 ± 36.61 [11.1-170.5]	11%	31.3 ± 2.49 [21.8-36.8]	5%
Agricultural equipment and buildings	91.4 ± 62.89 [27.2-217.2]	15%	53.5 ± 10.06 [36.5-82.4]	10%	68.5 ± 31.18 [16.2- 175.4]	10%
Total	601.1 ± 122.67 [449.7-843.9]	100%	558.5 ± 119.29 [297.9-874.9]	100%	677.4 ± 211.45 [383.5-1518.1]	100%

<sup>(\*)</sup> Standard deviation of the mean

The cultivated crops consist mainly of cereals and sugar beet/chicory (67 to 100% of the area). For all farm types, the most important items are fertilizer and fuel/by-products. With  $677.4 \pm 211.45$  LFE ha<sup>-1</sup>, the beef farms reach the higher energy consumption.

## Conclusions

Energy consumption assessment is a tool allowing farmers to compare their situation with other farms and to assess the possibilities of saving energy. Results showed the important variability that exists between and within farm types. This implies that improvements in energy consumption are possible in the Walloon context. This study has shown that for all kinds of farm, the four items of fuel, electricity, fertilizer and animal feed together represent the main part of the total energy consumption. However, the results presented in this paper are not representative of the variety of farming systems existing in Wallonia, as the number of farms analysed was small. In the context of the OPTENERGES project, assessment will be done on 60 Walloon livestock farms. For this bigger sample, the ways of reducing energy consumption will be studied.

## Acknowledgements

This study was supported by the Walloon Region and the European Union (FEDER fund) in the context of the OPTENERGES project financed in the INTERREG IV programme 'Wallonia – Luxembourg – French Lorraine area'.

## References

- Bochu J.L. (2007) *Synthèse des bilans Planete*, Ademe. 30 pp.
- Bouquiaux J.M. (2003) *Problématique de la consommation d'énergie en agriculture*. Ministère de la Région Wallonne, 4 pp.
- Institut de l'élevage (2008) *Evaluation des consommations d'énergie dans les exploitations bovines et ovines et identification des marges de progrès*. 224 pp.
- Meuls M., Nevens F., Reheul D. and Hofman G. (2007) Energy use efficiency of specialised dairy arable and pig farms in Flanders. *Agriculture, Ecosystems and Environment* 119, 135-144.



# The role of agri-environmental programmes in grassland conservation and environmental protection

Stypiński P.

*University of Life Sciences in Warsaw, Department of Agronomy, Faculty of Agriculture and Biology, 02-776 Warsaw, Poland*

Corresponding author: piotr\_stypinski@sggw.pl

## Abstract

The aim of this study was the estimation of practical realisation of agri-environmental agreements on the Podlaskie voivodship in Poland. The studies were carried out in the years 2007-2009. 110 and 126 farms were randomly selected in 2007 and 2009, respectively. On the basis of questionnaires and direct visits to the farms we wanted to know how many farmers decided to join agri-environmental programmes and what they expected from the government. Special attention was paid to the reasons for choosing the specific packages and what was the percentage of beneficiaries in comparison to all farmers on Podlaskie vojvodship. It was found that only 4.2% of farmers applied for agri-environmental programmes. The most popular packages were 'soil and water protection' and 'extensive grassland management'.

Keywords: permanent grassland, treats, environment, method of conservation

## Introduction

After becoming a member of the European Union (EU), Poland implemented agri-environmental schemes as a tool for proper, environmentally friendly management (Biuletyn Informacyjny, 2005). In the first period (2004-2007) seven different packages of agri-environmental Schemes (AES) were available and, since 2007, a new version of this programme, including 9 packages, has been offered to farmers. Official data from the Ministry of Agriculture and Rural Development (Biuletyn Informacyjny, 2005) and from the Central Statistical Office (CSO) confirmed a rather small involvement of Polish farmers in active grassland protection. Less than 1% of Polish farmers signed an environmental agreement with the Polish government. Protection of extensive meadows (e.g. through late and hand harvesting) and pastures (low stocking rate, counteracting of afforestation) is not very popular (Stypiński and Sienkiewicz-Paderewska, 2007; Brodzinska, 2009). The package 'Soil and water protection' seems to be the most popular. In this context, the aim of this paper was to analyse agri-environmental programmes which have been realized in the north-eastern part of Poland (Podlaskie voivodship) since 2004. A special attention was paid to the reasons of choosing specific packages by farmers. The direction of changes and evolution of agri-environmental programmes were also taken into consideration because it was possible to compare the situation in 2004 and in 2008 within the same region of Poland

## Material and methods

Podlaskie voivodship was chosen for this study as it is the region of Poland with a percentage of grassland, in terms of total area of agricultural land, that is higher than average (35% in comparison with 20% in Poland). This area has also a rather extensive agriculture, and high environmental value with large Environmentally Sensitive Area. In the first stage of study in 2007, 110 questionnaires were sent to farmers in all communes of Podlaskie voivodship. Farmers had been selected by random (one single farm for each commune) and the basic



question was: were they generally interested in the agri-environmental scheme (AES) for 2004-2007, and, if yes, in which package and why? The average area of tested farm was about 35 ha and the majority of farmers were milk producers. Data from these farms were compared with the official data and documents published by the Regional Office of the Agency of Restructuring and Modernization of Agriculture. In the second stage of our study, questionnaires were sent only to 126 randomly selected farmers who decided to join the programme and sign the environmental agreements for the years 2007-2013. The diversification between packages was estimated. The comparison of farmers' interest in the present and former versions of the AES was taken into consideration.

## Results and discussion

On Podlaskie voivodship, in 2007, there were 111.7 10<sup>3</sup> of holdings. In the framework of the agri-environmental programme, for the years 2004-2006, 4736 applications were sent, which means that 4.2% of all farmers were interested in AFS. The most popular package was the 'Soil and water protection' package. 'Management of extensive grassland' and 'Organic agriculture' were also accepted by farmers. In the second stage of AES, the total number of new farmers was similar to that of the first stage, but the "Extensive grassland" became the most popular package (Table 1)

Table 1 Number of applications for different packages of AEP in Podlaskie voivodship

	AEP package								Total	
	S01	S02	P01	P02	K01	K02	G01	G02		N
year	2004-2007									
number	89	690	1394	136	2376	3	48			4738
%	1.8	14.6	29.4	2.9	50.1	0.1	1.1			100
year	2007-2013									
number	288	955	2058		1121	2	124	54	131	4733
%	6.1	20.2	43.4		23.7	0.04	2.6	1.1	2.8	100
year	Total 2004-2013									
number	377	1645	3452		3497	5	172	54	131	9333
%	4.1	17.6	36.9		37.5	0.1	1.8	0.6	1.40	100

S01 sustainable agriculture, S02 organic farming P01 extensive meadows P02 extensive pastures K01 soil and water protection K02 buffer zones G01 protection of local animal breeds , G02 protection of local plant cultivars, N – Natura 2000

The agri-environmental programmes did not meet farmers' expectations, especially those farmers classified as good milk producers. Of 110 tested farms, only 7 confirmed their access to AES. Many factors contributed to the low participation in the AES; some of them might include delay in becoming accustomed to the programme, low level of farmers' knowledge in this respect, small number of skilled advisors, too much bureaucracy and very complicated procedures.

During the second stage of this study questionnaires were sent to farmers who decided to sign the agreement and join AES in the years 2007-2013. The results are presented in Figure 1. About 40% of beneficiaries chose package 'Soil and water protection' probably because it is connected with the farmers' normal practice (crop rotation and intercrops). Twenty-five percent of farmers decided to join the package 'Extensive grasslands' and organic farming is also beginning to be more popular than before. Unfortunately, farmers are not interested in packages connected with NATURA 2000. One of the important disadvantages of this programme is the requirement of getting the opinion of an expert. This means extra cost for farmers and makes the procedure much more complicated. The lack of ecological knowledge and the problem of farmer education and mentality is also a barrier. The economic efficiency of environmentally friendly farming activity does not meet their expectations. Agri-

environmental programmes should become very important tools for biodiversity management in agriculture (Knop *et al.*, 2005; Roeder *et al.*, 2007). Polish farmers, however, are afraid of bureaucracy and very complicated procedures. Even extra payments are not attractive enough (Stypinski and Sienkiewicz-Paderewska, 2007). Agri-environmental scheme applied to extensive meadows can preserve biodiversity in agricultural landscape (Knop *et al.*, 2005) but the management restrictions imposed by NATURA 2000 become inconvenient for farmers, particularly for good milk producers. Indeed, as already shown in some previous work (Stypinski and Sienkiewicz-Paderewska, 2007; Brodzinska, 2009), lack of knowledge seems to be one of the more important barriers in farmers' acceptance of AES.

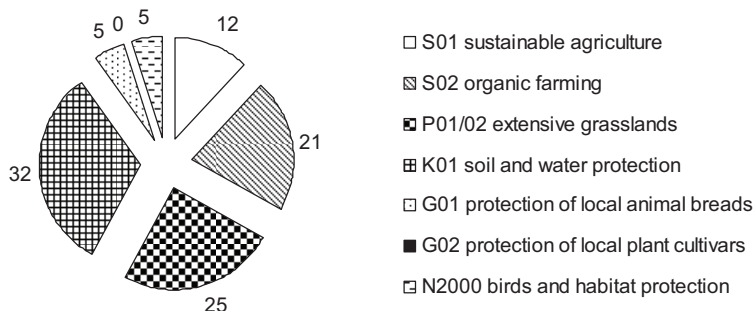

Figure 1 Percentage of packages chosen by the 126 farmers interviewed in Podlaskie voivodship in the framework of the 2007-2013 Agri-environmental Scheme.

## Conclusions

During the first stage of the Agri-environmental Scheme (2004-2007) farmers were not very interested in participation in this programme (4.3% of the total farmer population in Podlaskie voivodship and 6.6% of tested farmers). The most attractive package was the 'Soil and water protection' but in the second period of AFS the measure 'Extensive grassland' also seemed to be attractive for farmers. Farmers are not interested in the NATURA 2000 programme.

## References

- Ministry of Agriculture and Rural Development (ed.) (2005) Biuletyn Informacyjny, pp. 11-31.
- Brodzinska K. (2009) Kierunki i perspektywy Rozwoju Programu Rolnośrodowiskowego w Polsce po 2013 roku. *Water-Environment-Rural Areas* 9, 3(27), 5-18.
- Central Statistical Office (CSO) (2006) *Environment 2006*. Statistical Publications House, Warsaw.
- Knop E., Herzog F. and Schmid B. (2005) Effect of the Swiss agri-environmental scheme on biodiversity *Grassland Science in Europe* 10, 40-43.
- Roeder N., Hennessy T. and Stilmant D. (2007) Impact of CAP reform of 2003 on the use of pastoral land in Europe *Grassland Science in Europe* 12, 445-446.
- Stypinski P. and Sienkiewicz-Paderewska D. (2007) The protection and conservation of grassland in the Polish Landscape Parks. *Grassland Science in Europe* 12, 520-523.

# Threats to grassland plant diversity in Transylvania, Romania

Larkham K.S.<sup>1</sup> and Sutcliffe L.M.E<sup>2</sup>

<sup>1</sup> Imperial College London, South Kensington, London SW7 2AZ

<sup>2</sup> Univ. Göttingen, Dept. Vegetation Analysis, Untere Karspüle 2, 37073 Göttingen, Germany

Corresponding author: sutcliffe.laura@gmail.com

## Abstract

The Transylvanian region of Romania is home to some of the last truly intact semi-natural grasslands in Europe. Low rates of intensification and fragmented land-ownership have led to the retention of substantial areas of extremely biodiverse grassland. This biodiversity is inextricably linked to the traditional small scale pastoral sheep and cattle farming typical for Romania; however, land management practices are beginning to change. The increase in costs and outside competition, as well as the introduction of new EU regulations and subsidies, are causing an increase in farm size and in an intensification of their practices in order to remain competitive. One particular difficulty is the widespread reduction in cattle numbers due to a drop in milk prices. This, alongside the incipient socioeconomic changes and rural depopulation, is also already leading to the abandonment of marginal areas. Based on a description of the pressures facing grassland in the study region of Southern Transylvania and vegetation surveys in different grassland types, this paper will discuss the impacts that the predicted changes may have on lowland grassland plant diversity.

Keywords: Transylvania, Romania, semi-natural grassland, socioeconomic change, grassland biodiversity.

## Introduction

Romania joined the European Union on 1 January 2007. It brought with it around 2.4 million ha of semi-natural grassland (Sârbu *et al.*, 2004), including areas described as being the best and largest remaining areas of lowland semi natural grassland in Europe (Akeroyd and Page 2006). Southern Transylvania in particular contains large populations of many species, such as *Dianthus armeria* and *Echium russicum*, that are now of conservation concern in other parts of Europe (Akeroyd, 2006). This species-rich habitat is largely the result of an effective halt in agricultural industrialisation after the collapse of the communist regime, as well as a highly fragmented land-ownership structure preventing large-scale intensification: 99.5% of holdings in Romania are small semi-subsistence holdings with an average size of 2.15 ha (Redman, 2009). This is due to a complex combination of social, political and economic factors, including lack of alternative employment, lack of market integration, the relatively high cost of food in Romania, and the complicated land restitution process.

Much of this biodiversity is under threat from two major drivers of change in rural areas: agricultural intensification and abandonment. Socioeconomic changes are causing rural depopulation, with land being either consolidated into larger, more industrial holdings, or abandoned. In addition, competition from cheap imports from more industrialised agriculture in other countries is putting pressure on smallholders. For example, the main source of cash income for such subsistence farmers in Transylvania is milk production, yet the small-scale production methods mean that these farmers cannot compete with cheap foreign imports, nor easily meet stringent EU hygiene standards. A drop in the milk price has led to a decrease in the number of cows. This will impact on grassland plant (and animal) diversity through the undergrazing of cow pastures and the abandonment of hay meadows. Both the value to biodiversity and the pressures facing such species rich and relatively unproductive land are

recognised in the designation of 34% of utilised agricultural area in Romania as ‘High Nature Value’ (HNV) farmland (EEA, 2009). Under EU law, HNV farmland must be eligible for agri-environment scheme payments.

## Methods

Between the months of May and July 2009, the vascular flora of lowland mesic (Molinio-Arrhenatheretea R. Tx. 1937, and Festuco-Brometea Br.-Bl. et Tüxen ex Soó 1947) grassland around the villages of Saschiz, Bunesti and Viscri in Southern Transylvania was surveyed. Three types of grassland use were distinguished: cattle pasture, sheep pasture and hay meadow. For each grassland type, three different intensities of management – ‘intensive’ (a history of fertiliser/pesticide inputs and/or overgrazing), ‘extensive’ (no inputs, extensive grazing) and ‘recently abandoned’ (previously extensively grazed areas) - were sampled. For each of the nine combinations of grassland type and intensity, three repeats were sampled. For each repeat, five 100 m<sup>2</sup> plots were sampled with five randomly placed 0.25m<sup>2</sup> relevés in each, recording each species and its abundance/coverage (Braun-Blanquet). To avoid pseudoreplication, the relevés from each plot were then amalgamated to give a list of species and average coverage values for each plot.

## Results

Average vascular plant species richness in the extensive grassland areas (37.5 sp./plot) was significantly higher than in the intensive areas (27.4 sp./plot) but non-significantly lower than recently abandoned areas (39.7 sp./plot) (see Figure 1.a).

Regarding land use type, cattle pasture was the least diverse (29.9 sp./plot), followed by sheep pasture (34.0 sp./plot) and hay meadow (40.7 sp./plot). The differences were significant in all cases (see Figure 1.b).

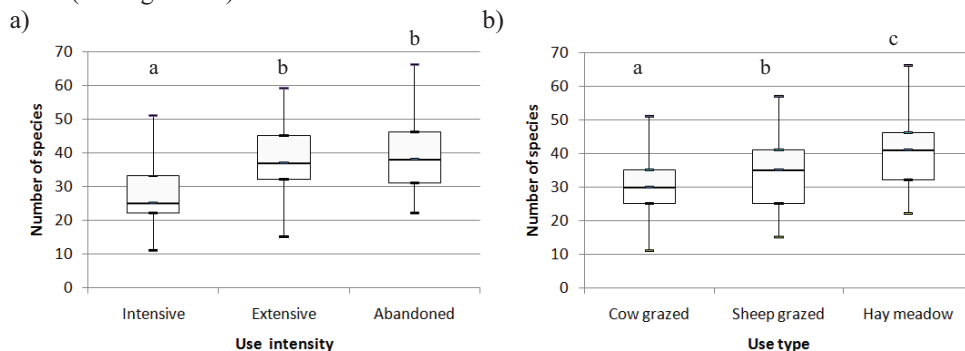

Figure 1. Box plot of differences in species richness between a) different use intensities, and b) different use types. Different letters denote significant differences where  $P < 0.05$ , d.f. = 88.

The maximum vascular plant species richness in a single relevé was 36 species on 0.25 m<sup>2</sup> (found in recently abandoned hay meadow) – a value judge by similar scale studies of semi-natural grassland in other areas of Europe to be highly diverse (see e.g. van der Maarel and Sykes, 1993).

## Discussion

This ‘average’ lowland mesic grassland contained high plant species diversity, compared to other European grasslands. Both abandonment and intensification – the two currently most

likely developments in grassland in the region – will negatively affect this diversity. The slight increase in diversity in recently abandoned areas seen here may be due to extinction debt and other factors such as increased structural diversity – we expect this to decrease as scrub encroachment progresses. The loss of traditional farming methods, such as shepherding and hand-mowing, may also have long-term negative effects on grassland specialists, which are sensitive to the loss of certain seed dispersal mechanisms or disturbance regimes. In particular, the loss of hay meadows associated with the decreasing numbers of cattle may have a large impact on grassland plant diversity. However, whilst species composition did change between the different intensity levels, there was no major difference between the use types (Sutcliffe and Larkham, 2010). At present, the only policy directly preventing the negative impacts of intensification and abandonment of species-rich grassland in Romania is that of the High Nature Value agri-environment scheme. Farmers must adhere to management prescriptions (such as stocking densities or input levels) in return for financial compensation. However, even optimistically, this will only delay abandonment and intensification and does not address the real socioeconomic drivers of change. Small-scale farming must once again be made profitable by mechanisms (such as milk cooperatives or value-added products such as cheese) to lower production costs and remove barriers to marketing of products by smallholders.

## Conclusion

This study supports the conclusion that the grasslands of Romania are highly biodiverse and, in the context of the major losses of species rich semi-natural grassland in much of the rest of Europe, should be considered with a biodiversity conservation priority. However, socioeconomic pressures leading to abandonment and intensification currently present a particularly acute threat. Current measures such as High Nature Value agri-environment schemes will not be sufficient to preserve this grassland on the scale at which it currently exists, and other support measures should be found before this valuable resource of biodiversity is lost.

## Acknowledgements

The authors gratefully acknowledge the support of Fundatia ADEPT throughout the research for this paper.

## References

- Akeroyd J.R. (2006): *The historic countryside of the Saxon Villages of Southern Transylvania*. Fundația ADEPT, Saschiz, 86 pp.
- Akeroyd J. R. and Page N. (2006) The Saxon Villages of Southern Transylvania: Conserving biodiversity in a historic landscape. In: Gafta D. and Akeroyd J. R. (Eds.) *Nature conservation: concepts and practice*. Springer, Heidelberg, pp. 199–210.
- EEA - European Environment Agency (2009) *Distribution and targeting of the CAP budget from a biodiversity perspective*. EEA Technical report series, 85 pp.
- Redman M. (2009) *The hidden “values” of HNV Farming Systems in Bulgaria and Romania*. Report for the WWF Danube-Carpathian Programme (WWF-DCP), 34 pp.
- Sârbu A., Coldea G., Negrean G., Cristea V., Hanganu J. and Veen P. (2004) *Grasslands of Romania. Final report on National Grassland Inventory 2000-2003*. University of Bucharest and Royal Dutch Society for Nature Conservation, Bucharest, 71 pp.
- Sutcliffe L.M.E. and Larkham K.S. (2010) High Nature Value grassland assessment in Transylvania: management, monitoring and indicator species. *Aspects of Applied Biology* 100 (in press).
- van der Maarel E. and Sykes M.T. (1993) Small-scale plant species turnover in a limestone grassland: the carousel model and some comments on the niche concept. *Journal of Vegetation Science* 4, 179-188.

## Environmental aspects of grazing animals in a European context

Van der Hoek K.W.

*National Institute for Public Health and the Environment (RIVM), 3720 BA Bilthoven, The Netherlands*

Corresponding author: Klaas.van.der.Hoek@rivm.nl

### Abstract

Ruminants spend a part of the year in the meadow and the length of the grazing period for ruminants has multiple effects on the environment. In general, increasing the grazing period leads to lower emissions of ammonia and methane and to higher leaching of nitrate and higher consumption of synthetic fertilizer. The effect on nitrous oxide emissions depends on the application method of the animal manure, whether surface spread or incorporated.

Key words: grazing period, housing period, ammonia, methane, nitrous oxide

### Introduction

The total agricultural area in the EU-27 member states is 190 million ha, divided in 121 million ha arable land and 69 million ha of permanent meadows and pasture.

Ruminants, like cattle and sheep, are able to utilize grass and grassland products and convert these products into meat, milk, and wool. Ruminants spent a part of the year in the meadow and changing the actual length of the grazing period for ruminants has multiple effects on the environment (Table 1).

Table 1 Overview of the environmental effects of increasing the duration of the grazing period in relation to the actual situation.

	Effect of increasing grazing period
Emission of ammonia	Lower
Emission of nitrous oxide	
surface spreading of animal manure	Higher
incorporation of animal manure	No much effect
Emission of methane	Lower
Leaching of nitrate	Higher
Consumption of synthetic fertilizer	Higher

### Impact of the length of the grazing period on the emission sources

Ammonia emission from animal manure deposited during grazing is lower than the emission from the same amount of animal manure excreted during housing and subsequent land spreading (Table 2). Calculations have been made for six scenarios, which differ in duration of the grazing period. These calculations are based on a dairy cow with an annual excretion of 100 kg of nitrogen. This excretion rate is about the European average. During winter time all animals are housed and the excretion is 50 kg of nitrogen for all six scenarios. In the summer time the scenarios range from A (100% of the excretion is deposited in the meadow) to F (zero nitrogen deposition in the meadow). Scenario C is nowadays the common situation in the Netherlands. Using the Dutch emission factors for animal housing, manure application and grazing the total ammonia emissions are decreasing with increasing time spent by cattle in the meadow.

For the emission of nitrous oxide the IPCC default emission factor for cattle grazing is 2% and for surface application of animal manure on mineral soils 1% (Chapter 11 in IPCC, 2006). This implies that nitrous oxide emissions are increasing with increasing grazing time.

The IPCC does not provide an emission factor for incorporation of animal manure, but this factor will be higher than for surface application (Van der Hoek *et al.*, 2007). In this situation there will be not much difference in nitrous oxide emissions with changes in grazing time.

For the emission of methane the IPCC default methane conversion factor for cattle grazing is 1%, and for stored animal manure 10-30% depending on the temperature and duration of storage (Chapter 10 in IPCC, 2006). Methane emissions are therefore decreasing significantly when cattle spend more time in the meadow.

Nitrogen in animal manure deposited in the meadow has a much lower efficiency for crop uptake than nitrogen that is spread in animal manure (Schröder *et al.*, 2007). Increasing the time cattle spend in the meadow will decrease the amount of collected manure to be spread. To maintain an equal grassland production this implies a higher consumption of synthetic fertilizer and a subsequent higher nitrogen surplus in the soil balance, leading to more nitrate leaching (see also Verloop *et al.*, 2006).

Table 2 Effect of the duration of the grazing period of dairy cattle on ammonia emissions for six scenarios ranging from 100% grazing in summer (scenario A) to zero grazing (scenario F). Data are given per dairy cow.

	A	B	C	D	E	F
N excretion in kg						
Winter stable	50	50	50	50	50	50
Summer stable	0	10	20	30	40	50
Summer pasture	50	40	30	20	10	0
Total excretion	100	100	100	100	100	100
NH <sub>3</sub> -N emission in kg						
Housing EF = 10%	5.0	6.0	7.0	8.0	9.0	10.0
Application EF = 15%	6.8	8.1	9.5	10.8	12.2	13.5
Meadow EF = 8%	4.0	3.2	2.4	1.6	0.8	0.0
Total NH <sub>3</sub> -N emission in kg	15.8	17.3	18.9	20.4	22.0	23.5
Total NH <sub>3</sub> -N emission in %	84%	92%	100%	108%	116%	125%

## Discussion

Grazing management is one of the key factors for improving nutrient-use efficiency on dairy farms. Restricted grazing contributes to increasing nutrient-use efficiency at farm level through better utilization of animal excretions, because these are collected in the manure storage instead of deposited in the meadow; and more balanced animal feeding, because cattle are fed in the animal house with the possibility of supplementing the grassland products with fodder maize and concentrates (Oenema *et al.*, 2006; Van Vuuren and Van den Pol-Van Dasselaar, 2006). On the other hand, economic aspects and animal welfare are arguments leading to more grazing.

From the foregoing it becomes clear that the precise effects of grazing management on the different types of emission are dependent on the specific farm conditions and therefore it is difficult to generalize the overall effect of changes in grazing period on the environment. Furthermore, the emission factors used are often site specific (Schils *et al.*, 2005; Webb *et al.*, 2005; Arsenaault *et al.*, 2009).

## Conclusion

In general, increasing the grazing period leads to lower emissions of ammonia and methane and to higher leaching of nitrate and higher consumption of synthetic fertilizer. The effect on nitrous oxide emissions depends on the application method of the animal manure, whether surface spread or incorporated. Extending the grazing period also means fewer possibilities



for adjusting the protein content of the animal feed. Finally, grazing is cheaper than housing and grazing benefits the animal welfare.

## References

- Arsenault N., Tyedmers P. and Fredeen A. (2009) Comparing the environmental impacts of pasture-based and confinement-based dairy systems in Nova Scotia (Canada) using life cycle assessment. *International Journal of Agricultural Sustainability* 7, 19–41.
- Eggleston H.S., Buendia L., Miwa K., Ngara T. and Tanabe K. (eds.) (2006) *2006 IPCC Guidelines for National Greenhouse Gas Inventories*. Prepared by the National Greenhouse Gas Inventories Programme. Published by IGES, Japan.
- Oenema O., Vellinga Th.V. and Van Keulen H. (2006) Nutrient management under grazing. In: Elgersma A., Dijkstra J. and Tamminga S. (eds.) *Fresh herbage for dairy cattle*, Springer, pp. 63-83.
- Schils R.L.M., Verhagen A., Aarts H.F.M. and Sebek L.B.J. (2005) A farm level approach to define successful mitigation strategies for GHG emissions from ruminant livestock systems. *Nutrient Cycling in Agroecosystems* 71, 163–175.
- Schröder J.J., Aarts H.F.M., Van Middelkoop J.C., Schils R.L.M., Velthof G.L., Fraters B. and Willems W.J. (2007) Permissible manure and fertilizer use in dairy farming systems on sandy soils in The Netherlands to comply with the Nitrates Directive target. *European Journal of Agronomy* 27, 102–114.
- Van der Hoek K.W., Van Schijndel M.W. and Kuikman P.J. (2007) *Direct and indirect nitrous oxide emissions from agricultural soils, 1990 – 2003*. Background document on the calculation method for the Dutch National Inventory Report. RIVM report 680125003, MNP report 500080003.
- Van Vuuren A.M. and Van den Pol-Van Dasselaar A. (2006) Grazing systems and feed supplementation. In: Elgersma A., Dijkstra J. and Tamminga S. (eds.) *Fresh herbage for dairy cattle*, Springer, pp. 85-101.
- Verloop J., Schils R.L.M., Aarts H.F.M. and Oenema J. (2006) Effects of the grazing period on nitrate leaching. *Grassland Science in Europe* 11, 77-79.
- Webb J., Anthony S.G., Brown L., Lyons-Visser H., Ross C., Cottrill B., Johnson P. and Scholefield D. (2005) The impact of increasing the length of the cattle grazing season on emissions of ammonia and nitrous oxide and on nitrate leaching in England and Wales. *Agriculture, Ecosystems and Environment* 105, 307–321.

## Abandonment of farming practices: impact on vegetation

Zarzycki J. and Misztal A.

University of Agriculture in Kraków, Kraków, Poland

Corresponding author: rmzarzyc@cyf-kr.edu.pl

### Abstract

Socio-economic changes reduce the profitability of agriculture and cause many people to migrate from mountain areas and abandon grassland farming in the mountains. The aim of the study was to distinguish plant communities which are at most endangered by abandonment of mowing and to assess habitat conditions in uncultivated areas as compared to areas that are still under cultivation. Based on phytosociological relevés of different types of meadow plant communities in the Beskid Sądecki Mountains (Western Carpathians) and analysis of some habitat-related factors, it was determined that uncultivated areas were characterized by a smaller number of species, lower Shannon-Wiener diversity indices, and a higher proportion of grasses in relation to the other species. The abandonment of farming practices was especially widespread at higher altitudes and where soils had low pH. Analysis of Ellenberg indicator values showed that the species found on unmowed areas were characterized by lower indices of light (L), soil acidity (R) and soil fertility (N). Ryegrass meadows were least affected by the abandonment of farming. Only 16% of phytosociological relevés of this community were recorded in uncultivated areas. Mat-grass meadows were abandoned to the largest extent. As many as 48% of the relevés of *Nardetum* were recorded in uncultivated areas. The most frequent was the abandonment of mowing plant communities typical of less fertile habitats. This is undesirable from a nature conservation perspective because species associated with these types of habitat are of great natural value.

Key words: mountain grasslands, species diversity, abandonment of farming

### Introduction

Mountain areas do not create optimum conditions for profitable farming. In addition to unfavourable climate, soil and altitude conditions, farming in the Polish Carpathians is hindered by fragmented agricultural landscape. Low prices for animal products and the impossibility of increasing scale of production have led to a sharp decrease in livestock population in recent years (Stypiński *et al.*, 2009). Only some of the farmers still raise animals to feed their own families. Very low demand for feed has caused farmers to abandon farming many meadow areas. These areas undergo secondary succession, which in the first phase is manifested by changes in species composition of the meadow sward. Being one of the most diverse plant communities, mountain meadows are the habitat of many rare species. The aim of the study was to distinguish plant communities which are at most endangered by abandonment of mowing and to assess habitat conditions in uncultivated areas as compared to areas that are still under cultivation.

### Materials and methods

The study was carried out in the Beskid Sądecki Mountains situated in the Western Carpathians (southern Poland). Traditional, extensive farming continues to be used in this area. Grasslands, which form a significant part of agricultural land, are at 400-1000 m above sea level. The soils are mainly leached and gleyed brown soils, and occasionally acid brown soils (mainly podzolized and typical podzols). In 2002-2005, 312 sociological relevés were made by the Braun-Blanquet method on selected 100 m<sup>2</sup> plots. We accounted for unmowed-

only areas (76) characterized by initial secondary succession and absence of lignified plants. The proportion of different species in the sward was determined by transforming the Braun-Blanquet scale into percent cover. Species diversity was presented using Shannon-Wiener diversity index and Simpson's dominance index (Magurran, 1988). We also used an index illustrating the proportion of grasses in relation to other species and calculated Ellenberg indicator values.

## Results and discussion

In the mountain range studied, meadow vegetation varies according to location and farming method used today and in the past. It was classified into three principal phytosociological units (Zarzycki 2008): ryegrass meadows (*Arrhenatheretum elatioris*), extensively used bent-grass meadows (*Gladiolo-Agrostietum*) and poor mat-grass meadows (*Hieracio-Nardetum*). The abandonment of farming largely depends on the type of plant community (Table 1) and the associated suitability for feeding. Farming was mostly abandoned on mat-grass meadows characterized by low productivity and poor nutritive value. As many as 48% of relevés made in this community were left unmowed. Meanwhile, the abandonment of mowing was found least frequently for ryegrass meadows (only 16% of relevés were made in uncultivated areas). Usually, these meadows were formed on old arable land and show good productivity with domination of cultivated grasses.

Table 1. Proportion of phytosociological relevés [%] made in mown and unmown meadows as a share of all relevés made in each type of plant communities

	Plant community		
	Mat-grass meadow <i>Nardetum</i> n=48	Bent-grass meadow <i>Agrostietum</i> n=118	Tall oat-grass meadow <i>Arrhenatheretum</i> n=140
Cultivated	52	76	84
Uncultivated	48	24	16
Total	100	100	100

Vegetation in unmowed areas was characterized by significantly lower species diversity, as evidenced by a smaller number of species on individual relevés (Table 2) and domination of one or several species, which was reflected in the lower Shannon-Wiener diversity and Simpson's dominance indices. Different species dominated unmowed sward according to the type of community. In poor habitats, these were mainly mat-grass (*Nardus stricta*), white woodrush (*Luzula luzuloides*) and red fescue (*Festuca rubra*). Fertile habitats were dominated by cocksfoot (*Dactylis glomerata*), tall oat-grass (*Arrhenatherum elatius*) and rough hawk's-beard (*Crepis biennis*). Grasses are usually the dominant species, as reflected in the higher proportion of grasses in relation to other species in unmowed areas. Analysis of habitat properties based on Ellenberg indicator values showed that unmowed areas were characterized by lower fertility (N), lower soil acidity (R) and poorer light conditions (L). However, there was no difference in moisture (F) indicator value. Uncultivated areas were found at higher altitudes and where soils had low pH (Table 2).

The current diversity of plants in cultivated and uncultivated areas results from two factors. The abandonment of mowing gives rise to secondary succession, which is mainly reflected in the accumulation of biomass that is not degraded. This results in accumulation of nutrients and increases habitat fertility, often leading to domination of nitrophilous species (Marrs, 1993). The accumulated mass of senesced plant parts also inhibits sprouting and growth of small plants while promoting growth of tall species that reproduce vegetatively. The results obtained do not completely confirm these patterns, because the differences in plants between

mowed and unmowed plots in the area studied result mainly from selective abandonment of farming some plant communities.

Table 2. Species diversity and habitat properties in cultivated and uncultivated areas

	Cultivated	Uncultivated
Number of species **	37	33
Shannon-Wiener index **	2.6	2.4
Simpson index **	9.8	8.3
Grass index **	1.1	1.4
Ellenberg indicator value		
F	5.2	5.2
R **	5.4	4.9
L **	7.1	6.9
N **	4.7	4.1
Altitude [m a.s.l.]*	640	677
pH *	4.3	4.1

\*  $P > 0.05$ ; \*\*  $P > 0.01$

This primarily concerns meadows lying at higher altitudes and on infertile and acidic soils. The cultivation of lowest-yielding and poor quality areas (mainly bent-grass and mat-grass meadow communities) is limited, while fodder production has moved to former arable land characterized by greater fertility and giving better quality feed (ryegrass communities). This process is observed in many parts of Eastern Europe (Roeder *et al.*, 2007). It is beneficial from an economic perspective, but limiting the use of poorest habitats results in the disappearance of many rare species associated mainly with low fertility habitats (Ellenberg, 1985).

## Conclusions

The abandonment of farming practices is especially widespread in meadow communities found in less fertile habitats and at higher altitudes. This particularly concerns mat-grass meadows (*Nardetum*). The abandonment of farming decreases the biological diversity of grasslands.

## References

- Ellenberg H. jun. (1985) Veränderungen der Gefäßpflanzenflora Mitteleuropas unter dem Einfluß von Düngung und Immissionen. *Schweizerische Zeitschrift für Forstwesen* 136 (1), 19–39.
- Magurran A.E. (1988) *Ecological diversity and its measurements*. Croom Helm Ltd., London, UK, 192 pp.
- Marrs R.H., (1993) Soil fertility and nature conservation in Europe: theoretical considerations and practical management solutions. *Advanced Ecological Research* 24, 241-300.
- Roeder N., Hennessy T. and Stilmant D. (2007) Impact of the CAP-reform of 2003 on the use of pastoral land in Europe. *Grassland Science in Europe* 12, 445-462.
- Stypiński P., Hejduk S., Svobodova M., Haki J. and Rataj D. (2009) Development, current state and changes in grassland in the past year. *Grassland Science in Europe* 14, 1-10.
- Zarzycki J. (2008) Roślinność łąkowa pasma Radziejowej (Beskid Sądecki) i czynniki wpływające na jej zróżnicowanie. *Zesz. Nauk. UR w Krakowie* 352, 113 pp.



## **Session 2**

### **The future of grassland productions systems**





# Grass biomethane: A sustainable alternative industry for grassland

Singh A.<sup>1,2</sup>, Korres N.E.<sup>1,2</sup> and Murphy J.D.<sup>1,2</sup>

<sup>1</sup>Department of Civil and Environmental Engineering, University College Cork, Cork, Ireland

<sup>2</sup>Biofuels Research Group, Environmental Research Institute, University College Cork, Cork, Ireland

Corresponding author: jerry.murphy@ucc.ie

## Abstract

The food fuel debate has led to a negative perception of biofuels. This influenced EU policy in that targets for biofuels have been replaced with targets for renewable energy in transport. Furthermore, the Renewable Energy Directive states that a biofuel must reduce the greenhouse gas (GHG) emissions of the fossil fuel replaced by 60% (post 2017) if the fuel is to be classed as a biofuel for the purposes of the 2020 target of 10% renewable energy in transport. Grass is a low energy-input crop which does not require annual ploughing; because of this biomethane (renewable natural gas) produced from grass has a superior energy balance to indigenous liquid biofuel systems and comparable to tropical biofuel systems. The use of grasslands for biofuel is encouraged by Cross Compliance Regulations requiring the ratio of permanent pasture to arable land to remain constant. Grasslands are also known to act as significant carbon sinks and, as such, ploughing grassland to produce biofuel crops does not lead to a sustainable biofuel. Proposed reductions in the cattle herd will free grass for biomethane production. Grass biomethane may readily effect a 67% reduction in GHG emissions leading to a sustainable biofuel.

Key words: Grassland, biomethane, anaerobic digestion, GHG

## Introduction

*Renewable energy, 'green tech' and sustainability*

Increasing competition for fossil fuels and the need to mitigate environmental pollution associated with their combustion has increased the search for alternative approaches to energy production (Prasad *et al.*, 2007a; Cheng *et al.*, 2009). Renewable energy sources occupy an increasingly important role in European and global energy markets due to associated benefits including reduced import dependency, potential for a new 'green-tech' industry with associated indigenous employment and potential to contribute to sustainability (Resch *et al.*, 2008). Sustainable development focused on eco-friendly biomass production and conversion technologies contributing economic and social benefits must be an ambition for bioenergy strategies and rural development. A considerable reduction in energy dependency and carbon emissions can be achieved by using liquid or gaseous biofuels from organic wastes (including tallow, slurries and municipal solid waste) and energy crops (such as maize, sugar beet and oil seed rape). Of late the potential for biogas from grass has shown to be very promising (Singh *et al.*, 2010a).

*Coupling of agricultural and energy production*

The productivism era in agriculture focused on production of food and fibre (Wilson, 2007). The post-productivism era emphasises environmental management and 'production of nature' (Marsden, 1999). This will lead to opportunities for non-traditional farm income such as production of renewable energy from energy crops (Marsden and Sonnino, 2008). The multifunctional role of agriculture is crucial for the success of the industry in the future (Holmes, 2006). Due to concerns regarding climate change and oil dependence (Prasad *et al.*,

2007a,b), substantial support programmes for biofuel production began in the EU states which lead to significant growth in biofuel capacity (IEA, 2003). The promotion of biofuels, through the specific targets for renewable energy in transport, is supported by energy policy in the EU (EC, 2003a). However, the introduction of sustainability criteria and minimum targets for reduction of greenhouse gas (GHG) emissions has heralded a rethink on the particular biofuel system (EC, 2009). As a result of the foregoing there is phenomenal potential for agriculture to be an integral part of an innovation technology in the green-tech sector, allowing for sustainable communities and rural employment (EC, 2005).

#### *Grasslands and grass biomethane*

There is a need to reassess utilization of grassland for a number of reasons, including: environmental legislation promoting sustainable biofuel production; changes in market dynamics due to the new single farm payment scheme (EC, 2003b); trade liberalization which will most probably influence the dynamics of agri-food supply chains (McCorriston and Sheldon, 2007); and the low family-farm income associated with beef farming (Smyth *et al.*, 2009). Ubiquitous grasslands may now be the source of clean indigenous biofuel that may be said to be free from the food fuel food debate and from land-use change issues (Murphy and Power, 2009).

Grassland has many benefits such as: long persistency of high dry matter yield; intercropping potential with legumes and subsequent reduction in fertilizer application rates; lower required rates of pesticide application (Peeters, 2009); a significant carbon sink (Tilman *et al.*, 2006) and now a source of energy production (Smyth *et al.*, 2009; Korres *et al.*, 2010).

The use of grass silage as a source of grass biomethane through anaerobic digestion is receiving increased attention in the scientific press (Prochnow *et al.*, 2005; Paavola *et al.*, 2007; Nizami *et al.*, 2009; Singh *et al.*, 2010a) particularly within the EU. The optimization and sustainability of anaerobic digestion of grass silage depends on the net production of renewable energy and the net GHG emission reduction (Gerin *et al.*, 2008). The integrated process of grass production for biomethane (Nizami *et al.*, 2009) lends itself to a sustainable biofuel with significant reduction in GHG emissions as opposed to the displaced fossil fuel (Korres *et al.*, 2010).

#### *The effect of energy and agricultural policy on grass biomethane*

The deployment of biofuels and the particular biofuel system is dependent on energy and agricultural policy (Zah and Ruddy, 2009; Smyth *et al.*, 2010). Sustainability of biofuel systems, the impact of biofuels on food prices, and indirect land use change have led to the establishment of certain, although in some cases not clearly defined, criteria in the EU Directive for Renewable Energy (EC, 2009). The Directive influences the biofuel feedstock as, for example, the double credit/counting of biofuels produced from wastes, residues and lignocellulosic materials. There is some lack of clarity in the Directive, in particular in the methodology for assessing the potential effects of indirect land use change and in the definition of lignocellulosic materials. Lignocellulosic material would, for example, include wood which is high in lignin, but does it include grass which has a significantly lower lignin content? Singh *et al.* (2010b) considers grass as a lignocellulosic source and, as such, is liable for a double count.

Irish agriculture, influenced by its mild temperate climate, has been characterized by extensive, grass-based livestock farming (Jensen *et al.*, 2003). Grass covers around 91% of all Irish agricultural land (CSO, 2009); the ratio of the cattle to human population in Ireland is the highest in the EU (8% of the cattle population with less than 1% of the human population) (Smyth *et al.*, 2010). Under the Common Agricultural Policy (CAP), EU farmers were required to set aside 10% of their land to qualify for CAP benefits (EC, 1999). Farmers were

allowed to plant oilseeds on the set-aside land as long as it was contracted solely for the production of biodiesel or other industrial products (Schnepf, 2006). On the other hand, Cross Compliance Regulations (EC, 2003b) require that land declared as permanent pasture in 2003 should be maintained under permanent pasture and the ratio of land under permanent pasture to total agricultural area of Member States must not decrease by 10% or more compared to the 2003 reference ratio. Ireland is therefore under obligation not to allow any significant reduction in the total area of permanent pasture, which restricts the type of energy crops for cultivation. Cattle livestock numbers in Ireland (Binfield *et al.*, 2008) and the EU (Flach, 2009) are predicted to decrease due to a number of policy and trade constraints. The Rural Environment Protection Scheme (REPS) aims to encourage farmers to carry out their activities in a more environmentally friendly manner. One of the targets of these schemes is reductions of farm GHG emissions through various mitigation strategies such as, for example, lower stocking rates (Hynes *et al.*, 2008; Lanigan *et al.*, 2008). Biofuels are also influenced by the Biodiversity Action Plan and EU Water Framework Directive. It is probable, considering the above mentioned issues, that a large proportion of grassland will be available for utilization in biomethane production.

### **Technology for biomethane production from grass**

#### *Anaerobic digestion*

Anaerobic digestion is a ubiquitous technique for converting organic, wet biomass into renewable energy in the form of biogas by bacteria in an oxygen-free environment. This biogas may be further upgraded to biomethane through the removal of CO<sub>2</sub>, H<sub>2</sub>S, H<sub>2</sub>O and other minor constituents (Singh *et al.*, 2010a). The process of anaerobic digestion has now become a more attractive source of renewable energy due to reduced technological cost and increased process efficiency (EEA, 2005). A plethora of substrates such as wastewaters, animal wastes and sewage sludge are extensively used for anaerobic digestion (Singh *et al.*, 2010a). Additionally, during the last few years, the use of lignocellulosic substrates and feedstock with a high solid content, such as the organic fraction of municipal solid waste (OFMSW), crops, crop residues and grass silage has received considerable attention particularly in Europe (Braun and Steffen, 1997; Mähnert *et al.*, 2005). Various researchers have reviewed and compared different digesters that are suitable for anaerobic digestion of solid wastes (Vandevivere *et al.*, 2003; De Baere and Mattheeuws, 2008). Digesters which are optimized for OFMSW may not be ideal for grass silage because the volatile solid content of grass silage is of the order of 92% whereas the volatile solid content of OFMSW may be as low as 60% (Murphy and Power, 2009). Thus the digestate from grass may be quite liquid in nature (solids content of less than 5%) as opposed to digestate from OFMSW which may have solids content of above 20%. This will lead to significant effects on materials handling. For example, vertical garage door batch digesters may be suitable for OFMSW but not for grass.

#### *Grass digesters*

Anaerobic digesters are available in a number of designs/configurations (Fig. 1) which are distinguished and characterized based on the following process parameters (Karagiannidis and Perkoulidis, 2009; Nizami and Murphy, 2010):

- Moisture content of the feedstock, and consequently within the digester (wet digestion versus dry digestion);
- Number of phases or number of stages of digestion activity (single or two/multi-stage/phase designs);
- Operating temperature (thermophilic or mesophilic);
- Method of feeding substrate (batch or continuous systems);

- Retention time in the digester.

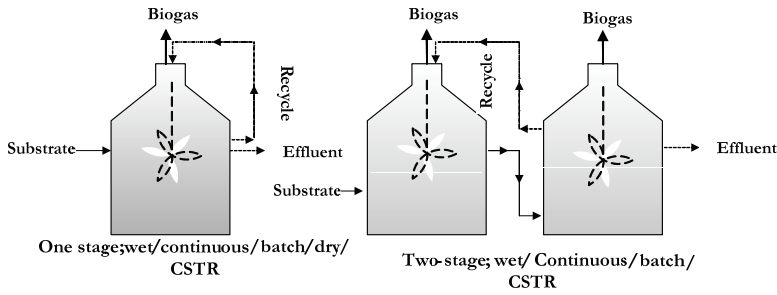

(i) One-stage and two-stage digesters

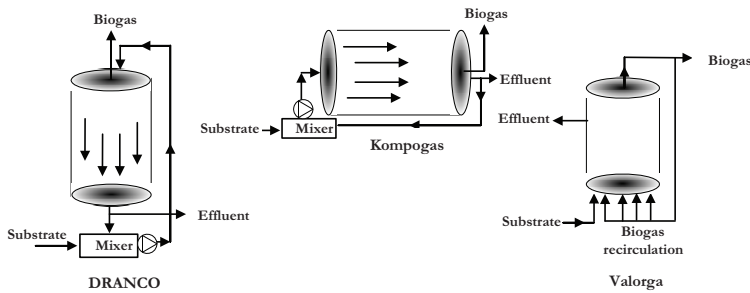

(ii) One-stage dry continuous digesters

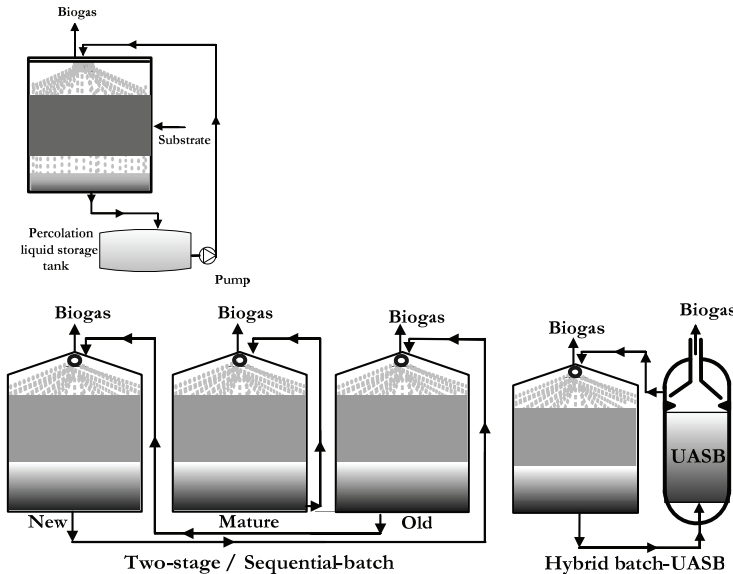

(iii) One-stage dry batch digester (iv) Two-stage dry batch digesters (v) Batch with UASB

Figure 1. Potential digester configurations (Nizami and Murphy, 2010)

The design of the digester for high organic loading rates should lead to increased methane yields at reduced hydraulic retention time. The loading rate and the response of the system to the loading rate dictate the efficiency of the anaerobic digestion process (Ward *et al.*, 2008) and the subsequent GHG emissions savings as compared to the replaced fossil fuel. The properties of the feedstock, and the operational parameters should indicate the preferred digester configuration (Nizami *et al.*, 2009). There are, however, discrepancies in the literature on optimal digester types using similar experimental set-ups (Vandevivere *et al.*, 2003), typically highlighting the importance of detailed engineering aspects and scaling-up problems (Durand, 2003). Research on mono-digestion of grass silage is limited to laboratory and pilot scale (Nizami *et al.*, 2009). In most full-scale commercial digester systems, the grass is used as co-substrate with manure and maize silage (Weiland, 2006). In the literature the configurations used for mono-digestion of grass are: wet continuous, dry batch, and dry continuous systems (Nizami *et al.*, 2009; Nizami and Murphy, 2010).

Table 1. Energy demand and GHG emissions for biomethane production from grass silage under base case scenario (Korres *et al.*, 2010).

Activity	Energy required (MJ ha <sup>-1</sup> a <sup>-1</sup> )	GHG CO <sub>2</sub> e emission (kg a <sup>-1</sup> )	GHG CO <sub>2</sub> e emission per energy replaced (g MJ <sup>-1</sup> )
Grass silage production			
Direct			
Agronomic operations	2975.3	264.5	2.67
Herbicide volatilization	-	5.44	0.054
Lime dissolution	-	550	5.55
Nitrous oxide emissions	-	514	5.18
Indirect			
Production of inputs	12630.2	628.5	6.34
Nitrous oxide emissions	-	10.9	0.11
Transportation			
Grass silage	381.82	33.92	0.34
Lime	625	55	0.55
Biomethane production			
Direct			
Heating of digesters	26930	1809.88	18.25
Biogas loss	-	1072.73	10.82
Indirect			
Maceration, mixing and pumping	4759.86	717.68	7.24
Upgrading and compression	8318	1253.82	12.6
Total	56620.18	6916.37	69.70

### Co-digestion

Co-digestion of solid wastes often results in a higher methane yield (measured in cubic metres of methane per kilogram of volatile solids (VS)) than mono-digestion (Jagadabhi *et al.*, 2008). This is apparently due to the synergistic effects of the co-substrates providing the missing nutrients and balancing the substrate composition (Mata-Alvarez *et al.*, 2000; Umetsu *et al.*, 2006). Co-digestion of 40% of sugar beet tops with dairy manure in batch and continuously fed laboratory reactors yielded about 1.5 times higher methane yield than from dairy manure alone (Umetsu *et al.*, 2006). Lehtomäki *et al.*, (2007) conducted a laboratory experiment using continuously stirred tank reactors (CSTRs) to digest crops (grass, sugar beet tops, straw) and dairy manure. When crops formed 30% of feedstock (measured by volatile solids) the methane yield was 16–65% higher than from dairy manure alone. The methane yield decreased when the crop component of feedstock was raised to 40% (Lehtomäki *et al.*, 2007). It is suggested that there is significant potential (and practical application) to co-digest grass

silage with agricultural slurry. The slurry may be beneficial in providing nutrients and on-going supplementation of microbial activity.

**Energy balance and greenhouse gas analysis of grass biomethane**

*Energy from grass*

Smyth *et al.* (2009) modelled a continuously stirred tank reactor (CSTR) digesting grass silage at 10% dry solids (DS) content and mesophilic temperature (38 °C). The daily mass balance for the digester is presented in Fig. 2. An assumption is 55% destruction of VS. In considering a grass biomethane farm of 137.5 ha, the total biogas production was assessed as 816750 m<sub>n</sub><sup>3</sup> a<sup>-1</sup>. This is equivalent to 121 GJ ha<sup>-1</sup> a<sup>-1</sup>. The analysis generated a parasitic demand of 47% allowing for the various agricultural operations, chemical inputs, transportation, biogas production process and upgrading and compression of biomethane (Table 1). The resultant net energy production is 64.4 GJ ha<sup>-1</sup> a<sup>-1</sup> (Fig. 3). The net energy production from one ha can be increased to 66.75 GJ ha<sup>-1</sup> a<sup>-1</sup> by modifying the digester configuration.

The energy balance can be significantly improved when mixed pastures (e.g. clover and ryegrass) are considered because of the potential biological nitrogen fixation which, depending on the proportion of clover in the pasture, varies between 3-150 kg ha<sup>-1</sup> a<sup>-1</sup> (Woodmansee, 1978; Moller-Hansen *et al.*, 2002; Brockman and Wilkins, 2003). This will substitute energy savings that would otherwise have been consumed in the production of nitrogen chemical fertilizer

Table 2. Typical values for greenhouse gas savings for biofuel systems from the Renewable Energy Directive

Biofuel System	Savings in greenhouse gas compared to fuel replaced
Wheat ethanol	32%
Rape seed biodiesel	45%
Sun flower biodiesel	58%
Sugar beet ethanol	61%
Palm oil biodiesel	62%
Biogas from Municipal Solid Waste	80%

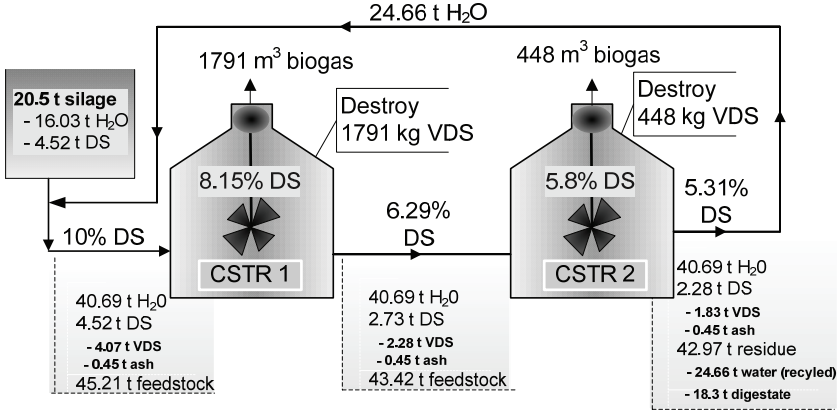

Figure 2. Daily mass balance of anaerobic digester (Smyth *et al.*, 2009)

### GHG emission savings

Korres *et al.* (2010) conducted a greenhouse gas analysis of grass biomethane as a transport fuel. It was based on a field to wheel analysis, with an 18% underperformance of the biomethane powered car on a km/MJ basis as compared to the replaced diesel. The base case resulted in an emission savings of 21.5% in comparison to diesel (Fig. 3). This does not allow for sustainability as defined by the EU Renewable Directive (60% reduction in GHG emissions for facilities after 2017). The main contributors to GHG emissions were (Table 1):

- Upgrading and compression of biomethane;
- Parasitic energy demand of biogas production process.

The situation may be improved by modifying the system. For example replacing of the source of electricity from the Irish grid (average kg CO<sub>2</sub>/MW<sub>e</sub>h) to wind energy resulted in 42% emission savings. Sustainability as defined by GHG emission savings in excess of 60% may be effected as follows:

- Use of woodchips to heat the digesters (62% emission saving).
- Improving the digester configuration (storage of digestate in an unheated vessel) and allowing a vehicle efficiency equal to that of diesel (68.9 %).

Grassland is a carbon sink. Values in the literature vary greatly. The most relevant data for Ireland (Byrne *et al.*, 2007) suggested a net sequestration of 0.6 t C /ha. This results in an 89 % emission savings.

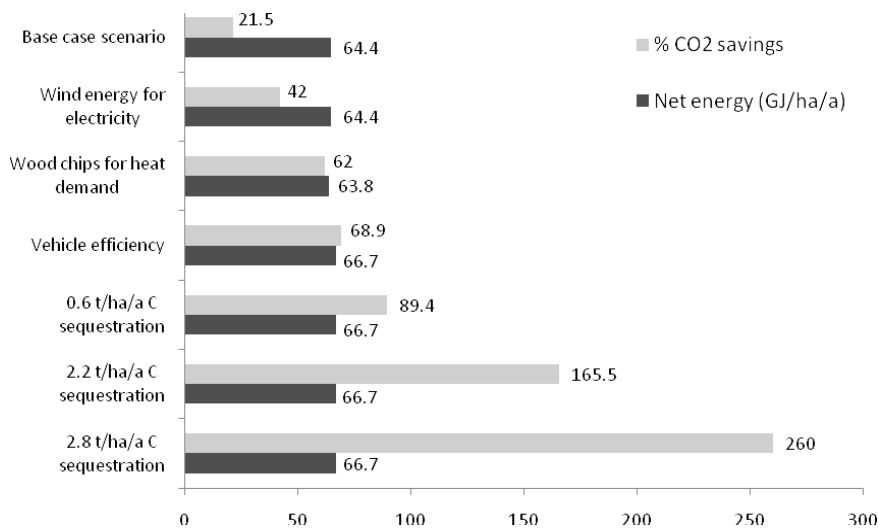

Figure 3. Percent CO<sub>2</sub> savings over fossil diesel and net energy production under various scenarios in biomethane production (the scenarios are cumulative from top downwards); (Korres *et al.*, 2010)

### Results

With reference to Table 2 it may be noted that grass biomethane is one of the most sustainable European indigenous biofuels. With reference to Fig. 4 it may be noted that grass biomethane has a similar energy balance to tropical biofuel systems and a superior energy balance to indigenous European Biofuel systems.



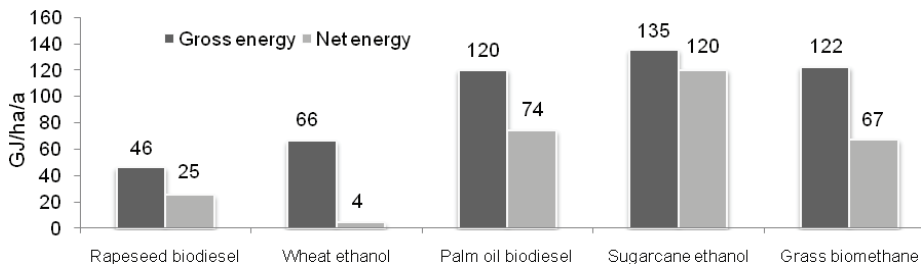

Figure 4. Comparative analysis of gross and net energy production per hectare for various biofuel systems (Smyth *et al.*, 2009)

## Conclusions

Grass biogas/biomethane allows for sustainable bioenergy production in combination with rural employment. It does not lead to a changed landscape and allows compliance with policy in energy and agriculture. The fuel produced is potentially the most sustainable indigenous transport biofuel with an energy balance similar to tropical biofuel systems.

## References

- Binfield J., Donnellan T., Hanrahan K. and Westhoff P. (2008) *FAPRI-Ireland 2008 WTO reform analysis: Potential impact on EU and Irish agriculture*. Teagasc Rural Economy Research Centre, Ireland.
- Braun R. and Steffen R. (1997) Anaerobic digestion of agro-industrial by-products and wastes. In: Verstraete W. (ed.) *Workshop on Anaerobic Conversions for Environmental Protection, Sanitation and Re-Use of Residue*, Sustainable Rural Environment and Energy Network, REUR Technical Series (FAO) , no. 52; FAO/SREN, FAO, Rome (Italy), pp. 27-41.
- Brockman J.S. and Wilkins R.J. (2003) Grassland. In: Soffe R. (ed.) *Primrose McConnell's the Agricultural Notebook*. Blackwell Science Ltd, pp. 131-176.
- Byrne K.A., Kiely G. and Leahy P. (2007) Carbon sequestration determined using farm scale carbon balance and eddy covariance. *Agriculture, Ecosystems and Environment* 121, 357-364.
- Cheng S., Xing D., Call D.F. and Logan B. E. (2009) Direct biological conversion of electrical current into methane by electromethanogenesis. *Environmental Science and Technology* 43 (10), 3953-3958.
- CSO (2009) *Area Farmed in June (000 Hectares) by type of Land Use, Region and Year*. Central Statistics Office, Ireland. <http://www.cso.ie>, accessed March 2010.
- De Baere L.D. and Mattheeuws B. (2008) State-of-the-art 2008—anaerobic digestion of solid waste. *Waste Management World* 9(4), <http://www.waste-management-world.com/index/display/article-display/339836/articles/waste-management-world/volume-9/issue-4/features/state-of-the-art-2008-anaerobic-digestion-of-solid-waste.html>
- EC (1999) Council Regulation (EC) No 1251/1999 of 17 May 1999 establishing a support system for producers of certain arable crops. *Official Journal of the European Union* L160, 113-118.
- EC (2003a) Directive 2003/30/EC of the European Parliament and of the Council of 8 May 2003 on the promotion of the use of biofuels or other renewable fuels for transport. *Official Journal of the European Union* L123, 42-46.
- EC (2003b) Council Regulation (EC) No 1782/2003 for establishing common rules for direct support schemes under the common agricultural policy and establishing certain support schemes for farmers. *Official Journal of the European Union* L270/1-L270/69.
- EC (2004) Commission Regulation 796/2004/EC of 21 April 2004 laying down detailed rules for the implementation of cross-compliance, modulation and the integrated administration and control system provided for in Council Regulation (EC) No 1782/2003 establishing common rules for direct support schemes under the common agricultural policy and establishing certain support schemes for farmers. *Official Journal of the European Union* L141, 18-58.
- EC (2005) Council Regulation EC/1698/2005 on support for rural development by the European Agricultural Fund for Rural Development. *Official Journal of the European Union* L 277, 1-40.
- EC (2009) Directive 2009/28/EC of The European Parliament and of The Council of 23 April 2009 on the promotion of the use of energy from renewable sources and amending and subsequently repealing Directives 2001/77/EC and 2003/30/EC. *Official Journal of the European Union 2009* L140, 16-62.

- EEA (European Environment Agency) (2005) How much biomass can Europe use without harming the environment? *EEA Briefing* 02, 1-5.
- Flach B. (2009) *EU-27 livestock and products annual*. GAIN report Number: NL9022. USDA Foreign Agricultural Service. Global Agricultural Information Network.
- Gerin P.A., Vliegen F. and Jossart J.M. (2008) Energy and CO<sub>2</sub> balance of maize and grass as energy crops for anaerobic digestion. *Bioresource Technology* 99, 2620-2627.
- Holmes J. (2006) Impulses towards a multifunctional transition in rural Australia: gaps in the research agenda. *Journal of Rural Studies* 22, 142-160.
- Hynes S., O'Donoghue C., Murphy E. and Kinsella A. (2008) *Are far off hills really greener? The Impact of REPS on Farmer Behaviour*. RERC Working Paper Series: RERC, Teagasc, Ireland.
- IEA (2003) Biofuels for Transport - an International Perspective. International Energy Agency.
- Jagadabhi P.S., Lehtomäki A. and Rintala J. (2008) Co-digestion of grass silage and cow manure in a CSTR by re-circulation of alkali treated solids of the digestate. *Environmental Technology* 29, 1085-1093.
- Jensen J., O'Toole R. and Matthews A. (2003) Controlling greenhouse gas emissions from the agricultural sector in Ireland: a CGE modeling approach. *6th Annual Conference on Global Economic Analysis*. The Hague, The Netherlands.
- Karagiannidis A. and Perkoulidis G. (2009). A multi-criteria ranking of different technologies for the anaerobic digestion for energy recovery of the organic fraction of municipal solid wastes. *Bioresource Technology* 100, 2355-2360.
- Korres N.E., Singh A., Nizami A.S. and Murphy J.D. (2010) Is grass biomethane a sustainable transport biofuel? *Biofuels, Bioproducts and Biorefining*. DOI: 10.1002/bbb.228.
- Lanigan G., O'Mara F., Murphy J., Finnan J., O'Kiely P. and Richards K. (2008) Gaseous Emissions in Agriculture: Challenges & Opportunities. *National REPS Conference 2008 Farming for a Better Environment*. Tullamore, Co. Offaly: Teagasc.
- Lehtomäki A., Huttunen S. and Rintala J.A. (2007) Laboratory investigations on co-digestion of energy crops and crop residues with cow manure for methane production; Effect of crop to manure ratio. *Resources Conservation and Recycling* 51, 591-609.
- Mähner P., Heiermann M. and Linke B. (2005) Batch- and semi-continuous production from different grass species. *Agricultural Engineering International: The CIGRE E Journal* vol. V11 Manuscript EE 05 010.
- Marsden T. (1999) Rural futures: The consumption countryside and its regulation. *Sociologia Ruralis* 39, 501-520.
- Marsden T.K. and Sonnino R. (2008) Rural development and the regional state: denying multi-functional agriculture in the UK. *Journal of Rural Studies* 24, 422-443
- Mata-Alvarez J., Macé S. and Llabrés P. (2000) Anaerobic digestion of organic solid wastes. An overview of research achievements and perspectives. *Bioresource Technology* 74, 3-16.
- McCorrison S. and Sheldon I. M. (2007) Trade liberalization and net distribution in vertically related markets. In: Swinnels J.F.W. (ed.) *Global Supply Chains, Standards and The Poor*. CAB International, pp. 59-74.
- Moller-Hansen E., Høgh-Jensen H. and Djurhuus J. (2002) Biological nitrogen fixation in a grazed perennial grass/clover ley and correlation with herbage and soil variables. *European Journal of Agronomy* 16, 309-320.
- Murphy J.D. and Power N.M. (2009) An argument for using biomethane generated from grass as a biofuel in Ireland. *Biomass and Bioenergy* 33, 504-512.
- Nizami A.S., Korres, N.E., Murphy J.D. (2009) A review of the integrated process for the production of grass biomethane. *Environmental Science and Technology* 43 (22), 8496-8508.
- Nizami A.S. and Murphy J.D. (2010) What type of digester configurations should be employed to produce biomethane from grass silage? *Renewable and Sustainable Energy Reviews* 14, 1558-1568.
- Paavola T., Lehtomäki A., Seppälä M. and Rintala, J. (2007) *Methane production from reed canary grass*. CROPGEN Publication. Jyväskylä, Finland.
- Peeters A. (2009) Importance, evolution, environmental impact and future challenges of grasslands and grassland-based systems in Europe. *Grassland Science in Europe* 55, 113-125.
- Prasad S., Singh A. and Joshi H.C. (2007a) Ethanol as an alternative fuel from agricultural, industrial and urban residues. *Resources, Conservation and Recycling* 50, 1-39.
- Prasad S., Singh A., Jain N. and Joshi H.C. (2007b) Ethanol production from sweet sorghum syrup for utilization as automotive fuel in India. *Energy and Fuels* 21(4), 2415-2420.
- Prochnow A., Heiermann M., Drenckhan A. and Schelle H. (2005) Seasonal pattern of biomethanisation of grass from landscape management. *Agricultural Engineering International: the CIGRE E Journal* Vol. VII, Manuscript EE 05 011.
- Resch G., Held A., Faber T., Panzer C., Toro F. and Haas R. (2008) Potentials and prospects for renewable energies at global scale. *Energy Policy* 36(11), 4048-4056.
- Schnepf R. (2006) *European Union biofuels policy and agriculture: an overview*. CRS Report for Congress.

- Singh A., Smyth B.M. and Murphy J.D. (2010a) A biofuel strategy for Ireland with an emphasis on production of biomethane and minimization of land take. *Renewable and Sustainable Energy Reviews* 14(1), 277-288.
- Singh A., Pant D., Korres N.E., Nizami A.S., Prasad S. and Murphy J.D. (2010b) Key issues in life cycle assessment of ethanol production from lignocellulosic biomass: challenges and perspectives. *Bioresource Technology* 101, 5003-5013.
- Smyth B., Murphy J.D., O'Brien C. (2009) What is the energy balance of grass biomethane in Ireland and other temperate northern European climates? *Renewable and Sustainable Energy Reviews* 13(9), 2349-2360.
- Smyth B.M., O Gallachoir B.P., Korres N.E. and Murphy J.D. (2010). Can we meet targets for biofuels and renewable energy in transport given the constraints imposed by policy in agriculture and energy? *Journal of Cleaner Production* (Submitted for publication).
- Tilman D., Hill J., Lehman C. (2006) Carbon-negative biofuels from low-input high-diversity grassland biomass. *Science* 314, 1598-1600.
- Umetsu K., Yamazaki S., Kishimoto T., Takahashi J., Shibata Y., Zhang C., Misaki T., Hamamoto O., Ihara I. and Komiyama M. (2006) Anaerobic co-digestion of dairy manure and sugar beets. *International Congress Series* 1293, 307-310.
- Vandevivere P., De Baere L. and Verstraete W. (2003) Types of anaerobic digester for solid wastes. In: Mata-Alvarez J. (ed.) *Biomethanization of the organic fraction of municipal solid wastes*. IWA Press, London, pp. 112-140.
- Ward A.J., Hobbs P.J., Holliman P.J., and Jones D.L. (2008) Review. Optimisation of the anaerobic digestion of agricultural resources. *Bioresource Technology* 99, 7928-7940.
- Weiland P. (2006) Biomass design in agriculture: a successful pathway for the energy production and waste treatment in Germany. *Engineering in Life Sciences*, 6, 302-309.
- Wilson G.A. (2007) *Multifunctional agriculture: A transition theory perspective*. CAB International, Wallingford, Cambridge, 368 pp.
- Woodmansee R. G. (1978). Additions and losses of nitrogen in grassland ecosystems. *Bioscience* 28(7), 448-453.
- Zah R. and Ruddy T.F. (2009) International trade in biofuels: an introduction to the special issue. *Journal of Cleaner Production* 17, S1-S3.

# The role of genetic resources for sustainable and productive grassland agriculture

Kölliker R. and Boller B.

*Agroscope Reckenholz-Tänikon Research Station ART, 8046-Zurich, Switzerland*

Corresponding author: roland.koelliker@art.admin.ch

## Abstract

Plant genetic resources (PGR) are not only fundamental for any plant breeding effort, but targeted utilization of PGR may also contribute to sustainable grassland agriculture through enhanced resilience to environmental influences. For forage crop species such as ryegrasses, fescues or clovers, wild relatives and semi-natural ecotype populations often co-exist with cultivated species. These PGR are characteristic for forage crop species and present an invaluable resource of genetic diversity readily accessible to plant breeders. For targeted utilisation of PGR for the improvement of agronomically important traits and for conserving diversity in natural and semi-natural grasslands, a detailed characterisation is indispensable. Besides the phenotypic characterisation based on agronomically important traits such as flowering time, growth habit or disease resistance, molecular genetic tools offer additional means to efficiently characterise forage crop PGR. Such tools have been successfully used to demonstrate that wild red clover populations most likely were introduced into Europe independently of the introduction of cultivated forms. For species such as meadow fescue or Italian ryegrass, natural, semi-natural and cultivated forms appear to have co-evolved in their respective areas of cultivation. Permanent grasslands not only provide valuable habitats for *in situ* conservation of PGR, they may also harbour ecotype populations which outperform cultivars in terms of dry matter yield or disease resistance.

Keywords: *ex situ* conservation, genetic diversity, *in situ* conservation, plant genetic resources

## Introduction

Diversity at different levels of organization (i.e. landscape, habitats, species and populations) significantly influences stability and productivity of agricultural and natural ecosystems. While the importance and the benefit of diversity at the species level is generally recognized, the role of diversity at the lowest level of organization, i.e. genetic diversity within populations and individuals, may be less apparent. Genetic diversity is indispensable for the response of species and populations to selection, either natural through environmental changes or human mediated through processes such as plant breeding (Reed and Frankham, 2003). This has long been recognized by plant breeders who routinely screen large germplasm collections for variation in specific traits or use ecotype populations to broaden their breeding germplasm. With increasing awareness that the Earth's biodiversity is rapidly declining, the targeted conservation and sustainable use of plant genetic resources (PGR) has been identified as a key to improving agricultural productivity, food security and poverty alleviation (FAO, 1996). PGR are defined as the diversity of genetic material contained in traditional varieties and modern cultivars grown by farmers as well as crop wild relatives and other wild plant species that can be used for food, feed or other domestic and industrial purposes.

While for arable crop species such as maize, wheat or rice wild relatives do not exist in most areas of cultivation, forage crop species often co-exist with wild forms which co-evolved with cultivated forms, or with feral forms that originated from cultivated forms but escaped and persisted in the natural environment. Such wild or semi-natural populations would not fall into any of the strict categories of PGR cited above. However, they can be regarded as wild

crop relatives and their close relation with cultivated forms make them an invaluable resource of genetic diversity readily accessible for use in breeding programmes. Well characterized PGR are fundamental for any plant breeding effort. They may not only provide desirable traits but also play an important role by adding new variability to existing breeding germplasm and reducing inbreeding depression. In addition, targeted utilization of PGR may also contribute to sustainable grassland agriculture through enhanced resilience to biotic and abiotic stresses. Genetic diversity is essential for the adaptability of populations and may therefore contribute to ecosystem stability. Preservation of genes controlling specific traits such as disease resistance has been shown to be crucial for improvement of population survival (Foster Hünneke, 1991) and reduced genetic diversity can directly influence population fitness (Oostermeijer *et al.*, 1995). For targeted utilisation of PGR for the improvement of agronomically important traits and for conserving diversity in natural and seminatural grasslands, a detailed characterization of forage crop PGR is indispensable.

### **Characterization and evaluation of genetic resources**

Characterization and evaluation of forage crop PGR has largely relied on the phenotypic characterisation of traits of agronomic importance such as flowering time, growth characteristics, yield potential and disease resistance. In an attempt to standardise characterisation of PGR, international descriptor lists have been published which list traits and procedures to be used for the characterisation of forage grasses and legumes (IBPGR, 1985). In addition, the International Union for the Protection of New Varieties of Plants (UPOV) has established a set of characteristics to be used for the evaluation of distinctness, uniformity and stability (DUS) of new cultivars (UPOV, 2002). Many of these characteristics have been successfully used to describe forage crop genetic resources. For example, leaf characteristics or flowering time have been used to describe collections of meadow fescue (Fjellheim *et al.*, 2007) or Italian ryegrass (Peter-Schmid *et al.*, 2008a). A large amount of genetic diversity has also been detected among numerous red clover accessions based on agronomically relevant traits such as dry matter yield (Dias *et al.*, 2007) and resistance to diseases such as *Stemphylium* leaf spot or *Fusarium oxysporum* (Berg and Leath, 1996; Venuto *et al.*, 1995). Morphophysiological and agronomic characteristics may allow for characterisation of PGR directly based on target traits, but they are strongly influenced by the environment and especially agronomic traits tend to be of low heritability. Therefore, carefully designed, replicated field experiments in several environments are often needed for their reliable evaluation. In addition, estimates of morphophysiological diversity are based on a relatively small number of traits and detection is often too cumbersome to allow for large scale investigations.

Biochemical and molecular genetic markers on the other hand allow for detecting genetic diversity at a large number of loci, largely independent of the environment. Isozyme polymorphisms based on different molecular forms of enzymes with the same catalytic activity were the first marker system to be used for the characterisation of genetic resources in forage crop species. Their detection does not require sophisticated equipment and they have been extensively used to detect genetic variation and population structure in red clover (e.g., Mosjidis *et al.*, 2004) or to elucidate relationships among forage grasses (Charmet and Balfourier, 1994). Isozymes are also accepted as supplemental discriminating properties in DUS testing. Despite their advantages, isozyme polymorphisms are limited to a relatively small number of loci and the diversity detected may therefore not be representative for a large part of the genome.

With the development of novel molecular genetic markers, these tools have been continuously evaluated, adapted and applied by scientists working on the characterisation of genetic resources. Hybridisation based methods like restriction fragment polymorphism (RFLP)

analysis have never been widely employed to characterise genetic diversity of forage crops, probably due to the laborious method of detection associated with these methods. On the other hand, PCR-based randomly amplified polymorphic DNA (RAPD) analysis has been widely used to detect genetic diversity in various clover and grass germplasm collections (e.g., Ulloa *et al.*, 2003; Bolaric *et al.*, 2005). In contrast to RAPD, amplified fragment length polymorphism (AFLP) suffer less from reproducibility problems and may therefore allow results to be transferred from one laboratory to another (Powell *et al.*, 1996). Although technically more demanding, the technique is suitable to partial automation and is therefore highly suitable to analyse a large number of individuals from a large number of populations (Herrmann *et al.*, 2005). With the development of a large number of genomic and gene associated simple sequence repeat markers (Sato *et al.*, 2005; Studer *et al.*, 2008) a highly efficient and informative marker system has become available for the characterisation of forage crop PGR. Dias *et al.* (2007) demonstrated the usefulness of SSR markers to characterise red clover germplasm and to assign individuals to their respective populations. More recently, diversity array technology (DArT) markers have also become available for forage grasses (Kopecky *et al.*, 2009). For DArT analysis, DNA samples for analysis are fluorescently labelled and hybridised to the DArT array which contains thousands of cloned marker fragments. Successful hybridizations are dominantly scored for marker presence. Although DArT does not require *a priori* sequence information, interesting markers may be sequenced *a posteriori*, adding further value to the analysis. Multiplex marker systems such as AFLP or DArT are very cost effective and allow to significantly reduce the effort required for characterisation of large germplasm collections. However, the variability detected with the markers mentioned above is often poorly correlated with the variability of traits relevant for survival and performance. Functional markers directly linked to specific traits or functions would allow for a more targeted characterization of genetic resources, but so far, only a few gene associated markers have been reported for forage and turf species (e.g. Miura *et al.*, 2007).

In addition to the choice of phenotypic traits or molecular genetic methods used, the number of individuals analysed per cultivar, accession or population may also influence accuracy of characterisation of PGR. Most forage crops are outbreeding species which are characterised by large genetic diversity within populations. To account for genotypes or alleles which occur at a frequency of at least ten percent, 40 plants have to be sampled, while 100 plants are needed to detect alleles occurring at a frequency of at least five percent (Crossa, 1989). This is also reflected by the well established requirements of UPOV for DUS testing, defined long before molecular markers became available, where 60 plants per population have to be analysed.

### **Cultivars, ecotypes and wild relatives**

The origin of most forage crop species is likely to be found in the Fertile Crescent in the Eastern Mediterranean from where they were introduced into Europe and other parts of the world. Following the spreading of forage crop cultivation, different forms of genetic resources evolved. While for some species wild forms were introduced independently of the introduction of cultivated forms, for other species natural, semi-natural and cultivated forms appear to have co-evolved in their respective areas of cultivation. This will be illustrated in the following using two examples, red clover and Italian ryegrass.

Red clover (*Trifolium pratense* L.) was probably introduced to Spain by the Moorish and shipped to the Netherlands and Brabant from where it gradually spread across entire Europe (Zeven and de Wet, 1982). Locally adapted populations have historically developed in most regions of red clover cultivation and wild forms occur spontaneously in permanent grassland. In Switzerland, a particular form of red clover, characterised through improved persistence



and known as Mattenkleee, was developed through decade-long ‘on farm’ seed production. AFLP analysis of Mattenkleee landraces, Swiss Mattenkleee cultivars, Swiss wild clover populations and field clover cultivars from different countries showed that wild clover populations are distinctly different from other germplasm investigated (Fig. 1; Herrmann *et al.*, 2005).

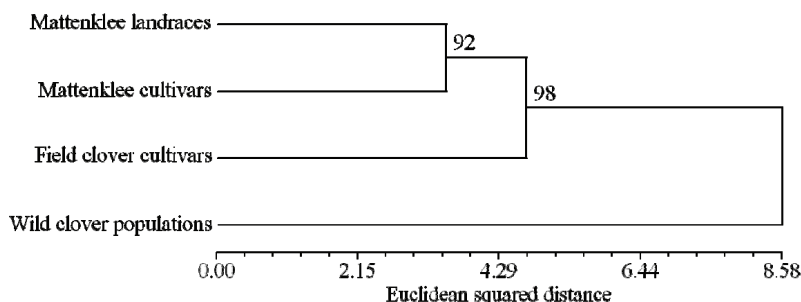

Figure 1. UPGMA clustering of 4 red clover germplasm groups. Analysis was based on 410 AFLP loci and 114 populations. Numbers above branches indicate the percentage of bootstrap values derived from 100 permutations. (Modified from Herrmann *et al.*, 2005)

However, AFLP diversity among Swiss wild clover populations was significantly influenced by the distance to the closest Mattenkleee landrace collection site, indicating gene flow between these two red clover groups which are often found in adjacent pastures or meadows. A similar relationship of local cultivars to wild populations was also observed in Russia, where seven populations from the Ural were clearly separated from seven Russian and two US cultivars based on isozyme analysis (Semerikov *et al.*, 2002). Thus, wild populations of red clover most likely are autochthonous and not naturalised cultivars. Due to their distinctness from cultivated accessions and their high genetic diversity, (Semerikov *et al.*, 2002; Herrmann *et al.*, 2005), wild red clover populations may form a particularly interesting resource to broaden gene pools in red clover breeding programmes, especially since wild clover populations have been shown to be highly adapted to specific environments (Mosjidis *et al.*, 2004).

Italian ryegrass, *Lolium multiflorum* Lam., is a forage grass species particularly valued for its high palatability and yield potential. Although the centre of origin of ryegrass species is also likely to be found in the Mediterranean basin, this species is thought to have been introduced deliberately from Italy as its former Latin name (*L. italicum*) and its common name suggest. Italian ryegrass is intensively utilised in leys for hay and silage production, but it can also be found in high proportions in permanent grassland. It thrives well in the mild and humid (average annual temperature +9° C and annual rainfall >900 mm) valley regions of central and northern Switzerland combined with a high management intensity with frequent mowing (5 to 6 cuts per year) and a high fertilisation level (mainly with manure). Ecotype populations from such grasslands form a valuable pool of PGR which have been successfully used to broaden the genetic diversity in breeding programmes and to develop improved cultivars (Boller *et al.*, 2005).



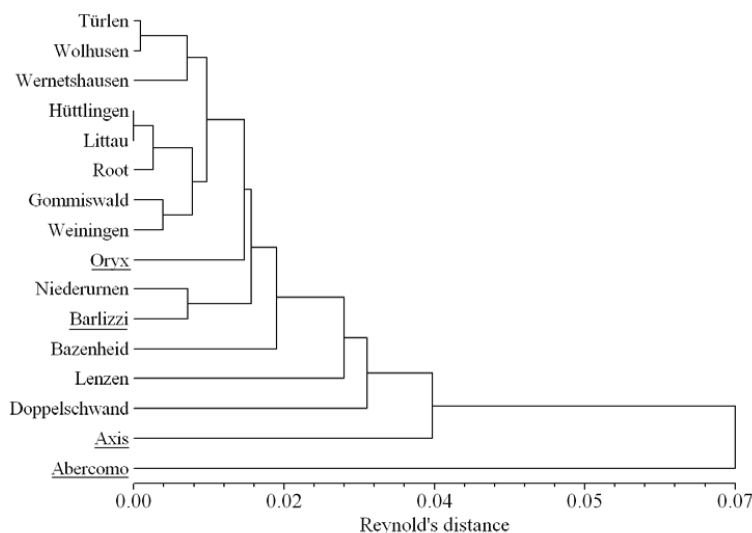

Figure 2. UPGMA clustering of 12 ecotype populations and four cultivars (underlined) of Italian ryegrass. Analysis was based on 24 SSR markers and Reynold's distance. No significant differences between clusters were determined by redundancy analysis (RDA) and 1000 permutations (modified from (Peter-Schmid *et al.*, 2008b)).

Peter-Schmid *et al.* (2008b) investigated genetic diversity of 12 Italian ryegrass ecotype populations sampled across Switzerland and of four reference cultivars using SSR markers. Only 1.6% of the total variation observed was found between the two groups of ecotype populations and cultivars, respectively, while 97.1 % was due to within population variability. In addition, no clear grouping of populations was observed in cluster analysis and ecotype populations were not clearly separated from cultivars (Fig. 2; Peter-Schmid *et al.*, 2008b).

The high abundance of Italian ryegrass in temporary leys and the associated gene flow to adjacent permanent grassland, facilitated by multiple reproductive growth cycles which enable abundant flowering throughout the growing season may be primarily responsible for the high similarity between and among ecotype populations and cultivars.

### ***Ex situ* and *in situ* conservation of genetic resources**

In appreciation of the importance to preserve genetic diversity for plant improvement programmes, germplasm collections have been established worldwide for many plant species. Such *ex situ* genetic resource collections conserve important genetic diversity and make it readily available to plant breeders and researchers. Several major PGR collections exist worldwide with total holdings of over 100000 accessions of temperate forage legumes and grasses (Boller and Greene, 2010). For Europe, an important collection of databases is offered by the European Cooperative Programme for Plant Genetic Resource (ECPGR) which covers a large number of forage grasses and legumes ([www.ecpgr.cgiar.org/](http://www.ecpgr.cgiar.org/)). For example, the European Central *Lolium* database of ECPGR currently (February 2010) lists 7348 *L. perenne* and 1255 *L. multiflorum* accessions from more than 30 countries. Although these collections cover a considerable amount of the expected genetic diversity, not all centres of diversity are equally represented and natural or wild populations are often under represented. In addition, description of accessions held in germplasm collections is often restricted to basic passport data and a detailed analysis of the genetic diversity available is missing.

Since utilisation of gene bank material is often hindered by the large size and heterogeneous structure of many collections, the need for the establishment of core collections which represent the genetic diversity of a crop species was long realised (Frankel, 1984). For example, Kouamé and Quesenberry (1993) used cluster analysis and 15 morphophysiological plant descriptors to characterise 463 accessions of *T. pratense*. They suggested a core collection consisting of at least one accession from every country of origin and at least two accessions from each cluster group. This core collection consisting of 81 accessions from 41 different countries is characterised by a large amount of genetic diversity as detected by isozyme characterisation (Mosjidis and Klingler, 2006). Although most accessions were clearly distinct, two pairs of identical accessions were identified and one accession was considered to be from another species (Mosjidis and Klingler, 2006). In an attempt to further characterise the US core collection, Dias *et al.* (2007) analysed 57 accessions using 21 morphological traits and seven SSR markers. Although only one individual per accession was used for SSR analysis, some concordances between phenotypic and genotypic characterisation were observed (Dias *et al.*, 2007). This is a further indication that molecular markers can provide valuable additional information to phenotypic characterisation.

Wild relatives, ecotypes and landraces may also be conserved *in situ* with the aim to maintain the environment which has driven the development of the distinctive properties of PGR. Thus, genetic evolution is deliberately made possible through *in situ* conservation in order to allow PGR to further adapt to specific environments. In an attempt to identify valuable habitats for *in situ* conservation of forage grasses, Peter-Schmid *et al.* (Peter-Schmid *et al.*, 2008a; Peter-Schmid *et al.*, 2008b) investigated 19 ecotype populations of both *F. pratensis* and *L. multiflorum* collected from different sites in Switzerland varying mainly in terms of geographical region, altitude and management intensity. Populations were characterised for phenotypic traits in a field experiment using sixteen morphological descriptors according to the UPOV guidelines (UPOV, 2002). Genetic diversity was analysed by means of SSR markers on a subset of 12 ecotype populations per species. The phenotypic variation of interesting traits such as heading date or winter damage was shown to be considerably higher in ecotype populations when compared to cultivars. Several ecotype populations were identified to be superior to cultivars in various traits. In addition, a clear phenotypic differentiation among *F. pratensis* ecotype populations from different geographical regions was observed. This was supported by the analysis of genetic diversity using SSR markers, where a clear grouping of *F. pratensis* ecotype populations was observed which largely corresponded to geographical regions they were sampled from. However, no clear grouping of *L. multiflorum* populations was observed. The results of this study indicated that habitat and management affected *F. pratensis* to a much larger extent than *L. multiflorum* ecotype populations. This may be due to the fact that *F. pratensis* occurs in locally rather isolated areas and in more contrasting environments than *L. multiflorum* which is restricted to the most favourable regions of grass growth but in these regions occurs frequently and in often coalescent habitats. Thus, in order to collect and maintain high amounts of genetic variation in species with considerable population differentiation such as *F. pratensis*, habitats from different geographic regions and different management intensities should be considered for both assuring *in situ* conservation and establishing *ex situ* core collections. For widespread species with little population structure such as *L. multiflorum*, the collection and conservation of only a small number of populations may already be sufficient to capture adequate genetic variability (Peter-Schmid *et al.*, 2008b).

## Permanent grasslands - valuable reservoirs of genetic resources for forage crop improvement

Historically, genetic resources growing in permanent grassland have been by far the most important sources of germplasm used in breeding of forages. In the search for well adapted and persistent genetic materials, breeders have explored permanent grassland in their target regions to collect ecotypes. However, the actual agronomic value of such ecotypes has rarely been studied.

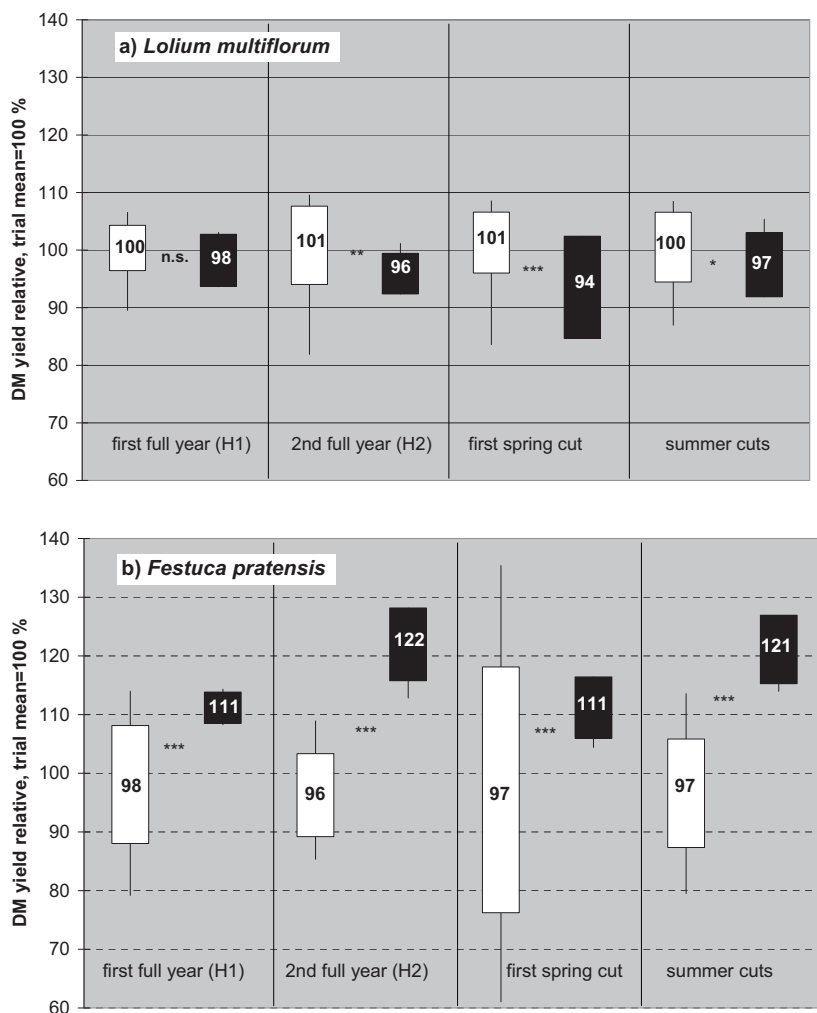

Figure 3. Ranges of relative dry matter yield of 20 ecotype populations (white bars) and 4 cultivars (black bars) each of (a) *Lolium multiflorum* and (b) *Festuca pratensis* evaluated at two to three locations for totals of first and second full years, and for means over both years for first spring cut and summer cuts. Bars indicate mean  $\pm$  s.d. for ecotype or cultivar means, lines span from minimum to maximum values. Figures indicate means for the groups of ecotypes/cultivars, asterisks the level of significance for differences between the groups (\* < 0.05, \*\* < 0.01, \*\*\* < 0.0001).

A recent investigation of the agronomic performance of 20 ecotype populations each of *Lolium multiflorum* (Fig. 3a, data from Boller *et al.* 2009) and *Festuca pratensis* (Fig. 3b) revealed a very high yield potential for *Lolium multiflorum* which often exceeded that of current recommended cultivars. The superiority of ecotype populations over cultivars was highly significant at the first spring cut and for the total yield of the second full harvest year. Conversely, the performance of *Festuca pratensis* ecotype populations was clearly inferior to that of recommended cultivars, especially so in the second full harvest year. However, the yield potential of the *Festuca pratensis* ecotype populations was very variable. The best performing populations equalled the best cultivar in DM yield of the first full harvest year and even exceeded it for the first spring cut.

Table 1. Dry matter yield in first (H1) and second (H2) full harvest year: F-values and probability of error of the interaction between accession and experimental location for 20 ecotype populations and 4 cultivars each of *Lolium multiflorum* and *Festuca pratensis* evaluated at two to three locations. Data analysed with GLM procedure of SAS.

Species	Year	Interaction accession × location			Cultivars		
		Ecotypes			DF	F value	prob
		DF	F value	prob			
<i>Lolium multiflorum</i>	H1	28	2.62	0.0003	4	1.26	0.3526
	H2	28	1.18	0.2773	4	2.18	0.1527
<i>Festuca pratensis</i>	H1	34	2.91	<0.0001	6	0.45	0.8311
	H2	34	2.18	0.0016	6	0.28	0.9371

Ecotypes and cultivars of *Lolium multiflorum* did not differ fundamentally in the environmental stability of their performance across experimental locations (Table 1). The F-values of the accession × location interaction were within a similar range for the two types of accessions and indicated statistical significance only for the ecotypes in the first full harvest year. In the second full harvest years, *Lolium multiflorum* cultivars appeared to be less stable than ecotypes, although the interaction with location was not statistically significant. Conversely, performance of *Festuca pratensis* ecotypes was markedly less stable across locations than that of cultivars. The latter finding suggests that *Festuca pratensis* ecotypes may be more specifically adapted to a certain environment, whereas highly performing *Lolium multiflorum* ecotypes are more generally adapted to agricultural use in different environments. These results confirm the high value of permanent grassland as a reservoir of genetic resources for breeding and conservation.

Clearly, grassland dominated regions provide the most diverse opportunities for collecting PGR of forages *in situ*. Grassland management contributes substantially to the diversity of grassland plant communities. Intensive management, specifically a high grazing pressure, tends to decrease species diversity. Therefore, targeted programmes aiming at a more relaxed grassland management as part of agri-environment measures have been established to increase biodiversity. However, these programmes have not considered genetic diversity within grassland species, and it is not known if such measures contribute to conserving genetic resources maintained *in situ*.

In a recent attempt to establish criteria for targeted *in situ* conservation of important grassland species, characteristics of ecotype populations of *Festuca pratensis* and *Lolium multiflorum* were compared to the floristic composition of the permanent grassland at the site of their origin (Peter-Schmid *et al.*, 2010). Genetic diversity within *F. pratensis* ecotype populations, as assessed using SSR markers and their expected heterozygosity  $H_E$ , was negatively correlated with species diversity (Shannon index and species evenness) at their collection sites. Moreover, rather intensively managed *Heracleum-Dactylis* grassland habitats held ecotype populations with significantly more rare alleles than extensively managed

*Mesobromion* and *Festuco Agrostion* habitats. These results indicate a possible conflict of the aims to maintain species-rich grassland types on the one hand, and to conserve ecotype populations of target species with a high genetic diversity and a high number of rare alleles on the other hand.

A similar conflict was detected when the agronomic performance of *Lolium multiflorum* ecotype populations from contrasting habitats was compared with cultivars (Boller *et al.*, 2009). Several performance characteristics were negatively correlated with the abundance of typical *Arrhenatheretum* species. Indeed, ecotype populations from species-poor *Lolietum multiflori* or even from degenerated *Poa trivialis-Ranunculetum repentis* vegetations performed significantly better than those from *Arrhenatheretum* vegetations, which are much more valuable from the nature value point of view. This conflict should be resolved by including the aim of conserving genetic diversity of grassland species in national or international programmes of biodiversity management.

## Conclusions

For future sustainable and productive grassland agriculture, conservation of valuable plant genetic resources of forage crop species both *ex situ* in gene banks and *in situ* in grassland habitats are indispensable. However, for targeted utilization collections have to be carefully characterised and documented and germplasm collections have to be complemented to cover all major sources of genetic diversity. Molecular markers may offer additional means to screen large germplasm collections, but major efforts are needed to develop functional markers more directly reflecting genetic diversity of agronomic importance. Agronomic potential of ecotypes from permanent grassland appears to depend on the forage plant species but even if ecotype populations of *Festuca pratensis* performed generally poorer than ecotype populations of *Lolium multiflorum*, both contained sufficient genetic variation for important traits to make them valuable resources to aliment breeding programmes for the future. Their *in situ* conservation should be considered an important environmental service of grassland agriculture. Evidence is accumulating that rather intensively managed permanent grassland contributes more to conserving useful genetic variation of forage plant species than extensively managed, species rich grassland of presumed higher nature value.

## References

- Berg C.C. and Leath K.T. (1996) Responses of red clover cultivars to stemphylium leaf spot. *Crop Science* 36, 71-73.
- Bolaric S., Barth S., Melchinger A.E. and Posselt U.K. (2005) Molecular genetic diversity within and among German ecotypes in comparison to European perennial ryegrass cultivars. *Plant Breeding* 124, 257-262.
- Boller B. and Greene S. (2010) Genetic resources. In: Boller B., Posselt U. K. and Veronesi F. (eds.) *Fodder Crops and Amenity Grasses*, Springer Science and Business Media, New York, pp. 13-37.
- Boller B., Peter-Schmid M., Tresch E., Tanner P. and Schubiger F. (2009) Ecotypes of Italian ryegrass from Swiss permanent grassland outperform current recommended cultivars. *Euphytica* 170, 53-65.
- Boller B., Schubiger F.X., Tanner P., Streckeisen P., Herrmann D. and Kölliker R. (2005) Genetic diversity in permanent grassland and its utilisation for breeding. *Fourrages* 182, 263-274.
- Charmet G. and Balfourier F. (1994) Isozyme variation and species relationships in the genus *Lolium* L. (ryegrasses, Gramineae). *Theoretical and Applied Genetics* 87, 641-649.
- Crossa J. (1989) Methodologies for estimating the sample-size required for genetic conservation of outbreeding crops. *Theoretical and Applied Genetics* 77, 153-161.
- Dias P.M.B., Julier B., Sampoux J.P., Barre P. and Dall'Agnol M. (2007) Genetic diversity in red clover (*Trifolium pratense* L.) revealed by morphological and microsatellite (SSR) markers. *Euphytica* 160, 189-205.
- FAO (1996) *Report on the State of the World's Plant Genetic Resources for Food and Agriculture*. Food and Agriculture Organization of the United Nations, Plant Production and Protection Division, Rome, Italy, pp.
- Fjellheim S., Blomlie A.B., Marum P. and Rognli O.A. (2007) Phenotypic variation in local populations and cultivars of meadow fescue - potential for improving cultivars by utilizing wild germplasm. *Plant Breeding* 126, 279-286.

- Foster Hünneke L. (1991) Ecological implications of genetic variation in plant populations. In: Falk D. A. and Holsinger K. E. (eds.) *Genetics and Conservation of Rare Plants*, Oxford University Press, New York, pp. 31-44
- Frankel O.H. (1984) Genetic perspectives of germplasm conservation. In: Arber W.K., Llimense K., Peacock W. J. and Startinger P. (eds.) *Genetic Manipulation: Impact on Man and Society*, Cambridge University Press, Cambridge, pp. 161-170
- Herrmann D., Boller B., Widmer F. and Kölliker R. (2005) Optimization of bulked AFLP analysis and its application for exploring diversity of natural and cultivated populations of red clover. *Genome* 48, 474-486.
- IBPGR (1985) *Descriptor List for Forage Grasses*. International Board for Plant Genetic Resources, IBPGR, Rome, 30 pp.
- Kopecky D., Bartos J., Lukaszewski A., Baird J., Cernoch V., Kölliker R., Rogli O., Blois H., Caig V., Lübberstedt T. et al. (2009) Development and mapping of DArT markers within the *Festuca-Lolium* complex. (in press).
- Kouamé C.N. and Quesenberry K.H. (1993) Cluster analysis of a world collection of red clover germplasm. *Genetic Resources and Crop Evolution* 40, 39-47.
- Miura Y., Hirata M. and Fujimori M. (2007) Mapping of EST-derived CAPS markers in Italian ryegrass (*Lolium multiflorum* Lam.). *Plant Breeding* 126, 353-360.
- Mosjidis J.A. and Klingler K.A. (2006) Genetic diversity in the core subset of the US red clover germplasm. *Crop Science* 46, 758-762.
- Mosjidis J.A., Greene S.L., Klinger K.A. and Afonin A. (2004) Isozyme diversity in wild red clover populations from the caucasus. *Crop Science* 44, 665-670.
- Oostermeijer J.G.B., Van Eijck M.W., Van Leeuwen N. and Den Nijs J.C.M. (1995) Analysis of the relationship between allozyme heterozygosity and fitness in the rare *Gentiana pneumonanthe* L. *Journal of Evolutionary Biology* 8, 739-759.
- Peter-Schmid M., Kölliker R. and Boller B. (2008a) Value of permanent grassland habitats for *in-situ* conservation of *Festuca pratensis* Huds. and *Lolium multiflorum* Lam. *Euphytica* 164, 239-253.
- Peter-Schmid M., Boller B. and Kölliker R. (2008b) Habitat and management affect genetic structure of *Festuca pratensis* but not *Lolium multiflorum* ecotype populations. *Plant Breeding* 127, 510-517.
- Peter-Schmid M., Kölliker R. and Boller B. (2010) Genetic diversity of *Festuca pratensis* Huds. and *Lolium multiflorum* Lam. ecotype populations in relation to species diversity and grassland type. In: Runas J. and Dahlgren T. (eds.) *Grassland Biodiversity: Habitat Types, Ecological Processes and Environmental Impacts*, Nova Science Publishers, New York, (in press).
- Powell W., Machray G.C. and Provan J. (1996) Polymorphism revealed by simple sequence repeats. *Trends in Plant Science* 1, 215-22.
- Reed D.H. and Frankham R. (2003) Correlation between fitness and genetic diversity. *Conservation Biology* 17, 230-237.
- Sato S., Isobe S., Asamizu E., Ohmido N., Kataoka R., Nakamura Y., Kaneko T., Sakurai N., Okumura K., Klimenko I. et al. (2005) Comprehensive structural analysis of the genome of red clover (*Trifolium pratense* L.). *DNA Research* 12, 301-364.
- Semerikov V.L., Belyaev A.Y. and Lascoux M. (2002) The origin of Russian cultivars of red clover (*Trifolium pratense* L.) and their genetic relationships to wild populations in the Urals. *Theoretical and Applied Genetics* 106, 127-132.
- Studer B., Asp T., Frei U., Hentrup S., Meally H., Guillard A., Barth S., Muylle H., Roldan-Ruiz I., Barre P. et al. (2008) Expressed sequence tag-derived microsatellite markers of perennial ryegrass (*Lolium perenne* L.). *Molecular Breeding* 21, 533-548.
- Ulloa O., Ortega F. and Campos H. (2003) Analysis of genetic diversity in red clover (*Trifolium pratense* L.) breeding populations as revealed by RAPD genetic markers. *Genome* 46, 529-535.
- UPOV (2002) General Introduction to the Examination of Distinctness, Uniformity and Stability and the Development of Harmonized Descriptions of New Varieties of Plants. International Union for the Protection of New Varieties of Plants, Geneva, Switzerland, 26 pp.
- Venuto B.C., Smith R.R. and Grau C.R. (1995) Virulence, legume host-specificity, and genetic relatedness of isolates of *Fusarium oxysporum* from red clover. *Plant Disease* 79, 406-410.
- Zeven A. and de Wet J. (1982) *Dictionary of Cultivated Plants and their Regions of Diversity*. International Book Distributors, Wageningen, 259 pp.

## **Session 2.1**

### **Grassland systems and technology**

*Editor: Michael Wachendorf*



# Dry matter and protein yields of red clover, Italian ryegrass and their mixtures

Alibegovic-Grbic S., Bezdrob M. and Civic H.

Faculty of Agriculture and Food Sciences, University of Sarajevo, Zmaja od Bosne 8. Bosnia and Herzegovina

Corresponding author: s.alibegovic-grbic@ppf.unsa.ba

## Abstract

Red clover (*Trifolium pratense* L.) is very important legume in Bosnia and Herzegovina, in terms of its good adaptation to a wide range of soil conditions, its high yield potential and its good nutritional value. It is usually sown in mixtures with Italian ryegrass (*Lolium multiflorum* Lam.) in order to facilitate its management and to reduce problems associated with animal nutrition or to acid soils. Lastly, it contributes to healthier environment and is very useful in organic farming.

An experiment was established in order to determine dry matter (DM) and protein yields of red clover and Italian ryegrass in pure stands, and in mixtures with three different proportions. Small rates of mineral nitrogen (30 kg ha<sup>-1</sup>) were also tested.

Results of this study indicated that a small rate of nitrogen affected positively both DM and protein yields. Effect of nitrogen was higher in pure stands for both species than that in mixtures. Two years DM yield for red clover in pure stand (34.4 t ha<sup>-1</sup>) was similar to that of the mixtures (33.3 and 31.6 t ha<sup>-1</sup>) with the proportion of red clover up to 50%, while DM yield of Italian ryegrass was only 19.0 t ha<sup>-1</sup>. Differences for protein yield were even higher.

Keywords: Red clover, Italian ryegrass, N, yield

## Introduction

Red clover (*Trifolium pratense* L.) is adapted to a wide range of soil conditions, which is of special interest for Bosnia and Herzegovina where a large area is characterized by heavy and acid soils. Red clover cultivation also contributes to reduce inputs of nitrogen fertilisers due to symbiotic nitrogen fixation. Deprez *et al.* (2004) underlined that red clover can fix from 256 up to 545 kg ha<sup>-1</sup> N. This also supports integrated and ecological agriculture. However, red clover grown in pure stand causes bloating when fed as green forage and it is difficult to dry for hay. These problems justify sowing red clover in mixtures with grasses. Italian ryegrass (*Lolium multiflorum* Lam.) is well suited to red clover because it is also short-lived, grows fast and has similar demands for soil. Sowinski and Nowak (2003) indicated that red clover in pure stands as well as in mixtures with hybrid ryegrass, without N fertilization, gave stable and high yields. An experiment was established with the aim to determine the effect of a small amount of N (30 kg ha<sup>-1</sup>) on dry matter and protein yield of red clover, and of Italian ryegrass, both in pure stands, and in their mixtures with three different proportions.

## Material and methods

The field experiment was established in Butmir near Sarajevo (518 m a.s.l.) with an average annual precipitation of 902 mm and an average annual temperature of 9.5 °C. Soil of the experimental field is loamy-clay, characterized by pH-5.6 (in H<sub>2</sub>O), P-11 mg, K-14.6 mg (determined by using ammonium lactate-acetic extraction) and 160 mg N in 100 g of soil. Nitrogen was determined by the Kjeltex method. We used a randomised complete block design with four replications and plot size of 5 m<sup>2</sup>. The experiment was set up in spring 2004

with following variants: red clover 100%; red clover 75% + Italian ryegrass 25% (S1); red clover 50% + Italian ryegrass 50% (S2); red clover 25% + Italian ryegrass 75% (S3) and Italian ryegrass 100%. Mineral nitrogen (30 kg ha<sup>-1</sup>) was applied in spring.

The sward was harvested at the beginning of flowering of red clover. In 2004 we made three cuts and in 2005 four cuts. Protein yield was calculated on the basis of dry matter (DM) yield and protein content (N × 6.25). Total N was determined using the Kjeldahl method. Results were subjected to ANOVA and compared by LSD test.

## Results and discussion

Weather conditions in 2004 were favourable and both species, and their mixtures, established well. DM yield ranged from 8.27 (Italian ryegrass) to 11.83 t ha<sup>-1</sup> (red clover), as presented in Table 1. DM yield was higher in the mixtures with the highest proportion of red clover. However, significant differences were not found. Applied N resulted in improvement in yield of 2.47 t ha<sup>-1</sup> for red clover, and by 2.24 t ha<sup>-1</sup> for Italian ryegrass. Differences in DM yield by mixtures were rather small. Although August August in 2004 was dry, in 2005 temperatures were normal and the rainfall sufficient throughout the vegetation season. The favourable conditions had a positive influence on plant growth and resulted in extremely high yields of DM. Red clover was most productive with 22.62 t ha<sup>-1</sup>. Italian ryegrass gave the lowest yield (10.9 t ha<sup>-1</sup>). The differences were highly significant.

When results from both years were pooled the efficiency of an application of 30 kg N resulted in 5.58 and 5.00 t ha<sup>-1</sup> DM for red clover and Italian ryegrass, respectively, while the DM yield for the mixtures was much less. DM yields were higher than 30 t ha<sup>-1</sup> obtained in red clover and in mixtures in which Italian ryegrass contributed up to 50% (similar to Kessler and Lehmann, 1998).

Table 1 Dry matter yield of red clover, Italian ryegrass and their mixtures (t ha<sup>-1</sup>)

	2004		2005		2004+2005	
	N30	N0	N30	N0	N30	N0
Red clover 100 %	11.83	9.36	22.62***	19.51	34.45***	28.87
Red clover 75 % + Italian ryegrass 25 % (S1)	11.68	11.43	21.66***	19.35	33.34***	30.78
Red clover 50 % + Italian ryegrass 50% (S2)	10.65	10.39	20.91***	18.76	31.56***	29.15
Red lover 25 % + Italian ryegrass 75 % (S3)	9.87	8.08	16.68***	16.09	26.55***	24.17
Italian ryegrass 100 %	8.27	6.03	10.83	8.07	19.10	14.10
LSD 0.05	3.79		2.00		3.17	
0.01	5.24		2.77		4.32	
0.001	7.24		3.84		5.85	

Crude protein content ranged from 6.85 to 18.4%, depending of several features (species, proportion of red clover or Italian ryegrass in mixtures, defoliation-cut, and applied N). The highest crude protein content was found in red clover and the lowest in Italian ryegrass. Mixtures with higher proportions of red clover were characterised by higher crude protein contents. It increased with increasing proportion of red clover in mixtures, as well as from first to the last cut in general (Table 2). Applied N had, in most cases, some positive effect on crude protein content. It is interesting to note that in 2005 Italian ryegrass had less crude protein in the N-fertilised treatment.

Table 2 Crude protein content (%) in dry matter at successive cuts

Year		1 <sup>st</sup> cut	2 <sup>nd</sup> cut	3 <sup>rd</sup> cut	4 <sup>th</sup> cut
2004	N0	9.0	13.700	9.292	-
	N30	11.986	13.174	14.324	-
2005	N0	11.938	10.748	11.560	15.608
	N30	11.607	11.240	14.390	15.134

A low rate of applied N (Table 3) had a positive effect on protein yield, even in red clover grown as a pure stand. In 2004 applied N in red clover resulted in an improvement of 553 kg ha<sup>-1</sup> and in 2005 of 1093 kg ha<sup>-1</sup>. Differences in protein yield decreased with increasing proportion of grass component in mixtures. Although Italian ryegrass yielded more in 2005 with applied N, protein yield was higher when N was not applied. Differences were, in most cases, highly significant among red clover and its mixtures compared to pure Italian ryegrass.

Table 3. Protein yield of red clover, Italian ryegrass and their mixtures (t ha<sup>-1</sup>)

Year	2004		2005		2004+2005	
	N30	N0	N30	N0	N30	N0
Red clover 100 %	1.836***	1.283	3.518***	2.425	5.353***	3.708
Red clover 75 %; Italian ryegrass 25 % (S1)	1.664***	1.484	3.135***	2.400	4.799***	3.883
Red clover 50 %; Italian ryegrass 50% (S2)	1.369**	0.879	2.378***	2.071	3.747***	2.950
Red clover 25 %; Italian ryegrass 75 % (S3)	1.190	0.722	1.954***	1.734	3.144***	2.455
Italian ryegrass 100 %	0.744	0.544	0.966	1.078	1.710	1.621
LSD 0.05	0.451		0.250		0.380	
0.01	0.624		0.345		0.518	
0.001	0.862		0.477		0.701	

Results of DM and protein yields also suggest that applied N supported both nitrogen use efficiency as well as apparent N recovery, especially by red clover due to its role in N fixation, and also in mixtures with high proportion of red clover.

## Conclusions

Results of these investigations showed that a low rate of applied nitrogen had positive effects on DM and protein yields of red clover, Italian ryegrass and their mixtures. In similar conditions the application of such small rate of mineral N in order to achieve higher DM and protein yield would be reasonable.

## References

- Deprez B., Lambert R., Decamps C. and Peeters A. (2004) Nitrogen fixation by red clover (*Trifolium pratense*) and lucerne (*Medicago sativa*) in Belgian leys. In: Luscher A. *et al.* (eds.) Land Use Systems in Grassland Dominated Regions. *Grassland Science in Europe* 9, 469-471.
- Kessler W. and Lehmann J. (1998) Evaluation of grass/clover mixtures for leys. In: Nagy G. and Peto K. (eds.) Ecological Aspects of Grassland Management. *Grassland Science in Europe* 3, 231-235.
- Sowinski J. and Nowak W. (2003) Yield potential of red/grass mixtures in southwest Poland. In: Kirilov A. *et al.* (eds.) Optimal Forage Systems for Animal Production and Environment. *Grassland Science in Europe* 8, 111-114.

# Analysis of hyperspectral data to estimate forage quality in legume-grass mixtures

Biewer S.<sup>1</sup>, Fricke T.<sup>2</sup> and Wachendorf M.<sup>2</sup>

<sup>1</sup>Landesbetrieb Landwirtschaft Hessen, D- 34117 Kassel, Germany

<sup>2</sup>Dept. of Grassland Science and Renewable Plant Resources University of Kassel, D-37213 Witzenhausen, Germany

Corresponding author: sonja.biewer@llh.hessen.de

## Abstract

This study was undertaken to explore the potential of field spectral measurements for a non-destructive prediction of metabolisable energy (ME), ash content, crude protein (CP), and acid detergent fibre (ADF) of legume-grass mixtures. A population of 200 legume-grass swards [*Lolium perenne* (L.), *Trifolium repens* (L.), *Trifolium pratense* (L.)] representing a wide range of legume proportions (0 to 100% of dry matter), and growth stages (beginning of tillering to end of flowering) were used in this investigation. One day before harvesting the reflection of incident light on the swards was measured with a spectrometer (FieldSpec, Analytical Spectral Devices) in the range 350-2500 nm. For further data processing, modified partial least square regressions (MPLS) were calculated and related to the forage quality variables of each sward. The results show high prediction accuracy for all quality variables ( $0.70 \leq R^2 \leq 0.83$ ). Even with a reduced spectral data set (630 to 1000 nm), estimates of MPLS models are still acceptable for forage ash ( $0.62 \leq R^2 \leq 0.78$ ) and CP ( $0.83 \leq R^2 \leq 0.86$ ), a finding, which could facilitate an application of field spectroscopy in practice.

Keywords: field spectroscopy, metabolisable energy (ME), ash content, crude protein (CP), acid detergent fibre (ADF) legume-grass mixtures, modified partial least squares regression (MPLS)

## Introduction

Accurate information on nutritive values of legume-grass swards is extremely useful in livestock and forage management. However, nutritive values of legume-grass swards can vary considerably within a field and during the growing period, due to disturbances such as lack of nutrients, frost, drought damage, or defoliation. Hence, a site-specific determination of the nutritive values such as metabolisable energy (ME) ash content, crude protein (CP), and acid-detergent fibre (ADF) in the field would help in detecting and quantifying this heterogeneity and optimise field and forage management.

## Materials and methods

The field experiment was conducted during the year 2006 on the organic experimental farm Neu Eichenberg of the University of Kassel. Pure swards of red clover (*Trifolium pratense* L.), white clover (*Trifolium repens* L.) and perennial ryegrass (*Lolium perenne* L.) as well as binary mixtures of each legume with perennial ryegrass were tested. After sward establishment on 02 June 2005, three main cuts were taken on 12 June, 25 July, and 14 Sept. in the following year, 2006. In between these cuts, samples from an area of 0.5 m<sup>2</sup> were harvested at weekly intervals to determine effects of growth stages. Biomass was cut at a height of 5 cm above soil surface and dried at 65 °C for 48h. Subsequently, samples were ground with a 1 mm sieve in order to determine the nutritive value with near infrared spectroscopy (NIRS) using the WinISI software in the spectral range between 1100 and 2498

nm (version 1.63, Foss NIRSystems/Tecator Infrasoft International, LLC, Silver Spring, MD, USA).

Spectral measurements in the field were conducted with a FieldSpec<sup>®</sup> Pro JR (Analytical Spectral Devices, CO, USA) one day before harvesting in the range from 350 to 2500 nm. Prior to spectral analysis, spectra were smoothed using eleven convoluting integers and a polynomial of degree five (Savitzky and Golay, 1964). Then reflectance values in the ranges from 1800 to 1939 nm, and 2430 to 2500 nm were omitted from analysis because of instrument noise or interaction with high atmospheric moisture absorption. Subsequently, Modified partial least square (MPLS) regression was conducted using the WinISI software (mathematical treatment: 1,4,4,1; weighted multiplicative scatter correction). Cross-validation was conducted by a random separation of the data set into four groups followed by predictions for the values of one group based on the calibrations developed from the other groups. In turn, predictions were made for all groups and finally averaged. The number of outlier elimination passes was two.

## Results and discussion

As swards were investigated at various growth stages ranging from tillering (BBCH 23; Meier, 2001) to finishing of flowering (BBCH 67), nutritive values varied widely over the growth period. ME content in dry matter (DM) was the highest in spring with 12.5 MJ kg<sup>-1</sup>, whereas in summer, where the growth of grass was strongly affected by very dry weather, the lowest values (6.6 MJ kg<sup>-1</sup>) were obtained. Variation in the stage of maturity was the highest in spring, which was reflected in ash and CP contents in DM showing a wide range from 4.2 to 14.1% and from 3.5 to 33.6%, respectively. The lowest ash and CP values were found for the pure-grass swards. The highest ADF values in DM were achieved in the summer period with 34.8%. Thus, the wide range of nutritive values found in our study provided an appropriate data set for the development of reflectance algorithms, as it covered most of the variability reported in literature for white clover, red clover and perennial ryegrass.

MPLS calibrations of the common data set explained 80, 87, 93 and 84% of the variance and had standard errors of cross-validation (SECV) of 0.4, 0.9, 3.1 and 2.4 for ME, ash, CP and ADF, respectively. Overall model accuracy was the lowest for ME and the highest for CP (Table 1). Residual predictive values (RPD) ranged between 1.8 and 2.4. An RPD value greater than three is considered adequate for analytical purposes in most of the laboratory near infrared applications for agricultural products (Cozzolino *et al.*, 2006). However, at field scale variable measurement conditions reduce prediction accuracy, so that even lower RPD values may indicate good results.

Owing to the availability of the already existing field sensor (Yara N-sensor<sup>®</sup> Yara International ASA, Oslo, Norway), which is used for site-specific fertilizer applications in practice, hyperspectral data were reduced to the range of 620 to 1000 nm with a resolution of 10 nm. In comparison to the full data set, the reduction resulted in lower prediction accuracies for MPLS models, except for the model of CP (Table 1). Ash and CP still obtained rather high coefficients of determination in the cross-validation (1-VR) ranging from 0.55 to 0.86, whereas ME and ADF only reached values of  $0.44 \leq 1-VR \leq 0.50$  and  $0.44 \leq 1-VR \leq 0.56$ , respectively. However, 10 of the 12 models showed RPD values  $\geq 1.4$ , indicating still satisfactory prediction accuracy.

Table 1: Calibration statistics of the prediction for metabolisable energy (ME), ash, crude protein (CP) and acid detergent fibre (ADF) in dry matter by modified partial least squares regression including sample number ( $N$ ), mean and standard deviation (SD) of the calibration data.

	Constituent	$N$	Mean	SD	SEC <sup>†</sup>	$R^2$	SECV <sup>‡</sup>	1-VR <sup>§</sup>	RPD <sup>¶</sup>
full dataset <sup>1</sup>	ME, MJ kg <sup>-1</sup>	186	11.0	0.7	0.3	0.80	0.4	0.70	1.8
	Ash, %	194	11.4	1.7	0.6	0.87	0.9	0.73	1.9
	CP, %	196	20.6	7.6	2.1	0.93	3.1	0.83	2.4
	ADF, %	190	22.2	4.8	2.0	0.84	2.4	0.75	2.0
reduced dataset <sup>2</sup>	ME	188	11.0	0.7	0.5	0.51	0.5	0.50	1.4
	Ash	198	11.3	16.9	9.9	0.66	10.4	0.62	1.6
	CP	193	20.7	7.5	2.8	0.86	3.1	0.83	2.4
	ADF	195	21.8	4.9	3.3	0.53	3.4	0.50	1.4

<sup>†</sup> SEC, standard error of calibration. <sup>‡</sup> SECV, standard error of cross validation. <sup>§</sup> 1-VR, coefficient of determination of cross-validation. <sup>¶</sup> RPD, ratio of standard deviation of the measured results to standard error of cross validation. <sup>1</sup> hyperspectral data range from 350-1799 and 1940-2430 nm with a resolution of 1 nm.

<sup>2</sup> reduced data range to 620-1000 nm with a resolution of 10 nm.

## Conclusions

Hyperspectral analysis by MPLS resulted in high statistical accuracy for the estimation of ME, ash, CP, and ADF with standard errors of cross validation for the respective variables of 0.4, 0.9, 3.1, and 2.4. The analysis of the reduced hyperspectral data set to the range of 620 to 1000 nm with a resolution of 10 nm indicated that it might be difficult to accurately predict forage ME and ADF, whereas forage ash could be predicted with satisfactory, and CP with comparable results to those of the full data set. The results are indicating that hyperspectral analysis is a useful tool to optimise field and forage management on a site-specific scale in the field.

## References

- Cozzolino D., Fassio A., Fernandez E., Restaino E., and La Manna A. (2006) Measurement of chemical composition in wet whole maize silage by visible and near infrared reflectance spectroscopy. *Animal Feed Science and Technology* 129, 329–336.
- Savitzky A. and Golay M.J.E. (1964) Smoothing and differentiation of data by simplified least squares procedures. *Analytical Chemistry* 36, 1627–1639.

# Modelling ammonia emissions after field application of biogas slurries on grassland sites

Pacholski A., Gericke D., Ni K. and Kage H.

*Institute of Crop Science and Plant Breeding, Department of Agronomy and Crop Science, Christian-Albrechts-University at Kiel, Hermann-Rodewald-Str. 9, 24108 Kiel, Germany*

Corresponding author: Pacholski@pflanzenbau.uni-kiel.de

## Abstract

In Germany the production of biogas from energy cropping systems is in the focus of the bio-energy strategy for the reduction of greenhouse gas emissions. In particular, at typical sites for grassland and fodder production, e.g. the coastal regions in Northern Germany, grasses have the potential to serve as an alternative to maize as the predominant biogas crop. Ammonia emissions are unavoidable in these systems as biogas residues have to be stored and are re-transferred to the field as N-fertilizers. For scenario analysis and regionalisation, model approaches for NH<sub>3</sub> emissions after field applications of biogas slurries are of particular interest. In this study, one dynamic and one empirical model approach for the calculation of NH<sub>3</sub> losses from grasses and other energy crops after application of biogas slurries were developed and tested. With respect to validation data the models showed a quantitative accuracy of cumulated NH<sub>3</sub>-N losses of between 2 and 4 kg ha<sup>-1</sup> which is in the range of the accuracy of commonly used measurement methods.

Keywords: biogas slurries, dynamic model, ammonia volatilization, grassland

## Introduction

In general, the highest ammonia emissions from agricultural production in Europe have been reported for animal production systems with intensive fodder production from grassland and arable land (FAO, 2001). Recently, there is an important trend in Germany towards agricultural biogas production systems. In most cases these are combined with traditional animal production using animal slurries and crop substrates as fermentation material. In traditional grass production systems, silage from ryegrass (*Lolium perenne* or *Lolium multiflorum*) is also used as fermentation substrate. Owing to their high pH and high total ammoniacal nitrogen contents (TAN), biogas slurries are characterized by even higher NH<sub>3</sub> emissions after field application compared to conventional slurries (Pacholski *et al.*, 2009). As dense grass swards can hamper slurry infiltration and increase the surface covered with slurry exposed to the atmosphere, comparatively high NH<sub>3</sub> emissions are expected from grassland systems. However, most of the simulation models dealing with NH<sub>3</sub> emissions focus on losses from bare soil or arable land. To close this gap, one empirical and one simple mechanistic approach for the modelling of ammonia emissions from organic fertilizers applied to grassland and arable land were developed and tested.

## Materials and methods

A simple mechanistic model was developed on the basis of a model by Sommer and Olesen (2000). The model considers only processes in the slurry/soil mixture at the top of the soil and in the atmosphere above it. The emission of NH<sub>3</sub> from the gaseous phase of the soil into the atmosphere above the soil/canopy is explicitly calculated by a resistance approach (Eq. 1).

$$F_v = \frac{1}{r_a + r_b + r_c} \cdot ([C_N] - [C_A]) \quad (\text{Eq. 1})$$



$F_V$  denotes the  $\text{NH}_3$  flux to the atmosphere above the soil or canopy,  $[C_N]$  the  $\text{NH}_3\text{-N}$  concentration at the surface of the slurry/soil mixture,  $[C_A]$  the  $\text{NH}_3\text{-N}$  concentration in ambient atmosphere,  $r_a$  the resistance within the turbulent layer above the soil or canopy,  $r_b$  the resistance within the laminar boundary layer above the soil or canopy and  $r_c$  the resistance within the crop canopy and slurry layer. Basic shortcomings of the original approach were the neglect of the effects of canopy structure, slurry infiltration, drying of slurry surface and crust formation, precipitation, incorporation of slurry into the soil and nitrification on  $\text{NH}_3$  emissions. Based on field and laboratory data these effects were integrated in the new model. The specific effect of grass swards on ammonia emissions was included by considering the effect of leaf area expansion on  $\text{NH}_3$  emissions.

As a second approach, an empirical model based on a Michaelis-Menten-type equation (Eq. 2) was applied (Sogaard *et al.* 2002):

$$N(t) = N_{\max} \frac{t}{t + K_m} \quad (\text{Eq. 2})$$

This equation describes the dynamic process of cumulative ammonia loss,  $N(t)$ , over time,  $t$ . Similar as in the ALFAM model approach (Sogaard *et al.*, 2002), the parameters  $N_{\max}$ , maximum ammonia loss at infinite time, and  $K_m$ , point in time when 50% of  $N_{\max}$  is reached, were modelled as functions of explanatory variables including slurry characteristics, canopy type, leaf area index (LAI), temperature, wind speed, precipitation and others. The multiplicative method was selected to avoid negative model values for  $N_{\max}$  or  $K_m$  (Eq. 3), with the letters  $x_i$  for explanatory variables in the exponent and values  $A_i$  and  $B_i$  for connected parameters which are estimated during model fitting for  $N_{\max}$  and  $K_m$ , respectively.

$$N_{\max} = A_0 \times A_1^{x_1} \times \dots \times A_m^{x_m} \quad \text{and} \quad K_m = B_0 \times B_1^{x_1} \times \dots \times B_m^{x_m} \quad (\text{Eq. 3})$$

The models were parameterized and tested based on a dataset obtained during 2 years (2007-2008) of simultaneous  $\text{NH}_3$  loss measurements in multi-plot field trials with 4 different organic fertilizers, 2 locations and 5 crop rotations including perennial ryegrass (*Lolium perenne*). Altogether 13 experimental campaigns for determination of  $\text{NH}_3$  losses were carried out with 4 replicates per treatment. Emissions were determined by passive flux samplers scaled to absolute losses by measurement with a calibrated dynamic chamber method. These were in very good agreement with simultaneous measurements with a micrometeorological reference method on adjacent fields (Pacholski *et al.*, 2009). For model evaluation  $R^2$  values as well as absolute model deviation (Root Mean Square Error *RMSE*) was calculated.

## Results and discussion

Simulations with the simple mechanistic model approach (Eq.1) showed a good agreement with measured final cumulated  $\text{NH}_3\text{-N}$  losses for the different organic fertilizers applied at both study sites on grasses and arable land (validation:  $R^2 = 0.61$ , *RMSE* 1.96 kg ha<sup>-1</sup>; data not shown). The model was also able to reproduce measured  $\text{NH}_3$  loss dynamics from grassland plots, simulated values always being very close to the observed ones (Fig. 1). Although there were minor discrepancies, the general trend was depicted as observed during measurements. Calculations with the empirical model approach for  $\text{NH}_3\text{-N}$  emissions from grassland (Eq. 2 and Eq.3) showed a particularly good fit with the parameterization data set ( $R^2$  0.72, *RMSE* 1.4 kg ha<sup>-1</sup>, slope of the regression curve close to 1, Fig. 2) with only one great deviation between measured and observed values. However, the agreement with the validation set was not as good, mainly due to a strong deviation of the values in one experimental campaign with pig slurry. There was also a general overestimation of  $\text{NH}_3\text{-N}$  emissions as compared to the validation data set. Nevertheless, an *RMSE* of 3.6 kg ha<sup>-1</sup> was still in the range of the accuracy of commonly applied methods for  $\text{NH}_3$  loss measurements.

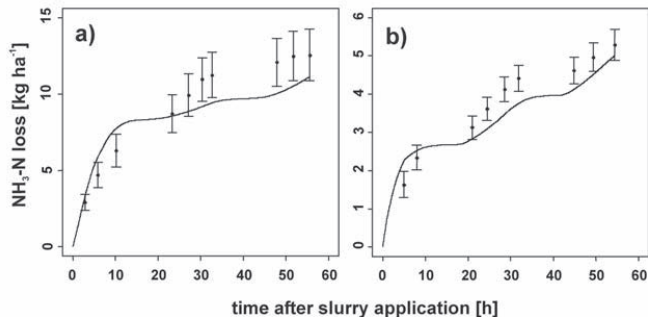

Figure 1: Measured  $\text{NH}_3$  loss dynamics from biogas slurries applied to grassland sites (sandy soil) with trail hoses and simulated by the mechanistic approach (Eq. 1) for two parameterization data sets a) May 2007,  $60 \text{ kg ha}^{-1} \text{ N}_{\text{tot}}$  b) May 2008,  $120 \text{ kg ha}^{-1} \text{ N}_{\text{tot}}$ ; error bars = std. error ( $n = 4$ ),  $\text{N}_{\text{tot}}$  = mineral nitrogen + organic nitrogen in slurry

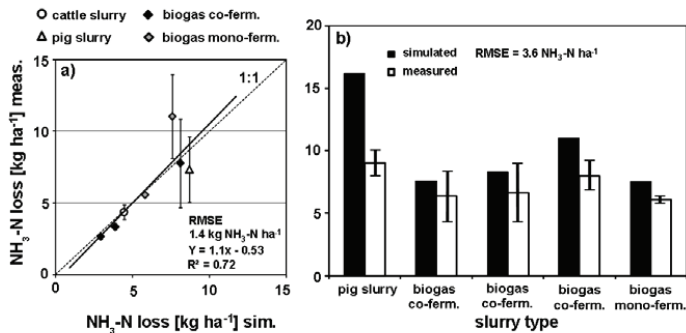

Figure 2: Measured cumulated  $\text{NH}_3$  losses from three organic fertilizers applied to grassland sites and simulated losses by the empirical approach (Eq. 2 and Eq. 3) for a parameterization data set a) and a validation data set b); error bars = std. errors ( $n = 4$ )

## Conclusion

The mechanistic, as well as the empirical model approaches were proven to be applicable for the simulation of  $\text{NH}_3$  emissions from grassland sites after application of animal and biogas slurries. A precondition for the modelling is the consideration of the effect of the canopy (LAI, canopy factor) on  $\text{NH}_3$  fluxes in the model structure.

## References

- FAO (2001) *Global estimates of gaseous emissions of  $\text{NH}_3$ ,  $\text{NO}$  and  $\text{N}_2\text{O}$  from agricultural land*. First version, FAO and IFA, Rome, Italy, 106 pp.
- Pacholski A., Gericke D. and Kage H. (2009) Measurement and modelling of  $\text{NH}_3$  emissions from field-applied biogas residues in North German energy crop rotations. In: Grignani C., Acutis M., Zavattaro L., Bechini L., Bertora C., Marino Gallina P. and Sacco D. (eds.) *Proceedings of the 16th Nitrogen Workshop - Connecting different scales of nitrogen use in agriculture*. 28 June – 1 July 2009, Turin, Facolta di Agraria, Turin, Italy, pp. 189 - 190.
- Sogaard H.T., Sommer S.G., Hutchings N.J., Huijsmans J.F.M., Bussink D.W. and Nicholson F. (2002) Ammonia volatilization from field-applied animal slurry - the ALFAM model. *Atmospheric Environment* 36, 3309-3319.
- Sommer S.G. and Olesen J.E. (2000) Modelling ammonia volatilization from animal slurry applied with trail-hoses to cereals. *Atmospheric Environment* 34, 2361-2372.

## Microwave for dock control on grassland

Latsch R. and Sauter J.

*Agroscope Reckenholz-Tänikon Research Station ART, CH-8356 Ettenhausen, Switzerland*

Corresponding author: roy.latsch@art.admin.ch

### Abstract

Experiments with microwave technology were carried out in order to provide an alternative method of controlling dock weed on grassland. Two microwave devices of 4.8 kW and 18 kW were therefore tested under different site and weather conditions. The microwaves were applied to heat the extremely regenerative dock roots to their physiological collapse. Time series were used to obtain optimum treatment times for a minimum plant dying rate of 80%; therefore, four different trial varieties were chosen. In general, microwave technology is suitable for the treatment of dock plants and to prevent re-sprouting. The optimum heating time with an 18 kW microwave device is 28 s, which means 0.09 l diesel per plant. The required length of all treatment variants, and hence the amount of energy to be applied, were shown to be high.

Keywords: Broad-leaved dock, *Rumex obtusifolius*, weed-control, microwave technology, grassland

### Introduction

Broad-leaved dock (*Rumex obtusifolius*) is a common but unwelcome plant in meadows and pastures. Dock species are very competitive and are therefore seen as appropriating the space and nutrients of valuable fodder crops. The chief method of dock control in organic farming is to dig out the plants by hand. Organic farmers are therefore interested in procedures that reduce the physical effort of dock control. Microwave technology is thought to be a possible method of eliminating dock plants without soil movement. The roots in the ground are heated to such a high temperature that proteins denature, DNA is destroyed and hence the plant dies. The aim of this research is to clarify if microwave treatment could be a practicable and economic alternative to traditional manual dock control.

### Materials and methods

Two self-propelled microwave prototypes with accompanying generators, built in cooperation with Gigatherm, Grub, CH and Odermatt Landtechnik, Hunzenschwil, CH, were used to treat dock in field trials at different locations. Key technical data are given in Table 1. Prototype I was tested with one power output setting, and Prototype II with three different power output settings (Table 2). 'Pulse' means an interrupted heating time with the aim of achieving better temperature distribution in the root. Heating at 25% power output was intended to clarify whether it was possible to achieve energy optimisation of the process by a corresponding extension of heating time at lower heating capacity. Prior to treatment isolated dock plants on various meadow locations were marked and measured with a high-precision RTK-GPS for rating purposes. During the treatment generated microwaves were discharged directly into the soil by way of dirt-protected waveguides. Plant treatment was carried out for different heating times so as to be able to identify an optimum time (Table 2). Soil moisture at the sites was determined by means of TDR (Moisture Point, Environmental Sensors Inc., Victoria, CA). Visual monitoring of re-sprouting was carried out four, eight and twelve weeks after treatment.

Table 1: Performance data of microwave prototypes

Trial variant	Prototype	Generator output (kW)	Power output (kW)	Magnetrons	Heating area (cm <sup>2</sup> )	Power density (W cm <sup>-2</sup> )	Time-out interval (s)
1	Type I 100 %	9.6	4.8	6	193	24.9	
2	Type II 100 %	36	18.0	12	302	59.6	
3	Type II pulse	36	18.0	12	302	59.6	6
4	Type II 25 %	9	4.5	12	302	14.9	

Table 2: Trial variants, heating times and quantity of treated plants

Trial variant	Proto-type	Power output	Number of treated plants depending on heating time in seconds														
			5	10	15	20	25	30	35	40	50	60	70	80	100	120	140
1	Type I	100 %		87	168	163	154	147	133	119							
2	Type II	100 %	25	24	35	57	60	49	15								
3	Type II	100 % pulse	12	35	50	40	15	15									
4	Type II	25 %								20		20	20	13	13		

In statistical evaluations of the trial series with Prototype II using the gls model (generalised least squares), interactions between the parameters of soil moisture, heating period and pulsing were tested by F-test. Heating energy per area (W cm<sup>-2</sup>) is a measure of the amount of energy needed to achieve a particular dieback rate in each machine configuration. The fuel requirement per plant indicates the effectiveness of the trial variant.

## Results and discussion

A minimum of 80% was set as the target plant dying rate (Figure 1). Optimum theoretical heating times could therefore be calculated by linear regression. For the variant with Prototype I the optimum heating time was 45 seconds. In the case of Prototype II the unpulsed (28 s) and pulsed (27 s) heating times were very close together. For pulsed heating the interval pauses still needed to be added on (Table 1, Table 3). With 25% power output the heating time increased just under fourfold at 101 s. These calculated values served as the basis for a variant comparison from an energy point of view.

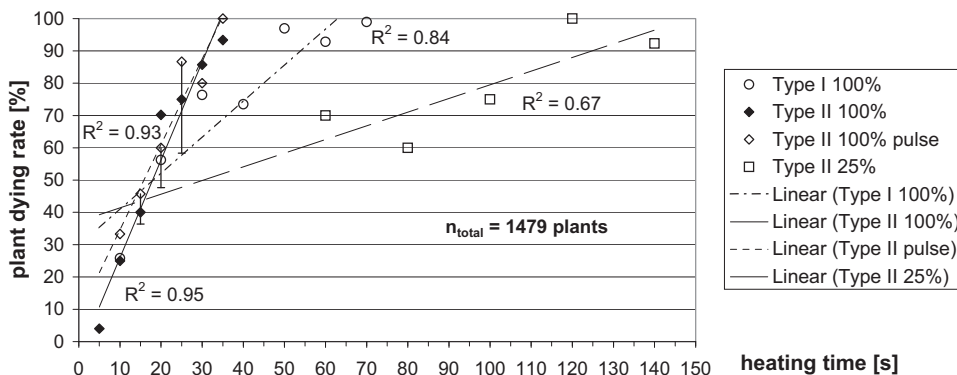

Figure 1: Percentage of dying plants when treated with two microwave prototypes (Type I: 4.8 kW, Type II: 18 kW) for different heating times

In statistical evaluations heating period and pulsing had a significant influence on plant dying rates, but there was no significant interaction with soil moisture. On average the treatment of plants using pulsed heating intervals was approximately 5 % more effective than that using continuous heating ( $F_{1.5} = 6.26$ ,  $p = 0.02$ ). When heating time was increased by one second, the plant dieback rate rose by approximately 3 % ( $F_{1.25} = 122.78$ ,  $p < 0.001$ ).

The target value of a minimum 80 % plant dying rate was achieved at a heating energy per area of around 1070 W cm<sup>-2</sup> with Prototype I and at approximately 1550 W cm<sup>-2</sup> with Prototype II, Prototype II having treated a larger area (Table 1). The variation in the data indicates that the site (series) played a subordinate role in successful treatment.

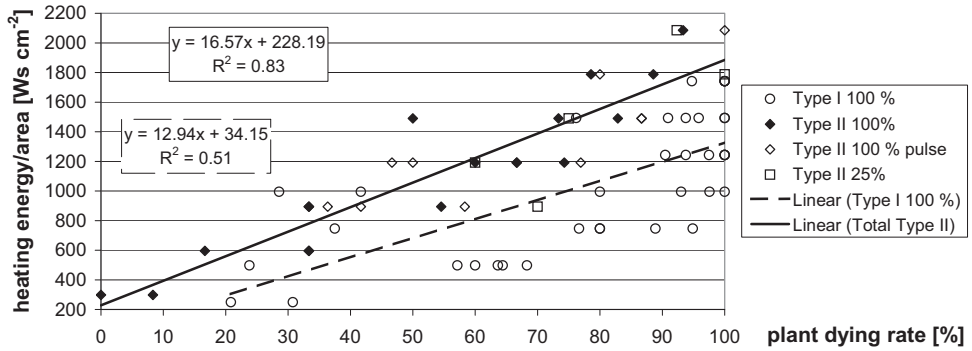

Figure 2: Heating energy input per area and plant dying rate in all field trial series

Efficiency during microwave generation was around 50 % of the energy supplied. A power generator which doubles the electrical output of the microwave's heating capacity is therefore required. According to Rinaldi *et al.* (2005), 272 g kWh<sup>-1</sup> fuel is needed for a diesel unit to generate 36 kWh energy. The average density of diesel fuel is 0.83 kg l<sup>-1</sup>. The consequential fuel requirement per dock plant is shown in Table 3.

Table 3: Optimum heating time and energy use of the microwave device at 80% success rate

Trial variant	Prototype	Optimum heating time (s)	Fuel requirement per dock plant (l)
1	Type I 100 %	45.0	0.04
2	Type II 100 %	27.9	0.09
3	Type II 100 % pulse	27.2	0.11 (including time-out interval)
4	Type II 25 %	101.3	0.08

## Conclusions

The field trials described show that the microwave operating principle works for dock control. The indication is that longer heating times at lower power output are more efficient from an energy viewpoint. The amounts of fuel which need to be used are still considerable, and 80-220 l ha<sup>-1</sup> of diesel are needed, assuming moderate densities of 2000 dock plants per hectare. In addition to the net cost of fuel for heating, the cost of fuel when idling between individual treatments, the towing vehicle's energy consumption, the acquisition cost as well as overheads and variable costs also need to be taken into account when costing the total process. Because of the extended heating times in the pulsed and the reduced-output variant, the area treated per hour also works out as comparatively lower, a fact reflected in the cost of the method. Due to the high energy requirement and, in some cases, the high time requirement, the methods tested cannot therefore be considered practicable.

## References

Rinaldi M., Erzinger S. and Stark R. (2005) Treibstoffverbrauch und Emissionen von Traktoren bei landwirtschaftlichen Arbeiten. In: Forschungsanstalt Agroscope Reckenholz-Tänikon ART (ed) *FAT-Schriftenreihe* 65, Ettenhausen, 92 pp.

# Influence of cutting date and pre-conditioning on the energy production from grassland through the integrated generation of solid fuel and biogas from biomass (IFBB)

Richter F., Fricke T. and Wachendorf M.

*Department of Grassland Science and Renewable Plant Resources, University of Kassel, Steinstr. 19, 37213 Witzenhausen, Germany*

Corresponding author: frichter@uni-kassel.de

## Abstract

A novel procedure, the integrated generation of solid fuel and biogas from biomass (IFBB), is suggested to improve the conversion of biomass from permanent grasslands into energy. The objective of this project was to determine the influence of cutting date and pre-conditioning of the biomass on the net energy yield of IFBB in comparison with anaerobic digestion of whole-crop silage (WCD) and combustion of hay (CH). Biomass samples were taken from a permanent lowland grassland (*Arrhenaterion*) on eight consecutive cutting dates between 27 April and 21 June 2007, ensiled for three months and subjected to a hydrothermal conditioning at different temperatures (10, 30, 50, 70 and 90 °C), followed by a mechanical separation into a press fluid and a press cake. Net energy yields based on methane yields and heating values were higher in CH and lower in WCD compared with IFBB. Highest net energy yield of the IFBB process (9.31 MWh ha<sup>-1</sup>) was obtained with biomass cut on 31 May and a conditioning temperature of 50°C. Energy production from press fluids (electricity and heat as proportion of gross energy yield) showed a significant relationship ( $R^2=0.81$ ,  $P<0.001$ ) to the dry matter concentration in the silage and to the conditioning temperature.

Keywords: bioenergy, biogas, solid fuel, permanent grassland, harvest date, conditioning

## Introduction

Among the potential sources of biomass in Europe, grassland plays a certain role since 0.08 of the total land area and 0.38 of the agricultural area is covered by permanent pastures and meadows (FAOSTAT, 2009). In many European countries the traditional management of large areas of permanent grassland as a feed source in animal husbandry is at risk of being abandoned because the herbage does not meet the yield and quality demands of intensive livestock production (Isselstein *et al.*, 2005). To ensure the conservation of these permanent grasslands, the production of energy as an alternative management option might be suitable, but this potential is limited due to plant compounds, which are detrimental for the conventional conversion techniques (anaerobic digestion, combustion). The integrated generation of solid fuel and biogas from biomass (IFBB) process was developed to overcome these limitations (Figure 1; Wachendorf *et al.*, 2009). Its basic principle is the separation of biomass into a liquid fraction (press fluid, PF) and a solid fraction (press cake, PC) after a hydrothermal conditioning (a mash of silage and heated water) in order to optimise energy conversion. The PF feeds the biogas plant with an adapted solid-state digester. Subsequently, the biogas is used in a combined heat and power plant (CHP) to produce electricity and heat. The PC, which is composed primarily of cellulose and lignin, is dried with the heat from CHP and processed to a solid fuel that has improved combustion characteristics compared with the untreated biomass. The objective of this study was to evaluate the influence of cutting date and pre-conditioning on the energy production from a permanent grassland sward converted according to the IFBB process, in comparison with anaerobic digestion of whole crop silage (WCD) and combustion of hay (CH).

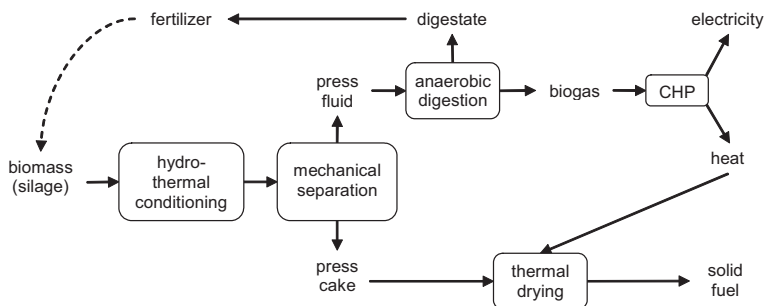

Figure 1. Flow chart of the integrated generation of solid fuel and biogas from biomass (IFBB). CHP refers to as combined heat and power plant.

## Materials and method

Biomass from a permanent lowland hay meadow (*Arrhenaterion*) in Northern Hesse, Germany, was harvested and ensiled at eight different dates during a primary growth from 27 April until 21 June 2007. In the previous 10 years the grassland has been managed with two annual cuts for hay making (beginning of June and mid August) followed by grazing with sheep, and no fertilizer or further treatments were applied. The silage from each harvest date was subjected to five different temperature treatments under hydrothermal conditioning (10°C, 30°C, 50°C, 70°C, 90°C) and subsequent mechanical separation with a screw press (type AV, Anhydro Ltd., Kassel, Germany) without any replication. The PF and the silage were used as feedstock for anaerobic digestion in batch experiments under mesophilic conditions. The concentrations of C, H and N in the PC and the silage were analysed and used for the calculation of the higher heating value (HHV) according to Friedl *et al.* (2005). Net energy yields were calculated as balance of energy input values based on Richter *et al.* (2010) and energy output based on observed methane yields for biogas production (IFBB and WCD) and HHV for heat production from solid fuel (IFBB and CH). Proportional DM field and storage losses were assumed to be 0.12 for WCD and IFBB and 0.25 for CH. The extent of waste heat utilization from the CHP was assumed to be 0.25 in WCD and 1 in IFBB.

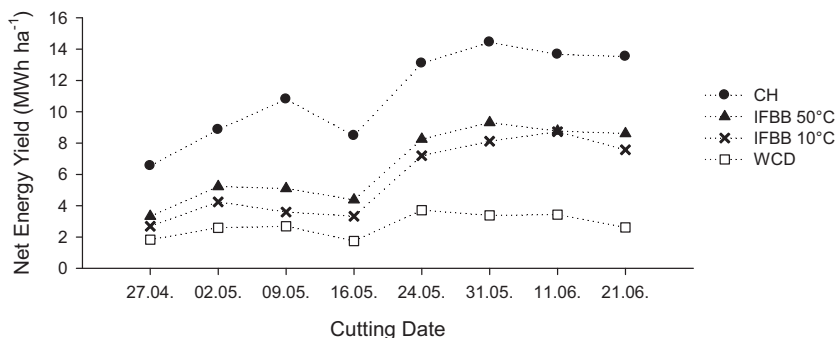

Figure 2. Net energy yield of grassland biomass converted through CH, WCD and IFBB with two conditioning temperatures (10°C and 50°C) at different cutting dates.

## Results and discussion

Net energy yields of CH and IFBB 50°C increased continuously over time until 31 May, with exception of 16 May, which was due to a very low DM yield at this date (Figure 2). They reached a maximum at the sixth cutting date with 14.3 and 9.31 MWh ha<sup>-1</sup> for CH and IFBB



50°C, respectively, and decreased slightly thereafter, because of the lower quality of the biomass of the last two cutting dates for energy production. IFBB 10°C had a maximum net energy yield at the seventh cutting date (8.72 MWh ha<sup>-1</sup>) and WCD at the fifth cutting date (3.71 MWh ha<sup>-1</sup>). Net energy yields of IFBB 30°C, IFBB 70°C and IFBB 90°C were between IFBB 10°C and IFBB 50°C (data not shown). Energy yield from press fluids (electricity and heat as proportion of gross energy yield) showed a significant relationship ( $R^2=0.81$ ,  $P<0.001$ ) to the dry matter concentration in the silage and to the conditioning temperature in a multiple regression analysis (Figure 3).

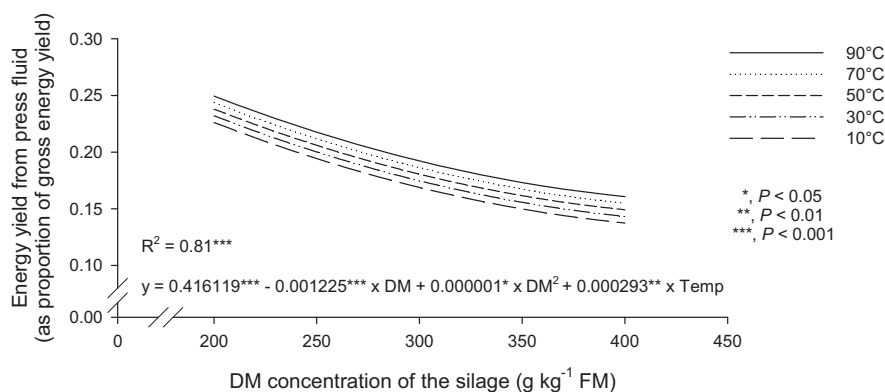

Figure 3. Relationship between energy yield from press fluids (electricity and heat) and dry matter (DM) concentration of the silage and temperature of hydrothermal conditioning.

## Conclusion

The combustion of hay achieved the highest net energy yields, but fuel quality, which is reduced through high mineral concentrations, must be considered. The IFBB procedure obtained intermediate net energy yield, with a maximum at a combination of cutting at 31 May and a hydrothermal conditioning at 50°C. Lowest net energy yields were achieved by the whole-crop digestion of silage. Based on a multiple regression it was possible to determine the energy yield via the press fluid from the DM concentration in the silage used as parent material for the IFBB process and the conditioning temperature ( $R^2=0.81$ ,  $P<0.001$ ).

## References

- FAOSTAT (2009) <http://faostat.fao.org/site/377/default.aspx#ancor> (accessed 29 January 2010)
- Friedl A., Padouvas E., Rotter H. and Varmuza K. (2005) Prediction of heating values of biomass fuel from elemental composition. *Analytica Chimica Acta* 544, 191-198.
- Isselstein J., Jeangros B. and Pavlu V. (2005) Agronomic aspects of biodiversity targeted management of temperate grasslands in Europe – A review. *Agronomy Research* 3, 139-151.
- Richter F., Fricke T. and Wachendorf M. (2010) Utilization of semi-natural grassland through integrated generation of solid fuel and biogas from biomass. III. Effects of hydrothermal conditioning and mechanical dehydration on solid fuel properties and on energy and green house gas balances. *Grass and Forage Science* 65, 185-199.
- Wachendorf M., Richter F., Fricke T., Graß R. and Neff R. (2009) Utilization of semi-natural grassland through integrated generation of solid fuel and biogas from biomass. I. Effects of hydrothermal conditioning and mechanical dehydration on mass flows of organic and mineral plant compounds, and nutrient balances. *Grass and Forage Science* 64, 132-143.

# Grassland yield response to knife/tine slurry injection equipment – benefit or crop damage?

Halling M.A.<sup>1</sup> and Rodhe L.<sup>2</sup>

<sup>1</sup>*Department of Crop Production Ecology, Swedish University of Agricultural Sciences, Box 7043, SE 75007 Uppsala, Sweden.*

<sup>2</sup>*JTI – Swedish Institute of Agricultural and Environmental Engineering, Box 7033, SE 75007 Uppsala, Sweden.*

Corresponding author: Magnus.Halling@vpe.slu.se

## Abstract

Slurry injection into grassland has advantages over slurry spreading as it decreases ammonia losses and odour and improves forage hygiene. However, injection may harm grassland plants, although similar knife-based equipment is used on lawns to stimulate growth.

In split-split-plot field experiments, four different types of knife/tine equipment were tested on three different grassland swards (monocultures of red clover, perennial ryegrass, red fescue), with or without added nitrogen. In two separate experiments, the injection treatments were applied in spring (late April) or after the first cut in mid-June. Different methods were used to measure crop damage during growth in order to predict yield decreases due to knife/tine damage, but not all results are presented here. Statistical analyses of total dry matter yields determined in three cuts per year showed significant differences between knife/injector tine treatments and the control. During the first year, sward yield decreased by 1-8% in the treatments with knives/injector tines compared with no knives/injector tines, whereas during the second year the yield decrease was 3-9%. All techniques had the same effect on all grassland species, with or without added mineral nitrogen. The least reduction in yields was obtained with vertical cut or angled disc injection applied in mid-June.

Keywords: injector tines, crop damage, grassland species, N-fertilisation

## Introduction

Slurry injection into grassland has certain advantages over slurry spreading as it decreases ammonia losses and odour and improves forage hygiene. However, in spite of the reduction in ammonia emissions with slurry injection compared with surface spreading, many studies report little or no effect on yield from the injection technique compared with surface spreading. The most common explanation given for this is that damage to the grass sward caused by injector tools balances out the larger amount of ammonium nitrogen left after slurry injection. Shallow injection without slurry application has been shown to significantly reduce grass yields compared with no injection (Rodhe *et al.*, 2006). On the other hand, knife attachments similar to injector tines are used on lawns to stimulate grass growth.

The overall objective of this study was to evaluate the sward damage caused by different kinds of knife/injector tine equipment used in spring or summer in three different grassland swards, with and without added mineral nitrogen.

## Materials and methods

### *Experimental site and design of experiments*

The experiments had three replicates and were conducted on a field located south-east of Uppsala (59°50'N, 17°42'E). In field experiments with a split-split-plot design, four types of knife/injector tine (sub-sub-treatment) were combined with three different grassland swards

(sub-treatment; monocultures of red clover (*Trifolium pratense* L.) cultivar Vivi; perennial ryegrass (*Lolium perenne* L.) cv. SW Birger; and red fescue (*Festuca rubra* L.) cv. Rubin), with or without added nitrogen (main treatment). In the treatment with added N, the two grass swards received 100, 80 and 60 kg ha<sup>-1</sup> N at the three cuts. For red clover, the corresponding levels were 50, 30 and 20 kg ha<sup>-1</sup> N. Control plots with no knife/injector tine treatments were also included. Two experiments were carried out, with treatments applied in spring or after the first cut in mid-June, respectively. The plots (15.5 m<sup>2</sup>) were harvested three times per year during 2008 and 2009 using a Haldrup plot harvester with 1.5 m working width. The herbage removed was weighed and sub-sampled for dry matter (DM) determination.

The Mixed procedure in the statistics programme SAS Version 9 (Littell *et al.*, 2006) was used for statistical analysis.

### Soil and crop conditions

One composite soil sample consisting of 10 sub-samples randomly collected from the experimental site was analysed for texture and organic matter content. The soil at the site was classified as a loam, with 17.5% clay, 46.5% silt, 30.3% sand and an organic matter content of 5.7%.

### Knife and injector tine equipment

The four knife/injector tine types used were: 1) Vertical cut made by a plain disc couler; 2) vertical and horizontal cuts made by a plain disc couler followed by a tine with a horizontal knife 3); injector with two angled discs (open slot) (Rodhe *et al.*, 2004); and 4) tubulator tine with slot closer (Rodhe *et al.*, 2006). The knives/injector tines were positioned at 0.25 m spacing over a total working width of 2 m and were operated at 0.05 m working depth.

## Results and discussion

### Yield

Statistical analyses revealed significant differences between the application techniques (Table 1). Application technique had no significant interaction with sward, which meant that all treatments (or levels) of this factor had the same effect with all application techniques. However, the type of application technique had a significant interaction with nitrogen in one of the two years.

Table 1. Mean dry matter yields (kg ha<sup>-1</sup>) in the control and in treatments with different knife/injector tine equipment (means for the three grassland species and with or without added nitrogen) in 2008, 2009 and sum of 2008 and 2009

Knife/tine equipment	2008		2009		Sum 2008-09	
	Spring	Summer	Spring	Summer	Spring	Summer
1. Control	11 498	11 478	10 252	10 398	21 723	21 916
2. Vertical cutter	10 604	11 361	9 530	10 022	20 191	21 383
3. Vertical and horizontal cutter	10 600	10 745	9 377	9 941	19 977	20 687
4. Injector with two angled discs	10 837	11 226	9 911	10 126	20 748	21 414
5. Tubulator tine	10 634	10 669	9 546	9 982	20 258	20 651
Mean	10835	11096	9723	10094	20579	21210
<i>P</i>	0.0043	0.0006	0.0018	0.0737	0.0002	0.0022
LSD	494	403	431	339	692	653

LSD = least significant difference at *P* < 0.05

The statistical analyses also revealed a significant interaction between species and N level (results not shown). The yield decreases caused by knife/tine injectors were larger when

treatments were applied in spring (April) compared with summer (mid-June), especially during the first year. In the second year, this was also the case for all techniques except the injector with two angled discs (treatment 3), while for the total yields of the two years all treatments gave a significantly lower yield than the control in the spring experiment. In the summer experiment, there was no significant difference in total yield between the control and the vertical cutter (treatment 1) or between the control and the injector with two angled discs (3), but the yields for the vertical and horizontal knives (2) and for the tubulator tines (4) were both significantly lower than in the control. The yield was significantly lower in most cases in the cut taken directly following treatment for most of the techniques during both years, e.g. spring treatment gave a significantly lower first cut yield and summer treatment gave a significantly lower second cut yield. For both years, summer treatment gave a higher total yield than spring treatment.

During the first year, yields decreased by between 1 and 8% for the treatments with knives/injector tines compared with no knives/injector tines, whereas in the second year the decrease was 3-9%. The least harmful knife/injector equipment in spring and summer was the injector with two angled discs (3), while in the summer experiment the vertical cut coulter (1) also caused the smallest yield decreases. Overall, the results show that crop damage caused by the injection knives/tines may counteract any yield increase from nitrogen saved through injecting slurry into grassland.

## **Conclusion**

All knife or injector tine equipment tested in grassland in spring resulted in significantly lower total yields compared with the control (no treatment). When such equipment was used in summer, the damage was not significant for all types of techniques, e.g. yields after treatment with a vertical cut coulter or an angled disc injector were not significantly lower than in the control.

Application technique had no significant interaction with sward and nitrogen level, which means that all sub-treatments (or levels) of these two factors had the same effect with all application techniques.

## **References**

- Littell R.C., Milliken G.A., Stroup W.W., Wolfinger R.D. and Schabenberger O. (2006) *SAS for Mixed Models*. SAS Institute Inc, Cary, NC.
- Rodhe L., Rydberg T. and Gebresenbet G. (2004) The influence of shallow injector design on ammonia emissions and draught requirement under different soil conditions. *Biosystems Engineering* 89 (2), 237-251.
- Rodhe L., Pell M. and Yamulki S. (2006) Nitrous oxide, methane and ammonia emissions following slurry spreading on grassland. *Soil Use and Management* 22, 229-237.

## Better grazing opportunities with a mobile milking robot

Haan M.H.A. de, Philipsen A.P., Van den Pol-van Dasselaar A., Holshof G., Lenssinck F.A.J. and Koning C.J.A.M. de

*Wageningen UR Livestock Research, P.O. Box 65, 8200 AB Lelystad, the Netherlands*

Corresponding author: michel.dehaan@wur.nl

### Abstract

Although grazing of dairy cows is very common in the Netherlands, the number of grazing cows is decreasing. Mobile milking robots might support grazing, in particular in situations of large herds, in remote grassland areas and in extensive natural grasslands. In the Netherlands, a stand-alone mobile milking robot has been developed using caterpillar tracks. Every day, this milking robot moves to a new part of the pasture and every two days concentrates, fuel, water and milk are separately transported from and to the mobile milking robot. The system was tested in the 2008 grazing season using a herd of 35 dairy cows. During the 2009 grazing season the project was scaled up to a herd of 60 cows on an area of 20 ha peat soil. In 2009 a strip grazing system with controlled as well as free cow traffic was used in order to increase the visit and milking frequency. The mobile milking robot was capable of managing a 60-cow herd grazing 24 hours while producing a rolling milk average of 7500 kg cow<sup>-1</sup> yr<sup>-1</sup>. The challenge is to improve the milk yield per cow and year by increasing the milking frequency.

Key words: grazing, grazing system, mobile milking robot, automatic milking

### Introduction

Although grazing of dairy cows is very common in the Netherlands and the north-western part of Europe, the number of grazing cows is decreasing. This development is unfavourable concerning farm economics and societal preferences (Van den Pol-van Dasselaar *et al.*, 2008). Grazing is the most cost-effective option to feed dairy cows and also animal health and animal welfare seem to profit from grazing. Furthermore, society appreciates a landscape with grazing cattle. A mobile milking robot might be an opportunity to support grazing, in particular in situations of large herds, remote grassland areas and extensive natural grasslands. Therefore a stand-alone mobile milking robot was developed in the Netherlands. Since it was unknown whether a mobile milking robot would function technically well in grazing conditions, the first goal was to explore the technical results of the milking procedure in the field. The next goal was to develop a suitable farming system, managing more than 60 cows yielding about 8000 kg cow<sup>-1</sup> yr<sup>-1</sup> of milk.

### Materials and methods

The developed mobile milking robot is based on three components, namely a track-wheeled carrier vehicle, a container storing the equipment needed for robotic milking, and a DeLaval VMS robot. The system is completely self-propelled and more mobile than other systems (Oudshoorn, 2008). The only inputs needed are diesel for driving and generating electricity, fresh water for rinsing the robot, and concentrates for feeding the animals. The caterpillar tracks were chosen to achieve low pressure on soil. Every day, the milking robot moves to a new part of the pasture and every two days the concentrates, fuel, water and milk are separately transported from and to the mobile milking robot. This is done using a trailer with different storage facilities, which was specially developed for the project that started on the experimental farm 'Zegveld' on peat soil in 2008. During that grazing season 35 dairy cows, remaining day and night in the field, were milked by the system. A continuous grazing system

was implemented. All cows stayed in the same, large paddock for 6 weeks. During the 2009 grazing season the project was scaled up to a herd of 60 dairy cows on an area of 20 ha. In 2009, a strip grazing system was used combined with controlled cow traffic. The cows could only enter a strip of fresh grass by passing the mobile milking robot. After a period of 10 hours, when all cows passed the robot, the fence was removed and cows could then visit the milking robot voluntarily. From September 2009 on, strip grazing was combined with free cow traffic, which means unlimited mobility for the cows. During the grazing period no additional roughage was supplied. In 2008 the project aimed to test the technical performance as well as monitor the continuous grazing system on a large surface. In 2009 the method of plan-do-check-act cycle was used. The project started with a strip grazing system and, if needed, the grazing system was adjusted every three weeks.

## Results and discussion

In 2008 the mobile milking robot proved to function technically very well. Within 5 minutes the complete system could be moved to a new grazing strip. Only a few failures occurred during the testing period. The number and size of technical failures were the same as for an indoor milking robot. However, the milk yield per cow and day was lower than in the winter period, when cows were kept inside.

Table 1 shows that the average milk yield in the winter period 2008-2009 was  $3.6 \text{ kg d}^{-1}$  higher than in the 2008 grazing period. Also, the milking frequency that is generally considered a main influencing factor for milk yield was lower in the grazing period than in the winter period. In 2008, walking distances to the mobile milking robot were relatively long (up to 400 metres) due to the implemented continuous grazing system using a large surface of land. This caused a decline in the milking frequency (van Houwelingen *et al.*, 2009). To increase the milking frequency strip grazing was introduced in May 2009 aiming at short walking distances and higher milk yields per cow and day compared with 2008. The maximum walking distance of the dairy cows to the mobile milking robot was 75 metres. The data presented in Table 1 indicate a higher milk yield and a higher milking frequency in the 2009 grazing period than in 2008. The grazing period with controlled cow traffic from June to August 2009 still showed lower milk yields than produced in the winter period. One of the reasons for this might have been the lower milking frequency  $\text{cow}^{-1}$  compared to the winter period.

Figure 1 shows the milking activity of the dairy cows for the indoor period and the grazing period in 2009. Cows seemed to be less active during the night on pastures than indoors. The next stage in this project will be to motivate cows to visit the mobile milking robot during the night by, for example, offering fresh grass in the night and only allow access to a new pasture when the cow has been milked. Free cow traffic combined with strip grazing might also be a solution. Table 1 shows that free cow traffic in September and October 2009 resulted in a high milking frequency; milk yield however was still  $3.8 \text{ kg d}^{-1}$  lower than in the indoor situation. The increased milking frequency was probably caused by the poor grass quality in September and the cows' eagerness for concentrates that were offered in the milking robot. On the other hand, the herd got more and more used to day and night grazing and to the mobile milking robot in 2008 and 2009 which might have increased the voluntary visitation frequency permanently. The challenge in this project is to improve the milk yield, probably by increasing the milking frequency.

Table 1. Milking frequency, milk yield and number of cows for different periods and different systems

Grazing/feeding system	Period	Number of cows	Milk yield (kg cow <sup>-1</sup> d <sup>-1</sup> )	Milking frequency (milkings cow <sup>-1</sup> d <sup>-1</sup> )
Continuous grazing, free cow traffic	June 2008 – Sept 2008	35	18.5	1.9
Winter period, indoor feeding, no grazing	Jan 2009 – May 2009	59	22.1	2.4
Strip grazing, controlled cow traffic	June 2009 – Aug 2009	61	19.3	2.1
Strip grazing, free cow traffic	Sept 2009 – Oct 2009	50	17.3	2.4

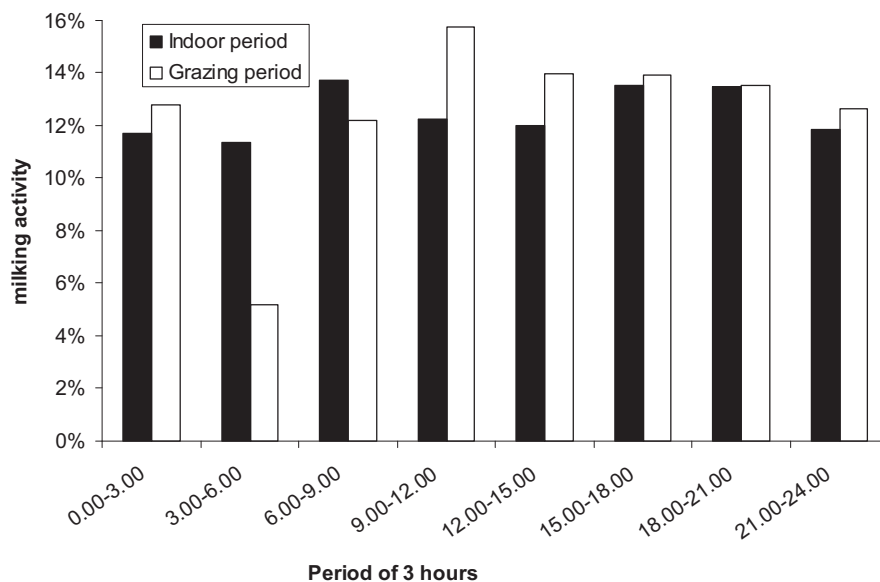

Figure 1. Milking activity of dairy cows during different periods of the day (% of day total, day total =100) for the indoor period and the grazing period of 2009.

## Conclusions

The mobile milking robot is capable of combining a herd of 60 dairy cows and a 24 hours grazing system without any additional roughage, producing a rolling average of 7500 kg cow<sup>-1</sup> yr<sup>-1</sup> milk with the option of up to 8000 kg cow<sup>-1</sup> yr<sup>-1</sup>. Long walking distances to the milking robot cause low milking frequencies and therefore low milk yields. Offering fresh grass when passing the milking robot motivates cows to visit the system. However, there is still a challenge in improving the milk yield by increasing milking frequency. Therefore, free cow traffic and steered strip grazing need to be explored further in spring and summer.

## References

- Houwelingen van K.M., Haan M.H.A. de, Lenssinck F., Philipsen A.P. and Baars R.N. (2009) *Eerste ervaringen met de mobiele melkrobot*. Lelystad, Animal Sciences Group of Wageningen UR, Rapport 196, 28 pp.
- Oudshoorn F.W. (2008) Mobile milking robot offers new grazing concept. *Grassland Science in Europe* 13, 721-723.
- Van den Pol-van Dasselaar A., Vellinga T.V., Johansen A. and Kennedy E. (2008) To graze or not to graze, that's the question. *Grassland Science in Europe* 13, 706-716.



## Slurry seeding in grassland in Norway

Nesheim L.

*Norwegian Institute for Agricultural and Environmental Research. Grassland and Landscape Division, Kvithamar, N-7000 Stjørdal, Norway*

Corresponding author: lars.nesheim@bioforsk.no

### Abstract

A method of mixing seeds of different crops and liquid animal manure is called slurry seeding or wet seeding. The method is so far more used for seeding forage crops than for grasses and clover. A Norwegian company has developed a system for adding and mixing seeds into animal slurry at the liquid manure spreader. The seed-enriched slurry is either applied on the surface by a trailing hose (band spreading) or injected in the soil. Thus, the process combines manure application, seeding of forage or cover crops, and aeration tillage if the slurry is injected. The method may also contribute to an increased sward age. During the last three years the system of slurry seeding has been investigated at different sites in Norway, from dry inland areas to coastal areas with a high annual precipitation. Slurry seeding by use of the injector or the band spreader was compared to direct drilling of seeds only, and full renovation of the swards including ploughing. Where the sward was killed by herbicides, slurry seeding resulted in about the same DM yields and botanical composition as traditional renovation. In the case of swards not destroyed by chemical treatment the results were more variable, particularly at the first cut.

Key words: Animal manure, band spreader, feed quality, slurry injector, wet seeding

### Introduction

The Norwegian company Agromiljø AS has developed a seed-dosing system for adding and mixing seeds into animal slurry at the liquid manure spreader immediately before the slurry is applied to the ground. The seed-enriched slurry is either applied on the surface by a trailing hose (band spreading) or injected in the soil. The method is called slurry seeding or wet seeding. The process combines manure application, seeding of forage or cover crops, and aeration tillage if the slurry is injected. By overseeding grasses and legumes, the sward may last longer, which is an additional benefit. Experiments by Volden *et al.* (2005) showed that the slurry had only minor negative effects on the seed germination of grasses and clover. Jones and Roberts (1989) investigated the effects of slurry seeding on sward maintenance of *Lolium multiflorum*. They concluded that slurry seeding is a useful technique for extending the life of an Italian ryegrass sward. Field trials in Norway showed that slurry seeding on the surface with a band spreader may increase the proportion of red clover in the sward (Volden, 2005). During the past three years the seed-dosing equipment of Agromiljø AS has been investigated at four sites in Norway, from dry inland areas to coastal areas with a high annual precipitation. In this paper results from field experiments with slurry seeding of swards, either chemically destroyed or with dense original vegetation, are presented.

### Materials and methods

During the years 2007 and 2008, thirteen experiments were established in Central Norway, South-Western Norway and Eastern Norway. Due to great differences in the time of establishing the experiments and in the growing conditions, it is difficult to interpret average values of the experiments. In this paper we have chosen to present results from only two experiments.

The slurry seeding was accomplished with a prototype rig with a width of 3 meters. The distance between the coulters was 15 cm. The seed-enriched slurry was either injected in the ground (AM injector) or applied on the surface with the rig lifted about 15 cm above the surface (AM band spreader). The experiments were established either on swards chemically destroyed (4 litres ha<sup>-1</sup> of Roundup Eco) or on swards where no herbicides were applied. In most experiments approximately 30 tons of diluted (3-5 % dry matter DM) animal manure per hectare was applied. The amount of seed mixture was, in most cases, 25 kg per hectare. Slurry seeding was compared to traditional methods of grassland renovation, as seeding on harrowed or ploughed land.

## Results and discussion

A field trial was established in April in a three-year-old sward dominated by timothy (*Phleum pratense*) and meadow fescue (*Festuca pratensis*). No herbicide was used. The treatments are shown in Table 1. The amount of a mixture of several varieties of perennial ryegrass (*Lolium perenne*) was 25 kg ha<sup>-1</sup>. At 6 and 8 weeks after seeding, the establishment of ryegrass was successful after seeding with the AM injector, with a cover of 60-70 per cent. In October the per cent cover of ryegrass was similar in plots seeded with the AM injector to plots seeded with the conventional seeding machine. However, the DM yield at the second cut was significantly higher where the injector was used (2.7 tons ha<sup>-1</sup>) than at plots seeded conventionally (1.8 tons ha<sup>-1</sup>).

Table 1. The cover of ryegrass (as %) recorded about 3, 6 and 8 weeks after seeding on 16 April. At 11 October the cover of ryegrass was visually estimated on four plots of 0.25 m<sup>2</sup> each. One field trial established in South-West Norway in the spring of 2007

Method of fertilization/seeding	% ryegrass in 1 m seed row			% ryegrass on small plots
	4 May	25 May	8 June	11 October
AM injector, with seeds	7	70	60	50
AM injector, no seeds	0	0	0	13
AM band spreader, with seeds	2	10	20	30
AM band spreader, no seeds	1	5	2	18
AM band spreader, conv. seeding machine	2	10	10	45
<i>P</i> -value	ns	ns	0.01	0.01

In Central Norway an old sward was sprayed with glyphosate at 7 August 2007. One week after the grass was cut and removed from the field. One treatment was sprayed the day before seeding. On 16 August all plots were seeded with timothy using the methods shown in Table 2. The germination was very slow due to wet and cold weather after seeding. The plots were cut twice in 2008 and once in 2009. The DM yield was significantly lower at the first cut in 2008 where the plots had been seeded just after spraying. The reason may be that the grass (approximate 20 cm height) was not removed. At the second cut and at the first cut in 2009 there were no significant yield differences between seeding methods. The proportion of timothy in 2008 was much higher where a conventional seeding machine was used, compared to seeding by the injector and the band spreader. In the following year the proportion of timothy was similar on all treatments. In addition to timothy the dominant species was *Taraxacum*.

Table 2. Dry matter yield and proportion of timothy at the first and second cut in 2008 and at the first cut in 2009. Results for one field trial in Central Norway, established in the autumn of 2007.

Method of fertilization/seeding	Yield, t ha <sup>-1</sup>		Timothy, % of DM yield			
	2008		2009		2009	
	Cut 1	Cut 2	Cut 1	Cut 1	Cut 2	Cut 1
AM injector, seeded just after spraying	1.8	3.9	6.3	30	20	73
AM injector, seeded 7 d. after spraying	3.6	3.9	6.7	43	30	68
AM band spreader, seeded 7 d. after spraying	4.2	3.7	6.6	50	38	80
AM band spreader, seeded 7 d. after spraying, with a conventional seeding machine	4.0	5.3	6.9	88	80	88
Commercial fertilizer, seeded 7 d. after spraying, with a conventional seeding machine	4.5	4.1	7.8	70	60	75
<i>P</i> -value	0.01	ns	ns	0.01	0.04	ns

## Conclusions

There is more likelihood of achieving a successful reseeding of grasses and clover on swards treated chemically than where the original vegetation is not destroyed. There was a great variation between field trials in terms of the success of reseeding by different methods. This was due to differences in climate, soil conditions etc. Reseeding at 0-2 days after spraying in autumn was a failure in most cases. In general, slurry seeding either by use of injector or band spreader was as successful as other methods.

## Acknowledgements

This work has been financed by The Research Council of Norway, the company Agromiljø AS and The Norwegian Agricultural Extension Service.

## References

- Jones E.L. and Roberts J.E. (1989) Sward maintenance of *Lolium multiflorum* by slurry seeding. *Grass and Forage Science* 44, 27-30.
- Volden B. (2005) Maintenance of red clover in established grassland by wet sowing of seed mixed into manure. *Proceedings from the 5th Circumpolar Agricultural Conference*, Umeå, Sweden.
- Volden B., Vastveit K. and Haugland E. (2005) Spiring av ert, bygg, rødkløver, raigras og timotei etter opphold av ulik varighet i konsentrert og uttynnet blautgjødsel av storfe. *Planteforsk Vågonens Report*, 6 pp.

## Continuous and rotational grazing system with horses: effects on gorse production understorey developed under *Pinus radiata* stand

Mosquera-Losada M.R.<sup>1</sup>, Mouhbi R.<sup>1</sup>, González-Hernández M.P.<sup>1</sup>, Boubaker A.<sup>2</sup> and Rigueiro-Rodríguez A.<sup>1</sup>

<sup>1</sup> Crop Production Department. High Politechnic School. University of Santiago de Compostela. Lugo Campus. 27002-Lugo

<sup>2</sup> INAT. Tunis. Tunisia

Corresponding author: mrosa.mosquera.losada@usc.es

### Abstract

Grazing systems have different effects on understorey productivity and biodiversity, and these effects should be evaluated to obtain better understorey management and sustainable production systems. This experiment aimed to evaluate the effects of two different grazing systems (continuous vs. rotational) on two different types of gorse understorey (*Ulex europaeus* (European gorse) and *Ulex gallii* (Galician gorse)) in terms of productivity (biomass and its fractions). The results of this study will promote more sustainable techniques for rangeland management. Both continuous and rotational grazing systems on each understorey are useful tools for reducing biomass and, therefore, fire risk, because gorse biomass is the fuel that is fired. The rotational grazing system caused significant damage to the European gorse shrub, limiting its recovery once grazing was stopped. In contrast, the more intensive grazing of European gorse plants under rotational, rather than continuous grazing, had a positive effect on the reduction of fire risk by decreasing the biomass. Under the conditions of our study area, the decline was more noted under European gorse rotational grazing system, but on the Galician gorse this decline was found under continuous grazing.

Key words: biomass, biodiversity, horse

### Introduction

Galicia is one of the most fired regions of Europe (Rigueiro-Rodríguez *et al.*, 2009). In *Pinus radiata* plantations, if no understorey management is implemented, a dense shrub understorey usually develops, creating an important fire risk. Shrubland origin seems to be the result of interactions between the climate, geology, soil, the historical evolution of the area and the human previous management (Webb, 1998). Shrub communities occupy nearly 30% of the Galician territory that was used for beekeeping, beef livestock grazing, bovine, goat, ovine and equine. Shrublands in Galicia include around twelve phytosociological classes corresponding to the associations Daboecio cantabricae-Ulicetum gr. Gallii europaei-Ericetum vagantis y Gentiano pneumonanthes-Ericetum mackaiana (Álvarez *et al.*, 2004). The reduction of biomass of the understorey is a key point to reduce forest fire risk and spread once the fire has started. Therefore, adequate shrub management is very important to reduce forest fires in Galicia (Rigueiro-Rodríguez *et al.*, 2009) and in Mediterranean regions of Europe (Robles *et al.*, 2009). Among other fire-reducing risk strategies, grazing is the most efficient tool for understorey reduction to achieve both conservation and productive objectives. Rustic breeds have been proven to be able to thrive on those poor resources, decreasing woody biomass and thus reducing the fire risk and preserving biodiversity. It produces a dominance of herbaceous species as a result of repeated animal actions of consumption and trampling (Rigueiro-Rodríguez *et al.*, 2009). In this paper, productivity of gorse spp. (*Ulex europaeus* (European gorse) and *Ulex gallii* (Galician gorse)) was studied in continuous and rotational grazing systems for horses.

## Materials and methods

The study was conducted in the forest of San Breixo (Parga-Guitiriz, province of Lugo, NW Spain; 43°09 N, 7° 48 W, at 500 m a.s.l.). The farm has 321 ha afforested with *Pinus radiata* D. Don between 30 and 35 years ago, 24 ha of which were used in the present study. Understorey initial vegetation was dominated by European gorse and Galician gorse (over 80%), being the main reason to choose the autochthonous breed of horse ‘Caballo Gallego de monte,’ due to the preference of this horse breed for this shrub. The experiment followed a randomized block design with two treatments (continuous and rotational grazing) and two replicates of 6 ha each. Every replica of the 6 ha rotational plots was sub-divided into four plots of 1.5 ha each. A global stocking rate of 0.33 animals per hectare was used, being 1.33 animals per hectare for the instantaneous stocking rate in the rotational grazing system. The initial weight of horses was 300 kg. Horses started to graze in July 2000 and grazing ceased in December 2002. Gorse biomass production for both types of grazing treatments was estimated by harvesting three quadrats in a 1 x 1 m cage every month. In the rotational grazing system, samples were taken before the horses entered each subplot and exclusion cages were used to quantify understorey biomass production in continuous plots. Samples were transported to the laboratory, where 100 g of shrub material was taken and separated into two fractions: stems (diameter > 0.5 cm) and sprouts (diameter < 0.5 cm). Each fraction was then split into woody (sum of woody components in the fractions above and below 0.5 cm) and leaf subfractions (sum of leaf components in the fractions above and below 0.5 cm). The different fractions were oven-dried (48 h at 60 °C) and weighed to determine the dry matter (DM) biomass production overall and for each fraction. ANOVA was performed to analyse the data and LSD to separate means, once ANOVA resulted significant.

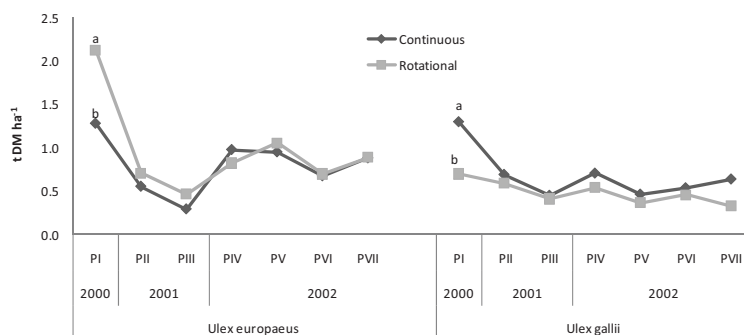

Figure 1. Total gorse (*Ulex europaeus* and *U. gallii*), biomass dry matter on offer ( $\text{t ha}^{-1}$ ) under continuous and rotational grazing in each case. P1: period 1, PII: period 2, PIII: period 3, PIV: period 4, PV: period 5, PVI: period 6, PVII: period 7, PXI: period 9. Different letters indicate significant differences between understorey species in the same period.

## Results and discussion

Gorse biomass production decreased significantly under both grazing systems (Fig. 1). At the beginning of the study, European gorse biomass was significantly higher than Galician gorse on the rotational system ( $P < 0.05$ ) but under the continuous grazing system Galician gorse biomass was significantly higher. After P1, gorse biomass was similar under both treatments and both understorey strata. This reduction as a result of grazing by lignivorous animals has been recorded in many experiments and is considered an important tool for reducing fire risk in the Atlantic (Rigueiro-Rodríguez *et al.*, 2009) and Mediterranean biogeographic regions of Europe (Etienne *et al.*, 1994; Robles *et al.*, 2009).

Total average European gorse ( $0.9 \text{ t ha}^{-1}$ ) biomass was higher than Galician gorse ( $0.7 \text{ t ha}^{-1}$ ) (Fig. 2). We see a reversible effect of grazing systems: highly rotational European gorse biomass and its stem proportion, and they were important on the continuous Galician gorse grazing system. For Galician gorse under continuous grazing the sprout, leaves and ligneous contribution were significantly high ( $P < 0.05$ ).

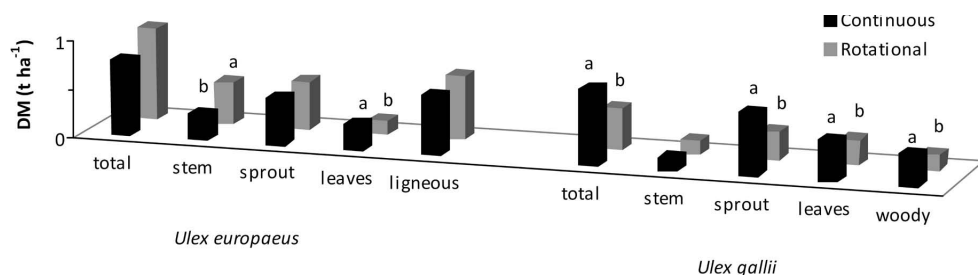

Figure 2. Total biomass dry matter and its components ( $\text{t ha}^{-1}$ ) averages on gorse understorey layers under continuous and rotational grazing systems. Different letters indicate significant differences between understorey species in the same period.

## Conclusions

Both continuous and rotational grazing systems grazed by horses are useful tools for reducing biomass and, therefore, fire risk, through their effects of causing significant damage to the gorse shrubs. Grazing systems had a positive effect on both types of gorse shrublands, and can induce important changes in the seasonal dynamics of the productivity and relative proportion of the species.

## References

- Álvarez M.A., García P. and Valderarabanco J. (2004) *Tipificación, cartografía y evaluación de los pastos españoles*: Ministerio de ciencia y tecnología.
- Etienne M., Huber B and Misika B. (1994) Sylvopastoralisme en région méditerranéenne. *Revue Forestière Française* 46, 30-41.
- Rigueiro-Rodríguez A., Fernández-Núñez E., Gonzalez-Hernandez M.P., McAdam J.H. and Mosquera-Losada M.R. (2009b) Agroforestry Systems in Europe: Productive, Ecological and Social Perspectives. In: Rigueiro-Rodríguez A., McAdam J. and Mosquera-Losada M.R. (eds.) *Agroforestry in Europe*. Springer, The Netherlands. Springer 6, pp. 43-61.
- Robles A.B., Ruiz-Mirazo J., Ramos M.E. and González-Rebollar J.L. (2009) Role of livestock in Spain Mediterranean Forest and scrubland as food recourse for Spanish Ibex. In: Rigueiro-Rodríguez A., McAdam J. and Mosquera-Losada M.R. (eds.) *Agroforestry in Europe*. Springer, The Netherland. Springer 6, pp. 211-231.
- Webb N.R. (1998) Forum: Biodiversity and high-nature-value farming. The traditional management of European heathlands. *Journal of Applied Ecology* 35, 987-990.

# Productivity and yield quality of white clover -grass mixed swards depending on cutting frequency

Adamovics A. and Adamovica O.

Latvia University of Agriculture, 2 Liela iela, LV 3001, Jelgava, Latvia.

Corresponding author: Aleksandrs.Adamovics@llu.lv

## Abstract

Field trials were carried out in 2005-2008 with the aim of studying continuous green forage production from white clover-grass swards in the stage of intensive growth. The 16 mixed binary swards were developed on silt loam cutanic luvisol and were fertilized with N 0, N 90<sub>(45+45)</sub>, P 78 and K 90 kg ha<sup>-1</sup>. The binary swards were composed of white clover cv. Rivendell and six perennial ryegrass, six *Festulolium* and four hybrid ryegrass cultivars. Swards were cut two to four times during the growing season. The white clover Rivendell in mixtures with grasses of various growth patterns provided continuous green forage production during the whole summer season. The botanical composition and frequency of cutting affected the average dry matter (DM) productivity of a sward (5.78 to 8.60 Mg ha<sup>-1</sup>). The ratio of white clover, and the interaction between clover and different grass cultivars in clover-grass swards, determined the crude protein content in the total DM yield of each sward as well as the CP content for each component in a sward. The average net energy of lactation (NEL) content of DM of mixed stands was 5.76-5.88 MJ kg<sup>-1</sup>.

Key words: white clover–grass, mixtures, cutting, productivity

## Introduction

A legume planted with a grass can improve the nutritive quality of the forage consumed by livestock and provide nitrogen to the grassland ecosystem. Perennial ryegrass (*Lolium perenne* L.) is one of the world's primary grazed grasses in temperate regions. It is an important species in Europe because of its easy establishment, fast regrowth after cutting, and high feeding quality. Hybrid ryegrass (*Lolium x boucheanum* Kunth.) gives better production than perennial or long rotation ryegrass, and in summer-wet areas, most varieties will persist for up to 5 years. *Festulolium* hybrids are promising species to be used as fodder grasses. Because of its competitive productivity *Festulolium* may be ranked equally with the main forage grasses timothy and meadow fescue grown in the climatic zone of Eastern Europe (Skuodiene and Daugeliene, 2001; Kryszak *et al.*, 2002; Gutmane and Adamovics, 2007). The goal of our research was to study the productivity and yield quality of the mixed white clover–grass swards in relation to cutting frequency.

## Materials and methods

Field trials (2005 - 2008) were carried out with the aim of studying continuous green forage production from white clover-grass swards in the stage of intensive growth. The 16 pure and 16 mixed binary swards were developed on silt loam cutanic luvisol (pH<sub>KCl</sub> 6.7), containing available P 52 mg kg<sup>-1</sup>, K 128 mg kg<sup>-1</sup>, organic matter content 21 to 25 g kg<sup>-1</sup> of soil, and were fertilized with N 0, N 90<sub>(45+45)</sub>, P 78 and K 90 kg ha<sup>-1</sup>. The binary swards were composed of white clover cv. Rivendell and six perennial ryegrass (Spidola, Napoleon, Belida, Tove, Tetramax, Tivoli), six *Festulolium* (Punia, Paulita, Perun, Lofa, Felina, Hykor) and four hybrid ryegrass (Saikava, Solid, Riga, Tapirus) cultivars. Swards were cut two to four times during the growing season.



The total seeding rate was 1000 germinating seeds per m<sup>2</sup>. The ratio of white clover–grass seeds in mixtures was 400:600 in binary mixtures.

The plots were fertilised as follows: P 40, K 150 and N 90<sub>(45+45)</sub> kg ha<sup>-1</sup>. Swards were cut two to four times per season. The botanical composition (white clover, grass, herbs) was determined both between the growth periods.

The chemical composition of the plants was determined by the following methods: dry matter (DM) by drying; crude protein (CP) by modified Kjeldahl; crude fibre (CF), neutral detergent fibre (NDF) and acid detergent fibre (ADF) by the van Soest method. The difference between metabolisable energy (ME) was calculated on the basis of the chemical composition of DM, using digestibility coefficients and full value coefficients. The DM yield data were statistically processed using the three-factor analysis of variance.

## Results and discussion

In pure stands the average DM yield of grasses was 6.12-7.06 t ha<sup>-1</sup> under two cuts of utilization, and 5.45-5.72 t ha<sup>-1</sup> under four cuts of sward utilization. White clover in binary mixtures with grasses developed productive forage grass swards with the average DM yields ranging from 8.91 to 10.30 t ha<sup>-1</sup> under a two-cut system in 3 years of sward utilization, and 8.56 to 10.21 t ha<sup>-1</sup> under a four-cut system in a growing season. Depending on the cutting regime, highly productive mixed swards of white clover in association with *Lolium x boucheanum* were developed (Table 1).

Table 1. White clover–grass swards productivity and yield quality (average from three years of sward use)

Regime of cutting (FA)	Composition of swards (F <sub>B</sub> )	DM yield t ha <sup>-1</sup>	Content in DM, g kg <sup>-1</sup>		Digestibility <i>in vitro</i> DM
			CP	NDF	
Two - cuts	<i>L. perenne</i> *	6.12	142	436	65.7
	<i>Lolium x boucheanum</i> **	6.93	153	452	67.0
	<i>Festulolium</i> ***	7.06	139	470	61.3
	<i>Tr. repens</i> + <i>L. perenne</i>	9.65	167	402	67.7
	<i>Tr. repens</i> + <i>Lolium x boucheanum</i>	10.30	162	429	68.3
	<i>Tr. repens</i> + <i>Festulolium</i>	8.91	147	433	63.7
	Average	8.16	152	437	65.6
Four - cuts	<i>L. perenne</i> *	5.45	162	368	72.5
	<i>Lolium x boucheanum</i> **	5.72	164	389	70.3
	<i>Festulolium</i> ***	5.55	153	403	68.7
	<i>Tr. repens</i> + <i>L. perenne</i>	8.56	179	325	72.0
	<i>Tr. repens</i> + <i>Lolium x boucheanum</i>	10.21	180	347	69.5
	<i>Tr. repens</i> + <i>Festulolium</i>	8.89	172	356	70.1
	Average	7.40	168	365	70.5
LSD <sub>0.05</sub>	(F <sub>A</sub> )	0.27			
	(F <sub>B</sub> ) and (F <sub>AB</sub> )	0.33			
	(F <sub>Trial</sub> )	0.40			

*L. perenne* \* - average from cv. Spidola, Napoleon, Belida, Tove, Tetramax, Tivoli.

*Lolium x boucheanum*\*\* - average from cv. Saikava, Solid, Riga, Tapirus.

*Festulolium*\*\*\* - average from cv. Punia, Paulita, Perun, Lofa, Felina, Hykor.

Perennial ryegrass in combination with white clover produced average DM yields of 8.56 to 9.65 t ha<sup>-1</sup>; hybrid ryegrass and *Festulolium* hybrids provided average DM yields of 10.25 and 8.90 t ha<sup>-1</sup>, respectively.

Increased sward cutting frequency reduced the DM yield of all swards, on average by 0.76 t ha<sup>-1</sup> (15.5%); however, the productivity of the mixed swards under intensified cutting was reduced only by 4.2%.

The botanical composition of the sward essentially influences CP and NDF content in the dry matter. In pure stands the average CP content in DM of the grass species ranged from 139–153 g kg<sup>-1</sup> under two cuts, and 153–164 g kg<sup>-1</sup> DM under four –cuts of sward utilization. The CP in DM of white clover-grass swards ranged from 147– 67 g kg<sup>-1</sup> and 172–180 g kg<sup>-1</sup> respectively. *T. repens* + *L. perenne* and *T. repens* + *Lolium x boucheanum* swards have a higher CP content. NDF content in DM was from 325 to 470 g kg<sup>-1</sup>. Our studies show that mixed white clover–grass swards provided CP yields of 1.31–1.86 t ha<sup>-1</sup>.

At the fertilizer N0 treatment there was a significant white clover content reduction in swards under the two-cut regime, in comparison with the four-cut regime. Under four cuts the share of white clover in the total yield of DM increased by 25-37%, depending on the grasses species. More frequent sward use resulted in the reduction of NDF content in dry matter by 10.2% on average and had a positive effect on DM digestibility. The coefficient of *in-vitro* DM digestibility for pure grass and mixed white clover-grass swards was comparatively high, being 61.3 to 72.5% on average.

## Conclusion

Pure perennial ryegrass, hybrid ryegrass, *Festulolium* and mixed white clover–grass swards have a high and comparatively stable productivity. These swards can be used in different forage production systems and produce quality grass forage. Depending on the cutting regime, highly productive mixed swards were developed when growing white clover in association with *Lolium x boucheanum*. Increasing cutting frequency of swards slightly reduced DM yield, but raised its quality.

## Acknowledgements

This publication has been prepared within the framework of the ESF Project „Attraction of human resources to the research of the renewable energy sources” Contract Nr. 2009/0225/1DP/1.1.1.2.0/09/APIA/VIAA/129.

## References

- Gutmane I. and Adamovich A. (2007) Productivity and persistency of *Festulolium* and *Lolium x boucheanum* swards. In: Permanent and Temporary Grassland ( EGF). *Grassland Science in Europe* 12, 59– 62.
- Kryszak J., Domański P. and Jokiś W. (2002) Use value of *Festulolium brauni* (K.Richter) A. Camus cultivars registered in Poland. *Grassland Science in Europe* 7, 436 – 437.
- Skudieniė R. and Daugeliėnė N. (2001) The productivity of *Festulolium*/ clover swards under different management systems. *Grassland Science in Europe* 6, 30 – 32.

# Comparison of three traditional uses of forage production of mountain meadows in western Azerbaijan, Iran

Akbarlou M., Mesdaghi M. and Sepehry A.

*Department of Range Sciences, University of Agricultural Sciences and Natural Resources, Gorgan, Iran.*

Corresponding author: akbarlo@gmail.com

## Abstract

The world's meadows are the most productive kind of rangelands. The development of croplands and overgrazing has led to a decline in diversity and reduced meadow areas. In Iran, mountain meadows mostly occur in north-west of the country, especially in the Chaldran areas. The people of Chaldran have different uses of mountain meadows which affects directly the forage production. The objective of this research was to investigate the effects of utilization methods on forage production of mountain meadows. To sample the study locations in Chaldran based on the current traditional uses and the soil moisture percentages, nine study units were selected and were randomly sampled by using 25×60 cm<sup>2</sup> plots. In each location, production and soil characteristics were measured and analysed by using completely randomized design with two factors of traditional uses and soil moisture regimes. The effects of edaphically factors on traditional uses were analysed by using canonical correlation analysis (CCA) as ordination technique. Significant differences were observed among traditional uses in different soil moisture contents ( $P < 0.05$ ). Therefore, the forage yield increased with increasing soil moisture. There was a significant difference among application of harvesting method so the forage production highly increased. The yield under direct grazing method was less than the other traditional uses.

Key words: mountain meadows, traditional uses, harvesting, forage production, soil moisture.

## Introduction

The mountain meadows of Iran are located mostly in western Azerbaijan, especially in the Chaldran region (Mesdaghi, 2004). Local people of Chaldran have different traditional uses of mountain meadows including harvesting, harvesting-grazing, and grazing (Fig. 1), which affect directly the forage production. The main objective of this research was to investigate the effects of different traditional uses on forage production in the Chaldran mountain meadows.



Figure 1. Traditional uses of mountain meadows in western Azerbaijan. A. harvesting, B. harvesting-grazing, and C. grazing.

## Material and methods

The mountain meadows of Chaldran are located in an area between latitude 38°44'29" and 39°24'10"N, and longitude 44°10'44" and 44°17'14"W, at an altitude range of 1800-3000 m. The study area is located in a semi-steppe region with cold climate and annual rainfall of 350 mm y<sup>-1</sup> (Akbarlou, 2009). To determine the study locations in Chaldran, nine study units were selected based on the current uses and the soil moisture regimes, the locations were randomly sampled by using 25×60 cm<sup>2</sup> plots (Daubenmire, 1959). In each location, production and soil characteristics were measured and analysed by using completely randomized design with two factors of uses and soil moisture regimes. The effects of edaphic factors on three different uses were analysed by using canonical correlation analysis (CCA) ordination technique (Jongman *et al.*, 1987).

Table 1. Mean forage production differences (kg ha<sup>-1</sup>) under three traditional uses (first number) at increasing soil moisture levels (second number) in Chaldran.

Study unit	1-1	1-2	1-3	2-1	2-2	2-3	3-1	3-2	3-3
1-1	0								
1-2	183 <sup>ns</sup>	0							
1-3	196 <sup>ns</sup>	12 <sup>ns</sup>	0						
2-1	205 <sup>ns</sup>	21 <sup>ns</sup>	9 <sup>ns</sup>	0					
2-2	224 <sup>ns</sup>	40 <sup>ns</sup>	28 <sup>ns</sup>	19 <sup>ns</sup>	0				
2-3	724 <sup>*</sup>	540 <sup>*</sup>	52 <sup>*</sup>	518 <sup>*</sup>	500 <sup>*</sup>	0			
3-1	338 <sup>*</sup>	154 <sup>ns</sup>	142 <sup>ns</sup>	133 <sup>ns</sup>	114 <sup>ns</sup>	384 <sup>*</sup>	0		
3-2	383 <sup>*</sup>	199 <sup>ns</sup>	187 <sup>ns</sup>	178 <sup>ns</sup>	159 <sup>ns</sup>	340 <sup>*</sup>	49 <sup>ns</sup>	0	
3-3	256 <sup>ns</sup>	72 <sup>ns</sup>	60 <sup>ns</sup>	51 <sup>ns</sup>	31 <sup>ns</sup>	468 <sup>*</sup>	83 <sup>ns</sup>	127 <sup>ns</sup>	0

Uses-Moisture \*Statistically significant ( $P < 0.05$ ) differences and ns non significant

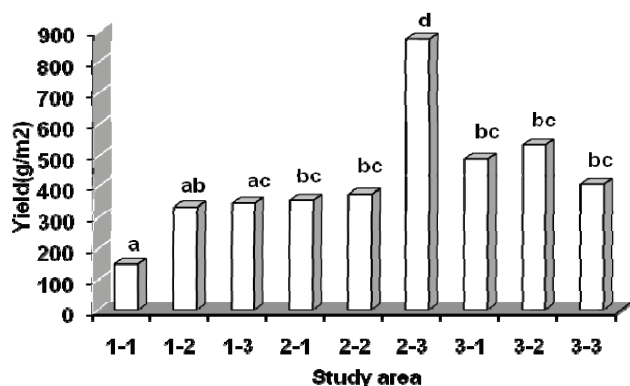

Figure 2. Comparison of mean forage production (kg ha<sup>-1</sup>) under three traditional uses (first number) at increasing soil moisture levels (second number); means followed by the same letter are not significantly different ( $P > 0.05$ ).

## Results

Most of the meadows in western Azerbaijan are located in high mountains near the border between Iran and Turkey. Significant differences were observed among different uses in different soil moisture content ( $P < 0.05$ ); therefore, by increasing soil moisture, the forage yield was also increased (Fig. 2). There were also significant differences in forage production among harvesting and other uses ( $P < 0.05$ ) (Table 1) and (Fig. 3). The analysis of CCA showed that harvesting meadows had high correlation with soil moisture, soil depth, and Carbon/Nitrogen.

## Conclusion

As the subsistence of people in Chalدران is highly dependent on meadows, so by harvesting and storage of forage, their benefits from meadow are quite sufficient (O'Connor, 1994; Sharifi Niyaragh, 1998). But grazing after harvesting is not so detrimental to grasses and thus can be considered more sustainable than harvesting only.

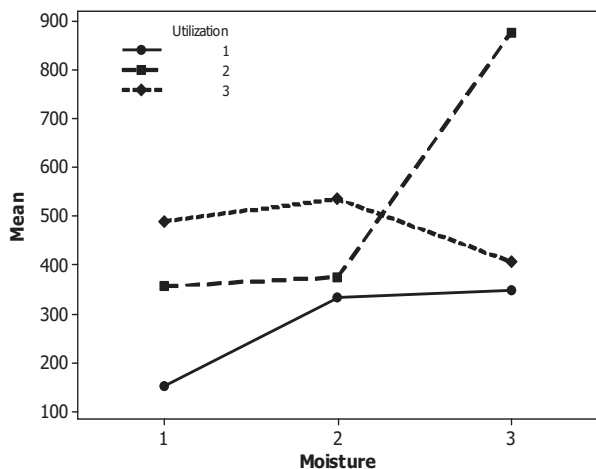

Figure 3. Interaction effect on mean forage production (kg ha<sup>-1</sup>) between three traditional uses and increasing soil moisture levels in study area in Chalدران

## Acknowledgment

This research was carried on with the financial support of Gorgan University of Agricultural Science and Natural Resources. Authors would like to thank Akbarzade A., and the colleagues of General office of West Azerbaijan Natural Resource Iran all who kindly helped in fulfilling the project.

## References

- Akbarlou M. (2009) *Current utilization impacts on vegetation parameters of mountain meadows in Chaldoran, west Azerbaijan*. PhD Thesis University of Agricultural Science and Natural Resources, Gorgan Iran, 113pp.
- Daubenmire R. F. (1959) A canopy-coverage method of vegetation analysis. *Northwest Science* 33, 43-66.
- Jongman R.H.G., Ter Braak C.J F. and van Tongeren O.F.R. (1987) *Data analysis in community and landscape ecology*. Pudoc, Wageningen.
- Mesdaghi M. (2004) *Range management in Iran*. Astane Ghouds Razavi, 333pp.
- O'Connor T.G. (1994) Composition and population response of an African savanna grassland to rainfall and grazing. *Journal of Applied Ecology* 31, 155-171.
- Sharifi Niyaragh (1998) An investigation on plant diversity and life forms of Ardebil meadows. *Periodic Journal of Pajouhesh Sazandegi* 33, 26-31.

## Pastures feeding value response to humic fertilizers

Klimas E. and Balezentiene L.

Lithuanian University of Agriculture (LUA), Studentų 11, LT-53361, Akademija, Kaunas distr., Lithuania

Corresponding author: Ligita.Balezentiene@lzuu.lt

### Abstract

Humus content determines soil fertility as well as affecting crop yield. Natural formation of humus is important, but this is a long and slow process. This process could be improved by applying different organic fertilizers. The humic fertilizer 'Turbo Grass' containing 9.7% of organic acids was applied at different rates to improve the feeding value of grass on dairy farms. The objective was to evaluate the impact of humic fertilizers (up to 32 l ha<sup>-1</sup>) on grass chemical composition, yield, metabolisable energy (ME), net energy (NEL) and digestibility of intensively managed sown pastures in combination with different rates of mineral fertilization. Rates of humic and complex fertilizers had different effects on recorded parameters.

Keywords: fertilizing, grass, yield, feeding value

### Introduction

Perennial grasses can grow without risk under natural conditions at middle latitudes due to their long vegetation, good utilization of environmental resources and high productivity (12-15 t ha<sup>-1</sup> dry matter (DM); 110-115 g kg<sup>-1</sup> protein in DM). Applications of bioactive humic fertilizers can help to improve productivity and feeding value of established grass on poor soils as well as increasing the humus content and soil bioactivity in intensive grassland (Peña-Mendez *et al.*, 2005). These fertilizers also improve humus decomposition in soil, trace element mobility and availability, soil structure, aeration and humidity balance. Turbo Grass (TG) is an organic fertilizer which originated from American leonardites and is composed of 7.8% humic acids, 1.9% fulvic acids and 19.5% K. Humic and fulvic acids improve soil physical and chemical properties, and therefore stimulate grass growth and productivity. K is specifically important for water transport, stress tolerance, photosynthesis, accumulation of amino acids and protein synthesis etc.; therefore, TG may increase grass feed value. Recommended TG rates are 20-25 l ha<sup>-1</sup> in spring and 5-10 l ha<sup>-1</sup> after each cut. TG improves interaction between soil fractions, aeration, water balance, and assimilation of N, P, K and microelements by transforming insoluble P forms into plant-available P. This humic fertilizer stimulates germination, promotes root system development, grass growth and stress-resistance during drought or frosts, and therefore helps reduce sward deterioration. The objective of this investigation was to evaluate the impact of different Turbo Grass application rates on grass chemical composition under different background rates of mineral fertilization.

### Materials and methods

Field trials were performed at O. Baltrušaitienė farm, Kauno distr. Lithuania in 2006-2007 on a sandy moraine, loam humic horizon of *Calcary Epihypogleyic Luvisol*. The sward (10% red clover 'Liepsna', 10% timothy 'Gintaras', 10% blue grass 'Lanka', 15% white clover 'Atoliai', 15% lucerne 'Birutė', 15% perennial raygrass 'Žvilgė', 25% meadow fescue 'Dotnuvos I') was sown (25 kg ha<sup>-1</sup>) in 2005. The area of each treatment plots was 2 m x 5 m (net area 2 m x 3 m). Complex fertilizers at 300 kg ha<sup>-1</sup> were applied early in spring, and 150 and 100 kg ha<sup>-1</sup> NH<sub>4</sub>NO<sub>3</sub> of supplementary fertilizers were applied after the 1<sup>st</sup> and 2<sup>nd</sup> cuts

respectively. The experimental site was not grazed, but used only for fresh herbage production. Four mineral fertilizer treatments ( $N_8P_{20}K_{30}$ ,  $N_8P_{20}K_{30} + M$  (microelement),  $N_8P_{13}K_{24}$ ,  $N_8P_{24}K_{24}$ ) were combined with five TG rates including an unfertilized control (Control (0), 8, 16, 24 and 32 l ha<sup>-1</sup>) which were applied as early as possible in spring (Fig. 1). The treatment  $N_8P_{20}K_{30}$  is commonly accepted as optimally balanced for grass, and this was therefore taken as the control. The 2-cut system was applied manually at the beginning of the flowering stage. Chemical content of the sward was determined at Kiel University. Botanical composition, dry matter, crude protein (CP) and crude fibre (CF) were determined according to the commonly used Wende forage analyses. Metabolisable energy (ME, MJ kg<sup>-1</sup>) and net energy of lactation (NEL, MJ kg<sup>-1</sup>) of grasses were calculated by the formula of Nauman and Bassler (1993). The level of statistical confidence of the data was calculated by the method of dispersion analysis using ANOVA. The SE was used to evaluate differences between chemical composition and ME of the fertilization treatments studied.

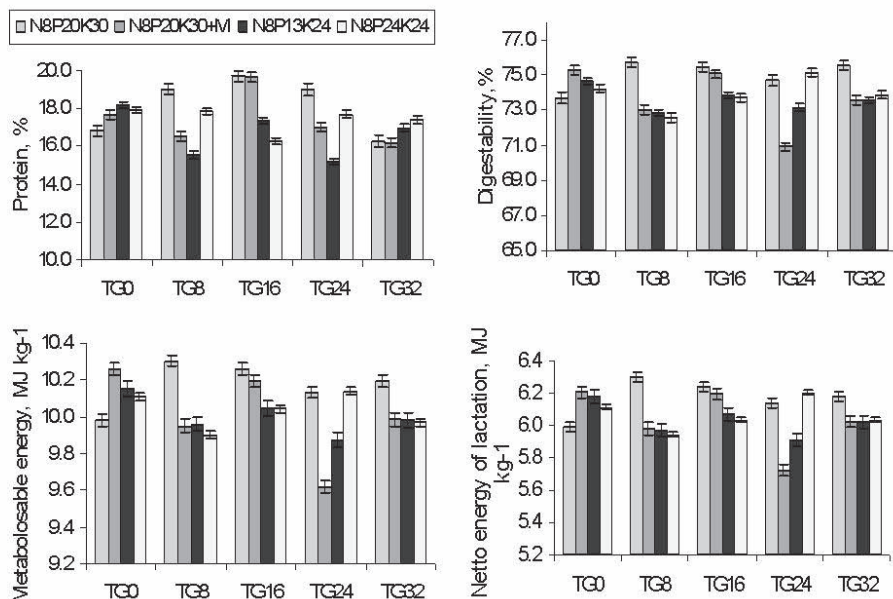

Figure 1. NPK +Turbo Grass impact on mean protein content, digestibility, metabolisable and net lactation energy (mean  $\pm$ SE,  $P < 0.05$ )

## Results and discussion

Application of the TG humic fertilizer improved grass nutritional indices significantly by increasing all of them at the 2<sup>nd</sup> cut due to its gradual and delayed effect on soil fertility by increasing soil bioactivity, content of humic acids and available nutritional elements. Rates of TG application affected grass quality differently according to mineral fertilizer composition (Fig. 1).  $N_8P_{20}K_{30}$  is commonly accepted as an optimal fertilization for grass; therefore the  $N_8P_{20}K_{30} + TG$  at 8-16 l ha<sup>-1</sup> and the  $N_8P_{20}K_{30} + M + TG$  at 16 l ha<sup>-1</sup> treatments significantly increased mean protein content, while higher TG rates (24-32 l ha<sup>-1</sup>) decreased the protein content to 19.00-16.29% ( $r = -0.4$ ). Other fertilization rates did not correspond to a balanced ratio for grass supplemented with TG rates and showed weak and medium negative correlations ( $r = -0.3$ ;  $-0.6$ ) with grass protein content.

TG rates were correlated with DM digestibility ( $r = 0.5$ ) only in the  $N_8P_{20}K_{30}$  and in the  $N_8P_{20}K_{30}+M$  treatments. Fertilization with lower  $P_{13-24} K_{24}$  rates+ TG was insufficient to



increase biomass digestibility. Mean DM digestibility varied insignificantly (between 72.60-76.60%) in  $N_8P_{13}K_{24}$  and  $N_8P_{24}K_{24}$  treatments ( $r = 0.1$ ;  $-0.3$ ).

Significant mean ME increases of 0.15-0.31 MJ kg<sup>-1</sup> were obtained only in the  $N_8P_{20}K_{30}+TG$  at 8-32 l ha<sup>-1</sup> when compared with the control ( $N_8P_{20}K_{30}+TG_0$ ; 9.98 MJ kg<sup>-1</sup>), although there were no significant differences in ME content (10.13-10.26 MJ kg<sup>-1</sup>) between TG at 8-16 l.  $P_{24} K_{24} + TG$  at 8 and 32 l ha<sup>-1</sup> significantly decreased ME by 0.21 and 0.20 MJ kg<sup>-1</sup> respectively, compared with that of TG 0 (Control).  $N_8P_{13}K_{24}$  fertilizer containing low P ratio (P13) resulted in the highest mean ME rate (10.36 MJ kg<sup>-1</sup>) only with TG at 32 l ha<sup>-1</sup>. Application of  $N_8P_{20}K_{30}+M + TG$  at 24 l ha<sup>-1</sup> decreased ME and NEL, mostly due to organic compounds in the DM.

Mean NEL increase (0.18-0.31 MJ kg<sup>-1</sup>) was obtained under the largest  $N_8P_{20}K_{30} + TG$ , as compared with the NEL mean value (6.0 MJ kg<sup>-1</sup>) for the Control. Importance of K use could be suggested by the NEL decrease observed for the fertilizing treatments with lower K application. Fertilizing with  $N_8P_{13}K_{24}$  and  $N_8P_{24}K_{24} +$  different TG rates caused NEL to vary insignificantly.

A weak residual effect of applied humic fertilizing on grass growth was observed in the following year after this 2-year experiment, possible due to gradual increase of labile humus substances in soil. Nonetheless, further studies are necessary to accurately determine the effect of TG on soil fertility.

## Conclusions

Fertilizer application using  $N_8P_{20}K_{30}+M$  without humic fertilizer TG stimulated the highest digestibility, metabolisable energy and net lactation energy. Tests have proven different impacts of the TG humic fertilizer, and its rates of application, on the effectiveness of complex fertilizers in changing various feed value indices. The highest Turbo Grass effectiveness was evaluated only in combination with the NPK rate most suitable for grass ( $N_8P_{20}K_{30}$ ). TG rates of 8-16 l stimulated formation of the highest protein content, digestibility, ME and NEL. NPK with lower K rates decreased the efficiency of humic fertilizer and grass value. Low rates of Turbo Grass (8-16 l) in combination with  $N_8P_{20}K_{30}$  may substitute analogous microelement fertilizers and improve the main indices of feed value.

## Acknowledgements

Research was carried in cooperation with Kiel University. We would like to express personal gratitude to F. Taube for his help in performing the chemical analyses.

## References

- Peña-Mendez E., Havel J. and Patočka J. (2005) Humic substances compounds of still unknown structure: applications in agriculture, industry, environment, and biomedicine. *Journal of Applied Biomedicine* 3, 13–24.
- Nauman C. and Bassler R. (1993) *Die chemische Untersuchung von Futtermitteln. Methodenbuch*. III. Damstadt, VDLLIFA, 256.

## Soil fertility and forage yield in a maize-Italian ryegrass rotation fertilized with pelletized broiler litter

Bande-Castro M.J.<sup>1,2</sup>, Gómez-Sánchez R.<sup>2</sup>, Sainz M.J.<sup>2</sup> and López-Mosquera M.E.<sup>2</sup>

<sup>1</sup>Centro de Investigaciones Agrarias de Mabegondo, INGACAL, E-15080 A Coruña, Spain

<sup>2</sup>Departamento de Producción Vegetal, Universidad de Santiago de Compostela, Campus Universitario, 27002 Lugo, Spain

Corresponding author: mariabande@ciam.es

### Abstract

Effects of two rates of dried pelletized broiler litter on soil fertility characteristics and forage production, as compared with conventional mineral fertilization, were studied in a rotation of maize (*Zea mays* L.) and annual Italian ryegrass (*Lolium multiflorum* L.). Forage yield of Italian ryegrass and maize in both broiler litter treatments were similar to, or above, those achieved with the conventional mineral fertilization, indicating a rapid mineralization and subsequent plant availability of broiler litter N. Compared to the mineral fertilizer treatment, application of dried pelletized broiler litter resulted in similar available P and higher soil K and Mg contents. At the end of the rotation, the organic fertilizer also reduced soil acidity compared with that of the mineral fertilizer and control treatments, thus improving the availability of phosphorus for both forage crops.

Key words: organic fertilizer, soil acidity, NPK mineral fertilizer.

### Introduction

In recent years, the transformation of the livestock sector towards greater intensification has generated a great amount of waste, the management of which is becoming one of the most important tasks to be developed from an environmental viewpoint in order to achieve the sustainability of the agricultural systems. The main destination of this material, which is generated on an ongoing basis throughout the year, is its application as fertilizer on agricultural land. Broiler litter has always been highly valued as a fertilizer for its high content of nutrients, especially N, and low moisture content (Stephenson *et al.*, 1990). When used as fertilizer on forage crops, such as maize and grass silage, fresh broiler litter has provided fodder yields equal or superior to those with other fertilizers (Evers, 1998; Moss *et al.*, 2001; Pederson *et al.*, 2002). However, storage of broiler litter at times when it can not be used in the field can cause losses of N to the atmosphere, water contamination by leachate, odours and microbial contaminants (Sims and Wolf, 1994). The dehydration and granulation of this manure are technologies that can ease handling and storage, helping to minimize nutrient losses and other environmental risks and facilitating dosage and distribution in the field. The aim of this work was to study the effects of a dried pelletized broiler litter fertilizer on soil fertility and forage production in a maize-Italian ryegrass rotation, as compared with conventional mineral fertilization.

### Materials and methods

A field experiment was established in a 1000 m<sup>2</sup> plot at Antas de Ulla (Lugo, NW Spain). The plot, which was cleared and cultivated, initially maintained a forest of *Quercus robur* L. with shrubs and a herbaceous cover. The soil was a humic Umbrisol, highly acidic (pH (H<sub>2</sub>O) 4.87, Al saturation 63.7%), high in organic matter (OM) (13.7%) and low in available P (8.9 mg kg<sup>-1</sup> P-Olsen) and K (64.1 mg kg<sup>-1</sup>).

The soil was limed and 16 subplots of 60 m<sup>2</sup> were established to apply the following fertilization treatments randomly (4 subplots each): Control (NPK application before sowing Italian ryegrass and no further fertilization); Mineral (fertilization with NPK fertilizers both for Italian ryegrass and maize, and calcium ammonium nitrate for Italian ryegrass); Biof-1 (3500 kg ha<sup>-1</sup> of dried pelletized broiler litter for Italian ryegrass and 7500 kg ha<sup>-1</sup> for maize); and Biof-2 (4500 kg ha<sup>-1</sup> of dried pelletized broiler litter for Italian ryegrass and 10000 kg ha<sup>-1</sup> for maize). Dates and rates of fertilizers in each treatment both for Italian ryegrass and maize are shown in Table 1. Main properties of the Biof fertilizer were: moisture content 12.7%, OM 72.6%, N 4.1%, P 1.2%, K 1.4%, Ca 2.3 %, Mg 0.4%.

On 6 October 2005, subplots were seeded with 40 kg ha<sup>-1</sup> of annual Italian ryegrass (cv. Elunaria), and on 3 May 2006, forage was cut for silage. On 24 May 2006, after applying the corresponding fertilizer treatments, maize cv. Abundance was planted at a density of 100,000 plants ha<sup>-1</sup>. Maize was harvested for silage on 8 September 2006, when the milk line in the grain was between 1/2 and 2/3. In each subplot, forage cut in the central 4 m<sup>2</sup> for Italian ryegrass and 2.4 m<sup>2</sup> for maize was fresh-weighed in the field. Dry weight was measured after oven-drying samples of Italian ryegrass forage and ten maize plants. In order to study the effects of fertilizers on soil characteristics, samples of soil from every subplot were taken before sowing both Italian ryegrass and maize, and after cutting forage maize for silage.

Table 1. Dates and rates of fertilizers applied in treatments.

Treatment	Italian ryegrass		Forage maize
	October 2005	February 2006	May 2006
Control	300 kg ha <sup>-1</sup> 8-24-16	-	-
Mineral	600 kg ha <sup>-1</sup> 8-24-16	300 kg ha <sup>-1</sup> calcic ammonium nitrate (20.5%N)	1000 kg ha <sup>-1</sup> 15-15-15
Biof -1	1000 kg ha <sup>-1</sup> Biof	2500 kg ha <sup>-1</sup> Biof	7500 kg ha <sup>-1</sup> Biof
Biof -2	2000 kg ha <sup>-1</sup> Biof	2500 kg ha <sup>-1</sup> Biof	10000 kg ha <sup>-1</sup> Biof

## Results and discussion

Forage yield of Italian ryegrass in subplots fertilized with 1000 kg ha<sup>-1</sup> Biof was similar to that achieved with the conventional mineral fertilization, and significantly higher when the rate of Biof was 2000 kg ha<sup>-1</sup> (Table 2). For maize, the largest forage productions were obtained when 7500 or 10000 kg ha<sup>-1</sup> Biof were applied, these organic fertilizer rates yielding 8 and 10 Mg ha<sup>-1</sup> more than the mineral fertilization treatment (Table 2). Both Italian ryegrass and forage maize requires good N availability in soil to be productive. Results suggest that mineralization of organic N from the pelletized broiler litter must have been rapid enough to fulfil both fodder crops N requirements. The present observation is supported by the work of Sistani *et al.* (2008).

Compared to the mineral treatment, the application of dried pelletized broiler litter resulted in similar available P and higher soil K and Mg contents in soil from the time of sowing Italian ryegrass until the forage maize was cut (Tables 3 and 4). At the end of the rotation, the percentage of Al saturation was significantly lower in both Biof treatments than in the mineral and control treatments, suggesting a liming effect of this organic fertilizer which might have improved P availability for both crops.

Table 2. Dry matter (DM) yield of Italian ryegrass and forage maize in the different fertilization treatments.

Treatment	Italian ryegrass	Forage maize
	DM yield (Mg ha <sup>-1</sup> )	
Control	2.88 a	19.78 a
Mineral	6.95 b	22.81 a
Biof -1	7.93 b	30.15 b
Biof -2	9.69 c	32.99 b

Within each column, values followed by a different letter are significantly different for  $P < 0.05$ .

Table 3. Soil fertility characteristics at the time of sowing Italian ryegrass.

Treatment	pH	C	OM	N	C/N	P	Ca	Mg	K	Al	Al sat.
		H <sub>2</sub> O	%				mg kg <sup>-1</sup>	cmol kg <sup>-1</sup>			%
Control	5.85	7.64	13.18	0.59	12.90	11.43 b	7.37	0.50 b	0.36 b	0.18	2.05
Mineral	5.84	8.14	14.04	0.64	12.67	23.02 a	6.69	0.68 b	0.31 b	0.16	2.12
Biof -1	6.05	7.97	13.75	0.62	12.87	23.41 a	7.78	0.92 a	0.70 a	0.18	1.81
Biof -2	5.82	7.98	13.76	0.63	12.60	23.06 a	7.55	0.95 a	0.66 a	0.19	1.93

Within each column, values followed by a different letter are significantly different for  $P < 0.05$ .

Table 4. Soil fertility characteristics after cutting forage maize for silage.

Treatment	pH	C	OM	N	C/N	P	Ca	Mg	K	Al	Al sat.
		H <sub>2</sub> O	%				mg kg <sup>-1</sup>	cmol kg <sup>-1</sup>			%
Control	5.62	7.63	13.1	0.60	12.81	6.05 b	4.83	0.32 b	0.28 b	0.40	6.42 a
Mineral	5.41	7.13	12.3	0.58	12.38	15.54 a	4.33	0.30 b	0.37 b	0.46	7.98 a
Biof -1	5.71	9.44	16.3	0.73	12.96	16.72 a	5.88	0.82 a	0.48 a	0.31	3.87 b
Biof -2	5.44	8.92	15.3	0.71	12.54	19.52 a	6.60	0.89 a	0.54 a	0.28	3.17 b

Within each column, values followed by a different letter are significantly different for  $P < 0.05$ .

## Conclusion

The results demonstrate the competitiveness of a dried pelletized broiler litter fertilizer for forage production with respect to the conventional mineral fertilization. The advantages of using this organic fertilizer on fodder crops are not only that it improved soil fertility and it provided similar or higher fresh and dry matter yields, but also it is an effective way of recycling broiler litter from intensive farms.

## References

- Evers G.W. (1998) Comparison of broiler poultry litter and commercial fertilizer for coastal Bermuda grass production in the southeastern US. *Journal of Sustainable Agriculture* 12, 55-77.
- Moss B.R., Reeves D.W., Lin J.C., Torbert H.A., McElhenney W.H., Mask P. and Kezar W. (2001) Yield and quality of three corn hybrids as affected by broiler litter fertilization and crop maturity. *Animal Feed Science and Technology* 94, 43-56.
- Pederson G.A., Brink G.E. and Fairbrother T.E. (2002) Nutrient uptake in plant parts of sixteen forages fertilized with broiler litter. *Agronomy Journal*, 94, 895-904.
- Stephenson A.H., McCaskey T.A. and Ruffin B.G. (1990) A survey of broiler litter composition and potential value as a nutrient resource. *Biological Wastes* 34, 1-9.
- Sims J.T. and Wolf D.C. (1994) Poultry waste management: agricultural and environmental issues. *Advances in Agronomy* 52, 1-83.
- Sistani K.R., Adeli A. and McGowen S.L. (2008) Laboratory and field evaluation of broiler litter nitrogen mineralization. *Bioresource Technology* 99, 2603-2611.

# Natural lucerne populations of Estonia: yielding ability, herbage quality and prospective ways of use

Bender A. and Tamm S.

Jõgeva Plant Breeding Institute, 48 309, Jõgeva, Estonia

Corresponding author: ants.bender@jpbi.ee

## Abstract

A plot trial was established in 2003 with seeds gathered in 2001–2002 from semi-natural grasslands of Estonia in order to determine the yielding ability of lucerne populations and their prospective uses. The total dry matter yields of one natural population exceeded the standard variety by 6.0%, in the sowing year and in three harvest years. From a plant breeding perspective this population is of interest. The remaining populations can be divided into two groups based on their growth rhythm, DM and CP yield. These are: 1) modest regrowth, predominantly yellow-flowered, spreading vegetatively by rhizomes, type *Medicago falcata* L. (DM and CP yields accounted for 48.0–55.7% and 49.6–59.2% of these of the standard variety, respectively) attracts attention as a source material for breeding specific varieties for landscape management; 2) populations of *M. media* Pers. with yellow and variegated flowers (range of DM and CP yields 65.8–92.0% and 64.5–86.2%, respectively). The seeds of these populations can successfully be used for improvement of semi-natural grasslands.

Keywords: population, dry matter yield, crude protein yield, yield dynamics

## Introduction

Estonia is situated on the northern border of area, where it is economically profitable to grow *Medicago media* Pers. and *M. falcata* L. These species were introduced and started to be used as cultivated crops approximately 150 years ago. Over the years more resistant imported lucerne forms have acclimatized and naturalized in Estonia and formed semi-natural grasslands of lucerne – red fescue (*Medicagini – Festucetum rubrae*) association. According to the latest inventory that was performed in 1978–1981, the above association was spread on 185 ha in North and West Estonia. Two natural subspecies also exist naturally in Estonia (*Medicago media* Pers., *M. Falcata* L.). One natural lucerne population ('Saaremaa kohalik') has been cultivated for forage production as a landrace, and in 1969–1992 it was even included in the national variety list.

The aim of the present research was to determine the yielding ability and herbage quality of natural lucerne populations collected from unexplored habitats and to estimate their breeding value.

## Material and methods

Expeditions were organised to the regions of natural lucerne habitats in 2001 and 2002. The seeds were gathered in sufficient amounts to establish a plot trial in July 2003 in order to study the yielding ability of 15 populations. The trial was established with four replications without a cover crop on a calcareic cambisol ( $K_0$ ) with  $pH_{KCl}$  6.2, humus concentration  $21 \text{ g kg}^{-1}$ , total nitrogen (N)  $1.3 \text{ g kg}^{-1}$ , P 230, K 229, Ca 1550 and Mg  $77 \text{ mg kg}^{-1}$ . Prior to the establishment and in the autumn of harvest years mineral fertilizers were applied at the rates P 19 and K  $67 \text{ kg ha}^{-1}$ . The herbage was cut and weighed once in the sowing year and three times in the following years. To assess the forage quality, the crude protein content in dry matter, the ratio of leaves and stems in the herbage and the protein content in these fractions

were determined. Estonian *M. media* Pers. varieties ‘Jõgeva 118’ (hay type, standard), ‘Karlu’ (rhizomatous, pasture type) and ‘Juurlu’ (creeping-rooted, pasture type) were compared with natural populations. Samples collected from the semi-natural habitats were named after the place where they were collected (Table 1). The choice of entries into the trial was based on geographic principles. Statistical analyses were performed using a programme Agrobases 20.

## Results and discussion

In terms of the sum of four testing years, the bred varieties of *M. media* Pers. produced almost equal dry matter and crude protein yields (Table 1 and Figure 1). The dry matter yields by cuts were also similar: the first cut yielded 55.5–57.1%, second cut 28.1–30.1% and the third 11.2–12.5% of the annual yield.

Table 1. Annual dry matter yields (Mg ha<sup>-1</sup>) of lucerne varieties or populations in 2003 to 2006, and 4-year total expressed as % of that of Jõgeva 118

Variety or population	Latitude	Longitude	2003	2004	2005	2006	2003-2006	%
Jõgeva 118			1.65	15.10	12.48	12.44	41.67	100.0
Karlu			1.83	16.50	11.74	12.47	42.54	102.1
Juurlu			1.67	15.49	12.10	11.19	40.45	97.1
Reigi	58° 59' 00"	22° 30' 42"	2.55	14.86	14.50	12.27	44.18	106.0
Pühalepa	58° 52' 28"	22° 57' 28"	1.47	14.07	12.24	10.54	38.32	92.0
Sutlepa	59° 03' 47"	23° 36' 02"	1.36	13.60	11.10	11.65	37.71	90.5
Hanila	58° 37' 10"	23° 37' 43"	1.53	13.42	10.70	10.87	36.52	87.6
Orjaku	58° 48' 07"	22° 47' 09"	1.25	12.83	10.77	10.12	34.97	83.9
Vormsi Saxby	59° 01' 11"	23° 08' 44"	1.20	10.67	11.37	10.62	33.86	81.3
Vormsi Fällerna	59° 01' 42"	23° 10' 19"	0.55	12.88	10.23	9.57	33.23	79.7
Vormsi Hullo	58° 58' 49"	23° 15' 24"	0.43	11.19	10.85	10.58	33.05	79.3
Vormsi Kersleti	59° 01' 24"	23° 08' 40"	1.33	10.85	10.55	9.99	32.72	78.5
Kärdla	58° 59' 27"	22° 46' 08"	0.47	12.16	9.99	9.81	32.43	77.8
Purtse	59° 24' 33"	27° 03' 03"	0.30	11.05	9.33	8.31	28.99	69.6
Kassari	58° 47' 28"	22° 50' 10"	0.50	9.13	9.03	8.77	27.43	65.8
Lasnamäe	59° 26' 57"	24° 48' 51"	0	8.08	7.47	7.64	23.19	55.7
Ridala	58° 54' 46"	23° 28' 02"	0	7.45	6.73	7.45	21.63	51.9
Padaorg	59° 26' 02"	26° 42' 45"	0	6.55	6.56	6.89	20.00	48.0
LSD 0.05			0.20	0.81	0.85	0.57	1.72	

Among the natural populations a sample from Reigi exceeded significantly the standard variety ‘Jõgeva 118’ in total DMY over four years, but not in the total CPY. The population exhibited fast initial development in the year of sowing and good regrowth in late summer. Its DM yield proportions by cuts were 46.5, 33.3 and 14.5%, respectively. The plant structure analysis indicated that the share of stems in the second and third cuts of this population was higher than of the standard variety but the CP content of leaves and stems was lower than that in standard variety in all cuts (0.8–2.6% and 1.7–2.9%, respectively).

The other studied natural populations were inferior to the standard variety in DMY by 8.0–52.0% and in CPY by 13.8%–50.4%. Based on the trial results these populations can be divided into two groups.

*M. falcata* L. populations from Padaorg, Ridala and Lasnamäe were characterised by slower initial development in the sowing year and more restricted aftermath growth in the following years. Of their total DMY 58.6–62.7% was harvested with the first cut, 29.3–32.8% with the second and only 8.0–9.2% with the third cut. By the autumn of the sowing year and by the time of the final cuts in the following years they had not produced enough aftermath for harvesting. Their yield was more leafy than that of the standard variety in all cuts but they did not differ from the standard variety in CP content of leaves. In terms of average values over

the four years, the CP content of stems of these three populations was similar to the standard variety in the herbage of the first cuts, exceeded that in the second cuts and remained below the respective value of standard in the third cuts.

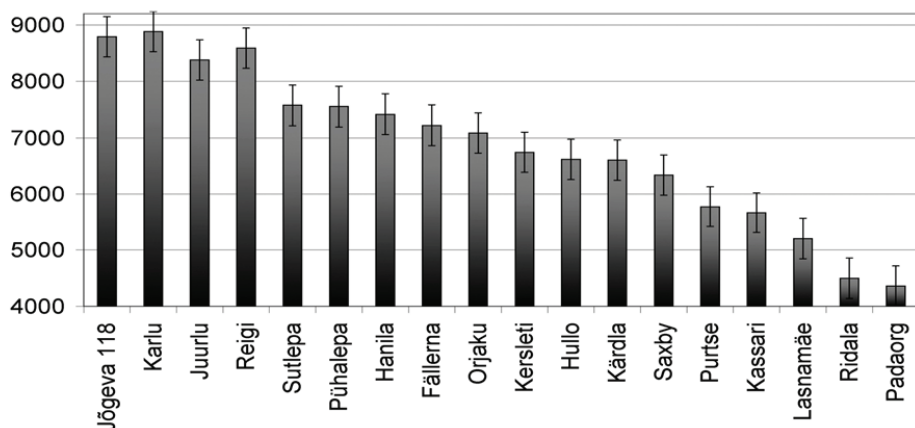

Figure 1. Total crude protein yields in 2003–2006, kg ha<sup>-1</sup> (LSD<sub>0.05</sub>=358 kg ha<sup>-1</sup>)

The remaining populations of *M. media* Pers. with yellow and variegated flowers (total DMY and CPY in comparison with the standard variety 65.8–92.0% and 64.5–86.2%, respectively) are valuable because of their longevity. The forms that are vegetatively spreading are important as initial material for breeding pasture varieties of lucerne.

## Conclusions

As a result of the comparison trial with natural populations of lucerne conducted in 2003–2006 the following prospective uses can be recommended:

The lucerne population gathered from Reigi on the island Hiiumaa needs additional post-control trials. It may be a remnant of a western European variety. In order to increase the yielding ability of semi-natural grasslands, top sowing of seeds of natural lucerne populations growing in Pühalepa, Sutlepa and Hanila can be recommended. Their yield potential remains below the standard variety but it is compensated by the fact that the plant stand maintains its yielding ability for a long time. The research so far has indicated that the top sowing of lucerne is successful and the plant cover persists and retains its competitive ability only in habitats that are suitable for the species. Neutral or alkaline soils are preferable, as are light texture and drying of soils during the vegetation period. Longevity is favoured by milder maritime climate and high phosphorous content of the soil (Lemetti *et al.*, 2001)

*M. falcata* L. populations from Lasnamäe, Ridala and Padaorg have prospective applications in landscape design and in particular for cultivating along the roadsides, on ditch banks and mountain slopes. Their plant cover is very decorative during flowering and because of modest aftermath growth the costs of cutting are also low.

## References

Lemetti I., Bender A., Tamm S. (2001) Edaphic factors of the habitats of natural lucerne populations. In: Kõlli R., Kanal A. and Roostalu H. (eds.) *Transactions of the Estonian Agricultural University* 212. Tartu, pp 73–78.



## A preliminary study on new biodegradable films to cover silages

Borreani G.<sup>1</sup>, Chion A.R.<sup>1</sup>, Piano S.<sup>1</sup>, Ranghino F.<sup>2</sup> and Tabacco E.<sup>1</sup>

<sup>1</sup> *Dep. Agronomia, Selvicoltura e Gestione del Territorio, University of Turin, Grugliasco, Italy*

<sup>2</sup> *Novamont S.p.A., Novara, Italy*

Corresponding author: giorgio.borreani@unito.it

### Abstract

Two different silage cover films, one made of standard polyethylene (PE) and the other made of Mater-Bi® biodegradable plastic (MB), with two different thicknesses (60 and 120 µm) have been compared. A whole maize crop was chopped, treated with a mixture of *Lactobacillus plantarum*, *L. buchneri*, and *Enterococcus faecium*, and ensiled in plastic bags with four replications for each treatment. After 55 and 110 d of conservation, all the silages were well fermented with no differences in fermentative and nutritional quality between the treatments, and few differences in mould count and aerobic stability after 110 d of conservation. These results showed the possibility of successfully developing a biodegradable cover for silage for 4 months after ensiling.

Keywords: maize silage, biodegradable film, plastic film, film thickness, silage quality

### Introduction

The production of agricultural plastic has greatly increased throughout the world over the last decade, reaching 3.6 million tons in 2008 (around 15% of the total world consumption of plastic). In Europe around 39% of the plastic utilized in agriculture is destined for silage packaging. Because of their wide use, the problems of the disposal of agricultural plastic wastes have become more and more severe (Kyrikou and Briassoulis, 2007). An alternative way of disposing of agricultural plastic wastes is through biodegradation. Most experts define a fully biodegradable polymer as a polymer that is completely converted, by microorganisms, into carbon dioxide, water, minerals and microbial biomass, without leaving any potentially harmful substances (Kyrikou and Briassoulis, 2007). The plastic film utilised to cover silages influences the degree of anaerobiosis reached in the silo. The aim of this research was to check the possibility of replacing polyethylene (PE) film with biodegradable film to cover maize silage in a laboratory experiment.

### Materials and methods

A whole-maize crop was harvested at 50% milk-line stage, chopped with a precision forage harvester to a 10 mm cut length, treated with Pioneer 11C33 inoculant applied directly from the harvester at the rate of 1.1 mg kg<sup>-1</sup> fresh forage to supply 1 × 10<sup>5</sup> cfu g<sup>-1</sup> of a mixture of *Lactobacillus plantarum*, *L. buchneri*, and *Ent. faecium* and ensiled in plastic bags (12 kg fresh matter), with eight replications for each treatment. The bags were housed inside a PVC cylinder (300 mm high and 300 mm in diameter) open at both sides, in order to compact them to a close DM density than those of bunker silos. Two different types of plastic films with two different thicknesses were compared: a 60 µm-thick PE film (PE60), a 120 µm PE film (PE120); a 60 µm Mater-Bi® biodegradable film (MB60), and a 120 µm Mater-Bi® film (MB120). The silages were conserved indoors at 20°C for 55 and 110 days. At silo opening, approximately 5 cm of silage from the top of each silo were separately analysed (data not shown) and then the silage in the top half of the silo was mixed thoroughly and sub-sampled

for microbial, fermentative and nutritional analyses. About 3 kg of each silage was allowed to aerobically deteriorate at room temperature in 17 l polystyrene boxes. The room temperature and the temperature of each silage were measured each hour by a mini temperature logger and aerobic stability was defined as the number of hours the silage remained stable before the temperature rose more than 2 °C above room temperature. The pre-ensiled forages and the silages were split into 2 sub-samples. One sub-sample was oven-dried at 60 °C for 72 h to determine the DM content, then air equilibrated, weighed, ground in a Cyclotec mill to pass a 1 mm screen and analysed for crude protein (total nitrogen, TN x 6.25), ash by ignition, starch, NDF, ADF, ADL, and ether extract (EE). The other wet sub-sample was extracted, using a Stomacher blender, for 4 min in distilled water at a water to herbage ratio (fresh weight) of 9:1 or in H<sub>2</sub>SO<sub>4</sub> 0.05 mol l<sup>-1</sup> at a acid to herbage ratio (fresh weight) of 5:1. The ammonia nitrogen (NH<sub>3</sub>-N) content, determined using a specific electrode, was quantified in the water extract. The lactic, acetic, propionic and butyric acids were determined by high performance liquid chromatography in the acid extract (Canale *et al.*, 1984). For the microbial counts, 30 g of wet sample were 1:10 w/v suspended in a peptone physiological salt solution and homogenized for 4 min in a laboratory Stomacher blender. Serial dilutions were prepared and mould and yeast numbers were determined using the pour plate technique with 40.0 g l<sup>-1</sup> of YGC Agar after incubation at 25 °C for 3 and 5 d for yeast and mould, respectively. The anaerobic spore content was determined by the most probable number (MPN) procedure on RCM, supplemented with sodium lactate syrup, agar and D-cycloserine. The data were analysed for their statistical significance via ANOVA, with their significance reported at a 0.05 probability level (SPSS Inc., v. 16). The Tukey range test ( $P < 0.05$ ) was used to interpret any significant differences among the mean values.

## Results and discussion

The maize silage showed a DM concentration of 335 g kg<sup>-1</sup>, with a 282, 413, 230, and 27 g kg<sup>-1</sup> DM of starch, NDF, ADF, and ADL, respectively. The fermentation quality and microbial composition of the maize silages, after 55 and 110 d of conservation, are shown in Table 1. All the silages were well fermented with no differences between treatments. The main fermentation acids encountered were lactic and acetic acids, whereas butyric acid was below the detection limit (less than 0.01 g kg<sup>-1</sup> DM, data not shown) in all the silages. The inoculum treatment containing *L. buchneri* shifted the fermentation to acetic acid in silages after 110 d of conservation relative to silages conserved for 55 d (i.e. lower lactate:acetate ratio), as expected with a heterolactic fermentation (Kleinschmit and Kung, 2006). Due to partial degradation of the film in one bag, a higher mould count and lower aerobic stability were observed after 55 d of conservation for the silage conserved in the MB120 bags. Some more slight degradation was observed in the MB films after 110 d of conservation and this was reflected by higher yeast and mould counts and by a lower aerobic stability of the silages conserved under the MB film than those conserved under the PE films. Some visible moulds were observed on the surface of the silages conserved under the MB films, but this degradation did not alter the nutritional profile of silages (Table 2). No differences between treatments were observed for any of the studied parameters.

## Conclusions

The MB120 treatment showed good silage quality even in the mass close to the film, till 110 d of conservation, with comparable results of those obtained with PE films, except for higher mould count. These promising results indicate that it could be possible to use these biodegradable films to cover silage by improving their formulation and stability over time.

Table 1. Fermentation and microbiological characteristics of the silages covered with different plastic film at 55 and 110 d of conservation

Conser- vation time (d)	Treat- ment	DM (g kg <sup>-1</sup> )	pH	Lactic acid in DM (g kg <sup>-1</sup> )	Acetic acid in DM (g kg <sup>-1</sup> )	NH <sub>3</sub> -N in total N (g kg <sup>-1</sup> )	Yeast (log CFU g <sup>-1</sup> )	Mould (log CFU g <sup>-1</sup> )	Spores (log MPN g <sup>-1</sup> )	Aerobic stability (h)
55	PE60	315	3.74	25.5	10.1	41	4.5	1.4b	2.3	37a
	PE120	313	3.74	26.1	8.8	49	4.4	1.2b	2.0	40a
	MB60	315	3.75	33.8	11.5	52	4.6	2.0b	1.7	40a
	MB120	319	3.75	29.8	9.3	42	5.8	3.6a	2.3	26b
	<i>P</i>	NS	NS	NS	NS	NS	NS	*	NS	*
	SE	3.10	0.004	1.97	0.61	0.032	0.28	0.37	0.16	1.92
110	PE60	309	3.79	15.6	14.2	58	3.6b	1.0b	2.2	72a
	PE120	297	3.78	15.8	12.1	59	3.1b	1.7b	1.6	65a
	MB60	320	3.83	19.7	17.6	51	5.5a	4.7a	1.8	29b
	MB120	319	3.80	12.1	8.4	55	5.2a	3.7a	1.6	41ab
	<i>P</i>	NS	NS	NS	NS	NS	*	**	NS	**
	SE	4.69	0.011	1.65	1.85	0.41	0.51	0.141	0.018	4.88

Table 2. Nutritional characteristics of the silages (% of DM) covered with different plastic film at 55 and 110 d of conservation

Conservation time (d)	Treatment	Starch	NDF	ADF	ADL	EE	CP	Ash
55	PE60	29.4	43.9	23.2	3.9	2.4	7.8	4.2
	PE120	29.8	43.4	22.7	3.7	2.5	8.2	4.2
	MB60	28.2	45.1	23.5	4.1	2.4	8.1	4.4
	MB120	29.7	44.3	22.4	3.9	2.3	8.6	4.1
	<i>P</i>	NS	NS	NS	NS	NS	NS	NS
	SE	3.06	3.78	3.18	1.42	0.35	0.98	0.39
110	PE60	28.4	43.7	25.3	3.1	2.6	7.5	4.4
	PE120	26.3	46.6	27.4	3.1	2.5	7.7	4.2
	MB60	28.1	44.2	25.8	3.2	2.8	7.7	4.4
	MB120	27.0	45.2	26.3	3.4	2.6	7.3	4.4
	<i>P</i>	NS	NS	NS	NS	NS	NS	NS
	SE	6.11	7.96	4.98	1.38	0.53	0.99	0.72

## References

- Canale A., Valente M.E. and Ciotti A. (1984) Determination of volatile carboxylic acids (C1-C5) and lactic acid in aqueous acid extracts of silage by high performance liquid chromatography. *Journal of the Science of Food and Agriculture* 35, 1178-1182.
- Kyriakou I. and Briassoulis D. (2007) Biodegradation of agricultural plastic films: a critical review. *Journal of Polymer Environment* 15, 125-150.
- Kleinschmit, D.H. and Kung, L. Jr. (2006) A meta-analysis of the effects of *Lactobacillus buchneri* on the fermentation and aerobic stability of corn and grass and small-grain silages. *Journal of Dairy Science* 89, 4005-4013.

# Utilisation of clover-grass silage of different cutting dates for solid fuel production

Bühle L., Richter F., Perbandt D., Stoll S. and Wachendorf M.

*Department of Grassland Science and Renewable Plant Resources, University of Kassel, Steinstr. 19, 37213 Witzenhausen, Germany*

Corresponding author: [buehle@uni-kassel.de](mailto:buehle@uni-kassel.de)

## Abstract

Clover-grass swards play a major role in crop rotations in organic farming systems due to their ability to fix nitrogen. On farms without livestock, an efficient utilisation of clover-grass swards is often not possible, and alternative applications with economic benefits are warranted. This work is aimed at the assessment of energy recovery from clover-grass silages by the integrated generation of solid fuel and biogas from biomass (IFBB), particularly the consideration of nitrogen flows within the biomass conversion procedure. A clover-grass sward was cut at four different dates in the spring of 2008 and the biomass was separated into a liquid fraction for biogas production and a solid fraction for combustion. Methane yields of 420 - 500 normal litres (l<sub>N</sub>) per kg volatile solids (VS) were obtained by the liquids which contained 0.69 of the initial nitrogen of the biomass if the harvest was at an early growth stage, but only 0.35 if the harvest was delayed. The liquid, which also contains 0.78 - 0.92 of the initial phosphorus and potassium, can be used as fertiliser. On the other hand, the corresponding solid shows significantly reduced concentrations of elements detrimental for combustion, such as potassium and chloride.

Keywords: bioenergy, biogas, clover-grass, IFBB, solid fuel

## Introduction

The extension of renewable energies is an important issue worldwide and energy from biomass is a significant part of it. In order to reduce competition between food production and energy production for limited resources, it is crucial to exploit biomass sources that are already available. Clover-grass is the mainstay of organic agriculture in terms of its importance for soil fertility and nutrient management. For farms without livestock production, there is, however, the question of how the clover-grass can be utilised with an economic outcome. Conversion of the biomass into energy may be an interesting possibility. The integrated generation of solid fuel and biogas from biomass (IFBB) was developed to improve the conversion efficiency of biomass into energy in comparison with conventional techniques, such as anaerobic digestion. The main principle is a separation of the biomass with a screw press into a press fluid for biogas production and a press cake to be used as solid fuel (Wachendorf *et al.*, 2009). The objectives of this study were to convert clover-grass according to this procedure and to determine (i) the mass flows of various elements into the press cake and the press fluid, (ii) the concentration of compounds detrimental for combustion in the press cake, and (iii) the methane yield of the press fluids.

## Materials and methods

The clover-grass was sown in August 2007 and harvested at four consecutive dates in May and June 2008 (Table 1). The seed mixture consisted of *Trifolium pratense* (15 kg ha<sup>-1</sup>) and *Lolium multiflorum* (20 kg ha<sup>-1</sup>). After the harvest, the clover-grass herbage was chopped and ensiled in 60 l barrels.

Table 1. Cutting date, dry matter yield and dry matter content of clover-grass.

Cutting date	Yield	DM content
	Mg ha <sup>-1</sup>	g kg <sup>-1</sup>
21 / 05 / 2008	2.7	184.7
11 / 06 / 2008	4.0	259.2
18 / 06 / 2008	4.1	303.5
25 / 06 / 2008	5.5	313.3

The silage of clover-grass was mixed with water, heated at 60 °C and stirred continuously for 15 minutes. Thereafter, the mash was mechanically separated into press fluid and press cake. The silage and the press cake were analysed for K, Ca, P, Mg, S and Cl by X-ray fluorescence analysis. The concentrations of N were analysed using an elemental analyser (EA 1106, Carlo Erba Ltd., Rodano, Italy). Dry matter and ash concentration were determined after drying at 105 °C and ashing at 550 °C. Determination of biogas production was performed in batch experiments, in accordance with the German Standard (VDI 4630, 2004) and based on a method described by Zerr (2006) with two replicates.

## Results and discussion

The proportion of the N in the silage that remained in the press cake after mechanical separation increased from 0.31 to 0.65 with advancing harvest date (Fig. 1a). Thus, 0.35 to 0.69 of the N was transferred into the press fluid and could be returned to the field after anaerobic digestion. K, P and Cl were transferred into the press fluid to a large extent, leaving only 0.07 to 0.22 in the press cake. There was a tendency that postponement of the date of harvest resulted in higher mass flows into the press cake. Mass flow of the ash into the press cake was also lowest at the first harvest date and amounted to 0.29. Regarding concentrations of N, K, P and Cl in the press cake, the cutting date had no influence (Fig. 1b). Ash content of the press cake decreased from 61 g kg<sup>-1</sup> in DM at the earliest date of harvest to 53 g kg<sup>-1</sup> in DM at the latest date.

Methane yields of press fluids after 13 days of fermentation from clover-grass harvested between 21/05 and 18/06 ranged between 476 and 501 l<sub>N</sub> CH<sub>4</sub> kg VS<sup>-1</sup> (Fig. 2). The press fluid from the latest cutting date obtained somewhat lower methane yields of 421 l<sub>N</sub> CH<sub>4</sub> kg VS<sup>-1</sup>.

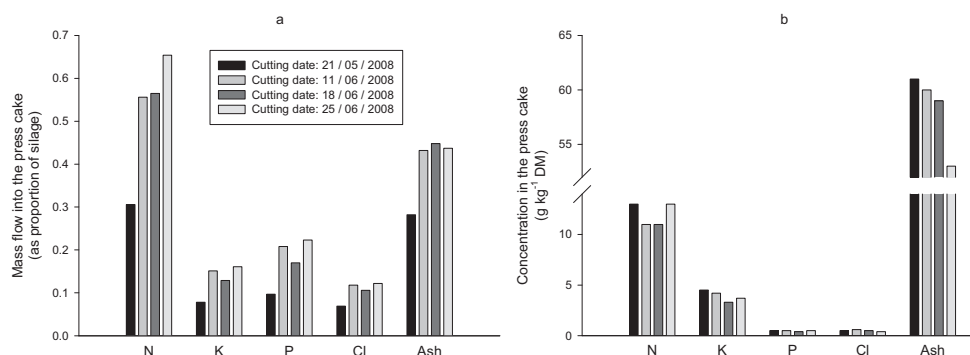

Figure 1. Mass flows of N, K, P, Cl and ash of clover-grass from 4 different cutting dates into the press cake during mechanical separation (a) and nutrient concentrations of the press cake (b).

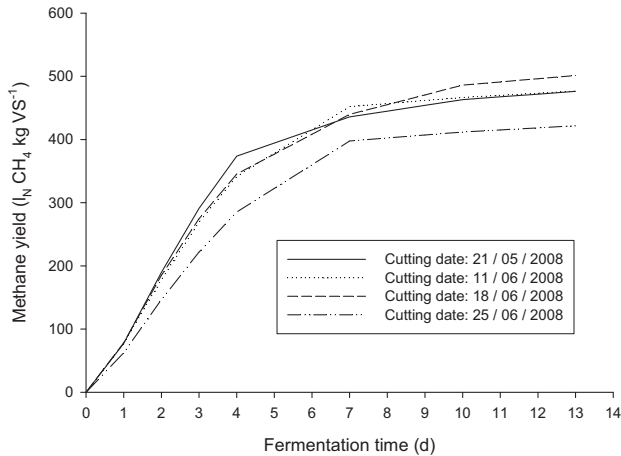

Figure 2. Methane yields of press fluids from clover-grass from 4 different cutting dates.

## Conclusion

Mass flows of N, K, P, Cl and ash from clover-grass silage into clover-grass press cake were between 0.07 (Cl) and 0.31 (N) when the clover-grass was cut on 21/05, the date with the lowest mass flows compared with three later cutting dates in June. In view of recirculation of N with the return of the press fluid-derived digestates, an early harvest of clover-grass can be advised. Concentrations of the mineral elements K, P, Cl in the press cake were not influenced by cutting date, whereas ash concentration from material obtained at the last cutting date was reduced by 0.13 compared with the first cutting date. Comparable methane yields of the press fluids for the first three cutting dates of up to 501 l<sub>N</sub> CH<sub>4</sub> per kg volatile solids could be obtained, whereas methane yield of the press fluid of the last cutting date was somewhat lower.

## References

- VDI 4630 (2004) *Vergärung organischer Stoffe (Fermentation of organic materials)*. Verein Deutscher Ingenieure, Düsseldorf, Germany.
- Wachendorf M., Richter F., Fricke T., Graß R. and Neff R. (2009) Utilization of semi-natural grassland through integrated generation of solid fuel and biogas from biomass. I. Effects of hydrothermal conditioning and mechanical dehydration on mass flows of organic and mineral plant compounds, and nutrient balances. *Grass and Forage Science* 64, 132-143.
- Zerr W. (2006) Versuchsanlage zur energetischen Beurteilung von Substraten und Kofermentaten für Biogasanlagen. (Experimental plant for the energy assessment of fermentation substrates for biogas plants). *UWSF – Zeitschrift für Umweltchemie und Ökotoxikologie* 18, 219–227.

## **PROGRASS – A mobile plant to produce solid fuel from grass harvested in the NATURA grassland habitats**

Bühle L.<sup>1</sup>, Donnison I.<sup>2</sup>, Heinsoo K.<sup>3</sup>, Südekum K.-H.<sup>4</sup> and Wachendorf M.<sup>1</sup>

<sup>1</sup>*Department of Grassland Science and Renewable Plant Resources, University of Kassel, Steinstrasse 19, 37213 Witzenhausen, Germany*

<sup>2</sup>*Institute of Biological, Environmental and Rural Sciences, Aberystwyth University, Gogerddan, Aberystwyth, SY23 3EB, UK*

<sup>3</sup>*Institute of Agricultural and Environmental Sciences, Estonian University of Life Sciences, Riia 181, Tartu 51014, Estonia*

<sup>4</sup>*Institute of Animal Science, University of Bonn, Endenicher Allee 15, 53115 Bonn, Germany*  
Corresponding author: buehle@uni-kassel.de

### **Abstract**

Species-rich grasslands are seriously threatened in many European countries. For the conservation of these areas, nature protection agencies propose an extensive grassland management with regular harvesting. However, the strongly lignified biomass has a low nutritional value even for ruminants and, therefore, provides poor economic returns through extensive grazing. Equally, there are technical constraints in energy recovery because of low degradability in conventional biogas plants and of high mineral and nitrogen concentrations in combustion systems. An innovative technical approach has been developed to produce solid fuel with improved combustion characteristics through hydrothermal conditioning and mechanical dehydration of the biomass (IFBB – integrated generation of solid fuel and biogas from biomass). Within the European wide PROGRASS project, the feasibility of this bioenergy system will be demonstrated and investigated on a pilot-plant scale. The mobile prototype will be operated in Germany, Wales and Estonia where six representative experimental areas per country have been chosen. In addition to technical considerations, the project comprises investigations on grassland biodiversity, economics and life cycle assessment. This paper reports the first results obtained for the productivity of the grasslands and a technical description of the prototype.

Keywords: biodiversity, bioenergy, biogas, nature conservation, semi-natural grassland, solid fuel

### **Introduction**

Large areas in European countries are covered by extensive and increasingly abandoned grasslands due to the withdrawal of livestock grazing. Due to the rich diversity in both flora and fauna, many of these grasslands are listed among the habitats within the NATURA 2000 ecological framework established under the 1992 Habitats Directive. Once designated, conservation measures have to be taken in order to maintain the habitats and species in a favourable conservation status (Anonymous, 1992).

The PROGRASS project is aimed at the demonstration and investigation of a technical approach to produce bioenergy from semi-natural grasslands in three European countries Germany (DE), Wales (UK) and Estonia (EE). The basic principle of the technology is the separation of silage in a liquid fraction for biogas production and a solid fuel to be used for combustion (Richter *et al.*, 2009; Wachendorf *et al.*, 2009). The technical feasibility of the approach will be investigated by a prototype plant processing about 400 kg of silage per day. In addition, ecological, economic and social consequences of the adoption of such energy production in extensive grasslands will also be considered.



## Description of the mobile demonstration plant

The IFBB prototype is installed in two standard ISO freight containers which are permanently fixed on a semi-trailer (Fig. 1). The storage tank is designed to contain the daily processed biomass of approximately 400 kg of silage. By means of a screw-conveyer, the silage is continuously brought forward to the hydro-thermal conditioning. The conditioner consists of a band-conveyor, on which the silage is treated over a defined retention time, under constant percolation with the circulating mash water at about 40° C. After the conditioning process, the biomass is fed into a screw press, where it is mechanically separated into a press cake and a press fluid. The press cake contains 50% water and is collected in a box for drying to a dry matter content of 85%. The press fluid is transferred to a second container into a storage tank. Digestion of the press fluid takes place in three solid-state fermenters. The biogas is used by a burner to produce heat for the water mashing process, the digestion and drying of the press cake. The mobile plant demonstrating the IFBB procedure will be used during 2010 and 2011. In each of the partner regions, the prototype will be operated for 3 months per year.

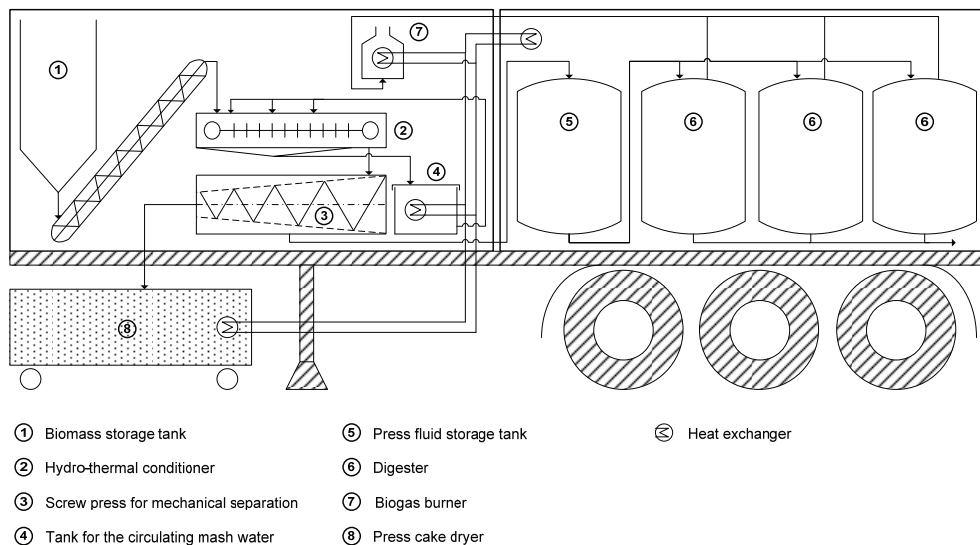

Figure 1. Diagram of the mobile IFBB demonstration plant.

## Characterisation of the grassland sites

The project aim is to evaluate a broad variety of European grasslands. Thus, altogether 18 experimental areas with test plots (x 3 replicates) of 100 m<sup>2</sup> were established (Table 1). The main variables of the two-year experiments are the botanical inventory, the quality and productivity of the biomass harvested and the conversion performance in the IFBB prototype plant. The grasslands selected in Germany and Wales are mainly characterised by upland swards with limited DM productivity of 3 to 6 t ha<sup>-1</sup> y<sup>-1</sup>. The Estonian grassland areas are dominated by very low yielding floodplain and mesic meadows. At the time of cutting (DE: 13/07 - 08/09/2009, UK: 27/07 - 22/09/2009, EE: 29/06 - 01/07/2009) most plant species had terminated flowering.

Table 1. Characteristics of semi-natural grassland sites in Germany, Wales and Estonia.

NATURA habitat type and code	Dominant species	Altitude m a.s.l.	DM yield t ha <sup>-1</sup> y <sup>-1</sup>
<b>German sites</b>			
Lowland hay meadow (6510)	<i>Festuca rubra</i> , <i>Agrostis capillaris</i> , <i>Crepis biennis</i>	570	5.2
Lowland hay meadow (6510)	<i>Festuca rubra</i> , <i>Agrostis capillaris</i> , <i>Trifolium pratense</i>	420	4.7
Mountain hay meadow (6520)	<i>Festuca rubra</i> , <i>Deschampsia</i> <i>cespitosa</i> , <i>Sanguisorba officinalis</i>	580	4.3
Species-rich <i>Nardus</i> grasslands (6230)	<i>Festuca rubra</i> , <i>Poa chaixii</i> , <i>Nardus</i> <i>stricta</i>	580	3.5
Molinia meadow (6410)	<i>Deschampsia cespitosa</i> , <i>Selinum</i> <i>carvifolia</i>	500	6.1
Humid tall herb fringes of watercourses and woodlands (6431)	<i>Scirpus sylvatica</i> , <i>Carex disticha</i> , <i>Calamagrostis canescens</i>	380	7.6
<b>Welsh sites</b>			
Degraded raised bogs still capable of natural regeneration (7120)	<i>Molinia caerulea</i> , <i>Juncus acutiflorus</i> , <i>Agrostis canina</i>	190	3.6
Degraded raised bogs still capable of natural regeneration (7120)	<i>Juncus effusus</i>	160	5.3
Degraded raised bogs still capable of natural regeneration (7120)	<i>Juncus effusus</i>	400	6.4
European dry heaths (4030)	<i>Vaccinium myrtillus</i> , <i>Nardus stricta</i> , <i>Festuca ovina</i>	560	5.0
Not classifiable	<i>Pteridium aquilinum</i>	300	4.8
Blanket bogs (7130)	<i>Nardus stricta</i> , <i>Festuca ovina</i>	440	2.5
<b>Estonian sites</b>			
Northern boreal alluvial meadows (6450)	<i>Alopecurus pratensis</i> , <i>Deschampsia</i> <i>cespitosa</i> , <i>Filipendula ulmaria</i>	40	3.2
Fennoscandian lowland species-rich dry to mesic grasslands (6270)	<i>Alopecurus pratensis</i> , <i>Deschampsia</i> <i>cespitosa</i>	40	3.8
Fennoscandian wooded meadows (6530)	<i>Scorzonera humilis</i> , <i>Brachypodium</i> <i>pinnatum</i> , <i>Calamagrostis epigeios</i>	60	1.0
Northern boreal alluvial meadows (6450)	<i>Carex disticha</i> , <i>Carex cespitosa</i>	40	4.1
Fennoscandian lowland species-rich dry to mesic grasslands (6270)	<i>Festuca rubra</i> , <i>Agrostis capillaris</i>	40	3.5
Fennoscandian wooded meadows (6530)	<i>Galium boreale</i> , <i>Anthriscus</i> <i>sylvestris</i>	60	1.7

## References

- Anonymous (1992) Council Directive 92/43/EEC of 21 May 1992 on the conservation of natural habitats and of wild fauna and flora. The council of the European communities.
- Richter F., Graß R., Fricke T., Zerr W. and Wachendorf M. (2009) Utilization of semi-natural grassland through integrated generation of solid fuel and biogas from biomass. II. Effects of hydrothermal conditioning and mechanical dehydration on anaerobic digestion of press fluids. *Grass and Forage Science* 64, 354-363.
- Wachendorf M., Richter F., Fricke T., Graß R. and Neff R. (2009) Utilization of semi-natural grassland through an integrated generation of solid fuel and biogas from biomass I: Effects of hydrothermic conditioning and mechanical dehydration on mass flows of organic and mineral plant compounds, and nutrient balances. *Grass and Forage Science* 64, 132-143.

## White clover effect on yield and quality of a *Lolium perenne* sward under cutting conditions

De Vliegheer A.

*Institute for Agricultural and Fisheries Research (ILVO), BE-9820 Merelbeke, Belgium*

Corresponding author: alex.devliegheer@ilvo.vlaanderen.be

### Abstract

In this experiment, we compared perennial ryegrass (PRG, *Lolium perenne* L.) with and without white clover (WC), under cutting conditions and under the maximum fertiliser rates stated in the Flemish decree on fertilisation. The experiment started in 2007 on a sandy loam soil (Merelbeke) and the results after two years are presented here. In this management regime with a annual total N fertilisation between  $170 N_{\text{slurry}} + 100 N_{\text{mineral}}$  and  $250 N_{\text{slurry}} + 180 N_{\text{mineral}}$ , the presence of white clover stimulated dry matter and crude protein production and forage quality of a PRG sward significantly in 2008. A higher crude protein content resulted in significantly higher level of true protein digested in the small intestine and in a non-significant higher level of degradable protein. In 2007 only a significant increase in crude protein content was measured. Leachable N-residue in the soil was low for a PRG-WC sward, but it was significantly higher than the PRG sward.

Keywords: perennial ryegrass, white clover, yield, protein content, residual N

### Introduction

Farmers in Flanders see great potential in introducing white clover (WC) into their grassland, because N-fertilisation is expensive and restricted by the Flemish Government in accordance with the EU Nitrate Directive. Important questions are: could WC in the sward compensate for the decrease in dry matter yield and protein content caused by a lower N-input? and, what are the consequences for the leachable N residue in the soil? In this experiment, we compared PRG with and without WC under cutting conditions and under different fertiliser rates stated in the Flemish decree on fertilisation.

### Materials and methods

In May 2006 a mixture of PRG and WC was sown on a sandy loam soil in Merelbeke. In some places PRG-WC areas were treated with a herbicide mixture to kill the WC in order to obtain PRG and PRG-WC plots. The experimental design was a split-plot design with four replicates, sward type as a split plot. The experiment started in March 2007 and runs until 2011. Data from 2007 and 2008 are presented.

The following total N fertilisation ( $\text{kg ha}^{-1}$ ) for grass and grass-clover was imposed:

- (1)  $170 N_{\text{slurry}} + 100 N_{\text{mineral}}$ ,
- (2)  $170 N_{\text{slurry}} + 180 N_{\text{mineral}}$ ,
- (3)  $250 N_{\text{slurry}} + 100 N_{\text{mineral}}$ ,
- (4)  $250 N_{\text{slurry}} + 180 N_{\text{mineral}}$ .

Treatment 2 corresponds with the maximum level of cattle slurry and total N on grassland that is allowed by the Flemish Government in common circumstances. When derogation is allowed more  $N_{\text{animal origin}}$  can be applied, so  $250 N_{\text{slurry}} + 100 N_{\text{mineral}}$  (Treatment 3) is legitimate. Cattle slurry was applied by shallow injection in March and May (Table 1). The real N-input corresponded very well with the assumed N input.  $N_{\text{mineral}}$  was applied as ammonia nitrate (27% N). The plots ( $56.3 \text{ m}^2$  gross area,  $8.4 \text{ m}^2$  harvested for yield

determination) were cut 5 times per year. At each cut dry matter (DM) yield was measured and a grab subsample was separated into the PRG, WC and unsown species. Samples were analysed by NIRS to determine chemical composition and digestibility and energy (fodder unit milk, VEM) and protein content (true protein digested in the small intestine, DVE and rumen degraded protein balance, OEB) were calculated. DVE and OEB are parameters of protein quality developed by Taminga *et al.* (1994). The nitrate nitrogen content of the 0-90 cm topsoil was determined each year in the beginning of November.

Table 1. Fertilisation and cutting regime in 2007 and 2008

		1 <sup>st</sup> cut	2 <sup>nd</sup> cut	3 <sup>rd</sup> cut	4 <sup>nd</sup> cut	5 <sup>th</sup> cut
170 N <sub>slurry</sub>	1 ha <sup>-1</sup>	25000	25000			
250 N <sub>slurry</sub>	1 ha <sup>-1</sup>	35000	35000			
100 N <sub>mineral</sub>	kg ha <sup>-1</sup>	45	30	25		
180 N <sub>mineral</sub>	kg ha <sup>-1</sup>	60	60	60		
Harvest dates 2007		2/05	30/05	10/07	30/08	31/10
Harvest dates 2008		13/05	16/06	22/07	3/09	28/10

## Results and discussion

There was no difference in dry matter yield between PRG and PRG-WC in 2007 but in 2008 PRG-WC had a significantly higher annual DM yield (Table 2). In 2007 the clover content, expressed by the clover percentage in the annual total dry matter, was much lower than in 2008. In 2007 there was almost no clover in the sward in the first 3 cuts (<5%) and a significant clover development in the 4<sup>th</sup> (40%) and 5<sup>th</sup> cut (17%), whereas in 2008 there was considerable clover content in the dry matter during the whole season: 18%, 23%, 22%, 24% and 18% in the 5 cuts, respectively. A study of more than 400 fields over several years confirmed that productivity of mixed swards is directly related to the contribution of white clover in the sward (Pfimlin *et al.*, 1993).

No differences were found in energy content between PRG and PRG-WC. The crude protein content on an annual basis was significantly higher in both years for PRG-WC. Within a whole year, the crude protein content was significantly higher on PRG-WC in the 4<sup>th</sup> and 5<sup>th</sup> cut in 2007 and in the 1<sup>st</sup>, 3<sup>rd</sup>, 4<sup>th</sup> and 5<sup>th</sup> cut in 2008. A higher crude protein content in combination with a higher DM yield resulted in a significantly higher protein production of 387 kg ha<sup>-1</sup> in 2008. PRG-WC stimulated the production of more farm-grown protein, even in growing conditions with a considerable N-fertilisation. This is in agreement with results in other studies (De Vlieghe *et al.*, 2006; Smit and Elgersma, 2006; De Vlieghe and Carlier, 2008).

DVE and OEB are calculated to predict the protein quality for animal nutrition. The higher crude protein content of PRG-WC resulted in a significant higher DVE in the second year and a non-significant higher degradation of protein in the rumen (OEB) in both years.

To avoid leaching, the nitrate nitrogen content in the 0-90 cm soil profile should not exceed 90 kg ha<sup>-1</sup> at the end of the growing season. The residual nitrate content in the soil in November 2007 and 2008 was significantly higher for PRG-WC in comparison with PRG but the level was far below this limit of 90 kg ha<sup>-1</sup>: 24 kg and 11 kg ha<sup>-1</sup> NO<sub>3</sub>-N (Table 1). This is a favourable situation from the environmental point of view but a normal situation under cutting conditions and is in agreement with other studies (Verbruggen *et al.*, 2003; De Vlieghe and Carlier, 2008).

In this synthesis of the first two years' results there is a tendency for a higher proportion of white clover in the sward, with a bigger effect on DM yield and crude protein content under derogation - 250 N<sub>slurry</sub> + 100 N<sub>mineral</sub> - in comparison with the common fertiliser limits of 170 N<sub>slurry</sub> + 180 N<sub>mineral</sub> (specific results not mentioned in this paper).

Table 2. Effect of white clover in the sward on forage yield and quality and on residual nitrate in the soil (Merelbeke 2007-2008)

	2007		2008	
	PRG	PRG-WC	PRG	PRG-WC
<i>Yield</i>				
Dry matter yield (kg ha <sup>-1</sup> y <sup>-1</sup> )	13516a	13099a	13284a	14305b
Crude protein (kg ha <sup>-1</sup> y <sup>-1</sup> )	2090a	2130a	2297a	2684b
Clover content in DM (g kg <sup>-1</sup> )	-	130	-	210
<i>Forage quality</i>				
Energy VEM in DM (kg <sup>-1</sup> )	848a	837a	862a	859a
Crude protein in DM (%)	15.45a	16.34b	18.30a	20.00b
DVE in DM (g kg <sup>-1</sup> )	77a	78a	84a	89b
OEB in DM (g kg <sup>-1</sup> )	3a	12a	26a	40a
<i>Residual nitrate in soil</i>				
NO <sub>3</sub> -N (kg ha <sup>-1</sup> )	15a	24b	6a	11b

VEM: fodder unit milk; DVE: true protein digested in the small intestine; OEB: rumen degraded protein balance  
Treatments with the same letter in the same row are not significantly different ( $P < 0.05$ )

## Conclusion

In a cutting regime with N fertilisation between 170 N<sub>slurry</sub> + 100 N<sub>mineral</sub> and 250 N<sub>slurry</sub> + 180 N<sub>mineral</sub> white clover stimulated dry matter and crude protein production and forage quality of a perennial ryegrass sward when the clover proportion was >20% of the annual yield (2008). A higher crude protein content resulted in a significantly higher level of DVE and in a non-significant higher level of degradable protein. The residual nitrate content in the soil was significantly higher for the grass-clover mixture but there was there was no risk of nitrate leaching during the winter period.

## References

- De Vliegher A. and Carlier L. (2008) Potential of fodder legumes under intensive farming conditions in Flanders. *Grassland Science in Europe* 13, 236-238.
- De Vliegher A., Van Waes C., Malengier M. and Ghesquiere A. (2006) N-content and N-export of grass/legume mixtures in the COST 852 experiment in Belgium. In: Helgadottir A. and Poetsch E. (eds) *Quality legume-based forage systems for contrasting environments*. Federal Research and Education Centre Raumberg – Gumpenstein, Austria, pp. 69-72.
- Pfimlin A., Annezo J.F., Le Gall A., Boscher A., Bayon D., Henot A.Y., Kerouanton J., Le Vil F. and Lymes T. (1993) Intérêt des prairies de ray-grass anglais-trèfle blanc dans les exploitations laitières bretonnes. *Fourrages* 135, 389-398.
- Smit H. and Elgersma A. (2006) Two years experiments with grass-legume mixtures in Wageningen. In: Helgadottir A. and Poetsch E. (eds) *Quality legume-based forage systems for contrasting environments*. Federal Research and Education Centre Raumberg – Gumpenstein, Austria, pp. 125-128.
- Tamminga S., Van Straalen W.M., Subnel A.P.J., Meijer R.G.M., Steg A., Wever C.J.G. and Blok M.C. (1994) The Dutch protein evaluation system: the DVE/OEB-system. *Livestock Production Science* 40, 139-155.
- Verbruggen I., Nevens F. and Reheul D. (2003) *A comparison of the risk of nitrate leaching on grass and grass/clover*. Ghent University, Stedula publication 3, 32 pp.

## Crop-livestock system: Influence of different sward heights in cattle performance

Carvalho P.C. de F.<sup>1</sup>, Wesp C. de L.<sup>1</sup>, Conte O.<sup>2</sup>, Machado A.P.<sup>2</sup>, Oliveira E.V.<sup>2</sup>, Bremm C.<sup>1</sup>

<sup>1</sup> *Department of Forage Plants and Agrometeorology, Federal University of Rio Grande do Sul (UFRGS), CH-15100 Porto Alegre, Brazil*

<sup>2</sup> *Department of Soil Science, Federal University of Rio Grande do Sul (UFRGS), CH-15100 Porto Alegre, Brazil*

Corresponding author: cristianewesp@yahoo.com.br

### Abstract

The objective of this study was to evaluate the influence of different sward heights on cattle performance in a crop-livestock system. The study was conducted in a crop-livestock system in Tupancireta, Rio Grande do Sul, from May to November 2008. A forage mixture of oats (*Avena strigosa* Schreb.) and annual ryegrass (*Lolium multiflorum* Lam) was cultivated in the winter before soybean (*Glycine max* (L.) Merr.) cultivation. A group of crossbred steers, mean age of 10 months and mean initial weight of  $202 \pm 1.73$  kg, was distributed in a randomized block design with three replications. The experimental area was adjusted in relation to the stocking rate required to achieve and maintain sward heights of 10, 20, 30 and 40 cm. The individual performance of steers was less in pastures with sward heights of 10 cm. The sward heights of 10 and 20 cm resulted in higher live weight gains per hectare (LWG) than the 30 and 40 cm sward heights, with linear regression of this variable as the sward height was increased.

Keywords: crop livestock-system, sward height, animal performance, average daily gain, *Avena strigosa*, *Lolium multiflorum*

### Introduction

An alternative approach to diversify agricultural production is to integrate grain crops with ruminant production (Franzluebbers, 2007; Russelle and Franzluebbers, 2007; Sulc and Tracy, 2007). Integrated crop and livestock production has the potential to provide positive economic and environmental outcomes, such as increasing profitability and nutrient cycling efficiency. The cultivation of the cool season species *Avena strigosa* Schreb. and *Lolium multiflorum* permits the finishing cattle during the dry season, and comes as an option to improve animal production in the subtropical region of South America. In studies with temperate-climate forage plants, the relationship between sward height, forage intake and animal performance are evident, and demonstrate that increases in sward height enable increased individual consumption by animals, provided no decrease in nutritive value of forage occurs. .

### Material and methods

The study was conducted in a crop-livestock system in Tupancireta, Rio Grande do Sul, from May to November 2008. A forage mixture of oats (*Avena strigosa* Schreb.) and annual ryegrass (*Lolium multiflorum* Lam) was cultivated in the winter before soybean (*Glycine max* (L.) Merr.) cultivation. The seeding rate used was  $85 \text{ kg ha}^{-1}$  and  $20 \text{ kg ha}^{-1}$  seed, respectively. The area was subdivided into twelve experimental units (paddocks) with the aid of electric fences, in order to maintain four different grazing heights. The experimental design was a randomised complete block with three replications, where each block was subdivided into

four paddocks of variable size from 1 to about 3 ha. A group of 81 Angus, Hereford and Nellore crossbred steers, mean age of 10 months and mean initial weight of  $202 \pm 1.73$  kg, was distributed in a randomized block design with three replications. The areas were adjusted for the stocking rate required to achieve and maintain sward heights of 10, 20, 30 and 40 cm, which were kept constant by continuous stocking, with variable stocking rate using the 'put-and-take' technique suggested by Mott and Lucas (1952).

In order to characterize the structure of the pasture during the 122 days of the grazing period, we monitored the pasture using a sward-stick (Barthram, 1985). Sward height measurements were taken at intervals of 15 days, based on the mean of a total of 100 readings at random sampling points in each experimental unit.

For performance evaluations, three 'tester' animals were used in each paddock. Animal performance was evaluated using starting and finishing weights obtained after 12 h fasting, with the average daily gain (ADG) calculated by the difference divided by the number of days grazing. The live weight gain per hectare (LWG) was obtained by multiplying the average stocking rate (number of animal per day) by the ADG of 'tester' animals.

**Results and discussion**

The average sward heights obtained by the use of variable stocking rates were similar to those previously established, being 14.1 cm, 22.6 cm, 32.1 cm, and 41.1 cm, respectively. The highest values were observed for LWG in the treatment of 10 cm, due to an increased stocking rate. There was an increase of individual animal performance as the grazing heights were increased, up to 30 cm sward height, with estimated ADG of  $0.97 \text{ kg animal}^{-1} \text{ day}^{-1}$  (Figure 1). For sward heights between 20 and 30 cm the response curve estimated performance values close to  $1.0 \text{ kg animal}^{-1} \text{ day}^{-1}$ , which represents an interesting rate of weight gain for the purpose of finishing beef cattle under appropriate conditions at the end of the cycle of winter pasture. The weakest performers in 10 cm reflects the dwindling herbage allowances available in this treatment and the likely reduction in depth, and hence bite mass, essential components in the composition of dietary dry matter intake. The trend of a lower ADG in the taller sward height is probably related to changes in sward structure, which can cause a decrease in consumption by reducing the bite depth and increased time spent searching, apprehending and manipulating the available forage (Carvalho *et al.*, 1999).

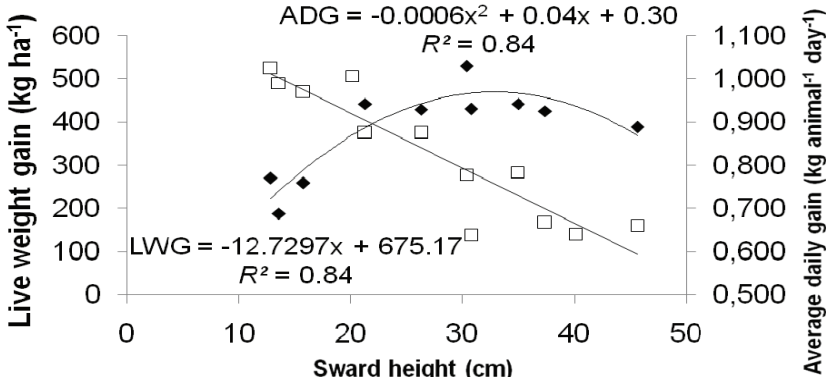

Figure 1. Relationship between sward height (cm), live weight gain ( $\text{kg ha}^{-1}$ ) and average daily gain ( $\text{kg animal}^{-1} \text{ d}^{-1}$ ) in pasture of oats and annual ryegrass, managed under different heights.



## Conclusions

Average daily gain per animal increased with increasing sward height, until the intermediate level of grazing intensity was reached. The best results were obtained from swards of 30 cm, with average daily gains of  $0.97 \text{ kg animal}^{-1} \text{ day}^{-1}$ . Since the gain per unit area is inversely proportional to sward height, the biggest gains were obtained in paddocks managed between 10 and 20 cm height.

## References

- Barthram G.T. (1985) Experimental techniques: the HFRO sward stick. In: Hill Farming Research Organization. *Biennial Report*, 29-30.
- Carvalho P.C.F *et al.* (1999) O processo de pastejo: desafios da procura e apreensão da forragem pelo herbívoro. In: 36 ° Reunião Anual Da Sociedade Brasileira De Zootecnia, *Anais 36 ° Reunião Anual Da Sociedade Brasileira De Zootecnia*, SBZ, Porto Alegre, BR, 36, 153-168.
- Franzluebbers, A.J. (2007) Integrated crop–livestock systems in the southeastern USA. *Agronomy Journal* 99, 361-372.
- Mott G.O. and Lucas H.L. (1952) The design, conduct, and interpretation of grazing trials on cultivated and improved pastures. In: International grassland congress, *Proceedings of International grassland congress*, Pennsylvania, 6, 1380-1385.
- Russelle M.P. and Franzluebbers A.J. (2007) Introduction to Symposium: Integrated crop–livestock systems for profit and sustainability. *Agronomy Journal* 99, 323-324.
- Sulc R.M. and Tracy B.F. (2007) Integrated crop-livestock systems in the U.S. corn belt. *Agronomy Journal* 99, 335-345.

## Grazing with a mobile milking robot

Dufrasne I., Robaye V., Istasse L. and Hornick J. L.

*Nutrition Unit, Veterinary Medicine Faculty, Liège University, B-4000 Liège, Belgium*

Corresponding author: Isabelle.Dufrasne@ulg.ac.be

### Abstract

The size of dairy cow herds in Europe is increasing. Farmers have to manage larger herds but want, at the same time, to benefit from a normal social life. So, the milking robot can bring solutions. Its use can reduce physical labour and allow flexibility. During the past 10 years, the number of milking robots has been increased in Europe. In farm practice, this technology has resulted in a reduction in the amount of grazing, even though grazing appears as a natural practice which is appreciated by the consumers. At the experimental farm of the University of Liège we are developing the concept of a mobile milking robot in collaboration with a private company. This prototype will allow cows to graze and could be moved to different locations on pastures during the grazing season. The prototype will be used indoors during the end of the winter season and will be moved outdoor during the 2010 grazing season. The feasibility of this prototype has to be tested in the field. Milk production and quality, the number of visits and the grazing parameters will be recorded. Different equipments in view to attract the cows to the robot as the presence of a cow brush, the location of the drinking point, will be compared. The behaviour of animals will be also assessed.

Keywords: grazing, dairy cows, mobile milking robot, behaviour

### Introduction

The increase in size of the dairy herds in Europe leads to reduced grazing practice. In Wallonia, in the southern part of Belgium, dairy cows still graze on most of the farms but the number of dairy farmers is decreasing and the milk quota per farm is becoming larger. Thus, grazing practice is likely to be reduced within the next years. However, grazing is associated with positive aspects such as improvements in animal health – the grazing period means generally a period of recovery (Hopster, 1996) – and in reduced labour requirements (Troxler *et al.*, 1992). The feeding costs are reduced with grazing as the harvest has not to be conducted by machines. The grazing system provides, therefore, cheaper feed than the roughage given in the barn. Regarding animal behaviour, Redbo (1990) reported a decrease of stereotypies and Miller and Wood-Gush (1991) a decrease of aggression in the herd at grazing. Furthermore, grazing is perceived positively by consumers and the picture of a grazing dairy cow on the milk carton is often used as a marketing strategy.

This project aims to develop strategies to use milking robots in pasture in order to benefit from advantages regarding feeding costs as well as animal welfare and health.

### Milking robot and grazing

The number of farms equipped with milking robots is rising and the use of this system will probably increase in the next years because it allows labour costs to be reduced. On most farms, the cows remain in the barn without any grazing opportunity resulting in loss of benefits from grazing practice.

There are, however, some experiences carried out with grazing cows milked by a robot. The frequency of milking with a robot available throughout a 24-h period, the effect of different grazing routines and factors affecting the milking frequency and the behaviour were evaluated by Ketelaar-de Lauwere *et al.* (1999) on cows in the barn with an access to the pastures. They

also investigated the effects of sward heights and the distance between the barn and the pasture on the cows' visits to the milking robot (Ketelaar-de Lauwere *et al.*, 2000). They concluded that milking grazing dairy cows by using a milking robot was possible; however, the cow behaviour can be affected by the weather. The cows preferred to lie in the pasture rather than in the cubicles when they had the choice. The number of milkings increased when sward height decreased and a distance of 360 m between pasture and barn did not affect the visits of cows. Conversely, some authors obtained negative effects of the distance on milking frequency (Wredle, 2005).

The location of drinking water points is used by the farmers to attract the cows to the milking robot. Spörndly and Wredle (2005) did not find any significant difference in milk yield and milking frequency between cows offered drinking water both in the barn and in the pasture, compared to drinking water only in the barn.

The high degree of synchronisation of cows' behaviour is a problem as the cows tend to visit the barn as a group and usually enter in the milking robot in close succession (Ketelaar-de Lauwere, 2000). To counteract this problem, there is a need to use individual signals to stimulate the cows to go to the milking robot: rotation between paddocks several times a day and selection gates in the pasture can be carried out to increase visits of the robot (Woolford *et al.*, 2004).

A mobile milking robot has been used in Denmark since 2007 by an organic farmer (Oudshoorn, 2007), in Netherlands in Wageningen University in 2008 and in Germany in 2009 by an organic farmer. Oudshoorn (2007) reported an average of 1.8 milkings per cow, and observed that cows visited the milking site individually, mostly during daytime.

### **Description of the mobile milking robot**

A prototype of a mobile milking robot that will be placed in the pasture is currently developed. The milking robot and equipments – compressor, milk separator, computer (Lely) – are located on a trailer that can easily be moved to different places by a tractor and can be lowered to ground level (Fig. 1). The milk tank is placed on another trailer designed as a conventional trailer. The two trailers are allowed to use the traffic road. The places where the robot will be operated have to be equipped with electricity points, water and facilities to collect the washing water. The trailer with the milk tank needs an easy access for milk collection by lorry.

The prototype will be used indoors at the end of the 2009-2010 winter season, and will be moved in the field during the 2010 grazing season. The feasibility of this prototype has to be tested in the field. The main challenge will be that cows visit the robot by themselves for milking. We will investigate different equipments to increase cows' welfare and to attract them to the robot area: presence of a shelter, a cow brush, drinking water near the robot, feed, lights during the night. The milk production and quality, the number of visits and the grazing parameters and the weight of cows will be recorded. The weather conditions will be also taken into account. The economy in labour and in feed costs will be calculated.

### **Conclusion**

First results about the feasibility of the prototype in the field are expected in the summer 2010.



Figure 1. Design of mobile milking robot

## References

- Hopster H. (1996) Effects of Housing and Management on Welfare and Health of Cattle Older than Six Months. *IVO-report B-405*, ID-DLO, Zeist, The Netherlands, 152 pp.
- Ketelaar-de Lauwere C.C., Ipema A. H., van Ouwkerk E.N.J., Hendriks M.M.W.B., Metz J.H.M., Noordhuizen J.P.T.M. and Schouten W.P.G. (1999) Voluntary automatic milking in combination with grazing of dairy cows. Milking frequency and effects on behaviour. *Applied Animal Behaviour Science* 64, 91-109.
- Ketelaar-de Lauwere C.C., A.H. Ipema A.H., Lokhorst C., Metz J.H.M., Noordhuizen J.P.T.M., Schouten W.P.G. and Smits A.C. (2000) Effect of sward height and distance between pasture and barn on cows visit to an automatic milking system and other behaviour. *Livestock Production Science* 65, 131-142.
- Miller, K. and Wood-Gush, D.G.M. (1991) Some effects of housing on the social behaviour of dairy cows. *Animal Production* 53, 271-278.
- Oudshoorn R.W. (2007) Mobile milking robot offers new grazing concept. *Grassland Science in Europe* 13, 721-723.
- Redbo I. (1990) Changes in duration and frequency of stereotypies and their adjoining behaviours in heifers, before, during and after the grazing period. *Applied Animal Behaviour Science* 26, 57-67.
- Spöndly E. and Wredle E. (2005) Automatic milking and grazing – Effects of location of drinking water on water intake, milk yield and cow behaviour. *Journal of Dairy Science* 88, 1171-1722.
- Troxler, J., Jans F., Wettstein J.B., Monteleone P. and Gmur P. (1992) The practical aspects of mobile milking equipment for grazing cows. *Revue Suisse d'Agriculture* 24, 229-236.
- Woolford M.W., Claycomb, R.W., Jago J; Davis K., Ohnstad I., Wieliczko R., Copeman P.J.A. and Bright K. (2004) *Automatic dairy farming in New Zealand using extensive grazing systems. Automatic Milking – A Better Understanding*. Academic Publishers, Wageningen, Netherlands, pp. 280- 285.
- Wredle E. (2005) *Automatic milking and grazing : factors and stimuli affecting cow motivation to visit the milking unit*. Thesis, Swedish University of Agricultural Science, Uppsala, 46 pp.

# Fermentation residues of biogas co-fermentation and their effects on grassland

Elsaesser M.

*Agricultural Centre for Cattle Production, Grassland Management, Dairy Management, Wild Deer Biology and Fisheries, Baden-Wuerttemberg (LAZBW), D - 88326 Aulendorf, Germany*

Corresponding author: Martin.Elsaesser@lvvg.bwl.de

## Abstract

Fermentation of grass and maize as co-ferments with cattle slurry is common in Baden-Wuerttemberg (Southern Germany), where more than 600 biogas plants for bioenergy production are installed. The effects of biogas fermentation residues of different origins as fertilizers on grassland have not yet been investigated, particularly in the context of the amount of nutrients permitted by the EU Nitrates Directive. LAZBW tests the effects of two different biogas slurries on yield and botanical composition of permanent grassland at two different locations with eleven treatments and four replications. Slurry 1 is half and half coferment and cattle slurry, Slurry 2 is from pure co-fermentation of maize and grass. The treatments differ in the amount of slurry, the number and time of application and the supplementation of mineral N, P and K. The preliminary results show that not only different nutrient contents of the substrates, but that also various effects on grassland and higher DM yields by additional fertilization of mineral nutrients. The date of additional mineral nitrogen application had no significant effect. N-removal with grassland biomass ranged from 250 kg ha<sup>-1</sup> to a maximum of 420 kg ha<sup>-1</sup>. The botanical composition of the grassland swards changed due to different fertilisation.

Keywords: biogas, slurry, coferment, permanent grassland, fermentation, bioenergy

## Introduction

It is a more and more common practice in Germany that maize and grass silages are used as co-ferments for the production of biogas as bioenergy. In order to be suitable for the fermentation processes, grass growths should be harvested in immature growth stages. The effects of long term fertilisation of fermentation residues on yields, N-removal and botanical composition of permanent grassland have not yet been investigated. It is assumed that the effects depend of the substrate attributes. Therefore, the objectives of our experiment were to investigate the effects of slurry with and without co-ferments on grassland and to compare this with earlier results using only pure cattle manure (Elsaesser *et al.*, 1995).

## Materials and methods

The effects of different amounts of two different fermentation residues were tested from 2007 to 2009 at two locations in Southern Germany, in 'Allgaeu' and 'Oberschwaben'. The fermentation residue (slurry) at the location 'Allgaeu' was exclusively from plant co-ferments; at 'Oberschwaben' it was half cattle manure and half co-ferment from grass and maize. The slurry was applied at two, three or four times per year, with a total of 51 - 68 m<sup>3</sup> at 'Allgaeu' and 38 - 57 m<sup>3</sup> at 'Oberschwaben'. Dry matter contents in the slurries varied between 2.9 and 6.6% in pure co-fermented slurry, and between 4.1 and 8.7% in the mixed slurry, and showed a wide range of nutrient contents (Haber, 2008). The slurry was distributed by typical farm machines using drag hoses. The field at 'Allgaeu' was harvested five times, and at 'Oberschwaben' four times per year. The experiment was a randomised complete block

design with four replications and a plot size of 1.6 m x 6.6 m. Dry matter (DM) and nitrogen (N) yields were measured. The abundance of each plant species was quantified by estimating its proportion of above-ground harvestable biomass following the method of Klapp and Stählin (Voigtländer and Voss, 1979).

Table 1. Application dates and amounts of applied nutrients of selected treatments at experimental site 'Oberschwaben' (Tr = Treatment).

Tr	Nutrients from substrate kg ha <sup>-1</sup>			Additional mineral fertilizer kg ha <sup>-1</sup>			Total kg ha <sup>-1</sup>		
	N	P	K	N	P	K	N	P	K
Fertilisation with fermentation residue to 1 <sup>st</sup> and 3 <sup>rd</sup> growth (2 x 19 m <sup>3</sup> ) → 38 m <sup>3</sup>									
1	185	34	141	0	0	0	185	34	141
3	185	34	141	3×28.7 (1.-3. cut)	7	176	271	43	317
4	185	34	141	1×86 (to 2. cut)	7	176	271	43	317
Fertilisation with fermentation residue to 1 <sup>st</sup> and 2 <sup>nd</sup> growth (2 x 19 m <sup>3</sup> ) → 38 m <sup>3</sup>									
5	178	34	133	0	0	176	178	34	309
7	178	34	133	3×28.7 (1.-3.cut)	7	176	265	43	309
8	178	34	133	1×86 (to 3. cut)	7	176	265	43	309
Fertilisation with fermentation residue to 1 <sup>st</sup> , 2 <sup>nd</sup> and 3 <sup>rd</sup> growth (3 x 19 m <sup>3</sup> ) → 57 m <sup>3</sup>									
9	274	51	204	0	0	105	274	51	309
10	274	51	204	0	0	0	274	51	204
11	274	51	204	3×28.7 (1.-3.cut)	0	105	360	51	309

Table 2. Application dates and amounts of applied nutrients of selected treatments at experimental site 'Allgaeu' (Tr = Treatment).

Tr	Nutrients from substrate kg ha <sup>-1</sup>			Additional mineral fertilizer kg ha <sup>-1</sup>			Total kg ha <sup>-1</sup>		
	N	P	K	N	P	K	N	P	K
Fertilisation with fermentation residue to 1 <sup>st</sup> , 2 <sup>nd</sup> and 3 <sup>rd</sup> growth (3 x 17 m <sup>3</sup> ) → 51 m <sup>3</sup>									
1	188	26	179	0	0	0	188	26	179
3	188	26	179	4×36.5 (1.-4. cut)	29	213	334	55	392
4	188	26	179	2×73 (2.+3.cut)	29	213	334	55	392
Fertilisation with fermentation residue to 1 <sup>st</sup> , 3 <sup>rd</sup> and 5 <sup>th</sup> growth (3 x 17 m <sup>3</sup> ) → 51 m <sup>3</sup>									
5	187	25	172	0	0	0	187	25	172
7	187	25	172	4×36.5 (1.-4.cut)	29	213	333	54	385
8	187	25	172	2×73 (2.+3.cut)	29	213	333	54	385
Fertilisation with fermentation residue to 1 <sup>st</sup> , 2 <sup>nd</sup> , 3 <sup>rd</sup> and 4 <sup>th</sup> growth (4 x 17 m <sup>3</sup> ) → 68 m <sup>3</sup>									
9	220	31	209	2×43.5 (1.+2.cut)	18	174	307	49	383
10	220	31	209	4× 27	18	174	328	49	383
11	220	31	209	0	0	0	220	31	209
12	220	31	209	0	29	213	220	60	422

## Results and discussion

In the experiment 'Oberschwaben' with mixed slurry the highest amount of fertilized nitrogen resulted in the highest DM and N yields. Slurry without additional application of mineral N gave the lowest DM yields. The date of slurry application had no significant effect on yields. Apparently, the N distribution had no significant impact on yields and N removal. The fertilization with pure co-ferment slurries at location 'Allgaeu' gave no consistent results. Higher amounts of fertilized N did not necessarily result in significantly higher DM yields and N removal. An even distribution of additional mineral N gave higher yields. Both experiments show that N efficiency was highest in the treatments where no mineral N was added. The botanical composition of the grassland swards changed during the experimental period. The percentage of legumes at both experimental sites decreased markedly in nearly all treatments. Presumably, this was caused by the higher N fertilization since the experiment



started. In contrast, the percentage of herbs and weeds mostly increased, except in the case of treatments 8 and 11 at location 'Oberschwaben'. Reasons for this effect are not yet clear.

Table 3. DM yields (2007-2009) and N yields (2007 - 2008) at the different sites

Treatment	Cattle slurry and coferments (Oberschwaben)		Only coferments (Allgaeu)	
	DM t ha <sup>-1</sup>	N kg ha <sup>-1</sup>	DM t ha <sup>-1</sup>	N kg ha <sup>-1</sup>
1	10.7 d	245.6 e	11.7 de	308.7 c
3	12.7 ab	296.3 abcd	14.1 ab	399.5 ab
4	12.5 abc	288.6 abcde	14.0 abc	408.2 ab
5	11.2 cd	262.8 cde	11.5 d	312.9 c
7	12.6 ab	304.9 abc	14.8 a	411.5 ab
8	13.5 a	322.5 ab	13.6 abcd	388.6 ab
9	11.6 bcd	276.2 bcde	13.7 abcd	407.7 ab
10	10.5 d	250.7 de	14.3 ab	431.5 a
11	13.4 a	327.5 a	12.5 bcd	364.0 abc
12			12.6 abcd	360.4 bc
LSD ( <i>P</i> < 0.05)	1.34	47.8	2.27	67.6

Table 4. Botanical composition of swards at different experimental sites in 2007 and 2009

Treatment Site Year	Herbs in % of total biomass				Legumes in % of total biomass			
	Oberschwaben		Allgaeu		Oberschwaben		Allgaeu	
	2007	2009	2007	2009	2007	2009	2007	2009
1	27.5	33.8	23.0	33.5	10.0	1.3	4.5	1.8
3	38.5	29.5	23.0	23.5	5.3	0.60	5.0	2.1
4	33.8	27.3	28.8	31.8	1.5	0.4	4.0	2.05
5	30.5	46.5	23.5	25	9.3	2.3	4.5	1.3
7	24.5	40.8	16.0	17.8	7.3	1.9	4.3	0.9
8	30.0	20.3	13.8	20.5	7.5	1.0	3.0	0.9
9	11.5	24.0	17.5	21.3	9.0	3.0	2.5	0.2
10	25.8	33.0	12.3	22.3	6.8	6.3	2.4	0.4
11	26.0	19.5	22.0	28.3	7.3	2.3	2.8	0.7
12			20.0	23.8			3.8	0.9

## Conclusion

Fermentation residues from biogas fermentation processes are well suited for the fertilization of grassland. The nutrient contents of the substrates differ widely depending on the contribution of the co-ferments used. A specific effect of the slurry origin on the grassland yields could not be observed. The N removal of the grassland swards was much higher than the fertilized N. The date of application and the frequency of applying additional nitrogen seem to be of minor importance.

## Acknowledgements

LAZBW thanks the Ministerium Ländlicher Raum Baden-Württemberg for financial support.

## References

- Elsaesser M., Kunz H.G. and Briemle G. (1995) Unterschiedliche technische Behandlung von Gülle und deren Auswirkungen auf intensiv genutztes Dauergrünland. *Zeitschrift für Acker- und Pflanzenbau* 174, 253-264.
- Haber N. (2008) *Inhaltsstoffe von Gärprodukten und Möglichkeiten zu ihrer geordneten pflanzenbaulichen Verwertung*. Projektbericht, Landwirtschaftliches Technologie Zentrum Augustenberg, Karlsruhe.
- Voigtländer G. and Voss N. (1979) *Methoden der Grünlanduntersuchung und -bewertung*. Grünland, Feldfutter, Rasen, Ulmer, Stuttgart, Germany, 207 pp.



## Forage yield and N<sub>2</sub> fixation of *Trifolium alexandrinum* in pure stand and in mixture with *Lolium multiflorum*

Giambalvo D., Amato G., Di Miceli G., Frenda A.S., Ruisi P. and Stringi L.  
*Dipartimento di Agronomia Ambientale e Territoriale, Università di Palermo, Viale delle Scienze, 90128 Palermo, Italy*

Corresponding author: giardo@unipa.it

### Abstract

The efficiency of grass-legume intercrop systems is affected by various agronomic factors such as crop density, plant spacing and arrangement that may alter the competitive relationships between component crops. The aim of this study was to evaluate yield, N concentration, and symbiotic N<sub>2</sub> fixation of berseem clover (*Trifolium alexandrinum* L.) grown in pure stand or in mixture with annual ryegrass (*Lolium multiflorum* Lam) either in alternating rows or in the same row. The experiment was conducted in two consecutive growing seasons in a semi-arid Mediterranean environment (Sicily, Italy). Dry matter (DM) yields were similar in the mixed stands and in the berseem pure stand; the annual ryegrass pure stand produced the lowest yields. Plant arrangement did not significantly affect the yield of the mixtures, but it did influence the proportion of the two components. Intercropped berseem had a significantly higher percentage of N derived from the atmosphere than the monocropped berseem, but no differences were observed by plant arrangement. The apparent transfer of fixed N from berseem to ryegrass was not detected in any arrangement treatment.

Keywords: berseem clover, intercropping, plant arrangement, Ndfa,

### Introduction

Compared with pure-stand systems, the intercropping of forage species has several advantages in terms of biomass yield, yield stability, quality of forage and ecological sustainability (Dhima *et al.*, 2007). Such advantages are realized when the components of the mixtures draw on limited environmental resources more efficiently than pure stands. However, the efficiency of intercropping depends on various agronomic factors, such as species and variety, plant density, plant arrangement and fertilization. These factors have not been sufficiently studied, particularly among annual forage species in Mediterranean environments. The objective of this research was to study the effect of plant arrangement (component crops in alternate rows or in the same row) on yield, N concentration, and N<sub>2</sub> fixation of a berseem clover (*Trifolium alexandrinum* L.)-annual ryegrass (*Lolium multiflorum* Lam subsp. *wersterwoldicum*) mixture. Both species were also grown in pure stands as controls.

### Materials and methods

The experiment was carried out in two consecutive growing seasons in a Mediterranean environment (37°30'N, 13°31'E; 178 m a.s.l, Sicily, Italy) on deep, well-structured soil classified as a Vertic Haploxerert. The experiment had a randomized block design with four replications and was conducted under rainfed conditions. Treatments were pure stands of berseem (cv. Lilibeo; B) and annual ryegrass (cv. Elunaria; R) and stands containing a mixture of the two arranged either in alternating rows (BR<sub>AR</sub>) or in the same row (BR<sub>SR</sub>). Plots were hand-sown on 16 December of both years using 1300 viable seeds m<sup>-2</sup> for pure stands and a 0.5:0.5 ratio for mixed stands. Weeds were manually removed at regular

intervals during the experiment. In both years, all plots were managed as follows: first cut 85 days after sowing and subsequent cuts at 28-day intervals. The  $^{15}\text{N}$  isotope dilution technique was used to estimate  $\text{N}_2$  fixation by clover.  $^{15}\text{N}$  fertilizer ( $[\text{NH}_4]_2\text{SO}_4$  with an isotopic composition of 10 atom%  $^{15}\text{N}$ ) was uniformly applied in liquid form to a  $2.88\text{-m}^2$  microplot in the middle of each plot.  $^{15}\text{N}$  fertilizer ( $8\text{ kg ha}^{-1}\text{ N}$ ) was applied at the emergence of crop and again 2 days after the first and second cuttings. All plots were harvested by hand at 5 cm stubble height, and total fresh weight was determined. At each harvest, a sample of plant material, taken from the centre of the microplots, was hand-disaggregated into its botanical components (B, R), dried, weighed, ground, and analysed for total N and  $^{15}\text{N}$  enrichment. Data on  $^{15}\text{N}$  enrichment of biomass were used to calculate the percentage of clover nitrogen derived from symbiotic  $\text{N}_2$  fixation (%Nd<sub>fa</sub>) according to Fried and Middleboe (1977). Analysis of variance was performed according to the experimental design on the combined 2-yr data set. Treatment means were compared using Fisher's protected LSD test at the 5% probability level. Where treatment  $\times$  year interactions were significant, LSDs were calculated separately for each year.

## Results and discussion

The DM yield of berseem grown in monoculture or in intercrop with ryegrass was higher than that of ryegrass grown in monoculture (Table 1). The DM yield of berseem grown in monoculture was similar to that of the mixed stand (either BR<sub>AR</sub> or BR<sub>SR</sub>) and no significant differences in DM yield were observed by intercrop row arrangement. In the mixtures of berseem and ryegrass, the proportion of berseem was significantly greater when plants of the two species were arranged in the same row rather than in alternating rows (83% vs. 72%, on average;  $P < 0.001$ ). On average, the N concentration in the aboveground biomass of berseem was slightly lower in the mixtures than in the pure stand. In contrast, N concentration of ryegrass was significantly higher in the mixtures than in the pure stand, as observed by several authors studying grass-legume intercrops (e.g. Malhi *et al.*, 2002). The difference in N concentration between intercropped and monocropped ryegrass was higher when ryegrass was grown in the same row rather than in alternating rows. This was mainly due to a concentration effect, as ryegrass in the same row produced a markedly lower DM yield than that in alternating rows. As a matter of fact, the differences in N uptake of ryegrass due to plant arrangement were low and not statistically significant. The N uptake of monocropped berseem was significantly higher than that of monocropped ryegrass, slightly higher than that of the mixture in alternating rows, and similar to that of the mixture in the same row. The fraction of berseem N derived from  $\text{N}_2$  fixation (%Nd<sub>fa</sub>) was, on average, 70% in monocropped berseem, very similar than that observed by Cazzato *et al.* (2003). Nd<sub>fa</sub>% was significantly higher when berseem was grown in mixture (irrespective of plant arrangement) compared to in the pure stand. This was because of the competition from the ryegrass in terms of the uptake of soil N, which obliged the legume to increase its  $\text{N}_2$  fixation rate to satisfy its needs, as was also observed by Carlsson and Huss-Danell (2003). No significant differences were observed between intercropped and monocropped ryegrass for average atom%  $^{15}\text{N}$  excess, suggesting that N transfer from berseem to ryegrass did not occur. Peoples and Herridge (1990) stated that direct N transfer is usually not observed in annual grass-legume intercropping; furthermore the  $^{15}\text{N}$  isotope dilution technique may underestimate N transfer on a short-term basis (Høgh-Jensen and Schjoerring, 2000). In conclusion, the results from the present study show that berseem clover-ryegrass intercropping has many advantages over monocropping in terms of forage yield, N content, symbiotic  $\text{N}_2$  fixation and efficiency. On the whole, the effects of plant arrangement were moderate. However, adopting alternate-row rather than same-row arrangement (i.e., reducing the interactions between the intercropped

species) improved the competitive ability of ryegrass, which in this experiment was the weaker component.

Table 1. Biomass yield (dry matter), N concentration, total N uptake, and Ndfa. Mean values of two growing seasons are reported when treatment  $\times$  year interaction was not significant. Within each factor and year, means with different letters differ significantly ( $P < 0.05$ ).

	Crop†							
	B		BR <sub>AR</sub>		BR <sub>SR</sub>		R	
	Year 1	Year 2	Year 1	Year 2	Year 1	Year 2	Year 1	Year 2
Biomass DM (g m <sup>-2</sup> )	1064a		1014a		1043a		626b	
N concentration (g kg <sup>-1</sup> )	35.2a		33.1b		33.1b		–	
<i>Berseem</i>	–		29.6b		33.5a		20.7c	
<i>Ryegrass</i>	37.5a		32.7b		34.4b		13.2c	
Total N uptake (g m <sup>-2</sup> )	33.1a	41.9a	23.1b	25.3c	26.9b	29.3b	–	–
<i>Berseem</i>	–		8.5b		6.3b		13.2a	
<i>Ryegrass</i>	73.4b	66.9b	80.7a	85.7a	79.5a	82.9a	–	–
Ndfa (%)	26.1a		20.1c		22.8b		–	
Ndfa (g m <sup>-2</sup> )	–		–		–		–	

† B, berseem pure stand; BR<sub>AR</sub>, berseem–ryegrass mixture in alternating rows; BR<sub>SR</sub>, berseem–ryegrass mixture in the same row; R, ryegrass pure stand

## Acknowledgements

The research was supported by the Project ‘Patti Territoriali Magazzolo-Platani’

## References

- Carlsson G. and Huss-Danell K. (2003) Nitrogen fixation in perennial forage legumes in the field. *Plant and Soil* 253, 353–372.
- Cazzato E., Annese V. and Corleto A. (2003) Azotofissazione in leguminose foraggere annuali in ambiente mediterraneo. Nota 1. Stima dell’azotofissazione mediante il metodo della diluizione dell’isotopo <sup>15</sup>N. *Rivista di Agronomia* 37, 57–61.
- Dhima K.V., Lithourgidis A.S., Vasilakoglou I.B., and Dordas C.A. (2007) Competition indices of common vetch and cereal intercrops in two seeding ratio. *Field Crops Research* 100, 249–256.
- Fried M. and Middleboe V. (1977) Measurements of amount of nitrogen fixed by a legume crop. *Plant and Soil* 47, 713–715.
- Høgh-Jensen H. and Schjoerring J.K. (2000) Below-ground nitrogen transfer between different grassland species: Direct quantification by <sup>15</sup>N leaf feeding compared with indirect dilution of soil <sup>15</sup>N. *Plant and Soil* 227, 171–183.
- Malhi S.S., Zentner R.P., and Heier K. (2002) Effectiveness of alfalfa in reducing fertilizer N input for optimum forage yield, protein concentration, returns and energy performance of brome-grass-alfalfa mixtures. *Nutrient Cycling in Agroecosystems* 62, 219–227.
- Peoples M.B. and Herridge D.F. (1990) Nitrogen fixation by legumes in tropical and subtropical agriculture. *Advances in Agronomy* 44, 155–223.

## Effect of different methods of sward renovation on selected physical and chemical soil properties

Zajac M.<sup>1</sup>, Spsychalski W.<sup>2</sup> and Goliński P.<sup>1</sup>

*Poznań University of Life Sciences (PULS), <sup>1</sup>Department of Grassland and Natural Landscape Sciences, <sup>2</sup>Department of Soil Sciences, Wojska Polskiego 38/42, 60-627 Poznań, Poland*

Corresponding author: pgorinski@up.poznan.pl

### Abstract

In permanent grassland renovation, the productivity, quality and ecological aspects (N and C cycles and soil quality dynamics) should be taken into consideration. During 2006-2008 an experiment was carried out with the aim of evaluating the effect of different renovation methods (old sward preparation by low cutting at a height of 3 cm and overdrilling, soil preparation by rototiller and overdrilling, spraying with glyphosate and direct drilling, ploughing and reseedling) on the selected physical and chemical properties of a soil of organic origin (Histosol). The following parameters were determined: soil moisture, bulk density, porosity, capillary water capacity, specific conductivity, content of  $\text{N-NO}_3^-$ ,  $\text{P-PO}_4^{3-}$ ,  $\text{K}^+$  in soil solution. Sward renovation methods significantly influenced physical and chemical properties of the soil. The observed effects were different in successive years after renovation. It is concluded that overdrilling and direct drilling are pro-ecological forms of grassland renovation on organic soils.

Keywords: direct drilling, overdrilling, physical and chemical soil properties, renovation

### Introduction

In order to counteract the degradation process of permanent grasslands, it is necessary to apply appropriate renovation methods which restore their high economic value. A number of interesting results have been obtained in recent years concerning production effects of various grassland renovation technologies, especially their impact on the quality and quantity of fodder for animals (Hopkins *et al.*, 1990). However, limited attention has been given to issues regarding the effect of the use of renovation methods on the soil environment (Taube and Conijn, 2004). The objective of this work was to evaluate the effect of different renovation methods on the selected physical and chemical properties of organic soil.

### Materials and methods

The experiment was carried out at Brody (52° 26'N, 16° 18'E) Experimental Station of PULS (Poland) during 2006-2008. The experiment (a randomized block with three replications of 25 m<sup>2</sup>) aimed to evaluate the effect of different renovation methods (old sward preparation by low cutting at the height of 3 cm and overdrilling, soil preparation by rototiller and overdrilling, spraying with glyphosate and direct drilling, ploughing and reseedling) on selected physical and chemical properties of organic soil (Histosols:  $\text{pH}_{\text{KCl}} - 7.8$ ,  $\text{N}_t - 0.71\%$ ,  $\text{P} - 296 \text{ mg kg}^{-1}$  (Egner-Riehm DL),  $\text{K} - 249 \text{ mg kg}^{-1}$  (Egner-Riehm DL),  $\text{Mg} - 71 \text{ mg kg}^{-1}$  (Schachtschabel)). Groundwater levels in the soil varied considerably during the year; in winter and early spring the site was flooded and in late summer the lowest level reached 80 cm. Every year after renovation, the following fertiliser rates were applied: 120 kg ha<sup>-1</sup> N, 26.2 kg ha<sup>-1</sup> P, 74.7 kg ha<sup>-1</sup> K, and three harvests were taken. Selected properties of soil were determined after three months, one year and two years after the renovation was performed.

Soil samples (100 cm<sup>3</sup>; cylinder 5.5 cm Ø, 4.2 cm height) with unaffected structure from 5-10 cm and 15-20 cm soil depth were taken from each plot to determine the following physical properties: soil moisture, bulk density and capillary water capacity. Porosity was calculated on the basis of specific and bulk density. Chemical properties were analysed in soil samples of 0-30 cm and 30-60 cm depths and were evaluated after preparing a soil solution using the saturated paste method (Jackson, 1964): electric conductivity, content of water soluble K<sup>+</sup> (AAS using Varian Spectra 220 FS), NO<sub>3</sub><sup>-</sup> and PO<sub>4</sub><sup>-3</sup> (colorimetric methods by Jackson). The data of physical properties were analysed by ANOVA. Tests for the main effects were performed by F-tests. Means were separated by the LSD and were declared at *P* < 0.05.

## Results and discussion

The annual mean temperature and total precipitation for 2006, 2007 and 2008 were 9.6, 9.9, 10.3 °C and 549, 827, 795 mm, respectively. These values were higher in comparison with long-term (1961-2008) averages of temperature (8.3 °C) and precipitation (599 mm), with the exception of precipitation in 2006. The results obtained show that the applied renovation methods influenced physical properties of organic soil (Table 1). Soil bulk density and porosity were significantly affected by the renovation method, but only in the year of renovation. They were increased as a result of the application of mechanical methods using rototiller and ploughing as well as direct drilling. The methods applied had no negative influence on soil moisture. In some treatments, after renovation and in consecutive years of utilization, there were significant increases of soil moisture and capillary water capacity compared with the soil in the area without renovation.

**Table 1. Physical soil properties depending on methods of sward renovation**

Method	Soil moisture (% w/w)			Bulk density (kg dm <sup>-3</sup> )			Porosity (% v/v)			Capillary water capacity (% v/v)		
	Years after renovation*			Years after renovation*			Years after renovation*			Years after renovation*		
	0	1	2	0	1	2	0	1	2	0	1	2
Soil layer 5-10 cm												
Without renovation	34.5b	38.7a	39.0a	1.11a	1.25a	1.12a	52.9c	46.7b	52.5a	40.6d	39.7b	40.4b
Low cutting and overdrilling	37.4a	34.1a	37.2b	1.13a	1.11a	1.12a	51.8c	52.9a	52.2a	40.6d	49.8a	37.6d
Rototiller and overdrilling	34.7b	35.2a	39.4a	0.65c	1.11a	1.12a	72.3a	52.8a	52.3a	79.6a	50.8a	38.5c
Glyphosate and direct drilling	39.4a	35.9a	35.4c	0.73b	1.10a	1.10a	68.8b	53.3a	53.2a	73.5c	48.0a	43.4a
Ploughing and reseeded	37.6a	38.5a	37.6b	0.76b	1.03a	1.11a	67.7b	56.2a	52.8a	75.3b	51.1a	43.3a
LSD <sub>0.05</sub>	2.690	ns	0.813	0.047	ns	ns	1.969	4.761	ns	0.042	5.592	0.416
Soil layer 15-20 cm												
Without renovation	31.1b	37.0a	38.7a	1.17a	1.15a	1.12a	50.4c	51.1a	52.5a	39.5c	39.8b	39.2d
Low cutting and overdrilling	38.0a	36.2a	45.4a	1.20a	1.04a	1.09a	48.8c	55.6a	53.6a	37.6e	45.5a	43.2b
Rototiller and overdrilling	36.7a	34.5a	40.7a	1.15b	1.10a	1.13a	50.9c	53.0a	51.9a	39.3d	47.7a	42.9c
Glyphosate and direct drilling	34.3ab	35.7a	40.7a	0.98c	1.10a	1.14a	58.2b	53.2a	51.3a	59.4b	47.8a	38.6e
Ploughing and reseeded	32.1b	35.6a	44.3a	0.82d	1.11a	1.09a	65.1a	52.8a	53.6a	68.4a	47.0a	47.1a
LSD <sub>0.05</sub>	4.127	ns	ns	0.049	ns	ns	2.114	ns	ns	0.125	4.368	0.068

\* 0 – three months; 1 – one year; 2 – two years

Changes in chemical properties after grassland renovation depend on techniques used for the cultivation and subsequent management of the sward (Table 2). After ploughing and grassland reseeded, increased electrical conductivity and N mineralisation occurred; this was attributed to the exposure of organic matter to microbial decomposition and improved aeration (Vertès *et al.*, 2004). Increased N-NO<sub>3</sub><sup>-</sup> content in soil solution was determined in our study, not only following the application of mechanical methods but also after direct drilling. In successive years, the N-NO<sub>3</sub><sup>-</sup> content in soil depended more on the current state of site conditions affected mainly by precipitation than on the previously applied renovation method.

Renovation methods also caused changes in P-PO<sub>4</sub><sup>-3</sup> and K<sup>+</sup> concentrations of the soil solution. In the case of sward overdrilling prepared by low cutting, changes in chemical properties in comparison with control conditions were negligible. This can indicate minimal soil damage during the overdrilling process, and reduced oxygen availability in soil which reduces organic matter mineralisation. Six *et al.* (2002) confirmed the beneficial effect of minimal tillage operations compared with conventional ploughing in terms of decreasing soil N mineralisation and, hence, the likelihood of reducing nitrate-N leaching losses to surface and ground waters.

Table 2. Chemical soil properties depending on methods of sward renovation

Method	Electrical conductivity (μS cm <sup>-1</sup> )			Content in soil solution (mg dm <sup>-3</sup> )											
				N-NO <sub>3</sub> <sup>-</sup>			P-PO <sub>4</sub> <sup>-3</sup>			K <sup>+</sup>					
	Years after renovation*			Years after renovation*			Years after renovation*			Years after renovation*					
			0	1	2	0	1	2	0	1	2	0	1	2	
Soil layer 5-10 cm															
Without renovation	862	2410	902	0.6	36.6	64.5	0.037	0.127	0.132	2.80	2.00	2.45			
Low cutting and overdrilling	1200	1883	869	0.6	36.3	61.0	0.010	0.108	0.049	1.28	1.08	4.37			
Rototiller and overdrilling	1142	1825	994	17.8	35.5	56.0	0.097	0.108	0.116	5.30	4.96	1.65			
Glyphosate and direct drilling	1011	1571	753	31.2	37.3	54.0	0.182	0.453	0.133	2.54	3.42	2.57			
Ploughing and reseeded	995	1139	1060	3.8	31.7	60.0	0.098	0.078	0.049	5.46	2.08	3.26			
Soil layer 15-20 cm															
Without renovation	1588	1568	1491	1.5	28.3	59.0	0.053	0.049	0.049	0.74	1.80	2.43			
Low cutting and overdrilling	2310	1898	1530	10.1	21.0	87.0	0.056	0.061	0.072	0.43	1.15	2.68			
Rototiller and overdrilling	1763	1922	2050	17.4	26.5	58.0	0.033	0.096	0.252	0.61	3.53	7.64			
Glyphosate and direct drilling	2390	2190	1303	17.8	17.2	51.0	0.047	0.304	0.139	1.05	2.54	2.60			
Ploughing and reseeded	1703	1864	1591	19.6	23.2	51.0	0.033	0.022	0.146	2.39	2.64	1.49			

\* 0 – three months; 1 – one year; 2 – two years

## Conclusions

Overdrilling carried out on low-cut sward is a method which impacts only on the surface soil layer. In the case of direct drilling, increases in porosity, water capillary capacity and the content of nitrate in the soil solution were found. Other renovation methods, such as ploughing with reseeded and rototiller with overdrilling, influenced physical soil properties to a greater extent. It is clear from the analysis obtained that soil loosening and its aeration during renovation leads to increased nitrate leaching and improved conductivity in the soil solution.

## References

- Hopkins A., Gilbey J., Dibb C., Bowling P.J. and Murray P.J. (1990) Response of permanent and reseeded grassland to fertilizer nitrogen. 1. Herbage production and herbage quality. *Grass and Forage Science* 45, 43-55.
- Jackson M.L. (1964) *Soil chemical analysis*. Prentice-Hall, Inc. Englewood Cliffs, New York, 498 pp.
- Six J., Feller C., Denef K., Ogle S., Sa Moraes J.C. and Albrecht A. (2002) Soil organic matter, biota and aggregation in temperate and tropical soils – effects of no-tillage. *Agronomie* 22, 755-775.
- Taube F. and Conijn J.G. (2004) Grassland renovation in Northwest Europe: current practices and main agronomic and environmental questions. *Grassland Science in Europe* 9, 520-522.
- Vertès F., Hatch D.J., Velthof G.L., Abiven S., Hopkins A. and Springob G. (2004) Effects of grassland cultivation on N and C cycles and soil quality dynamics. *Grassland Science in Europe* 9, 526-528.

## Biogas-Expert: grassland methane yield and short-term N efficiency of biogas residues

Wienforth B.<sup>1</sup>, Herrmann A.<sup>2</sup>, Sieling K.<sup>1</sup>, Ohl S.<sup>3</sup>, Hartung E.<sup>3</sup>, Taube F.<sup>2</sup> and Kage H.<sup>1</sup>  
Christian-Albrechts-University of Kiel, 24118 Kiel, Germany

<sup>1</sup>Institute of Crop Science and Plant Breeding; Agronomy and Crop Science

<sup>2</sup>Institute of Crop Science and Plant Breeding; Grass and Forage Science/Organic Agriculture

<sup>3</sup>Institute of Agricultural Engineering

Corresponding author: aherrmann@email.uni-kiel.de

### Abstract

Biogas production has expanded substantially in Germany - often in areas, where intensive livestock production is located, and large organic nutrient amounts are available. A field study was conducted to investigate the short-term N efficiency of different fertiliser types (mineral, biogas residue, cattle slurry) applied to grassland. Fertiliser type significantly influenced annual dry matter and methane yield, mainly explained by the NH<sub>4</sub>-N ratio. With respect to Relative N Fertiliser Value, differences between fertiliser types were pronounced only in the low N input range, where biogas residue showed a higher N availability than cattle slurry.

Keywords: anaerobic digestion, methane, biogas residue, fertiliser value, perennial ryegrass

### Introduction

Depending on environmental conditions, current agricultural and climate protection policies can result in food-fuel competition for forage crops. This applies in particular to regions dominated by forage production, where demand for maize silage is high due to milk and biogas production. Grassland therefore becomes more attractive for feedstock production. Although the biomass and methane yield potential of grassland is well documented (Amon *et al.*, 2007; Prochnow *et al.*, 2009), few data are available on N use efficiency of biogas residue. The objective of our study therefore was to quantify the short-term N use efficiency of biogas residue with respect to grassland dry matter yield and methane yield in comparison with mineral N fertiliser and cattle slurry.

### Materials and methods

The study was based on a 2-year (2007-2008) field trial conducted on a sandy aquod within the framework of the Biogas-Expert project of Kiel University, northern Germany. Mean annual temperature was above the long-term average (8.6 °C) in both years (10.3 °C in 2007, 9.7 °C in 2008). Rainfall with 898 mm surpassed its long-term average (844 mm) in 2007 (898 mm), and was somewhat below (726 mm) in 2008. The impact of N fertiliser type [(1) mineral N fertiliser, (2) biogas residue from cofermented pig slurry and maize, (3) cattle slurry] and of N fertiliser amount (0, 160, 320, 480 kg total N per ha) on dry matter yield and methane yield was investigated in a perennial ryegrass sward, cut 4 times per year. The sward had been established in 2006 using a seed mixture of the *Lolium perenne* varieties Fennema and Edda. Total N content of organic fertilisers varied between 2.8 and 4.0 kg m<sup>-3</sup> (with 46.8-65.0% NH<sub>4</sub>-N) for cattle slurry, and between 2.6 and 4.3 kg m<sup>-3</sup> (with 49.2-54.8% NH<sub>4</sub>-N) for biogas residue. Corresponding ranges for dry matter content were 7.5-11.2% (cattle slurry) and 4-8% (biogas residue). Organic fertiliser was applied in 4 dressings by trailing hoses. Specific methane yield was determined for the biogas residue and for the mineral fertiliser



treatments by the Hohenheimer Biogas Yield Test, in which pooled plant samples of 4 field replicates (3 unensiled lab replicates, dried at 58 °C, and ground to 1 mm) were anaerobically fermented for 28 d at 38 °C. Analyses of covariance were performed using SAS Proc GLM, with fertiliser type as fixed effect and total N input (kg ha<sup>-1</sup>) as covariable, to quantify the dependency of first cut and annual dry matter (DM, t ha<sup>-1</sup>) and methane yield (m<sup>3</sup><sub>N</sub> ha<sup>-1</sup>) on N input. The resulting N response curves were used to estimate the short-term N efficiency of biogas residue for annual DM and methane yield from the Relative N Fertiliser Value (RNFV). RNFV was obtained as ratio of the Apparent N Efficiency (ANE) of biogas residue, cattle slurry, and mineral fertiliser, with  $RNFV = ANE_{\text{manure}} / ANE_{\text{mineral}}$ , and  $ANE = (\text{yield of treatment} - \text{yield of control}) / (\text{N amount applied})$ , according to Schröder *et al.* (2005).

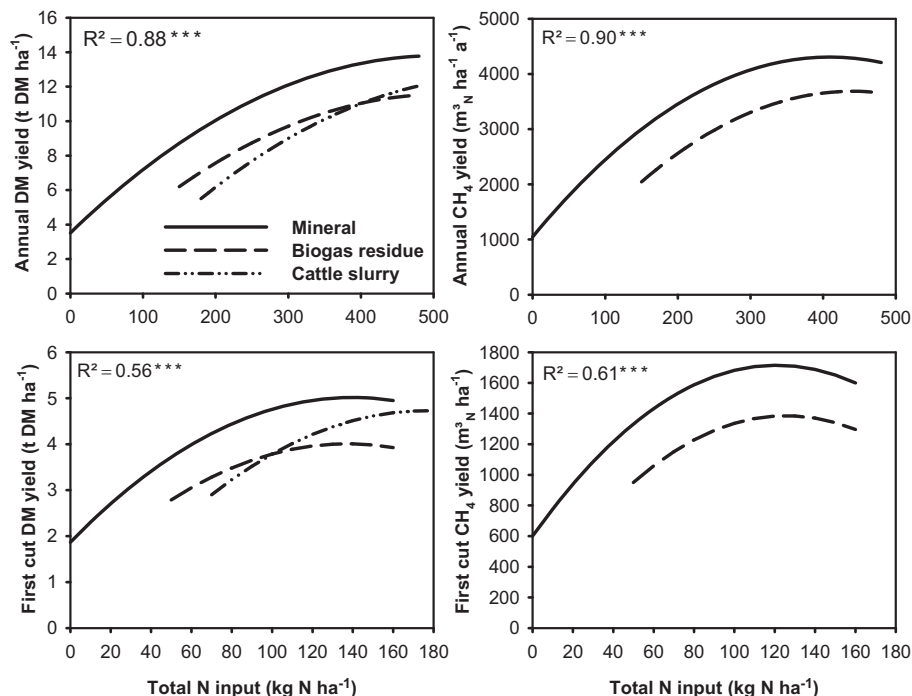

Fig. 1: Relationship of total N input (kg ha<sup>-1</sup>) to annual and first cut grassland dry matter (DM) and methane yield (m<sup>3</sup><sub>N</sub> ha<sup>-1</sup>) as influenced by fertiliser type.

## Results and Discussion

The analysis of covariance showed significant fertiliser type effects as well as linear and quadratic dependencies of annual DM and methane yield on N input, while the interaction fertiliser type × N amount was non-significant (not presented). For first cut, in contrast to annual yield, only the N input exhibited significant linear and quadratic terms, whereas fertiliser type and interactions were non-significant. If the mineral share of N input, i.e. nitrate plus ammonia content, instead of total N was used as covariable, fertiliser type no longer had an effect on annual yields. This confirms the hypothesis that the mineral share of N input explains most of the variation among mineral fertiliser, cattle slurry and biogas residue.

Methane yields varied in the first cut between 600 and 1700 m<sup>3</sup><sub>N</sub> ha<sup>-1</sup>, and annually between 1050 and 4300 m<sup>3</sup><sub>N</sub> ha<sup>-1</sup> (Fig. 1). These values are in the range reported for intensively managed permanent grassland and grass leys (Amon *et al.*, 2006; Schmalzer and Neubert,

2009). For all fertiliser types, annual DM yield increased with N input, whereas annual methane yield attained a maximum at 410 (mineral) and 440 (biogas residue) kg ha<sup>-1</sup> total N input. In agreement with other studies, DM yield turned out as the main driver of methane yield per hectare. Nevertheless, the specific methane yield of OM (I<sub>N</sub> kg<sup>-1</sup>) revealed a slight variation depending on the intensity of N fertilisation, where crude protein content of the grass in most cases was negatively correlated to specific methane yield (not presented). However, lodging of the swards additionally contributed to the decrease in methane yield observed for high N input. The RNFV functions for annual DM yield indicate a slightly higher short-term N-efficiency of biogas residue than cattle slurry (Fig. 2). This may be due to differences in NH<sub>4</sub>-N ratio, but also due to differences in viscosity, since e.g. NH<sub>4</sub>-N ratio was lower for biogas residue than for cattle slurry in 2008. RNFV functions have similar slope for annual DM and methane yield, with maximum values around 0.8 in the range reported for grassland with repeated cattle slurry application (Schröder *et al.*, 2005).

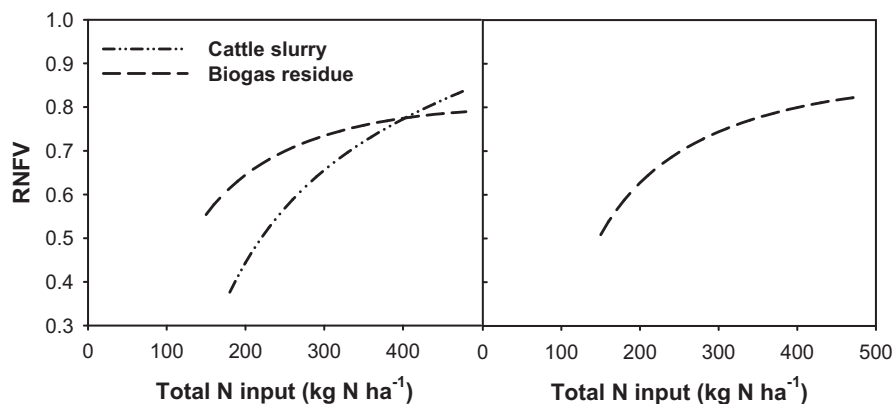

Fig. 2: Relative N Fertiliser Value (RNFV) for annual grassland dry matter yield (t ha<sup>-1</sup>; left) and annual methane yield (m<sup>3</sup><sub>N</sub> ha<sup>-1</sup> a<sup>-1</sup>; right) as function of total N input (kg ha<sup>-1</sup> a<sup>-1</sup>).

## Conclusion

Short term N effect of biogas residue on DM and methane yield of grassland was mainly determined by its NH<sub>4</sub>-N ratio, and is in the reported range for animal slurries. Further studies are required to investigate long-term effects on C/N flows, since biogas residues lack easily degradable C compounds.

## References

- Amon T., Amon B., Kryvoruchko V., Machmüller A., Hopfner-Sixt K., Bodiroza V., Hrbek R., Firedel J., Pötsch E., Wagentristsl H., Schreiner M. and Zollitsch W. (2007) Methane production through anaerobic digestion of various energy crops grown in sustainable crop rotations. *Bioresource Technology* 98, 3204-3212.
- Prochnow A., Heiermann M., Plöchl M., Linke B., Idler C., Amon T. and Hobbs P.J. (2009) Bioenergy from permanent grassland – A review. *Bioresource Technology* 100, 4931-4944.
- Schmalzer K. and Neubert K. (2009) Nutzung des mehrschnittigen Ackerfutters im Energiepflanzenanbau auf verschiedenen Standorten in Brandenburg. *Mitteilungen der Arbeitsgemeinschaft Grünland und Futterbau*, Band 10, 105-108.
- Schröder J.J., Jansen A.G. and Hilhorst G.J. (2005) Long-term nitrogen supply from cattle slurry. *Soil Use and Management* 21, 196-204.

# Using digital image analysis to estimate legume contents in legume-grass swards

Himstedt M., Fricke T. and Wachendorf M.

*University of Kassel, Department of Grassland Science and Renewable Plant Resources,  
37213 Witzenhausen, Germany*

Corresponding author: mwach@uni-kassel.de

## Abstract

An efficient and accurate detection of legume dry matter (DM) contribution in legume-grass mixtures is of great importance for a targeted management of legume-based swards. Digital image analysis (DIA) procedure was recently introduced to estimate legume contents in legume-grass swards based on greyscale pictures of swards. DIA was identified as a promising tool to estimate legume contributions (% of DM) with  $R^2$  0.87, 0.85 and 0.79 for red clover (*Trifolium pratense* L.), white clover (*T. repens* L.) and lucerne (*Medicago sativa* L.), respectively. The present paper describes a DIA procedure that improved classification accuracy by inclusion of colour information and the use of an improved algorithm for the relationship between legume coverage (% area) and legume contribution (% of DM). With this approach the estimation of legume contribution (% of DM) in legume-grass mixtures was significantly enhanced.

Keywords: Digital image analysis, legume contribution, legume-grass mixtures

## Introduction

Legume-grass swards are usually grown as short-term grassland for 1-3 years in a crop rotation system. The amount of fixed nitrogen in a sward is strongly related to the yield and contribution of legumes (Høgh-Jensen *et al.*, 2004). Frequent information on the status of legume-grass swards could help to direct fertilizer applications and to predict the nitrogen supply of the soil for the subsequent crop. Based on greyscale images a digital image analysis (DIA) procedure of near-ground imagery was proposed by Himstedt *et al.* (2009) which allows the estimation of legume DM contribution with an acceptable accuracy for swards with more than 30 g DM m<sup>-2</sup>. In younger and more open swards with less than 30 g m<sup>-2</sup> DM misclassification of bare soil as legume was a serious problem. The improved DIA procedure comprises the estimation of legume coverage (LC, % of the green area of the image) and the calculation of legume contribution (LD, % of DM) from LC. For the differentiation between bare soil and crop tissue and therefore a more precisely estimation of legume coverage the colour information hue (H), saturation (S) and lightness (L) were integrated. The improved calculation of LD comprises the inclusion of total biomass (BM) in order to increase the model accuracy and to allow for a wider range in terms of sward age. Additionally, LD and LC data were transformed to the logit-scale in order to prevent problems with negative predictions (Himstedt and Wachendorf, 2009). This paper gives results of the advanced DIA procedure for estimating LD when colour information and an improved algorithm were implemented.

## Material and methods

In 2004 a 9-week pot experiment under controlled conditions was conducted to examine the perspectives of DIA across a wide range of legume species, legume proportions (0-70 % of DM) and growth stages (start of tillering to start of heading). Eight experimental swards were

investigated in four replicates: monocultures of ryegrass (20 kg of seed ha<sup>-1</sup>), red clover (8 kg ha<sup>-1</sup>), white clover (4 kg ha<sup>-1</sup>) and lucerne (16 kg ha<sup>-1</sup>) and the binary mixtures red clover-ryegrass (8/20 kg ha<sup>-1</sup> and 2/20 kg ha<sup>-1</sup>), white clover-ryegrass (4/20 kg ha<sup>-1</sup>) and lucerne-ryegrass (16/20 kg ha<sup>-1</sup>). Sward size was 0.119 m<sup>2</sup>. Wooden pots were filled with 2 cm drainage substratum (Lavagrus) and about 16 cm homogenised sandy loam. Soil analysis indicated sufficient contents of phosphorus, magnesium and potassium and a pH-value of 6.7. No fertilizers were applied. To determine the sward composition, total aboveground BM was sorted to grass, legumes and unsown species. The samples were dried for 48 h at 65°C. For the development of DIA procedures legume specific datasets were used (red clover RCG, white clover WCG, lucerne LCG) with each including the mixtures and pure swards of the selected legume as well as pure grass swards. One day before the harvest, digital pictures of the swards were taken with a Canon Power Shot G6 Digital Camera using flashlight. All pictures were georeferenced to compensate for distortions. A total of 64 sward images were available. For image analysis the image processing software Optimas (Media Cybernetics) was used: digital RGB images were converted into 24-bit HSL images. To discriminate between bare soil and plants the threshold H (16-45) S (40-154) L (41-173) was used. Due to the differences in the shape of legume and grass leaves, the DIA procedure applies the morphological filters erode and dilate, as these filters support the differentiation of objects of different shape by shrinking and dilating. Subsequently, the legume-covered areas were identified with legume-specific thresholds RCG: H (54-91) S (35-200) L (75-200), WCG: H (55-75) S (52-188) L (80-200), LCG: H (54-85) S (39-211) L (81-152). The legume specific calculations of LD from LC:

$$\text{RCG: } \text{logit}(\text{LD}) = -0.298 + 0.923 * \text{logit}(\text{LC}) - 0.002 * \text{BM} \quad \text{Eq. [1]}$$

$$\text{WCG: } \text{logit}(\text{LD}) = 0.055 + 0.941 * \text{logit}(\text{LC}) - 0.004 * \text{BM} \quad \text{Eq. [2]}$$

$$\text{LCG: } \text{logit}(\text{LD}) = 0.275 + 0.990 * \text{logit}(\text{LC}) - 0.003 * \text{BM} \quad \text{Eq. [3]}$$

LC was transformed to the logit-scale (e.g. defined as  $\log[\text{LC}/(100-\text{LC})]$ ). The predictions of LD were back-transformed to the original scale (% of DM), using

$$\text{Predicted LD} = \frac{100 \times e^{\text{predicted logit(LD)}}}{1 + e^{\text{predicted logit(LD)}}} \quad \text{Eq. [4]}$$

For regression analysis, the GLM procedure of SAS 9.1 (SAS Institute) was used.

## Results

Based on the legume-specific DIA procedure, estimated LC showed good correlations with the measured values across the whole range of sward ages ( $R^2$  0.97, 0.96 and 0.94 for RCG, WCG and LCG, respectively; overall regression  $R^2$  0.96,  $SE$  4.7). A somewhat lower precision occurred in the lucerne-specific model with SEs of up to 12% area for pure grass swards. Legume contribution (% of DM) calculated from the estimated LC and the Eqs. 1 – 3 were closely related to the measured values ( $R^2$  0.90, 0.94 and 0.93 for RCG, WCG and LCG, respectively; overall regression  $R^2$  0.91,  $SE$  5.6, Figure 1).

## Discussion

Inclusion of colour information into DIA significantly improved the identification of legume leaves in mixed swards. This particularly applied to young and more open swards with low biomasses, where plenty of visible bare soil occurred. The HSL space is appropriate for the identification of bare soil and the segmentation among legume and grass after using the Erode and Dilate filters. In the present study HSL thresholds were determined with a wide scope of application across different sward ages allowing an accurate separation of green biomass and bare soil. An application on soils with different colours needs to be tested. Furthermore, problems with negative predictions, which emerged from the standard models, did not occur

as legume contribution and coverage were transformed to the logit-scale. The integration of total biomass into the model for determining legume contribution allows the application on a wide range of swards. Recent results from field experiments demonstrated the potential of near infrared field-spectroscopy for the prediction of total biomass of legume-grass mixtures (Biewer *et al.*, 2009). Thus, a combined estimate of total biomass and legume coverage by field spectroscopy and DIA, respectively, may allow an accurate prediction of the legume yield in legume-grass mixtures.

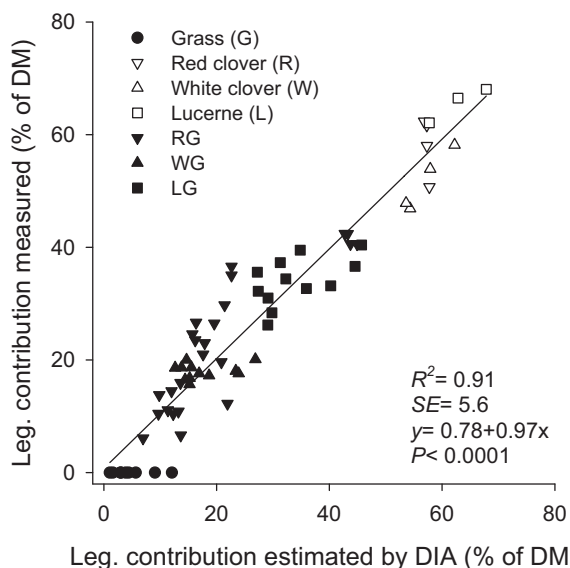

Fig.1: Relationship between the measured legume contribution (% of DM) and the legume contribution estimated by legume specific DIA (% of DM). Overall regression line includes 35-, 49- and 63-d old swards of all legume species.

## Conclusions

An advanced procedure for the determination of legume contribution by DIA is suggested, which comprises the inclusion of morphological filters and colour information and which applies an advanced function to predict legume contribution from legume coverage by considering total sward biomass. Bare soil areas in young and open swards could be determined very accurately, which in turn allowed a precise estimation of legume coverage. The suggested DIA procedure appears to be an appropriate sensor to be used for online assessment in the field. The procedure provides a rapid and precise estimation of legume DM contribution for different legume species across a wide range of sward age.

## References

- Biewer S., Fricke T. and Wachendorf M. (2009) Determination of dry matter yield from legume-grass swards by field spectroscopy. *Crop Science* 49, 1927-1936.
- Himstedt M., Fricke T. and Wachendorf M. (2009) Determining the contribution of legumes in legume-grass mixtures using digital image analysis. *Crop Science* 49, 1910-1916.
- Himstedt M. and Wachendorf M. (2009) The relationship between legume coverage and contribution as basis for the estimation of legume contribution by digital image analysis – in German. *Mitteilungen der Gesellschaft für Pflanzenbauwissenschaften* 21, 135-136.
- Høgh-Jensen H., Loges R., Jørgensen F., Vinther F. and Jensen E. (2004) An empirical model for quantification of symbiotic nitrogen fixation in grass-clover mixtures. *Agricultural Systems* 82, 181-194.

# Grassland potassium balance in a pot experiment using soils with different management histories

Seidel M.<sup>1,3</sup>, Kayser M.<sup>2</sup>, Moir J.L.<sup>3</sup> and Isselstein J.<sup>4</sup>

<sup>1</sup>Department of Forest and Soil Science, BOKU Vienna, AT-1180 Vienna, Austria

<sup>2</sup>Department of Crop Sciences, Location Vechta, Georg-August-University, Universitätsstraße 7, 49377 Vechta, Germany

<sup>3</sup>Department of Soil and Physical Sciences, Faculty of Agriculture and Life Sciences, Lincoln University, Christchurch, New Zealand

<sup>4</sup>Department of Crop Sciences, Grassland Science, Georg-August-University, Von-Siebold-Straße 8, D-37075 Göttingen, Germany

Corresponding author: Manfred.Kayser@agr.uni-goettingen.de

## Abstract

Potassium (K) management is important in grassland systems, especially in dairy farming. The interactions of potassium with other nutrients, such as magnesium (Mg), and enhanced potassium levels can have impacts on yields, product quality and on metabolic health issues of dairy cattle. A deeper understanding of potassium cycling is thus necessary for sustainable management. We used four sandy soils of similar genesis but with contrasting concentrations of available K and combined these with different levels of mineral K fertilisation in a glasshouse pot trial. A mass balance approach was used to examine soil K history and treatment fertiliser K effects on plant K and Mg uptake. The duration of the experiment was 5 months, growing Italian Ryegrass (*Lolium multiflorum* Lamark). Potassium concentrations in shoots were relatively high and were influenced by initial soil K and K input. Magnesium concentrations decreased the most in the soil with the lowest initial K and with increasing K input. Uptake of K by shoots and retention in soil were the main sinks for input K. The short-term reaction of the plant-available soil K pool seemed to be very dynamic but limited for soils with high initial K.

Keywords: potassium, magnesium, Italian Ryegrass, sustainable management

## Introduction

Potassium (K) is an essential nutrient in plant nutrition. In particular, organic fields benefit from an adequate K supply due to the high beneficial effects of K on the N<sub>2</sub>-fixing bacteria of legumes (Johnston, 2003). Because of differences in nutrient management on farms, deficiencies and surpluses might occur with consequences for nutrient efficiency and sustainability, the environment and animal health (Kayser and Isselstein, 2005). High levels of K in soil usually have negative impacts on the magnesium (Mg) uptake of grass, which results in low Mg intake and related metabolic issues in lactating cows.

The aim of this study focuses on the sustainable management of K. We followed the hypothesis that not only the actual K fertilisation, but also the previous soil K management history, have an effect on dynamics of K and of Mg in the plant–soil system. As sandy soils have relatively small absorption capacities for K and reserves are limited, they form the focus of this research.

## Material and methods

A glasshouse experiment with a two-factorial design using soil and K fertilisation as factors was carried out. Treatments included four sandy soils (of varying K input histories) and three K fertiliser levels, and were replicated four times. The soils coded 1, 2, 3 and 4, represent the

soil K status, where soil 1 had low plant-available soil K, soil 2 moderate, soil 3 high and soil 4 very high soil K (Table 1); soils 1 and 2 had been organically managed. The fertiliser treatments consisted of three levels of K applications: K0 had no K applied, K1 with 0.64 g pot<sup>-1</sup> K (30 g m<sup>-2</sup>) and K2 with 1.27 g pot<sup>-1</sup> (60 g m<sup>-2</sup>) as muriate of potash (33% K, 3.6% Mg). Each pot contained 3.25 kg moist soil. N fertilisation for all pots amounted 0.32 g pot<sup>-1</sup> (12.5 g m<sup>-2</sup>) applied as calcium ammonium nitrate. Both the K and the N fertilisation were applied in portions: 2/3 of the total amount was applied at the start and 1/3 applied after the second harvest. Italian ryegrass (*Lolium multiflorum* Lamark) was sown at a rate of 0.6 g seed pot<sup>-1</sup>. The field soils used in this study were sampled at 0–20 cm. Pots were watered to a constant gravimetric water content of 20%. In total, four harvests of the grass were taken: harvest 1, five weeks after sowing (14 July) and harvests 2–4 at three to four-week intervals (3 Aug., 25 Aug., 22 Sept.). After the final harvest, stubble and roots were sampled. Results for plant materials refer to dry matter (105°C); soils were air-dried. Plant available soil K was determined after CAL extraction, acid soluble soil K was extracted by 2 n HCl. The difference between the soil K<sub>CAL</sub> at the beginning and end gives the changes in soil K<sub>CAL</sub>. Statistical analysis was carried out by a two-way ANOVA in SPSS.

## Results and discussion

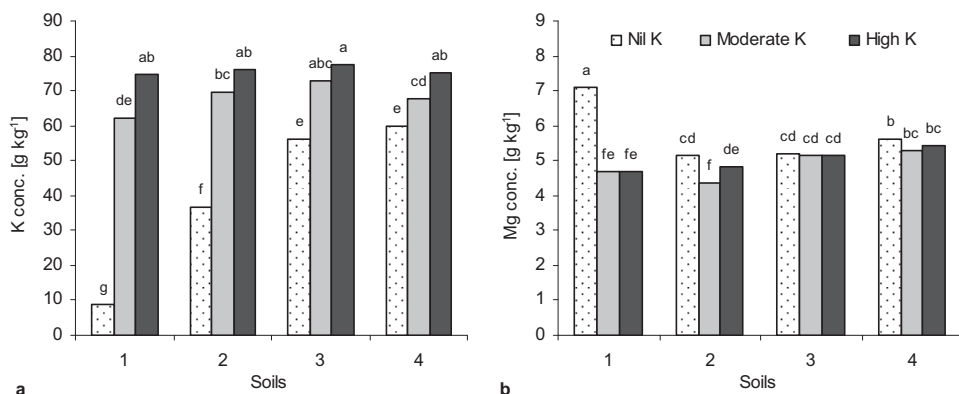

Figure 1: Mean potassium (a) and magnesium (b) concentrations of the plant shoots across all soils and the three K input treatments averaged over four harvests. Soil: 1 = low initial soil K, 2 = moderate K, 3 = high K, 4 = very high K; K input with fertiliser: Nil (K0), moderate (K1), high (K2) (see Table 1). Values with different letters are significantly different ( $P < 0.05$ ).

The shoot concentrations of K and Mg were highly affected by the soil and the K input ( $P < 0.001$ ). Potassium concentrations in the shoots were relatively high, partly due to the pot experiment situation, and differed between soils at K0 (Figure 1). After K input, K concentrations in shoots were similar for all soils. The grass magnesium concentrations rose from 4 g kg<sup>-1</sup> DM at cut 1 to around 6–7 g kg<sup>-1</sup> DM at cut 4. Soil initial K status as well as K input had an effect on Mg concentrations; Mg concentrations were higher at K0 compared to K1 and K2 in spite of the Mg concentration of K fertiliser. K increased both in the stubble and root components with increasing K fertilisation ( $P < 0.001$ ); the initial soil K status had a significant effect on the stubble K ( $P < 0.001$ ), but not on the root K concentration. Dry matter yields were not significantly influenced by K fertiliser input at cut 1, but had a strong effect in cuts 2 and 3. The organically managed soils 1 and 2 responded more strongly to a K input than soil 3 and 4 which already had high initial K levels in the soil (Table 1). This confirms the findings of Johnston (2003) who reported an increase of the DM yield on organic soils when K is applied. The moderate N fertilisation might have restricted stronger effects of



higher K input. The well supplied soils 3 and 4 showed a distinctly higher root K concentrations at the highest K input level.

Table 1: Potassium input, uptake and difference in plant available soil  $K_{CAL}$  of the beginning and end of the pot experiment; means and least significant differences (l.s.d.; values with different letters within columns are significantly different at  $P < 0.05$ ).

Soil	Initial $K_{CAL}$ [mg kg <sup>-1</sup> ]	K treatment	K input [mg pot <sup>-1</sup> ]	Shoot K uptake [mg pot <sup>-1</sup> ]	Stubble K uptake [mg pot <sup>-1</sup> ]	Root K uptake [mg pot <sup>-1</sup> ]	$K_{CALend} - K_{CALbeginning}$ [mg pot <sup>-1</sup> ]
1	18	0	0	56 g	5 f	1.3 b	-27 c
		1	636	481 de	74 bcd	4.2 ab	118 c
		2	1272	516 ab	77 bc	5.3 ab	756 a
2	93	0	0	272 f	38 e	2.8 ab	-202 d
		1	636	625 bc	75 bc	7.5 a	-8 c
		2	1272	510 ab	83 bc	4.8 ab	682 ab
3	168	0	0	540 e	55 de	3.2 ab	-371 e
		1	636	583 abc	74 bcd	3.3 ab	82 c
		2	1272	645 a	107 a	6.1 ab	776 a
4	295	0	0	526 e	66 cd	2.8 ab	-371 e
		1	636	530 cd	91 ab	3.2 ab	-23 c
		2	1272	598 ab	89 ab	6.6 ab	607 b

Soils 3 and 4 released substantial amounts of K for plant uptake at a moderate N fertilisation even when no K was applied. On the other hand, the control treatment of soil 1 with a low level of soil K had a much reduced capacity for providing K. Acid soluble  $K_{HCl}$  corrected for  $K_{CAL}$  can help to predict potential K release rates in soil and was distinctly lower for soil 1, while the level found in the other soils was about 3-fold. This indicates that mining of K has taken place in soil 1. Sandy soils are in the long-term completely dependent on K input (Holmqvist *et al.*, 2003).

## Conclusions

The concentrations of K and Mg in the shoots and stubble were significantly determined by initial soil K and by K fertiliser input. The organically farmed soils 1 and 2 especially, showed a positive response of DM yield to moderate K fertilisation. Magnesium concentrations in shoots were reduced with higher K input and at higher initial soil K level. With regard to dairy farming special attention might be given to Mg fertilisation or mineral supplement in situations of very high soil K status and when fields initially low in K receive substantial amounts of K.

## References

- Johnston A.E. (2003) *Understanding potassium and its use in agriculture*. European Fertilizer Manufacturers Association, Brussels. Available: <http://www.efma.org/>
- Holmqvist J., Øgaard A.F., Öborn I., Edwards A.C., Mattsson L. and Sverdrup H. (2003) Application of the PROFILE model to estimate potassium release from mineral weathering in Northern Europe agricultural soils. *European Journal of Agronomy* 20, 149-163.
- Kayser M. and Isselstein J. (2005) Potassium cycling and losses in grassland systems: a review. *Grass and Forage Science* 60, 213-244.

## **The intensity of grassland management on farms in the north-eastern part of Lublin province**

Jankowski K., Jodełka J., Kolczarek J. and Sosnowski J.

*University of Podlasie, Grassland Department, 08 – 110 Siedlce, Poland*

Corresponding author: laki@ap.siedlce.pl

### **Abstract**

The aim of this work is to demonstrate how the production potential of grassland agrees with the strategy of the CAP (Common Agricultural Policy) with regard to commodity milk production. The study involved studying a sample of 1656 randomly selected farms from the north-eastern part of Lublin province that had breeding dairy cattle. In the studied farms, the contribution of grasslands in the structure of agricultural lands was significantly higher than the average in the region and in the country. The largest research group accounted 49.5% of farms and they produced 20-50 thousand l of milk, had an average area of 21.23 ha and kept an average 9.8 cows. A large share of permanent grassland in the structure of agricultural lands, and a high stocking density per 100 ha of grasslands in north-eastern Lublin province, indicate a change in direction of grassland management from ‘existing’ to ‘integrated’.

Key words: grassland management, milk production, stocking density

### **Introduction**

In the north-eastern part of Lublin province there is a high concentration of grasslands and animal production (Michalczyk, 2003; Harkot and Lipinska 2008). The natural conditions and a long tradition have led to the development of cattle farming and economic conditions favour milk production (Lipinska and Gajda, 2006; Rybicki, 2006; Kolczarek *et al.*, 2007). Based on this analysis (Rybicki, 2006; Krasowicz, 2007) this region has a low utilization of the productive potential of agriculture. Under the CAP (Kaca, 2008) there are four directions set up for grassland management: the existing, environmental, production and integrated. The environmental direction concerns environmental and biodiversity protection, and production aspects are secondary. The CAP enforces modernization and increased efficiency of farms in order to secure food supplies and stabilize the market for agricultural products in accordance with the requirements of the environment and the principles of cross-compliance.

The aim of this work is to demonstrate the how of the production potential of grassland in the north-eastern part of Lublin province agrees with the strategy of the Common Agricultural Policy with regard to milk production.

### **Materials and method**

This research was carried out on a sample of 1656 randomly selected dairy cattle breeding farms in the north-eastern part of Lublin province. Source material for analysis was derived from the evaluation reports of dairy farms and the data of the Voivodeship Statistical Office. Based on the average annual milk production and the area of permanent grasslands, the sample was divided into three management-direction groups: I - existing, II- integrated, and III – productional (Wasilewski, 2009). Within group II a three subgroups were identified according to their volume of milk production: A (20-50 000 litres), B (50-100 000 litres), and C (100-350 000 litres).

Table 1. Characteristics of samples

Specification	Management direction on grasslands				
	Existing	Integrated			Productional
		A	B	C	
Number of farms	462	819	304	70	1
Share of farms in group (%)	24.9	49.5	18.4	4.2	0.1
Average annual milk yield ('000 litres)	< 20	20-50	50-100	100-350	>350
Average farm surface (ha)	18.77	22.6	29.5	56.14	77.0

## Results and discussion

Production of feed on permanent grasslands should realize the environmental and natural aspect of these communities. The 'integrated' direction of management seems to be a priority, because it combines three main tasks: the production of feed, concern about its quality, and its environmental protection (Wasilewski, 2009). In the studied farms the part of grassland in the structure of agricultural land was significantly higher than the average in the region as well as in the country. In a separate group of farms with 'existing direction' of the management on permanent grasslands (Table 2) and with the lowest milk yield (up to 20 000 litres) this index amounted 27%, whereas farms classified to the 'productional' direction were producing over 350 000 of litres the index was significantly higher (53.4%).

Table 2. Indexes for study farms in regard to province and country

Specification	Management direction on grasslands					Average for:	
	Existing	Integrated			Productional	Lublin province	Country
		A	B	C			
Average farmland surface (ha)	17.47	21.23	27.83	53.95	72	6.9	8.4
Share of grassland in farmlands (%)	27.0	32.4	39.1	358	53.4	16.4	20.1
Stocking cattle (DJP)	7.7	15.0	30.1	57.3	75.9	2.7	4.3
cows (no)	4.7	9.8	19.0	35.5	70	2.5	3.9
Stocking density (DJP) per 100 ha: of grasslands	160	220	280	300	200	158	155
of farmlands	40	70	108	106	105	33.7	41.0
Number of employers per 100 ha of farmlands	11.1	9.23	7.55	4.28	3.47	19.0	12.9

Farms with a large share (over 30%) of permanent grasslands are still looking for opportunities to increase profit. Michalczyk (2003) considers that such an agrarian structure provides the basis for directing, and even specialization in, commercial milk production. In the analysed material (Table 1), the largest group (49.5%) comprised farms producing 20-50 000 litres of milk with an average herd of 9.8 cows. The present group of farms was characterized by having a larger area of the farmland compared with the average for the province (6.9 ha) and Poland (8.4 ha). This is confirmed by Krasowicz (2006), who stated that the northern part of Lublin region is characterized by having a higher share of larger farms with a significant share of permanent grassland and with a greater concentration of livestock production. The largest average stocking density of cattle per 100 ha of agricultural land (over 105 DJP) have been reported for farms producing more than 50 thousand litres of milk per annum and more than 30 breeding cattle (Table 2). On these farms we can observe a much higher stocking per 100 ha of permanent grasslands, and this has undoubtedly forced the farmers to eliminate irregularities in the management of the farmland. In each direction of the grassland management the most important prato-technical element is fertilization. Annual production of nitrogen (Table 3) in natural fertilizers clearly shows that all examined farms do not exceed the total nitrogen 170 kg N ha<sup>-1</sup> of farmlands. It was confirmed by Rybicki (2006)

that milk production is the most sustainable form of animal production. In the examined farms the stocking density per hectare of agricultural land does not exceed a specified limit of 1.9 DJP. It shows that even high commodity milk production based on a large share of fodder from permanent grassland is environmentally friendly.

Table 3. Characteristics of animal maintenance and production of manure

Specification	Management direction on grasslands				
	Existing	Integrated			Productional
		A	B	C	
Functional type of barn (no):					
without mulching	3	16	18	12	x
with mulching	167	597	276	58	1
deep bedding	263	210	11	2	x
Nitrogen production supplied in natural fertilizers (kg per ha of farmland):					
manure	36.0	49.6	62.1	55.1	62.2
slurry	0.2	1.2	5.7	15.9	x
urine	32.6	10.5	20.1	18.1	21.6
total	68.9	61.4	87.9	89.1	83.8

## Conclusions

A large share of permanent grassland in the structure of agricultural land, and a high stocking rate per 100 ha of permanent grassland on farms in the north-east of Lublin province indicate a significant intensification of feed production on the farmland.

Concentration of milk production has, and will, exert influence on the structure of the area of permanent grassland, and their contribution to the forage area. Milk production was profitable on farms which had suitable areas of grasslands.

In recent years a change in direction of grassland management has been observed from the 'existing' category towards the 'integrated category.'

## References

- Harkot W. and Lipińska H. (2008) Kierunki zmian w gospodarowaniu na trwałych użytkach zielonych Lubelszczyzny w aspekcie zmian pogłowia zwierząt w latach 1980-2006. *Woda Środ. Obsz. Wiej.*, t.8, z.2a, 33-43.
- Kaca E. (2008) Rolnictwo a zanieczyszczenie wód w Polsce w aspekcie wdrażania Dyrektywy azotanowej oraz działań PROW. *Gos. Wod.* 10:419-423.
- Krasowicz S.(2006) Rolnictwo województwa lubelskiego na tle kraju. *Roczniki Naukowe S. t.IX, z.1, 254-258.*
- Kolczarek R., Jankowska J., Ciepiela G. and Jodełka J. (2007) Grassland forming as a way for increasing of milk production. *Grassland Ecology VII*, Bańska Bystrica, 369- 372.
- Lipińska H. and Gajda J. (2006) Powierzchnia paszowa i pogłowie bydła w specjalistycznych gospodarstwach mlecznych. *Annales UMCS, Sec. E*, 61: 225-236.
- Michalczyk J. (2003)Użytkowanie ziemi w województwie lubelskim na tle struktury użytkowania ziemi w Polsce. *Acta Agrophysica* 1(4), 681-696.
- Rybicki G. (2006) Rynek mleka w województwie lubelskim – przemiany i sytuacja na tle kraju. *Roczniki Naukowe S. t.IX, z.4, 161-165.*
- Wasilewski Z. (2009) Stan obecny i kierunki gospodarowania na użytkach zielonych zgodnie z wymogami wspólnej polityki rolnej. *Woda Środ. Obsz. Wiej.*, t.9, z.2, 169-184.

# Effects of *Trifolium incarnatum* proportion in binary mixtures with *Lolium multiflorum* on the soil N<sub>min</sub> content and the amount of symbiotically fixed N

Kramberger B.<sup>1</sup>, Gselman A.<sup>1</sup> and Podvrsnik M.<sup>1</sup>

<sup>1</sup> University of Maribor, Faculty of Agriculture and Life Sciences, Pivola 10, 2311 Hoče, Maribor, Slovenia

Corresponding author: branko.kramberger@uni-mb.si

## Abstract

Because of their ability to accumulate N in organic matter, winter cover crops have gained importance in sustainable farming. Aiming to find a compromise between the efficiency of *Trifolium incarnatum* L. and *Lolium multiflorum* Lam. in decreasing soil N<sub>min</sub> content and the efficiency of *T. incarnatum* in N fixation, a field experiment (designed as randomized complete blocks with eight replications) was carried out in eastern Slovenia in 2008-2009. *T. incarnatum* L. and *L. multiflorum* Lam. were sown in late August 2008 in pure stands in binary mixtures. Control treatment was without cover crop (bare fallow). At the end of April 2009, the contents of soil N<sub>min</sub> under *T. incarnatum* and mixtures with a high proportion of *T. incarnatum* were statistically at the same level as the control treatment, but significantly higher than were the N<sub>min</sub> contents under *L. multiflorum* in a pure stand and under mixtures with a low proportion of *T. incarnatum*. The calculated amount of symbiotically fixed N was highest in the treatment of *T. incarnatum* in the pure stand and decreased with decreasing proportion of *T. incarnatum* in binary mixtures. Because of the positive relationship between soil N<sub>min</sub> content and symbiotically fixed N, the results do not allow the overall advantage of any of treatment to be clearly stated.

Keywords: catch crops mixtures, *Lolium multiflorum*, N fixation, soil N<sub>min</sub>, *Trifolium incarnatum*

## Introduction

In areas with surplus rainfall during the late autumn, mild winter periods and early spring, winter cover catch crops have gained importance in soil N utilisation strategies in field crop rotations. Non-leguminous winter cover crops have been found to be very effective in taking up mineral N from the soil (Thorup-Kristensen, 2001; Kramberger *et al.*, 2007; Kramberger *et al.*, 2008) and, consequently, in decreasing the risk of its leaching and volatilization. Leguminous crops fix N biologically, which results in high herbage crop yield without adding N with fertilisers, thus highlighting their possible use as catch crops for forage. Leguminous winter cover crops also improve the soil fertility and increase the yield of succeeding crops in field rotation (Kramberger *et al.*, 2009). *Lolium multiflorum* Lam., as a non-legume plant, and leguminous *Trifolium incarnatum* L. are traditional winter cover crops and catch crops for forage production in central Europe. Aiming to find a compromise between their efficiency in decreasing soil N<sub>min</sub> content and the efficiency of *T. incarnatum* in N fixation, the effect of sowing in pure stands and in binary mixtures was studied in a field experiment.

## Materials and methods

The field experiment was carried out from August 2008 to May 2009 in a lowland area south of the city of Maribor (Slovenia) in a randomised complete blocks design with eight replications. Four of the blocks were at location 1: 46°29'55"N, 15°37'45"E; 320 m a.s.l., deep Dystric Cambisol; the remaining four were at location 2: 46°30'40"N, 15°40'25"E; 275 m

a.s.l., shallow Dystric Cambisol. The annual mean air temperature of the area is 10.7 °C, the mean monthly minimum is in January (0.4 °C), and the maximum is in July (20.8 °C). The average annual amount of precipitation is ~1000mm. Precipitation is, on average, relatively equally distributed over the whole year. The amount of precipitation during the period September 2008 to April 2009 was 518 mm (maximum in January with 107 mm as snow, minimum in April with 42 mm). On 26 August 2008, *T. incarnatum* and *L. multiflorum* were sown in pure stands (at rates of 30 and 50 kg ha<sup>-1</sup>, respectively) and in binary mixtures (75%: 25%; 50%: 50%; 25%: 75%; i.e. at rates of 22.5 kg *T. incarnatum* + 12.5 kg *L. multiflorum*; 15.0 kg *T. incarnatum* + 25.0 kg *L. multiflorum*; and 7.5 kg *T. incarnatum* + 37.5 kg *L. multiflorum* per ha, respectively). The control was without any crop (bare fallow). The previous crop was winter wheat. Before ploughing, straw was removed from the field. In August, at the beginning of the experiment, soil on average contained 25.6 kg ha<sup>-1</sup> of mineral N (NH<sub>4</sub>-N + NO<sub>3</sub>-N) in the soil layer 0-60 cm. No organic or mineral fertilizers were used in the experiment. On 22 April 2009, averaged soil samples for mineral N content determination and biomass measurements were taken from each plot. The contents of nitrate and ammonia N were determined according to Keeney and Nelson (1982). The N content in the biomass yield was determined by the Kjeldahl method. The amount of the symbiotically fixed N was calculated according to the N simple difference method (Evans and Taylor, 1987), subtracting the N yield of the grass monocultures from the total N yield of the mixtures or clovers in the pure stand. The data were analysed by ANOVA, means were separated by Duncan's multiple range test. Statistical significance was evaluated at  $P \leq 0.05$ .

## Results and discussion

Winter cover crop treatments significantly affected the soil N<sub>min</sub> content (Table 1). In comparison with the control (bare fallow) treatment (82.7 kg ha<sup>-1</sup> in the soil layer 0-60 cm), the soil N<sub>min</sub> contents at the end of April were statistically lower under *L. multiflorum* in the pure stand (55.3 kg ha<sup>-1</sup>) and under *T. incarnatum*/*L. multiflorum* mixtures with high proportions of *L. multiflorum* (60.2, 64.4 kg ha<sup>-1</sup>). The soil N<sub>min</sub> contents under *T. incarnatum* in the pure stand and under mixtures with high proportions of *T. incarnatum* (82.3 and 73.3 kg ha<sup>-1</sup>) were statistically at the same level as in the control treatment. The results obtained support earlier findings (Wallgren and Lindén, 1994; Kuo and Sainju, 1998) that, when seeded in autumn, non-leguminous crop decrease soil N<sub>min</sub> more than do leguminous crops and are suitable for cover crops aimed at decreasing the risk of N leaching. However, to avoid negative effects on the succeeding crops in field rotation, which might occur in the case of high C/N ratios in the cover crop biomass (Kramberger *et al.*, 2008; Kramberger *et al.*, 2009), winter cover crop mixtures should contain a high proportion of legume species. Low proportions of legumes in mixtures do not strongly increase soil N<sub>min</sub> content in comparison with non-legume species (Table 1).

As expected, the highest amount of symbiotically fixed N was achieved in the treatment of the pure stand of *T. incarnatum* (101.1 kg ha<sup>-1</sup>). With decreasing proportion of *T. incarnatum* (75%, 50%, and 25%) in binary mixtures with *L. multiflorum*, the amount of symbiotically fixed N decreased proportionally (62.8, 56.0, and 32.7 kg ha<sup>-1</sup>, respectively). Thus, when aiming to produce high N yields for forage (with a catch crop) or for a succeeding crop in field rotation (with a winter cover crop), it is more beneficial to use pure-sown *T. incarnatum* or high percentage mixtures of it, but only when the risk of N leaching is low.

Table 1. Effect of treatment on the  $N_{\min}$  content in the soil layer 0-60 cm and on the amount of symbiotically fixed N.

Treatment	Soil $N_{\min}$ (kg ha <sup>-1</sup> )	Symbiotically fixed N (kg ha <sup>-1</sup> )
<i>T. incarnatum</i> (100%)	82.3 <sup>d</sup>	101.1 <sup>a</sup>
<i>T. incarnatum</i> (75%) + <i>L. multiflorum</i> (25 %)	73.3 <sup>ab</sup>	62.8 <sup>b</sup>
<i>T. incarnatum</i> (50%) + <i>L. multiflorum</i> (50 %)	64.4 <sup>bc</sup>	56.0 <sup>bc</sup>
<i>T. incarnatum</i> (25%) + <i>L. multiflorum</i> (75 %)	60.2 <sup>bc</sup>	32.7 <sup>c</sup>
<i>L. multiflorum</i> (100%)	55.3 <sup>c</sup>	-
Control (without catch crop)	82.7 <sup>a</sup>	-

Numbers followed by a different letter within a column are significantly different ( $P \leq 0.05$ ) according to Duncan's multiple range test.

## Conclusion

Because of the positive relationship between soil  $N_{\min}$  content and symbiotically fixed N, the results do not allow the overall advantage of any of treatment to be singled out. Consequently, the composition of any selected mixture must be based on a trade-off involving many factors, especially the intended use of the mixture (cover or catch crop), on the potential effects of the mixture on the next crop in the field rotation, and on the risk of N leaching.

## References

- Evans J. and Taylor A.C. (1987) Estimating  $N_2$  fixation and soil accretion of nitrogen by grain legumes. *Journal of the Australian Institute of Agriculture Science* 53, 78–82.
- Keeney K. and Nelson D.W. (1982) Nitrogen – inorganic forms. In: Page A.L., Miller R.H. and Keeney D.R. (eds) *Methods of Soil Analysis*. American Society of Agronomy, Madison, USA, pp. 634–698.
- Kramberger B., Gselman A., Kapun S. and Kaligarić M. (2007) Effects of sowing rate of Italian ryegrass drilled into pea stubble on removal of soil mineral nitrogen and autumn nitrogen accumulation by herbage yield. *Polish Journal of Environmental Studies* 16, 717-725.
- Kramberger B., Lukac B., Gruskovnjak D. and Gselman A. (2008) Effects of Italian ryegrass and date of plow-in on soil mineral nitrogen and sugarbeet yield and quality. *Agronomy Journal* 100, 1332-1338.
- Kramberger B., Gselman A., Janzekovic M., Kaligarić M. and Bracko B. (2009) Effects of cover crops on soil mineral nitrogen and on the yield and nitrogen content of maize. *European Journal of Agronomy* 31, 103-109.
- Kuo S. and Sainju U.M. (1998) Nitrogen mineralization and availability of mixed leguminous and non-leguminous cover crop residues in soil. *Biology and Fertility of Soils* 26, 346-353.
- Thorup-Kristensen K. (2001) Are differences in root growth of nitrogen catch crops important for their ability to reduce nitrate-N content, and how can this be measured? *Plant and Soil* 230, 185-195.
- Wallgren B. and Lindén B. (1994) Effects of catch crops and ploughing times on soil mineral nitrogen. *Swedish Journal of Agricultural Research* 24, 67-75.



## Use of portable NIRS equipment in field conditions to determine the nutritional value of mountain pastures

Mendarte S., Ibarra A., Garbisu C., Besga G. and Albizu I.

*Department of Ecosystems, NEIKER-Tecnalia, Basque Institute of Agricultural Research and Development, Berreaga 1, E-48160 Derio, Spain*

Corresponding author: smendarte@neiker.net

### Abstract

The main objective of the current study was to obtain, by means of using portable NIRS equipment under field conditions, NIRS calibrations useful to determine the nutritional value of mountain pastures in the Basque Country (northern Spain). To this aim, NIRS spectral data were acquired *in situ* on grass samples (without cutting the grass) from a Basque pastoral agroecosystem. Afterwards, the grass was cut and immediately taken to the laboratory, where spectral data were acquired on the freshly cut grass. Grass samples were collected in a spatially homogeneous area in order to avoid the spatial heterogeneity caused by slope, aspect, vegetation, etc. Grass samples were taken in May and October 2008 (at the beginning and at the end of the grazing season) so that part of the temporal heterogeneity typical of these mountain pastures was considered. Nutritional parameters of pasture, such as dry matter and crude protein, were determined in the grass samples. Nitrogen was determined by the Kjeldahl method and thus crude protein calculated. GRAMS AI Chemometrics software was used to search for correlations between analytical data and NIRS spectral data. NIRS calibrations for freshly cut samples for dry matter ( $R^2 = 0.89$ , SECV = 0.35) and crude protein were obtained ( $R^2 = 0.63$ , SECV = 1.03). NIRS calibrations can be of great use for local decision-takers involved in the sustainable management and conservation of these Basque mountain pastures. Portable NIRS technology offers great potential for the fast acquisition of accurate data on nutritional quality of mountain pastures.

Keywords: portable equipment, NIRS, grassland, nutritional value

### Introduction

The determination of nutritional parameters in forage samples by means of NIRS is widely considered a valid method that has worldwide acceptance (Norris *et al.*, 1976; García-Ciudad *et al.*, 1993). The metabolizable or net energy of forages can be estimated from data on crude protein content and NIRS technology has proven most valuable for the estimation of forage crude protein (Givens *et al.*, 1993; De Boever *et al.*, 1996). Furthermore, NIRS has been reported to predict, with acceptable accuracy, the nitrogen content of heterogeneous and botanically complex grass samples from semi-arid grasslands (García-Ciudad *et al.*, 1999). On the other hand, the utilization of portable NIRS equipment has the advantage of allowing the determination of parameters under field conditions. The specific aim of this work was to calibrate our portable NIRS equipment for the prediction of the nutritional value (dry matter – DM – and crude protein – CP –) of mountain pastures under field conditions.

### Material and methods

For a successful calibration, it is essential to select a good population of samples representing as much of the heterogeneity of the studied matrix as possible. In our case, this is a most important factor as mountain pastures (in this case described as 6230 habitat in Natura 2000 Network) are usually characterized by a high temporal and spatial heterogeneity.

Our study was carried out in Urbia, Natural Park of Aizkorri-Aratz (16000 ha), Basque Country, northern Spain. In order to avoid the spatial heterogeneity, we chose a spatially homogenous area (3 ha) within Urbia pastureland (400 ha). Part of the temporal heterogeneity of the studied area was considered by including two different sampling times: spring (May 2008) and autumn (October 2008), coinciding with the beginning and the end of the grazing season in the area.

In each sampling plot (230 plots, consisting of 1 x 1 m squares, were randomly distributed in the studied area); (a) NIRS spectra were acquired *in situ* on grass samples (without cutting the grass), and b) grass samples were cut and immediately taken to the laboratory where NIRS spectra were again acquired on these freshly cut samples. In both cases, each spectrum consisted of 30 subspectra randomly acquired on the grass sample with a Field Spec® 5000 (Analytical Spectral Devices, Inc.). Finally, grass samples were dried and ground before their laboratory analysis of DM and CP.

Indico Pro software was used to obtain spectra and GRAMS Chemometry software to search for calibrations between both *in situ* and freshly cut grass, and both DM and CP laboratory determinations, respectively.

Our portable NIRS equipment scans samples between 350-2350 nm (spectral region). To avoid noise and irrelevant information, we only considered the following zones of the spectra when developing the calibrations: 500-850, 1050-1600 and 1850-2250 nm.

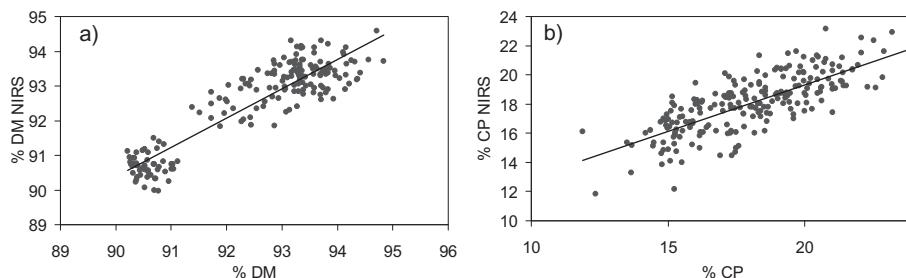

Figure 1. Regression for (a) % of DM and (b) % of CP for *in situ* grass samples.

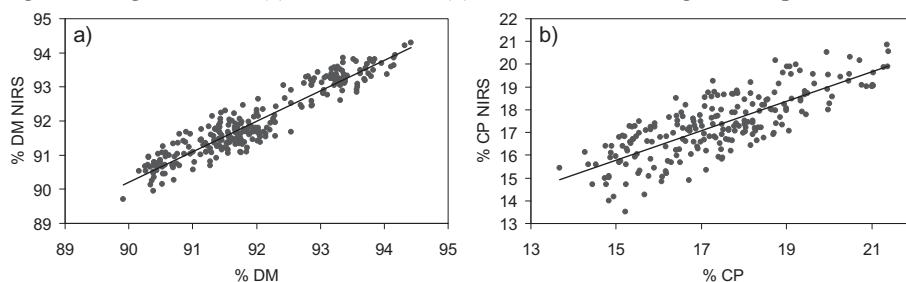

Figure 2. Regression for (a) % DM and (b) % CP for freshly cut grass samples.

## Results and discussion

For the *in situ* % DM calibration, Partial Least Square (PLS) method and Cross Validation (CV) were used, avoiding outliers. An equation with a 0.82 determination coefficient ( $R^2$ ) and a Standard Error of Cross Validation (SECV) of 0.56 were obtained (Fig. 1a).

For the *in situ* % CP calibration, a PLS and three partial spectral regions were considered. CV and a SNV (Standard Normal Variable) were taken into account. An equation with an  $R^2 = 0.63$  and  $SECV = 1.50$  was obtained (Fig. 1b). Good equations for the estimation of % DM and CP in grass samples have been previously reported (García-Ciudad *et al.*, 1993; Givens *et*

*al.*, 1993; De Boever *et al.*, 1996; García-Ciudad *et al.*, 1999). Our equations were not highly accurate, most likely due to the high heterogeneity, characteristic of the studied area. In consequence, a much larger number of samples is needed to get a more robust calibration that takes into account both the temporal and spatial heterogeneity. Actually, as seen in Fig. 1a, an empty space can be observed in our data equation, indicating the need for a much larger sampling effort.

Regarding spectra obtained in the laboratory on freshly cut grass, the same spectral regions were considered. The equation for % DM showed a  $R^2 = 0.89$  and a SECV = 0.35 (Fig. 2a). Corresponding values for % CP were:  $R^2 = 0.63$  and SECV = 1.03 (Fig. 2b).

These results support the aim that NIRS equations can be most useful for decision-takers involved in the sustainable management and conservation of mountain pastures because of possible fast and extensive prediction of the nutritional value of pastures.

## Conclusions

Our results show the potential of portable equipment NIRS technology for the determination of the nutritional value (DM and CP) of mountain pasture under *in situ* and laboratory conditions. However, the studied Basque pastoral agroecosystems present a very high heterogeneity (temporal and spatial heterogeneity). In consequence, a much larger number of grass samples is needed if we are to get a robust NIRS equation (not only for a rough screening).

## References

- De Boever J.L., Cottyn B.G., De Brabander D.L., Vanacker J.M. and Boucqué Ch. V. (1996) Prediction of the feeding value of grass silages by chemical parameters, *in vitro* digestibility and near-infrared reflectance spectroscopy. *Animal Feed Science and Technology* 69, 103-115.
- García-Ciudad A., García-Criado B., Pérez-Corona M.E., Vázquez de Aldana B.R. and Ruano-Ramos A.M. (1993) Application of near-infrared reflectance spectroscopy to chemicals analysis of heterogeneous and botanically complex grassland samples. *Journal of the Science of Food and Agriculture* 63, 419-426.
- García-Ciudad A., Ruano F., Becerro I., Zabalgogezcoa I., Vázquez de Aldana B.R., García-Criado B. (1999) Assessment of the potential of NIR spectroscopy for the estimation of nitrogen content in grasses of nitrogen content in grasses from semiarid grasslands. *Animal Feed Science and Technology* 77, 91-98.
- Givens D.I., Moss A.R. and Adamson A.H. (1993) Influence of growth stage and season on the energy value of fresh herbage. 2. Relationships between digestibility and metabolisable energy content and various laboratory measurements. *Grass Forage Science* 48, 175-180.
- Norris K.H., Barnes R.F., Moore J.E. and Shenk J.S. (1976) Predicting forage quality by infrared reflectance spectroscopy. *Journal of Animal Science* 43, 889-897.

## Dairy soiled water as an organic fertilizer for perennial ryegrass pasture

Minogue D.<sup>1,2</sup>, Murphy P.<sup>1</sup>, French P.<sup>1</sup>, Coughlan F.<sup>1</sup> and Bolger T.<sup>2</sup>

<sup>1</sup>Teagasc, Moorepark Dairy Production Research Centre, Fermoy, Co. Cork.

<sup>2</sup>School of Agriculture, Food Science & Veterinary UCD, Belfield, Dublin 4.

Corresponding author: Denis.Minogue@teagasc.ie

### Abstract

Soiled water is produced through the washing-down of milking parlours and holding areas. It contains significant quantities of nutrients (N, P, K) that are potentially available to plants. Substitution of soiled water for inorganic fertilizer N may help achieve both these goals. A field plot experiment was carried out to assess the fertilizer potential of soiled water when applied to grassland. Treatments included a control, soiled water and inorganic fertilizer N application at three rates (15, 22 and 30 kg ha<sup>-1</sup>). Treatments were applied every 6 weeks on fresh plots and were carried out over 1 year. Soiled water application significantly increased yields at 8 weeks and there were no significant differences between soiled water and chemical fertilizer yields at any of the application rates. Fertiliser replacement values of 60-93% were found, suggesting that land application of soiled water has potential to decrease inorganic fertiliser use. The effectiveness of soiled water as a fertiliser varied through the year with significant yield responses from March to September. Results indicate that soiled water has potential as a fertiliser but management should account for the seasonality in yield response to application.

Keywords: dairy effluent, dry matter production, fertilizer replacement value.

### Introduction

In Ireland, soiled water is produced on dairy farms through the washing-down of milking parlours and holding areas. Soiled water is typically applied to grasslands. This effluent contains nutrients that are potentially available to plants (Minogue *et al.*, 2010). The Nitrate Regulations (SI No. 101 of 2009) are focused on decreasing N loss to ground and surface waters through improved nutrient management on-farm. However, there are currently no guidelines on the fertilizer value of soiled water, as there are for slurries. Knowledge of the N fertilizer replacement value of soiled water is needed to incorporate soiled water into the farm nutrient management plan and there is currently a paucity of such knowledge in Ireland. We hypothesise that soiled water application to grassland will lead to a herbage yield response. This hypothesis was tested in a randomised block design plot experiment at a perennial grassland site in SW Ireland. The inorganic N fertilizer replacement value (FRV) of soiled water for herbage production was calculated. The effect of application timing (season) on yield response was also investigated.

### Materials and methods

This study was undertaken at Teagasc, Moorepark Research Centre in SW Ireland (52° 09' N 08° 15' W, 50 m a.s.l.). Total rainfall during the experiment was 1260 mm. The soil is a free draining sandy loam brown earth. The selected site had no previous history of effluent application and the herbage present was typical of dairy pastures within the region. At the commencement of the trial, pasture composition was predominantly perennial ryegrass (*Lolium perenne*). The experiment had a randomised block design with 4 replicates of 10 treatments and 9 application timings every 6 weeks from 1 August 2008 to 16 September 2009, giving a total of 360 plots. Plots were 1 m x 5 m in size and were discarded after use.

Treatments consisted of a control (C), a control receiving water at 45000 l ha<sup>-1</sup> (CW), soiled water at 22000, 33000 and 45000 l ha<sup>-1</sup> (SW1, SW2 and SW3, respectively) and calcium ammonium nitrate at 3 equivalent N rates (IF1, IF2 and IF3, respectively). There were also 2 treatments of diluted soiled water at the medium rate (33000 l ha<sup>-1</sup>) in which water at 0.45 and 0.7 times the initial soiled water volume was added to give application rates of 47850 and 56400 l ha<sup>-1</sup>, respectively. Fresh soiled water was sampled, analysed and prepared for application by dilution to give a total N content of 660 mg l<sup>-1</sup>. This concentration is close to the mean found by Minogue *et al.* (2010) in a survey of soiled water on Irish dairy farms (587 mg l<sup>-1</sup>). The three rates of soiled water and fertilizer N supplied 15, 22 and 30 kg N ha<sup>-1</sup>, respectively.

All plots were cut to a height of 5.5 cm 7 d prior to treatment application. Soiled water treatments were applied using a watering can and fertilizer was applied by hand. Yield (herbage DM mass in kg ha<sup>-1</sup>) above 5.5 cm was measured at weeks 4 and 8 by cutting a 0.65 m strip down the centre of the plot, using an Agria mowing machine (Agria-Werke GmbH, Mockmuhl, Germany). Harvested herbage was weighed and a sub-sample (>100 g) was removed for laboratory analyses. Sub samples were dried at 40 °C for 48 h to remove moisture content and derive percent dry matter. Yield for each application was calculated as the sum of herbage mass of both growth periods to give the total 8 week DM yield (kg ha<sup>-1</sup>). Data was analysed using ANOVA in SAS (SAS, 2008) with timing, N application rate and fertilizer type (soiled water, inorganic fertilizer, controls and diluted soiled water treatments) as factors. Mean annual yield was calculated from the sum of the mean yields for each of the 9 timings. Yield response to treatment was calculated as the yield for the treatment minus the yield of C. The FRV of soiled water at each N rate was calculated as the soiled water yield response divided by the inorganic fertiliser yield response, expressed as a percentage.

## Results and discussion

Table 1. The significance of main effects and interactions from ANOVA

Factor/Interaction	P value	Factor/Interaction	P value
Time	<0.0001	Time x Form	0.008
Form	0.01	Time x N Rate	0.056
N Rate	0.04	Form x N Rate	n.s
		Time x Form x N Rate	n.s

N Rate: rate of nitrogen applied, Time: application timing, Form: fertilizer type

There was no significant difference between C and CW. Therefore, C was used as the control for comparison. There was a significant effect of fertilizer form ( $P < 0.01$ ) on DM yield (Table 1). Mean DM yield on soiled water plots (1855, 2176 and 2224 kg ha<sup>-1</sup>, for SW1, SW2 and SW3, respectively) was significantly greater than the control (1438 kg ha<sup>-1</sup>), indicating that soiled water has a significant fertilizer value. However, there was also a significant interaction with application timing ( $P < 0.001$ ) with significant differences between soiled water treatments and control ( $P < 0.001$ ) for 6 out of the 9 application periods. Significant differences were found from March to August.

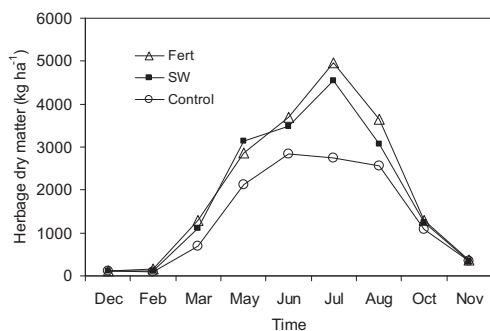

Figure 1. Mean herbage production for all soiled water (SW) and fertilizer treatments

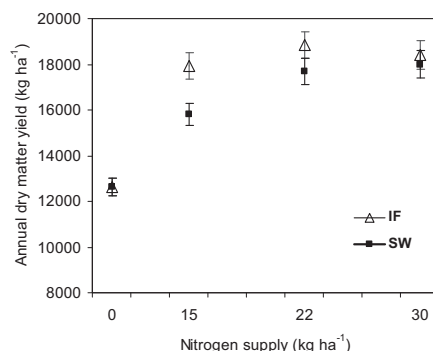

Figure 2. Mean annual dry matter yield depending on inorganic fertilizer (IF) and soiled water (SW) treatments

Significant differences were greatest from April to September. This seasonal interaction is illustrated by the mean of all application rates in Fig. 1. These results indicate that the best yield response to soiled water application occurs between March and September, while application between November and February is not likely to improve yields. Yield increased significantly with N rate ( $P < 0.05$ ), as would be expected (Table 1 and Fig. 2). However, the interaction of fertilizer form and N rate was not significant and mean DM yields of the inorganic fertilizer plots (1669, 2188 and 2181 kg ha<sup>-1</sup>, for IF1, IF2 and IF3, respectively) were not significantly different to those of the soiled water treatments. The FRV of soiled water (Fig. 2) was 60% for SW1, 81% for SW2 and 93% for SW3. Therefore, soiled water has potential to replace some of the inorganic fertiliser use on dairy farms. Dilution of soiled water did not affect yields.

## Conclusions

Results indicate that there is potential to use soiled water to increase grass yield during the growing season. There were no significant differences between soiled water and chemical fertilizer at any of the application rates and FRVs of 60-93% were found. Therefore, land application of soiled water has potential to decrease inorganic fertiliser use, offering cost savings to farmers. Incorporating soiled water into farm nutrient management planning could decrease N surpluses, thereby decreasing risks of N loss to the environment. Lack of a yield response in the winter period suggests that there may be a greater risk of N loss in this period. Management should therefore account for the seasonality of yield response to soiled water application.

## References

Minogue D., Murphy P., French P., Coughlan F. and Bolger T. (2010) Characterisation of soiled water on Irish dairy farms. In: Proceedings *Agricultural Research Forum/British Society of Animal Science 2010*, 121. SAS (Statistical Analysis System) 2008 User's Guide. Version 9.1. SAS Institute Inc., Cary, NC, USA.

# Fertilisation with different types of sewage sludge on pasture production and protein concentration in a silvopastoral system developed under *Fraxinus excelsior* L.

Mosquera-Losada M.R.<sup>1</sup>, Ferreiro-Domínguez N.<sup>1</sup> and Rigueiro-Rodríguez A.<sup>1</sup>

<sup>1</sup>*Crop Production Department. Escuela Politécnica superior. Universidad de Santiago de Compostela. 27002-Lugo.*

Corresponding author: mrosa.mosquera.losada@usc.es

## Abstract

The use of sewage sludge as fertilizer on grasslands is an adequate and suitable way to improve pasture production and to recycle the nutrients of this residue. Sewage sludge should be stabilised before using as fertilizer. The stabilisation process could cause differences in the mineralisation rates and therefore in the fertiliser efficiency. The aim of this study was to evaluate the effects of municipal sewage sludge stabilised using anaerobic digestion, composting and pelletisation on pasture production, and on concentration of crude protein in pasture compared with control treatments (mineral and no fertilisation) in a silvopastoral system established under *Fraxinus excelsior* L. (ash) and a sown sward with *Dactylis glomerata* L. (cocksfoot), *Lolium perenne* L. (ryegrass) and *Trifolium repens* L. (clover) in Galicia (Spain). The results showed that pelletised sewage sludge increased the pasture production and the concentration of crude protein in pasture. Moreover, the proportion of water in pelletised sludge was lower than in anaerobic sludge and composted sludge, which reduces application and storage costs.

Keywords: anaerobic digestion, composting, pelletisation, mineral

## Introduction

Sewage sludge stabilisation is a prerequisite for using this residue in agricultural systems in Spain (RD 1310/1990). The most important types of stabilisation are anaerobic digestion and composting, both of which are promoted by the EU if the sewage sludge is to be used as fertiliser (EC, 2000). However, both products contain high proportions of water which could be reduced by drying. Pelletised sludge is derived from the thermic treatment of anaerobic digested sewage sludge in order to reduce water content to 2%, which consequently reduces storage, transport and spreading costs compared with anaerobic or composted sludge (Mosquera-Losada *et al.*, 2009). The processes of stabilisation can alter the proportions of macronutrients and of micronutrients in the sludge (Mosquera-Losada *et al.*, 2009) and rates of incorporation into the soil (EPA, 1994). The objective of this study was to evaluate the effect of municipal sewage sludge that has been stabilised using anaerobic digestion, composting, and pelletisation on pasture production and on concentration of crude protein compared to control treatments (mineral and no fertilisation) in a silvopastoral system under ash (*Fraxinus excelsior* L.).

## Materials and methods

The experiment was conducted in a grassland used by a dairy farm, which was abandoned one year before experiment establishment in A Pastoriza (Lugo, Galicia, NW Spain) at an altitude of 550 m above sea level. Pasture was sown with a mixture of cocksfoot (*Dactylis glomerata* L. var. Artabro, 12.5 kg ha<sup>-1</sup>), ryegrass (*Lolium perenne* L var. Brigantia, 12.5 kg ha<sup>-1</sup>) and



clover (*Trifolium repens* L. var. Huia, 4 kg ha<sup>-1</sup>) in autumn 2004; trees being bare-rooted plants of ash planted at a density of 952 trees ha<sup>-1</sup>.

The experiment design was a randomized block, with three replicates and five treatments in experimental units of 168 m<sup>2</sup> with 25 trees distributed in a frame of 5x5. Treatments consisted of (a) no fertilization (NF); (b) mineral fertilization (MIN) with 500 kg ha<sup>-1</sup> of 8:24:16 at the beginning of the growing season; (c) fertilization with anaerobically digested sludge (ANA) with a total N input of 320 kg ha<sup>-1</sup> before pasture sowing; (d) fertilization with composted sewage sludge (COM) with a total N input of 320 kg ha<sup>-1</sup> before pasture sowing; and (e) application of pelletised sewage sludge (PEL), which involves a total N contribution of 320 kg ha<sup>-1</sup> split as 134 kg ha<sup>-1</sup> just after pasture sowing in 2004 and 93 kg ha<sup>-1</sup> at the end of 2005 and 2006. Sewage sludge was applied to the surface, and the calculation of the required amounts was conducted according to the percentage of total N and dry matter contents (EPA, 1994) and taking into account the Spanish regulation (RD1310/1990) regarding the heavy metal concentration for sewage sludge application. The percentage of N and dry matter in the anaerobic sludge was, respectively, around 2.62% and 29.47%, being around 1.19% and 65.19% in the composted sludge and 4.56% and 95.4% in the PEL sludge. To estimate pasture production and crude protein of pasture, four samples of pasture were randomly taken at a height of 2.5 cm per plot (0.3 x 0.3 m<sup>2</sup>) in June 2007 and May 2008 (other data collected are not shown). In the laboratory, two samples were dried for 48 hours at 60 °C and weighed to estimate pasture production. Crude protein of pasture was determined after a microkjeldahl digestion, with an autoanalyser (TRAACS-800+) as described by Castro *et al.* (1990). Data were analysed using ANOVA and differences between averages were shown by the LSD test using the statistical package SAS (SAS, 2001).

## Results and discussion

Pasture production in the harvests of June 2007 and May 2008 are shown in Figure 1. In June 2007, pasture production was positively increased by the PEL treatment compared with the ANA and COM treatments ( $P=7\%$ ). In May 2008, the PEL treatment increased the pasture production more than the ANA treatment ( $P<0.05$ ). This result can be explained by the fact that PEL sludge was applied as split doses in different years, which probably implied better incorporation into the soil, thereby increasing availability of cations to plants and reducing nutrient losses. Moreover, the ANA sludge tends to form patches over the soil which prevents the evaporation of soil water and which probably limits pasture development physically. This favours tree growth to reduce competition with pasture (López-Díaz *et al.*, 2007), providing that the weather conditions have reduced the real incorporation of the sludge into the soil.

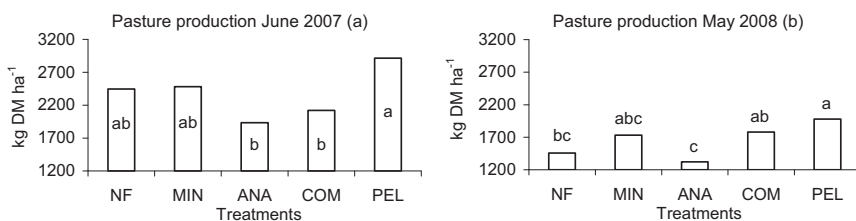

Figure 1. Pasture dry matter (DM) production (kg ha<sup>-1</sup>) under the different fertiliser treatments in the harvest of June 2007 (a), and May 2008 (b). NF: no fertilisation, MIN: mineral; ANA: anaerobic sludge, COM: composted sludge, and PEL: pelletised sludge. Different letters indicate significant differences between treatments.

In the June 2007 harvest, the concentration of crude protein in pasture (Figure 2) was significantly increased by the PEL treatment compared with the COM treatment ( $P=8\%$ ), as happened in pasture production, which revealed the highest availability of nitrogen in the PEL treatment. The lack of differences between PEL and COM treatments with respect to crude protein could be due to an initial lower mineralisation rate in COM sludge than in PEL sludge (EPA, 1994). In May 2008, only MIN treatment had a higher amount of crude protein in pasture than the NF treatment ( $P=6\%$ ), due to the input of nitrogen provided with this treatment in spite of having similar pasture production, which avoided the dilution effect in mineral fertilisation (MIN). This type of fertiliser offers nitrogen directly to pasture during a short period of time, and which leads to the plant increasing its concentration of crude protein (Whitehead, 1995). However, in the harvest of May 2008, no differences were found between sludge treatments. Crude protein levels of pasture were below the minimum maintenance needs for cattle ( $100 \text{ g kg}^{-1}$ ) (NRC, 2000) and sheep ( $94 \text{ g kg}^{-1}$ ) (NRC, 1985) in all treatments in the harvest of June 2007, with the exception of the PEL treatment and in the harvest of May 2008 in the NF treatment, which provided the necessary supply of this feed component for livestock.

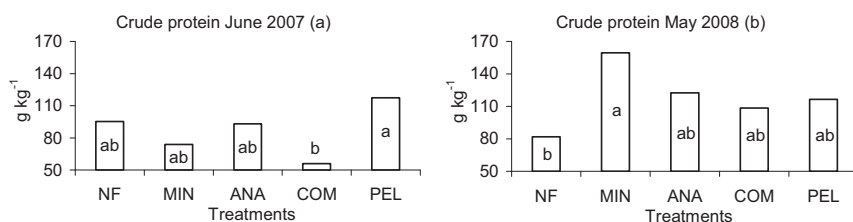

Figure 2. Concentrations of crude protein in pasture ( $\text{g kg}^{-1}$ ) under the different fertiliser treatments in the harvests of June 2007 (a) and May 2008 (b). NF: no fertilisation; MIN: mineral; ANA: anaerobic sludge; COM: composted sludge, and PEL: pelletised sludge. Different letters indicate significant differences between treatments.

## Conclusions

PEL sludge should be recommended among the types of sludge tested, as it increases pasture production and the concentration of crude protein in pasture. Moreover, PEL sludge contains less water than ANA and COM sludges, which reduces application and storage costs.

## References

- Castro P., González A. and Prada D. (1990) Determinación simultánea de nitrógeno y fósforo en muestras de pradera (Simultaneous determination of nitrogen and phosphorus in pasture samples). *XXX Reunión Científica de la Sociedad Española para el estudio de los pastos* 30, 200–207.
- EC (2000) *Working document on sludge3 3rd Draft*. Brussels, Belgium, pp 19.
- EPA (Environmental Protection Agency) (1994) *Land application of sewage sludge. A guide for land appliers on the requirements of the federal standards for the use of disposal of sewage sludge 40 CFR Part 503*. Environment Protection Agency, Washington D.C., USA.
- López-Díaz M.L., Mosquera-Losada M.R. and Rigueiro-Rodríguez A. (2007) Lime, sewage sludge and mineral fertilization in a silvopastoral system developed in very acid soils. *Agroforestry Systems* 70, 91–101.
- Mosquera-Losada M.R., Muñoz-Ferreiro N., and Rigueiro-Rodríguez A. (2009) Agronomic characterization of different types of sewage sludge: policy implications. *Waste Management*, in press.
- Whitehead D. (1995) *Grassland Nitrogen*. CAB International, Wallingford, UK, 397 pp.
- NRC (1985) *Nutrient Requirements of Sheep*. The National Academic Press, Washington D.C., USA, 99 pp.
- NRC (2000) *Nutrient Requirements of Beef Cattle*. The National Academic Press, Washington D.C., USA, 248 pp.
- SAS (2001) *SAS/Stat User's Guide: Statistics*. SAS Institute Inc., Cary, NC, USA, 1223 pp.

# Impact of different levels of inorganic and organic fertilizers on sward production

Rigueiro-Rodríguez A., García-Fernández M. and Mosquera-Losada M.R.

*Crop Production Department, Escuela Politécnica Superior, Universidad de Santiago de Compostela, 27002. Lugo, Spain*

Corresponding author: mrosa.mosquera.losada@usc.es

## Abstract

Rational use of sewage sludge as fertilizer is highly relevant for Europe, since the production of this residue has increased in the last years due to the implementation of the European directive 91/271/CEE. Moreover, increased fertilizer prices in recent years have meant that the recycling of this residue is even more important for farmers in order to reduce production costs. However, both the slow rate of sludge incorporation at the start of the year and the low proportion of K in the sludge may cause unbalanced inputs in the fertilizer programme. The objective of this experiment was to evaluate the effect of different sewage sludge doses, combined or not, with nitrogen and potassium, and two varieties of cocksfoot (*Dactylis glomerata* L. Artabro and Cambria) on forage biomass production and effect of this residue. If low doses of sewage sludge are applied complementary inputs of nitrogen and potassium are needed to supply nitrogen pasture needs at the start of the year, thereby enhancing pasture production. However, medium and high doses of sewage sludge enable adequate pasture production without inorganic complementation. Sward production in the third harvest was lower than at others because of low rainfall in summer months. Biomass production with variety Artabro was lower than variety Cambria during the spring and autumn.

Keywords: production, fertilizer, sewage sludge, cocksfoot.

## Introduction

Inorganic fertilizer consumption in Spain has decreased by 29% since 2008 and by around 36% during the period 2006-08. The consumption of nitrogen, phosphate and potassium fertilizers were reduced around 10%, 37% and 64% (MARM, 2010), respectively. These reductions were caused by increased fertilizer prices during recent years. For this reason, the use of sewage sludge as a fertilizer has increased in Galicia in the same period, which highlights the importance of optimizing the use of this residue. The rational use as fertilizer to increase pasture production could be a good way to dispose the residue for improving pasture production, as sewage sludge contains appreciable amounts of N and P, which makes it suitable for using as fertilizer (Smith, 1996). However, it usually has low K levels, and this element is necessary to improve legume production (Mosquera-Losada *et al.*, 1999; López-Díaz *et al.*, 2009). Sewage sludge use as a fertilizer depends not only on the dose, but also on application date and mineralization rate once applied (Mosquera-Losada *et al.*, 1999). The aim of this experiment was to evaluate the effect of the combination of sewage sludge and inorganic K and N fertilizers at the start of the season on pasture production.

## Materials and methods

The study was carried out in Lugo, north-west Spain (43°00' N, 7°32'W; altitude of 452 m a.s.l.), in the South West part of the Atlantic biogeographic region. In autumn 1997, two mixtures for pasture were sown: a) cocksfoot (*Dactylis glomerata* L.) cv. 'Artabro' at 25 kg ha<sup>-1</sup> + white clover (*Trifolium repens* L.) cv. 'Huia' at 3 kg ha<sup>-1</sup>; and b) cocksfoot cv. 'Cambria' at 25 kg ha<sup>-1</sup>

+ white clover at 3 kg ha<sup>-1</sup>. Eleven fertilization treatments in the two previously described varieties of cocksfoot were applied in experimental plots 2 m x 4 m in a randomised block design with four replicates. Treatments consisted of three sewage sludge doses of total N (L1: 160 kg ha<sup>-1</sup>; L2: 320 kg ha<sup>-1</sup>; L3: 480 kg ha<sup>-1</sup>), three other treatments with the same sewage sludge doses which had an addition of K at 83 kg ha<sup>-1</sup> (L1K; L2K; L3K) and another three treatments with the same sewage sludge doses and the application of 83 kg ha<sup>-1</sup> K and 40 kg ha<sup>-1</sup> N at the start of the growing season (L1NK; L2NK; L3NK). Also, two control treatments were established: a) no fertilization (NF) and b) mineral fertilization (Min) which meant the application of 80 kg ha<sup>-1</sup> N, 52 kg ha<sup>-1</sup> P and 166 kg ha<sup>-1</sup> K at the start of the growing season and 40 kg ha<sup>-1</sup> N after the second harvest. These treatments were applied yearly from the start of the year of 1998 to 2008. The results presented in this paper are part of a larger study, which aims to study the long-term residual effect of sewage sludge. Anaerobically digested sludge from the residual water plant of Lugo (Gestagua, S.A.) was used in the sludge (Table 1) and met the requirements to be applied to agricultural land according to the Spanish regulations (RD 1310/1990). Pasture samples were taken from an area of 1.1 m x 4 m before harvesting. Two harvests were carried out in spring, one in summer and one in autumn 2002. Subsamples were transported to the laboratory, dried at 60 °C during 48 h and subsequently weighed. ANOVA was used for data analysis and Duncan test for mean separation.

Table 1. Composition of sewage sludge applied in plots in year 2002.

pH (H <sub>2</sub> O)	% N	% P	% K	% Na	% Ca	% Mg	mg kg <sup>-1</sup> Mn
7.31	2.79	2.04	0.31	0.07	0.29	0.59	315.03

## Results and discussion

Treatments have lead to significant differences in biomass production for spring and autumn harvests, but not for summer, when pasture production was limited by drought (third spring harvest). Cocksfoot variety treatment only significantly affected pasture production in the third and fourth harvest (Table 2).

Table 2. ANOVA of biomass production in spring, summer and autumn 2002; where \* $P < 0.05$ ; \*\* $P < 0.01$ , \*\*\* $P < 0.001$  and ns (no significance).

	Treatment	Sp	Treatment*Sp
Annual production (2002)	***	ns	ns
1st harvest (May)	**	ns	ns
2nd harvest (June)	**	ns	ns
3rd harvest (July)	ns	***	ns
4th harvest (November)	***	*	ns

Spring biomass production (Figure 1) ranged between 4 and 8 Mg ha<sup>-1</sup>, which can be considered as a normal range in north-west Spain (Rigueiro-Rodriguez *et al.*, 1999). In the spring and autumn harvests, the use of inorganic nitrogen at the start of the year combined with high and medium dose of sewage sludge significantly increased pasture production compared with control (mineral and no fertilization treatments), low doses of sewage sludge without inorganic nitrogen and with potassium complementation. However, pasture production was not significantly increased by high doses of sewage compared with low doses, with or without inorganic complementation. This explains that initial inputs of nitrogen are necessary if low dose of sewage sludge is added to increase pasture production. Therefore, the low inorganic nitrogen mineralization at the start of the year in the low sludge inputs could be compensated by the addition of mineral or inorganic fertilizers. The incorporation of sludge and the mineralization of organic nitrogen to inorganic nitrogen into the soil depend on

temperature and humidity (Smith, 1996). Biomass production was higher in the third and fourth harvest with the cocksfoot variety Cambria than with Artabro.

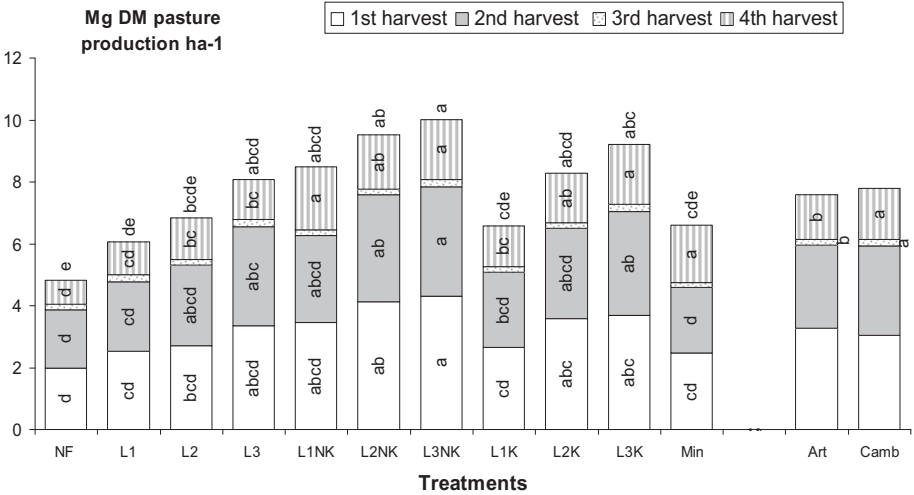

Figure 1. Dry matter production (Mg ha<sup>-1</sup>) in spring, summer and autumn 2002 with different fertilizer treatments and cocksfoot variety. NF: no fertilizer; L1: low sewage doses (160 kg ha<sup>-1</sup> total N); L2: medium sewage doses (320 kg ha<sup>-1</sup> total N); L3: high sewage doses (480 kg ha<sup>-1</sup> total N); K: sewage sludge complemented with 83 kg ha<sup>-1</sup> K; NK: sewage sludge complemented with 83 kg ha<sup>-1</sup> K and 40 kg ha<sup>-1</sup> N, Min: inorganic fertilizer; Art: cv ‘Artabro’; Camb: cv. ‘Cambria’. Different letters indicate significant differences between fertilization treatments.

**Conclusion**

After three continuous years of sewage sludge application it was seen that sludge inputs benefited pasture production more than mineral fertilizer applications, due to the higher number of nutrients applied with the sludge. At the beginning of the season mineral nitrogen is needed to supply pasture nitrogen needs if low doses of sewage sludge are applied. The cocksfoot variety Artabro was shown to be more susceptible to summer drought.

**References**

López-Díaz M.L., Rigueiro-Rodríguez A. and Mosquera-Losada M.R. (2009) Influence of pasture botanical composition and fertilization treatments on tree growth. *Forest Ecology and Management* 257 (4), 1363-1372. MARM 2010. <http://marm.es> (Accessed on 01/11/2010).  
 Mosquera-Losada M.R., González-Rodríguez A. and Rigueiro-Rodríguez A. (1999) *Ecología y manejo de praderas*. Ministerio de Agricultura, Pesca y Alimentación, España, 214 pp.  
 Rigueiro-Rodríguez A., López-Díaz M.L. and Mosquera-Losada M.R. (1999) Effect of different municipal sewage sludge doses on phosphorus cycling. *Grassland Farming*, 421-423.  
 Smith S.R. (1996) *Agricultural recycling of sewage sludge and the environment*, CAB International, Wallingford, UK, pp. 119-151.

## Effect of frost on regrowth ability and frost tolerance of rush (*Juncus* spp.)

Folkestad J.<sup>1</sup>, Østrem L.<sup>1</sup> and Netland J.<sup>2</sup>

Norwegian Institute for Agricultural and Environmental Research (Bioforsk), <sup>1</sup>Fureneset, 6967 Hellevik i Fjaler, Norway, <sup>2</sup>Plant Health and Plant Protection, 1430 Ås, Norway

Corresponding author: liv.ostrem@bioforsk.no

### Abstract

Soft rush (*Juncus effusus* L.) and compact rush (*J. conglomeratus* L.) have spread significantly in coastal parts of Norway during the past two decades, an increase that seems to have coincided with an observed rise in winter temperatures. This study investigated the effects of exposure to frost on plant regrowth of both species. Exposure to temperatures of  $-8$  °C to  $-10$  °C for more than 6 h resulted in significantly lower regrowth ability compared with non-frozen controls. Regrowth was still observed after 72 h, but with significantly lower regrowth ability for soft rush than for compact rush at 48 h and 72 h. These initial results indicate that soft rush is more susceptible to frost than compact rush. However, the species did not differ significantly in frost tolerance.

Keywords: perennial weeds, frost tolerance, LT<sub>50</sub>, low temperature, regrowth

### Introduction

Soft rush (*Juncus effusus* L.) and compact rush (*J. conglomeratus* L.) have spread significantly in coastal parts of Norway and now occur not only in low-input leys but recently also in intensively managed leys and pastures. Rush infestation causes a serious reduction in forage quality and lowers the motivation for landscape management. One hypothesis is that recent increase in winter temperatures might represent one of the driving forces facilitating the spread and distribution of rushes along the Norwegian coastline, which will continue with the predicted future temperature increase during winter (RegClim, 2005). Little is known about the effects of climate change on pests, diseases and weeds. In the temperate climate zone, increased temperature and precipitation could have major effects on the winter survival, growth and reproduction of plants (Fuhrer, 2003), and it is expected that weeds will adapt better to changes than crop plants (Ziska, 2008). Farming practices, e.g. fertilisation, grazing intensity, harvest stage and intervals, as well as soil compaction and poor drainage, are other possible factors behind the spread of rushes. The aim of this study was to test the effects of freezing temperatures on soft rush and compact rush. In late November 2009, initial tests were performed of frost tolerance as measured by LT<sub>50</sub> (lethal temperature for 50% of plants) and plant regrowth ability as affected by frost severity and duration.

### Materials and methods

The experiments were conducted at Fureneset, Fjaler, West Norway (61°34'N; 5°21'E, 10 m a.s.l.). In mid May 2009 seeds of both species were germinated on filter paper placed on top of fertilised soil in petri dishes and kept at 20 °C, 24 h light for about four weeks. The seedlings were established in plug trays (VEFI, VP54), transferred to a greenhouse and irrigated according to daily requirements. In mid September the plants were placed outdoors to provide natural hardening conditions.

Exp. 1. Frost tolerance. Seedlings were split into homogeneous plant units, each consisting of 2-3 aerial shoots and roots, and trimmed to 5 cm shoot and 1 cm root. Bundles of 15 plants were placed in moist sand in plastic boxes and left for approx. 12 h at around  $-2$  °C to freeze

homogeneously. The bundles (2 replicates per species and temperature) were then frozen to predetermined temperatures ranging from  $-3$  to  $-21$  °C at a cooling rate of  $-1$  °C  $h^{-1}$  down to  $-10$  °C and thereafter  $-3$  °C  $h^{-1}$ , using a programmable freezer in which the temperature was regulated by a monitoring system (Vekttek Ltd., Klepp, Norway). The temperature was recorded by a Campbell Scientific CR850 data logger. The plants were thawed at 2 °C for 24 h, transplanted into plastic trays (VP54, in fertilised soil) along with unfrozen controls, and transferred to a heated greenhouse (15 °C, 24 h light) for 28 days. The numbers of surviving plants were recorded according to Larsen (1978) and  $LT_{50}$  was calculated by probit analyses using the logistic distribution in PROC probit (SAS, 2004). Fiducial limits ( $\alpha = 0.05$ ) were used to test for significant differences in frost tolerance between the two species.

Exp. 2. Effect of frost duration on regeneration ability. Potted seedlings of both species were used, with aerial shoots trimmed to 5 cm. Trays of nine potted seedlings were placed in a freezer room at  $-8$  to  $-10$  °C, with two replicates per species and frost duration (unfrozen and 6, 12, 18, 24, 36, 48 and 72 h in the freezer room). To simulate frost exposure from above, the potted plants were insulated to prevent low temperature damage to roots during the frost treatment. Plants were thawed at 2 °C for 24 h and transferred to a heated greenhouse (15 °C, 24 h light) along with the unfrozen controls. After 4 weeks, dry weight (DW) was recorded. The data were analysed with a two-factorial analysis using the GLM procedure of SAS (2004) considering frost duration (h in freezer room) and rush species as fixed factors. Effects were considered significant at the  $P < 0.05$  level.

## Results

Exp. 1. Frost tolerance ( $LT_{50}$ ). The estimated  $LT_{50}$  value was  $-13.0$  °C for soft rush and  $-13.7$  °C for compact rush. This difference was not statistically significant.

Exp. 2. Tolerance to frost exposure. The DW mass of aerial shoots after frost exposure was affected by frost duration. The highest DW values were found in the control group in both species, and a decrease of DW regrowth was found with increasing frost duration, although with no significant difference between the species (Table 1). After only 6 h of frost exposure, both species had a significant decline in DW regrowth compared with the control. A significant species x frost duration interaction was observed at 48 h and 72 h, with compact rush producing significantly more shoot DW regrowth than soft rush (48 h,  $0.001 < P < 0.01$ ; 72 h,  $P < 0.001$ ).

Table 1. Regrowth (dry weight, g) of soft and compact rush after different frost duration treatments and significance levels between duration and species within treatments. Means of 18 biological replicates

Frost duration (hours)	Compact rush	Soft rush	Significance levels (betw. species)
0	0.318 a	0.378 a	Ns
6	0.215 bc	0.232 b	Ns
12	0.174 c	0.191 bc	Ns
18	0.220 bc	0.218 bc	Ns
24	0.238 b	0.216 bc	Ns
36	0.198 bc	0.174 c	Ns
48	0.123 d	0.091 d	**
72	0.099 d	0.041 e	***

Significance levels are indicated as follows: \*\*\*:  $P < 0.001$ , \*\*:  $0.001 < P < 0.01$ , \*:  $0.01 < P < 0.05$ , ns: not significant. Different letters (a-e) within columns indicate significant differences between treatment groups.



## Discussion

Freezing temperatures clearly decreased the regenerative ability of both soft and compact rush. These initial tests indicate that soft rush is less frost-tolerant than compact rush, a species difference observed in both tests. Exposure of whole plants gave a good picture of the regrowth ability. Significant differences between the species were only recorded at 48 h and 72 h. Similar results were reported by Larsen (1978), who found that long exposure gave better separation between varieties of cocksfoot (*Dactylis glomerata* L.). The test used for estimating the frost tolerance is widely used (Larsen, 1978), and the frost duration test was used in grasses (Østrem *et al.*, 2010). The results obtained in the present study confirm that the methods are also applicable for rush. Similar tests will be performed in mid-winter and early spring 2010 to observe changes during the winter, and older rush plants will be included when testing for frost tolerance, as plant age might influence frost tolerance. The results from the frost experiments are expected to give complementary knowledge on the general biological life cycle of the species investigated.

## Conclusions

These initial results show that frost affects the regrowth ability of both soft and compact rush, but significant differences between the species arise with increasing frost duration (48 h or 72 h). The results indicate that compact rush is less affected by frost exposure than soft rush, although the significant decline in DW regrowth after only 6 h of frost exposure indicates that neither rush species is particularly frost-tolerant. The absence of frequent frost events on the west coast of Norway during recent decades may partly explain why rush species have expanded. The freezing tests used appear to be useful for investigating frost tolerance and for discriminating between species.

## Acknowledgements

This study was funded by the Norwegian Research Council and Bioforsk as part of the project 'Control of rush (*Juncus* spp.) – an expanding weed in grassland and pasture areas in Western Norway' (2009-2012).

## References

- Fuhrer J. (2003) Agroecosystem responses to combinations of elevated CO<sub>2</sub>, ozone, and global climate change. *Agriculture, Ecosystems and Environment* 97, 1-20.
- Larsen A. (1978) Freezing tolerance in grasses. Methods for testing in controlled environments. *Scientific Reports of the Agricultural University of Norway* 57 (23), 1-56.
- Østrem L., Rapacz M., Jørgensen M. and Höglind M. (2010) Impact of frost and plant age on compensatory growth in timothy and perennial ryegrass during winter. *Grass and Forage Science* 65 (1), 15-22.
- RegClim. (2005) Regional Climate Development Under Global Warming. Available at: <http://regclim.met.no>. (accessed 19 March 2010).
- SAS Institute IN. (2004) SAS OnlineDoc® 9.1.3. Cary, NC, SAS Institute Inc.
- Ziska L.H. (2008) *Climate Change Impacts on Weeds*. Available at: <http://www.climateandfarming.org/pdfs/FactSheets/III.1Weeds.pdf> (accessed 19 March 2010).

# Hyperspectral measurements in maize (*Zea mays* L.) for silage

Perbandt D., Fricke T. and Wachendorf M.

University of Kassel, Steinstr. 19, 37213 Witzenhausen, Germany;

Corresponding author: mwach@uni-kassel.de

## Abstract

In a 3-yr experiment nadir and off-nadir hyperspectral measurements were conducted inside maize canopies. For off-nadir measurements different angle/height combinations were used to cover the whole maize plant. In general, off-nadir angle/height combinations showed improved prediction accuracies for dry matter yield (DM yield) and metabolisable energy (ME) of the whole crop compared to nadir measurements, whereas results of nadir measurements for crude protein (CP) could hardly be reached by off-nadir adjustments.

**Keywords:** maize, biomass yield, forage quality, field spectroscopy

## Introduction

The importance of mobile applications in precision farming increases permanently in order to determine crop status in real time and high spatial resolution. For cereal crops these applications already exist with sensors mounted on top of a tractor recording top of canopy reflectance. For maize with plant heights over three meters, technical limitations are reached considering the record of top of canopy reflectance. However, maize is one of the most important forage crops worldwide and increasing demand for renewable energy is leading to an expansion of maize production. Therefore, alternative approaches for the determination of biomass yield and the nutritional status of maize are required in order to optimise a site-specific crop management and hence, to reduce costs and environmental impacts.

## Materials and methods

Organically managed field plots (12 m\*80 m) of maize (*Zea mays* cv Ambrosius) were established on the experimental farm Neu Eichenberg of the University of Kassel, Germany, in 2006, 2007 and 2008. Measurements were carried out with three fully randomized replicates at different stages of plant maturity using a FieldSpec<sup>®</sup> 3 (Analytical Spectral Devices, CO, USA) in the range between 350 to 2500 nm. The sensor optic had a field of view of 25°. Readings were taken under a cloudless sky between 10:00 and 14:00 h Central European Time. To permit nadir measurements to be made 0.5 m above the canopy the sensor was mounted on a telescopic tube arm, installed on a front loader. Off-nadir measurements were carried out in-between the rows at five different height-sections and at three angles (Figure 1). Instrument optimisation and calibration was carried out prior to the nadir measurements and prior to each angle adjustment by holding the sensor in the nadir direction over a horizontally orientated Spectralon panel. Each data point represented a mean of 40 replicated scans. The biomass of each height segment was determined by harvesting one metre of maize plants of the measured row and then cutting these separately in 50 cm segments according to the measurement heights. Samples were dried at 65°C for a minimum of 72 h. Total biomass was calculated by summing the biomass over all segments. To obtain quality data, reflectance spectra of NIRS measurements were generated using an XDS-spectrometer (Foss NIRSystems, Hillerød, Denmark) and nutrient contents were determined based on calibrations developed by Volkers *et al.* (2003) with an  $R^2$  of 0.97 for CP and ME. A modified partial least squares (MPLS) method was used to develop calibration equations using the WinISI software (version 1.63, Foss NIRSystems/Tecator Infrasoft International,

LLC, Silver Spring, MD, USA). The assessment of the accuracy of the calibration models was based on the standard error of cross-validation (SECV), the coefficient of determination for cross-validation ( $RSQ_{cv}$ ) and the RSC, defined by the ratio of the standard deviation and the SECV.

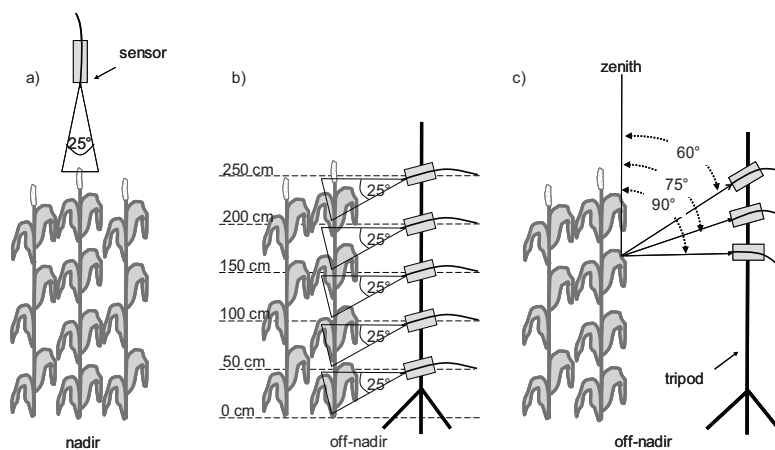

Figure 1: Schematic measuring setup for nadir (a) and off-nadir (b+c) measurements, including sensor field of view (a+b); segment heights (b) and zenith view angle (c)

## Results and discussion

For DM, CP and ME very good prediction accuracies could be obtained using off-nadir measurements with  $RSQ_{cv}$  values around 0.90 and RSC values of 3.0 and more. Therefore, each parameter has its own angle and height combination (Table 1).

Table 1: Statistics of the cross-validation (CV) for dry matter (DM) yield ( $t\ ha^{-1}$ ), crude protein (CP, % in DM) and metabolisable energy (ME,  $MJ\ kg^{-1}\ DM$ ) of the total crop biomass. The height and angle combinations for which SECV was lowest are shown.

Parameter	N	Angle	Height	Scatter correction	Math treatment	SECV	$RSQ_{cv}$	RSC
DM	32	90	000-050	MSC	0 10 10	1.7	0.92	3.6
CP	28	60	150-200	MSC	1 8 8	0.4	0.90	3.2
ME	28	75	100-150	MSC	1 6 6	0.3	0.89	3.0

N: number of samples; Angle: zenith view angle in degrees ( $^{\circ}$ ); Height: plant height-section above ground in cm; MSC: multiplicative scatter correction; Math treatment: derivative of spectra (1<sup>st</sup> number), gaps over which the derivative was to be calculated (2<sup>nd</sup> number) and number of data points over which spectra were smoothed (3<sup>rd</sup> number); SECV: standard errors of cross-validation;  $RSQ_{cv}$ : coefficient of determination of the cross validation; RSC: stability factor, ratio of standard deviation and SECV.

The comparison of nadir and off-nadir measurements shows distinctive differences in prediction accuracies for DM yield and ME (Table 2). Prediction accuracy for DM yield using off-nadir measurements is improved by 0.6 and for ME by 0.4.

Obviously, the bottom layer (0 to 50 cm above soil) is the segment with the highest soil interference although a zenith view angle of  $90^{\circ}$  minimises this impact. This part of the plant has only few large, dark green leaves and thick stalk elements, which might result in distinctive reflectance features, especially in the visible and near infrared region, known to be highly correlated to biomass (e.g., Biewer *et al.*, 2009).

Top reflectance measurements generally show good prediction accuracy for CP or related parameters using VIs (Miao *et al.*, 2009). This might be related to the high content of proteins in the upper plant leaves where optimal light conditions and maximum rates of photosynthesis occur, which results in high reflectance and hence good prediction accuracies (Lemaire and Gastal, 1997). The coefficients of determination obtained by nadir measurements in the present study (Table 2) correlate well with these earlier findings and are almost impossible to be achieved with off-nadir measurements inside the canopy. However, CP can be determined with an  $RSQ_{cv}$  value of 0.90 which is equivalent to a reduction in prediction accuracy of 0.1 compared to nadir measurements, but is still higher than in related research studies (e.g., Schmidt *et al.*, 2009).

Table 2: Statistics of the cross-validation (CV) for DM yield (t DM ha<sup>-1</sup>), crude protein (% CP in DM) and metabolisable energy (MJ ME kg<sup>-1</sup> DM) in total biomass of nadir measurements and relative reduction in RSC with off-nadir measurements compared to nadir measurements.

Nadir							Off-nadir
Parameter	N	Scatter correction	Math. treatment	SECV	RSQ <sub>cv</sub>	RSC	RSC reduction with off-nadir compared to nadir
DM	33	none	0 10 10	2.6	0.81	2.2	0.6
CP	32	none	2 4 4	0.8	0.92	3.4	-0.1
ME	32	MSC	2 4 4	0.4	0.78	2.1	0.4

N: number of samples; SECV: standard errors of cross-validation; RSQ<sub>cv</sub>: coefficient of determination of the cross-validation; RSC: stability factor, ratio of standard deviation and SECV; RSC reduction: relative reduction in RSC as compared to the RSC values for off-nadir measurements.

Off-nadir measurements in the present study show very good prediction accuracy for ME with an RSQ<sub>cv</sub> value of 0.89. These results exceed nadir measurements by 0.4 and are comparable to laboratory values (e.g., Castrillo *et al.*, 2005).

## Conclusions

These results show the potential of a new approach in directly measuring agronomically relevant plant and quality parameters for high growing crops, since measurements from the side with a distinct measurement height and a distinct zenith view angle offer a more precise prediction than top-of-canopy reflectance. This could reduce costs, labour and time and would allow the assessment of high growing canopies at all development stages.

## References

- Castrillo C., Baucells M., Vicente F., Muoz F. and Andueza D. (2005) Energy evaluation of extruded compound foods for dogs by near-infrared spectroscopy. *Journal of Animal Physiology and Animal Nutrition* 89, 194-198.
- Lemaire G. and Gastal A. (1997) N uptake and distribution in plant canopies. In: Lemaire G, ed. *Diagnosis of the nitrogen status in crops*. Springer-Verlag, Berlin, pp. 3-43.
- Miao Y., Mulla D.J., Randall G.W., Vetsch J.A. and Vintila R. (2009) Combining chlorophyll meter readings and high spatial resolution remote sensing images for in-season site-specific nitrogen management of corn. *Precision Agriculture* 10, 45-62.
- Schmidt J.P., Dellinger A.E. and Beegle D.B. (2009) Nitrogen recommendations for corn: an on-the-go sensor compared with current recommendation methods. *Agronomy Journal* 101, 914-924.
- Volkers K.C., Wachendorf M., Loges R., Jovanovic N.J. and Taube F. (2003) Prediction of the quality of forage maize by near-infrared reflectance spectroscopy. *Animal Feed Science and Technology* 109, 183-194.

# Effects of additional illumination under changing simulated sky cover on field spectroscopic measurements in clover-grass swards

Perbandt D., Fricke T. and Wachendorf M.

University of Kassel, Steinstr. 19, 37213 Witzenhausen, Germany;

Corresponding author: mwach@uni-kassel.de

## Abstract

The paper presents results of a one-year field experiment in which spectral reflectance of a binary legume-grass mixture was measured depending on the influence of an artificial lamp at different simulated cloud stages. Artificial illumination led to spectral accentuation at defined wavelengths due to the mixed energy provision from solar and artificial radiation.

Keywords: grassland, field spectroscopy, artificial illumination, simulated sky cover

## Introduction

Legume-grass mixtures show an excellent feeding value for animal production, but growth of the swards can vary considerably within a field and during the growing period, due to disturbances such as cutting or to lack of nutrients. Therefore, accurate information on biomass production of legume-grass swards are important factors for successful forage production, and the application of remote sensing for estimating biophysical parameters of forage swards is increasingly seen as an important first step to provide information on the spatial and temporal variability of legume-grass mixtures.

However, in-field measurements based on canopy reflectance are highly dependent on weather conditions, e.g. cloud cover. Cloudiness increases the fraction of scattered light and decreases the fraction of direct radiance. Therefore, standardised data recording under stable cloudless and sunny conditions are required for ground-based measurements to reduce weather impacts (e.g., Jain, *et al.*, 2007). Difficulties are encountered when routine ground-

based measurements are considered, particularly so in the case of agricultural research, where data collection depends on the conditions in the growing season.

The paper concentrates on results of a field experiment using artificially illuminated measurement plots. It shows how artificial light influences the spectral response, i) in combination with natural illumination, and ii) by excluding solar radiation.

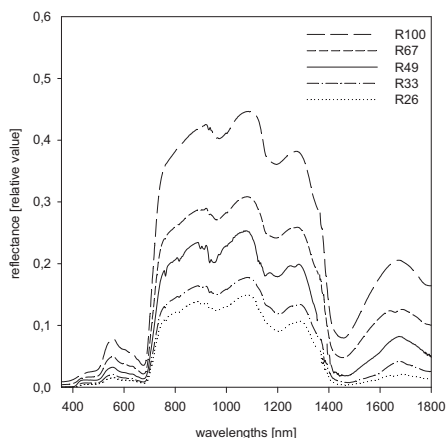

Figure 1: Reduction of reflectance under four different levels of shadow (R67 – R26) compared to the standard measurement (R100) (spectra are corrected from water band noise at 1400 nm)

## Materials and methods

A binary mixture of red clover (*Trifolium pratense* L.) and Italian ryegrass (*Lolium multiflorum* L.) was investigated in 2008 on the experimental farm Neu Eichenberg of the University of Kassel, Germany. Spectral measurements were carried out with a FieldSpec<sup>®</sup> 3

(Analytical Spectral Devices, CO, USA) in the range 350 to 2500 nm on seven dates from 28 April to 23 June, with a minimum of three replications on 0.25 m<sup>2</sup> plots. The sensor was stabilised on a tripod at a minimum distance of 0.50 m above the canopy. Readings were taken under cloudless atmospheric conditions between 10:00 and 14:00 h. A halogen bulb (1000 W) was established horizontally above the measurement plots at the same height as the sensor. To obtain five stages of simulated cloudiness, defined as percental reduction of incident light, a 1.55 m x 1.55 m x 1.80 m (length x width x height) rack covered with different layers of cotton was adjusted over the measurement plots totally covering them. The reduction of incoming radiation was achieved by combining several layers of cotton. The calculated percentage reduction of incident light compared to standard measurements was set 0, 33, 51, 67, and 74, respectively. Below, these levels of shadow are referred to as R100 (no darkening) R67, R49, R33, R26, respectively, where R stands for radiance (Figure 1). Additionally, sunlight was completely excluded by total shading and spectra were recorded with artificial illumination only (R0). Transferring these measured reductions of reflectance to real sky conditions, the levels of shadow ranged between cloudy sky (R67), overcast sky (R26) conditions, and night-time measurements (R0). Instrument optimisation and calibration were carried out prior to each measurement using a Spectralon panel. Each radiometric data point represents a mean of 40 replicated scans. Total biomass was determined after spectral measurements, cutting a 0.25 m<sup>2</sup> plot at a height of 5 cm above soil surface. Samples were dried at 65°C for a minimum of 72 h. Every second wavelength was used in the wavelength range between 355 and 1800 nm for the calculation of MPLS in order to reduce information loss. The assessment of the accuracy of the calibration model was based on the standard error of cross-validation (SECV), the coefficient of determination for cross-validation (RSQ<sub>cal</sub>) and the RSC, defined by the ratio of the standard deviation and the SECV.

## Results and discussion

The relative reflectance of artificially illuminated swards is clearly reduced (Figure 2b) compared with those under solar illumination (Figure 2a). This was ascribed to the experimental set up, since the spectralon panel, used for instrument calibration, was fixed approximately 10 cm under the sensor, and hence it was very close to the lamp, which led to different illumination conditions for instrument calibration and target measurement. The lambertian surface for collecting the white reference was lit up very brightly compared with the canopy examined beneath. As the data recorded were the ratio of the spectral responses of the target and the white reference, the white reference data were overestimated and the relative reflectance was low.

Unlike the natural illumination conditions, where spectral response increased with the degree of induced cloudiness (Perbandt *et al.*, 2009), the spectral response of artificially illuminated swards decreased with the degree of induced sky cover. With the spectralon panel very close to the halogen lamp, the fraction of artificial light that illuminated the spectralon panel to record the white reference was clearly increased compared to the solar radiation component. In contrast, recording the target, the artificial illumination energy was relatively low, due to the diffusion of light. Hence, the spectral response of the target was much more dependent on the fraction of solar radiation, which was reduced stepwise by the levels of shadow. This decreased the spectral response with increasing shadow.

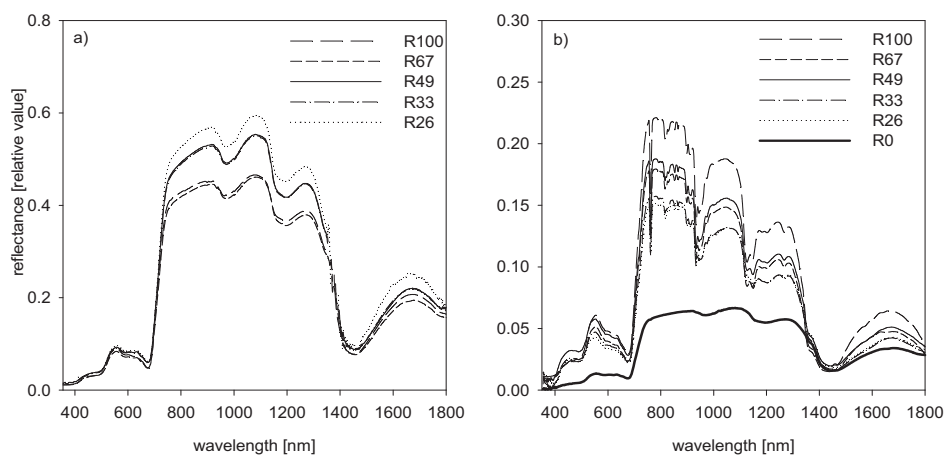

Figure 2: Measured spectra of defined darkening levels (R67-R0) compared to clear sky conditions (R100) a) without and b) with artificial illumination (white reference and measurements were conducted under the rack).

The accentuation of peaks in the spectra with combined illumination compared to spectra without additional light and pure artificial illumination spectra (R0) is another significant difference. This optical phenomenon occurred in spectral bands known as minor water absorption bands around 720, 820, 940 and 1120 nm, respectively. The spectral accentuation was also ascribed to the technical set up. The white reference panel used for reference measurements was illuminated by the continuous spectrum from the lamp and some negligible solar component. The measurements, however, were then taken with solar radiation and a very low lamp component. In the water absorption bands solar radiation is significantly reduced by atmospheric water absorption, which led to the visible reduction of reflectance at the named wavelengths. Furthermore, calibrations were developed for the prediction of DM yield, including all levels of shadow (R100-R0) in order to study the prediction accuracy under a wide range of weather conditions. The results allow us to assume good prediction accuracy under changing weather conditions with a SECV of 0.64, an  $RSQ_{cal}$  of 0.87 and an RSC of 2.8.

## Conclusions

Although evidence of interactions between measurement set up and spectral response was found, overall calibration shows a good result for DM yield as long as instrument calibration and target record is performed under the same illumination conditions.

## References

- Jain N., Ray S.S., Singh J.P. and Panigrahy S. (2007) Use of hyperspectral data to assess the effects of different nitrogen applications on a potato crop. *Precision Agriculture* 8, 225-239.
- Perbandt D., Fricke T. and Wachendorf M. (2009) Der Einfluss des Bewölkungsgrades auf hyperspektrale Messungen im Feld am Beispiel eines Klee-Gras-Bestandes. In: Märlander B., Christen O., Kenter C. and Düker A. (Eds.) *Mitteilungen der Gesellschaft für Pflanzenbauwissenschaften* 21, Verlag Liddy Halm, Göttingen, Germany, pp. 51-52.



# Analysis of land utilisation by red deer in the Apennine Mountains

Crocetti C.<sup>1</sup>, Ponzetta M.P.<sup>1</sup>, Minder I.<sup>2</sup>, Messeri A.<sup>2</sup>, Cervasio F.<sup>2</sup>, Argenti G.<sup>3</sup> and Maccelli S.<sup>1</sup>

<sup>1</sup> DiBA, Via delle Cascine 5, 50144 Firenze, Italy

<sup>2</sup> CIRSeMAF, Via Maragliano 77, 50144 Firenze, Italy

<sup>3</sup> DiPSA, P.le delle Cascine 18, 50144 Firenze, Italy

Corresponding author: mariapaola.ponzetta@unifi.it

## Abstract

Wild ungulates usually utilise for their activities wide ranges, constituted by different habitat types such as woodland, grassland, unproductive surfaces and also suburban areas. The knowledge of the home range extent and characteristics is important with regards to conflicts with agriculture and forest management and useful for best management practices of wildlife. We investigated the spatial behaviour and habitat use of 12 female red deer (*Cervus elaphus*) in a protected area in central Italy from spring to autumn 2009. Animals were equipped with GPS collars able to record locations (fix) taken once an hour. Seasonal home ranges were generated for each hind in a GIS system. Home range sizes were highly variable between individuals but generally consistent in time. Habitat composition within individual spring and summer home ranges differed from overall availability, showing marked preference for pastures and meadows. Moreover, within home ranges the animals used these open habitats more than suggested by their availability in spring and autumn. Our results confirm the great importance of pastures and meadows for red deer, especially in areas with a prevalence of woods with low availability of undergrowth.

Keywords: land use, red deer, home range, GPS-GSM collar

## Introduction

One of the lands most frequented by the deer (*Cervus elaphus*) population of the Tosco-Emiliano Apennine Mountains is the Nature Reserve Acquerino-Cantagallo and adjacent areas. These are characterized by forests of various types, interrupted by a few clearings for grazing, often encroached by shrubs and invasive species. In general, the natural habitat of deer is made up of vast tracts of forest, interspersed with extensive meadows. This habitat is differently used in relation to the variable geographical and climatic conditions and to the behavioural characteristics of each animal. For the Apennine deer population, the home range size and habitat selection patterns are not yet known. This study aims to investigate the mode of utilization of available trophic resources by deer in order to improve management interventions and, consequently, to mitigate the impact of animals on the surrounding cultivated fields. A large amount of data was collected by application of the GPS-GSM collar system. Data allowed evaluating deer habitat selection and seasonal exploitation of different categories of soil cover within each home range.

## Material and methods

The research was carried out in the Nature Reserve of Acquerino-Cantagallo and surrounding areas (study area). From November 2008 to March 2009, 12 red deer hinds were captured. GPS collars (Vectronic Aerospace®, Germany, mod. GPS-Plus) with GPS and VHF transmitters and sensors for activity, environmental temperature and mortality measurements were fitted (Girard *et al.*, 2002). The collars were programmed to record locations every hour and to transmit data by GSM system. The GPS/GSM collars obtained GPS fixes reliably, with

data missing for only about 4% of prescheduled times. For data analysis, only validated fixes (90%), based on the reception of five or more satellites, were used. The received data were exported in dBASE format and then displayed and processed through the software ArcView GIS ESRI 3.02. For all hinds, home ranges were calculated through the 95% Kernel method excluding the most outlying locations (Worton, 1989) to delimit the area used habitually by an individual in the course of its normal activities. The mapping of land use was obtained by combining the maps of the provinces of Prato and Pistoia (Corine Land Cover 2000). For each season (spring, summer and autumn) the habitat composition of individual home ranges was analysed. As proposed by Johnson (1980), resource selection was investigated by comparing the composition of habitat types present in the animals' home ranges with the available composition in the study area (*second-order selection*), as well as in terms of selection of particular land use categories within the animal's home range (*third-order selection*). As for second-order selection, habitat selection was assessed by evaluating the percentage presence of seven different categories of soil cover in each single home range, compared to the composition in the study area (total surface occupied by the twelve hinds throughout the study period). Moreover, the time spent in each habitat type, measured in terms of number of location/habitat type, was compared to home range composition to obtain the seasonal exploitation of different categories of soil cover within each home range (third-order selection). Overall habitat selection patterns were analysed by compositional analysis (Aebischer *et al.*, 1993), whereas use and availability of meadows and pastures were compared by the Wilcoxon's matched pairs test (Zar, 2009).

Animal	Spring	Summer ha	Autumn
F8	152	120	118
F12	43	102	135
F10	86	42	154
F4	79	55	141
F6	136	75	368
F11	124	39	735
F2	70	79	259
F5	87	53	207
F3	83	302	.
F7	171	225	279
F1	664	504	1343
F9	2809	242	2358

Table 1. Home range sizes (95% Kernel) of the 12 hinds (F3 deceased in autumn) in spring (21<sup>st</sup> March – 20<sup>th</sup> June), summer (21<sup>st</sup> June – 22<sup>nd</sup> September) and autumn (23<sup>rd</sup> September – 20<sup>th</sup> December).

## Results and discussion

Seasonal home range sizes of the 12 hinds were highly variable between individuals, ranging from 39 ha to 2809 ha with a median size of 136 ha (Table 1). However, most hinds showed considerably overlapping seasonal ranges (> 60% overlap) suggesting resident spatial behaviour, except for one female (F9) with a semi-migratory behavioural pattern. Similar home range sizes were found in a population of resident hinds in an area of eastern Italian Alps in summer (Bocci *et al.*, 2010). Land use in terms of habitat composition within spring and summer home ranges differed significantly from habitat availability in the study area (compositional analysis, spring:  $n = 12$ ,  $\Lambda = 0.3$ ,  $\chi^2 = 14.2$ ,  $P < 0.05$ ; summer:  $n = 12$ ,  $\Lambda = 0.3$ ,  $\chi^2 = 15.2$ ,  $P < 0.05$ ; Table 2). This result suggests that the hinds did not establish their home ranges at random in these periods of the year. In particular, in spring and in summer, hinds included a higher proportion of pastures and meadows in their home ranges than expected by their availability in the study area (Fig. 1). The use of different habitat types in terms of number of GPS locations in each type differed significantly from the habitat distribution within the seasonal home ranges for all seasons (compositional analysis, spring:  $n = 12$ ,  $\Lambda = 0.08$ ,  $\chi^2 = 30.4$ ,  $P < 0.001$ ; summer:  $n = 12$ ,  $\Lambda = 0.2$ ,  $\chi^2 = 20.7$ ,  $P < 0.05$ ; autumn:  $n = 11$ ,  $\Lambda = 0.1$ ,  $\chi^2 = 22.6$ ,  $P < 0.001$ ). In spring, with the beginning of the growing cycle, and in autumn, with the vegetative re-growth, hinds spent

more time in pastures and meadows than expected by their availability (Fig. 1). On the other hand, in summer no difference in use and availability was detected, probably because of the decreasing quality of most herbaceous plant species.

Table 2. Percentage habitat composition in the study area and average habitat composition within seasonal home ranges.

Land use	Study area	Spring	Summer	Autumn
Coniferous woodland (%)	6.7	5.3	6.1	5.3
Broadleaves woodland (%)	77.1	71.4	70.6	74.3
Chestnut woodland and orchards (%)	7.5	6.6	8.8	8.6
Pastures and meadows (%)	3.4	9.9	7.3	5.5
Road verges (%)	2.5	3.1	3.1	2.4
Arable land (%)	1.0	1.5	2.3	1.8
Urban areas (%)	1.8	2.2	1.8	2.1

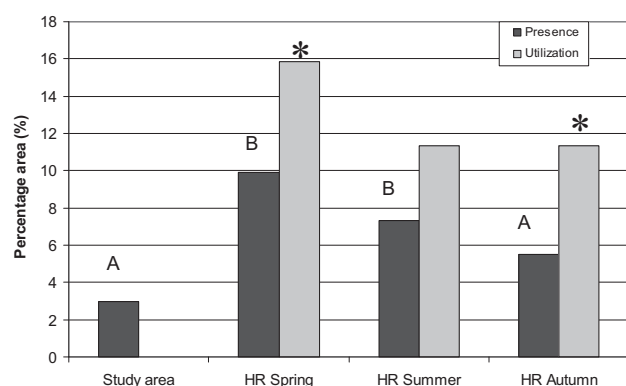

Figure 1. Percentage area of pastures and meadows (PM) in the study area and within home ranges (HR) and its utilization (% locations) in consecutive seasons. Different letters (A, B) indicate significant differences ( $P < 0.05$ ) between % presence of PM in the study area and in the seasonal home ranges; \* indicates significant difference ( $P < 0.05$ ) between % presence of PM and its use in seasonal home ranges.

## Conclusions

Our results confirm the great value of grassland as important forage resource for red deer, in particular in spring when hinds have high energetic demands due to gestation and lactation. Thus, the recovery of abandoned open areas, such as pastures and meadows, and the opening of new small areas are of particular importance for management purposes of these herbivores. Moreover, the enhancement and restoration of pastures and meadows may deter red deer from exploiting surrounding agricultural areas and forest regeneration stands, thus reducing damage to these sites.

## References

- Aebischer N.J., Robertson P.A. and Kenward R.E. (1993) Compositional analysis of habitat use from animal radio-tracking data. *Ecology* 74, 1313-1325.
- Bocci A., Monaco A., Brambilla P., Angelini I. and Lovari S. (2010) Alternative strategies of space use of female red deer in a mountainous habitat. *Annales Zoologici Fennici* 47, 1-10 (In print).
- Girard I., Ouellet J. P., Courtois R., Dussault C. and Breton L. (2002) Effects of sampling effort based on GPS telemetry on home-range size estimations. *Journal of Wildlife Management* 66, 1290-1300.
- Johnson D.H. (1980) The comparison of usage and availability measurements for evaluating resource preference. *Ecology* 61, 65-71.
- Worton B.J. (1989) Kernel methods for estimating the utilization distribution in home range studies. *Ecology* 70, 164-168.
- Zar J.H. (2009) *Biostatistical Analysis*, 5th Edition, Pearson Prentice-Hall, Upper Saddle River, NJ, 944 pp.

# Ammonia volatilization after application of biogas slurries in a coastal marsh region of Northern Germany

Quakernack R.<sup>1</sup>, Techow A.<sup>2</sup>, Herrmann A.<sup>2</sup>, Taube F.<sup>2</sup>, Kage H.<sup>1</sup> and Pacholski A.<sup>1</sup>

*Christian-Albrechts-University of Kiel, D-24118 Kiel*

<sup>1</sup>*Institute of Crop Science and Plant Breeding; Agronomy and Crop Science*

<sup>2</sup>*Institute of Crop Science and Plant Breeding; Gras and Forage Science/Organic Agriculture*

Corresponding author: quakernack@pflanzenbau.uni-kiel.de

## Abstract

Biogas production has increased rapidly in Germany, resulting in large amounts of biogas slurries. Physico-chemical properties of biogas slurries differ from those of conventional animal slurries. Due to this fact a field study has been established to determine ammonia losses by volatilization after supply of biogas slurries in grassland. Perennial ryegrass (*Lolium perenne*) was tested as an alternative to conventional biogas crops (silage maize, silage cereals) in the marsh region of Schleswig-Holstein in Northern Germany. Yield was determined under different N-fertilisation-levels of mineral fertiliser (CAN) and biogas slurry applied by trail hoses. Ammonia losses are mainly influenced by climate conditions and were investigated by a micrometeorological approach, backwards Lagrangian stochastic dispersion method. Because of strong wind in the coastal region the major fraction of the ammonia emissions were observed within the first 10 hours after application. The NH<sub>3</sub>-losses by volatilization were higher than in other regions of Schleswig-Holstein and substantially decreased yield of perennial ryegrass.

Keywords: Ammonia volatilization, Biogas slurry, Fertiliser value, Energy crop rotation

## Introduction

Biogas plays an important role in the German bio-energy production, with energy crops (silage maize, silage cereals) particularly grown as fermentation substrates. It is not only in coastal regions of Germany that grass can also serve as an alternative to the predominant biogas-crop, maize. However, the overall environmental benefit from growing of energy crops may be reduced by NH<sub>3</sub>-emissions after application of biogas slurries, unavoidable in these production systems. NH<sub>3</sub>-emissions are among the main sources of acidifying and eutrophying atmospheric compounds and are considered as indirect greenhouse gas emissions. Furthermore the N-fertilisation value of organic fertilisers can strongly be reduced by NH<sub>3</sub>-volatilization (Sommer and Hutchings, 2001). Marshlands are typical regions for grass cultivation and characterised by very particular growing conditions because of shallow groundwater levels, heavy, silt-clayey soils (Fluvisollic Gleysol) and strong wind speeds which can also strongly influence NH<sub>3</sub> loss processes. There exists only very limited information on the potential NH<sub>3</sub>-losses under such conditions.

## Materials and methods

Ammonia (NH<sub>3</sub>) losses after application of biogas slurries on grassland by trail hoses were determined on larger field plots (1 plot per fertilisation) by using the micrometeorological backwards Lagrangian stochastic dispersion technique (bLS, Sommer *et al.*, 2005) in the marsh of the federal state of Schleswig-Holstein, Northern Germany. The plot size of each fertilisation date depended on the working width of the trail hoses, which varied between the different dates of fertilisation (plot sizes at investigated fertilisations: 07.04.09: 48 m x 48 m;

28.05.09: 54 m x 54 m; 01.07.09: 36 m x 36 m). Yield of perennial ryegrass was investigated in a multi-plot field trial including a bi-annual energy crop rotation consisting of maize (*Zea mays*), wheat (*Triticum aestivum*), Italian ryegrass (*Lolium multiflorum*) and the monocultures of maize and perennial ryegrass. The latter was cut four times. Nitrogen fertilisers tested in this study included co-fermented biogas slurry (BGS) and CAN as mineral fertilizer. Besides the control treatments, N was applied in two levels (360 kg ha<sup>-1</sup> subdivided in 120/120/70/50 and 480 kg ha<sup>-1</sup> subdivided in 165/145/100/70 kg ha<sup>-1</sup>). Plot size was 12 m x 12 m with four replicates for each treatment. Ammonia loss measurements after biogas slurry application were carried out on the same date and with the same N-supply as for the moderate N-level treatment (360 kg ha<sup>-1</sup> N). Ammonia losses from CAN were considered as negligible. Yield of perennial ryegrass [t ha<sup>-1</sup>] was statistically analysed by two-way ANOVA including N-form and N-levels as treatment factors.

## Results and discussion

Nitrogen losses by NH<sub>3</sub>-volatilization differed between dates of fertiliser application. Figure 1 shows the cumulative and the relative ammonia losses after biogas slurry application on grassland determined in 3 experimental campaigns.

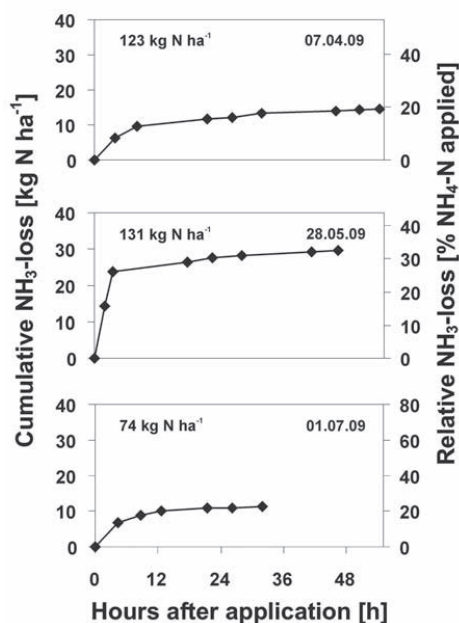

Figure 1 Cumulative and relative N-loss by NH<sub>3</sub>-volatilization after application of biogas slurry in different N levels, perennial ryegrass (*Lolium perenne*), marsh region of Schleswig-Holstein, micrometeorological bLS-technique, 3 dates during spring and summer 2009.

After N-application relative losses of about 20% of NH<sub>4</sub>-N applied could be observed on the application dates 7 April and 1 July, whereas on 28 May the NH<sub>3</sub>-losses were higher than 30% of supplied NH<sub>4</sub>-N. The higher relative losses were probably due to strong wind on 28 May, which is one of the main driving factors for NH<sub>3</sub>-volatilization. Average wind speed at a height of 2 metres for the first few hours after application was 7.4 m s<sup>-1</sup>, much higher than on 7 April (3.6 m s<sup>-1</sup>) and on 1 July (2.4 m s<sup>-1</sup>). NH<sub>3</sub>-volatilization losses after slurry application

with trail hoses in the marsh were about two fold higher than in other landscapes of Schleswig-Holstein (Pacholski *et al.*, 2009).

The yield of ryegrass was significantly lower for every cut in the biogas slurry treatment as compared to mineral fertilisation. No interaction between N fertiliser and N level was observed (Fig. 2).

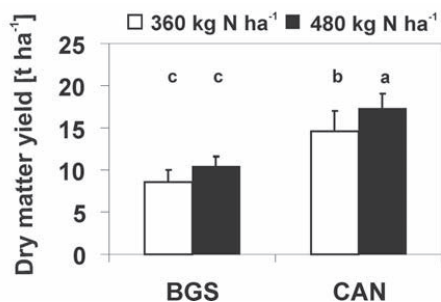

Figure 2 Dry matter yield [t ha<sup>-1</sup>] of perennial ryegrass, cut 4 times a year, at a moderate (360 kg ha<sup>-1</sup> N) and a high level (480 kg ha<sup>-1</sup>) of N fertilization with biogas slurry (BGS) and mineral fertilizer (CAN) in the marsh region of Schleswig-Holstein. Values with different letters are statistically different at  $P < 0.05$  (Tukey-test,  $n=4$ ).

As a result the total DM yield decreased from 14.5 t ha<sup>-1</sup> (CAN) to 8.5 t ha<sup>-1</sup> (BGS) by about 42% under the lower N level, and from 17.3 t ha<sup>-1</sup> (CAN) to 10.4 t ha<sup>-1</sup> (BGS) about 40% under the high N level (Fig. 2). The data suggest that N-losses by NH<sub>3</sub>-volatilization were the main factor for high differences in yield levels between the two N-fertilisers. In addition, lower yields under biogas slurry fertilisation could also be due to ammonium adsorption and fixation in the soil characterized by high clay contents, N<sub>2</sub>O-losses by microorganisms or N-leaching. Besides environmental impact, like acidification and eutrophication, NH<sub>3</sub>-volatilization can thus also strongly influence the N-fertilisation value of biogas slurry. Nevertheless, a DM yield of 14.5 t ha<sup>-1</sup> for grass with mineral fertilisation was competitive to the yield of dominant biogas crop maize at this site (average of 15 t ha<sup>-1</sup>).

## Conclusion

Fertilisation of biogas slurries with trail hoses can lead to high N-losses by NH<sub>3</sub>-volatilization. Losses were even higher than 30% of NH<sub>4</sub>-N applied, in situations with strong winds. Those losses substantially contributed to strongly decreased yields of perennial ryegrass and high environmental impact. In the study region, grasses cut 4 times a year can be considered as a realistic alternative to maize as substrate for biogas production due to similar dry matter yield levels.

## References

- Pacholski A., Gericke D. and Kage H. (2009) Measurement and modelling of NH<sub>3</sub> emissions from field-applied biogas residues in North German energy crop rotations. In: Grignani C., Acutis M., Zavattaro L., Bechini L. Bertora C., Marino Gallina P. and Sacco D. (eds.) *Proceedings of the 16th Nitrogen Workshop - Connecting different scales of nitrogen use in agriculture*. 28th June – 1st July 2009, Turin, Facolta di Agraria, Turin, Italy, 189-190.
- Sommer S.G. and Hutchings N.J. (2001) Ammonia emission from field manure and its reduction – invited paper, *European Journal of Agronomy* 15, 1-15.
- Sommer S.G., McGinn S.M. and Flesch T.K. (2005) Simple use of the backwards Langrangian stochastic dispersion technique for measuring ammonia emission from small field-plots. *European Journal of Agronomy* 23, 1-7.

# Changes in soil P status of grassland in the Netherlands between 1971 and 2009

Reijneveld J.A.<sup>1</sup>, Ehlert P.A.I.<sup>2</sup>, Schoumans O.F.<sup>2</sup>, Termorshuizen A.J.<sup>1</sup> and Oenema O.<sup>2</sup>

<sup>1</sup>BLGG AgroXpertus, P.O. Box 115, NL-6860 AC Oosterbeek, The Netherlands

<sup>2</sup>Wageningen UR, Alterra, P.O. Box 47, NL-6700 AA Wageningen, The Netherlands

Corresponding author: AR@Blgg.nl

## Abstract

In many EU countries, agricultural land has been heavily manured and/or fertilised in past decades. Many of these lands now have high soil phosphorus (P) status and are characterised as high risk areas for phosphorus (P) leaching. Here we report on regional and temporal changes in the soil P status of grassland in the Netherlands, using a database with ~ 2 million results of soil P determinations from farmers' fields over the period 1970-2009. Mean soil P-status of grasslands remained rather constant during the period, but there are large differences between regions and soil types. In general, soil P status increased in the order: loess soils < clay soils < peat soils < sandy soils. Manure policy has put increasingly tight restrictions on P application from 1984 onwards, but the effect on soil P status is not significant ( $P < 0.05$ ) yet. The relatively high soil P status of grasslands will have major implications for future livestock farming and manure management in these areas, because P application limits will be increasingly tightened to decrease the vulnerability of the soils to P leaching.

## Introduction

The acreage of agricultural land with soil phosphorus (P) status above the recommended ranges has become significant in countries in the northern hemisphere (e.g. Ketterings *et al.*, 2005). Accumulation of soil P increases the risk of P losses to the aquatic environment through erosion, overland flow and subsurface leaching (e.g. Sims *et al.*, 2000). Enrichment of water bodies with P leads to eutrophication. Implementation of policy measures to restrict P applications are hampered by lack of information about (variations in) the soil P status of farmers' fields, and by farmers' concerns that limiting P application will reduce crop production and will limit the room for animal manure application and hence will ultimately limit the intensity of livestock production. Agriculture in the Netherlands is characterized by high crop yields, high livestock density and high inputs of fertilizers and imported animal feed (e.g. Schröder and Neeteson, 2008). The need for P application limits in agriculture depends on the soil P status and the vulnerability of the soils for P leaching, which are not yet well known. Here we report on spatial variations in soil P status and on changes (1970 – 2009) in soil P status of farmers' fields in the Netherlands.

## Materials and methods

We used the soil database of BLGG AgroXpertus (BLGG.AgroXpertus.nl) with ~ 2 million records of soil P determinations of farmers' fields, to analyse spatial variations and changes over time in soil P status of grassland. Standard sampling depth for grassland was 0-5 cm until 2000 and 0-10 cm thereafter. The P-AI value was used as an indicator (Egnér *et al.*, 1960). P-AI is commonly expressed as mg P<sub>2</sub>O<sub>5</sub> per 100 g dry soil (note 1 mg P = 2.29 g P<sub>2</sub>O<sub>5</sub>). We assumed that the selected data from the database can be analysed as if it was a random sample, and that the errors in the estimation remain small enough to prevent grossly misleading conclusions. We tested the representativeness of our data statistically by



comparing the P values between ‘regular’ clients (farmers) and ‘new’ clients. Also, we tested the homogeneity of the datasets using a resampling procedure (Lemercier *et al.*, 2008).

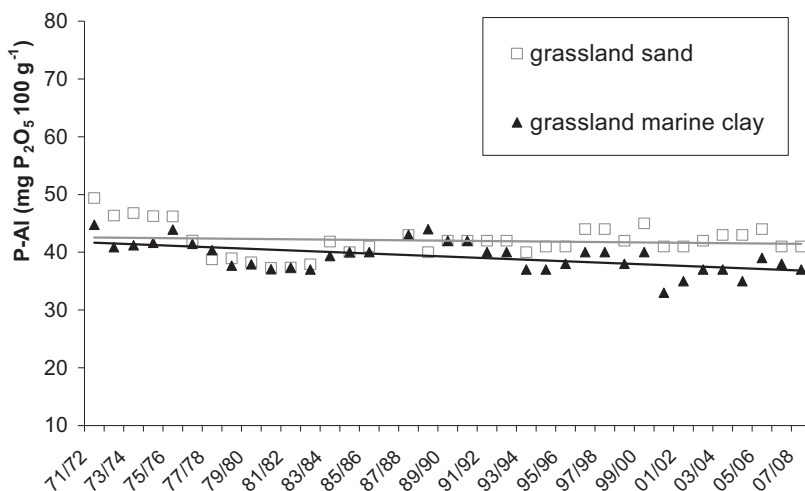

Figure 1. Changes in mean soil P status of grassland on sandy soil and marine clay soil in the Netherlands during 1970 – 2009 (soil sampling depth 0-5 cm till 2000, 0-10 cm thereafter).

## Results and discussion

The median P-AI values of grasslands on sand and clay soils ranged between 33 and 49 mg P<sub>2</sub>O<sub>5</sub> per 100 g soil in the period 1971–2000 (Figure 1). Median P-AI values of grassland on marine clay show a very small but significant ( $P < 0.05$ ) decline, and those on sandy soils remained stable. Mean differences between the periods 1984–1988 and 1996–2000 in median P-AI values of grassland were small. In 52% of the areas the median values changed less than 10%. In 34% of the areas there was an increase by more than 10%, and in 14% there was a decrease by more than 10%. Therefore, the manure policy from 1984 till 2000 seems to have had no influence on the median P status as yet.

The relatively small changes over time in median P-AI values and the ‘sufficient’ soil P status are surprising, given the large mean P surpluses (about 1200 kg P<sub>2</sub>O<sub>5</sub> ha<sup>-1</sup> in the last three decades) and the decreases in mean P surpluses in the period 1988 - present. One explanation for the relatively small change in soil P status over time is the steady leaching of P from the sampled top soil to the subsoil. Secondly, ploughing and reseeded of grassland have mixed the top soil with part of the subsoil and will have lowered the P status of the top soil. Thirdly, transformation of extractable soil P into non-extractable soil P may also explain the relative steadiness of the soil P status. Finally, there exists the possibility that farmers with high P soils do not request (so often) soil analyses anymore. This was indicated also in our test with ‘new’ clients: both on sandy soils and on marine clay soils the median P-AI was significantly ( $P < 0.01$ ) higher (~6, and ~ 2 P-AI units, respectively) on grasslands of new clients compared to the ‘regular’ clients.

Currently, the median soil P status of grassland is classified as ‘ample sufficient’, but with large variations (Figure 2). The median soil P status decreases in the order: sandy soils > peat soils > clay soils ≥ loess soils ( $P < 0.001$ ). Regions with high livestock density have higher soil P status than regions with arable farming only. Large differences between soil types and between regions in soil P status have been reported also, e.g. Vermeulen and Fey (1957). These differences are unlike the expectations based on the official P fertilization

recommendations, which are ‘designed’ to get all soils in the optimal range and to maintain that status. To comply with the objectives of the EU Nitrates Directive, accumulation of soil P beyond the agronomic range should stop, as it increases the vulnerability of the land for P leaching. In 2010, P application limits depending on soil P status have been implemented in the Netherlands; i.e., the higher the soil P status, the lower the allowed P application. Such limits also set constraints to manure application, and indirectly to livestock density.

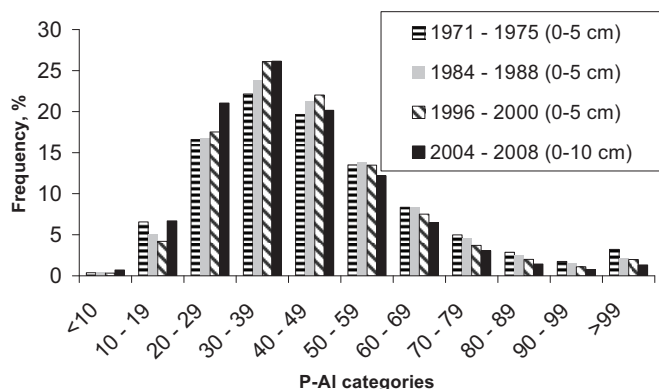

Figure 2. Frequency distribution of P-AI (mg P<sub>2</sub>O<sub>5</sub> per 100 g soil), grassland on marine clay soil in the Netherlands in 1971-1975, 1984-1988, 1996-2000, and 2004-2008 (note the change is soil sampling depth from 0-5 to 0-10 cm).

## Conclusion

The median soil P status of grassland has remained rather constant and in the agronomic sufficient (optimal) range during the last three to four decades. The manure policy from 1984 onwards has increasingly limited P application rates, but seems to have had no significant influence on median soil P status yet. Surprisingly, the differences between regions in median soil P status remained relatively large (see also Reijneveld *et al.*, 2010).

## References

- Egnér H., Riehm H. and Domingo W.R. (1960) Untersuchungen über die chemische Bodenanalyse als Grundlage für die Beurteilung des Nährstoffzustandes der Böden. II. Chemische Extraktionsmethoden zur Phosphor- und Kaliumbestimmung (in German). *Kunigl. Landbrukshögsk. Ann.* 26, 199-215. (Soil tests as basis of establishing soil nutrient status II Chemical extraction methods for P and K).
- Ketterings Q.M., Kahabka J.E. and Reid W.S. (2005) Trends in phosphorus fertility of New York agricultural land. *Journal of Soil and Water Conservation* 60, 10 – 20.
- Lemercier B., Gaudin L., Walter C., Arousseau P., Schwartz C., Saby N.P.A., Follain S. and Abrassart J. (2008) Soil phosphorus monitoring at the regional level by means of a soil test database. *Soil Use and Management* 24, 131-138.
- Schröder J.J. and Neeteson J.J. (2008) Nutrient management regulations in the Netherlands. *Geoderma* 144, 418-425.
- Sims J.T., Edwards A.C., Schoumans O.F. and Simard R.R. (2000) Integrating soil phosphorus testing into environmentally based agricultural management practices. *Journal of Environmental Quality* 29, 60-71.
- Vermeulen F.H.B. and Fey P.J. (1957) De fosfaattoestand van bouwland en grasland in Nederland (The phosphate status of arable land and grassland in the Netherlands, in Dutch). *Verlagen van landbouwkundige onderzoekingen* 631.416.2 (492) No. 63.7.
- Reijneveld J.A., Ehlert P.A.I., Termorshuizen A.J. and Oenema O (2010) Changes in soil phosphorus status of agricultural land in the Netherlands in the 20<sup>th</sup> century. *Soil Use and Management* (accepted).

# A comparison of different conversion techniques for the production of energy from permanent grasslands

Richter F. and Wachendorf M.

*Department of Grassland Science and Renewable Plant Resources, University of Kassel, Steinstraße 19, D-37213 Witzenhausen, Germany*

Corresponding author: frichter@uni-kassel.de

## Abstract

The integrated generation of solid fuel and biogas from biomass (IFBB) is aimed at an efficient conversion of biomass from semi-natural grassland into energy, which is otherwise problematic with conventional conversion techniques (hay combustion, anaerobic digestion), due to high contents of detrimental minerals and high contents of lignin. The objective of this study was to compare various conversion techniques (anaerobic whole-crop digestion [WCD], combustion of hay [CH] and IFBB) across a broad range of permanent grassland vegetations. Biomass from nine different grassland swards was conserved as silage which was directly used for WCD and separated according to the IFBB process into a press fluid for anaerobic digestion and a press cake for combustion. The press fluids obtained higher specific methane yields than the whole-crop silage. The press cakes showed significantly reduced concentrations of elements detrimental for combustion as compared to CH. The energy conversion efficiency of IFBB was higher compared to WCD and lower compared to CH. Differences between grassland communities in IFBB were marginal.

Keywords: IFBB, biogas, solid fuel, permanent grassland, energy conversion

## Introduction

The conservation of biodiversity of grasslands in Europe is endangered due to abandonment and also to increasing requirements for high forage quality. Little knowledge exists on how the utilization of biomass for energy production could contribute to conserve ecologically valuable habitats. The current conversion techniques for grassland biomass in practice are anaerobic digestion of whole-crop silage (WCD) for biogas production, and combustion of hay (CH) for heat production. However, if grasslands are managed for nature conservation interests, the biomass is harvested late in the year with high concentrations of lignocellulose, resulting in low digestibility of WCD. On the other hand, high concentrations of corrosive, ash-forming and emission-causing elements are detrimental for CH. The IFBB process is aimed at separating the biomass into a press cake (PC) for combustion, which is rich in lignocellulose and a press fluid (PF) for anaerobic digestion, which contains high concentrations of elements detrimental for combustion (Wachendorf *et al.*, 2009; Richter *et al.*, 2010). The objective of this study was to compare three conversion techniques (WCD, CH and IFBB) regarding biogas production (only IFBB and WCD), solid fuel quality (only IFBB and CH) and net energy yield per ha on nine typical semi-natural grasslands in Germany.

## Materials and method

Biomass from five montane hay meadows and four lowland grasslands was harvested from a first cut on single 25 m<sup>2</sup> plots without any replications, chopped and ensiled in 50 litre polyethylene barrels (Table 1). In the IFBB procedure, each silage was subjected to two treatments of hydrothermal conditioning (10 °C and 60 °C) and a subsequent mechanical dehydration with a screw press (type AV, Anhydro Ltd., Kassel, Germany) without any

replication. Anaerobic digestion experiments were conducted in batch fermenters with a fermentation time of 13 and 35 days for the PF and the whole-crop silage, respectively. The fresh biomass after harvest and the PC were analysed for K, Mg, Ca, Cl, S and P by X-ray fluorescence analysis and for C, H and N with an elemental analyser. Dry matter (DM) and ash concentration in fresh biomass, silage, PC and PF were determined after drying at 105 °C and ashing at 550 °C. The higher heating value (HHV) was calculated according to Friedl *et al.* (2005) and the ash softening temperature (AST) was calculated according to Hartmann (2001). Energy balance was calculated based on energy input values from Richter *et al.* (2010) and energy output based on observed methane yields for biogas production as well as HHV and DM yields for heat production from solid fuel. Proportional DM losses on the field and during storage were assumed to be 0.12 for WCD and IFBB and 0.25 for CH. The extent of waste heat utilization from the combined heat and power plant was assumed to be 0.25 in WCD and 1 in IFBB. ANOVA was performed with the nine grassland swards as replicates.

Table 1. Characteristics of permanent grassland swards

Grassland Sward	Location	Altitude [m a.s.l.]	Precip.† [mm]	Temp.‡ [°C]	Harvest date	DM yield [t ha <sup>-1</sup> ]
<i>Polygono-Trisetion</i>	Rhön	760-820	1070	6°C	19.07.2006	3.39
<i>Arrhenaterion</i> I	Black Forest	850-860	1520	6°C	17.07.2008	3.48
<i>Arrhenaterion</i> II	Black Forest	850-860	1520	6°C	17.07.2008	5.23
<i>Caricion fuscae</i>	Black Forest	850-860	1520	6°C	17.07.2008	4.66
<i>Filipendulion ulmariae</i>	Black Forest	850-860	1520	6°C	17.07.2008	8.17
<i>Arrhenaterion</i> III	Upper Rhine Valley	120-130	940	10°C	02.07.2008	4.10
<i>Glyceria maxima</i> swamp	Upper Rhine Valley	120-130	940	10°C	02.07.2008	7.11
<i>Phalaris arundinacea</i> fen	Upper Rhine Valley	120-130	940	10°C	02.07.2008	6.08
<i>Carex acuta</i> swamp	Upper Rhine Valley	120-130	940	10°C	02.07.2008	4.31

†Annual precipitation, ‡Mean annual temperature

## Results and discussion

Concentrations of the analysed compounds were significantly ( $P<0.05$ ) reduced in the IFBB press cakes compared to hay by up to 0.28, 0.91, 0.59, 0.92, 0.21 and 0.45 for XA, K, Mg, Cl, N and S, respectively (Table 2).

Table 2. Comparison of quality parameters between conventional biomass energy sources (hay and silage) and IFBB energy sources (press cake and press fluid) as means of nine different grassland swards.

	Unit†	Fresh biomass/hay	Press cake 10 °C	Press cake 60 °C
Crude ash (XA) in DM	g kg <sup>-1</sup>	72.38	53.53	52.39
Potassium (K) in DM	g kg <sup>-1</sup>	12.70	2.46	1.11
Magnesium (Mg) in DM	g kg <sup>-1</sup>	2.11	1.11	0.86
Chloride (Cl) in DM	g kg <sup>-1</sup>	3.33	0.55	0.27
Nitrogen (N) in DM	g kg <sup>-1</sup>	14.28	12.21	11.33
Sulphur (S) in DM	g kg <sup>-1</sup>	1.53	1.00	0.85
Higher heating value (HHV)	MJ kg <sup>-1</sup>	18.82	19.35	19.32
Ash softening temperature (AST)	°C	1158	1203	1224
	Unit†	Silage	Press fluid 10 °C	Press fluid 60 °C
Methane yield	L <sub>N</sub> kg <sup>-1</sup> VS	244.01	453.06	452.62
Degree of degradation		0.56	0.84	0.87

† VS, volatile solids

Reductions were higher after a hydrothermal conditioning at 60°C (IFBB<sub>60</sub>) compared to the 10°C treatment (IFBB<sub>10</sub>). The increase in AST from fresh biomass to IFBB press cakes was significant ( $P<0.05$ ) while for HHV it was not. Methane yield and degree of degradation of press fluids (453 L<sub>N</sub> kg<sup>-1</sup> VS and 0.84-0.87, respectively) were significantly ( $P<0.05$ )

higher compared to whole-crop silages (244 L<sub>N</sub> kg<sup>-1</sup> VS and 0.56, respectively). The average gross energy yield of the nine grassland swards was 27.1 MWh ha<sup>-1</sup> (Figure 1). The highest net energy yield (mean value ± standard error of mean in MWh ha<sup>-1</sup>) was obtained by CH (17.23 ± 1.88), followed by IFBB\_60 °C (13.19 ± 1.29), IFBB\_10 °C (11.26 ± 1.07) and WCD (3.30 ± 0.28). Thus, the conversion efficiency, as the ratio between net and gross energy yield, was 0.64, 0.49, 0.43 and 0.13 for CH, IFBB\_60 °C, IFBB\_10 °C and WCD, respectively.

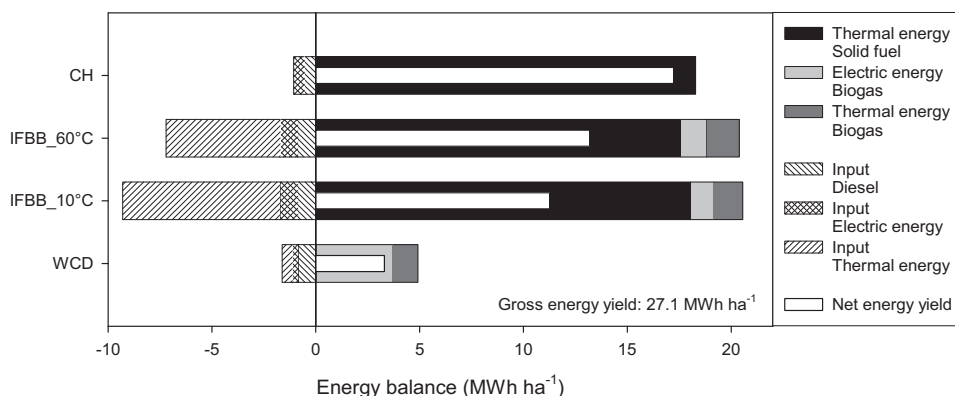

Figure 1. Net energy yields as balance of energy input and energy production of combustion of hay (CH), IFBB at two conditioning temperatures (10 °C and 60 °C) and anaerobic whole-crop digestion (WCD) as means of nine different grassland swards.

## Conclusion

Significantly higher specific methane yields were obtained from IFBB press fluids than from whole-crop silages. Concentrations of elements detrimental for combustion were significantly reduced in IFBB press cakes compared with concentrations in fresh biomass. Net energy yields of IFBB were in between those from hay combustion and anaerobic digestion of whole-crop silage. The 60 °C treatment resulted in a higher net energy yield than the 10 °C treatment and produced a total of 13.19 MWh ha<sup>-1</sup> as heat and electricity, on average, for the nine different permanent grassland swards.

## References

- Friedl A., Padouvas E., Rotter H. and Varmuza K. (2005) Prediction of heating values of biomass fuel from elemental composition. *Analytica Chimica Acta* 544, 191-198.
- Hartmann H. (2001) Brennstoffzusammensetzung und -eigenschaften (Composition and characteristics of fuels). In: Kaltschmitt M. and Hartmann H. (eds) *Energie aus Biomasse: Grundlagen, Techniken und Verfahren*, Springer-Verlag, Berlin, Germany, pp. 248-272.
- Richter F., Fricke T. and Wachendorf M. (2010) Utilization of semi-natural grassland through integrated generation of solid fuel and biogas from biomass. III. Effects of hydrothermal conditioning and mechanical dehydration on solid fuel properties and on energy and greenhouse gas balances. *Grass and Forage Science* 65 (185-199).
- Wachendorf M., Richter F., Fricke T., Graß R. and Neff R. (2009) Utilization of semi-natural grassland through integrated generation of solid fuel and biogas from biomass. I. Effects of hydrothermal conditioning and mechanical dehydration on mass flows of organic and mineral plant compounds, and nutrient balances. *Grass and Forage Science* 64, 132-143.

## Improvement of permanent grasslands in NE Romania

Samuil C., Vintu V., Iacob T. and Popovici I.C.

University of Agricultural Sciences and Veterinary Medicine, Aleea M. Sadoveanu 3, Iasi, Romania, 700490, [www.univagro-iasi.ro](http://www.univagro-iasi.ro)

Corresponding author: [csamuil@uaiasi.ro](mailto:csamuil@uaiasi.ro)

### Abstract

The total pastoral area of Romania, about 4.9 million ha, of which 3.4 million ha is grassland and 1.5 million ha is hay meadow, is an important source of fodder for feeding livestock. This experience was carried out on a degraded pastureland with *Festuca valesiaca* L., 120 m a.s.l., in the forest-steppe zone. In the experiment we investigated the influence of organic and mineral fertilizers, applied at rates of 10-40 Mg ha<sup>-1</sup> on the background of N50-100 kg ha<sup>-1</sup> P36-72 kg ha<sup>-1</sup>, on the production and content of crude protein, cellulose, phosphorus and ash. The *Festuca valesiaca* L. pasturelands from the Romania's forest steppe react positively to medium-level inputs of organic and mineral fertilization, through the improvement of botanical composition and structure and through increasing the crude protein content of the feed. The best results were obtained at 20-40 t ha<sup>-1</sup> manure applied at 2-3 years intervals, associated with annual mineral fertilizer applications of N 50-100 and P 36-72 kg ha<sup>-1</sup>.

Keywords: permanent grassland, manure, yield, food quality

### Introduction

The diminution of the productive potential of the permanent grasslands of north-eastern Romania, which occupy over 70% of the area, on sloping fields, is being caused by erosion, to which unfavourable climatic conditions and unsuitable management may be added (Samuil *et al.*, 2008). Increased productive potential of these grasslands can be done by fertilization with different rates and types of organic and mineral fertilizers. The investigations carried out until now have shown the positive effects of manure, combined with moderate rates of mineral fertilizers, which are applied on grasslands. The permanent grasslands from north-eastern Romania, situated on soils with low natural fertility, are of low productivity and have an unsuitable botanical composition (Britaňák *et al.*, 2008). The main means for improving these grasslands consists of adjusting soil fertility, changing the dominance in the vegetation canopy and through good management (Ryser *et al.* 2001). This paper presents the results obtained during 2006-2009, on *Festuca valesiaca* L. permanent grassland, improved by fertilization with different rates and combinations of organic and mineral fertilizers.

### Materials and methods

The trial was carried out on *F. valesiaca* L. permanent grassland with a low plant composition, situated at 107 m a.s.l., on a 10% slope. The soil was cambic chernozem, weakly leached, with a clayey texture and a pH of 6.5-6.7 at 0-30 cm depth. The weather conditions during the experimental period of 2006-09 were characterized by mean temperatures of 9.5°C and mean annual rainfalls of 552 mm. It should also be noted that at Ezăreni – Iași, the year 2007 was extremely dry and weather conditions in that year were completely unfavourable for good development of the vegetation on grasslands. The experiments are single factor type, laid out in randomized blocks, with four replications and nine experimental variants:

V<sub>1</sub>-unfertilized control;

V<sub>2</sub>-10 Mg ha<sup>-1</sup> cattle manure applied every year + N 50 kg ha<sup>-1</sup> + P 36 kg ha<sup>-1</sup>;

V<sub>3</sub>-10 Mg ha<sup>-1</sup> cattle manure applied every year + N 50 + 50 kg ha<sup>-1</sup> + P 7 2 kg ha<sup>-1</sup>;

V<sub>4</sub>-20 Mg ha<sup>-1</sup> cattle manure applied every 2 years + N 50 kg ha<sup>-1</sup> + P 36 kg ha<sup>-1</sup>;  
V<sub>5</sub>-20 Mg ha<sup>-1</sup> cattle manure applied every 3 years + N 50 + 50 kg ha<sup>-1</sup> + P 72 kg ha<sup>-1</sup>;  
V<sub>6</sub>-30 Mg ha<sup>-1</sup> cattle manure applied every 3 years + N 50 kg ha<sup>-1</sup> + P 36 kg ha<sup>-1</sup>;  
V<sub>7</sub>-30 Mg ha<sup>-1</sup> cattle manure applied every 3 years + N 50+50 kg ha<sup>-1</sup> + P 72 kg ha<sup>-1</sup>;  
V<sub>8</sub>-40 Mg ha<sup>-1</sup> cattle manure applied every 3 years + N 50 kg ha<sup>-1</sup> + P 36 kg ha<sup>-1</sup>;  
V<sub>9</sub>-40 Mg ha<sup>-1</sup> cattle manure applied every 3 years + N 50+50 kg ha<sup>-1</sup> + P 72 kg ha<sup>-1</sup>  
(N = nitrogen; P = phosphorus). Harvesting was carried out at the ear formation stage of dominant grasses, and yield was expressed in dry matter (DM). The changes that took place in the structure of canopy were determined gravimetrically.

Table 1 Influence of fertilization on dry matter production (Mg ha<sup>-1</sup>)

Fertilization variant	Ezăreni – Iași				Average
	2006	2007	2008	2009	
Unfertilized control	2.3	1.5	6.2	2.0	3.0
10 t ha <sup>-1</sup> cattle manure applied every year+N <sub>50</sub> P <sub>36</sub>	3.4	2.2	8.7	2.6	4.2*
10 t ha <sup>-1</sup> cattle manure applied every year+N <sub>50</sub> + <sub>50</sub> P <sub>72</sub>	3.7	2.4	9.4	2.7	4.6**
20 t ha <sup>-1</sup> cattle manure applied every 2 years+N <sub>50</sub> P <sub>36</sub>	3.5	2.3	9.0	2.4	4.3*
20 t ha <sup>-1</sup> cattle manure applied every 3 years+N <sub>50</sub> + <sub>50</sub> P <sub>72</sub>	3.9	2.5	10.3	2.9	4.9***
30 t ha <sup>-1</sup> cattle manure applied every 3 years+N <sub>50</sub> P <sub>36</sub>	3.9	2.6	8.4	2.8	4.4**
30 t ha <sup>-1</sup> cattle manure applied every 3 years+N <sub>50</sub> + <sub>50</sub> P <sub>72</sub>	4.1	2.6	10.3	3.1	5.0***
40 t ha <sup>-1</sup> cattle manure applied every 3 years+N <sub>50</sub> P <sub>36</sub>	3.9	2.3	9.3	2.8	4.6**
40 t ha <sup>-1</sup> cattle manure applied every 3 years+N <sub>50</sub> + <sub>50</sub> P <sub>72</sub>	4.7	2.6	11.3	3.6	5.6***
Average	3.7	2.4	9.2	2.8	4.5

\*= $P \leq 0.05$ ; \*\*= $P \leq 0.01$ ; \*\*\*= $P \leq 0.001$ ; NS= not significant

Table 2 Influence of fertilization on the canopy structure (%)

Fertilization variant	Grasses		Legumes		Others	
	2006	2009	2006	2009	2006	2009
Unfertilized control	69	49	10	20	21	31
10 t ha <sup>-1</sup> cattle manure applied every year+N <sub>50</sub> P <sub>36</sub>	76	36	13	25	11	39
10 t ha <sup>-1</sup> manure applied every year+N <sub>50</sub> + <sub>50</sub> P <sub>72</sub>	59	38	16	21	25	41
20 t ha <sup>-1</sup> cattle manure applied every 2 years+N <sub>50</sub> P <sub>36</sub>	70	37	11	28	19	35
20 t ha <sup>-1</sup> cattle manure applied every 3 years+N <sub>50</sub> + <sub>50</sub> P <sub>72</sub>	67	38	15	27	18	35
30 t ha <sup>-1</sup> cattle manure applied every 3 years+N <sub>50</sub> P <sub>36</sub>	62	37	11	28	27	35
30 t ha <sup>-1</sup> cattle manure applied every 3 years+N <sub>50</sub> + <sub>50</sub> P <sub>72</sub>	68	38	16	28	16	34
40 t ha <sup>-1</sup> cattle manure applied every 3 years+N <sub>50</sub> P <sub>36</sub>	71	34	12	27	17	39
40 t ha <sup>-1</sup> cattle manure applied every 3 years+N <sub>50</sub> + <sub>50</sub> P <sub>72</sub>	69	36	11	26	20	38
Average	68	38	13	26	19	36

Table 3 Influence of fertilization on the chemical composition of dry matter(g kg<sup>-1</sup>)

Fertilization variant	RA	CP	Fats	NDF	ADF	OM	ESN
Unfertilized control	78.2	120	25.1	672	406	832	343
10 Mg ha <sup>-1</sup> cattle manure applied every year+N <sub>50</sub> P <sub>36</sub>	96.1	128	28.1	625	379	809	344
10 Mg ha <sup>-1</sup> manure applied every year+N <sub>50</sub> + <sub>50</sub> P <sub>72</sub>	84.3	133	32.7	660	399	822	334
20 Mg ha <sup>-1</sup> cattle manure applied every 2 years+N <sub>50</sub> P <sub>36</sub>	79.7	127	30.3	692	390	824	333
20 Mg ha <sup>-1</sup> cattle manure applied every 3 years+N <sub>50</sub> + <sub>50</sub> P <sub>72</sub>	89.8	136	30.3	669	402	819	281
30 Mg ha <sup>-1</sup> cattle manure applied every 3 years+N <sub>50</sub> P <sub>36</sub>	84.4	134	31.2	688	390	822	274
30 Mg ha <sup>-1</sup> cattle manure applied every 3 years+N <sub>50</sub> + <sub>50</sub> P <sub>72</sub>	89.2	128	28.8	647	390	813	329
40 Mg ha <sup>-1</sup> cattle manure applied every 3 years+N <sub>50</sub> P <sub>36</sub>	98.0	128	34.6	653	387	804	269
40 Mg ha <sup>-1</sup> cattle manure applied every 3 years+N <sub>50</sub> + <sub>50</sub> P <sub>72</sub>	96.2	133	29.8	611	370	800	282

## Results and discussion

The DM yields were influenced very strongly by climatic conditions, type and level of organic and mineral fertilization. Analysing the production data, one may notice that in 2006, DM ranged from 2.3 Mg ha<sup>-1</sup> for the unfertilized control to 4.7 Mg ha<sup>-1</sup> under fertilization



with 40 Mg ha<sup>-1</sup> cattle manure, applied every 3 years + N50+50 kg ha<sup>-1</sup>+P72 kg ha<sup>-1</sup> (Table 1). In 2007, the vegetation of permanent grasslands was highly affected by the long-term drought that affected the testing area of Ezăreni. Therefore, the productivity was greatly diminished, resulting in a very low effect of fertilization on production. There was a uniformity of yields, irrespective of the fertilization level. The yields obtained in 2008 were higher than those obtained in the previous years. Analysing the mean yields, we found that their augmentation was due to the increase in the applied manure rate and, especially, to the increase in the rate of mineral fertilizers. The highest yields were obtained at the fertilization with 40 Mg ha<sup>-1</sup> cattle manure, applied every 3 years + N50 + 50 kg ha<sup>-1</sup> + P 72 kg ha<sup>-1</sup>.

In 2009, the analysis of the canopy structure has shown that the mean recorded values of the presence percentage were: 38% for grasses, 26% for legumes and 36% for other species (Table 2). The most important changes were found in the plants belonging to the 'various' group, which showed significant increases at the same time with the increase in the applied manure rate. In *F. valesiaca* grassland of Ezăreni, 45 species were recorded, of which six species were grasses, ten species were legumes and 29 species were 'other' species. The species that were found at high percentages were: *Festuca valesiaca* (39%), *Agropyron repens* (8%), *Bromus commutatus* (5%), *Lotus corniculatus* (7%), *Medicago falcata* (3%), *Centaurea jacea* (8%), *Daucus carota* (6%), *Achillea setacea* (4%) and *Plantago media* (3%). Table 3 shows the values of crude protein (CP), raw ash (RA), Neutral Detergent Fibre (NDF), Acid Detergent Fibre (ADF), organic matter (OM) and extractive substances without nitrogen (ESN). The fertilization of *F. valesiaca* grassland provides a means of increasing the crude protein content in DM up to 15.9 g kg<sup>-1</sup>, as compared with the unfertilized control.

## Conclusions

The obtained DM yields were influenced by weather conditions, and by type and level of organic and mineral fertilization. The highest yields were obtained at fertilization with 40 Mg ha<sup>-1</sup> cattle manure, applied every 3 years + N50+50 kg ha<sup>-1</sup> + P72 kg ha<sup>-1</sup>. Results have shown the positive effects of fertilization on productivity, botanical composition and canopy structure of the studied permanent grassland. On *Festuca valesiaca* grassland, the tested fertilization variants resulted in improved fodder quality, by increasing the content of CP in DM from 120 to 136 g kg<sup>-1</sup>.

## References

- Britaňák N., Hanses L. and Ilavská I. (2008) Alternative use of different grassland types: I Influence of mowing on botanical composition and dry matter production. *Grassland Science in Europe 14 (Proceedings of the 15<sup>th</sup> Symposium of the European Grassland Federation, Brno)*, pp 68-71.
- Ryser J., Walther U. and Flisch R. (2001) Données de base pour la fumure des grandes cultures et des herbages. *Revue suisse d'Agriculture* 33,1-80.
- Samuil C. Vintu V., Iacob T., Saghin Gh. and Trofin A. (2008) Management of permanent grasslands in the NE Romania. *Grassland Science in Europe 14 (Proceedings of the 15<sup>th</sup> Symposium of the European Grassland Federation, Brno)*, pp 234-237.

## Effects of different methods of meadow maintenance and non-tillage seeding on yield and plant composition

Sauter J. and Latsch R.

*Agroscope Reckenholz-Tänikon Research Station ART, CH-8356 Ettenhausen, Switzerland*

Corresponding author: joachim.sauter@art.admin.ch

### Abstract

This paper gives results from different alternative methods of meadow maintenance in spring, coupled with and without seeding of valuable plants. The following methods were used: grass-harrow technique, comb weeder, meadow aerator and a scarifier used mainly in golf-course maintenance. After two years of treatment no significant yield differences occurred. The botanical composition of all seeded areas tended to higher amounts of *Lolium perenne* than the unseeded areas. No significant interactions were found in this relationship, nor were there interactions between the different techniques used.

Keywords: *Lolium perenne*, ryegrass, overseeding, aerator, comb weeder, scarifier, meadow

### Introduction

To produce high-quality fodder for dairy husbandry, grass is mown before flowering. At this stage grasses have few energy reserves for fresh resprouting and so are particularly weak (Neff, 2006). The seed potential of valuable grasses such as English ryegrass (*Lolium perenne*) in the soil is also reduced, as no new seed is produced. Unwanted grasses and weeds, which propagate by stolons, e.g. roughstalk meadowgrass (*Poa trivialis*) and creeping buttercup (*Ranunculus repens*), then spread. Seeding with and without tillage is proposed as a corrective measure. Previous studies showed that even successful reseeded swards lose their effectiveness after three to four years and therefore seeding needs to be repeated (Frick and Rühlmann, 1991). Whereas Frick at least achieved short-term success, Ising *et al.* (2006) and Elsässer (2007) reported no success after a one-off treatment using different grassland maintenance tools. Huguenin-Elie *et al.* (2006a, 2006b) was only successful in three out of seven overseedings with various cultivation methods. He found no difference between the sowing methods used to deposit the seed in or on the soil. Possible causes he cited for failure were weather, state of competition and fertiliser application on the site. Techow (2008) therefore proposed no-till reseeding at regular intervals, as this could reduce the risk of bad weather influence during the sowing year. In contrast to Frick, he favours spring (March) as the ideal sowing time. Manufacturers advertise that the aeration of meadows should have positive effects on plant populations and growth. Measurements from Ireland (Fortune *et al.*, 1999) showed that the use of a meadow aerator produced no significant increase in yield. To date no measurements are available for the equipment in combination with seeding. The aim of this project is to investigate the effect of maintenance measures by different machines on forage yield and botanical composition, the machines being used with and without additional seeding.

### Methods

The efficacy of the methods selected was checked on two different sites in Tänikon (47°28'47.12 N / 8°54'25.52 E) and Wagen (47°13'40.26 N / 8°52'43.63 E) in combination with and without seeding. Tänikon is situated at an altitude of 535 m and has an average precipitation of 1200 mm y<sup>-1</sup>. Wagen is at 442 m a.s.l. and has an average precipitation of

1400 mm y<sup>-1</sup>. In spring of 2008 and 2009 the machines were used on both sites, on three replications each. Within these areas a split-plot design was realised in which each plot was either seeded or not and each subplot (12 m x 6 m) was treated with a different machine. The following variants listed in Table 1 were investigated in detail.

Table 1: Variants implemented and manufacturers of the machines used

Machine	Designation		Manufacturer and type of machine used
	without seeding	with seeding	
Control (non treatment)	C	C +	
Grass Harrow	H	H +	Otto Menke, D 59494 Soest, Type 5 m
Meadow Aerator	A	A +	Gregoire Agri, F-44390 Saffre, Type Ap312
Comp Weeder	W	W +	Hatzenbichler, A-9433 St. Andrä, Type 3 m
Scarifier	S	S +	Zappator I-48017 Conselice, Type 150 Syntesis

All the variants with the exception of C and C+ (non treatment) were rolled after treatment. Opitz von Boberfeld (1984) suggests an amount of seed of 20 kg ha<sup>-1</sup> for a one-off treatment. In this investigation the amount of sown seeds was reduced to 10 kg ha<sup>-1</sup> of U440 overseeding mixture (10% white clover, 30% smooth meadow grass and 60% English ryegrass), because of the annual repetition of seeding. The seeds were blown onto the surface with the seeder Air Control 8 from Hatzenbichler before treatment, except the variant with scarifier, which was seeded afterwards. Yields of five cuts per year on each plot were summarized and the botanical composition of individual plots was recorded twice per year by a population assessment according to the method of Dietl (1995). Statistical analysis was based on a linear mixed effects model calculated over all sites and years with software S-Plus®7.0

## Results and discussion

Figure 1 shows the annual dry matter yield of both sites. Due to the dry summer of 2009 the yield on the Wagen site was lower than in 2008 across all machine variants. On the Tänikon site the 2009 yield was somewhat higher than the previous year, as water is not the limiting factor on this site. It could be shown that treatments had no influence on DM yield ( $F_{4.92} = 1.76$ ,  $P = 0.14$ ). A trend in yield increase of 3.23 dt ha<sup>-1</sup> ( $F_{1.11} = 4.44$ ,  $P = 0.06$ ) was observed for seeding. Neither treatment nor seeding made any significant change to the percentage of *Lolium perenne* in the plant population (tillage:  $F_{4.92} = 1.12$   $P = 0.35$ , seeding:  $F_{1.11} = 2.09$ ,  $P = 0.18$ ). It was shown, however, that in 2009 on average the percentage yield of *Lolium perenne* on all plots decreased by 6.55% as compared to 2008. In 2009, in turn, the percentage yield of *Poa trivialis* across all the plots increased by 9.54% ( $F_{1.9} = 11.76$ ,  $P = 0.075$ ) The interaction between seeding and tillage shows that due to seeding the percentage of *Poa trivialis* in the plots treated with seed was slightly lower than in the unseeded plots ( $F_{4.88} = 2.65$ ,  $P = 0.04$ ). Table 2 shows the mean values of the percentage yield of *Lolium perenne* and *Poa trivialis* on both sites and in both years.

Table 2: Yield of *Lolium perenne* and *Poa trivialis* in seeded and unseeded variants

Site	Method	<i>Lolium perenne</i>		<i>Poa trivialis</i>	
		2008	2009	2008	2009
Tänikon	without seeding	17 %	17 %	22 %	23 %
	with seeding	20 %	18 %	18 %	20 %
Wagen	without seeding	21 %	14 %	14 %	34 %
	with seeding	21 %	15 %	15 %	30 %

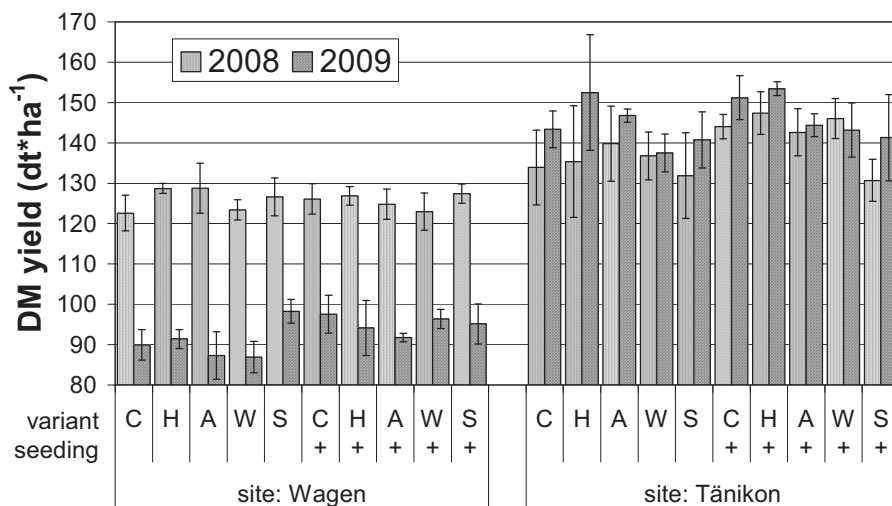

Figure 1: Average yield (with standard deviation) at Tänikon and Wagen in the years 2008 and 2009

## Conclusions

It is very difficult to achieve a targeted change in botanical composition by means of maintenance measures or overseeding. In Tänikon a new approach is currently being investigated in a four-year trial, using minimal annual interventions to produce a change in the plant population. After two years of trials the interim balance sheet still shows that the mechanical variants used have had no significant effect. It was possible to check the spread of *Poa trivialis* slightly by sowing seed. It is anticipated that stronger interactions between machine variants and seeding will appear in the coming trial years.

## References

- Dietl W. (1995) Wandel der Wiesenvegetation im Schweizer Mittelland. *Zeitschrift für Ökologie und Naturschutz* 4, 239–249.
- Elsässer M. and Grünenwald C. (2007) Nachsaat von Dauergrünland mit unterschiedlichen Methoden. In: N. Wrangé and J. Isselstein (eds) 51. Jahrestagung der AGGF - Neue Funktionen des Grünlands: Ökosystem, Energie, Erholung. *Mitteilungen der Arbeitsgemeinschaft Grünland und Futterbau*, Göttingen, 14–18.
- Fortune R. A., Forristal P. D. and Kelly F. (1999) Effects of soil aeration in minimising/alleviating soil compaction and sward damage in grassland. *Research Report* 15, Carlow, 16.
- Frick R. and Rühlmann M. (1991) Witterung und Nutzung entscheiden über Erfolg. *FAT-Bericht* 408, 11.
- Huguenin-Elie O., Stutz C. J., Gago R., Kessler W. and Lüscher A. (2006a) Influence of the seeder type and the initial sward composition on the success of overseeding. *Grassland Science in Europe* 11, 137–139.
- Huguenin-Elie O., Stutz C. J., Lüscher A. and Gago R. (2006b) Wiesenverbesserung durch Übersaat. *AgrarForschung* 13 (10), 424–429.
- Ising W., Kivelitz H. and Lütke N. (2006) Gemeine Rispe - was wirklich hilft. *top agrar* 4/2006, 92–97.
- Neff R. (2006) So gelingt die Nachsaat in Mittelgebirgslagen. *top agrar* 5/2006, 60–62.
- Opitz von Boberfeld W. (1984) Zur Saatmenge bei maschineller Nachsaat unter variierenden Bedingungen. *Zeitschrift für Acker- und Pflanzenbau* 153 4, 307–314.
- Techow E. (2008) Nachsaat - große Wirkung zum kleinen Preis. *top agrar* 3/2008, 94–96.

# Suitability of perennial grasses and legume-grass-mixtures for methane production

Schmaler K., Weiß K. and Krause R.

*Humboldt-University, Faculty of Agriculture and Horticulture, D-10099 Berlin, Germany*

Corresponding author: [Katrin.Schmaler@agrar.hu-berlin.de](mailto:Katrin.Schmaler@agrar.hu-berlin.de)

## Abstract

The aim of the investigation was to evaluate the suitability of perennial forage crops for methane production. Therefore, field grasses and legume-grass-mixtures grown under water limited conditions of the North-Eastern German Plain were tested for dry matter yield (8.3 – 26.0 Mg ha<sup>-1</sup>) and potential methane yield (2108 – 6323 m<sup>3</sup> ha<sup>-1</sup> CH<sub>4</sub>). Furthermore, the ensiling potentials of grass and legume-grass mixtures were estimated by analysis of dry matter content and water-soluble carbohydrates / buffering capacity ratio as well as nitrate content. All forage crops showed particularly low contents of nitrate up to 4.4 g kg<sup>-1</sup> NO<sub>3</sub> in dry matter and were therefore moderately difficult or difficult to ensile. For production of anaerobically stable and butyric acid-free silages it is necessary to combine wilting with the use of silage additives.

Keywords: grass, legume-grass-mixtures, dry matter yield, methane yield, ensiling potential.

## Introduction

The objective of this paper is to evaluate dry matter yield, potential methane yield and fermentability of perennial forage crops. The crop production for energy purposes in the North-Eastern German Plain is restricted by water supply. In other German regions (precipitation > 600 mm per year) *Lolium* species can result in potential methane yield per hectare similar to maize which is recommended for biogas production (Vetter *et al.*, 2009).

The production of anaerobically stable, butyric acid-free silages can be predicted by using the parameters fermentability and fermentability coefficient. A model was proposed for predicting fermentability for forages which are low in nitrate or nitrate-free, which considers the minimum nitrate content and the content of clostridia spores (Kaiser *et al.*, 2002; Kaiser and Weiß, 2007).

## Materials and methods

Split block designed field trials with four replicates were run at the site of Berge (Land Brandenburg; precipitation of 502 mm per year). The cutting management at two levels (early first cut: inflorescences just visible followed by four to five harvests per year; late first cut: at early flowering stage followed by three to four harvests per year) was randomized in strips across six forage mixtures (Table 1). The N fertilization of grass mixtures was 240 and 190 kg ha<sup>-1</sup> at first and second level of cutting management, respectively. All legume-grass mixtures were not fertilized with nitrogen. The precipitation sum from May to September was 184, 526 and 231 mm in 2006, 2007 and 2008, respectively.

The potential methane yield was calculated using dry matter yield and specific methane yield (Weiland, 2001). The contents of dry matter (DM), water-soluble carbohydrates (WSC) and nitrate as well as the buffering capacity (BC) were analysed in 2007. The fermentability coefficient (FC) was calculated using  $FC = DM (\%) + 8 WSC/BC$ . Threshold values of ensiling material based on the minimum dry matter content (DM<sub>min</sub>) were estimated using the model  $DM_{min} = 680 - 64 (g NO_3 \text{ per kg DM}) - 71 WSC / BC$  (Kaiser and Weiß, 2007).

Table 1. Forage crops (1-6) and sowing rates.

Forage crops	Composition	Sowing rate kg ha <sup>-1</sup>
1 Grass mixture	<i>Festulolium/Lolium multiflorum</i>	15/20
2 Grass mixture	<i>Lolium perenne/L. x boucheanum /L. multiflorum</i>	15/10/10
3 Red clover/grass	<i>Trifolium pratense/Lolium perenne/L. x boucheanum /L. multiflorum</i>	10/10/7.5/7.5
4 Red clover/grass	<i>Trifolium pratense/Festulolium/Phleum pratense</i>	12/8/2
5 Alfalfa/grass	<i>Medicago varia/Festulolium/Phleum pratense</i>	18/8/2
6 Alfalfa/red clover/grass	<i>Medicago varia/Trifolium pratense/Festulolium/Phleum pratense</i>	12/2/8/2

## Results and discussion

Alfalfa-grass mixtures exhibited a significantly higher annual DM yield and potential methane yield than the pure grass mixtures if a late first cut was applied (Table 2). This result was explained by advantages of alfalfa-grass mixtures in persistence, winter hardiness and drought tolerance compared with *Lolium* species. The two- to three-year-old alfalfa-grass mixtures showed a potential methane yield similar to maize (Schmaler and Neubert, 2009). An early cutting to improve forage quality resulted in a lower annual DM yield of alfalfa-grass mixtures. Although up to 240 kg ha<sup>-1</sup> of nitrogen were used, most primary growths of forage crops were virtually free of nitrate (< 1 g kg<sup>-1</sup> NO<sub>3</sub> in DM), whereas all regrowths contained higher amounts but could still be considered as low in nitrate (< 4.4 g kg<sup>-1</sup> NO<sub>3</sub> in DM). With the exception of primary grass growths all forages had a fermentability coefficient of lower than 45 and were therefore moderately difficult or difficult to ensile (Table 3). A minimum DM content of legume-grass mixtures between 448 and 572 g kg<sup>-1</sup> was determined to prevent silage from butyric acid production (Table 3). Thus, the required wilting degree is higher than that which is recommended from the technological point of view. Therefore a high silage quality cannot be ensured by wilting only. This finding is of particular practical importance since it applies to the majority of grass and legume crops. For nitrate-free crops it is recommended to combine rapid wilting to 350 – 400 g kg<sup>-1</sup> DM content with the use of biological silage additives. Up to 300 g kg<sup>-1</sup> DM content, the use of a directly acting chemical silage additive which inhibits clostridia (nitrite-containing products) is necessary, whereas above 300 – 350 g kg<sup>-1</sup> DM content inoculants can be used for rapid acidification (Kaiser *et al.*, 2002).

Table 2. Annual dry matter yield and potential methane yield of forage crops at different stand ages from 2006 to 2008. (Within columns, values followed by the same letters are not significantly different at  $\alpha < 0.05$  of Newman-Keuls test).

Cutting management Forage crops	Dry matter yield (Mg ha <sup>-1</sup> )			Potential methane yield (m <sup>3</sup> ha <sup>-1</sup> )		
	1-year-old	2-year-old	3-year-old	1-year-old	2-year-old	3-year-old
Early first cut; 4 – 5 harvests						
1 Grass mixture	9.7 <sup>a</sup>	19.1 <sup>b</sup>	12.5 <sup>a</sup>	2654 <sup>bc</sup>	5308 <sup>b</sup>	3562 <sup>a</sup>
2 Grass mixture	9.4 <sup>a</sup>	16.8 <sup>a</sup>	11.4 <sup>a</sup>	2571 <sup>b</sup>	4596 <sup>a</sup>	3223 <sup>a</sup>
3 Red clover/grass	8.3 <sup>a</sup>	20.6 <sup>b</sup>	18.5 <sup>b</sup>	2108 <sup>a</sup>	5159 <sup>b</sup>	4682 <sup>b</sup>
4 Red clover/grass	11.5 <sup>b</sup>	21.0 <sup>bc</sup>	19.1 <sup>b</sup>	2962 <sup>cd</sup>	5239 <sup>b</sup>	4830 <sup>b</sup>
5 Alfalfa/grass	12.0 <sup>b</sup>	23.5 <sup>c</sup>	20.8 <sup>bc</sup>	2944 <sup>cd</sup>	5686 <sup>bc</sup>	5174 <sup>bc</sup>
6 Alfalfa/red clover/grass	13.0 <sup>c</sup>	22.7 <sup>c</sup>	20.8 <sup>bc</sup>	3204 <sup>d</sup>	5473 <sup>b</sup>	5210 <sup>bc</sup>
Late first cut; 3 – 4 harvests						
1 Grass mixture	8.9 <sup>a</sup>	19.6 <sup>b</sup>	12.7 <sup>a</sup>	2456 <sup>b</sup>	5355 <sup>b</sup>	3645 <sup>a</sup>
2 Grass mixture	8.7 <sup>a</sup>	16.9 <sup>a</sup>	11.9 <sup>a</sup>	2369 <sup>b</sup>	4579 <sup>a</sup>	3400 <sup>a</sup>
3 Red clover/grass	11.8 <sup>b</sup>	23.0 <sup>c</sup>	19.5 <sup>b</sup>	2936 <sup>cd</sup>	5679 <sup>bc</sup>	4916 <sup>b</sup>
4 Red clover/grass	14.2 <sup>d</sup>	23.4 <sup>c</sup>	19.2 <sup>b</sup>	3577 <sup>e</sup>	5738 <sup>bc</sup>	4830 <sup>b</sup>
5 Alfalfa/grass	16.6 <sup>c</sup>	26.0 <sup>d</sup>	22.9 <sup>d</sup>	4139 <sup>f</sup>	6323 <sup>c</sup>	5714 <sup>c</sup>
6 Alfalfa/red clover/grass	16.0 <sup>c</sup>	25.6 <sup>d</sup>	22.7 <sup>d</sup>	3950 <sup>f</sup>	6272 <sup>c</sup>	5637 <sup>c</sup>

Table 3. Chemical composition in dry matter and fermentability of 2-year-old forage crops at primary growth.

Cutting management Forage crops	DM content  g kg <sup>-1</sup>	Water-soluble carbohydrates (WSC)  g kg <sup>-1</sup>	Buffering capacity (BC)  g of lactic acid per kg	Ratio WSC/ BC	FC	Nitrate content  g kg <sup>-1</sup>	DM <sub>min</sub> content  g kg <sup>-1</sup>
Early first cut							
1 Grass mixture	209	299	50	5.9	68	0.06	257
2 Grass mixture	219	296	55	5.4	65	0.35	274
3 Red clover/grass	185	192	63	3.0	43	0.30	448
4 Red clover/grass	177	176	66	2.7	39	0.28	470
5 Alfalfa/grass	163	75	84	0.9	24	0.78	566
6 Alfalfa/red clover/grass	160	77	85	0.9	23	0.69	572
Late first cut							
1 Grass mixture	238	208	51	4.1	57	0.38	365
2 Grass mixture	227	219	49	4.5	59	0.00	361
3 Red clover/grass	212	169	58	2.9	44	0.14	465
4 Red clover/grass	190	173	66	2.6	40	0.05	492
5 Alfalfa/grass	192	47	82	0.6	24	2.18	498
6 Alfalfa/red clover/grass	199	64	77	0.8	26	1.60	521

## Conclusions

Under water limited conditions alfalfa-grass mixtures yield higher in dry matter and methane per hectare than pure grass mixtures if a reduced level of cutting frequency is applied. In addition to maize, mixtures of alfalfa-grass could be used as a substrate for biogas production. Most forage crops show particularly low contents of nitrate and would be considered as moderately difficult or difficult to ensile. For production of anaerobically stable and butyric acid free-silages it is necessary to combine wilting with the strategic use of silage additives.

## Acknowledgements

The study was supported by the German Federal Ministry of Food, Agriculture and Consumer Protection and the German Agency of Renewable Resources (FNR-FKZ 22002305).

## References

- Kaiser E., Weiß K. and Iv P. (2002) A new concept for the estimation of the ensiling potential of forages. In: Gechie L.M. and Thomas C. (eds.) *Proceedings of the XIII<sup>th</sup> International Silage Conference*, Auchincruive, Scotland, 344-358.
- Kaiser E. and Weiß K. (2007) Nitrate content in green forage – importance for fermentation quality and ensiling technological measures. *Übersichten zur Tierernährung* 35, 13-30.
- Weiland P. (2001) Grundlagen der Methangärung – Biologie und Substrate. In: *VDI-Berichte Nr. 1620. Biogas als regenerative Energie – Stand und Perspektiven*, VDI-Verlag, Düsseldorf, Germany, pp. 19-32.
- Schmaler K. and Neubert K. (2009) Nutzung des mehrschnittigen Ackerfutters im Energiepflanzenanbau auf verschiedenen Standorten in Brandenburg. In: Berendonk C. and Riehl G. (eds) *Futterbau und Klimawandel: Grünlandbewirtschaftung als Senke und Quelle für Treibhausgase. Mitteilungen der Arbeitsgemeinschaft Grünland und Futterbau* 10, 105-108.
- Vetter A., Heiermann M. and Toews T. (eds) (2009) *Anbausysteme für Energiepflanzen. Optimierte Fruchtfolgen + effiziente Lösungen*. DLG-Verlags-GmbH, Frankfurt M., Germany, 336 pp.



## Defining optimum practices for Italian ryegrass seed production in Serbia

Simić A.<sup>1</sup>, Vučković S.<sup>1</sup>, Petrović S.<sup>2</sup> and Sokolović D.<sup>3</sup>

<sup>1</sup> Faculty of Agriculture, Zemun-Belgrade, Serbia

<sup>2</sup> Agriculture College of Applied Sciences, Šabac, Serbia

<sup>3</sup> Institute for Forage Crops, Kruševac, Serbia

Corresponding author: alsimic@agrif.bg.ac.rs

### Abstract

Italian ryegrass (*Lolium multiflorum* Lam.) cv. Tetraflorum sown at different inter-row spacings (IRS), seeding rates (SR) and spring nitrogen fertilization rates (SNR), was tested under the agroecological conditions of Western Serbia. The field experiments were carried out for four growing seasons (2002-2006) and seed yield (SY), straw yield (SDM) and harvest index (HI) were measured during the first production year. The highest SY in the first production year varied among treatments depending on seasonal conditions. SY was affected markedly by IRS; however, by an opposite effect under arid and humid weather conditions, and IRS of 40 cm was found to be the least uncertain for seed production. The increase in SR provided higher seed yields in years with unfavourable weather conditions, while in the years with favourable conditions, the SR had either no impact on SY, or decreased SY as a result of ryegrass lodging following seed shedding. Spring nitrogen fertilization decreased SY by increasing vegetative biomass as well as crop lodging. Abundant SDM was obtained in some treatments, but there was no linear correlation between seed and straw yield.

Key words: harvest characteristics, inter-row spacing, Italian ryegrass, N rate, seeding rate

### Introduction

Italian ryegrass is one of the leading forage grasses in Serbia, producing high-quality forage from early spring to late summer. Ryegrass is well adapted to high rainfall but can be grown where a minimum of about 500 mm rainfall occurs during the growing season. According to Vučković *et al.* (2003), excellent ryegrass SY were achieved in Serbia in the first year, but local seed production covers only 50% of total seed demand. Optimum stand density for maximum SY in Italian ryegrass has not been determined yet. Very dense crop stand, nitrogen nutrition and inadequate environmental conditions can play an important role in maximizing seed productivity. Recommended SRs, IRSs and SNRs for Italian ryegrass varied considerably (Young *et al.*, 2001), indicating that at very low SRs early season yield could be affected negatively. At high seed and nitrogen rates, seedling competition for resources may actually reduce yields. Maximization of the first-year SY is much more important than the cumulative productivity over several consecutive crops due to disorganization of established spatial conditions and an inability to predict the next stand density. As the amount of seed shattered can easily be 10% of the harvested crop (Young *et al.*, 1996), it can develop into a very dense stand in the next season, thus increasing the SR more than 10-fold. This field study was conducted to determine the methods for managing the seed crop of Italian ryegrass in the first production year using different SRs, IRSs and SNRs.

### Materials and methods

The study was maintained for 4 consecutive years, between 2002 and 2006, near Šabac, Serbia (44°47' N, 19°35' E, 80 m a.s.l.) which is located in a semi-humid region (with very variable years). Seed from the primary growth of tetraploid Italian ryegrass cv. Tetraflorum

was harvested in the first production year after the establishment. Italian ryegrass was planted each autumn prior to the preceding summer seed harvest. SR was equivalent to 5, 10, 15 and 20 kg ha<sup>-1</sup>, providing 12 plant spatial treatments in combination with IRS, i.e. 20, 40 and 60 cm. The harvest plot was 10 m<sup>2</sup>, and replicated four times in a randomized complete block design. NPK fertilizer 8-16-24 was applied in autumn (250 kg ha<sup>-1</sup>), with treatment application of N (0, 50, 100 and 150 kg ha<sup>-1</sup>) in spring. After seed threshing, the straw was collected and weighed as SDM. This measurement was done for calculating harvest index, using the formula HI (%) = [SY/(SY+SDM)] × 100. Soil in the experimental area was humofluvisol (2.54% humus), with rinsed limestone. The main characteristics of the soil (depth: 0-30 cm) were the following: soil texture: clay loam; CaCO<sub>3</sub>: 0.36%; pH in KCl: 5.25; K: 12.5 mg kg<sup>-1</sup> and P: 1.3 mg kg<sup>-1</sup>. Monthly precipitation during the 4 years of the experiment was very contrasting. Accumulated precipitation during the vegetation period was compared and is presented in Fig. 1.

Table 1 Statistical summary of harvest characteristics (LSD test) during the period of 2003-2006

Main factors	2003			2004			2005			2006		
	SY	SDM	HI	SY	SM	HI	SY	SM	HI	SY	SM	HI
IRS A	**	**	**	**	*	**	**	**	**	**	**	**
SR B	**	**	**	NS	**	**	NS	**	**	**	**	**
SNR C	NS	**	NS	*	NS	**	*	*	**	**	**	**
A X B	*	NS	NS	NS	NS	NS	**	NS	NS	NS	NS	NS
A X C	NS	NS	NS	NS	NS	NS	*	NS	NS	NS	NS	NS
B X C	**	**	NS	NS	NS	NS	NS	NS	*	*	**	**
A X B X C	NS	NS	NS	NS	*	NS	NS	NS	NS	**	NS	*
Average	785	1806	29.56	955	6746	12.62	1559	5941	21.13	839	3506	20.82
CV	34.7	30.4	11.4	22.7	18.0	25.4	22.5	23.3	19.3	21.6	26.6	25.4

SY, Seed yield (kg ha<sup>-1</sup>); SDM, straw dry mass (kg ha<sup>-1</sup>); HI, harvest index (%); CV, coefficient of variation (%); NS, not significant  $P > 0.05$ ; \* =  $P < 0.05$ ; \*\* =  $P < 0.01$

## Results and discussion

Accumulated precipitation during the spring of 2003 was deficient (Fig. 1), and the lowest average SY was observed in 2003, whereas the highest was in 2005: 785 and 1559 kg ha<sup>-1</sup> in 2003 and 2005, respectively (Table 1). Reduced SY and SDM in 2003, when compared to other years, were attributed to a spring rainfall shortage and a significant influence of the treatments. The SYs and SDM yields in 2003 were the highest with 20 cm IRS and the 20 kg ha<sup>-1</sup> SR, showing that SY can be managed by increasing stand density during drought stress conditions. The results indicate that there was no interaction effect between the applied factors, and that they influenced SY independently. Higher precipitation during the 2 consecutive years resulted in abundant SDM accumulation. In the spring of 2004 and 2005 lodging was extremely high and increased as crop density increased, especially when higher SNR were used. The SY differences in 2004 and 2005 were mainly due to a low accumulation of assimilates and early season lodging at the time of heading in 2004. Furthermore, the 2004 conditions favoured secondary tillering during seed filling; these vegetative tillers were competing for assimilates with seed sinks. There was also some crop lodging in 2006, but it occurred late in the seed-filling period. SY were affected by IRS all 4 years (Table 1), but an opposite effect occurred in arid and humid weather conditions, respectively. Lodging tolerance appeared to be the highest at the 60 cm IRS, as compared with the other treatments, as was reported by Choi *et al.* (2002). A favourable effect of increased SR and narrow IRS on SY was observed in 2003. SDM was strongly influenced by stand establishment throughout the experiment, and the biomass yield response to density was more consistent than that one of SY. The HY, as an indicator of seed production efficiency, was significantly influenced by

the applied treatments. The highest HY was observed in 2003, which was due to the very low SDM obtained. Regarding low SY and reduced SDM production, the HI could not be considered an objective indicator in this production year. SY compared with SDM allowed comparison through regression equations (Fig. 2), and presented correlation between straw and seed yield. The highest correlation was between seed and straw yield in arid year.

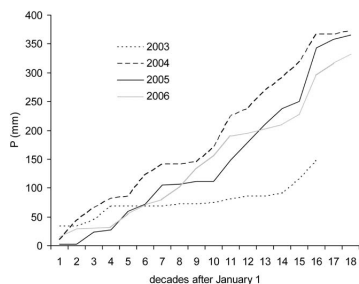

Figure 1. Accumulated precipitation yield during four consecutive years

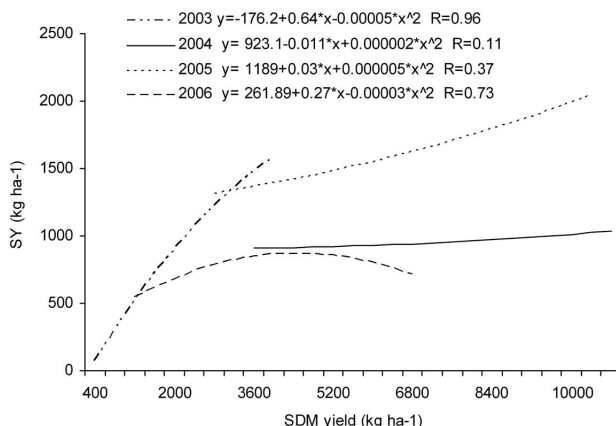

Figure 2. Effect of straw yield (SDM) on seed (SY)

## Conclusion

The results of the present study indicate that in order to maximize seed productivity in the first production year a high seeding rate is preferable ( $15\text{--}20\text{ kg ha}^{-1}$ ), and that medium row spacing (40 cm) is the least uncertain. Also, the results support the use of a relatively low nitrogen rate for Italian ryegrass seed production in the first harvest year. Future studies should focus on including additional sites with different soil drainage classes in contrasting climatic years.

## References

- Choi G.J., Jung E.S., Rim Y.W., Lim Y.C., Kim K.Y., Sung B.R. and Park G.J. (2002) Effects of drill widths and nitrogen application levels in early spring on the growth characteristics and seed productivity of Italian ryegrass (*Lolium multiflorum* Lam.). *Journal of the Korean Society of Grassland Science* 3, 221-226.
- Vučković S., Simić A., Čupina B. Stojanović I. and Stanisavljević R. (2003) The effect of vegetation area size on grass seed yield. *Journal of Agricultural Sciences* 1, 125-134.
- Young III W.C., Chastain T.G., Mellbye M.E., Silberstein T.B. and Garbacik C.J. (1996) Stand density effects on annual ryegrass seed crops. In: Young W. (ed.) *Seed Production Research*, III, OSU Ext/Crs 110, 4/97.
- Young III W.C., Mellbye M.E., Gingrich G.A., Silberstein T.B., Chastain T.G. and Hart J.M. (2001) Defining optimum nitrogen fertilization practices for fine fescue and annual ryegrass seed production systems in the Willamette Valley. 2001. In: Young W. (ed.) *Seed Production Research*, III, OSU Ext/Crs 121, 4/02

## Influence of sod seeding grassland on the quality of the first cut

Skládanka, J.<sup>1</sup>, Mikyska F.<sup>2</sup>, Doležal P.<sup>1</sup>, Šeda J.<sup>2</sup> and Rosická L.<sup>1</sup>

<sup>1</sup>Department of Animal Nutrition and Forage Production, Faculty of Agronomy, Zemědělská 1 613 00 Brno, Czech Republic

<sup>2</sup>Agrokonzulta-consluting, Ltd. Žamberk, Czech Republic

Corresponding author: jiri.skladanka@mendelu.cz

### Abstract

Sod seeding was carried out in the pasture sward in Bartošovice (Czech Republic). Four different ways of sowing into the existing vegetation were used. The mixture for sod seeding contained *Festulolium pabulare*, *Dactylis glomerata*, *Arrhenatherum elatius* and *Lotus corniculatus*. The first cut was used for conservation. Grassland quality (botanical composition) and content of nutrients in the silages were evaluated. Different technologies of sod seeding improve dominance of new sown species in a grass stand. The most successful was a radical disturbance of the original grass sward with technology Horsch Exaktor. Sod seeding improves grassland quality in terms of botanical composition (EGQ). Dominance of the sown species up to 20% was not sufficient to influence the nutrients in ensilaging of biomass. Content of CF and NDF was influenced by use of inoculants at ensilaging ( $P < 0.05$ ). Probiotic and probioenzymatic inoculants improve quality of the silage-making process, with a lower content of butyric acid ( $P < 0.01$ ).

Keywords: perennial grasses, forage, silages, content of nutrients

### Introduction

Grasslands can be used as a forage crop in a grass-arable land rotation. The first cut is harvested for conservation and the sward can be subsequently used for grazing until the end of the growing season. Winter feed ration is based on the conserved fodder from the first cut and serves also as additional feed in the autumn (Achilles *et al.*, 2002). As compared with haymaking, ensiling represents a much lower weather risk, lower labour costs and less conservation loss (Achilles *et al.*, 2002). Individual graminaceous species show great differences in their ensiling capacity (Holúbek *et al.*, 2007). The goal of this paper is to evaluate grassland quality and quality of silages after sod seeding of a mixture of *Festulolium pabulare*, *Arrhenatherum elatius*, *Dactylis glomerata* and *Lotus corniculatus*.

### Material and methods

The field experiment was conducted in the Bartošovice (north-east Bohemia, at 650 m a.s.l) and established on 5 May 2008 with three replicates. Soil mineral content was 133 mg kg<sup>-1</sup> P, 472 mg kg<sup>-1</sup> K, 1830 mg kg<sup>-1</sup> Ca and pH was 5.6 in the year of establishment. Size of experimental plots was 0.9 ha (20 m x 450 m). There were 5 sowing treatments: (1) control (no seeding), (2) sod seeding without disruption grass stand (Lehner), (3) sod seeding with strip seed drill (SSD), (4) sod seeding with Horsch exaktor SE3 (Exaktor) and (5) sod seeding with Horsch disk pronto 3DC (Disk). Sod seeding was carried out with a mixture of *Festulolium pabulare* (cv. Felina, 14.5 kg ha<sup>-1</sup>), *Dactylis glomerata* (var. Vega, 5 kg ha<sup>-1</sup>), *Arrhenatherum elatius* (var. Median, 14.5 kg ha<sup>-1</sup>) and *Lotus corniculatus* (var. Taborsky, 1.5 kg ha<sup>-1</sup>). Biomass from the first cut was harvested on 2 June 2009 and used for making silage. The silages were made in the bale (diameter 1.5 m). At the beginning of the silage making the dry matter contents were 20% to 24%. The silages additives were the probiotic preservative

(Mikrosil, 0.1 g kg<sup>-1</sup>) and probioenzymatic (Goldzym, 0.15 g kg<sup>-1</sup>) inoculants. Silages sampled 90 days after the beginning of conservation were assessed for organic acids and content of fibre. The content of nutrients was established according to the norm of the Czech Standard Institute (Anonymous, 1997). Botanical composition was evaluated with the method of projective dominants on an area of 2 m x 2 m. Grassland quality was evaluated according to a formula (Novak, 2004):

$$EGQ = \sum(FV.\%D)/8,$$

EGQ is evaluated grassland quality, FV is forage value and %D is dominance of species in grassland.

## Results and discussion

The dominance of sod seeding species was highest when the Horsch Exaktor was used. This technology disturbs a grass sward to a larger extent in comparison with the other technologies. Restriction of the competitive power of the old sward contributes to a favourable implementation of the new species. Sod seeding improves grassland quality (Table 1). The disturbance of the grass sward and subsequently access of sunlight increase dominance of white clover (not included in the mixture). The proportion of the additional sowing species up to 20% was not enough to influence the nutrient concentration in the ensilaged biomass (Table 2). However, higher dominance of the sod seeding grasses is expected in the following years and maybe it can improve nutrient content then. According to Skládanka (2005), in June 2004, the share of *Festulolium* in herbage was 23.1%. In 2001, the share of these species had been <2%. This indicates that the proportion of oversown herb species can increase over four years by more than 20%. Quality of ensilaging positively influences the use of inoculants. The content of crude fibre (CF) and neutral detergent fibre (NDF) was affected ( $P < 0.05$ ) by the use of probiotic and probioenzymatic preparations (Table 2). The preparations influenced considerably the quality of silage (Table 2). The lower content of butyric acid ( $P < 0.01$ ) in the treated silages is, especially, a sign of better silage quality.

Table 1 The projective dominance (%D) and grassland quality (EGQ) in dependence on technology of sod seeding on site Bartošovice

Species	FV	Non seeding	Lehner	SSD	Exaktor	Disk
<i>Phleum pratense</i>	8	3	2	1	1	4
<i>Poa pratensis</i>	8	8	7	4	4	5
<i>Alopecurus pratensis</i>	7	12	10	8	10	9
<i>Agrostis capillaris</i>	5	3	4	3	3	4
<i>Erytrigia repens</i>	4	3	2	1		1
<i>Dactylis glomerata</i>	7	8	8	9	7	9
<i>Arrhenatherum elatius</i>	7		+	3	12	2
<i>Festulolium pabulare</i>	7		+	2	1	4
Grasses		40	35	33	40	40
<i>Trifolium repens</i>	8	20	35	38	19	30
<i>Lotus corniculatus</i>	7		+	+	3	+
Legumes		20	35	38	22	30
<i>Heracleum sphondylium</i>	5	4	3	2	4	3
<i>Alchemilla vulgaris</i>	5	1	3	2	2	4
<i>Taraxacum officinale</i>	5	14	12	14	14	10
<i>Ranunculus repens</i>	-2	4	2			1
Herbs		36	27	27	33	28
EGQ		69	78	81	72	78

+ dominance < 1%; FV = forage value, 8 = most valuable species, 0 = worthless species, -1 to -4 = toxic species  
In the table are only selected species with dominance >3% at least in one variant

Table 2 Influence of sod seeding and preservative on the pH, content of lactic acid (LA), acetic acid (AA), butyric acid (BA), content of crude fibre (CF), acid detergent fibre (ADF) and neutral detergent fibre (NDF) in the dry matter (DM) of bale silages

Factor	DM g kg <sup>-1</sup>	pH	LA g kg <sup>-1</sup>	AA in g kg <sup>-1</sup>	BA g kg <sup>-1</sup>	CF g kg <sup>-1</sup>	ADF g kg <sup>-1</sup>	NDF g kg <sup>-1</sup>
Sod seeding								
Control	207.2	4.59	64.0	17.0	15.0	2500	356.2	447.9
Lehner	258.3	4.60	46.3	14.1	12.9	274.8	381.3	515.8
SSD	257.2	4.69	46.1	13.5	15.3	285.1	395.3	534.1
Exaktor	239.4	4.41	61.5	11.5	13.7	248.2	388.6	475.2
Disk	229.7	4.58	60.9	21.5	14.9	271.1	401.4	498.8
<i>P</i>	0.436	0.974	0.946	0.804	0.999	0.683	0.453	0.672
Preservative								
Control	242.3	5.09 <sup>a</sup>	22.8 <sup>a</sup>	20.2	27.6 <sup>a</sup>	297.4 <sup>a</sup>	402.8	550.7 <sup>a</sup>
Mikrosil	251.0	4.38 <sup>b</sup>	65.0 <sup>b</sup>	11.9	9.9 <sup>b</sup>	253.8 <sup>ab</sup>	365.1	487.9 <sup>ab</sup>
Goldzym	221.8	4.25 <sup>b</sup>	79.5 <sup>b</sup>	14.4	5.6 <sup>b</sup>	246.2 <sup>b</sup>	385.7	444.5 <sup>b</sup>
<i>P</i>	0.459	0.000	0.003	0.412	0.000	0.024	0.145	0.047

The mean with different superscripts (<sup>a,b,c</sup>) are significant at level  $P < 0.05$

$P$  = level of significance

## Conclusions

The more successful method was a radical disturbance of the 'old' grass sward with the technology of the Horsch Exaktor. Sod seeding improves grassland quality, but the dominance of the additional sown species was only 20%. The disturbance of the grass sward increase dominance of white clover (not used in the mixture). Nutrient content in the ensilaged biomass was not influenced by the sod seeding. Content of nutrients (CF and NDF) was influenced by the use of inoculants.

## Acknowledgement

This study was supported by the Research grant No. QH 81040 'Quality of the grass stand and its use in the nutrition of ruminants', financed by the National Agency for Agricultural Research (NAZV).

## References

- Anonymous (1997) ČSN 467092, *Testing method for feeding stuffs*. UZPI Praha, Praha.
- Achilles W., Golze M., Herrmann H.J., Opitz von Boberfeld W., Wassmuth R. and Zeeb, K. (2002) *Ganzjährige Freilandhaltung von Fleischrindern*. KTBL, Darmstadt, 103 pp.
- Haigh P.M. (1995) The composition of first-cut grass for ensilage in England and Wales from 1988 to 1991. *Grass and Forage Sci.* 50, 63-67.
- Holúbek R., Jančovič J., Gregorová H., Novák J., Ďurková E. and Vozár, L. (2007) *Forages - management of forage growing and utilization*. SPU Nitra, Nitra, 419 pp. (In Slovak)
- Novák J. (2002) Evaluation of grassland quality. *Ekológia* 23, 127 – 143.
- Skládanka J. (2005) Effects of the utilization term and additional sowing of *Festuca arundinacea* and *Festulolium* on the production of winter pasture. *Acta Universitatis Mendeliana Brunensis* 54, 95 – 105.

# The benefits of long-term legume swards in an organic farming system

Slepetys J. and Slepetiene A.

LRCFAF, Institute Agriculture, LT- 58344, Akademija, Kedainiai distr., Lithuania

Corresponding author: jonas.slepetys@lzi.lt

## Abstract

We studied long-yielding legume species grown pure and in mixed swards with other legumes and *Festulolium*. Seven sward types were managed according to organic farming system, over 7 years, under a 2-cut and 3-cut system. No mineral or organic fertiliser was applied. The highest Dry matter (DM) yield and metabolisable energy in herbage were recorded in the third year of use. The results averaged over seven years suggest that the highest DM yields were obtained with a mixed sward composed of fodder galega, alfalfa and *Festulolium*, or pure alfalfa. Even in the seventh year of use, the sown legumes persisted well enough in the swards. They accounted for 29-75% of the DM yield. Fodder galega and sainfoin persisted better than alfalfa. The annual DM yield did not differ between two or three cut management. Two-cut management gave lower protein contents than three cuts. Moreover, the frequent cuts resulted in thin swards followed by higher infestation of forbs of which *Taraxacum officinale* prevailed.

Key words: legumes, swards, forage production, organic farming

## Introduction

The economic and ecological benefits of forage legumes are well known. Symbiotic fixed nitrogen accumulated by legumes can be useful as it produces protein-rich forage and contributes to the nutrient balance in soils (Ledgard, 2001). However, some legumes also have undesirable characteristics, one of which is their short persistence in swards (Frame *et al.*, 1998; Vaiciulyte and Bacenas, 2008). Early flowering red clover, which is the most common legume in Lithuania, has high yields only in the first and second years of use and in the third year it often disappears completely. In Lithuania, fodder galega (*Galega orientalis*) is the most long-lived legume exhibiting the best overwinter survival (Balezientiene and Mikulioniene, 2006). On an organic farm where no mineral nitrogen is applied it is very important that legumes persist as long as possible in the swards; therefore it is necessary to look for more long living legumes that could replace red clover at least partly. For this study we selected a mixture of legumes, less commonly used than clover: common sainfoin (*Onobrychis viciifolia*), fodder galega (*Galega orientalis*) and alfalfa (*Medicago sativa*). The objective of our research was to study the productivity and persistence of more long-living legume species on an organic farm in a pure crop, and in mixtures with other legumes and grasses, under an extensive (2-3 cuts) management regime.

## Materials and methods

Field experiments were carried out on a sod gleyic loamy soil (Cambisol) in the central part of Lithuania. The soil characteristics were as follows: pH<sub>KCl</sub> 7.0, soluble P 67-80 mg kg<sup>-1</sup>, K 106-112 mg kg<sup>-1</sup>. In the spring of 2001 pure or mixtures of herb species were sown under barley:

1. *Galega orientalis* 100 %;
2. *Medicago sativa* 100 %;
3. *Onobrychis viciifolia* 100 %;
4. *Galega orientalis* 40 %, *Medicago sativa* 40 %, *Festulolium* 20 %;
5. *Galega orientalis* 40 %, *Onobrychis viciifolia* 40 %, *Festulolium* 20 %;
6. *Galega orientalis* 40 %, *Medicago sativa* 20% *Trifolium pratense* 20 %, *Festulolium* 20 %;



7. *Galega orientalis* 40 %, *Trifolium repens* 20 %, *Onobrychis viciifolia* 20 %, *Festulolium* 20 %. The seed rate for pure crop was as follows: *Galega orientalis* 30 kg ha<sup>-1</sup>, *Medicago sativa* 15 kg ha<sup>-1</sup>, *Onobrychis viciifolia* 80 kg ha<sup>-1</sup>, *Trifolium pratense* 15 kg ha<sup>-1</sup>, *Trifolium repens* 10 kg ha<sup>-1</sup>, *Festulolium* 18 kg ha<sup>-1</sup>. The experiment was a randomised complete block with 4 replications and a plot size of 2.5×14 m. The swards did not receive any fertiliser and were used for seven years (2002-2008). They were cut either two or three times per season. The first cut was taken in early June at the beginning (3-cut management) or at mass flowering (2-cut management) stage in the middle of June. The second cut was taken in the middle of July (at the beginning of flowering, 3-cut management) or early August (at mass flowering, 2-cut management). The last cut was taken in the middle of October (3-cut management). For the assessment of forage quality, chemical analyses of dry matter were performed for: crude protein (as nitrogen content × 6.25), crude fibre by the Hennerberg-Stohmann method, crude fat by the Rushkovski method, crude ash, by combustion. The differences in metabolisable energy were calculated on the basis of the chemical composition of the Dry Matter (DM), using digestibility coefficients and full value coefficients. The data (herbage DM yield, metabolisable energy, crude and digestible protein) were processed by an analysis of variance (two factor experimental design), applying the ANOVA procedure.

## Results and discussion

In the first year of use when the swards (Factor A) were cut two or three times (Factor B), the highest DM yield of 6.87 t ha<sup>-1</sup> was produced by a mixed sward composed of alfalfa, fodder galega and *Festulolium* (Table 1). Due to the weak development in the first year fodder galega had lowest yields. Similar results were reported from Estonia (Raig and Nommsalu, 2001). In the third year of use the swards produced the highest yields. Pure-sown fodder galega produced significantly lower yield than mixtures; similar findings were confirmed by other researchers (Adamovich, 2000; Balezentiene and Mikulioniene, 2006).

Table 1. The effect of different legume swards (Factor A) on the annual dry matter yield t ha<sup>-1</sup> (Sward was cut 2 and 3 times)

Sward	Year of sward use							Mean	Variation %
	I	II	III	IV	V	VI	VII		
1. <i>Galega orientalis</i> (G)	3.56	2.77	4.88	5.39	2.18	4.20	3.22	3.75	30.9
2. <i>Medicago sativa</i> (M)	6.41	4.77	9.03	5.05	3.33	4.07	3.09	5.11	40.4
3. <i>Onobrychis viciifolia</i> (O)	5.05	3.69	8.94	3.97	3.77	5.31	3.21	4.96	40.3
4. G + M + <i>Festulolium</i> (F)	6.87	5.31	8.41	5.66	4.09	4.65	3.16	5.45	32.3
5. G + O + F	5.67	3.81	8.34	4.14	3.07	4.68	3.05	4.68	39.7
6. G+M+T. <i>pratense</i> + F	6.32	5.04	7.25	5.18	3.43	3.94	2.88	4.86	32.3
7. G + O + T. <i>repens</i> + F	5.74	3.85	8.07	4.15	2.72	3.88	2.76	4.46	42.4
LSD <sub>05</sub> (FA)	0.35	0.24	0.74	0.27	0.16	0.37	0.31	0.40	

Table 2. The effect of cutting regime (Factor B) on dry matter yield, crude and digestible protein, and the metabolisable energy in swards (averaged data over seven years of sward use)

Cutting regime	Dry matter yield t ha <sup>-1</sup>	Metabolisable energy GJ ha <sup>-1</sup>	Crude protein kg ha <sup>-1</sup>	Digestible protein kg ha <sup>-1</sup>
3 cuts	4.86	46.5	747	486
2 cuts	4.64	46.6	708	464
LSD <sub>05</sub> (FB)	0.26	1.6	28	17

The swards of pure sainfoin, or sainfoin mixed with other grasses, were similar to those of alfalfa or its mixtures. Unfertilized legume swards yielded relatively satisfactorily in the (dry) fifth year of use. The herbage yield in the (wet) sixth year of use was markedly higher than in the previous years. In the drier seventh year of use the yield of all tested swards declined and

varied around 3 t ha<sup>-1</sup>. The data averaged over seven years suggest that the highest DM yield (5.45 t ha<sup>-1</sup>) was obtained when cutting the swards 2 or 3 times (Factor A), sown with mixture composed of fodder galega, alfalfa and *Festulolium*, or pure alfalfa (5.11 t ha<sup>-1</sup>). The variation (standard deviation) of productivity was high between years. This was influenced by the droughts that occurred during the growing season in the first, second, fifth and seventh years of use. A trend of sward productivity reduction was observed with increasing sward age, from the third year of use.

The metabolisable energy accumulated in the swards varied similarly to dry matter (Table 2). Two and three cuts produced a similar herbage yield. However, when cutting only twice, higher contents of legumes, especially alfalfa and sainfoin persisted in the sward. When the sward was cut three times, protein content was significantly higher than that of the sward cut twice.

Botanical dry matter composition depended on cutting frequency and sward age. In the first year of use, fodder galega accounted for 51-53% of the DM yield. Alfalfa and sainfoin in pure stands accounted for 83-89%, respectively. In the first year of use, *Festulolium* dominated by 53-84% in the mixed swards. In the second year of use legumes prevailed in all swards. The negative effect of more frequent cuts on legumes was revealed. When cut three times, legumes accounted for 60-86% of the dry matter, whereas with two cuts it was 78-95%. In the seventh year of use, alfalfa and 3-cut sainfoin swards were more thinned out. A higher percentage of legumes survived in the pure swards (40-70% in the DM) in comparison with mixtures (29-53%). *Festulolium* proportion in the DM yield amounted to 10-40% and that of *Taraxacum officinale* 15- 35%. Sainfoin was more affected by a high cutting frequency.

## Conclusions

In an organic farming system the highest herbage dry matter yield was produced by the swards composed of galega, alfalfa and *Festulolium* or pure alfalfa. Pure fodder galega swards produced significantly lower herbage yield, compared with alfalfa and sainfoin. Under the two-cut and three-cut management the swards produced similar yields; however, under the management involving less frequent cutting legumes persisted better.

## References

- Adamovich A. (2000) Productivity of eastern galega (*Galega orientalis* Lam.) grass swards. *Grassland Science in Europe* 5, 100-103.
- Balezientiene L. and Mikulioniene S. (2006) Chemical composition of galega mixtures silages. *Agronomy Research* 4(2), 483-492.
- Frame J., Charlton J.F.L. and Laidlaw A.S. (1998) *Temperate forage legumes*. CAB International, 328pp.
- Ledgard S.F. (2001) Nitrogen cycling in low input legume based agriculture, with emphasis on legume grass pastures. *Plant and Soil* 228, 43-59.
- Raig H. and Nommsalu H. (2001) Biological characterisation of fodder galega. In: Nommsalu H. (ed.) *Fodder galega*. Saku, 15-22.
- Vaiciulyte R. and Bacenas R. (2008) The productivity and feeding value of mixtures of legumes with *Festulolium*. *Zemdirbyste- Agriculture* 95, No. 4, 153-171.

## Grass and grass-legume mixtures for methane production

Sölter U.<sup>1</sup>, Höppner F.<sup>1</sup>, Luesink W.<sup>2</sup>, Ingwersen B.<sup>3</sup>, Feuerstein U.<sup>4</sup> and Greef J.M.<sup>1</sup>

<sup>1</sup>Julius Kühn-Institute, Federal Research Centre for Cultivated Plants, Institute for Crop and Soil Science, D-38116 Braunschweig

<sup>2</sup>Norddeutsche Pflanzenzucht, Zweigniederlassung Saatzeit Hans-Georg Lembke, D-23999 Malchow/Poel

<sup>3</sup>Norddeutsche Pflanzenzucht, Hans-Georg Lembke KG, D-24363 Holtsee

<sup>4</sup>Euro Grass Breeding GmbH & Co. KG, D-27330 Asendorf

Corresponding author: ulrike.soelter@jki.bund.de

### Abstract

At three sites in northern Germany (site 1: Braunschweig; site 2: Hannover; site 3: Kiel) dry matter (DM) and methane production of grass and grass-legume mixtures were compared to maize (*Zea mays*). Two cutting regimes were conducted for all 5 cuts: normal-cut, i.e. emergence of grass heads and late-cut, i.e. grass flowering. Pure stands of perennial ryegrass (*Lolium perenne*) and annual ryegrass (*L. multiflorum*) were sown as well as mixtures of perennial ryegrass with crimson clover (*Trifolium incarnatum*) and vetch (*Vicia villosa*) (grass-LEG) and annual ryegrass with red clover (*T. pratense*). At site 1, a late cut of grass and grass-LEG had similar DM and methane yields compared to maize. At site 2, grass under both cutting regimes did not differ from maize in DM yield, whereas in methane yield normal cut grass did not differ from maize. The third site had similar DM and methane yields of late cut grass compared to maize. The other treatments had lower yields in comparison to maize. In conclusion, late cut grass can be an alternative to maize.

Keywords: methane yield, dry matter yield, grass, legume, *Lolium*

### Introduction

To avoid maize monocultures, with its accompanying undesired environmental impacts such as nitrogen losses and decreasing biodiversity, it is very important to integrate further suitable energy crops into the crop rotation. Alternatives to maize could be annual ryegrass (*Lolium multiflorum*) and perennial ryegrass (*L. perenne*). Most important are high yielding first and second cut varieties. These grass species are also suitable to be grown in mixtures with legumes. They provide fermentable biomass earlier in the year than other energy crops, like maize (*Zea mays*), millet (*Setaria italica*) and sunflower (*Helianthus annuus*). An advantage of these grass species is that they provide biomass in autumn; furthermore, they do not leave a bare field over winter and have the main production period during the following year.

### Materials and methods

The experimental field trials were located in northern Germany (site 1: Braunschweig; site 2: Hannover; site 3: Kiel) with contrasting soil types, i.e. silty sand, sandy loam and loamy sand-sandy loam, respectively. Dry matter (DM) and methane production of grass and grass-legume mixtures were compared to maize (*Zea mays*). Two cutting regimes were conducted for all cuts: normal-cut, i.e. emergence of grass heads, and late-cut, i.e. grass flowering. Perennial ryegrass was sown alone and in mixture with crimson clover (*Trifolium incarnatum*) and vetch (*Vicia villosa*). Annual ryegrass was sown alone and in mixture with red clover (*Trifolium pratense*). Sowing was carried out in summer 2007 with one cut in autumn and 4 cuts in 2008. Pure stands of perennial and annual ryegrass were sown at a seeding rate of 30 and 35 kg ha<sup>-1</sup>, respectively. The sowing rate of perennial ryegrass, crimson

clover, and vetch were 25, 15, and 10 kg ha<sup>-1</sup> and of annual ryegrass and red clover were 20 and 8 kg ha<sup>-1</sup>, respectively. In 2007 the pure grass stands were fertilized with 80 kg ha<sup>-1</sup> N and the legume grass mixtures with 40 kg ha<sup>-1</sup> N at all sites. In 2008 the pure grass stands were fertilized with 200 kg at site 1, 285 kg at site 2 and 320 kg ha<sup>-1</sup> yr<sup>-1</sup> N at site 3, and the legume grass mixtures were fertilized with 40 kg, 130 kg and 0 ha<sup>-1</sup> yr<sup>-1</sup> N, respectively. Maize data were obtained from samples of trials in each of the three regions in 2008 taken at a developmental stage characterized by a DM content of about 32% (silage stage). Methane yield was estimated using the formula of Baserga (1998). In the statistical analyses, the SAS procedure GLM was used. Comparisons of mean values of main effects for testing for significance at  $P < 0.05$  were performed by Tukey.

## Results and discussion

At site 1 DM and methane yields of late-cut grass and crimson clover-vetch-grass did not differ from maize (Table 1). All normal-cut treatments and the late-cut red clover-grass treatment had significantly smaller yields compared to maize. All normal-cut treatments had significantly smaller yields than their corresponding late-cut treatments.

Table 1. Dry matter and methane yields at site 1 (Braunschweig); grass harvested at two different developmental stages (sum of five cuts), Figures in the same line with different letters are significantly ( $P < 0.05$ ) different

Crop	Crimson clover-vetch-grass		Red clover-grass		Grass		Maize
	normal cut	late cut	normal cut	late cut	normal cut	late cut	
DM yield [kg ha <sup>-1</sup> ]	14300d	18800ab	14500d	18400bc	15900cd	20500ab	21100a
Methane yield [Nm <sup>3</sup> ha <sup>-1</sup> ]	4056c	5339ab	4065c	4891b	4800bc	5883a	6023a

The results from site 2 did not reflect the results from site 1: DM yields of normal and late-cut grass and methane yield of normal-cut grass did not differ from maize (Table 2). All other treatments had significantly smaller yields compared to maize. Additionally, no significant differences between the normal-cut and their corresponding late-cut treatments were observed.

Table 2. Dry matter and methane yields at site 2 (Hannover); grass harvested at two different developmental stages (sum of five cuts), Figures in the same line with different letters are significantly ( $P < 0.05$ ) different

Crop	Crimson clover-vetch-grass		Red clover-grass		Grass		Maize
	normal cut	late cut	normal cut	late cut	normal cut	late cut	
DM yield [kg ha <sup>-1</sup> ]	10200c	10900c	11900bc	12900b	15900a	15900a	16600a
Methane yield [Nm <sup>3</sup> ha <sup>-1</sup> ]	2690d	2877d	3116cd	3345c	4338ab	4172b	4761a

At site 3 the late-cut grass treatment did not differ from maize in respect to DM and methane yield (Table 3). All the other treatments had significantly smaller yields. Significant differences between the normal-cut and their corresponding late-cut treatments were detected for crimson clover-vetch-grass and red clover-grass.

The results from the three sites showed that late-cut grass with one cut in the sowing year and four cuts during the following main production year can be an alternative to maize. At time, the estimated methane yields are verified by batch tests. It is supposed that due to the lower protein and fat contents especially the late cut grass treatments will result in a lower methane yield than calculated by the applied formula (Weiland, 2001). Additionally, the fermentability

of these late-cut treatments has to be tested, since late-cut substrates may negatively influence the fermentation process in silages and therefore may have an impact on the methane production (Prochnow, 1994). On average over all sites, the legume-grass mixtures of both cutting regimes did not achieve the DM and methane yields of maize.

Table 3. Dry matter and methane yields at site 3 (Kiel); grass harvested at two different developmental stages (sum of five cuts), Figures in the same line with different letters are significantly ( $P < 0.05$ ) different

Crop	Crimson clover-vetch-grass		Red clover-grass		Grass		Maize
	normal cut	late cut	normal cut	late cut	normal cut	late cut	
DM yield [ $\text{kg ha}^{-1}$ ]	8200e	11300d	13400c	16100b	16100b	17500ab	18900a
Methane yield [ $\text{Nm}^3 \text{ha}^{-1}$ ]	2280e	3196d	3663d	4389c	4680bc	4962ab	5411a

## Conclusion

The results show that grass can be an alternative crop to maize monoculture for methane production. Grass within a crop rotation for biogas production has the additional advantage of being a cover crop during winter, i.e. reduction of nutrient losses through leaching, and provides fermentable substrates earlier in the year in comparison to maize.

## Acknowledgements

This study was funded by ‘Fachagentur für Nachwachsende Rohstoffe (Agency for Renewable Resources) e.V. in Gülzow’ within the project ‘Evaluierung, Züchtung und Einsatz von Feldgras als pflanzlicher Energierohstoff für die Biogasnutzung (Evaluation, breeding and cropping of fodder grass in terms of an energy resource for biogas production)’.

## References

- Baserga U. (1998) Landwirtschaftliche Co-Vergärungs-Biogasanlagen. *FAT-Berichte* Nr. 512, Tänikon.
- Prochnow A. (1994) Verfahrenstechnische Grundlagen für die Großflächige Landschaftspflege am Beispiel der Nütke-Nieplitz-Niederung. *Forschungsbericht Agrartechnik* Nr. 265, Dissertation, Berlin.
- Weiland P. (2001) Grundlagen der Methangärung – Biologie und Substrate (Fundamentals of methane fermentation – biology and substrates). *VDI-Berichte* Nr. 1620, 19-32.

# **Biogas-Expert: Sustainable biomethane production in northern Germany - Nitrogen leaching after application of biogas residue**

Svoboda N.<sup>1</sup>, Wienforth B.<sup>2</sup>, Sieling K.<sup>2</sup>, Kage H.<sup>2</sup>, Taube F.<sup>1</sup> and Herrmann A.<sup>1</sup>

*Christian-Albrechts-University of Kiel, D-24118 Kiel*

<sup>1</sup>*Institute of Crop Science and Plant Breeding; Grass and Forage Science/Organic Agriculture*

<sup>2</sup>*Institute of Crop Science and Plant Breeding; Agronomy and Crop Science*

Corresponding author: svoboda@email.uni-kiel.de

## **Abstract**

In order to ensure the largest possible benefit from replacing fossil fuels by bioenergy, it is mandatory to produce bioenergy in a sustainable way. With respect to biomethane production there are limited data on its risk of contaminating the groundwater with nitrogen. A two-year trial located in two landscapes in northern Germany was conducted to analyse the N leaching potential of biogas residue compared with other N fertiliser types for monocropped maize. Nitrogen load was obtained from measured N concentration in leachate and simulated soil water flow. Significant differences in N load among the different N fertiliser types were detected, which could be attributed mainly to the mineral share of N input.

Keywords: methane, biogas residue, nitrate leaching, maize

## **Introduction**

Methane production from anaerobic digestion of slurry and/or biomass has greatly expanded in Germany due to substantial subsidisation (>4000 plants in 2009). This was initially regarded favourably, but criticism has been voiced recently due to fuel-food competition and potential environmental impacts. Biogas residue, which is produced in large amounts, should be used in a sustainable way. The objective of this study was to assess the N-leaching potential of biogas residue applied to maize compared with using animal manure and mineral fertiliser.

## **Materials and methods**

A study was conducted through a 2-year field experiment (2007-2009) on two experimental stations (Hohenschulen, Karkendamm) of Kiel University. Hohenschulen has an average precipitation of 750 mm and a mean annual temperature of 8.3 °C. Soil type is a luvisol with 17% clay in the topsoil (sandy loam). Karkendamm has an average precipitation of 844 mm and a mean annual temperature of 8.6 °C. Soil type can be classified as a gleyic Podzol with less than 1% clay in the topsoil (sandy sand). Weather conditions in the experimental years differed from the long term values. At Karkendamm, mean annual temperature (10.3 °C in 2007, 9.7 °C in 2008) was above long-term average (8.6 °C), while rainfall was slightly above long-term average in 2007 (898 mm), and somewhat below in 2008 (726 mm). At Hohenschulen, temperature and precipitation in 2007 were substantially higher (926 mm; 10.1 °C) compared to long term conditions, while 2008 was slightly drier (722) and warmer (9.8 °C). Maize (cv. Ronaldino) was planted in mid-late April. N fertiliser was applied as mineral N (calcium ammonium nitrate), cattle slurry (Karkendamm only), pig slurry (Hohenschulen only), and biogas residue (cofermentation) in four levels (0, 120, 240, 360 kg ha<sup>-1</sup> N), split into 2 equal dressings.

Leachate was sampled weekly from April 2007 till March 2009 using ceramic suction cups (P80), installed 60 cm below ground, while soil moisture content was determined by TDR-probes. N load in the leachate was obtained from measured N concentrations and simulated leachate amount. Soil water balance and plant growth were simulated using the object oriented model library HUME within the Delphi<sup>®</sup> Builder programming environment (Kage and Stützel, 1999). The model uses the Penman-Monteith equation for calculating the potential evapotranspiration. Plant growth was calculated by fitting simple functions to crop height and leaf area index (obtained by Licor LAI2000 instrument). Simulation of soil water movement was based on soil water potential. Relationship between soil water diffusivity and the volumetric water content was described using the functions of van Genuchten as revised by Woesten and Van Genuchten (1988). The required parameters were estimated based on field measurement; additionally empirical data were used. The relation of N input to N load in leachate was analysed by SAS Proc GLM assuming a quadratic function, where N input was considered as covariable. Data were analysed separately for each site and year since monitoring periods differed due to missing values caused by technical reasons.

## Results and discussion

It is generally assumed that the use of residues from biogas production in crop production would increase yield and consequently decrease the N leaching losses because of their higher NH<sub>4</sub>-N content compared to animal slurries. To test this hypothesis we compared the N load in the leachate after application of biogas residues with application of mineral fertiliser, cattle slurry and pig slurry. The biogas residues used in the present study were somewhat untypical since they had lower NH<sub>4</sub>-N content than cattle slurry and pig slurry (Table 1).

Table 1: Nitrogen and ammonia contents of cattle slurry, pig slurry and biogas residue applied to maize.

	Cattle slurry		Pig slurry		Biogas residue	
	kg m <sup>-3</sup> N	% NH <sub>4</sub> -N	kg m <sup>-3</sup> N	% NH <sub>4</sub> -N	kg m <sup>-3</sup> N	% NH <sub>4</sub> -N
Karkendamm 2007	3.1	54.1	-	-	3.7	51.0
Karkendamm 2008	2.9	64.6	-	-	4.0	53.7
Hohenschulen 2007	-	-	3.7	73.3	3.7	51.0
Hohenschulen 2008	-	-	4.2	65.3	4.0	53.7

The model calibration for the soil water balance resulted in a satisfactory agreement between observed and calculated soil water contents ( $R^2$  0.1-0.6; RMSE 0.03-0.06 cm<sup>3</sup> cm<sup>-3</sup>), which allowed calculation of the N loads. The major form of nitrogen in leachate was nitrate, accounting for at least 94% of total N. The statistical analysis refers only to periods, where measurements of N concentration in the leachate were available for all treatments (Fig. 1). The analysis of covariance using total N input as covariable showed a significant impact of fertiliser type, N input (quadratic term), and interaction between fertiliser type and N input (linear term) on N amount in leachate (not presented). As expected, a significantly higher N load was found for mineral N, while organic fertilisers had similar N losses. When the mineral share of N input was used as covariable, fertiliser type and the interaction between fertiliser type and N input no longer had an effect on N load, which confirms the hypothesis that the mineral share of N input explains most of the variation among the fertiliser types. This is surprising when taking into account that biogas residue produced higher ammonia emission than cattle slurry and pig slurry after field application (Gericke, 2010), while maize yield was similar (not shown). Comparable studies on the N leaching potential of biogas residues are scarce. Pötsch *et al.* (2005) reported significantly lower nitrate concentration in leachate for biogas residue compared to mineral N fertiliser applied on grassland. A lysimeter study on the effect of N losses in wheat reported differences between biogas residue and animal manure depending on the type of soil used (Sächsische Landesanstalt, 1999), with



biogas residue causing lower N losses on a loamy Chernozem. Brenner and Clemens (2005) detected less nitrate loss compared to unfermented slurry under cereals in one out of three leaching periods.

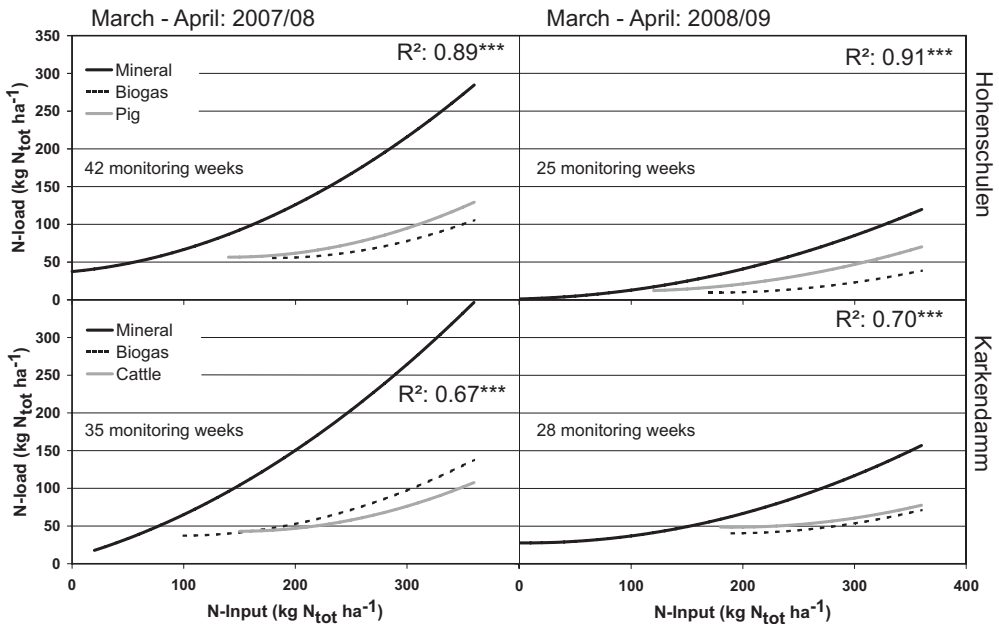

Fig. 1: Relationship of total N input ( $\text{kg ha}^{-1}$ ) and N load in leachate ( $\text{kg ha}^{-1}$ ) as influenced by fertiliser type.

## Conclusion

Application of biogas residue resulted in N losses comparable to animal manure. Potential N losses, however, are underestimated since the monitoring periods did not cover complete years. Therefore, the N balance will be simulated in a next step to allow N loss calculations over the whole 2-year period.

## References

- Brenner A. and Clemens J. (2005) Vergleich der Stoffflüsse mit ökologischer Bilanzierung von zwei Kofermentationsanlagen. Landwirtschaftliche Fakultät der Universität Bonn, Schriftenreihe des Lehr- und Forschungsschwerpunktes USL, Nr. 128. Online available: [http://www.uni-bonn.de/usl/docs/frame\\_pub.html](http://www.uni-bonn.de/usl/docs/frame_pub.html).
- Gericke D. (2010) *Measurement and modelling of ammonia emissions after field application of biogas slurries*. PhD thesis, Univ. of Kiel (in press).
- Kage H. and Stützel H. (1999) An object oriented component library for generic modular modelling of dynamic systems. In: Donatelli C.S.M., Villalobos F. and Villar J. M. (eds.) *Modelling Cropping Systems, ESA Conference*, June 1999, Lleida, pp. 299-300.
- Pötsch E. (2005) Nährstoffgehalt von Gärrückständen aus landwirtschaftlichen Biogasanlagen und deren Einsatz im Dauergrünland. Final report project BAL 2941. Online available: [http://www.raumberg-gumpenstein.at/cms/index.php?option=com\\_docman&task=doc\\_details&Itemid=&gid=1442](http://www.raumberg-gumpenstein.at/cms/index.php?option=com_docman&task=doc_details&Itemid=&gid=1442).
- Sächsische Landesanstalt (1999) Umweltwirkung von Biogasdünger. Abschlussbericht zum Forschungsprojekt. Online available: [http://www.landwirtschaft.sachsen.de/lfl/publikationen/download/1402\\_1.pdf](http://www.landwirtschaft.sachsen.de/lfl/publikationen/download/1402_1.pdf).
- Woesten J.H.M. and van Genuchten M.T. (1988) Using texture and other soil properties to predict the unsaturated soil hydraulic functions, *Soil Science Society of America Journal* 52, 1762-1770.

## **Biogas-Expert: Nitrous oxide emission from biogas production systems on a coastal marsh soil**

Techow A.<sup>1</sup>, Dittert K.<sup>2</sup>, Senbayram M.<sup>2</sup>, Quakernak R.<sup>3</sup>, Pacholski A.<sup>3</sup>, Kage H.<sup>3</sup>, Taube F.<sup>1</sup> and Herrmann A.<sup>1</sup>

*Christian-Albrechts-University of Kiel, D-24118 Kiel*

<sup>1</sup>*Institute of Crop Science and Plant Breeding; Grass and Forage Science/Organic Agriculture*

<sup>2</sup>*Institute of Plant Nutrition and Soil Science*

<sup>3</sup>*Institute of Crop Science and Plant Breeding; Agronomy and Crop Science*

Corresponding author: [atechow@email.uni-kiel.de](mailto:atechow@email.uni-kiel.de)

### **Abstract**

Nitrous oxide (N<sub>2</sub>O) emission was investigated in two biogas substrate production systems (grassland vs. maize-winter wheat-Italian ryegrass rotation) over eight months on a heavy clay soil in the marsh region of Northern Germany. N<sub>2</sub>O flux rates were measured after application of mineral N fertiliser or biogas residue in each system at two N levels (control, oversupply). Gas samples were taken daily after fertiliser applications with successive expansion of the sampling intervals up to one week. N<sub>2</sub>O emission usually followed fertiliser application events in all crops. Overall, cumulative emission was rather low, which may be attributed partly to low precipitation during the vegetation period. Neither the type of N fertiliser nor the biogas production system had a significant effect on N<sub>2</sub>O losses.

Keywords: biogas production, nitrous oxide emission, perennial ryegrass, maize, wheat

### **Introduction**

The production of methane from anaerobic digestion of slurry and/or biomass to generate electricity/heat has greatly expanded in Germany after the introduction of high subsidies in 2004. Due to its high methane yield potential, silage maize is by far the dominant substrate supplier. On marginal sites, however, as in the marsh region of Northern Germany, forage grasses and cereals grown for whole crop silage may outcompete maize with respect to methane yield. Typical marsh-region conditions (high precipitation, high ground water level, clay-rich soils with high water saturation, and low oxygen supply) bear the risk of high denitrification under intensive N fertilisation. Unfortunately, data on N<sub>2</sub>O emissions resulting from crop production under such conditions are scarce. The objective of the current study therefore was to (i) quantify N<sub>2</sub>O emission from grassland, and from two cropping sequences of maize-winter wheat and wheat-Italian ryegrass for a typical marsh site, and (ii) to analyse the N<sub>2</sub>O impact of fertiliser type (biogas residue vs. mineral fertiliser).

### **Materials and methods**

Nitrous oxide emission was monitored from April to December 2009 on a heavy clay soil (25% to 30% clay, Fluvimollic Gleysol, pH 7.0) close to the west coast of Schleswig-Holstein. These measurements were embedded in an ongoing field experiment that was established in 2007 as a randomised complete block design with 4 replicates. The present study considered the impact of cropping sequence (permanent grassland, maize-winter wheat, wheat-Italian ryegrass) and N fertilisation treatment (control, calcium ammonium nitrate (CAN), biogas residue). N rate differed between crops (480 kg ha<sup>-1</sup> for grassland, 240 kg ha<sup>-1</sup> for winter wheat, 200 kg ha<sup>-1</sup> for maize, and 80 kg ha<sup>-1</sup> in Italian ryegrass), and was applied in

one to four dressings. The permanent grassland (*Lolium perenne* cv. Trend) was cut four times a year, while Italian ryegrass was cut once in autumn and then treated with glyphosate. Biogas residue was applied by trail hoses. N<sub>2</sub>O emission was monitored daily after fertiliser applications with successive expansion of the sampling intervals up to one week, using the closed chamber method (Hutchinson and Mosier, 1981) (60 cm diameter). The N<sub>2</sub>O concentrations were determined with a Finnigan cryofocussing-gas chromatograph. Cumulative N<sub>2</sub>O emission was calculated by linear interpolation between measured daily fluxes. Data were analysed statistically by SAS Proc Mixed, where replicate, crop (grassland, maize-winter wheat, wheat-Italian ryegrass), fertilisation treatment (control, mineral N, biogas residue), and the crop × fertilisation treatment interaction were included as fixed factors. Multiple comparisons were conducted by the Tukey-Kramer method.

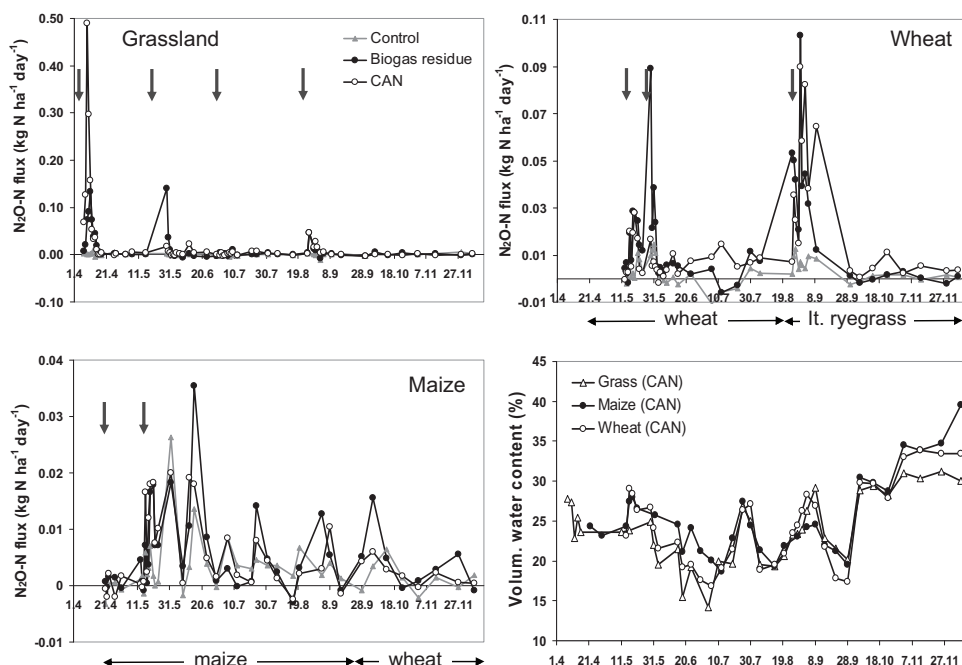

Fig. 1. Daily N<sub>2</sub>O-N fluxes from April to December 2009 for different crops and fertiliser treatments, and soil volumetric water content (upper 10 cm). Maize denotes the maize-winter wheat cropping sequence, while wheat represents the wheat(\*)-Italian ryegrass sequence. (\*summer wheat, since unfavourable conditions in autumn 2008 prevented sowing of winter wheat). Arrows indicate fertilisation events.

## Results and discussion

Nitrous oxide flux pattern mostly followed the fertilisation events in all crops (Fig. 1). In grassland, the largest daily flux was measured in the CAN treatment after the first N dressing, while biogas residue caused higher emission after the second dressing. The remaining two applications had only a small impact. The wheat-Italian ryegrass sequence showed emission peaks after each fertilisation event, where the Italian ryegrass peaks were probably caused in part by soil cultivation preceding the establishment of Italian ryegrass. Consistently, high N<sub>2</sub>O flux rates were detectable for one to two weeks after fertilisation. The maize-winter wheat

sequence was characterised by a very low emission level. The first dressing (50 kg ha<sup>-1</sup>, banded, 5 cm below and 5 cm from the row) did not cause any significant emission, while the application on May 14 (150 kg ha<sup>-1</sup>) showed a small peak, which lasted for about two weeks. In late autumn, no noticeable N<sub>2</sub>O losses could be observed, which is in agreement with Dittert *et al.* (2009), but in contrast to other studies (Kammann *et al.*, 1998).

Cumulative N<sub>2</sub>O emission (Tab. 1) was at a rather low level compared to other studies (Van Groenigen *et al.*, 2004; Dittert *et al.*, 2009). The ratio of N<sub>2</sub>O-N loss to N input was well below the 1% IPCC default value in all treatments. Fertiliser treatment had a significant effect on the cumulative N<sub>2</sub>O emission ( $P = 0.002$ ). No difference was detected between CAN and biogas residue application; both treatments emitted more than the control. It seems likely that this finding is attributable to low soil moisture, which is known to have a great influence on N<sub>2</sub>O emission. In accordance, Senbayram *et al.* (2009) found 5-fold higher fluxes at 85% than 65% water holding capacity, and effects of fertiliser type (CAN vs. biogas residue) were significant only at high soil moisture. The low soil moisture probably also diminished the impact of crop, which showed neither a significant main effect nor a crop × fertiliser interaction, although maize-winter wheat tended towards lower emission (Table 1). In contrast, Dittert *et al.* (2009) reported higher N<sub>2</sub>O losses for maize than grassland on a sandy soil, and higher emission than winter wheat on a sandy loam.

Tab. 1. Cumulative N<sub>2</sub>O-N emission (kg ha<sup>-1</sup>) monitored from April to December 2009 for different crops and fertiliser treatments. Maize denotes the maize-winter wheat cropping sequence, while wheat represents the wheat(\*)-Italian ryegrass sequence. (\*summer wheat, since unfavourable conditions in autumn 2008 prevented sowing of winter wheat).

Crop/Fertiliser treatment	Grassland	Maize	Wheat	Mean
Control	0.22	0.93	0.21	0.45
Mineral N (CAN)	2.00	1.15	2.43	1.86
Biogas residue	1.74	1.18	1.49	1.47
Standard error	0.44	0.44	0.44	0.25

## Conclusion

Our hypotheses stating that biogas substrate production on a coastal marsh soil will cause high N<sub>2</sub>O emission was not confirmed, which most likely was due to low precipitation in the first experimental year. A more comprehensive analysis, taking all N flows (N uptake, ammonia emission, N leaching) into account and supplemented by simulation models, is planned for the future and will provide more detailed insights into the underlying processes.

## References

- Dittert K., Senbayram M., Wienforth B., Kage H. and Mühling K.H. (2009) Greenhouse gas emissions in biogas production systems. UC Davis: *The Proceedings of the International Plant Nutrition Colloquium XVI*. Retrieved from: <http://www.escholarship.org/uc/item/18p5q83f>.
- Hutchinson G.L. and Mosier A.R. (1981) Improved soil cover method for field measurements of nitrous oxide. *Soil Science Society of America Journal* 45, 311-316.
- Kammann C., Grünhage L., Müller C., Jacobi S. and Jäger H.J. (1998) Seasonal variability and mitigation options for N<sub>2</sub>O emissions from differently managed grasslands. *Environmental Pollution* 102, 179-186.
- Senbayram M., Chen R., Mühling K.H. and Dittert K. (2009) Contribution of nitrification and denitrification to nitrous oxide emissions from soils after application of biogas waste and other fertilizers. *Rapid Communications in Mass Spectrometry* 23, 2489-2498.
- Van Groenigen J.W., Kasper G.J., Velthof G.L., Van den Pol-van Dasselaar A. and Kuikman P.J. (2004) Nitrous oxide emissions from silage maize fields under different mineral nitrogen fertilizer and slurry applications. *Plant and Soil* 263, 101-111.

# The evaluation of tall fescue, cocksfoot and reed canary grass as energy crops for biogas production

Tilvikienė V., Kadžiulienė Z. and Dabkevičius Z.

*Institute of Agriculture, Lithuanian Research Centre for Agriculture and Forestry, LT-58344 Akademija, Kedainiai district, Lithuania*

Corresponding author: vita@dobilas.lzi.lt

## Abstract

Cultivation of grasses should contribute to developing more profitable systems dealing not only with plants and animals, but also for people and their needs. Major changes in grassland management and utilization result from socio-economic, technological and political developments and global environmental change. Recently, the demand for biomass for bioenergy and fibre in many countries has been changing the traditional utilization of grasses for forage. Successful development of a bioenergy industry as well as animal husbandry depend on identifying species and cultivars with high yield potential and acceptable biochemical quality. The investigations of cocksfoot (*Dactylis glomerata* L.), tall fescue (*Festuca arundinacea* Schreb.) and reed canary grass (*Phalaris arundinacea* L.) were carried out to evaluate the biomass yield and chemical composition for alternative use of grasses. Four and three cuts per season were combined with two nitrogen fertilization levels. The results suggest that biomass of perennial grasses could be used for biogas production.

Keywords: perennial grasses, biomass yield, C:N, biogas

## Introduction

Grasslands are valued for their considerable contribution to the protection and conservation of soil and water resources. Perennial grasses are a promising stock for the bioenergy sector (Carlier *et al.*, 2009; Prochnow, 2009). The most important task for an agronomist in cultivation of swards for forage and also bioenergy is to choose varieties and species of grasses and cultivation technologies to get the highest biomass yield with defined and predictable nutritional values (Hopkins and Holz, 2006, Heiermann *et al.*, 2009). Recently, the reduction in livestock farms and the availability new farming technologies have prompted the need for alternative ways to utilize grass biomass. The aim in selection of energy crops for biogas production is to achieve the highest methane yield per area. The varieties of grasses significantly differ in yield and chemical composition. As a result, varietal peculiarities have a marked influence on biomass quality as a possible raw material for biogas production (Lemežienė *et al.*, 2009).

The aim of the present study was to estimate the biomass yield and carbon-to-nitrogen ratio of cocksfoot, tall fescue and reed canary grass as a raw material for biogas production.

## Materials and methods

Field and laboratory experiments were conducted in 2009 at the Lithuanian Institute of Agriculture (55°24'N, 23°50'E). The soil of the experimental site is an Endocalcari - Endohypogleyic Cambisol. In 2009, the grass-growing conditions were favourable (Table 1). Cocksfoot (Amba), tall fescue (Navas) and reed canary grass (Chiefton) were harvested three and four times per season. The first cut was taken at heading or flowering growth stages. 90 kg ha<sup>-1</sup> and 180 kg ha<sup>-1</sup> of mineral nitrogen fertilizers were applied. Dry matter yield and carbon-to-nitrogen ratio (C : N) were analysed in biomass of swards in the first year of use.

The total nitrogen and organic carbon were determined using the Dumas method (DIN/ ISO 13878). The yield data were statistically processed using analysis of variance.

Table 1. Temperature and precipitation during the growing season (data from the Dotnuva weather station)

Period	March	April	May	June	July	August	September	October
Mean air temperature C°								
2009	0.9	8.8	12.7	14.6	18.1	16.8	13.9	5.2
1924- 2009	-0.8	5.8	12.2	15.6	17.6	16.7	12.0	6.8
Precipitation mm per month								
2009	53.9	13.1	26.7	168.6	90.0	67.1	48.2	95.4
1924- 2009	28.5	36.9	51.8	62.4	73.4	73.7	51.3	50.2

## Results and discussion

In our study, the results of dry matter yield suggested that grass species had a significant influence on dry matter yield of all cuts and also on annual dry matter yield (Table 2). In Lithuania, cocksfoot is well known as a productive grass (Lemežienė *et al.*, 1998). In our research the annual biomass yield of cocksfoot varied from 9.5 to 11.4 Mg ha<sup>-1</sup> depending on management. In previous experiments the yield of tall fescue was found to reach 12.1 – 13.6 Mg ha<sup>-1</sup> under Lithuanian climatic conditions (Brenčienė, 1995). The results of our research confirmed this. The lowest biomass yield was produced by reed canary grass swards. Nitrogen fertilization did not exert any significant positive impacts on any of the swards. Growth stage of grasses at first cut influenced the biomass yield of this cut and the total annual yield.

Table 2. The influence of swards (A), the level of fertilization (B) and the growth stages of the first cut (C) on dry matter yield of perennial grasses

Swards	Dry matter yield, Mg ha <sup>-1</sup>									
	1 <sup>st</sup> cut		2 <sup>nd</sup> cut		3 <sup>rd</sup> cut		4 <sup>th</sup> cut		Annual	
	N <sub>90</sub>	N <sub>180</sub>	N <sub>90</sub>	N <sub>180</sub>	N <sub>90</sub>	N <sub>180</sub>	N <sub>90</sub>	N <sub>180</sub>	N <sub>90</sub>	N <sub>180</sub>
1 <sup>st</sup> cut at heading stage										
Cocksfoot	3.2	3.1	4.0	4.8	2.6	2.9	0.5	0.6	10.3	11.4
Tall fescue	5.1	5.0	4.5	4.1	3.4	3.5	0.7	0.7	13.7	13.3
Reed canary grass	3.0	3.3	3.7	3.8	2.1	2.1	0.2	0.2	9.0	9.4
1 <sup>st</sup> cut at flowering stage										
Cocksfoot	4.6	4.8	2.8	4.2	2.1	2.3	-	-	9.5	11.3
Tall fescue	8.2	8.1	3.6	3.6	1.7	2.1	-	-	13.5	13.8
Reed canary grass	3.7	3.8	3.9	3.8	0.7	0.7	-	-	8.3	8.3
	Fact C**		Fact C**		Fact C**				Fact. C:NS	
	Int. AB:NS		Int. AB*		Int. AB:NS				Int. AB:NS	
	Int. AC**		Int. AC*		Int. AC**				Int. AC:NS	

Fact. – factor; Int. – interaction; \* and \*\* Significant at the 0.05 and 0.01 probability levels; NS – non-significant differences. Factor A had significant influence on all treatments at the 0.01 probability level; the probability level of factor B and interactions BC and ABC were not significant for all treatments.

To ensure the stability of anaerobic process, the raw-material should have an optimal carbon : nitrogen ratio which could vary from 20 to 30 (Dennis and Burke, 2001). Carbon : nitrogen ratio, which is relevant for the biogas production process, alters significantly in relation to plant growth stages and nitrogen nutrition (Figure 1).

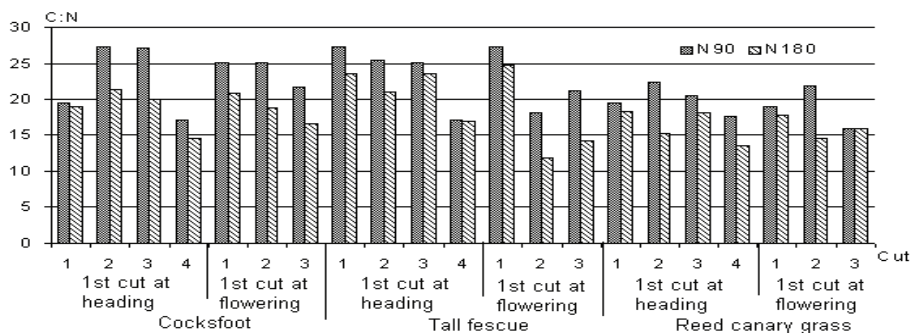

Figure 1. The carbon : nitrogen ratio in the biomass of different grasses in different cuts

The results from the first experimental year suggest that optimal carbon : nitrogen ratio was in cocksfoot and tall fescue biomass at all growth stages. Swards that were fertilized with 180 kg ha<sup>-1</sup> N had lower C:N ratio compared to those fertilized with 90 kg ha<sup>-1</sup> N.

## Conclusions

The highest dry matter yield was produced by tall fescue, while the lowest was by reed canary grass. The effect of grass species exerted the greatest influence on annual biomass yield compared to fertilization and timing of the first cut. Tall fescue biomass was the best for biogas production because it gave the highest biomass yield and optimal carbon to nitrogen ratio.

## Acknowledgements

The study was supported by the Lithuanian State Science and Studies Foundation.

## References

- Brencienė V. (1995) Varpinių žolių palyginimas Vakarų Lietuvos velėniniame jauriniame ir velėniniame jauriniame glejiškame dirvožemyje. *Žemdirbystė: LŽI mokslo darbai* 46, 16–22
- Charlie L., Rotar I., Vlahova M. and Vidican R. (2009) Importance and functions of grassland. *Notulae Botanicae Horti Agrobotanici Cluj-Napoca* 37 (1), 25 – 30.
- Dennis A. and Burke P.E. (2001) *Dairy Waste Anaerobic Digestion Handbook*. 57 p.
- Heiermann M., Plöchl M., Linke B., Schelle H. and Herrmann C. (2009) Biogas Crops – Part I: Specifications and Suitability of Field Crops for Anaerobic Digestion. In: *Agricultural Engineering International: the CIGR E journal*. Manuscript 1087. Vol. XI.
- Hopkins A. and Holz B. (2006) Grassland for agriculture and nature conservation: production, quality and multifunctionality. *Agronomy Research* 4 (1), 3 – 20.
- Lemežienė N., Kanapeckas J., Tarakanovas P. and Nekrošas S. (1998) Daugiamėčių žolių derlingumas bei kitos ūkiškai naudingos savybės. *Žemės ūkio mokslai* 1, 42–47
- Lemežienė N., Kanapeckas J. and Butkute B. (2009) Biodujų gamybai tinkamos paprastosios šunažolės (*Dactylis glomerata* L) veislės, selekcinės linijos ir ekotipai. *Žemdirbystė – Agriculture* 96 (3), 36 – 46.
- Prochnow A., Heiermann M., Plöchl M., Linke B., Idler C., Amon T. and Hobbs P.J. (2009) Bioenergy from permanent grassland – A review: 1. Biogas. *Bioresource Technology* 100, 4931 – 4944.



# Potential of leaching to optimise fuel quality of semi-natural grassland biomass

Tonn B., Thumm U. and Claupein W.

*Universität Hohenheim, Institute of Crop Science (340), 70593 Stuttgart, Germany*

Corresponding author: btonn@uni-hohenheim.de

## Abstract

Energy generation through combustion is a potential alternative use for biomass from species-rich, semi-natural grasslands that are no longer needed for animal feed. Fuel quality (particularly high K, Cl, and N concentrations) is a limiting factor for this utilisation strategy. Precipitation during the field drying period is thought to improve the quality of herbaceous biomass fuels by leaching unwanted elements. The leaching potential of K, Cl and N was determined for biomass from five semi-natural grasslands by a laboratory method for standardised assessment. While N was hardly leached from the biomass, both K and Cl had a high leaching potential of up to 55-82%. This is comparable to that found in other studies for rice or cereal straw and perennial energy grasses. In practice, the field period is limited by the regrowth below the swaths. If the probability of sufficient rainfall during this field period is high, then leaching offers a low-cost strategy for fuel quality optimisation of grassland biomass.

Keywords: bioenergy; combustion; semi-natural grassland; fuel quality leaching

## Introduction

Biomass from many biodiversity-rich, semi-natural grasslands is no longer needed as forage for livestock. It may be used to generate energy via combustion (Prochnow *et al.*, 2009). The elemental composition of herbaceous biofuels, however, may have negative effects during the combustion process. Particularly important issues are ash-related problems such as slagging and fouling due to high K and low Ca concentrations, corrosion processes due to high K, Cl and S concentrations, and emissions of NO<sub>x</sub>, SO<sub>2</sub> and HCl due to high fuel N, S and Cl contents (Oberberger *et al.*, 2006). There are few strategies to optimise the fuel quality of semi-natural grassland biomass. In contrast to other herbaceous biofuels, choice of species or varieties or variation of fertiliser application and harvest date are either not possible or offer only a limited scope if the botanical composition of the grassland is to be maintained.

Leaching of detrimental elements by precipitation during the field drying period could offer a low-cost strategy for quality-optimisation, with minimal effects on the botanical composition. Leaching by both natural rainfall (Hernández Allica *et al.*, 2001; Bakker and Jenkins, 2003) and a variety of washing techniques (Jenkins *et al.*, 1996; Dayton *et al.*, 1999) were shown to decrease consistently the K and Cl concentrations in cereal straw, rice straw, banagrass (*Pennisetum purpureum* Schumach.) and switchgrass (*Panicum virgatum* L.). Ash, N and S concentrations were also reduced in some cases. All the above-mentioned biofuels were harvested when either dead or senescent, whereas the majority of semi-natural grasslands are traditionally mown when the largest part of the biomass is living. This may have a strong influence on the leaching potential. It also leads mostly to far higher nitrogen concentrations in semi-natural grassland biomass at harvest, constituting a serious obstacle for combustion. The aims of this study were, therefore, to assess: a) whether K and Cl are leached from semi-natural grassland biomass, and in sufficient amounts to reduce ash-related problems, and b) whether the high N concentration of semi-natural grassland biomass can also be reduced by leaching. Since variations in rainfall characteristics, such as drop size or intensity, can

strongly influence leaching intensity (Smith and Brown, 1994), a laboratory method was used to simulate leaching under field conditions, with the purpose of standardisation.

### Material and methods

Biomass was harvested on 2 and 3 July 2007 from an area of approximately 10 m<sup>2</sup> at each of five species-rich semi-natural grassland sites in southwest Germany. Sites 1 and 2 were dry calcareous grasslands usually cut once a year; sites 3 to 5 were hay meadows usually cut once or twice a year (site 3 being a dry, site 4 an intermediate, and site 5 a wet hay meadow). None of the grassland sites had been fertilized for at least 10 years, except site 4, which is regularly fertilized with cattle manure (for details see Tonn *et al.*, 2008). The harvested biomass from each site was dried at 60 °C, cut to approximately 5 cm length and mixed to improve homogeneity. Samples of 30 g each were weighed into 1-litre wide-neck LDPE bottles. The bottles were then filled with tap water (electric conductivity: 277 µS cm<sup>-1</sup>) and immediately placed on a laboratory shaker set at 75 rounds per minute. After the end of a leaching period of either 10 minutes (treatment 1) or 120 minutes (treatment 2) the bottles were immediately emptied into plastic trays lined with a fine mesh cloth to prevent loss of biomass material, and left to drain. Previous experiments (Henrici *et al.*, 2007) showed that treatment 1 corresponded to approximately 30–40 mm of precipitation, while treatment 2 was equivalent to a precipitation of more than 70 mm. Samples were then dried at 60 °C and ground to pass a 1-mm sieve. Four replicate samples for each site x leaching treatment, as well as four unleached control samples per site, were analysed for N by combustion in a CNS analyser, for K by flame photometry after microwave digestion, and for Cl by ion chromatography after hot-water extraction. Data were subjected to an analysis of variance using site, leaching treatment and their interaction as fixed effects. Means were compared using Tukey's HSD.

### Results and discussion

Leaching for 10 minutes reduced the potassium concentration of biomass from all five sites significantly ( $P < 0.001$ ), by 22–38% of the initial concentration. Another significant reduction ( $P < 0.001$ ) occurred under the 120-minute leaching treatment, constituting 55–68% of the initial concentration. Chlorine was leached even more strongly, with reductions of 30–54% of the initial concentration after 10 minutes, and 64–82% after 120 minutes of leaching. Differences between control and treatment 1 as well as between treatments 1 and 2 were significant ( $P < 0.001$ ) for biomass from all sites, except for site 5, where Cl concentrations of treatments 1 and 2 were not significantly different. N concentrations of biomass from all sites were not significantly changed ( $P > 0.10$ ) by either of the leaching treatments. In practice, considerable variations in the leaching effect of an identical amount of precipitation may be expected, depending on rain intensity and duration and on swath characteristics.

Hernández Allica *et al.* (2001) found a 60–70% reduction of K and a 75–85 % reduction of Cl concentrations in wheat straw after a cumulative rainfall of about 140 mm, resulting in final K and Cl concentrations comparable to those reached after treatment 2 of the present study. Jenkins *et al.* (1996) found that wheat and rice straw soaked for 24 hours in distilled water lost over 80% of their initial K and over 90% of their initial Cl concentration. For these two elements, therefore, the leaching potential of semi-natural grassland biomass seems similar to that of rice or cereal straw. While Jenkins *et al.* (1996) found only small reductions in N concentration in rice and wheat straw after leaching, Dayton *et al.* (1999) reported that N concentrations in switchgrass were reduced from 0.31 to 0.17% after leaching in distilled water. In the present study, the initial N concentration was two to four times as high as that of straw or switchgrass in the two above-mentioned studies, and was not reduced by leaching.

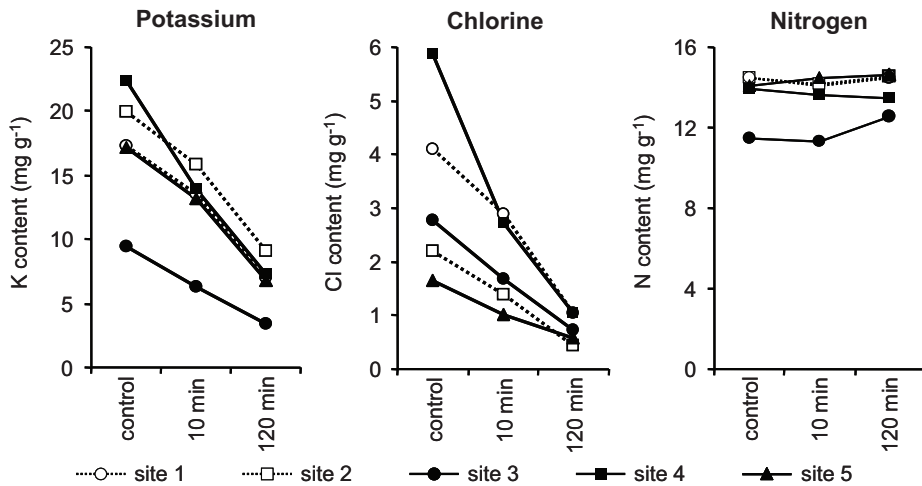

Figure 1: Potassium, chlorine and nitrogen concentrations of biomass from five semi-natural grassland sites without leaching (control) and after a leaching period of 10 or 120 minutes.

## Conclusions

The results of this study indicate that K and Cl concentrations in semi-natural grassland biomass can be as efficiently reduced by leaching as those in rice and cereal straw, which will lead to lower ash-related problems during combustion. In contrast to straw and perennial energy grasses, N concentrations also cause difficulties in grassland biomass. According to our results this problem cannot be overcome by leaching. Field periods of several weeks or months are possible for perennial energy grasses and, crop sequence permitting, for rice and cereal straw too. In contrast, the field period for semi-natural grassland biomass is limited by the regrowth below the swaths. A high probability of sufficient rainfall during a short field period is therefore a precondition for quality optimisation of grassland biomass by leaching.

## References

- Bakker R.R. and Jenkins B.M. (2003) Feasibility of collecting naturally leached rice straw for thermal conversion. *Biomass and Bioenergy* 25, 597-614.
- Dayton D.C., Jenkins B.M., Turn S.Q., Bakker R.R., Williams R.B., Belle-Oudry D. and Hill L.M. (1999) Release of inorganic constituents from leached biomass during thermal conversion. *Energy and Fuels* 13, 860-870.
- Henrici V., Tonn B., Thumm U. and Claupein W. (2007) Erfassung der Auswaschung von verbrennungsrelevanten Inhaltsstoffen aus Grünlandaufwüchsen durch simulierten Regen. *Mitteilungen der Arbeitsgemeinschaft Grünland und Futterbau* 8, 205-208.
- Hernández Allica J., Mitre A.J., González Bustamante J.A., Itoiz C., Blanco F., Alkorta I. and Garbisu C. (2001) Straw quality for its combustion in a straw-fired power plant. *Biomass and Bioenergy* 21, 249-258.
- Jenkins B.M., Bakker R.R. and Wie J.B. (1996) On the properties of washed straw. *Biomass and Bioenergy* 10, 177-200.
- Obernberger I., Brunner T. and Bärnthaler G. (2006) Chemical properties of solid biofuels – significance and impact. *Biomass and Bioenergy* 30, 973-982.
- Prochnow A., Heiermann M., Plöchl M., Amon T. and Hobbs P.J. (2009) Bioenergy from permanent grassland – A review: 2. Combustion. *Bioresource Technology* 100, 4945-4954.
- Smith D.M. and Brown D.M. (1994) Rainfall-induced leaching and leaf losses from drying alfalfa forage. *Agronomy Journal* 86, 504-508.
- Tonn B., Thumm U. and Claupein W. (2008) Suitability of low-intensity grassland for combustion as influenced by grassland community and harvest date. *Grassland Science in Europe* 13, 751-753.
- VDLUFA (2000) *Methodenbuch*, Vol 1, VDLUFA, Bonn, Germany.

# Improving grasslands of *Agrostis capillaris* and *Festuca rubra* in the Carpathian Mountains of Romania by organic fertilization

Vintu V.<sup>1</sup>, Samuil C.<sup>1</sup>, Popovici I.C.<sup>1</sup> and Saghin G.<sup>2</sup>

<sup>1</sup> University of Agricultural Sciences and Veterinary Medicine of Iasi, Romania

<sup>2</sup> Agricultural Research and Development Station of Suceava, Romania

Corresponding author: vvintu@uaiasi.ro

## Abstract

In Romania, grasslands occupy over 4.8 million ha, of which more than half are in the mountainous areas. In the intra-mountainous Depression of Campulung – Suceava County, in the North-Eastern Carpathians of Romania (770 m a.s.l.), we have investigated the influence of organic fertilizers on productivity, vegetal canopy and crude protein content, for application rates of 10-40 Mg ha<sup>-1</sup> and for three frequencies of application of cattle manure: every year, every 2-3 years, or by split application. The goal of this scientific paper was to emphasize the dynamics of productivity and the vegetal canopy composition, by the application of some technical and practical measures for improving the fodder production and the canopy of *Agrostis capillaris* and *Festuca rubra* in permanent grasslands, with a minimum impact on the environment. The applied fertilizers have determined changes in the dominant species of *Agrostis capillaris* and *Festuca rubra* in grasslands, by increasing the percentage of *Trisetum flavescens* and *Trifolium repens* by 1-9% and 2-15%, respectively, and the productivity by 22-28%, compared to the unfertilized control.

Keywords: grassland, fertilization, productivity, vegetal canopy

## Introduction

In Romania, permanent grassland is generally situated on degraded, poorly productive lands, and it has an unsuitable botanical composition. The yields obtained are low and of poor quality. Balanced fertilization and rational use of fertilizers are basic measures for improving grassland (Peeters and Kopec, 1996; Hopkins *et al.*, 1999; Elsaesser *et al.*, 2008). Organic fertilization and rational use of fertilizers can produce substantial increases in the production and biodiversity, and in fodder quality improvement (Vintu *et al.*, 2008).

## Materials and methods

A trial was carried out on *Agrostis capillaris* and *Festuca rubra* grassland in the mountainous region of the Campulung Depression, Suceava County, Romania, where fodder from the grassland is mainly used for feeding dairy cattle. Organic fertilization was used as an experimental factor, with fertilizer manure rates that varied between 10 and 40 Mg ha<sup>-1</sup>. The unfermented manure, had a content of 440 mg kg<sup>-1</sup> total N, 160 mg kg<sup>-1</sup> P, 310 mg kg<sup>-1</sup> K and 300 g kg<sup>-1</sup> DM, and was applied manually in very early spring, at the beginning of grass growth. The experimental design consisted of randomized blocks with four replicates, and manuring treatments were compared to an unfertilized control. The vegetation was studied by common geobotanical methodology by means of a 25 m<sup>2</sup> vegetation framework. Crude protein was determined by the Kjeldahl method. Eight variants of organic fertilization were used:

V1, control (unfertilized)

V2, 10 Mg ha<sup>-1</sup> cattle manure applied every year

V3, 20 Mg ha<sup>-1</sup> cattle manure applied every two years

V4, 30 Mg ha<sup>-1</sup> cattle manure applied every three years

V5, 20 Mg ha<sup>-1</sup> cattle manure applied in the first year + 10 Mg ha<sup>-1</sup> in the second year and no cattle manure applied in the third year;

V6, 20 Mg ha<sup>-1</sup> cattle manure applied in the first year + no cattle manure applied in the second year, and +10 Mg ha<sup>-1</sup> cattle manure applied in the third year

V7, 20 Mg ha<sup>-1</sup> cattle manure applied in the first year + 10 Mg ha<sup>-1</sup> cattle manure applied in the second year + 10 Mg ha<sup>-1</sup> cattle manure applied in the third year

V8, 10 Mg ha<sup>-1</sup> cattle manure applied in the first year + 20 Mg ha<sup>-1</sup> cattle manure applied in the second year + 10 Mg ha<sup>-1</sup> cattle manure applied in the third year.

Dominant grasses in the hayfields were harvested at the ear formation stage, and determinations were carried out at the first cycle of vegetation. Chemical analysis of the sward was carried out on samples taken from the first harvest cycle. The analysed data were the mean values for years 2006-2008.

## Results and discussion

In the grassland, which was made up of *Agrostis capillaris* and *Festuca rubra*, 46 species were found, of which 11 were grasses, 8 legumes and 27 species from other botanical families; the dominant species were *Agrostis capillaris* (19%) and *Festuca rubra* (7%), followed by *Trisetum flavescens* (4%), *Anthoxanthum odoratum* (3%) and *Trifolium repens* (10%).

Table 1. Influence of fertilization on biodiversity and percentage of main canopy species (%)

Species	V1	V2	V3	V4	V5	V6	V7	V8
<i>Agrostis capillaris</i>	19	13	14	11	10	10	13	12
<i>Festuca rubra</i>	7	3	4	3	2	2	2	2
<i>Cynosurus cristatus</i>	2	7	5	5	4	5	3	4
<i>Arrhenatherum elatius</i>	3	4	5	6	9	5	2	4
<i>Anthoxanthum odoratum</i>	3	1	2	1	+	2	2	1
<i>Trisetum flavescens</i>	4	5	6	6	7	9	13	7
<i>Briza media</i>	3	3	2	2	1	2	+	+
Grasses	47	39	43	37	34	43	36	32
<i>Trifolium repens</i>	10	12	15	17	20	12	16	25
<i>Trifolium pratense</i>	5	9	7	7	10	6	12	8
<i>Lotus corniculatus</i>	5	7	7	8	4	9	4	3
Legumes	21	33	30	32	36	27	32	36
<i>Chrysanthemum leucanthemum</i>	6	5	5	5	4	6	6	8
<i>Taraxacum officinale</i>	4	4	+	7	8	6	6	4
<i>Prunella vulgaris</i>	3	3	2	2	3	5	5	3
<i>Achillea millefolium</i>	4	3	3	3	1	1	1	1
<i>Filipendula sp.</i>	5	4	6	7	5	4	3	4
Forbs	32	27	21	29	27	29	32	30
Coverage %	100	99	94	98	97	99	100	98
Gaps %	0	1	6	0	3	1	0	2
Number of species	46	41	32	37	32	34	34	33

After three years of organic fertilization (10-40 Mg ha<sup>-1</sup>), the changes found in the botanical composition were as follows: there was a decrease by 5-9% in *Agrostis capillaris* and by 3-5% in *Festuca rubra*, and an increase by 1-9% in *Trisetum flavescens*, by 1-5% in *Cynosurus cristatus*, by 2-15% in *Trifolium repens* and by 1-7% in *Trifolium pratense*. Grasses comprised 32-43% of the vegetation, while legumes were 27-36% and the species from other botanical families were 21-32% (Table 1). The total number of species decreased with 4-14 species in the fertilized variants, according to the rates and the type of applying cattle manure: every year, two-three year or split application (Table 1).

In *Agrostis capillaris-Festuca rubra* grassland, organic fertilization resulted in a DM yield increase of 22-28% compared to the unfertilized control, and an increase of crude protein content in DM from 89.3 g kg<sup>-1</sup> for the control, up to 108.9 g kg<sup>-1</sup> in the case of the treatment which received 20 Mg ha<sup>-1</sup> manure applied in the first year +10 Mg ha<sup>-1</sup> applied in the second year. The split application of cattle manure did not result in a significant increases of crude protein content in the first cycle of production, except for the treatment with 20 Mg ha<sup>-1</sup> cattle manure applied in the first year + 10 Mg ha<sup>-1</sup> cattle manure applied in the second year (Table 2).

Table 2. Influence of organic fertilization on dry matter (DM) yield, crude protein content (CP) and CP quantity (kg ha<sup>-1</sup>) in the fodder obtained from grasslands made up of *Agrostis capillaris* and *Festuca rubra*

Treatment	Yield Mg ha <sup>-1</sup>	%	CP in DM g kg <sup>-1</sup>	CP kg ha <sup>-1</sup>
V1 (control)	3.55	100	89.3	317
V2	4.32**	122	94.5**	408
V3	4.36**	123	101.6***	443
V4	4.48***	126	95.1**	426
V5	4.47***	126	108.9***	487
V6	4.52***	127	92.7*	419
V7	4.55***	128	97.4***	443
V8	4.51***	127	96.1***	433

\* =  $P \leq 0.05$ ; \*\* =  $P \leq 0.01$ ; \*\*\* =  $P \leq 0.001$ ; NS = not significant

## Conclusions

The management of permanent grasslands, in terms of usage, type and intensity of manure fertilization and control method has a great influence on biodiversity, on species rate in the structure of vegetation and on the dominance of species in the canopy.

Organic fertilization with cattle manure resulted in changes in the botanical composition, by diminishing the contribution of *Agrostis capillaris* by 5-9% and of *Festuca rubra* by 3-5%, and by increasing the contribution of *Trisetum flavescens* by 1-9%, of *Cynosurus cristatus* by 1-5%, of *Trifolium repens* by 2-15% and of *Trifolium pratense* by 1-7%. The total number of species decreased by between 4 and 14. The manure rates in the treatments tested, and the frequency of cattle manure application (every year, every two-three years, or split application) significantly affected the DM yield and crude protein increases, compared to the unfertilized control, but there was only a little differentiation between the tested treatments. Therefore, on small and middle-sized farms, where relatively small quantities of cattle manure are obtained every year, the split application system may be used with good results (variants 5-8).

## References

- Elsaesser M., Kunz H.G. and Briemle G. (2008) Strategy of organic fertilizer use on permanent grassland – results of a 22-year-old experiment on meadow and mowing-pasture. *Grassland Science in Europe* 13, 580-582.
- Hopkins A., Pywell R.F., Peel S., Johnson R.H. and Bowling P.J. (1999) Enhancement of botanical diversity of permanent grassland and impact on hay production in Environmentally Sensitive Areas in the UK. *Grass and Forage Science* 54, 163-173.
- Peeters A. and Kopec S. (1996) Production and productivity of cutting grasslands in temperate climates of Europe. *Grassland Science in Europe* 1, 59-73.
- Vintu V., Samuil C., Sarbu C, Saghin Gh. and Iacob T. (2008) The influence of grassland management on biodiversity in the mountainous region of NE Romania. *Grassland Science in Europe* 13, 183-185.

## **Session 2.2**

### **The role of genetic resources**

*Editor: Antje Herrmann*



# The effect of evaluation protocol on the dry matter yield performance of *Lolium perenne* varieties

McEvoy M., O'Donovan M., Wims C. and Kennedy E.

Moorepark Dairy Production Research Centre, Fermoy, Co. Cork, Ireland.

Corresponding author: mary.mcevoy@teagasc.ie

## Abstract

An experiment was undertaken to identify the effect of management on the performance of perennial ryegrass (*Lolium perenne* L.) varieties. Twelve perennial ryegrass varieties were sown as monocultures. Three managements were imposed on the plots across 3 years representing a simulated grazing system with 10 defoliations (SG; 10 defoliations), a 2-cut conservation system, with 2 silage cuts and four simulated grazing defoliations (2CS; 6 defoliations) and a 3-cut conservation system, with 3 silage cuts and 2 simulated grazing defoliations (3CS; 5 defoliations). Results show an interaction ( $P < 0.001$ ) between management and variety. A change in the rank order of the varieties relative to the mean dry matter (DM) yield ( $\text{t ha}^{-1}$ ) was evident depending on which management a variety was exposed to. These results highlight that certain varieties are suited to grazing-only systems, while other varieties are more suited to use in silage systems. The evidence of re-ranking of cultivars based on their total DM production highlights the need to ensure that grass varieties are evaluated using the optimum protocol to represent the current and anticipated future needs of the industry.

Keywords: *Lolium perenne*, variety evaluation, defoliations, DM yield.

## Introduction

Eighty per cent of the world's cow milk and 70% of the world's beef and veal are produced from temperate grasslands (Wilkins and Humphreys, 2003). Perennial ryegrass (*Lolium perenne* L.) is considered the most important forage grass species used in temperate agriculture for ruminant animal production. In Ireland, the relative cost of grass on an energy basis relative to grass silage and concentrate is 1: 2.7: 3.7 (Kavanagh, *et al.*, 2008). Internationally, grass variety evaluation protocols are widely used to identify the varieties which are most suitable to conditions within that particular country. Following evaluation of individual varieties, the results of those that achieve satisfactory performance are generally made available on official recommendation lists, allowing farmers to make an informed decision on the variety most suited to their individual production systems. Throughout many European countries grass variety evaluation programmes incorporate a mixed grazing- and conservation-based protocol. Such protocols have a reduced number of cuts across the year compared to simulated grazing protocols and generally have between one and three cuts representing silage harvests. Fulkerson *et al.* (1994) reported a significant interaction between variety and defoliation management on dry matter (DM) yield, indicating that the type of management imposed influences the performance of a variety. The objective of this study was to evaluate the effect of simulated grazing and conservation managements under cutting on the DM yield performance of perennial ryegrass varieties.

## Materials and methods

One-hundred and eight plots ( $5 \text{ m} \times 1.5 \text{ m}$ ) were sown with twelve varieties of perennial ryegrass in autumn 2006 in a randomised block design. Four diploid varieties were used with

the following heading dates: Alto (15 May), Arrow (22 May), Portrush (14 June) and Tyrella (8 June) and eight tetraploids were used: Bealey (22 May), Dunloy (8 June), Dunluce (31 May), Glencar (6 June), Greengold (31 May), Lismore (28 May), Malone (22 May) and Navan (9 June). Three managements were imposed representing simulated grazing (SG); 2-cut silage (2C) and 3-cut silage (3C). Within each management each variety was replicated 3 times. The SG consisted of ten defoliations, beginning on 20<sup>th</sup> March and then every three to four weeks until the final harvest in late October. The 2C consisted of six defoliations beginning on 1<sup>st</sup> April, with 2<sup>nd</sup> and 3<sup>rd</sup> cuts taken after seven and six week intervals, and the final three cuts taken at intervals of four, five and six weeks, respectively. The 3C treatment consisted of five cuts with the first cut taken at 25<sup>th</sup> May (approx.), the 2<sup>nd</sup> and 3<sup>rd</sup> taken after six week intervals and the final two cuts on 1<sup>st</sup> Sept. and 1<sup>st</sup> Oct. Plots were harvested with a motor Agria (Etesia) scythe to 4 cm across three full growing seasons, 2007 (Y1), 2008 (Y2) and 2009 (Y3). All mown herbage from each plot was collected and weighed. Approximately 0.1 kg herbage was dried for 48 h at 40 °C to determine the DM content. The data were analysed by repeated measures analysis using PROC MIXED in SAS regarding the effects of year, cultivar, management and their interactions.

## Results and discussion

There was a significant effect ( $P < 0.001$ ) of year on DM yield, in Y1 average DM yield across all treatments and varieties was 13.8 t ha<sup>-1</sup> compared to 13.5 and 15.9 t ha<sup>-1</sup> in Y2 and Y3, respectively. Management had a significant effect ( $P < 0.001$ ) on total DM yield. Average DM yield was lowest for the SG treatment (12.2 t ha<sup>-1</sup>) compared to the 2C (15.2 t ha<sup>-1</sup>) and 3C (15.8 t ha<sup>-1</sup>). This is similar to the findings of Gilliland and Mann (2000) who reported higher yields under silage cutting systems compared to simulated grazing. There was a significant interaction between variety and management ( $P < 0.01$ ) on total DM yield. Table 1 presents the effect of management on total annual DM yield for the 12 varieties and the ranking of each variety within each management system. In the SG, Bealey and Tyrella ranked 1<sup>st</sup> and 2<sup>nd</sup>; however, as silage cutting was introduced their performance dropped and they ranked 8<sup>th</sup> and 10<sup>th</sup> in the 2C treatment compared to 9<sup>th</sup> and 10<sup>th</sup> in the 3C treatments. Malone, ranked 10<sup>th</sup> overall in the SG treatment compared to 5<sup>th</sup> and 1<sup>st</sup> in the 2C and 3C treatments, respectively. Other varieties such as Glencar, Greengold and Navan did not appear to rerank under changes in management type. This agrees with Gilliland and Mann (2000) who reported a change in the ranking of varieties between simulated grazing and a silage management. The evaluation protocol significantly affects the performance of a variety and results indicate that the protocol in place must closely reflect the conditions under which a variety will be grown and utilised. This agrees with Laidlaw and Reed (1993) who reported that the evaluation criteria should be appropriate to the conditions and use of the species for a given region. Gilliland and Mann (2000) also reported that when treatments switched from one year to the next in a 3-year study (e.g. 3C-SG-3C) variety ranking remained unchanged between treatments compared to the constant treatment (e.g. 3C or SG). This could potentially provide the opportunity for 3-year evaluations to occur and switch between managements, therefore reducing plot numbers by avoiding separate management systems within each year of the evaluation when evaluation is necessary under both simulated grazing and conservation systems. The evidence of re-ranking of cultivars based on their DM production highlights the need to ensure that grass varieties are evaluated using the optimum protocol to represent the current and anticipated future needs of the industry. The early and intermediate heading varieties (heading in May) generally ranked higher under the silage managements than the late heading varieties which tended to rank higher under the simulated grazing managements.

Table 1. Total annual simulated grazing or conservation dry matter yields (t ha<sup>-1</sup>; values are means of 3 years), with their performance ranking relative to the management

	Simulated grazing		2-cut silage system		3-cut silage system	
Alto	12.2	(5)	14.9	(9)	16.4	(2)
Arrow	12.5	(3)	15.9	(2)	15.7	(6)
Bealey	13.0	(1)	15.0	(8)	15.4	(9)
Dunloy	12.2	(6)	14.6	(12)	15.2	(12)
Dunluce	12.4	(4)	16.1	(1)	15.4	(11)
Glencar	12.0	(7)	15.4	(7)	15.5	(8)
Greengold	12.0	(8)	15.5	(4)	15.7	(5)
Lismore	11.8	(11)	15.5	(3)	15.9	(4)
Malone	11.9	(10)	15.4	(5)	16.9	(1)
Navan	11.9	(9)	15.4	(6)	15.6	(7)
Portrush	11.7	(12)	14.6	(11)	16.4	(3)
Tyrella	12.8	(2)	14.9	(10)	15.4	(10)
Significance	<i>P</i> value	SE*				
Management	<0.001	0.09				
Variety	NS*	0.19				
Management × variety	<0.01	0.32				

\*SE Standard Error, NS Not Significant

## Conclusion

The evaluation protocol significantly affects the performance of a variety, a large number of varieties reranked between simulated grazing and conservation managements. This highlights the need to ensure the protocol in place reflects grazing managements on farm to ensure the varieties most suited to the system are being identified during cultivar evaluations. In countries where intensive grazing is practised, and silage is used as a source of winter feed, two managements may need to be imposed to identify the optimum variety for two separate systems.

## Acknowledgements

The authors wish to acknowledge funding received by the Department of Agriculture, Fisheries and Food Research Stimulus Fund. The authors also wish to acknowledge technical assistance provided by Mr. M. Feeney, F. Flynn and J. Nash.

## References

- Fulkerson W.J., Slack K. and Lowe K.F. (1994) Variation in the response of *Lolium* genotypes to defoliation. *Australian Journal of Agricultural Research* 45, 1309-1317.
- Gilliland T.J. and Mann R.L. (2000) Effect of sward cutting management on the relative performance of perennial ryegrass varieties. *Journal of Agricultural Science, Cambridge* 135, 113-122.
- Laidlaw A.S. and Reed K.F.M. (1993) Plant improvement: the evaluation and extension processes. In: *Proceedings of the XVII International Grassland Congress*, New Zealand and Australia, pp. 385-392.
- Kavanagh S., Patton J. and Murphy J. (2008) Feed costs 2008. In: *Proceedings of the Teagasc National Liquid Milk Conference*, Teagasc, Dublin Ireland, pp. 10-21.
- Wilkins P.W. and Humphreys M.O. (2003). Progress in breeding perennial forage grass for temperate agriculture. *Journal of Agricultural Science* 140, 129-150.

## **A system to optimize forage crop variety trials for regionalized Recommended Lists in Germany**

Hartmann S.

*Institute of Crop Husbandry and Plant Breeding (IPZ) of the Bavarian State Research Centre for Agriculture (LfL), Am Gereuth 8, 85354 Freising, Germany*

Corresponding author: Stephan.Hartmann@lfl.bayern.de

### **Abstract**

The expenses for testing crop varieties are an increasing burden on all involved. This often leads to staff reduction in governmental institutions engaged in this activity. In many cases the result has been a decline in the density of testing, especially for so-called ‘minor crops’ like forage crops. However, a functioning system of field trials is the basis of any scientifically validated improvement in crop production. To make the federal system of variety trials for forage crop varieties in Germany more efficient, a new system of trials was implemented by a group of agricultural research centres in the mid and south of Germany. This system integrates crop-specific extra trials with design-checking characteristics of special interest, such as persistence and resistance. The data of the trials for registration are used as a first check for their dedication to the local target environment, and varieties can be grouped depending on these data. In consequence for each group, the scope of testing in expensive yield trials can be adjusted to the expected dedication to the local target environment. The result is a well nested system of coordinated unbalanced field trials.

Key words: forage, crop variety trials, statistic, unbalanced design

### **Introduction**

A functioning system of field trials is the basis of any scientifically validated improvement in crop production. Ultimately, all statements and advice are based on accurate field trials. Hence, saving the necessary functionality in this area of applied research is of special interest.

### **Overview of the system**

General principles and their crop specific implementation of the new system of variety trials for forage species were described in detail by Hartmann and Hochberg (2007). Therefore only a short overview of the system for perennial ryegrass (*Lolium perenne* L.) is given. The crop-specific maps into ‘producing areas’ harmonised for Germany were published by Graf *et al.* (2009). They are also available online (<http://geoportal.jki.bund.de/bodenklima.htm>).

The regional field trials (LSV Landessortenversuch) of the working group ‘middle south’ and the producing areas of forage species no 6: sommertrockene Lagen (Summer-dry sites), no 7: günstige Übergangslagen (Uplands), no 8: Hügelländer (Hilly country), no 9: Mittelgebirgslagen West (Mountain region West), no 10: Mittelgebirgslagen Ost (Mountain region East) and no 11: Voralpengebiet (Prealpine region) were included in this evaluation.

For establishing a sustainable system of regional field trials for English ryegrass, there is a necessity for an early and clear limitation to the number of records available for ranking cultivars for a validated advice to farmers. Candidate varieties are increasing by numbers, however, in contrast to corn or maize for which the date from the first vegetation can be used to select and to limit the group of newly listed varieties for LSV trials, the selection of entries in perennial ryegrass has to be done before the first vegetation. The varieties in these trials were grouped according to the rules published 2006 (Hartmann *et al.*, 2006) and 2007

(Hartmann and Hochberg, 2007). In 2006, the first forage crop trials were sown in this new design.

In contrast to major crops like wheat, the number of sites for forage crops trials used for registration in Germany ('WP' 'Wertprüfung') has been drastically limited at present to ten. So the supplementation of the database of local variety trials (LSV) by WP-trial data can only be done in some regions. However, the data of WP trials – especially the new specifically designed forage trials discussed by Hartmann *et al.* (2006) – can be used as a first check of suitability of the new varieties to local target environment and grouped depending on these data. In consequence, the scope of testing in expensive yield trials can be adjusted to the expected suitability to the local environment. The result is a well-nested system of coordinated unbalanced field trials. This gave governmental institutions the chance to keep or even to re-establish a standard of field trials for forage crops at least close to the level of the so-called 'major crops'. First results are presented hereafter for a forage species (*Lolium perenne*) regionalized to 'producing areas' in Germany (statistics under the terms of Michel *et al.*, 2007).

## Results and discussion

Table 1 shows large differences of forage yield over the producing areas, but these differences also vary in a large range. The values are clustered in the expected range predicted by experience of climate und soil data. For example the data of producing area 11 and 10 are more correlated (0.660) than producing area 11 and 6 (0.287).

Table 1. Correlation of dry matter yield of the first main harvest year (2007) between areas of forage production – LSV-data for perennial ryegrass collected by the working group 'middle-south'

		producing area					
		6	7	8	9	10	11
producing area	6		0.244	0.324	0.155	0.345	0.287
	7	0.244		0.529	0.253	0.562	0.468
	8	0.324	0.529		0.336	0.746	0.620
	9	0.155	0.253	0.336		0.357	0.297
	10	0.345	0.562	0.746	0.357		0.660
	11	0.287	0.468	0.620	0.297	0.660	

(63 varieties included; confidence interval 5%)

In Figure 1 dry matter yield between varieties differ within each producing area about 15 to 20 percent - the equivalent of a second or third cut yield. Producing areas with little correlation show big differences in the ranking of varieties. Even the arrangement of maturity groups differ between producing areas. For example, a high yielder in area 11 such as 'Eurostar' becomes a 'mid-ranger' in area 7. It seems that varieties with early heading dates have some advantage in area 11 (a region with shorter growing season). In area 7, varieties of intermediate maturity were ranked the first.

This underlines the importance and the advantage of regionalised analysis and interpretation of LSV datasets for recommendation.

More details concerning these trials are available online, for example at <http://www.lfl.bayern.de/ipz/gruenland/09212/index.php>.

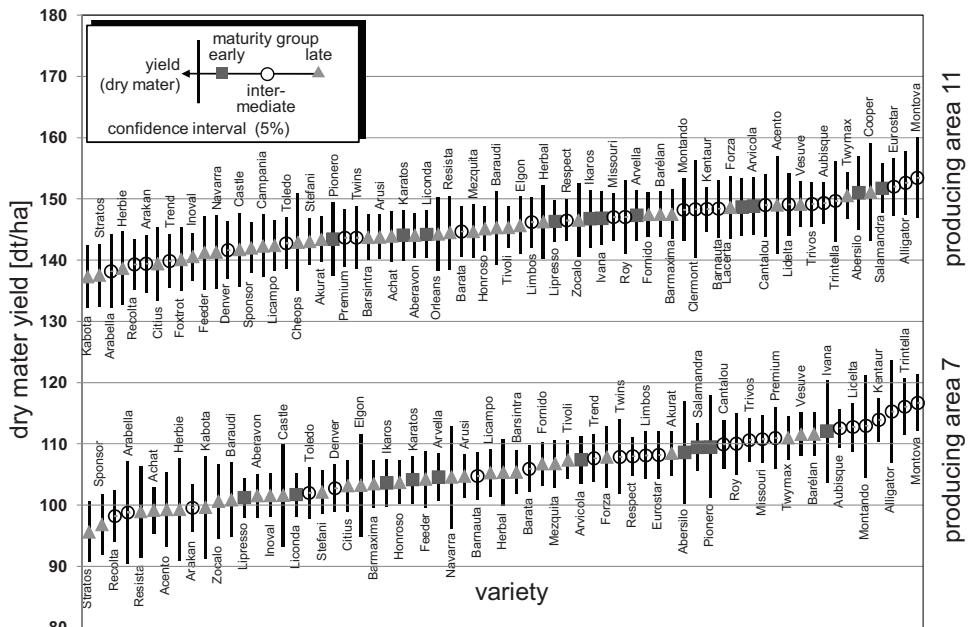

Figure 1. Dry matter yield of the first two main harvest years (2007/2008) in producing area 7 ‘Uplands’ and 11: ‘pre alpine region’ – based on data of local variety trials (LSV)

## References

- Hartmann S., Hochberg H. and Graf R. (2006) Das pflanzenbauliche Versuchswesen ‘Futterbau’ in Bayern : Teil 3 - Verbesserungen für das Bayerische Versuchswesen bei Futterpflanzen durch die verstärkte Integration in länderübergreifende Strukturen, *Schule und Beratung*, ISSN 0941-360X, 06/06, III-09 - III-14.  
[http://www.lfl.bayern.de/ipz/gruenland/15609/iii\\_konzept\\_futterbau\\_bayern\\_im\\_bund.pdf](http://www.lfl.bayern.de/ipz/gruenland/15609/iii_konzept_futterbau_bayern_im_bund.pdf)
- Hartmann S. (2006) Tiefgreifende Reform der Sortenprüfungssysteme bei Futterpflanzen in Deutschland, 50. Jahrestagung der Arbeitsgemeinschaft für Grünland und Futterbau der Gesellschaft für Pflanzenbauwissenschaften e.V. *Schriftenreihe LfL* ISSN 1611-4159, 17, 103-106.  
[http://www.lfl.bayern.de/ipz/gruenland/21695/aggf\\_2006\\_hartmann.pdf](http://www.lfl.bayern.de/ipz/gruenland/21695/aggf_2006_hartmann.pdf)
- Hartmann S. and Hochberg H. (2007) A new system of forage crop variety trials in Germany; *Proceedings of the International Symposium ‘Agricultural Field Trials – Today and Tomorrow’* October 8th to 10th, 2007, Stuttgart, Germany, ISBN 978-3-86186-541-4, 52-55.
- Michel V., Zenk A., Möhring J., Büchse A. and Piepho H.-P. (2007) Die Hohenheim-Gülzower Serienauswertung als bundesweites Basisverfahren im regionalen Sortenwesen. *Mitteilungen der LFA* 37, 72-82.
- Michel V. and Piepho H.P. (2006) *PIAFStat-Verfahren für die ‘Hohenheim-Gülzower Serienauswertung’*. [www.biomath.de/biomath/deu/load/mw.pdf](http://www.biomath.de/biomath/deu/load/mw.pdf) Online content of ‘Gesellschaft für Angewandte Mathematische Statistik in Biologie und Medizin mbH’
- Graf R., Michel V., Roßberg D. and Neukampf R. (2009): Definition pflanzenartspezifischer Anbaubereiche für ein regionalisiertes Versuchswesen im Pflanzenbau. *Journal für Kulturpflanzen* 61 (7), 247-253, ISSN 0027-7479 Verlag Eugen Ulmer.

## Genetic shift in white clover (*Trifolium repens* L.) after natural selection in a marginal area

Göransson M. and Helgadóttir Á.

Agricultural University of Iceland, Keldnaholt, IS-112 Reykjavik, Iceland

Corresponding author: magnusg@lbhi.is

### Abstract

Studies of genetic diversity are a prerequisite for any plant breeding programme. Where the primary breeding aims are to combine yield and survival it is important to be able to identify traits associated with these two factors. This is particularly important where species or cultivars are being grown at the margin of their distribution. The current study used AFLP markers and a traditional spaced plant trial to compare the genetic diversity of white clover cultivars of contrasting climatic origin with that of semi-wild and wild populations adapted to a marginal environment, and to monitor genetic shift in one of the cultivars after survival for four years in this environment. Observed patterns of genetic variation within and between populations were similar for both approaches used.

Keywords: Genetic diversity, adaptation, *Trifolium repens*, marginal area, genetic shift

### Introduction

The use of white clover in marginal areas is currently limited by the lack of persistent cultivars with acceptable yields. The objective of the study was to (1) evaluate morphological traits associated with winter survival and yield in a marginal environment; (2) assess the genetic structure of selected white clover populations in order to determine whether the genetic diversity is the same in bred cultivars of contrasting origin and in semi-wild and wild populations of the same species that are adapted to northern conditions, and (3) monitor genetic shift in a modern white clover cultivar, when grown in a marginal area. Genetic shift is defined as changes in population gene pools in response to environmental changes (Collins *et al.*, 2001). Two complimentary approaches were used to study changes in population dynamics over time in a marginal area: traditional trait-based morphological analysis and an AFLP-analysis.

### Materials and methods

Randomly selected genotypes of five white clover populations were included in the study. A Norwegian white clover cultivar ('Norstar') with a high level of winter hardiness and adequate yields was compared with a survival population ('NS'), being exposed to four years of natural selection in an experimental plot in Iceland subjected to standard fertiliser and cutting management. Three reference populations were included to determine the direction of the shift: one wild type Icelandic population ('Sk'), one locally adapted semi-wild population ('Ko') and one exotic cultivar ('Ramona'). Phenotypic traits (see Collins *et al.*, 2001) associated with yield and persistence were evaluated on 24 genotypes of each population in a field trial at Korpa Experimental Station in Iceland (64°09' N). The experimental design was a randomised block with three replicates. Data were subjected to analysis of variance and multivariate analysis (PCA). An AFLP study was performed according to the methods of Sköt *et al.* (2005) on four of the populations ('Norstar', 'NS', 'Sk' and 'Ramona'). The molecular data were analysed with AFLP-SURV (Vekemans, 2002), a PCA was performed and a bar plot of inferred population structure was produced with the software STRUCTURE (Pritchard



*et al.*, 2000), with admixture model assumed.

## Results and discussion

Winter survival was significantly higher in 'NS' than in 'Norstar', or 88% and 74% respectively, and the level of winter survival in 'NS' was not significantly different from 'Sk', although they differed significantly in a number of morphological traits associated with both yield and persistence. Previous studies (e.g. Collins and Rhodes, 1995; Frankow-Lindberg, 1997) have shown the importance of stolon carbohydrate allocation for winter survival. Allocation of resources was estimated in this study as dry weight per stolon length unit (SSL) and dry weight per leaf area unit (SLA). The SSL was 20% higher in 'NS' than 'Norstar', whereas there was no significant difference in SLA between 'Norstar' and 'NS'. Further, there was a positive correlation between SSL and winter survival ( $P < 0.05$ ), whereas no correlation was found between SLA and winter survival. Based on morphological traits changes in the survival population could be explained as directional selection for SSL. The coefficient of variation based on morphological data was highest in 'Norstar' and subsequently lower in 'NS', 'Ko' and 'Sk'. Gene diversity ( $H_j$ ) estimated in the AFLP analysis was highest in 'Norstar' (0.25), significantly lower in 'NS' (0.243;  $P < 0.05$ ), 'Ramona' (0.217;  $P < 0.05$ ) and lowest in 'Sk' (0.21;  $P < 0.05$ ). Analysis of molecular variance showed that 82 % of the total variation was distributed within and 18 % between populations. Observed patterns of genetic variation were similar for both approaches used. The principal component analysis (PCA) based on means of morphological data (see Collins *et al.*, 2001) (Figure 1) and the PCA based on results from the AFLP-analysis (Figure 2) show a similar pattern indicating a shift of 'NS' from 'Norstar' towards 'Sk'.

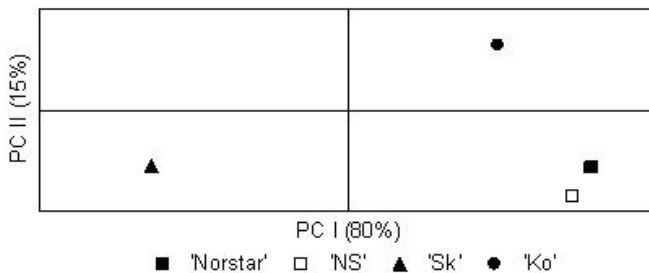

Figure 1. Principal component analysis based on means of morphological data associated with yield and persistence for four white clover populations grown in the field at Korpa Experimental Station.

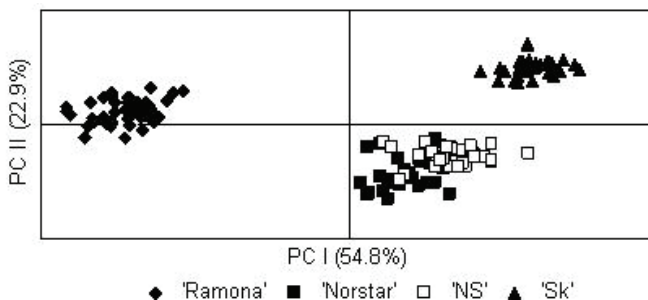

Figure 2. Principal component analysis based on binary data from an AFLP analysis (based on 332 polymorphic loci) of the populations 'Ramona' (n=47), 'Norstar' (n=32), 'NS' (n=32) and 'Sk' (n=32).

The bar plot of inferred diversity (Figure 3) resulted in distinct clusters of 'Ramona' (Cluster a) and 'Sk' (Cluster d) whereas 'Norstar' was split into two clusters (b, c) one of which was common with 'NS' (Cluster c). The virtual disappearance of cluster (b) from 'NS' indicates that the selection pressure had acted against genotypes of this particular type.

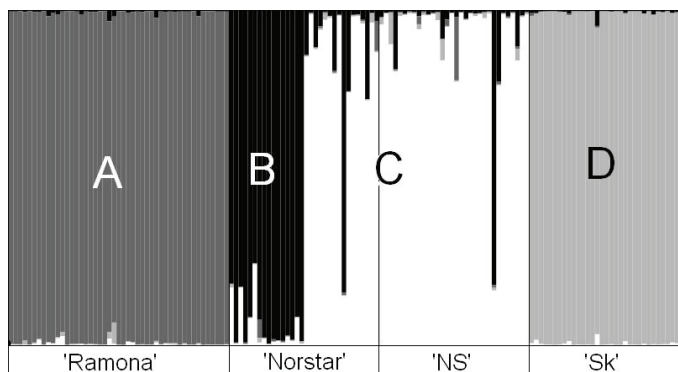

Figure 3. Bar plot of genetic diversity with four inferred populations (A, B, C and D); the true white clover populations are marked below the figure.

## Conclusion

The study found no conflict in breeding simultaneously for good winter tolerance and large leaves, and hence a high yielding capacity under northern conditions. The cultivar 'Norstar' seemed to contain sufficient genetic diversity to withstand the climatic conditions without loss, and possibly even with gain, in yielding capacity. There was a resemblance between the trait-based analysis and the AFLP-derived data, both with respect to the genetic variation within and between populations, and in the multivariate analyses.

## References

- Collins R.P., Helgadóttir Á., Fothergill M. and Rhodes I. (2001) Variation amongst survivor populations of two white clover cultivars collected from sites across Europe: Morphological and reproductive traits. *Annals of Botany* 88, 761-770.
- Collins R.P. and Rhodes I. (1995) Stolon characteristics related to winter survival in white clover. *Journal of Agricultural Science* 12, 11-16.
- Frankow-Lindberg B.E. (1997) Assimilate partitioning in three white clover cultivars in the autumn, and the effect of defoliation. *Annals of Botany* 79, 83-87.
- Pritchard J.K., Stephens M. and Donnelly P. (2000) Inference of population structure using multilocus genotype data. *Genetics* 155, 945-959.
- Skøt L., Humphreys M.O., Armstead I., Heywood S., Skøt K.P., Sanderson R., Thomas I., Chorlton K.H. and Sackville Hamilton N.R. (2005) An association mapping approach to identify flowering time genes in natural populations of *Lolium perenne* (L.). *Molecular Breeding* 15, 233-245.
- Vekemans X. (2002) *AFLP-SURV version 1.0*. Distributed by the author. Laboratoire de Génétique et Ecologie Végétale, Université Libre de Bruxelles, Belgium.

## Some plant characteristics of accessions of fescue species (*Festuca* sp.) collected from the Central-Black Sea Region of Turkey

Acar Z.<sup>1</sup>, Ayan I.<sup>1</sup>, Basaran U.<sup>1</sup>, Mut H.<sup>2</sup> and Asci O.<sup>3</sup>

<sup>1</sup> Ondokuz Mayıs University, Agricultural Faculty 55139 Samsun, TURKIYE

<sup>2</sup> Bozok University, Agricultural Faculty Yozgat, TURKIYE

<sup>3</sup> Ordu University, Agricultural Faculty Ordu, TURKIYE

Corresponding author: zekiacar@omu.edu.tr

### Abstract

Accessions of *Festuca arundinacea* (Schreb.), *Festuca drymeja* (Mertens and Koch) and *Festuca woronowii* (Hackel) subsp. *turcica* were collected from natural habitats to develop new cultivars for forage and pastoral use and to establish green areas. In total, 127 accessions were collected in 2007 and the quantitative characteristics of these samples were examined. The values and variation ranges of the measured and inspected characters of the accessions of *F. drymeja* and *F. arundinacea* were similar to each other, but they were larger in these two species than in accessions of *F. woronowii*.

Keywords: *Festuca*, forage, ecotypes, genetic diversity, Turkey

### Introduction

The grasses (*Poaceae*) are the fourth largest family of flowering plants, with some 11 000 species. They are distributed worldwide and are the main components of most rangeland and grassland ecosystems (Saarela, 2005). Due to their plant characteristics the grasses are suitable for amenity purposes and for the protection of soil and water (Acar and Ayan, 2004; Acar *et al.*, 2009). One of the biggest genera of *Poaceae* is Fescues (*Festuca*) and Turkey is a rich country in terms of fescue species, ecotypes, genetic diversity and genetic resources (Davis, 1985). In this study, seeds of different populations of fescue species were collected from the natural flora of the Central-Black Sea Region to develop new varieties.

### Materials and methods

In 2007, 127 accessions belonging to the fescue species *F. drymeja* (66), *F. woronowii* (20) and *F. arundinacea* (41) were collected from the Central Black Sea Region of Turkey. The seeds were sown in seed trays in January 2008. At the end of March 2008, 16 seedlings were transplanted into the field at about 5 cm depth, and at 70 cm row spacing with 50 cm plant spacing within the rows per accession. All observations and measurements were recorded in the second year of the study (2009) according to the method reported by Anon (1984). The simple statistics and principle component analysis (PCA) were performed using SPSS 13.0. Some characteristics were noted visually as follows: Leaf colour (1=yellow, 3=fair yellow-green, 5=green, 7=dark green and 9= very dark green) (Anon. 2001a), lodging (1=erect to 5=prostrate) (Anon. 2001b) and leaf tissue (1=soft to 5= tough) (Collow *et al.* 2003).

### Results and discussion

The mean values obtained from the measurements and observations of some plant characteristics of the accessions collected in 2007 are presented in Table 1. In terms of plant height, both the average value and the variation were higher in *F. drymeja* than in the other species. Davis (1985) found plant height values of *F. drymeja*, *F. woronowii* and *F. arundinacea* as 70-130, 30-70 and 30-150 cm, respectively. Although the mean values were in

the same range, the variation was larger in our study than in the study of Davis (1985). *F. woronowii* had thinner stems with less variation in stem diameter than the other species. Average internode length and variation were higher in *F. drymeja* than in *F. woronowii*. Node number on the main stem of *F. woronowii* was 3, whilst other species had, on average, slightly more than 3 nodes. *F. arundinacea* had the longest flag leaf blade. *F. drymeja* had values close to *F. arundinacea* for the same characteristics. In terms of average flag leaf blade width and variation, the values of *F. drymeja* were similar to *F. arundinacea*, while the flag leaf was shorter and narrower in *F. woronowii*. Davis (1985) stated that the length of inflorescences of *F. drymeja*, *F. woronowii* and *F. arundinacea* were 10-30, 4-10 and 10-20 cm, respectively. We found much higher values than Davis (1985) who also stated that *F. drymeja* and *F. arundinacea* had similar values regarding spikelet and tiller number, *F. woronowii*, which ranked lowest in terms of most morphological characteristics, had a higher tiller number than the other two species. Despite its short stature, *F. woronowii* had more prostrate growth than the other species. Although many characteristics were similar among the species, *F. arundinacea* had a more erect growth type than *F. drymeja*. In spite of similar variation, accessions of *F. drymeja* had a darker green colour compared to *F. arundinacea*. However, no variation in colour was observed among the accessions of *F. woronowii* and all plants were green. In general, *F. drymeja* had tough leaf tissues; *F. arundinacea* had average to average-tough leaf tissues, while *F. woronowii* had softer leaf tissues.

Table 1. Mean values and variation of plant characters in natural accessions of three fescue species from Turkey.

Features*	<i>F. drymeja</i>		<i>F. woronowii</i> subsp. <i>Turcica</i>		<i>F. arundinacea</i>	
	Mean±Sd.er	Range	Mean±Sd.er	Range	Mean±Sd.er	Range
PH (cm)	149.3±2042	85 – 187	78.15±2.94	55.0 – 105.0	138.9±2.34	98 – 160
MSD (mm)	4.50±0.09	1.99 – 6.77	2.47±0.06	1.91 – 2.89	4.45±0.08	3.58 – 5.62
IL (cm)	25.96±0.64	13.5 – 37	12.04±0.82	7.5 – 18.6	22.74±0.85	10 – 31
NN	3.32±0.07	2 – 5	3.00±0.15	2.0 – 4.0	3.29±0.10	2 – 5
FLL (cm)	13.17±0.56	3.2 – 22.5	11.35±0.85	4.2 – 17.2	14.09±0.61	6 – 24.5
FLW (cm)	0.59±0.02	0.25 – 1.05	0.45±0.03	0.25 – 0.65	0.54±0.03	0.25 – 0.95
PL (cm)	31.24±0.61	14.5 – 46	24.92±1.01	17.5 – 34.0	30.34±0.76	16.5 – 39.5
NSP	88.74±3.07	32. – 150	45.05±2.43	25.0 – 64.0	86.95±4.43	30 – 149
NT	53.26±3.92	7 – 132	95.10±8.99	31.0 – 183	53.02±4.52	10 – 138
GF	2.00±0.16	1 – 5	2.30±0.18	1 – 4	1.61±0.15	1 – 4
C	6.15±0.17	5 – 9	5.00±0.00	5 – 5	5.44±0.15	5 – 9
LT	4.24±0.12	1 – 5	1.30±0.13	1 – 3	3.76±0.15	2 – 5

\* PH: Plant height, MSD: Main stem diameter, IL: Internode length, NN: Node number, FLL: Flag leaf blade length, FLW: Flag leaf blade width, PL: Panicle length, NSP: Number of spikelet per panicle, NT: Number of tillers, GF: Growing form, C: Color, LT: Leaf texture.

For the PCA, performed using investigated plant characteristics, the first two components were considered. All the plant characteristics have positive effects on the first component for three species. According to the PCA, the first two components represented 57.55% of the variance for *F. drymeja*, 64.38% for *F. arundinacea* and 57.56% for *F. woronowii* (Figure 1). Results of the PCA clearly indicated that there are high variations amongst all the accessions in terms of investigated characteristics.

## Conclusion

Variation of measured and observed characteristics were very high in *F. drymeja* and *F. arundinacea*. Both species had bigger vegetative and generative organs compared to *F. woronowii*. It is expected that this variation will increase by adding the samples collected in 2008. It was found that *F. woronowii* had higher tiller numbers and softer tissues compared to the other species. It was concluded that the study should continue in order to improve suitable

forage varieties to use in pastures and green lands.

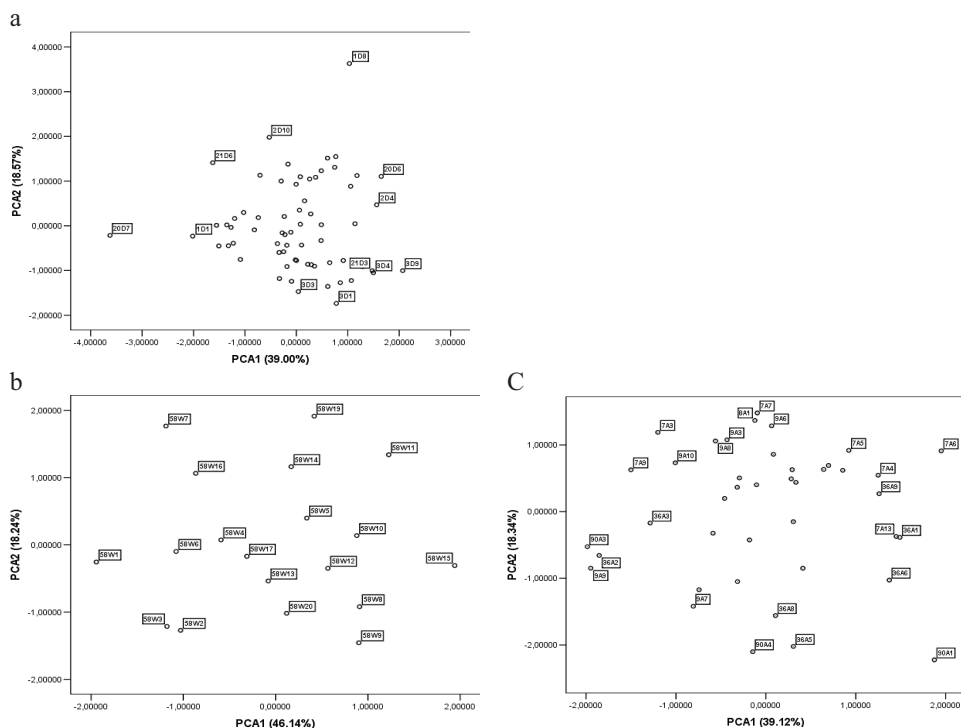

Fig.1. The results of PCA for accessions (a) *F. drymeja*, (b) *F.woronowii*, (c) *F. arundinacea* , within the figures; the first number is location, the letter is species and the last number is accessions.

## References

- Acar Z. and Ayan I. (2004) *Forage Culture*, Omu Press, Samsun, TR, 160 pp.
- Acar Z., Ayan I., Asci O., Basaran U. and Mut H. (2009) Biodiversity in morphological properties and nutritional values of forage grass species. *Journal of Environmental Biology* 30, 583-589.
- Anonymous (1984) *UPOV Guidelines for the Conduct of Tests for Distinctness*. Doc No. TG/39/6.
- Anonymous (2001a) *Technical Directions of Agricultural Characters Measurements*. Ministry of Agriculture and Rural Affairs, Ankara, TR, 40 pp.
- Anonymous (2001b) *Legume International Testing Program*, ICARDA, Aleppo, Syria.
- Collow M.N., Lowe K.F., Bowdler T.M., Lowe S.A. and Gobius N.R. (2003) Dry matter yield, forage quality and persistence of tall fescue (*Festuca arundinacea*) cultivars compared with perennial ryegrass (*Lolium perenne*) in a subtropical environment. *Australian Journal of Experimental Agriculture* 43, 1093-1099.
- Davis, P.H. (1985) *Flora of Turkey and East Aegean Islands*. Vol. 9, Edinburg, UK, 725 pp.
- Saarela J.M. (2005) North to Alaska: Grass collecting in America. *The Plant Press* 8, 1-12.

## White clover (*Trifolium repens* L.) germplasm evaluation under two levels of soil phosphorus: growth and phosphorus absorption

Acuña H., Inostroza L. and Sánchez M.P.

<sup>1</sup>*Instituto de Investigaciones Agropecuarias, CRI-Quilamapu, Casilla 426, Chillán, Chile.*

Corresponding author: hacuna@inia.cl

### Abstract

White clover is the most important forage legume species in grazing pastures in the central irrigated and southern humid regions of Chile. Naturalized germplasm was collected in 1994 from the central and southern regions of the country. To extend the use of the species in marginal areas of the aforementioned regions, genotypes are required that combine phosphorus deficiency tolerance with high nutritive value, forage productivity, persistence and grazing resistance. The objective of this work was to identify phosphorous deficiency tolerant populations for breeding programmes from nine white clover populations. The clover populations were grown with perennial ryegrass under grazing with two contrasting levels of soil phosphorus. Growth indicators, dry matter yield and plant and soil phosphorus were measured. The results showed two populations with high yields and the highest phosphorus uptake at low level of soil phosphorus. The two were also statistically equal in stolon length and dry weight at different levels of phosphorus. The tiller density and dry matter yield of the perennial ryegrass grown in mixture was also affected by the clover population and phosphorus treatments. It can be concluded that there is genetic variability among white clover populations in relation to phosphorus deficiencies in soil.

Keywords: Naturalized white clover, phosphorus dry matter responses, phosphorus absorption

### Introduction

Pastures composed of perennial ryegrass and white clover are the main support of animal production systems based on grazing in the irrigated central and central-southern regions and the southern rainy region of Chile. The soils, derived from volcanic ash, are phosphorus fixers because they contain amorphous clays that precipitate phosphate compounds through adsorption mechanisms. Therefore, to reach high levels of pasture dry matter (DM) yield, large applications of phosphorus are needed, resulting in fertilizer being a major cost in grass production. Taking this into account and given that pastures are being displaced to more marginal lands because of competition with more profitable crops, the objective of this experiment was to characterize nine populations of naturalized white clover and two contrasting cultivars under two levels of soil phosphorus in order to select populations with tolerance to phosphorus deficiency in soils.

### Materials and methods

The clover was sown in autumn 2007 in the experimental field of the Quilamapu Research Centre, INIA, at Chillán, Chile (36°36'S; 72°02'W). A randomized block experimental design was used with three replicates. All factorial combinations of two levels (low and high) of soil phosphorus and nine white clover naturalized populations, collected in southern Chile (Ortega *et al.*, 1994), plus two contrasting cultivars (Will and Huia, large- and small-leaved, respectively), were tested in mixture with perennial ryegrass (cultivar Nui). Plots were 1.5 m x 3.0 m, with a separation of 0.5 m. DM production was evaluated at approximately 21 day intervals in spring and 27 to 30 day intervals in summer and autumn, by cutting a strip of 0.5

m x 3 m, at a height of 5 cm (rotary grasscutter), alternately on the left and right side of each plot. After DM evaluation, the plots were grazed at a high stocking rate by 300 kg heifers for a short period (1 to 2 h) to avoid nutrient transference within plots. Immediately prior to each cut three small samples (10 cm x 20 cm) per plot were clipped for separation into the two species, and dried for determination of white clover/perennial ryegrass DM proportion. Before sowing, soil phosphorus (0-10 cm depth) was determined (7 mg kg<sup>-1</sup>). A high phosphorus level (20 mg kg<sup>-1</sup>) was generated by incorporating triple superphosphate (according to the phosphorus fixing capacity of the soil) to a depth of 0-10 cm. In autumn 2008 and 2009, 200 kg ha<sup>-1</sup> of triple superphosphate was applied to high phosphorus plots. Basic doses of potassium were applied annually and no nitrogen fertilizer was used. Stolon and tiller attributes were measured based on three cores of 11 cm diameter per plot. The phosphorus concentration in the herbage was determined for the clover and perennial ryegrass. The experiment is being evaluated for three growing seasons. Analyses of variance were carried out using SAS, according the following model:  $Y_{ijk} = \mu + (\text{white clover accessions})_i + (\text{phosphorus levels})_j + (\text{white clover accessions} \times \text{phosphorus levels})_{ij} + (\text{blocks})_k + (\text{error})_{ijk}$ . Values of standard error are presented for comparing the means when the main effect or the interaction was found to be significant.

Table 1. Density of white clover growing points and clover stolon length and dry weight at two contrasting levels (low and high) of soil phosphorus.

Clover accessions	Growing points (10 m <sup>-2</sup> )		Stolon length (10 m m <sup>-2</sup> )				Stolon dry weight (10 g m <sup>-2</sup> )					
	2008	2009	2008	2009	2008	2009	2008	2009	2008	2009		
	Low	High	Low	High	Low	High	Low	High	Low	High	Low	High
2-3-X	23	37	12	30	8.4	7.7	2.6	0.7	8.8	7.2	1.56	0.23
7-1-X	50	28	60	63	11.3	9.4	3.1	6.6	9.7	7.7	1.36	3.98
9-1-X	37	27	19	61	9.5	9.6	2.1	4.8	7.5	8.2	0.35	2.63
5-2-X	36	41	41	38	6.3	8.0	1.8	2.9	5.0	7.6	0.58	1.70
8-2-X	67	29	66	100	10.6	6.7	5.3	9.2	7.9	5.8	2.40	3.90
12-2-X	34	36	50	50	10.4	7.6	3.8	5.5	7.2	6.8	1.41	3.55
8-1-X	33	45	68	82	7.8	7.4	3.9	9.3	5.8	5.3	1.39	3.87
9-2-X	33	26	37	103	10.0	7.5	5.1	5.5	7.8	6.1	2.14	2.22
6-1-X	27	49	57	81	10.7	7.6	4.4	5.2	10.6	7.2	1.73	2.11
Huía	40	19	32	17	10.7	4.5	9.4	3.8	9.5	4.1	2.30	1.96
Will	33	58	20	77	5.3	7.1	9.1	2.6	8.4	11.0	1.07	2.19
Mean	38	36	42	64	9.2	7.6	4.6	5.1	8.0	7.0	1.48	2.58
s.e.m.	10.9		17.7		1.57		1.81		1.52		0.450	

s.e.m., standard error of mean for comparing phosphorus x accession means.

## Results and discussion

Total DM yield from ten cuttings during the second season, from September 2008 to May 2009, showed that three clover populations and ‘Will’ reached higher ( $P < 0.05$ ) yields when grown at a high level of soil phosphorus as compared to yields with a low phosphorus level. The DM yield of six populations and the cultivar Huía did not differ ( $P > 0.05$ ) at different levels of soil phosphorus (Figure 1A). The populations 9-2-X and 8-1-X, from the second group, and ‘Huía’ showed higher yields than the rest at a low level of phosphorus. These two populations did not vary in stolon length and dry weight when the soil phosphorus level was changed (Table 1). They showed the highest ( $P < 0.05$ ) values of phosphorus uptake at the low soil phosphorus level in the three first cuts of the third growing season (2009-2010), 0.87 and 1.11 kg ha<sup>-1</sup>, respectively. Therefore, these two populations are of great interest for future work in breeding white clover cultivars adapted to phosphorus deficient soils. Figure 1B shows the perennial ryegrass DM yields in relation to the associated clover population. The ryegrass grown with the accession 8-1-X reached one of the highest DM yields; indicating



that this mixture was the most productive ( $12.4 \text{ t ha}^{-1}$ ) at low levels of phosphorus, being superior to the mixture with 'Will', a highly productive cultivar.

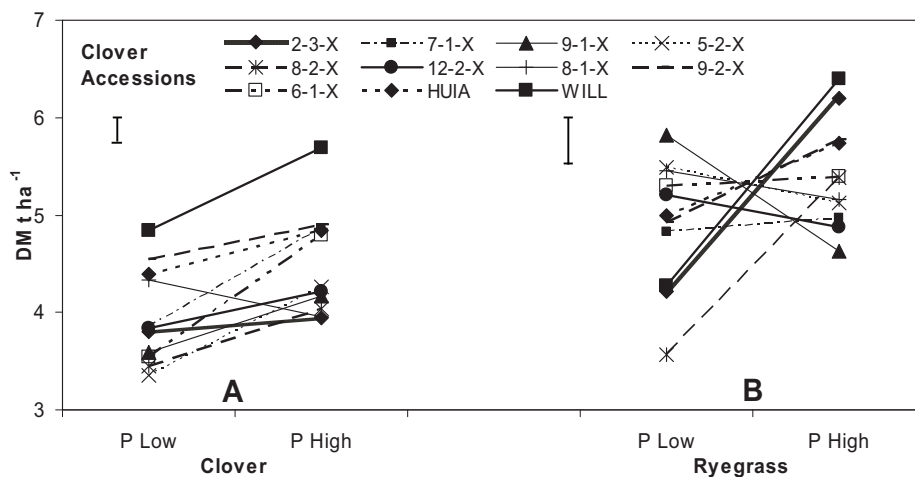

Figure 1. Effect of soil phosphorus levels on dry matter (DM) yields of pure white clover (A) and pure perennial ryegrass (B) in the mixture during the 2008-2009 growing season. Vertical bars indicate standard error of mean for comparing phosphorus x accession means.

## Conclusion

Two populations of white clover were found with equivalent DM yields to that of 'Huia' at a low level of soil phosphorus. One of them showed high compatibility with the companion grass at the aforementioned level of soil phosphorus. They presented high phosphorus uptake at a low soil phosphorus concentration and the same level of stolon development at the different levels of phosphorus in the soil.

## Acknowledgement

The financial support of FONTAGRO, Project #787.2005, is gratefully acknowledged.

## References

Ortega F., Demanet R., Paladines O. and Medel R. (1994). Colecta y caracterización de poblaciones de trébol blanco (*Trifolium repens*) en la zona sur de Chile. *Agricultura Técnica (Chile)* 54, 30-38.

## **Influence of the cutting regime on sainfoin yield (*Onobrychis viciifolia* Scop.)**

Demdoun S., Delgado I. and Muñoz F.

*Centro de Investigación y Tecnología Agroalimentaria de Aragón, Zaragoza, Spain*

Corresponding author: samir\_doum@hotmail.com

### **Abstract**

The influence of the cutting regime on agronomic parameters of sainfoin (*Onobrychis viciifolia* Scop.) was assessed in a pot trial in 2009, in Zaragoza (Spain). Two varieties of sainfoin, giant and common type, were grown in 50L pots and cut at the phenological stages of early bloom, mid bloom or late bloom. Aboveground production and proportion of leaves and stems, as well as morphological parameters (root and crown weight, number of leaflets, stems and inflorescences) were regularly assessed.

Common type of sainfoin showed smaller but more numerous leaflets and stems than giant type; crown and root weights were also higher for common type. Common type showed inflorescence only in the two first cut, whereas giant type flowered in all cuts. Depending on treatment, four, five or six cuts were applied for late, mid or early bloom treatments respectively. No difference was found between treatments in aboveground weight or in its partition, which decreased from 42% in the first cut to 10% in the last. Under a more intensive cutting regime, common type sainfoin increased the root weight to the detriment of the crown weight; giant type was not affected.

Key words: Forage production, root system, giant type, common type, leaf proportion

### **Introduction**

Sainfoin (*Onobrychis viciifolia* Scop.) is a forage legume well adapted to dry hilly environments with calcareous soils. It is much appreciated by farmers due to its high palatability, high nutritional value and non-bloating properties. In spite of these qualities, sainfoin cultivation has declined over the last 40 years in Europe, mainly due a low regrowth capacity after cutting, which implies that close to 75% of the production is harvested in one cut (Kallenbach *et al.*, 1996). Attempts to increase the biomass yield and to get a more even spread of the production throughout the year were based on the application of an intensive cutting regime focusing on the plant height (De Falco *et al.*, 2000). However, phenological stages may reflect more accurately the physiological status of the plant. The objective of this study was to assess the influence of three cutting regimes, defined as cut in early, mid or late bloom, on morphological and agronomical parameters of sainfoin plants to optimise the harvest stage.

### **Materials and methods**

In May 2008, two varieties of sainfoin, giant type, 'Reznos', and common type, 'Cotswold Common' respectively, were sown in 50 l pots, in a silty-loamy soil (0.41CE; 1.5d $\delta$ /m) in Zaragoza (41°3'N; 0°47'W). The climate of the area corresponds to a sub-humid Mediterranean type with mean temperatures of 6.0 °C min and 23.2 °C max and total average precipitation of 381mm. Four liters water were provided once or twice a week, by drip irrigation. Twelve plants were grown per pot. In 2009, the pots were divided into three groups corresponding to the cutting regimes (Early bloom: EB, Mid bloom: MB, Late bloom: LB). In the EB treatment, the plants were mown when at least 10% of blooming stems presented

racemes with 2-3 open flowers. In the MB treatment, the plants were mown when at least 50% of blooming stems presented racemes with 50% of open flowers. In the LB treatment, the plants were mown when at least 50% of blooming stems presented racemes with open flowers only in the upper part of the raceme. This corresponded to four, five and six cuts for late, mid or early bloom respectively. Dates of the the cuts are shown in Figure 1.

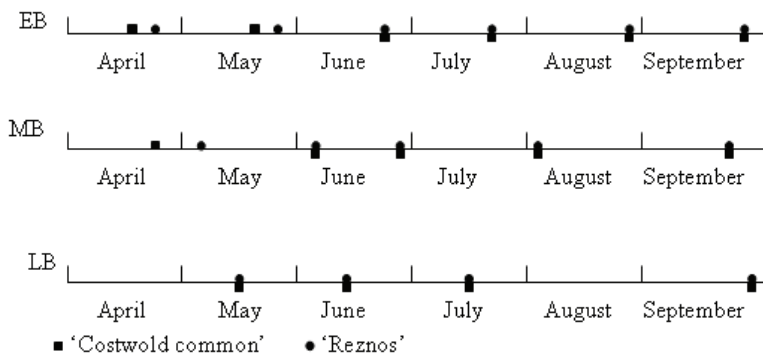

Figure 1: Dates of cut for 'Reznos' and 'Costwold Common' sainfoin varieties according to three different treatments (EB: early bloom, MB: mid bloom, LB: late bloom).

At each cut, three pots per variety were emptied and measurements made on twelve plants. The aboveground part, the crown and the taproot were fresh weighed, leaflets of the fifth leaf, stems and inflorescences were counted, on three plants the proportion of stems and leaves was evaluated as the ratio between stems or leaves dry weight and the total aerial dry weight. The proportion of leaves and stems were arcsine-transformed prior to statistical analysis. All data were analysed by ANOVA. Variety, treatment, cut and their interactions were regarded as fixed effects; cuts were considered as repeated measurements. Analysis of variance were undertaken using the PROC mixed procedure of the SAS statistical package (SAS 2004).

## Results and discussion

Dates of cut and intervals differed between treatments (Figure 1). EB treatment corresponded to one cut per month. Between the first, second and third cut of MB and LB treatments the interval was the same but was extended in the last cuts. 'Cotswold Common' flowered only in the first cut in MB and LB treatments and in the two first cuts in EB; in the following cuts it was harvested at the same time as 'Reznos'.

'Cotswold Common' had a higher number of leaflets and stems as well as greater crown and root weight. Its leaf proportion was higher too, as it presented fewer flowering stems in the last cuts. However, the total aboveground yield and the total inflorescence number were not significantly different between the two varieties (Figure 1). This is in accordance with the characterization of giant and common sainfoin type by Michelana and Hycka (1988). The absence of difference between 'Reznos' and 'Coswold Common' on aboveground weight contrasts with the results obtained for the same varieties in a small plot trial on individual plants where 'Reznos' had a production almost twice as large as 'Cotswold Common' (Demdoum *et al.*, 2009). This may indicate that the number of plants per pot, even if calculated as a normal field density of 120 plants  $\text{perm}^2$ , limited the development of individual plants. In all treatments, the aboveground weight decreased from the first cut to the last, the first representing 42% in EB and MB treatments and 46% in LB. The root and crown weight remained constant through the cuts. The leaflet and inflorescence number decreased

quickly from the first cut to the last, and consequently the leaf proportion increased in the last cuts. This decrease in aboveground weight through the season was reported in field conditions as well under intensive conditions of low cutting regime (De Falco *et al.*, 2000). Treatments affected crown weight, which was significantly higher in LB than in EB and MB.

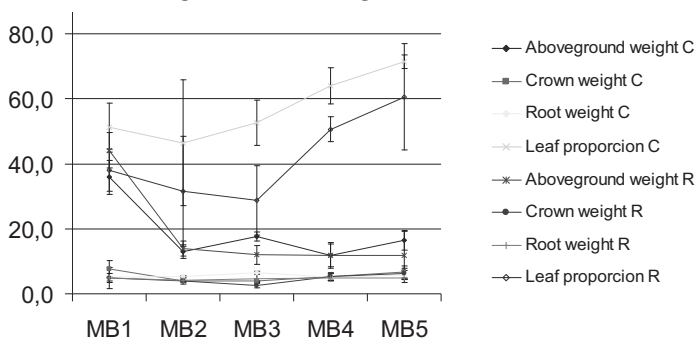

Figure 1: Effects of cut and variety in mid bloom (MB) treatment on agronomical parameters of sainfoin ('R': 'Reznos', 'C': 'Cotswold common')

The triple interaction variety\*treatment\*cut was significant for stem number and crown weight that remained equal through the cut in both varieties in MB treatment, but decreased in EB treatment and increased in LB treatment for 'Cotswold Common'. In contrast, root weight increased in EB and decreased in LB treatment for 'Costwold Common'; for 'Reznos' the root weight remained constant in all treatment as for 'Cotswold Common' in MB treatment. This may indicate that in 'Costwold Common' higher cutting intensity enhanced the development of the root system in deeper soil layers, as mentioned by De Giorgio *et al.* (2000).

## Conclusion

Varieties 'Cotswold Common' and 'Reznos' differed in leaflet and stem number, root and crown weight and leaf proportion. No difference was found in aboveground weight, which decreased dramatically after the first cut. In our conditions, cutting intensity showed few effects on morphology and agronomical performance except on root and crown weight for 'Cotswold Common'. This may indicate that sainfoin tolerates harvesting over a lengthy period of time and this may result in a more flexible crop management.

## References

- De Falco E., Landi G. and Basso F. (2000) Production and quality of the sainfoin forage (*Onobrychis viciifolia* Scop.) as affected by cutting regime in a hilly area of southern Italy. *Cahiers Options Méditerranéennes* 45, 275-279.
- De Giorgio D., Maiorana M. and Fornaro F. (2000) Root growth analysis in sainfoin (*Onobrychis viciifolia*, Scop.) submitted to different harvest times. *Cahiers Options Méditerranéennes* 45, 157-160.
- Demdoum S., Delgado I., Valderrabano J. and Muñoz F. (2009). Caracterización y evaluación agronómica de una colección de esparcetas (*Onobrychis viciifolia* Scop.). In: *Pastos, Sociedad española por el estudio de los pastos*, Huesca, pp. 319-325.
- Kallenbach R.L., Matches A.G. and Mahan J.R. (1996) Sainfoin regrowth declines as metabolic rate increases with temperature. *Crop Science* 36, 91-97.
- Michelana A. and Hycka M. (1988) Diferenciación y caracterización de dos tipos de esparceta (*Onobrychis viciifolia* Scop.) cultivada en España. *Investigación Agraria* 3(3), 285-290.
- SAS I. I. (2004) SAS. Cary, NC, USA.

## Morphogenetic and structural characterization of seven tropical forage grasses

Nascimento Jr. D.<sup>1</sup>, Rodrigues C.S.<sup>1</sup>, Da Silva S.C.<sup>2</sup>, Silveira M.C.T.<sup>1</sup>, Sousa B.M.L.<sup>1</sup>, Detmann E.<sup>1</sup>, Sbrissia A.F.<sup>3</sup>, Silva W.L.<sup>1</sup>, Pena K.S.<sup>1</sup>, Monteiro H.C.F.<sup>1</sup> and Vilela H.H.<sup>1</sup>

<sup>1</sup>Universidade Federal de Viçosa - DZO, Vicosa, MG- Brazil.

<sup>2</sup>Universidade de São Paulo – ESALQ, Piracicaba, SP- Brazil.

<sup>3</sup>Universidade do Estado de Santa Catarina - UDESC, Lages, SC- Brazil.

Corresponding author: domicio@ufv.br

### Abstract

The objective of this experiment was to characterize the developmental patterns of tropical forage grasses by means of morphogenetic and structural characteristics. The grasses were planted in experimental units of 1.0 m<sup>2</sup>, each containing 24 plants, arranged in a completely randomized block design with three replicates. Morphological and structural data were subjected to a factor analysis. Four factors were obtained, which revealed contrasting developmental patterns between groups of grasses. Our results indicate that the same features can be used in different ways by grasses of the same genus and/or species. This information could be valuable in improving current evaluation protocols for forage grasses.

Keywords: *Panicum*, *Melinis*, *Hyparrhenia*, *Brachiaria* grass evaluation

### Introduction

Analysis of the growth and development of forage plants is an important strategy for characterizing their production potential. Morphogenesis is a key concept for this type of assessment because it facilitates understanding of the growth processes, ecological adaptation and forage accumulation dynamics of a particular species. Thus, the study of morphogenesis can contribute to the planning and adoption of efficient management practices for each type of forage plant (Silveira *et al.*, 2010). Therefore, the characterization of the developmental pattern by description of the tissue flow using morphogenetic variables could bring new tools and improve the current protocols used in the evaluation of the material produced by the breeding and introduction grass programme.

### Materials and methods

This experiment was conducted at a site belonging to the Animal Science Department of the Universidade Federal de Vicosa, in Vicosa, Minas Gerais, Brazil, from November 2006 to May 2007. The experimental treatments consisted of seven forage grasses: three cultivars of *Panicum maximum* (Mombaca, Massai and Aruana grasses), two cultivars of *Brachiaria brizantha* (Marandu and Xaraes grasses), molasses grass (*Melinis minutiflora*) and jaragua grass (*Hyparrhenia rufa*). The grasses were planted in a greenhouse and seedlings were kept there until the time of transplantation. Twenty-four plants of a single species were transplanted into each 1.0 m<sup>2</sup> experimental unit. The experimental design consisted of completely randomized blocks with three replicates. In order to avoid edge effects, measurements were performed in plants at the centre of the plots. Fertilization was based on soil analysis - phosphorus was applied at the time of transplantation and potassium and nitrogen were applied when plants had begun tillering. The grasses were monitored from their establishment until the end of the experimental period, when more than 50% of the tillers were flowering in all of the plots. Morphogenetic and structural variables were measured

twice per week using marked tillers within two randomly selected clumps per plot. The rates of leaf appearance and elongation, stem elongation and leaf senescence were measured. When an inflorescence appeared in a marked tiller, a new tiller was marked; however, the reproductive tiller was monitored to evaluate the rate of senescence of existing leaves. Leaf appearance (LAR, leaves tiller<sup>-1</sup> day<sup>-1</sup>), elongation (LER, cm tiller<sup>-1</sup> day<sup>-1</sup>) and senescence rates (LSR, cm tiller<sup>-1</sup> day<sup>-1</sup>), stem elongation rate (SER, cm tiller<sup>-1</sup> day<sup>-1</sup>), number of living leaves per tiller (NLL), leaf lifespan (LLS, days) and final leaf length (FLL, cm) were calculated based on field data. Tillering was evaluated in two randomly marked clumps per plot. In these plants, the tillers were marked with different colours every 30 days. Tillers were differentiated by the apical or basal location of bud growth. The number of dead tillers per generation was also recorded to calculate the appearance rates of basal and aerial tiller (BTAR and ATAR), mortality rates of aerial and basal tillers (ATMR and BTMR) and rates of mortality and appearance of all tillers (TAR and TMR). The morphogenetic and structural variables related to tillering were subjected to multivariate analysis by employing factor analysis using the Varimax rotation method and orthogonalization factor (Johnson and Wichern, 1998). The analysis was performed on subsets of data corresponding to summer and autumn.

Table 1 – Summer and autumn means of four factors that describe the morphogenetic and structural characteristics of seven forage grass species: 'mass development' (MsDev), 'tiller mortality' (TiMor), 'developmental stage' (DevSt) and 'leaf longevity' (LeLon)

Class	MsDev	TiMor	DevSt	LeLon
<b>Summer</b>				
Mombaça	-0.0383	-0.3514	1.5992	0.1855
Molasses	1.6691	-0.4867	-1.8420	0.4707
Xaraes	0.3663	-0.3517	1.0971	-0.7607
Jaragua	2.3421	0.1191	1.0651	0.8472
Aruana	-0.6150	-0.7196	-1.2601	0.9253
Marandu	-0.2797	-1.3073	-0.4004	-1.1981
Massai	0.6216	-0.0467	0.4762	-0.1547
<b>Autumn</b>				
Mombaça	-0.7657	-0.2660	0.5555	-0.5128
Molasses	-0.3080	1.8267	-0.7315	0.0261
Xaraes	-0.8781	-0.9161	-0.1449	-0.4367
Jaragua	-1.0614	-0.2217	0.4207	1.9000
Aruana	-0.2451	2.3731	-0.1274	-0.4791
Marandu	-0.6471	0.0909	-0.8379	-0.1654
Massai	-0.6599	-0.2160	0.1614	-0.8055

## Results and Discussion

The morphogenetic and structural variables were reduced to four factors that explained 80% of the total variation in the data. The 'mass development' (MsDev) factor was positively correlated with the variables LAR, LER, NLL, BTAR and TAR. The 'developmental stage' (DevSt) factor was positively correlated with the variables LER and FLL and negatively correlated with the variables SER and ATAR. Finally, the 'leaf longevity' (LeLon) factor was positively correlated with LSR and negatively with LLS. The values of each factor for each grass species are reported in Table 1.

During summer, the values presented by molasses, xaraes, jaragua and massai grasses contrasted with those presented by mombaça, aruana and marandu grasses, reflecting a differentiated pattern of MsDev. Species in the first group promoted MsDev primarily through LAR, BTAR and TAR, while species in the second group primarily promoted MsDev

through LER and NLL. During autumn, all grasses presented negative values of MsDev. Because morphogenetic characteristics are affected by ambient conditions (Lemaire and Chapman, 1996), these negative values were probably influenced by the reduction in precipitation, temperature and photoperiod. Jaragua grass was the most strongly affected during this period; it ceased tillering, indicating stronger seasonality of production. The TiMor factor was negative for the majority of grasses during summer, with the exception of jaragua grass. During autumn, molasses, aruana and marandu grasses presented positive TiMor factors, probably due to the greater mortality of aerial tillers. However, mombaca, xaraes, jaragua and massai grasses presented negative values due to the absence of aerial tillers and late flowering. This observation indicates that the behaviour of these two groups of grasses differs during this time of year.

The DevSt factor was positive for mombaca, xaraes, jaragua and massai grasses during the summer due to elevated LER and FLL values, which are characteristic of plants with longer vegetative periods. For molasses and aruana grasses, the values were negative due to elevated SER and ATAR values. Marandu grass also presented a negative value; however, this behavior was due to SER because this grass did not present aerial tillers during the summer. The behaviour of grasses in autumn was similar to that in summer; the species retained their respective magnitudes, with the exception of xaraes grass, which presented negative values. This pattern is due to the increase in SER during this period; competition for light intensifies in the canopy as grasses approach the reproductive stage, promoting stem elongation. For the LeLon factor, mombaca, molasses, jaragua and aruana grasses presented positive values during summer due to elevated LSR. Xaraes, marandu and massai grasses presented negative values because they exhibited elevated LLS. In autumn, only molasses and jaragua grasses presented positive values. Jaragua grass presented the highest value due to its greater LSR during this period, which may have been caused by the absence of new tillers during autumn. The cessation of tillering resulted in an older tiller population with greater leaf mortality.

## Conclusions

Morphogenetic and structural characteristics facilitate description of the developmental pattern of the grasses studied, indicating that they use available resources differently for growth and development. Our results indicate that some morphogenetics measurements could be added at final stages of tropical grasses evaluation programmes. The variables to be measured would depend on which plant traits the researcher is looking for.

## References

- Johnson R.A. and Wichern D.W. (1998) *Applied multivariate statistical analysis*. 4<sup>th</sup> ed. New Jersey: Prentice-Hall, 816 p.
- Lemaire G. and Chapman D.F. (1996) Tissue flows in grazed plant communities. In: Hodgson J. and Illius A.W. (eds.). *The ecology and management of grazing systems*. Oxon, CAB International, Wallingford UK, 3-36.
- Silveira M.C.T., Nascimento Júnior D., Da Silva S.C., Euclides V.B.P., Montagner D.B., Sbrissia A.F., Rodrigues C.S., Sousa B.M.L., Pena K.S. and Vilela H.H. (2010) Morphogenetic and structural comparative characterization of tropical forage grass cultivars under free growth. *Scientia Agricola* 19(2), 136-142.



## Morphogenetic and structural characteristics of *Andropogon gayanus* cut to different heights over seasons

Nascimento Júnior D.<sup>1</sup>, Sousa B.M.L.<sup>1</sup>, Da Silva S.C.<sup>2</sup>, Monteiro H.C.F.<sup>1</sup>, Rodrigues C.S.<sup>1</sup>, Souza Júnior S.J.<sup>2</sup>, Sbrissia A.F.<sup>3</sup> and Ramos R.S.<sup>1</sup>

<sup>1</sup>Universidade Federal de Viçosa - DZO, Viçosa, MG - Brazil.

<sup>2</sup>Universidade de São Paulo - ESALQ, Piracicaba, SP- Brazil.

<sup>3</sup>Universidade do Estado de Santa Catarina, Lages, SC- Brazil.

Corresponding author: domicilio@ufv.br

### Abstract

Morphogenetic and structural characteristics of *Andropogon gayanus* cv. Planaltina (gamba grass), were evaluated under three different cutting heights (20, 27 and 34 cm) when the canopy reached 95% light interception during regrowth. The cutting heights were allocated to experimental units (12 m<sup>2</sup>) in a completely randomized block design with three replicates. The lowest cutting height (20 cm) negatively influenced the final leaf length (FLL - leaf lamina), number of living leaves (NLL) and leaf lifespan (LL), and it positively affected the phyllochron (PHYL) and leaf senescence rate (LSR). Cutting to 20 cm probably caused increased decapitation and death of tillers. The least favourable conditions for growth and flowering occurred during autumn, resulting in greater stem elongation rate (SER) and NLL and lower values of PHYL, FLL and LL during this season. Under conditions of intermittent maintenance, defoliation of gamba grass should be interrupted when the stubble height is approximately 27 cm.

Keywords: *Andropogon gayanus*, light interception, morphogenesis, grass cutting

### Introduction

Several studies of tropical forage grasses indicate that the optimum time for interrupting regrowth coincides with 95% interception of incident light by the canopy (Difante *et al.*, 2009; Giacomini *et al.*, 2009). However, the severity of defoliation must be adjusted to ensure that sufficient leaf area remains to promote quick and efficient regrowth without compromising the organic reserves of the plant or canopy structure. In this context, the study of morphogenetic and structural characteristics has proven to be of great importance for helping to define management goals. The objective of this study was to evaluate the morphogenetic and structural characteristics of the forage grass *Andropogon gayanus* cv. Planaltina (gamba grass) when cut at three different heights.

### Materials and methods

The experiment was conducted at a site belonging to the Animal Science Department of the Universidade Federal de Vicosa in Vicosa, Minas Gerais, Brazil (20°45'S; 42°51'W; 651 m altitude), during the period from November 2007 to November 2008. The climate, according to Köppen's classification, is Cwa subtropical, with well-defined dry (winter) and rainy seasons (summer). The annual means of temperature and rainfall are 19°C and 1340 mm, respectively. Local soil is classified as Inceptic Hapludults, with clay-loam texture.

Plants of *Andropogon gayanus* (gamba grass) already established were cut to three different heights (20, 27 and 34 cm) when reaching 95% light interception during regrowth. The cutting heights were applied to experimental units (12 m<sup>2</sup>) in a completely randomized block design with three replicates. Before beginning the experimental treatments, a maintenance

fertilization was carried out with 50 kg ha<sup>-1</sup> of P, 200 kg ha<sup>-1</sup> of N and 100 kg ha<sup>-1</sup> of K in the form of single superphosphate, ammonium sulphate and potassium chloride, respectively. Canopy light interception was monitored using a LI-COR® model LAI 2000 canopy analyzer. The height of the canopy was recorded using a graduated ruler and a sheet of transparency film as a reference, in five points in each experimental unit.

At the beginning of each period of regrowth, ten tillers were marked in each experimental unit for evaluation of morphogenetic and structural characteristics. Recorded green leaf blade and pseudostem (stem and leaf sheaths) lengths were used to calculate leaf senescence (LSR, cm tiller<sup>-1</sup> day<sup>-1</sup>) and stem elongation rate (SER, cm tiller<sup>-1</sup> day<sup>-1</sup>) and final leaf length (FLL, cm leaf<sup>-1</sup>). Phyllochron (PHYL, days leaf<sup>-1</sup>), number of living leaves per tiller (NLL, leaves tiller<sup>-1</sup>) and leaf lifespan (LL, days leaf<sup>-1</sup>), were also estimated from the same tillers.

The data were subjected to analysis of variance using the MIXED procedure of the SAS statistical package. Means were estimated by LSMEANS and compared using Student's t-test with a significance threshold of 5%.

Table 1 - Morphogenetic and structural characteristics of *Andropogon gayanus* cut at different heights when reaching 95% light interception during regrowth

Time of year	Cutting height (cm)			SEM
	20	27	34	
	Final leaf length (FLL, cm leaf <sup>-1</sup> )			
Late spring	16.8 Ca	18.2 Ba	19.8 Aa	0.43
Summer	16.2 Ba	17.7 Aa	17.8 Ab	0.58
Autumn	13.7 Cb	16.3 Ab	15.5 Bc	0.34
	Phyllochron (PHYL, days leaf <sup>-1</sup> )			
Late spring	11.0 Bb	12.5 Aa	10.9 Bb	0.21
Summer	13.2 Aa	13.6 Aa	12.8 Aa	0.46
Autumn	10.7 Aa	7.5 Bb	6.1 Bc	0.80
	Number of living leaves (NLL, leaves tiller <sup>-1</sup> )			
Late spring	3.13 Ba	3.36 Abc	3.76 Ac	0.105
Summer	2.98 Cb	3.66 Bb	4.34 Ab	0.110
Autumn	3.55 Cab	4.84 Ba	5.88 Aa	0.158
	Leaf lifespan (LL, days leaf <sup>-1</sup> )			
Late spring	34.5 Bb	41.9 Ab	40.7 Ab	0.47
Summer	39.4 Ba	49.6 Aa	55.4 Aa	1.87
Autumn	37.9 Aa	30.0 Bc	35.8 Ac	0.75

Means followed by the same lowercase letters within columns and uppercase letters within rows are not significantly different ( $P > 0.05$ )

SEM = standard error of the mean.

## Results and discussion

Few morphogenetic- and structural-characteristic differences were observed between the cut to 27 and 34 cm of heights (Table 1). Montagner *et al.* (2008) did not report any remarkable difference in the morphogenetic and structural characteristics in guinea grass (*Panicum maximum* Jacq.) submitted to different grazing severity, when reaching 95% of light interception, indicating that the defoliation frequency may be more determining than the defoliation severity in promoting modifications in the tiller morphogenetic characteristics. However, plants cut to a height of 20 cm presented lower values of FLL, NLL and LL (Table 1) and greater LSR (0.564 cm tiller<sup>-1</sup> day<sup>-1</sup> compared to 0.508 and 0.417 cm tiller<sup>-1</sup> day<sup>-1</sup> for cuts to 27 and 34 cm, respectively). Cutting heights of 20 cm were drastic enough to damage the canopy structure, causing increased decapitation and death of tillers and thus resulting in diminished growth rate. Therefore, after this cutting, the remaining leaves may have accelerated the senescence process in order to allocate assimilates to the new leaves that were appearing, because the quantity of reserves of these plants could have been at lower levels.

Although summer is characterized by better growth conditions (temperature, light incidence, rainfall), the plant growth rate during that season was lower than during late spring; lower FLL and greater PHYL, NLL and LL values were observed (Table 1). The greater growth rate in spring might be explained by the fertilization performed before starting the experiment. The greatest SER was observed in autumn ( $0.503 \text{ cm tiller}^{-1} \text{ day}^{-1}$ ) and the lowest in late spring ( $0.091 \text{ cm tiller}^{-1} \text{ day}^{-1}$ ) and summer ( $0.093 \text{ cm tiller}^{-1} \text{ day}^{-1}$ ) due to the flowering of the grass during the latter period. Flowering changes the patterns of growth and development of the plants. Acceleration of stem elongation causes the apical meristem to be situated in a higher position in the canopy. This situation allows the leaves to expand quickly in the case of a rapid defoliation, for example, increasing FLL and decreasing PHYL (Lemaire and Chapman, 1996). The reduction of LL in autumn is consistent with the decrease in PHYL because the NLL is genetically determined and assumed to be relatively constant (Davies, 1988). Therefore, a lower value of PHYL (i.e., more rapid leaf initiation) should be associated with a reduction in LL. However, despite this relationship between PHYL and LL, the NLL was greatest in the autumn. Although regulated by genetic factors, the NLL varies due to environmental conditions and pasture management methods (Lemaire and Chapman, 1996).

## Conclusions

A cutting height of 20 cm may be drastic for gamba grass subjected to management when the canopy reaches 95% interception of incident light.

Under conditions of intermittent maintenance, defoliation of gamba grass should be interrupted when the stubble height is approximately 27 cm.

## References

- Davies A. (1988) The regrowth of grass swards. In: Jones M.B. and Lazenby A. (eds.) *The grass crop: The physiological basis of production*, Chapman and Hall, London, UK, pp. 85-127.
- Difante G.S., Nascimento Júnior D., Euclides V.P.B., Barbosa R.A. and Gonçalves W.V. (2009) Sward structure and nutritive value of tanzânia guineagrass subjected to rotational stocking managements. *Revista Brasileira de Zootecnia* 38, 9-19.
- Giacomini A.A., Da Silva S.C., Sarmento D.O.L., Zeferino C.V., Souza Júnior S.J., Trindade J.K., Guarda V.D. and Nascimento Júnior D. (2009) Growth of marandu palisadegrass subjected to strategies of intermittent stocking. *Scientia Agricola* 66, 733-741.
- Lemaire G. and Chapman D. (1996) Tissue flows in grazed plant communities. In: Hodgson J. and Illius A.W. (eds.) *The ecology and management of grazing systems*, CAB International, Wallingford, UK, pp. 3-36.
- Montagner D.B., Nascimento Júnior D., Euclides V.P.B., Da Silva S.C. and Carlotto M.N. (2008) Características morfofisiológicas e acúmulo de forragem em pastos de capim-mombaça submetidos a intensidades de pastejo rotativo. *Reunião Anual da Sociedade Brasileira de Zootecnia* 45, 1-3

## Legumes increase forage *Brassica* yield in low-input systems

Fustec J.<sup>1</sup>, Cortés-Mora F.A.<sup>1</sup>, Piva G.<sup>1</sup>, Oury V.<sup>1</sup>, Pineau S.<sup>1</sup> and Renaud S.<sup>1</sup>

<sup>1</sup>UP-SP LEVA Laboratory of Plant Ecophysiology and Agroecology, Ecole Supérieure d'Agriculture - PRES L'UNAM - , F-49007 Angers, France.

Corresponding author: j.fustec@groupe-esa.com

### Abstract

*Brassica* sp. are interesting forages in late summer and autumn. Since they have high nitrogen requirements, intercropping with legumes may increase yield in low-input systems. However, brassica/legume intercrops still remain poorly documented. Using rhizotrons in a greenhouse, we compared root development of (1) forage rapeseed either grown with faba bean or crimson clover to that of forage rapeseed monoculture and (2) fodder cabbage grown with common vetch to that of fodder cabbage monoculture. Legumes were labelled with <sup>15</sup>N urea. Seven to eight weeks after sowing, *Brassica* yield and N content were higher under intercropping than in pure stand. Under intercropping, distribution of root ramifications along the taproot differed from that of monoculture, which reduced the effect of competition. In addition, N transfer from legumes to *Brassica* was found to be significant.

Keywords: N fixation, niche separation, N transfer, facilitation, intercropping, yield

### Introduction

Land Equivalent Ratios (LER) higher than one are often reported for cereal/legume intercrops (Corre-Hellou *et al.*, 2006). These results may be due to niche separation and/or to nutrient transfer between species (Jensen, 1996; Paynel *et al.*, 2008). Forage *Brassica* sp. are fast growing, highly productive and digestible crops. They offer great potential and flexibility for improving stocking rate in late summer and autumn, especially under drought conditions. Since *Brassica* sp. have relatively high nitrogen requirements, intercropping with legumes may help to increase yield in low-input systems. However, the effect of *Brassica*/legume intercropping is still poorly documented. The aims of our study were (1) to compare root development, dry matter and N content in fodder rapeseed and fodder cabbage grown either with legumes or in monoculture and, (2) to investigate the N transfer from legume to the intercropped *Brassica* sp.

### Material and methods

Seeds were sown in rhizotrons (50 cm length × 40 cm width × 6 cm depth, 50° inclination) filled with a sandy soil in June 2009. We studied five modalities with two plants per rhizotron: (1) monospecific forage rapeseed (*Brassica napus* L. cv. 'Licapo'), (2) forage rapeseed with faba bean (*Vicia faba* L. ssp. *minor* cv. 'Gloria'), (3) rapeseed with crimson clover (*Trifolium incarnatum* L. cv. 'Primo'), (4) monospecific fodder cabbage (*B. oleracea* L. cv. 'Proteor'), and (5) fodder cabbage with common vetch (*Vicia sativa* L. cv. 'Pepite'). Rhizotrons were randomly distributed on a culture table in greenhouse. During the first 6 or 8 weeks of growth (modalities 1-3 or 4-5 respectively), young roots were drawn on the lowest side of the rhizotrons (n=8-10). In five rhizotrons of each *Brassica*/legume intercrop, the vetch and faba bean cultivar were labelled with <sup>15</sup>N urea by cotton wick stem-feeding (Mahieu *et al.*, 2009) and the crimson clover, by petiole labelling (Fustec *et al.*, 2009). At the end of July, the aboveground part was harvested, dried (70°C), weighed and ground before preparation for <sup>15</sup>N:<sup>14</sup>N mass spectrometer measurements. Biological N fixation was

calculated using the natural abundance method (Hansen and Vinther, 2001). N transfer from legume to *Brassica* was calculated as described by Høgh-Jensen and Schjoerring (2000).

## Results and discussion

Yield and N content of *Brassica* cultivars were significantly higher when they were grown with a legume than in monospecific rhizotrons (Table 1). These results can be partly explained by niche separation that occurred in rhizotron when the *Brassica* grew with a legume crop. In agreement with previous studies of root competition (Gersani *et al.*, 2001), roots in monoculture of *Brassica* competed in all soil layers. As a consequence, the distribution of root ramifications in the upper, medium and lower parts of the rhizotrons did not differ between the two plants ( $P > 0.05$ , data not shown). Conversely, roots in a *Brassica*-legume intercrop developed in different rhizotron layers (Fig. 1). Vetch produced a markedly higher amount of ramifications than cabbage in the upper and the middle part of the rhizotron before 420 degree-days (Fig. 1A). At 970 degree-days, most of root ramifications in the cabbage cultivar were located in the upper section, while there were more vetch roots in the middle section.

During the experiment, rapeseeds produced fewer roots in the middle section of monoculture compared to intercrops, especially with crimson clover ( $P < 0.001$ , data not shown). At 600 degree-days, the number of root ramifications in faba bean differed significantly from that of rapeseed in the upper and lower part of the rhizotron (Fig. 1B). As demonstrated in pea-barley mixtures by Corre-Hellou *et al.* (2006), spatial niche separation may be positively involved in yield differences between monoculture and intercropped *Brassica* sp.

Furthermore, over the 6-8 weeks of the experiment, N acquisition in nodules represented 66.3% (standard error s.e. 1.9%) of the total N in vetch, 75% (s.e. 5.7%) in faba bean and 82.7% (s.e. 2.5%) in crimson clover. From the beginning of biological N fixation, intercropped *Brassica* and legume cultivars used different N sources, which enhanced the niche separation. Because of niche complementarity, Corre-Hellou *et al.* (2006) showed that barley meets its N requirement more easily in pea-barley intercrops than in monoculture. Similarly to *Brassica* in our experiment, barley had a greater soil N supply, resulting in a higher crop N status and ability to compete against the legume cultivars. During the first 6-8 weeks of growth, N transfer between legume and *Brassica* was not negligible: the ratio of N originating from neighbouring legume plants was 7.8% (s.e. 0.4%) in vetch-cabbage, 12% (s.e. 2.9%) in faba bean-rapeseed but only 0.43% (s.e. 0.17%) in crimson clover-rapeseed. N transfer may represent up to 30-50% of N rhizodeposition of legumes, especially from vetch and faba bean (Fustec *et al.*, 2010).

Table 1: Dry matter weight and N content in *Brassica* grown either with a legume or in a monospecific rhizotron – mean (s.e.).

Companion plant	Dry matter weight (g plant <sup>-1</sup> )		N content (g plant <sup>-1</sup> )	
	Cabbage	Rapeseed	Cabbage	Rapeseed
Monoculture	1.77 (0.13) b	4.37 (0.30) b	2.69 (0.22) b	4.99 (0.46) b
Common vetch	2.39 (0.22) a	-	3.77 (0.33) a	-
Faba bean	-	6.91 (0.80) a	-	8.67 (0.94) a
Crimson clover	-	7.47 (0.98) a	-	10.44 (0.69) a
<i>P</i>	*	**	*	***

(\*  $P < 0.05$ ; \*\*  $P < 0.001$ ; \*\*\*  $P < 0.0001$  – letters a and b indicate significant differences between lines within a column). N = 10 (except for rapeseed-faba bean: N = 6), Mann-Whitney and Kruskal-Wallis tests.

Figure 1: Distribution of *Brassica* and legume roots in the upper, middle and lower layers of the rhizotrons. A- Cabbage with cabbage. B – Rapeseed with rapeseed. C – Vetch sown with cabbage. D – Faba bean sown with rapeseed.

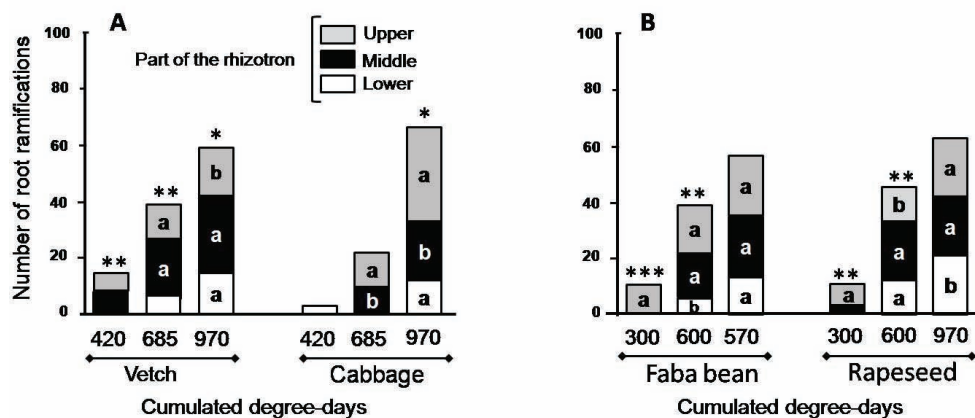

\*, \*\*, \*\*\* indicate statistical differences between depth sections at the same date. (a, b) indicate significant differences between *Brassica* and legumes for a given depth at a given date. N=6 for faba bean-rapeseed, N=10 for vetch-cabbage - Mann-Whitney and Kruskal-Wallis tests.

## Conclusion

Our results suggest that LER values higher than one can be obtained by co-cultivating a legume with a forage *Brassica*. Further experiments should be undertaken in greenhouse and in field conditions to better characterise the plant-to-plant belowground interactions. Better management of these complex biotic interactions would be useful for increasing yield by optimising the balance between competition, niche complementarity and facilitation.

## Acknowledgements

We thank Marie-Paule Bataillé (University of Caen, France) for performing the mass spectrometer measurements. This study was funded by the Region Pays de la Loire (France).

## References

- Corre-Hellou G., Fustec J. and Crozat Y. (2006) Interspecific competition for soil N and its interaction with N<sub>2</sub> fixation, leaf expansion and crop growth in pea-barley intercrop. *Plant and Soil* 282, 194–208.
- Fustec J., Lesuffleur F., Mahieu S. and Cliquet J.B. (2010) Nitrogen rhizodeposition of legumes. *Agronomy for Sustainable Development* 30, 57–66.
- Gersani M., Brown J.S., O'Brien E.E., Maina G.M. and Abramsky Z. (2001) Tragedy of the commons as a result of root competition. *Journal of Ecology* 89, 660–669.
- Hansen J.P. and Vinther F.P. (2001) Spatial variability of symbiotic N<sub>2</sub> fixation in grass-white clover pastures estimated by the <sup>15</sup>N isotope dilution method and the natural <sup>15</sup>N abundance method. *Plant and Soil* 230, 257–266.
- Høgh-Jensen H. and Schjoerring J.K. (2000) Below-ground nitrogen transfer between different grassland species: direct quantification by <sup>15</sup>N leaf feeding compared with indirect dilution of soil <sup>15</sup>N. *Plant and Soil* 227, 171–183.
- Jensen E.S. (1996) Barley uptake of N deposited in the rhizosphere of associated field pea. *Soil Biology & Biochemistry* 28, 159–168.
- Mahieu S., Fustec J., Jensen E.S. and Crozat Y. (2009) Does labelling frequency affect N rhizodeposition assessment using the cotton-wick method? *Soil Biology and Biochemistry* 41, 2236–2243.
- Paynel F., Lesuffleur F., Bigot J., Diquélou S. and Cliquet J.B. (2008) A study of <sup>15</sup>N transfer between legumes and grasses. *Agronomy for Sustainable Development* 28, 281–290.



# Influence of 1000-grain weight on predicted density of selected varieties of pasture grass species

Harkot W., Czarnecki Z. and Gawryluk A.

Department of Grassland and Landscape Forming, University of Life Sciences in Lublin, 20-950 Lublin, Poland

Corresponding author: wanda.harkot@up.lublin.pl

## Abstract

Laboratory studies dealt with the evaluation of germination ability and 1000-grain (seed) weight of 31 Polish varieties of 4 pasture grass species: *Festuca pratensis*, *Dactylis glomerata*, *Lolium perenne*, and *Phleum pratense*. Investigations revealed that 1000-grain weight varied most among varieties of *D. glomerata* (0.82 g to 1.85 g), followed by *L. perenne* (1.39 g to 2.90 g), and *F. pratensis* (1.52 g to 2.36 g), and least with *Ph. pratense* (0.40 g to 0.54 g). The grain germination ability for the majority of the assessed varieties complied with the standards. The predicted plant density ( $\text{m}^{-2}$ ), calculated on the basis of current seeding density recommendations and taking into account 1000-grain weight and grain germination ability, depending on a variety, ranged from 1555 to 2841 for *Ph. pratense*, from 914 to 2197 for *L. perenne*, from 1067 to 2290 for *D. glomerata*, and from 1865 to 2662 for *F. pratensis*.

Keywords: varieties, 1000-grain weight, predicted plant density

## Introduction

Standards that have been used in Poland so far with regard to sowing pasture grass seeds refer to species (Grzyb, 1975; Polska Norma, 1979). However, recent years have seen considerable progress in the breeding of varieties. In 2009, the list of agricultural plant varieties in the Polish register contained 158 pasture grass varieties, including 49 varieties of *Lolium perenne*, 21 *Festuca pratensis*, 14 *Dactylis glomerata*, and 17 *Phleum pratense* (Lista odmian roślin rolniczych wpisanych do krajowego rejestru w Polsce, 2009). Varieties within a particular species may vary with regard to 1000-grain weight. If the same sowing standard is used for varieties within a particular species, the number of plants per  $\text{m}^2$  will vary. The study aimed at predicting plant density on the basis of 1000-grain (seed) weight, as well as germination ability of 31 Polish varieties of 4 grass species (*D. glomerata*, *F. pratensis*, *L. perenne*, and *Ph. pratense*) that are commonly sown in mixtures on pastures in Poland.

## Materials and methods

The laboratory studies were conducted in 2009. Examinations included 31 Polish varieties of 4 pasture grass species (Tables 1-2). The particular varieties of seeds were obtained from Polish Plant Breeding Stations, from their 2008 harvest. 1000-grain weight was determined by taking 1000 seed grains of each variety in three replications (with the use of an LN-S-50 grain counter). Grain germination ability (100 grains of each variety in three replications) was assessed for varieties of *Ph. pratense* after 10 days, *F. pratensis* and *L. perenne* after 14 days, while *D. glomerata* after 21 days (Polska Norma, 1979). Considering the standards of grain sowing ( $\text{kg ha}^{-1}$ ) recommended for each species (Grzyb, 1975) and 1000-grain weight for every variety (g), the predicted plant density ( $\text{m}^{-2}$ ) was calculated both for grains assumed to have a 100% germination ability, and taking into account their real germination ability. The study results were analysed statistically (SAS).



Table 1. Grain sowing norms for *Festuca pratensis*, *Dactylis glomerata*, *Lolium perenne*, and *Phleum pratense*, regardless of a variety, as well as predicted plant density (m<sup>-2</sup>)

Species	Minimum grain germination ability (%)†	Grain sowing norm (kg ha <sup>-1</sup> )‡	1000-grain weight (g)§	Predicted plant density (m <sup>-2</sup> )
<i>Festuca pratensis</i>	84	48	1.8 to 2.2	2181 to 2666
<i>Dactylis glomerata</i>	82	21	0.8 to 1.3	1615 to 2625
<i>Lolium perenne</i>	87	31	1.3 to 2.5	1240 to 2385
<i>Phleum pratense</i>	87	12	0.4 to 0.6	2000 to 3000

†Polska Norma (1979); ‡Grzyb (1975); §Kozłowski i in. (1998)

Table 2. 1000-grain weight, germination ability (%), and predicted plant density (number of plants per m<sup>2</sup>) for examined varieties of *F. pratensis*, *D. glomerata*, *L. perenne*, and *Ph. pratense* (D-diploid, T-tetraploid)

Species	Variety	1000-grain weight (g)	Real grain germination ability (%)	Predicted plant density (m <sup>-2</sup> )	
				for 100% grain germination ability	for real grain germination ability
<i>F. pratensis</i>	Ardenna	2.16	88.0	2222	1955
	Artema	1.52	84.3	3158	2662
	Dagra	2.36	91.7	2034	1865
	Damara	1.72	95.0	2791	2651
	Wanda	1.62	83.4	2963	2471
	LSD <sub>0.05</sub>	0.06	-	69	364
<i>D. glomerata</i>	Amera	1.06	96.7	1981	1916
	Amila	0.82	89.4	2561	2290
	Bepro	1.16	93.0	1810	1684
	Berta	1.10	87.5	1909	1670
	Dika	1.19	98.0	1765	1729
	Krysta	1.00	97.0	2100	2037
	Minora	1.09	86.7	1927	1670
	Nera	1.85	94.0	1135	1067
	Tukan	1.00	96.5	2100	2026
	LSD <sub>0.05</sub>	0.26	-	444	473
<i>L. perenne</i>	Anna (D)	1.57	84.3	1975	1664
	Argona (D)	1.59	88.3	1950	1722
	Arka (D)	1.81	85.7	1713	1468
	Bajka (D)	1.76	83.7	1761	1474
	Marysieńka (D)	1.44	91.0	2153	1959
	Naki (D)	1.73	89.0	1792	1595
	Rela (D)	1.39	98.5	2230	2197
	Akwamaryn (T)	2.87	87.6	1080	946
	Diament (T)	2.49	80.0	1245	996
	Gagat (T)	2.90	85.5	1069	914
	Maja (T)	2.47	82.7	1255	1038
	Solen (T)	2.00	76.0	1550	1178
	LSD <sub>0.05</sub>	0.48	-	131	215
	<i>Ph. pratense</i>	Kaba	0.41	89.7	2927
Karta		0.49	89.3	2449	2187
Obra		0.40	94.7	3000	2841
Orlica		0.45	83.7	2667	2232
Prosna		0.54	70.0	2222	1555
LSD <sub>0.05</sub>		0.02	-	147	385

## Results and discussion

The predicted plant density of the species examined (number of plants  $m^{-2}$ ), calculated on the basis of recommended grain sowing standards (Grzyb, 1975), with a defined minimum germination ability (Polska Norma, 1979) and typical 1000-grain weight (Kozłowski *et al.*, 1998), was the largest for *Phleum pratense*, amounting to 2000 to 3000, and the smallest for *Lolium perenne*, amounting to 1240 to 2385 (Table 1).

Varieties of the examined species differed significantly with regard to 1000-grain weight (Table 2). The smallest differences in 1000-grain weight were found among varieties of *Ph. pratense* (up to 35%) and *F. pratensis* (up to 55%), whereas the largest differences were recorded among varieties of *D. glomerata* (up to 126%) and *L. perenne* (up to 109% among di- and tetraploid varieties, but up to 30% among diploid varieties, and up to 45% among tetraploid varieties). Therefore, the 1000-grain weight of *D. glomerata* and *L. perenne* oscillated within a wider range as compared to values reported by Kozłowski *et al.* (1998).

The predicted plant density ( $m^{-2}$ ) calculated for a 100% grain germination ability, depending on variety, ranged from 2222 to 3000 for *Ph. pratense*, from 2034 to 3158 for *F. pratensis*, from 1135 to 2561 for *D. glomerata*, and from 1069 to 2230 for *L. perenne*. However, such high germination ability is rarely observed in practice. The real grain germination ability of all examined varieties was below 100% even though it did not meet the required standards (Polska Norma, 1979) only in the case of 7 varieties of *L. perenne* (Anna, Arka, Bajka, Diament, Gagat, Maja, and Solen) and 2 varieties of *Ph. pratense* (Orlica and Proсна). The predicted plant density ( $m^{-2}$ ), determined taking into account the grain germination ability of the studied varieties, ranged from 1555 to 2841 for *Ph. pratense*, from 914 to 2197 for *L. perenne*, from 1067 to 2290 for *D. glomerata*, and from 1865 to 2662 for *F. pratensis*. The highest predicted plant density calculated taking into account the real grain germination ability, was predicted for the following varieties: Obra, Kaba, and Orlica (*Ph. pratense*); Artema and Damara (*F. pratensis*); Amila, Krysta, and Tukan (*D. glomerata*); and Rela, Marysieńka, and Argona (*L. perenne*).

## Conclusions

The 1000-grain weight varied most among varieties of *D. glomerata* (0.82 g to 1.85 g), *F. pratensis* (1.52 g to 2.36 g) and *L. perenne*, particularly among di- and tetraploid varieties (1.39 g to 2.90 g), while the least among varieties of *Ph. pratense* (0.40 g to 0.54 g). Differences in predicted plant density were the largest among varieties of *Ph. pratense* (1286 plants), *L. perenne* (among di- and tetraploid up to 1283 plants, but up to 729 plants among diploid varieties, and up to 264 plants among tetraploid varieties), and *D. glomerata* (1223 plants), while the smallest among varieties of *F. pratensis* (797 plants). Great differences in 1000-grain weight and calculated predicted plant density among varieties within a particular species indicate that grass grain sowing standards should refer to varieties instead of species.

## References

- Grzyb S. (1975) Problem doboru komponentów i norm wysiewu mieszanek łąkowych. *Wiad. Melior. i Łąkarskie* 28(4), 100-102.
- Kozłowski S., Goliński P. and Swędrzyński A. (1998) Trawy w barwnej fotografii i związłym opisie ich specyficznych cech. *PARNAS*, Inowrocław, pp. 344.
- Lista odmian roślin rolniczych wpisanych do krajowego rejestru w Polsce. (2009) Centralny Ośrodek Badania Odmian Roślin Uprawnych, Słupia Wielka.
- Polska Norma. (1979) *PN-79/R-65950. Materiał siewny, metody badania nasion*. Wydawnictwa Normalizacyjne, Warszawa, pp. 62.

# Genetic diversity of red clover varieties listed in Germany concerning the resistance to Southern Anthracnose

Jacob I.<sup>1</sup>, Hartmann S.<sup>1</sup>, Schubiger F.X.<sup>2</sup> and Struck C.<sup>3</sup>

<sup>1</sup> Institute of Crop Husbandry and Plant Breeding (IPZ) of the Bavarian State Research Centre for Agriculture (LfL), Am Gereuth 8, 85354 Freising, Germany

<sup>2</sup> Agroscope Reckenholz-Tänikon (ART), Reckenholzstrasse 191, 8046 Zürich, Switzerland

<sup>3</sup> University of Rostock, Faculty of Agricultural and Environmental Sciences, Institute for Land Use, Crop Health, Satower Str. 48, 18059 Rostock, Germany

Corresponding author: irene.jacob@lfl.bayern.de

## Abstract

Recently, there has been evidence both from testing sites and agriculturally used fields concerning the appearance of *Colletotrichum trifolii* Bain et Essary, causing Southern Anthracnose in red clover and red clover pasture stands. This disease is able to cause large losses in yield. The aim of this investigation was to evaluate all red clover cultivars listed in Germany (in 2009) with regard to their resistance against the pathogen. One foreign genotype ‘Starfire’, bred in the USA and known to be highly resistant to Southern Anthracnose, was also incorporated into this research. A ranking of the cultivars could be generated based on a test for resistance performed in the greenhouse. The resistance of the cultivars was expressed as a percentage of plant survival seven weeks after inoculation. Results showed a wide range in quantitative resistance characteristics towards *Colletotrichum trifolii* from 29 to 87% survival. Hence the evaluated genotypes can be classified into resistant to susceptible forms. Another important finding was that among the screened varieties diploid cultivars overall seemed to be more resistant than tetraploid genotypes.

Keywords: *Colletotrichum trifolii*, red clover, Southern Anthracnose, *Trifolium pratense*, variety

## Introduction

Red clover (*Trifolium pratense* L.) is an essential element in crop rotations, especially for organic farming. In recent years, it became more obvious that there were failures of red clover plants in the field because of ‘Southern Anthracnose’, a disease caused by the fungus *Colletotrichum trifolii* Bain et Essary.

This seed-borne pathogen is known to cause aggressive damage in red clover fields. Typical symptoms are stem lesions resulting in a bending of the stem in the upper zone of the plant. The fungus spreads out via conidia preferentially under warm and moist weather conditions. At the beginning of 2009, twenty-eight cultivars of *Trifolium pratense* were listed in Germany. This research was intended to find out if there are differences in resistance to *C. trifolii* among the red clover cultivars listed in Germany and to identify sources of resistance for further breeding.

## Materials and methods

To classify these listed genotypes according to their level of susceptibility against *C. trifolii*, a test for resistance as stated by Schubiger *et al.* (2003) was performed in the greenhouse under controlled conditions in 2008 and 2009. For that purpose, germinated grains were planted into Quickpots™. The spatial arrangement was totally randomized. The plants were cut five weeks after planting. Two weeks later, they were inoculated with a conidia suspension (spore density

$3 \times 10^6$  spores ml<sup>-1</sup>; inoculum provided by ART Zürich). Subsequently, the plants were covered with a PVC-tent for incubation for six days. Plants were cut two and six weeks after inoculation and after one week of regrowth (seven weeks after inoculation) the number of dead plants was determined. After having converted the data with the arcsin square root transformation, analysis of variance was performed with the SAS program. The Student-Newman-Keuls Test was used to identify significant differences among genotypes.

## Results and discussion

The tested genotypes showed a clear differentiation in terms of susceptibility against the pathogen. The number of survived plants varied over a wide range (Table 1).

Table 1. Ranking of the tested cultivars concerning their resistance against *Colletotrichum trifolii* based on a biennial test in the greenhouse. Same letters mark non-significant differences,  $P = 0.05$  (Student-Newman-Keuls Test).

Genotype	Level of ploidy	Plant survival [%]
Starfire	2n	87 a
Pavo	2n	79 b
Merula	2n	69 c
Elanus	4n	66 cd
Global	2n	65 cde
Lemmon	2n	64 cde
Harmonie	2n	60 cdef
Odenwaelder Rotklee	2n	59 cdef
Larus	4n	57 cdefg
Regent	2n	54 defgh
Astur	4n	54 defgh
Milvus	2n	53 defgh
Nemaro	2n	53 defgh
Pirat	2n	50 defgh
Montana	2n	50 efghi
Rotra	4n	48 fghij
Temara	4n	47 fghijk
Diplomat	2n	47 fghijk
Heges Hohenheimer	2n	47 fghijk
Tempus	4n	41 ghijkl
Wiro	2n	39 hijkl
Lucrum	2n	38 hijkl
Taifun	4n	35 ijkl
Maro	4n	35 ijkl
Atlantis	4n	35 ijkl
Titus	4n	35 jkl
Amos	4n	34 jkl
Mars	4n	31 kl
Kvarta	4n	29 l

As expected, the American cultivar ‘Starfire’ showed the highest level of resistance (87% plant survival). Among the varieties listed in Germany, ‘Pavo’ showed the best level of resistance, the percentage of surviving plants was 79% on average. The most susceptible cultivar tested was ‘Kvarta’ with a plant survival rate of 29% only.

The two varieties with the highest level of resistance among the cultivars listed in Germany, ‘Pavo’ and ‘Merula’, were bred in areas where *C. trifolii* was present (Boller *et al.*, 1998; Schubiger *et al.*, 2003).

A correlation between plant survival and year of listing can be excluded. Among the screened cultivars in this investigation, diploid genotypes appeared to have a higher rate of plant survival than tetraploid ones. The improvement of resistance occurs earlier in the diploid varieties because of the breeding process performed in praxis, as preselected diploid genotypes are in most cases base material in breeding tetraploid red clover (Boller *et al.*, 2010). In surveys by Schubiger *et al.* (2003) the best ranked varieties were also diploid.

## Conclusion

The results demonstrated that there were differences in resistance to the fungus *C. trifolii* among red clover cultivars listed in Germany. Although the greenhouse data have to be verified in field tests, it seems to be already possible to identify sources of resistance for further breeding.

## References

- Boller B., Schubiger F.X. and Kölliker R. (2010) Red clover. In: Boller B., Posselt U.K. and Veronesi F. (eds.) Fodder Crops and Amenity Grasses. *Handbook of Plant Breeding* 5, Springer, New York, 439-455.
- Boller B., Bigler P., Bucanovic I. and Bänziger I. (1998) Southern Anthracnose – a new threat for red clover persistence in cooler regions? In: Boller B. and Stadelmann F.J. (eds.) Breeding for a Multifunctional Agriculture. *21<sup>st</sup> Meeting, Fodder Crops and Amenity Grasses Section of EUCARPIA*, Switzerland, 195-198.
- Schubiger F.X., Streckeisen P. and Boller B. (2003) Resistance to Southern Anthracnose (*Colletotrichum trifolii*) in cultivars of red clover (*Trifolium pratense*). *Czech Journal of Genetics and Plant Breeding* 39 (Special Issue), 309-312.

# Osmotic adjustment and water use efficiency of seven cultivars of *Lotus corniculatus* L.

Inostroza L.<sup>1</sup>, Acuña H.<sup>1</sup> and Rivera H.<sup>2</sup>

<sup>1</sup>Instituto de Investigaciones Agropecuarias, CRI-Quilamapu, Casilla 426, Chillán, Chile.

<sup>2</sup>Universidad de Concepción, Casilla 537, Chillán, Chile.

Corresponding author: linoostroza@inia.cl

## Abstract

Two physiological mechanisms, osmotic adjustment (OA) and water use efficiency (WUE) were evaluated in seven cultivars of *L. corniculatus* to determine their contribution to drought tolerance of this species. A greenhouse experiment was carried out during the spring of 2008 in Chillán, Chile (36°03' S, 72°07' W). The seven cultivars were planted in pots (3l capacity) containing soil as a substrate. The plants were grown under two soil water treatments: with water stress (WWS; -0.01 MPa soil water potential) and with non water stress (NWS; -1.0 MPa soil water potential). The experiment was arranged in a randomized complete block design with four replicates. Osmotic ( $\Psi\pi$ ) and xylematic ( $\Psi_x$ ) water potentials were measured and water pressure potential was estimated ( $\Psi_p = \Psi\pi - \Psi_x$ ). Transpired water (T) was recorded daily by weighing the pots. Dry matter growth (DM = eaf+shoot) was measured and WUE was calculated (DM/T). No differences were found among cultivars for  $\Psi_x$ ,  $\Psi_p$  and  $\Psi\pi$  ( $P > 0.05$ ). However, a highly significant effect was observed due to the water treatments ( $P \leq 0.001$ ). The  $\Psi\pi$  value decreased by 44% under WWS conditions compared to NWS conditions. However, OA was not associated with DM production. WUE varied broadly among cultivars and was positively correlated ( $r = 0.90$ ;  $P \leq 0.01$ ) to DM production under drought conditions.

Keywords: Drought tolerance, forage legume, physiological traits.

## Introduction

Birdsfoot trefoil (*Lotus corniculatus* L.) is a perennial forage legume of high yield potential in marginal environments, where common forage species like alfalfa and white clover do not thrive (Kelman, 2006). Good performance under drought conditions has been attributed principally to its deep root system (Striker *et al.*, 2005). The contribution of physiological mechanisms is unknown. The objective of this work was to evaluate osmotic adjustment (OA) and water use efficiency (WUE) of seven cultivars of *L. corniculatus* introduced in Chile, and to determine their relevance in drought tolerance.

## Materials and methods

The experiment was carried out under greenhouse conditions during the spring of 2008 at the Instituto de Investigaciones Agropecuarias INIA, Chillán, Chile (36°03' S, 72°07' W). Seeds were germinated in seedbeds with 27 cm<sup>3</sup> of capacity (3×3×3 cm) that contained peat moss as a substrate (Biolan, Finland). A week after their emergence, the seedlings were inoculated with a solution of *Mesorhizobium loti*. The plants were transplanted to pots with 3 l capacity (25 cm diameter) that contained a substrate of soil derived from volcanic ash with a silty loam texture (Andisol). The substrate was not fertilized and five plants per pot were established. Two soil water treatments were designed, one non water stress (NWS), where the soil was maintained at 54% water content and -0.01 MPa water potential, and the other with water stress (WWS), with soil maintained at 25% water content and -1.0 MPa water potential. Fully

developed plants were submitted to soil water treatments for 26 days. During this period, xylematic water potential ( $\Psi_x$ ) was measured in one shoot per pot with a Scholander pump. Osmotic potential ( $\Psi_\pi$ ) was determined in an aliquot of 20  $\mu$ l leaf sap with an osmometer (Advanced Instruments, Inc., UK) and the pressure potential was estimated ( $\Psi_p = \Psi_x - \Psi_\pi$ ). Transpired water (T) was recorded daily by weighing the pots. Dry matter growth (DM = leaf+shoot) was measured and WUE was calculated (DM/T). During the experimental period, the greenhouse was maintained at an average temperature of 28/20 °C (day/night), with a relative humidity of 43/63% (day/night). The experiment was arranged in a factorial randomized complete block design (7 cultivars x 2 water treatments x 4 replications). The data were analysed using ANOVA and the least significant difference (LSD) test for comparison of means was used.

## Results and discussion

There was no variation in  $\Psi_x$ ,  $\Psi_p$  and  $\Psi_\pi$  among cultivars, and the cultivar  $\times$  water treatment interaction was not significant ( $P > 0.05$ ). There was only a highly significant effect ( $P \leq 0.001$ ) of the water treatments (Fig. 1). Osmotic adjustment involves the net accumulation of solutes at the cellular level in response to a fall in the plant water potential. As a consequence of this net accumulation, the  $\Psi_\pi$  of the cell is lowered, which in turn attracts water into the cell and tends to maintain  $\Psi_p$  (Turner *et al.*, 2007). In this work, *L. corniculatus* showed a strong capacity for osmotic adjustment, given that plant water potential ( $\Psi_x$ ) decreased by 86% under the WWS treatment compared to the NWS treatment. This provokes a 44% reduction in  $\Psi_\pi$  and a 35% increase in  $\Psi_p$  (Fig. 1). The  $\Psi_\pi$  values did not correlate with DM growth. On the other hand, WUE decreased by 30% under water stress. The South American cultivars (San Gabriel, Quimey and Ganador) obtained highest WUE, while the North American cultivar, Empire, obtained the lowest WUE (Fig. 2). A highly significant correlation was found under drought conditions between WUE and DM growth ( $r = 0.90$ ;  $P \leq 0.01$ ), similar results has been found by Inostroza and Acuña (2010) in white clover.

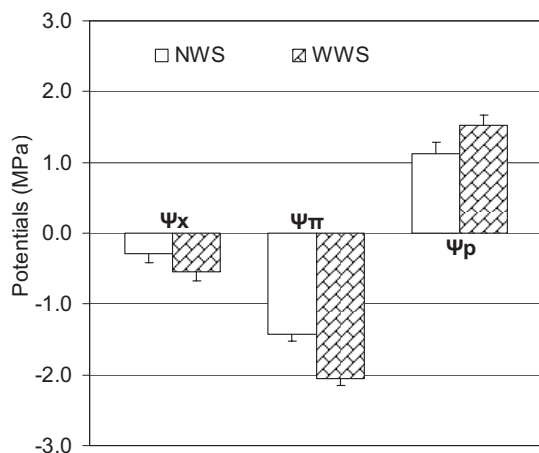

Figure 1. Xylematic ( $\Psi_x$ ), osmotic ( $\Psi_\pi$ ) and pressure ( $\Psi_p$ ) water potentials of *Lotus corniculatus* subjected to two soil water availability treatments: with water stress (WWS) and non water stress (NWS). Average of seven cultivars; vertical bars indicate LSD value ( $P = 0.05$ ).



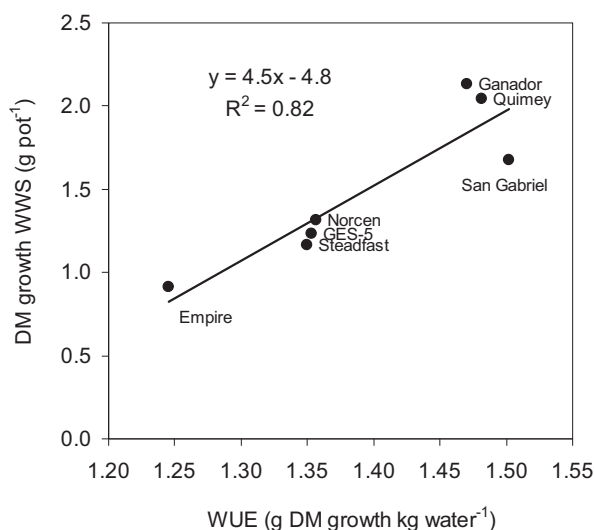

Figure 2. Relationship between water use efficiency (WUE) and dry matter (DM) growth of seven cultivars of *Lotus corniculatus* from South America (Ganador, Quimey and San Gabriel), United State (Norcen, Steadfast and Empire) and Australia (GES-5), subjected to water stress treatment (WWS).

## Conclusion

*Lotus corniculatus* displays a pronounced capacity for osmotic adjustment. However, the physiological mechanism did not contribute to increasing DM production under drought conditions and is only associated with plant survival. On the other hand, water use efficiency is a physiological mechanism that increases DM production under water stress conditions. WUE also showed broad genetic variation among cultivars.

## Acknowledgement

The financial support of FONTAGRO, Project #787.2005, is gratefully acknowledged.

## References

- Inostroza L. and Acuña H. (2010) Water use efficiency and associated physiological traits of nine naturalized white clover populations in Chile. *Plant Breeding* doi: 10.1111/j.1439-0523.2009.01742.x
- Kelman W.M. (2006) Germplasm sources for improvement of forage quality in *Lotus corniculatus* L. and *L. uliginosus* Schkuhr (Fabaceae). *Genetic Resources and Crop Evolution* 53, 1707-1713.
- Striker G., Insausti P., Grimoldi A., Ploschuk E. and Vasellati V. (2005) Physiological and anatomical basis of differential tolerance to soil flooding of *Lotus corniculatus* L. and *Lotus glaber* mill. *Plant and Soil* 276, 301-311.
- Turner N.C., Abbo S., Berger J., Chaturvedi S., French R., Ludwig C., Mannur D., Singh S. and Yadava H. (2007) Osmotic adjustment in chickpea (*Cicer arietinum* L.) results in no yield benefit under terminal drought. *Journal of Experimental Botany* 58, 187-194.

# Root system development of *Lolium perenne* under different management of landscape lawns

Straková M., Janků L. and Straka J.

*Agrostis Trávníky, Ltd., Npor. Krále 16, 683 01 Rousínov, Czech Republic*

Corresponding author: janku@agrostis.cz

## Abstract

The objective of this study was to compare the weight of roots and their stratification under 2-mow and 5-mow management of landscape lawns of *Lolium perenne*. Trials were carried out at Rousínov in the Czech Republic from 2007 to 2009. Nitrogen (N) was applied as fertilizers differing in forms and actions and at different levels of N rate (0, 50 and 100 kg ha<sup>-1</sup> y<sup>-1</sup>). Samples of root biomass were obtained using a soil probe in the 0-200 mm soil layer. The root samples were collected after the last mowing, at the end of the growing season. The 0-20 mm layer and the 21-200 mm layer were evaluated separately. In the third year of the experiment the root weight of *Lolium perenne* was the highest. High doses of nitrogen (100 kg ha<sup>-1</sup> y<sup>-1</sup>) increased the weight of the root biomass in the 21-200 mm layer.

Keywords: fertilization, landscape lawn, *Lolium perenne*, nitrogen form, roots

## Introduction

In the context of preservation of valuable environments and landscape patterns, the importance of grass growing shifts increasingly to their non-producing ecological function. Formation of a larger volume of active roots (with a larger amount of storage of substances) means higher resistance of growths to the changes in external conditions and resistance to the stress influences.

The essential factor that influences the growth and vertical distribution of the root biomass is the content of nutrients in the vegetation substrate (Straková and Hrabě, 2001). In general, nutrient deficiency causes a relatively higher root mass accumulation because the root apices usually penetrate faster through the zones with lower nutrient reserves. Root growth is frequently limited at high levels of N-fertilization associated with an increase of the above-ground matter and thereby a related demand for assimilates. CO<sub>2</sub> concentration in the soil increases as a result of a higher density of plants, especially in connection with the increasing intensity of tillering brought about by a higher utilization of nutrients.

The influence of the application of differently acting forms of nitrogen in fertilizer, nitrogen dosage, and different mowing frequencies upon the root system of *Lolium perenne* were monitored over three years.

## Materials and methods

A multi-factorial small-plot experiment was established in a randomized block design with three replications in September 2006 on the site of Rousínov, Czech Republic (phytogeographical region - termophyticum; soil class - loamy; altitude 229 m above sea level). Temperature and precipitation data at the experimental site are reported in Table 1. The plots measured 1.8 x 1.8 m<sup>2</sup>. In the experiment the seeding rate of *Lolium perenne* was 25 g m<sup>-2</sup> and the cultivars Jakub, Kelt and Ahoj were sown at the ratio of 1:1:1. A cylindrical soil probe (50 mm diameter) was used to take samples of grass turf monolith to a soil depth of 200 mm at the end of the vegetation season in October. The soil monolith was divided into the layers at 0-20 mm and 21-200 mm. The soil samples were washed out on sieves under

running water and the washed roots were air dried. Dried roots were weighed and the results expressed as weight per unit of surface area. Taking samples of the root biomass by the monolith method (Fiala, 1987) was carried out regularly each year from the first utility year of 2007. The data were analysed with analysis of variance and the Tukey test and significance expressed at  $P < 0.05$  (Statistica 9).

The experimental factors were:

Factor 1 – year: a) 2007, b) 2008, c) 2009

Factor 2 – frequency of mowing: a) 5M - five per year, b) 2M - two per year

Factor 3 – the applied form of nitrogen in fertilizer: a) RN – N in a fast-soluble form, ratio of nutrients 15N-5P-20K + micro-elements; b) SN – with N stabilizer (nitrification inhibitor DMPP – Dimethylpyrazole phosphate), ratio of nutrients 14N-7P-17K + micro-elements; c) DN – N in a long-term form (IBDU-condensate of urea), ratio of nutrients 16N-7P-15K + micro-elements; d) C – control (without fertilizing)

Factor 4 – nitrogen dose: a) 0 kg ha<sup>-1</sup> y<sup>-1</sup>; b) 50 kg ha<sup>-1</sup> y<sup>-1</sup>; c) 100 kg ha<sup>-1</sup> y<sup>-1</sup> applied in two doses

## Results and discussion

The evaluation of dry root biomass and stratification for the *Lolium perenne* monoculture during three utility years showed a root weight increase in the 0-20 mm layer. The root weight difference between the years 2008 and 2009 in this layer was statistically significant (Table 2). In 2008, precipitation was significantly lower (Table 1) than the long-term average, and this was manifested by a considerable, though not statistically significant, decrease in the root weight in the soil layer of 21-200 mm in the year 2008 as compared to 2007. The root weight increase in the layer of 21-200 mm between the years 2008 and 2009 was statistically significant. These results correspond to those of Jančovič *et al.* (2002) who concluded that the determining factor of root weight was the sum of atmospheric precipitation in the vegetation season, and that root weight biomass was significantly different between individual years.

Root biomass increased from the 2-mow to the 5-mow variant in both the monitored soil layers. However, this difference was not statistically significant (Table 2). Root biomass did not increase in the dry year 2008, and the 2-mow variant even showed a 2.27% reduction in the total weight of root biomass compared to 2007. In contrast, in 2009 which was favourable in precipitation, the root weights in both layers showed statistically significant higher values than in 2008 in both the 2-mow and the 5-mow variant. Compared to 2008, the increase of the total root biomass in 2009 amounted to 98.7% in the 5-mow variant, and even to 142.8% in the 2-mow variant (Figure 1).

Slightly higher values of root weight were achieved in the variants fertilized using nitrogen with a nitrification inhibitor and nitrogen in a long-term form. However, the differences were not statistically significant. Higher doses of nitrogen significantly increased the weight of the root biomass of *Lolium perenne* in the soil layer 0-20 mm while, in the layer 21-200 mm, the values of root biomass weight remained constant in all the variants of fertilization dosage (Table 2).

Table 1. Climatic characteristics of the Rousínov site

	Long-term averages	2006	2007	2008	2009
Average annual day temperature (°C)	9.0	9.1	10.6	10.7	10.2
Total annual precipitation (mm)	511	590.7	627.8	426.0	612.5

Table 2. Impact of the factors on the root biomass weight and stratification in *Lolium perenne*

Factor		Roots in the layer 0-20 mm (g m <sup>-2</sup> )	Roots in the layer 21-200 mm (g m <sup>-2</sup> )	Roots 0-200 mm (g m <sup>-2</sup> )
Year	2007	256.8a	163.1a	419.9a
	2008	302.8a	118.1a	420.9a
	2009	546.4b	372.1b	918.5b
Number of mowings	2M	341.9a	212.9a	554.8a
	5M	395.5a	222.7a	618.2a
Nitrogen form	C – without fertilization	305.4a	209.9a	515.3a
	RN – quick-acting	352.5a	222.2a	574.7a
	SN – with N stabilizer	391.9a	218.3a	610.2a
	DN – slow-acting	393.3a	216.7a	610.0a
Nitrogen dose	0 kg ha <sup>-1</sup> y <sup>-1</sup>	305.4ab	209.9a	515.3a
	50 kg ha <sup>-1</sup> y <sup>-1</sup>	320.6a	212.2a	532.8a
	100 kg ha <sup>-1</sup> y <sup>-1</sup>	437.8b	225.9a	663.7a

a, b - means followed by the same letter within a row and one factor are not significantly different ( $P < 0.05$ )

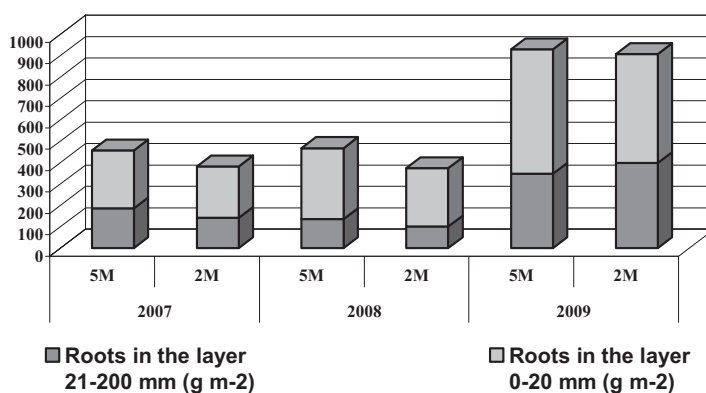

Figure 1. Comparison of the root biomass weight and stratification in individual variants of mowing of *Lolium perenne*

## Conclusion

This multifactorial study of the *Lolium perenne* root system within a three-year period provides information about the root system's response in two soil layers (0-20 mm and 21-200 mm) to different methods of extensive management of landscape lawns. Root biomass stagnated in the dry year 2008 and increased markedly in the wet year 2009. The only management factor that produced significant differences was nitrogen dosage.

## Acknowledgement

The information acquired in solving the 2B06034 Research Project supported by the Ministry of Education, Youth and Sports within the framework of the National Research Programme II were used to elaborate this study.

## References

- Jančovič J., Slamka P., Vozár L. and Kováčik P. (2002) Changes of root system of various types of grasslands influenced by mineral nutrition. *Ekológia* 21, 356-362.
- Fiala K. (1987) Stanovení podzemní biomasy porostů – metoda monolitů. In: Rychnovská M. et al. (eds.) *Metody studia travinných ekosystémů*, Academia, Praha, Czech Republic, pp. 104-108.
- Straková M. and Hrabě F. (2001) Weight and stratification of root biomass in selected turf cultivars. *Rostlinná výroba* 10, 451-455.

# Genotypic differences in maize phenology, growth and biomass in response to different N fertilizer sources applied at variable rates

Amanullah

*Department of Agronomy, Faculty of Crop Production Sciences, NWFP Agricultural University, Peshawar-Pakistan*

Corresponding author: draman\_agronomist@yahoo.com

## Abstract

Declining nitrogen (N) fertility is the most widespread and dominant factor limiting maize (*Zea mays* L.) productivity in the wheat-maize cropping systems in Northwestern Pakistan. The objective of this experiment was to investigate the response of different maize genotypes [local high yielding cultivars (Azam and Jalal) vs. hybrid (Pioneer-3025)] to variable N rates (50, 100, 150 and 200 kg ha<sup>-1</sup>) and sources [urea, calcium ammonium nitrate (CAN) and ammonium sulphate (AS)] of N in comparison with a control (N not applied) on calcareous soils having wheat-maize cropping system for long time. A field study was conducted at the Agriculture Research Farm of NWFP (Northwest Frontier Province) Agricultural University, Peshawar, during summer 2008. Hybrid Pioneer-3025 applied with 150 or 200 kg ha<sup>-1</sup> N either as CAN or urea resulted in higher maize productivity in the study area.

Keywords: *Zea mays* L., genotypes, N levels, N source, phenology, biomass

## Introduction

Maize (*Zea mays* L.) is the second most important crop after wheat in the North West Frontier Province (NWFP) of Pakistan but its yield per unit area is very low. Judicious use of N is a key factor in the cereals-based system of Pakistan for sustainable agriculture. Imbalanced fertilizer use especially has created concern in Pakistan as it may affect overall agricultural productivity and economic growth. The selection of fertilizers commonly depends upon price: the least costly fertilizer per kilogram of plant food is the one commonly selected. Application of a unit fertilizer is economical if the value of the increase in the crop yield due to the quantity of fertilizer added is greater than the cost of fertilizer used. The aim of this research project was to find out suitable N source and level for improving maize growth and maximizing biomass yield using different maize genotypes. This study was therefore performed to investigate effects of variable rates using different N sources on phenology, growth and biomass of maize genotypes “hybrid Pioneer-3025” vs. “Jalal” and “Azam” as checks.

## Materials and methods

A field experiment was conducted at the Agriculture Research Farm of the NWFP Agricultural University, Peshawar during summer 2008. The area is generally semiarid with mean annual rainfall ranges between 300 and 500 mm per year. Of which 60-70% rainfall occurs during summer (July-September) called monsoon rains, and the remaining 30-40% rainfall occurs in winter. A 4 x 3 x 3 factorial experiment was conducted in randomized complete block (RCB) design with split-plot arrangement using three replications. Factorial experimental treatments were four N (nitrogen) levels (N<sub>1</sub> = 50 kg ha<sup>-1</sup>, N<sub>2</sub> = 100 kg ha<sup>-1</sup>, N<sub>3</sub> = 150 kg ha<sup>-1</sup> and N<sub>4</sub> = 200 kg ha<sup>-1</sup>) and three N-fertilizer sources (S<sub>1</sub> = Urea (46 % N), S<sub>2</sub> = Calcium Ammonium Nitrate (26 % N) and S<sub>3</sub> = Ammonium Sulphate (21 % N)) applied to main plots, while three maize genotypes (G<sub>1</sub> = Jalal, G<sub>2</sub> = Azam and G<sub>3</sub> = Pioneer-3025) were

kept in sub plots. One control plot (N not applied) was also used in each replication as a check. A sub-plot size of 3.5 m by 3 m, having 5 rows, 3 m long and 70 cm apart was used. A uniform basal dose of 60 kg ha<sup>-1</sup> P as single superphosphate and 60 kg ha<sup>-1</sup> K as sulphate of potash was applied and mixed with the soil during seedbed preparation. Nitrogen was applied in two equal splits i.e. 50% at sowing and 50% at first irrigation (10 days after sowing).

### Statistical Analysis

Data were subjected to analysis of variance (ANOVA) according to the methods described by Steel and Torrie (1980), and means between treatments were compared by least significant difference ( $P \leq 0.05$ ).

### Results and discussion

The preplanned comparison indicated that N-applied plots significantly delayed their physiological maturity by three and half days, produced 19 cm taller plants, 3.29 more leaves per plant, 81.17 cm<sup>2</sup> (21%) greater leaf area, and 3533 kg ha<sup>-1</sup> (35%) more biomass than the plots where N was not applied (control), (Table 1). Days to physiological maturity was delayed significantly with each increment in N rate, and enhanced with application of AS compared with urea and CAN. Application of CAN produced taller plants, more leaves per plant, leaf area and thus higher biomass than urea and AS. Although there was no significant difference in the biomass of CAN (10352 kg ha<sup>-1</sup>) and AS (10062 kg ha<sup>-1</sup>) applied plots, it was significantly higher than the biomass of those plots which received urea (9472 kg ha<sup>-1</sup>) as the N source (Table 2). Plant height reached to maximum level with N application of 150 kg ha<sup>-1</sup>. Number of leaves plant<sup>-1</sup>, leaf area and biomass were statistically not different between the two higher N rates (150 and 200 kg ha<sup>-1</sup>) and were significantly higher than the two lower rates of N (50 and 100 kg N ha<sup>-1</sup>), (Table 3). The hybrid, Pioneer-3025 was 13 days later maturing, produced 36.25 cm (20%) taller plants, 3.2 (21%) more leaves per plant, 88 cm<sup>2</sup> (20%) greater leaf area, and 1939 kg ha<sup>-1</sup> (17%) higher biomass than the average of the two local cultivars (Table 4).

Table 1. Preplanned comparison in physiological maturity (PM), plant height (PH), number of leaves plant<sup>-1</sup> (LPP), mean single leaf area (MSLA) and biomass of maize as influenced by control (N not applied) vs. rest (N applied)

Control vs. Rest	PM (days)	PH (cm)	LPP	MSLA (cm <sup>2</sup> )	Biomass (kg ha <sup>-1</sup> )
Control	87.67 <sup>b</sup>	146.11 <sup>b</sup>	10.11 <sup>b</sup>	298.89 <sup>b</sup>	6429 <sup>b</sup>
Rest	91.14 <sup>a</sup>	164.97 <sup>a</sup>	13.40 <sup>a</sup>	380.06 <sup>a</sup>	9962 <sup>a</sup>
Difference	3.47	18.86	3.29	81.17	3533

Mean values of the same category followed by different letters are significantly different at  $P \leq 0.05$  using LSD.

Table 2. Days to physiological maturity (PM), plant height (PH), number of leaves plant<sup>-1</sup> (LPP), mean single leaf area (MSLA) and biomass of maize as influenced by different sources of nitrogen

N Sources	PM (d)	PH (cm)	LPP	MSLA (cm <sup>2</sup> )	Biomass (kg ha <sup>-1</sup> )
Urea	91.61 <sup>a</sup>	162.28 <sup>b</sup>	13.11 <sup>b</sup>	375.33 <sup>b</sup>	9472 <sup>b</sup>
CAN	91.78 <sup>a</sup>	167.89 <sup>a</sup>	13.89 <sup>a</sup>	400.56 <sup>a</sup>	10352 <sup>a</sup>
AS	90.03 <sup>b</sup>	164.75 <sup>b</sup>	13.19 <sup>b</sup>	364.28 <sup>b</sup>	10062 <sup>a</sup>
LSD <sub>0.05</sub>	0.44	2.60	0.37	20.34	395

Mean values of the same category followed by different letters are significantly different at  $P \leq 0.05$  using LSD.

Table 3. Days to physiological maturity (PM), plant height (PH), number of leaves plant<sup>-1</sup> (LPP), mean single leaf area (MSLA) and biomass of maize as influenced by variable rates of nitrogen

N rates (kg ha <sup>-1</sup> )	PM (d)	PH (cm)	LPP	MSLA (cm <sup>2</sup> )	Biomass (kg ha <sup>-1</sup> )
50	88.37 <sup>d</sup>	158.81 <sup>d</sup>	11.78 <sup>c</sup>	353.15 <sup>b</sup>	8575 <sup>c</sup>
100	90.37 <sup>c</sup>	162.33 <sup>c</sup>	13.00 <sup>b</sup>	335.11 <sup>b</sup>	9883 <sup>b</sup>
150	92.07 <sup>b</sup>	171.96 <sup>a</sup>	14.48 <sup>a</sup>	418.37 <sup>a</sup>	10543 <sup>a</sup>
200	93.74 <sup>a</sup>	166.78 <sup>b</sup>	14.33 <sup>a</sup>	413.59 <sup>a</sup>	10846 <sup>a</sup>
LSD <sub>0.05</sub>	0.51	3.00	0.43	23.48	456

Mean values of the same category followed by different letters are significantly different at  $P \leq 0.05$  using LSD.

Table 4. Differences in days to physiological maturity (PM), plant height (PH), number of leaves plant<sup>-1</sup> (LPP), mean single leaf area (MSLA) and biomass of maize genotypes

Genotypes	PM (d)	PH (cm)	LPP	MSLA (cm <sup>2</sup> )	Biomass (kg ha <sup>-1</sup> )
Azam	85.86 <sup>c</sup>	153.56 <sup>b</sup>	12.31 <sup>b</sup>	349.03 <sup>b</sup>	8980 <sup>c</sup>
Jalal	87.83 <sup>b</sup>	152.22 <sup>b</sup>	12.36 <sup>b</sup>	352.42 <sup>b</sup>	9651 <sup>b</sup>
Pioneer-3025	99.72 <sup>a</sup>	189.14 <sup>a</sup>	15.53 <sup>a</sup>	438.72 <sup>a</sup>	11254 <sup>a</sup>
LSD <sub>0.05</sub>	0.51	3.59	0.38	24.18	237

Mean values of the same category followed by different letters are significantly different at  $P \leq 0.05$  using LSD.

## Conclusions

It is concluded from this study that growing Pioneer-3025 applied with either CAN or urea as N source at the higher rates of 150-200 kg N ha<sup>-1</sup> could result in higher maize productivity in the highly intensified wheat-maize cropping system area. Pioneer-3025 remained stay-green for 13 days more than local cultivars, which resulted in 20% taller plants, 21% more leaves per plant, 20% greater leaf area, and 17% more biomass than the average of the two local cultivars. Further research work on best management practices is also suggested in the wheat-maize based system of the country for increasing N-use efficiency, reducing N losses to decrease pollution of groundwater and emission of ammonia and greenhouse gases, and to increase crop productivity on a sustainable basis.

## References

- Amanullah, Khattak R.A. and Khalil S.K. (2009) Effects of plant density and N on phenology and yield of maize. *Journal of Plant Nutrition* 32, 246-260.
- Amanullah, Marwat K.B. and Shah P. (2009) Nitrogen levels and its time of application influence leaf area, height and biomass of maize planted at low and high density. *Pakistan Journal of Botany* 41, 761-768.
- Amanullah, Asif M., Malhi S.S. and Khattak R.A. (2009) Effects of P-fertilizer source and plant density on growth and yield of maize in Northwestern Pakistan. *Journal of Plant Nutrition* 32, 2080-2093.
- Amanullah and Shah P. (2010) Timing and rate of nitrogen application influence grain quality and yield in maize planted at high and low densities. *Journal of the Science of Food and Agriculture* 15, 21-29.



# Conservation characteristics of maize cultivars ensiled as whole-crop, cob or stover at sequential stages of maturity

Lynch J.P.<sup>1,2</sup>, O'Kiely P.<sup>1</sup> and Doyle E.M.<sup>2</sup>

<sup>1</sup>Teagasc, Grange Beef Research Centre, Dunsany, Co. Meath, Ireland

<sup>2</sup>UCD School of Biology and Environmental Science, University College Dublin, Belfield, Dublin 4, Ireland

Corresponding author: joseph.lynch@teagasc.ie

## Abstract

This study evaluated the effects of stage of maturity at harvest on the conservation characteristics of cob, stover and whole-crop silages made using contrasting maize cultivars. Cultivars selected for conventional forage maize silage use (Tassilo and Beethoven), cold tolerance (Andante and Nescio) and high biomass (Atletico and KXA 7211) were sown in field plots (72 m<sup>2</sup>) under plastic mulch on 7 May 2008. Triplicate plots were harvested on 16 September, 7 October and 28 October. Representative samples of each plant component were precision-chopped and ensiled in laboratory silos for 130 days. Later maturity at harvest restricted fermentation and increased the lactic acid bacteria numbers on maize silage. The high biomass cultivars tended to have higher concentrations of fermentation products compared to the conventional cultivars and the cold-tolerant cultivar Andante. The low dry matter concentrations for crops harvested at early maturity and for the high biomass cultivars likely contributed to the increased fermentation observed.

Keywords: Maize, maturity, cultivar, silage, fermentation

## Introduction

Forage maize (*Zea mays*) has the potential to produce high yields of excellent quality feed for ruminants when the crop's temperature, light, water and nutrient requirements are provided. However, under cooler, overcast climatic conditions whole-crop yield and quality can decline considerably, with this decline being most evident in the cob component of the crop. The limitations often imposed by relatively low solar radiation and temperatures in Ireland need to be overcome, and the use of early maturing cultivars sown under plastic mulch has facilitated a major increase in the area of maize grown. This study evaluated the effects of stage of maturity at harvest on the conservation characteristics of cob, stover and whole-crop silages made using maize cultivars selected for cold tolerance, high biomass and conventional forage maize silage use.

## Materials and methods

Two cultivars of forage maize from each of conventional (Tassilo and Beethoven), cold tolerant (Andante and Nescio) and high biomass (Atletico and KXA 7211) types were sown in 72 m<sup>2</sup> plots under plastic mulch on 7 May 2008. Within each of three replicate blocks, harvest date (16 September, 7 October and 28 October) constituted the main plots and cultivar the sub plots within a split-plot design. Samples of whole crop, stover and cob were precision chopped and 6 kg of each were ensiled in laboratory scale silos for 130 days at 15 °C. After opening, sub-samples were subjected to chemical and microbial analyses, while aerobic stability was estimated by measuring silage temperature during eight days exposure to air. Lactic acid bacteria (LAB) and yeast in silage were enumerated using MRS and malt extract agar, respectively. Silage fermentation products (lactic acid, acetic acid, propionic acid,

butyric acid, and ethanol) and ammonia-N were measured as described by McEniry *et al.* (2006). Data were analysed as a split-plot randomised complete block design using GLM procedures of SAS (SAS, 2002).

Table 1. Effects of harvest date and cultivar on conservation characteristics of whole-crop (Whole), cob and stover silages.

		Harvest date (H)				Cultivars (C) <sup>1</sup>							Significance		
		16 Sept.	7 Oct.	28 Oct.	s.e.m.	T	B	An	N	At	K	s.e.m.	H	C	HxC
DM <sup>2</sup> (pre-ensiled)	Whole	206	248	333	4.4	287	285	298	255	207	242	6.6	***	***	***
	Cob	226	310	404	10.5	369	352	375	307	209	269	9.6	***	***	*
	Stover	186	178	222	1.1	185	199	208	186	192	203	4.6	***	**	***
Starch <sup>3</sup> (pre-ensiled)	Whole	69	119	200	9.5	160	160	148	143	56	110	13.5	**	***	NS
	Cob	218	400	533	25.2	415	478	483	416	194	312	19.0	**	***	**
	Stover	7	9	12	1.6	9	8	15	9	7	11	3.3	NS	NS	NS
LAB <sup>4</sup>	Whole	6.97	7.43	8.18	0.090	7.72	7.64	7.48	7.32	7.63	7.36	0.143	**	NS	NS
	Cob	6.78	6.76	7.59	0.119	6.90	7.01	7.21	7.00	6.94	7.22	0.177	*	NS	*
	Stover	7.65	7.71	7.97	0.062	7.85	7.62	7.88	7.90	7.74	7.68	0.095	*	NS	NS
Lactic acid <sup>3</sup>	Whole	74	60	26	11.6	39	50	51	52	67	60	9.4	†	NS	NS
	Cob	36	35	14	2.5	26	24	26	27	37	29	4.6	**	NS	NS
	Stover	22	24	21	3.8	25	20	18	18	27	26	4.5	NS	NS	*
Acetic acid <sup>3</sup>	Whole	37	38	38	3.0	36	33	28	39	51	39	4.5	NS	*	NS
	Cob	29	25	19	3.5	14	12	13	25	49	35	4.8	NS	***	NS
	Stover	67	66	49	3.7	63	56	57	66	64	60	2.1	*	*	***
Ethanol <sup>3</sup>	Whole	43	37	29	2.6	35	30	22	38	52	43	3.2	*	***	**
	Cob	37	31	20	5.1	15	15	14	29	58	45	5.8	NS	***	NS
	Stover	62	49	26	2.8	46	37	37	46	60	46	2.3	**	***	***
Ammonia-N <sup>5</sup>	Whole	45	45	70	3.0	55	45	53	60	64	46	5.4	**	NS	NS
	Cob	63	48	49	1.8	46	40	71	63	54	45	8.1	**	NS	NS
	Stover	91	92	107	6.3	81	97	132	101	87	84	11.5	NS	*	NS
pH	Whole	3.61	3.69	4.18	0.092	3.93	3.84	3.79	3.89	3.82	3.71	0.075	*	NS	NS
	Cob	3.86	3.73	4.05	0.036	3.81	3.82	3.94	3.95	3.87	3.90	0.049	**	NS	**
	Stover	4.31	4.19	4.39	0.057	4.26	4.27	4.44	4.34	4.21	4.26	0.060	NS	NS	**
DM recovery <sup>2</sup>	Whole	862	945	918	21.1	928	893	913	910	880	927	19.6	NS	NS	NS
	Cob	873	949	964	21.1	947	937	938	911	922	919	21.5	†	NS	NS
	Stover	857	934	894	15.2	901	913	886	904	867	900	22.4	†	NS	NS
Interval (h) to +2 °C temp. rise	Whole	169	155	168	11.9	161	159	169	184	144	168	18.1	NS	NS	NS
	Cob	96	127	160	21.3	107	116	100	164	142	136	16.4	NS	NS	*
	Stover	176	192	168	10.5	174	177	176	186	168	192	12.7	NS	NS	NS
ACT 120 h <sup>6</sup>	Whole	3.2	2.7	2.3	1.51	5.1	3.1	2.5	1.7	2.2	2.0	1.38	NS	NS	NS
	Cob	28.0	8.5	1.5	3.34	21.2	18.5	14.2	3.2	11.2	7.7	3.67	*	*	*
	Stover	3.8	1.4	1.3	1.02	3.1	3.8	1.6	1.6	1.6	1.2	1.22	NS	NS	NS

NS= not significant, †=  $P < 0.10$ , \* =  $P < 0.05$ , \*\* =  $P < 0.01$ , \*\*\* =  $P < 0.001$ , <sup>1</sup>= Tassilo (T), Beethoven (B), Andante (An), Nescio (N), Atletico (At), KXA 7211 (K). <sup>2</sup>= g kg<sup>-1</sup>. <sup>3</sup>= g kg<sup>-1</sup> DM. <sup>4</sup>=(Log<sub>10</sub> (cfu/g)). <sup>5</sup>= g kg<sup>-1</sup> N. <sup>6</sup>= Accumulated temperature rise (°C) to 120 h.

## Results and discussion

The pre-ensiling dry matter (DM) and starch concentrations of maize whole-crop and cob increased ( $P < 0.01$ ) with the advancing maturity associated with later harvesting (Table 1). Whole-crop silages made from crops harvested on 28 October had lower ( $P < 0.10$ ) lactic acid concentrations and higher pH ( $P < 0.05$ ) and ammonia-N ( $P < 0.01$ ) values than silages from earlier harvests. The corresponding increase ( $P < 0.01$ ) in LAB numbers with later harvesting is noteworthy. The general restriction in fermentation with later harvesting is likely due to the simultaneous increase in whole-crop DM concentration. These results agree with Filya (2004).

Acetic acid concentrations in whole-crop silages did not decline ( $P > 0.05$ ) with later harvesting, and were higher than lactic acid and ethanol concentrations for the final harvest. This indicates that later harvesting lead to a shift from homofermentative to heterofermentative LAB activity. It consequently disagrees with Kirkland *et al.* (2006) and McEniry *et al.* (2007) who found lower acetic acid concentrations in silage from maize of higher maturity and grass of higher DM concentrations, respectively.

High biomass crops had lower ( $P < 0.001$ ) pre-ensiling DM and starch concentrations than either the conventional cultivars or the cold-tolerant cultivar Andante. Acetic acid and ethanol concentrations were higher ( $P < 0.001$ ) in silages from the high biomass cultivar Atletico compared to the conventional cultivars or Andante. Although not significant, lactic acid concentrations tended to be higher in the low DM silages associated with the high biomass crops than in other cultivars. There were no significant effects ( $P > 0.05$ ) of harvest date or cultivar on DM recovery or aerobic deterioration of whole-crop silages. The conservation characteristics of whole-crop maize silage were generally between those for cob and stover silages. However, much of the changes due to harvest date or cultivar effects in whole-crop conservation characteristics reflected changes primarily in the cob component.

## Conclusion

Later harvesting resulted in a more restricted fermentation due to increasing DM concentration. High biomass whole-crop silages had more extensive fermentation due to their lower DM concentration. However, no treatment effects on whole-crop DM recovery or aerobic stability were observed. The effects of harvest date and cultivar had on whole-crop silages primarily reflected effects which occurred in cob silages.

## References

- Filya I. (2004) Nutritive value and aerobic stability of whole crop maize silage harvested at four stages of maturity. *Animal Feed Science and Technology* 116, 141-150.
- Kirkland R. M. and Patterson D. C. (2006) The effect of quality of grass and maize silage on the intake and performance of beef cattle. *Livestock Science* 100, 179-188.
- McEniry J., O'Kiely P., Clipson N. J. W., Forristal P. D. and Doyle E. M. (2007) The relative impacts of wilting, chopping, compaction and air infiltration on the conservation characteristics of ensiled grass. *Grass and Forage Science* 62, 470-484.
- McEniry J., O'Kiely P., Clipson N. J. W., Forristal P. D. and Doyle E. M. (2006) The microbiological and chemical composition of baled and precision-chop silages on a sample of farms in county Meath. *Irish Journal of Agricultural and Food Research* 45, 73-83.
- SAS (2002-2003) Statistical Analysis Institute (version 9.1). SAS Institute inc., Cary, N. Carolina, USA

## Response of *Dactylis glomerata* to low temperature stress

Borawska-Jarmułowicz B.<sup>1</sup>, Mastalerczuk G.<sup>1</sup> and Kalaji M.H.<sup>2</sup>

<sup>1</sup> Department of Agronomy, Warsaw University of Life Sciences, Poland,

<sup>2</sup> Department of Plant Physiology, Warsaw University of Life Sciences, Poland

Corresponding author: barbara\_borawska\_jarmulowicz@sggw.pl

### Abstract

The aim of this study was to estimate the freezing tolerance of two Polish varieties of *Dactylis glomerata* L. – Amera and Amila. Plants were exposed to two levels of temperature stress (-5 °C and -10 °C) for 24 hours at emergence and tillering-growth phases. Leaf greenness index and chlorophyll *a* fluorescence were measured. The number of shoots which survived one week after the application of thermal stress was also registered. Exposure to low temperatures caused a significant decrease in chlorophyll content and maximum quantum efficiency of Photosystem II (Fv/Fm) of both varieties as compared to control treatment. After 48 hours of application of low temperature (-5 °C) both varieties showed recovery of photosynthetic efficiency of photosynthetic apparatus only at emergence phase, while at lower temperature (-10 °C) none of the tested varieties were able to recover (neither at emergence nor tillering phase). After one week of low temperature stress application (-5 °C) the survival percentage of shoots at tillering phase was higher than at emergence phase.

Keywords: chlorophyll content, chlorophyll fluorescence, *Dactylis glomerata*, freezing tolerance

### Introduction

*Dactylis glomerata* L. is very popular and widely grown forage grass in Poland. Polish varieties of *D. glomerata* characterize good persistence and tolerance to unfavourable weather conditions, especially to drought (Borawska-Jarmułowicz, 2005). The ability to tolerate low temperatures, especially in early spring, is integral to the survival of *D. glomerata*. Since the development of freezing tolerance is crucial for the survival and productivity of overwintering crops, it is important to understand the basis of resistance or tolerance to low temperatures conditions (Pojedyniec and Martyniak, 1988). Chlorophyll *a* fluorescence measurement is one of the physiological parameters exploited as a reliable indicator of plant stress tolerance. It is a fast, non-destructive and informative tool to study the physiological state of the photosynthetic apparatus of any photosynthesizing material and under any growth conditions (Kalaji and Łoboda, 2009). The aim of the present study was to investigate the freezing tolerance of two *D. glomerata* varieties differing in earliness, and evaluate the use of some physiological features such as chlorophyll content and plant photosynthetic efficiency.

### Materials and Methods

The experiment was conducted in controlled growth conditions (Phytotron) in 2008. Fifty seeds of each of two Polish varieties of *D. glomerata*, Amera and Amila, were sown per pot filled with 3 kg mineral brown soil of 70% capillary water capacity. The concentration of available phosphorus, potassium and magnesium were medium and the soil pH<sub>KCl</sub> was 5.1. Fertilization was applied once before sowing (g per pot): N – 1.039, P – 0.268, K – 0.162. At emergence and tillering phases (22 and 43 days after sowing, respectively) plants were treated with two levels of low temperature (separately): -5 °C and -10 °C for 24 hours. Leaf greenness index was measured using a SPAD-502 Chlorophyll Meter (Minolta, Japan) and

chlorophyll *a* fluorescence by Fluorescence Imaging System - FluorCam 800MF (Photon Systems Instruments, Czech Republic). Measurements were carried out once before (control) and twice after each low temperature treatment (directly and after 48 hours). Leaf greenness was measured only during the tillering phase, whereas chlorophyll *a* fluorescence was measured during both emergence and tillering phases. Measurements were made for 15 replications on fully developed leaves of randomly selected plants. The amount of survived shoots after one week of thermal stress was also registered. The experimental data were analysed using analysis of variance (one way ANOVA).

## Results and Discussion

Low temperature causes damage to plants' photosynthetic apparatus (Choluj *et al.*, 1997; Kalaji and Loboda, 2009). During the tillering phase, regardless of the level of the applied low temperature, plants of both the analysed varieties of *D. glomerata* showed similar chlorophyll content of leaves expressed as leaf greenness (SPAD units) (Figure 1). Low temperatures (-5 °C and -10 °C) caused significant decrease of chlorophyll content directly after its application, compared with the control. More reduction of chlorophyll content was found in plants treated with lower temperature (-10 °C) for both varieties (about 24.3%) as compared to temperature -5 °C treatment (16.4% for Amila and 22.7% for Amera). After 48 hours of low temperature treatment (-5 °C) chlorophyll content significantly increased only in Amera. However, that value was lower than that of control plants (Figure 1).

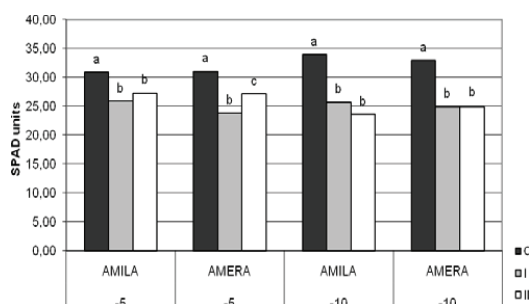

Figure 1. Leaf greenness index (SPAD units) of *D. glomerata* varieties (Amila and Amera) at tillering phase before (control – C) and after (I – directly and II – after 48 hours) low temperatures (-5 °C and -10 °C) application. Values on diagram followed with the same letters (for each set of data) had no significant differences between them at  $P = 0.05$  according to Tukey's test.

One of the main targets to be affected by low temperature is photosystem II (PSII) (Öquist *et al.*, 1987). The measurements of fluorescence *a* chlorophyll showed that during emergence and tillering phases the maximum quantum efficiency of Photosystem II (Fv/Fm) of plants of both *D. glomerata* varieties was distinctly lower after thermal stress in comparison with the control (Figure 2). During the emergence phase, after 48 hours from freezing temperature of -5 °C only Amila variety plants showed recovery from thermal stress. No recovery was observed after -10 °C application. A significant reduction in Fv/Fm values was denoted for all plants of tested varieties treated with both low temperatures during tillering. There was no recovery from thermal stress during the second measurement. The survival of the shoots, estimated one week after thermal stress, was observed only in plants exposed to -5 °C (Table 1). It was also found that, at tillering phase, the survival was clearly better than in the emergence phase. Amila showed better survival compared to Amera. It was also observed that all plants treated with stress temperature of -10 °C did not survive.

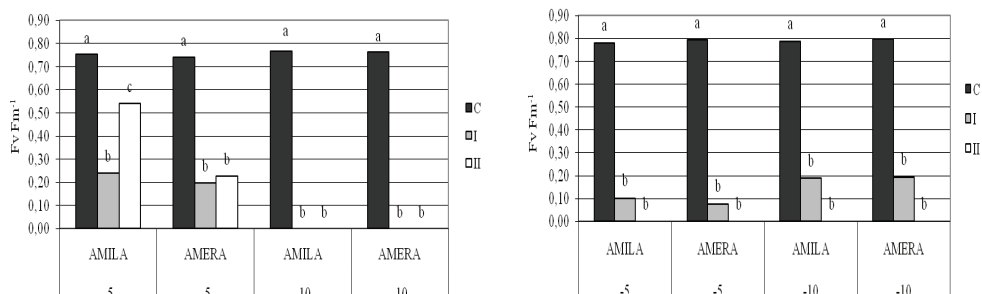

Figure 2. Maximum quantum efficiency of Photosystem II (Fv/Fm) of *D. glomerata* varieties (Amila and Amera) at emergence (left) and tillering (right) phases before (control – C) and after (I – directly and II – after 48 hours) low temperatures (-5 °C and -10 °C) application. Values on diagram followed with the same letters (for each set of data) had no significant differences between them at the probability level of  $P = 0.05$  according to Tukey's test.

Table 1. Survival of shoots of *D. glomerata* varieties (Amila and Amera) at emergence and tillering phases one week after low temperature treatments (%).

Variety	-5 °C		-10 °C	
	emergence phase			
Amera	7.0	a	0.0	a
Amila	19.4	b	0.0	a
tillering phase				
Amera	16.6	a	0.0	a
Amila	38.5	b	0.0	a

Values in column followed with the same letters had no significant differences between them at the probability level of  $P = 0.05$  according to Tukey's test.

## Conclusions

Our results indicated that the exposure of both *D. glomerata* varieties to low temperatures caused a decrease in chlorophyll content. Higher reduction in the maximum quantum efficiency of Photosystem II (Fv/Fm) than chlorophyll content was observed. Photosynthetic apparatus of both varieties was more sensitive to -10 °C at the emergence growth phase. The variety Amila was more tolerant to low temperature stress during the emergence phase, due its better recovery of photosynthetic efficiency from stress after withholding of low temperature application and better survival of its shoots as compared to the variety Amera.

## Acknowledgements

The authors express their thanks to Ms. Marlena Dublińska for her laboratory work.

## References

- Borawska-Jarmulowicz B. (2005) The response of *Dactylis glomerata* used in meadow mixture on the course of weather conditions in the long term. *Grassland Science in Poland* 8, 27-33 (in Polish).
- Chojuj D., Kalaji M.H. and Niemyska B. (1997) Analysis of the gas exchange components in chilled tomato plants. *Photosynthetica* 34, 583-589.
- Kalaji M.H. and Łoboda T. (2009) *Chlorophyll fluorescence to in plants' physiological state researches*. Warsaw University of Life Sciences -SGGW, Warsaw 2009.
- Pojedyniec M. and Martyniak J. (1988) Attempt of determination of frost resistance of some important species and varieties of fodder grasses. *Zeszyty Problemowe Postępów Nauk Rolniczych* 366, 35-41 (in Polish).
- Öquist G., Greer D.H. and Ögren E. (1987) Light stress at low temperature. In: Kyle J., Osmond C.B. and Arntzen C.J. (eds.): *Photoinhibition*. Elsevier, Amsterdam, pp. 67-87.

# Apex development and stem morphology of vernalized and regrowing tillers of timothy

Seppänen M.<sup>1</sup>, Pakarinen K.<sup>2</sup>, Jokela V.<sup>1</sup>, Andersen J.R.<sup>3</sup>, Fiil A.<sup>3</sup>, Santanen A.<sup>1</sup> and Virkajärvi P.<sup>2</sup>

<sup>1</sup> Department of Applied Biology, University of Helsinki, Finland

<sup>2</sup> North Savo Research Station, MTT Agrifood Research Finland

<sup>3</sup> Department of Genetics and Biotechnology, Aarhus University, Denmark

Corresponding author: mervi.seppanen@helsinki.fi

## Abstract

The transition of apex from vegetative to reproductive stage is considered to be necessary for the formation of true stem. The progressive lignification during maturation of yield-forming stems reduces digestibility and so there is a negative correlation between the quantity and quality of grass biomass. The canopy structure of spring growth consists mainly of flowering and stemforming tillers, whereas in the regrowing sward only few stems can be found. Spring growth is affected by vernalization which induces flowering. We have studied in greenhouse and field experiments the effect of vernalization on canopy structure, stem morphology and expression of flowering genes *VRN1* and *VRN2* in timothy (*Phleum pratense* L.). Our results show that the lignified sclerenchyma ring formed in vernalized and non-vernalized elongating tillers irrespective of the developmental stage of the apex. The result uncouples the processes of stem elongation, lignification and reduced digestibility from flowering. The peak expression of vernalization genes *VRN1* and *VRN2* coincided with the transition of apex to reproductive stage in vernalized tillers but not in regrowing non-vernalized tillers. This indicates that the regulatory processes leading to the development of flowering and elongating tillers in the first and second harvests is different.

Keywords: Apex development, elongation, flowering, lignification, *Phleum pratense*, regrowth, sclerenchyma ring, spring growth, timothy, vernalization.

## Introduction

Timothy (*Phleum pratense* L.) is a common forage grass species in mixtures for silage in Nordic conditions, since it has good overwintering capacity and the harvested biomass is palatable to livestock. As the accumulation of flowering stems reduces the digestibility of forage grass biomass, the control of flowering is one of the targets in forage grass breeding. Whereas many *Lolium* and *Festuca* spp. require vernalization and long days for flowering, timothy flowers without vernalization. However, timothy responds to day length and flowering tillers develop as the critical day length is exceeded (Heide, 1982). Here we have studied the development of elongating, yield-forming tillers in timothy with special attention to the relationship between apex development and lignification and to the role of vernalization signals in this process.

## Materials and methods

Timothy plants (cv. Tammisto) were grown under field conditions at the MTT Agrifood Research, Maaninka Research Station, Finland (63°10'N, 27°18'E). Samples for morphological or RNA analysis were harvested at indicated time points and the developmental stage of the shoot apex was recorded using a scale adapted from the 11-stage scale developed for *L. perenne* by Sweet *et al.* (1991). Sample harvesting and preparation was done as described in



Seppänen *et al.* (2010). Three replicate stems of each apex developmental stage were prepared, dyed with safranin-alcian blue, examined, and photographed. For the amplification of two putative vernalization-responsive gene orthologues in timothy, the flowering inducer *VRN1* and the flowering repressor *VRN2*, primers were designed against corresponding genes and the used primers as well as real time PCR conditions are reported in Seppänen *et al.* (2010).

## Results and discussion

A reduction in the digestibility of forage biomass is thought to be a result of extensive lignification of flowering stems (Akin, 1989). In this study, a hollow stem and a lignified sclerenchyma ring was found at very early developmental stages of elongating tillers, already at apex stage A1 (Figure 1). The height of elongating tillers with vegetative and reproductive apices was the same, and we conclude that lignification was required for mechanical support of the stem. We also studied the expression of two flowering genes, which regulate the transition to reproductive stage in elongating tillers in controlled greenhouse conditions and in field experiments. We found that the induction of *VRN1* and *VRN2* expression required vernalization signal, and that the expression peaked at apex stage A3, when the floral structures start to develop. In field conditions, the expression of both *VRN1* and *VRN2* peaked in June when the day length was the longest, 20 hours (Figure 2). These observations indicate that the expression level of *VRN1* and *VRN2* was also dependent on day length and light intensity. The studied genes were active only in vernalized tillers, and not in elongating tillers in the regrowth. This indicates a similar low-temperature requirement of *VRN1* induction in timothy as has been reported earlier in barley (Sasani *et al.*, 2009).

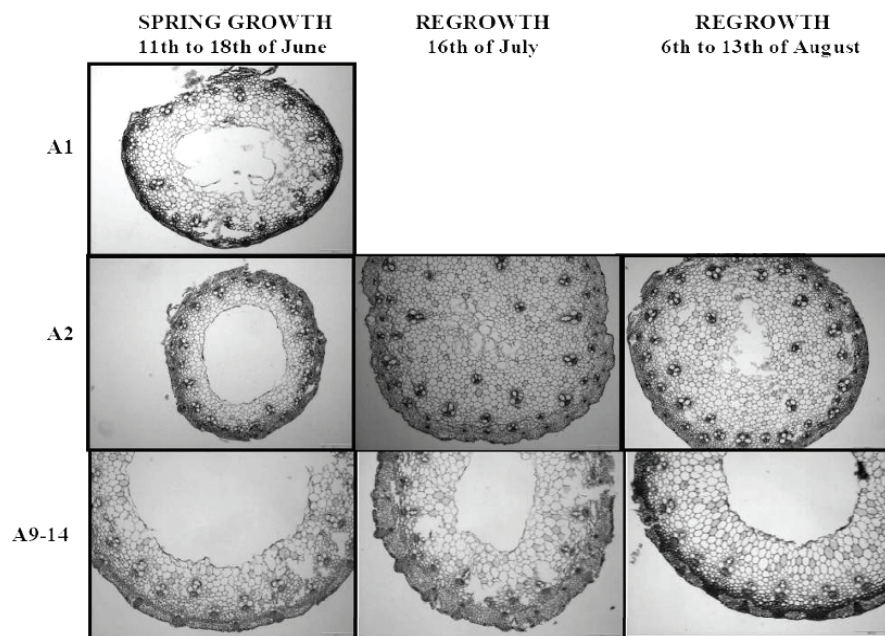

Figure 1. An example of the morphology of stems in spring growth and regrowth at different developmental stages of the apex. A1 to A2 - vegetative stage, and A9-A14 reproductive stages of apices (Sweet *et al.*, 1991). Samples were stained with conventional safranin-alcian blue stain for lignin (dark) and polysaccharides.

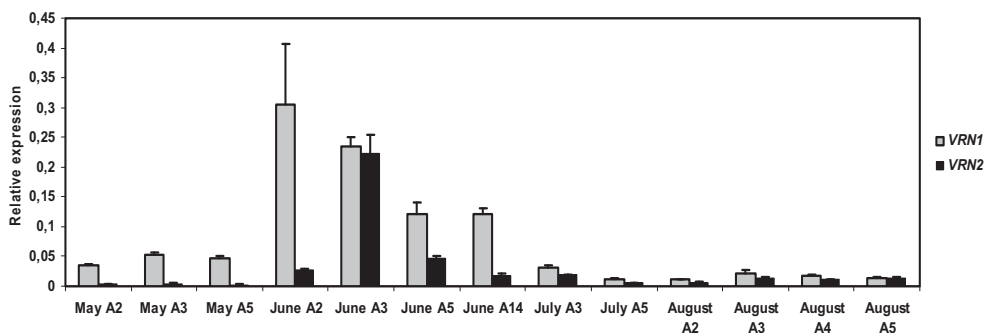

Figure 2. Relative amounts of putative *VRN1* and *VRN2* orthologue transcripts as compared with *Actin* transcript levels in the leaves of field grown timothy plants grown at different developmental stages (Seppänen *et al.*, 2010).

## Conclusion

The transition of apex from vegetative to generative stage is commonly considered to occur prior to intensive lignification of stem. However, the exact developmental stage of the apices has not been accurately monitored. Our results reveal that the formation of a lignified sclerenchyma ring that efficiently reduces the digestibility of the stem develops in vernalized tillers, the apices of which are still at vegetative stage. The vegetative tillers could be as tall as the reproductive tillers and it was concluded that the lignification of the stem was not related to apex development but rather to a requirement for mechanical support. In the regrowing tillers the lignification occurred somewhat later. Both *VRN1* and *VRN2* homologues required a vernalization signal for expression, so the development of yield forming tillers in the regrowth was regulated independently of the studied genes.

## References

- Akin D.E. (1989) Histological and physiological factors affecting digestibility of forages. *Agronomy Journal* 81, 17-25.
- Heide O.M. (1982) Effects of photoperiod and temperature on growth and flowering in Norwegian and British timothy cultivars (*Phleum pratense* L.). *Acta Agriculturae Scandinavia* Section B, Soil and Plant Science 32, 241-252.
- Sasani S., Hemming M.N., Oliver S.N., Greenup A., Tavakkol-Afshari R., Mahfoofi S., Poustine K., Sharifi H.R., Dennis E.S., Peacock W.J. and Trevaskis B. (2009) The influence of vernalization and daylength on expression of flowering time genes in the shoot apex and leaves of barley (*Hordeum vulgare*). *Journal of Experimental Botany* 60, 2169-2178.
- Seppänen M.M., Pakarinen K., Jokela V., Andersen J.R., Fiil A., Santanen A. and Virkajärvi P. (2010) Vernalization response of *Phleum pratense* L. and its relationship to stem lignifications and floral transition. (manuscript pending for publication in *Annals of Botany*).
- Sweet N., Wiltshire J.J.J. and Baker C.K. (1991) A new descriptive scale for early reproductive development in *Lolium perenne* L. *Grass and Forage Science* 46, 201-206.

# Lifespan of white clover (*Trifolium repens* L.) plant organs under northern temperate climatic conditions

Sturite I.<sup>1</sup>, Henriksen T.M.<sup>2</sup> and Breland T.A.<sup>3</sup>

<sup>1</sup> Norwegian Institute for Agricultural and Environmental Research, Arctic Agriculture and Land Use Division, NO-8860 Tjøtta, Norway

<sup>2</sup> Norwegian Institute for Agricultural and Environmental Research, Arable Crops Division, NO-2849 Kapp, Norway

<sup>3</sup> Norwegian University of Life Sciences, Department of Plant and Environmental Sciences, NO-1432 Ås, Norway

Corresponding author: ievina.sturite@bioforsk.no

## Abstract

Sturite *et al.* (2007) investigated growth and death of the major parts of white clover (*Trifolium repens* L. cv. 'Snowy') plants in pure stand and in mixture with meadow fescue (*Festuca pratensis* L. cv. 'Fure') in a combined plot and root window experiment in Norway (60°42' N, 10°51' E). Leaves, stolons and roots were tagged and their lifespan was monitored in harvested and non-harvested stands during two experimental years. The longevity of leaves and petioles ranged from 21 to 86 d (mean = 59 d). About 60% of the leaves produced during the growing season turned over before the autumn. Of the remaining leaves, 70–80% were dead or had disappeared by the subsequent spring. The lifespan of sections of the main stolons ranged from 111 to over 677 d (mean = 411 d). In particular, stolon sections close to the parent fragment of undisturbed plants were long lived, whereas sections towards the terminal bud overwintered more poorly and had a much shorter lifespan. The longevity of roots was from 27 to 621 d (mean = 290 d) and was higher for roots appearing in spring and autumn than in summer. Harvesting significantly reduced the longevity of stolons and caused an increased fragmentation of the white clover plant but did not decrease leaf/petiole or root lifespan.

Keywords: Harvesting, lifespan, leaves, main stolons, roots, *Trifolium repens*, white clover

## Introduction

In order to understand population dynamics and N cycling in plant communities including white clover and to secure economically and environmentally sound management practices, more knowledge about the longevity and turnover of white clover plant organs throughout the year is needed. Under Norwegian conditions, Sturite *et al.* (2006) found that white clover leaves lost between 59 and 88% of their N from autumn till spring. Similar results have been reported in England, where the climate is milder (Woledge *et al.*, 1990). Sturite *et al.* (2006) found that roots seemed to live longer than leaves. Watson *et al.* (2000), on the other hand, found that root turnover was quite rapid and more so in a warmer (Italy) than in a cooler (UK) climate. In the present paper, we focus on results originally published by Sturite *et al.* (2007). Our main objective was to determine the longevity of white clover plant organs in harvested and non-harvested stands.

## Materials and methods

A combined plot and root window experiment was conducted at Apelsvoll Research Centre in central southeast Norway (60°42' N, 10°51' E), where the climate is typical to inland Scandinavia. The experiment lasted from June 2002 until May 2004. On June 7, 2002, three

field plots of 1 m<sup>2</sup> each were established along each of the three root window frames, which represented blocks of replicate treatments. Four white clover plants (cv 'Snowy'), originating from a stolon section hereafter termed parent fragment, were planted on each 1 m<sup>2</sup> plot. On one of these, 40 meadow fescue (*Festuca pratensis* L. cv. 'Fure') plants were planted in mixture with the white clover. During the experimental years, one white clover plot in each block was left undisturbed while the other plots were harvested three times. Plots with white clover mixed with meadow fescue were split in two, and half of the plot was left undisturbed. The condition of leaves/petioles, stolons and roots were monitored regularly by visual assessment of the colour of individually tagged leaves/petioles, stolon and root sections on a scale where, 1 = green (leaves, stolons) or white (roots), 2 = yellow (leaves) or browning has begun (Stolons and roots), 3 = brown (leaves, stolons, roots) and 4 = dark brown or missing (assumed dead; leaves), dark brown and soft or light brown (stolons), or black or not visible (roots). For harvested leaves, petiole status was monitored. Analysis of variance (ANOVA) was used to assess whether time of plant part emergence (tagging date used as proxy variable) influenced the total lifespan. Further details have been presented by Sturite *et al.* (2007).

## Results and discussion

The longevity of leaves/petioles (from the moment of 90–95% leaf unfolding until leaves were dark brown or missing) ranged from 21 to 86 days regardless of treatment. The mean leaf lifespan was not significantly longer in the first (65 days SD = ± 12, n = 222) than the second (53 ± 17 days, n = 76) growing season. Leaves emerging early in the growing season lived slightly longer than leaves appearing later on ( $P < 0.001$ ; Figure 1). If plants were not harvested, about 60% of the leaves turned over within the growing season. Of 60 leaves marked in October 2002, 76% were dead or had disappeared by April 2003. In April 2004, the observed disappearance of leaves over the winter was similar. It seems likely that the inherently short leaf lifespan itself played an important role in the winter loss. This means that the leaves may be a source of readily plant-available N, but also a pool of N at risk to being lost between growing seasons.

The tagged sections of the main stolons lived from 111 to over 677 days (average 411 days). The lifespan of stolon sections depended on time of emergence ( $P < 0.01$ ; Figure 1). Their mean longevity differed between non harvested and harvested plants ( $P < 0.001$ ) but not between the pure stand and the grass–clover mixture. Harvesting led, in particular, to death of sections tagged close to the parent stolon fragment. The death of stolon sections disrupted the physical continuity within the plants and broke them up into smaller individuals towards the end of the growing season of 2003. The dead stolon sections underwent very slow decomposition and were visible for about 80 days after they were assessed as dead.

The roots lived between 27 and 621 days and the average lifespan (290 days) was unaffected by the harvesting treatments. The root lifespan was, however, dependent on the time of their appearance ( $P < 0.001$ ; Figure 1). Root death occurred mainly in the spring and towards the autumn and to a greater extent in the second than in the first growing season. Watson *et al.* (2000), in contrast to our results, found that white clover roots were very short-lived both in Italy (7–14 days) and in the UK (35–42 days). Under controlled conditions, Forbes *et al.* (1997) similarly demonstrated a significant decrease in ryegrass (*Lolium perenne* L.) root longevity with increasing temperature. These findings support our results of a very long white clover root lifespan in the northern climate.

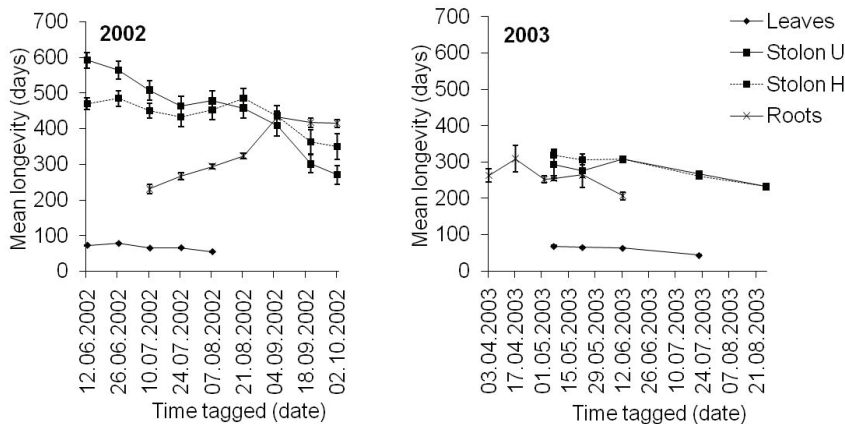

Figure 1. Longevity of white clover leaves/petioles, stolons and roots as dependent on time tagged in 2002 and 2003. Mean of all treatments, except for stolons, where letters U and H indicate means of non-harvested and harvested plants, respectively (from Sturite *et al.*, 2007).

## Conclusions

The leaves were the most dynamic part of white clover plants and substantially more ephemeral than stolons and roots. About 60% of the leaves produced during the growing season senesced, died and disappeared by late autumn. Stolons and roots were much more winter resistant than leaves, which may constitute a risk of N loss to the environment.

## References

- Forbes P., Black K. and Hooker J. (1997) Temperature-induced alteration to root longevity in *Lolium perenne*. *Plant and Soil* 190, 87-90.
- Sturite I., Henriksen T.M. and Breland T.A. (2007) Longevity of white clover (*Trifolium repens* L.) leaves, stolons and roots under northern temperate climatic conditions. *Annals of Botany* 100, 33-40.
- Sturite I., Uleberg M.V., Henriksen T.M., Jørgensen M., Bakken A.K. and Breland T.A. (2006) Accumulation and loss of nitrogen in white clover (*Trifolium repens* L.) plant organs as affected by defoliation regime on two sites in Norway. *Plant and Soil* 282, 165-182.
- Watson C.A., Ros J.M., Bagnaresi U., Minotta G., Roffi F., Atkinson D., Black K.E. and Hooker J.E. (2000) Environment-induced Modifications to Root Longevity in *Lolium perenne* and *Trifolium repens*. *Annals of Botany* 85, 397-401.
- Wolledge J., Tewson V. and Davidson I.A. (1990) Growth of grass clover mixtures during winter. *Grass and Forage Science* 45, 191-202.

## Effects of fungal endophyte infection in the grass *Festuca rubra* on germination and growth of four legume species

Vázquez-de-Aldana B.R., Romo M., García-Ciudad A., Petisco C. and García-Criado B.  
*Instituto de Recursos Naturales y Agrobiología de Salamanca, IRNASA-CSIC; Apdo 257;*  
*37071 Salamanca; Spain*

Corresponding author: beatriz.dealdana@irnasa.csic.es

### Abstract

Red fescue (*Festuca rubra*) is a perennial grass present in a wide range of ecological conditions. It is also included in mixtures with other grasses and legumes for several purposes. The objective of this paper was to determine the effect of *Festuca rubra* plants, infected and non-infected by the endophyte *Epichloë festucae*, on the germination and seedling growth of four legume species. During three weeks, a greenhouse experiment was carried out with infected and non-infected plants of *F. rubra*, and four legume species: *Trifolium pratense*, *Trifolium repens*, *Trifolium subterraneum* and *Lotus corniculatus*. The emergence of the legumes was not affected by the presence of *F. rubra* plants. However, the length and biomass production of the four legumes was reduced in the presence of *F. rubra* plants. The decrease in shoot length was greater than that in root length. There was a significant effect of endophyte infection status of *F. rubra* plants on the root length and root biomass of legumes. The reduction in root length and root dry weight of legume seedlings was greater in the presence of infected plants than in the presence of non-infected plants.

Keywords: red fescue, endophytes, *Epichloë*, competition, legumes

### Introduction

*Festuca rubra* is a perennial grass, very persistent and tolerant of a wide range of ecological conditions. Compared with other grass species, it grows well on soils of poor to moderate fertility (Peeters, 2004). It is frequent in natural grasslands with complex floristic composition, and it is included in mixtures for dry soils, mountain areas and extensive use with other grasses and with legumes (Peeters, 2004). In companion with legumes it is also used for silage making (Laser and Von Boberfeld, 2004) and in post-fire recovery (Fernández-Abascal *et al.*, 2003).

In Mediterranean grasslands of western Spain, a high percentage of *F. rubra* plants are asymptotically infected by the fungal endophyte *Epichloë festucae* (Zabalgogezcoa *et al.*, 1999). A number of studies indicate that endophyte-infected grasses exhibit a considerable competitive advantage over their non-endophytic congeners. Thus, as compared to non-infected, infected plants are more resistant to abiotic stress factors such as drought, heavy metal accumulations and nutrient deficiency (Kuldau and Bacon, 2008), as well as more resistant to invertebrate herbivores due to the alkaloid production. This may affect the growth of companion species in mixtures, for instance, *Trifolium pratense* performance appeared to be better in the presence of endophyte-free *Festuca arundinacea* plants (Malinowski *et al.*, 1999).

The objective of the research reported in this paper was to determine the effect of *F. rubra* plants, infected and non-infected by *E. festucae* endophyte, on the germination and seedling growth of four legume species (*Trifolium pratense*, *Trifolium repens*, *Trifolium subterraneum* and *Lotus corniculatus*).



## Materials and methods

*Festuca rubra* plants infected by *E. festucae* endophyte were collected from ‘dehesa’ grasslands in western Spain (province of Salamanca). Infection by *E. festucae* endophyte was verified by microscopic analysis of stem-pith scraping, as well as by isolation of the fungus from stems and leaf sheaths on potato dextrose agar. Plants were grown in pots until they were divided into several ramets; one half of the ramets was used to produce endophyte-free tillers by treatment with propiconazole (TILT®, Ciba), a systemic fungicide. In this way, we obtained infected (E+) and non-infected (E-) plants derived from a common mother plant (half-sib lines). All plants were transplanted in a research farm. Seeds produced were collected and E+ and E- seeds were obtained from ramets of each original plant. Seeds of the legumes *T. pratense*, *T. repens*, *T. subterraneum* and *L. corniculatus* were obtained from Zulueta Co.

Seeds of red fescue (E+ and E-) were germinated and individual plants were grown in pots in a mixture containing peat moss, perlite and sand, in a glasshouse. After six months, plants of equal size were selected and individually transplanted into new pots and placed in a growth chamber with a photoperiod 16 h light at 25 °C and 8 h dark at 20 °C during two acclimatization weeks. The experiment consisted of a factorial combination of four legume species and two infection levels with ten replications, and it was carried out in pots containing one plant of *F. rubra* and 10 seeds of the legume species. As control, ten seeds of the legume were sown in pots without *F. rubra* plants. Seedling emergence was controlled daily for three weeks, until no further seedlings emerged. After 21 days, seedlings were harvested; shoot and root lengths were obtained from scanned images and shoot and root biomass were obtained from dried samples. Data were presented as percentage of reduction over control based on mean values for all ten seedlings per pot. For each legume species, analysis of variance with endophyte infection as factor was applied to the data (SPSS v17.0).

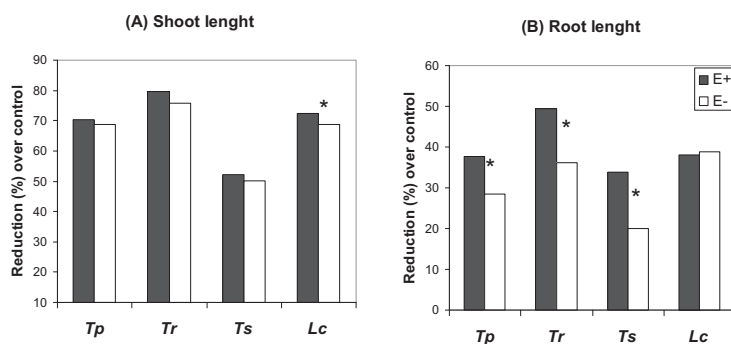

Figure 1. Reduction in shoot (A) and root (B) length (% over control) of four legume species (Tp= *T. pratense*; Tr= *T. repens*; Ts= *T. subterraneum*; Lc= *L. corniculatus*) when growing with *F. rubra* plants infected (E+) and non-infected (E-) by the endophyte *E. festucae*. \* = significant differences between E+ and E- pair of means at  $P < 0.05$  ( $n=20$ ).

## Results and discussion

There were no significant differences between the effect of E+ and E- plants on the emergence of the legume species. The presence of *F. rubra* plants decreased seedling length of the legumes. The inhibitory effect on the shoot length was stronger than on the root length. The inhibition of the shoot length of *L. corniculatus* was significantly ( $P < 0.05$ ) greater when



growing with E+ plants than when growing with E- plants (Fig. 1A). The reduction of the root length of *T. pratense*, *T. repens* and *T. subterraneum* species growing with E+ plants was significantly ( $P < 0.05$ ) greater than when growing with E- plants (Fig. 1B).

Seedling biomass (shoot and root) of the legume species decreased in presence of *F. rubra* plants (Fig. 2). The decrease in shoot biomass was not significantly ( $P > 0.05$ ) affected by the presence of *Epichloë* endophyte in *F. rubra* plants (Fig. 2A). However, the reduction in root length of the four legumes was significantly ( $P < 0.05$ ) greater in presence of E+ than in presence of E- plants (Fig. 2B).

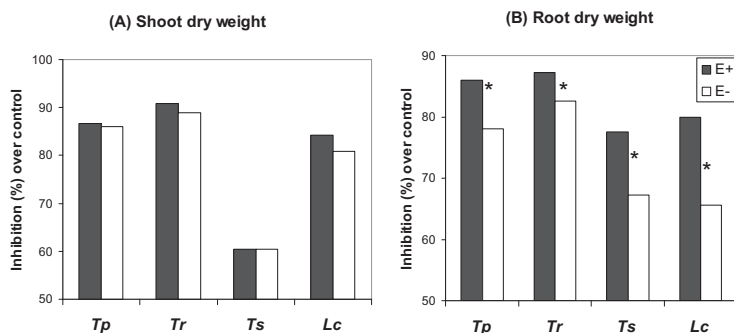

Figure 2. Reduction in shoot (A) and root (B) dry matter (% over control) of four legume species (Tp= *T. pratense*; Tr= *T. repens*; Ts= *T. subterraneum*; Lc= *L. corniculatus*) as affected by the presence of *F. rubra* plants infected (E+) and non-infected (E-) by the endophyte *E. festucae*. \* = significant differences between E+ and E- pair of means at  $P < 0.05$  (n=20).

## Conclusion

When growing with endophyte-infected *F. rubra* plants, root length and root biomass of legumes was lower than when growing with non-infected plants. Therefore, fungal infection by *Epichloë festucae* increases competitiveness of *F. rubra*, mainly by a greater inhibition of root growth of companion legumes.

## Acknowledgements

This research was funded by AGL2008-01159AGR project, from the Spanish Ministry of Science and Technology and FEDER.

## References

- Kuldau G. and Bacon C. (2008) Clavicipitaceous endophytes: Their ability to enhance resistance of grasses to multiple stresses. *Biological Control* 46, 57-71.
- Fernández-Abascal I., Tárrega R., Luis-Calabuig E. and Marcos E. (2003) Effects of sowing native herbaceous species on the post-fire recovery in a heathland. *Acta Oecologica* 24, 131-138.
- Laser H. and von Boberfeld W.O. (2004) Effect of legume proportion and physiological age on forage quality and the suitability of *Agrostis capillaris* L. and *Festuca rubra* L. for silage making. *Plant, Soil and Environment* 50, 315-323.
- Malinowski D.P., Belesky D.P. and Fedders J.M. (1999) Endophyte infection may affect the competitive ability of tall fescue grown with red clover. *Journal of Agronomy and Crop Science* 183, 91-101.
- Peeters A. (2004) *Wild and Sown Grasses*. FAO and Blackwell, Rome, Italy, 311 pp.
- Zabalgoeazcoa I., Vázquez-de-Aldana B.R., García Criado B. and García Ciudad A. (1999) The infection of *Festuca rubra* by the fungal endophyte *Epichloë festucae* in Mediterranean permanent grasslands. *Grass and Forage Science* 54, 91-95.

# Cytoplasmic genetic diversity in molecular markers within and between *Lolium* cultivars

Wallace M.D.<sup>1,2</sup>, Provan J.<sup>1</sup> and Gilliland T.J.<sup>1,2</sup>

<sup>1</sup>*School of Biological Sciences, Queens University Belfast, Northern Ireland*

<sup>2</sup>*Agri-Food and Biosciences Institute, Crossnacreevy, Northern Ireland*

Corresponding author: Margaret.Wallace@afbini.gov.uk

## Abstract

The current study investigated whether genetic distance using molecular markers may be used to describe the genetic relationships between registered *Lolium* cultivars and determine levels of shared plant identities across different species and cultivars. Twenty-four ryegrass cultivars, representative of current commercial diversity, were screened by sequencing chloroplast genome regions to identify ten single nucleotide polymorphisms, using allele-specific PCR. Nineteen haplotypes were identified. The same haplotype was found in individual plants across five *Lolium* species. Four of the cultivars showed no variation, not only within but also over the four cultivars. Twelve haplotypes were unique to eight cultivars. However, demarcation of species was not maintained by these markers. It was concluded that further gene markers would be required to more accurately describe the genetic relationships.

Keywords: *Lolium*, chloroplast, SNPs, reference collections.

## Introduction

The award of Plant Breeder's Rights requires a *Lolium* cultivar to be distinct from all other cultivars in known existence (UPOV, 1991). This requires morphological features of candidates to be tested against recognised cultivars each year. On passing, candidates are then added to the ever escalating control set (FERA, 2008). The answer to the growing control set is thought to lie in the use of molecular markers (Button, 2007). However, solely applying these techniques raises difficulties due to the allogamous nature of grasses. It is thought that managing the reference collection by dividing cultivars into subsets by way of a common marker (or set of markers) would be a more reliable system. Genetic diversity is vast in grass populations; therefore focussing on the cytoplasm reduces this to a manageable size. McGrath *et al.* (2007) have already shown that there is a high level of cytoplasmic diversity not only between, but also within cultivars using microsatellites. Also, microsatellites have problems with homoplasmy (Freeland, 2005). The aim of this study was to identify the potential of SNPs (Single Nucleotide Polymorphisms) to manage the control set.

## Materials and methods

The plant material consisted of 15 perennial ryegrass (*Lolium perenne*), three Italian ryegrass (*L. multiflorum*), four hybrid (*L. x boucheanum* Kunth.), one Festulolium (*L. multiflorum x Festuca arundinacea*) and one Westerwold (*L. multiflorum var. Westerwoldicum*) cultivars (names given in Table 1). The three maturity groups of *L. perenne* were represented within the 15 cultivars. Seed from the definitive stocks of the cultivars was acquired from the AFBI germplasm store at the Plant Testing Station, Crossnacreevy.

DNA was extracted from eight individual plants of each cultivar, except Veritas with only five, using MN Nucleo Spin Plant II extraction kit. The *trnT-trnL* intergenic spacer was sequenced in one representative from each variety using the universal primers of Taberlet *et*

al. (1991) to identify SNPs. Ten SNPs were screened using allele-specific PCR. The median joining network was analysed using the Network package (www.fluxus.com)

## Results and discussion

Four of the 24 cultivars were each found to contain a unique haplotype (Table 1 and Fig. 1: Brutus(12), Numan(15), AberElan(16) and Tewera(19)) and four cultivars each contained 2 unique haplotypes (Table 1 and Fig. 1: Grasslands Manawa(6, 13), RVP Lemtal(9, 14) Bealey(7, 10) and Kent Indigenous(17,18)). Only in Grasslands Manawa and Bealey were all individual plants found to express their cultivar's unique haplotypes. In all other cases the unique haplotype was only found in one of the eight plants sampled. Four of the other cultivars (BX421, Barsilo, Danergo and Loretta) showed no variation and so all eight plants carried the same identifying haplotype. This haplotype was also common to all four of these cultivars. The remaining cultivars varied in the number of different haplotypes they contained. The most common haplotype was present in 16 cultivars but not in Grasslands Manawa, RVP Lemtal, Bealey, Bronsyn, Kent Indigenous, Melle, Tyrone and Veritas. Moy and AberElan had the lowest number of plants containing the most frequent haplotype. AberElan, Numan and RVP Lemtal were the most diverse cultivars as they each contained four different haplotypes. AberDart, Fennema and Herbal had exactly the same distribution of haplotypes.

Table 1. Details of Haplotype groupings of 15 cultivars of *Lolium perenne* (PRG), four *L. x boucheanum* Kunth. (HRG), three *L. multiflorum* (IRG), one *L. multiflorum x Festuca arundinacea* (F) and one *L. multiflorum var. Westerwoldicum* (WW) as described by ten SNPs. \*single plants expressing unique haplotypes.

Cultivar	Species	Haplotype Group												
		1	2	3	4	5	6	7	8	9	10	11	12-19*	
BX421	F	8	-	-	-	-	-	-	-	-	-	-	-	
Barsilo	HRG	8	-	-	-	-	-	-	-	-	-	-	-	
Brutus	HRG	7	-	-	-	-	-	-	-	-	-	-	-	(12)
Gr. Manawa	HRG	-	-	-	-	-	7	-	-	-	-	-	-	(13)
Foyle	HRG	3	5	-	-	-	-	-	-	-	-	-	-	
AberComo	IRG	4	4	-	-	-	-	-	-	-	-	-	-	
RVP Lemtal	IRG	-	2	-	2	-	-	-	-	3	-	-	-	(14)
Danergo	IRG	8	-	-	-	-	-	-	-	-	-	-	-	
AberElf	PRG	7	-	-	-	-	-	-	-	-	-	-	1	
Loretta	PRG	8	-	-	-	-	-	-	-	-	-	-	-	
Numan	PRG	3	-	2	-	-	-	-	2	-	-	-	-	(15)
Bealey	PRG	-	-	-	-	-	-	5	-	-	3	-	-	
Bronsyn	PRG	-	-	7	-	-	-	-	1	-	-	-	-	
Moy	PRG	2	-	5	-	-	-	-	1	-	-	-	-	
AberDart	PRG	6	-	-	-	2	-	-	-	-	-	-	-	
AberElan	PRG	2	-	3	-	2	-	-	-	-	-	-	-	(16)
AberStar	PRG	6	-	-	-	-	-	-	-	-	-	-	2	
Fennema	PRG	6	-	-	-	2	-	-	-	-	-	-	-	
Kent Indig.	PRG	-	6	-	-	-	-	-	-	-	-	-	-	(17, 18)
Melle (Vigor)	PRG	-	4	-	4	-	-	-	-	-	-	-	-	
Tyrone	PRG	-	4	-	4	-	-	-	-	-	-	-	-	
Veritas	PRG	-	2	-	3	-	-	-	-	-	-	-	-	
Herbal	PRG	6	-	-	-	2	-	-	-	-	-	-	-	
Tewera	WW	3	-	-	-	4	-	-	-	-	-	-	-	(19)
Total		87	27	17	13	12	7	5	4	3	3	3	3	1 each

Demarcation between species was not maintained by these markers. For example, haplotype 1 was present in all five species. Similarly haplotype 2 was present, for example, in Foyle (hybrid), AberComo (Italian) and Veritas (perennial). This diversity was also true, to a lesser

extent, for haplotypes 4 and 5. BX421, Barsilo, Danergo and Loretta were identical and yet are from different species. This meant that when genetic relationships between the species was examined by median joining analysis there was no clear separation of the cultivars into species groups Fig. 1.

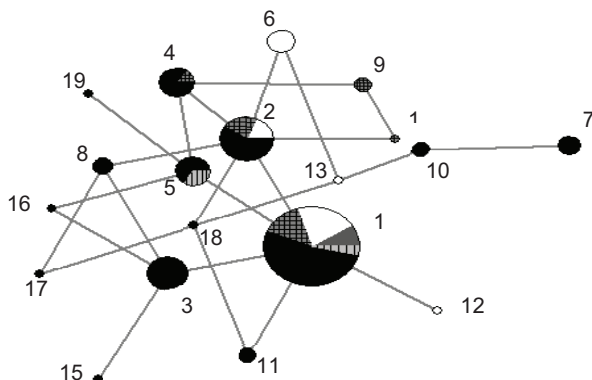

Figure 1. Haplotype groupings of 15 cultivars of *Lolium perenne* (black), 4 *L. x boucheanum* Kunth. (white), 3 *L. multiflorum* (grey crosshatch), 1 *L. multiflorum x Festuca arundinacea* (grey) and 1 *L. multiflorum Westerwoldicum* (light grey lined) as described by 10 SNPs.

## Conclusion

Although considerable genetic variation was observed, not all cultivars were distinct; nor were species demarcations maintained. Even given the relatively small plant numbers examined, differing levels of diversity within each cultivar was clearly evident. This may be a consequence of the close inter-breeding that is frequently conducted both within and between these species in the development of these commercial cultivars (Humphreys, 1997). Partially shared gene pools add complexity to the task of aligning genetic distances to breeding histories. It is therefore evident that if their genetic relationships are to be successfully described, further gene markers are required.

## Acknowledgements

M. D. Wallace is supported by a studentship from the Agri-Food and Biosciences Institute. Seed was obtained from the AFBI germplasm store, the Plant Testing Station, Crossnacreevy.

## References

- Button P. (2007) New developments in the International Union for the Protection of New Varieties of Plants (UPOV). *Proceedings of the XXII<sup>th</sup> Eurcarpia Symposium on Improvement of Fodder Crops and Amenity Grasses 19-23 August 2007*, pp. 32-45.
- FERA (2008) United Kingdom National List/Plant Breeders Rights Technical Protocol for the Official Examination of Distinctness, Uniformity and Stability (DUS). [www.fera.defra.gov.uk/plants/plantCultivars/](http://www.fera.defra.gov.uk/plants/plantCultivars/)
- Freeland J.R. (2005) *Molecular Ecology*. John Wiley & Sons, England.
- Humphreys M.O. (1997) The contribution of conventional plant breeding to forage crop improvement. *Proceedings XIII<sup>th</sup> International Grassland Congress 1*, 4 71-78. [www.internationalgrasslands.org/publications](http://www.internationalgrasslands.org/publications)
- McGrath S., Hodkinson T.R. and Barth S. (2007) Extremely high cytoplasmic diversity in natural and breeding populations of *Lolium* (Poaceae). *Heredity* 2007, 1-14.
- UPOV (1991) International Convention for the Protection of New cultivars of Plants. *UPOV Publication No. 644 (E) Section 1*.
- Taberlet P., Gielly L., Patou G. and Bouvet J. (1991) Universal primers for amplification of three non-coding regions of chloroplast DNA. *Plant Molecular Biology* 17, 1105-1109.

# Effect of maturity type of *Lolium perenne* cultivars on performance of grass-clover mixtures under frequent cutting

Wulfes R.<sup>1</sup> and Taube F.<sup>2</sup>

<sup>1</sup>University of Applied Sciences Kiel, Department of Agriculture, D-24783 Osterrönfeld, Germany

<sup>2</sup>Christian-Albrechts-University Kiel, Institute of Crop Science and Plant Breeding, Grass and Forage Science/Organic Agriculture, D-24118 Kiel, Germany

Corresponding author: rainer.wulfes@fh-kiel.de

## Abstract

*Lolium perenne* L. is the main companion grass in grass-white clover mixtures of north Germany. The main aim of this investigation is to quantify the influence of maturity type (early, late, mixture) of *Lolium perenne* cultivars in grass-white clover mixtures on productivity, forage quality parameters and white clover (*Trifolium repens* L.) compatibility. In this paper data of a three-year field experiment are presented. The field experiment was carried out on a loamy, sandy soil in Schleswig-Holstein. The swards were managed with different nitrogen levels (0 to 200 kg ha<sup>-1</sup> y<sup>-1</sup>) in a frequent cutting system. Harvesting dates were adjusted to a defined stage of maturity of the grass part of the mixtures. Compared with mixtures with late varieties of *Lolium perenne*, performance of grass-clover mixtures with early varieties of *Lolium perenne* was clearly superior, had a higher proportion of white clover, produced higher yields (DM: +3.5%, NE<sub>L</sub>: +5.9%, N: +13%), had a better quality (NE<sub>L</sub>: +0.08 MJ kg TM<sup>-1</sup>, CP: +0.5%) but required a higher cutting frequency. Marked differences between mixtures were found especially at low nitrogen fertilisation because of reduced yield in mixtures with late varieties of *Lolium perenne*.

Keywords: *Lolium*, clover-grass mixture, genotype, maturity group, nitrogen fertilization

## Introduction

Perennial ryegrass (*Lolium perenne* L. (Lp)) is the main companion grass in grass-white clover mixtures in permanent pastures of north Germany. There are many varieties of perennial ryegrass in different maturity groups, as characterised by time of ear emergence. Earlier investigations of pure early and late ryegrass varieties showed differences not only in spring growth, but also in the phenological composition of the tiller population (Wulfes, 1993). The higher proportion of reproductive tillers of the late variety resulted also in lower quality values at comparable phenological stages, especially under high nitrogen (N) level. In grass-clover mixtures these differences in phenological development can influence the competition between grass and clover. The main aim of this investigation is to quantify the influence of maturity type (early, late, mixture) of *Lolium perenne* cultivars in grass-white clover mixtures on productivity, forage quality parameters and white clover (*Trifolium repens* L.) compatibility.

## Materials and methods

Perennial ryegrass varieties (*Lolium perenne* L., 27 kg ha<sup>-1</sup>) in an early (cv. 'Gremie', diploid and cv. 'Bastion', tetraploid, each 50%), a late (cv. 'Vigor', diploid, and cv. 'Condesa', tetraploid, each 50%) and an early/late mixture (all cultivars, each 25%) were sown in 1992 together with 3 kg ha<sup>-1</sup> white clover (*Trifolium repens* L., cv. 'Milkanova'). The mixtures were tested in a field experiment on a loamy, sandy soil in Schleswig-Holstein, carried out in

a split-plot design with four replicates and harvested from 1993 to 1995. The nitrogen fertilization was increased in steps of 50 kg ha<sup>-1</sup> y<sup>-1</sup> from 0 to 200 kg ha<sup>-1</sup> y<sup>-1</sup>. Beyond this level it has been shown that the mixtures would change to pure grass swards (Wachendorf *et al.*, 2004). The amount of N fertilizer (0, 50, 100, 150, 200 kg ha<sup>-1</sup> y<sup>-1</sup>) was applied with emphasis on the first part of the vegetation period (0, 50 kg only to the first cut, 50 kg to each first and second cut, 50 kg to each first, second and third cut, 50 kg to all four cuts) in order to optimize the competition between grass and clover. The harvesting dates were adapted to practical conditions and were oriented towards maximizing productivity of the swards. The first cut was taken by ear emergence of the ryegrass varieties, the following cuts at a dry matter (DM) stage considered optimum for grazing (1.5 to 2 Mg ha<sup>-1</sup>). This resulted in different cutting frequencies and fertilization dates of the treatments.

In addition to yield parameters DM yield, net energy (NE<sub>L</sub>) yield and nitrogen (N) yield, quality parameters NE<sub>L</sub>-content and crude protein (CP) content were measured by NIRS.

## Results and discussion

On average over three years and five N-levels the cutting frequency of the mixtures differed between 3.7 (late mixture) and 4.4 (early mixture) cuts y<sup>-1</sup>. With increasing N-level, the cutting frequency increased from 3.8 (N0, N50) to 4.4 (N200) cuts y<sup>-1</sup>. The mixtures with the early Lp-maturity types produced the highest clover contents, especially at low nitrogen fertilization (Table 1).

Table 1. Effect of N-fertilization and maturity type of perennial ryegrass (Lp) on white clover content (% of dry matter) of the mixture (mean of 3 years)

Lp maturity type	N-fertilization (kg ha <sup>-1</sup> y <sup>-1</sup> )				
	0	1x50	2x50	3x50	4x50
Early	32	26	17	6	5
Late	26	20	14	4	4
early/late	24	22	13	7	4
Mean	27	23	15	6	4

On average over all tested N-levels, the grass-clover mixtures with the early Lp-varieties performed clearly superior (Table 2). The increased white clover content in these mixtures lead to significantly higher annual DM yields (+ 3.5%), NE<sub>L</sub>-yields (+5.9%) and N-yields (+ 13%) than the mixture with the late Lp-varieties but both were not significantly different from the mixtures with early and late Lp-varieties. The mean annual NEL and CP content of the early mixtures was significantly higher compared with all other mixtures. These results confirmed the observations of Frame and Boyd (1986) who found similar effects of early Lp-varieties on the performance of grass-white clover swards in Great Britain.

Table 2. Effect of maturity type of perennial ryegrass (Lp) on yield and quality parameters of the grass/white clover mixtures (mean of 3 years, 5 N-levels)

Lp maturity type	DM-yield	NE <sub>L</sub> -content in DM	NE <sub>L</sub> -yield	CP-content in DM	N-yield
	Mg ha <sup>-1</sup>	MJ kg <sup>-1</sup>	GJ ha <sup>-1</sup>	g kg <sup>-1</sup>	kg ha <sup>-1</sup>
early	9.00 <sup>a</sup>	6.66 <sup>a</sup>	59.1 <sup>a</sup>	174 <sup>a</sup>	224 <sup>a</sup>
late	8.69 <sup>b</sup>	6.58 <sup>c</sup>	55.8 <sup>b</sup>	169 <sup>b</sup>	197 <sup>b</sup>
early/late	8.90 <sup>ab</sup>	6.62 <sup>b</sup>	58.2 <sup>a</sup>	169 <sup>b</sup>	216 <sup>a</sup>
LSD <sub>0.05</sub>	0.29*	0.03***	1.9***	4*	10.8***

DM = dry matter, NE<sub>L</sub> = net energy of lactation, CP = crude protein, N = nitrogen. LSD = least significant difference with  $P < 0.05$ . Means in the same column with the same superscript letters do not differ at  $P < 0.05$ .

The superiority of mixtures with early Lp-varieties was especially pronounced at low N-input ( $NE_L: + 10 \text{ GJ ha}^{-1} \text{ y}^{-1}$ ). There was no statistical influence of nitrogen fertilization on the yield of these mixtures, whereas with low nitrogen fertilization the yield of the late mixtures decreased significantly.

### Conclusion

It can be concluded that the grass-clover mixtures with early Lp-varieties are superior in low input systems. They are an interesting alternative especially for organic farming. A higher proportion of white clover in these mixtures combined with a higher cutting frequency under practical conditions, especially with low nitrogen input, are the main reasons for higher dry matter, energy and nitrogen yield and net energy content. In addition, the better usage of winter moisture of early Lp-varieties on sandy soils improved the effect of early nitrogen application rates. The mixtures with late Lp-varieties build up their yield more in summer, so they grow more in concurrence with the white clover, especially with higher nitrogen yield. The mixtures with late Lp-varieties are more suitable in fertilised systems.

### References

- Frame J. and Boyd A.G. (1986) Effect of cultivar and seed rate of perennial ryegrass and strategic fertilizer nitrogen on the productivity of grass/white clover swards. *Grass and Forage Science* 41, 359-366.
- Wachendorf M., Büchter M., Trott H. and Taube F. (2004) Performance and environmental effects of forage production on sandy soils. II. Impact of defoliation system and nitrogen input on nitrate leaching losses. *Grass and Forage Science* 59, 56-68.
- Wulfes R. (1993) *Wachstumsanalytische Untersuchungen zur Dynamik der Qualitätsentwicklung von Deutschem Weidelgras und Knaulgras im Vegetationsablauf in Abhängigkeit von der Stickstoffdüngung und vom Standort*. PhD Thesis University Kiel.



## **Session 3**

### **From grass to milk and meat**



## Forage conservation, feeding value and milk quality

Huhtanen<sup>1</sup>, P., Südekum, K.-H.<sup>2</sup>, Nousiainen, J.<sup>3</sup>, Shingfield, K.J.<sup>4</sup>

<sup>1</sup>Swedish University of Agricultural Sciences, Department of Agricultural Research for Northern Sweden, SE-901 83 Umeå, Sweden

<sup>2</sup>University of Bonn, Institute of Animal Science, DE-53115 Bonn, Germany

<sup>3</sup>Valio Ltd., Farm Services, PO Box 10, FI-00039 Valio, Helsinki, Finland

<sup>4</sup>MTT Agrifood Research Finland, FI-31600 Jokioinen, Finland

Corresponding author: pekka.huhtanen@njv.slu.se

### Abstract

This paper provides an overview of the effects of conservation methods on forage nutritive value, considers recent developments in the estimation of forage feeding value and examines the impact of conservation method and forage specific factors on milk composition and quality. The changes in nutritive value during forage conservation are relatively small provided that extensive wilting and ensiling losses are avoided. These losses are inevitably due to feed fractions that have complete or almost complete true digestibility. Accurate and precise evaluation of the nutritive value is essential in order to optimize the amount and composition of supplementary feeding and minimize nutrient emissions to the environment. Empirical equations based on forage chemical components are not sufficiently accurate for practical forage evaluation, because they do not describe mechanisms related to lignification and maturation of plant cell walls. Biological methods based either on rumen fluid or fungal enzymes often predict forage digestibility with acceptable accuracy and precision. Fractionating the forage cell walls into potentially indigestible and digestible fractions is essential in mechanistic feed evaluation models, and empirical indigestible neutral detergent fibre models have provided accurate predictions of *in vivo* organic matter digestibility. Relative silage intake potential is a step forward in estimating relative feeding value of forages. Evaluation of published experiments strongly suggests that intake and digestibility are the most important forage factors influencing milk protein yield, whereas protein factors (concentration, soluble non-ammonia N, predicted degradability) had a minimal or no effect on milk protein yield. This suggests that ideal forage for milk production should have a high intake potential and digestibility and moderate crude protein concentration in order to minimise N emissions to the environment.

Forage factors can have a substantial influence on milk fat and protein concentrations, but also contribute to nutritive value (vitamins, fatty acids), sensory properties and physical characteristics of milk and milk products. Fresh forages represent a low-cost approach to enhance the nutritional quality of milk compared with plant oils or oilseeds and offer the advantage of minimizing increases in *trans* fatty acids other than *trans*-11 18:1 during attempts to decrease milk 12:0, 14:0 and 16:0 concentrations and increase milk fat *cis*-9, *trans*-11 conjugated linoleic acid, 18:2*n*-6 and 18:3*n*-3 content. The impact of forage in the diet on milk fat composition is dependent on several factors including forage species, conservation method, and the proportion of forage in the diet and composition of concentrate supplements. Available data would tend to suggest that milk from hay diets containing higher polyunsaturated fatty acid concentrations and lower levels of  $\alpha$ -tocopherol and  $\beta$ -carotene would be more susceptible to oxidation and the development of off-flavours compared with silage based diets. Off-flavours in milk may originate from concentration differences of a common set of substances rather than being due to the absence or presence of specific compounds.

Keywords: Forage, feed evaluation, digestibility, intake potential, protein value, milk composition

## Introduction

Forages must be conserved for the indoor feeding of dairy cows for variable periods of time depending on geographical location. The two principle forage conservation techniques include drying to a dry matter (DM) concentration that allows preservation in aerobic conditions and ensiling under anaerobic conditions. During conservation both quantitative DM losses and qualitative decreases in nutrient value occur, and the goal of forage conservation is to keep these losses to a minimum. Whilst changes in nutrient concentrations (e.g. digestibility) during conservation may not be large, the intake potential of conserved forages can be substantially lower than that of the standing crop before harvest.

Optimal utilization of farm-produced forages in ruminant livestock requires an accurate and precise determination of forage nutritive value. Determination of forage feeding value is also important in attempts to minimize the impact of ruminant livestock production systems on the environment. Most emphasis has been placed on the estimation of forage digestibility/energy content and protein value, even though the intake potential of forages has a much greater effect on nutrient intake from basal forages, and as a consequence total DM and energy intake, than forage nutrient concentrations. Forage preservation methods are known to affect the profile of nutrients absorbed from the digestive tract and thereby influence milk fat and protein concentrations.

During the past decade there has been increased awareness of the association between diet and health, stimulating interest in the development of nutritional strategies to decrease 12:0, 14:0 and 16:0 concentrations and increase *cis*-9, *trans*-11 conjugated linoleic acid (CLA), 18:2*n*-6, 18:3*n*-3 and vitamin content in ruminant milk. Forages represent a low-cost approach to enhance the nutritional quality of milk but the impact is dependent on several factors including forage species, conservation method, and proportion of forage in the diet and composition of concentrate supplements.

The objectives of this paper are to provide an overview of the effects of conservation methods on forage nutritive value, consider recent developments in the estimation of forage feeding value and examine the impact of conservation method and forage specific factors on milk composition and quality.

## Evaluation of forage energy value

Detergent analysis developed by Van Soest (1967) provides the basis for a more complete understanding of the biological mechanisms of forage digestion than proximate analysis. This analysis separates forage DM into neutral detergent fibre (NDF) and neutral detergent solubles (NDS). Originally NDS was estimated as DM – NDF, but because ash does not provide energy, calculation of NDS as organic matter (OM) – NDF may be preferable in feed evaluation. The NDF fraction can only be digested by microbial enzymes, whereas the NDS fraction can also serve as substrates for mammalian enzymes. The true digestibility of the NDS fraction is close to unity (Van Soest, 1994) when estimated by the Lucas test. The Lucas test allows ideal nutritional entities that have uniform digestibility across a wide range of feedstuffs to be identified by plotting the digestible nutrient concentration in DM against the nutrient concentration in DM. The slope of regression provides an estimate of true digestibility and the intercept is an estimate of the metabolic and endogenous faecal matter (M) for the nutrient. True digestibility of NDS is unity or close to unity (Van Soest, 1994; Weisbjerg *et al.*, 2004). Huhtanen *et al.* (2006) reported a value of 0.963 for true NDS digestibility for different forages. A value less than unity was due, in the most part, to a lower

true NDS digestibility (0.925) of regrowth grass silages, the reasons for which are not known. Since the output of M on an OM basis is around 100 g kg<sup>-1</sup> of DM intake (DMI), maximum apparent OM digestibility (OMD) of forages cannot exceed 0.90.

Based on the Lucas principle the concentration of digestible OM (DOM) can be expressed as (on a g kg<sup>-1</sup> of DM basis):

$$\text{DOM} = \text{NDS} + \text{dNDF} - \text{M} \quad [1]$$

Where: dNDF = digestible NDF concentration and all other variables are as defined earlier. Given that dNDF = NDF × NDF digestibility coefficient (NDFD), NDS = OM – NDF and M = 100, the summative equation can be expressed as:

$$\text{DOM (g kg}^{-1}\text{)} = (\text{OM} - \text{NDF}) + \text{NDF} \times \text{NDFD} - 100 \quad [2]$$

This equation indicates that variation in DOM and OMD of forages is primarily a function of NDF concentration and digestibility, with the implication that the main emphasis in the evaluation of forage OMD should be directed towards the determination of NDF concentration and digestibility.

A fraction of NDF in forages is not digested by rumen microbes even when it is subjected to digestion for an infinite amount of time. This fraction can be defined as indigestible NDF (iNDF) an entity that represents intrinsic attributes of the inter- and intra-molecular structure of plant cell walls, which determines the potential extent of cell wall digestion in ruminants. The concentration of iNDF can be determined by extended incubations *in vitro* or *in situ*. Potentially digestible NDF (pdNDF) can be calculated as:

$$\text{pdNDF} = \text{NDF} - \text{iNDF} \quad [3]$$

Since iNDF is by definition a uniform nutritional entity, equation [2] can be rewritten as follows:

$$\text{DOM (g kg}^{-1}\text{)} = (\text{OM} - \text{NDF}) + \text{pdNDF} \times \text{pdNDFD} - 100 \quad [4]$$

where pdNDFD is pdNDF digestibility. This equation indicates that variation in DOM is a function of iNDF concentration and pdNDFD. The smaller coefficient of variation (4.1 vs. 11.4%) and range (0.79 - 0.94 vs. 0.48 - 0.87) in pdNDF digestibility compared with total NDF digestibility for a wide range of grass and legume silages (Huhtanen *et al.*, 2006) indicates that pdNDF is a much more ideal nutritional entity than total NDF. It is therefore important to distinguish between iNDF and undigested NDF (uNDF). Indigestible NDF is not digested by ruminants, whereas uNDF represents faecal output of NDF per kg DMI, i.e. the fraction of NDF that is not digested at a given level of feeding. Undigested NDF exceeds iNDF, because uNDF also includes a proportion of pdNDF that is not digested due to the retention time in the fermentation compartments being too short for complete pdNDF digestion. A recent evaluation based on 86 silages indicated that pdNDFD was on average 0.85 with a mean faecal pdNDF output of 60 (standard deviation (SD) 23; range 13 – 105) g kg<sup>-1</sup> of DMI (Huhtanen *et al.*, 2006). Faecal pdNDF, defined as upNDF (= faecal NDF - iNDF), represents the loss of potentially digestible OM in faeces in addition to obligatory losses of metabolic and endogenous OM (M).

### *In vivo* digestibility

Digestibility determined in sheep fed at maintenance can be used to describe the intrinsic digestibility (i.e. *in vivo* digestibility under optimal conditions, refer to Mertens, 1993) of the diet. However, *in vivo* digestibility determined at maintenance is lower than potential OMD, since pdNDF is not digested completely during residence in the fore-stomachs and hind-gut. Nevertheless, digestibility measured in sheep fed at maintenance still forms the basis of many feed evaluation systems, but this is too labour intensive and expensive for practical feed evaluation, but such studies *in vivo* are required for the calibration and validation of *in vitro* methods. In carefully run trials, measurements of digestibility are associated with a SD of 0.02 units (Van Soest, 1994). For studies conducted according to Latin square designs the

residual SD (RSD) was 0.014 units (Nousiainen, 2004) indicating that determination of forage *in vivo* digestibility based on a  $4 \times 4$  Latin square, would be associated with a minimum inherent error of 0.007 units. Results from a ring test involving 13 laboratories and diets of varied composition and OMD highlighted that inter-laboratory variation of *in vivo* digestibility measurements can be minimized provided that a standardized protocol is strictly adhered to (Spiekers *et al.*, 2006).

#### *Empirical models*

Considerable effort has been directed towards developing regression equations that relate various chemical components to digestibility, although these attempts have not been very successful owing to large interspecies and environmental variation (Van Soest, 1994). In a recent analysis statistically significant relationships between chemical components and digestibility were identified, but prediction error using CP, NDF and ADF as independent variables was not markedly lower than SD of *in vivo* OMD (Huhtanen *et al.*, 2006). Lignin was the best single predictor of OMD, but this entity could only account for proportionately 0.43 of observed variation, whilst the prediction error (0.042) was too high to be practicable for feed evaluation and ration formulation. All relationships were found to be stronger when estimated by a mixed model regression analysis with study as a random factor. These findings indicate that chemical parameters describe changes in digestibility within a single field and growing year, but are not reliable indicators of more global changes.

#### *In vitro methods*

Owing to the constraints in routine measurements of *in vivo* digestibility, several *in vitro* laboratory methods have been used for estimating forage digestibility. The two-stage rumen fluid *in vitro* technique developed by Tilley and Terry (1963) and Goering and Van Soest (1970) are the most widely used methods. Both techniques are based on the incubation of forage samples in rumen fluid for 48 h followed by incubation in pepsin-HCl (Tilley and Terry, 1963) or extraction with neutral detergent (Goering and Van Soest, 1970). Tilley and Terry (1963) demonstrated a close correlation between OMD determined *in vivo* and *in vitro* and reported that the values determined based on *in vitro* incubations were almost the same as OMD determined in sheep. Even though values determined *in vitro* may approach digestibility coefficients *in vivo*, it is important to calibrate *in vitro* methods using *in vivo* data to derive reliable prediction equations. Furthermore, reference samples of known *in vivo* digestibility need to be used in each batch of incubations to account for variation in the activity of rumen fluid (refer to Weiss, 1994).

Due to difficulties in obtaining rumen fluid in commercial laboratories, standardisation of the *in vitro* incubation system, variation in the activity of rumen fluid and increasing concern over the use of surgically modified animals, enzymatic *in vitro* procedures for the determination of forage digestibility have been developed and evaluated (Jones and Theodorou, 2000). In principle these methods include removing cell solubles with HCl-pepsin or neutral detergent followed by a 24 or 48 h incubation in buffered enzyme solution. However, the cellulase method differs from measurements of *in vivo* digestion in at least two key respects; no endogenous matter is produced such that solubility reflects true rather than apparent digestibility, and the capacity of commercial enzymes to degrade cell wall carbohydrates is lower than that of rumen microbes (McQueen and Van Soest, 1975; Nousiainen, 2004).

A review of reports in the literature highlighted that correlation coefficients and corresponding RSD were not consistently different between the pepsin-cellulase and rumen fluid based methods (Jones and Theodorou, 2000). In a recent evaluation based on 86 forage samples of known *in vivo* digestibility measured in sheep the coefficient of determination ( $R^2$ ) was 0.804 and RSD 0.025 digestibility units (Huhtanen *et al.*, 2006). Because the relationship

between pepsin-cellulase solubility and *in vivo* OMD was highly dependent on forage type, using a forage specific correction equation was found to increase the  $R^2$  of this relationship to 0.925 associated with a decrease in RSD to 0.015. With a mixed model regression analysis, RSD was further decreased to 0.010 units, indicating that the pepsin-cellulase method provided an accurate prediction of differences in OMD within a study. The reduction in RSD can be attributed to differences between sheep used in different trials to determine OMD and/or the contribution of between-year variation to measurements of digestibility. Using the general correction equation derived from a dataset that included different forage species underestimated the OMD and D-value of primary growth grass silages but overestimated these parameters in regrowth grass and whole-crop cereal silages (Huhtanen *et al.*, 2006).

Predicting silage OMD from the pepsin-cellulase method for herbage samples before ensiling was found to be as accurate as predictions based on the analysis of corresponding silage samples, provided that silages are well-preserved with only moderate ensiling losses (Huhtanen *et al.*, 2005). Pepsin-cellulase digestibility was 0.024 units lower for silages compared with ensiled fresh herbage. The lower digestibility of silage can be attributed to ensiling losses of digestible OM. Sampling of herbage during harvesting allows more representative samples to be obtained and provides a more complete description of variation in silage digestibility compared with the collection of core samples from silos, particularly those from the top layer of large tower silos. Recent investigations also highlighted that the residuals of OMD predictions based on herbage and silage samples were highly correlated ( $R^2 = 0.64$ ) suggesting that part of RSD is related to random variation in reference *in vivo* digestibility data (Huhtanen *et al.*, 2005). Owing to the problems in calibrating the pepsin-cellulase solubility between the laboratories (Nousiainen, 2004), it is recommended that each laboratory should develop their own forage specific correction equations, or convert measured solubility values to those used for calibration with *in vivo* OMD.

Empirical models can also be combined with *in vitro* methods to estimate *in vivo* OMD or metabolizable energy (ME) concentrations of forages. Based on a large number ( $n = 506$ ) of *in vivo* digestibility trials in wether sheep, the use of generalized equations for estimating the ME of grass products, i.e. fresh grass, grass silage and hay without considering forage type or season (cut number) was proposed (GfE, 2008). Predictions were based on a combination of *in vitro* (gas production or two-stage enzyme soluble OM) and chemical variables including ash, ether extract, CP (only for the equation using gas production) and acid detergent fibre (ash-free). The  $R^2$  values of the derived equations were 0.82 and 0.81, respectively with a residual mean square error (RMSE) of circa 0.45-0.50 MJ  $\text{kg}^{-1}$  ME in DM. A separate evaluation of maize products yielded an equation based on two-stage enzyme soluble OM, NDF (ash-free) and ether extract (GfE 2008). This model allows the prediction of ME content of maize silage, maize cob products and maize stem silage without corn and cob as well as the ME of forage maize prior to harvest that is the material typically investigated in breeding experiments or agronomy trials. Further advances in the accuracy of near-infrared spectroscopy-based determinations of forage ingredients, and the combination of empirical and *in vitro*-based approaches for estimating forage OMD or ME will permit rapid and robust predictions of essential variables used to estimate forage feeding value.

#### *Indigestible NDF*

Determination of iNDF concentration either by extended *in vitro* or *in situ* incubation divides forage OM into three components: NDS, iNDF and pdNDF. Two of these fractions (NDS, iNDF) are nutritionally uniform entities that have a constant digestibility; NDS is completely digestible and iNDF by definition is indigestible. Indigestible NDF determined by 12-d *in situ* incubations in nylon bags of small pore size was shown to be highly correlated with *in vivo* OMD over a range of silages (Huhtanen *et al.*, 2006). The relationship between iNDF and *in*



*vivo* OMD was more uniform for iNDF compared with estimates of digestibility based on the pepsin-cellulase method. Mean square prediction error of OMD was 0.010 for mixed regression model (within study) and 0.019 for fixed regression model. A reliable prediction of OMD can be attributed to a more consistent digestibility of pdNDF compared with total NDF and the inverse relationship between iNDF content and the rate of pdNDF digestion, particularly for primary growth silages. Compared with the typical 48 h duration of *in vitro* digestions the much longer *in situ* incubations required to estimate iNDF may decrease variation arising from differences in the activity of rumen inoculum. However, iNDF underestimates the digestibility of legume silages, mainly lucerne, that have a higher rate of pdNDF digestion relative to iNDF concentration (Rinne *et al.*, 2006).

Precision of digestibility estimates was marginally improved when the iNDF/NDF ratio and NDF concentration was used for the data of Huhtanen *et al.* (2006):

$$\text{OMD} = 0.982 - 0.634 \times \text{iNDF/NDF} - 0.0030 \times \text{NDF} \text{ (g kg}^{-1}\text{)}$$

Prediction error for the mixed model regression was 0.0081 and 0.0186 for the fixed model regression.

#### *Near infrared reflectance spectroscopy*

Near infrared reflectance spectroscopy (NIRS) offers a cheap, rapid, precise and relatively accurate method of forage evaluation method for both practical farms and research purposes. Since Norris *et al.* (1976) first introduced NIRS equations for predicting forage quality, considerable progress has been made to implement NIRS applications for the analysis of forage nutritive value. The development of computers, optical devices and calibration software has facilitated this process (Deaville and Flinn, 2000).

In NIRS monochromatic light of varying wavelengths (1100–2500 nm) is directed onto the feed sample and the reflected light is measured. Part of the light energy is absorbed by the bending and stretching vibrations of O–H, C–H and N–H bonds of chemical components within the feed. Total absorbance depends on the wavelength, physical characteristics (e.g. moisture and particle size) and absolute concentration of chemical bonds in the sample studied. Forages contain a number of chemical substances, which absorb infrared light at various wavelengths and the specific absorption tracks overlap, and therefore direct interpretation of spectra for assessing chemical composition is not possible. An additional difficulty arises from the parameters used to characterize forages (e.g. NDF, lignin, OMD, intake potential) that are not specific chemical entities, but merely reflect functional properties in the digestion process of ruminants. However, quantitative analysis of forage quality by NIRS is possible by calibrating the reflectance spectrum against biologically sound reference methods (Deaville and Flinn, 2000; Nousiainen, 2004) with regression analysis after various mathematical transformations of the spectra (Barnes *et al.*, 1989). NIRS applications for forage evaluation include quantitative analysis of both cell wall (NDF, iNDF) and cell content (CP, WSC, silage fermentation products) characteristics (Deaville and Flinn, 2000; Nousiainen, 2004). The scans may be obtained from dried and finely ground or coarse undried samples, although accuracy of the latter for the quantitative analysis of biological traits may be unacceptable.

A robust NIRS calibration intended for a specific forage type requires a reference dataset of at least 100–200 samples, while a more universal calibration requires an even greater number of samples. This ensures sufficient spectral variation from a wide range of reference values. The reference methods may be based on traditional feed wet-chemistry or *in vitro* and *in situ* measurements (Deaville and Flinn, 2000), but before the latter can be used data from these techniques need to be validated with appropriate *in vivo* measurements. Nousiainen (2004) compared different reference methods for the determination of grass silage D-value and demonstrated that while the proportion of reference error increases the total NIRS prediction

error (observed<sub>in vivo</sub> vs. predicted<sub>NIRS</sub>) increase significantly. Therefore a good NIRS calibration and validation statistics does not automatically guarantee acceptable total prediction performance. If the reference errors are not recognised then serious misuse of NIRS for the evaluation of forages can occur.

The most important trait in practical forage evaluation is OMD that is the primary constraint on intake potential and energy and protein value in ruminants (Huhtanen *et al.*, 2006). NIRS has been criticized as a “black box” method for the determination of forage digestibility. Interpretation of published NIRS equations reveal that OM digestion of forages is often associated to spectral regions near to 1650-1670 and 2260-2280 nm (Deaville and Flinn, 2000). Nousiainen *et al.* (2004) demonstrated that absorbance in these regions was negatively correlated with iNDF content of grass silages. Earlier evaluations also highlighted that these spectral regions relate to lignin bonding (Russell *et al.*, 1989).

For commercial laboratories measurements of *in vitro* cellulase solubility (OMS) may be the most practical method to calibrate NIRS data for the prediction of OMD or D-value (Nousiainen, 2004; Huhtanen *et al.*, 2006). By using forage specific corrections for OMS and a sufficiently diverse range of reference samples total prediction performance can be considered satisfactory. The standard error of prediction (SEP) for D-value using cellulase based calibrations was reported to be circa 17-20 g kg<sup>-1</sup> of DM (Huhtanen *et al.*, 2006), consistent with a SD of 14 g kg<sup>-1</sup> of DM for measurements of OMD in carefully conducted digestion trials (Nousiainen, 2004). Alternatively, iNDF can be used for OMD or D-value calibration for NIRS. Measurements of iNDF may be used to produce reference values in one of two ways: (1) predict digestibility with a direct regression equation (Nousiainen, 2004) or (2) use a summative method of uniform feed fractions (Huhtanen *et al.*, 2006). A comparison of these methods for the prediction of D-value of silages is presented in Table 1. The reference values (except *in vivo*) were based on either general or specific forage equations. All reference methods resulted in good calibration statistics, as indicated by the R<sup>2</sup> values of the calibration of >0.96 and for cross-validation > 0.91. These parameters are consistent with previous estimates (Nousiainen, 2004), and highlight the high precision of NIRS. The total prediction error (Observed - Predicted) was lowest for the forage specific OMS and highest for general OMS.

In the future, NIRS may be used to predict forage traits for use in dynamic digestion models (Huhtanen *et al.*, 2006). These traits include the digestion (k<sub>d</sub>) rate of potentially digestible NDF (pdNDF = NDF-iNDF; Nousiainen *et al.*, 2004). However, it is questionable whether predicting k<sub>d</sub> provides significant advantages over traditional methods to predict OMD.

Table 1. Comparison of total prediction performance of three NIRS D-value calibrations applied to primary growth (PG) grass, regrowth (RG) grass and legume silages and within forage species prediction performance with a calibration using a forage-specific OMS equation as a reference method (adapted from Huhtanen *et al.*, 2006).

Calibration	Intercept	Slope	R <sup>2</sup>	RMSE <sup>1</sup>	Distribution of MSPE <sup>2</sup>		
					Bias	Slope	Random
<b>Calibration 2003</b>							
2003	-19	1.02	0.623	31.9	0.04	0.00	0.96
2004	97	0.85	0.689	29.3	0.00	0.06	0.94
2005	9	0.99	0.783	23.7	0.00	0.00	1.00
<b>Calibration 2005</b>							
PG <sup>3</sup> grass	30	0.97	0.902	19.9	0.28	0.01	0.71
RG <sup>4</sup> grass	-68	1.08	0.688	22.8	0.50	0.01	0.49
Legume	100	0.85	0.661	29.6	0.03	0.06	0.92

<sup>1</sup>RMSE =  $\sqrt{(\sum(\text{Observed}_{in\ vivo} - \text{Predicted}_{NIRS})^2/n)}$

<sup>2</sup>MSPE = mean squared prediction error

### Digestibility at production intake

Traditionally tabulated feed values for cattle are computed using the digestibility coefficients estimated in sheep fed at maintenance with the energy value of the diet assumed to be the sum of individual dietary components. In general, the digestibility coefficients for a given feed are similar in sheep and cattle (Yan *et al.*, 2002), but it is well-known that diet digestibility decreases with increased feeding level and therefore energy values are adjusted for the level of feeding in some feed evaluation systems. In a recent meta-analysis based on the evaluation of 497 diets in lactating cows, OMD was on average 0.038 units lower in cows fed to meet requirements for milk production compared with OMD estimated in sheep fed at maintenance (Huhtanen *et al.*, 2009). Digestibility in cows was shown to decrease with DMI, the extent of which was greater for highly digestible diets (Huhtanen *et al.*, 2009). Furthermore, dietary CP concentration had a positive effect on OM and NDF digestibility, while OMD was found to be decreased in a quadratic manner in response to increases in the proportion of whole-crop silage or fat in the diet. The RDS of a multivariate mixed regression model was 0.007 indicating that differences in OM or NDF digestibility between diets in lactating cows could be predicted accurately from digestibility estimated at maintenance, feed intake and diet composition (Huhtanen *et al.*, 2009; Table 2). Interestingly, there was no difference in the accuracy of OMD prediction in cows when OMD values at maintenance were determined either *in vivo* with sheep or based on predictions from *in vitro* measurements. Observed decreases in digestibility to increases in intake were markedly smaller than the discount factor used in the NRC (2001) system. This may reflect a smaller decrease in digestibility with increased feed intake for typical North European grass silage-based diets compared with North American diets comprised of maize silage and grain or lucerne forages (hay or silage) and cereals. The modelling (Huhtanen *et al.* 2009) clearly showed that in dairy cows the variation in OMD is almost entirely related to dietary NDF concentration and digestibility. This means that the negative associative effects of feeding level and diet composition on OMD for diets at the production level of intake are mainly associated with decreased NDF digestibility.

Table 2. The best-fit equation for multiple regression of OM or NDF digestibility (OMD or NDFD, respectively) in lactating dairy cows<sup>a</sup>; adjusted RMSE for OMD 7.1 g kg<sup>-1</sup> (n = 497) and for NDFD 12.4 g kg<sup>-1</sup> (n = 394)

Effect	Unit	Estimate (g kg <sup>-1</sup> )	
		OMD	NDFD
Intercept		18.4	-285
OMD <sub>m</sub> <sup>b</sup> in DM	g kg <sup>-1</sup>	0.651	
pdNDF <sup>c</sup> /NDF	g kg <sup>-1</sup>		0.647
DMI	g d <sup>-1</sup>	-2.72	-4.85
Ln CP <sup>d</sup> in DM	g kg <sup>-1</sup>	53.7	101
Wcrop <sup>e</sup>		22.2	-28
WCrop × Wcrop		-61.4	-70
(NFC <sup>f</sup> /NDF) × (NFC/NDF)			-55
Cfat <sup>g</sup>	kg d <sup>-1</sup>	-17.7	-33

<sup>a</sup>All values are adjusted for the random study effect.

<sup>b</sup>OM digestibility determined at maintenance level of feeding in sheep or with a corresponding *in vitro* method.

<sup>c</sup>pdNDF = potentially digestible NDF.

<sup>d</sup>Natural logarithm of crude protein concentration.

<sup>e</sup>Proportion of whole crop cereal silage in forage (range: 0 – 1).

<sup>f</sup>Concentration of non-fibre carbohydrates in the diet DM (range: 0 – 1).

<sup>g</sup>Concentrate fat intake.

## Evaluation of forage protein value

The primary function of feed protein in the diet is to provide the ruminants with absorbed amino acids (AA), often denoted as metabolizable protein (MP) in the form of  $\alpha$ -amino nitrogen. The MP requirement of ruminants is met from two sources: microbial protein synthesized in the rumen and feed protein that escapes microbial degradation in the rumen. Determination of the protein value of ruminant diets is complex, because the dietary supply of AA is modified both quantitatively and qualitatively by microbial fermentation in the fore-stomachs before digestion in the small intestine. During the last decades the main emphasis in feed protein evaluation has been the determination of effective protein degradability in the rumen (EPD) and intestinal digestibility of rumen undegraded protein. Protein degradability has most commonly been determined by ruminal *in situ* incubations and digestibility of undegraded feed protein by the mobile nylon bag method. The merits and demerits of these methodologies have been discussed in several excellent reviews (Broderick, 1994; Noziere and Michalet-Doreau, 2000; Hvelplund and Weisbjerg, 2000; López, 2005). However, the data derived using these methods have seldom been validated against *in vivo* measurements of post ruminal nutrient flow or milk protein yield responses.

In a recent meta-analysis the milk protein yield response to bacterial MP was 5-fold higher compared with that of feed MP (Huhtanen and Hristov, 2009). The data consisted of measurements from production trials in cows (ca. 1800 diets) fed North American and North European diets. Protein values were estimated with the NRC (2001) system, in which rumen degradability parameters are estimated using an extensive *in situ* dataset. A much lower regression coefficient for feed MP indicates that productive responses to feed protein were overestimated. These findings are consistent with reports of the regression coefficient between predicted (NRC, 2001) and observed post-ruminal feed protein flow of 0.77 (Broderick *et al.*, 2010) indicating that the true difference in EPD for diets of variable composition are smaller than predicted.

To establish whether these findings also hold true for forage protein, a meta-analysis was conducted to evaluate the effects of different forage variables on milk protein yield. The data included 547 diets fed in 107 studies, in which silage ammonia N, soluble N and fermentation acids were determined. The proportion of soluble non-ammonia N in silage (SNAN) was calculated as (soluble N - ammonia N) and that of insoluble N (ISN) as (total N - soluble N). Data were analysed with a mixed model regression model with random study effect. In addition to forage variables, linear and quadratic effects of concentrate MP estimated according to the Finnish protein evaluation system (MTT, 2006) were included in the prediction model.

The model shown in Table 3 includes forage parameters that had a significant influence on milk protein yield. When expressed per one SD unit of the variable, DMI and D-value were the most important variables, whilst the relative effect of D-value was 2-fold compared with CP concentration. Because both increased DMI and digestibility have positive effects on the supply of fermentable energy for rumen microbes, it appears that microbial protein provides the major contribution to forage MP content. Since mean silage DMI was 11.1 kg d<sup>-1</sup>, the marginal utilisation of CP from increased forage CP concentration was only 3.7% (0.417/11.1).

The proportion of soluble CP tended ( $P = 0.14$ ) to have a negative influence on milk protein yield, when included in the model instead of ammonia N, but this trend disappeared ( $P = 0.78$ ) when soluble N was separated into ammonia N and SNAN. Similarly, the proportion of insoluble N in forage had no effect ( $P = 0.78$ ) on milk protein yield when included as an additional variable to the model (Table 3). These findings are in contrast with the assumptions of the Ørskov and McDonald (1979) model that consider the soluble fraction to be degraded at infinite rate and that only the insoluble fraction can yield digestible RUP. There is

substantive evidence based on various experimental approaches to indicate that a considerable fraction of soluble NAN fraction can escape the rumen in the liquid phase as amino N (refer to Reynal *et al.*, 2007; Huhtanen *et al.*, 2008a). It is also possible that the degradability of the insoluble fraction is greater than predicted by the Ørskov and McDonald (1979) model, since it ignores the selective retention of feed particles in the large or non-escapable ruminal particle pool. Intestinal digestibility of the SNAN fraction escaping the rumen is higher than that of ISN containing the entire indigestible ADF-bound N, which also serves to diminish the difference in true biological value of silage soluble and insoluble protein.

Table 3. The best-fit mixed model regression equation of milk protein yield ( $\text{g d}^{-1}$ ) to forage variables (RMSE adjusted for random study effect = 16.0)

Effect	Unit	Estimate	Error	P-Value	SD <sup>a</sup>	Response per SD unit
Intercept		-310	46.8	<0.001		
CMP <sup>b</sup>	kg d <sup>-1</sup>	790	66.7	<.0001		
CMP × CMP	kg d <sup>-1</sup>	-192	38.7	<.0001		
Forage DMI <sup>c</sup>	kg d <sup>-1</sup>	27.7	1.42	<0.001	1.53	42.4
D-Value <sup>d</sup> in DM	g kg <sup>-1</sup>	0.490	0.069	<0.001	40.9	20.1
Forage CP in DM	g kg <sup>-1</sup>	0.417	0.114	<0.001	22.4	9.3
Ammonia N in total N	g kg <sup>-1</sup>	-0.217	0.067	0.001	21.5	4.7

<sup>a</sup>SD = standard deviation

<sup>b</sup>CMP = concentrate metabolisable protein

<sup>c</sup>DMI = dry matter intake

<sup>d</sup>D-value = digestible organic matter in dry matter

Total acid concentration had no effect on milk protein yield, when it was used as independent variable in the model. This is unexpected, since restricting *in-silo* fermentation has decreased microbial protein synthesis in the rumen (Harrison *et al.*, 2003; Jaakkola *et al.*, 2006). The negative effects of increased silage acid concentration on milk protein can be almost entirely explained by a reduction in intake (Huhtanen *et al.*, 2003) in the absence of specific effects attributable to decreases in microbial protein supply. It is possible that propionate production from silage lactate increases glucose supply and thereby improves the utilisation of absorbed amino acids.

Yan and Agnew (2004) developed empirical equations predicting rumen degradability of silage CP from other silage variables typically analysed. In addition to CP and solubility of CP their model included silage DM and NDF concentration. However, the effect of CP degradability estimated according to this model was non-significant ( $P = 0.42$ ) when included in the basal model (Table 3), and the regression coefficient was positive in contrast to expectations. It is possible that the differences in forage CP degradability determined by the *in situ* method more closely reflect inherent technical problems of the method (e.g. microbial contamination of the residues, escape of soluble NAN, etc) than true differences in degradability.

Huhtanen (2010) proposed a theoretical model incorporating escape of SNAN fraction in the liquid phase and selective retention of feed particles (ISN fraction) in the rumen to predict forage protein value. This model would reduce variability in forage protein degradability, but it is questionable if the current experimental methodologies are sufficiently accurate to justify more complicated models. Evidence from the present meta-analysis suggests that marginal, if any, improvements in forage protein evaluation can be expected from using complicated and highly involved methodologies and models compared with the use of constant values for both ruminal CP degradability and intestinal digestibility of undegraded protein. Excluding forage CP and ammonia N from the model (Table 3) resulted in marginal increases in the residual

mean squared error (adjusted for random study effect) from 16.0 to 16.4 g d<sup>-1</sup>. These values are not markedly greater than the 14 g d<sup>-1</sup> SE for milk protein yield, assuming a 5% coefficient of variation, 10 cows per treatment and the mean protein yield of the current dataset of 880 g d<sup>-1</sup>. Such findings also indicate the relatively low potential of improvements in forage protein evaluation to increasing the accuracy of estimates of rumen undegraded protein and total MP supply.

### Forage intake potential

Accurate prediction of DMI is central to the low cost formulation of lactating diets in cows, since most of the variation in total nutrient intake is related to differences in intake rather than digestibility. However, energy intake, DMI and digestibility are interrelated, due to the importance of diet digestibility on DMI. Regulation of feed intake in ruminants involves multiple mechanisms related to dietary and animal factors that are poorly understood (Mertens, 1994). Despite extensive effort over the past 30-40 years, no generally accepted intake model has been developed. Limited success in this field is, at least in part, due to the complicated interactions between the animal and diet characteristics, and the difficulties in distinguishing and quantifying these factors.

Accurate estimation of differences in intake potential is the first step towards predicting the relative milk production potential of given forage. This is especially important for conserved forages, since modifications during wilting and *in-silo* fermentation can markedly modify intake potential compared with that of the forage at the time of harvest. To overcome the problems arising from variation in animal and environmental factors in the estimation of effects of feed factors on DMI, Huhtanen *et al.* (2007) proposed a relative silage DMI index (SDMI index) using treatment mean data from milk production studies and mixed model regression analysis. This model was subsequently extended to include concentrate factors allowing the prediction of total DMI (Huhtanen *et al.*, 2008b).

Silage D-value was identified as the most important factor influencing forage DMI and provided a more accurate prediction of SDMI compared with CP or NDF concentration (Huhtanen *et al.*, 2007). Silage DMI increased 0.017 kg per 1 g kg<sup>-1</sup> increase in D-value. However, when silage NDF was separated into iNDF and pdNDF fractions the prediction accuracy was the same as for D-value. The magnitude of the regression coefficient of the inverse relationship between iNDF and SDMI was much greater than that of pdNDF against SDMI that probably reflects the slower turnover of iNDF compared with pdNDF. Increased NDF concentration had a small negative effect on intake.

It is considered that ensiling depresses forage intake potential compared with conservation as dried hay. However, the strong negative effect of silage total acid concentration on SDMI suggests that extent of *in-silo* fermentation rather than preservation method *per se* influences silage intake. Differences between individual acids were too small to be considered as single factors in prediction models, and therefore the extent of fermentation was expressed as the concentration of total acids. It was shown that DMI was decreased 0.0128 kg per 1 g kg<sup>-1</sup> increase in the DM concentration of total acids (Huhtanen *et al.*, 2007). However, the dataset did not include many poorly fermented silages and it is possible that intake of silages displaying extensive secondary fermentation is lower than predicted. However, in another meta-analysis encompassing diets more typical for central European regions than those in the study of Huhtanen *et al.* (2007), who almost exclusively investigated data from the Nordic countries and the UK, the concentration of acetic acid was closely and negatively correlated with SDMI when concentrate and forage were offered separately (Eisner *et al.*, 2006). These results are consistent with previous studies demonstrating that the addition of acetic acid to silage before feeding decreased SDMI. The effects of other short-chain fatty acids and of lactic acid and ammonia were unclear. However, total acid concentration was reported to be



closely and inversely related to DMI of diets fed as total mixed rations (Eisner *et al.*, 2006; Huhtanen *et al.*, 2007).

In addition to D-value and fermentation quality, SDMI was influenced in a quadratic manner by silage DM content reaching a maximum intake at 370 g kg<sup>-1</sup> (Huhtanen *et al.*, 2007). Feeding mixtures of grass and red clover silages or grass and whole-crop cereal silages demonstrated positive associative effects on intake; i.e. the intake of mixtures was greater than the mean of both forages when fed separately. Intake of regrowth silage was 0.44 kg d<sup>-1</sup> lower than that of primary growth silage even when other factors (D-value, fermentation, DM and NDF concentration) were taken into account. The reasons for this are unclear, but could be related to increases in the amount of dead material in offered silages.

Standardised regression coefficients for silage DMI (change in silage DMI per one unit SD variation in parameter) were 0.68, 0.34, 0.46 and 0.13 kg d<sup>-1</sup> per unit of SD of the variable in the dataset (n = 998) for D-value and the concentrations of DM, total acids and NDF, respectively. Because silage ME concentration is a linear function of D-value, the differences in standardised regression coefficients were greater for silage ME intake (14.0, 3.6, 5.0 and 1.4 MJ d<sup>-1</sup>, respectively). These differences emphasize the importance of an accurate determination of silage D-value (digestibility) in practical ration formulation.

The total DMI (TDMI) index (Huhtanen *et al.*, 2008b) takes into account various concentrate factors (e.g. quadratic effects of the amount of concentrate and concentrate CP) and interactions between forage intake potential and the amount of concentrate supplementation. The depression in TDMI with increased concentrate feeding is greater for silages with a high intake potential. For example, the model predicts a 0.7 kg d<sup>-1</sup> greater depression for high intake potential (index value 115) silage compared with a low intake potential (index value 85) silage when concentrate DMI increases from 8 to 12 kg d<sup>-1</sup>. This highlights the value of forage intake potential on low concentrate input systems.

Residual MSE adjusted for the random study effects were 0.34 and 0.37 kg d<sup>-1</sup> for the SDMI and TDMI index, respectively (Huhtanen *et al.*, 2007; 2008b) indicating that the models accurately predict differences in intake potential between diets within a study. This analysis corresponds to the comparison of different diets on the same farm. Quantitative DMI responses to increased total intake index were not related to production level of cows, stage of lactation (below or above 100 days in milk) nor silage intake potential (Huhtanen *et al.*, 2008b).

Keady *et al.* (2004) presented an intake model that uses NIRS predicted silage intake potential. Rather than evaluating factors affecting intake separately, the NIRS calibration was developed based on feeding a large number of farm silages to growing cattle. This approach assumes that the intake potential in growing cattle and lactating dairy cows are highly correlated. The system is expensive to develop but inexpensive to use in practice.

## **Milk composition and quality**

### *Milk fat and protein concentration*

Early reports in the literature have mainly focused on the effect of concentrates on milk composition, even though forage factors can have substantial effects on both milk fat and protein concentration. Table 4 shows the results of a meta-analysis of the effects of various forage factors on milk composition. Milk protein concentration was positively associated with silage D-value and DM concentration, and negatively correlated with the proportion of legumes in forage DM and total acid concentration. Milk protein concentration was affected quadratically by increases in the proportion of whole-crop silage in forage DM with maximum value at 0.46. In most cases the responses are related to changes in DM and ME intake. It has often been suggested that diets based on grass silage typically decrease milk protein content compared with fresh or dried forages, but in most cases the differences are



related to the extent of silage fermentation rather than forage conservation method *per se* (Huhtanen *et al.*, 2003; Lock and Shingfield, 2004). The reasons for reduced milk protein concentration with red clover silages are not known. Intake of ME was marginally higher in response to increases in the proportion of legumes in forage DM and protein flow from the rumen is markedly higher following the replacement of grass silages with red clover silages (Dewhurst *et al.*, 2003; Vanhatalo *et al.*, 2009). In addition to protein content, the distribution of nitrogenous compounds in milk is important with respect to cheese making. Direct comparisons in cows fed grass silage or barn dried hay harvested from the same swards indicate that conservation method has no effect on the casein:true protein ratio in milk (Coulon *et al.*, 1998).

Forage conservation method tends to have inconsistent effects on milk fat synthesis and diets based on hay have been reported to either increase or decrease milk fat content relative to silage (Lock and Shingfield, 2004). Legume silages often decrease milk fat concentration, whereas the effects of whole-crop silages have been variable. Improvements in silage digestibility result in marginal increases in milk fat concentration. Increases in the extent of *in silo* fermentation decrease milk fat content that is probably related to the changes in rumen fermentation pattern, since silage lactic acid is fermented to propionate, whereas water soluble carbohydrates in restrictedly fermented silages is associated with increases in molar proportions of acetate and/or butyrate in rumen VFA (Harrison *et al.*, 2003).

Table 4. Effect of forage factors on milk protein and fat concentrations ( $\text{g kg}^{-1}$ )

	Units	Studies / Diets	Intercept	SE	Slope	SE	P-value	RMSE <sup>a</sup>
<b>Milk protein</b>								
Legume	b	20/60	31.6	0.34	-0.56	0.183	0.01	0.36
Whole crop	c	25/83	32.7	0.48	-0.09	0.449	0.85	0.95
Dry matter	10 $\text{g kg}^{-1}$	42/90	31.9	0.34	0.06	0.018	<0.001	0.49
D-value of DM	10 $\text{g kg}^{-1}$	40/96	27.4	1.64	0.15	0.046	<0.001	0.69
Total acids in DM	10 $\text{g kg}^{-1}$	86/238	33.3	0.22	-0.20	0.026	<0.001	0.43
<b>Milk fat</b>								
Legume	b	20/60	43.5	0.69	-2.36	0.602	0.001	1.20
Whole crop	c	25/83	41.9	0.95	-0.35	0.502	0.49	0.90
Dry matter	10 $\text{g kg}^{-1}$	42/90	42.9	0.61	0.00	0.015	0.96	0.81
D-value of DM	10 $\text{g kg}^{-1}$	40/96	37.3	2.70	0.08	0.039	0.05	1.08
Total acids in DM	10 $\text{g kg}^{-1}$	86/238	46.1	0.54	-0.41	0.057	<0.001	0.96

<sup>a</sup> RMSE = Residual mean square error adjusted for the random study effect

<sup>b</sup> Proportion of legume (mainly red clover) silage in total forage DM (range: 0 – 1)

<sup>c</sup> Proportion of whole-crop cereal silage in total forage DM (range: 0 – 1)

### Sensory characteristics of milk and dairy products

The quality of milk and dairy products can be defined in terms of chemical composition, nutritional value, sensory attributes and processing properties. Effects of forage conservation on the sensory characteristics of milk, cheese and butter can be defined in terms of the impact on colour, texture and flavour. Colour is determined by the concentrations of pigments in milk including  $\beta$ -carotene (Martin *et al.*, 2005), texture is related to milk fatty acid composition (Chilliard *et al.*, 2006), while the factors contributing to flavour are less well defined but are also related to the relative proportions of unsaturated and saturated fatty acids in milk. Several studies have demonstrated major sensory differences between dairy products from cows offered conserved forages relative to pasture characterized as a decrease in colour and an increase in firmness (Martin *et al.*, 2005). The role of forage conservation method on the sensory attributes of cheese has been the subject of considerable debate due to possible contamination of milk from grass silage with anaerobic spore-forming clostridia that promote butyric acid fermentation during ripening. However, direct comparisons of cheeses manufactured from milk from silage or hay prepared from the same sward indicate that

provided silage is of high quality, then conservation method has limited effects on the sensory properties of cheese, other than a more intense colour of cheese from ensiled grass (Martin *et al.*, 2005).

#### *Nutritional quality*

During the past decade there has been increased awareness of the association between diet and health, which has led to nutritional quality becoming an increasingly important determinant of consumer food choices. Clinical studies have implicated that excessive consumption of saturated fatty acids and *trans* fats as risk factors for cardiovascular disease, with emerging evidence suggesting that high intakes of saturated fatty acids may also be related to lowered insulin sensitivity which is a key factor in the development of the metabolic syndrome (refer to Shingfield *et al.*, 2008). Whilst it is generally accepted that saturated fatty acids raise plasma total and low-density lipoprotein cholesterol concentrations in humans, atherogenic effects are confined to 12:0, 14:0 and 16:0 and there is emerging evidence to indicate that physiological responses to *trans* fatty acids are isomer dependent (Shingfield *et al.*, 2008). The majority of 12:0 and 14:0 and a significant amount of 16:0 in the human diet are derived from whole milk, cheese and butter (Givens and Shingfield, 2006). The TRANSFAIR survey of fatty acid consumption in European countries revealed that milk and dairy products were consistently the largest sources of saturated fatty acids (27.4-57.1%) and a significant source of *trans* fatty acids (16.7-71.8%) in the human diet (Hulshof *et al.*, 1999). Developing foods that enhance human health is central to dietary approaches for preventing and reducing the economic and social impact of chronic disease. It has been estimated, based on predicted changes in plasma cholesterol concentrations, that decreasing the concentration of saturated fatty acids in milk fat in the human food chain from 70 to 55% of total fatty acids combined with a simultaneous enrichment in *cis*-9 18:1 from 20 to 32% of total fatty acids would prevent approximately 10,500 and 3,900 deaths from coronary heart disease and stroke per annum in the 27 member states of the European Union (Givens, 2008).

Fresh forages represent a low-cost approach to enhance the nutritional quality of milk compared with plant oils or oilseeds and offer the advantage of minimizing increases in *trans* fatty acids other than *trans*-11 18:1 during attempts to decrease milk 12:0, 14:0 and 16:0 concentrations and increase milk fat *cis*-9, *trans*-11 conjugated linoleic acid (CLA), 18:2 $n$ -6 and 18:3 $n$ -3 content (Dewhurst *et al.*, 2006). The impact of forage in the diet on milk fat composition is dependent on several factors including forage species, conservation method, the proportion of forage in the diet and composition of concentrate supplements (Dewhurst *et al.*, 2006; Chilliard *et al.*, 2007). Direct comparisons of the role of forage species on milk SFA content are limited but indicate that replacing grass silage with red clover (*Trifolium pratense*) silage can be expected to result in small decreases in milk saturated fatty acid concentrations and enhance 18:2 $n$ -6 and 18:3 $n$ -3 content (Table 5). In contrast, white clover (*Trifolium repens*) silage in the diet has been reported to result in marginal increases in milk 12:0 and 14:0 content (Dewhurst *et al.*, 2006) compared with grass or red clover silage. Incremental replacement of grass silage with maize silage has relatively minor effects on milk fat composition (Kliem *et al.*, 2008) findings consistent with direct comparisons of these forage sources on milk fatty acid composition (Nielsen *et al.*, 2006).

A recent experiment demonstrated the effects of harvesting and conservation of perennial ryegrass on milk fatty acid composition (Mohammed *et al.*, 2009). Milk from grazing cows was found to contain lower amounts of 14:0 and 16:0 and elevated *cis*-9 18:1, *trans* fatty acids and CLA concentrations compared with zero grazing or silage harvested from the same grass swards (Table 5). Milk from grazed grass contained lower saturated fatty acid concentrations compared with zero-grazing or grass silage (62.4, 67.1 and 75.8 g per 100 g fatty acids, respectively) that was attributed to the higher lipid content of grazed fresh grass

compared with chopped grass or grass silage (41, 33 and 19 g kg<sup>-1</sup> DM, respectively). Decreases in 12:0, 14:0 and 16:0 and increases in *cis*-9 18:1, *trans* fatty acids and CLA in milk from pasture have often been considered to be due to higher intakes of polyunsaturated fatty acids (PUFA) compared with diets based on conserved forages. However, the effects of fresh relative to dried or ensiled grass on milk fatty acid composition are not solely explained by changes in forage lipid content and other changes in lipid metabolism must be involved (Chilliard *et al.*, 2007).

Studies reporting a direct comparison of the impact of forage conservation method on milk fatty acid profile are limited. Comparisons of the composition of milk from cows fed hay or grass silages prepared from timothy and meadow fescue swards indicated that conservation method had no overall effect on saturated or mono-unsaturated fatty acid concentrations (Shingfield *et al.*, 2005). However, the apparent transfer of 18:3*n*-3 from the diet into milk was higher for cows fed hay compared with grass silage based diets (17.2 vs. 3.3%) that would tend to imply that the biohydrogenation of polyunsaturated fatty acids in the rumen is lower in cows fed dried than ensiled forages. These observations are consistent with reports of lower biohydrogenation of 18:3*n*-3 in timothy conserved as hay compared with fresh grass, wilted grass, haylage or silage *in-vitro* (Boufaïed *et al.*, 2003).

Wilting forages for the production of hay, and to a lesser extent prior to ensiling, decreases forage fatty acid and PUFA content due to oxidative losses and leaf shatter (Dewhurst *et al.*, 2006). Advances in plant maturity is also associated with decreases in the lipid content of grasses (Dewhurst *et al.*, 2006), that contribute to the lower fatty acid content of dried compared with fresh or ensiled grass. Losses of 18:3*n*-3 of up to 37 % have been recorded after 24 h wilting of *Lolium perenne* (Dewhurst *et al.*, 2006), whilst extensive wilting and drying of timothy and meadow fescue for 96 h resulted in a 73% disappearance of 18:3*n*-3 (Shingfield *et al.*, 2005). Oxidative losses of PUFA during wilting are associated with the lipoxygenase system that is a plant defence mechanism which is initiated in damaged tissues. Plant lipases release non-esterified 18:2*n*-6 and 18:3*n*-3 from damaged membranes that are rapidly converted to hydroperoxides via the action of lipoxygenases and further catabolised to yield volatile compounds, including aldehydes and alcohols (Dewhurst *et al.*, 2006). Furthermore, leaf tissue contains higher amounts of lipid compared with the stem and therefore leaf shatter will contribute to the loss of polyunsaturated fatty acids during the production of dried grass and legumes. Ensiling of grass or legumes is not associated with substantial decreases in forage polyunsaturated fatty acid content (Dewhurst *et al.*, 2006; Vanhatalo *et al.*, 2007), but results in extensive hydrolysis of the major fatty acid containing fractions resulting in an increase in the levels of non-esterified fatty acids (Dewhurst *et al.*, 2006; Vanhatalo *et al.*, 2007). Several studies have provided evidence that ensiling of grass with a formic acid based additive results in higher total fatty acid and 18:3*n*-3 in silages (Shingfield *et al.*, 2005; Dewhurst *et al.*, 2006), but the mechanisms involved are not known.

The shelf life of milk and dairy products is dependent on complex interactions between pro- and anti-oxidative processes that are influenced by the degree of fatty acid unsaturation, concentration of transition metal cations and levels of anti-oxidants. High concentrations of  $\alpha$ -tocopherol in milk are associated with a decrease in the development of spontaneous oxidised flavours, while increases in 18:2*n*-6 and 18:3*n*-3 content increases the susceptibility of milk to peroxidation (Timmons *et al.* 2001; Kristensen *et al.* 2004). Milk also contains carotenoids including  $\beta$ -carotene which serves as a scavenger of singlet oxygen and peroxy radicals and ascorbic acid that is thought to be involved in the regeneration of tocopherol radicals produced during reactions with lipid free radicals (Timmons *et al.*, 2001). Even though the transport of  $\alpha$ -tocopherol and  $\beta$ -carotene from plasma lipoproteins into the mammary gland conforms to Michealis-Menten kinetics and is breed dependent, concentrations in milk are a function of intake (Weiss, 1998; Nozière *et al.*, 2006). Direct comparisons indicate that

relative to silage, milk from hay diets contains lower concentrations of riboflavin,  $\alpha$ -tocopherol and  $\beta$ -carotene (Weiss, 1988; Shingfield *et al.*, 2005; Nozière *et al.*, 2006). The impact of forage conservation method on milk  $\alpha$ -tocopherol and  $\beta$ -carotene concentrations is related to extensive losses of fat-soluble vitamins in forages during drying and ensiling. Losses of  $\alpha$ -tocopherol and  $\beta$ -carotene are higher during drying than ensiling due to the exposure to incident radiation. Conservation results in 20-80% decreases in forage  $\alpha$ -tocopherol content (Weiss, 1998). Exposure to UV radiation and oxygen during wilting and barn storage can result in hay containing up to 83% less carotenoids than the corresponding parent herbage (Nozière *et al.*, 2006). Ensiling is known to decrease forage  $\beta$ -carotene concentrations that may approach 80% in extreme conditions (high pH, delayed sealing of silos, prolonged storage) but in well preserved forages, losses during ensiling are typically less than 20% (Nozière *et al.*, 2006). Few studies have examined the role of silage fermentation on milk vitamin content, but limited data suggest that the use of ensiling additive may enhance milk thiamine content, while concentrations of  $\alpha$ -tocopherol and  $\beta$ -carotene were found to be higher in milk from cows fed silage ensiled with a biological inoculant than formic acid (Shingfield *et al.*, 2005). Available data on the impact of forage conservation method on milk vitamin concentrations and milk fatty acid composition would tend to suggest that milk from hay diets containing higher PUFA concentrations and lower levels of  $\alpha$ -tocopherol and  $\beta$ -carotene would be more susceptible to oxidation and the development of off-flavours compared with silage based diets.

#### *Conservation effects on milk hygienic quality*

It is well documented that for acceptable organoleptic and bacteriological attributes of raw milk, high quality silage of acceptable fermentation characteristics is a basic requisite. Silage fermentation quality may affect raw milk hygienic quality in two ways: (1) transfer of microbes in silage or (2) contamination of milk with volatile fermentation products. Silages that contain excessive amounts of water or are extensively fermented may induce off-flavours in milk. Mounchili *et al.* (2004) reported that 69% of observed tank milk taints were classified as transmitted off-flavours originating from poor quality baled silage. In a field survey from 909 dairy farms, 7.7% of bulk tank milk samples were interpreted as tainted (Nousiainen J., Valio Ltd, Farm Division, unpublished) and 14.3% of these were directly associated to the transmission of off-flavours from the diet and 17.1% classified as being unclean without a specified off-taste. Once released into barn air, volatile fermentation products in silage may be transmitted into milk through the respiratory or digestive system of the cow into blood and milk (Shipe *et al.*, 1962; Moio *et al.*, 1996). Direct transmission of contaminants from barn air into milk may occur via the milking machine. The volatile compounds that are present in silage and may be found in milk with off-flavours include alcohols (ethanol, propanol), ketones and aldehydes (Shipe *et al.*, 1962; Gordon and Morgan, 1972). However, butyric and propionic acid, typically present in badly fermented silage, did not induce an off-taste in milk when introduced into the lungs of lactating cows (Shipe *et al.*, 1962). It is logical that these acids do not induce off-tastes in milk because they are formed in large quantities during ruminal fermentation. Milk may contain off-flavours even when the fermentation quality of silage is adjudged as good based on traditional parameters (pH, VFA, ammonia N). Randby *et al.* (1999) fed restrictively fermented grass silage supplemented with 600 g d<sup>-1</sup> ethanol. Ethanol supplementation decreased milk organoleptic quality due to feed off-flavours that could not be explained solely by the transfer of ethanol into milk (Mounchili *et al.*, 2005). It has been suggested that the transmission of feed off-flavours in milk may be controlled with the timing of the silage feeding. Milk samples taken prior to the access to bad quality silage contained the same aroma compounds (n=75) than those taken 0.5 or 3.0 h post feeding, but the concentrations of certain compounds (e.g. ethanol, acetone and dimethyl sulphide) were

higher (Mouchili *et al.*, 2005). It was concluded that off-flavours in milk may originate from concentration differences of a common set of substances rather than due to the absence or presence of specific compounds.

Harmful microbes in milk that originate from bad quality silage include *Clostridia* (CS) and *Bacillus* (BS) spores or enterobacteria (*Listeria* or enterococci) (Driehuis and Oude Elferink, 2000). Most commonly found harmful *Clostridia* are endospore-forming anaerobic bacteria. Both CS and BS can survive the passage through the alimentary tract of a dairy cow and are transferred to milk via faeces and faecal contamination of the udder. The acid-tolerant *Clostridium tyrobutyricum* is the most relevant CS for the dairy industry causing the late-blowing defect of hard cheeses. A high number of BS in milk may decrease the shelf life of fresh dairy products. Good milking practice and stall hygiene may help to control this problem, but if the silage is of very poor quality, high CS numbers in raw milk are unavoidable (Vissers *et al.*, 2006). Rasmussen *et al.* (2002) reported an increase in the number of milk anaerobe spores on farms moving from traditional to automatic milking (AMS). A combination of bad quality silage, low stall hygiene and AMS may be difficult to handle, because udder hygiene during milking is not manually controlled and the equipment may transmit spores from dirty cows to clean cows. A low CS count is an important factor for many dairies, due to a general trend for making cheese without antibacterial additives (nitrate). Although CS and other bacteriological problems in raw milk may be overcome or minimised with modern dairy processing technology [bactofugation, micro-filtration, and ESL (extended shelf life) treatment], this does add additional costs to milk processing.

## Conclusions

The changes in nutritive value during forage conservation are relatively small provided that extensive wilting and ensiling losses are avoided. These losses are inevitably due to feed fractions that have complete or almost complete true digestibility. Accurate and precise evaluation of the nutritive value is essential in order to optimize the amount and composition of supplementary feeding and minimize nutrient emissions to the environment. Empirical equations based on forage chemical components are not sufficiently accurate for practical forage evaluation, because they do not describe mechanisms related to lignification and maturation of plant cell walls. Biological methods based either on rumen fluid or fungal enzymes often predict forage digestibility with acceptable accuracy and precision. Fractionating the forage cell walls into potentially indigestible and digestible fractions is essential in mechanistic feed evaluation models, and empirical iNDF models have provided accurate predictions of *in vivo* OMD. Relative silage intake potential is a step forward in estimating relative feeding value of forages. The meta-analysis strongly suggested that intake and digestibility are the most important forage factors influencing milk protein yield, whereas protein factors (concentration, soluble NAN, predicted degradability) had a minimal or no effect on milk protein yield. This suggests that ideal forage for milk production should have a high intake potential and digestibility and moderate CP concentration in order to minimise N emissions to the environment. It appears that the scope for improving the accuracy of forage protein value by determining ruminal protein degradability is rather limited. Forage factors can have a substantial influence on milk fat and protein concentrations, but also contribute to nutritive value (vitamins, fatty acids), sensory properties and physical characteristics of milk and milk products.

Table 5. Effect of forage species and conservation method on bovine milk fatty acid composition

Forage species	Fatty acid composition (g (100 g) <sup>-1</sup> fatty acids)											CLA <sup>a</sup>	Reference	
	4:0	6:0	8:0	10:0	12:0	14:0	16:0	18:0	<i>cis</i> -9:18:1	<i>trans</i> 18:1	18:2- <i>n</i> -6			18:3- <i>n</i> -3
Perennial ryegrass silage	4.91	2.69	1.36	2.95	3.52	11.7	32.5	11.0	20.7	1.13 <sup>b</sup>	1.05	0.40	0.36	Dewhurst <i>et al.</i> (2003)
Red clover silage	5.78	2.98	1.43	2.83	3.31	11.3	30.6	11.6	20.2	1.25 <sup>b</sup>	1.58	1.28	0.41	
White clover silage	5.16	3.04	1.57	3.47	4.16	12.7	32.9	9.70	17.9	1.06 <sup>b</sup>	1.54	0.96	0.34	
Grass silage early cut	5.60	2.79	1.51	3.20	3.60	12.0	29.4	10.4	16.9	3.63	1.24	0.41	0.38	Varhatalo <i>et al.</i> (2007)
Red clover silage early cut	6.17	2.82	1.46	2.79	3.01	10.4	25.5	11.2	19.9	3.98	1.80	1.34	0.36	
Grass silage late cut	5.58	2.73	1.47	3.09	3.48	11.8	28.2	10.7	18.1	3.66	1.32	0.37	0.41	
Red clover silage late cut	5.91	2.75	1.42	2.79	3.05	10.7	27.0	10.5	19.3	4.10	1.65	0.88	0.42	
Perennial ryegrass silage	NR <sup>c</sup>	NR	NR	NR	3.67	12.3	38.5	8.88	17.7	2.24	1.00	0.56	0.45	Moorby <i>et al.</i> (2009)
Red clover silage	NR	NR	NR	NR	3.11	11.3	36.5	8.74	19.9	2.28	1.63	1.49	0.39	
Grass silage (F:C 73:27)	3.73	1.94	1.09	2.16	2.39	9.73	22.1	13.7	25.5	4.86	1.17	0.63	0.89	Nielsen <i>et al.</i> (2006)
Maize silage (F:C 69:31)	3.22	1.51	0.93	1.68	2.12	8.71	19.1	11.9	27.5	9.25	1.59	0.36	1.61	
Grass silage (F:C 53:47)	3.59	1.97	1.17	2.29	2.64	9.79	21.8	13.0	25.3	5.08	1.56	0.64	0.92	
Maize silage (F:C 52:48)	2.69	1.36	0.87	1.78	2.34	8.59	18.6	11.0	27.2	10.5	1.93	0.41	1.17	
Grass silage	2.65	2.01	1.15	2.67	3.00	11.4	35.3	8.12	17.4	2.02	1.41	0.57	0.48	Kliem <i>et al.</i> (2008)
Maize silage	2.71	2.32	1.49	3.61	4.11	12.3	32.9	7.81	16.3	2.43	2.30	0.24	0.54	
Ryegrass pasture	3.63	2.34	1.34	2.76	2.96	9.79	23.7	10.1	18.4	7.83	1.08	0.68	2.07	Mohammed <i>et al.</i> (2009)
Zero grazed ryegrass	3.87	2.57	1.45	3.02	3.16	10.4	26.3	10.6	16.5	6.18	1.03	0.82	1.38	
Grass silage	3.94	2.57	1.39	2.95	3.29	11.2	37.9	7.26	13.2	2.67	0.82	0.34	0.54	
Grass hay	2.51	2.16	1.47	3.41	3.97	13.3	34.5	9.17	15.2	3.78	1.21	0.50	0.45	Shingfield <i>et al.</i> (2005)
Grass silage no additive	2.89	2.23	1.49	3.31	3.79	12.9	34.7	9.75	15.1	3.62	0.96	0.35	0.41	
Grass silage inoculant	2.94	2.34	1.53	3.43	3.90	13.1	33.8	10.0	15.3	3.71	0.96	0.43	0.41	
Grass silage formic acid	2.58	2.21	1.50	3.43	3.99	13.2	34.2	10.0	14.5	4.25	0.93	0.29	0.49	

<sup>a</sup> CLA, *cis*-9, *trans*-11 conjugated linoleic acid.<sup>b</sup> *Trans*-11 18:1.<sup>c</sup> NR: not reported



## References

- Barnes R.J., Dhanoa M.S. and Lister S.J. (1989) Standard normal variate transformation and de-trending of near-infrared diffuse reflectance spectra. *Applied Spectroscopy* 43, 772–777.
- Boufated H., Chouinard P.Y., Tremblay G.F., Petit H.V., Michaud R. and Bélanger G. (2003) Fatty acids in forages. II. In vitro ruminal biohydrogenation of linolenic and linoleic acids from timothy. *Canadian Journal of Animal Science* 83, 513–522.
- Broderick G.A. (1994) Quantifying forage protein quality. In: Fahey G.C. Jr., Collins D.R., Mertens D.R. and Moser L. E (eds.) *Forage Quality, Evaluation, and Utilization*. American Society of Agronomy, Inc., Crop Science Society of America, Inc. and Soil Science Society of America, Inc., Madison, Wisconsin, USA, pp. 200–228
- Broderick G.A., Huhtanen P., Ahvenjärvi S., Reynal S.M. and Shingfield K.J. (2010) Quantifying ruminal nitrogen metabolism using the omasal sampling technique in cattle - A meta-analysis. *Journal of Dairy Science* (in press).
- Chilliard Y., Rouel J., Ferlay A., Bernard L., Gaborit P., Raynal-Ljutovac K., Lauret A. and Leroux C. (2006) Optimising goat's milk and cheese fatty acid composition. In: Williams C. and Buttriss J. (eds.) *Improving the fat content of foods*. Woodhead Publishing Limited, Cambridge, UK, pp. 281–312.
- Chilliard Y., Glasser F., Ferlay A., Bernard L., Rouel J. and Doreau M. (2007) Diet, rumen biohydrogenation and nutritional quality of cow and goat milk fat. *European Journal of Lipid Science and Technology* 109, 828–855.
- Coulon J.B., Hurtaud C., Remond B. and Verite R. (1998) factors contributing to variation in the proportion of casein in cows' milk true protein: a review of recent INRA experiments. *Journal of Dairy Research* 65, 375–387.
- Deaville E.R. and Flinn P.C. (2000) Near-infrared (NIR) spectroscopy: an alternative approach for the estimation of forage quality and voluntary intake. In: Givens, D.I., Owen E., Axford R.F.E. and Omed, H.M. (eds.) *Forage evaluation in ruminant nutrition*. CABI Publishing, Oxon. pp. 301–320.
- Dewhurst R.J., Evans R.T., Scollan N.D., Moorby J.M., Merry R.J. and Wilkins R.J. (2003) Comparison of grass and legume silages for milk production. 2. In vivo and in sacco evaluations of rumen function. *Journal of Dairy Science* 86, 2612–2621.
- Dewhurst R.J., Shingfield K.J., Lee M.R.F. and Scollan N.D. (2006) Increasing the concentrations of beneficial polyunsaturated fatty acids in milk produced by dairy cows in high-forage systems. *Animal Feed Science and Technology* 131, 168–206.
- Driehuis F. and Oude Elferink S.J.W.H. (2000) The impact of the quality of silage on animal health and food safety: a review. *Veterinary Quarterly* 22, 212–216.
- Eisner I., Südekum K.-H. and Kirchhof S. (2006) Beziehungen zwischen fermentationscharakteristika von silagen und der Futteraufnahme von milchkühen. *Übersichten zur Tierernährung* 34, 197–221.
- GfE (2008) Communications of the Committee for Requirement Standards of the Society of Nutrition Physiology. New equations for predicting metabolisable energy of grass and maize products for ruminants. *Proceedings of the Society of Nutrition Physiology* 17, 191–198.
- Givens D.I. (2008) Impact on CVD risk of modifying milk fat to decrease intake of saturated fatty acids and increase intake of *cis*-monounsaturates. *Proceedings of the Nutrition Society* 67, 419–427.
- Givens D.I. and Shingfield K.J. (2006) Optimising dairy milk fatty acid composition. In: Williams C.M. and Buttriss J. (eds.) *Improving the fat content of foods*. Woodhead Publishing Ltd., Cambridge, UK, pp. 252–280.
- Goering M.K. and Van Soest P.J. (1970) *Forage Fibre Analysis (Apparatus, Reagents, Procedures and Some Applications)* Agricultural Handbook No. 379, ARS, USDA, Washington DC.
- Gordon D.T. and Morgan M.E. (1972) Principal volatile compounds in feed flavored milk. *Journal of Dairy Science* 55, 905–912.
- Harrison J., Huhtanen P. and Collins M. (2003) Perennial grasses. In: Buxton, D.R., Muck, R.E. and Harrison, J.H. (eds.) *Silage Science and Technology*. American Society of Agronomy. pp. 665–747.
- Hulshof K.F.A.M., van Erp-Baart M.A., Anttolainen M., Becker W., Church S.M., Couet C., Hermann-Kunz E., Kesteloot H., Leth T., Martins I., Moreiras O., Moschandreas J., Pizzoferrato L., Rimstad A.H., Thorgeirsdottir H., van Amelsvoort J.M.M., Aro A., Kafatos A.G., Lanzmann-Petithory D. and van Poppel G. (1999) Intake of fatty acids in Western Europe with emphasis on trans fatty acids: The TRANSFAIR study. *European Journal of Clinical Nutrition* 53, 143–157.
- Huhtanen P. (2010) Evaluation of protein value of forages. *Proceedings of XIV<sup>th</sup> International Symposium Forage Conservation*. Brno, Czech Republic, pp. 58–76.
- Huhtanen P. and Hristov A.N. (2009) A meta-analysis of the effects of protein concentration and degradability on milk protein yield and milk N efficiency in dairy cows. *Journal of Dairy Science* 92, 3222–3232.
- Huhtanen P., Nousiainen J. and Rinne M. (2006) Recent developments in forage evaluation with special reference to practical applications. *Agricultural and Food Science* 3, 293–323.



- Huhtanen P., Nousiainen J.I., Khalili H., Jaakkola S. and Heikkilä T. (2003) Relationships between silage fermentation characteristics and milk production parameters: analyses of literature data. *Livestock Production Science* 81, 57-73.
- Huhtanen P., Nousiainen J. and Rinne, M. (2005) Prediction of silage composition and organic matter digestibility from herbage characteristics. *Agricultural and Food Science* 2, 154-165.
- Huhtanen P., Rinne M. and Nousiainen J. (2007) Evaluation of the factors affecting silage intake of dairy cows; a revision of the relative silage dry matter intake index. *Animal* 1, 758-770.
- Huhtanen P., Rinne M. and Nousiainen J. (2008a) Effects of silage soluble N components on metabolizable protein concentration: a meta-analysis of dairy cow production experiments *Journal of Dairy Science* 91, 1150-1158.
- Huhtanen P., Rinne M. and Nousiainen J. (2008b) Evaluation of the concentrate factors affecting silage intake of dairy cows; a development of the relative total diet intake index. *Animal* 2, 942-953.
- Huhtanen P., Rinne M. and Nousiainen J. (2009) A meta-analysis of feed digestion in dairy cows. 2. The effects of feeding level and diet composition on digestibility. *Journal of Dairy Science* 92, 5031-5042.
- Hvelplund T. and Weisbjerg M. (2000) In situ techniques for prediction rumen degradation and post-ruminal availability of protein. In: Givens D.I., Owen E., Axford R.F.E. and Omed H.M. (eds.). *Forage evaluation in ruminant nutrition*. CABI Publishing, Oxon. pp. 233-258.
- Jaakkola S., Kaunisto V. and Huhtanen P. (2006) VFA proportions and microbial protein synthesis in the rumen of cattle receiving grass silage ensiled with different rates of formic acid. *Grass and Forage Science* 61, 282-292.
- Jones D.I.H. and Theodorou M.K. (2000) Enzyme techniques for estimating digestibility. In: Givens D.I., Owen E., Axford R.F.E. and Omed, H.M. (eds.). *Forage evaluation in ruminant nutrition*. CABI Publishing, Oxon, pp. 155-173.
- Keady T.V.J., Mayne S., Offer N.W. and Thomas C. (2004) Prediction of voluntary intake. In: Thomas C. (ed.) *Feed into Milk*. Nottingham University Press, Nottingham, UK. pp. 1-7.
- Kliem K.E., Morgan R., Humphries D.J., Shingfield K.J. and Givens D.I. (2008) Effect of replacing grass silage with maize silage in the diet on bovine milk fatty acid composition. *Animal* 2, 1850-1858.
- Kristensen D., Hedegaard R.V., Nielsen J.H. and Skibsted L.H. (2004) Oxidative stability of buttermilk as influenced by the fatty acid composition of cows' milk manipulated by diet. *Journal of Dairy Research* 71, 46-50.
- Lock A.L. and Shingfield K.J. (2004) Optimising milk composition. In: Kebreab E., Mills J. and Beever D.E. (eds.) *Dairying-Using Science to Meet Consumers' Needs*. British Society of Animal Science, Publication 29, Nottingham University Press, Loughborough, UK, pp. 107-188.
- Lopez S. (2005) In vitro and in situ techniques for estimating digestibility. In: Dijkstra J. et al. (ed.). *Quantitative Aspects of Ruminant Digestion and Metabolism*. CABI Publishing, UK, pp. 87-122.
- Martin B., Verdier-Metz I., Buchin S., Hurtaud C. and Coulon J.B. (2005) How do the nature of forages and pasture diversity influence the sensory quality of dairy livestock products? *Animal Science* 81, 205-212.
- McQueen R. and Van Soest P.J. (1975) Fungal cellulase and hemicellulase in prediction of forage digestibility. *Journal of Dairy Science* 58, 1482-1491.
- Mertens D.R. (1993) Kinetics of cell wall digestion and passage in ruminants. In: Jung H.G., Buxton D.R., Hatfield R.D. and Ralph J. (eds.) *Forage cell wall structure and digestibility*. American Society of Agronomy, Madison, WI, USA. pp. 535-570.
- Mertens D.R. (1994) Regulation of forage intake. In: Fahey G.C. Jr., Collins D.R., Mertens D.R. and Moser L. E (eds.) *Forage Quality, Evaluation and Utilization*. American Society of Agronomy, Crop Science Society of America, and Soil Science Society of America, Madison, WI, USA, pp. 450-493.
- Mohammed R., Stanton C.S., Kennelly J.J., Kramer J.K.G., Mee J.F., Glimm D.R., O'Donovan M. and Murphy J.J. (2009) Grazing cows are more efficient than zero-grazed and grass silage-fed cows in milk rumenic acid production. *Journal of Dairy Science* 92, 3874-3893.
- Moio L., Rillo L., Leda A. and Addeo F. (1996) Odorous constituents of ovine milk in relationship to diet. *Journal of Dairy Science* 79, 1322-1331.
- Moorby J.M., Lee M.R.F., Davies D.R., Kim E.J., Nute G.R., Ellis N.M. and Scollan N.D. (2009) Assessment of dietary ratios of red clover and grass silages on milk production and milk quality in dairy cows. *Journal of Dairy Science* 92, 1148-1160.
- Mouchili A., Wichtel J.J., Dohoo I.R., Keefe G.P. and Halliday L.J. (2004) Risk factors for milk off-flavours in dairy herds from Prince Edward Island, Canada. *Preventive Veterinary Medicine* 64, 133-145.
- Mouchili A., Wichtel J.J., Bossert J.O., Dohoo I.R., Imhof M., Altieri D., Mallia S. and Stryhn H. (2005) HS-SPME gas chromatographic characterization of volatile compounds in milk tainted with off-flavour. *International Dairy Journal* 15, 1203-1215.
- MTT (2006) *Rehutaulukot ja ruokintasuosituksset* (Feed tables and feeding recommendations, in Finnish). <http://www.mtt.fi/rehutaulukot>. Accessed Feb 1, 2008.

- Nielsen T.S., Straarup E.M., Vestergaard M. and Sejrsen K. (2006) Effect of silage type and concentrate level on conjugated linoleic acids, trans-C18:1 isomers and fat content in milk from dairy cows. *Reproduction, Nutrition, Development* 46, 699-712.
- Norris K.H., Barnes R.F., Moore D.E. and Shenk J.S. (1976) Predicting forage quality by infrared reflectance spectroscopy. *Journal of Animal Science* 43, 889- 897.
- Nousiainen J. (2004) Development of tools for the nutritional management of dairy cows on silage-based diets. Academic dissertation. University of Helsinki, Department of Animal Science Publications 72, 61 p. + 5 encl. Available on the Internet: <http://ethesis.helsinki.fi/julkaisut/maa/kotie/vk/nousiainen/>
- Nousiainen J., Ahvenjärvi S., Rinne M., Hellämäki M. and Huhtanen P. (2004) Prediction of indigestible cell wall fraction of grass silage by near infrared reflectance spectroscopy. *Animal Feed Science and Technology* 115, 295-311.
- Nozière P., Graulet B., Lucas A., Martin B., Grolier P. and Doreau M. (2006) Carotenoids for ruminants: From forages to dairy products. *Animal Feed Science and Technology* 131, 418-450.
- Nozière P. and Michalet-Doreau B. (2000) In sacco methods. In: D'Mello J.P.F. (ed.) *Farm Animal Metabolism and Nutrition*. CAB International, Oxon, pp. 233-253.
- NRC (2001) *National Research Council. Nutrient Requirements of Dairy Cattle*. 7th revised Edition. National Academy Press, Washington, DC. pp. 381.
- Ørskov E.R. and McDonald I. (1979) The estimation of protein degradability in the rumen from incubation measurements weighted according to rate of passage. *Journal of Agricultural Science* 92, 499-503.
- Randby A.T., Selmer-Olsen I. and Bavre L. (1999) Effect of ethanol in feed on milk flavor and chemical composition. *Journal of Dairy Science* 82, 420-428.
- Rasmussen M.D., Bjerring M., Justesen P. and Jepsen L. (2002) Milk quality on Danish farms with automatic milking systems. *Journal of Dairy Science* 85, 2869-2878.
- Reynal S. M., Ipharraguerre I. R., Lineiro M., Brito A.F., Broderick G.A. and Clark J.H. (2007) Omasal flow of soluble proteins, peptides, and free amino acids in dairy cows fed diets supplemented with proteins of varying ruminal degradabilities. *Journal of Dairy Science* 90, 1887-1903.
- Rinne M., Olt A., Nousiainen J., Seppälä A., Tuori M., Paul C., Fraser M.D. and Huhtanen P. (2006) Prediction of legume silage digestibility from various laboratory methods. *Grass and Forage Science* 61, 354-362.
- Russell J.D., Murray I. and Frazer A.R. (1989) Near and mid-infrared studies of the cell wall structure of cereal straw in relation to its rumen degradability. In: Chesson A. and Ørskov E.R. (eds.) *Physico-Chemical Characterisation of Plant Residues for Industrial and Feed Use*. Elsevier Applied Science, London, pp. 13-24.
- Shingfield K.J., Chilliard Y., Toivonen V., Kairenius P. and Givens D.I. (2008) Trans fatty acids and bioactive lipids in ruminant milk. In: Böse Z. (ed.) *Bioactive components of milk*, Advances in Experimental Medicine and Biology, Volume 606, Springer, New York, NY, pp. 3-65.
- Shingfield K.J., Salo-Väänänen P., Pahkala E., Toivonen V., Jaakkola S., Piironen V. and Huhtanen P. (2005) Effect of forage conservation method, concentrate level and propylene glycol on the fatty acid composition and vitamin content of milk. *Journal of Dairy Research* 72, 349-361.
- Shipe W.F., Ledford R.A., Peterson R.D., Scanlan R.A., Geerken H.F., Dougherty R.W. and Morgan M.E. (1962) Physiological mechanisms in transmitting flavors and odors to milk. II. Transmission of some flavor components of silage. *Journal of Dairy Science* 45, 477-480.
- Spiekers H., Menke A. and Pfeffer E. (2006) Ringversuch zur bestimmung der verdaulichkeiten der rohnährstoffe von heu, milchleistungsfutter und palmkernexpeller an hammeln. *Züchtungskunde* 78, 384-398.
- Tilley J.M.A. and Terry R.A. (1963) A two-stage method for the in vitro digestion of forage crops. *Journal of the British Grassland Society* 18, 104-111.
- Timmons J.S., Weiss W.P., Palmquist D.L. and Harper W.J. (2001) Relationships among dietary roasted soybeans, milk components, and spontaneous oxidized flavor of milk. *Journal of Dairy Science* 84, 2440-2449.
- Vanhatalo A., Kuoppala K., Ahvenjärvi S. and Rinne M. (2009) Effects of feeding grass or red clover silage cut at two maturity stages in dairy cows. I. Nitrogen metabolism and supply of amino acids. *Journal of Dairy Science* 92, 5620-5633
- Vanhatalo A., Kuoppala K., Toivonen V. and Shingfield K.J. (2007) Effects of forage species and stage of maturity on bovine milk fatty acid composition. *European Journal of Lipid Science and Technology* 109, 856-867.
- Van Soest P.J. (1967) Developments of a comprehensive system of feed analysis and its application to forages. *Journal of Animal Science* 26, 119-128.
- Van Soest P.J. (1994) *Nutritional ecology of the ruminant*. Second Edition. Comstock Publishing Associates, Cornell University Press, Ithaca and London, 476 pp.
- Vissers M.M.M., Driehuis F., Te Giffel M.C., De Jong P. and Lankveld J.M.G. (2006) Improving farm management by modeling the contamination of farm tank milk with butyric acid bacteria. *Journal of Dairy Science* 89, 850-858.

- Weisbjerg M.R., Hvelpund T. and Søegaard K. (2004) Prediction of digestibility of neutral detergent solubles using the Lucas principle. *Journal of Animal and Feed Sciences* 13 (Suppl. 1), 239–242.
- Weiss W.P. (1994) Estimation of digestibility of forages by laboratory methods. In: Fahey G.C.Jr., Collins D.R., Mertens D.R. and Moser L.E (eds.) *Forage quality, evaluation and utilization*. American Society of Agronomy, Crop Science Society of America, and Soil Science Society of America, Madison, WI, USA. pp. 644–681.
- Weiss W.P. (1998) Requirements of fat-soluble vitamins for dairy cows: A review. *Journal of Dairy Science* 81, 2493-2501.
- Yan T. and Agnew R.E. (2004) Prediction of nutritive value of grass silages: II. Degradability of nitrogen and dry matter using digestibility, chemical composition and fermentation data. *Journal of Animal Science* 82, 1380-1391.
- Yan T., Agnew R.E. and Gordon F.J. (2002) The combined effects of animal species (sheep versus cattle) and level of feeding on digestible and metabolizable energy concentrations in grass silage-based diets of cattle. *Animal Science* 75, 141-151.

## Authenticity and traceability of grassland production and products

Monahan F.J.<sup>1</sup>, Moloney A.P.<sup>2</sup>, Downey G.<sup>3</sup>, Dunne P.G.<sup>2</sup>, Schmidt O.<sup>1</sup> and Harrison S.M.<sup>1</sup>

<sup>1</sup>*UCD School of Agriculture, Food Science and Veterinary Medicine, University College Dublin, Belfield, Dublin 4, Ireland.*

<sup>2</sup>*Teagasc, Grange Beef Research Centre, Dunsany, Co. Meath, Ireland*

<sup>3</sup>*Teagasc, Ashtown Food Research Centre, Ashtown, Dublin 15, Ireland*

Corresponding author: frank.monahan@ucd.ie

### Abstract

Grassland-based production of meat and milk products has ‘added value’ among both food producers and consumers because of the perceived healthiness of the food products derived from it and its perceived environmental acceptability. This added value carries with it an onus to be able to trace and authenticate the food products derived from grassland. In recent years a range of techniques has been used to gather data with the potential to discriminate between food products of grassland production and other production systems. Chromatographic and spectroscopic methods, along with mass spectrometry, have been widely used to quantify fatty acids, volatile compounds, carotenoids, tocopherols and stable isotope ratios and to obtain fingerprint data capable, following multivariate statistical analysis, of discriminating between production systems. Among the challenges to the discrimination process and ultimately to the authentication and traceability of grassland products are, firstly, defining grassland production, secondly, the seasonal and geographic variation in the composition of grassland feedstuffs consumed by animals and, thirdly, the difficulty of detecting the consumption of non-grass feedstuffs in a grassland production system. To overcome these challenges, the potential of analysing incremental animal tissues and minimising factors likely to contribute to variation in potential markers of grassland production are discussed.

Keywords: grassland production, meat, milk, authentication, traceability

### Introduction

Traceability and authenticity are terms now commonly used in the context of food. A Web of Science search using these search terms shows an initial record of publications in the early 1990s and year-on-year increases thereafter (ISI Web of Knowledge, 2010). In the case of animal-derived foods, a number of factors have contributed to research interest in traceability and authentication, including the high profile coverage of food scares such as the Bovine Spongiform Encephalopathy and Foot and Mouth outbreaks and the dioxin contamination of meats, which arose from the consumption of improper or contaminated feedstuffs by animals. In addition, evidence of health benefits associated with consumption of foods enriched in particular constituents, as a result of particular food production practices (e.g. high  $\omega$ -3 fatty acid and conjugated linoleic acid (CLA) content in pasture-raised milk and meat), and interest in production practices that are more environmentally sustainable, has led to interest among scientists, consumers and food producers in the authenticity and traceability of such high value foods. These factors have also led to the introduction of increasing numbers of quality assurance schemes in the agri-food sector (Gawron and Theuvsen, 2009).

Traceability is defined by the Codex Alimentarius Commission as “the ability to follow the movement of a food through specified stages of production, processing and distribution” (WHO/FAO, 2007). Thus, traceability requires a record of the various steps in the journey of a food from its site of production to consumption and “each link requires keeping records of preceding and succeeding links” (TRACE, 2010). Because traceability systems depend on the

maintenance of records, paper or computer-based, they are open to error. Authentication, defined as “the process by which a food is verified as complying with its label description” (Dennis, 1998), is therefore necessary to support traceability systems and to demonstrate that it is possible to prove beyond doubt that a particular food product is as is stated on the product label. This paper will focus on the authentication methodologies that underpin such an “authenticity-based traceability system” (TRACE, 2010) for products of grassland production, i.e. it will focus on authentication of products of grassland production, and not on traceability *per se*, recognising that authentication is an essential validation tool for any traceability system.

The products of grassland production can be defined primarily as meat and dairy products. However, defining the term “grassland production” is challenging because the extent of grassland usage in meat and dairy production can vary and this can affect the applicability of authenticity and traceability methods to such production systems. For example, animals may graze predominantly pasture at certain times of the year, e.g. in late spring and in summer, but receive cereal concentrate or non-grass inputs at other times (Dunne *et al.*, 2009; Keane and Drennan, 1991).

This review will refer briefly to the methods commonly used in authentication of food products before elaborating on specific examples of the application of these methods to meat and dairy products of grassland origin. It will conclude with a discussion of the challenges inherent in the authentication process as applied to meat and dairy products of grassland origin.

### **Food authentication techniques**

Authentication of milk and meat production systems including grassland production systems has, not surprisingly, focussed on the measurement of components that are likely to be influenced by inclusion of grass/grass products in animal feed (Vasta and Priolo, 2006; Prache, 2009). As outlined by Prache (2009), scientists have sought firstly to measure components in meat that directly reflect the diets consumed, such as fatty acids, carotenoids, and volatile compounds including terpenes and phenolics. Secondly, a ‘fingerprint’ approach can be taken whereby scientists typically use spectroscopic techniques to determine differences in the optical properties of foods derived from different production systems. In addition, molecular techniques are now being used to study the impact of different production systems on gene expression (Hocquette *et al.*, 2009). Several excellent reviews describe in detail the methodologies now available for application to authentication of foods including milk and meat (Lees, 2003; Sun, 2008). The methods include chromatography (GC, HPLC), isotope ratio mass spectrometry (IRMS), spectroscopy (IR, NMR, UV, fluorescence, Raman), molecular (DNA and PCR-based) techniques and enzymatic techniques.

To obtain useful information from the data collected by fingerprint methods in particular, a classification or class-modelling approach involving the deployment of multivariate mathematical, often referred to as chemometric, methods is appropriate. Popular tools in this context are discriminant partial least squares regression (D-PLS), linear discriminant analysis (LDA), support vector machines (SVM), soft independent modelling of class analogy (SIMCA), potential functions (POTFUN) methods and unequal dispersed classes (UNEQ) to name but a few. Chemometric methods may be applied to complete datasets or after a variable reduction procedure has been applied; in the case of spectral data in particular, the raw data may also be pre-treated mathematically to reduce or remove interferences caused by physical factors related to the sample.

## Meat and meat products

For meat and meat products, fatty acid, volatile, stable isotope and spectroscopic analysis have been commonly used to obtain information about the production system from which those products were derived.

### *Fatty acid analysis*

It is well established that the fatty acid profiles of meat are influenced by the fatty acid profile of the diet consumed by the animals. Thus, numerous studies have shown that grass-fed beef is significantly higher in certain  $\omega$ -3 polyunsaturated fatty acids (PUFA), CLA and PUFA:saturated fatty acid (SFA) ratio and lower in  $\omega$ -6 PUFA compared to concentrate-fed animals (reviewed in Woods and Fearon, 2009). A clear effect of duration of feeding grass following a switch from a grass silage/concentrate-based diet has been demonstrated with C18:3( $\omega$ -3), CLA and PUFA:SFA ratio increasing and  $\omega$ -6/ $\omega$ -3 decreasing as the period on grass was extended from 0 to 40, 99 or 158 days pre-slaughter (Noci *et al.*, 2005). Feeding mixtures of grass and red clover relative to grass alone increased the deposition of both  $\omega$ -6 and  $\omega$ -3 PUFA in muscle of finishing beef steers, resulting in increases in the PUFA:SFA ratio (Scollan *et al.*, 2006). Companion studies have revealed that the red clover response is related to reductions in ruminal biohydrogenation of PUFA, which is possibly related to the protective effects of the enzyme polyphenol oxidase (Lee *et al.*, 2004). A potential challenge to the use of fatty acid profile as an indicator of grassland production is that non-grass sources of fatty acids, e.g. soybean (Cooper *et al.*, 2004), sunflower, linseed (Noci *et al.*, 2007; Scollan *et al.*, 2001) and camelina (Noci *et al.*, 2010) oils, or combinations thereof, could give C18:3( $\omega$ -3), C18:2( $\omega$ -6) or CLA contents in muscle similar to those derived from grass. In this scenario it will be necessary to examine dietary fatty acid combinations and ratios to establish if it is possible to produce a grassland fatty acid profile in beef from a diet without grass.

### *Volatile compounds*

The volatile profile of meats is affected by the diet of animals and, thus, measurement of volatile profile can be used as an indicator of production system. Vasta and Priolo (2006) give an overview of the impact of diet on meat volatiles in ruminants. Among the meat volatile components influenced by diet, particularly grass vs concentrate feeding, are branched chain fatty acids, lactones, aldehydes, phenolic compounds, indoles, 2,3-octanedione, terpenes and sulphur compounds. Some compounds are directly incorporated into tissues from the dietary components while others, for example certain sulphur compounds and lipid oxidation products, are indirect markers of dietary background because they are generated as a result of reactions involving the absorbed dietary compounds that occur during cooking of meat fat. In this regard, relating these latter compounds to dietary background needs to be done carefully because the particular cooking method can influence volatile generation and profile (Vasta *et al.*, 2007).

Priolo *et al.* (2004) identified four terpenes in ovine fat, from a total of 33 terpenes detected, which permitted discrimination of lamb from sheep raised and finished on pasture from that of sheep raised on concentrate or concentrate/pasture combinations. However, Serrano *et al.* (2007) in a study with veal calves urged caution, concluding, based on variability in the extent of enrichment of terpene components in different lipid fractions, that 'only strongly contrasted feeding systems could be distinguished by using the terpene fingerprint in meat products'. Another consideration is that terpenoid content and profile of pasture is highly variable, depending on plant species, stage of growth and grazing management (Mariaca, 1997;



Tornambé *et al.*, 2006) so that it is therefore not easy to conclude that terpenes generally, or indeed specific terpenes, are higher or lower in one production system compared to another.

#### *Stable isotopes analysis in meat products*

Boner and Förstel (2004) were among the first to apply stable isotope approaches to the identification of beef from different geographical and production sources. They demonstrated the potential application of measurement of D/H,  $^{18}\text{O}/^{16}\text{O}$ ,  $^{15}\text{N}/^{14}\text{N}$  and  $^{34}\text{S}/^{32}\text{S}$  ratios for differentiating between south American (Argentinian and Chilean) and German beef and between organic and conventionally produced beef in Germany. They highlighted a number of issues for consideration in applying stable isotope measurement to authentication of beef. Among these are the seasonal and geographic (e.g. the continental shift) variation in D/H and  $^{18}\text{O}/^{16}\text{O}$  ratios within a particular country or region and the contribution that feed water and the organic component of feed make to D/H and  $^{18}\text{O}/^{16}\text{O}$  in meat. Within Germany, inter-farm differences in beef and differences between organic and conventionally-produced beef were studied using C, N and S as indicators of production factors, with C known to be strongly influenced by the ratio of C<sub>3</sub>/C<sub>4</sub> plant material in the diet, N by soil and fertilizer usage and S by sea spray, proximity to the sea and feeding of marine feed sources. The requirement to have a knowledge of potential seasonal influences on C, N or S inputs affecting beef production is evident. For example, while an organic production system could be primarily based on C<sub>3</sub> plant material, there could be a period during the beef production cycle where a significant component of maize (C<sub>4</sub>) is used. This is of direct relevance to potential methodologies for authentication of grassland production systems. Interestingly, Boner and Förstel (2004) demonstrated consistency in  $^{15}\text{N}/^{14}\text{N}$  and  $^{34}\text{S}/^{32}\text{S}$  on some farms, permitting these farms to be differentiated from others. Overall, however, given that animal feed inputs are rarely produced entirely on the farm where the animals are raised and that feed sourced off farm is not necessarily locally grown, with its availability and composition fluctuating with the vagaries of world markets for animal feeds, the probability of significant regional and seasonal variability in stable isotope ratios is high.

Also among the early papers, Piasentier *et al.* (2003) reported on  $^{15}\text{N}/^{14}\text{N}$  and  $^{13}\text{C}/^{12}\text{C}$  ratios in small numbers of lamb samples from six European countries, encompassing three broad production systems, including one classified as 'pasture, eating fresh temperate herbage without any solid supplementation'. In their conclusion the authors refer to the promise offered by stable isotopes and the likely additional benefit, for discriminative purposes, of including the measurement of D/H,  $^{18}\text{O}/^{16}\text{O}$ ,  $^{34}\text{S}/^{32}\text{S}$  and  $^{87}\text{Sr}/^{86}\text{Sr}$ . The potential for multi-element stable isotope analysis (C,N,H,S) to discriminate between lamb sourced in different parts of Europe has been demonstrated (Camin *et al.*, 2007). Furthermore, Franke *et al.* (2008) demonstrated the usefulness of measuring  $^{18}\text{O}/^{16}\text{O}$  in the water fraction of chicken meat and  $^{87}\text{Sr}/^{86}\text{Sr}$  in the ash fraction of chicken for origin determination purposes.

One of the biggest challenges in authentication of grassland production of milk or meat is that rarely is the production system based solely on grass. In Ireland, for example, where ruminant meat and milk production would in general be considered 'grass-based', seasonal variation in stable isotope ratios exists, due to non-grass, including maize-based, inputs particularly in the winter months when animals may be housed (Schmidt *et al.*, 2005; Bahar *et al.*, 2008). Indeed seasonal variation in  $^{13}\text{C}/^{12}\text{C}$  was shown to be lower in organic beef compared to conventionally-produced beef and this was attributed to the lower likelihood of maize being used in organic production systems compared to conventional systems (Bahar *et al.*, 2008).

Supplementation of grass with cereal-based concentrates may go undetected using stable isotope ratio analysis if the stable isotope ratio of the cereal-based concentrate is not greatly different from that of grass. For example, unpublished work from our laboratory showed that while there was a significant difference in the  $^{13}\text{C}/^{12}\text{C}$  ratio of beef following 3 or 4 months of



consumption of a diet of 83% grass (dry matter, DM, basis) compared to 74% concentrate, there was no difference between beef from animals fed the different diets for 1 or 2 months. Thus, obvious questions arising from the diet switch scenario are: ‘how long does it take for a change in diet to be reflected in tissues’ and ‘how different do stable isotope ratios between diets need to be to elicit differences in tissue stable isotope ratios’. These questions are dealt with later in the section on ‘Challenges and solutions for authentication of products of grassland production systems’.

#### *Optical properties and carotenoids*

Visible reflectance spectroscopy has been used in an attempt to differentiate between meats produced under different production systems, including pasture *vs* cereal-based systems. Prache and co-workers have undertaken many studies on the application of reflectance spectroscopy in the visible region (450-510 nm) to discriminate between lamb production systems (Prache and Theriez, 1999; Prache *et al.*, 2003b; Dian *et al.*, 2007; Prache, 2009; Prache *et al.*, 2009). Along with reflectance in subcutaneous adipose tissue, carotenoids in blood were measured in many of these studies as an indicator of feeding regime. Indeed, Prache *et al.* (2003b) advocate measurements on both adipose tissue and blood to lower the likelihood of miss-classification. As for stable isotopes, the confounding effect of diet switches on classification is recognised. Prache *et al.* (2003a) showed that following a switch from pasture to concentrates, plasma carotenoids decreased over a 13 day period in lambs. The implication is that following a switch from grass to concentrates, grazing lambs would be considered ‘pasture-fed’ if plasma carotenoids are measured for up to 13 days after the switch and ‘concentrate-fed’ if plasma carotenoids are measured thereafter. A further confounding effect identified by Prache *et al.* (2003b) is that depletion of carotenoids in adipose tissue, after a change to a low carotenoid diet, occurs due to a dilution of existing adipose tissue by new adipose tissue; thus in mature animals carotenoid measurement in adipose tissue may not be an appropriate indicator of diet. Furthermore, the carotenoid content in cut (zero-grazed) grass was found to be higher than in the grazed grass (Serrano *et al.*, 2006) and this has been attributed to the fact that cut grass may consist of herbage taken at a stage of growth when it is particularly rich in carotenoids. Indeed, in our laboratory we found a 1.8 fold higher mean  $\beta$ -carotene level in grass silage compared to the mean for pasture sampled monthly over a 1 year period (Röhrle *et al.*, 2010a).

Another consideration is that the reflectance methods (450-510 nm) applied to differentiate between feeding systems rely on the availability of perirenal or caudal fat or plasma for successful differentiation (Prache *et al.*, 2003b). This would restrict their usage to the slaughterhouse, making them of limited value for authentication of meat on the supermarket shelf. It is also worth considering that even if the methods could be applied to the adipose tissue associated with meat cuts (e.g. subcutaneous adipose tissue), this fat is often trimmed from the muscle prior to packaging or display to make the meat more appealing to health conscious consumers concerned about dietary fat intake.

The work of Prache and co-workers also usefully illustrates the application of a chemometric approach to authentication of grassland production systems. Building on work by Prache and Theriez (1999) who used reflectance spectra of animal fat in the visible wavelength range (450-510 nm) to discriminate pasture-fed from concentrate-fed lambs based on carotenoid pigments, Dian *et al.* (2007) applied multivariate methods to reflectance spectra of perirenal and subcutaneous caudal fat collected over the entire 400-700 nm visible wavelength range. Discrimination between the two feeding regimes was attempted using D-PLS, while measurements were made at slaughter and at 24 h post mortem. Correct classification rates of between 87.4 and 93.9% were achieved, with the latter being achieved for perirenal fat at 24 h post mortem. Examination of the PLS loadings of these models indicated that, in addition to

carotenoid content, haem pigments may also have been involved in the discrimination. In a further extension of this approach, Dian *et al.* (2008) examined the ability of spectroscopy between 400 and 2500 nm to address this classification issue. Again using perirenal fat, the longer wavelength range produced models of higher discriminant ability producing correct classification rates of 97.7%, in contrast to a value of 94.9% for the attenuated range between 400 and 700 nm. These authors suggest that the wider wavelength range may be incorporating information about differences in fatty acid composition of fat produced by the two diets. Cozzolino *et al.* (2002a) reported on the use of visible and near infrared reflectance spectroscopy of beef *Longissimus dorsi* muscle to discriminate between pasture and corn silage diets. These authors applied principal component regression (PCR) and D-PLS to segregate intact or minced meat samples using the entire spectral range and wavelength subsets. Correct classification rates exceeded 80% in all cases, with values of 100% being achieved for some ranges and classification methods. It was noted that inclusion of the visible wavelength range (400-750 nm) improved classification accuracy. In a related publication, Cozzolino *et al.* (2002b) described the application of the class-modelling technique SIMCA to near infrared reflectance spectroscopy data to discriminate between beef raised on pasture or a maize silage-based diet. In this application, a correct classification rate of 81% of samples was achieved, revealing some potential utility.

In agreement with the work of Prache and co-workers, recent findings on beef in our group showed contrasting reflectance spectra (400-700 nm) for subcutaneous adipose tissue from animals fed pasture (P) vs a barley-based concentrate (C) for a 12 month period. Furthermore, subcutaneous adipose tissue from a group fed silage for 6 months followed by pasture for 6 months (SiP) was distinguishable at slaughter from that of the group fed pasture for 12 months, indicating an effect of a diet consumed 6 months earlier on adipose tissue reflectance at slaughter. However, a group fed silage for 6 months followed by a 50:50 (DM basis) pasture/concentrate mixture for 6 months (SiPC) was not distinguishable from the SiP group, somewhat undermining this methodology as a means of diet discrimination (Röhrle *et al.*, 2010a).

#### *Vitamin E stereoisomers*

Analysis of stereoisomeric forms of  $\alpha$ -tocopherol in animal tissues can give information about whether animals received vitamin E from natural or synthetic sources. In a recent study we showed that in muscle from grass-fed beef cattle the RRR stereoisomer dominated, while in concentrate-fed animals and in beef of unknown dietary background stereoisomers of synthetic origin were evident (Röhrle *et al.*, 2010b).

#### *Functional genomics*

Among the more recent approaches with potential for use in discriminating between production systems is functional genomics, in particular transcriptome (Hocquette *et al.*, 2009; Prache, 2009) and proteome (Shibato *et al.*, 2009) profiling. Cassar-Malek *et al.* (2009), in a comparison of outdoor pasture vs indoor concentrate feeding of Charolais cattle, found Selenoprotein W to be under-expressed in pasture-fed animals and proposed it as a putative gene marker of the grassland system. Duckett *et al.* (2009) studied expression of genes involved in lipogenesis in muscle and found up-regulation of stearoyl-CoA desaturase, fatty acid synthase and Spot-14 and down regulation of signal transducer and activator of transcription-5 (STAT5) in the subcutaneous fat of grazing steers finished on a high-concentrate diet compared with a pasture only diet.

Differences in the energy density of the diets, with subsequent effects on animal growth rate and fat deposition, may contribute to differences in gene expression, especially for genes associated with lipogenesis. Using 2-dimensional electrophoresis with mass spectrometry and

Western blot analysis, Shibato *et al.* (2009) showed that differential expression of muscle proteins, attributed to a change in muscle fibre type and changes in metabolic enzymes, occurred during the fattening period in concentrate-fed vs grazed cattle. In many studies, including a recent study conducted by our research group (Lejeune *et al.*, 2010), pasture-fed animals are grazed outdoors while concentrate-fed animals are housed indoors or under conditions that limit animal mobility and exercise. In future studies efforts should be made to isolate the potential confounding effect of exercise on the pasture vs concentrate feeding comparison. One of the big challenges, however, to using genomic approaches to elicit information on meat production systems is the post-mortem degradation of mRNA and proteins that occurs during the conversion of muscle to meat (Bahar *et al.*, 2007).

## **Milk and milk products**

### *Fatty acids in dairy products*

As for ruminant meats, milk fatty acids respond to changes in dietary fatty acids and it is well established that CLA, vaccenic acid (VA) and C18:3( $\omega$ -3) increase as grass replaces non-grass constituents in the diet of ruminants (Couvreux *et al.*, 2006; Dewhurst *et al.*, 2006; Kelly *et al.*, 1998; Stanton *et al.*, 2003). In ewes, Ostrovsky *et al.* (2009) found three times more CLA and VA and twice as much C18:3( $\omega$ -3) in the milk fat of grazing ewes than that of ewes fed a total mixed ration (TMR). However, a doubling of CLA could be achieved by including meadow hay in the TMR diet. Furthermore, in the grazing ewes, the CLA and VA decreased two fold when C18:3( $\omega$ -3) content decreased in mid-summer compared to May and September, indicating the difficulty of attributing fatty acid composition in milk or dairy products to any particular production system, including grassland. As for meat it is possible to enhance the CLA content of milk fat by including dietary fat sources rich in C18:2( $\omega$ -6) (Coakley *et al.*, 2007). In addition, even within a grassland production system, milk fat composition varies with stage of maturity of the grass and its botanical composition (Collomb *et al.*, 2002). Meluchová *et al.* (2008) related seasonal variations in CLA content in ewes' milk fat primarily to the seasonal variations in C18:3( $\omega$ -3) content in grass lipids. In sheep grazing pasture, Nudda *et al.* (2005) reported that concentrations of C18:3( $\omega$ -3), CLA and VA declined by 0.36, 0.48 and 0.61, respectively, between spring and summer. Studies in milk have revealed that Alpine pasture results in a higher content of C18:3( $\omega$ -3) than lowland pasture, as a result of reduced ruminal biohydrogenation of dietary C18:3( $\omega$ -3) (Leiber *et al.*, 2005). Contributory factors to differences in milk fatty acids between pasture-based production systems, in addition to the fatty acid composition of grasses themselves, are the potential inhibitory effects of dietary tannins and polyphenol oxidase on biohydrogenation (Lee *et al.*, 2006).

Vetter and Schroeder (2010) attributed higher levels of phytanic acid and its degradation product pristanic acid, in organic dairy products compared to conventionally-produced dairy products, to the predominant use of grass-based feedstuffs in organic production. Phytanic acid is synthesized *de novo* in ruminants following the release of phytol from chlorophyll by rumen bacteria. These authors set a target value of at least 200 mg phytanic acid/100 g lipid for the verification of grass-fed, organic dairy products. However, this assumes that all conventional production is 'less' grass-based and uses diets that are sufficiently different from the organic diets. Organic and conventional production systems may not always be different, as Bahar *et al.* (2008) showed for organic and conventional beef production in Ireland.

### *Stable isotopes analysis in dairy products*

Rossmann *et al.* (2000) measured C, N, O and S stable isotope ratios in butter of different origins, and using principal component analysis, demonstrated some clustering of samples

from particular regions but not regional discrimination. The authors highlighted the potential of the stable isotope technique when combined with measurements of other markers including fatty acids, carotenoids and trace elements. Manca *et al.* (2001) used  $^{13}\text{C}/^{12}\text{C}$  and  $^{15}\text{N}/^{14}\text{N}$  ratios in pecorino cheese from 3 regions in Italy for regional designation as opposed to investigating differences in farm production practices specifically, although the latter are likely to have contributed to the regional differences. In cow's milk, Renou *et al.* (2004) demonstrated differences in  $^{18}\text{O}/^{16}\text{O}$  between milk of animals raised in 2 regions of France (Brittany vs the Massif Central). They also showed differences between milk in the Massif Central produced in spring from pasture, in winter from grass silage and in winter from hay, but in Brittany there was no difference between milk produced in winter from maize silage and in winter from hay. While differences between sites may reflect differences in the drinking water  $^{18}\text{O}/^{16}\text{O}$  the contribution of water from feedstuffs must be considered, which can either eliminate or accentuate inter-site differences.

#### *Carotenoids in dairy products*

Noziere *et al.* (2006a,b) demonstrated the complexities associated with attempting to relate carotenoid content of milk to production system. The nature of the forage is considered the main variable influencing milk fat  $\beta$ -carotene (Noziere *et al.*, 2006b). While recognising that the carotenoid content of fresh grasses is higher than that of conserved forage, especially hay, and concentrates, seasonal variation in fresh grass carotenoids affected by the stage of growth, is also a contributory factor as alluded to earlier. Furthermore, practical factors such as the pooling of milk and its bulk storage prior to processing pose a significant challenge in terms of authentication of milk or the processed dairy products derived from it. Reflectance measurements have also been applied to milk in an attempt to distinguish between grass vs hay and concentrate feeding (in individual cows) – this was possible provided there was a least a 36 day interval between time of diet switch from the low carotenoid (concentrate, hay) to the high concentrate (pasture) diet (Noziere *et al.*, 2006a).

#### *Volatile compounds*

In milk and cheese, Martin *et al.* (2005) reviewed a number of studies undertaken in France and elsewhere on discrimination of milk and cheese from cows fed different diets. Terpene transfer from forages to milk was shown to be fast – as early as the first milking after consumption (Viallon *et al.*, 2000) – and terpenes were transferred into cheese with minor alteration. Analysis of terpenes was used to discriminate between milk from 2 regions of France in both summer and winter with geographical discrimination attributed to botanical differences in the forages.

### **Challenges and solutions for authentication of products of grass-based production systems**

It is clear that one of the major challenges associated with authenticating grassland production of meat and dairy products is the ability to detect the consumption of non-grass feeds by the animals. An even more fundamental challenge is defining 'grassland production' in the first instance. In the U.S. a grass (forage) fed claim on meat indicates a diet 'derived solely from forage consisting of grass (annual and perennial), forbs (e.g., legumes, Brassica), browse, or cereal grain crops in the vegetative (pre-grain) state' (USDA, 2007). While grain is obviously excluded, the wide range of feed ingredients permitted, together with the geographic and the seasonal variation in available feedstuffs, clearly indicates that the potential markers of grass feeding in animal-derived food products will vary widely from product to product under a 'grass-fed' label, posing significant challenges for authentication of grassland production.

Taking grassland production systems and fatty acids as an example, the fatty acid content and profile of forages have been shown to be affected by growth stage, fertilization, conservation method, growth period, species, and cultivar. Thus, in timothy (*Phleum pratense* L.) concentrations of C16:0, C18:2, C18:3, and total fatty acids decreased by 15, 16, 31, and 23%, respectively between stem elongation and early flowering (Boufaïed *et al.*, 2003) and Vanhatalo *et al.* (2007) demonstrated a decrease in C16:0 and a pronounced increase in C18:2( $\omega$ -6) and C18:3( $\omega$ -3) concentrations in milk from animals fed an early vs late cut red clover silage diet.

Rather than developing authentication methods for broad categories of animal-derived foods, such as 'grass-fed', 'organic', 'free range' or 'extensive' production, another approach is to develop authentication methodologies for products produced locally and to specific restricted feeding regimes, akin to the French *Terroir* production. Animal products produced to a particular feed 'recipe' in a specific location are more likely to hold a unique marker fingerprint to differentiate them from other products and thus underpin an authenticity-based traceability system associated with their production. Examples include individual farmers or groups of farmers producing meat or dairy products from animals fed a defined diet in one location or locality. Even within such defined production systems, the feed ingredients themselves may vary in composition seasonally and if a number of feedstuffs are permitted the proportions may vary at different times of the year.

To understand how changes in diet impact on tissue signatures and what tissues potentially hold a record of diet history, much of our research in Ireland has been concerned with (i) the effect of changes to the animal's diet on potential authentication markers in meat (ii) how quickly diet switches bring about changes in marker composition in meat, i.e. tissue turnover and (iii) the value of incremental tissues in recording pre-slaughter diet.

Using stable isotope analysis we have conducted a number of studies on the time taken for changes in animal diet to elicit changes in meat (Bahar *et al.*, 2005, 2009; Harrison *et al.*, 2010a,b). We showed, as have others (Boner and Förstel, 2004; De Smet *et al.*, 2004; Gebbing *et al.*, 2004), that beef from animals fed diets containing C<sub>4</sub> plant material (e.g. maize) can be clearly differentiated from beef from animals fed C<sub>3</sub> plant material (e.g. barley, temperate grass) and this difference is useful in discriminating between meat from different regions of the world where production systems differ (Schmidt *et al.*, 2005; Guo *et al.*, 2010; Nakashita *et al.*, 2008; Rossmann and Schlicht, 2007). From the stable isotope data of muscle from beef cattle fed either grass silage or maize silage or a 50:50 (DM basis) mixture of both for 167 days we calculated that that each 10% change in dietary C<sub>4</sub> carbon (from maize) resulted in a 0.9-1.0‰ shift in  $\delta^{13}\text{C}$  value of muscle (Bahar *et al.*, 2005). While the animals in this latter study were fed different diets for 167 days pre-slaughter, an important question arises regarding the time taken for a change in diet to bring about a change in isotope ratios in meat, i.e. how long does it take for C or N in muscle to turn over in response to a diet switch? After 167 days, has the stable isotope ratio of muscle tissue come to equilibrium with that of the diet?

In a study in which beef cattle were switched from a barley grain to a maize grain-based diet for various periods ranging from 2 to 22 weeks pre-slaughter, we calculated half lives of 151 and 157 days for C and N, respectively, in *Longissimus dorsi* (Bahar *et al.*, 2009). In lamb, we calculated shorter half lives with values of ~76 days for C in *Longissimus dorsi* muscle (Harrison *et al.*, 2010a). In contrast to muscle, C and N turnover in blood is much faster, with half-life values of 29 and 36 days for C and N in bovine plasma, respectively (Bahar *et al.*, unpublished results). However, in terms of meat authentication, measurements of  $^{13}\text{C}/^{12}\text{C}$  and  $^{14}\text{N}/^{13}\text{N}$  ratios in blood are of limited use.

A similar approach to that described above is needed for all potential markers of diet, production system or geographical origin if we are to understand their usefulness in



authentication. Indeed Prache *et al.* (2003a), while not specifically calculating half-lives, have investigated the issue of turnover of carotenoids in lamb plasma in response to diet switches from pasture to concentrates. Similarly in pork, vitamin E uptake in response to a switch to a high vitamin E diet was found to be in the order blood > liver > muscle > adipose tissue (Monahan *et al.*, 1990). Different response times to a diet switch, in different tissues, could be used to calculate the exact time of the switch by (i) knowing the exact response time of the tissue and (ii) analysing two or more tissues with significantly different response times. Using stable isotopes, Phillips and Eldridge (2006) developed a model capable of estimating the time of a diet switch when two or more tissues with different response times are analysed in wildlife species.

A useful approach to reconstructing changes in diet over an animal's lifetime is the use of incremental tissues such as hair, hoof or wool which contain a record of changes to diet over time (Schwertl *et al.*, 2005; Schnyder *et al.*, 2006; Harrison *et al.*, 2007a,b; Zazzo *et al.*, 2007, 2008). For example, shifts from barley concentrate (C<sub>3</sub>)-based diets to maize (C<sub>4</sub>)-based diets were clearly evident from stable isotope analysis of hair (Zazzo *et al.*, 2007) and hoof (Harrison *et al.*, 2007a,b) in cattle and wool in sheep (Zazzo *et al.*, 2008). Interestingly, from a forensic perspective, an unplanned change in the diet of cattle on a maize-based diet was detected using stable isotope analysis of tail hair (Zazzo *et al.*, 2007).

It is also evident that measurement of a range of potential markers is necessary to arrive at a more robust authentication protocol. For example, Martin *et al.* (2005), in attempting to discriminate between diets fed to dairy cows, identified ten terpenes,  $\beta$ -carotene and five fatty acids as being most useful. We are currently adopting a similar approach to beef produced under defined production systems in Ireland, including grassland.

Finally, in applying chemometric approaches to authentication, irrespective of the chemometric approach used, several key steps need to be observed so that any predictive models generated may be used with confidence. Key to this is the requirement to define precisely the problem to be solved (e.g. is it desired to identify the feed history of a particular species produced anywhere in the world or to confirm that only grass has been fed to Friesian cattle produced on the island of Ireland?) and to elucidate a well-defined sample collection strategy. This latter point is particularly important with biological samples given the large number of interferences that may be foreseen in any one problem type; it also has significant cost implications.

## Conclusion

Much progress has been made in recent years in advancing our capabilities in the area of food authentication. Challenges clearly remain in applying authentication methodologies to foods of animal origin because potential markers of geographical origin or production systems are influenced by the complexities of pre-slaughter diets available to animals and of the production systems themselves. Novel approaches are required to overcome these hurdles. These are likely to involve, initially, the use of multiple methodologies to measure multiple markers in multiple tissues and advanced chemometric techniques. From a grassland production perspective, success in overcoming these hurdles may require a simplification of the production process so that high value meat or dairy products are produced to a recipe which can be easily validated by authentication methodologies but cannot be mimicked by fraudulent production practices.

## References

Bahar B., Moloney A.P., Monahan F.J., Harrison S.M., Zazzo A., Scrimgeour C.M. Begley, I.S. and Schmidt O. (2009) Turnover of C, N and S in bovine *Longissimus dorsi* and Psoas major muscles: implications for isotopic authentication of meat. *Journal of Animal Science* 87, 905–913.

- Bahar B., Monahan F.J., Moloney A.P., O’Kiely P., Scrimgeour C.M. and Schmidt O. (2005) Alteration of the carbon and nitrogen stable isotope composition of beef by substitution of grass silage with maize silage. *Rapid Communications in Mass Spectrometry* 19, 1937-1942.
- Bahar B., Monahan F.J., Moloney A.P., Schmidt O., MacHugh D.E. and Sweeney T. (2007) Long-term stability of RNA in post-mortem bovine skeletal muscle, liver and subcutaneous adipose tissues. *BMC Molecular Biology* 8, article number 108.
- Bahar B., Schmidt O., Moloney A.P., Scrimgeour C.M., Begley I.S. and Monahan F.J. (2008) Seasonal variation in the C, N and S stable isotope composition of retail organic and conventional Irish beef. *Food Chemistry* 106, 1299-1305.
- Boner M. and Förstel H. (2004) Stable isotope variation as a tool to trace the authenticity of beef. *Analytical and Bioanalytical Chemistry* 378, 301-310.
- Boufaïed H., Chouinard P.Y., Tremblay G.F., Petit H.V., Michaud R. and Bélanger F. (2003) Fatty acids in forages. 1. Factors affecting concentrations. *Canadian Journal of Animal Science* 83, 501-511.
- Camin F., Bontempo L., Heinrich K., Horacek M., Kelly S.D., Schlicht C., Thomas F., Monahan F.J., Hoogewerff J. and Rossmann A. (2007) Multi-element (H,C,N,S) stable isotope characteristics of lamb meat from different European regions. *Analytical and Bioanalytical Chemistry* 389, 309-320
- Cassar-Malek I., Jurie C., Bernard C., Barnola., Micol D. and Hocquette J.-F. (2009) Pasture-feeding of Charolais steers influences skeletal muscle metabolism and gene expression. *Journal of Physiology and Pharmacology* 60, Suppl 3, 83-90.
- Coakley M., Barrett E., Murphy J.J., Ross R.P., Devery R. and Stanton C. (2007) Cheese manufacture with milk with elevated conjugated linoleic acid levels caused by dietary manipulation. *Journal of Dairy Science* 90, 2919-2927.
- Collomb M., Butikofer U., Sieber R., Jeangros B. and Bosset J.O. (2002) Correlations between fatty acids in cows’ milk produced in the lowlands, mountains and highlands of Switzerland and botanical composition of the fodder. *International Dairy Journal* 12, 661-666.
- Cooper S.L., Sinclair L.A., Wilkinson R.G., Hallett K.G., Enser M. and Wood J.D. (2004) Manipulation of the n-3 polyunsaturated fatty acid content of muscle and adipose tissue in lambs. *Journal of Animal Science* 82, 1461-1470.
- Couvreur S., Hurtaud C., Lopez C., Delaby L. and Peyraud J.L. (2006) The linear relationship between the proportion of fresh grass in the cow diet, milk fatty acid composition, and butter properties. *Journal of Dairy Science* 89, 1956-1969.
- Cozzolino D., De Mattos D. and Martins V. (2002) Visible/near infrared reflectance spectroscopy for predicting composition and tracing system of production of beef muscle. *Animal Science* 74, 477-484.
- Cozzolino D., Martins V. and Murray I. (2002) Visible and near infrared spectroscopy of beef *longissimus dorsi* muscle as a means of discriminating between pasture and corn silage feeding regimes. *Journal of Near Infrared Spectroscopy* 10, 187-193.
- De Smet S., Claeys E., Boeckx P. and Cleemput O.V. (2004) Stable carbon isotope analysis of different tissues of beef animals in relation to their diet. *Rapid Communications in Mass Spectrometry* 18, 1227-1232.
- Dennis M.J. (1998) Recent developments in food authentication. *Analyst* 123, 151R-156R.
- Dewhurst R.J., Shingfield K.J., Lee M.R.F. and Scollan N.D. (2006) Increasing the concentrations of beneficial polyunsaturated fatty acids in milk produced by dairy cows in high-forage systems. *Animal Feed Science and Technology* 131, 168-206.
- Dian P.H.M., Andueza D., Jestin M., Prado I.N. and Prache S. (2008) Comparison of visible and near infrared reflectance spectroscopy to discriminate between pasture-fed and concentrate-fed lamb carcasses. *Meat Science* 80, 1157-1164.
- Dian, P.H.M., Chauveau, B., Prado I.N. and Prache S. (2007) A dose response study relating the concentration of carotenoid pigments in blood and fat to carotenoid intake level in sheep. *Journal of Animal Science* 85, 3065-3061.
- Duckett S.K., Pratt S.L. and Pavan E. (2009) Corn oil or corn grain supplementation to steers grazing endophyte-free tall fescue. II. Effects on subcutaneous fatty acid content and lipogenic gene expression. *Journal of Animal Science* 87, 1120-1128.
- Dunne P.G., Monahan F.J., O’Mara F.P. and Moloney A.P. (2009) Colour of bovine subcutaneous adipose tissue: a review of contributory factors, associations with carcass and meat quality and its potential utility in authentication of dietary history. *Meat Science* 81, 28-45.
- Franke B.M., Koslitz S., Micaux F., Piantini U., Maury V., Pfammatter E., Wunderli E., Gremaud G., Bosset J.O., Hadon R. and Kreuzer M. (2008) Tracing the geographic origin of poultry meat and dried beef with oxygen and strontium isotope ratios. *European Food Research and Technology* 226, 761-769.
- Gawron J.-C. and Theuvsen L. (2009) Certification schemes in the European agri-food sector: Overview and opportunities for Central and Eastern Europe. *Outlook on Agriculture* 38, 9-14.



- Gebbing T., Schellberg J. and Kühbauch W. (2004) Switching from grass to maize diet changes the C isotope signature of meat and fat during fattening of steers. In: Lüscher A., Jeangros B., Kessler W., Huguenin O., Lobsiger M., Millar N. and Suter D. (Ed.), *Land Use Systems in Grassland Dominated Regions*, Vol. 9, vdf Hochschulverlag AG, Zürich, Switzerland, pp. 1130-1132.
- Guo B.L., Wei Y.M., Pan J.R. and Li Y. (2010) Stable C and N isotope ratio analysis for regional geographical traceability of cattle in China. *Food Chemistry* 118, 915-920.
- Harrison S.M., Monahan F.J., Moloney A.P., Kelly S.D., Cuffe F., Hoogewerff J. and Schmidt O. (2010b) Intra-muscular and inter-muscular variation in carbon turnover of ovine muscles as recorded by stable isotope ratios. *Food Chemistry* (in press).
- Harrison S.M., Monahan F.J., Zazzo A., Bahar B., Monahan F.J., Moloney A.P., Scrimgeour C.M. and Schmidt O. (2007a) Three-dimensional growth of bovine hoof as recorded by carbon stable isotope ratios. *Rapid Communications in Mass Spectrometry* 21, 3971-3976.
- Harrison S.M., Schmidt, O., Moloney A.P., Kelly S.D., Rossmann A., Schellenberg A., Camin F., Perini M., Hoogewerff, J. and Monahan F.J. (2010a) Tissue turnover in ovine muscles and lipids as recorded by multiple (H, C, O, S) stable isotope ratios. *Food Chemistry* (in press).
- Harrison S.M., Zazzo A., Bahar B., Monahan F.J., Moloney A.P., Scrimgeour, C.M. and Schmidt O. (2007b) Using hooves for high-resolution isotopic reconstruction of bovine dietary history. *Rapid Communications in Mass Spectrometry* 21, 479-486.
- Hocquette J.-F., Cassar-Malek I., Bernard-Capel C., and Picard B. (2009) Functional genomics and new markers for beef production – mini review. *Animal Science Papers and Reports* 27, 4, 273-280.
- ISI Web of Knowledge (2010) <http://apps.isiknowledge.com/>
- Keane M. G. and Drennan M.J. (1991) *Two-year old beef production for Friesian and Friesian cross steers*. Beef Series No. 9. Dublin, Ireland: Teagasc. ISBN 0948321601.
- Kelly M.L., Kolver E.S., Bauman D.E., Van Amburgh M.E. and Muller L.D. (1998) Effect of intake of pasture on concentrations of conjugated linoleic acid in milk of lactating cows. *Journal of Dairy Science* 81, 1630–1636.
- Lee M.R.F., Winters A.L., Scollan N.D., Dewhurst, R.J., Theodorou M.K and Minchin F.R. (2004) Plant-mediated lipolysis and proteolysis in red clover with different polyphenol oxidase activities. *Journal of the Science of Food and Agriculture* 84, 1639–1645.
- Lees M. (2003) *Food Authenticity and Traceability*, Woodhead Publishing Ltd., Cambridge, UK, 612 pp.
- Leiber F., Kreuzer M., Nigg D., Wettstein H.-R. and Scheeder M.R.L. (2005) A study on the causes for the elevated n-3 fatty acids in cow's milk of alpine origin. *Lipids* 40, 191–202.
- Lejeune A., Monahan F.J., Moloney A.P., Earley B., Black A.D., Campion D.P., Englishby T., Reilly P., O'Doherty J. and Sweeney T. (2010) Peripheral and gastrointestinal immune systems of healthy cattle raised outdoors at pasture or indoors on a concentrate-based ration. *BMC Veterinary Record* 6, article number 19.
- Manca G., Camin F., Coloru G.C., Del Caro A., Depentori D., Franco M.A. and Versini G. (2001) Characterization of the geographical origin of Pecorino Sardo cheese by casein stable isotope ( $^{13}\text{C}/^{12}\text{C}$  and  $^{15}\text{N}/^{14}\text{N}$ ) ratios and free amino acid ratios. *Journal of Agricultural and Food Chemistry* 49, 1404–1409.
- Mariaca R.G., Berger T.F.H., Gauch R., Imhof M.I., Jeangros B. and Bosset J.O. (1997) Occurrence of volatile mono- and sesquiterpenoids in highland and lowland plant species as possible precursors for flavor compounds in milk and dairy products. *Journal of Agricultural and Food Chemistry* 45, 4423-4434.
- Martin B., Cornu A., Kondjoyan N., Ferlay A., Verdier-Metz I., Pradel P., Rock E., Chilliard Y., Coulon J.B. and Berdagué J.L. (2005) Milk indicators for recognizing the types of forages eaten by dairy cows. In: Hocquette J.F. and Gigli S. (eds) *Indicators of milk and beef quality*. EAAP Publication No. 112, Wageningen Academic Publishers, The Netherlands, pp. 127-136.
- Meluchová B., Blaško J., Kubinec R., Górová R., Dubravská J., Margetin M. and Soják L. (2008) Seasonal variations in fatty acid composition of pasture forage plants and CLA content in ewe milk fat. *Small Ruminant Research* 78, 56–65.
- Monahan F.J., Buckley D.J., Morrissey P.A., Lynch P.B. and Gray J.I. (1990) Effect of dietary  $\alpha$ -tocopherol supplementation on  $\alpha$ -tocopherol levels in porcine tissues and on susceptibility to lipid peroxidation. *Food Sciences and Nutrition* 42F, 203-212.
- Nakashita R., Suzuki Y., Akamatsu F., Iizumi Y., Korenaga T. and Chikaraishi Y. (2008) Stable carbon, nitrogen and oxygen isotope analysis as a potential tool for verifying geographic origin of beef. *Analytica Chimica Acta* 617, 148-152.
- Noci F., French P., Monahan F.J. and Moloney A.P. (2007) Fatty acid composition of muscle fat and subcutaneous adipose tissue of grazing heifers supplemented with plant oil-enriched concentrates. *Journal of Animal Science* 85, 1062-1073.
- Noci F., Monahan F.J. and Moloney A.P. (2010) The fatty acid profile of muscle and adipose tissue of lambs fed camelina or linseed as oil or seeds. *Animal* (in press).

- Noci F., Monahan F.J., French P. and Moloney A.P. (2005) The fatty acid composition of muscle fat and subcutaneous adipose tissue of pasture-fed beef heifers: influence of the duration of grazing. *Journal of Animal Science* 83, 1167-1178.
- Nozière P., Graulet B., Lucas A., Martin B., Grolier P. and Doreau M. (2006a) Carotenoids for ruminants: From forages to dairy products. *Animal Feed Science and Technology* 131, 418-450.
- Nozière P., Grolier P., Durand D., Ferlay A., Pradel P. and Martin B. (2006b) Variations in carotenoids, fat-soluble micronutrients, and color in cows' plasma and milk following changes in forage and feeding level. *Journal of Dairy Science* 89, 2634-2648.
- Nudda A., McGuires M.A., Battacone G. and Pulina G. (2005) Seasonal variation in conjugated linoleic acid and vaccenic acid in milk fat of sheep and its transfer to cheeses and ricotta. *Journal of Dairy Science* 88, 1311-1319.
- Ostrovsky I., Pavlikova E., Blasko J., Gorova R., Kubinec R., Margetin M. and Sojak L. (2009) Variation in fatty acid composition of ewes' milk during continuous transition from dry winter to natural pasture diet. *International Dairy Journal* 19, 545-549.
- Phillips D.L. and Eldridge P.M. (2006) Estimating the timing of diet shifts using stable isotopes. *Oecologia* 147, 195-203.
- Piasenter E., Valusso R., Camin F. and Versini G. (2003) Stable isotope ratio analysis for authentication of lamb meat. *Meat Science* 64, 239-247.
- Prache S. (2009) Diet authentication in sheep from composition of animal tissues and products. *Revista Brasileira de Zootecnia* 38, 362-370. (supl. especial)
- Prache S. and Theriez M. (1999) Traceability of lamb production systems: carotenoids in plasma and adipose tissue. *Animal Science* 69, 29-36.
- Prache S., Kondjoyan N., Delfosse O., Chauveau-Duriot B., Andueza D. and Cornu A. (2009) Discrimination of pasture-fed from lambs fed dehydrated alfalfa indoors using different compounds measured in the fat, meat and plasma. *Animal* 3, 598-605.
- Prache S., Priolo A. and Grolier P. (2003a) Persistence of carotenoid pigments in the blood of concentrate-finished grazing sheep: its significance for the traceability of grass feeding. *Journal of Animal Science* 81, 360-367.
- Prache S., Priolo A. and Grolier P. (2003b) Effect of concentrate finishing on the carotenoid content of perirenal fat in grazing sheep: its significance for discriminating grass-fed, concentrate-fed and concentrate-finished grazing lambs. *Animal Science* 77, 225-233.
- Priolo A., Cornu A., Prache S., Krogmann M., Kondjoyan N., Micol D. and Berdagué J.-L. (2004) Fat volatile tracers of grass feeding in sheep. *Meat Science* 66, 475-481.
- Renou J.P., Deponge C., Gachon P., Bonnefoy J.-C., Coulon J.-B., Garel J.-P., Vérité R. and Ritz P. (2004) Characterization of animal products according to geographic origin and feeding diet using nuclear magnetic resonance and isotope ratio mass spectrometry: cow milk. *Food Chemistry* 85, 63-66.
- Röhrle F.T., Moloney A.P., Black A., Osorio M.T., Sweeney T., Schmidt O. and Monahan F.J. (2010b)  $\alpha$ -Tocopherol stereoisomers in beef as an indicator of vitamin E supplementation in cattle diets. *Food Chemistry* (in press).
- Röhrle F.T., Moloney A.P., Osorio M.T., Luciano G., Priolo A., Caplan P. and Monahan F.J. (2010a) Carotenoids, colour and reflectance parameters in bovine adipose tissue to discriminate between feeding systems. *Meat Science* (submitted).
- Rossmann A. and Schlicht C. (2007) Stable isotope analysis for origin assignment of animal products. *Fleischwirtschaft* 87, 104-109.
- Rossmann A., Haberhauer G., Hölzl, S., Horn P., Pichlmayer F. and Voerkelius S. (2000) The potential of multielement stable isotope analysis for regional assignment of butter. *European Food Research and Technology* 211, 32-40.
- Schmidt O., Quilter J.M., Bahar B., Moloney A.P., Scrimgeour C.M., Begley I.S. and Monahan F.J. (2005) Inferring the origin and dietary history of beef from C, N and S stable isotope ratio analysis. *Food Chemistry* 91, 545-549.
- Schnyder H., Schwertl M., Auerswald K. and Schäufele R. (2006) Hair of grazing cattle provides an integrated measure of the effects of site conditions and interannual weather variability on  $\delta^{13}\text{C}$  of temperate humid grassland. *Global Change Biology* 12, 1315-1329.
- Schwertl M., Auerswald K., Schäufele R. and Schnyder H. (2005) Carbon and nitrogen stable isotope composition of cattle hair: ecological fingerprints of production systems? *Agriculture, Ecosystems and Environment* 109, 153-165.
- Scollan N., Choi N.-J., Kurt E., Fisher A.V., Enser M. and Wood J.D. (2001). Manipulating the fatty acid composition of muscle and adipose tissue in beef cattle. *British Journal of Nutrition* 85, 115-124.

- Scollan N., Hocquette J.-F., Nuernberg K., Dannenberger D., Richardson I. and Moloney A. (2006) Innovations in beef production systems that enhance the nutritional and health value of beef lipids and their relationship with meat quality. *Meat Science* 74, 17–33
- Serrano E., Cornu A., Kondjoyan N., Figueredo G., Agabriel J. and Micol D. (2007) Terpene accumulation in muscle and fatty tissues of calves supplemented with essential oils. *Journal of Animal and Feed Sciences* 16, 168–179.
- Serrano E., Prache S., Chaveua-Duriot B., Agabriel J. and Micol D. (2006) Traceability of grass-feeding in young beef using carotenoid pigments in plasma and adipose tissue. *Animal Science* 82, 909–918,
- Shibata M., Matsumoto K., Oe M., Ohnishi-Kameyama M., Ojima K., Nakajima I., Muroya S and Chikuni K. (2009) Differential expression of the skeletal muscle proteome in grazed cattle. *Journal of Animal Science* 87, 2700–2708.
- Stanton C., Murphy J., McGrath E. and Devery R. (2003) Animal feeding strategies for conjugated linoleic acid enrichment of milk. In: Sébédio J.L., Christie W.W. and Adlof R. (eds.) *Advances in Conjugated Linoleic Acid Research. Volume 2*. AOCS Press, Champaign, IL., USA, pp. 123–145.
- Sun D.-W. (2008) *Modern Techniques for Food Authentication*, Academic Press, London, UK, 689 pp.
- Tornambé G., Cornu A., Pradel P., Kondjoyan N., Carnat A. P., Petit M. and Martin B. (2006). Changes in terpene content in milk from pasture-fed cows. *Journal of Dairy Science* 89, 2309–2319
- TRACE (2010). Tracing the Origin of Food. EU Framework 6 Programme. <http://www.trace.eu.org/>
- USDA (2007). <http://www.ams.usda.gov/AMSV1.0/getfile?dDocName=STELPRDC5063842>
- Vanhatalo A., Kuoppala K., Toivonen V. and Shingfield K. J. (2007) Effects of forage species and stage of maturity on bovine milk fatty acid composition. *European Journal of Lipid Science and Technology* 109, 856–867.
- Vasta V. and Priolo, A. (2006) Ruminant fat volatiles as affected by diet. A review. *Meat Science* 73, 218–228.
- Vasta V., Ratel J. and Engel E. (2007) Mass spectrometry analysis of volatile compounds in raw meat for the authentication of the feeding background of farm animals. *Journal of Agricultural and Food Chemistry* 55, 4630–4639.
- Vetter W. and Schroeder M. (2010) Concentrations of phytanic acid and pristanic acid are higher in organic than in conventional dairy products from the German market. *Food Chemistry* 119, 746–752.
- Viallon C., Martin B., Verdier-Metz I., Pradel P., Garel J.P., Coulon J.B. and Berdagué J.L. (2000) Transfer of monoterpenes and sesquiterpenes from forages into milk fat. *Lait* 80, 635–641.
- WHO/FAO (2007). *World Health Organization – Food and Agriculture Organization of the United Nations. Codex Alimentarius. Food Import and Export Inspection and Certification Systems*. 3<sup>rd</sup> edition. 79 pp.
- Woods V.B. and Fearon A.M. (2009) Dietary sources of unsaturated fatty acids for animals and their transfer into meat, milk and eggs: A review. *Livestock Science* 126, 1–20
- Zazzo A., Harrison S.M., Bahar B., Moloney A.P., Monahan F.J., Scrimgeour C.M. and Schmidt O. (2007) Experimental determination of dietary carbon turnover in bovine hair and hoof. *Canadian Journal of Zoology* 85, 1239–48.
- Zazzo A., Moloney A.P., Monahan F.J., Scrimgeour C.M. and Schmidt O. (2008) Effect of age and food intake on dietary carbon turnover recorded in sheep wool. *Rapid Communications in Mass Spectrometry* 22, 2937–2945.

## **Session 3.1**

### **Forage conservation, feeding value and product quality**

*Editor: Martin Gierus*

# Harvest dates affect fungal counts and fungal composition of baled haylage

Schenck J.A.<sup>1,2</sup> and Müller C.E.<sup>1</sup>

<sup>1</sup>*Department of Animal Nutrition and Management, 753 23 Uppsala, Sweden*

<sup>2</sup>*Department of Forest Mycology and Pathology, 750 07 Uppsala, Sweden*

Corresponding author: jessica.schenck@huv.slu.se

## Abstract

The use of baled forage with dry matter (DM) contents between 500 and 800 g kg<sup>-1</sup>, also known as haylage, has increased in recent years, particularly for the feeding of equines. Haylage contains less fermentation products and more residual sugars, and it has a higher pH compared to silage, as lactic acid fermentation is restricted in haylage. These factors may favour fungal growth, but the fungal flora of haylage is not well-known at present. One factor that may be important is the harvest date, as it is often delayed when forage is produced for horses. To improve our understanding of fungal flora in both grass and haylage, an experiment with three harvest dates (June, July, August) of the primary growth of a grass-clover ley was conducted, with samples for fungal analysis taken both pre- and post conservation. Delaying harvest resulted in higher yeast counts both pre- and post-conservation, but mould counts were generally low and they were less affected by than yeast counts. The number of mould species was higher pre- than post-conservation.

Keywords: haylage, fungi, mould, microbial enumeration

## Introduction

The use of forage with dry matter (DM) content exceeding 500 g kg<sup>-1</sup>, also known as haylage, has increased in recent years especially in equine nutrition (Holmquist and Müller, 2002). However, the microbiology and fermentation of haylage during conservation and storage is not well-known. As DM content is one of the factors that has the largest impact on the extent of fermentation in silage (e.g. Finner, 1966), it is highly influential on the resulting content of fermentation products and pH in the forage (Haigh, 1990; Müller, 2005). Compared to silage, which has a lower DM content allowing lactic acid fermentation, haylage contains less fermentation products and more residual sugars, and it has a comparatively high pH. These factors may favour fungal growth. Also, O'Brien *et al.* (2008) found that the risk of mould growth in wrapped bales increased as DM content increased.

Furthermore, forages for horses are often harvested comparatively late to better suit the low nutritional requirements of the majority of horses. This delay in harvest time may result in an increased flora of field fungi as well as a higher risk of storage mould growth, as a crop harvested late is more stemmy and may puncture the wrapping more easily. A previous experiment with laboratory silos (Müller, 2009) reported that a delayed harvest of grass resulted in increased counts of yeasts and moulds as well as a higher number of mould species pre-conservation, but these differences were not present post-conservation (Müller, 2009). As the experiment by Müller (2009) was conducted in air-tight laboratory silos, it is of interest to investigate if the same result would be achieved in conventional wrapped haylage bales where the air tightness may be challenged to a higher extent. Therefore, an experiment with three harvest dates of the primary growth of a grass-clover ley was conducted, with samples for fungal analysis taken both pre- and post conservation.

## Materials and methods

A grass-dominated sward outside of Uppsala, Sweden, consisting of approximately 0.45 timothy (*Phleum pratense*), 0.45 meadow fescue (*Festuca pratensis*) and 0.10 red clover (*Trifolium pratense*) was used for the experiment. Harvests of the primary growth were taken on 8 June, 2 July and 5 August in 2009. The crop was mowed with a mower conditioner with flails, wilted to 550-610 g kg<sup>-1</sup> DM and baled in conventional round bales that were wrapped with ten layers of white stretch film. Samples for fungal analysis were taken pre-conservation in the field at harvest both before wilting and after wilting prior to baling, and post-conservation from haylage bales (during a feeding experiment running from 5 October to 4 December 2009). Enumeration of fungi in the samples (sample size 50 g) was done using tenfold dilution series, inoculated on malt extract agar plates in triplicate. Fungal characterization was performed on macro- and microstructures as described by Samson *et al.* (2000). Isolated mould colonies were also used for confirmation of the species by DNA sequencing (Gardes and Bruns, 1993).

Grass samples taken pre-conservation were also analysed for concentrations of DM, crude protein (CP) and neutral detergent fibre (NDF) according to methods described by Müller (2009) to provide background information about the crops.

Statistic evaluation included a variance analysis of the effects of harvest dates using a SAS general linear models procedure (SAS 9.1 for Windows), using the following model:

$$Y_{ij} = \mu + (\text{harvest date})_i + (\text{error})_{ij}$$

where the error term is the random residual with mean = 0 and variance  $\sigma^2$ .

## Results and discussion

Yeast counts in grass samples taken pre-conservation increased largely from June to August (Table 1). In the haylage samples taken post-conservation, yeast counts were higher in July and August than in the June harvest (Table 2). This increase is in agreement with previous results from laboratory silo experiments (Müller, 2009), and may reflect the changing microclimate in the ageing sward (Fehrmann and Müller, 1990). Mould counts in grass and haylage samples were generally low, although small differences occurred among harvests (Tables 1 and 2).

Mould genera commonly present pre-conservation were *Cladosporium spp.*, *Fusarium spp.*, *Mucor spp.* and *Penicillium spp.*, while *Mucor spp.* dominated post-conservation (identified on macro- and microstructures). However, identification of mould species on macro- and microstructures may be difficult and further identification through DNA-sequencing may provide more accurate information. DNA-sequencing of isolates found pre-conservation confirmed the species identified on macro- and microstructures. Isolates found post-conservation are currently being sequenced. As not all mould species are equally important for the hygienic quality of forages, it is not the total amount of moulds that are most important, but the presence and amount of species with known pathogenic or mycotoxigenic effects.

For June, July, and August harvests, respectively, concentrations in DM were 566, 567 and 610 g kg<sup>-1</sup>, 123, 91 and 91 g kg<sup>-1</sup> for CP, and 513, 596 and 597 g kg<sup>-1</sup> for NDF.

Table 1. Microbial counts ( $_{10}\log$  CFU  $g^{-1}$ ) and number of mould species present in grass sampled pre-conservation (n=36 except otherwise mentioned)

Variable	June harvest	July harvest	August harvest	SE	P
Yeast <sup>1</sup>	1.65 <sup>a</sup>	6.45 <sup>b</sup>	7.42 <sup>c</sup>	0.143	<0.0001
Mould	1.89 <sup>a</sup>	2.49 <sup>b</sup>	2.11 <sup>a,b</sup>	0.146	0.02
No. of mould species	2	2	3	0.5	0.14

<sup>1</sup>n = 35 for yeast counts

<sup>a,b,c</sup> Values in a row with different superscript letters differ at the P-level presented.

Table 2. Microbial counts ( $_{10}\log$  CFU  $g^{-1}$ ) and number of mould species present in haylage sampled post-conservation (n = 27)

Variable	June harvest	July harvest	August harvest	SE	P
Yeast	4.96 <sup>a</sup>	6.34 <sup>b</sup>	6.53 <sup>b</sup>	0.221	<0.0001
Mould	1.26 <sup>a</sup>	1.66 <sup>a,b</sup>	2.04 <sup>b</sup>	0.170	0.01
No. of mould species	<1 <sup>a</sup>	1 <sup>a</sup>	2 <sup>b</sup>	0.3	0.002

<sup>a,b,c</sup> Values in a row with different superscript letters differ at the P-level presented.

## Conclusion

A late harvest date of a grass-dominated ley resulted in higher yeast counts both pre- and post conservation, compared to earlier harvest dates. Mould counts pre- and post conservation were also affected by harvest dates, but to a much smaller extent. The number of mould species were higher pre- than post-conservation.

## References

- Fehrmann E. and Müller Th. (1990) Seasonal changes of epiphytic micro-organisms on a grassland plot. (*In German, English summary*). *Das wirtschaftseigene Futter* 36, 66-78.
- Finner M.F. (1966) Harvesting and handling low-moisture silage. *Transactions of the ASAE* 9, 377-381.
- Gardes I. and Bruns T.D. (1993) ITS primers with enhanced specificity for basidiomycetes – Application to the identification of mycorrhizae and rusts. *Molecular Ecology* 2, 113-118.
- Haigh P.M. (1990) The effect of dry matter content on the preservation of big bale grass silage made during the autumn on commercial farms in South Wales 1983-87. *Grass and Forage Science* 45, 29-34.
- Holmquist S. and Müller C.E. (2002) Problems related to feeding forages to horses. In: Gechie L.M. and Thomas C. (eds.) *Conference Proceedings XIIIth International Silage Conference*, Auchincruive, Scotland, UK, pp. 152-153.
- Müller C. E. (2005) Fermentation patterns of small-bale silage and haylage produced as a feed for horses. *Grass and Forage Science* 60, 109-118.
- Müller C. (2009) Influence of harvest date of primary growth on microbial flora of grass herbage and haylage, and on fermentation and aerobic stability of haylage conserved in laboratory silos. *Grass of Forage Science* 64, 328-338.
- O'Brien M. O'Kiely P., Forristal P.D. and Fuller H. (2008) Fungal contamination of big-bale grass silage on Irish farms: predominant mould and yeast species and features of bales and silage. *Grass and Forage Science* 63, 121-137.



# Influence of genotype and mechanical stress on the specific polyphenol oxidase activity in pure red clover swards

Weiber N., Krawutschke M., Gierus M. and Taube F.

*Grass and Forage Science/Organic Agriculture, Institute of Crop Science and Plant Breeding, Christian-Albrechts-University, 24118 Kiel, Germany*

Corresponding author: nweiber@email.uni-kiel.de

## Abstract

Increasing the nitrogen use efficiency in ruminant nutrition may contribute to reducing nitrogen losses in specialized dairy farms in Europe. Red clover is known to have high polyphenol oxidase (PPO) activity among forage legumes. The enzyme oxidizes phenols to quinones. These highly reactive quinones undergo further reactions with other phenols or proteins forming stabilized quinone-protein-complexes, protecting protein from fast degradation. However, the variation in specific PPO-activity due to genotype, season and management is not clearly defined. The aim of the study is to investigate differences in the specific PPO-activity determined between several genotypes submitted in two management systems (with and without stress). In total, twelve red clover genotypes with different origins were grown in pure stands in a four-cut-system. In one system plots were rolled with a Cambridge-roller about three weeks before harvest to generate mechanical stress. The results show that for almost all genotypes the specific PPO-activity increased after applying mechanical stress. Seasonal effects were observed, and the autumn harvest showed the highest specific PPO-activity for both systems. In conclusion, the variation in specific PPO-activity among the genotypes was present. However, effect of the management system and seasonal effects were also pronounced.

Keywords: polyphenol oxidase, specific PPO-activity, red clover, forage legume

## Introduction

Red clover is known to have high polyphenol oxidase (PPO)-activity among forage legumes. The enzyme oxidizes mono- and diphenols to quinones. These highly reactive quinones undergo further reactions with other phenols or proteins forming stabilized quinone-protein-complexes, protecting protein from fast degradation. Increasing the nitrogen use efficiency in ruminant nutrition may contribute to reducing nitrogen losses in specialized dairy farms in Europe. Differences in the PPO-activity have been observed among red clover genotypes and during the growing season (Fothergill and Rees, 2006; Winters *et al.*, 2008; Eickler *et al.*, 2010), but also due to the management system. However, the variation in specific PPO-activity due to genotype, season and management is not clearly defined. The aim of the study is to investigate differences in the specific PPO-activity determined between several genotypes submitted to two management systems.

## Material and methods

In total, twelve red clover (*Trifolium pratense* L.) genotypes with different origins and white clover (*T. repens* L.) as a control were grown in pure stands in a four-cut-system with three replications in two management systems (with and without stress) in Hohenlieth/Northern Germany (soil texture: loamy sand, average temperature 8.9 °C, average precipitation 804.5 mm). In one system (with stress) plots were rolled with a Cambridge-roller about three weeks before harvest to generate mechanical stress. The phenological stage of the plants was

monitored at each sampling date on 50 plants per plot according to Fagerberg (1988) to calculate the mean stage by count (MSC), yields and leaf weight ratio (LWR = proportion of leaves in total tiller weight) were determined. Fresh plants were harvested at six-week interval by hand, to a cutting height of 5 cm, and separated into leaves and stems. Leaves were immediately frozen at -27 °C. The specific PPO-activity was spectrometrically determined in frozen leaves according to Escribano *et al.* (1997). The specific PPO-activity, measured in IU per protein ( $\mu\text{g g}^{-1}$  DM), was related to LWR, given as  $\text{PPO}_{\text{LWR}} = \text{PPO [IU]} \times \text{LWR [\%]}/100$ . All data were submitted to an analysis of variance (mixed procedure, ANOVA) using SAS 9.1. Effects were considered significant in all statistical calculations for  $P < 0.05$ . Comparisons of mean values were tested using Tukey-Kramer. Cuts were treated as repeated measurements.

## Results and discussion

The specific PPO-activity was measured for all four cuts. Measurements in the system with stress were mostly higher than in the system without stress. White clover (genotype 13) showed the lowest PPO-activity at all times. Significant differences between the genotypes in the system without stress could be confirmed for the autumn harvest (cut 4). In the system with stress the specific PPO-activity differed between red clover genotypes (Table 1).

Table 1: Specific PPO-activity in IU ( $\mu\text{g protein g}^{-1}$  DM) related to LWR

Genotype	Cut 1		Cut 2		Cut 3		Cut 4	
	without stress	with stress	without stress	with stress	without stress	with stress	without stress	with stress
01	0.41	0.57 <sup>ab</sup>	0.35	0.59	0.58	1.85 <sup>a</sup>	1.39 <sup>ab</sup>	3.32 <sup>abA</sup>
02	0.24	0.85 <sup>ab</sup>	0.46	0.66	0.38	0.98 <sup>ab</sup>	0.96 <sup>abA</sup>	1.49 <sup>defA</sup>
03	0.74	1.60 <sup>a</sup>	0.49	0.72	0.49	1.67 <sup>a</sup>	1.18 <sup>abA</sup>	1.78 <sup>cdefA</sup>
04	0.59	0.56 <sup>ab</sup>	0.25	0.35	0.51	1.05 <sup>ab</sup>	1.45 <sup>aA</sup>	1.03 <sup>fgA</sup>
05	0.66	0.99 <sup>ab</sup>	0.78	0.63	0.47	1.42 <sup>ab</sup>	0.97 <sup>abB</sup>	3.92 <sup>aA</sup>
06	0.42	0.67 <sup>ab</sup>	0.24	0.85	0.57	1.19 <sup>ab</sup>	1.23 <sup>abB</sup>	2.61 <sup>abcdA</sup>
07	0.16	0.76 <sup>ab</sup>	0.32	0.32	0.77	2.07 <sup>a</sup>	0.73 <sup>abB</sup>	3.27 <sup>abA</sup>
08	0.35	0.84 <sup>ab</sup>	0.51	0.97	0.72	1.45 <sup>a</sup>	1.58 <sup>ab</sup>	3.07 <sup>abcA</sup>
09	0.53	0.64 <sup>ab</sup>	0.42	0.50	0.57	1.34 <sup>ab</sup>	1.93 <sup>aA</sup>	2.42 <sup>bcdeA</sup>
10	0.51	0.64 <sup>ab</sup>	0.44	0.59	0.70	1.66 <sup>a</sup>	1.90 <sup>aA</sup>	2.16 <sup>bcdefA</sup>
11	0.38	0.64 <sup>ab</sup>	0.39	0.78	0.58	1.29 <sup>ab</sup>	0.69 <sup>abB</sup>	2.21 <sup>bcdefA</sup>
12	0.23	0.38 <sup>ab</sup>	0.55	0.84	0.60	0.98 <sup>ab</sup>	0.81 <sup>abA</sup>	1.21 <sup>efgA</sup>
13†	0.04	0.02 <sup>b</sup>	0.06	0.06	0.06	0.10 <sup>b</sup>	0.02 <sup>bA</sup>	0.08 <sup>gA</sup>

<sup>a - g</sup> Within columns, LSM means with different small letters are significantly different between genotypes within system and cut at  $P < 0.05$

<sup>A, B</sup> Within rows, LSM means of the same cut followed by different capital letters are significantly different between management systems within genotype ( $P < 0.05$ , SE = 0.21)

† genotype 13 is white clover.

In both systems highest values occurred at the 4<sup>th</sup> cut on the end of the growing season, as reported in previous studies (Eickler *et al.*, 2010). At the 4<sup>th</sup> cut the system had a great impact. Significant differences could be detected for the genotypes 1, 5, 6, 7, 8 and 11. Growth also plays a decisive role for the specific PPO-activity among genotype and system. MSC of all genotypes was lowest at the 4<sup>th</sup> cut (Figure 1). Accordingly, plants were less developed in phenological stage than the first three cuts. That has implications for the seasonal effect on the specific PPO-activity. Higher MSC tended to result in lower specific PPO-activity, but the specific PPO-activity varied in a wide range at a similar MSC, especially in the 4<sup>th</sup> cut. With

increasing LWR specific PPO-activity increased (Figure 1). However, there is a high variation of the specific PPO-activity within similar ranges of LWR, especially for 1<sup>st</sup> and 4<sup>th</sup> cut.

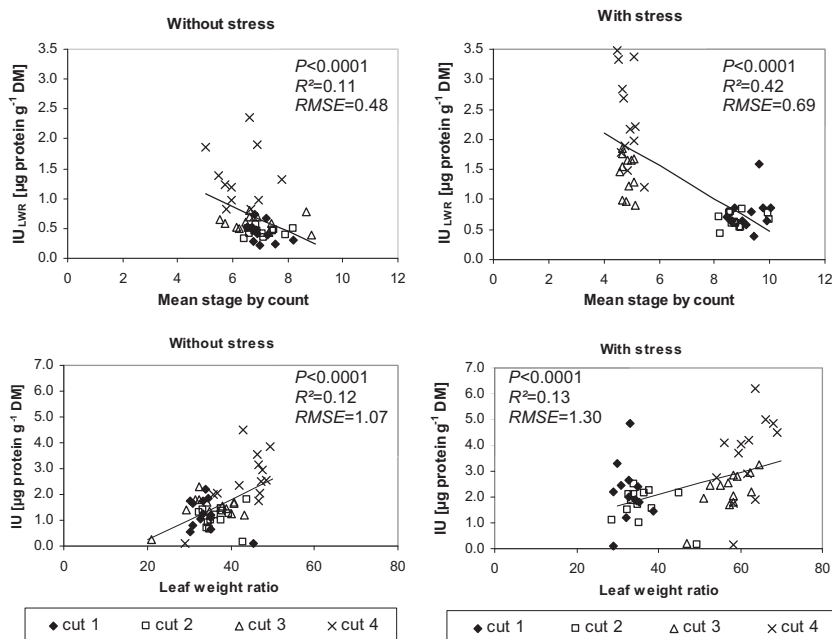

Figure 1: Relation between the specific PPO-activity and MSC or LWR of red clover genotypes. IU: Specific PPO-activity in IU ( $\mu\text{g protein per g DM}$ ); IU<sub>LWR</sub>: Specific PPO-activity in IU related to LWR

## Conclusion

Mechanical stress due to rolling induced a higher specific PPO-activity. Among genotype and system, the harvest time also plays a decisive role. Highest values in specific PPO-activity were measured at the autumn growth, where the red clover plants had the lowest MSC. However, specific PPO-activity was poorly related with MSC or LWR expressed by low  $R^2$ .

## References

- Eickler B., Gierus M., Kleen J. and Taube F. (2010) Specific polyphenol oxidase activity of red clover (*Trifolium pratense*) and its relation with forage quality in field experiments. *Acta Agriculturae Scandinavica* (in press).
- Escribano J., Cabanes J., Chazarra S. and Garcia-Carmona F. (1997) Characterization of monophenolase activity of table beet polyphenol oxidase. Determination of kinetic parameters on the tyramine/dopamine pair. *Journal of Agricultural and Food Chemistry* 45, 4209-4214.
- Fagerberg B. (1988) Phenological development in timothy, red clover and lucerne. *Acta Agriculturae Scandinavica* 38, 159-170.
- Fothergill M. and Rees M.E. (2006) Seasonal differences in polyphenol oxidase activity in red clover. In: Wachendorf M., Helgadottir A. and Parente G. (eds.) Sward dynamics, N-flows and forage utilisation in legume-based systems. *Proceedings of the 2nd COST 852 Workshop*, Grado, Italy, 2005, pp.141-144.
- Winters A.L., Minchin F.R., Michaelson-Yeates T.P.T., Lee M.R.F. and Morris P. (2008) Latent and active polyphenol oxidase (PPO) in red clover (*Trifolium pratense*) and use of a low PPO mutant to study the role of PPO in proteolysis reduction. *Journal of Agricultural and Food Chemistry* 56, 2817-2824.

## Variation of fatty acid content in grass and milk during the grazing season

Wyss U., Munger A. and Collomb M.

*Agroscope Liebefeld-Posieux Research Station ALP, Posieux, Switzerland*

Corresponding author: ueli.wyss@alp.admin.ch

### Abstract

Fatty acid composition in grass varies during the growth season. Grass fed to dairy cows may yield corresponding changes in milk fatty acid content. To investigate this, monthly individual milk samples of 16 (2005) and 20 cows (2007) and corresponding grass samples were analysed throughout the grazing season. The cows were grazing full time in a rotational system on a mixed sward. As supplements, the cows were offered carbohydrate-type concentrate restrictively according to their milk production. In spring and autumn, the grass had lower crude fibre and higher crude protein contents than in summer.  $\alpha$ -linolenic acid (C18:3) was the most important fatty acid in the grass. With higher crude fibre contents, the grass had less  $\alpha$ -linolenic acid. In 2005, conjugated linoleic acid (CLA) concentration in milk was higher in spring and in autumn than in summer. In 2007, CLA increased continuously from spring to autumn. In both years, the mean CLA content was 1.5 g per 100 g fat. The concentration of omega-3 fatty acids did not vary much during the pasture season in 2005. In 2007, the omega-3 increased during the grazing season. The average content was 1.4 g per 100 g fat.

Keywords: grazing, milk, fatty acid content, CLA, omega-3

### Introduction

Fatty acid content varies in forages during the grazing season. Their composition depends on different factors such as plant species, development stage, temperature, and light intensity (Hawke, 1973). Differences in feed fatty acid composition also influence the concentrations of fatty acids in milk (Schroeder *et al.*, 2004). Furthermore, grazing alone is often not sufficient to meet total nutritional requirements in high producing lactating dairy cows (Delaby *et al.*, 2003). Consequently, different types of concentrates are often supplemented in order to prevent energy, protein, mineral, and vitamin deficiencies as well as to enhance milk yield. The objective of this study was to compare feed and milk fatty acid profiles of cows over the grazing season in two different years.

### Materials and methods

The experiments were conducted from April to November in both 2005 and 2007 in Posieux (altitude 650 m a.s.l.; average annual rainfall: 1014 mm). The cows were grazing full time in a rotational system on a mixed sward composed of 78% grasses (mainly ryegrass), 13% clover and 9% other herbs. In spring and autumn, the diet was supplemented in-barn with conserved forage. In 2005, 16 dairy cows were allotted to two groups. The two groups received concentrate supplements that differed by their carbohydrate composition. They consisted either of a starchy concentrate (corn-barley) or a highly digestible fibre concentrate (beet pulp) offered at variable levels during the trial according to milk production: 0.5 kg per kg of milk production above 24 kg per day with a maximum of 6.5 kg of concentrate. The fat content of the concentrates amounted 35 and 10 g kg<sup>-1</sup> in dry matter (DM). In August 2005, due to drought conditions occurring in the region, maize silage was added to the diet in both groups of cows during several weeks.

In 2007, 20 cows were assigned to two groups. One group was offered concentrate (corn-barley) according to their actual milk production as in 2005. The other group received the same concentrate but at a fixed amount of 3.5 kg d<sup>-1</sup> during the first 150 days of lactation. During the grazing season, grass samples were collected to determine the nutrient contents as well as the fatty acid composition. The milk yield and the intake of concentrate were registered daily. Every month, a milk sample of every cow was taken and the fatty acid composition in the milk fat was analysed. The milk fat composition was analysed according to Collomb and Bühler (2000).

## Results and discussion

In spring and autumn of both years, the grass had higher crude protein and lower crude fibre contents than in summer (Fig. 1). The fatty acid concentrations of the grass, especially the  $\alpha$ -linolenic acid, were lower in summer (Fig. 2). The  $\alpha$ -linolenic acid was the most important fatty acid in the grass, varying between 59 and 73% of the sum of the fatty acids. The correlation between the crude fibre content and the sum of the fatty acids was -0.60 and with  $\alpha$ -linolenic acid -0.63; with other fatty acids, these correlations were lower being -0.49 for C16:0, -0.05 for C18:0, -0.10 for C18:1 and -0.43 for C18:2.

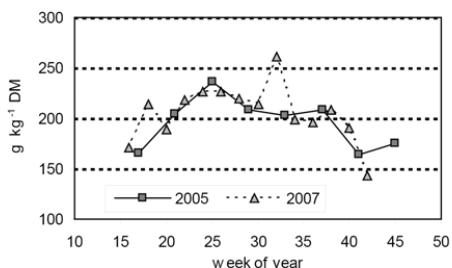

Figure 1. Crude fibre content in the grass

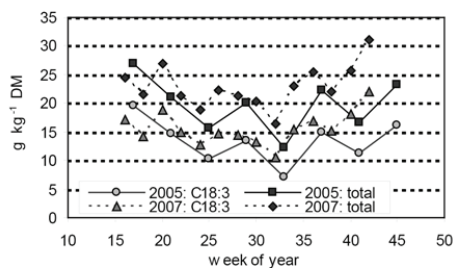

Figure 2.  $\alpha$ -linolenic acid (C18:3) and sum of the fatty acids in the grass

In both years, the daily milk production per cow decreased during the grazing season. At the end of the season in 2005, the milk production increased again because 7 of the 16 cows were replaced by cows at the beginning of lactation (Fig. 3). The decreasing milk production during the season resulted in less concentrates being offered. In 2005, the average quantity of concentrate per day decreased from 5.0 to 2.7 kg. In 2007, the two groups received respectively 4.5 and 3.5 kg of concentrate per day at the beginning of the trial but no concentrates were given at the end of the trial. The average milk fat contents varied between 33 and 44 g kg<sup>-1</sup> (Fig. 4).

In 2005 and 2007, the milk fat contained respectively 57.5 and 56.6 g saturated fatty acids per 100 g fat, 25.0 and 26.6 g mono-unsaturated fatty acids per 100 g fat, and 4.8 and 4.9 g poly-unsaturated fatty acids per 100 g fat. In 2005, the concentration of conjugated linoleic acid (CLA) in milk was higher in spring and in autumn than in summer. In 2007, CLA increased continuously from spring to autumn (Figure 5). In both years, the mean CLA content was 1.5 g per 100 g fat.

The variation of the CLA during the grazing season in 2007 was similar to the results obtained by Collomb *et al.* (2008) in milk from mountain regions in Switzerland as well as to results from a pasture-based system with low concentrate supplementation (Wyss *et al.*, 2010). The different concentrate types in trial 2005, starchy or containing highly digestible fibre, had no significant influence on the concentrations of total CLA. The content of omega-3

fatty acids did not vary much during the pasture season in 2005. In 2007, the omega-3 increased during the grazing season (Figure 6). The mean content was 1.4 g per 100 g fat.

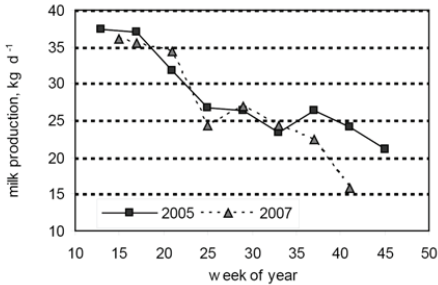

Figure 3. Average milk production over the grazing season

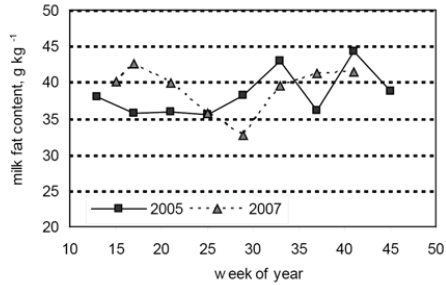

Figure 4. Mean milk fat content

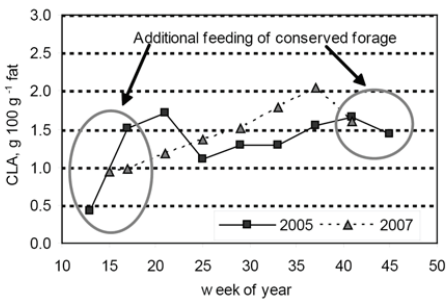

Figure 5. Concentration of CLA in milk fat

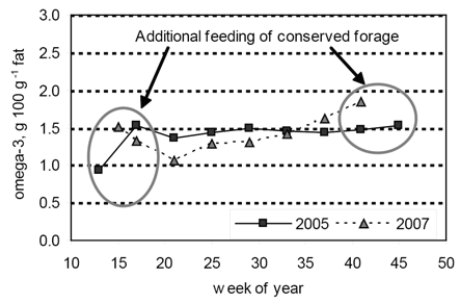

Figure 6. Omega-3 fatty acids in milk fat

## Conclusions

- The fatty acid content in grass, especially the  $\alpha$ -linolenic acid, varies during the grazing season. In young grass (lower crude fibre content), the fatty acid content is higher than in older grass.
- Milk from the pasture has high amounts of CLA and omega-3 fatty acids.
- CLA and partly omega-3 fatty acids vary during the grazing season. This can be partly explained by the variations of the fatty acid contents of the forage.

## References

- Collomb M. and Bühler T. (2000) Analyse de la composition en acides gras de la graisse de lait. I. Optimisation et validation d'une méthode générale à haute résolution. *Mitteilungen aus Lebensmitteluntersuchung und Hygiene* 91, 306-332.
- Collomb M., Bisig W., Bütikofer U., Sieber R., Bregy M. and Etter L. (2008) Seasonal variation in the fatty acid composition of milk supplied to dairies in the mountain regions of Switzerland. *Dairy Science Technology* 88, 631-647.
- Delaby L., Peyraud J.L. and Delagarde R. (2003) Faut-il compléter les vaches laitières au pâturage? *INRA Productions Animales* 16, 183-195.
- Hawke J.C. (1973) Lipids. In: Butler G.W. and Bailey R.W. (eds.) *Chemistry and Biochemistry of Herbage*. London Academic Press, pp. 213-263.
- Schroeder G.F., Gagliostro G.A., Bargo F., Delahoy J.E. and Muller L.D. (2004) Effects of fat supplementation on milk production and composition by dairy cows on pasture: A review. *Livestock Science* 86, 1-18.
- Wyss U., Collomb M., Frey H.J. and Hofstetter P. (2010) Seasonal variation in fatty acid contents of cow milk from indoor and a pasture-based feeding. *Grassland Science in Europe* 15 (this volume).

# Effect of pasture botanical composition on milk composition in organic production

Adler S.<sup>1,2</sup>, Dahl A.V.<sup>3</sup>, Vae A.H.<sup>2</sup>, Thuen E.<sup>2</sup>, Garmo T.<sup>2</sup>, Krogh-Jensen S.<sup>4</sup>, Hansen-Møller J.<sup>4</sup> and Steinshamn H.<sup>1</sup>

<sup>1</sup>Bioforsk Organic Food and Farming Division, N-6630 Tingvoll, Norway

<sup>2</sup>Department of Animal and Aquacultural Sciences, Norwegian University of Life Sciences, N-1432 Ås, Norway

<sup>3</sup>Nofima Food, N-1432 Ås, Norway

<sup>4</sup>Faculty of Agricultural Sciences, Aarhus University, DK-8830 Tjele, Denmark

Corresponding author: steffen.adler@bioforsk.no

## Abstract

Milk samples from sixteen Norwegian Red dairy cows grazing mixed swards of either grass-red clover (GR) or mixed swards of sown and unsown species of grass, clover and other herbs (GCH) were collected during four periods. Both pastures were organically managed. Pasture botanical composition had no effect on milk fat, protein or vitamin concentration and only minor effects on fatty acid composition. Milk from GR had higher concentrations of the phytoestrogens equol, genistein and biochanin A than the milk from GCH. Concentrations of equol in milk from GR were higher than concentrations reported from experiments with red clover silage. The oxidative stability of the milk lipids was not affected by pasture type.

Keywords: Dairy production, grazing, botanical composition, fatty acids, vitamins, phytoestrogens, oxidative stability

## Introduction

Forages with high proportions of legumes tend to increase the proportion of polyunsaturated fatty acids (PUFA) in milk fat (Dewhurst *et al.*, 2003). Red clover (*Trifolium pratense* L.)-grass silage also increases the milk proportion of PUFA, in particular  $\alpha$ -linolenic acid (ALA), compared to white clover (*Trifolium repens* L.)-grass silage (Steinshamn and Thuen, 2008). However, increased proportion of PUFA in milk fat may increase the susceptibility of milk lipids to photo-oxidation (Havemose *et al.*, 2004). Red clover has also shown to yield high concentrations of phytoestrogens in milk (Mustonen *et al.*, 2009). The aim of this study was to examine if milk composition of fatty acids (FA), vitamins and phytoestrogens, and the susceptibility of milk to photo-oxidation are affected by pasture botanical composition.

## Material and methods

A continuous grazing experiment was conducted in Ås, Norway, with sixteen Norwegian Red dairy cows ( $80 \pm 15.0$  days in milk (d.i.m.)) with three 3-week periods of measurements: in June, July and September 2008. The cows were blocked by genetic line, d.i.m. and milk yield and were allocated randomly to the two treatments: a grass-red clover pasture (GR) in the first production year, and a five-year-old pasture including sown and unsown species of grass, clover and other herbs (GCH) with a daily dry matter (DM) allowance of approximately 20 kg cow<sup>-1</sup> d<sup>-1</sup> and supplemented with 3.0 kg d<sup>-1</sup> of barley pellets, including minerals. Both pastures were organically managed. A period with indoor silage feeding before grazing was used as a baseline period. Both groups were grazing together between the three 3-periods on pastures similar to GCH. GR contained 54% grasses, 28% red clover, 1% white clover and 17% other herbs, and GCH contained 66% grasses, 3% red clover, 21% white clover and 10% other



herbs as estimated with the dry-weight-rank method (Mannetje and Haydock, 1963). Pasture intake was estimated as net energy requirement for lactation and maintenance minus net energy in concentrates divided by net energy concentration in pasture samples. Individual pooled samples from four consecutive milkings in each period were analysed for the content of fat, protein, free FA, vitamins, phytoestrogens, FA composition and milk oxidative stability. Milk oxidative stability was analysed in a light exposure experiment (three replicates were exposed for light for 0, 24 or 48 hours at 4 °C) by determination of lipid hydroperoxides as described by Østdal *et al.* (2000) and front face fluorescence spectroscopy as described by Veberg *et al.* (2007). Milk composition variables were analysed using the mixed model procedure by SAS 9.2 with treatment, period and treatment-period interaction as fixed effects and cow within treatment, and block as random effects accounting for repeated measurement on cow. The statistical model for hydroperoxides included also fixed effects of light exposure and treatment-light exposure interaction. For milk yield and milk chemical composition the baseline data were used as a covariate. The fluorescence emission spectra were analysed in a principal component analysis (Unscrambler).

Table 1. Pasture dry matter intake, milk yield and milk composition from cows grazing swards of grass-red clover (GR) or sown and unsown species of grass, clover and herbs (GCH)

	GR	GCH	SED	P <sup>a</sup>
Pasture DM intake (est.), kg day <sup>-1</sup>	15.4	15.3	0.76	NS
Milk yield, kg d <sup>-1</sup>	24.6	24.9	0.74	NS
Fat, g kg <sup>-1</sup>	37.7	37.2	1.04	NS
Protein, g kg <sup>-1</sup>	33.6	33.2	0.82	NS
Free FA, meq L <sup>-1</sup>	0.49	0.62	0.122	NS
Total saturated FA, g per 100 g FAME <sup>b</sup>	66.72	68.37	1.032	NS
Total monounsaturated FA, g per 100 g FAME	28.35	26.93	0.820	NS
Total polyunsaturated FA, g per 100 g FAME	4.95	4.70	0.314	NS
n-6:n-3 FA ratio	2.00	1.89	0.120	NS
β-caroten, mg L <sup>-1</sup>	0.25	0.24	0.022	NS
α-tocopherol, mg L <sup>-1</sup>	1.51	1.32	0.082	NS
Retinol, mg L <sup>-1</sup>	0.52	0.45	0.041	NS
Enterolactone, µg L <sup>-1</sup>	172.3	120.9	28.54	(*)
Formononetin, µg L <sup>-1</sup>	49.4	5.5	16.01	(*)
Equol, µg L <sup>-1</sup>	1230.8	88.0	220.40	*
Genistein, µg L <sup>-1</sup>	15.5	2.6	4.11	*
Biochanin A, µg L <sup>-1</sup>	16.2	1.2	5.12	*
Hydroperoxides, after 48 h of light exposure	0.47	0.46	0.041	NS

<sup>a</sup>P-value: NS  $P > 0.10$ , (\*)  $P < 0.10$ , \* $P < 0.05$ ; <sup>b</sup>Fatty acid methyl esters

## Results and discussion

There was no significant effect of pasture botanical composition on pasture intake, milk yield, concentration of fat, protein and vitamins and composition of most FA in milk (Table 1). The elevating effect of red clover diets on milk content of ALA (Dewhurst *et al.*, 2003; Steinshamm and Thuen, 2008) is due to the activity of polyphenol oxidase (PPO) that inhibits lipolysis (Lee *et al.*, 2009). The activation of the enzyme requires the presence of oxygen and occurs during mastication of fresh red clover, but it is limited by the anaerobe condition in the rumen (Lee *et al.* 2009). Thus, the lack of effect in the present experiment might be due to the short period of time the red clover is exposed to oxygen during the grazing and mastication process. Concentrations of the phytoestrogens equol, genistein and biochanin A were significantly higher in milk from GR than GCH. This is in accordance with other experiments where red clover has been compared with white clover containing diets (Steinshamm *et al.*,

2008; Andersen *et al.*, 2009). The milk concentrations of equol, enterolactone and formononetin from GR fed cows in the present experiment were several times higher than found in other experiments with red clover based diets, both from silage (Steinshamn *et al.*, 2008; Mustonen *et al.*, 2009) and pasture (Andersen *et al.*, 2009). Pasture type did not affect concentration of hydroperoxides. In the principal component analysis of the fluorescence spectra principal component (PC) 1 explained 94% and PC2 6% of the total variation. PC1 grouped the samples by light exposure time which was correlated with reduction of the photosensitiser riboflavin. PC2 grouped the pasture types to some degree but the correlated peaks in the fluorescence spectra are of unknown substances and it is not sure that these are oxidation products since differences were consistent even for samples not exposed to light.

## Conclusions

Pasture with red clover did not affect FA composition in milk to an extent susceptible to a higher risk of milk fat oxidation compared to pasture including several grass species, white clover and herbs. Grazing GR compared to GCH increased the concentrations of phytoestrogens in milk.

## Acknowledgements

This work was part of the CORE Pilot project 'PhytoMilk' funded by the CORE Organic Funding Body Network.

## References

- Andersen C., Nielsen T.S., Purup S., Kristensen T., Eriksen J., Søgaard K., Sørensen J. and Fretté X.C. (2009) Phyto-oestrogens in herbage and milk from cows grazing white clover, red clover, lucerne or chicory-rich pastures. *Animal* 3, 1189-1195.
- Dewhurst R.J., Fisher W.J., Tweed J.K.S. and Wilkins R.J. (2003) Comparison of grass and legume silages for milk production. 1. Production responses with different levels of concentrate. *Journal of Dairy Science* 86, 2598-2611.
- Havemose M.S., Weisberg M.R., Bredie L.P. and Nielsen J.H. (2004) Influence of feeding different types of roughage on the oxidative stability of milk. *International Dairy Journal* 14, 563-570.
- Lee M.R.F., Tweed J.K.S., Minchin F.R. and Winters A.L. (2009) Red clover polyphenol oxidase: Activation, activity and efficacy under grazing. *Animal Feed Science and Technology* 149, 250-264.
- Mannetje L. and Haydock K.P. (1963) The dry-weight-rank method for the botanical analysis of pasture. *Journal of the British Grassland Society* 18, 268-275.
- Mustonen E.A., Tuori M., Saastamoinen I., Taponen J., Wähälä K., Saloniemi H. and Vanhatalo A. (2009) Equol in milk of dairy cows is derived from forage legumes such as red clover. *British Journal of Nutrition* 102, 1552-1556.
- Steinshamn H., Purup S., Thuen E. and Hansen-Møller J. (2008) Effects of clover-grass silages and concentrate supplementation on the content of phytoestrogens in dairy cow milk. *Journal of Dairy Science* 91, 2715-2725.
- Steinshamn H. and Thuen E. (2008) White or red clover-grass silage in organic dairy milk production: Grassland productivity and milk production responses with different levels of concentrate. *Livestock Science* 119, 202-215.
- Veberg A., Olsen E., Nilsen A.N. and Wold J.P. (2007) Front face fluorescence measurement of photosensitizers and lipid oxidation products during photooxidation of butter. *Journal of Dairy Science* 90, 2189-2199.
- Østdal H., Andersen H.J. and Nielsen J.H. (2000) Antioxidative activity of urate in bovine milk. *Journal of Agricultural and Food Chemistry* 48, 5588-5592.

## Top losses in maize silage sealed with different plastic films

Bernardes T.F.<sup>1</sup>, Nussio L.G.<sup>2</sup> and Amaral R.C.<sup>2</sup>

<sup>1</sup>Federal Rural University of Amazon, Department of Animal Science, Belém, Pará, Brazil

<sup>2</sup>University of São Paulo, Department of Animal Science, Piracicaba, São Paulo, Brazil

Corresponding author: tbernardes@yahoo.com

### Abstract

Proper sealing with a plastic cover is essential to reduce surface losses from silage. The objective of this work was to study the effectiveness of different plastic films to reduce the top losses in maize silage. The treatments evaluated were: 1) oxygen barrier film, 125- $\mu\text{m}$  thick (OB), 2) black-on-white (200- $\mu\text{m}$  thick) PE film (PE), 3) black-on-white (300- $\mu\text{m}$  thick) polyvinyl chloride film (PVC), 4) black-on-white (200- $\mu\text{m}$  thick) polyvinyl alcohol film (PVOH). The forage was ensiled in macro silos (500 L) which were opened 162 days after ensiling. During the silo filling, one plastic net bag with well-mixed fresh material and one data logger were buried in the upper layer of the silo. The quality of the sealing was assessed by temperature measurements. Top losses in the silages were also evaluated by chemical and microbiological analyses. Oxygen permeability of the films influenced the DM losses in the upper 30 cm of the silage. The OB film reduced the DM losses of the silage ( $P < 0.05$ ). More lactic acid was produced in the silage sealed with the OB film, and the yeast counts were always under the detection limit ( $1 \times 10^5$  cfu  $\text{g}^{-1}$ ) in the OB-sealed maize silage.

Keywords: film cover, maize silage, management practices, losses

### Introduction

Whole-plant maize silage is the major source of forage in parts of Europe and in North and South America. On commercial farms throughout the world, maize silage is typically stored in horizontal silos with or without side walls. Among the silages, maize silage is particularly susceptible to aerobic deterioration, especially in the upper layer of horizontal silos (Borreani *et al.*, 2007). Although polyethylene sheeting has been the most common method used to protect silage near the surface, the protection provided is highly variable and often changes during storage (Savoie, 1988). A new black-on-white coextruded oxygen barrier film has recently been developed for silage sealing and has been compared to conventional polyethylene in several parts of the world. The aim of this work was to study the effectiveness of plastic films to reduce the top losses in maize silage in a tropical climate.

### Material and methods

The trial was carried out in Piracicaba, Brazil (22°42'S, 47°38'W). The whole maize crop was harvested at around the 50% milk line stage and chopped with a forage harvester to a 15 mm theoretical length of cut. The 4 sealing treatments were: 1) oxygen barrier film, 125- $\mu\text{m}$  thick (OB), 2) black-on-white (200- $\mu\text{m}$  thick) PE film (PE), 3) black-on-white (300- $\mu\text{m}$  thick) polyvinyl chloride film (PVC), 4) black-on-white (200- $\mu\text{m}$  thick) polyvinyl alcohol film (PVOH). The characteristics of the plastic sheets are shown in Table 1. The forage was ensiled in 500 l concrete containers (1100 mm diameter and 750 mm height) in order to achieve a final packing density of approximately 215  $\text{kg m}^{-3}$  DM. During the silo filling, one plastic net bag with well-mixed fresh material (approximately 4 kg per bag) and one data logger were buried in the upper layer of the silo. The plastic films were secured to the silos with adhesive tape and the silos were stored outside. After 162 days of conservation the bags and data loggers were removed from the silos for analysis. The quality of the sealing was

assessed by temperature measurements. Top losses in the silages were also evaluated by chemical and microbiological analyses. Microbial data were converted to  $\log_{10}$  and presented on a fresh weight basis. Chemical data were presented on a DM basis. The experiment was a completely randomized design with four replicates per treatments and data were analysed using the GLM procedure (SAS Institute, 1999). Means separation was performed using Tukey's test with an  $\alpha$  level of  $P < 0.05$  being deemed as significant.

Table 1. Characteristics of the films used in the trial.

Item	Plastic film			
	OB	PE	PVC	PVOH
Nominal thickness ( $\mu\text{m}$ )	125	200	300	250
Measured thickness ( $\mu\text{m}$ )	121	189	280	238
Oxygen permeability ( $\text{cm}^3 \text{m}^{-2} \text{d}^{-1}$ )	$75 \pm 1$	$722 \pm 19$	$289 \pm 5$	$982 \pm 32$

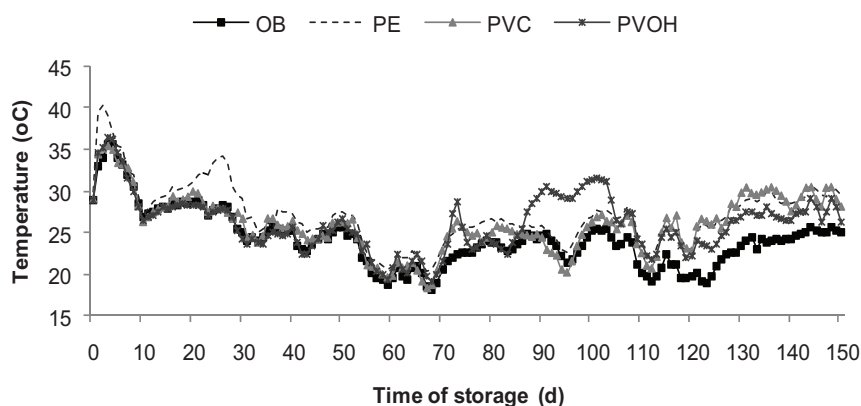

Figure 1. Effect of plastic sheet on temperature of maize silages during 150 days of storage.

Table 2. Fermentation quality and microbial counts in maize silage sealed with different plastic films.

Treatment	OB	PE	PVC	PVOH	SE
DM ( $\text{g kg}^{-1}$ )	329	318	322	319	0.93
Ash in DM ( $\text{g kg}^{-1}$ )	41.2	46.7	43.5	47.7	1.09
pH	4.21 <sup>a</sup>	5.11 <sup>b</sup>	5.23 <sup>b</sup>	4.99 <sup>b</sup>	0.26
Lactic acid in DM ( $\text{g kg}^{-1}$ )	31.1 <sup>a</sup>	20.9 <sup>b</sup>	21.1 <sup>b</sup>	18.8 <sup>b</sup>	0.61
Acetic acid in DM ( $\text{g kg}^{-1}$ )	26.9	30.6	31.2	28.4	0.39
Butyric acid in DM ( $\text{g kg}^{-1}$ )	<0.01	<0.01	<0.01	0.08	-
Yeasts ( $\log_{10} \text{cfu g}^{-1}$ )	4.35 <sup>a</sup>	5.89 <sup>b</sup>	5.37 <sup>b</sup>	5.44 <sup>b</sup>	0.19
Molds ( $\log_{10} \text{cfu g}^{-1}$ )	2.76	3.96	3.87	2.97	0.43
DM losses ( $\text{g kg}^{-1}$ )	82 <sup>a</sup>	138 <sup>b</sup>	128 <sup>b</sup>	145 <sup>b</sup>	1.43

## Results and discussion

The changes in temperature of the maize silages during storage are reported in Figure 1. The temperature at ensiling was about 29°C for all the silages. The increases in temperature in PE silages showed two peaks, corresponding to 1 and 26 d. The PVOH film also showed peaks of temperature, corresponding to 73, 91 and 101 d. The maximum temperatures observed in the PVC silages were reached at the end of the storage period. The temperature did not increase in OB silage and their changes corresponded to environmental temperature.

The characteristics of the silages are shown in Table 2. A film type effect occurred for the pH and lactic acid. More lactic acid was produced in the silage sealed with the OB film, which is consistent with the lower pH values. Borreani *et al.* (2007) reported a better fermentation profile in maize silage in the top 0 to 40 cm under a 125- $\mu\text{m}$  OB film compared with maize silage under a 180- $\mu\text{m}$  polyethylene sheet. The pH value of the silage sealed with the OB film was 4.21, which is not typical of severely deteriorated whole crop maize silages, as reported by Ashbell and Weinberg (1992). The lower oxygen permeability of the OB film also affected the microbial counts by reducing yeasts, whereas the concentration of mould counts was similar in the 4 treatments. The yeast counts were under the detection limit ( $1 \times 10^5$  cfu  $\text{g}^{-1}$ ) in the OB maize silage. The role of yeasts in initiating aerobic deterioration of many silage crops has been widely recognized by several authors (Woolford, 1990; Pahlow *et al.*, 2003). Their activity results in an increase in pH level, in heat production that increases the temperature of the silage, and in a loss of DM. Tabacco *et al.* (2009) observed that the rise in the silage temperature and pH levels only happened when the yeast count was higher than  $5 \log_{10}$  cfu  $\text{g}^{-1}$ . This value is consistent with the value suggested by Woolford (1990), who stated that asilage with a yeast population in excess of  $5 \log_{10}$  cfu  $\text{g}^{-1}$  is particularly prone to aerobic deterioration. Oxygen permeability of the films influenced the DM losses in the upper 30 cm of the silage. The OB film reduced the DM losses of the silage ( $P < 0.05$ ). Although the DM losses were numerically higher in the silage sealed with the other films, Ashbell and Lisker (1988) reported, in a subtropical climate, that DM losses of maize silage in the upper layer and near the walls were between 102 and 358 g kg DM $^{-1}$ .

## Conclusion

The results obtained in the current study indicate that the OB film improved fermentation profile and reduced the occurrence of spoilage microorganisms and DM losses in maize silages at the upper layer of the silo.

## References

- Ashbell G. and Lisker N. (1988) Aerobic deterioration in maize silage stored in a bunker silos under farm conditions in a subtropical climate. *Journal of the Science of Food and Agriculture* 45, 307–315.
- Ashbell G. and Weinberg Z.G. (1992) Top silage losses in horizontal silos. *Canadian Journal Engineering* 34, 171–175.
- Borreani G., Tabacco E. and Cavallarin L. (2007) A new oxygen barrier film reduces aerobic deterioration in farm-scale corn silage. *Journal of Dairy Science* 90, 4701–4706.
- Pahlow G., Muck R.E., Driehuis F., Oude Elferink S.J.W.H. and Spoelstra S.F. (2003) Microbiology of ensiling. In: Buxton D.R., Muck R.E. and Harrison J.H. (eds.) *Silage Science and Technology*, ASA-CSSA-SSSA, Madison, USA, pp. 31–93.
- Savoie P. (1988) Optimization of plastic covers for stack silos. *Journal of Agriculture Engineering Research* 41, 65–73.
- Tabacco E., Piano S., Cavallarin L., Bernardes T.F. and Borreani G. (2009) Clostridia spore formation during aerobic deterioration of maize and sorghum silages as influenced by *Lactobacillus buchneri* and *Lactobacillus plantarum* inoculants. *Journal of Applied Microbiology* 107, 1632–1641.
- Woolford M.K. (1990) The detrimental effect of air on silage. *Journal of Applied Bacteriology* 68, 101–116.

## Comparison of grazed grass and a TMR diet on early lactation milk production performance

Kennedy E., Lewis E., Murphy J.P. and O'Donovan M.

*Grassland Science Research Department, Animal & Grassland Research and Innovation Centre, Teagasc Moorepark, Fermoy Co. Cork, Ireland*

Corresponding author: emer.kennedy@teagasc.ie

### Abstract

In Ireland, winter milk producers tend to house freshly calved cows and offer them a Total Mixed Ration (TMR) diet. However, this feeding regime results in increased feed input costs, especially when compared with grazed grass, a cheaper feed. An experiment was undertaken at Teagasc Moorepark, Ireland in autumn 2008 to compare a TMR diet with grazed grass-based diets with three levels of concentrate. Forty-eight Holstein Friesian autumn-calving dairy cows were balanced and randomly assigned to one of four treatments which investigated: i) grazed grass + 1 kg concentrate (G1), ii) grazed grass + 4 kg concentrate (G4), iii) grazed grass + 8 kg concentrate (G8), and iv) indoors fulltime offered TMR (TMR). Treatments were applied for 6 weeks; following this all cows were housed and offered a common TMR diet for a further 13 weeks to monitor carryover effects. Milk production, milk composition, dry matter intake, bodyweight and body condition score were measured. Results indicate that offering 1 kg concentrate reduced milk yield compared to all other treatments. There was, however, no difference in milk solids yield between the TMR and G8 treatments during the 6-week period when treatments were applied. There was no difference between any of the four treatments during the carryover period in terms of milk production.

### Introduction

The profitability of winter milk production is constrained by higher costs of production relative to the spring. Using grass herbage effectively in this period would allow these constraints to be reduced as feed costs account for a major proportion of total variable costs in most milk production systems. In countries, such as Ireland, where there is a lengthy grass growing season, pasture-based systems of milk production tend to be more profitable (Dillon *et al.*, 2005). However, pasture-based systems can be characterised by little or no growth over the late autumn and the grass at this time has a lower net energy or feeding value compared with grass grown earlier in the season. Nutrient supply from this grass may therefore be insufficient to support high levels of milk production, especially when offered to dairy cows in early lactation. Previous studies have reported significantly higher levels of milk production from a total mixed ration (TMR) compared to a pasture diet (Kolver and Muller, 1998).

The objective of this study was to examine the effect of offering three levels of concentrate at pasture to autumn-calving dairy cows in early lactation and to compare the milk production performance of these cows to those offered a TMR diet indoors.

### Materials and methods

Forty-eight (18 primiparous and 30 pluriparous) autumn-calving Holstein-Friesian dairy cows (mean calving date – 12 September; s.d. 15 days), were balanced on the first 7 days milk yield of the present lactation (22.2; s.d. 3.52 kg day<sup>-1</sup>), parity (2.3; s.d. 1.23), previous lactation milk yield (35 weeks; 5088; s.d. 974.7 kg), milk fat (41.0; s.d. 3.03 g kg<sup>-1</sup>), protein (32.9; s.d. 1.58 g kg<sup>-1</sup>) and lactose content (46.1; s.d. 1.30 g kg<sup>-1</sup>), body weight (530; s.d. 66.1 kg) and

body condition score (3.08; s.d. 0.487) and randomly assigned to a four treatment study ( $n = 12$ ) at 10 days in milk. The four treatments were: outdoors full-time offered fresh herbage + 1 kg DM concentrate (G1); outdoors full-time offered fresh herbage + 4 kg DM concentrate (G4); outdoors full-time offered fresh herbage + 8 kg DM concentrate (G8); indoors full-time offered a total mixed ration (TMR). Fresh herbage was allocated daily to the G1, G4 and G8 treatments. Treatment groups grazed separately for the duration of the study, yet they were offered similar swards. Each animal was assigned to her respective treatment for a 6-week period; following this 6-week experimental period, cows were housed on a full-time basis and offered *ad-lib* TMR for 13 weeks to monitor carryover effects. The composition in DM of the TMR was on average 4.1 (s.d. 0.55) kg cow<sup>-1</sup> d<sup>-1</sup> grass silage, 8.2 (s.d. 0.98) kg cow<sup>-1</sup> d<sup>-1</sup> maize silage, 0.7 (s.d. 0.07) kg cow<sup>-1</sup> d<sup>-1</sup> straw, 10.4 (s.d. 0.99) kg cow<sup>-1</sup> d<sup>-1</sup> concentrate and 1.5 (s.d. 0.133) kg cow<sup>-1</sup> d<sup>-1</sup> molasses. Pre- and post-grazing sward heights were measured daily. Milk yield was recorded daily and milk composition and bodyweight were measured weekly. Dry matter intake was estimated using the n-alkane technique. All animal parameters were analysed using repeated measures analysis of variance with covariate in SAS. The variables included in the model were parity, treatment, days in milk and the appropriate pre-experimental variables were also included. Week was used as a repeated measure in the model.

Table 1. Milk production performance of autumn calving cows assigned to one of four early lactation experimental treatments and the production performance during the carryover period

<i>Experimental Period</i>	G1	G4	G8	TMR	SE	Sig
Milk Yield (kg d <sup>-1</sup> )	20.7 <sup>b</sup>	23.4 <sup>c</sup>	25.0 <sup>d</sup>	26.9 <sup>a</sup>	0.48	0.001
Milk Fat Content (g kg <sup>-1</sup> )	39.9 <sup>b</sup>	37.5 <sup>a</sup>	36.0 <sup>a</sup>	37.1 <sup>a</sup>	0.019	0.001
Milk Protein Content (g kg <sup>-1</sup> )	32.1 <sup>a</sup>	32.3 <sup>a</sup>	33.2 <sup>b</sup>	32.4 <sup>a</sup>	0.025	0.01
Milk Solids Yield (kg d <sup>-1</sup> )	1.50 <sup>a</sup>	1.63 <sup>b</sup>	1.72 <sup>c</sup>	1.87 <sup>c</sup>	0.037	0.001
End Bodyweight (kg)	498 <sup>b</sup>	505 <sup>ab</sup>	524 <sup>a</sup>	525 <sup>a</sup>	3.6	0.01
End Body Condition Score	2.52	2.66	2.56	2.68	0.049	0.529
<i>Carryover Period</i>						
Milk Yield (kg d <sup>-1</sup> )	23.8	23.9	23.4	24.6	0.34	0.06
Milk Fat Content (g kg <sup>-1</sup> )	38.3	37.2	37.1	38.1	0.05	0.117
Milk Protein Content (g kg <sup>-1</sup> )	32.5 <sup>a</sup>	31.5 <sup>b</sup>	33.1 <sup>a</sup>	32.7 <sup>a</sup>	0.02	0.001
Milk Solids Yield (kg d <sup>-1</sup> )	1.68 <sup>b</sup>	1.64 <sup>c</sup>	1.64 <sup>c</sup>	1.74 <sup>a</sup>	0.026	0.022
End Bodyweight (kg)	552	540	569	542	5.5	0.222
End Body Condition Score	2.57	2.62	2.70	2.75	0.045	0.488

<sup>abc</sup> values in the same row not sharing a common superscript are significantly different

## Results and discussion

Animals assigned to the G1, G4 and G8 treatments were offered similar swards as there was no significant difference in pre-grazing height (12.5 cm) or pre-grazing DM yield (1708 kg ha<sup>-1</sup>). This suggests that differences between treatments are due to the imposed experimental treatments. A common post-grazing height of 6 cm was realised by all treatments; consequently there were differences ( $P < 0.001$ ) in the daily herbage allowance (DHA) of the G1, G4 and G8 treatments (19, 14 and 12 kg cow<sup>-1</sup> d<sup>-1</sup>, respectively). Sward utilisation was similar for all treatments (0.77). The grass dry matter intake (GDMI;  $P < 0.01$ ) of the G1, G4 and G8 treatments was 13.7, 14.2 and 12.1 kg cow<sup>-1</sup> day<sup>-1</sup>, respectively. As all concentrate was utilised, this resulted in a total dry matter intake (TDMI) of 14.7, 18.2 and 20.1 kg cow<sup>-1</sup> d<sup>-1</sup>. There was no difference in GDMI between G1 and G4 treatments, but they ate significantly ( $P < 0.05$ ) more herbage than the G8 treatment. When dry matter intake was measured by weighing back refusals it was determined that the TMR cows were consuming 21 (s.d. 1.4) kg cow<sup>-1</sup> d<sup>-1</sup>.



The milk production results from the 6-week period when experimental treatments were applied are shown in Table 1. All treatments differed ( $P < 0.001$ ) from each other in terms of milk yield – the TMR treatment had the highest milk yield ( $26.9 \text{ kg cow}^{-1} \text{ d}^{-1}$ ) while the G1 cows had the lowest milk yield and milk solids yield ( $20.7$  and  $1.50 \text{ kg cow}^{-1} \text{ d}^{-1}$ , respectively). However, milk solids yield was similar for the G8 and TMR treatments ( $1.80 \text{ kg cow}^{-1} \text{ d}^{-1}$ ) due to the higher ( $P < 0.01$ ) protein content of the G8 milk. This is probably due to the high quality herbage that was offered on the grass treatments. These results indicate that autumn grazing management which incorporates low pre-grazing herbage masses of high quality grass results in good animal performance. Typically, in Ireland pre-grazing herbage DM masses offered during the autumn period are greater than  $2000 \text{ kg ha}^{-1}$  resulting in poorer quality grass. Thus autumn grazing management needs to be improved on-farm. Increasing the concentrate allowance of grazing cows from 1 to 4 kg DM concentrate resulted in a response of  $0.90 \text{ kg milk per kg concentrate}$ . When supplementation level was increased from 4 to 8 kg DM concentrate the response was  $0.4 \text{ kg milk per kg concentrate}$ .

There was no significant difference between the four treatments in the carryover period in terms of milk yield ( $23.9 \text{ kg cow}^{-1} \text{ d}^{-1}$ ). However, milk solids yield was highest ( $P < 0.05$ ) for the TMR treatment. The G1 treatment had higher milk solids yield ( $1.68 \text{ kg cow}^{-1} \text{ d}^{-1}$ ) than the G4 and G8 treatments ( $1.64 \text{ kg cow}^{-1} \text{ d}^{-1}$ ) during the carryover period. Even though the bodyweight of the G1 treatment was lower by the end of the experimental period this difference disappeared after the cows were offered a TMR diet during the carryover period. There was no difference in body condition score during the experimental or carryover periods.

## Conclusion

Offering autumn-calving dairy cows a TMR diet in early lactation increases milk yield compared with cows offered grazed grass and different levels of concentrate. However, similar milk solids yield can be achieved by offering grazed grass and 8 kg concentrate or TMR. This study also established that restricting cows (G1) during the first 6 weeks of lactation does not impact on their subsequent milk production performance.

## References

- Dillon P., Roche J.R., Shalloo L. and Horan B. (2005) Optimising financial return from grazing in temperate pastures. In: Murphy J. (ed) *Utilisation of Grazed Grass in Temperate Animal Systems (XX International Grassland Congress)*, pp. 131-147. Wageningen: Wageningen Academic Publishers.
- Kolver E.S. and Muller L.D. (1998) Performance and nutrient intake of high producing Holstein cows consuming pasture or a total mixed ration. *Journal of Dairy Science* 81, 1403–1411.

## **Influence of tree and shrub presence on plant nutrient content of pasture in dehesa system**

López-Díaz M.L., Moreno Marcos G. and Rolo Romero V.

Forestry School, University of Extremadura, Plasencia 10600. Spain. [lurdesld@unex.es](mailto:lurdesld@unex.es)

Corresponding author: [lurdesld@gmail.com](mailto:lurdesld@gmail.com)

### **Abstract**

Iberian dehesa is usually defined as a two-layered silvopastoral system, where native grasses cohabit with a scattered, widely spaced tree layer. The failure of natural regeneration of the trees is one of the most outstanding threats. Several works have pointed out the positive role that shrubby vegetation can play in tree regeneration. However, shrubs could also act competitively with herbaceous pasture, and then affect negatively its productivity and quality. We aim to analyse the influence of dehesa encroachment on herbaceous pasture quality (N, P, K and Ca concentration) comparing adjacent wooded plots with and without a shrubby layer. Pasture quality was increased underneath trees. The response of pasture to the shrub presence depended on both the herbaceous and the shrub species.

Key words: grass, legume, nutrient content, *Ornithopus compressus*

### **Introduction**

At present, dehesa covers more than 3 million ha in the south-western quadrant of the Iberian Peninsula. Dehesa has been frequently described as one of the best examples of extensive and sustainable land use in Europe. However, in the last decades, they have experienced several management changes and many authors have questioned the sustainability of this agro-silvopastoral system, at least under the current management practices. Soil compaction, the failure of the tree natural regeneration, dieback in old-ageing oak stands, and loss of biodiversity are some of the most outstanding threats. Recently, several authors have shown different positive effects of encroachment on tree natural regeneration (Plieninger *et al.*, 2003). This facilitation effect of shrubs is explained in terms of water stress attenuation and/or protection of trees from herbivores. The complex of plant-to-plant interactions and the high variety of shrub species, covers and morphology present in encroached dehesa plots makes it very difficult to generalise conclusions and recommendations about the role of shrubs for dehesa oaks. Several authors have shown the positive effects of trees on pasture quality growing under the tree crowns. It is related to the influence of trees on phenology and botanical composition. But there is no evidence about the effect of the shrubs on nutrient content in forage. The objective of this project is to study the effects of trees and shrubs in the dehesa on nutrient content in several herbage species at a fixed phenological state.

### **Materials and methods**

The experiment was conducted in six dehesas of Cáceres, with a density of 15-35 trees per ha (*Quercus ilex*), in the mid-west of Spain. Annual accumulated precipitation and mean temperature are 645 mm and 16 °C, respectively. Two species of shrubs were present: *Retama sphaerocarpa* L. (three dehesas) and *Cistus ladanifer* L. (three dehesas). In each dehesa with *C. ladanifer*, 12 trees were selected, with (six trees) and without (six trees) shrubby understorey. Under each tree, pasture samples were collected beneath and beyond (10 m out of the tree crowns) the tree canopy. In the dehesas with *R. sphaerocarpa*, the design of the experiment was changed because there was no shrub presence under the trees. In this case, eight trees were selected and pasture samples were taken in three different positions: underneath crown, beyond the trees in areas without shrub, and beyond the trees in areas with

a shrubby layer. We tried to select three species which belong to different botanical families (Fabaceae, Poaceae and Compositae) and these were present in all studied positions. The selected species were: *Ornithopus Compressus* L. (legume) and *Avena sativa* L. (grass). With respect to the Compositae, it was not possible to find a single species present in both kinds of dehesas; therefore, *Senecio vulgaris* L. was the species collected in dehesas with *Cistus ladanifer*, and *Taraxacum officinale* Weber et Wiggers was the species sampled in the plots with *Retama sphaerocarpa*. In spring 2009, all of them were harvested when they were in a flowering state (excluding variations caused by being in a different phenological state). Herbage samples were dried in an oven at 80 °C for 48 h. Nutrients were determined after wet digestion (H<sub>2</sub>SO<sub>4</sub> 96% and H<sub>2</sub>O<sub>2</sub> 30%) at 350 °C, by Kjeldahl (for N), by the vanadomolibdate phosphorus complex method (for P) and spectrophotometry (flame photometer, for K and Ca). Data were analysed by factorial ANOVA with LSD tests for pair wise comparison of means. All analyses were performed with the Statistica 6.0 package.

Table 1. N, P, K and Ca content (g kg<sup>-1</sup>) in pasture collected in different positions respect to tree, *C. ladanifer* and *R. sphaerocarpa* presence.

	Tree			<i>Cistus ladanifer</i>			<i>Retama sphaerocarpa</i>		
	Tree	Control	Sig.	Shrub	Control	Sig.	Shrub	Control	Sig.
Mean N	18.17	17.48	*	15.84	17.53	*	18.56	17.61	*
Mean P	1.62	1.73	*	1.60	1.89	*	1.50	1.51	ns
Mean K	20.13	16.62	***	17.19	19.00	ns	16.10	16.02	ns
Mean Ca	6.01	5.21	**	5.49	6.22	ns	4.65	4.43	ns
O.c. N	25.74	24.88	ns	22.48	25.59	***	25.91	24.27	*
O.c. P	1.35	1.54	**	1.40	1.52	ns	1.51	1.40	ns
O.c. K	18.22	15.44	*	17.42	17.01	ns	16.07	15.00	ns
O.c. Ca	6.95	5.42	*	6.76	6.60	ns	7.04	4.66	***

Mean: mean concentration of different nutrients in the studied species (*A. sativa*, *O. compressus*, *S. vulgaris* and *T. vulgare*). O.c.: mean concentration in *O. compressus*. ns: not-significant, \*:  $P < 0.05$ , \*\*:  $P < 0.01$ , \*\*\*:  $P < 0.001$ .

## Results and discussion

Mineral (N, P, K and Ca) concentrations in pasture can be observed in Table 1. In most cases, the values were similar to those observed by Gea-Izquierdo *et al.* (2010) in dehesa systems. Table 1 shows the mean values of the nutrients averaged for the four studied herbaceous species and considering only *O. compressus*. The data of the other three studied species (*A. sativa*, *S. vulgaris* and *T. vulgare*) were not presented because, in general, there were not significant differences with respect to tree position or with respect to the shrubs presence. In dehesa systems, Gea-Izquierdo *et al.* (2010) have shown the increment of nutrient extraction by herbage as affected by tree presence due to the increment of nutrient availability in soil, and pasture production and the influence on botanical composition. In our experiment, N, K and Ca concentrations were increased significantly beneath tree canopy, in spite of removing the variations produced by the phenological state, pasture production and botanic composition. However, the highest P values were observed beyond the tree canopy. With respect to the different pasture species, *O. compressus* increased significantly its K and Ca concentration and reduced its P values underneath the crown. The effect of *R. sphaerocarpa* presence was similar to tree canopy. The mean N values of the different species and N and Ca content of *O. compressus* were increased with the presence of this shrub, as was also detected in the study of Moro *et al.* (1997). This could be explained by the improvement of physical and chemical soil conditions which this shrub produces, especially by nutrient pumping from the subsoil associated with its deep rooting system and by its capacity for fixing atmospheric nitrogen (Campillo *et al.*, 2003). *O. compressus* was the most improved species, in spite of the fact that the legume presence was very low with respect to the grass species (López-Díaz *et al.*, 2009). The low proportion of legume in pasture could be explained because grass species were favoured by N increment in soil caused by *R. sphaerocarpa* (Campillo *et al.*, 2003),

which displaces the rest of the herbage species. Moreover, in dehesa, legumes are usually annual species which are affected by grasses that are well installed when legumes are established. N and P values in herbaceous plants were significantly reduced in areas with *C. ladanifer*, when the three plant species were analysed together (mean values). For *O. compressus*, only N decreased significantly. Accordingly, pasture production was also reduced with the presence of *C. ladanifer* (Rolo *et al.*, 2009). Chaves-Lobón *et al.* (2002) have shown there are allelopathic effects of *C. ladanifer* on the surrounding vegetation which affects the nutrition of herbage species growing beneath this shrub. Moreover, the shallow root system of natural pasture in dehesa system (Moreno *et al.*, 2005) can produce a strong overlap in the first horizons with the root system of *C. ladanifer* (Silva *et al.*, 2002) and, then, a strong competition for water and nutrients between them.

## Conclusions

Pasture quality was increased underneath trees. The response of pasture to the shrub presence depended on both the herbaceous and the shrub species. *Ornithopus compressus* was the species that was most affected by the different microhabitats studied, and it seems a good indicator species of the effects of dehesa management and/or vegetation structure.

## Acknowledgements

We are grateful to Junta de Extremadura (III PRI+D+I, PRI07C044) for financial assistance.

## References

- Campillo R., Urquija S., Pino, I. and Montenegro A. (2003) Estimación de la fijación biológica de nitrógeno en leguminosas forrajera mediante la metodología del N<sup>15</sup>. *Agricultura Técnica* 63, 169-179.
- Chaves Lobón N., Alias Gallego J.C., Sosa Díaz T. and Escudero García J.C. (2002) Allelopathic potential of *Cistus ladanifer* chemicals in response to variations of light and temperature. *Chemoecology* 12, 139-145.
- Gea-Izquierdo G., Allen-Díaz B., San Miguel A. and Cañellas I. (2010) How do trees affect spatio-temporal heterogeneity of nutrient cycling in mediterranean annual grasslands? *Annals of Forest Science* 67, 112-122.
- López-Díaz M.L., Rolo V. and Moreno G. (2009) Variación espacial del pasto en la dehesa: interrelación árbol-pasto-matorral. *V Congreso Forestal Español*, Sociedad Española de Ciencias Forestales, Madrid (Spain).
- Moreno G., Obrador J.J., Cubera E. and Dupraz C. (2005) Fine root distribution in dehesas of Central-Western Spain. *Plant and Soil* 277, 153-162.
- Moro M.J., Pugnaire F.I., Haase P. and Puigdefabregas J. (1997) Effect of the canopy of *Retama sphaerocarpa* on its understorey in a semiarid environment. *Functional Ecology* 11, 425-431.
- Plieninger T., Pulido F.J. and Konold W. (2003) Effects of land use history on size structure of holm oak stands in Spanish dehesas: implications for conservation and restoration. *Environmental Conservation* 30, 61-70.
- Rolo V., López-Díaz M.L. and Moreno G. (2009) Influencia del matorral en la producción de biomasa forrajera de la dehesa. *V Congreso Forestal Español*, Sociedad Española de Ciencias Forestales, Madrid.
- Silva S.S., Rego F.C. and Martins-Loução M.A. (2002) Belowground traits of Mediterranean woody plants in a Portuguese shrubland. *Ecologia Mediterranea* 28, 5-13.

## Enrichment of $^{13}\text{C}$ in *Medicago sativa* and *Lolium multiflorum* n-alkanes

Bulang M.<sup>1</sup>, Boguhn J.<sup>2</sup> and Rodehutschord M.<sup>2</sup>

<sup>1</sup>Martin-Luther-Universität Halle-Wittenberg, Nutztierwissenschaftliches Zentrum Merbitz, Im Institut 22, 06193 Nauendorf, Germany

<sup>2</sup>Universität Hohenheim, Institut für Tierernährung, Emil-Wolff-Str. 8-10, 70599 Stuttgart, Germany

Corresponding author: michael.bulang@landw.uni-halle.de

### Abstract

n-alkanes are often used to study digestibility and feed intake. Our main objective was to test whether the  $^{13}\text{C}$  enrichment of n-alkanes can be modified in order to use them as inert plant markers for fractional passage-rate studies in ruminants. Lucerne and Italian ryegrass were grown under a  $\text{CO}_2$  atmosphere that was enriched with  $^{13}\text{C}$  for seven days. Carbon isotope ratios in different plant fractions and the enrichment of  $^{13}\text{C}$  in n-alkanes extracted from leaves and stems was measured with an isotope ratio mass spectrometer. Native  $\delta^{13}\text{C}$  abundances ( $[^{\circ}\text{‰}]_{\text{PDB}}$ ) of lucerne and Italian ryegrass prior to labelling was in a typical range between -21 and -31 ‰. One day after labelling was stopped, plant samples showed  $^{13}\text{C}$ -APE values in the range of 1.6 to 2.3 for leaves and from 2.8 to 3.8 for stems. In the subsequent 30 days,  $^{13}\text{C}$ -APE decreased. n-alkanes showed different  $\delta^{13}\text{C}$ -values in leaves and stems at 1 and 30 days after labelling was stopped. It can be concluded that a  $^{13}\text{C}$  enrichment of plant n-alkanes is possible and that they may be suitable markers in fractional passage-rate studies.

Keywords: fractional passage rate, alkanes,  $^{13}\text{C}$ -enrichment, marker, lucerne, ryegrass

### Introduction

Markers that are used for estimating the fractional passage rate in ruminants are not ideal (Owens and Hanson, 1992). Known labelling procedures can change the degradability characteristics of the marker carrier (Bulang *et al.*, 2008), the density and the specific weight of particles, and they can cause marker migration. In consequence, estimated fractional passage rates can only be interpreted with regard to passage of the marker or the labelled feed particles. Markers that are enriched in the natural plant matrix could be of advantage for studying fractional passage rate. Natural and synthetic (dosed) n-alkanes have been used to calculate digestibility and feed intake. n-alkanes are located in the cuticular wax layer of plants. Their pattern varies between plant species and different parts of the same plant (leaf vs. stem) (Dove *et al.*, 1996). The natural stable isotopes ( $^{13}\text{C}/^2\text{H}$ ) proportion of n-alkanes has been used for estimating fractional passage rates based on marker excretion curves. However, this approach requires an abrupt change of diet, especially between  $\text{C}_3$  and  $\text{C}_4$  plants, and in turn does not allow for any adaptation of the animal to the diet (Svejcar *et al.*, 1993).  $^{13}\text{C}$  enrichment of plant material maybe an alternative if enrichment level of the marker material of nearly 0.67  $^{13}\text{C}$  - APE is achieved (Pellikaan 2004). This level also seems to be high enough for using plant n-alkanes, but concentrations of alkanes should be higher than 10 mg per kg of dry matter.

Therefore, our main objective was to test whether the  $^{13}\text{C}$  enrichment of NDF, ADF and n-alkanes in two fodder plants can be modified in order to use them as inert markers for fractional passage rate studies in ruminants.

## Materials and methods

Lucerne (*Medicago sativa*) and Italian ryegrass (*Lolium multiflorum*) were grown under a CO<sub>2</sub> atmosphere that was enriched with <sup>13</sup>C for a total period of one week (2 hours/day). The labelling procedure was based on Svejcar *et al.* (1990) with modifications according to Pellikaan (2004). Samples of stems and leaves were taken before labelling was started and also at 1 and 30 days after labelling was terminated. Dry matter, NDF and ADF were analysed according to VDLUFA official methods (Naumann and Bassler, 1976). Carbon isotope ratios of leaves and stems, as well as their NDF and ADF fractions, were measured with an isotope ratio mass spectrometer (IRMS) coupled with an elemental analyser. After plant n-alkane extraction according to Elwert *et al.* (2004), the alkanes were separated by GC and their carbon ratios were measured directly by the connected IRMS.

## Results and discussion

Native δ<sup>13</sup>C abundances ([‰]<sub>PDB</sub>) of lucerne and Italian ryegrass were in a typical range of plants between -21 and -31 ‰. One day after labelling was stopped, lucerne and ryegrass showed high <sup>13</sup>C-APE values in leaves of 2.17 and 1.85, respectively (Table 1). Stems showed higher <sup>13</sup>C-APE values of 2.79 and 3.78 for lucerne and ryegrass, respectively. In NDF and ADF similar <sup>13</sup>C-APE values were detected. As expected, all <sup>13</sup>C-APE values were smaller 30 days after the labelling was stopped. This might be caused mainly by marker dilution due to plant biomass production. In Italian ryegrass, from one day to thirty days after labelling was stopped, the enrichment ratio between leaf and stem changed in the opposite direction. This indicates that relative biomass growth was greater in stems than in leaves.

Table 1. Enrichment (<sup>13</sup>C - APE) in two plant species, their parts and fibre fractions (mean and SD, n=3)

Period	Species	Sample /part	Fraction		
			Plant part	NDF	ADF
one day after enrichment	<i>Medicago sativa</i>	leaf	2.17 (0.02)	2.25 (0.01)	2.14 (0.07)
		stem	2.79 (0.30)	3.34 (0.13)	3.20 (0.05)
	<i>Lolium multiflorum</i>	leaf	1.85 (0.18)	1.59 (0.14)	1.40 (0.04)
		stem	3.78 (0.12)	3.62 (0.16)	3.66 (0.04)
30 days after enrichment	<i>Medicago sativa</i>	leaf	1.13 (0.01)	1.26 (0.08)	1.38 (0.04)
		stem	1.40 (0.08)	1.75 (0.07)	1.75 (0.03)
	<i>Lolium multiflorum</i>	leaf	0.70 (0.06)	0.87 (0.03)	0.80 (0.04)
		stem	0.46 (0.05)	0.60 (0.02)	0.69 (0.05)

In Table 2, alkane chain length specific δ<sup>13</sup>C<sub>PDB</sub> values are shown. δ<sup>13</sup>C<sub>PDB</sub> in alkanes of both species before labelling was started was similar to values found in terrestrial vegetation samples (C<sub>3</sub> plants) by Bird *et al.* (1995). One day after labelling was stopped, δ<sup>13</sup>C<sub>PDB</sub> values of alkanes differed between 400 (C<sub>27</sub>, ryegrass leaf) to 2251 ‰ (C<sub>31</sub>, ryegrass stem). Surprisingly, δ<sup>13</sup>C<sub>PDB</sub> values developed differently in individual alkanes from one to 30 days after the labeling was stopped. We have no explanation for this, but it indicates a redistribution of the marker between different fractions of the plant during growth.

## Conclusion

<sup>13</sup>C -APE values in plant species samples as well as δ<sup>13</sup>C<sub>PDB</sub> values in n-alkanes can be manipulated and increased up to a level that appears high enough for using them to study fractional passage rate of roughages in ruminants. Additionally, the differences in enrichment between individual alkanes indicate that they can be used as a multiple marker system. This hypothesis needs testing in further studies.

Table 2.  $\delta^{13}\text{C}_{\text{PDB}}$  (‰) for n-alkanes from leaves and stems of two plant species (arithmetic mean, n = 2)

Period	Species	Sample/part	Alkane chain length			
			C <sub>27</sub>	C <sub>29</sub>	C <sub>31</sub>	C <sub>33</sub>
Before start of enrichment	<i>Medicago</i>	leaf	-40	-33	-33	-22
	<i>sativa</i>	stem	-39	-41	-41	-39
	<i>Lolium</i>	leaf	-27	-28	-19	-30
	<i>multiflorum</i>	stem	-40	-40	-40	-40
One day after enrichment	<i>Medicago</i>	leaf	2130	933	1397	1409
	<i>sativa</i>	stem	436	1207	1635	808
	<i>Lolium</i>	leaf	400	945	1106	816
	<i>multiflorum</i>	stem	878	2121	2251	1686
30 days after enrichment	<i>Medicago</i>	leaf	2181	1081	861	- <sup>1)</sup>
	<i>sativa</i>	stem	568	987	1135	663
	<i>Lolium</i>	leaf	465	662	539	587
	<i>multiflorum</i>	stem	1233	601	560	522

<sup>1)</sup> not detected

## References

- Bird M.I., Summons R.E., Gagan M.K., Roksandic Z., Dowling L., Head J., Keith Fifield L., Cresswell R.G. and Johnson D.P. (1995) Terrestrial vegetation change inferred from n-alkane [ $\sigma$ ]<sup>13</sup>C analysis in the marine environment. *Geochimica et Cosmochimica Acta* 59, 2853.
- Bulang M., Elwert C., Spilke J. and Rodehutschord M. (2008) Suitability of synthetic alkanes as markers for the estimation of passage rate in sheep. *Livestock Science* 115, 42-52.
- Dove H., Mayes R.W. and Freer M. (1996) Effects of species, plant part, and plant age on the n-alkane concentrations in the cuticular wax of pasture plants. *Australian Journal of Agricultural Research* 47, 1333-1347.
- Elwert C., Kluth H. and Rodehutschord M. (2004) Effect of variable intake of alfalfa and wheat on faecal alkane recoveries and estimates of roughage intake in sheep. *Journal of Agricultural Science Cambridge* 142, 212-223.
- Naumann C. and Bassler R. (1976) *VDLUFA-Methodenbuch, Vol. III. Die chemische Untersuchung von Futtermitteln*. VDLUFA-Verlag, Darmstadt, Germany.
- Pellikaan W.F. (2004) *Passage of <sup>13</sup>C-labelled feed components through the digestive tract of dairy cows*. PhD-Thesis, Wageningen Institute of Animal Sciences, Wageningen University, Wageningen.
- Svejcar T.J., Boutton T.W. and Trent J.D. (1990) Assessment of carbon allocation with stable carbon isotope labeling. *Agronomy Journal* 82, 18-21.
- Svejcar T.J., Judkins M.B. and Boutton T.W. (1993) Technical note: labeling of forages with <sup>13</sup>C for nutrition and metabolism studies. *Journal of Animal Science* 71, 1320-1325.



# The condensed tannins in sainfoin cause digestive synergy on *in vitro* rumen fermentation of cocksfoot

Niderkorn V., Le Morvan A. and Baumont R.  
INRA, UR1213 Herbivores, 63122 Saint-Genès Champanelle, France  
Corresponding author: vniderk@clermont.inra.fr

## Abstract

This study investigated the role of condensed tannins (CT) in sainfoin (*Onobrychis viciifolia*) on the rumen fermentation of mixtures of cocksfoot (*Dactylis glomerata* L.) and sainfoin. Freeze-dried samples of cocksfoot and sainfoin in different proportions (100:0, 75:25, 50:50, 25:75 and 0:100) were fermented in culture bottles containing buffered rumen fluid from sheep in presence or in absence of polyethylene glycol (PEG), a compound that inactivates CT. *In vitro* true dry matter digestibility (IVTDMD), total gas production (GP) and ammonia concentration in the incubation medium were determined at 3.5 and 24 h of incubation. In the absence of PEG, ammonia production decreased dramatically at 3.5 and 24 h of incubation ( $P < 0.001$ ) as the proportion of sainfoin increased in the mixture, with a quadratic effect at 3.5 h ( $P < 0.01$ ). At 24 h of incubation, GP was lower and IVTDMD was slightly greater for mixtures incubated in absence of PEG than in presence of PEG ( $P < 0.001$  and  $P < 0.01$ , respectively). It was concluded that the CT in sainfoin are responsible for the synergy between cocksfoot and sainfoin, making it possible to maximize the degradation of plant substrates while minimizing protein degradation and gas losses.

Keywords: cocksfoot, sainfoin, grass-legume mixtures, condensed tannins, *in vitro* rumen fermentation, digestive interactions

## Introduction

Animals fed with forage from multi-species or permanent grasslands may be eating plants containing secondary metabolites that are potentially bioactive on rumen digestive processes. In some cases, these secondary metabolites are responsible for digestive interactions, and the digestive profile of a combination of forages can differ from the balanced average values of its components (Niderkorn and Baumont, 2009). These synergistic effects could be useful for reconciling animal productivity and environmental requirements, such as the role of condensed tannins (CT) on N losses and methane emissions. In a previous *in vitro* study, we showed that mixing cocksfoot (*Dactylis glomerata* L.) and sainfoin (*Onobrychis viciifolia*) results in a synergy on rumen fermentation parameters (Niderkorn *et al.*, 2008). This study was carried out to describe more accurately the effects of mixing cocksfoot and sainfoin and to clarify the role of CT contained in sainfoin in digestive interactions.

## Materials and methods

Cocksfoot and sainfoin were grown at the INRA's Clermont-Ferrand-Theix Centre (France) and harvested at a vegetative stage (NDF in DM: 542 and 346 g kg<sup>-1</sup>, CP in DM: 144 and 157 g kg<sup>-1</sup>, respectively; protein binding activity of sainfoin CT: 15.2 g eq-tannic acid per kg of DM). Ground freeze-dried samples (0.6 g) of cocksfoot and sainfoin in different proportions (100:0, 75:25, 50:50, 25:75 and 0:100) were incubated according to Theodorou *et al.* (1994) in anaerobic conditions at 39 °C during 24 h in culture bottles containing 40 ml of buffered rumen juice from sheep. Incubations were done using artificial saliva with and without polyethylene glycol (PEG) 4000 (2.3 g l<sup>-1</sup>), a compound that can bind and inactivate CT. Gas

production (GP), *in vitro* true dry matter digestibility (IVTDMD), and concentration of ammonia in the fermentation medium were measured at 3.5 and 24 h. Values were adjusted by subtracting the values from blanks without substrate at each collection point. Data were submitted to analysis of variance using the MIXED procedure of the SAS suite (SAS Institute, Inc., Cary, NC) considering the proportion of sainfoin and PEG as fixed effects and the repetition as random effect. Orthogonal contrasts were used to evaluate IVTDMD, GP and ammonia for linear, quadratic, cubic and quartic effects of the proportion of sainfoin in the mixture either with or without added PEG using PROC MIXED. PROC IML was used to adjust the contrast coefficients.

Table 1. Effects of proportion of sainfoin and addition of polyethylene glycol (PEG) to the incubation medium on *in vitro* rumen fermentation characteristics of mixtures of cocksfoot and sainfoin at T = 3.5 and T = 24 h of incubation.

Item <sup>a</sup>	Orthogonal contrasts <sup>b</sup>		% sainfoin	PEG	PEG×% sainfoin
	PEG <sup>a</sup>	no PEG			
<i>T</i> = 3.5 h					
IVTDMD (%)	L***, Q*	L***	***	ns	ns
GP (mmol)	L***, C*	L***, Q*	***	***	***
Ammonia (mmol)	ns	L***, Q**	***	***	***
<i>T</i> = 24 h					
IVTDMD (%)	ns	Q*	ns	**	ns
GP (mmol)	L***	ns	***	***	**
Ammonia (mmol)	ns	L***	ns	***	***

<sup>a</sup> IVTDMD: *in vitro* true dry matter digestibility; GP: gas production; PEG: polyethylene glycol

<sup>b</sup> L: linear effect; Q: quadratic effect; C: cubic effect

Significant effects are quoted as \*  $P < 0.05$ , \*\*  $P < 0.01$ , \*\*\*  $P < 0.001$ ; ns: not significant

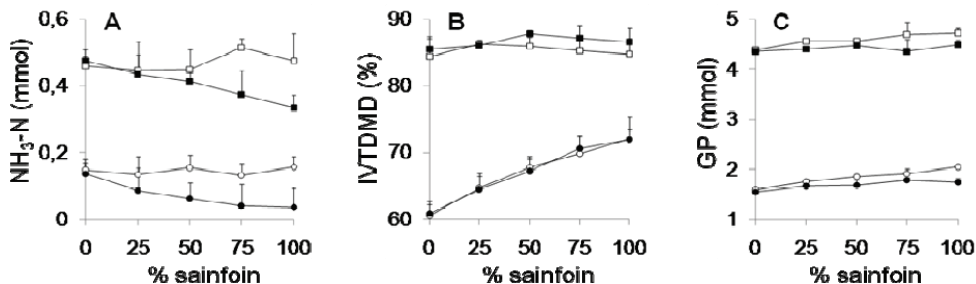

Figure 1. Net ammonia production (NH<sub>3</sub>-N, mmol) (A), *in vitro* true dry matter digestibility (IVTDMD, %) (B), and total gas production (GP, mmol) (C), measured at 3.5 h (○,●) and 24 h (□,■) of incubation with (○,□) and without polyethylene glycol (PEG) (●,■).

## Results and discussion

At 3.5 h of incubation, increasing the proportion of sainfoin in the mixture significantly impacted on all the fermentation parameters ( $P < 0.001$ ) (Table 1). When the sainfoin level increased from 0 to 100%, the IVTDMD increased considerably from 60.7% to 72.0%, with or without PEG, likely due to the lower NDF content of the mixture. At the same time, ammonia production decreased dramatically without PEG, from 0.137 to 0.037 mmoles per batch (Fig. 1). Interestingly, GP was lower in mixtures incubated in absence of PEG than in presence of PEG (up to -14.5%,  $P < 0.001$ ) while no significant PEG effect was observed on IVTDMD. These results suggest that CT could allow a better utilization of plant substrates by

the rumen ecosystem. Quadratic effects were detected on several parameters, indicating the presence of interactions between plant components during the early phase of fermentation. Indeed, a significant non-linear effect highlighted a difference between the values measured for the cocksfoot plus sainfoin mixtures and the balanced median values of the two plants incubated individually. In particular, mixing cocksfoot and sainfoin quadratically decreased ammonia production in absence of PEG ( $P < 0.01$ ). As this quadratic effect was not significant in the presence of PEG, it seems that sainfoin CT decreased the degradation of the proteins in the whole mixture, including the proteins in cocksfoot, rather than just the proteins in sainfoin.

At 24 h of incubation, there was no significant effect of sainfoin level on IVTDMD, indicating that while the rate of sainfoin digestion was faster during the early phase of fermentation compared to cocksfoot, it was reversed thereafter. On the other hand, a quadratic effect on IVTDMD was detected without PEG ( $P < 0.05$ ), indicating a synergistic action of cocksfoot plus sainfoin on plant substrate degradation. The highest IVTDMD value was recorded when the proportion of sainfoin in the mixture was 50%, which appears to be optimal. Increasing the sainfoin level in absence of PEG still decreased ammonia production (from 0.475 to 0.335 mmoles per batch, linear effect,  $P < 0.001$ ), whereas in the presence of PEG this effect of sainfoin proportion was no longer significant, showing that at least a part of the CT was active on the degradation of the proteins in the mixture throughout the fermentation process. Similarly to the results observed at 3.5 h of incubation, GP was lower for mixtures incubated in absence of PEG than in presence of PEG (up to -7.2%,  $P < 0.001$ ). In addition, IVTDMD was slightly greater without PEG than with PEG (up to 2.3%,  $P < 0.01$ ). It was demonstrated that substrates that induce a low GP per unit of substrate truly degraded induced a comparatively high microbial biomass production (Blümmel *et al.*, 1997). Consequently, our results suggest that CT could allow a better utilization of plant substrates by the rumen ecosystem, likely due to increased microbial protein synthesis.

## Conclusion

Based on the results of this experiment, it can be concluded that the CT in sainfoin are responsible for a synergy between cocksfoot and sainfoin, making it possible to maximize the degradation of plant energy substrates while minimizing protein degradation and energy losses as gases. This synergy is relevant in terms of productivity and environmental requirements, and needs to be validated *in vivo*.

## References

- Blümmel M., Steingass H. and Becker K. (1997) The relationship between *in vitro* gas production, *in vitro* microbial biomass yield and  $^{15}\text{N}$  incorporation and its implications for the prediction of voluntary feed intake of roughages. *British Journal of Nutrition* 77, 911-921.
- Niderkorn V., Le Morvan A., Bergeault R., Papon Y., Baumont R. and Macheboeuf D. (2008) Effect of two grass-legume associations on rumen fermentation *in vitro*. *The 6<sup>th</sup> INRA-RRI Symposium. Gut Microbiome: Functionality, Interaction with the Host and Impact on the Environment*, INRA, Clermont-Ferrand, France, p.75.
- Niderkorn V. and Baumont R. (2009) Associative effects between forages on feed intake and digestion in ruminants. *Animal* 3, 951-960.
- SAS Institute. 2003. *SAS/STAT User's Guide* (Version 9.1.3 Service Pack 4). Cary, NC.
- Theodorou M.K., Williams B.A., Dhanoa M.S., McAllan A.B. and France J. (1994) A simple gas production method using a pressure transducer to determine the fermentation kinetics of ruminant feeds. *Animal Feed Science and Technology* 48, 185-197.

## **A scheduling model for forage harvesting**

Sørensen C.G., Bochtis D.D., Green O. and Oudshoorn F.W.

*University of Aarhus, Faculty of Agricultural Sciences, Department of Biosystems*

*Engineering, Blichers Allé 20, 8830 Tjele, Denmark*

Corresponding author: Claus.Soerensen@agrsci.dk

### **Abstract**

As estimated by the Danish Advisory Centre, one-third of forage grass is harvested while too dry and another third is harvested while too wet as compared with the optimal moisture content level. This indicates that dedicated systems, supporting decisions that affect grass quality, are highly needed.

This paper presents the preliminary results on the functionalities and performance of a scheduling model for forage harvesting. The model input consists of weather forecast data, expected yield data, availability of required recourses, and machinery-related specifications. It comprises sub-models for the prediction of the grass moisture content based on weather forecast data. The system provides, as a result, one of three types of decisions or suggestions, namely: (i) harvest, (ii) harvest under uncertainty, and (iii) no harvest.

The model was tested for a five-month harvesting period. Based on the preliminary results, the suggestions presented to the farmer were proven to be successful in 80% of the examined cases.

### **Introduction**

For the production of high-quality silage, decision-making frameworks dealing with the overall feeding strategy and cost effectiveness are essential for the farmer's decision-making process (Foulds and Wilson, 2005; Bochtis and Sørensen, 2009; Sørensen and Bochtis 2010). High quality forage is achieved when, for example, the grass is cut, raked, and collected at the right time in terms of digestibility (Kuoppala *et al.*, 2008). It is estimated that one-third of forage grass on farms is harvested too dry and that another third is harvested too wet, as compared with the optimal moisture content in terms of quality (Danish Advisory Centre, 2001).

One of the most crucial information items that a farmer will need, in order to conduct an efficient machinery planning task, is the number of potential field working hours. The concept of potential fieldwork time is contained within the term workability, which is to be considered an attribute of a crop or a soil. The estimation of potential operational working time from meteorological data is essential to any decision-making process surrounding the planning of field operations. This paper presents the preliminary results on the performance of a scheduling model for forage harvesting. The model is based on the prediction of the cut grass moisture content using forecasted weather data. The model provides support to the decision regarding the harvesting time and the subsequent quality of the grass. Typically, this is a decision that is determined by a simple assessment made by the individual farmer.

### **Materials and methods**

In the current form of the model three types of decisions or suggestions are considered, namely: (i) harvest, (ii) harvest under uncertainty, and (iii) no harvest. In practice, these decisions are closely related to the expected quality, expressed by the expected moisture content, of the collected grass. The input of the system consists of weather forecast data, expected yield data, the time period in which the required recourses for the grass collection are available, the time period in which the required recourses for the grass spreading are

available, and the specifications of the corresponding machines in term of field coverage by the cut grass. The model comprises a model for the prediction of the moisture content based on weather data. The moisture content prediction is based on the moisture prediction model described by Atzema (1992) and has been validated on independent data showing statistically reliable predictions. This particular model was selected due to the fact that it uses, as input, weather elements typically measured by weather stations, namely air temperature, dew point, precipitation, wind speed, cloud cover, and global radiation.

The weather data for the simulations were extracted from a climate database developed and run by the Faculty of Agricultural Sciences at Aarhus University, Denmark. The database provides scientists, farmers and other open-air users with local meteorological data on a real-time basis. The latest development includes an operational interface of the system, which is being incorporated into the *PlanteInfo* system (Jensen *et al.*, 2001). A critical parameter for the outcome of the system is the measurement of the uncertainty (*u*) inherent in the forecast and the grass moisture content prediction models. The following experimental results are given for five different levels of uncertainty, corresponding to 1 to 5% error in the prediction of the minimum moisture content within the forecast time length.

Table 1. Percentage of the successful decisions for the five predefined uncertainty (*u*) levels

<i>u</i> (%)†	Successful decisions (%)			
	Harvest	Uncertain	No Harvest	In total
1	90.87	71.05	71.05	81.53
2	91.63	65.57	65.57	78.98
3	90.79	51.02	51.02	78.69
4	88.58	45.71	45.71	80.97
5	87.44	42.86	42.86	81.53

† the presumed uncertainty in the prediction of the moisture content

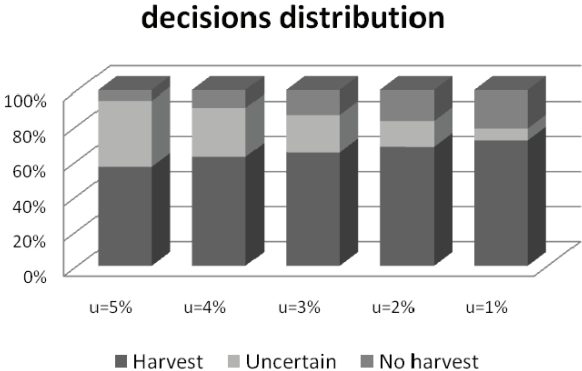

Figure 1. The distribution of the decision outcomes from the model

## Results

For the whole harvesting period (May to September, 2009) the model was run on a daily basis given suggested decisions based on the forecasted weather data of the upcoming 48 h. The distribution of the outcome decisions is given in Fig. 1.

In order to evaluate the accuracy of a suggested decision, the same period was run using the historical or the revealed weather data. The successful ratio for each decision type is given in Table 1.

## Conclusions

Based on the preliminary results, the model suggestions presented to the farmer proved to be successful in 80% of the examined cases. The future of the decision support system could be transforming the model into an adapted system to be used directly by farmers. A prerequisite for such a transformation would be a thorough validation of the model. In the latter case, a user interface would also have to be developed.

## References

- Atzema A.J. (1992) A model for the drying of grass with realtime weather data. *Journal of Agricultural Engineering Research* 53, 231–247.
- Bochtis D.D. and Sørensen C.G. (2009) The vehicle routing problem in field logistics: part I. *Biosystems Engineering* 104, 447–457.
- Bochtis D.D., Sørensen C.G. (2010) The vehicle routing problem in field logistics: part II. *Biosystems Engineering* 105, 180–188.
- Danish Advisory Centre (2001) *Treatment of cut grass*. FarmTest, Århus, Denmark.
- Foulds L.R. and Wilson J.M. (2005) Scheduling operations for the harvesting of renewable resources. *Journal of Food Engineering* 70, 281–292.
- Jensen A.L., Boll P.S., Thyssen I. and Pathak B.K. (2001) PI@nteInfo® - a web-based system for personalised decision support in crop management. *Computers and Electronics in Agriculture* 25, 271–293.
- Kuoppala K., Rinne M., Nousiainen J. and Huhtanen P. (2008) The effect of cutting time of grass silage in primary growth and regrowth and the interactions between silage quality and concentrate level on milk production of dairy cows. *Livestock Science* 116, 171–182.
- Sørensen C.G. and Bochtis D.D. (2010) Conceptual model of fleet management in agriculture. *Biosystems Engineering* 105, 41–50.

# Forage botanical and chemical composition on dairy farms with different grassland systems and production systems

Adler S.<sup>1,2</sup> and Steinshamn H.<sup>1</sup>

<sup>1</sup>Bioforsk Organic Food and Farming Division, N-6630 Tingvoll, Norway

<sup>2</sup>Department of Animal and Aquacultural Sciences, Norwegian University of Life Sciences, N-1432 Ås, Norway

Corresponding author: steffen.adler@bioforsk.no

## Abstract

Thirty-two dairy farms in Middle-Norway with different grassland systems (short-term (<4 years) grassland (S) or long-term (>7 years) grassland (L)) and different production systems (organic (O) or conventional (C)) were compared in a field study in 2007. In a principal component analysis on variables including farm details, botanical composition and chemical forage composition, the farms were separated into organic and conventional farms with the exception of one farm. Amongst the organic farms most SO farms were distinguished from LO farms. Concentration of forage crude protein was positively correlated with proportion of grass. Concentration of non-fibrous carbohydrates, in vitro digestibility and net energy lactation was positively correlated with proportion of legumes. Species diversity and cutting time at first cut was positively correlated with proportion of non-legume herbs.

Keywords: Grassland system, production system, botanical composition, dairy farming, feed composition

## Introduction

The choice of how grassland is managed on dairy farms affects the botanical composition and the herbage chemical composition. Besides choice of seed mixture, climatic conditions, soil-chemical conditions, grassland duration, harvesting time, frequency of cuts and fertilization affect the community of plant species. Wachendorf and Taube (2001) found higher proportion of white clover (*Trifolium repens* L.) and lower proportion of grass in the herbage of long-term organic grassland compared to long-term conventional grassland in Northern Germany. Herbage botanical composition can alter fatty acid composition in milk (Dewhurst *et al.*, 2003; Leiber *et al.*, 2005). In coastal or mountainous regions in Norway with high precipitation, soil tillage is often difficult and long-term grasslands are more common in contrast to regions where conditions are suitable for grain production and where short-term grassland typically is part of a crop rotation. Organic and conventional production systems are present in both regions, but with different adaptation according to specific conditions in each production system. The objective of the current field study was to examine the relationship between farming system, forage botanical composition and the herbage chemical properties.

## Material and methods

Thirty-two dairy farms in Middle-Norway participated in 2007 in a field study with the objective to study effects of grassland system (short-term (<4 years) grassland (S) or long-term (>7 years) grassland (L)) and production system (organic (O) or conventional (C)) on milk quality. Nine SO farms were paired with nine SC farms and seven LO farms were paired with seven LC farms matched by proximity and calving pattern (Table 1). Every second month feed samples in addition to tanker milk samples were collected from each farm and analysed for chemical composition. Botanical composition on three fields per farm was



analysed before first cut by using the dry-weight-rank method (Mannetje and Haydock, 1963). A principal component analysis (PCA) included the variables harvesting time at first cut (CUT), altitude (ALT), timothy (*Phleum pratense* L., b\_TIM), meadow fescue (*Festuca pratensis* L., b\_MEA), perennial ryegrass (*Lolium perenne* L., b\_RAI), common couch (*Elytrigia repens* L., b\_COU), smooth meadow-grass (*Poa pratensis* L., b\_SMO), sum of grasses (b\_GRA), red clover (*Trifolium pratense* L., b\_RED), white clover (b\_WHI), sum of legumes (b\_LEG), common dock (*Rumex longifolius* DC., b\_DOC), dandelion (*Taraxacum* F. H. Wigg., b\_DAN), creeping buttercup (*Ranunculus repens* L., b\_CBU), meadow buttercup (*Ranunculus acris* L., b\_MBU), sum non-legume herbs (b\_HER), number of species (SPE), crude protein (CP), crude fat (CF), NDF (NDF), non-fibrous carbohydrates (NFC), organic matter (OM), *in vitro* true digestibility (IVT), NDF digestibility (dNDF), and net energy lactation (NEL).

Table 1. Farm details for organic (O) or conventional (C) dairy farms with short-term (S) or long-term (L) grassland management (standard deviation in brackets)

	SO	SC	LO	LC
n	9	9	7	7
Altitude, m a.s.l.	68 (39.2)	62 (38.2)	106 (71.6)	141 (125.1)
Herd size	24 (10.7)	24 (12.6)	14 (3.4)	19 (5.3)
Forage area proportion	0.9 (0.05)	0.8 (0.23)	1.0 (0.02)	1.0 (0.00)
Grassland age, years	3 (0.9)	3 (0.8)	11 (3.6)	10 (4.1)
Date first cut, date (days)	12 June (4.9)	11 June (6.0)	22 June (10.8)	18 June (7.9)
Manure, tons ha <sup>-1</sup>	27 (8.3)	33 (14.4)	33 (16.0)	57 (30.6)
N fertiliser, kg ha <sup>-1</sup>	0	145 (83.7)	0	119 (52.6)

## Results and discussion

The PCA principal component (PC) 1 explained 23.2% of the total variation and distinguished O farms from C farms with the exception of one extensively managed C farm (Figure 1). O farms had lower proportions of grasses and higher proportions of dicotyledons than C farms in their grassland. PC 2 explained 17.0% of the total variation and divided most LO farms from SO farms. The dicotyledon proportion was dominated by legume species on SO farms and non-legume species on LO farms. All non-legume herb species were clustered in the PCA score plot and positively correlated with species diversity and cutting time at first cut (Figure 2). Red clover was positively correlated with white clover and concentration of non-fibrous carbohydrates, *in vitro* digestibility and NEL. Grass species showed more variation than legumes or non-legume herbs. Timothy was positively correlated with C farms and perennial ryegrass was positively correlated with S farms, while other species like meadow fescue and smooth meadow grass were not correlated with any of the farm types. Concentration of herbage crude protein was positively correlated with proportion of grasses indicating that both grass proportion and grass N concentration increased with N-fertilisation on C farms compared to O farms.

## Conclusions

Differences between organic and conventional herbage in botanical and chemical composition seemed to be larger than differences between grassland systems. These differences indicate that conventional farms had forage qualities different from organic farms, which may affect milk quality. The effect of legumes vs. non-legume herbs in the herbage may be studied on organic farms with different grassland systems.

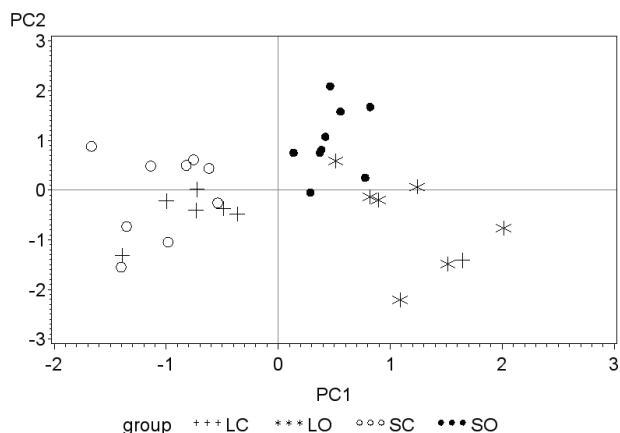

Figure 1. Component scores of principal component analysis of thirty-two farms with short-term (S) or long-term (L) grassland system and organic (O) or conventional (C) production system.

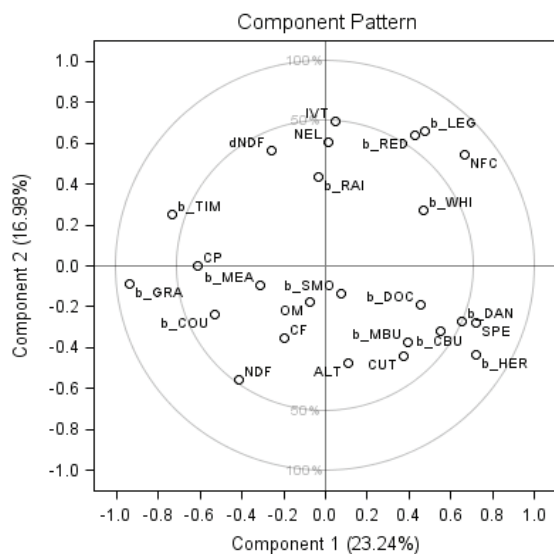

Figure 2. Score plot of principal component analysis (variable names explained in material and methods).

## References

- Dewhurst R.J., Fisher W.J., Tweed J.K.S. and Wilkins R.J. (2003) Comparison of grass and legume silages for milk production. 1. Production responses with different levels of concentrate. *Journal of Dairy Science* 86, 2598-2611.
- Leiber F., Kreuzer M., Nigg D., Wettstein H-R. and Scheeder M.R.L. (2005) A study on the causes for the elevated n-3 fatty acids in cows' milk of alpine origin. *Lipids* 40, 191-202.
- Mannetje L.T and Haydock K.P. (1963) The dry-weight-rank method for the botanical analysis of pasture. *The Journal of British Grassland Society* 18, 268-275.
- Wachendorf M. and Taube F. (2001) Artenvielfalt, Leistungsmerkmale und bodenchemische Kennwerte des Dauergrünlands im konventionellen und ökologischen Landbau in Nordwestdeutschland. *Pflanzenbauwissenschaften* 5, 75-86.

## Using NIR spectroscopy to determine cow diet and geographical origin from milk samples

Andueza D.<sup>1</sup>, Coppa M.<sup>2</sup>, Agabriel C.<sup>3,4</sup>, Constant I.<sup>1</sup>, Lombardi G.<sup>2</sup> and Martin B.<sup>1</sup>

<sup>1</sup>INRA, UR1213 Herbivores, Site de Theix, F-63122 St Genès-Champanelle

<sup>2</sup>Dep. AGROSELVITER, University of Turin, Via L. da Vinci 44, 10095, Griuglasco, Italy

<sup>3</sup>Clermont Université, VetAgro Sup, UR EPR 2008.03.102, F-63012 Clermont-Fd Cedex 1

<sup>4</sup>INRA, USC 2005, F-63370

Corresponding author: donato.andueza@clermont.inra.fr

### Abstract

An experiment was done to evaluate the ability of NIR spectroscopy to discriminate among tanker milk samples according to cow diet and geographical origin in relation to production systems. Milk from cows fed maize silage (121 samples) vs. pasture (245 samples) and of lowland (151 samples) vs. upland (180 samples) origin were used. Near-infrared reflectance spectra of oven-dried milk samples were recorded. PLS-DA multivariate analysis correctly classified 93% of the pasture vs. maize silage fed cow milk but only 81% of the samples by geographical origin. NIR spectroscopy can thus classify milk samples by cow diet, but not reliably by origin.

Keywords: Upland; lowland; maize silage; pasture; NIRS authentication

### Introduction

Recently growing consumer demand for knowledge about the quality and production conditions of dairy products has prompted dairy producers to improve information on milk origin and animal diet. It has been shown that detailed chemical analysis of milk, such as assay of terpenoids or fatty acids (Agabriel *et al.*, 2004; Martin *et al.*, 2005; Engel *et al.*, 2007), can be used to trace its geographical origin and the diets of the cows. However, these techniques are cumbersome and time-consuming, and their large-scale application for routine analysis is not feasible. Near-infrared spectroscopy (NIRS) has shown potential for use in quality assurance for a number of foodstuffs, being non-destructive, fast, and suitable for online measurements. Martin *et al.* (2006) successfully applied NIRS technology to the authentication of milk geographical origin (lowland vs. upland). However, their experimental design did not clearly show whether the discrimination reflected geographical origin *sensu stricto* or the combined effects of origin and animal diet. The aim of this work was to test the ability of NIRS to discriminate among tanker milk samples according to cow diet (maize silage vs. pasture) and geographical origin (lowland vs. upland).

### Materials and methods

A total of 425 tanker milk samples were collected from 172 farms in France and north-western Italy. The farms chosen covered a broad variety of milk production conditions. During sampling periods, data on farming conditions and animal feeding were recorded. Surveys included questions about forage management (forage characteristics, forage harvesting and storage, cutting and grazing periods), and feeding the herd when stabled (types of feed) and at pasture. Special attention was paid to forage (maize, grass), grassland (permanent or temporary grassland) and preservation methods (pasture, hay, silage and wrapped forage). On the basis of this information, two different farming systems (lowland and upland) and two different main cow diet types (maize silage and pasture) were identified.

The lowland farming system (151 milk samples) was characterized by intensive agronomic practices where cow diet was based mainly on maize silage in winter and maize silage plus grazing in summer. The upland farming system (180 samples) was characterized by more extensive agronomic practices, cow diet being based mainly on hay in winter (with minimal proportion of maize silage) and grazing on upland or alpine grassland in summer. For data collected on cow diet, milk samples were assigned to the maize silage category if at least 30% of forage dry matter (DM) was derived from silage (121 samples) and to the pasture category if at least 70% of forage DM was derived from grazing. Bulk samples were collected from the tank from 2 to 6 consecutive milkings and were immediately frozen and taken to the laboratory. Milk samples were stored at  $-18^{\circ}\text{C}$  until analysis. Samples were removed from cold storage and left for 2 h at room temperature. An aliquot (0.5 ml of each milk sample was placed on a glass microfibre filter (Whatman GF/A, 55 mm, Cat. No. 1820 055 (Whatman International Ltd, Maidstone, UK)), inserted in a 50 mm diameter ring cup (Thyholt and Isaksson, 1997) and oven-dried at  $40^{\circ}\text{C}$  for 24 h. Samples were then scanned in reflectance mode in a Foss NIRSystems 6500 monochromator (Foss NIRSystems, Silver Spring, MD, USA) equipped with an autocup module and controlled by ISIScan software version 2.21 (Infrasoft International LLC, State College, PA, USA). Each reflectance spectrum was time-averaged from 32 scans and was compared with the 32 average measurements of a ceramic reference. Spectra were transformed using the ‘standard normal variate and detrend’ (SNVD) method as scatter correction and the first derivative. Discriminant analysis was performed using the PLS-DA technique, and the models were tested using a cross-validation procedure.

## Results and discussion

Table 1 shows the characteristics of geographical origin and cow diet datasets. ‘Maize silage’ and ‘Pasture’ groups contain samples obtained in farms of both farming systems. Similarly, both, ‘lowland’ and ‘upland’ groups contain, each one, samples with different proportions of maize silage and pasture.

Table 1. Characteristics of the geographical origin and cow diet data sets (mean with minimum and maximum values in brackets)

	Lowland	Upland	Maize silage	Pasture
Number of samples	151	180	121	245
Altitude (m)	127 (1-580)	1652 (800-2500)	342 (1-950)	1207 (2-2500)
Grass (%) <sup>†</sup>	62 (0-100)	89 (0-100)	15 (0-69)	94 (74-100)
Maize silage (%) <sup>†</sup>	27 (0-92)	1 (0-32)	63 (31-100)	1 (0-26)
Preserved forages (%) <sup>†</sup>	11 (0-63)	10 (0-100)	22 (0-68)	5 (0-30)

<sup>†</sup>% total forage dry matter

The performance of the classification models is summarised in Table 2. Correct classification rates exceeded 80% for both models. For the maize silage vs. pasture analysis, the model correctly classified 342 out of 366 samples (Table 2). The feeding regime model showed only 6.56% error in cross-validation, although milk samples were collected in lowland and upland in both maize silage and pasture groups. On the other hand, 62 samples (18.73%) were misclassified by the geographical origin-based model. The lower classification errors obtained by Martin *et al.* (2006) on a similar model might be related to the combined effects of cow diet and geographical origin revealed in their study.

Table 2. NIRS classification of milk samples according to the feeding regime or the geographical origin of samples

	<i>n</i>	Milk correctly classified	Cross-validation error (%)
Maize silage vs. pasture	366	342	6.56
Upland vs. lowland	331	269	18.73

*n* = number of samples

## Conclusion

In conclusion, the low classification error confirmed that NIR spectroscopy can correctly classify milk samples according to cow diet (pasture vs. maize silage). However, this method was not powerful enough to discriminate reliably between milk geographical origins (lowland vs. upland).

## References

- Agabriel C., Ferlay A., Journal C., Sibra C., Teissier D., Grolier P., Bonnefoy J.C., Rock E., Chilliard Y. and Martin B. (2004) Composés d'intérêt nutritionnel de laits de grand mélange : teneurs en acides gras et vitamines selon l'altitude et la saison. *Rencontres Recherches Ruminants* 11, 51-54.
- Engel E., Ferlay A., Cornu A., Chilliard Y., Agabriel C., Bielicki G. and Martin B. (2007) Relevance of isotopic and molecular biomarkers for the authentication of milk according to production zone and type of feeding of the cow. *Journal of Agricultural and Food Chemistry* 55, 9099–9108.
- Martin B., Cornu A., Kondjoyan N., Ferlay A., Verdier-Metz I., Pradel P., Rock E., Chilliard Y., Coulon J.B. and Berdagué J.L. (2005) Milk indicators for recognizing the types of forages eaten by dairy cows. In: Hocquette J.F. and Gigli S. (eds.) *Indicators of milk and beef quality*, EAAP Publication 112, Wageningen Academic Publishers, Wageningen, The Netherlands, pp. 127-136.
- Martin B., Jestin M., Constant I., Agabriel C. and Andueza D. (2006) Authentification de la zone de production de laits de grand mélange (plaine - montagne) à partir de méthodes spectrales dans le visible et le proche infrarouge. *Rencontres Recherches Ruminants* 13, 194.
- Thyholt K. and Isaksson T. (1997) Near infrared spectroscopy of dry extracts from high moisture food products on solid support – a review. *Journal of Near Infrared Spectroscopy* 5, 179–193.

## Development and nutritive value of three varieties of sainfoin compared to lucerne during primary growth

Theodoridou K., Aufrère J., Andueza D., Pourrat J. and Baumont R.  
INRA, UR1213 Herbivores, 63122 Saint-Genès Champanelle, France  
Corresponding author: aufrere@clermont.inra.fr

### Abstract

Sainfoin (*Onobrychis viciifolia*) is a temperate legume plant containing condensed tannins (CT), which are polyphenols able to bind proteins and thus reduce protein degradation in the rumen. This study focused on five dates in the first growth cycle to track the time-course evolution of phenological stage, morphological composition (leaf proportions), nitrogen content and organic matter digestibility (OMd) of three varieties of sainfoin (Esparcette, Ambra, Villahoz) compared with a tannin-free legume, lucerne (var. Aubigny). Although sainfoin developed earlier than lucerne, its digestibility was higher or close to that of lucerne. Among the three varieties of sainfoin, Villahoz had the highest OMd and N content and the lowest CT content. Although nitrogen content was lower in sainfoin than lucerne, the tannins contained in sainfoin lead to similar nitrogen values. These results highlight sainfoin as a valuable alternative legume forage to lucerne.

Keywords: sainfoin, lucerne, variety, chemical composition, phenological stage.

### Introduction

There is renewed interest in forage legumes due to their important role in sustainable feeding systems through their ability to fix nitrogen and their potential high feed value for ruminants. Sainfoin (*Onobrychis viciifolia*) is a temperate legume with few references on its nutritive value. One important characteristic of this forage is that it contains condensed tannins (CT) which are able to bind proteins and thus to reduce protein degradation in the rumen (Waghorn, 2008). The differences among sainfoin varieties in terms of agronomical and nutritive value are not well known. This study was designed to compare the evolution of leaf proportion, phenological stage, chemical composition and nutritive value of three varieties of sainfoin against lucerne, over the course of the first cycle of growth.

### Materials and methods

Three varieties of sainfoin (*Onobrychis viciifolia*) (Esparcette from Ukraine, Ambra from France and Villahoz from Spain) were studied in comparison with lucerne (*Medicago sativa*) (var. Aubigny). They were sown in August 2008 and cultivated on the INRA's Clermont-Ferrand-Theix site (France) at an altitude of 870 m on a granitic brown soil in a fully factorial design with three replicate blocks. Samples of the three replicates were harvested at 6 cm above ground level at five dates in 2009 (30 April, 12 May, 26 May, 9 June and 23 June) during the first growth cycle. At each harvest date, we evaluated phenological stage and morphological composition (leaf-to-whole-plant ratio) for each variety of sainfoin and for lucerne on 50 plants for each variety/species and for each replicate, and classified the results using the stage classification system developed by Borreani *et al.* (2003) and modified for our study. The codes and definitions of the phenological stages in our study were the following: 1=early vegetative, 2=mid vegetative, 3=late vegetative, 4=early bud, 5=late bud, 6=early flower, 7=late flower, 8=early seed pod.

Each herbage sample was analysed using near-infrared reflectance spectroscopy (NIRS) to determine nitrogen content (N) (Kjeldahl method) and pepsin-cellulase DM digestibility. *In vivo* organic matter digestibility (OMd) was calculated from the models proposed by Aufrère *et al.* (2007). CT content was determined by HCl-butanol method (Reed, 1986) on freeze-dried samples. Data were analysed using the Mixed Procedure of the SAS software package (2000) and were submitted to ANOVA, testing species, variety and sampling date as fixed effects. Sampling date was considered as repeated variable.

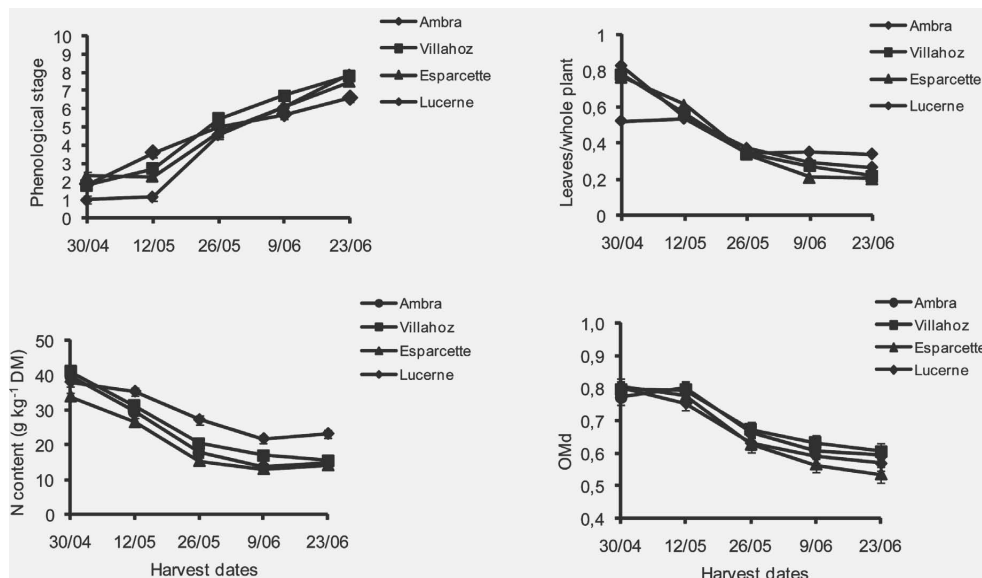

Figure 1. Time-course evolution of phenological stage (1=early vegetative, 2=mid vegetative-3=late vegetative, 4=early bud 5=late bud, 6=early flower, 7=late flower, 8=early seed pod), leaf to-whole plant ratio, N content in DM (g kg<sup>-1</sup>) and organic matter digestibility (OMd) at the different harvest dates, with standard errors.

## Results and Discussion

Sainfoin showed a higher development rate than lucerne. Results showed that on 12 May, the mean phenological stage value was 2.8 (late vegetative) for sainfoin and 1.3 (mid vegetative) for lucerne, while on 23 June these values were 6.5 (between early and late flower) for sainfoin and 5.4 (around early bud) for lucerne (Figure 1). Leaf percentage decreased from 0.79 on 30 April to 0.23 at 23 June for sainfoin and from 0.52 to 0.34 for lucerne. The N content in DM of sainfoin followed a similar pattern to leaf percentage during the first growth cycle, rapidly decreasing from 38.0 g kg<sup>-1</sup> on 30 April to 18.0 g kg<sup>-1</sup> on 26 May, and remaining constant thereafter, as was also observed by Upfold and Wright (1994). The higher mean value of N content in lucerne was related to its less mature phenological stage. The higher proportion of leaves in lucerne on 23 June can explain its higher mean N content in DM at this date (23.1 g kg<sup>-1</sup> vs. 15.0 g kg<sup>-1</sup> for sainfoin). OMd decreased as harvest date increased, and followed a quadratic trend with differences between species (Fig 1). The higher OMd of sainfoin compared to lucerne confirmed the results obtained by Aufrère *et al.* (2008) who compared sainfoin at vegetative and early flowering stage and lucerne at vegetative and bud flowering stage. The time-course evolution of phenological stage differed among varieties of sainfoin ( $P<0.003$ ). Ambra showed an earlier phenological development than the



other varieties. In contrast, Villahoz reached its development plateau at the last harvest date. The leaves-to-whole-plant ratio varied among sainfoin varieties, with Ambra showing the highest value. CT content in DM was higher in Esparcette (10.6 g kg<sup>-1</sup>) than Villahoz (8.7 g kg<sup>-1</sup>) and Ambra (9.4 g kg<sup>-1</sup>) ( $P < 0.025$ ). For sainfoin varieties, there was a high negative correlation between phenological stage or N content and OMD ( $r = -0.813$  and  $-0.844$  respectively). The correlation between leaf percentage and N or OMD was also high ( $r = 0.947$  and  $0.937$  respectively) (data not shown).

## Conclusion

Ambra showed an earlier phenological development than others sainfoin varieties at the beginning of the cycle, whereas Villahoz reached its development plateau at the last harvest date. The lower CT content in Villahoz may have enhanced its OMD value compared to the other two sainfoin varieties at the same harvest date. Although the literature has reported contradictory results on the effects of CT on digestibility, the CT content of forage should be an important criterion during variety selection. Even though N content was lower in sainfoin than lucerne when comparing across the same harvest dates, the CT content in sainfoin may have protected proteins against rumen degradation, with the result that nitrogen value was actually similar. This makes sainfoin an interesting alternative to lucerne.

## Acknowledgements

This work was supported by the EU's Marie Curie Research Training Network 'HealthyHay' (MRTN\_CT-2006-035805). The authors thank Bernard Debotte and his staff for growing the forages, the RAPA laboratory, and the staff at the URH experimental facilities for their assistance.

## References

- Aufrère J., Baumont R., Delaby L., Peccatte J. R., Andrieu J., Andrieu J.P. and Dulphy J.P. (2007) Prévission de la digestibilité des fourrages par la méthode pepsine-cellulase. Le point sur les équations proposées. *INRA Productions Animales* 20, 129-136.
- Aufrère J., Dudilieu M. and Poncet C. (2008) *In vivo* and *in situ* measurements of the digestive characteristics of sainfoin in comparison with lucerne fed to sheep as fresh forages at two growth stages and as hay. *Animal* 2:9, 1331-1339.
- Borreani G., Peiretti P.G. and Tabacco E. (2003) Evolution of yield and quality of sainfoin (*Onobrychis Viciifolia* Scop.) in the spring growth cycle. *Agronomie* 23, 193-201.
- Reed J.D. (1986) Relationships among soluble phenolics, insoluble proanthocyanidins and fiber in East African browse species. *Journal of Range Management* 39, 5-7.
- Upfold R.A. and Wright H.C. (1994) *Forage Production*. Ontario Ministry of Agriculture Food, and Rural Affairs, Publ. 30. Queens Printer for Ontario; Toronto, ON.
- Waghorn G. (2008) Beneficial and detrimental effects of dietary condensed tannins for sustainable sheep and goat production. Progress and challenges. *Animal Feed Science Technology* 147, 116-139.

## Quality of grass silages wilted as swathed or wide-spread crop

Bakken A.K.<sup>1</sup>, Johansen A.<sup>1</sup> and Synnes O.M.<sup>2</sup>

<sup>1</sup>Norwegian Institute for Agricultural and Environmental Research, Stjørdal, Norway

<sup>2</sup>The Norwegian Agricultural Extension Service, Sunnmøre, Ålesund, Norway

Corresponding author: anne.kjersti.bakken@bioforsk.no

### Abstract

In experiments on farms on the western coast of Norway, a dry matter (DM) content regarded as acceptable for baling was reached within 6-8 h after mowing in wide-spread crops, as opposed to within 24 h for swathed crops. Samples containing *Clostridia* and butyric acid were more frequent in silages that were wilted wide-spread for 24 h and then windrowed, than in silages wilted in swaths for an equal period. This difference in hygienic quality might have been caused by differences in DM content and fermentation in the two types of silages, as well as by contamination with soil-borne organisms through additional handling and wheeling of wide-spread crops. Rapidly wilted crops and silages had a higher concentration of water soluble carbohydrates (WSC).

Key words: *Clostridia*, hygienic quality, water soluble carbohydrates, wilting rate

### Introduction

In the humid climate of the Atlantic coast of Norway, it is a challenge to produce wilted silages. Crop yields are rather high and mowers with increased working widths contribute further to the building of thick swaths. To speed up the drying rate it may be worthwhile to invest in machinery for wide-spreading and later windrowing of the crop before baling. The study presented here is part of a project investigating the cost-benefits related to such an investment. The hygienic quality of silages has been analysed because there are concerns that windrowing and additional handling of the wilted crop may cause contamination with soil-borne organisms. Another hypothesis investigated was that rapid wilting improves the conservation of WSC to such an extent that the nutritional quality of silages is positively affected.

### Materials and methods

A series of experiments (6 in primary, 6 in secondary growth) were conducted on farms located along the western coast of Norway in the years 2006-2009. Most leys were dominated by *Phleum pratense* and a few by *Lolium perenne*. Dry matter (DM) yields varied from 3400 kg ha<sup>-1</sup> (2<sup>nd</sup> cut) to 10500 kg ha<sup>-1</sup> (1<sup>st</sup> cut). At all sites, disc-mower-conditioners with polyethylene fingers and a built-in spreading device were used. When making swaths, the device was turned off, resulting in 40% coverage of the harvested area by the crop. The wide-spread crop covered about 80% of the area. Because initial studies revealed small effects of conditioning on drying rates in wide-spread crops, the conditioner was set at its lowest level in this treatment. There were two or three replicates (harvested lengths of ca. 100 m) of each treatment. In most instances the crop was cut before midday. During succeeding wilting, it was sampled at irregular intervals for drying and later determination of DM and WSC content by near infrared spectroscopy (NIRS) (Fystro and Lunnan, 2006). The weather during wilting varied between experiments from cloudy conditions at 10 °C to sunny and windy weather at 20-24 °C. Rain rewetted the wilting crop in three of the trials.

In 9 of the 12 experiments (5 in 1<sup>st</sup> cuts and 4 in 2<sup>nd</sup> cuts), the swathed and the windrowed and previously wide-spread crop was baled simultaneously with six layers of plastic after about 24

hours of wilting. Additives containing formic and propionic acid were applied in 7 of them. After two months, samples were taken from two or four bales per treatment and site and kept frozen until analysis. Organic acids, pH, ammonia, yeast, mould and spores of bacteria were analysed in thawed silages. Samples dried at 60 °C were analysed chemically for content of WSC. All analyses were performed at the commercial laboratory Eurofins AS, in Moss, Norway. Data summarized in Table 1 and 3 were subjected to ANOVA with experiment as random effect and crop treatment (swathed, wide-spread) as fixed, whereas data presented in Table 2 were analysed according to a linear model for binary responses with the same fixed and random factors. Cut (1<sup>st</sup> cut, 2<sup>nd</sup> cut) was also included as a fixed effect in the models for silage components/contaminants presented in Tables 2 and 3.

## Results and discussion

On average, wide-spread crops reached nearly 30% DM after eight hours of drying, whereas swathed crops had to dry for one more day to reach the same DM content (Table 1). The content of WSC was higher in wide-spread than in swathed crop both after 6-8 and 24-28 hours of wilting (Table 1).

Table 1. Content of dry matter in fresh weight (DM, g kg<sup>-1</sup>) and water soluble carbohydrates in DM (WSC, g kg<sup>-1</sup>) in swathed and wide-spread grass crops at mowing and later samplings during wilting. LSmeans for 12 experiments are given.

	At mowing		After 2-4 h		After 6-8 h		After 16-23 h		After 24-28 h	
	DM	WSC	DM	WSC	DM	WSC	DM	WSC	DM	WSC
Swathed	193	161	209*	-	225*	137*	237*	-	273*	146*
Wide-spread	197	166	240	-	283	159	292	-	345	166
SE	11.3	12.4	11.5	-	12.2	6.5	18.7	-	18.4	4.3

\*: significant ( $P < 0.05$ ) differences between treatments.

Five out of 48 silage samples contained butyric acid and four of them were from wide-spread crops (Table 2). Spores of *Clostridiae* were also more frequent in wide-spread than in swathed silages. These results are not in agreement with the findings of Spörndly *et al.* (2008). In their experiment, the content of butyric acid was higher in swathed than in wide-spread crop. The DM content of the last type was as high 420 g kg<sup>-1</sup> FW, and this silage probably represented a less favourable environment for bacterial growth than the wetter silage made from wide-spread crop in the present study (Table 3) (Mo, 2005). With both types in the 'risk-zone' regarding DM content, the more extensive fermentation and lower pH in swathed crops (Table 3) may have prevented growth of unfavourable organisms.

Table 2. Number of samples from silages wilted either in swaths or wide-spread, with incidences of moulds, yeast, spores of bacteria and butyric acid. There were in total 24 samples from each treatment.

	Moulds	Yeast	<i>Bacillus</i>	<i>Clostridiae</i>	Butyric acid
Swathed	5	6	10	10(*)	1*
Wide-spread	7	9	11	16	4
SE for covariance parameter	1.1	2.9	1.5	2.2	4.9

\* and (\*): significant ( $P < 0.05$  and  $P = 0.06$ ) differences between treatments.

It is also possible that the windrowing and wheeling of wide-spread crops had contaminated the silage with soil-borne bacteria. However, there was not a higher incidence of *Bacillus* in windrowed silages. This genus of bacteria has often been linked to dirt and splashes of filthy water on the crop during harvest (Mo, 2005).

The differences between treatments in crop content of WSC just before baling sustained during fermentation (Tables 1 and 3). According to Huhtanen *et al.* (2003), an increase of 164 g energy-corrected milk per day might be expected from the extra 10 grams of WSC, mediated mainly through increased DM intake from less extensively fermented silages.

Table 3. Content of dry matter in fresh weight (DM, g kg<sup>-1</sup>), water soluble carbohydrates in DM (WSC, g kg<sup>-1</sup>), different volatile fatty acids in DM (g kg<sup>-1</sup>) and NH<sub>3</sub>-N (g kg<sup>-1</sup>) and pH in silages wilted for 24 hours in swathed or wide-spread crops before baling. LSmeans for 7 experiments with two or three replicates each are given.

	DM	pH	WSC	Lactic acid	Acetic acid	Butyric acid	Propionic acid	NH <sub>3</sub> -N
Swathed	259*	4.25*	51*	80*	10.3*	0.1*	1.0*	84*
Wide-spread	325	4.41	62	67	6.8	1.0	0.1	73
SE	20.2	0.06	15.1	3.7	0.63	0.45	0.37	18.4

\*: significant ( $P < 0.05$ ) differences between treatments.

## Conclusion

By avoiding the extra night and day of wilting needed for swathed as opposed to wide-spread crop, the risks for rewetting and unfavourable conditions during harvest were considerably diminished. More frequent contamination of *Clostridia* and butyric acid in wide-spread silages may be of concern for farmers planning the investment in machinery for wide-spreading and windrowing. However, the observed differences in hygienic quality might well have been caused by differences in DM content and fermentation in the two types of silages.

## Acknowledgements

The study has been financially supported by the Foundation for Research Levy on Agricultural Products, the Agricultural Agreement Research Fund, the Research Council of Norway, Tine BA, Addcon Nordic AS, Nortura BA.

## References

- Fystro G. and Lunnan T. (2006) Analysar av förkvalitet på NIRS. *Bioforsk FOKUS* 1 (3), 180-181.
- Huhtanen P., Nousiainen J.I., Khalili H., Jaakkola S. and Heikkilä T. (2003) Relations between silage fermentation characteristics and milk production parameters: analyses of literature data. *Livestock Production Science* 81, 57-73.
- Mo M. (2005) *Surförboka*. Tun Forlag/Landbruksforlaget, Oslo, Norway, 221 pp.
- Spöndly R., Knicky M., Pauly T. and Lingvall P. (2008) Quality and economics of pre-wilted silage made by wide-spreading or by swathng. *Grassland Science in Europe* 13, 645-647.

## Top losses of corn silage sealed with oxygen barrier film

Basso F.C.<sup>1</sup>, Reis R.A.<sup>1</sup>, Nogueira M.<sup>1</sup>, Bernardes T.F.<sup>2</sup> and Roth A.P.T.P.<sup>1</sup>

<sup>1</sup>*Animal Science Department, Faculty of Agricultural Sciences and Veterinary, São Paulo State University-UNESP, São Paulo, Brazil*

<sup>2</sup>*Animal Science of Department, Federal Rural University of Amazon, Belém, Pará, Brazil*  
Corresponding author: fcarvalhobasso@yahoo.com.br

### Abstract

The aim of this trial was to study the effectiveness of oxygen barrier film on the reduction of top-silage losses. One trial was carried out on a commercial farm in Jaboticabal, Brazil in 2009. Whole-corn crops (264 g kg<sup>-1</sup> of fresh weight) were harvested and ensiled in a stack silo. The covering treatments were: a sheet of 200- $\mu$ m-thick black-on-white polyethylene film (ST) and a sheet of 45- $\mu$ m-thick transparent oxygen barrier film (OB) plus a sheet of ST over the OB film. The stack silo was divided into two parts along its length: half was covered with ST film and half with OB + ST film. During the filling of the silo, 20 bags containing herbage were buried at the peripheral zone of the silos to determine losses. Samples were collected for measured dry matter (DM) content and microorganism counts in acidified potato agar. Twice during the feed-out period, temperatures were recorded at the silo face with data loggers at 12 locations on the silo face. The corn silage under the OB+ST film showed higher DM content and lower occurrence of moulds compared to the silage under only the ST film ( $P < 0.05$ ). The DM losses were lower under OB+ST film (10.2 vs. 7.4% for ST and OB+ST film, respectively). During the feed-out phase the top temperatures at the silo face exceeded 40 °C in the silage covered with ST film, while in the silage sealed with OB+ST film the top temperature was 32 °C. Oxygen barrier film plus polyethylene film reduced the occurrence of moulds and the top losses of corn silage in the stack silo.

Keywords: Polyethylene film, Silostop 2-step clear, Stack silo

### Introduction

When exposed to oxygen, corn silage becomes particularly susceptible to aerobic deterioration (Ashbell and Weinberg, 1992; Kung *et al.*, 1998). Air is the major cause of spoilage in silage. When the cover is inadequate, air and moisture enter into the silo and affect both the ensiling process and silage quality during the storage and feeding phases. The sealing of bunker and stack silos is normally done with plastic sheeting, usually polyethylene of various colours and thicknesses. A translucent oxygen barrier film (Silostop 2-step clear) has recently been developed for silage sealing and has been compared with conventional polyethylene in several parts of the world. Usually, the Silostop 2-step is used in combination with a protective tarpaulin, but in Brazil studies are performed in combination with a polyethylene sheet (black or black-on-white). Therefore, the aim of this research was to study the effectiveness of the oxygen barrier film combination with a polyethylene sheet on the reduction of top-silage losses.

### Materials and methods

One trial was carried out on commercial farm in Jaboticabal, Brazil in 2009. Whole-corn crops (264 g kg<sup>-1</sup> of fresh weight) were harvested and ensiled in a stack silo in March, 2009 (temperature average 22 °C). The covering treatments were: a sheet of 200- $\mu$ m-thick black-on-white polyethylene film (ST) and a sheet of 45- $\mu$ m-thick translucent oxygen barrier film (OB) plus a sheet of ST over the OB film (OB+ST). The stack silo was divided into two parts

along the length: half was covered with ST film and half with OB plus ST film. During the filling of the silo, 20 bags (10 for each treatment) containing 3.5 kg of herbage, were buried at the peripheral zone (15 cm of depth) of the silos to determine losses during the conservation period. The bags were weighed before and after the ensilage to measure losses. After 45 days of ensilage, the bags were removed. Samples were collected to measure dry matter (DM) content and microorganism-counts in acidified potato agar. Twice during the feed-out period (30 and 60 days after opening the silo), by morning (08:00), the temperature was measured at the silo face. Data were collected with data loggers (each 5 minutes by 20 minutes) at 12 locations on silo face. The ambient temperature ranged from 17 to 21 °C on days when temperatures were recorded. The statistical analysis included one way analysis of variance with significance reported at the 0.05 probability level (*P* value).

## Results and discussion

The corn silage under the OB+ST film had higher DM content ( $P < 0.05$ ) (Table 1). The occurrence of moulds under the OB+ST film was lower compared to the silage under the ST film ( $P < 0.05$ ) (Table 1). The DM losses were lower under OB+ST film (10.2 vs. 7.4% for ST and OB+ST film, respectively); although without significant difference, this difference represents less than 27.5% of top loss (Table 1). Basso *et al.* (2009), in a similar study in Brazil in 2008, found that the silage covered with OB+ST film showed lower yeast-counts and better fermentation compared to the silage under the ST film. During the feed-out phase, the top temperatures at the silo face exceeded 40 °C in the silage covered with ST film, while in the silage sealed with OB+ST film the top temperature was lower at 32 °C (Figure 1). The increase in temperature in the silage is an indicator of aerobic deterioration, and it reflected mould activity. Therefore, preventing oxygen ingress in the silo may minimize the proliferation of moulds and consequently the deterioration and losses of silage.

Table 1. Occurrence of microorganisms and dry matter losses in corn silage covered with two types of plastic film.

Item	ST <sup>1</sup>	OB+ST <sup>2</sup>	<i>P</i> -value	CV (%) <sup>3</sup>
DM (%)	25.86	27.31	0.0142	2.77
Yeasts (Log <sub>10</sub> CFU/g)	5.93	5.27	0.4630	24.19
Moulds (Log <sub>10</sub> CFU/g)	4.61	3.93	0.0131	7.15
DM losses, %	10.18	7.39	0.2296	36.57

<sup>1</sup>ST – polyethylene film. <sup>2</sup>OB+ST – oxygen barrier film plus polyethylene film. <sup>3</sup>CV - Coefficient of variation.

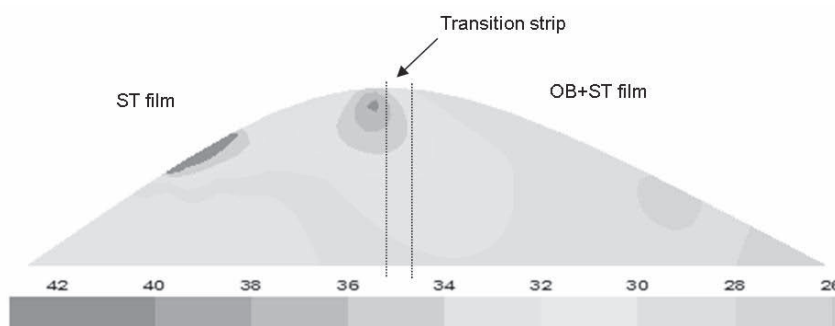

Figure 1. Contour map of temperatures (°C) of the silo face covered with polyethylene film (ST) or oxygen barrier film associated to ST (OB+ST)

## Conclusions

Oxygen barrier film plus polyethylene film reduced the occurrence of moulds and the top losses of corn silage in a stack silo.

## References

- Ashbell G. and Weinberg Z. G. (1992) Top silage losses in horizontal silos. *Canadian Agricultural Engineering* 34, 171–175.
- Basso F.C., Bernardes T.F., Casagrande D.R., Lodo B.N., Roth A.T.P.R. and Reis R.A. (2009) Aerobic deterioration in corn silage sealed with oxygen barrier film under farm conditions. In: Broderick G.A., Adesogan A.T., Bocher L.W., Bolsen K.K., Contreras-Govea F.E., Harrison J.H. and Muck R.E. (eds.) *XVth International Silage Conference*, Madison, WI, pp. 211-212.
- Kung Jr. L., Sheperd A.C., Smagala A.M., Endres K.M., Bessett C.A., Ranjit N.K. and Glancey J.L. (1998) The effect of preservatives based on propionic acid on the fermentation and aerobic stability of corn silage and a total mixed ration. *Journal Dairy Science* 8, 1322–1330.



# ***Propionibacterium acidipropionici*, *Lactobacillus plantarum* or its combination on the aerobic stability and microbial dynamics of corn silage**

Basso F.C., Reis R.A., Assis F.B., Lara E.C. and Rodrigues J.F.H.

*Animal Science Department, Faculty of Agricultural Sciences and Veterinary, São Paulo State University-UNESP, São Paulo, Brazil*

Corresponding author: fcarvalhobasso@yahoo.com.br

## **Abstract**

Our objective was to evaluate the effects of microbial inoculation with *Propionibacterium acidipropionici* MA26/4U, *Lactobacillus plantarum* MA18/5U, or their combination, on aerobic stability and microbial dynamics of corn silage. Whole-plant corn (350 g kg<sup>-1</sup> fresh weight) was ensiled in quadruplicate laboratory silos (7 L) after the following treatments: untreated (control), *P. acidipropionici* (1 x 10<sup>5</sup> CFU g<sup>-1</sup> of fresh forage), *L. plantarum* (1 x 10<sup>5</sup> CFU g<sup>-1</sup> of fresh forage) and *P. acidipropionici* plus *L. plantarum*. After 96 days of ensilage, DM content was lower in silages treated ( $P < 0.05$ ). DM recovery and gas losses were not different ( $P > 0.05$ ) among treatments. Under aerobic conditions, silages treated with *P. acidipropionici* showed lower yeasts and mould numbers up to 96 h. Aerobic stability was improved ( $P < 0.05$ ) in silages treated. Silages inoculated with *Propionibacterium acidipropionici* and their combination with *L. plantarum* enhanced the aerobic stability of the corn silage without affect on the gas losses, under laboratory conditions.

Keywords: Facultatively heterofermentative bacteria, microbiology, *Propionibacteria*

## **Introduction**

Microbial additives containing facultative heterofermentative lactic acid bacteria (<sup>hc</sup>LAB) as the *Lactobacillus plantarum* are used to rapidly decrease the pH of mass during ensilage, because the lactic acid is produced as primary end products, thus avoiding undesired fermentation (Kung, 2009). However, corn plants have a high soluble carbohydrate content that are fermented by natural LAB producing lactic acid. Nevertheless, soluble carbohydrates and lactic acid are consumed by yeast in the post-opening, raising the pH of silage, resulting in aerobic deterioration. Inoculants containing *Propionibacterium acidipropionici* are used to improve aerobic stability by producing acetic and propionic acids, which have antifungal effects (Moon, 1983). But the DM losses (from CO<sub>2</sub> production) during fermentation are higher when using *Propionibacteria* (Kung Jr., 2009). Thus, the combination of facultative <sup>hc</sup>LAB (*L. plantarum*) inoculant with *Propionibacteria* inoculant as an alternative to avoid DM losses may be a strategy, because the use of facultative <sup>hc</sup>LAB inoculant results in a well preserved silage and *Propionibacteria* inoculant ensures longer stable silage in the post-opening. Therefore, the aim of this trial was to evaluate the effects of microbial inoculation with *Propionibacterium acidipropionici* MA26/4U, *Lactobacillus plantarum* MA18/5U or its combination on aerobic stability and microbial dynamics of corn silage.

## **Materials and methods**

Whole-plant corn (350 g kg<sup>-1</sup> of fresh weight) was ensiled in quadruplicate laboratory silos (7 L) after the following treatments: untreated (control), *P. acidipropionici* (PA - 1 x 10<sup>5</sup> CFU g<sup>-1</sup> of fresh forage), *L. plantarum* (LP - 1 x 10<sup>5</sup> CFU g<sup>-1</sup> of fresh forage) and *P. acidipropionici* plus *L. plantarum* (PALP - 1 x 10<sup>5</sup> CFU g<sup>-1</sup> of fresh forage). The inoculants were diluted with distilled water at the rate of 5 mL kg<sup>-1</sup> of fresh forage water and they were applied in a

uniform manner with a spray on fresh forage with constant mixing. Plastic buckets with 7 L capacity were filled with 3.5 kg of corn forage, weighed, sealed and stored at room temperature. After 96 days of ensilage, silos were weighed, opened, spoiled forage was discarded, and the remainder was homogenized, placed in plastic buckets, and maintained in a closed place at room temperature (average 26 °C). The silos were weighed before and after to measure the gas losses and DM recovery. Silage temperature was measured every half hour by a data logger inserted in the centre of the silage mass during the aerobic exposition (0, 4, and 8 days). Room temperature was recorded by a data logger situated near the experimental silos (average 26 °C). Aerobic stability was considered when temperature of silage increased 2 °C above room temperature (Kung Jr. *et al.*, 2003). Samples were collected to evaluate the counting of yeasts and moulds in acidified potato agar (Difco). The statistical analysis included one way analysis of variance and Tukey's test ( $P < 0.05$ ).

## Results and discussion

After 96 days of ensilage DM content was lower ( $P < 0.05$ ) in silages treated (PA: 33.91%; LP: 34.05% and PALP: 35.05%) compared with control silage (35.51%), probably because of the addition of water to dilute the inoculant. The DM recovery (Control: 95.74%; PA: 93.91%; LP: 94.92% and PALP: 97.29%) and gas losses (Control: 5.28%; PA: 4.93%; LP: 4.40% and PALP: 7.54%) were not different among treatments. These results are satisfactory because the DM recovery is lower and gas losses are higher when the inoculant used contains bacteria that produce CO<sub>2</sub>, among others products, during the fermentation. Silages treated with *P. acidipropionici* presented lower yeast numbers at time 0 ( $P < 0.05$ ) (Table 1). Under aerobic conditions, silages treated with *P. acidipropionici* showed lower mould ( $P < 0.05$ ) numbers at 96 h (Table 1). Aerobic stability was improved ( $P < 0.05$ ) in silages treated with *P. acidipropionici*, *L. plantarum* and its combination, compared to untreated (Figure 1). The increase in temperature in the silage is an indicator of aerobic deterioration, and it is reflected in the activities of yeasts and moulds. The *P. acidipropionici* was efficient in controlling microorganisms and, in consequence, improving the aerobic stability. Filya *et al.* (2004) reported that the addition of *P. acidipropionici* decreased yeasts and moulds and improved of aerobic stability of corn silage, because of higher levels of acetic and propionic acid in treated silages with this inoculant, the same did not occur in silage inoculated with *P. acidipropionici* plus *L. plantarum*. Dawson *et al.* (1998) reported lower number of yeasts and moulds, higher level of acetic and propionic acid and improving of aerobic stability of high moisture corn inoculated with *P. acidipropionici*.

Table 1. Effects of microbial inoculants on microbial dynamics of corn silage.

Time	Treatments <sup>1</sup>				CV <sup>2</sup> (%)
	Control	PA	LP	PALP	
	Yeasts (Log CFU/ g)				
0	3.82 <sup>AB</sup>	2.39 <sup>B</sup>	3.86 <sup>A</sup>	3.89 <sup>A</sup>	15.85
4 (96 hours)	8.93 <sup>A</sup>	7.93 <sup>A</sup>	7.98 <sup>A</sup>	8.18 <sup>A</sup>	7.51
8 (192 hours)	9.33 <sup>A</sup>	8.76 <sup>A</sup>	8.59 <sup>A</sup>	8.84 <sup>A</sup>	4.99
	Moulds (Log CFU/ g)				
0	4.11 <sup>A</sup>	3.55 <sup>A</sup>	3.80 <sup>A</sup>	3.57 <sup>A</sup>	11.58
4 (96 hours)	6.55 <sup>A</sup>	4.78 <sup>B</sup>	5.56 <sup>AB</sup>	6.35 <sup>A</sup>	7.55
8 (192 hours)	7.10 <sup>A</sup>	7.24 <sup>A</sup>	7.34 <sup>A</sup>	7.24 <sup>A</sup>	2.87

\*Means followed by equal letters do not differ by Tukey test ( $P > 0.05$ ).

<sup>1</sup> PA – *Propionibacterium acidipropionici*, LP – *Lactobacillus plantarum*, PALP – *Propionibacterium acidipropionici* + *Lactobacillus plantarum*.

<sup>2</sup> CV = Coefficient of variation.

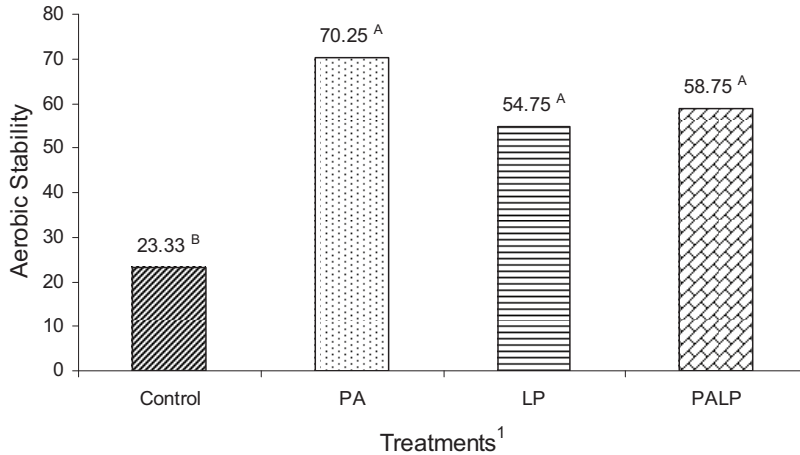

Figure 1. Effects of microbial inoculant on aerobic stability of corn silage.

\*Means followed by equal letters do not differ by Tukey test ( $P > 0.05$ ).

<sup>1</sup> PA – *Propionibacterium acidipropionici*, LP – *Lactobacillus plantarum*, PALP - *Propionibacterium acidipropionici* + *Lactobacillus plantarum*.

## Conclusions

Silages inoculated with *Propionibacterium acidipropionici* and its combination with *L. plantarum* enhanced the aerobic stability of the corn silage without affecting gas losses, under laboratory conditions.

## References

- Dawson T.E, Rust S.R. and Yokoyama M.T. (1998) Improved fermentation and aerobic stability of ensiled, high moisture corn with the use of *Propionibacterium acidipropionici*. *Journal of Dairy Science* 81, 1015-1021.
- Filya I., Sucu E. and Karabulut A. (2004) The effect of *Propionibacterium acidipropionici*, with or without *Lactobacillus plantarum*, on the fermentation and aerobic stability of wheat, sorghum and maize silages. *Journal of Applied Microbiology* 97, 818-826.
- Kung Jr. L. (2009) Effects of microbial additives in silages: facts and perspectives. In: Zopollatto M., Muraro G.B. and Nussio L.G. (eds.) *International Symposium on Forage Quality and Conservation*, FEALQ, Piracicaba, Brazil, 7-22.
- Kung Jr. L., Taylor C.C., Lynch M.P. and Neylon J.M. (2003) The effect of treating alfalfa with *Lactobacillus buchneri* 40788 on silage fermentation, aerobic stability, and nutritive value for lactating dairy cows. *Journal of Dairy Science* 86, 336-343.
- Moon N.J. (1983) Inhibition of the growth of acid tolerant yeasts by acetate, lactate and propionate and their synergistic mixtures. *Journal of Applied Bacteriology* 55, 453-460.

## ***Lactobacillus buchneri*, *Lactobacillus plantarum* or their combination effects on aerobic stability and microbial dynamics of corn silage**

Basso F.C., Reis R.A., Nogueira M., Assis F.B. and Roth A.P.T.P.

*Animal Science Department, Faculty of Agricultural Sciences and Veterinary, São Paulo State University-UNESP, São Paulo, Brazil*

Corresponding author: fcarvalhobasso@yahoo.com.br

### **Abstract**

The aim of this trial was to evaluate the effects of microbial inoculation with *L. buchneri* NCIMB 40788, *L. plantarum* MA18/5U, or their combination, on aerobic stability and microbial dynamics of corn silage. Whole-plant corn (350 g kg<sup>-1</sup> of fresh weight) was ensiled in quadruplicate laboratory silos (7 L) after the following treatments: untreated (control), *L. buchneri* (1 x 10<sup>5</sup> CFU g<sup>-1</sup> of fresh forage), *L. plantarum* (1 x 10<sup>5</sup> CFU g<sup>-1</sup> of fresh forage) and *L. buchneri* plus *L. plantarum*. After 96 days of ensilage dry matter (DM) content was lower in silages treated ( $P < 0.05$ ). DM recovery and gas losses were not different ( $P > 0.05$ ) among treatments. Under aerobic conditions, silages treated with *L. buchneri* and *L. buchneri* plus *L. plantarum* presented lower yeast numbers up to 96 h and silages treated with *L. buchneri* plus *L. plantarum* presented lower mould numbers up to 192 h. Aerobic stability was improved ( $P < 0.05$ ) in silages treated with *L. buchneri* by 100 h and *L. buchneri* plus *L. plantarum* by 87 h, while the untreated corn silage did not deteriorate until 23 h of aerobic exposure. The *L. buchneri* and their association with *L. plantarum* were effective in protecting corn silages exposed to air under laboratory conditions.

Keywords: Facultatively heterofermentative bacteria, heterofermentative bacteria, microbiology

### **Introduction**

Microbial additives containing facultative heterofermentative lactic acid bacteria (<sup>hc</sup>LAB) as the *Lactobacillus plantarum* are used to rapidly decrease the pH of mass during ensilage, because the lactic acid is produced as primary end products, thus avoiding undesired fermentation (Kung, 2009). However, corn plants have a high content of soluble carbohydrates that are fermented by natural LAB producing lactic acid. Nevertheless, soluble carbohydrates and lactic acid are consumed by yeast in the post-opening, raising the pH of silage, resulting in aerobic deterioration. Inoculants containing obligate heterofermentative LAB as the *Lactobacillus buchneri* are used to control the aerobic deterioration, by producing volatile organic acids, which has antifungal effect (Moon, 1983), but the DM loss, by gases and water, during fermentation is increased when using this strain (McDonald *et al.*, 1991). Thus, the combination of facultative with obligate <sup>hc</sup>LAB inoculant may be an alternative to avoid losses of DM, because the use of facultative <sup>hc</sup>LAB inoculant result in a well preserved silage and obligate <sup>hc</sup>LAB inoculant ensure stable longer silage in the post-opening. Therefore, the aim of this trial was to evaluate the effects of microbial inoculation with *L. buchneri* NCIMB 40788, *L. plantarum* MA18/5U or their combination on aerobic stability and microbial dynamics of corn silage.

### **Materials and methods**

Whole-plant corn (350 g kg<sup>-1</sup> of fresh weight) was ensiled in quadruplicate laboratory silos (7 L) after the following treatments: untreated (control), *L. buchneri* (LB - 1 x 10<sup>5</sup> CFU g<sup>-1</sup> of

fresh forage), *L. plantarum* (LP -  $1 \times 10^5$  CFU g<sup>-1</sup> of fresh forage) and *L. buchneri* plus *L. plantarum* (LBLP -  $1 \times 10^5$  CFU g<sup>-1</sup> of fresh forage). The inoculants were diluted with distilled water at the rate of 5 mL kg<sup>-1</sup> of fresh forage water and they were applied in a uniform manner with a spray on fresh forage with constant mixing. Plastic buckets with 7 L capacity were filled with 3.5 kg of corn forage, weighed, sealed and stored at room temperature. After 96 days of ensilage, silos were weighed, opened, spoiled forage discarded, and the remainder was homogenized, placed in plastic buckets, and maintained in a closed place at room temperature. The silos were weighed before and after to measure the gas losses and DM recovery. Silage temperature was measured every half hour by a data logger inserted in the centre of the silage mass during the aerobic exposure (0, 4, and 8 days). Room temperature was measured by data logger distributed near of the experimental silos (average 26 °C). Aerobic stability was considered when temperature of silage increased 2 °C above room temperature. Samples were collected to evaluate the counting of yeasts and moulds in acidified potato agar (Difco). The statistical analysis included one way analysis of variance and Tukey's test ( $P < 0.05$ ).

Table 1. Effects of microbial inoculants on dry matter (DM) content, DM recovery and gas losses of corn silage. Means followed by equal letters do not differ by Tukey test ( $P > 0.05$ ).

Item	Treatments <sup>1</sup>				CV (%) <sup>2</sup>
	Control	LB	LP	LBLP	
DM content (%)	35.51 <sup>A</sup>	34.11 <sup>B</sup>	34.05 <sup>B</sup>	34.46 <sup>B</sup>	1.09
DM recovery (%)	95.75 <sup>A</sup>	94.52 <sup>A</sup>	94.92 <sup>A</sup>	91.48 <sup>A</sup>	2.67
Gas losses (%)	5.28 <sup>A</sup>	5.57 <sup>A</sup>	4.40 <sup>A</sup>	5.96 <sup>A</sup>	25.92

<sup>1</sup> Control; LB – *Lactobacillus buchneri*; LP – *Lactobacillus plantarum*, LBLP – *L. buchneri* + *L. plantarum*.

<sup>2</sup> CV - Coefficient of variation.

## Results and discussion

After 96 days of ensilage DM content was lower in silages treated ( $P < 0.05$ ), probably because of the addition of water to dilute the inoculant. The DM recovery and the gas losses did not differ ( $P > 0.05$ ) among treatments (Table 1). These results are satisfactory because the DM recovery is lower and gas losses are higher when heterofermentative bacteria that produce CO<sub>2</sub>, among others products, during the fermentation are used. In the opening and at 96 hours after open (time 4), silages treated with *L. buchneri* and its combination with *L. plantarum* presented lower yeast numbers (Table 2). The same treatments (LB and LBLP) showed lower number of moulds on the fourth time (Table 2). Silage with *L. buchneri* plus *L. plantarum* presented lower number of moulds up to 192 h after opening (Table 2).

Table 2. Effects of microbial inoculants on microbial dynamics of corn silage.

Time	Treatments <sup>a</sup>				CV <sup>b</sup> (%)
	Control	LB	LP	LBLP	
	Yeasts (Log CFU g <sup>-1</sup> )				
0	3.90 <sup>A</sup>	1.25 <sup>B</sup>	3.86 <sup>A</sup>	3.37 <sup>A</sup>	9.94
4 (96 hours)	9.00 <sup>A</sup>	6.24 <sup>B</sup>	7.98 <sup>A</sup>	6.80 <sup>B</sup>	4.50
8 (192 hours)	9.25 <sup>A</sup>	8.51 <sup>A</sup>	8.59 <sup>A</sup>	8.28 <sup>A</sup>	4.78
	Moulds (Log CFU/ g)				
0	3.82 <sup>A</sup>	3.85 <sup>A</sup>	3.80 <sup>A</sup>	3.65 <sup>A</sup>	13.92
4 (96 hours)	6.46 <sup>A</sup>	3.82 <sup>B</sup>	5.56 <sup>A</sup>	4.17 <sup>B</sup>	7.96
8 (192 hours)	7.13 <sup>A</sup>	7.19 <sup>A</sup>	7.34 <sup>A</sup>	5.29 <sup>B</sup>	3.16

Means followed by equal letters do not differ by Tukey test ( $P > 0.05$ ).

<sup>a</sup> LB – *Lactobacillus buchneri*, LP – *Lactobacillus plantarum*, LBLP – *L. buchneri* + *L. plantarum*.

<sup>b</sup> CV - Coefficient of variation.

Aerobic stability was improved ( $P < 0.05$ ) in silages treated with *L. buchneri* and its combination with *L. plantarum*, compared untreated and with *L. plantarum* alone ( $CV = 18.34\%$ ) (Fig. 1). The increase in temperature in the silage is an indicator of aerobic deterioration, and it is reflected of activities of yeasts and moulds. The *L. buchneri* alone and its combination with *L. plantarum* were efficient in control microorganisms and, consequently improved the aerobic stability. Filya (2003) reported that after ensilage and five days of aerobic exposure yeasts and moulds were lower in corn silages inoculated with *L. buchneri* and and its combination with *L. plantarum* than the control, the silages inoculated showed higher levels of acetic acid which has antifungal effect. Hu *et al.* (2009) reported that the aerobic stability of corn silage was improved in silages treated with *L. buchneri* alone or combined with *L. plantarum* compared with those not treated with this organism.

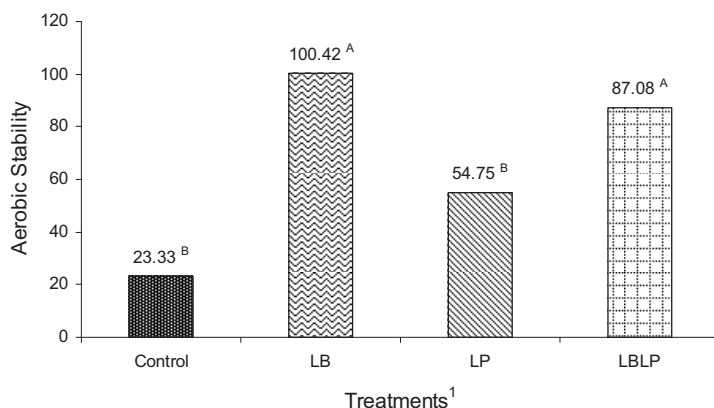

Figure 1. Effects of microbial inoculant on aerobic stability of corn silage. Means followed by equal letters do not differ by Tukey test ( $P > 0.05$ ). <sup>1</sup> LB – *Lactobacillus buchneri*, LP – *Lactobacillus plantarum*, LBLP – *L. buchneri* + *L. plantarum*.

## Conclusions

The inoculant *L. buchneri* and its combination with *L. plantarum* is effective in protecting corn silages exposed to air, improving aerobic stability without affecting gaseous losses, under laboratory conditions.

## References

- Hu W., Schmidt R.J., McDonell E.E., Kligerman C.M. and Kung Jr. L. (2009) The effect of *Lactobacillus buchneri* 40788 or *Lactobacillus plantarum* MTD-1 on the fermentation and aerobic stability of corn silages ensiled at two dry matter contents. *Journal of Dairy Science* 92, 3907-3914.
- Filya I. (2003) The effect of *Lactobacillus buchneri* and *Lactobacillus plantarum* on the fermentation, aerobic stability, and ruminal degradability of low dry matter corn and sorghum silages. *Journal of Dairy Science* 86, 3575-3581.
- Kung Jr. L. (2009) Effects of microbial additives in silages: facts and perspectives. In: Zopollato M., Muraro G.B., Nussio L.G. (1<sup>st</sup> ed.) Proceedings of the International Symposium on Forage Quality and Conservation, FEALQ, Piracicaba, BR, 7–22.
- McDonald P., Henderson A.R. and Heron S.J.E. (1991) *The biochemistry of silage*. (2<sup>nd</sup> ed.) Marlow UK: Chalcomb Publications. 340 pp.
- Moon N.J. (1983) Inhibition of the growth of acid tolerant yeasts by acetate, lactate and propionate and their synergistic mixtures. *Journal of Applied Bacteriology* 55, 453-460.

# The effect of forage species on kinetics of large and small particles in dairy cows

Bayat A.R.<sup>1,3</sup>, Rinne M.<sup>1</sup>, Ahvenjärvi S.<sup>1</sup> and Huhtanen P.<sup>2</sup>

<sup>1</sup>MTT Agrifood Research Finland, FI-31600 Jokioinen, Finland

<sup>2</sup>Swedish University of Agricultural Sciences, Department of Agricultural Research for Northern Sweden, S-901 83 Umeå, Sweden

<sup>3</sup>Animal Science Department, Shiraz University, Shiraz, 7144165186, Iran

Corresponding author: bayat@shirazu.ac.ir

## Abstract

The objective of this study was to compare ruminal pool sizes and digesta kinetics of large (>1.25 mm; LP) and small (1.25-0.038 mm; SP) particles in dairy cows fed grass and red clover silage diets in a cross-over experiment. Grass (timothy-meadow fescue) and red clover silages were used as dietary treatments and comprised 0.55 of total dry matter intake. Ruminal contents and faeces were divided into LP and SP by wet sieving. Indigestible NDF (iNDF) was determined by a 12d ruminal *in situ* incubation followed by NDF extraction. Ruminal iNDF content was greater in LP of red clover compared to grass silage diet. Potentially digestible NDF (pdNDF) content in ruminal LP and SP was smaller with red clover compared to grass silage diet and the difference was more considerable in SP. Passage rates of iNDF and pdNDF increased with decreasing particle size for both treatments. Particle breakdown rate tended to be slower for LP of red clover compared to grass silage diet. Contribution of particle breakdown to turnover of LP of rumen iNDF was numerically lower in red clover compared to grass silage diet.

Keywords: steady-state model, indigestible NDF, passage rate, ruminal particle breakdown rate, red clover, grass

## Introduction

Constant rates of digestion and passage are important determinants of fibre digestibility in the rumen. Fibre fraction can be divided into indigestible and potentially digestible neutral detergent fibre (iNDF and pdNDF, respectively) which have different properties based on their digestion and passage kinetics. On the other hand, particles are selectively retained in the rumen and they can be divided into escapable and non-escapable pools. Both size and specific gravity of particles are considered to define the particles as escapable or non-escapable, but in the current work, we only used particle size as an indicator of the escapability of the particles. Huhtanen *et al.* (2007) indicated that rumen evacuation technique together with wet sieving and iNDF determination can be used to estimate passage rate ( $k_p$ ) of iNDF and  $k_p$  and digestion rate ( $k_d$ ) of pdNDF for both escapable and non-escapable ruminal pools. Grass and legume forages differ in digestion and passage kinetics due to different histological characteristics. Therefore, this experiment was conducted to compare ruminal pool sizes and digesta kinetics of small and large particles in dairy cows fed grass and red clover silage diets.

## Materials and methods

Two ruminally fistulated multiparous Ayrshire dairy cows with body weight of  $658 \pm 27$  kg and milk production of  $34.0 \pm 8.0$  kg  $d^{-1}$  were assigned randomly to a  $2 \times 2$  Latin square design with 21 d periods. Experimental silages were prepared from primary growth of timothy-meadow fescue (*Phleum pratense-Festuca pratensis*) and red clover (*Trifolium pratense*)



swards harvested in Finland in 2006. The grass silage was harvested on 4 July and the red clover silage on 30 June. The silages were fed *ad libitum* and supplemented with a barley, wheat and soybean meal-based concentrate so that the proportion of forage was 0.55 of total diet DM intake. Diets were offered four times daily. Ruminal contents were evacuated at 6 and 12 h on d 14 and 21 of each experimental period, respectively. The average weight of ruminal contents of the two evacuations was used as the estimation of the diurnal mean. Faecal spot samples were collected during d 17-21 of each period. Particle size distribution of ingested silages was adopted from Bayat *et al.* (2010). The particle size distribution of dietary concentrate, ruminal digesta and faeces was determined by a wet sieving apparatus (Retsch AS200 Digit, GmbH, Haan, Germany). The samples were divided into large (LP, >1.25 mm) and small (SP, 1.25-0.038 mm) particles by wet sieving. After drying, the materials were ground (1 mm) and NDF concentration was analysed by ANKOM<sup>220</sup> Fiber Analyser. To determine iNDF concentration, 1.0 g DM of sample was weighed into nylon bags (60 × 120 mm, pore size of 0.017 mm) and duplicate bags were incubated for 12 d in the rumen of two cows fed a forage based diet. The pdNDF concentration in DM (g kg<sup>-1</sup>) was calculated as NDF – iNDF. Calculations of ruminal pool sizes and kinetics of iNDF and pdNDF are described by Huhtanen *et al.* (2007). No NDF was assumed in the material <0.038 mm. A Latin square split-plot model was used to analyse the data (PROC Mixed; SAS, 2003), where the treatment and particle size were considered as the main and sub plots, respectively. Orthogonal contrasts were used to compare the effects.

## Results and discussion

Ruminal iNDF content was higher with LP and lower with SP of red clover compared to those of grass silage diet ( $P < 0.05$  for interaction of forage species and particle size; Table 1). In a previous study we observed that iNDF content was higher with both LP and SP of red clover compared to grass silage diets (Bayat *et al.*, 2010), but in the current experiment, the grass silage was rather late cut (*in vivo* D-value in sheep 570 and 585 g kg<sup>-1</sup> DM in grass and red clover silages, respectively). Ruminal pdNDF content in both LP and SP of red clover was less than those of grass silage diet while the decrease was more considerable with SP ( $P < 0.05$  for interaction of forage species and particle size).

Passage rates ( $k_p$ ) of iNDF and pdNDF increased with decreasing particle size for both treatments ( $P < 0.01$ ). The  $k_p$  of pdNDF tended to be faster for LP and SP of red clover compared to grass silage diets ( $P < 0.10$ ). In a previous study,  $k_p$  of iNDF in LP and SP of red clover silage diets were slower compared to grass silage diets (Bayat *et al.*, 2010). Particle breakdown rate tended to be slower for red clover compared to grass silage diets ( $P < 0.10$ ). Similar result has been observed by Bayat *et al.* (2010) and, in spite of a greater resistance of grasses to particle size reduction, it can be attributed to more intensive chewing of grasses than legumes (Buxton and Redfean, 1997). Digestion rate ( $k_d$ ) of pdNDF was not different between LP and SP of grass and red clover silage diets even though it was numerically smaller in SP than LP of red clover silage diet. This lack of difference suggests that digestibility of pdNDF is mainly regulated by  $k_d$ . Contribution of  $k_d$  in clearance of pdNDF from ruminal pools increased by decreasing particle size of grass silage diets while it decreased by decreasing particle size of red clover silage diet ( $P < 0.01$  for interaction of forage species and particle size). This result confirms our previous results by two grass and two red clover silage diets, differing in forage maturity stage (Bayat *et al.*, 2010). The reason can be attributed to faster  $k_d$  of pdNDF in LP than SP of red clover and slower  $k_r$  of red clover compared to grass silage diets.

Table 1. Ruminal pools and faecal excretion of dry matter (DM), indigestible fibre (iNDF) and potentially digestible fibre (pdNDF), and ruminal rates of intake ( $k_i$ ), passage ( $k_p$ ), particle breakdown ( $k_r$ ) and digestion ( $k_d$ ) of large (LP) and small (SP) particles of dairy cows fed diets based on grass or red clover silages

	Grass silage		Red clover silage		SEM <sup>1</sup>	Orthogonal contrasts <sup>2</sup>		
	LP	SP	LP	SP		S	P	S × P
Ruminal digesta, kg								
DM	3.96	4.05	4.26	3.09	0.607	†	*	*
iNDF	1.35	1.49	1.94	1.13	0.267	ns	†	*
pdNDF	2.24	1.88	1.76	1.08	0.247	**	**	*
Faeces, kg d <sup>-1</sup>								
DM	0.46	3.63	0.91	2.64	0.239	ns	**	†
iNDF	0.18	1.84	0.47	1.38	0.126	ns	**	†
pdNDF	0.25	1.72	0.49	1.22	0.079	ns	**	*
iNDF kinetics								
$k_i$ , h <sup>-1</sup>	0.0534	0.0087	0.0333	0.0130	0.00261	*	**	*
$k_p$ , h <sup>-1</sup>	0.0057	0.0522	0.0106	0.0522	0.00354	ns	**	ns
$k_r$ , h <sup>-1</sup>	0.0477		0.0227		0.00244	†	-	-
$k_r (k_r + k_p)^{-1}$	0.89		0.68		0.03120	ns	-	-
pdNDF kinetics								
$k_i$ , h <sup>-1</sup>	0.0945	0.0226	0.0768	0.0394	0.00640	ns	**	†
$k_p$ , h <sup>-1</sup>	0.0047	0.0389	0.0117	0.0477	0.00336	†	**	ns
$k_d$ , h <sup>-1</sup>	0.0422	0.0409	0.0425	0.0289	0.00460	ns	ns	nNs
$k_d (k_r + k_p + k_d)^{-1}$	0.44	0.51	0.55	0.38	0.02061	ns	†	**
$k_p \text{ iNDF} (k_p \text{ pdNDF})^{-1}$	1.21	1.34	0.90	1.09	0.05796	*	†	ns

<sup>1</sup> SEM, standard error of means, n = 2 ns, non significant; †,  $P < 0.10$ ; \*,  $P < 0.05$ ; \*\*,  $P < 0.01$

<sup>2</sup> S, forage species (i.e. grass vs. red clover); P, particle size (i.e. large vs. small particles); S × P, Interaction of forage species and particle size

## Conclusions

Grass and red clover silage-based diets differ in iNDF and pdNDF ruminal pool sizes, and they tended to be different in passage and breakdown rates. In addition, large and small particles have different kinetic characteristics in the rumen. Therefore, considering the effects of forage species and particle size in the models predicting feed intake and fibre digestibility may improve the accuracy of predictions.

## References

- Bayat A.R., Rinne M., Kuoppala K., Ahvenjärvi S., Vanhatalo A. and Huhtanen P. (2010) Ruminal large and small particle kinetics in dairy cows fed red clover and grass silages harvested at two stages of growth. *Animal Feed Science and Technology* 155, 86-98.
- Buxton D.R. and Redfearn D.D. (1997) Plant limitations to fiber digestion and utilization. *Journal of Nutrition* 127, 814S-818S.
- Huhtanen P., Asikainen U., Arkkila M. and Jaakkola S. (2007) Cell wall digestion and passage kinetics estimated by marker and *in situ* methods or by rumen evacuation in cattle fed hay 2 or 18 times daily. *Animal Feed Science and Technology* 133, 206-227.

## Forage species effects on particle digestion kinetics estimated by rumen evacuation or gas production technique

Bayat A.R.<sup>1,3</sup>, Rinne M.<sup>1</sup>, Seppälä, A.<sup>1</sup>, Ahvenjärvi S.<sup>1</sup> and Huhtanen P.<sup>2</sup>

<sup>1</sup>MTT Agrifood Research Finland, FI-31600 Jokioinen, Finland

<sup>2</sup>Swedish University of Agricultural Sciences, Department of Agricultural Research for Northern Sweden, S-901 83 Umeå, Sweden

<sup>3</sup>Animal Science Department, Shiraz University, Shiraz, 7144165186, Iran

Corresponding author: bayat@shirazu.ac.ir

### Abstract

Digestion rate ( $k_d$ ) is an important determinant of fibre digestion in ruminants. This study provides digestion kinetic information for different particle sizes of grass and red clover silage diets fed to dairy cows. Dietary treatments and *in vivo* digesta kinetic measurements are described in a companion summary. Ruminal and faecal particles were divided into large (>1.25 mm; LP), medium (1.25-0.315 mm; MP) and small (1.25-0.038 mm; SP) sizes by wet sieving and *in vitro* gas production from potentially digestible NDF (pdNDF) was measured from all particle size fractions. The pdNDF content in ruminal LP, MP and SP was greater with grass compared to red clover silage diet while indigestible NDF (iNDF) content tended to be greater in LP of red clover compared to grass silage diet. The  $k_d$  of pdNDF, estimated by rumen evacuation, was slower for SP compared to LP and MP of both grass and red clover silage diets. Effective  $k_d$  and digestibility of pdNDF, estimated by gas production, of ruminal samples decreased in a quadratic manner by decreasing particle size but were not affected by treatment and were lower for faecal samples compared to ruminal samples. Effective  $k_d$  for ruminal LP and MP was slower but for SP was faster when determined by *in vitro* gas production compared to  $k_d$  estimated by rumen evacuation.

Keywords: steady-state model, gas production, indigestible NDF, digestion rate, red clover, grass

### Introduction

Constant rate of digestion ( $k_d$ ) of feedstuffs can be estimated from *in vivo* and alternatively *in situ* or *in vitro* techniques. The *in vivo* methods are preferred as they present the true situation, but they are laborious, expensive, time consuming and raise ethical concerns due to use of animals in experimentation. The *in situ* methods measure the disappearance of the sample rather than the actual digestion rate. Several inherent problems such as slower fermentation inside the bag than in the rumen and escape of particles from bag have been recognized. The *in vitro* methods are relatively inexpensive and the obtained data have typically good correlation with *in vivo* data. Huhtanen *et al.* (2007) have combined *in vivo* and *in situ* techniques together with indigestible NDF (iNDF) determination and modelling approaches proposed by Allen and Mertens (1988) to estimate passage rate of iNDF and passage and digestion rates of pdNDF. Therefore, the objectives of this study were to compare: 1) ruminal pool sizes and digesta kinetics of large, medium and small particles in dairy cows fed grass or red clover silage diets, and 2) digestion rate of pdNDF estimated by rumen evacuation or *in vitro* gas production technique.

## Materials and methods

The description of the cows, silages, dietary concentrate, feeding, rumen evacuation, wet sieving, NDF and iNDF determination and experimental design have been presented in a companion summary in these proceedings (Bayat *et al.* 2010). The only difference here is that ruminal and faecal samples were divided into large (>1.25 mm; LP), medium (1.25-0.315 mm; MP) and small (1.25-0.038 mm; SP) particles by wet sieving. After sieving, different size ruminal and faecal particle fractions were exposed to an automated *in vitro* gas production analysis as described by Huhtanen *et al.* (2008). Latin square split-plot model was used to analyse the data (PROC Mixed; SAS, 2003), where the treatment and particle size were considered as the main and sub plots, respectively. Orthogonal contrasts were used to compare the effects. In order to compare *in vitro* parameters of ruminal and faecal samples, a paired t-test was used.

Table 1. Ruminal pools and faecal excretion of dry matter (DM), indigestible fibre (iNDF) and potentially digestible fibre (pdNDF), and ruminal rates of intake ( $k_i$ ), passage ( $k_p$ ), particle breakdown ( $k_r$ ) and digestion ( $k_d$ ) of large (LP), medium (MP) and small (SP) particles of dairy cows fed diets based on grass or red clover silages

	Grass silage			Red clover silage			SEM <sup>1</sup>	Orthogonal contrasts <sup>2</sup>		
	LP	MP	SP	LP	MP	SP		S	P	S × P
Ruminal digesta, kg										
DM	4.58	2.92	1.76	5.10	1.75	1.94	0.519	ns	**	†
iNDF	1.35	1.08	0.40	1.94	0.74	0.39	0.213	ns	**	†
pdNDF	2.24	1.19	0.69	1.76	0.59	0.50	0.184	**	**	ns
Faeces, kg d <sup>-1</sup>										
DM	0.59	2.42	2.26	1.36	1.65	2.29	0.219	ns	**	*
iNDF	0.18	1.03	0.81	0.47	0.69	0.69	0.078	ns	**	*
pdNDF	0.25	0.95	0.78	0.49	0.59	0.63	0.045	*	**	**
iNDF kinetics										
$k_i$ , h <sup>-1</sup>	0.0534	0.0098	0.0062	0.0333	0.0144	0.0103	0.00229	*	**	**
$k_p$ , h <sup>-1</sup>	0.0057	0.0414	0.0830	0.0106	0.0396	0.0773	0.00661	ns	**	ns
$k_r$ , h <sup>-1</sup>	0.0477	0.0291	-	0.0227	0.0339	-	0.00149	*	†	**
$k_r$ ( $k_r + k_p$ ) <sup>-1</sup>	0.89	0.42	-	0.68	0.46	-	0.028	*	**	**
pdNDF kinetics										
$k_i$ , h <sup>-1</sup>	0.0945	0.0268	0.0155	0.0768	0.0448	0.0330	0.00564	ns	**	*
$k_p$ , h <sup>-1</sup>	0.0047	0.0342	0.0472	0.0117	0.0428	0.0535	0.00365	*	**	ns
$k_d$ , h <sup>-1</sup>	0.0422	0.0544	0.0182	0.0425	0.0367	0.0197	0.00549	ns	**	ns
$k_d$ ( $k_i + k_p + k_d$ ) <sup>-1</sup>	0.44	0.46	0.28	0.55	0.32	0.27	0.027	ns	**	*
$k_p$ iNDF ( $k_p$ pdNDF) <sup>-1</sup>	1.21	1.20	1.76	0.90	0.92	1.44	0.116	*	**	ns

<sup>1</sup> SEM, standard error of means, n = 2 ns, non significant; †,  $P < 0.10$ ; \*,  $P < 0.05$ ; \*\*,  $P < 0.01$

<sup>2</sup> S, forage species (i.e. grass vs. red clover); P, particle size (i.e. large vs. small particles); S × P, Interaction of forage species and particle size

## Results and discussion

Ruminal iNDF content tended to be higher only in LP of red clover compared to grass silage diet ( $P < 0.10$  for interaction of forage species and particle size; Table 1). Ruminal pdNDF content was higher in LP, MP and SP of grass compared to those of red clover silage diets ( $P < 0.01$ ) and it was higher in LP compared to MP or SP of both treatments ( $P < 0.01$ ). Ruminal passage rate ( $k_p$ ) of iNDF and pdNDF increased with decreasing particle size ( $P < 0.01$ ; Table 2). The  $k_p$  of iNDF was not different between LP, MP and SP of two treatments, respectively while  $k_p$  of pdNDF in all particle fractions was faster for red clover compared to grass silage diets ( $P < 0.05$ ). The  $k_d$  of pdNDF was not different between two treatments whereas it was slower for SP compared to LP and MP of both grass and red clover silage diets. This difference is probably due to depletion of SP from digestible materials as LP and MP are

gradually reduced in size to make these particles. Effective  $k_d$  and digestibility of pdNDF, estimated by gas production, tended ( $P < 0.10$ ) to be faster for ruminal compared to faecal LP of grass samples and they were faster ( $P < 0.01$ ) for ruminal compared to faecal LP of red clover samples. Effective  $k_d$  estimated by gas production was numerically slower for ruminal LP and MP compared to  $k_d$  of those particles estimated by rumen evacuation but for SP the opposite trend was observed even though no statistical analysis was performed.

Table 2. Effective digestion rate (effective  $k_d$ ) and digestibility of potentially digestible fibre from large (LP), medium (MP) and small (SP) particles of ruminal and faecal samples estimated from *in vitro* gas production

	Grass silage			Red clover silage			SEM <sup>1</sup>	Orthogonal contrasts <sup>2</sup>		
	LP	MP	SP	LP	MP	SP		S	P	S × P
Effective $k_d$ , h <sup>-1</sup>										
Rumen	0.0312	0.0236	0.0275	0.0330	0.0244	0.0296	0.00199	ns	**	ns
Faeces	0.0268	0.0227	0.0274	0.0260	0.0228	0.0268	0.00184	ns	†	ns
Significance <sup>3</sup>	†	ns	ns	**	ns	ns				
Digestibility, g kg <sup>-1</sup>										
Rumen	695	611	658	711	620	680	21.5	ns	**	ns
Faeces	651	598	657	641	598	649	22.9	ns	†	ns
Significance <sup>3</sup>	†	ns	ns	**	ns	ns				

<sup>1</sup> and <sup>2</sup>, for footnotes refer to Table 1.

<sup>3</sup> Significance level from paired t-test between each ruminal and faecal particle size fraction.

## Conclusions

The grass and red clover silage diets differed in ruminal iNDF and pdNDF pool sizes. Passage rate of pdNDF in all particle fractions was faster for red clover compared to grass silage diet, while the digestion rate of pdNDF was not different. Effective digestion rate and digestibility of pdNDF, estimated by gas production, were faster only for ruminal compared to faecal LP of red clover samples. Digestion rate values estimated by gas production were generally slower than those estimated by rumen evacuation data.

## References

- Huhtanen P., Asikainen U., Arkkila M. and Jaakkola S. (2007) Cell wall digestion and passage kinetics estimated by marker and *in situ* methods or by rumen evacuation in cattle fed hay 2 or 18 times daily. *Animal Feed Science and Technology* 133, 206-227.
- Bayat A.R., Rinne M., Ahvenjärvi S. and Huhtanen P. (2010) The effect of forage species on kinetics of large and small particles in dairy cows measured by rumen evacuation. *Grassland Science in Europe* 15 (this volume).
- Huhtanen P., Seppälä A., Ots M., Ahvenjärvi S. and Rinne M. (2008) In vitro gas production profiles to estimate extent and effective first-order rate of neutral detergent fiber digestion in rumen. *Journal of Animal Science* 86, 651-659.
- SAS User's Guide, 2003. Statistics, Version 9.1 Edition. SAS Inst., Inc., Cary, NC, USA.

## Non structural carbohydrate concentration of AM and PM-cut forage species

Bélanger G.<sup>1</sup>, Pelletier S.<sup>1</sup>, Tremblay G.F.<sup>1</sup>, Bertrand A.<sup>1</sup>, Drapeau R.<sup>2</sup>, Castonguay Y.<sup>1</sup> and Pageau D.<sup>2</sup>

<sup>1</sup>Soils and Crops Research and Development Centre, Agriculture and Agri-Food Canada, 2560 Hochelaga Blvd., Québec, QC, G1V 2J3, Canada

<sup>2</sup>Normandin Research Farm, Agriculture and Agri-Food Canada, 1468 Saint-Cyrille Street, Normandin, QC, G8M 4K3, Canada

Corresponding author: gilles.belanger@agr.gc.ca

### Abstract

Non structural carbohydrates are a source of readily fermentable energy for rumen microbes. We compared total non structural carbohydrates (TNC) concentration of eight forage species (six grasses and two legumes) cut at 0900 h in the morning (AM) or at 1530 h in the afternoon (PM) in the spring growth and summer regrowth of two harvest years. Starch was determined by colorimetry and other carbohydrates by high-performance liquid chromatography. The TNC concentration was estimated by the sum of sucrose, glucose, fructose, fructans (grasses) or pinitol (legumes), and starch. Red clover (*Trifolium pratense* L.) and tall fescue [*Lolium arundinaceum* (Schreb.) S.J. Darbyshire] had the greatest TNC concentration (average of 94 mg g<sup>-1</sup> DM for both spring growth and summer regrowth in both species) whereas reed canarygrass (*Phalaris arundinacea* L.) had the lowest TNC concentration (65.5 mg g<sup>-1</sup> DM). Concentration of TNC of all species increased with a delayed cutting during the day but the extent of this increase varied among forage species from 13% in smooth brome (*Bromus inermis* Leyss) to 68% in reed canarygrass. Forage TNC concentration can be increased by choosing species such as tall fescue and red clover and by cutting the forage in the afternoon.

Keywords: carbohydrates, species, time of cutting, forage

### Introduction

The increased concentration of TNC in forages improves the N use efficiency and milk production of dairy cows (Moorby *et al.*, 2006; Brito *et al.*, 2008, 2009). Forage TNC concentration also closely correlates with preference and production in ruminants (Shewmaker *et al.*, 2006). Carbohydrate concentrations vary among forage species and reported TNC concentrations in DM of several cool-season forage species range from 35 to 257 mg g<sup>-1</sup>. Plant carbohydrate concentration generally increases with the length of the daylight period due to a greater production than utilization. The increase in forage TNC concentration with the delayed cutting during the day has been reported previously but only for a few forage species.

### Materials and methods

Eight forage species were grown as single species on a silty clay soil in Normandin (48°51'N, 72°32'W), Québec, Canada. The grass species were reed canarygrass (cv. Bellevue), meadow brome (*Bromus biebersteinii* Roemer & J.A. Schultes; cv. Paddock), smooth brome (*Bromus inermis* Leyss; cv. Radisson), tall fescue (cv. Kokanee), timothy (*Phleum pratense* L., cv. Champ), and Kentucky bluegrass (*Poa pratensis* L., cv. Balin). The legume species were red clover (cv. AC Charlie) and alfalfa (*Medicago sativa* L., cv. AC Caribou). Four replicates of each sward were sown in 2006 and 2007, and harvested in 2007 and 2008, respectively. Forage legumes

were N fertilized with 25 kg ha<sup>-1</sup> in the spring whereas grasses were fertilized with 60 kg ha<sup>-1</sup> in the spring and 40 kg ha<sup>-1</sup> after the first harvest. In the spring growth and summer regrowth of both harvest years, an area of 0.25 m<sup>2</sup> was harvested in each plot at two cutting times: in the morning (AM; 0900 h) and in the afternoon (PM; 1530 h). Harvests were taken at the recommended stage of development for each species (grasses: early heading to late heading in spring growth and vegetative to heading in summer regrowth; legumes: early bud to 50% flowering in spring growth and 10% flowering in summer regrowth). A sub-sample of 250 g was heated in a microwave oven during 1 min at maximum intensity to reach approximately 70 °C, then dried at 55 °C for 72 h, and ground through a 1-mm screen. Extraction of forage legume TNC and grass starch, and determination of grass and legume TNC were performed according to Pelletier *et al.* (2009). Briefly, soluble carbohydrates (SC) were extracted from dried samples with a methanol:chloroform:water solution, except for fructans from grass samples that were extracted in hot water. Carbohydrates were analysed by high-performance liquid chromatography. The non-soluble residues left over after the methanol : chloroform : water extraction were washed twice with methanol and used for starch quantification. The TNC concentration was estimated by the sum of sucrose, glucose, fructose, fructans (grasses) or pinitol (legumes), and starch. Forage species were assigned to main plots, time of cutting to subplots, and growth periods to subsubplots. Replicates and production years were considered to be random effects, and harvests within years were considered to be repeated measurements. Data were analysed using the MIXED procedure of SAS.

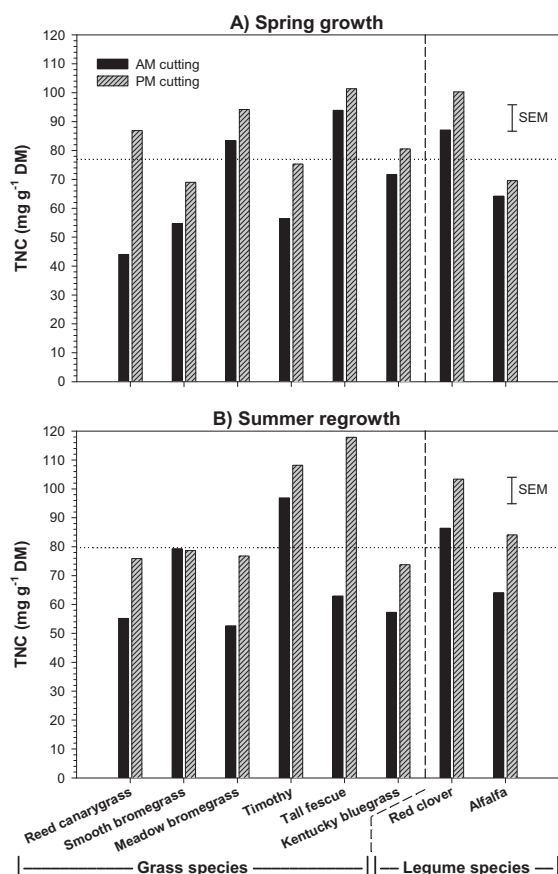

Figure 1. Concentration of total non structural carbohydrates (TNC) in eight forage species cut in the morning (AM) or the afternoon (PM) in the spring growth (A) and summer regrowth (B) (average of two harvest years; SEM: standard error of the means).



## Results and discussion

Forage TNC concentration in DM of grasses, averaged across time of cutting and growth period, varied from 65.5 mg g<sup>-1</sup> for reed canarygrass to 94.0 mg g<sup>-1</sup> for tall fescue. In forage legumes, it averaged 70.5 mg g<sup>-1</sup> in alfalfa and 94.3 mg g<sup>-1</sup> in red clover. The TNC concentrations in the present study are similar to those reported in the literature for timothy, tall fescue, and red clover, but tend to be lower for reed canarygrass, smooth brome grass, meadow brome grass, Kentucky bluegrass, and alfalfa. These variations can be due to several factors such as growth conditions and stages of development at harvest.

The TNC concentration was greater in the PM- than in the AM-cutting in all forage species and for both growth periods, except in the smooth brome grass summer regrowth (Fig. 1). Averaged across growth periods, the extent of the increase in TNC concentration with a delayed cutting during the day varied from 13% in smooth brome grass to 68% in reed canarygrass. The increase in forage TNC concentration with the delayed cutting during the day has been reported previously for alfalfa, tall fescue, and timothy, but to our knowledge, it is the first time that such an increase is reported for reed canarygrass, smooth brome grass, meadow brome grass, Kentucky bluegrass, and red clover. These results confirm that most forage species, grasses or legumes, are likely to have a greater TNC concentration when cut in the afternoon compared to the morning.

## Conclusions

Concentration of TNC of all forage species increased with a delayed cutting during the day and the extent of this increase varied among forage species from 13% in smooth brome grass to 68% in reed canarygrass. Red clover and tall fescue had the greatest TNC concentration in DM with an average of 94 mg g<sup>-1</sup> for both spring growth and summer regrowth in both species. Reed canarygrass was the species with the lowest TNC concentration (65.5 mg g<sup>-1</sup>). Forage TNC concentration can be increased by choosing species such as tall fescue and red clover and by cutting the forage in the afternoon.

## References

- Brito A.F., Tremblay G.F., Bertrand A., Castonguay Y., Bélanger G., Michaud R., Lapierre H., Benchaar C., Petit H.V., Ouellet D.R. and Berthiaume R. (2008) Alfalfa cut at sundown and harvested as baleage improves milk yield of late-lactation dairy cows. *Journal of Dairy Science* 91, 3968–3982.
- Brito A.F., Tremblay G.F., Lapierre H., Bertrand A., Castonguay Y., Bélanger G., Michaud R., Benchaar C., Ouellet D.R. and Berthiaume R. (2009) Alfalfa cut at sundown and harvested as baleage increases bacterial protein synthesis in late-lactation dairy cows. *Journal of Dairy Science* 92, 1092–1107.
- Moorby J.M., Evans R.T., Scollan N.D., MacRae J.C. and Theodorou M.K. (2006) Increased concentration of water-soluble carbohydrate in perennial ryegrass (*Lolium perenne* L.). Evaluation in dairy cows in early lactation. *Grass and Forage Science* 61, 52–59.
- Pelletier S., Tremblay G.F., Lafrenière C., Bertrand A., Bélanger G., Castonguay Y. and Rowsell J. (2009) Non-structural carbohydrate concentrations in timothy forage as affected by N fertilization, stage of development, and time of cutting. *Agronomy Journal* 101, 1372–1380.
- Shewmaker G.E., Mayland H.F., Roberts C.A., Harrison P.A., Chatterton N.J. and Sleper D.A. (2006) Daily carbohydrate accumulation in eight tall fescue cultivars. *Grass and Forage Science* 61, 413–421.

# Characterization of forages produced and used in the production area of Parmigiano-Reggiano cheese

Bortolazzo E., Ligabue M. and Pacchioli M.T.

<sup>1</sup>CRPA S.p.A – Research Centre on Animal Production, Corso Garibaldi, 42, 42121 - Reggio Emilia, Italy.

Corresponding author: elebor@crpa.it

## Abstract

In the Parmigiano-Reggiano cheese production area, dairy cow rations are based on local forages: 50% of forage dry matter (DM) must be provided by hay; at least 35% of forage DM must be produced by the farm itself and 75% of forage DM must come from farms located in the production area. For this reason, forage production techniques are very important from both quantitative and qualitative points of view. The objective of this study was to describe and evaluate the nutritional quality of hays produced and used in the Parmigiano-Reggiano cheese production area. To achieve this objective, three monitoring campaigns were conducted involving 163 farms representatively distributed in the Parmigiano-Reggiano cheese production area. During these campaigns, 2105 forage samples were collected and analysed; firstly to determine the nutritional composition, and secondly to calculate the relative feed value (RFV). Results were analysed to make information available describing nutritional characteristics of forage crops broken down by type, altitude and harvest season.

Keywords: Parmigiano-Reggiano, forage, RFV, dNDF, protein fractions

## Introduction

Parmigiano-Reggiano (PR) cheese is a PDO (protected designation of origin) product; this means that the production is governed by strict regulations from the feeding of the dairy cattle all the way through to the marking of cheese wheels (Consorzio del Formaggio Parmigiano-Reggiano, 2002). The production area is located in the north of Italy, in a well-defined area of the Po valley which includes the provinces of Parma, Reggio Emilia, Modena, Bologna (to the left side of the River Reno) and Mantua (on the right side of the River Po). About 80% of the hay produced in this area is lucerne (*Medicago sativa* L.) hay and about 20% comes from permanent meadows. The dairy cattle feeding regulations place great emphasis on hay forage as a means of maintaining close links with the area of origin – thus the quality and quantity of hay forage is extremely important to the subsequent cheese production. The objective of this study was to describe and evaluate the nutritional quality of hays produced and used in the PR cheese production area.

## Materials and methods

Three monitoring campaigns were conducted from 2005 to 2007. A total of 2105 hay samples were taken from 163 farms (about 5% of the total number of farms producing milk for PR). An identification form was compiled for each hay sample specifying the following information: forage crop (lucerne -L, lucerne mixed with grasses -ML, permanent meadows – PM, and other grasses); the harvest (1<sup>st</sup>, 2<sup>nd</sup>, other); the production area, and the result of the visual inspection. Geographical distribution of the samples is shown in Table 1.A manual core gauge ('Quas') specially designed for hay bales, was used for hay sampling following the ASPA (Association for the Science and Animal Production) procedures.

Table 1: Geographical distribution of samples

Altitude	Mountain			Hill			Plain			Other grasses	Total
	L	ML	PM	L	ML	PM	L	ML	PM		
Forage crop											
Bologna	21	17	2	7	4	1	98	41	1	6	198
Mantua							129	44	5	5	183
Modena	50	53	7	50	58	6	114	70	11	6	425
Reggio Emilia	53	49	3	65	48	37	203	50	164	25	697
Parma	19	25	2	157	123	11	136	71	13	45	602
Total	143	144	14	279	233	55	680	276	194	87	2105

Individual samples were taken from two cores removed from bales, the first from a hole made 20 cm from the top edge, and the second at 3/4 of the height of the bale. Individual samples were mixed together to obtain a global sample, then directly milled to 0.5 mm.

The chemical composition (crude protein content, ashes, neutral detergent fibre (NDF), acid detergent fibre (ADF), neutral detergent insoluble protein (NDIP), acid detergent insoluble protein (ADIP), soluble protein and NDF digestibility (24 h) (dNDF)) of all hay samples was determined through Near Infrared Spectrometry (NIRS). In order to provide summary parameters to evaluate the hay quality, the chemical composition was used to calculate the relative feed value (RFV), which represents an expression of the overall forage quality and estimates the intake of digestible energy when forage is the only source of energy and protein (Rohweder *et al.*, 1978), as well as the protein fractions (Sniffen *et al.*, 1992). Statistical analysis was carried out through the analysis of the variance with Duncan's separation of means test using SPSS statistical package Ver. 17.0.

## Results and discussion

Results show that there were no significant differences between hays from different provinces when compared on the basis of the RFV quality index (Table 2). Differences were found, however, between mountain and hill-produced lucerne and mixed lucerne hay on the one hand, and hay produced in plain areas on the other. Hay produced in the plain areas had higher RFV than hays produced in hills and mountains.

Table 2: Relative feed value according to forage type and topography

Altitude	Lucerne	Mixed lucerne	Permanent meadow
Mountain	128.0 B	95.2 b	105.1
Hill	128.0 B	96.4 b	105.0
Plain	133.6 A	100.9 a	105.9
Mean	131.5	98.1	105.7
Sig.	***	***	n.s.

n.s. not significant, \* significant  $P < 0.05$ , \*\* significant  $P < 0.01$ , \*\*\* significant  $P < 0.001$

It is well known that lucerne hays have higher crude protein content than mixed lucerne and permanent-meadow hays. In the PR cheese production area this difference was, on average, equal to 6 points ( $P < 0.001$ ). Differences in protein content were mainly due to variations in soluble protein (B1 and B2) content, both of which were higher in pure lucerne hays than in the other two types of hay (Figure 1). Regarding differences in protein content due to the altitude it was found that, in the case of L and ML hays, the hay produced in hills or mountains had lower protein content than hay produced in the plains ( $P < 0.001$ ), whereas for the PM no difference was found.

The NDF content and the NDF digestibility have a straight influence on cows' forage intake (Oba *et al.*, 1999). In this study, results showed that NDF content was lower for lucerne hays than for mixed lucerne and permanent meadows hays. On the other hand, NDF digestibility was higher for PM and ML hays ( $P < 0.001$ ). Regarding the influence of the number of

harvest, it was found that for the first harvest, usually done by the end of April to beginning of May in this area, the NDF content was significantly higher than for the second harvest (end of May) or summer harvests for the three types of forages and the three altitude areas, except for ML and PM from mountain areas. NDF digestibility was higher for the spring harvest, for all kind of forages, although this difference was only significant for L hay produced in plain areas and ML produced in hilly areas (Table 3).

Table 3: NDF (% in DM) content and dNDF (% of NDF)

Altitude	Harvest	Lucerne		Mixed lucerne		Permanent meadow					
		NDF	dNDF	NDF	dNDF	NDF	dNDF				
Mountain	1	48.90	b	34.58	56.90	41.57	54.61	43.63			
	2	44.75	a	33.21	52.68	39.17	48.31	34.34			
	Summer	43.61	a	34.93	57.89	41.27	52.28	42.22			
	Sig.	**	n.s.	n.s.	n.s.	n.s.	n.s.	n.s.			
Hill	1	48.25	c	34.97	56.78	b	42.59	a	55.35	b	44.62
	2	45.21	b	33.87	52.63	a	40.53	a	52.06	ab	43.19
	Summer	43.08	a	33.96	50.86	a	37.05	b	51.06	a	41.66
	Sig.	***	n.s.	***	**	*	n.s.	n.s.			
Plain	1	46.15	c	37.37	a	54.61	b	43.54	54.94	b	47.14
	2	43.62	b	34.71	b	50.12	a	41.11	52.15	a	44.22
	Summer	42.35	a	34.70	b	49.36	a	42.71	52.01	a	45.68
	Sig.	***	***	***	n.s.	**	n.s.				

n.s. not significant, \* significant  $P < 0.05$ , \*\* significant  $P < 0.01$ , \*\*\* significant  $P < 0.001$

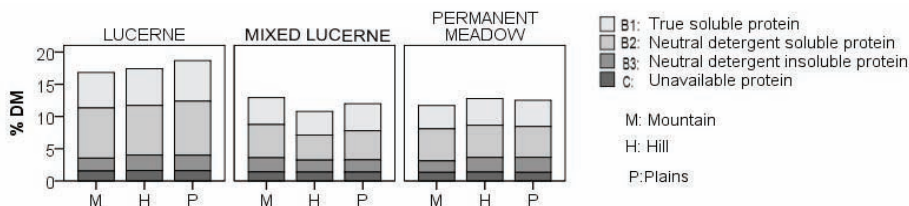

Figure 1: Protein content (CP %) and protein fractions in hay produced in PR production area

## Conclusion

Based on the results obtained from this study it can be concluded that forage quality in the PR cheese production area depends on the altitude and not on the province of origin. The RFV shows that, on average, good quality hays are produced in the area, although fairly low dNDF results were found, and indicate that forage production techniques, mainly the timing of the harvest, could be improved in order to increase forage intake. The use of high quality hays is useful to improve dairy cattle rations. In this way it is possible to increase the forage-to-concentrate ratio, thereby reducing the use of concentrates. This is important especially for the production of valuable dairy products, such as PR cheese.

## References

- Consorzio del Formaggio Parmigiano-Reggiano (2002) *Regolamento per l'alimentazione delle bovine*. Consorzio del Formaggio Parmigiano-Reggiano. Reggio Emilia. Italy. 8 pp.
- Oba M. and Allen M.S. (1999) Evaluation of the importance of the digestibility of neutral detergent fiber from forage: Effects on dry matter intake and milk yield of dairy cows. *Journal of Dairy Science* 82, 589-596.
- Rohweder D., Barnes R and Jorgensen N. (1978) Proposed hay grading standards based on laboratory analyses for evaluating quality. *Journal of Animal Science* 47, 747-759.
- Sniffen C., O'Connor J., Van Soest P., Fox D. and Russell J. (1992) A net carbohydrate and protein system for evaluating cattle diets: II: Carbohydrate and protein availability. *Journal of Animal Science* 70, 3562-3577.

## Variability in composition of grass samples in a national testing system for *Lolium perenne* L.

Burns G.A.<sup>1,5</sup>, Gilliland T.J.<sup>1,2</sup>, McGilloway D.A.<sup>3</sup>, Lewis E.<sup>4</sup>, O'Donovan M.<sup>4</sup> and O'Kiely P.<sup>5</sup>

<sup>1</sup> School of Biological Sciences, Queen's University Belfast, Northern Ireland

<sup>2</sup> Agri-Food & Biosciences Institute, Crossnacreevy, Northern Ireland

<sup>3</sup> Department of Agriculture, Fisheries and Food, Backweston, Ireland

<sup>4</sup> Teagasc, Moorepark Dairy Production Research Centre, Fermoy, Ireland

<sup>5</sup> Teagasc, Grange Beef Research Centre, Dunsany, Ireland

Corresponding author: gburns12@qub.ac.uk

### Abstract

National variety evaluation schemes in Ireland have recently supplemented yield with quality data to improve predictions of the animal production value of perennial ryegrass. Late and intermediate varieties, of two ploidies, were analysed by NIRS for crude protein (CP) ( $R^2 = 0.99$ ), water soluble carbohydrate (WSC) ( $R^2 = 0.97$ ) and digestibility (DMD) ( $R^2 = 0.92$ ). No significant variation was found in CP, but variety diversity in WSC and DMD was consistent with breeding effort. While transient interactions between variety quality and maturity or ploidy across the season must be accounted for, inclusion of these two parameters in variety evaluation trials was considered beneficial to improving recommendations in Ireland.

Keywords: perennial ryegrass, NIRS, digestibility, water soluble carbohydrate, crude protein

### Introduction

Traditional breeding approaches in ryegrasses have focused on improving yield and persistency and this is reflected in the national variety lists. An increase in yield of around 4% per decade has been reported for perennial ryegrass (*Lolium perenne*) crops on farms, with genetic improvement generally considered to account for just under half of this (Humphreys, 1997). Recommended variety lists for Ireland reported both water soluble carbohydrate (WSC) and dry matter digestibility (DMD) for the first time in 2008 (DAFF, 2008), reflecting current breeding objectives to improve ryegrass quality. To avoid prohibitive costs and workloads a near infrared reflectance spectroscopy (NIRS) calibration was developed for WSC ( $R^2 = 0.97$ ), DMD ( $R^2 = 0.92$ ) and crude protein (CP) ( $R^2 = 0.99$ ). The most commonly used measure of nutritional benefit in grasses has been DMD and this is often assessed in breeding and evaluation programmes (Casler, 2001). Recently, WSC has become an additional quality parameter in certain breeding programmes as it is a consistent and heritable trait (Humphreys, 1989). Humphreys (1989) proposed that an increase in WSC can increase the palatability of a variety and therefore lead to higher intakes and thus improved animal production, while Miller *et al.* (2001) reported increased proportions of ingested N being available for milk production and less secreted in urine. Ingested CP is of nutritional benefit by supplying N to the rumen microflora and amino acids to the animal, and can limit intake if below 80 g kg<sup>-1</sup> DM (Coleman and Moore, 2003). The current study examined these parameters in National List trials in Ireland, to assess levels of diversity between varieties and how ploidy, maturity, and season influenced ryegrass quality.

## Materials and methods

Three intermediate diploid (Cashel, Respect, Splega), three intermediate tetraploid (Greengold, Magician, Napoleon), two late diploid (Cancan, Gilford) and four late tetraploid (Mammout, Navan, Sarsfield, Delphin) varieties were sown the year prior to harvest at the Department of Agriculture, Fisheries and Food (DAFF) Variety Testing Unit, Backweston, Co. Kildare, Ireland. Data from three sowing years each with 4 replicates were analysed. In each harvest year six individual cuts were taken using a Haldrup harvester (DAFF, 2008). The total yield for each cut was calculated using an on-board balance and a 300 g subsample to determine the DM. These samples were then hammer milled (1 mm sieve). Samples were scanned on a NIRsystems 6500 (Foss UK Ltd., Warrington, UK). Absorbance (log 1/reflectance) was measured every 2 nm between 400-2500 nm. ANOVA was undertaken using Genstat to quantify the effects of variety, maturity group, ploidy and their interactions.

Constituent	Mean	SECV	R <sup>2</sup>
Crude protein in DM (g kg <sup>-1</sup> )	149.5	3.74	0.99
DMD (g kg <sup>-1</sup> )	796.8	13.10	0.92
WSC in DM (g kg <sup>-1</sup> )	197.2	10.39	0.97

Table 1 Modified Partial Least Square statistics of calibration for three composition variables

Table 2 Seasonal variation in three nutritional parameters and yield of perennial ryegrass. Seasonal divisions were spring, Sil.1 and Sil.2 as first and second silage cuts respectively and 'Rest Of Year' (ROY), harvested under a simulated grazing regime (DAFF, 2008).

	WSC in DM (g kg <sup>-1</sup> )				DMD (g kg <sup>-1</sup> )			
	Spring	Sil.1	Sil.2	ROY	Spring	Sil.1	Sil.2	ROY
Intermediate	234	181	167	182	859	797	783	806
Late	265	187	176	199	860	817	801	814
Diploid	230	169	171	187	853	793	791	804
Tetraploid	262	195	172	193	864	818	792	814
Variety	NS	<0.05	NS	<0.001	<0.05	<0.001	<0.001	<0.001
Maturity	<0.05	NS	NS	<0.001	NS	<0.001	<0.001	<0.001
Ploidy	<0.05	<0.005	NS	NS	<0.001	<0.001	NS	<0.001
Variety x Maturity	NS	<0.05	NS	<0.05	<0.01	<0.001	NS	<0.001
Variety x Ploidy	NS	NS	NS	<0.001	NS	<0.001	NS	<0.001

	CP in DM (g kg <sup>-1</sup> )				DM Yield (t ha <sup>-1</sup> )			
	Spring	Sil.1	Sil.2	ROY	Spring	Sil.1	Sil.2	ROY
Intermediate	185	123	138	160	0.4	6.5	3.7	4.2
Late	179	123	142	159	0.7	5.6	3.6	4.5
Diploid	185	123	141	159	0.6	6.1	3.4	4.3
Tetraploid	181	122	139	160	0.6	6.0	3.7	4.4
Variety	NS	NS	NS	NS	NS	<0.005	<0.005	<0.005
Maturity	NS	NS	NS	NS	<0.05	<0.001	NS	<0.001
Ploidy	NS	NS	NS	NS	NS	NS	<0.005	NS
Variety x Maturity	NS	NS	NS	NS	NS	<0.05	<0.005	NS
Variety x Ploidy	NS	NS	NS	NS	NS	<0.001	<0.05	<0.005

## Results and discussion

The calibration equations (Table 1) were accurate and robust and were used to study the differences between three factors (maturity, ploidy, variety) for four seasonal periods, for the three quality parameters (Table 2). There were no significant interactions between maturity and ploidy, and no differences for CP between any of the factors studied. This was not unexpected, as perennial ryegrass is known for its comparatively high CP content among forage grasses and breeders are not actively selecting for this parameter. As this NIRS estimate of CP is also a measure of total plant nitrogen and, given that the trials were conducted at 400 kg ha<sup>-1</sup> y<sup>-1</sup> of N, it is not improbable that some degree of luxury N levels



were induced. This was not tested, but could have contributed to the lack of significant differences. For WSC, significant variety x ploidy interactions occurred for Sil.1 and ROY, and for variety x maturity only for Sil.1. During these times, higher variety content was linked to tetraploidy while late maturity was associated with higher WSC contents. While no other interactions occurred there were still significant differences between ploidies, maturities and varieties at various stages of the season. Gilliland *et al.* (2002) also found tetraploids to have higher WSC content in spring and that there was a seasonal effect on which maturity group performed better. Digestibility showed more significant differences than with the other three factors. The differences were related to variety x maturity and variety x ploidy interactions at certain stages of the season. Varieties with later maturity tended to have higher quality through the growing season, except for Sil.2. Similarly, tetraploids had higher variety digestibility for Sil.1 and ROY. Beyond this, significant variety differences existed throughout the growing season, with higher DMD values being recorded for tetraploids and for late maturity. The higher DMD in the silage cuts for late maturing swards may be due to a higher proportion of vegetative herbage, rather than an innate difference in grass quality. The DM yield production (Table 2) was also affected by interactions between factors. Variety and maturity interacted only during the silage growths, with earlier tending to out-yield later heading varieties. Similar interactions were recorded between variety and ploidy during silage growth, but in different directions for Sil.1 and Sil.2. The higher association between variety yield and tetraploidy for Sil.2 was maintained to the end of the season.

## Conclusions

There was more variation in digestibility than in the other quality parameters, possibly reflecting the improvements made by breeders over many years, whereas improving WSC content is a much more recent breeding objective. The absence of differences in CP could similarly be expected due to the lack of breeding effort, but the naturally occurring high CP contents and the high N fertiliser rates used are probable contributing causes to the absence of variation. The differences in WSC and DMD did not appear to mirror the DM yield differences and so listing varieties primarily on a yield basis may not adequately reward breeding for improved grass quality. Although a higher WSC content may contribute to increasing the DMD the absence of significant interactions between these parameters suggests that they should be treated as separate evaluation factors. Significant differences within both maturity and ploidy suggest that other genetic factors have an influence on these two parameters. Overall, the observed amounts of variability in WSC and DMD appear to justify their incorporation in recommended list testing schemes, but care in interpretation is necessary to account for the reported interactions.

## References

- Casler M.D. (2001) Breeding forage crops for increased nutritional value. *Advances in Agronomy* 71, 51–107.
- Coleman S.W. and Moore J.E. (2003) Feed quality and animal performance. *Field Crops Research* 84, 17–29.
- Department of Agriculture, Fisheries and Food (DAFF) (2008) *Grass and Clover. Recommended List Varieties for Ireland 2008*, Ireland, 23 pp
- Gilliland T.J., Barrett P.D., Mann R.L., Agnew R.E. and Fearon A.M. (2002) Canopy morphology and nutritional quality traits as potential grazing value indicators for *Lolium perenne* varieties. *Journal of Agricultural Science* 139, 257–273.
- Humphreys M.O. (1989) Water-soluble carbohydrates in perennial ryegrass breeding. 3. Relationships with herbage production, digestibility and crude protein-content. *Grass and Forage Science* 44, 423–429.
- Humphreys M.O. (1997) The contribution of conventional plant breeding to forage crop improvement. In: Buchanan-Smith J.G. *et al.* (eds) *Proceedings 18<sup>th</sup> International Grassland Congress*, Canada, pp. 71–78.
- Miller L.A., Moorby J.M., Davies D.R., Humphreys M.O., Scollan N.D., MacRae J.C. and Theodorou M.K. (2001) Increased concentration of water-soluble carbohydrate in perennial ryegrass *Lolium perenne*: milk production from late-lactation dairy cows. *Grass and Forage Science* 56, 383–394.



## Aerobic deterioration in maize silages under different covering methods of the plastic film

Amaral R.C.<sup>1</sup>, Queiroz B.C.<sup>1</sup>, Garcia E.H.C.<sup>1</sup>, Sá Neto A.<sup>1</sup>, Bernardes T.F.<sup>2</sup> and Nussio L.G.<sup>1</sup>

<sup>1</sup>University of São Paulo, Department of Animal Science, Piracicaba, São Paulo, Brazil

<sup>2</sup>Federal Rural University of Amazon, Department of Animal Science, Belém, Pará, Brazil

Corresponding author: rcamaral@esalq.usp.br

### Abstract

Our aim was to study the effectiveness of covering methods to reduce the top losses in maize silages. The experiment comprised a completely randomized design, with five replicates of each of three treatments: 1) black polyethylene (PE) film 200  $\mu\text{m}$  thick, 2) black PE plus sugarcane bagasse (10  $\text{kg m}^{-2}$ ) over the film, and 3) black PE plus soil (30  $\text{kg m}^{-2}$ ) over the film. The forage was packed in macro silos (500 litres) which were opened 95 days after ensiling. During the silo filling one bag with well-mixed fresh forage (approximately 4  $\text{kg bag}^{-1}$ ) containing one data logger was buried into the upper layer (25 cm) of the silo to measure the temperature and sealing efficiency. Top losses in the silages were also determined by chemical and microbiological analyses. The difference in the covering methods did not affect the mean temperatures during the storage period, but started to rise only for the control silage after 81 days. Lower yeast-counts (colony forming units - cfu) were noticed in the silage covered with soil over the film (2.44  $\log \text{cfu g}^{-1}$ ). Better aerobic stability and hygienic aspects were achieved when the film was covered at ensiling, either with soil or sugarcane bagasse.

Keywords: film cover, maize silage, management practices, losses

### Introduction

The establishment of anaerobic conditions in silage is important to avoid the growth of aerobic microorganisms. Nevertheless, silage is stored in horizontal silos, which are exposed to air and prone to aerobic deterioration, mainly in the upper layer of those silos (Ashbell and Lisker, 1988). The plastic sheet used to cover silage has oxygen permeability and small amounts of air will penetrate the silage. Thus, the use of film cover materials over the plastic sheet may avoid the aerobic deterioration of silage during the storage and after the silo is opened. The amount of soil placed on top of the polyethylene plastic also affects silage quality (Bernardes *et al.*, 2009). Many farmers are particularly resistant to covering horizontal silos with soil, and consider that the labour and handling of the soil to add weight on the plastic are not worthwhile. Moreover, the use of soil can also be a source of contaminants in silage, mainly during the silo feed-out. Therefore, the use of sugarcane bagasse may be an alternative in order to reduce aerobic deterioration in the peripheral area of the maize silage. Sugarcane bagasse is lighter and is less likely to contaminate silage. The objective of this trial was to study the effectiveness of covering methods to reduce the top losses in maize silage.

### Material and methods

The trial was carried out in Piracicaba, Brazil (22°42'S, 47°38'W). Treatments consisted of three covering methods distributed in a completely randomized design with five replicates each over the black polyethylene film (200  $\mu\text{m}$  thick): 1) control – without coverage over the plastic film; 2) sugarcane bagasse – plastic sheet covered with sugarcane bagasse (10  $\text{kg m}^{-2}$ ); and 3) Soil – plastic sheet covered with soil (30  $\text{kg m}^{-2}$ ). Forage was ensiled (30-35% DM)

into macro experimental silos made on concrete, each containing 500 litres and of cylindrical shape (1.04 m<sup>2</sup> working area) which were packed by feet to reach 300 kg. During the ensiling one plastic bag with well-mixed chopped forage (approximately 4 kg of fresh weight per bag) and one data logger were buried into the upper layer (25 cm depth) of the silo. The plastic films were adjusted on the top of the silos and were fixed with adhesive tape and the silos were stored in an open field. The bags and data loggers were removed from the silos for analysis after 95 days after ensiling and silages were kept at room temperature exposed to air during 240 hours for stability measurements. The quality of the sealing method was assessed by temperature measurements, and top losses in the silages were also determined by chemical and microbiological analyses. Effects of treatments (covering methods) were analysed according to a randomized design, and temperature data during the 95 days from ensiling were analysed as repeated measurements over the experimental units by using the MIXED procedure (SAS Institute, 2002) and the statistical significance was declared at the 5% level.

## Results and discussion

Changes in the silage temperatures in the top layer of the treatments during the storage period are shown in Figure 1. Differences in the covering method did not affect ( $P > 0.05$ ) the mean temperatures during the storage period. However, after about 81 days of fermentation there was an interaction between treatments and time ( $P < 0.001$ ). The temperature started to rise in the control silage until the time of opening the silos. This might be attributed to the effect of oxygen permeability of the film during a long storage period because the gas transmission rate would be reduced by the presence of soil (Bernardes *et al.*, 2009) or sugarcane bagasse over the film. Chemical composition, microbial counts and dry matter (DM) losses from silages are shown in Table 1.

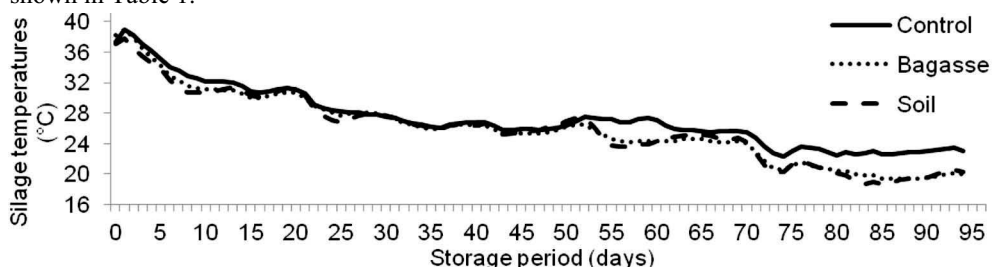

Figure 1. Effects of cover type over the plastic sheet on the temperature in the upper layer of maize silage during 95 days of storage. Treatment effect:  $P = 0.49$ ; Day effect:  $P < 0.001$ ; Interaction treatment  $\times$  time:  $P < 0.001$ .

Table 1. Fermentation parameters, microbial counts and aerobic stability in maize silage under different covering methods.

	Treatments			SEM <sup>1</sup>
	Control	Bagasse	Soil	
Dry matter (g kg <sup>-1</sup> )	274	275	272	0.09
Ash in DM (g kg <sup>-1</sup> )	51.3	52.9	52.3	0.10
pH	3.91	3.92	3.84	0.02
Yeasts (log <sub>10</sub> cfu g <sup>-1</sup> )	4.80 <sup>a</sup>	4.54 <sup>ab</sup>	2.44 <sup>b</sup>	0.41
Moulds (log <sub>10</sub> cfu g <sup>-1</sup> )	5.44	4.35	3.50	0.47
Dry matter losses (g kg <sup>-1</sup> )	67	72	77	0.53
$\Sigma 240$ (°C) <sup>3</sup>	298.9 <sup>a</sup>	269.42 <sup>ab</sup>	235.58 <sup>b</sup>	11.7

<sup>1</sup>SEM = standard error mean; <sup>2</sup>cfu = colony forming units; <sup>3</sup> $\Sigma 240$  = Thermal accumulation between the difference of silage and environment temperatures during 240 hours of air exposure.

There were no differences across treatments ( $P > 0.05$ ) for the mean values of DM ( $274 \text{ g kg}^{-1}$ ) and ash ( $52 \text{ g kg}^{-1}$ ). The average value of pH (3.89) did not differ ( $P > 0.05$ ) across the treatments either. The lack of differences in chemical composition between treatments might be explained by the reduced time between the onset of the increase in control silage temperature and the opening of the silos. Although the chemical composition and DM losses did not differ across treatments, yeast counts showed higher values ( $P < 0.05$ ) for the control silages. Lower yeasts were counts in the silage covered with soil over the film ( $2.44 \text{ log cfu g}^{-1}$ ), even though not statistically different than sugarcane bagasse over the plastic sheet ( $4.54 \text{ log cfu g}^{-1}$ ). The role of yeasts in initiating aerobic deterioration of many silage crops has been widely recognized by several authors (Pahlow *et al.*, 2003). Thus, the increased activity of aerobic microorganisms in this treatment would probably explain the rise in silage temperature, promoting heating of forage mass. The silage temperatures in the top layer of treatments during the aerobic stability are shown in Figure 2. The first temperature peak of control silage (24 hours) appeared earlier than those covered by bagasse (56 hours) or soil (104 hours). At the silos opening, the control silage showed more yeasts counts (Table 1), probably due to the greater diffusion of oxygen allowed by the plastic sheet used. Thus, the greatest amount of spoiling microorganisms during the feed out phase would have allowed an earlier deterioration of the silage (Figure 2). Another possibility to explain the later increase of temperature in the bagasse and soil covering treatments could be related to the packing effect by the silo covering, preventing oxygen influx into the silage mass. Thermal accumulation (Table 1) between the difference of silage and environmental temperatures during 240 hours of air exposure was minor ( $P < 0.05$ ) in silage covered with soil over the plastic sheet, which also helps on demonstrate the effectiveness of this covering strategy.

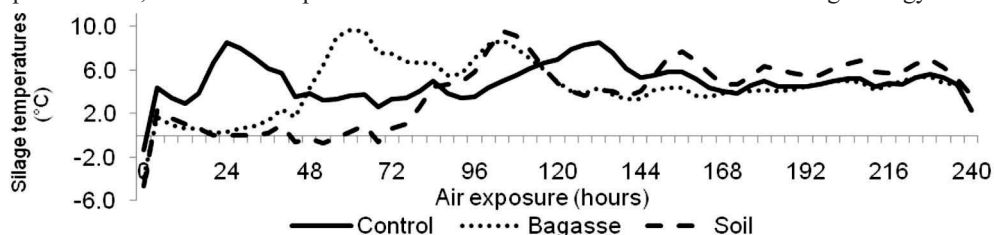

Figure 2. Effects of covering methods on temperature in the upper layer of corn silages during 240 hours of air exposure. Treatment effect:  $P = 0.48$ ; Time effect:  $P < 0.001$ ; Interaction treatment  $\times$  time:  $P = 0.017$ .

## Conclusion

Covering the plastic sheet with soil or sugarcane bagasse was effective in controlling the heating of silage preserved, and delayed the onset of aerobic deterioration in the upper layer of maize silage. The lower count of yeasts on silages in which the plastic film was covered also suggests a better hygienic condition. However, after 95 days from the ensiling, the dry matter losses were not different across the covering methods studied.

## References

- Ashbell G. and Lisker N. (1988) Aerobic deterioration in maize silage stored in a bunker silos under farm conditions in a subtropical climate. *Journal of the Science of Food and Agriculture* 45, 307–315.
- Bernardes T. F., Nussio L.G., Amaral R.C. and Schogor A.L.B. (2009) Sealing strategies to control the top losses of corn silage. *Proceedings of International Silage Conference*, Madison, Wisconsin, USA, pp. 213-214.
- Pahlow G., Muck R.E., Driehuis F., Oude Elferink S.J.W.H. and Spoelstra S.F. (2003) Microbiology of ensiling. In: Buxton D.R., Muck R.E. and Harrison J.H. (eds.) *Silage Science and Technology*, ASA-CSSA-SSSA, Madison, USA, pp. 31-93.

## Description and prediction of multi-species pasture nutritive value across the grazing season

Delaby L.<sup>1</sup>, Baumont R.<sup>2</sup>, Peccatte J.R.<sup>3</sup>, Aufrère J.<sup>2</sup> and Peyraud J.L.<sup>1</sup>

<sup>1</sup> INRA, AgroCampus Ouest, UMR 1080, Production du Lait, 35590 Saint Gilles, France

<sup>2</sup> INRA, UR sur les Herbivores, Theix, 63122 Saint Genès Champanelle, France

<sup>3</sup> INRA, Experimental farm, UE 326, Le Pin-au-Haras, Borculo, 61310 Exmes, France

Corresponding author: luc.delaby@rennes.inra.fr

### Abstract

Multi-species pastures with grasses and legumes have the potential to enhance ruminant nutrition. The nutritive value of two multi-species pastures was evaluated *in vivo* (standard sheep digestibility measures) during the April to October period, over 5 consecutive years in Normandy. The first multi-species were a mixed sward recommended for use in the Swiss lowlands and the second came from the Loire valley in France. While the nutritive value of both pastures was high on average during the year, the Loire valley mixture had a light advantage in spring and autumn. The high nutritive values observed during autumn reaffirm the nutritional potential of autumn grazing. The results indicate that the prediction of organic matter OM digestibility of multi-species swards using the equation including pepsin-cellulase is imprecise compared to monocultures, but is improved when the age of regrowth is included.

Keywords: multi-species pasture, feeding value, season, forecasting

### Introduction

It is now widely accepted that multi-species pastures have substantial agronomic and animal nutrition advantages compared to monocultures. The feeding values, in terms of voluntary intake, digestibility, energy and protein content and their variation according to season and management are poorly described. The objective of the 5-year experiment described in this paper was to evaluate the feeding value of two sown multi-species pastures using *in vivo* sheep digestibility measurements.

### Material and methods

In September 2004, two multi-species pastures were sown (at a seeding rate of 34.5 kg ha<sup>-1</sup>) at the INRA experimental farm of Le Pin-au-Haras (Normandy - 48.44°N - 0.09° E). The Le Pin-au-Haras drained clay-loam soil type and oceanic climate are favourable for grass production with annual mean temperature of 10.7 °C and cumulative rainfall of 725 mm distributed evenly over 160 rainy days during the year. The first multi-species, named “Swiss”, was a mixed sward (Mst 444) recommended by ADCF (Switzerland) for use in the Swiss lowlands and contained foxtail (7.5 kg ha<sup>-1</sup>), red fescue (3.5 kg ha<sup>-1</sup>), meadow fescue (7.5 kg ha<sup>-1</sup>), common meadow grass (9.5 kg ha<sup>-1</sup>), perennial ryegrass (3.0 kg ha<sup>-1</sup>) and white clover (3.5 kg ha<sup>-1</sup>). The second multi-species, named “Loire valley”, was composed by the advisory services of the Loire valley in France and contained tall fescue (9.0 kg ha<sup>-1</sup>), timothy (4.5 kg ha<sup>-1</sup>), perennial ryegrass (7.0 kg ha<sup>-1</sup>), red clover (4.5 kg ha<sup>-1</sup>), white clover (2.5 kg ha<sup>-1</sup>), hybrid clover (3.5 kg ha<sup>-1</sup>) and birds-foot trefoil (3.5 kg ha<sup>-1</sup>). During the experiment (2005-2009), the pastures were never nitrogen fertilized and received only one application of 100 kg of P and 200 kg of K per hectare. The grass was always harvested by cutting except in autumn when the last harvest was achieved by grazing with heifers.

During the April to October period, 145 digestibility measurement periods (62 and 83 for the Swiss and Loire Valley pastures, respectively) distributed in 16 (Swiss pasture) and 19 (Loire Valley pasture) sequences of 3 to 7 weeks in duration were realised to evaluate the chemical composition, nutritive value and variation according to age of regrowth. Fresh grass was cut each morning with a motor scythe and distributed *ad libitum* to 6 castrated sheep maintained in metabolism cages to control intake and collect faeces. During a digestibility measurement period, grass offered, the refusals and the total faeces excreted were individually weighed daily and dried during 6 consecutive days to measure voluntary intake (DMI in g DM per kg BW<sup>0.75</sup>) and organic matter digestibility (OMd). Each week, a composite of the 6-days daily samples of grass offered, refusals and faeces were analysed to determine OM in DM (g kg<sup>-1</sup>), crude protein (CP in DM in g kg<sup>-1</sup>) and crude fibre (CF in DM in g kg<sup>-1</sup>) concentrations. The net energy for lactation (NEL) expressed in UFL (1 UFL = 1700 kcal kg<sup>-1</sup>), the protein digestible in the intestine (PDI in DM in g kg<sup>-1</sup>) value and the lactation fill unit (LFU in DM in kg<sup>-1</sup>) value were calculated using the INRA feed value equations revised by Baumont *et al.* (2007). To establish equation to predict the OM digestibility, the pepsin-cellulase digestibility (CSD) technique was applied on the 145 offered grass samples according to the methodology proposed by Aufrère *et al.* (2007). Each week, a representative sample of the grass offered was selected to determine the floristic composition of the multi-species sward and the species contribution to the biomass. The chemical composition and nutritive value data have been analysed by variance analysis including the effect of year (n=5), pasture type (n=2), season (n=4), the interaction between the last two main factors and the age of regrowth as continuous variables in the model. The predicted OM digestibility equation was developed using linear regression.

## Results and discussion

During the first year, the Loire valley pasture was dominated by perennial ryegrass (36% of the biomass) and later tall fescue and timothy had an important contribution (50% in 2007 and 2008). The red clover was dominant during the first two years (between 40 to 55%) in particular during summer (up to 80%) was reduced in aid of white clover (27 to 34%) while birds-foot trefoil was never present. The Swiss pasture was rapidly dominated by foxtail (from 23 in 2005 to 70% in 2008) while white clover contributed 25% of the biomass. Both multi-species grasses were characterised by a high nutritive value (152 g kg<sup>-1</sup> of CP in DM and 71.9% of OMD). At the same age of regrowth, the Loire valley pasture had a higher nutritive value than the Swiss pasture for all parameters analysed. The CP content in DM (+12 g kg<sup>-1</sup>) and OM digestibility (+1.3%) were higher and the CF content in DM (-9 g kg<sup>-1</sup>) was lower for the Loire valley pasture. Consequently, the UFL and PDI values were slightly higher and the LFU value was somewhat lower. In fact, as confirmed by the significant interaction, the greatest differences between the two multi-species pastures were observed in spring for OMD and UFL and in spring and autumn for voluntary DM intake. During the remainder of the year, the two pastures had very similar characteristics. These differences can be attributed to the high proportion of foxtail (early heading grass and high growth potential in spring) in the Swiss mixture in contrast to the opposite effect for the high proportion of red and white clover in the Loire valley mixture. Each year, the nutritive value declined from spring to late summer, however the decline is less pronounced in comparison to grass monocultures because of the higher summer contribution of the legumes. This is particularly true for the crude protein content and PDI value observed in summer. Both pastures had high nutritive value in autumn (protein content and energy value) resulting in high voluntary intake and re-emphasised the benefits of grazing autumn regrowth, eventually supplemented with conserved forages like maize silage. The age of regrowth had a significant effect on the nutritive value. On average, the weekly decline in CP content, OMD and UFL was -8.4 g, -2

points and -0.03 UFL, respectively and the CF and LFU content increasing was +7.8 and +0.013 g respectively. The variation observed is consistent with the effect of ageing of the vegetation cell walls (Daccord *et al.*, 2002).

The best relationship obtained to predict the OMD value included age of regrowth (Rgw in days), the CSd value (%) and the season but with no significant effect of pastures type. The equation was

$$\text{OMd} = 60.5 + \text{Season} - 0.16 \times \text{Rgw} + 0.31 \times \text{CSd} \quad (n=145, R^2=0.63, \text{RSE} = 3.15)$$

with a Season effect of +0.84 ; -0.14 ; -3.27 and +2.58 respectively for spring, early summer, late summer and autumn. This equation is interesting but is less precise than those published by Baumont *et al.* (2007) for monocultures.

Table 1: Chemical composition in dry matter and nutritive value of two multi-species pastures according to the season and age of regrowth.

Pasture - Season - Age of regrowth (days) <sup>(1)</sup>	DM %	OM g kg <sup>-1</sup>	CP g kg <sup>-1</sup>	CF g kg <sup>-1</sup>	OMd %	DMI g kg <sup>-1</sup> in BW <sup>0.75</sup>	UFL kg <sup>-1</sup>	PDIN g kg <sup>-1</sup>	PDIE g kg <sup>-1</sup>	LFU g kg <sup>-1</sup>
<b>Swiss pasture (n=62)</b>	<b>21.9</b>	<b>882</b>	<b>148</b>	<b>259</b>	<b>72.0</b>	<b>72.9</b>	<b>0.84</b>	<b>101</b>	<b>93</b>	<b>1.02</b>
Spring - 33 to 68 days	20.6	891	124	273	70.7	57.7	0.82	86	89	1.12
Early summer - 28 to 65 days	23.2	882	132	271	71.4	77.3	0.83	90	90	0.99
Late summer - 30 to 63 days	25.7	890	156	263	69.4	81.3	0.81	107	93	0.97
Autumn - 37 to 63 days	18.1	867	179	227	76.4	75.2	0.89	121	100	1.00
<b>Loire valley pasture (n=83)</b>	<b>20.2</b>	<b>888</b>	<b>160</b>	<b>250</b>	<b>73.3</b>	<b>78.8</b>	<b>0.86</b>	<b>110</b>	<b>97</b>	<b>0.98</b>
Spring - 33 to 91 days	17.9	890	141	266	75.2	66.1	0.89	96	95	1.06
Early summer - 29 to 64 days	20.8	894	137	266	71.8	79.1	0.84	94	92	0.98
Late summer - 30 to 71 days	23.5	895	167	262	68.6	85.1	0.80	113	91	0.94
Autumn - 37 to 70 days	18.6	874	195	204	77.6	85.0	0.92	132	104	0.95
RSE	3.85	8.86	19.6	21.6	3.37	6.5	0.05	12.8	4.4	0.04
<b>Age of regrowth slope (d<sup>-1</sup>)</b>	<b>0.10</b>	<b>0.44</b>	<b>-1.20</b>	<b>1.12</b>	<b>-0.29</b>	<b>-0.30</b>	<b>-0.004</b>	<b>-0.78</b>	<b>-0.39</b>	<b>0.0019</b>
Pasture effect	0.012	0.001	0.001	0.019	0.025	0.001	0.003	0.001	0.001	0.001
Season effect	0.001	0.001	0.001	0.001	0.001	0.001	0.001	0.001	0.001	0.001
Pasture x season interaction	0.368	0.029	0.583	0.219	0.006	0.045	0.019	0.608	0.054	0.027

(1) Spring: April and May; Early summer: June to mid July; Late summer: mid July to mid September and Autumn: mid September to end of October. The first rotation in spring is considered to start the 1<sup>st</sup> of March.

DM: dry matter; OM: organic matter; CP: crude protein; CF: crude fibre; OMD: organic matter digestibility; DMI dry matter intake; UFL: unite fourragère lait; PDIN and PDIE: Protein digestible in the intestine according to nitrogen (N) or energy (E) available; LFU: lactation feed unit

## Conclusion

In this experiment, the multi-species pastures were shown to be high of interest for ruminant feeding due to the high contribution of legumes (red and white clovers) in the mixture. The predictions of the digestibility and the nutritive value of these pastures remain difficult because of the large variation of the contribution of each species during the grazing season or between years.

## References

- Aufrère J., Baumont R., Delaby L., Peccatte J.R., Andrieu J., Andrieu J.P. and Dulphy J.P. (2007) Prédiction de la digestibilité des fourrages par la méthode pepsine-cellulase. Le point sur les équations proposées, *INRA Productions Animales* 20(2), 129-136.
- Baumont R., Dulphy J.P., Sauvart D., Meschy F., Aufrère J. and Peyraud J.L. (2007) Valeur alimentaire des fourrages et des matières premières: tables et prévision. In: Quae (eds) *Alimentation des bovins, ovins et caprins* Versailles, France, pp 149-179.
- Daccord R., Arrigo Y., Jeangros B., Scehovic J., Schubiger F.X. and Lehmann J. (2002) Valeurs nutritives des plantes de prairies. 6. Valeurs azotés et énergétiques. *Revue suisse d'Agriculture* 9(1), 22-27.



## Physico-chemical characterisation of forage fibre from different C<sub>3</sub>-grasses in South Brazil

Eggers M.<sup>1</sup>, Bockor J.<sup>2</sup>, Oliveira Júnior J.M.<sup>2</sup>, Warpechowski M.B.<sup>2</sup>, Dittrich J.<sup>2</sup> and Gierus M.<sup>1</sup>

<sup>1</sup> *Grass and Forage Science/Organic Agriculture Group, Institute of Crop Science and Plant Breeding, Christian-Albrechts-University, 24098 Kiel, Germany*

<sup>2</sup> *Departamento de Zootecnia, Universidade Federal do Paraná, Curitiba, Brasil*

Corresponding author: eggers.markus@yahoo.de

### Abstract

The physico-chemical characteristics of fibre influence the availability of nutrients and energy in diets for ruminants and monogastric animals. Depending on its buffering capacity (BC), fibre exchange cations with H<sup>+</sup> in the lumen of the gastrointestinal tract. The objective was to examine relations between quality parameters and the linearised form of the BC (the linear buffering rate, LBR) of different forages. Three grass species (*Avena sativa*, *Avena strigosa*, *Lolium multiflorum*) normally grown in the winter in South Brazil were evaluated. CP, NDF, ADF, ash and gas production (GP) were measured. The BC was evaluated in the whole sample and in the residue after NDF extraction, representing the fibre fraction. The results showed a higher BC in the whole sample compared to the NDF fractions. Differences for BC between species were observed in the intact material, but not for their NDF fractions. CP was positively, and cell wall contents were negatively, related to LBR in the whole sample. The relation was weak between accumulated GP and LBR estimated in the whole sample and in the NDF fraction. In conclusion, the LBR showed a clear relationship with nutrients in the forages. This relation was weaker using the NDF fraction of samples.

Keywords: buffering capacity, pH, physico-chemical property, gas production

### Introduction

Although chemical *in vitro* methods have led to a greater understanding of the interactions between the plant material and gastrointestinal anatomy, as well as the duration and extent of the fermentation process, there is a lack of information about intrinsic physical properties of substrates. Such properties of feeds may have a large influence on the microbial fermentation capacity in the rumen and are not taken into account by the widespread (routine) forage-classification systems (McBurney *et al.*, 1983). Among different physico-chemical properties, the buffering capacity (BC) of the feed is commonly used, because it influences the pH in the reticulorumen of ruminants and the NDF-BC influences the pH in the gastrointestinal tract of monogastric animals during the digestive process (Van Soest *et al.*, 1991). The BC depends on the chemical composition of diets, i.e. the macromolecular structure and free reactive groups capable of exchanging ions with the environment. Hence the cell wall fulfils an important function in the optimization of the gastrointestinal pH, besides the stimulation of the salivary production (Van Soest *et al.*, 1991). In the rumen, the pH decrease results in accumulation of H<sup>+</sup>-ions, which are buffered by the negative charged free radicals of the fibre matrix. In this way, cellulolytic microbes may not adhere to the cell walls. The intrinsic buffering capacity through the titration curves was measured to estimate the BC of different forages and feeds for ruminants and monogastric animals. The objective of the present study was to investigate the correlation between different forage quality parameters and the linearized form of the BC (the linear buffering rate, LBR) to increase the precision of the relationship between the fibre content in diets and the degradation characteristics of feeds.



## Materials and methods

### Feed samples and chemical analyses

The chemical analyses, BC and gas production has been evaluated for three forages: annual ryegrass (*Lolium multiflorum*), green oats (*Avena sativa*) and black oats (*Avena strigosa*), typically grown in South Brazilian during the winter months. All 2007 harvested samples were fresh forages which originated from second-cut swards at the experimental area of the UFPR in Curitiba, Brazil. All samples were ground to 1 mm screen and the chemical analyses (NDF, ADF, CP, lignin) were determined in accordance with Goering and Van Soest (1970).

### Titration

Replicated samples (0.5 g) of the intact material and its NDF fraction were suspended into 50 ml distilled-deionised water. The initial pH was determined and the pH of these suspensions were raised to 8.0 with NaOH and then titrated with HCl to pH 2.0. The TA (titratable acidity) was determined as the amount of acid needed to reduce the pH from 8.0 to 2.0, expressed in mEq g<sup>-1</sup> dry matter of the sample (intact or NDF fraction). BC was obtained by dividing the values of TA by the standardized pH range (8.0 to 2.0). The pH data were transformed by the function  $Y = \text{EXP}(1/\text{pH})$ , and the LBR (linear buffering rate) was calculated as the inverse of the slope of the linear regression between Y and the cumulated amount of acid added (Oliveira Júnior *et al.*, 2010).

### Gas production method

The cumulative gas curve was obtained using the automated pressure evaluation system (APES) (Davies *et al.*, 2000). Each sample was replicated three times in each run, and two runs were performed. To obtain the apparent gas production rate (e) an asymptotic three-parameter regression model with the mean function was used:  $f(x) = c + (d-c)(1 - \exp(-x/e))$ . The parameter c is the lower limit (at x = 0), the parameter d is the upper limit and the parameter e > 0 is determining the steepness of the increase as x.

Table 1. Average values of the gas production (GP in DM) after 24 h, gas production rate (e), titratable acidity (TA in DM), buffering capacity (BC in DM) and the linear buffering rate (LBR in DM) for the intact material and the fibre fraction (NDF)

Species	Intact material					NDF-fraction		
	GP <sup>1</sup> (ml g <sup>-1</sup> )	e <sup>2</sup> (ml min <sup>-1</sup> )	TA	BC (mEq H <sup>+</sup> g <sup>-1</sup> )	LBR	TA	BC	LBR
Black oats	111	0.043	3.09	0.511 <sup>a</sup>	5.519 <sup>a</sup>	1.45	0.240	2.614
Green oats	131	0.037	2.71	0.448 <sup>b</sup>	4.835 <sup>b</sup>	1.62	0.261	2.759
Annual ryegrass	145	0.048	2.53	0.415 <sup>b</sup>	4.597 <sup>b</sup>	1.41	0.229	2.356

<sup>1</sup> gas production after 24 h, method APES

<sup>2</sup> the increasing run of the curve during the gas production period

abc: significant differences ( $P < 0.05$ ) between species

## Results and discussion

The slopes of the titration curves differed highly ( $P < 0.001$ ) between the intact material and their NDF fraction. To achieve the pH decrease from 8 to 2 for the intact material 2.88 mEq H<sup>+</sup> g<sup>-1</sup> DM TA were necessary on average. For the NDF material 1.54 mEq H<sup>+</sup> g<sup>-1</sup> DM were sufficient (Table 1). The removal of cell contents and pectin through the NDF-procedure leads to the lower observed and expected BC/LBR-values of the fibre fraction in comparison to the intact material.

Black oats had the significantly greatest BC in the intact material, followed by green oats and annual ryegrass. Although a ranking among the fibre fraction of the species regarding their

buffering capacity or LBR is possible, they were statistically not significant with the NDF fraction. The treatment with the neutral detergent solution seems to offset the differences.

Table 2. Correlation coefficients ( $r$ ) between the LBR and selected forage quality parameters of the intact material and the fibre fraction from the second-cut sward

	Intact material								NDF-fraction		
	CP	NDF	ADF	Lignin	Hem.	Cell.	Ash	e	NDIN	Ash	e
Black oats	0.49	-0.71	-0.58	-0.57	<b>-0.83</b>	-0.55	0.46	0.06	0.01	0.37	0.41
Green oats	<b>0.88</b>	-0.66	-0.64	-0.71	-0.60	-0.57	0.68	0.11	-0.21	-0.03	-0.16
Annual ryegrass	0.73	-0.75	-0.54	-0.73	<b>-0.88</b>	-0.36	0.82	-0.04	0.33	0.10	0.16
all samples	0.67	-0.65	-0.44	-0.46	-0.69	-0.42	0.64	0.19	0.38	0.25	0.24

Hem. = hemicellulose; Cell. = cellulose; NDIN = neutral detergent indigestible nitrogen; e  $\approx$  the gas production rate

High protein and ash contents showed a good correlation ( $r = 0.67$  and  $0.64$ ) with the buffering capacity respectively the linear buffering rate (Table 2). The reasons are the direct buffering properties of the amino groups and the presence of  $\text{NH}_3$  from the deamination of the proteins. Furthermore, the mineral ion contents of the forages are acting directly on the BC. The cell wall components were negatively related to the LBR: e.g. the hemicelluloses ( $r = -0.69$ ) and NDF ( $r = -0.65$ ), but the relation with the lignin fraction was weaker ( $r = -0.46$ ). The relationship between the gas production rate (e) and the LBR ( $r = 0.19$ ) was rather poor and did not appear to be a good indicator for any kind of degradation characteristics.

The LBR shows a weak correlation from  $r = 0.24$  to  $r = 0.38$  with the parameters of the NDF fraction described in Table 2. This was probably due to the NDF-procedure and the heating, which may have damaged the macromolecular structure and changed the capability of exchanging ions. Because of that, the BC of the fibre seems rather unsuitable to describe or specify degradation kinetics in the gastrointestinal tract.

## Conclusions

The LBR showed a clear relationship with nutrients and the structural carbohydrates in the intact forage material. However, this relation was rather poor using the NDF fraction of samples. Furthermore a rather poor correlation was obtained between the linear buffering rate and the degradation process, as represented by the gas production rate..

## References

- Davies Z.S., Mason D., Brooks A.E., Griffith G.W., Merry R.J. and Theodorou M.K. (2000) An automated system for measuring gas production from forages inoculated with rumen fluid and its use in determining the effect of enzymes on grass silage. *Animal Feed Science and Technology* 83, 205-221.
- Goering H. K. and Van Soest P.J. (1970) Forage fiber analyses (apparatus, reagents, procedures, and some applications). *Agriculture Handbook* No. 379. ARS-USDA, Washington, USA.
- McBurney M.I., Van Soest P.J. and Chase L.E. (1983) Cation exchange capacity and buffering capacity of neutral-detergent fibres. *Journal of the Science of Food and Agriculture* 34, 910-916.
- Oliveira Junior J.M., Bockor L., Eggers. M. Gierus M., Dittrich J.R. and Warpechowski M.B. (2010) Linearização de curvas de titulação para determinação da capacidade tamponante da fibra de alimentos em faixas amplas de pH. *Acta Scientiarum. Animal Sciences* 2010 (in press).
- Van Soest P.J., Robertson J.B. and Lewis B.A. (1991) Symposium: carbohydrate methodology, metabolism, and nutritional implications in dairy cattle. Methods for dietary fiber, neutral detergent fiber, and nonstarch polysaccharides in relation to animal nutrition. *Journal of Dairy Science* 74, 3583-3597.

## Fatty acid composition of forage herb species

Warner D.<sup>1,2</sup>, Jensen S.K.<sup>3</sup>, Cone J.W.<sup>2</sup> and Elgersma A.<sup>1</sup>

<sup>1</sup>Wageningen University, Plant Sciences Group, P.O. Box 16, 6700 AA Wageningen, The Netherlands

<sup>2</sup>Wageningen University, Animal Nutrition Group, P.O. Box 338, 6700 AH Wageningen, The Netherlands

<sup>3</sup>Aarhus University, Faculty of Agricultural Science, P.O. Box 50, 8830 Tjele, Denmark

Corresponding author: Anjo.Elgersma@wur.nl

### Abstract

The use of alternative forage species in grasslands for intensive livestock production is receiving renewed attention. Data on fatty acid composition of herbs are scarce, so four herbs (*Plantago lanceolata*, *Achillea millefolium*, *Cichorium intybus*, *Pastinaca sativa*) and one grass species (timothy, *Phleum pratense*) were sown in a cutting trial. The chemical composition and concentration of fatty acids (FA) of individual species were determined during the growing season. Concentrations of crude protein and FA were generally higher in the herbs than in timothy. *C. intybus* had the highest nutritive value and FA concentrations. FA concentrations were generally lower in June after a heavy cut than in May and August.

Keywords: Forage herbs, fatty acid methyl esters, seasonal variation, C18:3, timothy

### Introduction

In recent years, much effort has been made to elucidate the fatty acid (FA) profile of forage plants in relation to meat and milk quality with regard to potential health aspects. Most studies on the FA composition of individual species were carried out with common grasses (Dewhurst *et al.*, 2001; Elgersma *et al.*, 2003) and some legume species. Data on alternative forage species are scarce. Clapham *et al.* (2005) compared traditional and novel forage species grown under greenhouse conditions and observed significant differences in the FA profile of grass and herb species. The proportion of C18:3 was lower and more variable in herbs than in grasses. Increased concentrations of polyunsaturated FA in milk from higher altitudes could be related to a higher percentage of herbs (Collomb *et al.*, 2002). However, to our knowledge, no data are available on the FA profile of individual herb species grown in a sward. Therefore, a cutting trial was set up with four herb species and timothy. The chemical composition and concentrations of FA of these species were determined during three cuts during the growing season to quantify seasonal variation.

### Material and methods

The trial was established on a clay soil in 2003 in Wageningen, The Netherlands (51°58'N and 5°39'E, 7 m a.s.l.). Plots of 1.5 by 8 m were sown in triplicate in a randomized block design with four entries: monocultures of ribwort (*Plantago lanceolata*), yarrow (*Achillea millefolium*), chicory (*Cichorium intybus*) and a mixture of parsnip (*Pastinaca sativa*) and timothy (*Phleum pratense*).

The trial had been established in 2003 and was cut 4 to 5 times annually during 2004-2006. Results for 2007 are presented here only. In 2007, a summer drought occurred and, as the plots were not irrigated, they were only cut three times (with a Haldrup forage harvester) i.e., 14 May, 18 June and 27 August (Table 1). The trial was N fertilised with ammonium nitrate: 30 kg ha<sup>-1</sup> in March and 20 kg ha<sup>-1</sup> after every cut; P and K were applied according to

requirements. Samples of about 125 g of the harvested material were taken directly after cutting in 2007 and hand-separated into sown species and weeds, to obtain pure species samples for analyses. Samples were immediately stored in a freezer ( $-20\text{ }^{\circ}\text{C}$ ), freeze-dried and stored. Samples were ground to pass a 1-mm sieve. FA analysis was performed at Aarhus University in Foulum, Denmark. Lipids were extracted according to the HCl-Bligh and Dyer extraction with a mixture of water, methanol and chloroform and esterified to form methyl esters (FAME) which were quantified by gas chromatography with C17 as internal standard (Jensen, 2008).

Table 1. Content in DM ( $\text{g kg}^{-1}$ ) of ash, crude protein (CP), neutral detergent fibre (NDF), individual and total fatty acids (TFA) of grass and herb species over three cuts in 2007.

Harvest date	DM content ( $\text{g kg}^{-1}$ )	Ash	CP	NDF	C16:0	C18:2	C18:3	TFA
<i>Phleum pratense</i>								
14/05/2007	182	52	102	396	2.68	3.46	10.49	18.28
18/06/2007	199	63	65	539	1.93	2.38	5.92	11.48
27/08/2007	215	71	103	361	2.48	3.58	10.57	18.10
<i>Plantago lanceolata</i>								
14/05/2007	145	102	115	174	3.20	3.57	12.86	20.84
18/06/2007	155	100	87	295	2.41	3.03	7.56	14.07
27/08/2007	206	115	108	237	3.29	4.13	11.71	20.77
<i>Cichorium intybus</i>								
14/05/2007	108	127	123	169	6.06	6.15	18.59	32.63
18/06/2007	121	141	101	171	5.23	5.55	15.63	28.03
27/08/2007	144	152	110	174	4.70	5.33	13.96	25.60
<i>Achillea millefolium</i>								
14/05/2007	156	108	139	174	3.98	6.25	13.96	25.92
18/06/2007	169	102	87	284	3.37	5.18	8.45	18.56
27/08/2007	220	151	115	209	3.43	5.27	9.65	19.97
<i>Pastinaca sativa</i>								
14/05/2007	134	101	86	171	4.16	8.89	8.00	24.95
18/06/2007	153	110	88	286	3.75	8.78	4.30	20.48
27/08/2007	191	147	119	163	4.20	9.13	7.19	20.02
Mean	167	109	103	257	3.64	5.13	10.88	21.52
SEM	5	6	3	28	0.221	0.279	0.712	1.30
Significances								
Species (S)	***	***	**	***	***	***	***	**
Harvest (H)	***	***	***	**	NS	NS	**	*
S x H	**	**	***	*	NS	NS	NS	NS

\*\*\*  $P < 0.001$ ; \*\*  $P < 0.01$ ; \*  $P < 0.05$ ; NS, non significant; SEM, standard error of the mean.

## Results and discussion

Herbage chemical composition, and total and individual FAME concentrations were characteristic to species (Table 1); particularly the three major FA, C18:3, C18:2 and C16:0, were highly affected by the plant material ( $P < 0.001$ ). Timothy differed from the herbs in terms of having particularly low levels of total FA (TFA), C18:3, C18:2 and C16:0. Besides expected differences between the grass and the herbs, a further distinction could be made among the individual herb species studied. Chicory was highest in TFA and C18:3 concentrations, which is in accordance with the results of Clapham *et al.* (2005). Ribwort and yarrow were similar in terms of FAME levels. Parsnip had fibre and protein levels that were comparable to chicory, but a unique FA profile with very low concentrations of C18:3 (27% of TFA) and high concentrations of C18:2 (39% of TFA).

The cutting date affected the concentration of C18:3 ( $P < 0.01$ ) and TFA ( $P < 0.05$ ): all species had lower values in mid-June (after a heavy cut) than in mid-May or in late August. In other studies with grass species, cutting date was a central factor in determining FA concentration in fresh forage (Dewhurst *et al.*, 2001; Elgersma *et al.*, 2003), and particularly high FA concentrations were found in autumn at low temperatures (Witkowska *et al.*, 2008). In our study, no autumn cut was taken due to poor growth.

## Conclusions

Herbs were superior to timothy in crude protein and FA concentrations; the latter differed considerably among herb species. Chicory contained the highest concentration of total FA and C18:3, and was also superior to other herb species in terms of nutritional composition. Parsnip had a distinctive FA profile, with a particularly low proportion of C18:3.

## Acknowledgements

Financial support of D. Warner by the Grassland Science Foundation (SGW) is gratefully acknowledged.

## References

- Clapham W.M., Foster J.G., Neel J.P.S. and Fedders J.M. (2005) Fatty acid composition of traditional and novel forage species. *Journal of Agriculture and Food Chemistry* 53, 10068-10073.
- Collomb M., Bütikofer U., Sieber R., Jeangros B. and Bosset J.O. (2002) Correlation between fatty acids in cow's milk fat produced in the lowlands, mountains and highlands of Switzerland and botanical composition of the fodder. *International Dairy Journal* 12, 661-666.
- Dewhurst R.J., Scollan N.D., Youell S.J., Tweed J.K.S. and Humphreys M.O. (2001) Influence of species, cutting date and cutting interval on the fatty acid composition of grass. *Grass and Forage Science* 56, 68-74.
- Elgersma A., Ellen G., van der Horst H., Muuse B.G., Boer H. and Tamminga S. (2003) Influence of cultivar and cutting date on the fatty acid composition of perennial ryegrass (*Lolium perenne* L.). *Grass and Forage Science* 58, 323-331.
- Jensen S.K. (2008) Improved Bligh and Dyer extraction procedure. *Lipid Technology* 20, 280-281.
- Witkowska I.M., Wever C., Gort G. and Elgersma A. (2008) Effects of nitrogen rate and regrowth interval on perennial ryegrass fatty acid content during the growing season. *Agronomy Journal* 100, 1371-1379.

# Effects of row spacing and seeding rate on sorghum whole crop yield and quality

Emile J. C., Bolaños-Aguilar E.D., Le Roy P. and Audebert G.  
INRA (Institut National de la Recherche Agronomique), 86600 Lusignan, France  
Corresponding author : jean-claude.emile@lusignan.inra.fr

## Abstract

Sorghum (*Sorghum bicolor*) could be a real alternative to silage maize in areas affected by summer drought. As its ability to feed dairy cows has been demonstrated, it is time to adapt the crop management, inherited from maize management. Therefore, our objective was to determine the best row spacing and seeding rate for optimising biomass yield without lowering maturity and quality of sorghum forage. From 2007 to 2009, comparisons were made of two row spacings: narrow (0.20 m) and wide (0.75 m) with the same seeding rate and the same dwarf cultivar in an experimental design with 2 to 4 replications. In 2007 and 2008 we added a treatment consisting in a higher seeding rate. The main yield components (Forage yield, dry matter content in the whole plant), the plant height and the forage quality (fibre and protein contents, and digestibility) were recorded. The narrow row spacing provided higher forage yield (66 % more) each year, even when the yield was limited by the water supply, and without decreasing the harvest index and the forage quality. Doubling the seeding rate did not lead to better performances and should not be recommended.

Keywords: sorghum, forage yield, quality, row spacing, seeding density

## Introduction

In the central-west of France, maize production is hardly conceivable today without recourse to irrigation because of major summer droughts. In the same region, sorghum can be grown without irrigation and can be considered as a less intensive alternative to maize cultivation (Emile *et al.*, 2006). Regarding the row spacing, in France cultivation techniques in sorghum have been derived historically from those applied to corn grain; i.e., 0.75 m. As regards the impact of population density, Conley *et al.*, (2005) did not observe any difference in DMY in populations between 150000 and 375000 plants ha<sup>-1</sup>. Comprehensive information on the effect of row spacing and seeding density on forage yield and quality is lacking. Thus, it is now time to adapt the crop management that has been inherited from maize management. The main objective should be to improve the forage yield during the sorghum short growth period, in relationship with its specific growth pattern and physiology. Therefore, this paper is focused in the respective effects of row spacing and seeding density on yield and forage quality of sorghum. Only a few studies are available on this subject (Butler and Muir, 2003) because most of them have been devoted to grain production (Baumhardt and Howell, 2006) or limited to the within-row spacing influences (Caravetta *et al.*, 1990) in sorghum.

## Materials and methods

This paper summarizes data from 3 climatically contrasting years. The experiments took place at the Lusignan Research Center, Poitou-Charentes, France (0°08'35''E, 46°40'39''N). The soil was classified as a Dystric Cambisol (FAO-ISRIC, 1990). The experiment was conducted for three consecutive years (2007, 2008 and 2009, to determine the effect of row spacing of 0.75 and 0.20 m at seeding density of 330 000 grains ha<sup>-1</sup>. In 2007 and 2008 we added a double

seeding density of 660 000 grains ha<sup>-1</sup> in the narrow row spacing (0.20 m) to determine the effect of two contrasting seeding densities. Pest control practices and fertilisation were in accordance with recommended practices. No irrigation supplies were provided to the crops. At harvest (to reach 28 to 35% DM at whole-plant level), plant number within row, plant height, whole plant dry matter content, morphological composition (grains, panicles, leaves and stems) and forage yield were estimated by weighing and separating three 1-m replications from each plot. The harvest index was expressed as the proportion of panicles in the whole-plant dry matter. Plant quality was measured from forage harvester. Samples were chopped to a particle size of 1 mm and dried at 60 °C for 48 h to determine neutral detergent fibre (NDF), crude protein (CP) and *in vitro* dry matter digestibility (IVDMD). Effects of row spacing and seeding density were tested by randomized complete blocks in split plot arrangements with four replicates in 2007 and 2008, and two replicates in 2009, using SAS procedure (SAS, 2003).

Table 1 Average weather data from sowing to harvest of sorghum during three years.

	2007	2008	2009
Sowing date	May 10	May 20	June 2
Harvest date	October 15	September 24	September 16
Accumulated rainfall (mm)	353	329	163
Temperature (°C)	15.9	16.4	18.0

Table 2. Means for plants number, plant height, harvest index, plant dry matter content, yield, *in vitro* dry matter digestibility (IVDMD), protein and neutral detergent fibre (NDF) of sorghum at two row spacing and three years.

Traits	Row Spacing		Years		
	Large (0.75 m)	Narrow (0.20 m)	2007	2008	2009
Plants number (m <sup>-1</sup> )	16.7 a	7.2 b	16.3 a	8.3 c	11.5 b
Plant height (cm)	111 a	114 a	137 a	122 b	91 c
Harvest index (%)	45.7 a	44.2 a	54.0 a	51.6 a	34.4 b
Plant dry matter (%)	33.0 a	31.4 b	33.1 a	32.6 a	31.4 a
Forage yield (t ha <sup>-1</sup> )	10.1 b	16.6 a	17.0 a	13.6 ab	10.2 b
IVDMD (%)	64.4 a	63.8 a	59.8 a	64.8 ab	68.8 b
Protein in DM (g kg <sup>-1</sup> )	88.9 b	104.1 a	95.8 a	-	99.8 a
NDF in DM (g kg <sup>-1</sup> )	498.6 a	513.6 a	515.3 a	497.3 a	508.1 a

Within columns means followed by the same letter are not significantly different according to Student Newman and Keuls ( $\alpha = 0.05$ ).

## Results

Sorghum was sown in May when the soil temperature was warm enough, except in 2009 when bird damage made it necessary to reseed again in June. The summers of 2007 and 2008 were abnormally wet and cold, whereas the summer of 2009 was hotter and drier (Table 1) and led to a low level of forage yield. Rainfall data during the different growing season are shown in Table 1. These contrasting weather conditions had strong effect on sorghum growth and yield: the lower the summer rainfall, the lower the yield. But quality parameters were not affected, except digestibility which decreased when forage yield increased. There were no significant traits  $\times$  year interactions, except plant height at harvest. As row spacing decreased from 0.75 to 0.20 m (Table 2), forage yield increased from 10.0 to 16.6 t ha<sup>-1</sup> (66 % more), even when the yield was limited by the water supply (7.0 to 14.0 t ha<sup>-1</sup>, year 2009). The lower forage yield in the wide row spacing was partly due to plant death by competition for soil nutrients within-row (data not shown). Plant height was not affected by row spacing, varying from 1.37 to 0.91 m depending on the year. Harvest index (45.7 and 44.2%), digestibility (64.4 and 63.8%) and NDF (49.9 and 51.4%) remained unchanged. The crude protein content increased from 8.9 to 10.4% as row spacing decreased. This result is in agreement with Cox



(2001) who observed that corn accumulates more N as row spacing decreased from 0.76 to 0.38 m. In our study, variation in protein concentration between row spacing was related ( $r^2 = -0.72$ ;  $P < 0.05$ ) to variation in dry matter content at the whole-plant level. Whole plants harvested in narrow row spacing were 1.6% lower in DM content than those harvested in wide row spacing (Table 2). The highest protein concentration in plants at narrow row spacing may be due to less dilution of N by lower DM concentration (Gastal and Lemaire, 2002). Doubling the seeding rate (Table 3) from 7 to 14 grains  $m^{-1}$  (at 0.20 m row spacing) did not affect plant density at harvest time (8.2 plants per ha). Thus, it was not surprising that none of the other criteria were significantly affected. Yield (19.5 vs. 18.3 t  $ha^{-1}$ ), harvest index (51.6 vs. 51.7%), digestibility (61.6 vs. 61.2%) remained equivalent between the two contrasting seeding densities evaluated.

Table 3. Means for plants number, plant height, harvest index, plant dry matter content, yield, in vitro dry matter digestibility (IVDMD), protein and neutral detergent fibre (NDF) of sorghum at two sowing densities and two years

Traits	Seeding Densities (grains $ha^{-1}$ )		Years	
	330000	650000	2007	2008
Plant number ( $m^{-1}$ )	7.0 a	8.2 a	9.2 a	6.0 b
Plant height (cm)	126 a	126 a	131.5 a	120.8 b
Harvest index (%)	50.7 a	51.6 a	51.7 a	50.5 a
Plant dry matter (%)	31.8 a	31.7 a	32.2 a	31.4 a
Forage yield (t $ha^{-1}$ )	18.3 a	19.5 a	20.8 a	16.9 a
IVDMD (%)	61.2 a	61.6 a	59.0 b	63.7 a
NDF (g $kg^{-1}$ )	516.7 a	520.5 a	522.1 a	515.1 a

Within columns means followed by the same letter are not significantly different according to Student Newman and Keuls ( $\alpha = 0.05$ ).

## Conclusions

The narrow row spacing treatment provided higher forage yield each year without decreasing the harvest index and the forage quality. Narrow row spacing seems to optimize the soil cover at early plant growth stages and also to limit within-row competition among plants. Additionally, narrow spacing probably limits weed development and competition effects. These events involve the interests of the establishment of narrow row spacing to improve yield and forage quality of sorghum. As increasing seeding rate did not improve forage production, it should therefore not be recommended.

## References

- Baumhardt R.L. and Howell T.A. (2006) Seeding practices, cultivar maturity, and irrigation effects on simulated grain sorghum yield. *Agronomy Journal* 98, 462-470.
- Butler T.J. and Muir J.P. (2003) Row spacing and maturity of forage sorghum silage in north central Texas. *Forage research in Texas*, CPR-5267, <http://forageresearch.tamu.edu>
- Caravetta G.J., Cherney J.H. and Johnson K.D. (1990) Within-row spacing influences on diverse sorghum genotypes: dry matter yield and forage quality. *Agronomy Journal* 82, 210-215.
- Conley S.P., Stevens W.G. and Dunn D.D. (2005) *Grain sorghum response to row spacing, plant density, and planter skips*. Online. Crop Management doi: 10.1094/CM-2005-0718-01-RS
- Cox W.J. and Cherney D.J.R. (2001) Row spacing, plant density, and nitrogen effects on corn silage. *Agronomy Journal* 93, 597-602.
- Emile J.C., Al Rifai M., Charrier X., Le Roy P. and Barrière Y. (2006) Grain sorghum silages as an alternative to irrigated maize silage. *Grassland Science in Europe* 11, 80-82.
- Gastal F. and Lemaire G. (2002) N uptake and distribution in crops: an agronomical and ecophysiological perspective. *Journal of Experimental Botany* 53, 789.

## Yields and contents of condensed tannins of some forage legumes and herbs

Goeritz M., Loges R. and Taube F.

*Institute of Crop Science and Plant Breeding - Grass and Forage Science/ Organic Agriculture (CAU), D-24118 Kiel, Germany*

Corresponding author: mgoeritz@email.uni-kiel.de

### Abstract

To determine annual dry matter (DM) yields, content of condensed tannins (CT) and total phenolics (TPh) as well as tannin yields, six legumes (*Onobrychis viciifolia*, *Lotus corniculatus*, *Trifolium hybridum*, *T. repens*, *Melilotus officinalis*, *Medicago sativa*), four herb species (*Cichorium intybus*, *Sanguisorba minor*, *Plantago lanceolata*, *Taraxacum officinale*) and the reference species *Trifolium pratense* and *Lolium perenne* were cultivated in 2007 and 2008 at the organic experimental farm 'Lindhof' of the University of Kiel, Germany. The experimental factors species and year had a strong impact on DM yields. The reference species *T. pratense* showed highest yields while the herb species and *O. viciifolia* showed significantly lowest DM yields, in particular in 2008. The highest tannin levels were found in *O. viciifolia*, and medium contents were found for *L. corniculatus*. Calculated tannin yields per hectare indicate highest CT amounts for *L. corniculatus* followed by *O. viciifolia*. Their DM yields, however, were medium or low.

Keywords: dry matter yield, tannin yield, legumes, herbs, organic farming

### Introduction

Feeding protein and energy-rich pasture and forage plants to ruminants often leads to high N-losses induced by large amounts of rapidly degradable protein. An important part of protein is metabolised to ammonia which will partially be excreted as urea in urine. This problem could be alleviated by increased amounts of bypass protein in the diet that, in fact, could be achieved by condensed tannins (CT). CT precipitate protein at neutral pH-value appearing in the rumen and re-precipitate under acid conditions (pH < 3.5; abomasum). As a result, less ammonia is produced in the rumen, N-losses in urine are reduced, supply of essential amino acids is more balanced and N-utilisation is more efficient (Min *et al.*, 2003). Both conventional and organic farmers can take advantage of these properties; however, organic farming directives limit the source of conventional CT used in diets. Thus, cultivation of tanniferous forage species would be the most interesting way to include CT into ruminant nutrition.

Several temperate plant species show high or moderate concentrations of CT. However, up to now less is known about their cultivation under organic farming field conditions. To determine crop suitability, tannin content and tannin yield, six tanniferous or potentially tanniferous legumes and four herb species were cultivated for these studies.

### Materials and methods

Field trials were conducted in 2007 and 2008 at the organic experimental farm 'Lindhof' of the University Kiel in Northern Germany. The area is characterised by maritime weather conditions with an averaged precipitation of 779 mm *p. a.* and by sandy clay as the predominant type of soil. The cultivated legumes were *Onobrychis viciifolia* (OV), *Lotus corniculatus* (LC), *Trifolium hybridum* (TH), *T. repens* (TR), *Melilotus officinalis* (MO), *Medicago sativa* (MS) and the herb species were *Cichorium intybus* (CI), *Sanguisorba minor* (SM), *Plantago lanceolata* (PL) and *Taraxacum officinale* (TO). In addition, *Lolium perenne*

(LP) was grown as a reference species for the herb (non-legume) group and *T. pratense* (TP) was grown as a reference species for the legume group. Only a moderate phosphatic and potassic fertilisation was distributed every spring-time. All species were cultivated in pure stands in a 3- and a 4-cut cutting system. The experiment was constructed in a split-plot design with three field replicates. Dry matter (DM) yields were calculated from 1/4 m<sup>2</sup> plots. Fresh material was oven-dried at 58°C to constant weight. Synchronously to yield sampling, a small quantity of fresh material was taken as quality sample which was frozen subsequently after sampling. Concentrations of CT were analysed by using the butanol-HCl method of Terrill *et al.* (1992) with slight modifications. Additionally, total phenolics (TPh) were determined using a modification of the Folin-Ciocalteu assay of Singleton and Rossi (1965). The statistical analyses were done with the software 'R'.

## Results and discussion

Annual dry matter yields were strongly affected by species (S), year (Y) and the interaction between species and year, but no significant influence was identified from the factor cutting frequency (CF) (Table 1).

Table 1. The influence of the cultivation factors and its interactions on dry matter and tannin yield, content of tannins and total phenolics.

Factors/Parameters	Annual DM yield	Annual CT yield	CT content %	TPh content %
Species (S)	<0.001***	<0.001***	<0.001***	<0.001***
Cutting Freq. (CF)	0.493 <sup>ns</sup>	0.816 <sup>ns</sup>	0.584 <sup>ns</sup>	<0.05*
Year (Y)	<0.001***	0.075 <sup>ns</sup>	<0.001***	<0.001***
S*CF	0.255 <sup>ns</sup>	0.680 <sup>ns</sup>	0.789 <sup>ns</sup>	0.684 <sup>ns</sup>
S*Y	<0.001***	0.113 <sup>ns</sup>	<0.001***	<0.001***
CF*Y	0.203 <sup>ns</sup>	0.725 <sup>ns</sup>	<0.01**	0.708 <sup>ns</sup>
S*CF*Y	0.887 <sup>ns</sup>	0.888 <sup>ns</sup>	<0.001***	0.110 <sup>ns</sup>

Significance codes: \*\*\*  $P < 0.001$ ; \*\*  $P < 0.01$ ; \*  $P < 0.05$ ; ns = non significant

Highest DM yields were obtained from the legume reference species *T. pratense* (Fig. 1). Compared to TP, *T. hybridum*, *L. corniculatus*, *M. sativa* and *T. repens* reached medium yields, which were more limited by unfavourable climatic and soil conditions than TP.

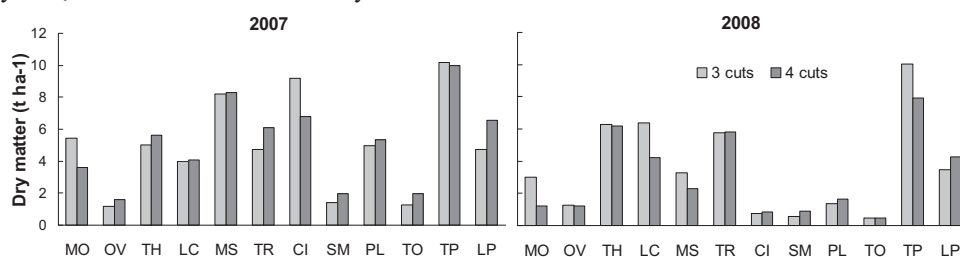

Figure 1: Dry matter yields of the different species for each harvest year as affected by cutting regime.

(MO = *M. officinalis*, OV = *O. viciifolia*, TH = *T. hybridum*, LC = *L. corniculatus*, MS = *M. sativa*, TR = *T. repens*, CI = *C. intybus*, SM = *S. minor*, PL = *P. lanceolata*, TO = *T. officinale*, TP = *T. pratense*, LP = *L. perenne*)

Compared to both references, extremely low DM yields were obtained from *O. viciifolia*, *S. minor* and *T. officinale*. The low growth of these species may be related to species-specific growth rates and improper fertiliser and mineral supply, e.g. *O. viciifolia* needs calcareous

soils to achieve optimal growth rates and it typically shows a slow development in the first year after sowing (Neuhoff and Bücking, 2006). Yields from *C. intybus* and *P. lanceolata* varied considerably between both years with a strong decline in 2008. Generally lower DM yields in 2008 may be explained by unfavourable climatic conditions (heavy rainfalls) in the establishing phase 2007 and a distinctive drought from April to June in 2008.

The analysis of tannin contents indicated significant differences between species, years and the interaction of S\*Y, CF\*Y and S\*CF\*Y (Table 1). *O. viciifolia* showed highest CT contents followed by *L. corniculatus* with medium CT contents. The remaining species had only marginal tannin levels. Calculating tannin yields from dry matter yields, data show highest annual tannin yields from *L. corniculatus* (Fig. 2). Despite its very low DM yields, *O. viciifolia* achieved the second highest tannin yields per hectare.

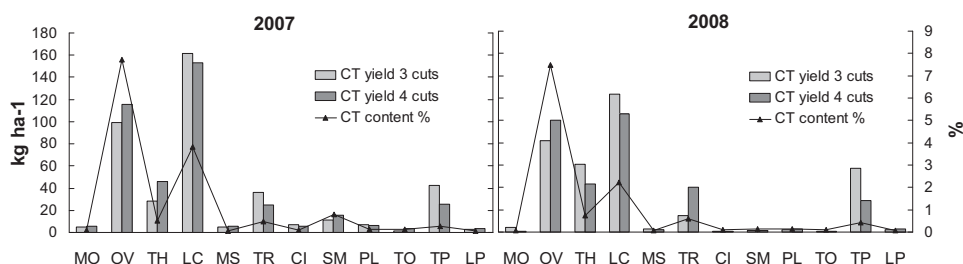

Figure 2: Tannin yields of the different species as affected by the cutting regime, and mean tannin contents averaged over both cutting regimes.

(MO = *M. officinalis*, OV = *O. viciifolia*, TH = *T. hybridum*, LC = *L. corniculatus*, MS = *M. sativa*, TR = *T. repens*, CI = *C. intybus*, SM = *S. minor*, PL = *P. lanceolata*, TO = *T. officinale*, TP = *T. pratense*, LP = *L. perenne*)

## Conclusions and forecast

Compared to the reference *T. pratense*, the DM yields of tanniferous forage plants such as *O. viciifolia* and *L. corniculatus* are unsatisfactory if not cultivated under optimal conditions. However, tannin yields per hectare show a certain potential for cultivation even with low DM yields (e.g. seeding in mixture with high-productive forage plants).

Continuing studies will determine the influence of optimised fertilisation on potential increases in DM yields. Currently, the protein precipitating capacity of the different species is analysed, in particular with respect to the content of total phenolics.

## References

- Min B.R., Barry T.N., Attwood G.T. and McNabb W.C. (2003) The effect of condensed tannins on the nutrition and health of ruminants fed fresh temperate forages: a review. *Animal Feed Science and Technology* 106, 3-19.
- Neuhoff D. and Bücking K. (2006) Integration of the fodder legume sainfoin (*Onobrychis viciifolia*) in crop rotations of organic agriculture (Möglichkeiten zur Integration der Futterleguminose Esparssette (*Onobrychis viciifolia*) in Fruchtfolgen des Ökologischen Landbaus). *Abschlussbericht Bundesprogramm Ökologischer Landbau*. Bonn, Germany.
- Singleton V.L. and Rossi Jr. J.R. (1965) Colorimetry of total phenolics with phosphomolybdic-phosphotungstic acid reagents. *American Journal of Enology and Viticulture* 16, 144-158
- Terrill T.H., Rowan A.M., Douglas G.B., and Barry T.N. (1992) Determination of extractable and bound condensed tannin concentrations in forage plants, protein concentrate meals and cereal grains. *Journal of the Science of Food and Agriculture* 58, 321-329.

# Effects of dry matter and additive on wilted bale silage quality and milk production

Heikkilä T.<sup>1</sup>, Saarisalo E.<sup>1,4</sup>, Taimisto A.-M.<sup>2</sup> and Jaakkola S.<sup>3</sup>

<sup>1</sup>MTT Agrifood Research Finland, Animal Production Research, FI-31600 Jokioinen, Finland

<sup>2</sup>Valio Ltd, Research and Development, 00039 Valio, Finland

<sup>3</sup>University of Helsinki, Department of Agricultural Sciences, FI-00014 University of Helsinki, Finland

<sup>4</sup>Ministry of Agriculture and Forestry, Department of Food and Health, FI-00023 Valtioneuvosto, Finland

Corresponding author: terttu.heikkila@mtt.fi

## Abstract

First-cut timothy-meadow fescue ley was wilted to two dry matter (DM) contents and ensiled using two additive treatments to study the effects of silage quality on milk production. Grass was cut with a mower conditioner and wilted for 9 or 56 h, aiming at DM of about 300 and 500 g kg<sup>-1</sup>, baled with a chopper baler with no additive or with a buffered formic acid-based additive, and wrapped using six plastic layers. A milk production trial was carried out as a replicated 4 x (4 x 4) Latin square experiment with 16 dairy cows in a 2 x 2 factorial arrangement of treatments. Silage was fed *ad libitum* and concentrate fed at 11 and 13 kg d<sup>-1</sup> for primiparous and multiparous cows, respectively. The fermentation quality of all silages was good, and acid-based additive restricted fermentation in the lower DM silage. Acid additive improved aerobic stability of both silages. Longer wilting time decreased diet organic matter digestibility in dairy cows. No significant differences were found in milk or milk constituent yields, or milk protein and lactose contents, or dietary nitrogen utilization between silage DM contents or additive treatments. Energy utilization was better with higher DM silages.

Keywords: additive, aerobic stability, bale silage, cow, milk production, wilting

## Introduction

Wilting of grass is required to obtain efficient bale silage production, and to improve fermentation quality and decrease clostridial deterioration of silage. However, risks of aerobic spoilage may increase with increasing dry matter content. Bale silages are often made without additive. Weather is one of the risks in silage making. Harvesting conditions affected feeding value of untreated bale silage more than that of minimum-wilted additive-treated bunker silage (Jaakkola *et al.*, 2008), and additive treatment of bale silage improved milk production and quality compared to untreated (Heikkilä *et al.*, 1997). The aim of this study was to assess the effects of grass dry matter content and an acid-based additive on bale silage fermentation, microbiological quality, aerobic stability, and their effects on milk production.

## Materials and methods

Silages were made from a ley of timothy (64%) - meadow fescue (34%) (*Phleum pratense* - *Festuca pratensis*) having a dry matter (DM) yield 4910 kg ha<sup>-1</sup>. Grass was cut on 16 June with a mower conditioner in windrows and wilted for either 8-10 h or 55-57 h, aiming at DM content of 300 or 500 g kg<sup>-1</sup> (DM1 and DM2). Grass was baled into round bales with a chopper baler using no additive or a buffered formic acid-based additive (formic acid 425, ammonium formate 303, propionic acid 100, benzoic acid 22 and water 150 g kg<sup>-1</sup>; Kemira

Oyj), 4.6 and 5.0 1 Mg<sup>-1</sup> for DM1 and 2, respectively. Bales were wrapped using white 750 mm stretch film in six layers. Drying of the grass of DM2 was delayed due to 1.5 mm of rainfall during the second day after cutting. A milk production trial, which started on 11 November, was carried out with 16 dairy cows in a replicated 4 x (4 x 4) Latin square experiment with 2 x 2 factorial arrangement of treatments to evaluate the effects of two silage DM contents and two additive treatments. Data were collected during the last week of four 3-week periods. Silages were fed *ad libitum* allowing 5-10% refusals, and concentrate fed at 11 and 13 kg d<sup>-1</sup> for four primiparous and twelve multiparous cows, respectively. The concentrate consisted of barley 303, oats 300, rapeseed meal 260, molassed sugar beet pulp 110 and minerals 27 g kg<sup>-1</sup> including crude protein 177 and neutral detergent fibre (NDF) 279 g kg<sup>-1</sup> DM. Digestibility of the diets in cows was measured using acid insoluble ash as an internal marker. Data were analysed with the general linear model procedure of SAS using a model including block, cow within block, period and treatment. The treatment effect was separated into contrasts for effects of silage DM and additive and their interaction.

## Results and discussion

At cutting, dry matter content of grass was 198 g kg<sup>-1</sup> and it contained crude protein 137, water soluble carbohydrates (WSC) 113 and digestible organic matter (D-value) 714 g kg<sup>-1</sup> DM. Acid treatment of lower dry matter grass restricted silage fermentation compared with no additive, as evidenced by higher WSC content and lower lactic acid content (Table 1). Higher DM content of DM2 grass due to the longer wilting time increased silage pH and decreased fermentation. Other differences in silage fermentation and microbiological quality were relatively small between dry matter contents and additive treatments. Fermentation quality of all silages was good. Average counts of yeasts in all silages at feeding time were higher than that of moulds, aerobic bacteria spores and clostridia spores. The counts of yeasts and moulds also varied between bales, being 2.8-6.7 log cfu g<sup>-1</sup> for yeasts and 1-5.2 log cfu g<sup>-1</sup> for moulds. Longer storage time after opening of bale can impair microbiological quality of silage.

Table 1. Dry matter content (DM), fermentation and microbiological quality of bale silages.

Silage Additive treat- ment	Fermentation quality							Microbiological quality			
	DM g kg <sup>-1</sup>	pH	WSC g kg <sup>-1</sup>	Lactic acid g kg <sup>-1</sup>	Acetic acid g kg <sup>-1</sup>	Butyric acid g kg <sup>-1</sup>	NH <sub>4</sub> - N g kg <sup>-1</sup>	Yeast log cfu g <sup>-1</sup>	Mould log cfu g <sup>-1</sup>	Aer.bact spores log MPNg <sup>-1</sup>	Clostridia spores log MPNg <sup>-1</sup>
Dry matter 1											
No	310	4.50	50	61	12	0.32	63	5.02	2.87	1.63	1.45
Acid	311	4.45	92	36	10	0.29	83 †	4.36	2.72	1.33	1.07
Dry matter 2											
No	472	5.06	84	23	6	0.27	41	4.69	1.36	2.15	0.72
Acid	490	5.10	94	14	6	0.24	42 †	5.00	2.11	1.65	0.73

†Ammonium N from the additive is included in the results.

Cows ate more untreated lower DM silage than higher DM silage ( $P < 0.05$ ), but DM did not affect intake of acid-treated silage (interaction  $P < 0.05$ , Table 2). No significant ( $P < 0.05$ ) differences were found in milk or milk constituent yields, or milk protein and lactose contents, or dietary nitrogen utilization for milk protein production between silage DM contents or additive treatments. Milk urea content was higher ( $P < 0.001$ ) when higher DM silages were fed. Milk fat content tended to be lower ( $P < 0.10$ ) with acid than untreated silage feeding. Longer wilting time decreased diet organic matter digestibility in cows ( $P < 0.05$ ) compared with shorter wilting time, but this was not reflected in milk production. Organic matter digestibility of the diet was 0.721 and 0.726 in the lower DM silage diet with no additive and acid-treated silages, respectively, and 0.713 and 0.711 with the higher DM

silage diet, again for no additive and acid-treated silages, respectively. Additive treatment did not affect diet digestibility. Energy utilization for milk production (ME kl), calculated with *in vivo* diet digestibility and by ignoring live weight change, was better ( $P < 0.01$ ) with higher DM silages than lower DM silages (interaction  $P < 0.10$ ).

The acid additive improved aerobic stability of both DM silages compared with the no-additive treatment. No additive silages started to warm up two days faster, on the second day after opening of the bale, and the acid-treated silage on the fourth day (Fig. 1).

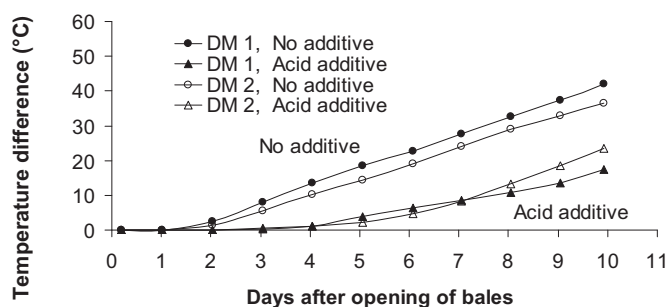

Figure 1. Aerobic stability of bale silages are presented as a cumulative temperature difference (sample temperature minus ambient temperature), four bales per treatment.

Table 2. The effect of dry matter (DM 1 and DM 2) of silages and silage additive on round bale silage intake, milk yield, milk composition and feed utilization.

Silage Additive treatment	DM Intake		Yield				Milk composition				Utilization	
	Silage --	Conc kg d <sup>-1</sup>	Milk kg d <sup>-1</sup>	Fat -----	Prot. g d <sup>-1</sup>	Lact -----	Fat -----	Prot. g kg <sup>-1</sup>	Lact -----	Urea mg dl <sup>-1</sup>	ME kl	Milk N/Feed N
Dry matter 1												
No	12.7	11.0	35.8	1457	1201	1755	40.6	33.5	49.0	21.6	0.61	0.33
Acid	12.4	11.0	36.2	1457	1200	1778	40.1	33.1	49.1	22.9	0.62	0.33
Dry matter 2												
No	12.1	11.0	35.8	1454	1195	1762	40.6	33.4	49.3	24.9	0.65	0.33
Acid	12.4	11.0	36.0	1420	1207	1771	39.4	33.5	49.2	25.2	0.63	0.32
SEM	0.14	0.01	0.24	15.5	6.8	12.8	0.41	0.18	0.10	0.46	0.006	0.003
Statistical significance												
DM 1 vs 2	*										***	**
Additive							o					
Interact.	*										o	

Statistical significances: o  $P < 0.10$ , \*  $P < 0.05$ ; \*\*  $P < 0.01$ ; \*\*\*  $P < 0.001$ , SEM = standard error of the mean

## Conclusions

In favourable harvesting conditions the dry matter content and the acid additive treatment of bale silage had only minor effects on the silage quality and on the milk production, when all the silages were of good quality. However, the acid additive improved the aerobic stability of the silages, suggesting better microbiological status in acid-treated than in untreated silage.

## References

- Heikkilä T., Toivonen V. and Tupasela T. (1997) Effect of additives on big bale silage quality and milk production. In: van Arendonk J.A.M. (Editor-in-Chief) *Book of Abstracts of the 48th Annual Meeting of the European Association for Animal Production*: Vienna, Austria, 25-28 August 1997, Wageningen Pers., 119 pp.
- Jaakkola S., Saarisalo E., Heikkilä T., Nysand M., Suokannas A., Mäki M. and Taimisto A.M. (2008) The effect of silage making technology on production and quality of milk. *Grassland Science in Europe* 13, 642-644.



# Aerobic stability and fermentation quality of round bale silage treated with inoculants or propionic acid

Jaakkola S.<sup>1</sup>, Saarisalo E.<sup>2,3</sup> and Heikkilä T.<sup>3</sup>

<sup>1</sup>University of Helsinki, Department of Agricultural Sciences, FI-00014 University of Helsinki, Finland

<sup>2</sup>Ministry of Agriculture and Forestry, Department of Food and Health, FI-00023 Valtioneuvosto, Helsinki, Finland

<sup>3</sup>MTT Agrifood Research Finland, Animal Production Research, FI-31600 Jokioinen, Finland  
Corresponding author: seija.jaakkola@helsinki.fi

## Abstract

A timothy-meadow fescue sward was cut with a mower conditioner. After wilting to a dry matter (DM) concentration of 440 (DM1), 560 (DM2) and 643 (DM3) g kg<sup>-1</sup>, the grass was round baled and ensiled with or without additive treatment. The additives included propionic acid (43%) + ammonium propionate (27%), 8 l Mg<sup>-1</sup> grass (PA), *Lactobacillus plantarum* 10<sup>6</sup> colony forming units (cfu) g<sup>-1</sup> grass + *L. buchneri* 10<sup>5</sup> cfu g<sup>-1</sup> (LP + LB), *L. plantarum* 10<sup>6</sup> cfu g<sup>-1</sup> + sodium benzoate (300 g Mg<sup>-1</sup>) (LP + SB), and *L. rhamnosus* 5 x 10<sup>5</sup> cfu g<sup>-1</sup> (LR). Fermentation quality and aerobic stability of the silages were measured.

The inoculants maintained lactic acid fermentation and decreased water soluble carbohydrate concentration (WSC) in DM concentrations below 600 g kg<sup>-1</sup>. In DM3 silages, fermentation was suppressed, and only small differences were observed between the treatments in lactic acid and WSC concentrations. However, PA lowered pH as compared to other treatments. Except for LR-treated DM2 silage, all other silages were stable for four days after opening the bales. Thereafter, propionic acid was more efficient in preventing silage heating than the inoculants, and the LP + SB treatment was more efficient than the other inoculant treatments.

Keywords: aerobic stability, inoculant, lactic acid bacteria, propionic acid, silage, wilting

## Introduction

High dry matter (DM) silage (haylage) is a widely used feed for horses. Due to the high DM concentration, haylage is prone to heating and to aerobic deterioration which may compromise the health of horses. High intake of water soluble carbohydrates (WSC), especially fructans, has been attributed as a potential cause of laminitis (van Eps and Pollitt, 2006). Thus, well-preserved haylage might also cause problems since low water activity restricts fermentation and most of the WSC remains intact in haylage. In a pilot-scale study, inoculants stimulated fermentation and decreased WSC concentration in high DM silage (600 g kg<sup>-1</sup>) as compared to untreated and propionic acid-treated silage (Jaakkola *et al.*, 2009). Further, propionic acid and a combination of *Lactobacillus plantarum* and *L. buchneri* were efficient in preventing silage heating. The aim of the present experiment was to study the effects of inoculants and propionic acid on the fermentation quality and aerobic stability of high DM bale silage.

## Materials and methods

A timothy (*Phleum pratense*) - meadow fescue (*Festuca pratensis*) sward (WSC 115 g kg<sup>-1</sup>, crude protein 137 g kg<sup>-1</sup>, neutral detergent fibre 549 g kg<sup>-1</sup> in DM) was cut with a mower conditioner. After wilting to a DM concentration of 440 (DM1), 560 (DM2) and 643 (DM3) g kg<sup>-1</sup>, the grass was round baled and ensiled with or without (UT) additive treatment. The additives included propionic acid (43%) + ammonium propionate (27%), 8 l Mg<sup>-1</sup> (PA)

(Kemira Oyj), *L. plantarum* (VTT E-78076)  $10^6$  colony forming units (cfu)  $g^{-1}$  + sodium benzoate (300 g  $Mg^{-1}$ ) (LP + SB) (Kemira Oyj), *L. plantarum*  $10^6$  cfu  $g^{-1}$  + *L. buchneri* VTT E-93445 (DSM 20057),  $10^5$  cfu  $g^{-1}$  (LP + LB) and *L. rhamnosus* LC705 (DSM 7061)  $5 \times 10^5$  cfu  $g^{-1}$  (LR) (Valio Oy). After six months, silages were analysed for aerobic stability and fermentation quality. The data were subjected to analysis of variance using the general linear model procedure (PROC GLM) of Statistical Analysis Systems Institute (SAS).

Table 1. Fermentation quality (g  $kg^{-1}$  in dry matter (DM)) of the silages.

	DM, g $kg^{-1}$	pH	WSC	Lactic acid	Acetic acid	Prop. Amm N, acid g $kg^{-1}$	
<b>Dry matter 1</b>							
Untreated (UT)	476	4.94	95.5	32.8	6.58	0.17	27.3
Propionic acid + ammonium propionate (PA)	490	5.35	137.7	2.9	5.78	18.27 <sup>X</sup>	64.3 <sup>X</sup>
<i>L. rhamnosus</i> (LR)	475	4.17	57.7	75.6	5.56	0.09	26.8
<i>L. plantarum</i> + <i>L. buchneri</i> (LP + LB)	472	4.28	51.7	71.9	7.71	0.08	28.4
<i>L. plantarum</i> + Na-benzoate (LP + SB)	472	4.27	64.9	71.1	5.43	0.13	22.4
SEM	3.5	0.061	3.77	3.93	0.432	1.679	4.45
UT vs. additives		***	**	**			
PA vs. inoculants	**	***	***	***		***	***
LR vs. LP + LB and LP + SB							
LP + LB vs. LP+SB			*		**		
<b>Dry matter 2</b>							
Untreated (UT)	568	5.75	121.0	10.0	6.47	0.24	26.5
Propionic acid + ammonium propionate (PA)	587	5.17	142.4	2.6	6.11	29.19 <sup>X</sup>	91.7 <sup>X</sup>
<i>L. rhamnosus</i> (LR)	563	4.94	98.4	36.4	5.92	0.09	27.4
<i>L. plantarum</i> + <i>L. buchneri</i> (LP + LB)	562	4.40	57.3	57.2	8.49	0.25	26.2
<i>L. plantarum</i> + Na-benzoate (LP + SB)	555	4.78	96.6	39.7	6.57	0.11	22.2
SEM	3.7	0.109	3.69	3.19	0.280	0.451	1.92
UT vs. additives		***	**	***		***	***
PA vs. inoculants	***	**	***	***	**	***	***
LR vs. LP + LB and LP + SB		*	**	*	***		
LP + LB vs. LP+SB		*	***	**	***		
<b>Dry matter 3</b>							
Untreated (UT)	652	5.88	130	2.90	6.99	0.60	19.4
Propionic acid + ammonium propionate (PA)	651	5.29	139	1.91	6.96	20.1 <sup>X</sup>	65.4 <sup>X</sup>
<i>L. rhamnosus</i> (LR)	646	5.93	121	1.59	6.70	0.24	20.7
<i>L. plantarum</i> + <i>L. buchneri</i> (LP + LB)	645	5.85	125	2.24	6.22	0.41	20.8
<i>L. plantarum</i> + Na-benzoate (LP + SB)	644	5.89	147	1.18	6.98	0.14	19.8
SEM	2.0	0.055	9.4	0.800	0.317	1.938	6.37
UT vs. additives	**	*					
PA vs. inoculants	**	***				***	***
LR vs. LP + LB and LP + SB							
LP + LB vs. LP + SB							

<sup>X</sup> Includes N and propionic acid from the additive PA (propionic acid + ammonium propionate)

## Results and discussion

Lactic acid fermentation was stimulated when the inoculants were used at the two lower DM concentrations (Table 1). This resulted in lower pH and WSC concentration as compared to untreated or PA-treated silages. *L. plantarum*-based additives and *L. rhamnosus* stimulated fermentation equally in DM1 silage, while in DM2 silage *L. plantarum* was more efficient. Addition of *L. buchneri* together with *L. plantarum* increased acetic acid concentration in DM1 and DM2 silages as compared to the treatment with a combination of *L. plantarum* and SB. Acetic acid is known to be efficient in improving the aerobic stability of silage. In DM3

silages, fermentation was suppressed, and only small differences were observed between treatments in lactic acid and WSC concentrations. However, PA lowered pH as compared to other treatments (5.29 vs. 5.85). The formation of volatile fatty acids and ammonia was limited in all silages. High propionic acid and ammonia N concentrations in the PA silages reflect the amounts of propionic acid and N added with the PA-additive.

Except for LR treated DM2 silage, all other silages were stable for four days after opening the bales (Fig. 1). Thereafter propionic acid-based additive was more efficient in preventing silage heating than the inoculants, and the combination of *L. plantarum* and sodium benzoate was more efficient than the combination of *L. plantarum* and *L. buchneri*. All the bales treated with propionic acid were stable while the variation between the bales was large among the inoculated silages.

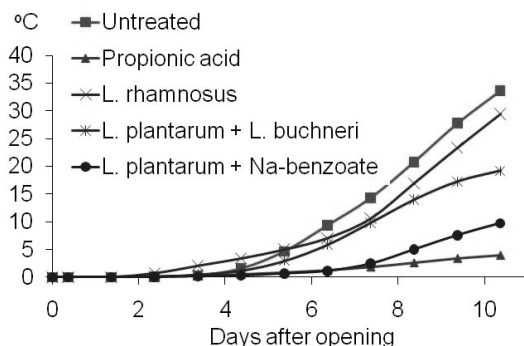

Figure 1. Aerobic stability (cumulative temperature difference, sample temperature minus ambient temperature) of the silages averaged over three dry matter concentrations (1, 2 and 3).

## Conclusions

Efficient inoculants are able to stimulate fermentation and decrease pH and WSC concentration of bale silage in DM concentrations up to 600 g kg<sup>-1</sup>. In untreated and propionic acid-treated silage, WSC remained intact in DM concentrations higher than 450 g kg<sup>-1</sup>. In all DM concentrations a good aerobic stability was achieved by using buffered propionic acid. The improvement of aerobic stability by using *L. buchneri* or sodium benzoate together with *L. plantarum* was observed only in DM concentrations below 600 g kg<sup>-1</sup>, the effect of sodium benzoate being better than that of *L. buchneri*.

## References

- Jaakkola S., Saarisalo E. and Heikkilä T. (2009) Aerobic stability of high dry matter silage treated with inoculants or propionic acid. In: Broderick G.A., Adesogan A.T., Bocher L.W., Bolsen K.K., Contreras-Govea F.E., Harrison J.H. and Muck R.E. (eds.) *Proceedings XVth International Silage Conference*, Madison, Wisconsin, USA. pp. 245-246.
- van Eps A.W. and Pollit C.C. (2006) Equine laminitis induced with oligofructose. *Equine Veterinary Journal* 38, 203 – 208.

# Effects of a combination of selected lactic acid bacteria strains on the fermentation quality and aerobic deterioration of maize silage

Jatkauskas J. and Vrotniakiene V.

Department of Animal Nutrition and Feeds, Institute of Animal Science of LVA, Baisogala, Lithuania

Corresponding author: pts@lgi.lt

## Abstract

Chopped whole-plant maize was ensiled at the waxy stage of maturity from five fields in 0.7-L laboratory silos when determining pH after 2 d or in 3-L silos when determining the fermentation parameters and aerobic stability of silages after 100 d. The forage was ensiled without additives (control) or treated with either a multicomponent probiotic inoculant (*E. faecium*, *L. casei*, *L. plantarum*, *L. buchneri* and *Pediococcus pentosaceus*) applied at 150000 cfu g<sup>-1</sup> fresh weight. Three replicates were made for each treatment from each field. The inoculant resulted in significantly higher ( $P < 0.01$ ) dry matter concentration, lower ( $P < 0.05$ ) neutral detergent fibre (NDF) and acid detergent fibre (ADF) concentrations. Inoculated silages had lower pH-values both after 2 d and 100 d compared with untreated control. The concentration of lactic acid was generally higher and the concentration of acetic acid lower in the inoculated silages than in the control. There were no differences in the lactic acid concentrations among treatments. However, the bacterial blend produced less ( $P < 0.01$ ) acetic acid and increased lactate:acetate ratios (3.1 vs. 4.2). Inoculation reduced proteolysis of plant proteins, because ammonia-N concentration was lower ( $P < 0.01$ ) in inoculated silage compared to the control. Treatment with multicomponent inoculant significantly ( $P < 0.01$ ) reduced dry matter losses compared with the control. However, the inoculated maize silage was more prone to aerobic deterioration than the control.

Keywords: maize silage, inoculant, fermentation, aerobic stability

## Introduction

Classical microbial inoculants containing homofermentative lactic acid bacteria (HOM) (e.g., *Lactobacillus plantarum*) are often added to silage because they produce large quantities of lactic acid very rapidly, which decrease the pH of silage (Muck *et al.*, 2007). However, homolactic inoculants can often have no effect or even make the aerobic stability of silages worse due to high levels of lactic acid. It has been observed that inoculation of whole-crop maize with homofermentative lactic acid bacteria leads to silages which have low stability against aerobic deterioration, while inoculation with heterofermentative lactic acid bacteria (HET), such as *Lactobacillus brevis* or *Lactobacillus buchneri*, increases stability (Danner *et al.*, 2003). We studied the influence of mixing HOM and HET lactic acid bacteria (LAB) on the reduction of pH, fermentation parameters and aerobic stability of maize silage.

## Materials and methods

The experiment was performed according to the DLG Guidelines for the testing of silage additives (Weißbach and Honig, 1997). Whole-plant maize from five different fields was harvested at the beginning of the waxy stage of maturity, chopped at  $\approx 2$  cm and ensiled in 0.7-L jars when determining pH after 2 d, or 3-L jars when determining the remaining parameters after 100 d. The additives applied to maize were: (C) no additive and (I) a bacterial blend (*Enterococcus faecium*, *Lactobacillus casei*, *Lactobacillus plantarum*, *Lactobacillus buchneri*

and *Pediococcus pentosaceus*) at 4 ml kg<sup>-1</sup>, corresponding to a dose of 150000 cfu g<sup>-1</sup> treated forage. Silos were subsequently sealed and stored in a room at +20 °C. According to DLG approval for category 1, silos were fully filled so that the density was 1 kg DM per 5 liter volume. Dry matter losses, lactic acid, acetic acid butyric acid and ammonia nitrogen were determined after 100 d of ensiling. Furthermore, at day 100 five replicates of 1000 g silages from each treatment were subjected to an aerobic stability test whereby the silages were exposed to air for 8 d. A rise in temperature of 3 °C or more above background was taken as indicative of aerobic instability. The SAS statistical package was used to analyse the data. Separation of untreated and inoculated means was either done for each field (per field) or in a collected analysis in which fields was used as one factor (over fields). Three replications (glass jars) were used per additive treatment. Silos were analysed as a randomized complete block.

## Results and discussion

The whole-crop maize (n = 15) contained 223 g kg<sup>-1</sup> (SEM, Standard error of a mean: 4.41) dry matter (DM); 103 g kg<sup>-1</sup> DM (SEM: 1.20) crude protein, and 142 g kg<sup>-1</sup> DM (SEM: 6.34) of water soluble carbohydrate (WSC). Forage buffering capacity was 200 mE kg<sup>-1</sup> DM (SEM 0.63). The ensilability of the whole-plant maize was good because WSC/BC (water soluble carbohydrates to buffering capacity) ratio was 7.1 and maize had a low concentration of nitrate (2.6 g kg<sup>-1</sup> in DM; SEM 0.215).

Differences in a range of fermentation parameters were found between the treatments. Treatment I resulted in higher ( $P < 0.01$ ) DM concentration and lower ( $P < 0.05$ ) NDF and ADF concentrations (Table1).

Table 1. Chemical composition and fermentation parameters of whole-crop maize silages

Measured parameter	Untreated control (C)	Treatment I	SE <sup>1</sup>	Sig <sup>2</sup> .
Dry matter, DM, g kg <sup>-1</sup>	205	209	1.036	**
NDF in DM, g kg <sup>-1</sup>	438	421	5.378	*
ADF in DM, g kg <sup>-1</sup>	248	236	3.256	*
Lactic acid in DM, g kg <sup>-1</sup>	54	59	1.825	NS
Acetic acid in DM, g kg <sup>-1</sup>	17	14	0.345	**
Butyric acid in DM, g kg <sup>-1</sup>	0.8	0.3	0.176	NS
Ammonia N, g kg <sup>-1</sup>	43	38	0.914	**
pH after 100 d	3.75	3.71	0.008	**
pH after 2 d	5.19	4.37	0.060	**
DM losses, g kg <sup>-1</sup>	90	68	4.355	**

<sup>1</sup>Standard error of a treatment; <sup>2</sup>statistically significant difference vs. control \* =  $P < 0.05$  and \*\* =  $P < 0.01$  respectively; NS-not significant

Inoculated silage had lower ( $P < 0.01$ ) pH-values both after 2 and 100 d. The bacterial blend had a marginal effect on lactic acid and butyric acid production in whole-crop maize silages compared with the control. However, compared with the untreated control, acetic acid concentration was decreased ( $P < 0.01$ ) and the inoculant produced higher lactate:acetate ratio (4.2) compared with that of the control (3.1). Treatment I apparently reduced proteolysis of plant proteins as ammonia-N concentration was lower ( $P < 0.01$ ) in inoculated silage. The use of silage inoculants containing homofermentative lactic acid bacteria to increase lactic acid production and enhance the rate and extent of pH decline can also lead to reduction in protein breakdown (Merry *et al.*, 1997). Inoculated silage also reduced dry matter losses by 22 g kg<sup>-1</sup> DM ( $P < 0.01$ ) compared with treatment C.

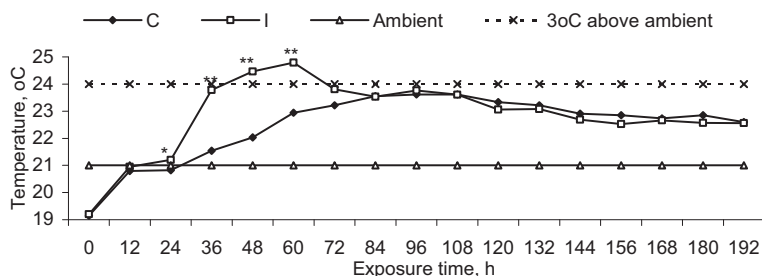

Figure 1. Aerobic stability of inoculated (I) or untreated (C) maize silage (\* =  $P < 0.05$  and \*\* =  $P < 0.01$  respectively)

The silages treated with bacteria blend (I) started to heat after 24 h and had a temperature rise of more than 3 °C above the ambient after 48 h. The untreated silages (C) started to heat after 36 h and no had a temperature rise of more than 3 °C above the ambient. Therefore, silage C was more stable compared with the control silage. Apparently, *L. buchneri* was not sufficiently active to increase the concentration of acetic acid and improve aerobic stability. This confirms the results reported by Inglis *et al.* (1999) who found that silage starters consisting exclusively of homofermentative lactic acid bacteria reduced aerobic stability.

## Conclusion

Upon examination of pooled treatment data, a blend of bacteria strains significantly increased dry matter concentration and significantly reduced DM losses, pH value, acetic acid concentrations and N-NH<sub>3</sub> fraction relative to that of the control whole-crop maize silages. However, inoculation with the bacterial blend had no effect in the formation of lactic acid and butyric acid and reduced aerobic stability of the whole-crop maize silages.

## References

- Danner H., Holzer M., Mayrhuber E. and Braun R. (2003) Acetic acid increases stability of silage under aerobic conditions. *Applied and Environmental Microbiology* 69:1, 562-567.
- Inglis G.D., Yanke L.J., Kawchuk L.M. and McAllister T.A. (1999) The influence of bacterial inoculants on the microbial ecology of aerobic spoilage of barley silage. *Canadian Journal of Microbiology* 45, 77-87.
- Merry R.J., Lowes K.F. and Winters A.L. (1997) Current and future approaches to biocontrol in silage. In: V.Jambor, L.Klapil, P.Chromec and P. Prochazka (eds.) *Proceedings of the 8<sup>th</sup> International Symposium on Forage Conservation*, Brno, Czech Republic, pp. 17-27.
- Muck R.E., Filya I. and Contreras-Govea F.E. (2007) Inoculant effects on alfalfa silage: In vitro gas and volatile fatty acid production. *Journal of Dairy Science* 90, 5115-5125.
- Weibach F. and Honig H. (1997) *DLG-Schlüssel zur Beurteilung der Gärqualität von Grünfuttersilagen auf der Basis der chemischen Untersuchung*. Deutsche Landwirtschafts-Gesellschaft e.V., Fachausschuss "Futterkonservierung", 2 July 1997.

# Evaluation and performance of five maize hybrids for silage cut at different cutting heights

Jobim C.C.<sup>1</sup>, Oliveira F.C.L.<sup>2</sup>, Branco A.F.<sup>1</sup> and Santos G.T.<sup>1</sup>

<sup>1</sup>Department of Animal Science, State University of Maringá, Paraná, Brazil

<sup>2</sup>Animal Science Graduate Programme, State University of Maringá, Paraná, Brazil

Corresponding author: ccjobim@uem.br

## Abstract

The performance of five maize (*Zea mays* L.) hybrids and three cutting heights (15, 35 and 55 cm) on the productivity of dry matter (DM), nutritive value of silage and estimated milk yield using the model Milk 2006 were evaluated. There was no difference in the yield of DM biomass among the hybrids, with an average of 15.0 t ha<sup>-1</sup>. Biomass DM productivity decreased with increasing height of cut, and average values were 14.6, 13.0 and 12.6 t ha<sup>-1</sup> for 15 cm, 35 cm and 55 cm of cutting height, respectively. There was an effect of hybrid and cutting height on the chemical composition of silage. Milk productivity (kg of milk per hectare) was similar in the three heights of cut. The cutting height does not replace the best choice of hybrids for silage production of high quality and productivity.

Keywords: digestibility, milk productivity, nutritive value, silage, hybrid performance

## Introduction

An alternative to improve the nutritional value of corn silage is to increase the cutting height of the maize plants, which concentrates grains and reduces the contribution of stem and senescent leaves. Wu and Roth (2005) reviewed 11 studies about management of cutting height (15 to 45 cm), and found incremental effects on content of dry matter (DM), crude protein (CP) and starch, and reduction on contents of neutral detergent fibre (NDF) and acid detergent fibre (ADF), respectively. Kung Jr. *et al.* (2008) also found elevation in the concentration of some nutrients (CP, starch and net energy for lactation NE<sub>l</sub>), but the increase in height (from 15 cm to 50 cm) did not alter the digestibility of NDF (NDFIVD). This study aimed to evaluate the effect of different cutting heights on the performance and nutritive value of silage corn hybrids.

## Materials and methods

The experiment was conducted at State University of Maringá, Paraná-Brazil (23° 21' 13" S, 52° 04' 27" W; 550 m a.s.l.). Five hybrids of maize (AS 32, AG 9090, CD 308, P 30F87 and DKB 747) were evaluated at three cutting height (15, 35 and 55 cm). The hybrids were seeded in plots of 2100 m<sup>2</sup>, with spacing between rows of 0.90 m and density of sowing 70000 plants per ha. The experimental design was a randomized block with split plots and three replicates. Experimental silos were 45 Polyvinyl Chloride tubes with 20 cm of diameter and 40 cm of height. After sealing, the silos were opened after 125 d. The following were determined: DM, organic matter (OM), CP, ether extract (EE), NDF, ADF, acid detergent lignin (ADL), starch, *in vitro* digestibility of DM at 48 h of incubation (DMIVD, 48 h), cell wall *in vitro* digestibility with 48 h of incubation (NDFIVD, 48 h). The performance of the hybrids was evaluated by using the model Milk2006, developed by Shaver and Lauer (2006), for estimating the feed value in terms of milk per ton and milk per hectare. Net energy for lactation (NE<sub>l</sub>) and total digestible nutrients (TDN) were also calculated. The data were submitted to analysis of variance using GLM procedure of SAS<sup>®</sup> (SAS Institute, 1999).



Table 1 – Dry matter (DM) content and chemical composition in DM of silage corn hybrids harvested at different cutting heights

Hybrid <sup>1</sup>	DM	OM	CP	EE	Starch	NDF	ADF	ADL
	(%)	(g kg <sup>-1</sup> )						
AS 32	27.6 <sup>ab</sup>	958 <sup>c</sup>	86.1	23.4 <sup>b</sup>	186 <sup>b</sup>	48.8 <sup>ab</sup>	25.9 <sup>ab</sup>	5.0 <sup>b</sup>
AG 9090	28.2 <sup>ab</sup>	960 <sup>c</sup>	85.1	27.2 <sup>a</sup>	195 <sup>b</sup>	49.0 <sup>ab</sup>	25.4 <sup>b</sup>	5.0 <sup>b</sup>
CD 308	26.3 <sup>a</sup>	961 <sup>bc</sup>	83.3	27.6 <sup>a</sup>	171 <sup>b</sup>	46.9 <sup>b</sup>	26.0 <sup>ab</sup>	5.0 <sup>b</sup>
P 30F87	27.6 <sup>ab</sup>	965 <sup>ab</sup>	84.4	26.4 <sup>ab</sup>	183 <sup>b</sup>	51.8 <sup>a</sup>	27.9 <sup>a</sup>	6.0 <sup>a</sup>
DKB 747	29.4 <sup>b</sup>	967 <sup>a</sup>	81.3	29.0 <sup>a</sup>	243 <sup>a</sup>	47.0 <sup>b</sup>	26.1 <sup>ab</sup>	5.4 <sup>ab</sup>
Cutting height								
15	26.6 <sup>a</sup>	960 <sup>b</sup>	82.1	25.1	159 <sup>c</sup>	51.5 <sup>a</sup>	27.6 <sup>a</sup>	5.6 <sup>a</sup>
35	28.0 <sup>b</sup>	963 <sup>a</sup>	83.7	27.3	203 <sup>b</sup>	47.6 <sup>b</sup>	26.2 <sup>b</sup>	5.4 <sup>a</sup>
55	28.7 <sup>b</sup>	963 <sup>a</sup>	86.3	27.7	225 <sup>a</sup>	47.0 <sup>b</sup>	25.0 <sup>b</sup>	4.8 <sup>b</sup>
Average	27.8	962	84.0	26.7	196	48.7	26.3	5.3
CV <sup>2</sup>	4.6	0.22	5.63	11.00	9.06	5.9	5.7	10.7
Effect <sup>3</sup>	(H), (A)	(H), (A)	-	H	(H),(A), H×A	H, (A)	H, (A)	H, A

<sup>1</sup> The values represent the average of different cutting heights. <sup>2</sup> Coefficient of variation. <sup>3</sup> Probability of significant effect of H = hybrid, and A = cutting height. Averages with different letters in columns indicate significant difference by Tukey test at 5%.

Table 2 – Averages for DM (IVDMD) and NDF (NDFIVD) *in vitro* digestibility, total digestible nutrients (TDN) and net energy for lactation (NE<sub>l</sub>) of five hybrids used for corn silage cut in different heights and estimative of milk productivity

Variable	Hybrids average <sup>1</sup>			Average	CV <sup>2</sup>	Effect P > F <sup>3</sup>		
	15	35	55			H	A	H × A
	g kg <sup>-1</sup>							
IVDMD (48 h)	72.2 <sup>b</sup>	73.7 <sup>ab</sup>	74.8 <sup>a</sup>	73.6	2.92	**	*	*
NDFIVD (48 h)	46.1	44.8	46.3	45.7	5.81	**	ns	**
TDN (%)	64.0 <sup>b</sup>	65.5 <sup>b</sup>	68.6 <sup>a</sup>	66.1	3.96	**	**	*
NE <sub>l</sub> <sup>4</sup> (Mcal/kg)	1.3 <sup>b</sup>	1.4 <sup>b</sup>	1.5 <sup>a</sup>	1.4	4.49	**	**	ns
	Milk production <sup>5</sup>							
kg t <sup>-1</sup> in DM	1226 <sup>b</sup>	1291 <sup>b</sup>	1393 <sup>a</sup>	1303	6.70	**	**	ns
kg ha <sup>-1</sup>	17956	16819	17791	17522	13.10	**	ns	ns

<sup>1</sup>The values represent the averages of hybrids cut in different heights. <sup>2</sup>Coefficient of variation. <sup>3</sup>Probability of significant effect of H = hybrid, A =cutting height; \* and \*\* represent level of significance  $P \leq 0.05$  and  $P \leq 0.001$  respectively; ns = not significant. <sup>4</sup>Net energy for lactation. <sup>5</sup> Calculated using MILK2006 (Shaver & Lauer, 2006) and NDFD after 48 h of digestion. Averages with different letters in lines indicate significant difference by Tukey test at 5%.

## Results and discussion

There was no difference ( $P > 0.05$ ) in DM yield between the hybrids, with an average of 15 t ha<sup>-1</sup>. The average DM productivities of forage were 14.6, 13 and 12.6 t ha<sup>-1</sup> for cutting heights of 15, 35 and 55 cm, respectively. Increasing the cutting height increased ( $P < 0.01$ ) DM content (Table 1). This DM increase is well documented (Kung Jr. *et al.*, 2008) and is related to the fact that the ear is normally drier than leaves and stems. There was no effect ( $P < 0.05$ ) of hybrid and cutting height on CP content. EE content was affected by hybrid ( $P < 0.05$ ), but not by cutting height ( $P > 0.05$ ). The cutting height of 35 cm reduced ( $P < 0.01$ ) NDF and ADF contents compared to cutting at 15 cm height. Increasing cutting height from 15 to 55 cm increased ( $P < 0.05$ ) DMIVD (3.5%), total digestible nutrients (TDN) (6.7%) and NE<sub>l</sub> (9.3%), but without alteration in NDFIVD (Table 2). There were effects of hybrid ( $P < 0.05$ ) on the performance and nutritive value of silage corn hybrids. The results of the study suggest that there are differences among hybrids to nutritive value and effect hybrid is more relevant than cutting height.

## Conclusion

Hybrids with similar yields of DM present differences in chemical composition and nutritive value. Increase in cutting height improves quality and nutritive value of silage. Cell wall digestibility and milk productivity were not influenced by hybrids. The choice of hybrids to production of high quality silage is more important than cutting height.

## References

- Kung Jr L., Moulder B.M., Mulroone C.M. *et al.* (2008) The effect of silage cutting height on the nutritive value of a normal corn silage hybrid compared with Brown Midrib corn silage fed to lactating cows. *Journal Dairy Science* 91, 1451-1457.
- SAS Institute (1999) *SAS/STAT User's Guide*. Version 8. SAS Institute Inc., Cary, NC.
- Shaver R.D. and Lauer J.G. (2006) Review of Wisconsin corn silage milk per ton models. *Journal Dairy Science* 89 (Supplement 1), 282.
- Wu Z. and Roth G. (2005) *Considerations in managing cutting height of corn silage*. Extension publication DAS 03-72. Pennsylvania State University, College Park.

# Characterisation of the fibre composition of fresh and ensiled herbage species under varying management conditions

King C.<sup>1,2</sup>, McEniry J.<sup>1</sup>, Richardson M.<sup>2</sup> and O’Kiely P.<sup>1</sup>

<sup>1</sup>Teagasc, Grange Beef Research Centre, Dunsany, Co. Meath, Ireland

<sup>2</sup>School of Architecture, Landscape & Civil Engineering, University College Dublin, Belfield, Dublin 4, Ireland

Corresponding author: colman.king@teagasc.ie

## Abstract

This study characterised the fibre concentration of fresh (pre-ensiling) and ensiled herbage species produced under varying management conditions. Five grass species were grown in field plots under two nitrogen fertiliser regimes and harvested at five dates in the primary growth. On each harvest date, the plots were harvested and ensiled in laboratory silos for 100 days. Both fresh and ensiled herbage species were chemically analysed for neutral detergent fibre (NDF) and acid detergent fibre (ADF) concentrations. In general, fibre concentration increased with advancing plant maturity for all grass species. Timothy and cocksfoot had the highest fibre concentration with the ryegrasses having the lowest. The effect of ensiling on ADF and NDF concentrations in response to harvest date, nitrogen fertiliser and grass species was inconsistent. However, in general, ensiling resulted in a slight increase in the fibre concentration of all grasses, particularly for the early harvest periods where the fermentation of soluble compounds may have been most extensive.

Keywords: Grass, species, maturity, silage, NDF, ADF

## Introduction

Traditionally, grass and grass silage have formed the backbone of most beef and dairy production systems in Ireland and in many northern European countries (Wilkinson, 2005). However, in recent years interest has developed in alternative uses (e.g. renewable energy) for grasslands and the potential of grass for purposes other than as an animal feed (Kromus *et al.*, 2004). In a ‘Green Biorefinery’ that processes grass, the fibre fraction would be one of the largest material streams produced, and if this fibre were to be used in industrial applications its composition would need to be characterised. Furthermore, the continuous processing of fresh herbage would be logistically impractical, so the herbage would need to be preserved to ensure year-round availability of consistent quality feedstock. The purpose of this study was to quantify the changes in the fibre composition of silages produced from a range of common grasses, grown under different nitrogen fertiliser regimes and harvested at different stages of maturity.

## Materials and methods

Five common grass species, perennial ryegrass (PRG; *Lolium perenne* L. var. Gandalf), Italian ryegrass (IRG; *Lolium multiflorum* var. Prospect), cocksfoot (*Dactylis glomerata* var. Pizza), timothy (*Phleum pratense* var. Erecta) and tall fescue (*Festuca arundinacea* var. Fuego) were grown in field plots (each 20 m<sup>2</sup>; with three replicate blocks;  $n = 150$ ) under two nitrogen fertiliser inputs (low = 0 kg ha<sup>-1</sup>, high = 125 kg ha<sup>-1</sup>; applied in mid-March) and harvested at five sequential dates (fortnightly from 12 May – 7 July; Harvests 1 to 5) in the primary growth. On each harvest date, the appropriate plots were harvested to a 5 cm stubble height and the herbage was passed through a precision-chop harvester (nominal chop-length =

19 mm). A 6 kg representative sample of each herbage was then ensiled in laboratory pipe silos (O'Kiely and Wilson, 1991) for a period of 100 days. Representative samples of both the fresh grass and silage were taken for chemical analysis. Samples were oven dried at 40°C for 48 hours, milled through a 1 mm screen and analysed for NDF and ADF concentrations using an ANKOM fibre analyser according to the method of Van Soest (1963). Silage NDF and ADF values and the difference in NDF and ADF concentrations as a result of ensiling (calculated by subtracting silage NDF and ADF values from fresh grass values) are presented. Data were analysed as a split-split plot design using the Proc MIXED procedure of SAS, Version 9.1.2 (SAS, 2004) with harvest date as the main plot, nitrogen fertiliser as the sub-plot and grass species as the sub-sub plot, and with replicate blocking being accounted for.

## Results and discussion

In general, silage NDF and ADF concentrations increased ( $P < 0.001$ ) with advancing plant maturity (Figures 1 and 2). On average, NDF concentration was highest ( $P < 0.001$ ) for timothy and lowest ( $P < 0.001$ ) for IRG silage. The ADF concentration was also highest ( $P < 0.001$ ) for timothy followed by the PRG and cocksfoot, while the lowest ADF concentration was observed for the IRG silage. As harvest date advanced, NDF concentration increased ( $P < 0.01$ ) for all grass silages, with the exception of the IRG and tall fescue where a decrease in NDF concentration was observed from Harvest 3 to 4. A similar trend was observed for silage ADF concentration, where a slight decrease ( $P < 0.01$ ) was observed for all silages at harvest period 4. Although statistically significant ( $P < 0.05$ ; data not shown), differences in NDF and ADF concentrations across harvest dates for the low and high N treatments were negligible.

Silage fibre concentration was compared with that of fresh grass pre-ensiling. In general, an increase in both NDF and ADF concentrations were observed for the silages, compared with the fresh grass pre-ensiling. As a result of ensiling, average NDF concentration increased ( $P < 0.001$ ) for all harvest dates except Harvest 4 where no change was observed. Average ADF concentration also increased ( $P < 0.001$ ) for Harvests 1 to 3, while in contrast a slight decrease was observed for the later harvests. On average, the largest increase ( $P < 0.001$ ) in NDF and ADF concentrations as a result of ensiling were observed for the ryegrass silages. Further interactions for the effect of ensiling on ADF and NDF concentrations in response to harvest date, nitrogen fertiliser and grass species showed no consistent differences compared to values for fresh grass.

As expected, fibre concentration increased with advancing plant maturity as a result of an increase in the proportion of plant cell walls. The proportionately greater loss of non fibrous constituents during ensiling resulted in an increase in NDF and ADF concentrations, and this was particularly evident in the early harvest periods where the silage fermentation may have been more extensive. This is in agreement with Krizsan and Randby (2007) who reported an increase in NDF concentration during ensiling. In addition, losses in soluble organic substances through effluent production (which was collected for most silage) may have contributed. Little evidence of the hydrolysis of hemicellulose during ensiling was observed. Of the five grass species investigated timothy and cocksfoot had the highest NDF and ADF concentrations, in accordance with Mitchel (1973).

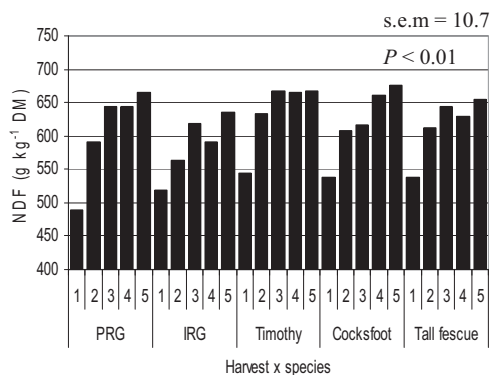

Figure 1. NDF concentration of five grass silages across five harvests (1-5)

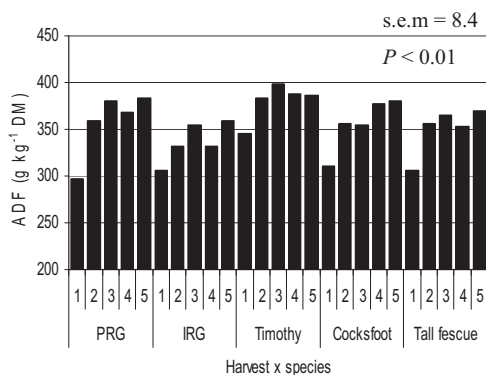

Figure 2. ADF concentration of five grass silages across five harvests (1-5)

## Conclusion

In general, fibre concentrations increased with advancing plant maturity for silages made from each grass species. The effect of ensiling on ADF and NDF concentrations in response to harvest date, nitrogen fertiliser and grass species was inconsistent. However, in general, ensiling resulted in a slight increase in the fibre concentration of all species, particularly at the early harvests where the fermentation of soluble compounds may have been most extensive.

## References

- Krizsan S.J. and Randby Å.T. (2007) The effect of fermentation quality on the voluntary intake of grass silage by growing cattle fed silages as sole feed. *Journal of Animal Science* 85, 984–996.
- Kromus S., Wachter B., Koschuh W., Mandl M., Krotscheck C. and Narodslawsky M. (2004) The green biorefinery Austria – development of an integrated system for green biomass utilization. *Chemical and Biochemical Engineering Quarterly* 18: 1, 7-12.
- Mitchel P.J. (1973) Relations between fibre and water soluble carbohydrate contents of pasture species and their digestibility and voluntary intake by sheep. *Australian Journal of Experimental Agriculture and Animal Husbandry* 13, 165-170.
- O'Kiely P. and Wilson R. K. (1991) Comparison of three silo types used to study in-silo processes. *Irish Journal of Agricultural Research* 30: 1, 53-60.
- SAS (2004) *SAS for windows*, Version 9.1.2, Statistical Analysis System, Institute Inc., Cary, North Carolina, USA.
- Van Soest P. J. (1963) The use of detergents in the analysis of fibrous feeds. II. A rapid method for the determination of fiber and lignin. *Journal of Association of Official Analytical Chemists* 46, 829-835.
- Wilkinson J.M. (2005) *Silage*. Chalcombe Publications, Marlow. UK, 254 pp.

# Silage fermentation characteristics as influenced by red clover/ryegrass-mixing ratio, degree of wilting and silage inoculants

Krawutschke M.<sup>1</sup>, Thaysen J.<sup>2</sup>, Weiher N.<sup>1</sup>, Gierus M.<sup>1</sup> and Taube F.<sup>1</sup>

<sup>1</sup>*Institute of Crop Science and Plant Breeding – Grass and Forage Science/Organic Agriculture, Christian-Albrechts-University, D-24118 Kiel, Germany*

<sup>2</sup>*Chamber of Agriculture Schleswig Holstein, Department of Crop Production/Crop Protection/Agricultural Engineering, D-24768 Rendsburg, Germany*

Corresponding author: mkrawutschke@email.uni-kiel.de

## Abstract

Pure red clover stands are difficult to ensile. Therefore, a laboratory ensiling trial was conducted to investigate the effects of varying proportions of red clover and perennial ryegrass (100/0, 66/33, 33/66, 0/100) on silage fermentation quality. In addition, the efficiency of the ensiling management, consist of lactic acid bacteria (LAB) inoculants combined with two levels of wilting (target dry matter: 300 vs. 400 g kg<sup>-1</sup>) were tested. Herbage was ensiled, either untreated or with inoculation of homofermentative LAB (low wilted herbage) or homo- and heterofermentative LAB (heavy wilted herbage). Early-July and mid-August growths were used. After 90 days of storage, each of the analysed parameters (lactic acid, acetic acid, pH, ammonia-N) showed a significant interaction cutting date x mixing ratio x ensiling management. Silages inoculated with homofermentative LAB increased the lactic acid production, but additives consist of heterofermentative LAB resulted in higher acetic acid concentrations, irrespective of harvest date and mixing ratio. These facts led to significant differences in silage pH between the applied LAB inoculants. However, wilting had only minor effects on the fermentation patterns. The influence of the mixing ratio was dependent on cutting date. Overall, the ensiling management was effective to improve the fermentation process.

Keywords: fermentation quality, red clover, perennial ryegrass, wilting, lactic acid bacteria inoculant

## Introduction

Red clover is a high quality forage crop, which plays an important role as a protein source for ruminants in sustainable farming systems. However, compared to grasses, the ensilability of red clover is more difficult. This is mainly due to lower concentrations of water soluble carbohydrates, higher buffering capacity and lower dry matter (DM) contents at harvesting (McDonald *et al.*, 1991). Despite these facts, previous studies have shown that improved fermentation can be achieved by wilting (Opitz von Boberfeld, 2008) and inoculation with LAB (Shurkhno *et al.*, 2005). Red clover-grass mixtures also represent an alternative to pure red clover stands.

The objective of the present study was to examine the effects of red clover and perennial ryegrass in different proportions on silage fermentation characteristics. Furthermore, it was of special interest whether degree of wilting and silage additives based on LAB are effective to improve fermentation quality.

## Materials and methods

In 2008 an ensiling experiment was carried out using pure stands of red clover (*Trifolium pratense* L., variety ‘Harmonie’) and perennial ryegrass (*Lolium perenne* L., variety

'Fennema'). Pure grass swards were N fertilized with 360 kg ha<sup>-1</sup> y<sup>-1</sup> (140/120/100) as calcium-ammonium nitrate. The silages were made from second growth cut on 2 July and third growth cut on 13 August, respectively.

At each cutting date, four different mixing ratios were tested as follows: (1) 100% red clover, (2) 66% red clover + 33% perennial ryegrass, (3) 33% red clover + 66% perennial ryegrass and (4) 100% perennial ryegrass. The ensiling material (chopping length 2 - 3 cm) was wilted to a target DM of about 300 g kg<sup>-1</sup> and 400 g kg<sup>-1</sup>. After wilting, the forages were ensiled, either untreated or with LAB inoculation into three 1.5-litre glass jars per treatment. Low-wilted herbage was inoculated with a commercial preparation containing homofermentative LAB (*Pediococcus acidilactici*, *Lactobacillus paracasei*, *Lactococcus lactis*), whereas a combination of homo- (*Lactobacillus plantarum*, *Pediococcus pentosaceus*, *Lactobacillus rhamnosus*) and heterofermentative LAB (*Lactobacillus brevis*, *Lactobacillus buchneri*) were applied to the high DM level. The silos were stored for 90 days in a dark room at 25 °C and then sampled to determine fermentation patterns and total N at 'IS Forschung' in Wahlstedt (Germany). Silage DM content was corrected for volatile compounds afterwards.

All data were statistically evaluated using analysis of variance, in which the factor ensiling management included both degree of wilting and LAB treatment. Multiple mean comparisons were performed by the Bonferroni-Holm procedure with  $P < 0.05$  as the significance level.

Table 1. Effects of mixing ratio, degree of wilting and LAB inoculation (homofermentative LAB additive (LABho), combined LAB preparation (LABcomb)) on silage fermentation quality at different cutting dates

Mixing ratio (red clover/ryegrass)	Lactic acid in DM (g kg <sup>-1</sup> )								SE = 2.89
	Second cut				Third cut				
	Low wilted		Heavy wilted		Low wilted		Heavy wilted		
	untreated	LABho	untreated	LABcomb	untreated	LABho	untreated	LABcomb	
100/0	82.5 bAB	89.1 bA	88.9 aA	77.6 abB	87.7 aB	101.6 aA	67.5 bC	71.0 bC	
66/33	103.5 aB	114.7 aA	86.2 aC	68.6 bD	76.8 bC	93.1 bA	90.0 aAB	82.2 aBC	
33/66	96.2 aB	109.3 aA	80.7 aC	80.7 aC	65.9 cB	75.2 cA	63.4 bcB	49.4 cC	
0/100	60.1 cC	94.5 bA	55.9 bC	77.8 abB	45.2 dA	55.3 dA	55.9 cA	53.2 cA	
	Acetic acid in DM (g kg <sup>-1</sup> )								SE = 1.39
100/0	44.2 aA	39.9 aA	41.6 aA	44.5 aA	16.6 cB	16.4 bB	18.3 cB	25.6 cA	
66/33	30.4 bB	30.7 bB	28.3 bB	43.0 aA	21.8 abBC	20.9 abC	25.9 bB	31.6 bA	
33/66	21.9 cA	20.6 cA	18.8 cA	23.9 bA	17.5 bcC	17.8 bC	31.8 aB	47.2 aA	
0/100	15.4 dB	23.5 cA	15.5 cB	26.1 bA	23.5 aBC	25.2 aB	19.3 cC	30.9 bA	
	pH-value								SE = 0.03
100/0	4.7 aAB	4.6 aB	4.7 aAB	4.8 aA	4.1 bC	4.1 cC	4.4 bB	4.5 cA	
66/33	4.3 bB	4.2 cC	4.4 bAB	4.5 bA	4.5 cA	4.3 bB	4.4 bA	4.5 cA	
33/66	4.2 cA	4.1 cA	4.2 dA	4.2 cA	4.4 cB	4.3 bC	5.0 aA	5.0 aA	
0/100	4.3 bB	4.4 bA	4.3 cB	4.2 cC	5.4 aA	5.1 aB	5.0 aC	4.9 bC	
	Ammonia-N in total-N (g kg <sup>-1</sup> )								SE = 0.44
100/0	110.3 aA	96.3 abA	107.7 aA	106.7 abA	61.7 dA	69.3 dA	72.7 dA	72.7 cA	
66/33	93.3 bA	98.7 abA	93.7 aA	92.0 bA	89.0 cB	88.3 cB	107.7 cA	103.0 bAB	
33/66	95.0 abA	88.0 bA	93.3 aA	94.7 abA	108.0 bD	120.3 bC	220.3 aA	196.0 aB	
0/100	97.7 abA	107.3 aA	94.3 aA	110.7 aA	228.3 aB	245.3 aA	184.3 bD	200.7 aC	
	Butyric acid in DM (g kg <sup>-1</sup> )								
100/0	n.d.	n.d.	n.d.	n.d.	n.d.	1.1	n.d.	n.d.	
66/33	n.d.	n.d.	n.d.	n.d.	3.8	n.d.	0.6	n.d.	
33/66	n.d.	n.d.	n.d.	n.d.	n.d.	n.d.	17.9	5.8	
0/100	n.d.	n.d.	n.d.	n.d.	0.4	0.6	5.2	2.4	

n.d. = not determined; a,b,c indicate significant differences between mixing ratios within one treatment and cutting date ( $P < 0.05$ ); A,B,C indicate significant differences between treatments within one mixing ratio and cutting date ( $P < 0.05$ ).



## Results and discussion

The fermentation quality of tested silages is given in Table 1. All measured parameters showed a significant interaction cutting date x mixing ratio x ensiling management ( $P < 0.0001$ ). Herbage ensiled with homofermentative LAB resulted in significantly higher lactic acid concentrations than those treated with a combination of homo- and heterofermentative LAB, except for pure grass silage at third cutting date. Moreover, in most cases, the applied homofermentative LAB preparation was effective to compensate for low degrees of wilting, as defined by a significant increase of lactic acid production in low-wilted silages with LAB inoculation compared to the untreated silages at high DM level. As a result of the presence of heterofermentative LAB, silage inoculated with combined LAB additives generally had higher acetic acid formation. The exceptions were three silages in the second cut. A significant reduction of acetic acid production was only observed in the early-July cut when the proportion of ryegrass increased ( $R^2 = 0.75$ ;  $P < 0.0001$ ; RMSE = 5.08). On the one hand high acetic acid concentrations result in improved aerobic stability (Danner *et al.*, 2003), but on the other hand, the silage intake can be reduced.

The silage pH was significantly influenced by mixing ratio and applied LAB additives. Both levels of wilting led to only small differences. At second harvest date, silage pH was negatively correlated with grass proportion ( $R^2 = 0.51$ ;  $P < 0.0001$ ; RMSE = 0.16), whereas an inverse correlation was found out in the third growth ( $R^2 = 0.65$ ;  $P < 0.0001$ ; RMSE = 0.22). Within all cuts, pH-values of the 90 days silages demonstrated a downward tendency when homofermentative LAB inoculants were used.

In the third cut, pure red clover silages had the lowest ammonia-N concentrations with no effect of silage inoculants. The ammonia-N concentrations of the grass-rich silages tended to be lower at second harvest date. High ammonia-N concentrations, as observed in the mid-August cut, originated from extensive proteolysis that occurred during silage fermentation. Consequently, a rapid pH decline will be inhibited by a slow acidification process. These findings are manifested in a positive relationship between silage pH and ammonia-N as well as a negative relationship between lactic acid and ammonia-N. Butyric acid concentrations could not be measured in all samples and are only available for third-cut silages (Table 1).

## Conclusions

Based on the present results, it can be concluded that silage fermentation quality is mainly influenced by red clover/ryegrass-mixing ratio. However, high proportions of ryegrass in grass-clover mixtures do not ensure a good fermentation. Well fermented silages were also achieved when pure red clover was ensiled. In addition, the ensiling management (e.g. wilting, LAB preparations) is an effective tool to improve silage fermentation. At low wilting levels, compensatory effects through the application of LAB inoculants are possible.

## References

- Danner H., Holzer M., Mayrhuber E. and Braun R. (2003) Acetic acid increases stability of silage under aerobic conditions. *Applied and Environmental Microbiology* 69, 562-567.
- McDonald P., Henderson A.R. and Heron S.J.E. (1991) *The Biochemistry of Silage*, Second Edition, Chalcombe Publications, Marlow, UK, 340 pp.
- Opitz von Boberfeld W. (2008) Verdaulichkeit organischer Substanz von Schnittgut für die Gärfutterbereitung in Abhängigkeit vom Vorwelkegrad. *Pflanzenbauwissenschaften* 12, 64-68.
- Shurkhno R.A., Gareev R.G., Abul'khanov A.G., Validov S.Z., Boronin A.M. and Naumova R.P. (2005) Fermentation of high-protein plant biomass by introduction of lactic acid bacteria. *Applied Biochemistry and Microbiology* 41, 69-78.

# The effect of different fodder galega-grass mixtures and nitrogen fertilization on forage yield and chemical composition

Lättemäe P., Meripõld H., Tamm U. and Tamm S.

*The Estonian Research Institute of Agriculture, 75501 Saku, Estonia*

Corresponding author: paul.lattetae@eria.ee

## Abstract

Fodder galega (*Galega orientalis*) is a forage legume. As a pure crop, galega is rich in nutrients, in particular crude protein, but is poor in soluble sugars. In order to improve fermentation properties, optimize nutrient concentrations and increase dry matter yield, galega usually is grown in mixture with suitable grass species. In this study, galega mixtures with timothy 'Tika', meadow fescue 'Arni' and brome grass 'Lincoln' were investigated in two successive years, 2008-2009. Three cuts were carried out during the vegetation period. Nitrogen fertilization rates applied were N0, N50, N100 and nitrogen was applied in spring prior to the first and second cut. The total dry matter (DM) yield varied from 7.2 to 12.4 t ha<sup>-1</sup>. DM yield was dependent on the year, mixture and fertilization level. The yields of the first cut were approximately 53% of total yield. The crude protein (CP) concentration in the DM varied from 125-226 g kg<sup>-1</sup>. CP was dependent on the year, mixture and fertilization. High N fertilization rate favoured grass growth and reduced the role of galega in the sward.

Keywords: Fodder-galega, galega-grass mixtures, forage yield, fertilization, goat's rue

## Introduction

Along with other legume fodder crops such as lucerne and clovers, goat's rue, i.e. fodder galega (*Galega orientalis*) has been grown in Estonia for almost forty years. Galega is very persistent with a high yielding ability. Results have shown that the yielding ability can possibly be 8.5 to 10.5 t of dry matter (DM) and 1.7 to 1.8 t of crude protein (CP) per hectare, with CP concentration of 200-220 g kg<sup>-1</sup> in the DM (Raig *et al.*, 2001). The nutritive value is the highest when the first cut was taken at shooting, budding or at the beginning of flowering (Nõmmsalu *et al.*, 1998). In order to connect the need for nitrogen fertilizer with biologically fixed nitrogen, it is favourable to grow galega in a mixture with grass. Among plant nutrients, nitrogen has the highest effect on yield and quality of forage crops. When choosing grasses for mixtures, the species' development speed, duration, and the effect on nutritive value should be considered. Earlier results have shown that growing galega in mixtures with grasses improves the nutritive value and ensiling properties of forage crop (Adamovich *et al.*, 2005; Lättemäe *et al.*, 2005). The aim of this investigation was to study the effects of different galega-grass mixtures and N fertilization rates on the DM yield and chemical composition of forage.

## Materials and methods

The field trial was carried out in two successive years 2008 and 2009 at Saku (latitude 57° 25'N). The trial plots were established on a typical soddy-calcareous soil where the agrochemical indicators were as follows: pH<sub>KCl</sub> 7.4 (ISO 10390); humus concentration C<sub>org</sub> 4.1% and concentration of lactate soluble P and K being 97 and 166 mg kg<sup>-1</sup> respectively. Three galega-grass mixtures were used. The galega variety 'Gale' was sown in binary mixtures with meadow fescue 'Arni' (seed 10 kg ha<sup>-1</sup>), timothy 'Tika' (6 kg ha<sup>-1</sup>) and brome grass 'Lincoln' (15 kg ha<sup>-1</sup>) respectively. The sowing rate of the seed of 'Gale' was 20

kg ha<sup>-1</sup> in all mixtures. In order to increase the competitiveness of grasses and yield at the first cut, three N fertilization levels were used: N0, N50 and N 100 kg ha<sup>-1</sup> (April, May I or II decade).

The crop was cut by a scythe, weighed, and then samples were taken for analyses. Prior to sampling the botanical composition of the crop was determined. A 3-cut system was used during harvest and there were three replicates of the plots of each treatment. All statistical analyses were carried out using the GLM procedure of the computer package SAS.

## Results and discussion

The results indicate that galega-grass mixtures ensured a high DM yield. In the first year the yields were relatively stable varying from 10.7 to 12.4 t ha<sup>-1</sup> (Table 1). There were no significant differences between the average yields at different N levels.

Table 1. The DM yield of fodder galega-grass mixtures in 2008-2009

Mixture	Year 2008			Year 2009		
	N0	N50	N100	N0	N50	N100
Gale/Arni	11.6	10.7	11.6	7.6	7.2	7.8
Gale/Tika	10.8	11.3	10.8	8.2	11.4	11.4
Gale/Lincoln	11.3	12.4	10.9	8.1	10.1	11.4
Average	11.2	11.5	11.1	8.0	9.6	10.2
*LSD <sub>0.05</sub> 0.39				*LSD <sub>0.05</sub> 0.64		
**LSD <sub>0.05</sub> 0.22				**LSD <sub>0.05</sub> 0.37		

\*- Least significant difference of N treatment; \*\*- LSD<sub>0.05</sub> of mixture treatment

In the second year the average yield was lower and more variable, varying from 7.2 to 11.4 t ha<sup>-1</sup>. There were significant differences between 'Gale'+ 'Arni' vs. 'Gale'+ 'Tika' and 'Gale'+ 'Lincoln', or between the N0 and N50 fertilization levels. The 'Gale'+ 'Arni' mixture resulted in lower DM yield compared to the other mixtures.

In the first year the first cut comprised about 51% of total yield, and in the second year 54%. (data not shown) The effect of N fertilization on the first cut was higher in the 'Tika' and 'Lincoln' mixtures where the proportion of 'Gale' was lower in the sward. The fertilization level of N50 increased the yield of the first cut and the total yield of 'Gale'+ 'Tika' and/or 'Gale'+ 'Lincoln'.

The average 'Gale' proportion in the pasture was 59% in 2008. In the second year 'Gale' percentage decreased to 27%. The 'Gale' proportion declined considerably also when fertilization increased (Figure 1). The results varied but there were significant differences between gale-grass mixtures ( $P < 0.02$ ). At fertilization levels of N0 and N50 the meadow fescue 'Arni' was less competitive. The highest competitiveness was shown by the bromegrass 'Lincoln' at the N100 fertilization in 2009. The proportion of 'Gale' was only 5% of the sward.

The nutritive value of mixtures is presented in Table 2. In general, the nutritive value of mixtures was mainly dependent on fertilization level. In the first year the average CP concentration in DM was 170 g kg<sup>-1</sup> and metabolisable energy (ME) 10.1 MJ kg<sup>-1</sup>. In the second year the CP and ME were 181 g kg<sup>-1</sup> and 10.2 MJ kg<sup>-1</sup>, respectively. Lower CP and ME were found in treatments when N fertilizer was not used. When fertilization level increased, CP concentration and ME increased, but NDF and ADF decreased. The mixture effects were less pronounced.

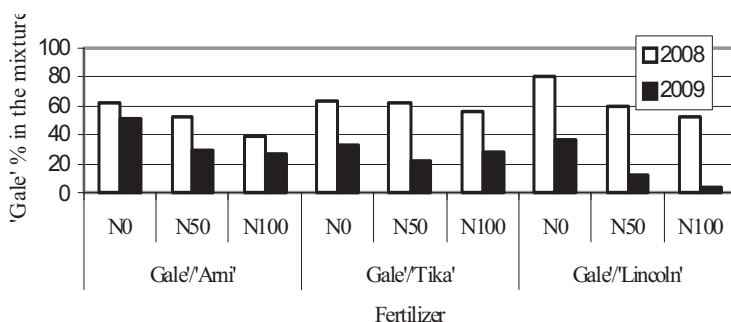

Figure 1. The botanical composition of galega-grass mixture of first cut in 2008-2009

Table 2. The nutritive value of the fodder galega-grass mixtures of first cut in 2008-2009

Mixture	N fertilizer	CP in DM g kg <sup>-1</sup>	NDF in DM g kg <sup>-1</sup>	ADF in DM g kg <sup>-1</sup>	ME in DM MJ kg <sup>-1</sup>
'Gale/'Arni'	N0	174	437	310	10.1
'Gale/'Arni'	N50	171	415	307	10.2
'Gale/'Arni'	N100	187	401	278	10.6
'Gale/'Tika'	N0	160	463	339	9.8
'Gale/'Tika'	N50	187	455	329	10.0
'Gale/'Tika'	N100	202	388	278	10.6
'Gale/'Lincoln'	N0	138	463	335	9.8
'Gale/'Lincoln'	N50	175	470	329	10.0
'Gale/'Lincoln'	N100	197	466	306	10.3

## Conclusions

The DM yield was dependent on the year, mixture and fertilization level. The total yield was lower in the second year, and in that year the yield from the mixture of 'Gale' + 'Arni' was the lowest. The nutritive value of mixtures was mainly dependent on fertilization. High N fertilization rate favoured grass growth and reduced the role of galega in the sward. On the basis of these results, fertilization rate of N50 should be recommended in order to avoid galega being lost from the pasture.

## References

- Adamovich A., Drikis J. and Auzins V. (2001) Fodder Galega-grass swards for forage production in organic arable-livestock systems. *Proceedings of the Conference on Sustainable Agriculture in Baltic States*, Tartu, pp. 10-17.
- Lättemäe P., Meripõld H., Lääts A. and Kaldmäe H. (2005) The improvement of fodder galega silage quality by using galega-grass mixtures and additive. In: *Integrating Efficient Grassland Farming and Biodiversity, Grassland Science in Europe* 10, 635-638.
- Raig H., Nõmmsalu H., Meripõld H. and Metlitskaja J. (2001) *Fodder Galega*, monographia, ERIA, Saku, 141 pp.

# Insights into carbohydrate and protein fractionation in perennial ryegrass (*Lolium perenne* L.) genotypes using the Cornell Net Carbohydrate and Protein System. 1. Carbohydrate and protein fractionation

Lösche M., Salama H., Gierus M., Herrmann A. and Taube F.

*Institute of Crop Science and Plant Breeding, Grass and Forage Science / Organic Agriculture, Christian Abrechts-University of Kiel, Germany*

Corresponding author: mloesche@email.uni-kiel.de

## Abstract

Perennial ryegrass is considered to be the most important grassland species in North-west Europe, due to its high nutritive value among temperate grasses. However, the imbalance between the supply of rumen degradable protein and fermentable energy resulting from inefficient carbohydrate fermentation enhances the risk of environmental pollution and leads to higher feed costs. Within the framework of a two-year field trial (2006-2007), carried out at three experimental sites in Northern Germany, the variation in the composition of crude protein (CP) and carbohydrate fractions among a set of twenty diploid *Lolium perenne* L. genotypes was examined. The result of the first cut revealed genotypic variation for the carbohydrate and protein fractions as well as for the total carbohydrate and protein contents. However, the magnitude of variation detected for the carbohydrates was very small except for the simple sugars (Fraction A). An even smaller variation was found for the protein fractions which could be partially attributed to low CP content of the genotypes.

Keywords: *Lolium perenne* L., CNCPS, carbohydrate fractions, protein fractions

## Introduction

Grassland-based feeding systems for ruminants are often characterised by low N-use efficiency caused by the imbalanced availability of degradation products of proteins and carbohydrates in the rumen. This may generate an accumulation of ammonia in the rumen, which is mainly excreted in the form of urea in the urine after conversion in the liver. In this manner the environmental N pollution is enhanced. Breeding grasses for improved forage quality would support efficient farming systems. On the one hand, selection for high sugar content in grasses might provide the opportunity to optimise the supply of energy and N in the rumen. On the other hand, this objective could be achieved by improving the protein quality through selection of genotypes with lower protein degradation rate. The present study comprises two aspects. First, carbohydrates and proteins among twenty tested perennial ryegrass genotypes were analysed and fractionated according to the Cornell Net Carbohydrate and Protein System (CNCPS). Second, the CNCPS was further used as a tool to achieve prognoses whether and how far differences in carbohydrate and protein fractions may enhance their utilisation in the rumen (Salama *et al.*, 2010). Considering the dynamic processes of degradation and passage rate in the rumen, forage plant breeders are provided with basic information and methodological tools which supports the improvement of the N-use efficiency by the animal. The objective, therefore, was to analyse and evaluate the composition of crude protein (CP) and carbohydrate fractions of twenty perennial ryegrass genotypes.

## Materials and methods

The data base comprised a two-year field trial carried out at three experimental sites in Northern Germany during the growing seasons 2006 and 2007. A set of twenty diploid perennial ryegrass genotypes belonging to the early-intermediate heading group was tested in a randomised complete block design with three replicates in a four-cut system. Fertiliser was applied at an amount of 300 kg N ha<sup>-1</sup> split into four dressings. Plots were harvested to 5 cm stubble height with a Haldrup plot harvester. Representative subsamples were dried at 60 °C till reaching constant weight and then ground to 1 mm particle size. Neutral detergent fibre (NDF), acid detergent fibre (ADF) and acid detergent lignin (ADL) were determined using a semi automatic apparatus (ANKOM, USA). Carbohydrate fractions A, B1, B2 and C, expressed as percentage of CHO, were calculated according to the CNCPS formulae (Sniffen *et al.* 1992). Feed protein was partitioned into five protein fractions, expressed as proportion of the total N, after the procedures described by Licitra *et al.* (1996). The nitrogen content was determined through rapid combustion (850 °C) by CN Analyser (Vario Max CN, Elementar Analysensysteme, Hanau, Germany). Data were statistically analysed using the mixed procedure of SAS, with the least significant difference procedure for mean comparison and probabilities being adjusted by Tukey-Kramer test.

## Results

Analysis of variance for the first-cut data revealed a significant variation among the three sites in the investigated carbohydrate and protein fractions and the total CHO content, as well as among the tested genotypes, except for the carbohydrate fraction B1. The total N content was additionally affected by the site x genotype interaction. Evaluation of the carbohydrate values revealed that the high-sugar genotype 9 produced the highest CHO-fraction A content (411 g kg<sup>-1</sup> CHO) and in turn the lowest CHO-fraction B1 and B2 values. The situation was reversed for genotype 6 which showed superiority for CHO-fraction B2 and also had the lowest CHO-fraction A content (Table 1). Total CHO contents in DM ranged from 774 to 809 g kg<sup>-1</sup> (data not presented). Analysis of the protein contents presented in Table 1 revealed significant genotypic differences in all CP-fractions. Genotypes 6 and 20 were characterised by the highest CP-fraction A contents and the lowest CP-fraction B<sub>total</sub> values, with 680 and 676 g kg<sup>-1</sup> N, respectively (data not presented). The opposite was detected for genotype 4 which stood out because of its low CP-fraction A and high fraction CP-B<sub>total</sub> values (714 g kg<sup>-1</sup> N). Considering the composition of true protein, genotypes 6 and 20 showed low CP-fraction B1 and B3 and a relatively high B2 value, whereas genotype 4 is characterised by relatively high B1, B2 and B3 contents. The high-sugar genotype 9 was distinguished by its relatively high CP-fraction A, B1 and B3 values and low B2 content. Despite of the significant variation in CP-fraction C, the range between highest and lowest value was very small (33 g kg<sup>-1</sup> N vs. 28 g kg<sup>-1</sup> N). Concerning the total N concentrations, significant differences among genotypes were detected at each site, but variations between maximum and minimum values as well as the mean N contents in DM of the three sites (17.1, 17.2, 20.3 g kg<sup>-1</sup>) were very small.

## Discussion

Significant variation among the tested genotypes in the investigated carbohydrate and protein fractions were documented. However, the magnitude of variability was relatively small. Range between highest and lowest values accounted for 7, 1, 5 and 2% CHO for the carbohydrate fractions A, B1, B2 and C, respectively. A smaller difference was achieved for the protein fractions accounting for 4, 3, 4, 3 and 0.5% for the respective fractions A, B1, B2, B3 and C. The results are in good agreement with studies performed by Hoekstra *et al.* (2007) who pointed out that nearly a quarter of total protein was in form of non-protein nitrogen (CP-fraction A) and that the true protein was mainly composed of CP-fraction B2.

Smith *et al.* (2002) reported that CP-fraction C represented only a small part of protein in the first cut, which is in accordance with the results of the present study. A difference of 6% WSC (CHO-fraction A) was achieved between the high-sugar genotype (9) and the low-sugar genotype (6), which is higher or comparable with CHO-fractions found in other studies (Hoeckstra *et al.*, 2007). The crude protein contents were less than the ranges recommended by the NRC (2001) for animal feeding in grass-based production systems, which could be attributed to the moderate rate of N fertiliser application.

Table 1. Means of first-cut carbohydrate and protein fractions of the twenty tested genotypes over 2006/2007

Geno- type	Carbohydrate fractions (g kg <sup>-1</sup> CHO)				Protein fractions (g kg <sup>-1</sup> N)				
	A	B1	B2	C	A	B1	B2	B3	C
1	371 cdef	3 a	572 abcd	55 abc	276 ab	93 abc	355 a	245 fg	31 abcde
2	380 cde	3 a	566 bcde	52 bcde	286 ab	96 abc	334 abc	253 defg	32 abcde
3	378 cde	3 a	568 bcd	50 bcde	279 ab	104 abc	323 abc	265 abcde	30 abcde
4	399 abc	4 a	555 def	43 fg	256b	117 a	324 abc	274 abc	30 abcde
5	363 ef	4 a	579 abc	55 abc	277 ab	89 bc	349 abc	252 efg	33 ab
6	345 f	3 a	593 a	59 a	287 a	84 c	353 ab	243 g	33 a
7	372 cdef	4 a	574 abcd	50 bcde	263 ab	103 abc	339 abc	267 abcde	28 e
8	377 cde	3 a	574 abcd	47 defg	269 ab	104 abc	323 abc	275 ab	30 abcde
9	411 a	3 a	543 f	41 g	278 ab	104 abc	315 bc	275 ab	28d e
10	410 ab	3 a	544 ef	45 efg	263 ab	106 abc	348 abc	254 defg	29 abcde
11	377 cde	3 a	569 bcd	51 bcde	270 ab	99 abc	343 abc	257 bcdefg	30 abcde
12	380 bcde	3 a	568 bcd	50 bcdef	271 ab	95 abc	334 abc	271 abcd	29 bcde
13	392 abcd	3 a	558 cdef	46 defg	266 ab	109 ab	330 abc	264 abcdef	31 abcde
14	368 def	3 a	575 abcd	54 abc	286 ab	91 bc	331 abc	260 abcdefg	32 abc
15	363 ef	3 a	582 ab	53 abcd	278 ab	103 abc	313 c	277 a	30 abcde
16	388 abcde	3 a	561 bcdef	48 cdefg	265 ab	104 abc	329 abc	274 ab	29 bcde
17	367 def	3 a	575 abcd	55 abc	278 ab	93 bc	341 abc	259 abcdefg	29 abcde
18	380 bcde	3 a	568 bcd	50 bcdef	273 ab	110 ab	313 c	276 ab	29 cde
19	384 abcde	3 a	563 bcdef	49 cdef	276 ab	103 abc	340 abc	250 efg	32 abcd
20	359 ef	3 a	582 ab	57 ab	292 a	91 bc	331 abc	255 cdefg	32 abcde
S.E.	5.8	0.2	4.5	1.4	6.1	4.7	9.0	4.7	0.8

Means followed by different letter(s) within the same column are significantly different according to the LSD test at 0.05 level of probability. S.E. Standard error

## Conclusion

Analysis of the carbohydrate and protein fractions revealed differences among the tested genotypes. However, the small variation highlights the need of introducing different genetic background as basis of selection for the investigated quality parameters.

## References

- Hoeckstra N.J., Schulte R.P.O., Latinga E.A. and Struik P.C. (2007) Pathways to improving the N efficiency of grazing bovines. *European Journal of Agronomy* 26, 363-374.
- Licitra G., Hernandez T.M. and Van Soest P.J. (1996) Standardization of procedures for nitrogen fractionation of ruminant feeds. *Animal Feed Science and Technology* 57, 347-358.
- NRC (2001) *Nutrient Requirements of Dairy Cattle*. National Academy Press. Washington DC.
- Smith K.F., Culvenor R.A., Humpreys M.O. and Simpson R.J. (2002) Growth and carbon partitioning in perennial ryegrass (*Lolium perenne*) cultivars selected for high water-soluble carbohydrate concentrations. *Journal of Agricultural Science, Cambridge* 138, 375-385.
- Salama H., Lösche M., Gierus M., Herrmann A. and Taube F. (2010) Insights into carbohydrate and protein fractionation in perennial ryegrass (*Lolium perenne* L.) using the CNCPS. 2. Ruminal kinetics. *Grassland Science in Europe* 15 (this volume).
- Sniffen C.J., O'Connor J.D., Van Soest P.J., Fox D.G. and Russel J.B. (1992) A net carbohydrate and protein system for evaluating cattle diets. II. Carbohydrate and protein availability. *Journal of Animal Science* 70, 3562-3577.



## Performance of ewes fed long or chopped grass silage using different feeding strategies

Helander C.<sup>1</sup>, Eilersen R.<sup>2</sup>, Nørgaard P.<sup>2</sup>, Arnesson A.<sup>1</sup> and Nadeau E.<sup>1</sup>

<sup>1</sup>*Department of Animal Environment and Health, Swedish University of Agricultural Sciences, Skara, Sweden*

<sup>2</sup>*Department of Basic Animal and Veterinary Sciences, Faculty of Life Sciences, University of Copenhagen, Frederiksberg C, Denmark*

Corresponding author: Carl.Helander@hmmh.slu.se

### Abstract

Effects of chopping of grass silage and mixing of grass silage and concentrate on performance of ewes in late pregnancy and lactation were studied. Twenty-one ewes were fed long grass silage and concentrate separately (LS) or chopped grass silage and concentrate separately (CS) or in a total mixed ration (TMR). The silage averaged 10.9 MJ metabolizable energy and 578 g NDF per kg DM. The daily DM intake in late pregnancy was 2.6, 2.5 and 2.6 kg and in lactation 3.5, 2.9 and 3.8 kg for LS, CS and TMR, respectively ( $P < 0.10$ ). The effective chewing time per kg DM intake was 272, 289 and 264 minutes in late pregnancy and 198, 253 and 210 minutes in lactation for LS, CS and TMR, respectively, with a significant effect of metabolic state ( $P < 0.001$ ). Mixing chopped grass silage with concentrate increased the feed intake by 19% in lactating ewes. Chopping of silage increased ruminating time ( $P < 0.001$ ) with no increase in DM intake. Ewes had a higher intake but a shorter ruminating time in minutes per day and per kg of DM intake and silage NDF intake during lactation than during late pregnancy ( $P < 0.05$ ).

Keywords: ewes, grass silage, mixing, chopping, feed intake, chewing time

### Introduction

Swedish lamb production is traditionally based on pasture grazing in summer and indoor feeding with grass silage and concentrate around parturition in winter. The intake of ewes is related to metabolic state of the animal (Robinson *et al.*, 1999), forage quality and physical form (Deswysen and Vanbelle, 1978; Nadeau and Arnesson, 2008) and the feeding conditions (Mertens, 1994). Sheep increase their voluntary feed intake as they eat faster when fed chopped compared with long silage (Deswysen and Vanbelle, 1978). Feeding sheep a total mixed ration potentially can increase their intake and milk yield as simultaneous feeding of forage and concentrate can result in more even rumination patterns and a more stable rumen fermentation (Nocek *et al.*, 1986). Our aim was to investigate the effects of chopping of grass silage and mixing of grass silage and concentrate on intake and chewing activity in ewes around parturition.

### Materials and methods

The experiment was conducted with 21 twin-bearing Finull x Dorset ewes, mated with a purebred Texel ram, at Götala Beef and Sheep Research Centre, Skara, Sweden. The ewes were assigned to three dietary treatments, with seven ewes per treatment from six weeks before to six weeks after parturition. The dietary treatments were: *ad libitum* feeding of long grass silage ( $170 \pm 110$  mm; LS), chopped grass silage ( $12 \pm 2$  mm; CS), each supplemented with 0.8 kg of concentrate, or of a total mixed ration (TMR) of chopped grass silage and concentrate. The forage to concentrate ratio in the TMR treatment was adjusted to be equal to

the ratio in the CS treatment. Chemical composition of the grass silage containing *Lolium perenne* L., *Festuca pratensis* L. and *Phleum pratense* L. is shown in Table 1.

Table 1. Particle size of grass silages and chemical composition of concentrate and grass silages fed to the ewes.

	Concentrate	Late pregnancy		Lactation	
		Long silage	Chopped silage	Long silage	Chopped silage
Particle size, mm	-	170 ± 110	12 ± 2	170 ± 120	13 ± 2
DM, g kg <sup>-1</sup>	877	528 ± 96	600 ± 39	611 ± 23	551 ± 17
CP in DM, g kg <sup>-1</sup>	179	87 ± 17	92 ± 6	89 ± 13	91 ± 8
NDF in DM, g kg <sup>-1</sup>	278	571 ± 7.6	568 ± 4.8	604 ± 35.0	570 ± 12.7
ADF in DM, g kg <sup>-1</sup>	124	319 ± 6.2	312 ± 4.1	339 ± 24.7	315 ± 7.1
ADL in DM, g kg <sup>-1</sup>	38	27 ± 8.5	23 ± 2.5	27 ± 5.6	22 ± 1.1
ME in DM, MJ kg <sup>-1</sup>	12.7	11.0 ± 0.2	11.1 ± 0.04	10.9 ± 0.4	10.6 ± 0.3

The concentrate contained 4.5 g crude fat and 218 g starch per kg DM.

The ewes were fed once daily. The intake of the ewes was recorded daily during a four-day period, on average 17.0 ± 6.4 days before and 17.3 ± 2.9 days after parturition. During the same four-day period, jaw movement oscillations (JMO) were recorded by a 'Hall sensor' located in a soft tube surrounding the mouth and stored. Eating and ruminating time was identified from the JMO values (Nørgaard and Hilden, 2004). The ewes and lambs were weighed once a week. The ewes also were scored for body condition when they were weighed. Data were analysed statistically using a completely randomized design in the mixed procedure of SAS (ver. 9.01, 2002) with n = 7 for the LS and TMR and with n = 6 and 5 for the CS in late pregnancy and lactation, respectively. Metabolic state (before and after parturition) and diet were used as fixed effects and ewe as a random effect. When a significant *F* - test occurred at *P* < 0.05, pair wise comparisons between means were made according to the (LSD)<sub>0.05</sub>-test.

Table 2. Body weight (BW), body condition score (BCS) and intakes of DM (DMI) and NDF (NDFI) of ewes fed diets of long silage (LS) or chopped silage (CS) supplemented with concentrate or a total mixed ration (TMR) of the chopped silage and concentrate.

	Late pregnancy			Lactation			SEM	<i>P</i> - value		
	LS	CS	TMR	LS	CS	TMR		M x D	M	D
BW, kg	92	95	94	91	90	92	4.0	NS	**	NS
BCS <sup>1</sup>	3.1	3.2	3.4	3.0	2.9	3.0	0.13	NS	**	NS
DMI, kg d <sup>-1</sup>	2.6	2.5	2.6	3.5	2.9	3.8	0.16	T	***	*
DMI per BW <sup>0.75</sup> , g kg <sup>-0.75</sup>	88	83	86	119	101	127	5.2	NS	***	*
(Silage NDFI)/BW, g kg <sup>-1</sup>	9.5	8.7	9.0	16	12	15	0.88	NS	***	*

See footnote for Table 3.

## Results and discussion

Feeding of TMR increased intakes of DM and NDF compared to feeding CS (*P* < 0.05). Chopping of silage increased ruminating time (*P* < 0.001) with no increase in DM intake (Tables 2 and 3). The DM intake of the ewes was 0.8 kg higher during lactation than during late pregnancy (*P* < 0.001), resulting in a 58% higher silage NDF intake per kg of BW in lactation compared to late pregnancy. Ruminating time, both per kg of DM intake and per kg of silage NDF intake, was shorter for the ewes during lactation than during late pregnancy, which probably was due to a higher passage rate because of the higher DM intake during lactation (*P* < 0.001; Mertens, 1994). Due to the higher DM intake, total daily eating time was longer during lactation than during late pregnancy (*P* < 0.001). As a result, total chewing time

per kg of DM intake and per kg of silage NDF intake was shorter during lactation than during late pregnancy ( $P < 0.001$ ).

Table 3. Effective eating time, ruminating time and total chewing time in minutes per day, per kg of DM intake (DMI) and per kg of silage NDF intake (NDFI) in ewes fed diets of long silage (LS) or chopped silage (CS) supplemented with concentrate or a total mixed ration (TMR) of the chopped silage and concentrate.

Effective chewing time	Late pregnancy			Lactation			SEM	P – value			
	LS	CS	TMR	LS	CS	TMR		M x D	M	D	
Eating time, min											
per day	330 <sup>b</sup>	243 <sup>c</sup>	234 <sup>c</sup>	385 <sup>a</sup>	341 <sup>ab</sup>	361 <sup>ab</sup>	19	**	***	**	
per kg DMI	133	97	94	113	116	98	10	T	NS	T	
per kg silage NDFI	409	301	291	272	328	266	34	T	NS	NS	
Ruminating time, min											
per day	358	483	437	296	402	416	23	NS	*	***	
per kg DMI	139	192	170	86	137	112	8	NS	***	***	
per kg silage NDFI	424	598	523	204	282	305	31	NS	***	***	
Total chewing time, min											
per day	696	726	670	681	742	778	32	T	NS	NS	
per kg DMI	272	289	264	198	253	210	16	NS	***	NS	
per kg silage NDFI	833	899	813	477	709	570	59	NS	***	NS	

SEM = standard error of the mean, M = metabolic state (late pregnancy vs. lactation), D = diet; <sup>a,b</sup>Means with different superscripts within a row differ significantly at  $P < 0.05$ . NS = not significant ( $P > 0.05$ ), T = tendency to significance ( $0.05 < P < 0.10$ ), \*\*\* $P < 0.001$ , \*\* $P < 0.01$ , \* $P < 0.05$ ; <sup>1</sup>Scale from 1 to 5, where 1 is very thin and 5 is excessively fat.

## Conclusion

Mixing chopped grass silage with concentrate increased the feed intake in ewes. Chopping of silage increased ruminating time per kg of DM intake and per kg of silage NDF intake. Ewes had a higher DM intake but a shorter total effective chewing time per kg of DM intake and per kg of silage NDF intake, due to a shorter ruminating time, during lactation than during late pregnancy.

## References

- Deswysen A. and Vanbelle M. (1978) How chopping improves grass silage intake by sheep and heifers. Constraints to grass growth and grassland output. *Proc. 7th General Meeting, European Grassland Federation*, Gent, Belgium, 5-9 June 1978, pp. 619-626.
- Mertens D.R. (1994) Regulation of forage intake. In: Fahey G.C.Jr., Collins M., Mertens D.R. and Moser L.E. (eds.) *Forage Quality, Evaluation and Utilization*. American Society of Agronomy, Crop and Soil Science Society of America, Madison, WI.
- Nadeau E. and Arnesson A. (2008) Performance of pregnant and lactating ewes fed grass silages differing in maturity. *Grassland Science in Europe* 13, 834-836.
- Nocek J., Steele R. and Braund D. (1986) Performance of dairy cows fed forage and grain separately versus a total mixed ration. *Journal of Dairy Science* 69, 2140-2147.
- Nørgaard P. and Hilden K. (2004) A new method for recording mastication during eating and ruminating in sheep. *Journal of Animal and Feed Sciences* 13, 171-174.
- Robinson J.J., Sinclair K.D., Randel R.D. and Sykes A.R. (1999) Nutritional management of the female ruminant: mechanistic approaches and predictive models. In: Jung H.J.G. and Fahey G.C.Jr. (eds.) *Nutritional Ecology of Herbivores*. *Proc. Vth International Symposium on Nutrition of Herbivores*. ASAS, Savoy, Illinois, USA.

## Volatile fraction from sugarcane silage and forage proportion on the ingestive behaviour of beef steers

Daniel J.L.P., Nussio L.G., Zopollatto M., Goulart R.S., Santos V.P. and Toledo Filho S.G.  
*University of São Paulo, Luiz de Queiroz College of Agriculture, Piracicaba-SP, Brazil*  
Corresponding author: nussio@esalq.usp.br

### Abstract

This study aimed to evaluate whether volatile fermentation end-products from sugarcane silage and the forage:concentrate ratio might affect the ingestive and feed sorting behaviour by the animals. Six Nellore steers were randomly assigned in a replicated 3x3 Latin square design over a 14-d period. Dietary treatments were: 75D – 75% sugarcane silage without volatile fraction (dried and re-hydrated) and 25% concentrate; 75W – 75% wet sugarcane silage and 25% concentrate; and 40W – 40% wet sugarcane silage and 60% concentrate (dry matter (DM) basis). The volatile fraction from silage did not impair intake and ingestive behaviour. Despite presenting higher DM intake, steers fed lower forage:concentrate ratio (40W) spent less time eating and ruminating. Sorting was unaffected by treatment, whereas sorting index showed increased orts percentage for longer particles. Feeding sugarcane silage with shorter particle size may reduce sorting and keep the DM intake of the diet according to the predicted formulation.

Keywords: volatile organic compounds, intake, particle selection, chewing, silage dry matter

### Introduction

During the winter season tropical pasture production decreases, and alternative forage resources are used to feed ruminants. In this context, the use of sugarcane (*Saccharum officinarum* L.) fresh cut has increased in Brazil, because its harvesting period coincides with the period of pasture scarcity. However, to avoid daily harvesting, chopping and hauling of the crop, and to prevent crop loss by burning from accidental fire, this forage could be ensiled. In addition, as sugarcane is a semi-perennial tropical grass, the field lifespan may increase due to uniform harvesting and post-harvesting management.

The ensiling of sugarcane will result in the conversion of most of the water soluble carbohydrates in fermentation products, which may decrease the dry matter (DM) intake of diets by ruminants. The effects of these components on ingestion and digestion had been studied previously for maize (Phillip *et al.*, 1980) and sorghum (Senel and Owen, 1966) forages. Fermentation end-products from sugarcane silage are well characterized by high levels of volatile organic compounds, mainly ethanol. Ingestive behaviour of animals fed sugarcane silage and fresh cut sugarcane are reported in the literature (Queiroz, 2006; Mari, 2008). Nevertheless, there is no detailed understanding of how the fermentation profile of sugarcane silage may affect the ingestive behaviour. The objective of this study was to determine whether volatile fermentation end products from silage, measured indirectly, and the forage:concentrate ratio may affect the intake, ingestive behaviour, and feed sorting by beef cattle.

### Material and methods

Six Nellore beef steers were randomly assigned to a replicated 3x3 Latin square design with a 14-d period. Steers were housed in a tie-stall barn, and individually fed *ad libitum* daily at 0800 h. Dietary treatments were balanced to reach isonitrogen content: 75D (dry) – 75%

sugarcane silage without volatile fraction (dried at 60°C and re-hydrated) and 25% concentrate; 75W(wet) – 75% wet sugarcane silage and 25% concentrate; and 40W(wet) – 40% wet sugarcane silage and 60% concentrate (DM basis). Silage DM was determined by oven heating (DM<sub>oven</sub>) or by toluene distillation (DM<sub>tol</sub>) to verify indirectly the presence of volatile compounds. Intake data were recorded daily while chewing activity and feed sorting were monitored for each animal on d 11 of each period. Oral activity of each steer was recorded by direct observation at 5-min intervals throughout 24 h. Particle size distribution of diets and orts were determined by using Penn State particle size separator adapted with a top screen (38 mm pore size), resulting in four fractions (long, medium, short and fine particle size). Sorting was calculated as the observed intake of each particle size fraction expressed as a percentage of the predicted intake (as fed basis). Values <100% indicate selective refusal, >100% indicate preferential intake, and 100% no sorting (Leonardi and Armentano, 2003). Rumen evacuation was performed on d 14 of each period. The ruminal turnover rate of DM<sub>oven</sub> was calculated as  $100 \times (\text{DM}_{\text{oven}} \text{ intake} / \text{ruminal DM}_{\text{oven}} \text{ pool}) / 24$ .

Table 1. Intake, ingestive behaviour and rumen digesta parameters of beef steers fed sugarcane silage-based diets

Variable	Treatment			SE	P - Value	
	75D	75W	40W		75D vs. 75W	75W vs. 40W
<b>Intake</b>						
DM <sub>oven</sub> (kg d <sup>-1</sup> )	5.32	5.11	7.99	0.31	0.49	<0.01
DM <sub>tol</sub> (kg d <sup>-1</sup> )	5.32	6.32	9.40	0.36	0.03	<0.01
Forage DM <sub>oven</sub> (kg d <sup>-1</sup> )	4.02	3.83	3.20	0.22	0.41	0.02
Forage DM <sub>tol</sub> (kg d <sup>-1</sup> )	4.02	4.74	3.76	0.26	0.03	<0.01
<b>Ingestive behaviour</b>						
Eating (min d <sup>-1</sup> )	264	268	227	19.50	0.81	0.03
Ruminating (min d <sup>-1</sup> )	518	561	472	34.47	0.34	0.05
Chewing (min d <sup>-1</sup> )	782	829	698	47.16	0.36	0.02
Chewing/DM <sub>tol</sub> intake (min kg <sup>-1</sup> )	145	133	74	6.96	0.14	<0.01
Chewing/Forage DM <sub>tol</sub> intake (min kg <sup>-1</sup> )	193	177	185	12.10	0.25	0.54
Eating during 4 h after feed (min)	90	94	96	14.19	0.72	0.86
<b>Rumen digesta</b>						
Fresh weight (kg)	42.60	38.40	38.98	2.48	0.01	0.64
DM <sub>oven</sub> weight (kg)	4.91	3.97	4.33	0.37	0.02	0.25
DM <sub>oven</sub> turnover rate (% h <sup>-1</sup> )	4.61	5.46	7.82	0.64	0.14	<0.01

75D – 75% sugarcane silage without volatile fraction (dried and re-hydrated) and 25% concentrate; 75W – 75% wet sugarcane silage and 25% concentrate; and 40W – 40% wet sugarcane silage and 60% concentrate (DM basis).

## Results and discussion

The volatile fraction of sugarcane silage, measured indirectly, did not affect DM<sub>oven</sub> intake and chewing activities (Table 1). However, when volatile fraction was taken into account, DM<sub>tol</sub> intake of wet sugarcane based ration (75W) was higher than ration without volatile components (75D). Decreasing of forage:concentrate ratio (75W vs. 40W) increased DM intake, but did not alter the mass of rumen digesta (wet or dry) (Table 1). These results suggest that consumption had been restricted by the physical limitation (rumen fill). Eating pattern followed the same trend across treatments (Figure 1). Furthermore, the time spent eating during the first 4 h after feeding was similar across diets (Table 1), showing that volatile components did not impair consumption. DM<sub>tol</sub> intake over time is given in Figure 2. As expected, the steers fed lower forage:concentrate ratio (40W) spent less time eating, ruminating, and chewing, despite the higher DM intake. The higher consumption was probably allowed by higher ruminal turnover rate of DM<sub>oven</sub> (Table 1). Sorting behaviour was unaffected by treatment, whereas sorting index was decreased ( $P < 0.05$ ) as sieve size of

screens was increased (fine 103%, short 99%, medium 84%, long 77%), which reflects the significant contribution of long length particles in the Orts.

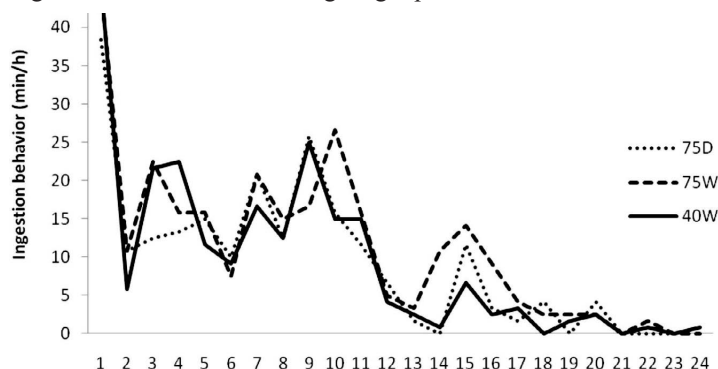

Figure 1. Time trend on eating pattern.  $P = 0.40$  for treatment;  $P < 0.01$  for time;  $P = 0.98$  for treatment  $\times$  time interaction.

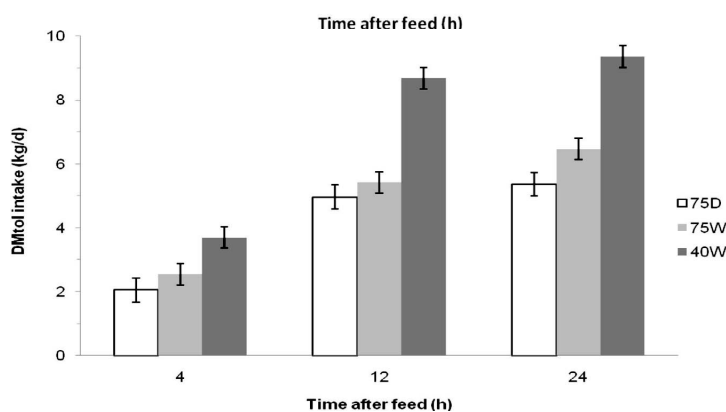

Figure 2. Dry matter intake (corrected for DM volatile losses).  $P < 0.01$  for treatment;  $P < 0.01$  for time;  $P < 0.01$  for treatment  $\times$  time interaction.

## Conclusion

Volatile components from sugarcane silage, which represented more than 30% of the DM, did not alter ingestive behaviour. Decreasing of forage:concentrate ratio is a tool to promote intake of sugarcane silage-based diets. Feeding sugarcane silage with shorter particle size may reduce sorting and keep the dry matter intake of the diet according to the predicted formulation.

## References

- Leonardi C and Armentano L.E. (2003) Effect of quantity, quality and length of alfalfa hay on selective consumption by dairy cows. *Journal of Dairy Science* 86, 557-564.
- Mari L. J. (2008) *Performance of beef cattle fed with rations containing sugar cane (Saccharum officinarum L.) either green chopped or ensiled and the fermentation profile and aerobic stability of silages with additives*. PhD Thesis, University of São Paulo – ESALQ, Piracicaba, Brazil, 315 pp.
- Phillip L. E., Buchanan-Smith J. G. and Grovum W. L. (1980) Effect of ensiling whole plant corn on voluntary intake, rumen fermentation, retention time and rate of digestion in steers. *Journal of Animal Science* 51, 1003-1010.
- Queiroz O.C.M. (2006) *Microbial additives on ensiling and the performance of lactating cows fed with sugarcane silage compared to traditional roughage sources*. Dissertation, University of São Paulo – ESALQ, Piracicaba, Brazil, 99 pp.
- Senel S. H. and Owen F. G. (1966) Relation of dietary acetate and lactate to dry matter intake and volatile fatty acid metabolism. *Journal of Dairy Science* 49, 1075-1079.

## Effect of additive treatment on fermentation quality and ruminal degradability of red clover-timothy silage

Olt A.<sup>1,2</sup>, Kaldmäe H.<sup>1</sup>, Ots M.<sup>1,2</sup>, Kärt O.<sup>1</sup> and Songisepp E.<sup>2</sup>

<sup>1</sup>Estonian University of Life Sciences, Department of Nutrition and Animal Products Quality, Kreutzwaldi 46, Tartu 51006, Estonia,

<sup>2</sup>Bio-Competence Centre of Healthy Dairy Products, Estonia

Corresponding author: andres.olt@emu.ee

### Abstract

The objective of this study was to investigate the effect of biological additives on fermentation quality and ruminal degradation of red clover-timothy mixture silages. During ensiling, a chemical additive and selected biological inoculants were used. Silage chemical composition and fermentation parameters were analysed and dry matter (DM), crude protein (CP), neutral detergent fibre (NDF) and acid detergent fibre (ADF) degradability, using the *in sacco* method, were assessed.

Silages treated with biological and chemical additives had higher DM and nitrogen-free extractives contents and lower contents of CP and cell wall fractions. Additives also improved the silage fermentation quality. The pH values were lower in the silages with the biological inoculants, which had a mean pH of 4.2. Ruminal degradability of CP and fibre fraction in the well fermented silages was slower compared to the untreated silage. The effective DM degradability of all silages was within the range 622 to 650 g kg<sup>-1</sup>.

Keywords: red clover, silage, fermentation quality, degradability

### Introduction

The ensiling process is a continuous battle between microorganisms, under anaerobic conditions, competing for available substrate in the forage. Nutrients, chemical compounds, enzymes and various microorganisms can be added to the forage to promote the desired fermentation. The effect of silage additive on silage fermentation, composition and animal performance depends on the additive used and the type of forage. Year on year there has been an increase in the cultivation of legumes together with grasses, as pure legumes are difficult to ensile.

During ensilage, a rapid drop in pH is important to improve silage fermentation and to decrease the activity of plant proteases and undesirable microorganisms. This can be achieved through efficient lactic acid bacteria (LAB) or acid addition. The aim of this paper was to examine the efficiency of selected LAB strains on silage quality. Untreated and chemical additive were used as control silages.

### Material and methods

A 50:50 mixture of red clover (*Trifolium pratense* L.) – timothy (*Phleum pratense* L.) was studied. The raw material for silage was cut at the early bud formation stage and was wilted for 24 hours. After thorough mixing, the additive was sprayed onto the silage material, supplemented with either a formic acid-based chemical additive (AIV 2000; 55% formic acid, 24% ammoniumformate, 5% propionic acid, 1% benzoic acid and 1% ethylbenzoate) or four variants of biological inoculants (I-1, I-2, I-3 and I-4.) containing combinations of four *Lactobacillus* sp. belonging to the facultatively and obligately heterofermentative groups: *L. plantarum* and *L. fermentum*, either alone or in combination. The addition rate of chemical



additives was 5 l per ton of raw material. The LAB inoculant was added in the same volume of solution such that the concentration of inoculant in the raw material was  $8 \times 10^9$  cfu  $g^{-1}$ . Silages were made into 3-litre glass jars with three repetitions. The jars of test silages were opened after 90 days and analysed for DM, CP, NDF, ADF, pH and ammonia-N in total N ( $NH_3 - N$  in TN). Ethanol, 2,3-butanediol, volatile fatty acids and lactic acid (LA) were analyzed by gas chromatography.

*In sacco* experiments with fistulated cows were conducted to assess animal factors. Rumen effective degradability of DM, CP, NDF and ADF were calculated as described by McDonald (1981) and the particle flow rate constant was assumed to be  $0.05 h^{-1}$  (Hristov and Broderick, 1996).

Data were analysed using the GLM procedure of SAS (SAS Institute Inc., 2003). The statistical significance of additive effect was tested by means of orthogonal contrasts. The contrasts were calculated using the following model:  $Y_{ij} = \mu + K_i + E_{ij}$ ; where  $Y_{ij}$  = trait;  $\mu$  = mean;  $K_i$  = effect of additive;  $E_{ij}$  = random error. Propionic acid and 2,3-butanediol values were transformed to ranks and other traits were transformed to their logarithmic values.

Table 1. Effect of additive on chemical composition, fermentation characteristics and nutrient degradability of silage.

Item	UT	I-1	I-2	I-3	I-4	CA	PSE	<i>P</i> -value
<i>Chemical composition</i>								
DM, g $kg^{-1}$	256 <sup>a</sup>	294 <sup>b</sup>	279 <sup>c</sup>	274 <sup>c</sup>	279 <sup>c</sup>	295 <sup>b</sup>	2.26	
CP in DM, g $kg^{-1}$	178 <sup>a</sup>	167 <sup>b</sup>	170 <sup>bc</sup>	172 <sup>bc</sup>	174 <sup>c</sup>	172 <sup>bc</sup>	1.59	
NDF in DM, g $kg^{-1}$	414 <sup>a</sup>	419 <sup>a</sup>	409 <sup>a</sup>	408 <sup>a</sup>	394 <sup>b</sup>	409 <sup>a</sup>	3.64	
ADF in DM, g $kg^{-1}$	260 <sup>a</sup>	255 <sup>a</sup>	259 <sup>a</sup>	256 <sup>a</sup>	250 <sup>ab</sup>	242 <sup>b</sup>	3.68	
N-free extracts in DM, g $kg^{-1}$	467 <sup>a</sup>	496 <sup>b</sup>	497 <sup>b</sup>	497 <sup>b</sup>	499 <sup>bc</sup>	506 <sup>c</sup>	2.06	
ME in DM, MJ $kg^{-1}$	10.0	10.1	10.2	10.1	10.2	10.1	0.05	
<i>Fermentation characteristics</i>								
$NH_3-N$ in total N, g $kg^{-1}$	63.3 <sup>a</sup>	15.3 <sup>b</sup>	16.3 <sup>b</sup>	16.3 <sup>b</sup>	16.7 <sup>b</sup>	18.95 <sup>b</sup>	0.14	<0.001
pH	5.0 <sup>a</sup>	4.2 <sup>b</sup>	4.2 <sup>b</sup>	4.2 <sup>b</sup>	4.2 <sup>b</sup>	4.8 <sup>c</sup>	0.01	<0.001
Lactic acid in DM, g $kg^{-1}$	73.7 <sup>a</sup>	127.5 <sup>b</sup>	108.4 <sup>b</sup>	110.0 <sup>b</sup>	96.4 <sup>ab</sup>	44.3 <sup>c</sup>	11.02	0.001
Acetic acid in DM, g $kg^{-1}$	8.32	8.15	8.76	8.56	9.35	9.7	0.36	0.394
Propionic acid in DM, g $kg^{-1}$	0.02	0.00	0.00	0.01	0.02	0.00	0.02	0.364
Butyric acid in DM, g $kg^{-1}$	23.87 <sup>a</sup>	0.38 <sup>b</sup>	0.16 <sup>c</sup>	0.14 <sup>c</sup>	0.12 <sup>c</sup>	0.16 <sup>c</sup>	0.33	<0.001
Ethanol in DM, g $kg^{-1}$	19.32 <sup>a</sup>	10.07 <sup>bc</sup>	12.93 <sup>b</sup>	12.65 <sup>b</sup>	12.67 <sup>b</sup>	7.94 <sup>c</sup>	1.05	0.001
2,3-Butanediol in DM, g $kg^{-1}$	0.00 <sup>a</sup>	0.47 <sup>b</sup>	0.43 <sup>b</sup>	0.44 <sup>b</sup>	0.43 <sup>b</sup>	0.26 <sup>a</sup>	0.02	0.002
<i>In sacco effective degradability</i>								
DM, g $kg^{-1}$	631	622	639	641	650	635		
CP, g $kg^{-1}$	821	769	792	782	781	746		
NDF, g $kg^{-1}$	351	323	347	347	339	327		
ADF, g $kg^{-1}$	391	368	432	379	359	320		

UT: untreated silage; I-1, I-2, I-3 and I-4: silages inoculated with different lactic acid bacteria strains; CA: silage treated with chemical additive; PSE: pooled standard error; DM: dry matter; CP: crude protein; NDF: neutral detergent fibre; ADF: acid detergent fibre; ME: metabolizable energy

<sup>a,b,c</sup> – Least square means within a row with different superscript letters differ significantly ( $P < 0.05$ )

## Results and discussion

Additive-treated silages had higher DM and nitrogen-free extracts contents and lower CP, NDF and ADF contents (Table 1). As there were higher DM contents in the treated silages, it is concluded that the effect of additives decreased DM losses during fermentation. The application of silage additives also had a positive effect on silage fermentation quality. Using biological inoculants increased the LA content of silages, and therefore the pH value was lower in these silages. They also had a positive impact on other fermentation products, such as the contents of  $NH_3-N$  in TN, butyric acid, ethanol and 2,3-butanediol, the production of each

of which were inhibited in biologically inoculated silages. The effect of additives on most fermentation characteristics was statistically significant (Table 1).

The main factors affecting proteolysis are DM content, temperature, pH and plant species (McDonald *et al.*, 1991). The amount of protein hydrolysed during ensiling is largely dependent upon the rate of acidification. High buffering capacity, low DM and low water soluble carbohydrate content of legumes are unfavourable for acidification. In this experiment, the acid-treated silage had a higher pH value, but the cell wall fractions, and especially protein effective degradability, were lower compared with the untreated and LAB inoculated silages. So, a rapid decline in pH is more important than a low final pH. Higher NDF and ADF degradability in untreated silage could have been caused by naturally occurring epiphytic microfloral fermentation.

## **Conclusion**

The result of the study showed that inoculation with LAB strains significantly improved the fermentation quality, and reduced effective degradability, of silage protein and the cell wall fraction.

## **References**

- Hristov A. N. and Broderick G. A. (1996) Microbial protein synthesis in ruminally cannulated cows fed alfalfa silage, alfalfa hay, or corn silage. *Journal of Dairy Science* 79, 1627-1637.
- McDonald I. (1981) A revised model for the estimation of protein degradability in the rumen. *Journal of Agricultural Science Cambridge* 96, 251-252.
- McDonald P., Henderson A.R. and Heron S.J.E. (1991) *The biochemistry of silage*. 2<sup>nd</sup> ed. Chalcombe Publications, Marlow, UK. 340 pp.
- SAS Institute Inc. (2003) *SAS OnlineDoc*, Version 9.1. Cary, NC, SAS Institute Inc.

## Effect of fungicidal control of Chewing's fescue (*Festuca rubra* L. ssp. *commutata*) and strong creeping red fescue (*F. rubra* L. ssp. *rubra*) on seed infection with fungi

Panka D.<sup>1</sup>, Jeske M.<sup>1</sup> and Szczepanek M.<sup>2</sup>

<sup>1</sup>Department of Phytopathology and Molecular Mycology, <sup>2</sup>Department of Plant Cultivation University of Technology and Life Sciences, 20 Kordeckiego St., 85-225 Bydgoszcz, Poland  
Corresponding author: panka@utp.edu.pl

### Abstract

The aim of the study was to determine the influence of fungicidal control of chewing's fescue and strong creeping red fescue crops grown for seed on kernels infection by fungi. Fungicides were applied twice before yield harvest. Seed infection with fungi was analysed. There was a significant effect of fungicidal control on the occurrence of fungi on kernels. Almost 89% of fungi, including grass pathogens, were detected more often on seeds obtained from non-protected plots. Lower infection of seeds harvested in the first year of full use than in the second one was observed.

Keywords: *Festuca rubra*, red fescue, fungi, fungicidal control

### Introduction

During the vegetation period, red fescue (*Festuca rubra*) can be infected by many fungal species. Some of them are dangerous grass pathogens. Under favourable conditions they can weaken the root system considerably and seriously reduce the green area of the leaf, which disturbs growth and decreases the yield. In addition, the products also deteriorate. On herbage seed plantations, high rates of plant infection can result in high rates of kernel infection by pathogenic microorganisms, which constitute a real threat for young plants growing from infected seeds. Chemical control of the seed crop can reduce the threat posed by pathogens; however, such treatments are not always cost-effective. The present research aimed at determining the effect of fungicidal control of a red fescue herbage seed crop on the infection of kernels by fungi.

### Materials and methods

The research was carried out on the Chewing's fescue (*Festuca rubra* L. ssp. *commutata*) cultivars Mirena and Nimba, and the strong creeping red fescue (*F. rubra* L. ssp. *rubra*) cultivar Nista, grown for seed. The experiment was set up at the Experimental Station for Variety Testing in Chrzastowo (53°09' N; 17°35' E), in two series, including the sowing year and two years of full use (2004 – 2006, 2005 – 2007). All the cultivars were sown in mid-July, in a split-plot design, in four replicates. NPK fertilisation was applied at the rate of N 40, P 60 and K 80 kg ha<sup>-1</sup> of pure component, at pre-sowing and after-seed-harvesting. Additionally, nitrogen was applied before the start of vegetation. Weeds were exposed to mechanical control, which involved harrowing and applying herbicides. Protection from diseases was performed over the sowing years, in September, by applying Amistar 250 SC fungicide at the rate of 1.0 l ha<sup>-1</sup> (azoxystrobine - 250 g l<sup>-1</sup>). Over the years of full use the first treatment was made in the second decade of May (beginning of panicle emergence) also with Amistar 250 SC fungicide at the dose of 1.0 l ha<sup>-1</sup>, and again in mid June (end of flowering/ beginning of seed formation) with Bumper Super 490 EC fungicide (prochloraz 400 g l<sup>-1</sup> + propiconazole 90 g l<sup>-1</sup>) at the dose of 1 l ha<sup>-1</sup>. The insecticide control involved applying, at the

beginning of panicle emergence, the treatment with Decis 2.5 EC at the dose of 0.3 l ha<sup>-1</sup> (deltamethrine – 25 g l<sup>-1</sup>). The control combination received neither fungicide nor insecticide treatments. Analysis of the occurrence of diseases on plants (Panka *et al.* 2009) and analysis of infection of the collected seeds with fungi were performed. Three samples were collected from each plot, 100 kernels each, disinfected and then placed onto Petri dishes with acidified PDA medium. The dishes were incubated at 18°C. After 7-14 days the cultures grown were identified based on the available mycological keys. Whenever no sporulation was identified, the cultures were exposed to UV light. The results of seed infestation with the most numerous and pathogenic fungi were, after square root transformation, calculated by two-way ANOVA in completely randomized design. The first factor was fungicidal protection system, and variety was the second one. Homogenous groups were separated by Tukey's HSD test at  $P < 0.05$ .

Table 1. Mean number (cfu/100 kernels) of the most often isolated and pathogenic fungi detected on seeds of red fescue cultivars harvested in the first and the second years of full use

Fungi	'Mirena'		'Nista'		'Nimba'		Mean	
	P†	NP	P	NP	P	NP	P	NP
Seeds harvested in the first year of full use§								
<i>Alternaria alternata</i> (Fr.) Keissler	0.8 a	2.8 b	0.9 a	2.1 b	0.5 a	3.1 b	0.6 a	2.5 b
<i>Bipolaris sorokiniana</i> (Sacc.) Shoem.	0.0 a	0.9 b	0.1 a	1.1 a	0.3 a	1.6 b	0.1 a	1.4 b
<i>Drechslera</i> spp.	0.1 a	1.1 b	0.1 a	1.5 b	0.4 a	1.9 b	0.3 a	1.7 b
<i>Epicoccum nigrum</i> Ehrenb.ex Schlecht.	0.5 a	3.3 b	0.0 a	0.8 b	0.0 a	0.0 a	0.2 a	1.4 b
<i>Fusarium culmorum</i> (W.G.Smith) Sacc.	0.3 a	1.1 a	0.5 a	1.0 a	0.0 a	0.0 a	0.3 a	1.1 b
<i>Fusarium equiseti</i> (Corda) Sacc	0.1 a	1.0 a	0.0 a	0.0 a	0.4 a	1.0 b	0.2 a	0.7 b
<i>Penicillium</i> spp.	2.4 a	7.3 b	9.3 a	8.5 a	2.9 a	2.6 a	4.9 a	6.4 b
<i>Trichoderma koningii</i> Oudemans aggr.	0.5 a	1.4 a	1.3 a	1.0 a	3.0 a	6.4 b	1.8 a	3.0 b
<i>Microdochium nivale</i> (Fr.) Sam.ex I.C.Hallett	0.0 a	0.0 a	0.0 a	0.9 b	0.3 a	0.4 a	0.1 a	0.5 a
Seeds harvested in the second year of full use§								
<i>Alternaria alternata</i> (Fr.) Keissler	23.9 a	26.0 b	14.9 a	19.9 b	10.3 a	15.6 b	16.3 a	20.7 b
<i>Bipolaris sorokiniana</i> (Sacc.) Shoem.	0.5 a	2.1 b	0.4 a	2.0 b	0.4 a	2.5 b	0.2 a	2.2 b
<i>Drechslera</i> spp.	0.5 a	4.4 b	0.6 a	3.8 b	0.8 a	4.3 b	0.8 a	4.7 b
<i>Epicoccum nigrum</i> Ehrenb.ex Schlecht.	19.8 a	25.8 b	20.9 a	22.4a	4.3 a	7.0 b	14.8 a	18.7 b
<i>Fusarium culmorum</i> (W.G.Smith) Sacc.	0.0 a	3.3 b	0.4 a	2.3 b	2.3 a	4.8 b	0.8 a	3.7 b
<i>Fusarium equiseti</i> (Corda) Sacc	2.1 a	7.5 b	0.9 a	3.9 b	1.1 a	6.5 b	1.3 a	6.2 b
<i>Penicillium</i> spp.	5.3 a	6.3 a	11.3 a	12.9 a	1.9 a	4.3 b	5.9 a	8.0 b
<i>Trichoderma koningii</i> Oudemans aggr.	6.0 a	8.9 a	1.6 a	7.5 b	1.4 a	3.0 a	2.9 a	6.7 b
<i>Microdochium nivale</i> (Fr.) Sam.ex I.C.Hallett	0.0 a	0.9 a	0.8 a	1.0 a	1.4 a	1.6 a	0.7 a	1.3 a

† Combinations with (P) and without (NP) fungicidal protection

§ Mean values within cultivar, or in average for the cultivars, marked with the same letter in rows do not differ significantly at  $P < 0.05$

## Results and discussion

The present analysis showed infestation of kernels of the investigated red fescue cultivars by numerous fungi. In total, 17 fungal species were isolated, representing 15 genera and non-sporulating colonies. In addition to the species given in Table 1, the following were also isolated: *Aspergillus* spp., *Aspergillus niger*, *Acremoniella fusca*, *Acremonium strictum*, *Arthrium phaeospermum*, *Aureobasidium pullulans*, *Cladosporium herbarum*, *Stemphylium botryosum*. The most frequent fungi included: *A. alternata*, *A. niger*, *Drechslera* spp., *Penicillium* spp. and *T. koningi*. They were isolated from kernels of all the cultivars, in each harvest year, both in the combinations without fungicidal control and in those sprayed with fungicides. Similarly, the occurrence of fungi of *Fusarium* genus: *F. culmorum* and *F. equiseti*, *B. sorokiniana*, as well as *E. nigrum* were also very frequent. *Fusarium* spp. was isolated especially frequently from kernels collected in warm and wet years which were favourable to infection of spikes with those pathogens. Similar observations were also

reported by Agarwal and Sinclair (1997). The kernels collected in the first year of use demonstrated considerably lower infestation than those collected in the second year (Table 1). On average, 62.7% of the species of the fungi isolated were identified in the first year of harvest, whereas in the second year the figure was 91.2%. Many more isolates were also obtained in the second year than in the first year. Then *A. alternata* was most abundant; infesting 26.0% of 'Mirena' kernels and *E. nigrum* – infesting 25.8% of the kernels of the same cultivar. The older the seed crop plantation, the more frequent the infestation of the plants with various microorganisms, especially facultative parasites and saprotrophs, which must have been the cause of a much greater infestation of kernels from the second year of harvest, as compared with the first one. Weather conditions before harvest are also very important (Wiewiora and Pronczuk 2000, 2002). In the vast majority of cases, especially in the second year of use, it was also observed that there was a stronger infestation of kernels in the combinations without fungicidal control. The statistical analysis showed in those cases a significant effect of fungicide treatments on the decrease in the number of isolated fungi. The pathogens *B. sorokiniana*, *Drechslera* spp., *F. culmorum* and *F. equiseti* were seriously limited by the fungicides applied, especially in the second year of use. The analysis of the average values for the three cultivars confirmed, in almost 89% of the fungi tested, a positive effect of fungicidal control. *M. nivale* was the only one which was demonstrated to be practically insensitive to the preparations applied. In practice, the application of fungicides is not frequent, despite a favourable effect on both the infestation of kernels and plant infection (Panka *et al.*, 2009), which is most often due to a lack of cost-effectiveness since we do not always observe in such conditions an increase in yield which would make up for the costs of the treatment (Labruyere, 1980).

## Conclusions

Fungicide treatment of red fescue seed crop plantations considerably limits the infestation of kernels by the vast majority of the fungi isolated. The number of pathogens of genera *Drechslera* and *Fusarium*, as well as *Bipolaris sorokiniana*, decreases considerably. These pathogens can constitute a potential threat for young seedlings. Fungicide treatments, however, do not affect the occurrence of *M. nivale* on red fescue kernels. The older the plantation, the greater the number and species composition of the fungi isolated from the seeds collected.

## References

- Agarwal V.K. and Sinclair J.B. (1997) *Principles of seed pathology*, 2nd ed., CRC Press, Boca Raton, Florida, 539 pp.
- Labruyere R.E. (1980) Fungal diseases of grasses grown for seed. In: Hebblethwaite P.D. (ed.) *Seed Production*, Butterworths, London, UK, pp. 173-187.
- Panka D., Jeske M. and Szczepanek M. (2009) Susceptibility of *Festuca rubra* L. ssp. *commutata* and *rubra* to infestation by fungal pathogens under conditions of fungicidal protection. *Acta Scientiarum Polonorum, Agricultura* 8(4), 35-45.
- Wiewiora B. and Pronczuk M. (2000) Microorganisms colonising seeds of grasses and their influence on turf diseases (in polish). *Bulletin of Plant Breeding and Acclimatization Institute* 214, 269-284.
- Wiewiora B. and Pronczuk M. (2002) *Rhizoctonia solani* and other fungi detected in perennial ryegrass seeds after harvest and storage. *Phytopathologia Polonica* 26, 19-27.

## Suitability of seed mixtures for intensively farmed permanent meadows in a mountain environment

Peratoner G., Gottardi S., Werth E., Figl U., Bodner A. and Kasal A.  
Research Centre for Agriculture and Forestry Laimburg, I-39040 Auer, Italy  
Corresponding author: giovanni.peratoner@provinz.bz.it

### Abstract

In a 7-year field trial, persistency, yield and forage quality of newly sown permanent meadows were investigated in South Tyrol (890 m a.s.l.) under a 4-cut regime. Two recommended seed mixtures: DWi-t (lead species *Lolium perenne*) and DWi-h (lead species *Alopecurus pratensis*) were compared with two new seed mixtures: DWi-Lp, containing high proportion of *Lolium perenne* (30% by weight) and DWi-Fa, containing 40% by weight of *Festuca arundinacea*. Each treatment developed a distinctive botanical composition over time. In DWi-t and DWi-Lp, the share of *Lolium perenne* was low in 2009 and DWi-Lp had the largest share of opportunistic species and weeds. Forage yield was affected by the seed mixture only in the beginning, with DWi-Lp and DWi-Fa being the most productive treatment in 2004 and 2005 respectively. Since *Alopecurus pratensis* became dominant in DWi-h, higher herbage fibre contents were found in this treatment, due to its earliness. No such effect was observed for DWi-Fa at an average share of *Festuca arundinacea* around 20%.

Keywords: seed mixtures, permanent meadows, persistency, forage yield, forage quality

### Introduction

Testing new seed mixtures provides valuable information about the opportunity of recommending them for a local agricultural context. The seed mixtures for permanent meadows should indeed fulfil not only the prerequisites of adequate productivity and forage quality, but also of long-term persistency under the given agronomic management and the actual climatic conditions. In South Tyrol, less than 5% of the area presently covered with meadows is located at altitudes below 800 m a.s.l., while about one-third can be found between 800 and 1200 m a.s.l. At these altitudes are located most of the intensively managed meadows (at least 3 cuts  $y^{-1}$ ). For these reasons, a 7-year field experiment (from 2003 to 2009) was conducted in a mountain environment to evaluate new and already recommended seed mixtures for intensive meadow management.

### Material and methods

The field trial was established in August 2003 at the experimental farm Mair am Hof in Dietenheim (890 m a.s.l., Bruneck, South Tyrol, I). The mean annual temperature and precipitation sum in the investigation period were 7.7 °C and 798 mm. Four seed mixtures (Table 1) were compared under an intensive management regime (4 cuts  $y^{-1}$ , fertilisation after each cut with approximately 20  $m^3 ha^{-1}$  of 2:1 water-diluted slurry). DWi-t is a seed mixture recommended for low altitudes (lead species *Lolium perenne*), while DWi-h (lead species *Alopecurus pratensis*) is recommended for higher sites not suitable for *Lolium perenne*. DWi-Lp and DWi-Fa were tested for the first time in the course of the present experiment. DWi-Lp is characterised by a very high share of *Lolium perenne*, while DWi-Fa contained a high share of *Festuca arundinacea*. Plots of 8 x 4.8 m were sown at a seed rate of 30  $kg ha^{-1}$  with a plot seeder trm 2200 Plotmatic (Wintersteiger, Ried, A), with the plots arranged as a Latin square with four replications.

Table 1. Composition of the seed mixtures (weight percentage).

Species	Seed mixture			
	DWi-t	DWi-h	DWi-Lp	DWi-Fa
<i>Trifolium repens</i>	10	10	10	10
<i>Dactylis glomerata</i>	30	16	30	30
<i>Phleum pratense</i>	-	8	-	20
<i>Festuca pratensis</i>	-	10	-	-
<i>Alopecurus pratensis</i>	-	10	-	-
<i>Lolium perenne</i>	30	15	60	-
<i>Poa pratensis</i>	30	25	-	-
<i>Festuca rubra</i>	-	6	-	-
<i>Festuca arundinacea</i>	-	-	-	40

The yield share of each species occurring in the plots was assessed immediately before the first cut. A 1.35 m-wide strip was harvested in the middle of the plot along its longest side and the fresh yield weighed with a field scale. A 500 g sample was used to determine water content and forage quality after drying at 60 °C for at least 4 days. Forage quality was determined from 2004 to 2008 according to Van Soest (Naumann *et al.*, 1997). Summary variables were calculated as weighted means with respect to the yield of the single cuts or years. Data analysis was performed, depending on the occurrence of the factor year, either with ANOVA or with a mixed model, taking into account the seed mixture and design factors (lines and columns) as fixed and the year as a repeated factor with the plots as subject of repeated measurements. The second order-interactions of the year with the seed mixture and design factors were included in the model. Data were checked for normality of residuals and homogeneity of variances. Multiple comparisons were performed by protected LSD test. A probability of  $P < 0.05$  was considered to be significant.

## Results and discussion

Seven years after sowing clear differences in the botanical composition depending on the seed mixture used were observed (Table 2).

Table 2. Yield share (%) of selected species and species groups at the end of the experiment (2009) depending on the seed mixture. Results of multiple comparisons are shown for species groups only. Means in a row without common letters differ significantly from each other.

Species and species groups	Seed mixture			
	DWi-t	DWi-h	DWi-Lp	DWi-Fa
<i>Lolium perenne</i>	13.3	1.8	8.3	3.5
<i>Dactylis glomerata</i>	38.0	15.3	38.5	34.5
<i>Poa pratensis</i>	21.8	10.5	17.8	11.5
<i>Alopecurus pratensis</i>	0.3	51.0	0.3	0.5
<i>Festuca arundinacea</i>	0.0	0.0	0.0	21.0
<i>Trifolium repens</i>	6.0	2.5	4.3	4.3
Sown species	79.0 <sup>b</sup>	89.5 <sup>a</sup>	51.0 <sup>d</sup>	62.8 <sup>c</sup>
Opportunistic species and weeds	20.8 <sup>b</sup>	10.4 <sup>c</sup>	30.9 <sup>a</sup>	21.4 <sup>ab</sup>

*Dactylis glomerata* was the most abundant grass in all treatments except in DWi-h, in which *Alopecurus pratensis* was dominant. *Lolium perenne*, the lead species in DWi-t and DWi-Lp, decreased to relatively low values (13.3 and 8.3 %, respectively). *Poa pratensis* was fairly abundant in all treatments, with higher values around 20% for DWi-t and DWi-Lp. *Festuca arundinacea* occurred only in DWi-Fa with a moderate share around 20%. *Trifolium repens* exhibited a low share (2.5 to 6%) in all treatments. DWi-h proved to be the most persistent seed mixture, as it had the highest share of sown species, while the lowest value was found for DWi-Lp. This mixture exhibited the highest share of opportunistic species (mainly



*Taraxacum officinale* and *Poa trivialis*) and weeds (mainly *Rumex obtusifolius*), which was used here as an index of the appearance of vegetation gaps due to the poor persistency of the sown species. A similar decline of the sown species was observed over time in a multi-site field experiment in a mountain environment for seed mixtures with a high proportion of *Lolium perenne* (above 35% seed weight) (Partl, 2008). DM-yield, neutral detergent fibre (NDF) and acid detergent fibre (ADF) were all significantly affected by the interaction of seed mixture and year. In the first harvest year highest yield was achieved by DWi-Lp and lowest by DWi-t (Table 3), while in 2005 DWi-Fa yielded more than any other treatment. Afterwards, differences depending on the seed mixture were no longer observed. Concerning the fibre content, since 2005 the highest NDF and ADF contents were consistently observed for DWi-h because of the earliness of *Alopecurus pratensis*, which was dominant in this treatment and the quality of which is known to decline very rapidly (Schubiger *et al.*, 2001). No such effect was observed for DWi-Fa at an average share of *Festuca arundinacea* of about 20%. The lowest fibre contents were consistently found for DWi-t and DWi-h.

Table 3. Yield and forage quality depending on seed mixture and year. Means without a common letter within each column do not differ significantly from each other.

Variable	Seed mixture	Year					Total across all years
		2004	2005	2006	2007	2008	
DM-yield (Mg ha <sup>-1</sup> )	DWi-t	9.8 <sup>b</sup>	11.8 <sup>b</sup>	12.2 <sup>a</sup>	12.0 <sup>a</sup>	13.7 <sup>a</sup>	59.5 <sup>a</sup>
	DWi-h	10.8 <sup>ab</sup>	11.9 <sup>b</sup>	12.9 <sup>a</sup>	11.9 <sup>a</sup>	13.7 <sup>a</sup>	61.2 <sup>a</sup>
	DWi-Lp	11.3 <sup>a</sup>	11.9 <sup>b</sup>	12.6 <sup>a</sup>	12.3 <sup>a</sup>	12.8 <sup>a</sup>	60.8 <sup>a</sup>
	DWi-Fa	10.3 <sup>ab</sup>	13.3 <sup>a</sup>	12.2 <sup>a</sup>	12.0 <sup>a</sup>	13.5 <sup>a</sup>	61.5 <sup>a</sup>
NDF (g kg <sup>-1</sup> )	DWi-t	492 <sup>a</sup>	333 <sup>b</sup>	499 <sup>b</sup>	460 <sup>b</sup>	529 <sup>b</sup>	464 <sup>b</sup>
	DWi-h	492 <sup>a</sup>	342 <sup>a</sup>	525 <sup>a</sup>	489 <sup>a</sup>	575 <sup>a</sup>	488 <sup>a</sup>
	DWi-Lp	499 <sup>a</sup>	327 <sup>b</sup>	512 <sup>ab</sup>	458 <sup>b</sup>	491 <sup>c</sup>	458 <sup>b</sup>
	DWi-Fa	506 <sup>a</sup>	334 <sup>ab</sup>	507 <sup>ab</sup>	475 <sup>ab</sup>	524 <sup>b</sup>	467 <sup>b</sup>
ADF (g kg <sup>-1</sup> )	DWi-t	290 <sup>a</sup>		349 <sup>b</sup>	297 <sup>b</sup>	322 <sup>b</sup>	316 <sup>b</sup>
	DWi-h	290 <sup>a</sup>		368 <sup>a</sup>	312 <sup>a</sup>	344 <sup>a</sup>	331 <sup>a</sup>
	DWi-Lp	289 <sup>a</sup>		359 <sup>ab</sup>	296 <sup>b</sup>	318 <sup>b</sup>	316 <sup>b</sup>
	DWi-Fa	296 <sup>a</sup>		350 <sup>b</sup>	306 <sup>ab</sup>	319 <sup>b</sup>	319 <sup>b</sup>

## Conclusions

Although showing an initial high productivity and satisfactory forage quality, DWi-Lp proved to be prone to a deterioration of the botanical composition in a mountain environment. A further development of DWi-Fa for summer-dry areas seems to be advisable.

## References

- Naumann N., Bassler R., Seibold R. and Barth C. (1997) *Methodenbuch Band III, Chemische Untersuchung von Futtermitteln*. VDLUFA-Verlag, Darmstadt, D.
- Partl C. (2008) *A comparison of international grassland mixtures concerning persistence, forage yield and forage quality in alpine regions*. PhD thesis, University of Natural Resources and Applied Life Sciences, Vienna, A, 180 pp.
- Schubiger F.X., Lehmann J., Daccord R., Arrigo Y., Jeangros B. and Sechovic J. (2001) Nährwert von Wiesenpflanzen: Verdaulichkeit. *Agrarforschung* 8, 354-359.

## **A simple model for the estimation of protein content of first-cut meadow forage**

Peratoner G.<sup>1</sup>, Bodner A.<sup>1</sup>, Stimpfl E.<sup>1</sup>, Werth E.<sup>1</sup>, Schaumberger A.<sup>2</sup> and Kasal A.<sup>1</sup>

<sup>1</sup> *Research Centre for Agriculture and Forestry Laimburg, I-39040 Auer, Italy*

<sup>2</sup> *Agricultural Research and Education Centre Raumberg-Gumpenstein, A-8952 Irdning, Austria*

Corresponding author: giovanni.peratoner@provinz.bz.it

### **Abstract**

A project aiming at the development of an affordable tool for estimating the forage quality of permanent meadows at the first cut was conducted in South Tyrol (I) from 2003 to 2007. Forage quality was investigated at 35 sites scattered across the whole province and representing a wide range of climatic conditions and management practices. At each site, small-size samples were collected in 4 replications on a weekly basis for 7 weeks, starting at an average vegetation height of 15 cm (BE). Eleven factors related to geomorphology, vegetation, soil and agronomic management significantly explained the crude protein content in a stepwise logistic regression; 86.7% of the observations were correctly classified. As years explained a significant part of the variation of the dependent variable, a replacement of this factor was attempted using at each site cumulative and/or average values of the potential solar radiation and of the temperature departure from the long-term average of the respective agricultural district; all of them referred to the time period between BE and each sampling date. Their inclusion in the statistical analysis in replacement of years maintained a satisfactory level of correctly classified observations (86.8%).

Keywords: permanent meadows, first cut, crude protein, logistic regression, year effect

### **Introduction**

The forage quality of meadows declines over time with increasing developmental stage of plants. Harvest timing is therefore pivotal in the management of meadows for achieving a satisfactory forage quality; knowledge of this quality is important to formulate a suitable ration for dairy cows. Chemical analyses are the most reliable method to assess forage quality, but they are costly to farmers. For this reason, a 5-year survey was conducted in permanent meadows at first cut to collect data for the development of an affordable and reliable tool for estimating forage quality as a function of harvest timing and other factors related to vegetation, geomorphology, soil and agronomic management. In a first step, crude protein (CP) was chosen as a dependent variable for model development. The present paper focuses on the possibility of replacing year effects, not useful for predictive purposes, with other factors related to the climatic features of the sites and to the weather conditions during vegetation growth.

### **Material and methods**

Forage samples were obtained from 2003 to 2007 at thirty-five sites scattered across South Tyrol and representing a wide range of climatic conditions and management practices. Meadows with a cutting regime of 2 to 5 cuts year<sup>-1</sup> at altitudes between 667 and 1593 m a.s.l. were included in the survey. At each site (a permanent sampling area of 50 to 100 m<sup>2</sup>), small-size samples (0.25 m<sup>2</sup>) were randomly collected in 4 replications on a weekly basis for 7 weeks, starting at a mean vegetation growing height of 15 cm (BE). The CP content of the

samples was determined with the N-analyzer TruSpec<sup>TM</sup> (Leco Instrumente GmbH, D) after having been dried at 60 °C for at least 4 days and ground with a P 25 mill (Fritsch GmbH, D) to pass a 0.5 mm screen. Altogether, twenty-one metrical and categorical factors potentially affecting forage quality were used for statistical analysis (Table 1). Geomorphologic factors (altitude, slope and exposition) were obtained from a digital terrain model with 5 m-resolution using ArcGIS 9.2. Furthermore, each site was attributed to one of five agricultural districts, roughly reflecting different climatic situations. Soil properties (texture, organic matter, pH, P-content and K-content) were determined in samples taken at each site at the beginning of the investigation period and coded into classes according to Aichner and Drahorad (2004). Information about management practice (cut frequency, N-input, dung type and irrigation) was obtained by interviews to the farmers at the beginning of the survey. The botanical composition of each sample was classified into four categories according to Daccord *et al.* (2007). Once per year, around the time of the third or fourth cut, the contribution of each species to yield was assessed. A cluster analysis of these data averaged across the years and transformed according to Dietl (1995), using the squared Euclidean distance as dissimilarity measure and the Ward's clustering method, led to the definition of seven vegetation types and allowed the attribution of each site to one of them.

Further factors were also calculated in the attempt of replacing the year effects. The potential daily solar radiation was calculated for each sampling point with the Point solar radiation-tool of ArcGis 9.2 at a raster resolution of 20 m. Values were calculated for single dates being 14 days apart from each other and missing values were obtained through linear interpolation. The solar radiation sum (hence SRS), computed for each sample referring to the time interval between one week before BE and the harvest date, was used for further analysis as an estimate of potential available energy during plant growth. Furthermore, three to seven reference weather stations (RWS) with temperature records from 1986 until 2007 were selected per agricultural district and a 20-year mean temperature (LTM) was calculated for each RWS and day. A daily departure (DD) of the recorded temperature from the respective LTM was calculated for the investigation period. DD were averaged on daily basis within each agricultural district. Both the sum and the mean of the obtained values (hence DDS and DDM respectively) were calculated for the time interval between one week before BE and the harvest date of each sample. In this way, a mean temperature departure of the respective agricultural district during the plant growth time of each sample was obtained. A binary logistic regression was used to test the effect of the predictor variables on the dichotomous variable CP150 (0 for CP < 150 g kg<sup>-1</sup>; 1 for CP ≥ 150 g kg<sup>-1</sup>, assumed to be a satisfactory protein content). This kind of linear regression makes no assumptions about data distribution and both metric and categorical factors can be used at the same time (Quinn and Keough, 2005). A classification cut off of 0.5 was used. Logistic regression was performed either with all factors except SRS, DDS and DDM (Analysis 1) or with all factors except year and time since BE (Analysis 2). In Analysis 2, time since BE was excluded from the regression model because of strong collinearity with SRS. SRS was retained because of better model fit. Two interactions (agricultural district x irrigation and aspect x irrigation) were included in the analysis after checking for significance with a Pearson  $\chi^2$ -test.

## Results and discussion

In Analysis 1, ten out of eighteen factors were found to be significant, together with the interaction exposition x irrigation. The largest Wald statistics was found for time since BE, but a significant contribution came from the vegetation traits, soil P-content, and year (Table 1). Analysis 1 correctly classified 86.0% of the observed CP150 = 0 and 87.5% of the CP150 = 1, with a mean correct prediction of 86.7%. In Analysis 2, replacing time since BE and year with FPV led to the inclusion in the model of several factors, which had not been found to be

significant in Analysis 1. Altogether, 15 factors and 2 interactions were found to be significant. SRS exhibited by far the largest Wald statistics, proving to be able to replace time since BE. Very similar percentages of correctly classified values were achieved (86.1% of the CP150 = 0, 87.5% of the CP150 = 1, mean correct prediction = 86.8%). Soil texture was the only factor found to be significant in Analysis 1, but not in Analysis 2. Nitrogen input at first cut, dung type and irrigation were found not to be significant in both analyses.

Table 1. List of factors, scale (M = continuous, C = categorical), Wald  $\chi^2$  and significance (\*\*\*)  $P < 0.001$ , \*\*  $P < 0.01$ , \*  $P < 0.05$ , n.s. not significant ) in a forward stepwise binary logistic regression taking into consideration all factors except SRS, DDS and DDM in Analysis 1 or year and time since BE in Analysis 2.

Factor	Type	df	Analysis 1		Analysis 2	
			Wald $\chi^2$	Sig.	Wald $\chi^2$	Sig.
Time since BE (days)	M	1	1174.3	***		
Year	C	4	194.0	***		
Altitude (m a.s.l.)	M	1	41.6	***	109.8	***
Slope	M	1		n.s.	19.7	***
Exposition	C	3		n.s.	51.4	***
Agricultural district	C	4		n.s.	79.8	***
Soil texture	C	1	31.0	***		n.s.
Organic matter content	C	2	64.3	***	32.6	***
Soil pH	C	2	12.6	**	53.0	***
Soil P-content	C	4	159.0	***	104.0	***
Soil K-content	C	3		n.s.	84.1	***
Cut frequency (cut year <sup>-1</sup> )	M	1	68.9	***	55.7	***
Yearly N-input (kg ha <sup>-1</sup> )	M	1		n.s.	15.2	***
N-input at first cut (kg ha <sup>-1</sup> )	M	1		n.s.		n.s.
Dung type	C	1		n.s.		n.s.
Irrigation	C	1		n.s.		n.s.
Exposition x Irrigation	C	3	21.1	***	24.7	***
Agricultural district x Irrigation	C	4		n.s.	74.3	***
Botanical composition of sample	C	3	124.7	***	100.9	***
Vegetation type	C	6	231.8	***	59.0	***
SRS (w m <sup>-2</sup> )	M	1			1085.0	***
DDS (°C)	M	1			40.6	***
DDM (°C)	M	1			8.4	**

## Conclusions

Factors including cumulative and/or average values of the potential solar radiation, and of the temperature departure from the long-term average for the respective agricultural district, successfully replaced the year effect in the logistic regression and resulted in a satisfactory prediction accuracy. Further research is needed to refine the prediction of CP content for practical applications.

## References

- Aichner M. and Drahorad W. (2004) *Boden und Pflanzenernährung im Obstbau, Weinbau und Bioanbau*. Laimburg/Südtiroler Beratungsring, Lana, I, 232 pp.
- Daccord R., Wyss U., Jeangros B. and Meisser M. (2007) *Bewertung von Wiesenfutter*. AGGF, Zürich, CH, 6 pp.
- Dietl W. (1995) Wandel der Wiesenvegetation im Schweizer Mittelland. *Zeitschrift für Ökologie und Naturschutz* 4, 239-249.
- Quinn G.P. and Keough M.J. (2002) *Experimental design and data analysis for biologists*. Cambridge University Press, Cambridge, UK, 537 pp.

## **A test of sampling methods for the investigation of forage quality in permanent meadows**

Kasal A., Stimpfl E. and Peratoner G.

*Research Centre for Agriculture and Forestry Laimburg, I-39040 Auer, Italy*

Corresponding author: giovanni.peratoner@provinz.bz.it

### **Abstract**

In order to optimise the sampling method for a larger project aiming at estimating the first-cut forage quality of permanent mountain meadows in South Tyrol (I), a three-year investigation was conducted at three different sites at altitudes between 1210 and 1290 m a.s.l. Two small-scale sampling methods were applied: the sampling of a stripe-shaped area of 0.2 m<sup>2</sup> and 10 cm width was compared to the sampling of a square-shaped area of 0.25 m<sup>2</sup>. Starting at the beginning of stem elongation of the main grass species, forage samples were taken weekly in 6 replications during a time period of 7 weeks. The content of ash, crude protein, crude fibre and neutral detergent fibre were analytically determined. All quality traits were unaffected by the sampling method with the exception of crude fibre, which was slightly higher in the square-shaped sampling areas. Sampling of square-shaped areas seems to be a suitable method because of a smaller work load and easier sampling collection. Four replications per site, sampling date and year allowed an estimate of the investigated traits with reasonable accuracy.

Keywords: permanent meadows, first cut, forage quality, sequential sampling, shape of sampling area

### **Introduction**

The forage quality is known to be negatively affected by plant senescence. This is particularly apparent in permanent meadows at the first cut, which is usually rich in grasses. The quality decrease of grasses is indeed more pronounced than that of plants belonging to other functional groups, such as legumes and forbs (Jeangros *et al.*, 2001). Sequential sampling is a suitable method for describing changes in forage quality over time, but different plot sizes (from 0.25 m<sup>2</sup> up to 9 m<sup>2</sup>) and shapes (square, rectangle, stripe-shaped) have been adopted by different authors (e.g. Rodaro *et al.*, 2000; Rutzmoser, 2000; Jeangros *et al.*, 2001; Bovolenta *et al.*, 2008). Choosing the sampling method is very important in determining the needed effort of experiments designed to collect a large amount of data. A three-year preliminary trial from 2000 to 2002 was conducted in South Tyrol, in order to optimise the sampling method for a larger project aiming at investigating of the forage quality of permanent meadow at the first cut depending on the harvest time.

### **Material and methods**

Three experimental sites were established in permanent meadows within the municipality of Aldein (South Tyrol, I). The three sites were located at similar altitudes (from 1210 to 1290 m a.s.l.), but differed in their botanical composition. According to Scotton and Rodaro (2000), sites 1 and 3 were tall oat-grass meadows, the latter with a relatively large yield share of meadow foxtail, while site 2 was a yellow oat-grass meadow of nutrient-rich soils. At each site, a sampling area of 70 m<sup>2</sup> was established. Starting at the beginning of stem elongation of the dominant grass species, forage was weekly sampled for 7 weeks. The independent variable harvest time point was coded as the ordinal number of the cut within each year. Two

small-scale sampling methods, mainly differing in the shape of the sampling area, were investigated. In method 1 samples were taken within a stripe-shaped area of 0.2 m<sup>2</sup> (10 m long and 10 cm wide) along a measuring tape lying on the ground. In method 2 samples were obtained within a square-shaped area of 0.25 m<sup>2</sup> delimited by a metal frame. At each sampling date, samples were obtained with electric scissors in six replications per treatment, which were randomly arranged within the sampling area. The forage samples were dried at 60 °C for at least 4 days and ground with a P 25 mill (Fritsch GmbH, D) to pass a 0.5 mm-screen. Total ash (TA) was determined by combustion at 550°C, crude protein (CP) with a FP 2000 elemental analyser (Leco, Michigan, USA), crude fibre (CF) and neutral detergent fibre (NDF) with an Ankom 200/220 fibre analyser (ANKOM, New York, USA).

Statistical analysis of data was performed with a mixed model, taking into consideration harvest time point and sampling method as fixed factors and site and year as random factors. A full factorial model was used.

## Results and discussion

As expected, forage quality traits were highly significantly affected by the harvest time point (Table 1) in accordance with the results of other experiments using sequential sampling (Rutzmoser, 2000). An increase of 111 g kg<sup>-1</sup> between the first and the last sampling time point was observed on average.

Table 1. Significance of the fixed effects harvest time point, sampling methods and of their interaction on total ash (TA), crude protein (CP), crude fat (CF) and neutral detergent fibre (NDF).

Source	TA	CP	CF	NDF
Harvest time point (T)	***	***	***	***
Sampling method (M)	n.s.	n.s.	***	n.s.
T x M	n.s.	n.s.	n.s.	n.s.

\*\*\*  $P < 0.001$ , n.s. not significant).

The sampling method did not affect TA, CP and NDF, while CF was found to be higher in the square-shaped than in the stripe-shaped area (260 g kg<sup>-1</sup> vs. 253 g kg<sup>-1</sup> respectively). It is remarkable that this effect was observed for CF but not for NDF. CF is not an accurate measure of total fibre as a quite large amount of the lignin and hemicellulose is lost by the Weender analysis (Bittante *et al.*, 1990). We tentatively suggest that a different extent of lignin and hemicellulose depending on the sampling methods may occur. Method 2 allows refining the cut within the metal frame before collecting the samples and usually leads to a more accurate collection of the cut biomass and lower leaf losses. Keeping a consistent cutting height is instead not easy during the stripe-shaped sampling in method 1. Furthermore, during sample collection plants contiguous to the cut area are often accidentally torn and collected together with the intended forage sample. In method 1, this may lead to higher lignin and hemicellulose content, which are partly lost during the Weender analysis. Taking into consideration that the Van Soest analysis is a current method for determining fibre components in forage, that the differences between the methods account for less than 3% of the total CF and that difference in CF caused by the sampling methods was small in comparison to the large variation caused by the harvest time point, being the main factor to be investigated in future research, the two sampling methods can be considered to be nearly equivalent. No significant interaction was found between harvest time point and sampling method.

By increasing number of replications, the standard error of mean decreased for all quality traits (Fig. 1). The standard error was highest for NDF and smallest for TA. By a number of

replications of four, the slope of the curve had already apparently decreased and a further increase of the replication number brought only small improvements of the standard error.

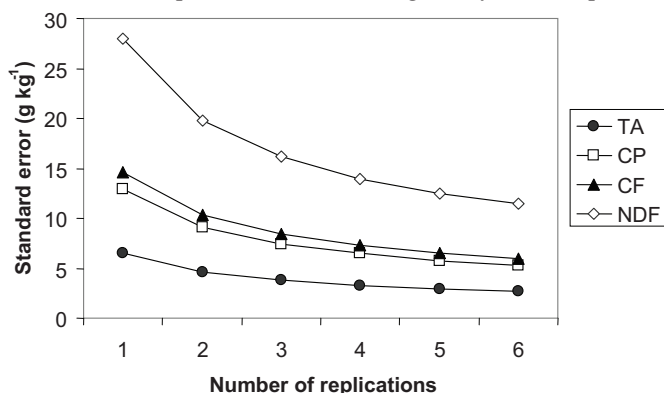

Figure 1. Relationship between the standard error of the dependent variables and the number of replications.

## Conclusions

The investigated sampling methods proved to be nearly equivalent. Method 2 should be preferred because of a higher sampling speed and easier sample collection thanks to the use of the metal frame. Furthermore, a smaller area is trampled during sampling. A number of 4 samples seem to be a good compromise between needed effort and accuracy to describe forage quality traits.

## References

- Bittante G., Andrighetto I. and Ramanzin M. (1990) *Fondamenti di zootecnia*. Liviana Editrice, Padova, I, 490 pp.
- Bovolenta S., Spanghero M., Dovier S., Orlandi D. and Clementel F. (2008) Chemical composition and net energy content of alpine pasture species during the grazing season. *Animal Feed Science and Technology* 140, 164-177.
- Jeangros B., Sechovic J., Schubiger F.X., Lehmann J., Daccord R. and Arrigo Y. (2001) Nährwert von Wiesenpflanzen: Trockensubstanz-, Rohrprotein- und Zuckergehalte. *Agrarforschung* 8, 1-8.
- Rodaro P., Scotton M. and Ziliotto U. (2000) Effetti delle caratteristiche stazionali e delle pratiche agronomiche su composizione floristica e produzione d'alcuni prati permanenti del Veneto. *Rivista di Agronomia* 34, 435-451.
- Rutzmoser K. (2000) Verlaufskurven von Inhaltswerten und Ertrag auf Grünlandstandorten in Bayern. In: Arbeitsgemeinschaft Grünland und Futterbau (eds.) *44. Jahrestagung vom 24. bis 26. August 2000 in Kiel*, Wissenschaftlicher Fachverlag, Giessen, D, pp. 117-120.
- Scotton M. and Rodaro P. (2000) *Tipologia dei prati permanenti delle Valli del Noce*, Monografie ESAT, Trento, I, 56 pp.



# The effect of Na-buffered acid-based additives on wilted roundbale grass silage

Randby Å.T.

Norwegian University of Life Sciences, Department of Animal and Aquacultural Sciences, N-1432 Ås, Norway

Corresponding author: ashild.randby@umb.no

## Abstract

Silage additives buffered by sodium, instead of ammonium as used formerly, were recently launched on the Norwegian market. The main objective of this study was to evaluate the effect of three sodium formate or/and  $\text{-propionate}$ -based silage additives (Ensil 1 Na (E), Ensil Pluss Na (EP) and GrasAAT N-Plus (GP)) on the quality of wilted roundbale silage. Untreated control silage (C) and Kofasil Ultra (KU) were included. The crop was wilted to reach 30% dry matter. All additives significantly improved fermentation quality and aerobic stability of roundbale grass silage. The effect of EP and GP was similar in spite of slightly different composition. When used at the same dose, the pure formate-based additive (E) restricted lactic acid and acetic acid fermentation somewhat more than the formate/propionate-based EP and GP, but WSC concentration tended to be lower, probably because of increased ethanol fermentation. None of the additives restricted mould growth significantly. When acid-treatment is needed in order to improve fermentation quality or aerobic stability of wilted silage, additives based on both formic and propionic acid may be recommended rather than pure formic acid-based additives in order to restrict ethanol fermentation, improve aerobic stability and, under some circumstances, restrict fungal growth.

Keywords: silage additives, roundbales, fungal growth, aerobic stability, fermentation

## Introduction

Due to less compaction and larger surface area, air leakage with resulting poor hygienic quality of silage is a greater problem in bales than in silos. This problem increases with increased wilting and increased crop maturity because such crops are difficult to compact. If compaction and sealing are sufficient, however, good fermentation quality is more easily obtained in wilted silage of mature grasses compared with immature crops and wet silages. The main objective of this study was to evaluate the effect of three sodium-buffered silage additives containing formate or a mixture of formate and propionate on fermentation quality, hygienic quality, and aerobic stability of wilted roundbale silage.

## Materials and methods

On 18-19 June 2007, a total of 42 roundbales (6 blocks) were harvested from the primary growth of an organically grown meadow at Ås, Norway. The meadow herbage comprised 0.4 timothy (*Phleum pratense*), 0.4 meadow fescue (*Festuca pratensis*), 0.06 red clover (*Trifolium pratense*), 0.06 white clover (*Trifolium repens*) and 0.08 weeds. The crop was wilted for 1 (during daytime) to 23 (overnight) h to reach 300 g kg<sup>-1</sup> dry matter (DM). Bales were subjected to one of 6 additive treatments as shown in Table 1, or kept untreated (C). The bales were wrapped in 6 layers of 0.75 m wide and 0.025 mm thick Triowrap stretch plastic film. The wilted herbage contained, on average, 298 g kg<sup>-1</sup> DM, 84 g crude protein (CP) per kg DM, 131 g water soluble carbohydrates (WSC) per kg DM, and had buffering capacity of

285 mEq per kg DM. Bales weighed on average 692 kg, contained 206 kg DM and 145 kg DM per m<sup>3</sup> and were stored for 5 months before opening.

Table 1. Composition of additives and target rate of application

Additive	Target rate of application	Formic acid g kg <sup>-1</sup>	Propionic acid g kg <sup>-1</sup>	Benzoic acid g kg <sup>-1</sup>
Ensil 1 Na (E)	4 l Mg <sup>-1</sup>	750	0	0.0
Ensil Pluss Na (EP)	4 and 6 l Mg <sup>-1</sup>	540	180	0.0
GrasAAT-N-Plus (GP)	4 and 6 l Mg <sup>-1</sup>	578	120	1.5
Kofasil Ultra <sup>1)</sup> (KU)	4 l Mg <sup>-1</sup>	0	37	11.0

<sup>1)</sup> Kofasil Ultra contains also 10.6% NaNO<sub>2</sub> and 7.2% hexamethylentetramin which are not included in the table.

Table 2. Obtained rate of application and effect of additives on fermentation quality

Additive <sup>1)</sup> treatment	Applied l Mg <sup>-1</sup>	DM g kg <sup>-1</sup>	g kg <sup>-1</sup> in DM						EtOH <sup>6)</sup> g kg <sup>-1</sup>	NH <sub>3</sub> -N g kg <sup>-1</sup>	pH
			CP	WSC	LA <sup>2)</sup>	FA <sup>3)</sup>	AcA <sup>4)</sup>	PA <sup>5)</sup>			
C	0	292	94	14 <sup>a</sup>	98 <sup>a</sup>	0.6 <sup>a</sup>	17.4 <sup>a</sup>	1.1 <sup>a</sup>	18.0 <sup>bc</sup>	83 <sup>a</sup>	4.05 <sup>a</sup>
E	4.0	291	95	60 <sup>b</sup>	45 <sup>bc</sup>	18.6 <sup>cd</sup>	7.6 <sup>bc</sup>	1.6 <sup>b</sup>	24.3 <sup>a</sup>	51 <sup>bc</sup>	4.19 <sup>b</sup>
EP	4.0	302	93	64 <sup>bc</sup>	55 <sup>b</sup>	13.1 <sup>b</sup>	9.3 <sup>b</sup>	2.9 <sup>cd</sup>	19.7 <sup>bc</sup>	59 <sup>b</sup>	4.22 <sup>b</sup>
EP	6.4	298	89	75 <sup>cd</sup>	43 <sup>bc</sup>	17.7 <sup>c</sup>	7.4 <sup>c</sup>	3.2 <sup>d</sup>	18.3 <sup>bc</sup>	56 <sup>bc</sup>	4.22 <sup>b</sup>
GP	4.0	284	93	61 <sup>b</sup>	54 <sup>b</sup>	14.0 <sup>b</sup>	9.4 <sup>b</sup>	2.5 <sup>c</sup>	20.3 <sup>b</sup>	54 <sup>bc</sup>	4.18 <sup>b</sup>
GP	5.9	292	96	83 <sup>d</sup>	36 <sup>c</sup>	20.7 <sup>d</sup>	6.3 <sup>c</sup>	2.8 <sup>cd</sup>	16.2 <sup>c</sup>	47 <sup>c</sup>	4.23 <sup>b</sup>
KU	4.0	292	97	55 <sup>b</sup>	89 <sup>a</sup>	0 <sup>a</sup>	18.8 <sup>a</sup>	1.0 <sup>a</sup>	7.3 <sup>d</sup>	95 <sup>d</sup>	4.21 <sup>b</sup>
s.e.m.		6.1	2.1	4.7	4.4	0.83	0.60	0.16	1.33	3.4	0.02
<i>P</i>		NS	NS	<0.001	<0.001	<0.001	<0.001	<0.001	<0.001	<0.001	<0.001

<sup>1)</sup> C = control, E = Ensil 1 Na, EP = Ensil Pluss Na, GP = GrasAAT N-Plus, KU = Kofasil Ultra <sup>2)</sup> Lactic acid

<sup>3)</sup> Formic acid <sup>4)</sup> Acetic acid <sup>5)</sup> Propionic acid <sup>6)</sup> Ethanol

Table 3. Number of bales with mould detected, percent of bale surfaces covered by mould, and aerobic stability of silages

Additive treatment	Target appl. rate	N	Number of bales with mould <sup>1)</sup> on			Percent of bale surfaces moulded <sup>2)</sup>			Aerobic stability h
			end surfaces	side surfaces	total surfaces	end surfaces	side surfaces	total surfaces	
C	0	6	3	3	3	1.7	2.0	1.9	284 <sup>a</sup>
E	4	6	4	2	4	4.1	0.2	1.6	320 <sup>ab</sup>
EP	4	6	4	3	5	0.5	0.3	0.4	447 <sup>bc</sup>
EP	6	6	5	1	5	1.1	0.5	0.7	502 <sup>c</sup>
GP	4	6	5	4	6	2.3 <sup>3)</sup>	1.8 <sup>3)</sup>	1.9 <sup>3)</sup>	423 <sup>abc</sup>
GP	6	6	4	2	4	2.0	2.8	2.5	497 <sup>c</sup>
KU	4	6	5	3	5	1.9	0.3	0.9	499 <sup>c</sup>
$\chi^2$			2.8	3.9	5.3				
s.e.m						1.62	1.17	1.12	51.0
<i>P</i>			NS	NS	NS	NS	NS	NS	0.02

<sup>1)</sup> Includes scattered, nearly invisible yeast, that did not imply that silage was discharged

<sup>2)</sup> Includes only clearly visible mould or yeast colonies

<sup>3)</sup> With exclusion of one GrasAAT N-Plus-bale that was damaged by birds: Percent of bale surfaces moulded: end surfaces: 1.0, side surfaces: 1.3, total surfaces: 1.2.

## Results and discussion

All silages were, in general, well-fermented (Table 2). Butyric acid was not detected in any silage. The concentration of WSC was low in untreated silage. All treatments increased WSC concentrations significantly, with the highest levels found in the EP6 and GP6 treatments. All treatments except KU4 restricted lactic acid (LA) and acetic acid (AcA) fermentation, and the strongest effect was found by the E4, EP6 and GP6 treatments. All treatments increased silage pH slightly.

Treatment E4 increased, and treatment KU4 restricted, ethanol fermentation significantly, whereas no effect on ethanol fermentation was found by the other treatments. Compared with the pure formic acid (FA) containing additive (E), however, the FA + propionic acid (PA) containing additives (EP and GP) significantly restricted ethanol concentrations. An increased dose of the PA-containing additives (EP and GP) seemed to further restrict ethanol fermentation, although the difference between 4 and 6 l t<sup>-1</sup> was significant only for GP. Kofasil Ultra was the only additive that significantly restricted ethanol fermentation compared with control silage.

Surface mould was detected on 32 of the 42 bales (Table 3), and the majority of the fungal growth was found on the bottom of the bales (end surface). On average 0.2% of silage was discharged from bale surfaces due to mould, and less than 0.1% of silage was discharged from the inside of bales during feed out (results not presented). None of the measures of fungal growth showed statistical significance.

All silages had very good aerobic stability. Although untreated bales were stable for nearly 12 days, the EP4, EP6, GP6 and KU4-treatments improved aerobic stability significantly compared with untreated bales. The great effect on aerobic stability of silage may be a separate reason for using additive treatment, for example in big bunker or clamp silos, or when a limited number of animals are to be fed from silos or bales. The increased effect of PA-containing additives on aerobic stability and inhibition of ethanol fermentation is probably caused by a yeast inhibitory effect of PA compared with FA. This effect could be a good reason for choosing PA-containing additives rather than pure FA-containing additives when acid treatment is required to ensure good fermentation quality of silage.

## **Conclusions**

All the studied additives significantly improved fermentation quality and aerobic stability of wilted roundbale grass silage. The effect of EP and GP was similar. When used at the same dose, E restricted LA and AcA fermentation somewhat more than EP and GP, but WSC concentration tended to be lower, probably because of increased ethanol fermentation.

None of the additives restricted mould growth significantly. This does not mean that an antifungal effect of propionic acid-containing additives is absent, but it may be weak, dose dependant and difficult to detect. When acid-treatment is needed in order to improve fermentation quality or aerobic stability of wilted silage, propionic acid-based additives may be recommended rather than pure formic acid-based additives, in order to restrict ethanol fermentation, improve aerobic stability and under some circumstances, restrict fungal growth.

# Relationships between dry matter yield, forage nutritive value, and some canopy parameters of alfalfa crop

Rimi F., Macolino S. and Ziliotto U.

*Department of Environmental Agronomy and Crop Production, University of Padova, 35020 Legnaro (PD), Italy*

Corresponding author: [filrimi@tin.it](mailto:filrimi@tin.it)

## Abstract

The cultivar choice is one of the most important factors affecting dry matter yield and forage quality of alfalfa (*Medicago sativa* L.) crops. Canopy parameters such as plant height, Leaf Area Index (LAI), and Stem Area Index (SAI) are often related to the cultivar selection. With the aim to investigate the relationships existing between dry matter (DM) yield, forage nutritive value, and some canopy parameters of alfalfa, a 3-year study was conducted at the experimental farm of Padova University in Legnaro (NE Italy) from March 2005 to November 2007. Sixteen cultivars of alfalfa were compared under two harvest regimes: early bud and early flower. In 2006 and 2007 dry matter yield, plant height, leaf dry weight per area unit, stem dry weight per area unit, LAI, and SAI were measured at each harvest. The forage nutritive value (UFL= French milk forage units) was calculated based on forage nutrient concentrations determined via near infrared reflectance spectroscopy (NIRS). DM yield increased with the increase of plant height. A strong positive correlation existed between plant height and UFL ha<sup>-1</sup>. Furthermore, both leaf to stem ratio and LAI to SAI ratio were positively related to UFL.

Keywords: harvest stage, cultivar, forage quality, plant height

## Introduction

Yield and quality of alfalfa forage are greatly influenced by the cultivar choice. Genotypic differences cause variation in the plant anatomy, morphology and chemical composition producing a large effect on alfalfa performances (Dougherty and Collins, 2003). Breeding programmes improve quality by using nutritive values and morphological traits of alfalfa canopy (Tucak *et al.*, 2008), such as plant height, leaf dry weight, LAI, stem dry weight. In most cases, there is a negative correlation between yield and quality, and this is mainly due to the decrease of crude protein concentration with advancing maturity (Hinz and Albrecht, 1991). The objective of this study was to investigate the relationships existing between yield and forage nutritive value and the main morphological traits of alfalfa plants subjected to an intensive harvest regime.

## Materials and methods

The trial was conducted from March 2005 to November 2007 at the experimental farm of Padova University (NE Italy) on a silt loam soil, with pH 8.1. The climate in the area is considered sub-continental with an annual mean temperature of 12.3 °C and average annual rainfall of 820 mm. The experimental design was a split-plot with harvest regimes as the main plot. The plot size was 11.2 m<sup>2</sup> with the test area for yield of 6 m<sup>2</sup> (1.2 m x 5.0 m). Plots were seeded on 29 April 2005 with 16 cultivars: 'Barlydia', 'Centauro', 'Delta', 'Equipe', 'Garisenda', 'Gigante Romea', 'Hystory', 'La Torre', 'Linfa', 'Lodi', 'Palladiana', 'PR56S82', 'PR57N02', 'Riviera Vicentina', 'Robot', and 'Triade'. Before seeding the soil was fertilized with 65 kg ha<sup>-1</sup> of P and 250 kg ha<sup>-1</sup> of K. Then, plots were fertilized once a year in February

with 65 kg ha<sup>-1</sup> of P and 250 kg ha<sup>-1</sup> of K. Plots were subjected to two harvest regimes based on phenological stage: early bud and early flower (Kalu and Fick, 1981). In 2005 all plots received 4 cuts, and in 2006 and 2007 plots harvested at bud stage received 7 cuts, while plots harvested at early flower received 6 cuts. At each cut a 0.5 kg herbage sample was collected from each plot to determine DM yield and forage nutrient components. Nutrient concentrations were determined using the near infrared reflectance (NIR) spectroscopy. The nutritive value (UFL = unité fourragère lait, French milk forage units) was estimated (INRA, 2007) and expressed as content per DM and hectare. Plants in 30 cm rows were collected at each harvest and leaves were separated from stems. The LAI and SAI were measured using a rotary tape area meter. Finally, stems and leaves were dried at 65 °C in a forced air oven to determine leaf DM to stem DM ratio (LSR). Plant height was determined at each harvest by measuring the height of the canopy at four points randomly selected within each plot.

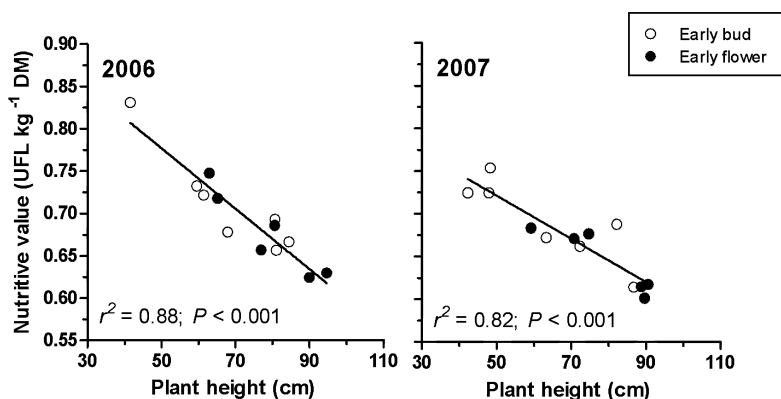

Figure 1. Relationship between alfalfa forage nutritive value and plant height at harvest in 2006 and 2007. Data points are the average of 16 cultivars harvested at early bud or early flower stage.

## Results and discussion

Plant height in both 2006 and 2007 was negatively correlated with UFL in DM (Fig. 1), whereas it was positively correlated with DM yield (2006:  $r^2 = 0.74$ ;  $P < 0.001$ ; 2007:  $r^2 = 0.79$ ;  $P < 0.001$ ). These results are confirmed by other authors, who have reported plant height as an important yield component (Tucak *et al.*, 2008), and suggested that canopy height could be considered a valuable tool to make a rough estimation of dry matter yield. The plant height was also positively related to UFL ha<sup>-1</sup>; however, the correlation was greater in 2007 ( $r^2 = 0.79$ ;  $P < 0.001$ ) than in 2006 ( $r^2 = 0.63$ ;  $P < 0.01$ ). A negative relationship was found between DM yield and UFL in 2006 ( $r^2 = 0.54$ ;  $P < 0.01$ ) and 2007 ( $r^2 = 0.74$ ;  $P < 0.001$ ). That correlation between yield and nutritive value has been broadly reported as a consequence of high yield productivity associated with high fibre and low protein content (Elliot *et al.*, 1972).

A strong positive correlation existed between LAI to SAI ratio and UFL (Fig. 2). LSR showed a similar correlation with forage nutritive value in 2006 ( $r^2 = 0.77$ ;  $P < 0.001$ ) and 2007 ( $r^2 = 0.61$ ;  $P < 0.01$ ), confirming the decrease in forage quality with reducing leaf contribution (Woodbury and Evans, 1935). From this study we have come to the conclusion that the major canopy parameters can be recommended for improving DM yield and forage quality of alfalfa crops subjected to intense harvest management.

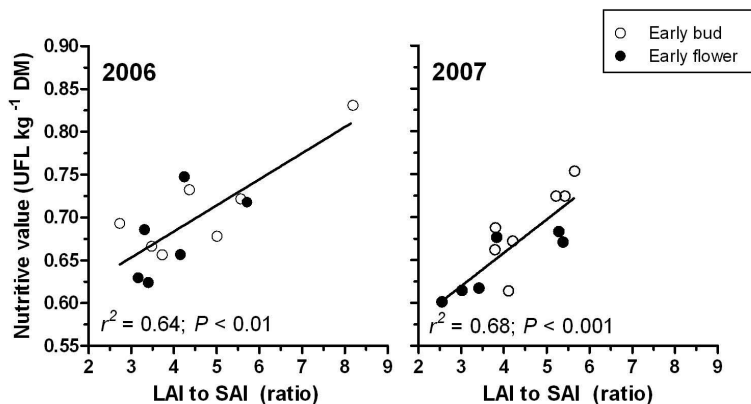

Figure 2. Relationship between alfalfa forage nutritive value and leaf area index to stem area index ratio in 2006 and 2007. Data points are the average of 16 cultivars harvested at early bud or early flower stage.

## References

- Dougherty C.T. and Collins M. (2003) Forage utilization. In: Barnes R.F., Nelson C.J., Collins M. and Moore K.J. (eds.) *Forages. An Introduction to Grassland Agriculture*, 6th ed., Iowa State Press, Ames, IA, pp. 391-414.
- Elliot F.C., Johnson J. and Schonhorst M.H. (1972) Breeding for forage yield and quality. In: (eds.) *Alfalfa Science and Technology*, American Society of Agronomy Inc. Publisher, Madison, pp. 320-332.
- Hintz R.W. and Albrecht K.A. (1991) Prediction of alfalfa chemical composition from maturity and plant morphology. *Crop Science* 31, 1561-1565.
- INRA (2007). *Alimentation des Bovins, Ovins et Caprins*, Éditions Quae, Versailles, 308 pp.
- Kalu B.A. and Fick G.W. (1981) Quantifying morphological development of alfalfa for studies of herbage quality. *Crop Science* 21, 267-271.
- Tucak M., Popovic S., Grljusic S., Cupic T., Kozumplik V. and Simic B. (2008) Variability and relationship of important alfalfa germplasm agronomic traits. *Periodicum Biologorum* 110, 311-315.
- Woodbury R.M. and Evans R.E. (1935) Nutritive value of lucerne. IV. The leaf-stem ratio. *Journal of Agronomic Science* 25, 578-597.

## Insights into carbohydrate and protein fractionation in perennial ryegrass (*Lolium perenne* L.) genotypes using the Cornell Net Carbohydrate and Protein System. 2. Ruminant kinetics

Salama H., Lösche M., Gierus M., Herrmann A. and Taube F.

*University of Kiel, Grass and Forage Science/Organic Agriculture, Institute of Crop Science and Plant Breeding. D-24118 Kiel, Germany*

Corresponding author: salama@email.uni-kiel.de

### Abstract

The Cornell Net Carbohydrate and Protein System (CNCPS) is used as a tool to provide detailed information about grass nutritional value, involving rumen kinetics. The current study, evaluating 20 diploid perennial ryegrass genotypes, revealed small, but significant variations concerning the ruminally degraded and undegraded proteins (RDP and UDP) and the ruminally digested and undigested carbohydrates (RDC and UDC). Genotypes 6 and 9 represented the maximum variation in the investigated set of genotypes, and helped in the interpretation of the results. The dry-matter based first cut difference between the genotypes 6 and 9 accounted for 24, 1, and 1 g kg<sup>-1</sup> in DM, for the respective parameters RDC, RDP and UDP, in favour of the high-sugar genotype 9, even though the two genotypes had similar total carbohydrate and total protein contents. This highlights the importance of feed fractionation procedures in achieving a detailed view into the fate and utilisation of the different fractions in the rumen, and supports the optimisation of diet composition which meets the animal's requirements to achieve its appropriate maintenance and production levels.

Keywords: *Lolium perenne*, CNCPS, rumen kinetics, carbohydrate, protein, fractionation

### Introduction

Production and efficient utilisation of high yields of high-quality grass throughout the growing season are critical for cost-efficient milk and beef production in many systems (O'Riordan *et al.*, 2000). After fresh plant material enters the rumen, there is often a phase of rapid proteolysis providing N in excess of that required to maintain the rumen microbial population (Kingston-Smith and Theodorou, 2000). This asynchrony leads to the accumulation of the ammonia in the rumen, which increases the risk of its loss in the form of urea which will be excreted via urine (Hoekstra *et al.*, 2008). The N loss results in increasing risk of environmental N pollution (Tamminga, 1992). Using the Cornell Net Carbohydrate and Protein System (CNCPS), the objective of the current study was to provide information about the genotypic variability in the rumen kinetics of 20 tested genotypes from the early-intermediate heading group.

### Materials and methods

A two-year field trial was conducted at three sites in northern Germany during the growing seasons of 2006 and 2007. Twenty diploid intermediate heading perennial ryegrass genotypes were evaluated in a Randomised Complete Block Design with three replicates in a 4-cut system. In the current study, data from the first cut will be analysed and discussed. N fertilisation amounted to 300 kg ha<sup>-1</sup> divided into four applications, namely 100, 80, 80 and 40 kg ha<sup>-1</sup> applied before the first, second, third and fourth harvests, respectively. Using the estimates of the rumen degradation (Kd) and passage (Kp) rates, described by Sniffen *et al.* (1992) in the CNCPS, the variations in the ruminally degraded and undegraded protein (RDP



and UDP) and the ruminally digested and undigested carbohydrates (RDC and UDC), for the 20 tested genotypes were investigated. Nitrogen values were used to present the RDP and UDP ( $CP = N \times 6.25$ ). For more information concerning the carbohydrate and protein fractionation of the tested genotypes, see Lösche *et al.* (2010). Data were statistically analysed using the mixed procedure of SAS<sup>®</sup>9.1, with the least significant difference procedure for mean comparison, and probabilities being adjusted by Tukey-Kramer test.

Table 1. Means of first cut ruminally digested (RDC) and undigested (UDC) carbohydrate ( $g\ kg^{-1}$ ) contents and ruminally degraded (RDP) and undegraded (UDP) protein ( $g\ kg^{-1}$ ) contents of the 20 tested genotypes over the 2006 and 2007 growing seasons.

Genotype	RDC	RDP	UDC	UDP
1	681 defg	722 a	319 abcd	279 c
2	686 cdef	719 abc	314 bcde	282 abc
3	687 bcdef	714 abc	313 bcdef	286 abc
4	700 abc	707 c	300 efg	293 a
5	678 efg	716 abc	322 abc	284 abc
6	667 g	721 a	333 a	279 c
7	684 cdef	711 abc	316 bcde	289 abc
8	688 bcdef	707 c	312 bcdef	293 a
9	706 a	709 abc	294 g	291 abc
10	703 ab	718 abc	297 fg	282 abc
11	686 cdef	715 abc	314 bcde	285 abc
12	686 bcdef	708 bc	313 bcdef	292 ab
13	696 abcd	712 abc	305 defg	288 abc
14	680 defg	714 abc	320 abcd	287 abc
15	678 efg	707 c	322 abc	293 a
16	692 abcde	707 c	308 cdefg	293 a
17	679 defg	715 abc	321 abcd	285 abc
18	688 bcdef	709 bc	312 bcdef	291 ab
19	690 abcdef	720 ab	310 bcdefg	281 bc
20	675 fg	718 abc	326 ab	282 abc
S.E.	3.3	2.8	3.3	2.8

Means followed by different letter(s) within the same column are significantly different according to the LSD test at 0.05 level of probability. S.E. Standard error

## Results and discussion

Analysis of first cut carbohydrates and proteins degraded in the rumen showed significant main effects for the three sites and the 20 genotypes ( $P < 0.001$ ). Genotype 6 was distinguished with its significantly high RDP (721.3 g N per kg total N) and UDC (333.4 g  $kg^{-1}$  total CHO) contents, accompanied with the low RDC (666.6 g  $kg^{-1}$  total CHO) and UDP (278.7 g  $kg^{-1}$  total N) contents over all the tested genotypes (Table 1). The highest RDC component was in favour of the high-sugar genotype 9 (706.2 g  $kg^{-1}$  total CHO). It was also characterised with its moderate RDP and UDP contents, amounting to 709.1 and 290.9 g  $kg^{-1}$  total N, respectively. Despite the significant variations among the 20 tested genotypes, the magnitude of variability was relatively small. Genotypes 6 and 9 represented the maximum variation in the investigated set of genotypes. Both genotypes revealed a difference in the ruminally digested carbohydrates of 24 g  $kg^{-1}$  in DM in favour of the high-sugar genotype 9 (Table 2). Accompanied with the similar RDP content for the respective genotypes 6 and 9 accounting for 11 and 12 g  $kg^{-1}$  in DM, it could be suggested that the high-sugar genotype 9 has a better chance in achieving a balanced carbohydrate/protein metabolism. Sinclair *et al.* (1995) suggested that the proportion of rumen available CP, expressed as N, to rumen available carbohydrates should be around 32 g N per kg available carbohydrates. Applying this proposed value to our results revealed that all the tested genotypes had enough RDC contents to degrade the available RDP. Noticeably, all genotypes had low N content resulting

from the moderate N fertilisation rate in our trial. Many studies highlighted the CNCPS to be an efficient and reliable system in predicting UDP content of different diets (Tremblay *et al.*, 2003). Thus, selecting genotypes for increased UDP concentrations is one effective way to supply the small intestine with a reasonable amount of amino acids to support animal needs. Calculated on dry matter basis, the UDP content of the two respective genotypes 6 and 9 were 4 and 5 g UDP per kg DM, which is not a relevant difference, but combined with its higher RDC and RDP contents, supports the superiority of the high-sugar genotype over the conventional one. Similar studies investigating the ruminal kinetics of the different carbohydrate and protein fractions in *Lolium perenne* is very rare. However, the UDP values achieved in the current study are comparable to those by Tremblay *et al.* (2002) for alfalfa.

Nutritional aspects	Low-sugar genotype 6	High-sugar genotype 9
RDC	538	562
RDP	11	12
UDC	269	234
UDP	4	5

Table 2. First cut ruminally digested (RDC) and undigested (UDC) carbohydrate contents and ruminally degraded (RDP) and undegraded (UDP) protein contents for the two selected high- and low-sugar genotypes expressed as g kg<sup>-1</sup> in DM.

## Conclusion

The small variations observed among genotypes suggested that the tested genetic material was similar, and highlights the need of introducing more variation to the genetic base of selection for the investigated quality parameters. The CNCPS proved to be a suitable tool to provide detailed information about grass nutritional value, in relation to rumen kinetics. Consequently, it supports the optimization of diet composition which meets the animal's requirements to achieve its appropriate maintenance and production levels. Screening the 20 tested genotypes revealed that introducing high-sugar genotypes to the diet, which are characterised by their low fibre content and high digestibility, would positively contribute in improving the carbohydrate/protein balance and thus decreasing the risk of high ammonia excretion and environmental N pollution.

## References

- Hoekstra N.J., Struijk P.C., Lantinga E.A., Van Amburgh M.E. and Schulte R.P.O. (2008) Can herbage nitrogen fractionation in *Lolium perenne* be improved by herbage management? *Netherlands Journal of Agricultural Science* 55, 167-180.
- Kinston-Smith A.H. and Theodorou M.K. (2000) Post-ingestion metabolism of fresh forage. *New Phytologist* 148, 37-55.
- Lösche M., Salama H., Gierus M., Herrmann A. and Taube F. (2010) Insights into carbohydrate and protein fractionation in perennial ryegrass (*Lolium perenne* L.) using the CNCPS. I. Carbohydrate and protein composition. *Grassland Science in Europe* 15 (this volume).
- O'Riordan E.G., McGilloway D. and French P. (2000) Beef from grass-based system. *Irish Grassland and Animal Production Association* 34, 105-111.
- Sinclair L.A., Garnsworthy P.C., Newbold J.R. and Buttery P.J. (1995) Effects of synchronizing the rate of dietary energy and nitrogen release in diets with a similar carbohydrate composition in rumen fermentation and microbial protein synthesis in sheep. *Journal of Agricultural Science, Cambridge* 124, 463-472.
- Sniffen C.J., O'Connor J.D., Van Soest P.J., Fox D.G. and Russell J.B. (1992) A net carbohydrate and protein system for evaluating cattle diets. II. Carbohydrate and protein availability. *Journal of Animal Science* 70, 3562-3577.
- Tamminga S. (1992) Nutrition management of dairy cows as a contribution to pollution control. *Journal of Dairy Science* 75, 345-357.
- Tremblay G.F., Bélanger G., McRae K.B. and Michaud R. (2002) Leaf and stem dry matter digestibility and ruminal undegradable proteins of alfalfa cultivars. *Canadian Journal of Plant Science* 82, 383-393.
- Tremblay G.F., Michaud R. and Bélanger G. (2003) Protein fractions and ruminal undegradable proteins in alfalfa. *Canadian Journal of Plant Science* 83, 555-559.

# Floristic composition and herbage quality changes with tree cover in NW Patagonia, Chile

Sánchez-Jardón L.<sup>1</sup>, Acosta B.<sup>1</sup>, Elizalde H. F.<sup>2</sup>, del Pozo A.<sup>3</sup>, Casado, M.A.<sup>1</sup>, Ovalle, C.<sup>4</sup>, Hepp C. and de Miguel J.M.<sup>1</sup>

<sup>1</sup>Universidad Complutense de Madrid, Dpto. Ecología, Madrid, Spain

<sup>2</sup>Instituto de Investigaciones Agropecuarias (INIA) Tamel Aike, Coyhaique, Chile

<sup>3</sup>Universidad de Talca, Fac. Agronomía, Talca, Chile

<sup>4</sup>Instituto de Investigaciones Agropecuarias (INIA) Quilamapu, Chillán, Chile

Corresponding author: laurasj@bio.ucm.es

## Abstract

In order to test the feasibility of implementing a silvopastoral system with the native tree species lenga (*Nothofagus pumilio* [Poepp. et Endl.] Krasse), we studied the understorey grasslands in a marginal lenga woodland with varying canopy openness in the Aysén Chilean region. In the present work we examine the influence of tree cover on herbage quality. Concentration of crude protein, fibres by the acid detergent method and water soluble carbohydrates were measured in a range of tree covers at the peak of the growing season. Herbage nutritive quality along the tree cover gradient is discussed with reference to changes in its botanical composition and the chemical composition of two dominant species with forage potential.

Keywords: silvopastoral agroforestry, canopy, cattle, forest fragmentation, biodiversity, *Nothofagus pumilio*, plant biomass

## Introduction

Aimed at establishing the scientific basis for silvopasture management with the native tree species lenga (*Nothofagus pumilio* [Poepp. et Endl.] Krasse), we conducted a study on grassland productivity on a tree cover gradient in marginal woodlands from the Aysén region. Previous works showed that productivity was as high or higher higher at intermediate canopy openness than in open grasslands but decreased in dense forests (Sánchez-Jardón *et al.*; 2008, 2010). Nutritive quality can be influenced by the presence of trees due to changes in floristic composition or to morphological and physiological adaptations of the individual species (Buegler *et al.*, 2006). In the present work we discuss tree cover influence on herbage quality with reference to changes in its floristic composition and the chemical composition of the two dominant species with forage potential *Dactylis glomerata* L. and *Trifolium repens* L.

## Material and methods

The study site was a moderately altered lenga forest located in the experimental field of Tamel Aike –INIA (Coyhaique County, Aysén region, Chile; 45° S, 72° W). Fifteen sites (20 m x 20 m) were distributed in five classes of tree cover (three sites per class) from open grassland to dense forests. One open grassland site was found to be unsuitable and was thus discarded for further analyses. At the peak of growing season 2007-8 (January), herbage was harvested by cutting at random four plots (100 cm x 50 cm) at ground level, using an electric shearing handpiece. Prior to quality analyses, herbage dry matter (DM) was determined by drying for 48 h at 60 °C and samples were analysed for floristic composition as classified into four main taxonomic families (grasses, composites, legumes, others) by manual separation. Green fully extended leaves of the two selected species were collected from the 14 sites as

well. Quality analyses were made in both sets of samples (general sample and green leaves). Concentration of water soluble carbohydrates (WSC) was determined by the Anthrone method and by reading the absorbance at 620 nm, following Thomas (1977). Nitrogen content was determined with the Kjeldhal method, and crude protein (CP) was obtained through multiplication of nitrogen concentration by a factor of 6.25 (AOAC, 1970). Fibres were assessed by the acid detergent method (ADF) following Van Soest (1963). Comparison of means across the tree cover classes was performed with multiple range tests (LSD procedure,  $P < 0.05$ ) using the package STATGRAPHICS Plus Version 5.0.

## Results and discussion

Biomass production was highest at intermediate tree cover levels (Table 1). These low values agreed with previous results on annual productivity for the same marginal unimproved grasslands from NW Patagonia (Sánchez-Jardón *et al.*, 2008; 2010). The nature of the herbage differed in plant composition and more importantly in nutritive quality. Dense forests showed the most different plant species composition. Even though the differences were not significant for grasses or composites, these and legumes (mostly *T. repens*) reduced its growth under dense shade (as expected; Lin *et al.*, 2001) where other families' abundance was significantly higher. The latter are relevant to biodiversity conservation since this fraction includes many (nearly 60%) of the native species. Quality varied with tree cover (Table 2) and differences were only significant for green leaves, not for general samples. However, a previous work described linear relationships between these quality parameters measured and radiation transmitted through the canopy for all sets of samples (Sánchez-Jardón *et al.*, 2010); therefore, lack of significance between classes would indicate high heterogeneity within each class. In any case, a general decrease in WSC with increasing tree cover was observed, while the opposite was found for CP and ADF. Concentration of WSC is known to influence herbage intake by herbivores (Jones and Roberts, 1991) and thus a loss in WSC under shade would diminish a more nutritive (higher CP), though less digestible (higher ADF), pasture in woodlands. Nonetheless, the relationship between herbage quality and actual intake by cattle remains to be examined.

Table 1. Total dry matter (DM) biomass yield ( $\text{g m}^{-2}$ ) and composition in taxonomic families (% of the DM) across the tree cover classes. Mean average for the three replicates per class.

	DM	Grasses		Composites	Legumes *	Others
		All	<i>D. glomerata</i>			
Open areas	151.3 <sup>ab</sup>	31.5	11.7	27.1	10.3 <sup>ab</sup>	23.5 <sup>b</sup>
Scattered trees	192.0 <sup>a</sup>	36.2	12.4	24.2	15.0 <sup>ab</sup>	13.9 <sup>b</sup>
Low-density	191.3 <sup>a</sup>	47.0	24.5	16.1	14.3 <sup>ab</sup>	9.5 <sup>b</sup>
Medium-density	153.2 <sup>ab</sup>	36.0	15.3	13.0	24.5 <sup>a</sup>	21.4 <sup>b</sup>
Dense forests	80.0 <sup>b</sup>	25.8	24.5	9.5	1.5 <sup>b</sup>	62.5 <sup>a</sup>

\* *T. repens* comprises most of the legumes; occasionally the rare species *Vicia nigricans* Hook et Arn. occurs at a negligible abundance.

Different letters denote statistically significant differences between tree cover classes

The variation in herbage quality across the tree cover classes was seemingly more related to the individual species' chemical composition than to changes in the floristic composition. This statement is based on two facts: (1) the significant variation in the quality parameters measured in green leaves of the selected species, and (2) lack of significant changes in the relative abundance of the most profuse families: grasses (including the selected species *D. glomerata*) and composites.

Table 2. Concentration (g kg<sup>-1</sup>) of water soluble carbohydrates (WSC), fibres by the acid detergent method (ADF) and crude protein (CP) in the general herbage sample (DM) and in green leaves of the two selected species across the tree cover classes.

	Dry matter			<i>D. glomerata</i> L.			<i>T. repens</i> L.		
	WSC	ADF	CP	WSC	ADF	CP	WSC	ADF	CP
Open areas	9.7	29.5	9.05	14.1 <sup>a</sup>	26.2 <sup>b</sup>	14.6	10.3	12.9 <sup>b</sup>	15.6 <sup>c</sup>
Scattered trees	7.5	31.0	10.0	11.5 <sup>a</sup>	26.9 <sup>b</sup>	17.4	8.8	13.6 <sup>b</sup>	20.3 <sup>b</sup>
Low-density	7.1	32.7	10.3	8.4 <sup>b</sup>	31.0 <sup>a</sup>	16.6	6.9	16.0 <sup>a</sup>	22.1 <sup>ab</sup>
Medium-density	6.7	33.9	10.8	7.1 <sup>b</sup>	31.2 <sup>a</sup>	17.3	7.8	16.6 <sup>a</sup>	21.7 <sup>ab</sup>
Dense forests	5.7	34.9	11.1	6.1 <sup>b</sup>	32.5 <sup>a</sup>	16.1	5.8	18.2 <sup>a</sup>	23.1 <sup>a</sup>

Different letters denote statistically significant differences between cover classes

## Conclusion

Results suggest that herbage quality varied along the tree cover gradient mainly through changes in the individual species' chemical composition. In any case, pasture in woodlands was more nutritious though less digestible and probably less desirable, but had more native plant species, which might encourage biodiversity conservation. However, the actual response of herbivores to quality changes by canopy openness is unknown in these systems. Further studies are required in order to describe the influence of varying quality on potential grazing intensity, and eventually state the implications for silvopastoral management in the area.

## Acknowledgements

Funding came from *Universidad Complutense de Madrid* and *Fundación Biodiversidad* (Spain). The Bromatology lab of INIA Remehue (Chile) performed the chemical analyses. Special thanks to all INIA Tamel Aike staff.

## References

- AOAC (1970) *Official methods of analysis*. Association of Official Analytical Chemists, Washington DC, USA, 1015 pp.
- Buergler A.L., Fike J.H., Burger J.A., Feldhake C.M., McKenna J.R. and Teutsch C.D. (2006) Forage nutritive value in an emulated silvopasture. *Agronomy Journal* 98, 1265-1273.
- Jones E.L. and Roberts J.E. (1991) A Note on the relationship between palatability and water-soluble carbohydrates content in perennial ryegrass. *Irish Journal of Agricultural Research* 30, 163-167.
- Lin C., McGraw M., George M. and Garrett H. (2001) Nutritive quality and morphological development under partial shade of some forage species with agroforestry potential. *Agroforestry Systems* 53, 269-281.
- Sánchez-Jardón L., Casado M.A., Del Pozo A., Ovalle C., Acosta B. and De Miguel J.M. (2008) Grassland productivity and consumption under different tree cover in the Aysén region, Patagonia, Chile. *Grassland Science in Europe* 13, 311-313.
- Sánchez-Jardón L., Acosta B., Casado M.A., del Pozo A., Ovalle C., Elizalde H.F., Hepp C. and de Miguel J.M. (2010) Grassland productivity and diversity on a tree cover gradient in *Nothofagus pumilio* in NW Patagonia. *Agriculture Ecosystem and Environment* 137, 213-218.
- Thomas T.A. (1977) An automated procedure for the determination of soluble carbohydrates in herbage. *Journal of the Science of Food and Agriculture* 28, 639-642.
- Van Soest P.J. (1963) Use of detergents in the analysis of fibrous feeds. II. A rapid method for determination of fiber and lignin. *Journal of the Association Official of Analytical Chemists* 46, 829-835.

## Aerobic stability evaluation by carbon dioxide (CO<sub>2</sub>) production on corn silages using Infrared Gas Analyzer

Schmidt P.<sup>1</sup>, Junges D.<sup>1</sup>, Campos G.P.<sup>2</sup> and Marques R.<sup>1</sup>

<sup>1</sup>Federal University of Paraná, Curitiba/PR, Brazil

<sup>2</sup>Nutron Alimentos Ltda.

Corresponding author: patricks@ufpr.br

### Abstract

The silage spoilage process with oxygen exposure caused by the microbial population results in carbon dioxide (CO<sub>2</sub>) production, which is a measure of dry matter losses. This trial evaluated the aerobic stability in corn silages without additives or with a combination of *Lactobacillus plantarum*, *Lactobacillus brevis* and *Enterococcus faecium*, with five replicates. Aerobic stability was measured as hours to reach a temperature increase of 2 °C above ambient, using data loggers buried on the forage. The CO<sub>2</sub> production evaluation was made using the IRGA (Infrared Gas Analyzer) equipment. 30 g of corn silage was used from each replication and the CO<sub>2</sub> measures were taken every hour with the results expressed in parts per million (ppm) of CO<sub>2</sub> produced and detected in aerobic condition. The data were converted to CO<sub>2</sub> microliters per hour per gram of silage, on a dry matter basis (μL h<sup>-1</sup> g<sup>-1</sup>). A good correlation was observed between CO<sub>2</sub> production and temperature increase. The carbon dioxide production was a good indicator of dry matter losses of silage under aerobic conditions.

Keywords: additives, carbon dioxide, IRGA, *Lactobacillus*, silage.

### Introduction

Aerobic deterioration or spoilage is the result of aerobic microorganisms metabolizing components of the silage using oxygen. Most often, lactate-assimilating yeasts utilize lactic acid and raise pH allowing other aerobic microorganisms such as bacilli to flourish (Pahlow and Muck, 2009); these authors emphasized the primary key to controlling the growth of aerobic spoilage microorganisms is the degree of oxygen exposure.

Microbial additives containing heterolactic bacteria raise the acetic and propionic acid production of silages and are used to minimize silage degradation when exposed to oxygen (Nkosi *et al.*, 2009).

The increase in forage temperature and accumulate temperature have been used as indicator of aerobic deterioration of silages (Kung Jr. *et al.*, 2000). However, other authors (Ashbell *et al.*, 1991) have proposed the use of the amount of carbon dioxide (CO<sub>2</sub>) produced as an indicator of silage degradation under aerobic conditions.

This study aimed to evaluate the aerobic stability of whole-plant corn silage inoculated with microbial additives, by monitoring temperature and CO<sub>2</sub> production.

### Materials and methods

The test was conducted at the Paraná Federal University (UFPR) Animal Science Department, in Curitiba, PR, Brazil. Two treatments were tested: Control – with no use of additives; Combo – additives containing strains of *Lactobacillus plantarum*, *Lactobacillus brevis* and *Enterococcus faecium* (1x10<sup>5</sup> CFU g<sup>-1</sup>).

Silages were produced in experimental silos which were opened after 60 days to evaluate aerobic stability, using five replicates per each treatment, in a temperature-controlled room at



23°C. The temperature of the silage was measured for 140 hours, at intervals of 30 minutes, using data loggers buried on the forage. The CO<sub>2</sub> production was measured for 140 hours, at intervals of 60 minutes, using the IRGA (Infrared Gas Analyzer) equipment. The system consists of 18 channels, an air pump, two bottles of acid water washing gas, with a flow controller with a needle valve for each channel, a mass flow meter, an infrared gas analyser and a computer for data storage. There was an empty channel (blank), with no sample, to measure the air CO<sub>2</sub> concentration. A sample of 30 g of silage was used per replicate, with 297 g of dry matter (DM) per kg. The results were expressed in µL of CO<sub>2</sub> produced per g of DM per hour. The variables were: AS - aerobic stability (hours to increase 2 °C); Tmax – maximum temperature; HTmax – hours to reach the maximum temperature; T140 – accumulated temperature in 140 hours; DML140 – dry matter losses after 140 hours; CO<sub>2</sub>max – maximum production of CO<sub>2</sub>; HCO<sub>2</sub>max – hours to reach maximum production of CO<sub>2</sub>; CO<sub>2</sub>140 - CO<sub>2</sub> accumulated production after 140 hours.

A completely randomized design was used and the treatment means were compared by F test. Correlations were established between all variables using the PROC CORR of SAS.

## Results and discussion

The temperature development and CO<sub>2</sub> production over 140 hours showed similar performance (Figure 1). The evaluated variables for the studied treatments are presented in Table 1. The use of the Combo additive on silage influenced only the accumulated temperature in 140 hours, with a small reduction on this variable. The other variables were not affected by treatments. The average stability time observed in this study (30.4 hours) was similar to those reported by Kung *et al.* (2000) for corn silage (36 hours).

The additive used was not effective in increasing the aerobic stability of silage and in reducing CO<sub>2</sub> emission, possibly due to the predominance of homolactic fermentation mediated by *L. plantarum* and *E. faecium*.

Table 1. Aerobic stability of whole plant corn without additives (Control) or with microbial additive (Combo)

Variables	Treatments <sup>1</sup>		CV (%)
	Control	Combo	
Aerobic Stability, hours to increase 2 °C	30.4	30.4	10.5
Maximum temperature, °C	37.2	37.0	1.86
Hours to maximum temperature, hours	43.2	43.8	15.3
Accumulated temperature after 140 hours, °C	1277.9 <sup>a</sup>	1120.8 <sup>b</sup>	8.26
Dry matter losses, g kg <sup>-1</sup>	89.8	96.4	13.3
Maximum CO <sub>2</sub> production, µL CO <sub>2</sub> h <sup>-1</sup> g <sup>-1</sup> DM	50.2	48.7	14.5
Hours to maximum CO <sub>2</sub> production, hours	34.0	31.8	17.3
Accumulated CO <sub>2</sub> prod. after 140 hours, µL CO <sub>2</sub> g <sup>-1</sup> DM	3199.8	3267.8	8.83

Control – no additives; Combo - combination of *Lactobacillus plantarum*, *Lactobacillus brevis* and *Enterococcus faecium* (1x10<sup>5</sup> CFU g<sup>-1</sup>).

A positive correlation coefficient of 0.60 was observed between the number of hours to the peak temperature and the number of hours to the peak of CO<sub>2</sub> ( $P = 0.06$ ). This means that CO<sub>2</sub> production can be a good parameter to estimate aerobic deterioration of silages, as proposed by Ashbell *et al.* (1991). There was also a strong positive correlation ( $r = 0.78$ ) between the number of hours to the peak of CO<sub>2</sub> and the aerobic stability of silages ( $P < 0.01$ ). The correlation between DM losses and accumulated CO<sub>2</sub> production in 140 hours was positive ( $r = 0.52$ ), although not significant ( $P = 0.12$ ).



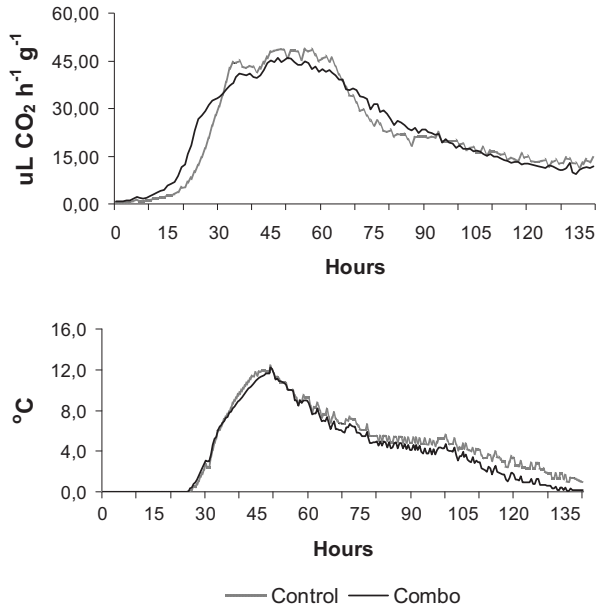

Figure 1. Productions of CO<sub>2</sub> and temperature curves (difference to the room temperature) of aerobic exposed silages by 140 hours of whole plant corn without additives (Control) or with microbial additive (Combo).

## Conclusion

The additive used was not effective in improving corn silage stability, probably due to the predominance of homolactic fermentation. The CO<sub>2</sub> production evaluated by Infrared Gas Analyzer was well correlated to the increase of the silages temperature, being a good indicator of losses under aerobic conditions.

## References

- Ashbell G., Weinberg Z.G., Azrieli A., Hen Y. and Horev B. (1991) A simple system to study the aerobic deterioration of silages. *Canadian Agricultural Engineering* 33, 171-175.
- Kung Jr L., Robinsom J.R., Ranjit N.K., Chen J.H., Golt C.M. and Pesek J.D. (2000) Microbial populations, fermentation end-products and aerobic stability of corn silage treated with ammonia or a propionic acid-based preservative. *Journal of Dairy Science* 83, 1479-1486.
- Nkosi B.D., Meeske R., Palic D., Langa T., Leeuw K.J. and Groenewald L.B. (2009) Effects of ensiling whole crop maize with bacterial inoculants on the fermentation, aerobic stability, and growth performance of lambs. *Animal Feed Science and Technology* 154, 193-203.
- Pahlow G. and Muck R.E. (2009) Managing for improved aerobic stability. In: Broderick G.A., Adesogan A.T., Bocher L.W. (eds.) *The 15<sup>th</sup> International Silage Conference*, University of Wisconsin, Madison, USA, pp. 77-90.

## Hygiene is crucial in controlling the heating of total mixed ration

Seppälä A.<sup>1</sup>, Heikkilä T.<sup>1</sup>, Miettinen H.<sup>2</sup> and Rinne M.<sup>1</sup>

<sup>1</sup>MTT Agrifood Research Finland, FI-31600 Jokioinen, Finland

<sup>2</sup>Kemira Ltd., P.O. Box 330, FI-00101 Helsinki, Finland

Corresponding author: arja.seppala@mtt.fi

### Abstract

A factorial experimental design was used to examine ways to control the heating of total mixed ration (TMR). The studied factors were hygienic quality of raw materials, type of preservative and application rate of preservatives. The two levels of hygienic quality were created by using all fresh raw materials or 10 % inclusion of spoiled raw materials. The examined preservatives were a liquid preservative (propionic acid, ammoniumpropionate and ammoniumformiate) or a solid preservative (sodium-calcium-propionate) and the examined application rates were 0, 2 or 3 g kg<sup>-1</sup>. Aerobic stability of the TMR feeds was measured in laboratory scale. Fresh raw materials lead to a clearly better aerobic stability (66.2 h compared to 9.2 h,  $P < 0.001$ ) of the TMR than the partly spoiled raw materials. The preservatives improved aerobic stability only slightly (3.2 hours,  $P < 0.001$ ). No differences between the liquid and the solid preservative nor between the two levels of application were detected.

Key words: total mixed ration, aerobic stability, preservative, propionic acid

### Introduction

In practice, poor aerobic stability and heating of total mixed ration (TMR) may be a problem particularly during warm weather. Heating hastens the growth rate of spoiling micro-organisms. Hygienic quality of the raw materials of the TMR also plays a crucial role in the heating. The number of spoiling micro-organisms is related to the speed of the spoiling process. Mixing of various substrates and air during the preparation of TMR further increases the problem, because oxygen is a prerequisite for growth of aerobic microbes. Potential negative consequences of the heating of TMR are dry matter (DM) losses, reduced feed intake and thus reduction in milk production (Kung, 2005).

Aerobic stability describes the length of time that silage or TMR remains stable, i.e. no heating due to microbial activity in the feed is noted. Under experimental situations, aerobic stability is usually defined as the time taken to increase the temperature of the feed 2 or 3 degrees above the ambient temperature. Aerobic stability of silages after silo opening has been widely examined. However the aerobic stability of grass silage based TMR has received only limited attention.

To delay the onset of spoiling, preservatives may be added at the time of mixing the TMR. Propionic acid is known to have strong antifungal properties, and has been examined as a preservative of maize silage based TMR (Kung, 2005). The objective of the current experiment was to examine the role of hygienic quality of raw materials and the propionic acid based preservatives on the aerobic stability of a grass silage based TMR.

### Materials and methods

The experimental design was 2×2×3 –factorial. Two batches of TMR were prepared using the same recipe. The first batch (TMR-fresh) was mixed from high quality fresh raw materials. The second batch (TMR-contaminated) was otherwise similar but 10 % of raw materials were replaced by spoiled TMR. The spoiled TMR was made one week earlier with the same recipe

and let to stay in aerobic environment in room temperature. This inclusion of spoiled TMR was made to demonstrate the effect of leftovers to the quality of TMR.

The base ingredient of the TMR feeds was good quality grass silage (630 g kg<sup>-1</sup> on DM basis). The silage was prepared from regrowth of timothy – meadow fescue – red clover sward and it was ensiled prewilted using formic acid as preservative. The silage was restrictively fermented (DM 315 g kg<sup>-1</sup>, pH 4.15, water soluble carbohydrates 93 g kg<sup>-1</sup> DM, lactic acid 52 g kg<sup>-1</sup> DM, ammonium N 49 g kg<sup>-1</sup> N and in vitro D-value 644 g kg<sup>-1</sup> DM). The other ingredient of the TMR was a pelleted concentrate feed comprising barley, oats, molassed sugar beet pulp, rapeseed meal and minerals in proportions of 30:30:11:26:3.

A liquid preservative (propionic acid, ammoniumpropionate and ammoniumformiate) and a solid preservative (sodium-calcium-propionate) were separately added at application levels 0, 2 or 3 g kg<sup>-1</sup> on both the TMR-fresh and TMR-contaminated. All TMR treatments were weighed into 600 g batches in triplicate and placed in 2.5 dm<sup>3</sup> styrox containers. Temperature changes were recorded twice daily. Aerobic stability was defined as the time taken to increase the temperature of the silage for 3.0 °C above the ambient temperature. Dry matter losses during 5.7 days aerobic exposure were measured as weight changes of oven dried (105 °C) material. Statistical analysis was performed using SAS GLM-procedure. The statistical model included the type of TMR, preservative application and the interaction between the type of TMR and preservative application. Contrasts were performed to exam the effect of application (preservative vs. control, liquid vs. solid preservative, application level 2 vs. 3 g kg<sup>-1</sup>).

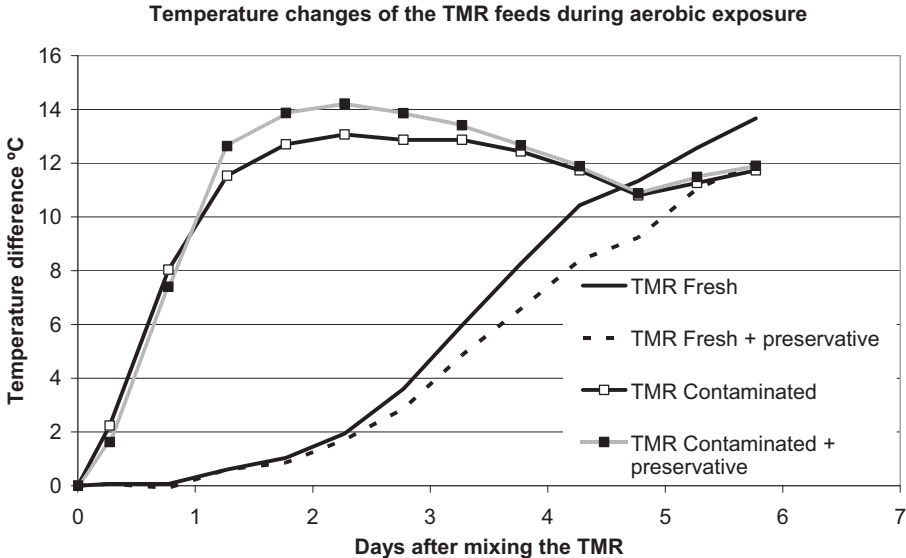

Figure 1. Temperature changes during aerobic exposure of total mixed rations prepared from all fresh ingredients (TMR Fresh) or partly spoiled materials (TMR Contaminated). The TMR feeds were untreated or treated with propionic acid –based preservatives at the time of mixing.

**Results**

The aerobic stability of TMR was clearly reduced by the contamination with spoiled material. Aerobic stability of TMR-contaminated was 9.23 h compared to 66.24 h of TMR-fresh (*P* < 0.001, Figure 1). All the preservative treatments improved aerobic stability slightly (3.2

hours,  $P < 0.001$ ). No differences between the two types of preservatives and the two levels of applications were detected.

The dry matter losses after 5.7 days aerobic exposure were  $112 \text{ g kg}^{-1}$  and  $89.9 \text{ g kg}^{-1}$  ( $P < 0.01$ ) for TMR-contaminated and TMR-fresh, respectively. No correction for volatile compounds was made.

## Discussion

The TMR-fresh stayed stable for 66 hours, which is clearly longer than normally detected under farm conditions. This is at least partly due to the high quality raw materials together with the good hygiene in the mixing procedure. Under farm conditions aerobic stability less than 12 hours for more than half of the farm TMR samples was detected by Kung (2005). This is in accordance with the short aerobic stability of the TMR-contaminated.

In this experiment the preservative applications improved aerobic stability only slightly. The tested application levels were close to those used by others (Kung *et al.*, 1998 and 2000). Under farm conditions higher levels ( $5 \text{ g kg}^{-1}$ ) of application are used to prevent the problems of feed heating. More research is needed to define recommendations of the application level of preservatives when grass silage is the base ingredient of TMR.

Measuring DM losses after 5.7 days aerobic exposure was not most appropriate, because normally the TMR feed has already been used within 24 hours or at least within 48 hours. After such a long aerobic exposure, even the aerobically rather stable feeds had heated so that the practically important differences between the treatments in potential DM losses will not be fully demonstrated. The losses of volatile compounds during aerobic exposure should be taken into account. The heterogeneity of the material and the small changes challenge the sampling procedure and the methodology when measuring DM losses.

## Conclusions

The current results emphasize the importance of high quality raw materials in order to prepare aerobically stable TMR. Contamination due to earlier batches of TMR should be avoided. Preservatives added at the time of TMR mixing improved slightly the aerobic stability of TMR.

## References

- Kung L., Sheperd A.C., Smagala A.M., Endres K.M., Bessett C.A., Ranjit N.K. and Glancey J.L. (1998) The effect of preservatives based on propionic acid on the fermentation and aerobic stability of corn silage and a total mixed ration. *Journal of Dairy Science* 81: 5, 1322-1330.
- Kung L., Robinson J.R., Ranjit N.K., Chen J.H., Golt C.M. and Pesek J.D. (2000) Microbial populations, fermentation end-products, and aerobic stability of corn silage treated with ammonia or a propionic acid-based preservative. *Journal of Dairy Science* 83, 1479-1486.
- Kung L. Jr. (2005) Aerobic Stability of Silages. *Proc. of the Conference on Silage for Dairy Farms*. Harrisburg, PA. 2005 <http://ag.udel.edu/anfs/faculty/kung/documents/05AerobicStability.pdf>

# The effect of climate, clover species and swath management on pre-wilting of a mixture of grass and clover

Søegaard K.

Department of Agroecology and Environment, Aarhus University, P.O. Box 50, DK-8830 Tjele, Denmark

Corresponding author: Karen.Søegaard@agrsci.dk

## Abstract

When ensiling grass it is essential to obtain a specific dry matter content. The climate and swath management have significant effects on the drying rate. Experiments in the field were therefore carried out to quantify these effects with the aim of making a climate-dependent pre-wilting prognosis. Throughout the growing season perennial ryegrass (*Lolium perenne* L.) mixed with either red clover (*Trifolium pratense* L.) or white clover (*Trifolium repens* L.) was harvested with different dry matter yields and different swath management (narrow, broad, and broad combined with inversion three hours after harvesting). The drying rate (increase in dry matter (DM) concentration per hour) was higher in a broad swath than in a narrow, and was higher still in the inverted broad swath. These differences increased with a better drying climate (mainly a higher temperature). Air humidity and radiation also had a significant effect on the drying rate, whereas the wind speed did not. In the narrow swath the drying rate was the same for the two sward types, but in the broad swaths the drying rate was faster in the mixture with white clover than with red clover.

Keywords: drying rate, pre-wilting, swath type, grass, clover, climate

## Introduction

Under Danish conditions a dry matter (DM) content of 450-500 g kg<sup>-1</sup> is recommended for grass ensiled in round bales and 320-370 g kg<sup>-1</sup> for storage in silos. The sward is mostly a mixture of grass and clover, and therefore at harvest crimping is gentle to reduce the loss of clover leaves. Frequently the optimal DM content is not obtained, and that affects the ensiling process. The drying rate is highly affected by both the actual climate and the swath management, and the time of ensiling could be improved if we had better knowledge on these. A study with a mixture of grass and clover sward was carried out in order to quantify these effects.

## Materials and methods

During 2008 and 2009 two sward types were harvested 24 times from mid-May to mid-October at 10 a.m. and the DM content was measured six times until 3 p.m. the next day (10 a.m. and 8 p.m. the first day and 10 p.m. and 3 a.m. the next day). The swards were composed of perennial ryegrass mixed with either white clover or red clover. There were three plots of both swards, which were cut at different dates. The herbage was harvested by a swath-forming mower with gentle crimper. The swath was not pressed. There were three swath managements: 1) Narrow swath covering half of the ground area, 2) Broad swath covering the whole area and 3) Broad swath combined with an inversion three hours after harvesting. At sampling time herbage was collected in four 20-cm bands across each swath. The herbage was dried and DM concentration calculated. Before harvest the sward height was measured by a rising plate meter and an inch rule, and the herbage mass was calculated from a 'sward height-herbage mass' equation developed from earlier experiments for each sward type and

each measuring method. The N-fertilization rate was chosen with the aim of reaching approximately 50% clover as yearly mean. The yearly N application rate was 200 kg ha<sup>-1</sup> in 2008 and 230 kg ha<sup>-1</sup> in 2009. The clover content was visually estimated at harvest and was in the range of 45-60% in 2008 and 40-70% of DM in 2009. The sward was irrigated and was in drought stress. Climate parameters were measured per hour approximately 200 m from the experiment area. Between two harvest times the drying rate (DM increase of g kg<sup>-1</sup> h<sup>-1</sup>) was calculated. The mean climate was also calculated between the exact harvest times, assuming a constant climate in the hour between climate registrations.

## Results and discussion

In general, the broad swath had a faster drying rate than the narrow swath, with the inverted broad swath having the fastest drying rate (Fig. 1). There were no significant differences between mean DM contents at harvest of the white clover and red clover mixtures. The range was 115-263 g kg<sup>-1</sup> DM in red clover/grass and 118-224 g kg<sup>-1</sup> DM in white clover/grass at harvest. The mean estimated DM yield was not significantly different between the two sward types.

In the narrow swath the drying rate was faster in the red clover/grass than in the white clover/grass shortly after the harvest (Fig. 1). This could be due to a less compact structure in the swath caused by the red clover stems. Over the measuring period the two sward types had the same drying rate. The increase in DM concentration was 137 in white clover/grass and in red clover/grass 136 g kg<sup>-1</sup> h<sup>-1</sup>.

The opposite was the case in the broad swath. The white clover/grass had a faster drying rate in the first five hours after lying in swaths (10 am – 3 pm). For the whole period there was a significantly faster drying rate in white clover/grass than in red clover/grass ( $P < 0.05$ ). The mean increase in DM concentration was 274 and 233 g kg<sup>-1</sup>, respectively. In the broad swath the drying conditions were better, as the layer was thinner and had a larger surface. The reason for the slower drying in red clover could be a lower drying rate in red clover stems. The slower drying in red clover meant that only in 9 out of the 24 occasions was the DM optimal for ensiling in silos before 8 pm on the day of harvest, whereas in white clover swards this was the case on 15 occasions.

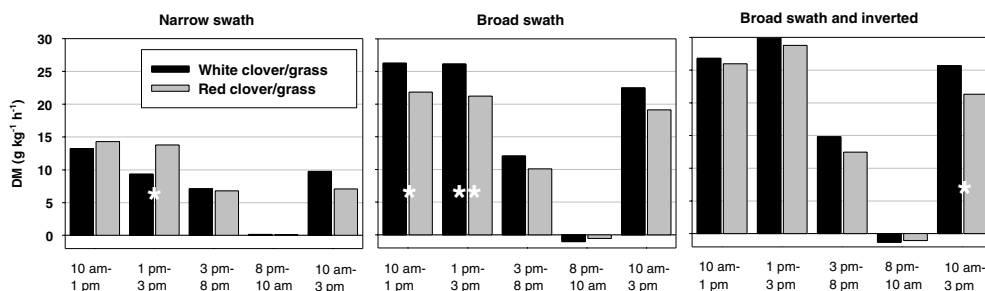

Figure 1. Drying rate of grass/clover from 10 am at harvest to 3 pm the following day. The broad swath was inverted at 1 pm just before sampling. Mean of 24 occasions.

\*  $P < 0.05$  and \*\*  $P < 0.01$

When the swath was inverted three hours after harvest, there was no significant difference between the clover species in the first five hours from 10 am to 3 pm. The inversion thus improved the drying conditions for red clover. However, there was still a significant ( $P < 0.01$ ) difference for the whole period. The increase was 310 for white and 276 g kg<sup>-1</sup> for red clover/grass.

During the night (8 pm – 10 am) there was a slow drying rate in the narrow swath, whereas the DM content decreased in the broad swath (Fig. 1). This could primarily be due to the greater surface in the broad swath that could absorb dew, combined with the fact that the content of DM was higher in the broad swath at the beginning of the night period.

The climate had a considerable effect on the drying rate (Table 1). There were no significant differences between the clover species in terms of climate effect; that is why the parameter estimates in Table 1 include both species. In general, the effect of climate on the drying rate was higher in the broad than in the narrow swath, especially for temperature and global radiation. This means that with better drying weather the differences between narrow and broad swath increased. For example, the mean drying rate in the narrow swath increased from 7 to 15 g kg<sup>-1</sup> h<sup>-1</sup>, when the temperature increased from 10-15 °C to 20-25 °C. The drying rate of the broad swath increased correspondingly from 14 to 32 g kg<sup>-1</sup> hour<sup>-1</sup>. Temperature had the largest effect on drying rate in this experiment. In the literature, temperature (e.g. Lamond and Graham, 1993) and radiation (e.g. Wright *et al.*, 2001) are those usually quoted as the main climate parameters.

Precipitation had a larger effect on the broad swaths ( $P < 0.01$ ), especially during the night when drying conditions were poor. There were 11 nights with rainfall (8 pm – 10 am), and the mean decrease in DM content on those occasions was 1.9 in the narrow, 3.4 in the broad and 3.9 g kg<sup>-1</sup> in the broad and inverted swath.

The wind had no significant effect on the drying rate (Table 1) and we could not confirm the results of Jasinskas (2006), who concluded that wind was the only climate parameter for macerated and pressed red clover swaths.

Table 1. Regression coefficients for drying rate (g kg<sup>-1</sup> h<sup>-1</sup>) in the daytime (10 am – 8 pm) in a model including herbage mass and climate parameters.

	Unit	Narrow swath		Broad swath		Broad and inverted swath		Range of data
			<i>P</i>		<i>P</i>		<i>P</i>	
Intercept		41.6	***	37.3	***	38.1	***	
Herbage DM mass	t ha <sup>-1</sup>	-6.3	***	-8.0	***	-7.8	***	1.4-4.4
Temperature (2 m)	°C	0.70	***	1.16	***	1.29	***	5-26
Relative humidity	%	-0.45	***	-0.40	***	-0.39	***	33-89
Global radiation	MJ m <sup>-2</sup>	0.0016	***	0.025	***	0.028	***	20-817
Wind	m s <sup>-1</sup>	0.6	NS	0.26	NS	-0.06	NS	0-8
Precipitation	mm h <sup>-1</sup>	-3.0	NS	-10.73	*	-15.23	*	0-1
<i>R</i> <sup>2</sup>		0.50		0.61		0.59		

\*\*\*:  $P < 0.001$ ; \*:  $P < 0.05$ ; NS: not significant

## Conclusions

In broad swaths the mixture of red clover and grass had a lower drying rate than the mixture white clover and grass. In narrow swaths the opposite was the case during the first hours after harvest. Temperature, global radiation and air humidity had a large effect on the drying rate, whereas wind had no significant effect.

## References

- Jasinskas A. (2006) The drying dynamics of red clover mats. *Biosystems Engineering* 93, 261-268.
- Lamond W.J. and Graham R. (1993) Relationship between air conditions and the drying rate of thin-layers of grass. *Journal of Agricultural Science, Cambridge* 121, 21-28.
- Wright D.A., Frost J.P., Patterson D.C. and Kilpatrick D.J. (2001) Development of a model to predict drying rates of cut ryegrass. *Journal of Agricultural Engineering Research* 79, 23-35.



## Micro-mineral profile in different grassland species

Søegaard K.<sup>1</sup>, Sehested J.<sup>2</sup> and Jensen S.K.<sup>2</sup>

<sup>1</sup>Department of Agroecology and Environment, <sup>2</sup>Department of Animal Health and Bioscience, Aarhus University, P.O. Box 50, DK-8830 Tjele, Denmark

Corresponding author: Karen.Søegaard@agrsci.dk

### Abstract

The aim was to investigate the micro-mineral profile of herbage as affected by grassland species, cutting time and seasonality and in relation to dairy cow requirements. The different grassland species were grown and harvested in mixtures with one grass and one legume for two growing seasons. The species turned out to have very individual mineral profiles, not influenced by year. Among the legumes red clover (*Trifolium pratense*) had high concentrations of Co, Cu and Zn, white clover (*Trifolium repens*) of Mn and Fe, lucerne (*Medicago sativa*) of Se and lotus (*Lotus corniculatus*) of Co, Mn, Zn and Fe. Among the grasses, perennial ryegrass (*Lolium perenne*) generally had the highest concentrations of all the micro-minerals. Hybrid ryegrass (*Lolium hybridum*) had slightly lower concentrations than perennial ryegrass for all minerals. Meadow fescue (*Festuca pratensis*) had lower concentrations still, and timothy (*Phleum pratense*) had, with the exception of Zn, the lowest concentrations. In general, the mineral concentrations were higher in summer than in spring growth. During the growth Cu, Zn and Fe concentrations decreased, whereas Co, Se and Mg were unaffected. It was concluded that a mixture of red clover and perennial ryegrass had the best profile of micro-minerals for cattle feeding.

Keywords: micro-mineral, grass, legumes, mineral profile, organic production

### Introduction

Inorganic micro-minerals are usually allocated as supplements in dairy cow feeding to avoid deficiency. However, on organic dairy farms self-sufficiency at farm level is a central element in the organic farming principles. One method to increase self-sufficiency of micro-minerals is to choose plant species with different micro-mineral profiles that can complement each other. A range of plant species could thus help to balance the mineral status of the diet. For examining the possibility to affect the mineral profile in the herbage we studied the effect of grassland species, cutting time and seasonality. As the species normally grow in mixtures with grass and legumes and the species affected each other's mineral uptake, we examined the species under mixed growing conditions. This paper focuses on a limited range of micro-minerals in relation to dairy cattle requirements and feeding.

### Materials and methods

Seven different mixtures each composed of one grass and one legume were established in plots in four replicates at Research Centre Foulum (9°34'E, 56°29'N) in 2006. The plots consisted of five subplots, one used for five cuts per year and the others for examining the growth during spring growth and second regrowth by harvesting one week before and one week after the normal cutting time.

There were four grass species, all mixed with white clover: perennial ryegrass, hybrid ryegrass, meadow fescue and timothy. There were further four legumes, all mixed with perennial ryegrass: white clover, red clover, lucerne and lotus (birdsfoot trefoil). Perennial ryegrass and white clover was thus the reference mixture.

The plots were fertilized with 300 kg total N in cattle slurry with the following distribution per cut: 100, 80, 60, 60 and 0 kg N. The plots were irrigated at drought stress.

The dry matter yield and the botanical composition measured by hand separation were determined at each harvest. Mineral composition was measured in the hand-separated species three times during spring growth in May and the second regrowth in August in 2007 and 2008. The mineral composition of white clover and perennial ryegrass was measured in samples of the mixture with these two species. Samples were digested with a mixture of nitric acid and perchloric acid according to the AOAC procedure no. 996.16. The elements were determined using ICP-MS on an X-Series II instrument from Thermo Fischer (Bremen, Germany).

## Results

The species had very different micro-mineral contents and profiles (Table 1). Among the legumes, all grown together with perennial ryegrass, red clover had the highest concentrations of Co, Cu and Zn, whereas white clover had the highest concentrations of Mn and Fe, and lotus had high concentrations of Co, Mn, Zn and Fe. In general, lucerne had low concentrations of both macro-minerals (not shown) and micro-minerals, except for Se. Lotus also had a low concentration of macro-minerals, except for K, which was considerably higher than in the other legumes (data not shown).

Among the grass species, all grown together with white clover, perennial ryegrass had, in general, a high concentration of micro-minerals as well as macro-minerals (not shown). In contrast, timothy had, in general, low concentrations both of macro-minerals (not shown) and micro-minerals, with Cu and Zn as the only exceptions.

Comparing legumes and grasses, the legumes had significantly ( $P < 0.05$ ) higher concentrations of Co, Se and Cu than grasses, and grasses had significantly higher concentrations of Mn than legumes.

Table 1. Annual dry matter (DM) yield of the mixture ( $\text{t ha}^{-1}$ ). Proportion of the species in the two species mixtures (% of DM) and concentration of micro-minerals in DM ( $\text{mg kg}^{-1}$ ) as a mean of samples in spring growth and summer growth. Different letters within variable and group indicate significant differences ( $P < 0.05$ ). Table value for requirement is shown at the bottom of the table.

	DM yield	Proportion	Co	Se	Mn	Cu	Zn	Fe
Mixed with perennial ryegrass								
White clover	12.6 <sup>b</sup>	37.2 <sup>c</sup>	0.048 <sup>b</sup>	0.019 <sup>c</sup>	51.4 <sup>a</sup>	6.7 <sup>b</sup>	17.9 <sup>b</sup>	89.4 <sup>a</sup>
Red clover	15.6 <sup>a</sup>	78.8 <sup>a</sup>	0.057 <sup>a</sup>	0.025 <sup>b</sup>	42.9 <sup>b</sup>	8.7 <sup>a</sup>	22.2 <sup>a</sup>	61.3 <sup>b</sup>
Lucerne	13.4 <sup>b</sup>	66.3 <sup>b</sup>	0.041 <sup>c</sup>	0.033 <sup>a</sup>	38.0 <sup>c</sup>	6.5 <sup>b</sup>	18.6 <sup>b</sup>	63.4 <sup>b</sup>
Lotus	9.6 <sup>c</sup>	18.8 <sup>d</sup>	0.054 <sup>a</sup>	0.022 <sup>bc</sup>	47.8 <sup>a</sup>	6.2 <sup>b</sup>	22.4 <sup>a</sup>	81.7 <sup>a</sup>
Mixed with white clover								
Per. ryegrass	12.6 <sup>b</sup>	62.8 <sup>b</sup>	0.031 <sup>a</sup>	0.019 <sup>a</sup>	68.1 <sup>a</sup>	6.7 <sup>a</sup>	22.6 <sup>a</sup>	96.1 <sup>a</sup>
Hybrid ryegrass	13.1 <sup>ab</sup>	72.9 <sup>a</sup>	0.023 <sup>b</sup>	0.018 <sup>ab</sup>	56.8 <sup>b</sup>	6.2 <sup>ab</sup>	20.4 <sup>b</sup>	78.0 <sup>b</sup>
Meadow fescue	13.3 <sup>a</sup>	72.4 <sup>a</sup>	0.023 <sup>b</sup>	0.016 <sup>bc</sup>	56.9 <sup>b</sup>	5.1 <sup>c</sup>	15.5 <sup>c</sup>	75.5 <sup>b</sup>
Timothy	11.8 <sup>c</sup>	63.1 <sup>b</sup>	0.016 <sup>c</sup>	0.014 <sup>c</sup>	46.1 <sup>c</sup>	5.9 <sup>b</sup>	24.3 <sup>a</sup>	72.6 <sup>b</sup>
Dairy cow requirement (NRC, 2001)								
Dietary content	-	-	0.11	0.3	14	11	48	15

During the three-week period in spring and summer growth, the concentrations of Co, Se and Mn were constant for both legumes and grasses, even when herbage dry matter increased significantly (Table 2). The Cu, Zn and Fe concentration, on the other hand, decreased over time. Harvesting at an earlier development stage would thus increase the relative contents of these three minerals.

The concentrations of the micro-minerals were higher ( $P < 0.05$ ) in summer than in spring growth (Table 2); also when comparing at the same herbage mass.

Table 2. Concentration of micro-minerals in DM ( $\text{mg kg}^{-1}$ ) as a mean of species, and herbage DM mass ( $\text{t ha}^{-1}$ ) as a mean of mixtures during a three-week period. Different letters within variable and period indicate significant differences ( $P < 0.05$ ).

		Co	Se	Mn	Cu	Zn	Fe	DM-yield
May	One week before	0.030	0.019	48.7	5.73 <sup>a</sup>	20.7 <sup>a</sup>	73.2 <sup>a</sup>	2.5 <sup>c</sup>
	Cut	0.030	0.018	50.1	5.23 <sup>b</sup>	19.0 <sup>b</sup>	64.0 <sup>b</sup>	3.3 <sup>b</sup>
	One week after	0.030	0.018	48.7	4.60 <sup>c</sup>	17.5 <sup>c</sup>	56.9 <sup>c</sup>	4.4 <sup>a</sup>
August	One week before	0.045	0.023	53.0	8.11 <sup>a</sup>	22.9 <sup>a</sup>	95.5	2.5 <sup>c</sup>
	Cut	0.044	0.022	52.7	7.82 <sup>ab</sup>	22.2 <sup>a</sup>	89.6	2.9 <sup>b</sup>
	One week after	0.040	0.022	52.3	7.49 <sup>b</sup>	20.7 <sup>b</sup>	84.4	3.5 <sup>a</sup>

## Discussion and conclusion

In this experiment there were significant differences in mineral content and profile between grassland species. This indicates a potential for optimizing dairy cow micro-mineral intake from home-grown herbage by manipulating grassland species composition. For example, the highest Co concentration of  $0.051 \text{ mg kg}^{-1}$  in DM was found in the red clover/perennial ryegrass mixture and the lowest of  $0.023$  in lotus/timothy. The species composition could thus contribute significantly to the Co content in the herbage. The concentration of Cu ranged from 5.7 to 8.3, Zn from 16.1 to 23.9 and Se from  $0.016$  to  $0.028 \text{ mg kg}^{-1}$  in DM between the different mixtures. The calculations are given as the mean of year and taking the proportion of the species (Table 1) into account. Despite species differences, the micro-mineral contents were generally above dairy cow requirements according to the NRC (2001) (Table 1) for Mn and Fe, close to requirement for Cu and Zn, and below requirements for Co and Se. However, there are indications that commercial organic micro-minerals might have a significantly higher bioavailability in dairy cows than inorganic micro-minerals, and that supplementation can be reduced by 25% when using organic minerals (Spears, 1996; Nocek *et al.*, 2006). Overall, the red clover/perennial ryegrass mixture had the highest concentrations of Co, Cu, Zn and Se and at the same time low concentrations of Mn and Fe. This mixture is therefore concluded to have the best micro-mineral profile in this experiment in relation to the recommended profile and level for dairy cow feeding.

## References

- Nocek J.E., Socha M.T. and Tomlinson D. J. (2006) The effect of trace mineral fortification level and source on performance of dairy cattle. *Journal of Dairy Science* 89, 2679-2693.
- NRC. (2001) *Nutrient Requirements of Dairy Cattle*. The National Research Council. Seventh Revised ed. National Academy Press.
- Spears J.W. (1996) Organic trace minerals in ruminant nutrition. *Animal Feed Science and Technology* 58, 151-163.

# Yields of forage crops in Schleswig-Holstein 1985-2008 under farm-scale and trial conditions

Thaysen J.<sup>1</sup>, Dreyer H.<sup>2</sup>, Sierts H.-P.<sup>1</sup> and Thomsen J.<sup>1</sup>

<sup>1</sup> Chamber of Agriculture Schleswig Holstein, Department of Crop Production/Crop Protection/Agricultural Engineering, D-24768 Rendsburg, Germany

<sup>2</sup> University of Giessen, Germany

Corresponding author: jthaysen@lksh.de

## Abstract

The objective of this study was to analyse the impact of climatic conditions on the development of energy yield of maize and grass silage under farm conditions. Additionally, data on silage maize yield obtained from field trials were included. Maize NEL energy yield increased by about 1000 MJ ha<sup>-1</sup> y<sup>-1</sup> to a current level of 70-75 GJ ha<sup>-1</sup>. Correspondingly, energy yield of grass silage increased by 450 MJ ha<sup>-1</sup> annually to a level of 50-55 GJ ha<sup>-1</sup>. With regard to maize, this improvement can be attributed to an increase in dry matter (DM) yield and energy concentration. Grass, in contrast, only revealed a rise in energy concentration. A clear relationship was detected between the increase in temperature, amounting to 0.08 °C y<sup>-1</sup> over the period of April to September, and the improvement in energy yield. An increase in temperature by one degree Celsius resulted in an increase in energy yield by 5930 MJ ha<sup>-1</sup> for maize and by 3217 MJ ha<sup>-1</sup> for grass, respectively.

Keywords: Dry matter yield, energy yield, grass silage, maize silage, climatic conditions

## Introduction

Forage production in the federal state of Schleswig-Holstein, Northern Germany, is dominated by the production of maize and grass silage. A considerable improvement of energy yield has been observed over the last decades, which can be attributed to (i) breeding progress, (ii) improved crop management, and (iii) climate change. The objective of the present study therefore was to quantify the increase in maize and grass energy yield recorded under farm and trial conditions over several decades and to relate it to changes in climatic conditions.

## Materials and methods

The study was based on two data sets. The first one included data on dry matter (DM) and energy yield of maize and grass silages collected under farm conditions during the 1985-2008 period, which were published annually in the 'Results of cost analysis of dairy cattle farms in Schleswig-Holstein (Rinderreport)'. Dry matter yield was estimated on the basis of silo volume and acreage grown with maize and grass, and multiplied by the energy concentration in order to determine energy yield. The second data set comprised multi-site, multi-hybrid silage maize DM yield data from field trials conducted during the 1966 to 2009 period.

By means of regression analysis, the impact of climatic conditions (temperature, duration of sunshine, precipitation and irradiation) on the development of DM and energy yield data was estimated. Weather data were kindly provided by the German Weather Service (DWD).

## Results and discussion

The federal state of Schleswig-Holstein comprises an agriculturally used area of about one million hectares. The permanent grassland area amounted to 480,000 ha until 1991, and has

decreased annually by 10000 ha since then. In 2008, around 317000 ha (31.8; -9.2% compared to the year before) were still used as permanent grassland. In contrast to permanent grassland, silage maize has become much more interesting as feedstock during the last decades due to progress in yield stability and yield performance. Consequently, maize acreage has substantially expanded from 2000 ha in 1966 to 131,000 ha in 2008 (13.3%; + 5.9%).

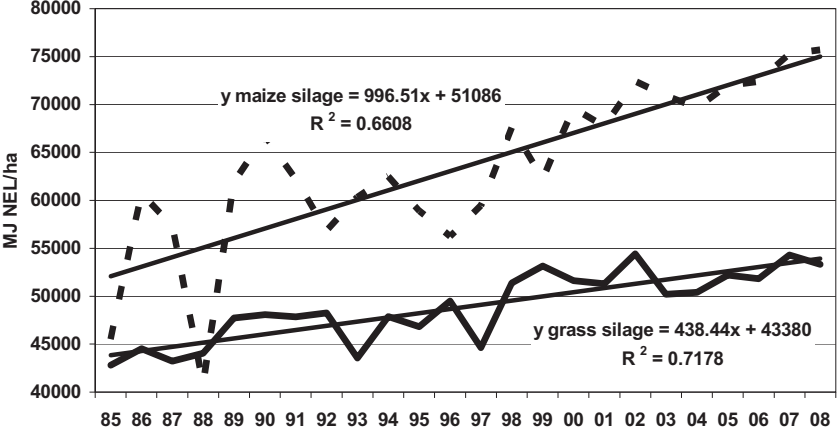

Figure 1. Energy yield development of grass and maize silage under farm conditions in Schleswig-Holstein during the 1985-2008 period.

Progress achieved by breeding and crop management, together with climate change, caused a considerable annual increase in maize silage DM yield of  $0.125 \text{ t ha}^{-1} \text{ yr}^{-1}$ , while the increase in grass DM silage yield was substantially lower ( $0.013 \text{ t ha}^{-1} \text{ yr}^{-1}$ ). Corresponding yield progress estimation, based on the field trial data, showed an even higher value of  $0.19 \text{ t ha}^{-1} \text{ yr}^{-1}$ . The improvement in yielding performance was accompanied by an increase in NEL concentration of about  $0.02 \text{ MJ kg}^{-1}$ , which led to an annual progress in NEL yield of about  $1000 \text{ MJ ha}^{-1} \text{ yr}^{-1}$  (Fig. 1). At present, an average energy yield of  $70\text{-}75 \text{ GJ ha}^{-1}$  can be achieved at the farm level. Field trial data revealed an even higher progress in NEL yield of  $1500 \text{ MJ ha}^{-1} \text{ yr}^{-1}$  (Fig. 2).

The improvement in grass silage NEL concentration was two-fold higher ( $0.04 \text{ MJ kg}^{-1}$ ) compared to maize silage, resulting in an annual progress in NEL yield of  $450 \text{ MJ ha}^{-1}$ . Currently, NEL yield obtained from permanent grassland ranges between  $50$  and  $55 \text{ GJ ha}^{-1}$ . While the energy yield improvement of silage maize is caused by progress in DM yield as well as in energy concentration, the increase in grassland energy yield is mainly due to enhanced energy concentration. This can be explained by changes in management practices (earlier cutting dates) and the improvement in production technology.

Temperature is the primary yield-limiting factor for silage maize cultivation in Northern Germany. Commonly, the temperature sum approach is applied to characterise the temperature requirement of different hybrids. Early ripening hybrids have a lower temperature demand and thus can be grown in regions with lower average temperature. However, these hybrids usually achieve lower yield compared to later-ripening hybrids (Messner, 1999), since a negative relationship exists between maturation behaviour and yield potential (Wang, 2001).

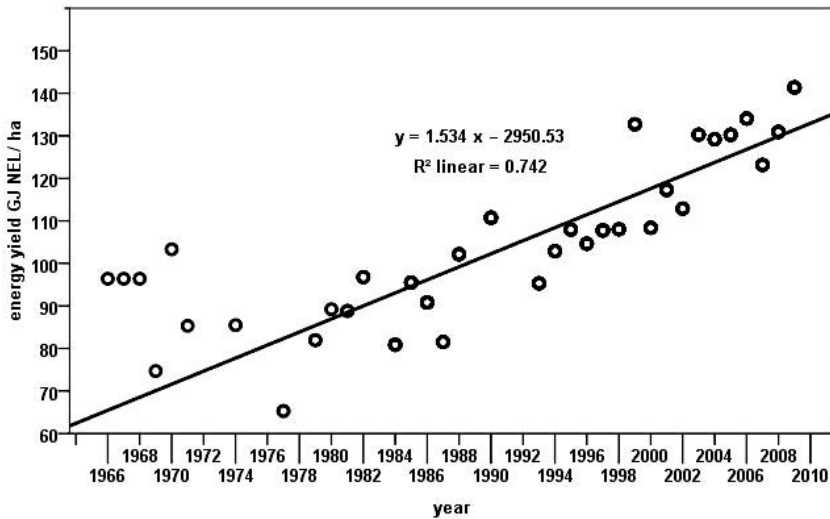

Figure 2. Development of energy yield of maize under trial conditions in Schleswig-Holstein during the 1966-2009 period.

Annual average temperature in Schleswig-Holstein has risen by 0.068 °C since 1985 ( $R^2 = 0.29$ ). During the vegetation period, i.e. April to October, the temperature increase was slightly higher (0.08 °C). Correspondingly, temperature sum (base temperature: 8.9 °C) increased by 12 units annually. When relating the average temperature to the energy yield data, we found that maize and grass NEL yield rose by 5900 MJ ha<sup>-1</sup> and 3200 MJ ha<sup>-1</sup>, respectively, with each increase in average temperature (vegetation period) by one degree Celsius. For the documented annual temperature increase of 0.08 °C this means an annual rise of NEL yield by about 475 MJ ha<sup>-1</sup> for maize and of 260 MJ ha<sup>-1</sup> for permanent grassland. When applying the temperature sum approach, we found a one unit higher temperature sum to cause a rise in NEL yield of 31 MJ ha<sup>-1</sup> for maize and of 16 MJ ha<sup>-1</sup> for grassland. If we assume that temperature sum (20 April to 15 October) increases by 12.4 units annually, this would cause an improvement of NEL yield by 385 MJ ha<sup>-1</sup> for maize and of 200 MJ ha<sup>-1</sup> for grassland.

## Conclusions

Improvements of energy yield have been documented for silage maize and permanent grassland over the last decades. For maize, this development was due to gains in DM yield and energy concentration, while for grassland progress was due to improved energy concentration caused by better production technology and earlier cutting dates. With growth rates of energy yield being substantially higher for maize, the divide between maize and grassland energy yield will become even larger in future. Thus, grass breeders are challenged to improve grassland yields. Climate change has contributed considerably to the development of energy yield, where temperature increase explained approximately half of the progress achieved in energy yield of maize and grassland.

## References

- Messner H. (1999) Helfen Wärmesummen bei der Sortenwahl? *Mais* 27 (4), 142-143.  
 Wang S.-H. (2001) *Einfluss von Blattstellung und Bestandesdichte auf Ertrag und Qualität*, PhD thesis, Humboldt-University Berlin.

# Does tiller type distribution explain the differences in yield and nutritive value of timothy genotypes?

Virkajarvi P.<sup>1</sup>, Pakarinen K.<sup>1</sup>, Hyrkäs M.<sup>1</sup>, Savolainen J.<sup>1</sup> and Isoolahti M.<sup>2</sup>

<sup>1</sup>MTT Agrifood Research Finland

<sup>2</sup>Boreal Plant Breeding Ltd

Corresponding author: perttu.virkajarvi@mtt.fi

## Abstract

The basic difficulty in grass breeding for silage is the negative correlation between the amount of herbage mass produced and its nutritive value. The yield of timothy (*Phleum pratense* L.) is composed of three different tiller types (vegetative, vegetative elongated, and generative) that differ in respect of growth process and nutritive value. The aim of the study was to find out if the distribution of these tiller types affects the differences in yield formation and nutritive value of timothy genotypes. The field experiment included 15 different genotypes that were planted at MTT Maaninka, Finland, and the yield and nutritive value was determined in the first and the second cut in 2008 and 2009. The effects of tiller type distribution on the yield formation and the nutritive value of genotypes are presented and the importance of tiller types is discussed.

Keywords: breeding, crop physiology, nutritive value, tillering, timothy (*Phleum pratense* L.)

## Introduction

Improving our understanding of the processes behind yield formation would increase our chances of achieving simultaneously high yield and nutritive value. The yield of timothy, the most important grass species in Scandinavia, is composed of three different tiller types. In addition to vegetative (VEG) and generative (GEN) tillers, timothy has also vegetative elongated tillers (ELONG; Höglind *et al.*, 2005). In ELONG, a true stem is formed and the apex is elevated from the soil surface, being either in a vegetative stage or an aborted generative stage. Pakarinen *et al.* (2008) reported that these three tiller types differ in growth processes and nutritive value, at least in cv. Tammisto II. The differences between the tiller types were significant to both the contribution to the yield and to the content of digestible organic matter in dry matter (D value). Whether this applies generally to timothy is unknown. In this study, the objectives were: i) to determine the abundance of different tiller types in the first and the second cut of different genotypes of timothy, and ii) to test whether the distribution of tiller types explains the yield and D value of different genotypes.

## Materials and methods

The experiment was conducted at MTT Maaninka, Finland (68°10'N, 27°18'E) during the growing seasons 2008 and 2009. The experimental field was established in 2007 in three replicates by growing the material in pots and by planting to plots (100 cm x 25 cm; two seeding rows), surrounded by a nurse crop (timothy). The experiment included 13 different timothy genotype clones (Boreal Plant Breeding Ltd) and two commercial cultivars, 'Iki' and 'Grindstad', as controls. The genotype clones were classified into three groups by their digestibility in the first cut (good, average and weak) in a previous experiment. In 2008 and 2009, the experimental field was fertilized for both cuts with 100 kg N ha<sup>-1</sup>. The first cut was harvested by hand (stubble height 3 cm) when the D value was estimated to be 680-700 g kg<sup>-1</sup> DM. The second cut was cut 7-8 weeks later. From each plot, a total yield sample was taken



as well as a subsample which was fractionated into three tiller types (VEG, ELONG and GEN), loose senesced and loose living material and weeds. The VEG, ELONG and GEN fractions were then divided into living leaf blades, stems, inflorescence, and attached senesced tissue. All total yield and fraction samples were dried at 60 °C for 40 h and the dry matter (DM) weights determined. The nutritive value (e.g. D value, organic matter digestibility, NDF, indigestible NDF, lignin) was analysed by the NIR technique. The differences between genotypes were analysed using ANOVA, for each cut and year separately. The amount of weeds was used as a covariate, when needed. The relationship between the yield and D value and the sward characteristics was analysed using correlation analysis.

## Results and discussion

Genotypes significantly differed for most of the variables measured (Table 1). In the first cut of 2008, however, no significant differences were observed for DM and FU yields, and for the distribution of tiller types; this might be explained by the fact that the establishment phase of the sward was not fully completed.

Table 1. Statistical significance (P values) of the effect of timothy genotypes on DM yield, leaf to weight ratio (LWR), proportion of tiller types, organic matter digestibility (OMD), D value, and feed unit (FU) yield in the first and the second cut in 2008 and 2009.

	DM yield	LWR	VEG(%)	ELONG(%)	GEN(%)	OMD	D value	FU yield
Cut 1 2008	0.19	0.009	0.70	0.47	0.55	<0.001	0.001	0.23
Cut 1 2009	<0.001	<0.001	0.31	0.005	0.007	<0.001	<0.001	<0.001
Cut 2 2008	0.21 <sup>a</sup>	<0.001	<0.001	0.030 <sup>a</sup>	0.007 <sup>a</sup>	0.001	0.028	0.38 <sup>a</sup>
Cut 2 2009	<0.001 <sup>a</sup>	<0.001	<0.001 <sup>a</sup>	0.004 <sup>a</sup>	0.001 <sup>b</sup>	0.008	0.036 <sup>a</sup>	<0.001 <sup>a</sup>
Total annual yield 2008	0.39 <sup>a</sup>	-	-	-	-	-	-	0.54 <sup>a</sup>
Total annual yield 2009	<0.001 <sup>a</sup>	-	-	-	-	-	-	<0.001 <sup>a</sup>

<sup>a</sup> Proportion of weeds as a covariate. <sup>b</sup> Square root transformation.

Because the genotypes were initially grouped by their observed D value and yield in the first cut from a previous experiment, it was not surprising to see that in the first cut the groups were still obvious (Fig. 1). In the second cut, however, the groups could not be distinguished (Fig. 1b), meaning that selecting genotypes for a high D value in the first cut does not guarantee a high D value in second cut. In the first cut, there are more genotypes that are positive outliers from the negative yield – D value trend line than in second cut. ‘Grindstad’ was by far the highest yielding genotype in second cut, but this was associated with a low D value and a high proportion of GEN tillers and, consequently, low LWR. If ‘Grindstad’ were excluded from the data, there would hardly be any correlation between the HM yield and D value in the second cut.

The proportion of VEG tillers was very low in first cut (0.2-2.6 %), but was much higher (4.5-73.7 %) in the second cut. The GEN tillers were the most common tiller type in first cut (69.1-92.0 %), but ELONG tillers were more abundant in the second cut (ELONG 16.3-82.2 % ; GEN 0.0-45.5 %). The differences between genotypes in HM and D value could be partly attributed to the tiller type distribution (Table 2). As expected, the importance of stem formation for HM production was seen in a positive correlation of GEN tillers and a negative correlation of LWR in both cuts and both years. The proportion of ELONG tillers correlated negatively with HM in the first cut but not in the second cut. On the other hand, VEG tillers correlated positively with the D value in second cut as expected. The proportion of ELONG tillers did not correlate with the D value in the first cut, but had a negative correlation in the second cut. Surprisingly, the proportion of GEN tillers did not correlate with the D value and LWR correlated positively with the D value only in 2008. In this dataset, ELONG tillers were not as favourable for HM production or D value as had previously been reported by Pakarinen

et al. (2008). However, their proportion was much higher than the proportion of VEG tillers, which means that ELONG tillers play an important part in the yield formation of timothy.

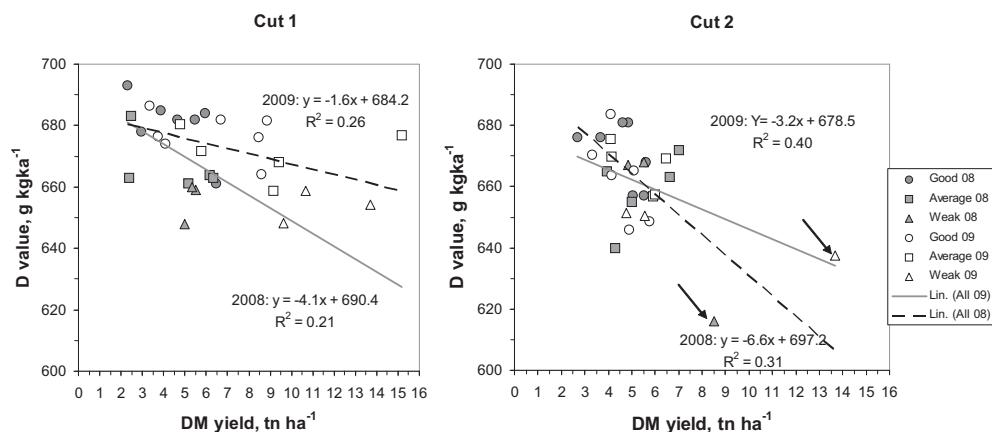

Figure 1. Relationship between DM yield and D value in the first and the second cut in 2008 and 2009. Genotypes were classified into three groups by digestibility in a previous experiment (good, average and weak). Arrows indicate cv. Grindstad in the second cut which has alone a strong effect on the correlation observed.

Table 2. Correlation coefficients for the proportion of different tiller types and LWR with DM yield and D value in the first and the second cut in 2008 and 2009.

	2008		Cut 2		2009		Cut 2	
	Cut 1 DM yield	D value	DM yield	D value	Cut 1 DM yield	D value	DM yield	D value
VEG	NS	NS	-0.43	0.56	NS	NS	NS	0.44
ELONG	-0.52	NS	NS	-0.37	-0.34	NS	NS	-0.34
GEN	0.53	NS	0.39	NS	0.33	NS	0.38	NS
LWR	-0.51	0.32	-0.50	0.54	-0.41	NS	-0.41	NS

## Conclusions

Timothy genotypes significantly differ in their tiller type distribution. The tiller type distribution explained partly the differences in herbage mass production and D value of timothy genotypes. Nevertheless, true stem formation in contrast to leaf formation was an essential process in the high herbage mass production

## Acknowledgements

The financial support of the Ministry of Agriculture and Forestry and the A. & A.J. Tiura Agricultural Research Foundation are greatly acknowledged.

## References

- Höglind M., Hanslin H. M. and van Oijen M. (2005) Timothy regrowth, tillering and leaf area dynamics following spring harvest at two growth stages. *Field Crops Research* 93, 51-63.
- Pakarinen K., Virkajärvi P., Seppänen M., Rinne M. (2008) Effect of different tiller types on the accumulation and digestibility of the herbage mass of timothy (*Phleum pratense* L.). *Grassland Science in Europe* 13, 495-497.

# Fermentation quality and dry matter losses of grass-legume silage treated with lactic acid bacteria mixture

Vrotniakiene V. and Jatkauskas J.

*Department of Animal Nutrition and Feeds, Institute of Animal Science of LVA, Baisogala, Lithuania*

Corresponding author: pts@lgi.lt

## Abstract

The effect of adding the inoculant blend of *Enterococcus faecium* (BIO 34, DSM 3530), *Lactobacillus brevis* (IFA 92, DSM 19456) and *Lactobacillus plantarum* (IFA 96, DSM 19457), to medium-wilted legume-grass silage was evaluated. Two silages were prepared from a grass-legume sward treated with either inoculant or no additive (control). Herbage was wilted to a dry matter (DM) content of 320 g kg<sup>-1</sup> and mean crude protein and water soluble carbohydrate concentrations in DM at ensiling were 174 and 88 g kg<sup>-1</sup> respectively. Treatment resulted in significantly higher crude protein in DM (149.4 vs. 159 g kg<sup>-1</sup>;  $P < 0.05$ ) and digestible protein (108.9 vs. 117.8 g kg<sup>-1</sup>;  $P < 0.01$ ) concentrations. Inoculant treatment increased fermentation rate, resulting in a significant ( $P < 0.05$ ) pH drop and in a significant ( $P < 0.05$ ) increase of total fermentation acids concentration compared with the control. The inoculant produced higher ( $P < 0.01$ ) lactic acid content and numerically higher acetic acid content compared with that of the control. Butyric acid and ammonia N concentrations were significantly ( $P < 0.01$ ) decreased by application of inoculant blend. DM loss values were significantly ( $P < 0.01$ ) lower for treated grass-legume silages.

Keywords: legume-grass silage, inoculant, fermentation, DM loss

## Introduction

The key factor influencing the feeding value of silages for dairy cattle include the crop characteristics, stage of development of the crop at ensiling, and the extent and type of fermentation achieved within the silo. Silage additives have elicited much interest through the years. It is widely accepted that silage additives can increase animal intake and animal performance through their effect on silage quality (Merry *et al.*, 2000). Opportunities for promoting grassland utilisation are related to the positive health characteristics it gives to animal products. Obtaining good fermentation quality, digestibility of nutrients and high energy and protein value in silages, requires the regulation of the ensilage process, particularly for herbage with the higher values of buffering capacity (McDonald *et al.*, 1991). The advantages of the use of biological inoculants, recently obtained bacterial additives, thanks to the suitable selection of lactic acid bacteria, have been stressed by many workers, and it is clear from the results that inoculants have a beneficial effect on the improvement of the fermentation quality of silages (Muck and Kung, 1997; Wrobel *et al.*, 2004). The current study was designed to examine the effect of a silage additive based on a bacteria strain mix (*Enterococcus faecium* BIO 34 (DSM 3530), *Lactobacillus brevis* IFA 92 (DSM 19456) and *Lactobacillus plantarum* IFA 96 (DSM 19457)) on the fermentation parameters and aerobic stability of grass-legume silage.

## Materials and methods

In the experiment, mown herbage of a mixed grass-legume sward (35% *Lolium perenne*, 15% *Phleum pratense*, 45% *Trifolium pratense* and 5% others) was wilted to 320 g kg<sup>-1</sup> dry matter (DM) and ensiled. The experiment was conducted according to the DLG Guidelines for the testing of silage additives and to the Guidelines on the assessment of safety and efficacy of silage additives, on a request from the Commission under Article 7(5) of Regulation (EC) No 1831/2003 (EFSA-Q-2004-088), adopted on 20 April 2006. The sward was cut with a mower conditioner and was picked up with a precision chop forage harvester (chop length ≈ 30 mm) after a 6-8 hour wilt. Herbage was either untreated (C-control) or treated (I) with bacteria blend inoculant (*Enterococcus faecium* BIO 34 (DSM 3530), *Lactobacillus brevis* IFA 92 (DSM 19456) and *Lactobacillus plantarum* IFA 96 (DSM 19457), (BioStabil Plus, BIOMIN GmbH, Austria). The inoculant was dissolved in water according inoculant usage recommendation (4 g /tonne of green forage) and was applied at rate of 4 litre solution per tonne grass to give 2 x 10<sup>5</sup> colony forming units per gram of forage. Additive was applied using a commercial pump (HP-20) installed on the harvester and equipped with nozzles placed between the pick-up reel and cutting rollers. Treatments were applied in order of control and inoculant. After weighing, grass was transferred to one of two ferro-concrete trenches (100-t capacity each). Five control bags (made from four layers cheesecloth) filled with 1 kg of ensiling mass were put in each silo to determine DM loss. Samples of ensiled material were collected from control bags (5 from each treatment). The data were analysed by one-way ANOVA, and a mean comparison by Fisher's PLSD.

Table 1. Chemical composition and buffering capacity of herbage at ensiling

Parameters	N <sup>a</sup>	Herbage	SEM <sup>b</sup>
Dry matter, g kg <sup>-1</sup>	5	320.2	1.407
Crude protein in DM, g kg <sup>-1</sup>	5	174.3	1.546
WSC <sup>c</sup> in DM, g kg <sup>-1</sup>	5	88.34	3.884
Buffering capacity in DM, meq (100 g) <sup>-1</sup>	5	39.8	0.651
Nitrate in DM, g kg <sup>-1</sup>	5	0.405	0.058

<sup>a</sup>Number of observations; <sup>b</sup>Standard error of the mean; <sup>c</sup>Water soluble carbohydrates

## Results and discussion

The chemical composition of herbage before ensiling is presented in Table 1. The grass-legume sward was characterized as of moderate quality for ensiling, because the water soluble carbohydrate to buffering capacity ratio (WSC/BC) was 1:2.22. Fermentation coefficient (FC) (calculated using the formula: FC = DM + 8 WSC/BC) was 49. There were no significant differences between untreated and treated silages in terms of dry matter, crude fibre, acid detergent fibre (ADF) and neutral detergent fibre (NDF) content. However, treatment with inoculant resulted in significantly higher crude protein (149.4 vs. 159 g kg<sup>-1</sup> DM; *P* < 0.05) and digestible protein (108.9 vs. 117.8 g kg<sup>-1</sup> DM; *P* < 0.01) concentrations. The results are shown in Table 2.

Bacteria strains *E. faecium* BIO 34 (DSM 3530), *L. brevis* IFA 92 (DSM 19456) and *L. plantarum* IFA 96 (DSM 19457) treatment increased fermentation rate, resulting in a significant (*P* < 0.05) pH drop and in a significant (*P* < 0.05) increase of total fermentation acids concentration compared with the control. In four experiments carried out in the Netherlands (Driehuis *et al.*, 1997) inoculant-treated silages showed significantly lower pH and significantly higher lactic acid concentration than control silages. The inoculant produced higher (*P* < 0.01) lactic acid content and numerically higher acetic acid content compared with that of the control. Marginal differences were detected in the lactate:acetate ratios (1.3 vs. 1.4) among the treatments. Butyric acid and ammonia N concentrations were significantly

( $P < 0.01$ ) decreased by application of inoculant. DM loss values were significantly ( $P < 0.01$ ) lower for the treatment I grass-legume silages, as a consequence of better fermentation (Table 2).

Table 2. Chemical composition and fermentation parameters of ensiled grass-legume silage

Measured parameters	Untreated control (C)	Treatment I	SE <sup>a</sup>	Sig. <sup>b</sup>
Dry matter, DM, g kg <sup>-1</sup>	315.4	319.2	1.072	0.079
Crude protein in DM, g kg <sup>-1</sup>	149.4	159.0	1.732	*
Crude fibre in DM, g kg <sup>-1</sup>	284.4	276.5	2.049	0.053
WSC in DM, g kg <sup>-1</sup>	9.4	10.7	0.433	0.139
NDF <sup>c</sup> in DM, g kg <sup>-1</sup>	456.3	455.6	6.548	0.955
ADF <sup>d</sup> in DM, g kg <sup>-1</sup>	331.9	326.2	5.833	0.635
Total organic acids in DM, g kg <sup>-1</sup>	67.16	76.62	1.970	*
Lactic acid in DM, g kg <sup>-1</sup>	36.74	44.15	1.419	**
Acetic acid in DM, g kg <sup>-1</sup>	28.23	32.17	1.021	0.051
Butyric acid, g kg <sup>-1</sup>	2.15	0.23	0.362	**
Ethanol, g kg <sup>-1</sup>	7.87	7.06	0.217	0.059
Ammonia N in total N, g kg <sup>-1</sup>	57.5	46.0	1.746	**
pH	4.38	4.25	0.023	*
DM losses in DM, g kg <sup>-1</sup>	106.2	88.3	3.565	**

<sup>a</sup>Standard Error of a treatment; <sup>b</sup>statistically significant difference vs. control \* $P < 0.05$  and \*\*  $P < 0.01$  respectively; <sup>c</sup>neutral detergent fibre; <sup>d</sup>acid detergent fibre

## Conclusions

Microbial inoculant based on a bacteria strain mix (*Enterococcus faecium* BIO 34 (DSM 3530), *Lactobacillus brevis* IFA 92 (DSM 19456) and *Lactobacillus plantarum* IFA 96 (DSM 19457)) had a significant effect on legume-grass silage quality characteristics in terms of lower pH and shifting fermentation slightly toward lactic acid with homofermentative lactic acid bacteria (LAB). The heterofermentative LAB *Lactobacillus brevis* added in microbial mix had a marginal effect on acetic acid production and the lactate:acetate ratios. Inoculant treatment significantly decreased butyric acid content, ammonia-N fraction and dry matter loss. As a consequence of better fermentation, inoculated silage had a higher digestible energy (DE) and a higher net energy lactation (NEL) concentration, when compared to untreated silage.

## References

- Driehuis F., Wikselaar van P.G., Vuuren van A.M. and Spoelstra S.F. (1997) Effect of a bacterial inoculant on rate of fermentation and chemical composition of high dry matter grass silage. *Journal of Agricultural Science Cambridge* 128, 323–329.
- Merry R.J., Jones R. and Theodorou M.K. (2000) *The conservation of grass*, Oxford, UK, pp. 196-228.
- McDonald P., Henderson N. and Heron S. (1991) *The biochemistry of silage*, 2nd ed. Chalcombe Publ., Marlow, UK.
- Muck R.E. and Kung L. Jr. (1997) *Effects of silage additives on ensiling*. Proc. Silage: Field to Feedbunk. NRAES-99. Ithaca, NY, pp. 187-199.
- Wrobel B. and Zastawny J. (2004) The nutritive value and aerobic stability of big bale silage treated with bacterial inoculants. *Grassland Science in Europe* 9, 978-980.

## A comparison between cut and intensively grazed swards on dry matter yield of perennial ryegrass

Wims C.<sup>1,2</sup>, McEvoy M.<sup>1</sup>, Boland T.<sup>2</sup> and O'Donovan M.<sup>1</sup>

<sup>1</sup>Dairy Production Research Centre, Teagasc, Moorepark, Fermoy, Co. Cork, Ireland

<sup>2</sup>School of Agriculture, Food Science and Veterinary Medicine, UCD, Belfield, Dublin 4, Ireland

Corresponding author: cathal.wims@teagasc.ie

### Abstract

The objective of this study was to compare the total dry matter (DM) and seasonal DM production of perennial ryegrass (*Lolium perenne*) varieties managed under either animal grazing or simulated grazing and to evaluate the effect of incorporating a silage harvest into these managements on total and seasonal DM production. Four managements were employed; i) Animal Grazing (AG), ii) Simulated Grazing (SG), iii) One Cut Silage and AG and iv) One Cut Silage and SG. The SG managements yielded 14.4 t ha<sup>-1</sup>, which was significantly ( $P < 0.001$ ) higher than the AG managements yielding 11.8 t ha<sup>-1</sup>. Incorporation of a silage harvest also had a significant effect ( $P < 0.001$ ) on total DM yield, summer DM yield and autumn DM yield but not on spring DM yield. Managements that incorporated a silage harvest yielded 14.1 t ha<sup>-1</sup>, which was 18.0% higher than managements without a silage harvest. It can be concluded that cultivars evaluated under simulated grazing yielded higher than cultivars evaluated under animal grazing. However, as no re-ranking was found between cultivar and management, it indicates that simulated grazing is representative of the relative performance of a cultivar under animal grazing.

Keywords: *Lolium perenne*, variety, yield, simulated grazing

### Introduction

In recent years a renewed interest in agricultural grazing systems has taken place in many temperate and subtropical regions of the world. This interest has been stimulated by increased production costs and lower product prices, as well as the perceived environmental and animal welfare concerns associated with intensive indoor production systems (Dillon *et al.*, 2005). To achieve the optimum performance from a grass sward the most appropriate grass variety must be selected. Different grass variety evaluation protocols are employed throughout Ireland and Europe, and testing is generally conducted under cutting management practices. The protocols employed can generally be segregated into simulated grazing or conservation-based cutting regimes, with some integrating both conservation and simulated grazing. Simulated grazing protocols entail more frequent harvesting of the varieties, and they mirror or 'simulate' typical animal grazing rotations with eight to ten harvests per year. Grass evaluation protocols based on conservation cutting regimes have less-frequent harvesting of the varieties, with two to three conservation harvests and five to six harvests in total. Wims *et al.* (2009) reported that grass cultivars re-rank between simulated grazing and conservation-based cutting regimes. However, mechanical defoliation of cultivars may not be directly comparable to animal grazing, due to the effects of treading and plant pulling inflicted by animal grazing on the plant. The objective of this study was to compare the total DM and seasonal DM production of cultivars managed under either animal grazing or simulated grazing and to evaluate the effect of incorporating a silage harvest into these managements on total and seasonal DM production.



## Materials and methods

The study was carried out at Moorepark Dairy Production Research Centre, Fermoy, Co. Cork, Ireland (50° 09'N; 8°16'W). The soil type is a free draining, acid brown-earth of sandy loam-to-loam texture. The experimental plots were established in August 2008 and measurements commenced in February 2009.

Four managements were employed as follows:

- i) Animal Grazing (AG) (300 kg ha<sup>-1</sup> N) incorporating ten animal grazing rotations from February to November (n = 60);
- ii) Simulated Grazing (SG) (350 kg ha<sup>-1</sup> N) incorporating ten mechanical defoliations from February to November (n = 60);
- iii) One-Cut Silage and AG (300 kg ha<sup>-1</sup> N) incorporating seven animal grazing rotations from February to November with a silage harvest in late May (n = 30);
- iv) Simulated One-Cut Silage (335 kg ha<sup>-1</sup> N) incorporating eight mechanical defoliations from February to November with silage harvested in late May (n = 30);

Managements were either classified as AG (Managements i and iii) or as SG (Managements ii and iv). Managements (iii) and (iv) incorporated a silage harvest in late May. Ten cultivars were assessed across the four managements with three replicates per cultivar for each management. The cultivars used were Abermagic, Aberstar, Astonenergy, Dunluce, Magician, Millenium, Navan, Spelga, Twystar and Tyrella. All plots were harvested with an Etisa mower. A 1.5 m wide strip was cut from the AG plots with the remainder of the plot grazed with dairy cows. All dung pads were removed after each grazing. Nitrogen fertiliser was applied within two days of defoliation. All plots had adequate amounts of phosphorous and potassium from soil analysis and application levels. Within each management the overall grazing season was divided into spring (harvests between 1 February and 10 April), summer (harvests between 11 April and 6 August) and autumn (harvests from 7 August onwards). All data were analysed using analysis of variance in SAS. Cultivar, management and the effect of silage harvest were included in the model. Interactions were tested for and none were found, so interactions were excluded in the final analysis.

## Results and discussion

Table 1 shows the effect of management and the integration of a silage harvest on seasonal and total dry matter production. Cultivar had a significant effect ( $P < 0.05$ ) on both seasonal DM yield and total DM yield. Whether the sward was managed under AG or SG also had a significant effect ( $P < 0.001$ ) on both seasonal DM yield and total DM yield. The SG managements yielded 14.4 t ha<sup>-1</sup>, which was significantly ( $P < 0.001$ ) higher than the AG managements yielding 11.5 t ha<sup>-1</sup>. These findings do not agree with the study of Smith *et al.*, (1971) who reported that when cutting is compared to an intermediate severity of grazing, no differences were obtained in the amount of grass harvested. The study of Smith *et al.* (1971) used a technique to eliminate fouling and treading, which may account for some of the differences between the two studies. However, further study is required to establish effect of grazing on the grass sward compared to mechanical cutting.

Interaction between varieties and managements were tested for and none was found, which can lead us to conclude that varieties did not re-rank between the managements and that simulated grazing is representative of the relative performance of a cultivar under animal grazing.

Incorporating a silage harvest into the management significantly ( $P < 0.001$ ) increased total DM yield (+2314 kg ha<sup>-1</sup>), summer DM yield (+2047 kg ha<sup>-1</sup>) and autumn DM yield (+234 kg ha<sup>-1</sup>) compared to managements without a silage harvest (which yielded 11787 kg ha<sup>-1</sup>, 6093 kg ha<sup>-1</sup> and 3953 kg ha<sup>-1</sup> for total, summer, and autumn yields, respectively). This did not have



an effect on spring DM yield, which is logical given there was no difference in harvest strategy during the spring period.

Table 1: Effect of grass management and integration of a silage harvest on seasonal and total dry matter (DM) production

DM Yield kg ha <sup>-1</sup>	AG	SG	No Silage Harvest	Silage Harvest	Significance		SED
					Management	Silage Harvest	
Spring	1515	1998	1741	1772	<0.001	0.3981	24
Summer	5787	8446	6093	8140	<0.001	<0.001	62
Autumn	4221	3921	3953	4187	<0.001	<0.001	38
Total	11523	14365	11787	14101	<0.001	<0.001	97

SED = SE of the difference. AG= Animal Grazing. SG= Simulated Grazing

## Conclusion

Cultivars evaluated under simulated grazing had higher DM yields than cultivars evaluated under animal grazing. However, as no interaction was found between cultivar and management, it indicates that simulated grazing is representative of the relative performance of a cultivar under animal grazing.

## References

- Dillon P., Roche J.R., Shalloo L. *et al.* (2005) Optimising financial return from grazing in temperate pastures. In: Murphy J.J. (ed.) *Utilisation of grazed grass in temperate animal systems: proceedings of a satellite workshop of the XXth International Grassland Congress*, Cork, Ireland, July 2005. Wageningen Academic Publishers, Wageningen, pp. 131-147.
- SAS (2006) SAS Institute Inc., Cary, NC 33.
- Smith A., Arnott R.A. and Peacock J.M. (1971) A comparison of the growth of a cut sward with that of grazed swards, using a technique to eliminate fouling and treading. *Journal of the British Grassland Society* 26, 157-162.
- Wims C., Kennedy E., Boland T. and O'Donovan M. (2009) Effect of evaluation protocol and cultivar on the classification of seasonal and total dry matter yield. *Agricultural Research Forum* 35, 136

# The influence of natural fertilisation on quality and nutritive value of grass silage

Wróbel B. and Jankowska-Huflejt H.

*Institute of Technology and Natural Sciences, Falenty, Al. Hrabaska 3, 05-090 Raszyn, Poland*

Corresponding author: B.Wrobel@imuz.edu.pl

## Abstract

The effect of different forms and doses of natural fertilisers (manure/liquid manure) on chemical composition and microflora of grass silage was evaluated. Three different fertilisers were compared: mineral NPK (control), manure (in doses: 22 t ha<sup>-1</sup> and 33 t ha<sup>-1</sup>) and liquid manure (in doses: 25 m<sup>3</sup> ha<sup>-1</sup> and 37 m<sup>3</sup> ha<sup>-1</sup>). Herbage from grassland was ensilaged in cylindrical big bales. There was a significant influence of type and dose of fertilisation on chemical and microbiological parameters. Use of manure had the most unfavourable impact on silage quality. Silages made of grass fertilised with manure had significantly higher pH and ammonium content, lower lactic acid and higher fatty acids content. They also showed higher total aerobic bacteria and *Enterobacteria* counts than other silages. But silages made from swards fertilised with manure had higher nutritive value, with more crude protein, less fibre fractions and a higher value of RFQ index.

Keywords: liquid manure, manure, natural fertilisers, nutritive value, silage

## Introduction

Organic fertilisers of animal origin, i.e. manure, liquid manure and slurry, are important for plant production on many farms, particularly on organic farms. Grass from meadows is commonly preserved by making silage. From a few recent studies it appears that grassland fertilisation with natural fertilisers may affect the process of ensilaging and consequently the quality of silage obtained, and indirectly the quality of produced milk. A particularly negative effect on ensilaging and the quality of silage is exerted by non-fermented manure applied in large doses and at inappropriate times (Rammer *et al.*, 1994; Davies *et al.*, 1996; Rammer and Lingvall, 1997; Johansen and Todnem, 2002; Pauly and Rodhe, 2002). The aim of this study was to evaluate the effect of various forms of natural fertilisation on the nutritive value and the quality of grass silages produced in big bales.

## Materials and methods

Studies were carried out in 2008 in a plot experiment on a permanent meadow (over 20 years old) situated on mineral soil at the Experimental Farm in Falenty. The sward comprised 80% grasses and 20% weeds and herbs. The dominant grass species were: *Poa pratensis*, *Alopecurus pratensis*, *Dactylis glomerata*, *Arrhenatherum elatius* and *Lolium perenne*. Six plots, each of 0.3 ha, were fertilised as follows: plot 1, mineral NPK fertiliser (60 kg ha<sup>-1</sup> N, 13 kg ha<sup>-1</sup> P, 50 kg ha<sup>-1</sup> K) (NPK I); plot 2, mineral NPK fertiliser (90 kg ha<sup>-1</sup> N, 22 kg ha<sup>-1</sup> P, 90 kg ha<sup>-1</sup> K) (NPK II); plot 3: solid manure 22 t ha<sup>-1</sup> (M I); plot 4: solid manure 33 t ha<sup>-1</sup> (M II); plot 5: liquid manure 25 m<sup>3</sup> ha<sup>-1</sup> + 13 kg ha<sup>-1</sup> mineral P (LM I); plot 6: liquid manure 37 m<sup>3</sup> ha<sup>-1</sup> + 18 kg ha<sup>-1</sup> mineral P (LM II). N and K as mineral fertilisers were applied in three equal doses in spring and after the first and second cuts, and P was applied once in spring. Manure (20% DM) was applied in autumn 2007, after 6 months of storage on manure slab. Liquid manure (4% DM) was applied in two equal doses in spring (April 2008) and after the first cut (end of May 2008). It was applied to soil by shallow injection (to 20 mm) with injectors at 15 cm spacing. Chemical analyses of manure and liquid manure were made by the

Agro-Chemical Station according to standard methods. The lower doses of manure (M I) and liquid manure (LM I) were equivalent to approximately 60 kg N applied in the control (NPK I). The higher doses of manure (M II) and liquid manure (LM II) were equivalent to approximately 90 kg N applied in mineral fertilisers (NPK II). Grass was first cut at full heading of *Dactylis glomerata*, on 20 May 2008. Mown grass after pre-wilting on the meadow surface was collected with the rolling press and ensiled into big bales without any additives. Three big bales of silage, each with four layers of wrapping, were made from each fertilisation plot. In November, silage samples were taken for chemical analyses. Dry matter (DM) (oven method at 105 °C) and pH of fresh mass (potentiometric method) were determined. The fresh samples of silage were analysed also for crude protein, crude ash, crude fat, neutral detergent fibre (NDF), acid detergent fibre (ADF), acid detergent lignin (ADL), lactic acid (LA), volatile fatty acids (VFA) and ammonia content. Analyses were made using the near infrared spectroscopy (NIRS technique using NIRFlex N-500 spectrophotometer using calibrations prepared for wet fermented forages by the firm INGOT<sup>R</sup>). Nutritive value of silage was expressed as an index of relative feed value (RFQ) (Undersander and Moore, 2002). Moreover, total number of aerobic bacteria, *Enterobacteriaceae*, *E. coli*, and numbers of yeasts and moulds (cultures on Petrifilm<sup>TM</sup> 3M plates) in fresh silage samples (FM) were determined. Data concerning the chemical composition of silages were analysed using analysis of variance in ANOVA 1. Differences between treatments were tested using Student's t-test.

## Results and discussion

Fertilisation applied in lower doses (N-60) had a significant impact on the content of nutritive components in analysed forage samples. Silages from the treatment fertilised with manure (M I) showed the highest content of crude protein and the lowest NDF and ADF fractions (Table 1). Silages from the control variant (NPK I) showed the lowest content of crude protein, significantly lower than those from the sward fertilised with manure, and crude fat, which was significantly lower than those from the sward fertilised with liquid manure. They also had the highest content of NDF and ADF fibre fractions – higher than in silages from treatments fertilised with manure and liquid manure. The content of nutritive components in silages from plots fertilised with fertilisers at higher doses (N-90) was not significantly different, except for ADL and crude ash content, which were significantly higher in silage from the M II treatment than from two remaining ones. Fertilisation also affected the index of RFQ. The best nutritive value was for silages from grasses fertilised with liquid manure at the higher dose (LM II) and manure at the lower dose (M I). Fertilisation also had a significant effect on ammonia concentration, the LA and VFA contents and on silage pH (but only in silages fertilised with higher doses of fertilisers). Silage from the sward fertilised with liquid manure at both doses showed significantly lower ammonia concentration, lower VFA content with a significantly higher content of LA in the dry mass of silage, and in the sum of fermentation products, than silages from treatments fertilised with manure and NPK. Fertilisation with manure exerted the most unfavourable effect on the quality of silage. The highest content of ammonia and VFA and the least of LA were found in silages from treatments M I and M II (Table 1). Fertilisation exerted a significant effect only on total number of aerobic bacteria, *Enterobacteria* (at higher doses of fertilisers) and yeasts and moulds (lower doses of fertilisers). The total number of aerobic bacteria and *Enterobacteria* in silages from swards fertilised with manure (M I and M II) and liquid manure (LM II) was significantly higher than in that fertilised with mineral fertilisers (Table 1). The number of mould colonies also depended on applied fertilisation, but only for lower doses. Significantly fewer moulds were found in silages from the sward fertilised with manure, and less yeast in silages from the sward fertilised with liquid manure.

Table 1. Nutritive value, fermentation quality and microflora of silage

Examined parameters	Lower level of fertilisation (N-60)				Higher level of fertilisation (N-90)			
	NPK I	M I	LM I	Sign.	NPK II	M II	LM II	Sig.
DM (g kg <sup>-1</sup> )	299	306	276	NS	274	276	274	NS
Crude protein in DM (g kg <sup>-1</sup> )	117a	135b	125a	**	127	129	127	NS
Crude ash in DM (g kg <sup>-1</sup> )	85.2	91.9	92.5	NS	88.5a	94.7b	88.8ab	*
Crude fat in DM (g kg <sup>-1</sup> )	29.7a	31.2ab	32.0b	**	32.6	29.7	31.5	NS
NDF in DM (g kg <sup>-1</sup> )	463b	435a	447ab	**	447	444	430	NS
ADF in DM (g kg <sup>-1</sup> )	279b	262a	263ab	*	264	259	264	NS
ADL in DM (g kg <sup>-1</sup> )	68.9b	69.2b	66.0a	**	60.7a	74.2b	61.7a	**
TDN in DM (%)	62.8a	63.1ab	62.8a	*	63.3b	62.4a	63.7b	**
DMI (% body weight)	2.88a	2.97c	2.91b	**	2.94a	2.91a	2.97ab	*
RFQ	147a	152c	149b	**	151a	147a	154ab	*
pH	4.87	4.84	4.75	NS	4.11a	4.47b	3.91a	**
NH <sub>3</sub> -N in total N (g kg <sup>-1</sup> )	127b	138b	96a	**	89a	132b	95ab	*
LA in DM (g kg <sup>-1</sup> )	43.1ab	41.5a	56.5b	*	60.0b	33.4a	65.5b	**
VFA in DM (g kg <sup>-1</sup> )	28.9ab	34.0b	24.6a	*	17.7a	40.5b	11.7a	**
Sum of FP in DM (g kg <sup>-1</sup> )	72.0a	75.5ab	81.1b	*	77.7	73.9	77.2	NS
Share of LA in FP sum (%)	59.7ab	54.6a	69.3b	*	76.4b	44.3a	85.0b	**
Microbial counts in FM (log <sub>10</sub> cfu g <sup>-1</sup> )								
Total number of aerobic bacteria	5.48ab	5.76b	5.23a	*	4.90a	5.35b	5.37b	*
<i>Enterobacteria</i>	1.63	1.57	2.59	NS	0.50a	2.40b	1.45ab	*
<i>E. coli</i>	1.48	1.23	2.21	NS	0.45	2.04	1.45	NS
Yeasts	3.03b	3.03b	2.15a	**	2.64	2.72	2.90	NS
Moulds	3.19b	1.12a	3.38b	*	2.74	2.82	2.09	NS

NPK, mineral fertilisation; M, manure; LM, liquid manure; DM- dry matter; NDF, neutral detergent fibre; ADF, acid detergent fibre; ADL, lignin; TDN, total digestible nutrients; DMI, dry matter intake; RFQ, Relative Forage Quality = DMI \* TDN/1.23; LA, lactic acid; VFA, volatile fatty acids; FP, fermentation products; VFA = acetic + butyric + propionic acid; Values with different letters are significantly different ( $P < 0.05$ ); NS, not significant; \*, \*\*, significance of differences and interactions at  $P < 0.05$  and  $P < 0.01$  respectively

In previous work, Rammer *et al.* (1994) found poorer quality of silage from a sward fertilised with manure, and comparable results were obtained for the control and treatments fertilised with liquid manure, and more bacteria (in that case *Bacillus* spores and *Clostridium* spores) after fertilisation with manure were also found. They explained the differences by the presence of fragments of undecomposed manure applied in spring.

## Conclusions

There was a significant influence of natural fertilisation on some chemical and microbiological parameters. Fertilisation with manure had the most unfavourable impact on silage quality and on some selected parameters of microbial evaluation. However, silages made from the sward fertilised with manure had higher nutritive values; they contained more crude protein, less fibre fractions and had higher value of RFQ index.

## References

- Davies D.R., Merry R.J. and Bakewell E.L. (1996) The effect of timing of slurry application on the microflora of grass, and changes occurring during silage fermentation. *Grass and Forage Science* 51, 42-51
- Johansen A. and Todnem J. (2002) Effects of cattle and sheep slurry on grass silage quality. In: *Conference Proc. the XIIIth International Silage Conference*, September 11-13, 2002, Auchincruive, Scotland, pp. 408-409.
- Pauly T.M. and Rodhe L. (2002) Slurry application on ley – Effect of application method on the hygienic quality of grass silage. In: *Proc. the XIIIth International Silage Conference*, (op cit.), pp 410-411
- Rammer C. and Lingvall P. (1997) Influence of farmyard manure on the quality of grass silage. *Journal of the Science of Food and Agriculture* 75(1), 133-140.
- Rammer C., Östling C., Lingvall P. and Lindgren S. (1994) Ensiling of manured crops – effects on fermentation. *Grass and Forage Science* 49, 343-351.
- Undersander D. and J.E. Moore (2002) Relative forage quality. UW Extension. *Focus on Forage*. 4 (5).



## **Session 3.2**

### **Authenticity and traceability of grassland production and products**

*Editor: Karl Auerswald*

## The effect of allocation frequency in rotational grazing systems on the fatty acid profile in milk fat of dairy cows

Vlaeminck B.<sup>1</sup>, Abrahamse P.A.<sup>2</sup>, Fievez V.<sup>1</sup>, Lourenço M.<sup>1</sup>, Dijkstra J.<sup>2</sup> and Tamminga S.<sup>2</sup>

<sup>1</sup>Laboratory for Animal Nutrition and Animal Product Quality, Ghent University, Proefhoevestraat 10, 9090 Melle, Belgium

<sup>2</sup>Animal Nutrition Group, Wageningen Institute of Animal Sciences, Wageningen University, P.O. Box 338, 6700 AH Wageningen, The Netherlands

Corresponding author: bruno.vlaeminck@ugent.be

### Abstract

Four Holstein cows were used to evaluate the effect of allocating cows every 4 day (d) to a new 0.5-ha plot of *Lolium perenne* L. on the profile of fatty acids (FA) in milk. The experiment was run during 2 rotations with 2 measuring periods of 4 d each. During the 4 d period, the proportion (g per 100 g FA) of 18:3n-3 and total FA content (mg per g DM) of grass decreased linearly. Similarly, milk FA composition was largely affected by day within the 4 d period. Proportions of t11-18:1 in milk fat increased on d 2 (4.52 g per 100 g FA) and decreased thereafter (3.77 g per 100 g FA on d 4). Proportions of c9t11-18:2 (2.36 and 1.83 g per 100 g FA), t11c15-18:2 (0.81 and 0.63 g per 100 g FA) and 18:3n-3 (0.92 and 0.88 g per 100 g FA) in milk followed the same pattern. Results from this study suggest short term variation in pasture quality during the 4 d affected milk FA composition, with a greater effect on biohydrogenation intermediates in milk fat compared with its major precursor, 18:3n-3.

Keywords: fatty acids

### Introduction

Long chain n-3 poly-unsaturated FA and c9t11-18:2 have potential human health benefits. Thus, increasing the concentration of these FA in milk is beneficial to public health. Feeding fresh grass is an efficient way to increase 18:3n-3 and c9t11-18:2 in milk fat (Dewhurst *et al.*, 2006). Schroeder *et al.* (2004) compared concentrations of c9t11-18:2 in milk of cows fed pasture-based diets to that of cows fed TMR diets from 7 studies, and reported an increase of 134% compared to the control, with considerable variation in the responses ranging from 15 to 396%. Differences in herbage allowance, herbage mass, growth stage and N fertilization rate might explain these large variations (Dewhurst *et al.*, 2006). In rotational grazing systems, both herbage allowance and mass and morphological characteristics of the paddock changes within a rotation with a decrease in herbage allowance and mass and increase in leaf/stem ratio of the grass (Abrahamse *et al.*, 2008). As the latter is an important factor of the 18:3n-3 content of the grass (Dewhurst *et al.*, 2006), this might affect both 18:3n-3 and c9t11-18:2 content in milk fat. The objective of this experiment was to determine changes in milk FA profile in dairy cows reallocated every 4 d to a fresh plot.

### Material and methods

A detailed description of the experimental design is presented by (Abrahamse *et al.*, 2008). Briefly, 10 lactating Holstein dairy cows were allocated to a fresh 0.5-ha plot every 4 d. Cows were milked twice daily at 0600 and 1600 h and allocated to a new plot after the morning milking. After adaptation to grazing during 3 wk and further adaptation to the grazing system during 4 d, the treatment was evaluated during 2 rotations with 4 periods of 4 d in the first rotation and 3 periods of 4 d in the second rotation. Samples from 4 cows during 2



consecutive periods in each rotation (periods 2 and 3) were analysed and results are presented here. Grass was sampled during the morning milking, by cutting grass at 4 cm above ground level from approximately 40 sites per plot, during all 4 d per period and residual grass was sampled after cows were removed from the plot. Samples were stored frozen (-20 °C) and freeze dried prior to FA analysis (Lourenço *et al.*, 2005). During both periods per rotation, a 10 ml aliquot of milk was collected at each milking and stored frozen (-20 °C). Samples of two consecutive milkings (i.e. evening and subsequent morning milking) were pooled, resulting in 4 milk samples per cow per period prior to FA analysis (Lourenço *et al.*, 2005). All statistical analyses were performed using the MIXED procedure of SAS (version 9.1, SAS Institute 2004). Least square means are presented in the tables and significance was declared at  $P < 0.05$ . Changes in grass FA composition during the 4 d were analysed as:  $Y_{ij} = \mu + D_i + R_j + \epsilon_{ij}$  with  $Y_{ij}$  the individual observation,  $\mu$  the overall mean,  $D_i$  the effect of d ( $i = 1..5$ , i.e. the morning samples of the 4 d and the residual of the 4th day),  $R_j$  the effect of rotation, and  $\epsilon_{ij}$  the residual error. The interaction term day  $\times$  rotation was not significant ( $P > 0.05$ ) and not included in the model. Day was treated as a repeated measure assuming an autoregressive order one covariance structure. Orthogonal contrasts were used to test for significance of linear and quadratic effects of d. Changes in milk FA composition during the 4 d were analysed using the same model as for grass FA composition including the random effect of cow.

Table 1. Total fatty acid content in DM (g kg<sup>-1</sup>) and fatty acid composition (g per 100 g fatty acids) of pasture and milk when dairy cows are reallocated every four days to a new plot

	Day 1	Day 2	Day 3	Day 4	residue	SEM <sup>1</sup>	L <sup>2</sup>	Q <sup>3</sup>
PASTURE								
total fatty acids	22.7	20.8	18.0	16.0	15.9	1.42	0.001	0.271
14:0	2.58	2.49	2.76	2.54	2.58	0.162	0.918	0.582
16:0	12.9	13.5	14.0	14.9	15.3	0.48	0.003	0.957
18:0	1.86	2.11	2.01	2.72	2.75	0.279	0.027	0.666
<i>cis</i> -9-18:1	1.41	1.78	1.78	1.97	1.98	0.210	0.092	0.415
18:2 <i>n</i> -6	10.7	11.7	12.3	13.8	14.4	0.49	<0.001	0.866
18:3 <i>n</i> -3	67.6	65.7	63.9	61.1	59.9	1.34	<0.001	0.880
MILK								
SMCFA <sup>4</sup>	22.7	23.3	21.7	21.1		0.51	<0.001	0.064
C16-fatty acids <sup>5</sup>	25.9	24.8	23.5	22.9		0.72	<0.001	0.475
18:0	10.45	9.47	10.25	10.90		0.371	0.036	<0.001
<i>trans</i> -11-18:1	4.05	4.52	4.49	3.77		0.368	0.256	<0.001
<i>cis</i> -9-18:1	20.9	20.9	22.6	23.3		0.54	<0.001	0.270
<i>cis</i> -9, <i>trans</i> -11-18:2	1.85	2.36	2.29	1.83		0.135	0.745	<0.001
<i>trans</i> -11, <i>cis</i> -15-18:2	0.677	0.807	0.760	0.629		0.046	0.113	<0.001
18:2 <i>n</i> -6	0.800	0.854	0.834	0.895		0.041	0.043	0.903
18:3 <i>n</i> -3	0.881	0.917	0.905	0.878		0.056	0.814	0.022

<sup>1</sup> standard error of the mean, <sup>2</sup> linear effect of day, <sup>3</sup> quadratic effect of day, <sup>4</sup> short and medium-chain fatty acids (4:0 + 6:0 + 8:0 + 10:0 + 10:1 + 12:0 + 14:0 + *cis*-9-14:1), <sup>5</sup> C16-fatty acids (16:0 + *cis*-9-16:1)

## Results and discussion

Total FA content and proportion of 18:3*n*-3 in grass linearly decreased between the beginning of d 1 and the residue at the end of d 4 (Table 1). These effects are probably related to the gradual decrease in the leaf : stem ratio during the 4 d in this experiment (Abrahamse *et al.*, 2008) as leaves are enriched in 18:3*n*-3 compared with the stem (Dewhurst *et al.*, 2006). Changes in FA composition (Table 1) and proximate chemical composition (Abrahamse *et al.*, 2008) of the grass during the 4 d largely influenced milk FA composition (Table 1). Changes in short- and medium-chain FA (SMCFA) in milk fat during the 4 d (Table 1), confirm the findings of Stockdale *et al.* (2003). In 3 experiments investigating the effects of

low or high herbage allowance (Stockdale *et al.*, 2003), a difference in pasture DMI (dry matter intake) of 9.4 or 5.2 kg d<sup>-1</sup> did result in higher levels of milk SMCFA at the high herbage level, whereas a smaller difference in pasture DMI of 2.1 kg d<sup>-1</sup> did not affect levels of these FA. Both a decreased supply of precursors (i.e. acetate and butyrate) and mobilization of body fat (mainly long-chain FA) through decreased DMI or energy intake might explain these effects. Milk fat concentrations of 18:3n-3 between days were highest at d 2 (Table 1), probably reflecting the increased intake of 18:3n-3 when cows were allocated to a new plot and assuming a delay in occurrence of effect of approximately 1 d. In the current experiment, variation in 18:3n-3 of the grazed pasture between d was related with its content in milk ( $R^2 = 0.58$ ). Concentrations of t11c15-18:2 in milk fat showed a similar pattern as 18:3n-3 during the 4 days (Table 1). The t11c15-18:2 is formed during biohydrogenation of 18:3n-3 in the rumen which might explain the positive relation between 18:3n-3 content of grass and secretion of t11c15-18:2 in the current experiment ( $R^2 = 0.65$ ). The variation between days of 18:3n-3 in milk fat was smaller compared to t11c15-18:2 (Table 1). Both substrate supply (i.e. 18:2n-6 and 18:3n-3) and the ruminal formation and hydrogenation of t11-18:1 are reported to regulate the rumen supply of t11-18:1. The importance of substrate supply was illustrated by Stockdale *et al.* (2003) who showed that increased intake of pasture and 18:3n-3 in grazing dairy cows increased concentrations of c9t11-18:2 in milk fat. In the current experiment, the gradual decline in 18:3n-3 content of the pasture during the 4 d was related with decreased secretion of c9t11-18:2 ( $R^2 = 0.81$ ), suggesting the variation of c9t11-18:2 during the 4 days was associated with an altered supply of 18:3n-3.

## Conclusions

This study showed that the milk FA of dairy cows reallocated every 4 d was largely affected by day within the rotation system. The observed effects were greater for biohydrogenation intermediates in milk fat compared with its major precursor, 18:3n-3.

## Acknowledgements

B. Vlaeminck is a Postdoctoral Fellow of the Fund for Scientific Research-Flanders (Belgium) and in 2006 was in receipt of a Wageningen Institute of Animal Sciences research fellowship. The financial support from the Product Board Animal Feed and the Dutch Dairy Board is greatly acknowledged.

## References

- Abrahamse P. A., Dijkstra J., Vlaeminck B. and Tamminga S. (2008) Frequent allocation of rotationally grazed dairy cows changes grazing behavior and improves productivity. *Journal of Dairy Science* 91, 2033-2045.
- Dewhurst, R. J., Shingfield K.J., Lee M.R.F. and Scollan N.D. (2006) Increasing the concentrations of beneficial polyunsaturated fatty acids in milk produced by dairy cows in high-forage systems. *Animal Feed Science and Technology* 131, 168-206.
- Lourenço M., Vlaeminck B., Bruinenberg M., Demeyer D. and Fievez V. (2005) Milk fatty acid composition and associated rumen lipolysis and fatty acid hydrogenation when feeding forages from intensively managed or semi-natural grasslands. *Animal Research* 54, 471-484.
- Schroeder G.F., Gagliostro G.A., Bargo F., Delahoy J.E. and Muller L.D. (2004) Effects of fat supplementation on milk production and composition by dairy cows on pasture: a review. *Livestock Production Science* 86, 1-18.
- Stockdale C.R., Walker G.P., Wales W.J., Dalley D.E., Birkett A., Shen Z.P. and Doyle, P.T. (2003) Influence of pasture and concentrates in the diet of grazing dairy cows on the fatty acid composition of milk. *Journal of Dairy Research* 70, 267-276.

# Influence of the botanical diversity and development stage of mountain pastures on milk fatty acid composition, carotenoids, fat-soluble vitamins and sensory properties

Tornambé G.<sup>1,4</sup>, Ferlay A.<sup>1</sup>, Farruggia A.<sup>1</sup>, Chilliard Y.<sup>1</sup>, Loiseau P.<sup>2</sup>, P. Pradel.<sup>3</sup>, Graulet B.<sup>1</sup>, Chauveau-Duriot B.<sup>1</sup> and Martin B.<sup>1</sup>

<sup>1</sup>INRA, UR Herbivores, 63122 Saint Genès Champanelle, France

<sup>2</sup>INRA, UR FGEP, 63000 Clermont Ferrand, France

<sup>3</sup>INRA, UE Marcenat, 15190 Marcenat, France

<sup>4</sup>Università Degli Studi di Palermo, Dipartimento SENFIMIZO, 90128 Palermo, Italy

Corresponding author: gtornambe@unipa.it

## Abstract

The objective of this study was to verify if the botanical diversity of grazed grasslands influences milk fatty acid (FA) composition, carotenoid and vitamin A and E contents and sensory properties. During 3 weeks (W1, W2 and W3), 18 cows divided into 3 homogenous groups grazed 3 mountain grasslands differing in diversity: D0, temporary grassland (17 species); D1, permanent grassland (31 species); D2 species-rich permanent grassland (50 species). The milk FA composition varied according to the grass development stage. Milk C16:0 percentage increased progressively from W1 to W3, stearic and oleic acid percentages reached a maximum in W2 and the percentages of *trans* isomers of C18:1 and CLA decreased from W1 to W3. The influence of the grass botanical diversity on the major milk FA was less important than that of grass maturity. The milk C18:1t11, C18:2n-6 and C18:3n-3 percentages were slightly higher for D2 than for D0 and D1. The milk  $\beta$ -carotene content decreased from W1 to W3 and vitamin E content was highest at W3. The milk  $\beta$ -carotene and vitamin A and E content were similar between D0, D1 and D2. The milk sensory properties evaluated by non-expert tasters in triangular tests (D0 vs. D1 and D0 vs. D2) did not differ significantly according to the grassland botanical diversity.

Keywords: mountain pasture, cow, botanical diversity,  $\beta$ -carotene, vitamins A and E

## Introduction

Many studies have recently evidenced that the botanical composition of the grassland and the growing stage of the grass influence milk content in carotenoids, fat soluble vitamins and fatty acids (FA) profile (Collomb *et al.*, 2002; Calderon *et al.*, 2006; Tornambé *et al.*, 2007). The aim of this study was to verify, in controlled conditions, if the botanical diversity of grazed grasslands could influence the milk FA profile, the content in carotenoids and fat-soluble vitamins, and the milk sensory properties.

## Material and methods

Three different mountain grasslands differing in botanical diversity were selected at the INRA experimental farm of Marcenat (1100 m elevation, Cantal, France): a temporary grassland (D0, 17 species, 5 graminaceous and 12 dicotyledons), a permanent grassland (D1, 31 species, 13 graminaceous species and 18 dicotyledons including 4 aromatic species) and a species-rich permanent grassland particularly rich in aromatic species (D2, 50 species, 14 graminaceous species and 36 dicotyledons, including 9 aromatic species). During 3 consecutive weeks in June, grass was sampled to determine the available biomass, the grass nutritional value, FA profile and carotenoid content. Eighteen dairy cows (150 days in milk on average) were

allocated to 3 equivalent groups of 6 cows. In June, during 3 consecutive weeks, each group grazed one of the different grasslands and did not receive concentrate. Milk yield was recorded at each milking, and milk fat and protein on 4 consecutive milkings each week. Once a week, individual milks (from morning and evening milkings) were collected for determining FA composition (by GC), carotenoid and vitamin A and E content (by HPLC). Sensory properties of the bulk milk from morning milking of each group were analysed at the end of W1, W2 and W3 by triangular tests (D0 vs. D1 and D0 vs. D2). For milk production and composition, data were analysed as repeated measures (MIXED procedure of the SAS (2000)). Data collected at W0 corresponded to covariate. Grasslands, weeks, the interaction week  $\times$  grassland, and covariate were the fixed effects, and the animal was the random effect.

Table 1. Evolution of grazed grass parameters for three grasslands.

Grassland type Week	D0			D1			D2		
	1	2	3	1	2	3	1	2	3
Net energy in DM, MJ kg <sup>-1</sup>	6.8	6.7	6.1	6.6	6.6	6.0	6.9	6.7	6.4
Fat, % of DM	1.9	2.1	2.1	1.6	1.9	2.0	1.6	1.4	1.8
C16:0 in total FA, g (100 g) <sup>-1</sup>	12.1	14.2	16.4	14.6	14.1	15.2	14.8	15.6	15.0
C18:1c9 in total FA, g (100 g) <sup>-1</sup>	1.9	2.5	2.8	2.0	1.9	3.0	2.6	2.4	3.9
C18:2n-6 in total FA, g (100 g) <sup>-1</sup>	13.4	13.6	15.1	13.4	15.0	15.3	16.7	17.3	22.0
C18:3n-3 in total FA, g (100 g) <sup>-1</sup>	65.4	62.0	56.1	63.6	61.6	57.6	57.2	55.7	49.0
$\Sigma$ Xanthophylls in DM, $\mu\text{g g}^{-1}$	576	496	176	489	618	243	322	404	254
$\Sigma$ Carotenes in DM, $\mu\text{g g}^{-1}$	198	167	73	166	207	90	111	135	104

## Results and discussion

The grass nutritive value (Net energy) was equivalent on average for the 3 grasslands (Table 1) but it decreased with time, slightly between W1 and W2, then sharply during W3, especially for D0 and D1. The C18:2n-6 and C18:3n-3 content was lower and higher for D0 and D1 than to D2, respectively. Whatever the grassland, grass C18:3n-3 content decreased over time to the benefit of C18:2n-6, C18:1c9 and C16:0, which increased, especially between W2 and W3. These variations of FA in plants could be due to changes in the leaf/stem ratio (Abrahamse *et al.*, 2008). The grass xanthophyll and carotene contents were, on average, higher for D0 and D1 than for D2. For the three grasslands, the grass carotene content decreased sharply from W2 to W3. From W1 to W2, they increased in D1 and D2 while they decreased in D0.

Milk yield and protein content were higher for D0 than for D1 and D2 (average increase 1.7 kg cow<sup>-1</sup> d<sup>-1</sup> for milk yield, and 1.1 g kg<sup>-1</sup> for protein content) (Table 2). In the 3 grasslands, milk yield decreased sharply over time with an average loss of 1.8 kg cow<sup>-1</sup> week<sup>-1</sup>. The milk fat content was similar for the 3 grasslands and did not vary between weeks. The milk FA profile varied according to the time. The saturated FA (C4 to C10) and C14:0 percentage decreased from W1 to W2. Then it increased from W2 to W3 while C16:0 percentage increased linearly from W1 to W3 for D0 and D1, and remained constant in D2 (Table 2). In contrast, C18:1c9 reached a maximum during W2. The C18:3n-3 decreased from W1 to W2 for D0, while it increased for D2 and remained constant for D1. From W2 to W3, C18:3n-3 decreased sharply in D2. C18:1t11 and CLA decreased from W1 to W3 (Table 2) but the decrease was more important for D1 than for D2. The decrease of these FA is in line with Ferlay *et al.* (2006). This is due to both the evolution of grass phenological stage and the composition of the grasslands. The influence of botanical diversity seems less important than development stage of the grass. In fact, the sum of C8:0+C10:0 and C14:0 were higher, and the C18:1c9, C18:2n-6 and C18:3n-3 were lower, for D1 than for D0 and D2. The highest

values of C18:3n-3, C18:2n-6 and C18:1t11 were observed for D2. CLAc9t11 did not differ between grasslands.

The milk  $\beta$ -carotene content was marginally affected by the grassland type. In contrast, it significantly decreased from W1 to W3 in parallel to the decline in the grass carotenoid content. Milk vitamin A followed the same trend, except for D1 where, surprisingly, it increased from W2 to W3. Milk vitamin E was, on average, similar between the 3 grasslands and it significantly increased from W2 to W3.

In the triangular tests only 37% ( $P > 0.1$ ) and 35% ( $P > 0.1$ ) of the panellists found the unique samples for the comparisons of D0 vs. D1 and D0 vs. D2, respectively.

Table 2. Evolution of the milk yield and composition, fatty acid profile (g (100 g)<sup>-1</sup> in total FA) and content in  $\beta$ -carotene and fat-soluble vitamins between weeks (W1 and W3) for the 3 grasslands differing in diversity (D0 to D2).

Grassland type	D0			D1			D2			P value		
	1	2	3	1	2	3	1	2	3	W	D	W×D
Milk, kg cow <sup>-1</sup> d <sup>-1</sup>	20.2	17.6	15.4	16.7	15.7	14.7	18.3	16.3	14.3	<0.001	0.01	0.004
Fat, g kg <sup>-1</sup>	36.9	37.1	36.4	39.2	39.0	37.8	36.7	37.6	38.5	0.55	0.17	0.19
Protein, g kg <sup>-1</sup>	32.8	33.0	32.5	32.1	30.8	31.1	32.3	31.9	32.0	<0.001	<0.001	<0.001
C4:0 + C6:0	5.66	5.02	5.44	5.44	4.87	5.31	6.01	5.03	5.52	<0.001	0.056	0.553
C8:0 + C10:0	4.54	4.04	4.07	5.23	4.43	4.29	4.57	3.73	4.15	<0.001	0.020	0.284
C14:0	11.86	11.45	12.10	12.63	12.15	12.56	11.26	10.35	10.87	0.002	0.004	0.756
C16:0	22.14	23.59	24.89	22.95	23.51	25.58	23.65	23.35	23.44	<0.001	0.637	0.001
C18:0	8.91	9.21	8.47	8.13	9.07	8.61	8.84	10.01	9.24	0.008	0.384	0.687
C18:1c9	21.70	22.57	21.14	19.48	20.75	19.94	20.97	22.76	22.25	0.001	0.036	0.517
C18:1t11	3.22	2.70	2.51	3.74	2.86	2.69	3.87	3.78	3.22	0.001	0.056	0.397
C18:2n-6	0.91	0.84	0.79	0.74	0.79	0.74	1.01	1.12	1.00	0.001	<0.001	0.002
C18:3n3	0.68	0.59	0.61	0.58	0.57	0.56	0.70	0.81	0.65	0.004	0.013	<0.001
CLAc9t11	2.06	1.83	1.77	2.15	1.57	1.47	1.64	1.68	1.52	0.004	0.690	0.058
$\beta$ -carotene $\mu$ g mL <sup>-1</sup>	0.24	0.22	0.20	0.22	0.19	0.19	0.22	0.18	0.16	0.001	0.132	0.679
Vitamin A $\mu$ g mL <sup>-1</sup>	0.24	0.26	0.20	0.18	0.16	0.23	0.22	0.21	0.18	0.884	0.288	0.018
Vitamin E $\mu$ g mL <sup>-1</sup>	0.54	0.57	0.84	0.53	0.51	0.67	0.65	0.46	0.61	0.004	0.599	0.223

## Conclusions

The grass phenological stage had an important effect on the milk FA composition, and the botanical diversity of the grasslands also had a minor effect of on some unsaturated FA beneficial to human health. In our conditions, the botanical diversity of the grasslands did not impact on the sensory properties of milks.

## References

- Abrahamse P. A., Dijkstra J., Vlaeminck B. and Tamminga S. (2008) Frequent allocation of rotationally grazed dairy cows changes grazing behavior and improves productivity. *Journal of Dairy Science* 91, 2033-2045.
- Calderón S.F., Tornambe G., Martin B., Pradel P., Chauveau-Duriot B. and Nozière P. (2006) Effects of mountain grassland maturity stage and grazing management on carotenoids in sward and cow's milk. *Animal Research* 55, 533-44.
- Collomb M., Bütikofer U., Sieber R., Jeangros B. and Bosset J.O. (2002) Correlation between fatty acids in cow's milk fat produced in the lowlands, mountains and highlands of Switzerland and botanical composition of the fodder. *International Dairy Journal* 12, 661-666.
- Ferlay A., Martin B., Pradel P., Coulon J.B. and Chilliard Y. (2006) Influence of grass-based diets on milk fatty acid composition and milk lipolytic system in Tarentaise and Montbéliarde cow breeds. *Journal of Dairy Science* 89, 4026-4041
- Tornambé G., Ferlay A., Farruggia A., Chilliard Y., Loiseau P., Garel P. and Martin B. (2007) Effet de la diversité botanique des pâturages de montagne sur le profil en acides gras et les caractéristiques sensorielles des laits. *14 Rencontre Recherche Ruminants*, Institut de l'élevage – INRA, Paris, France, pp. 333-336.

## Meat quality of Norwegian lambs finished on semi-natural pastures, concentrate or ryegrass pastures

Lind V.<sup>1</sup>, Berg J.<sup>2</sup>, Eik L.O.<sup>2</sup>, Eilertsen S.M.<sup>1</sup>, Hersleth M.<sup>3</sup> and Haugland E.<sup>1</sup>

<sup>1</sup> Institute for Agricultural and Environmental Research, Arctic agriculture and land use division, N-8860 Tjøtta, Norway

<sup>2</sup> Department of Animal and Aquacultural sciences, Norwegian University of Life Sciences, N-1432 Ås, Norway

<sup>3</sup> Nofima Mat, N-1432 Ås, Norway

Corresponding author: [vibeke.lind@bioforsk.no](mailto:vibeke.lind@bioforsk.no)

### Abstract

The effects of different production systems on sensory profile and fatty acid composition were examined in a study performed in northern Norway (65°50'N, 12°28'E) in 2008. For three months or more, 150 Norwegian White Sheep lambs grazed the same semi-natural pasture with their dams. The effect of pre-slaughter fattening on meat quality was compared using a control group of lambs slaughtered directly from the pasture. Four pre-slaughter treatments were established: weaning and indoor-feeding on concentrate and grass silage for either 24 or 44 days before slaughtering (Conc24, Conc44), weaning and grazing on ryegrass (*Lolium multiflorum*) pasture for the same periods (Rye24, Rye44). Loin samples of *M. Longissimus dorsi* including the subcutaneous fat over the muscle from fifteen carcasses from each treatment were analysed for sensory attributes and fatty acid composition. A lower intensity of acid taste was observed in meat from lambs in treatment Conc44 compared with the control. A higher content of the fatty acids C18:1*t*-11 and C18:3*n*-3 was found in meat from grazing lambs whereas lambs fed concentrate had the highest *n*-6/*n*-3 ratio.

Keywords: concentrates, fatty acid composition, lamb, meat quality, sensory profile

### Introduction

In Norway, most of the sheep-meat production is based on lambs slaughtered directly from unimproved mountain range pastures in the autumn. To reach the minimum carcass weight, lambs below 40 kg live body weight (LBW) are either stall-fed using grass silage and concentrates or grazed on improved lowland pastures supplemented with concentrates. The type of fattening system used may influence the sensory profile of lamb meat. Meat obtained from concentrate-fed lambs typically has a substantially different flavour compared to meat obtained from grazing lambs (Resconi *et al.*, 2009). The fatty acid composition of lamb meat is affected by the length of the fattening period and also by the type of feed used for fattening with pasture-fed lambs having a higher content of poly-unsaturated fatty acids (PUFA), lower levels of some of the saturated fatty acids and a lower *n*-6/*n*-3 ratio than meat from concentrate-fed lambs (Aurousseau *et al.*, 2007).

Across Europe, there is an increase in consumer demand for regional and traditional foods. The image of natural pastures and home-grown feeds is often used for marketing special brands of local food. However, at Norwegian abattoirs no distinction is made between lambs raised according to these guidelines and those subjected to different types of fattening regimes before being slaughtered. The objective of this study was to compare meat from suckling lambs slaughtered directly from a semi-natural lowland pasture with meat from weaned lambs raised on a semi-natural pasture and finished on various pre-slaughter diets. The hypothesis was that compared with lambs slaughtered directly from semi-natural lowland pastures,



neither fattening periods of 24 or 44 days grazing on ryegrass swards, nor stall-feeding with concentrates and silage for the same time, altered the quality of the lamb meat.

## Materials and methods

The experiment was carried out at an experimental farm at Tjøtta in northern Norway (65°50'N, 12°28'E) from May to September 2008. All animals grazed the same semi-natural lowland pasture for three months or longer. The effect of the pre-slaughter fattening on meat quality was compared using a control group of suckling lambs slaughtered directly from the semi-natural pasture, and lambs that were weaned and subjected to the following pre-slaughter diets: stall-feeding with concentrate and grass silage for a period of 24 (Conc24) or 44 days (Conc44) or grazing on Italian ryegrass (*Lolium multiflorum*) for the same periods (Rye24 or Rye44).

One-hundred and fifty Norwegian White Sheep lambs were born indoors during April and May and turned out to graze the semi-natural pasture with their dams in mid-May. On 11 August ewes and lambs were gathered from the pasture and 40 lambs with a minimum of 32 kg LBW were randomly selected. All 40 lambs were weaned and allocated for treatment Rye44 and Conc44. The rest of the flock was returned to graze in the pasture. Three weeks later on 1 September, the same procedure was repeated to establish the Rye24 and Conc24 treatments, this time using 36 kg LBW as the minimum weight for the selection of lambs. Finally, on 24 September the control treatment was established from lambs that weighed a minimum of 40 kg LBW grazing the semi-natural pasture. Lambs from the five treatments were sent to the local abattoir where they were shorn and slaughtered immediately after arrival. After slaughter, 15 carcasses from each treatment were selected for both descriptive sensory and fatty acid analyses following these criteria: minimum 40 kg LBW, gender (nine female and six male), age (133-177 days) and age of dam (2-7 years). After chilling, the saddles (both loins – *M. longissimus dorsi* – with bones) were removed from the carcasses, wrapped and vacuum-packed in sealable polyamide bags at the abattoir and brought to Nofima Mat where the saddles were aged for six days. The methods for sensory evaluation of 19 characteristics and determination of fatty acid composition are described in details in Lind *et al.* (2009). Sensory data were analysed using a mixed-model ANOVA with the assessor and animal (nested within treatment) effects and their interactions as random effects and treatment as fixed effect (SAS for Windows, Version 9.1.3). The fatty acid composition was analysed using a one-way ANOVA analysis with treatment as fixed effect, single animal as experimental unit and live weight and age prior to slaughter as covariates. When the treatment effects were significant ( $P < 0.05$ ), means were separated by the Tukey Simultaneous test.

## Results and discussion

Meat from the control treatment had a higher intensity in acid taste ( $P < 0.05$ , results not shown) than did meat from the Conc44 treatment. Meat from lambs fed concentrate has been characterised as more rancid and more bitter than meat from grazing lambs. Also, higher intensity of 'typical lamb' flavour, more fatty and less livery flavour are characteristics related to concentrate-fed lambs. In contrast, meat from pasture-fed lambs has been characterised to be more intense in odour and flavour than meat from concentrate-fed lambs.

Table 1 shows that meat from grazing lambs had a higher content of C18:1*t*-11 and C18:3*n*-3 than meat from concentrate-fed lambs. The C18:1*t*-11 fatty acid is of interest since it is a precursor of conjugated linoleic acids (CLA; Sinclair, 2007), a fatty acid which is of interest due to its effect on human health. However, there is still uncertainty about the health effect of C18:1*t*-11. In total, lambs grazing ryegrass had the lowest *n*-6/*n*-3 ratio, while lambs fed concentrate for 44 days had the highest ratio. The amount of fat in lamb depends on various



factors, e.g. age and dietary energy intake. Young growing lambs normally have a low fat content. The content of phospholipids is relatively constant and has a high content of PUFA. In contrast, the proportion of triacylglycerols, which are the main energy reserves, can vary and their level rise with an increase in fatness. Triacylglycerols mainly consist of the fatty acids C16:0, C18:0 and C18:1*n*-9, which comprise approximately 80% of fatty acids.

In growing lambs, adipose tissue is the principal site of *de novo* fatty acid synthesis. C16:0 is the end product which can be elongated to C18:0 and then desaturated to C18:1*n*-9 by the stearoyl-CoA desaturase. Feeding concentrate increases stearoyl-CoA desaturase activity, resulting in an increased C18:1*n*-9 content in adipose tissue. In contrast, dietary PUFAs, particularly C18:3*n*-3, appear to suppress desaturase activity. An estimation of desaturation activity revealed that Rye44 had significantly lower values than the other treatments. Rye44 probably had the lowest energy intake and highest intake of C18:3*n*-3, thus explaining lower desaturase activity, a higher proportion of C18:0 and a lower proportion C18:1*n*-9 compared to the other treatments. It could be argued that higher level of C18:3*n*-3 fatty acids could decrease oxidative stability of fat. However, pasture diets contribute natural antioxidants in sufficient amounts and this is an efficient way to prevent lipid oxidation in fresh meat (Descalzo *et al.*, 2005).

Table 1. Least square means of fatty acids in subcutaneous fat over the *M. Longissimus dorsi* of lambs fattened in five different treatments.

	Control	Conc44	Conc24	Rye44	Rye24	P
Palmitic (C16:0)	27.4 <sup>ab</sup>	28.0 <sup>ab</sup>	28.3 <sup>a</sup>	27.1 <sup>b</sup>	27.0 <sup>b</sup>	0.05
Stearic (C18:0)	19.8 <sup>b</sup>	19.5 <sup>b</sup>	18.7 <sup>b</sup>	22.9 <sup>a</sup>	19.0 <sup>b</sup>	0.02
t-vaccenic (C18:1 <i>t</i> -11)	5.9 <sup>a</sup>	4.1 <sup>c</sup>	4.7 <sup>b</sup>	6.6 <sup>a</sup>	5.7 <sup>a</sup>	< 0.001
Oleic (C18:1 <i>n</i> -9)	32.2 <sup>b</sup>	35.2 <sup>a</sup>	34.3 <sup>a</sup>	31.3 <sup>b</sup>	34.6 <sup>a</sup>	0.004
Linoleic (C18:2 <i>n</i> -6)	1.38 <sup>ab</sup>	1.65 <sup>a</sup>	1.51 <sup>a</sup>	1.20 <sup>bc</sup>	0.99 <sup>c</sup>	< 0.001
$\alpha$ -Linolenic (C18:3 <i>n</i> -3)	1.66 <sup>a</sup>	0.96 <sup>b</sup>	1.52 <sup>a</sup>	1.59 <sup>a</sup>	1.59 <sup>a</sup>	< 0.001
<i>n</i> -6/ <i>n</i> -3	0.83 <sup>bc</sup>	1.80 <sup>a</sup>	1.00 <sup>b</sup>	0.78 <sup>c</sup>	0.63 <sup>c</sup>	< 0.001

<sup>ab</sup> Means with different superscript within a row differ significantly.

## Conclusion

The fatty acid composition of meat from lambs fed concentrate for more than four weeks prior to slaughter was changed unfavourably with respect to human dietary needs. This could indicate a need for separate marketing of meat subjected to pre-slaughter fattening for more than four weeks.

## References

- Aurousseau B., Bauchart D., Faure X., Galot A.L., Prache S., Micol D. and Priolo A. (2007) Indoor fattening of lambs raised on pasture: (1) Influence of the stall finishing duration on lipid classes and fatty acids in the *longissimus thoracis* muscle. *Meat Science* 76, 241-252.
- Descalzo A.M., Insani E.M., Biolatto A., Sancho A.M., García P.T., Pensel N.A. and Josifovich J.A. (2005) Influence of pasture or grain-based diets supplemented with vitamin E on antioxidant/oxidative balance of Argentine beef. *Meat Science* 70, 35-44.
- Lind V., Berg J., Eik L.O., Mølmann J., Haugland E., Jørgensen M. and Hersleth M. (2009) Meat quality of lamb: Pre-slaughter fattening on cultivated or mountain range pastures. *Meat Science* 83, 706-712.
- Resconi V.C., Campo M.M., Font I Furnols M., Montossi F. and Sañudo C. (2009) Sensory evaluation of castrated lambs finished on different proportions of pasture and concentrate feeding systems. *Meat Science* 83, 31-37.
- Sinclair L.A. (2007) Nutritional manipulation of the fatty acid composition of sheep meat: A review. *Journal of Agricultural Science Cambridge* 145, 419-434.

## Variation of fatty acid profile during the grazing season in cows' milk from mountain permanent meadows

Coppa M.<sup>1</sup>, Lonati M.<sup>1</sup>, Gorlier A.<sup>1</sup>, Falchero L.<sup>1</sup>, Cugno D.<sup>1</sup>, Lombardi G.<sup>1</sup> and Cavallero A.<sup>1</sup>  
<sup>1</sup>Dep. AGROSELVITER, University of Turin, Via L. da Vinci 44, I-10095, Grugliasco (TO)  
Corresponding author: mauro.coppa@unito.it

### Abstract

Evolution of milk fatty acid (FA) profile derived from three subsequent grazing events (GE) on the same alpine permanent meadow was compared on two farms. Bulk milk produced from two highly biodiverse paddocks (47 species) dominated by *Dactylis glomerata* and *Poa pratensis*, and managed under daily-ration grazing, was sampled for 3 days in succession during each GE, after 4 days of rumen adaptation on the same vegetation. Botanical composition and herbage dry matter (DM) content were surveyed on the day before each exploitation. GE effects were limited to few FA: short-chain saturated FA decreased along the season, while C15:0 and cis9trans11-CLA increased. Differences between farms and interactions farm × GE occurred for vaccenic, rumenic, linoleic, linolenic acids and for total polyunsaturated FA (PUFA). PUFA was less (i) when small quantities of hay were supplied to cows or at higher herbage DM content, or (ii) when the specific contribution of forbs to sward composition was high, particularly *Apiaceae* and *Geraniaceae*, which are reported as rich in secondary metabolites that could inhibit rumen PUFA bio-hydrogenation. Total saturated FA showed an opposite trend.

Keywords: milk fatty acid; permanent meadow; botanical diversity; lactation stage; herbage dry matter content; grazing season.

### Introduction

There is an increasing consumer demand for dairy products of high nutritional quality. Pasture-based extensive dairy farming could easily and cheaply satisfy this requirement. Nevertheless, it is necessary to ensure a constant quality production that could be difficult to maintain in season depending farming systems. This work aimed at evaluating the changes of fatty acid (FA) profile of milk derived from three subsequent exploitations by dairy cows in the same permanent alpine valley floor meadows during the grazing season, and understanding their main reasons for changes observed.

### Materials and methods

On two dairy farms in the valley floor of Valle Orco (south-west Alps) rearing Valdostana Red Pie cattle, two herds composed of primiparous and multiparous cows at various lactation stages grazed two highly biodiverse paddocks (47 species) dominated by *Dactylis glomerata* and *Poa pratensis*. Cattle grazed each paddock during three grazing events (GE) from April to October 2008 by daily rationed grazing. Botanical composition and herbage dry matter (DM) content were surveyed the day before each GE. As hay and concentrates were supplied to cows, their diet was registered and herbage intake measured as the difference between herbage allowance and residues after grazing. Farm bulk milks were sampled after four days of rumen adaptation on the same vegetation for three successive days during each GE. Milk samples were stored at -20 °C until fatty acid (FA) analysis. The FA contents were analysed with a repeated measures ANOVA, using GE as within-subject factor, farm as fixed factor. Their interaction was also tested. The each-day milk sample was assumed a statistical unit.

Table 1: Herd characteristics, cow diet and paddocks botanical composition (GE: grazing event; P: *Poaceae*; F: *Fabaceae*; D: other dicots; fl: flowering; fr: fructification; s: shooting; v: vegetative stage; DM: dry matter; SC: specific contribution).

Farm	1			2		
	905 m a.s.l.			685 m a.s.l.		
Altitude						
GE	1	2	3	1	2	3
Exploitation start date	12/5	9/7	8/9	28/4	13/8	6/10
Herd size (cows)	15	16	16	7	11	11
Early lactation cows (% herd)	0	6	0	0	36	0
Milk yield (kg cow <sup>-1</sup> day <sup>-1</sup> )	7.7	7.2	5.6	11.6	9.8	7.9
Supplementation DM (kg cow <sup>-1</sup> d <sup>-1</sup> )	2.7	2.7	2.7	3.2	3.2	3.2
Hay DM (kg cow <sup>-1</sup> day <sup>-1</sup> )	0	0	0	2.9	0	2.4
Herbage DM (kg cow <sup>-1</sup> d <sup>-1</sup> )	12.9	12.9	12.9	10.0	13.0	10.5
Herbage DM (% fresh weight)	24.2	25.6	21.7	22.3	27.2	23.6
	P:s	P:fr	P:v	P:v	P:fr	P:v
Sward phenology	F:v	F:fl	F:fl	F:v	F:fl	F:fl
	D:fl	D:fl	D:v	D:fl	D:fr	D:v
<b>Botanical composition</b>						
<i>Poaceae</i> (SC %)	31.6	42.6	42.1	63.3	36.0	45.4
<i>Fabaceae</i> (SC %)	16.7	19.1	21.1	3.5	8.3	8.8
<i>Asteraceae</i> (SC %)	17.3	6.9	15.8	15.1	13.3	19.9
<i>Apiaceae</i> (SC %)	7.4	5.3	1.0	0.8	12.4	8.1
<i>Polygonaceae</i> (SC %)	11.5	11.0	8.7	3.2	9.1	6.2
<i>Plantaginaceae</i> (SC %)	3.5	5.4	3.8	1.4	1.5	1.6
<i>Ranunculaceae</i> (SC %)	3.3	4.4	5.4	0.5	2.6	3.0
<i>Geraniaceae</i> (SC %)	0.0	0.4	0.0	0.3	5.3	2.2
<i>Lamiaceae</i> (SC %)	0.0	0.2	0.4	0.0	1.4	0.2

## Results and discussion

Table 1 summarises herd characteristics, cow diets and paddock botanical composition. GE affected the content of a limited number of FA (Table 2): short chain saturated FA (SFA) tended to decrease during the season, while C15:0, and cis9trans11-CLA increased, probably in relation to a combined effect of herbage intake and herbage DM content and phenology (Falchero *et al.*, 2009). Linoleic and linolenic acids were highest during GE2 when average herbage intake was higher (Couvreur *et al.*, 2006; Khanal *et al.*, 2008). Differences between farms occurred for the main saturated FA (except for C16:0 and C18:0) and for vaccenic and rumenic acid, as well as in a tendency for the total saturated, polyunsaturated FA and total fat. They may result from average lactation stage of the herds and differences in the composition of supplementation (Dewurst *et al.*, 2006). We observed interactions between farm and GE for vaccenic, rumenic, linoleic, linolenic acids, as well as for total polyunsaturated FA (PUFA), which were less when small quantities of hay were present in the diet or when herbage DM content was higher and the herbage aged. The high proportion of cows at an early lactation stage could have increased these effects (Palmquist *et al.*, 1993). Lower values of the above-mentioned FAs could also be related to a seasonal increase of forbs at the expense of *Poaceae*, particularly species of *Apiaceae* and *Geraniaceae*, which are reported as being rich in secondary metabolites that could inhibit PUFA rumen biohydrogenation (Leiber *et al.*, 2005). Total SFA showed an opposite trend.

## Conclusions

In general, FA profile was quite stable during the season. Farm and grazing event affected the content of some FA. Differences in herd lactation stage, the diet of cows, herbage quality and

composition explained these differences. Such factors could be easily managed through calving, diet and grazing management, aiming for a high nutritional milk quality throughout the season, thereby achieving consumer demand.

Table 2: Milk fat (g (100 g)<sup>-1</sup> of milk), FA profile (g (100 g)<sup>-1</sup> of FA methyl esters).

Fatty acid	GE 1	GE 2	GE 3	Farm 1	Farm 2	SEM	GE	Farm	GExFarm
Fat	3.69	3.19	3.71	3.78	3.28	0.227	ns	†	ns
C04:0	2.50 <sup>a</sup>	2.17 <sup>b</sup>	1.33 <sup>c</sup>	2.44	1.56	0.233	†	†	ns
C06:0	1.65 <sup>a</sup>	1.34 <sup>b</sup>	1.10 <sup>c</sup>	1.43	1.29	0.096	†	ns	ns
C08:0	1.03 <sup>a</sup>	0.80 <sup>b</sup>	0.82 <sup>b</sup>	0.83	0.93	0.047	†	ns	ns
C10:0	2.26 <sup>a</sup>	1.74 <sup>b</sup>	1.99 <sup>b</sup>	1.73	2.26	0.106	†	*	ns
C12:0	2.64 <sup>a</sup>	2.08 <sup>b</sup>	2.55 <sup>a</sup>	2.03	2.81	0.138	†	***	ns
C14:0	9.82	8.77	10.30	8.66	10.60	0.364	ns	**	ns
cis9-C14:1	1.23	1.06	1.27	1.06	1.31	0.073	ns	†	ns
C15:0	1.17 <sup>c</sup>	1.32 <sup>b</sup>	1.51 <sup>a</sup>	1.22	1.44	0.050	***	*	*
C16:0	26.46	26.45	27.58	26.91	26.76	0.427	ns	ns	ns
cis9-C16:1	1.15 <sup>a</sup>	1.00 <sup>b</sup>	0.98 <sup>b</sup>	1.14	0.94	0.037	**	*	*
C17:0	0.70	0.80	0.88	0.78	0.81	0.044	ns	ns	ns
cis9-C17:1	0.31	0.31	0.35	0.33	0.31	0.028	ns	ns	ns
C18:0	12.91	14.03	12.68	13.19	13.22	0.341	ns	ns	ns
cis9-C18:1	26.03	26.36	24.96	26.73	24.84	0.548	ns	ns	ns
trans11-C18:1	4.28	4.46	4.54	4.74	4.11	0.125	ns	*	*
C18:2n-6	1.94 <sup>c</sup>	2.48 <sup>a</sup>	2.28 <sup>b</sup>	2.27	2.20	0.074	**	ns	*
C18:3n-3	1.08 <sup>c</sup>	1.37 <sup>a</sup>	1.23 <sup>b</sup>	1.15	1.31	0.086	†	ns	*
cis9trans1-CLA	1.64 <sup>b</sup>	1.73 <sup>b</sup>	2.15 <sup>a</sup>	1.94	1.73	0.102	†	*	†
SFA	61.23	59.86	61.18	59.45	62.06	0.683	ns	†	†
MUFA	33.73	34.02	32.92	34.79	32.32	0.588	ns	ns	ns
PUFA	5.07	5.96	5.82	5.71	5.53	0.220	ns	†	†

GE: grazing event; SEM: mean standard error; small letters: significant differences to REGWQ post-hoc test; ns: not significant; †:  $P < 0.1$ ; \*:  $P < 0.05$ ; \*\*:  $P < 0.01$ ; \*\*\*:  $P < 0.001$

## Acknowledgements

Research project funded by Regione Piemonte. The authors would like to thanks C. Vernetti and D. and M. Aimonino for giving their farms at disposal for the trial.

## References

- Couvreur S., Hurtaud C., Lopez C., Delaby L. and Peyraud L. (2006). The linear relationship between the porportion of fresh grass in the cows diet, milk fatty acid composition, and butter proprieties. *Journal of Dairy Science* 89, 1965-1969.
- Dewhurst R.J., Shingfield K.J., Lee M.R.F. and Scollan N.D. (2006) Increasing the concentration of beneficial polyunsaturated fatty acids in milk produced by dairy cows in high-forage systems. *Animal Feed Science and Technology* 131, 168-206.
- Falchero L., Coppa M., Lonati M., Odoardi M. and Lombardi G. (2009). Milk fatty acid profile in relation to botanical and chemical composition of Alpine pasture. In: Agroscope Changins-Wädenswil Research Station ACW (eds) *15<sup>th</sup> FAO CIHEAM Mountain Pasture Network 7-9*, October, Led Diableretz Switzerland, 165-166.
- Khanal R.C., Dhiman T.R. and Boman R.L. (2008). Changes in milk fatty acid composition of milk from lactating dairy cows during transition to and from pasture. *Livestock Science* 114, 164-175.
- Leiber F., Kreuzer M., Nigg D., Wettstein H.R. and Scheeder M.R.L. (2005) A study of the causes for the elevated n-3 fatty acids in cows' milk of Alpine origin. *Lipids* 40, 191-202.
- Palmquist D.L., Beaulieu A.D. and Barbano D.M. (1993). Feed and animal factors influencing milk fat composition. *Journal of Dairy Science* 76, 1753-1771.

## Milk fatty acids and cheese from hay based diet and continuous or rotational grazing

Coppa M.<sup>1,2</sup>, Ferlay A.<sup>2</sup>, Monsallier F.<sup>3</sup>, Farruggia A.<sup>2</sup>, Pradel P.<sup>4</sup> and Martin B.<sup>2</sup>

<sup>1</sup>Dep. AGROSELVITER, University of Turin, Via L. da Vinci 44, I-10095, Grugliasco (TO)

<sup>2</sup>INRA, UR 1213 Herbivores, F-63122 Saint-Genès-Champanelle, France

<sup>3</sup>INRA, UR 545 Fromagères, Route de Salers F-15000 Aurillac, France

<sup>4</sup>INRA, UE 1296 Unité expérimentale des Monts d'Auvergne, F-15190 Marcenat, France

Corresponding author: mauro.coppa@unito.it

### Abstract

This work compares Cantal cheeses obtained from three groups of 12 Montbéliarde cows fed either a hay-based diet (H) or grazing two mountain pastures: a diversified pasture (74 species) grazed continuously (E) and a less diversified (31 species) old temporary grassland, grazed rotationally (R). Under controlled conditions 27 cheeses were manufactured during three consecutive days in early June, July and late August in 2008. Cheese H was, on average, firmer, less melting and less yellow than cheeses E and R, which did not differ. Total saturated FA (SFA) and monounsaturated FA (MUFA) percentages were respectively higher and lower in H milks than in pasture milks. Vaccenic and oleic acids and polyunsaturated FA (PUFA), cheese colour and melting texture decreased during the season in E, while they remained constant in R because of a combined effect of the grass vegetative stage and selective grazing. Our results underline the relationship between milk FA profile and cheese texture.

Keywords: Mountain pasture, milk fatty acids, cheese color, cheese texture

### Introduction

Cheese characteristics are reported by cheese-makers to be related to the type of forage supplied to dairy cows. Several studies have been carried out to understand the effects of animal feeding on milk fatty acid (FA) profile and cheese sensory properties (Martin *et al.*, 2005; Chilliard *et al.*, 2007). Differences in milk FA profile between pasture types have been proven (Falchero *et al.*, 2008), but little is known about the relative importance of the grassland type on cheese sensory properties, especially under experimental conditions. The aim of this work was to compare the FA profile of milk and the texture and colour of cheese deriving from a hay-based diet (H) or from two different grazing systems: continuous grazing on highly biodiverse pastures (E) or rotational grazing on intensively managed grassland (R).

### Material and methods

At the INRA experimental farm of Marcenat (mountain area of central France) three equivalent groups of 12 Montbéliarde dairy cows were used: the first group (H) was kept indoors and fed a concentrate and hay-based diet; the second one (E) grazed continuously at low stocking density (0.96 LU ha<sup>-1</sup>) a species-rich heterogeneous pasture (74 species; 12.5 ha); the third one (R) grazed rotationally at 1.56 LU ha<sup>-1</sup> an old temporary, less diversified (31 species) grassland (7.7 ha). Milk from two consecutive milkings was collected and cheese manufactured during 3 days in succession in June (P1), July (P2) and August (P3). Twenty-seven 10 kg Cantal type cheeses were produced from full-fat unpasteurised milk. Tanker milk FA composition was determined. Ten trained panellists analysed the cheeses after 3 months ripening for cheese texture and colour (6 attributes), giving scores within a 0-10 range. The

data were analysed using the MIXED procedure of SPSS (16.0) to assess the differences among feeding systems (fixed factor), periods (repeated factor) and their interaction.

Table 1: Seasonal variation of milk and cheese characteristics according to diet.

SEM = Standard error of the mean; T = treatment; P = period; E: continuous grazing; R: rotational grazing; H: hay; P1: June; P2: July; P3: August; ns: not significant; †:  $P < 0.1$ ; \*:  $P < 0.05$ ; \*\*:  $P < 0.01$ ; \*\*\*:  $P < 0.001$ ; <sup>a</sup>: Strength for 50% of sample deformation

	E			R			H			SE M	Effect		
	P1	P2	P3	P1	P2	P3	P1	P2	P3		T	P	TxP
<b>Milk</b>													
Fat (g l <sup>-1</sup> )	38.9	39.3	43.5	37.0	39.1	40.4	36.6	38.9	40.6	0.46	ns	***	ns
Protein (g l <sup>-1</sup> )	33.2	32.2	33.4	33.0	34.3	35.3	31.8	33.9	36.5	0.31	*	***	*
Fat/Protein	1.17	1.22	1.30	1.12	1.14	1.14	1.15	1.15	1.11	0.01	***	ns	*
<b>Cheese</b>													
Fat/DM	52.7	52.8	53.9	52.2	51.6	51.6	52.2	51.6	50.6	0.21	***	ns	†
Strength <sup>a</sup> (N cm <sup>2</sup> )	4.81	5.19	4.23	4.53	6.11	6.21	6.40	7.84	7.32	0.30	**	ns	ns
Yellowness (b)	22.8	22.6	19.9	21.6	23.1	22.1	17.9	18.0	15.7	0.51	***	***	†
Firmness (0-10)	5.43	4.93	5.00	4.86	5.14	5.28	5.44	5.53	6.50	0.07	***	ns	**
Meltingness (0-10)	4.60	4.49	4.80	4.49	4.68	4.27	4.40	4.19	3.80	0.07	**	ns	ns
Paste colour (0-10)	7.24	6.36	5.64	6.14	5.93	6.72	4.45	3.54	4.25	0.05	***	***	***

## Results and discussion

Milk fat and protein contents increased during the season due to the evolution of the stage of lactation (Table 1). Milk protein content was significantly lower in E than in R and H milks (-1.2 g l<sup>-1</sup>), especially during P2 and P3, probably because of the low grass quality and the low energy intake. Consequently, E milk had higher fat/protein ratio than R and H milks (+9.5). Myristic and palmitic acids and total SFA (Figure 1) were more in FA of H than of E and R milks (+2.1, +7.5 and +6.4 g (100 g)<sup>-1</sup>, respectively). In contrast, total MUFA and total PUFA were more in pasture milk (+5.9 and +2.0 g (100 g)<sup>-1</sup>). SFA, MUFA and PUFA did not differ in E and R milks but milk from pasture during P1 had a lower SFA and a higher MUFA content because of the earlier grass phenological stage. For E milk, the higher content of  $\alpha$ -linolenic acid (+0.21 g (100 g)<sup>-1</sup> of FA) could indicate a lower rumen bio-hydrogenation of this FA as suggested for species-rich pastures (Chilliard *et al.*, 2007). The FA in E milk were also richest in stearic (+3.1 g (100 g)<sup>-1</sup>) and oleic acids, which probably resulted from lipomobilisation of the animals at least during P3. Rumenic acid (1.6, 2.2 and 0.6 g (100 g)<sup>-1</sup> for E, R and H) and vaccenic acid contents (3.8, 4.3 and 1.1 g 100g<sup>-1</sup> for E, R and H) were higher in FA of R than E milk, especially in P2 and P3 when animals could graze vegetative regrowths in R while the grass was more aged for E pasture. The content of rumenic, vaccenic acids and PUFA tended to remain stable during the season in R, while it decreased sharply in E ( $P < 0.001$ ), probably because of a combined effect of grass phenological stage and cow grazing selection (Coppa *et al.*, 2009). The oleic/palmitic acid ratio, which is a good indicator of milk fat melting point, was higher in E and R than in H milks (+0.27).

Cheese DM contents did not vary with treatment and period, while fat/DM ratio was higher in E than in R and H cheeses (+1.5), because of the higher fat/protein ratio in E milk, especially in P3. The H cheeses were firmer (+0.7) and less melting (-0.5) than E and R ones. The instrumental texture measurement confirmed these differences. The firmer texture of hay-based diet vs. pasture cheeses has been already observed by Martin *et al.* (2005), in relation to the higher melting point of H milk fat. Indeed, the proportions of FA having a high melting point (C14:0; C16:0; C18:0) were higher in H milks at the expense a low melting point FA (MUFA and PUFA). Although the texture of E and R cheeses was similar on average during the season, a significant interaction between period and treatment was observed: during P1, E cheeses were firmer than R, while the reverse was true during P3. E cheeses also had a softer

texture than R and H ones (-0.5), which could be related to fat/DM ratio of E cheeses. On average, the paste was less yellow for H than for pasture cheese both evaluated visually by the panel (+2.2) and instrumentally (b index, +4.8), confirming literature data (Martin *et al.*, 2005). R cheese colour score was constant over the season while it decreased in E, both with panel evaluation and instrumental measurement (Table 1). Interaction could be explained by the forage content of  $\beta$ -carotene, which decreased with sward maturity (Nozière *et al.*, 2005), especially in E, while cows could always exploit better quality swards in R.

Figure 1: Seasonal variation of milk FA profile according to diet. E = continuous grazing; R = rotational grazing; H = hay-based diet; T = treatment; P = period; I = interaction TxP; E: continuous grazing; R: rotational grazing; H: hay; P1: June; P2: July; P3: August; ns: not significant; \*:  $P < 0.05$ ; \*\*:  $P < 0.01$ ; \*\*\*:  $P < 0.001$ .

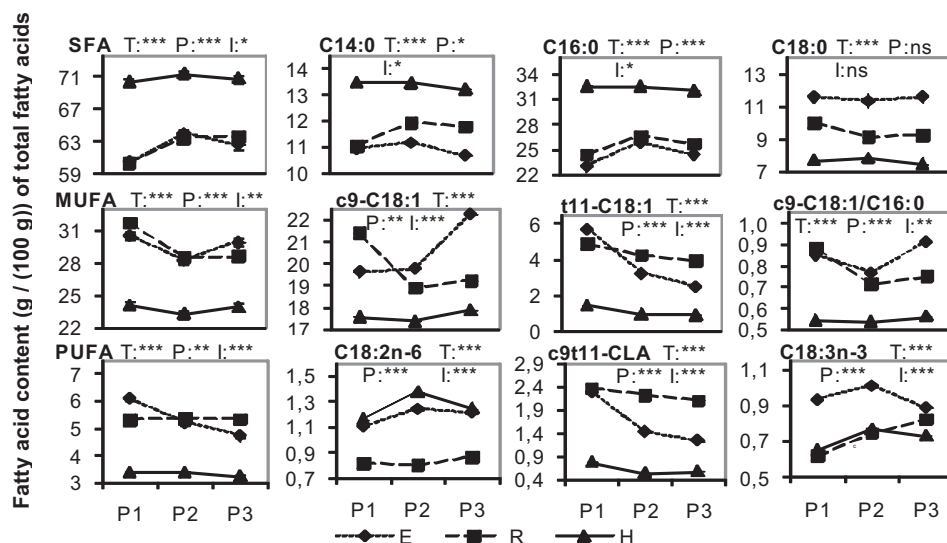

## Conclusions

The experiment confirmed that cheese sensory properties are affected by cows' diet (hay vs. pasture) and that milk FA profile affects texture. Differences in vegetative stage of grass species and animal feeding behaviour between the two grazing systems explained the evolution of milk FA composition and cheese texture across the season.

## References

- Chilliard Y., Glasser F., Ferlay A., Bernard L., Rouel J. and Doreau M. (2007) Diet, rumen biohydrogenation and nutritional quality of cow and goat milk fat. *European Journal of Lipid Science and Technology* 109, 828-855.
- Coppa M., Farruggia A., Pradel P., Lombardi G. and Martin B. (2009) How does grazing management influence selection and foraging behaviour of dairy cows on upland pastures? *15<sup>th</sup> Meeting of the FAO-CIHEAM Mountain Pastures Network*. 7-9 October, Les Diablerets, Switzerland.
- Falchero L., Coppa M., Fossi A., Lombardi G., Lonati M. and Cavallero A. (2008). Variation of milk fatty acid composition depending on the alpine vegetation type grazed by dairy cows. *5<sup>th</sup> IDF symposium on cheese ripening*. 9-13 March, Bern, Switzerland.
- Martin B., Verdier-Metz I., Buchin S., Hurtaud C. and Culon J.B. (2005) How do nature of forages and pasture diversity influence the sensory properties of dairy livestock products? *Animal Science* 81, 205-212.
- Nozière P., Graulet B., Lucas A., Martin B., Grolier P. and Doreau M. (2006) Carotenoids for ruminants: from forages to dairy products. *Animal Feed Science and Technology* 131, 418-450.



## Milk production and composition of day and night grazing of cows fed a total mixed ration

Hernández-Ortega M., Morales-Almaráz E., Martínez-Fernández A., de la Roza-Delgado B. and Vicente F.

*Department of Animal Nutrition, Grasslands and Forages. Regional Institute for Agro-Food, Research and Development (SERIDA). PO Box 13; E-33300 Villaviciosa (Asturias), Spain.*

Corresponding author: fvicente@serida.org

### Abstract

The possibilities of using high quality pastures in conjunction with total mixed ration (TMR) feeding during the grazing season have been examined. The aim of this study was to determine the influence of time of grazing and TMR type as supplementation on milk production and milk composition. A trial was performed with 16 lactating Holstein cows divided into four groups during four experimental periods of 21 days each. Two TMRs, based on grass or maize silage, combined with 12 hours of grazing at day or at night, were evaluated with a 2 x 2 factorial arrangement change-over design. Total dry matter intake was higher with the grass silage-based TMR than with the maize silage-based TMR. Cows grazing during the day consumed more TMR indoors than cows grazing during the night. Treatments did not affect milk production, milk protein or lactose contents. Milk fat was higher in cows feeding on a grass silage-based TMR and grazing at night than for any of the other treatments.

Keywords: Grazing timing, total mixed ration, dairy cows, milk

### Introduction

Using pasture during the grazing season as part of the diet could reduce feed costs and benefit herd health. However, grazing alone cannot meet the nutritional requirements of high production dairy cows, particularly in early lactation, and supplementation is required to provide the energy required for an animal's genetic potential to be fully reached. Supplementation with a total mixed ration (TMR) could help produce high yields of milk while enhancing protein and fat contents. The effect of pasture relative to TMR on milk production and composition, and on feed savings, has been reported by several authors (Soriano *et al.* 2001; Vibart *et al.* 2008). However, it is necessary to find if the time of grazing (day or night) influences milk production and milk composition. The aim of this work was to compare milk production and composition and TMR intake between cows fed TMR *ad libitum* and grazing for 12 hours during the day or at night, both with high quality pasture.

### Materials and methods

Sixteen Holstein dairy cows (live weight  $648 \pm 20$  kg; milk  $31.2 \pm 2.0$  L d<sup>-1</sup>) in the first third of lactation were blocked into four groups and randomly assigned to four treatments:

- 1) EHD, feeding a grass silage-based TMR with day grazing;
- 2) EHN, feeding a grass silage-based TMR with night grazing;
- 3) EMD, feeding a maize silage-based TMR with day grazing and;
- 4) EMN, feeding a maize silage-based TMR with night grazing.

Two TMRs were designed for cows giving 30 L d<sup>-1</sup> milk including maize (EM) or grass (EH) silages as conserved forages, cereal straw, alfalfa, and concentrate offered *ad libitum*. Cows on day grazing (EHD and EMD) were moved to a fresh paddock after morning milking and kept indoors at night, while cows on night grazing (EHN and EMN) were moved to a fresh

paddock after evening milking and kept indoors in the day. Cows were kept in a rotational grazing area with a botanical composition typical for an oceanic climate with grasses (*Agrostis tenuis* Sibth., *Dactylis glomerata* L., *Lolium perenne* L.), legumes (*Trifolium repens* L., *Vicia cracca* L) and other species (*Hypochoeris radicata* L., *Leontodon* sp.). The area used was 4.75 ha and was divided into 4 paddocks. After an adaptation period of fourteen days, the TMR intake and milk production were recorded daily during the assay period (seven days). The TMR (offered and refused) and milk production from both milkings, were sampled daily. Pastures were sampled on the first and last days in each assay period. Feedstuffs and pasture were dried at 60 °C for 24 h, to determine dry matter (DM), then ground (0.75 mm) and analysed by near infrared reflectance spectroscopy for organic matter, crude protein (CP), neutral detergent fibre (NDF), acid detergent fibre and starch. Milk samples were analysed by a MilkoScan FT6000. Statistical analysis was performed in SAS (1999) using the GLM procedure for a 2 x 2 Latin square design.

## Results and discussion

Forage and TMR nutritive values are shown in Table 1. The protein content in DM of both TMRs was similar at around 142 g kg<sup>-1</sup>. Including maize silage in EM increased the starch concentration and, consequently, the net energy content. The grazed pasture had a high nutritive value with 215 g CP kg<sup>-1</sup> DM, 454 g NDF kg<sup>-1</sup> DM, and 1.67 Mcal kg<sup>-1</sup> DM.

Table 1. Nutritive value of forage and total mixed rations based on maize (EM) or grass (EH) silage.

	EM	EH	Forage
Dry matter (DM), g kg <sup>-1</sup>	522	496	120
Organic matter in DM, g kg <sup>-1</sup>	913	894	896
Crude protein in DM, g kg <sup>-1</sup>	141	144	215
Neutral detergent fibre in DM, g kg <sup>-1</sup>	403	434	454
Acid detergent fibre in DM, g kg <sup>-1</sup>	251	263	230
Starch in DM, g kg <sup>-1</sup>	196	150	ND
Net Energy <sup>1</sup> in DM, Mcal kg <sup>-1</sup>	1.57	1.49	1.67

<sup>1</sup> NRC (2001); ND: No determined

Table 2. Dry matter intake (DMI) of total mixed ration (TMR), milk production and composition under different dairy cows feeding strategies.

	Day grazing		Night grazing		MSE	Significance <sup>1</sup>		
	EMD	EHD	EMN	EHN		S	T	S x T
DMI TMR, kg d <sup>-1</sup>	13.2	14.9	12.3	12.9	0.31	0.07	*	NS
Milk yield and composition								
Milk yield, kg d <sup>-1</sup>	31.2	30.7	32.3	31.2	0.30	NS	NS	NS
Milk protein, g kg <sup>-1</sup>	31.9	32.2	31.7	31.7	0.01	NS	NS	NS
Milk fat, g kg <sup>-1</sup>	31.9	32.9	32.7	34.3	0.03	0.08	NS	NS
Milk lactose, g kg <sup>-1</sup>	49.8	49.5	49.8	49.7	0.01	NS	NS	NS

EMD: TMR with maize silage and day grazing; EHD: TMR with grass silage and day grazing; EMN: TMR with maize silage and night grazing; EHN: TMR with grass silage and night grazing; <sup>1</sup>Significant statistical probabilities \**P*<0.05; NS: Non Significant; S: effect of type of silage in TMR; T: effect of time of grazing; S x T: Interaction

Dry matter intake was higher for cows grazing in the day than for cows grazing at night (Table 2). However, milk production was not affected by the treatments in spite of the lower intake with night grazing. Milk protein and lactose yields were not affected by the feeding

strategies, but the milk fat content tended to be higher for EH than EM ( $P=0.08$ ), most likely because of the lower NDF concentration of NDF in EM treatment.

As consequence of the greater TMR intake with day grazing, cows spend less time in active grazing than cows grazing at night. This agrees with known grazing animal behaviour, that is, the majority grazing activity occurs between dawn and dusk (Hodgson, 1985). These results are accordance with those observed by Soriano *et al.* (2001), where grazing cows supplemented with corn spent more time grazing after the evening milking than the morning milking. Our results could provide an alternative for farmers to adopt a good compromise between feeding and yield, because cows have two different grazing periods of sunrise or sunset.

## Conclusion

Cows grazing between evening and morning milkings saved 1.5 kg of TMR per day without affecting milk production and composition. Differences in TMR intake suggest that the most economical returns were obtained by grazing after evening milking and by allowing cows to feed TMR during the day.

## Acknowledgements

Work supported by Spanish Project INIA RTA 2007-0058-C02. Stage of Ms Hernández-Ortega and Mr. Morales-Almaráz are financed by CONACYT-México.

## References

- Hodgson J. (1985) Ingestive behaviour. In: J.D. Leaver (ed.) *Herbage intake handbook*. British Grassland Society, Berkshire, UK, pp.113-138.
- NRC (2001) *Nutrient requirements of dairy cattle 7th rev.* National Research Council, National Academy Press, Washington, DC, 381 pp.
- SAS (1999) *SAS (Statistical Analysis System) Institute, SAS/STAT<sup>TM</sup>. User's guide*, SAS Institute, Inc. 10. Carry, NC, 378 pp.
- Soriano F.D., Polan C.E. and Miller C.N. (2001) Supplementing pasture to lactating Holsteins fed a total mixed ration diet. *Journal of Dairy Science* 84, 2460-2468.
- Vibart R.E., Fellner V., Burns J.C., Huntington G.B. and Green Jr J.T. (2008) Performance of lactating dairy cows fed varying levels of total mixed ration and pasture. *Journal of Dairy Research* 75, 471-480.

# Fatty acids and antioxidant profiles in summer milk from different biodynamic and conventional systems in Southern Germany

Kusche D., Ruebesam K. and Baars T.

Kassel University, Department for Biodynamic Agriculture, Nordbahnhofstr. 1, 37213 Witzenhausen, Germany

Corresponding author: daniel.kusche@uni-kassel.de

## Abstract

Milk quality at biodynamic and conventional dairy farms was evaluated. Bulk milk samples were taken bimonthly on 24 farms in Southern Germany. Four groups, each of six farms, were representing characteristic farming systems: biodynamic high-input (BHI), biodynamic low-input (BLI), conventional high-input (CHI) and conventional low-input (CLI). Current feeding, pasture and performance of the cows were registered. The fatty acid (FA) compositions, as well as  $\alpha$ -tocopherol, retinol and  $\beta$ -carotene were analysed. Biodynamic farms had a lower concentrate input in the ration than conventional farms. Otherwise, BLI and CLI cows were essentially fed with grass combined with a small proportion of hay, BHI cows with about similar quantities of both grass and silage, and CHI cows essentially with silage. BLI and then CLI milk showed the highest levels of conjugated linoleic acid and n-3 FAs compared to both high-input systems due to the highest intake of grass. In both biodynamic milks  $\alpha$ -tocopherol and  $\beta$ -carotene levels were highest. Summer milk from biodynamic and from low-input conventional systems could be differentiated from CHI by FA and antioxidant profiles and shows a nutritional beneficial milk composition.

Keywords: organic milk quality, fatty acid profile, antioxidant profile

## Introduction

Milk from organic and from low-input systems has higher n-3 fatty acids (FA), conjugated linoleic acids (CLA) and selected antioxidant (AO) concentrations than conventional milk (Butler *et al.*, 2008). In a health and nutrition study the incidence of eczema in two-year-old infants was lower in children consuming organic dairy products, like their mothers during pregnancy and breastfeeding (Kummeling *et al.*, 2008). In our study we evaluated in a system-comparison how milk quality was affected through different farming strategies: low input (LI) versus high-input (HI) in both biodynamic (B) and conventional (C) systems. The main question was: which management factors at the farms are responsible for the differences in milk quality?

## Material and methods

*Farms, groups:* On 24 farms in Southern Germany (Franken/Hohenlohe und Allgäu/Bodensee), divided into four groups (BLI, BHI, CLI and CHI), bulk milk samples were taken in May, July and September in 2008. Animal breed, animal feeding, pasture and milk performance of the cows were registered.

*Sampling:* Bulk tank milk samples (total n = 72) were taken at the same day on all 24 farms and transported at 5°C. Samples for the analysis of FAs were deep-frozen at -1°C within 24 hours. Fresh cooled milk was delivered within 24 hours for the analysis of AO.

*Analysis of FA and AO:* Lipid extraction, preparation of FA methyl esters and analysis by gas chromatography were performed according to Kraft *et al.* (2003). High performance liquid

chromatography was used for the analysis of AO according to Schweizerisches Lebensmittelhandbuch (2005).

Statistics were performed by jmp 8.0 using ANOVA with a Post hoc Tukey test.

Table 1. Average estimated composition of the dry matter ration of different groups of farms during summer in kg cow<sup>-1</sup> d<sup>-1</sup>.

Group	Grazed and fresh cut grass	Hay	Grass/(clover) Silage	Maize silage	Concentrates
Biodynamic low-input	12.5	2.0	0.0	0.0	1.0
Biodynamic high-input	5.5	1.8	6.8	1.7	1.8
Conventional low-input	9.3	3.2	0.0	0.0	3.5
Conventional high-input	1.2	0.3	5.9	3.6	7.1

## Results

Each group showed a characteristic management profile: BHI mainly used high yielding milking breeds (Holstein Friesian, HF), mixed roughage of fresh grass and silage plus concentrates aiming for a higher milk performance; BLI, localized in traditional grassland regions used mainly local, dual-purpose breeds (German Brown Cattle, BC), cows were fully grazed, a low concentrate input, aiming for a lower milk performance; CHI were mainly indoor-fed cows, used modern milking breeds (HF), silage and concentrates, aiming for a higher milk performance and CLI, also localized in traditional grassland regions, used partly pasturing during summer, also including local, dual-purpose breeds (BC and German Simmental), concentrates, and aiming for a higher milk performance. BLI had the highest grazed and fresh cut grass share and lowest concentrates input without any additional silage (Table 1). BLI showed the highest contrast with CHI, which used high inputs of silage, fodder maize and concentrates.

Table 2. Concentrations of selected fatty acids, antioxidants and milk performance in the different groups of farms in summer milk (n = 72), comparison within group, between farming system and between intensification level.

	Group				Farming system			Intensification level		
	BLI	BHI	CLI	CHI	B	C	P value	LI	HI	P value
n-3 in milkfat (mg g <sup>-1</sup> )	16.4 a	11.6 b	12.2 b	8.8 c	14.0	10.5	<.0001	14.2	10.2	<.0001
CLA in milkfat (mg g <sup>-1</sup> )	16.4 a	11.2 bc	14.1 ab	7.7 c	13.9	10.9	.002	15.2	9.6	<.0001
α-Tocopherol in milk (μg l <sup>-1</sup> )	977 a	836 ab	695 b	658 b	904	676	<.0001	836	745	.066
Retinol in milk (μg l <sup>-1</sup> )	340	374	394	388	356	391	.023	366	381	.336
β-Carotene in milk (μg l <sup>-1</sup> )	158 a	136 ab	120 bc	98 c	147	109	<.0001	139	117	.004
SFA in milkfat (mg g <sup>-1</sup> )	684.2	699.8	695.8	699.4	692.0	697.6	.383	690.0	699.6	.136
MUFA in milkfat (mg g <sup>-1</sup> )	268.5	264.2	263.8	268.5	266.4	266.1	.972	266.2	266.3	.976
PUFA in milkfat (mg g <sup>-1</sup> )	47.3 a	36.0 bc	40.4 b	32.2 c	41.6	36.3	<.0001	43.8	34.1	<.0001
Milk performance (kg yr <sup>-1</sup> )	4836 c	6307 b	7335 a	7890 a	5578	7612	<.0001	6092	7099	<.0001

Different letters mark a significant difference in between the four system groups ( $P < .0001$ ); B = Biodynamic; C = Conventional, HI = High-input; LI = Low-input; n-3 = n-3 fatty acids, CLA = conjugated linoleic acids; SFA = saturated fatty acids; MUFA = mono unsaturated fatty acids; PUFA = poly unsaturated fatty acids.

High concentrations of n-3 FA and CLA occurred in low-input systems, with highest levels in BLI (Table 2). B milks had the highest levels of  $\alpha$ -tocopherol and  $\beta$ -carotene, whereas levels of retinol were higher in C milks. Milk performance levels were higher in conventional systems. Polyunsaturated fatty acids (PUFA) were higher in milk from low-input systems, while the levels of saturated- and mono unsaturated fatty acids were similar within all groups.

## Discussion and conclusions

BLI milk contained the highest concentrations of CLA and n-3 FA. Second highest was the CLI milk; these results were in accordance with Butler *et al.* (2008).  $\alpha$ -Tocopherol and  $\beta$ -carotene were higher in both B than in C milks. BLI farms had the highest share of grass in the ration compared to the other groups which affected the FA and AO profiles. Although Moltenkin (2009) suggested that milk from organic origin could be distinguished from conventional milk on the basis of n-3 FA concentrations and the carbon stable isotope ratio, this study, which only analysed the n-3 FA concentrations, showed differences in n-3 FA concentration only between the two most differentiating systems in terms of intensification level (BLI and CHI). The two systems in between (BHI and CLI) showed similarities in their FA and AO profiles. BLI milk had a characteristic and nutritional beneficial milk composition. We concluded that this unique selling proposition might get lost if intensification of organic dairy production systems prevails. High levels of concentrates, and especially maize silage, reduced the quality of the FA profiles, which has also been shown in other studies (Kliem *et al.*, 2008).

## Acknowledgements

Many thanks to Prof. Dr. G. Jahreis and his team at the Friedrich Schiller University in Jena for the opportunity to use his laboratory facilities to analyse the fatty acids.

## References

- Butler G., Nielsen J.H., Slots T., Seal C. Eyre M.D., Sanderson R. and Leifert C. (2008) Fatty acid and fat soluble antioxidant concentrations in milk from high- and low-input conventional and organic systems: seasonal variations. *Journal of the Science of Food and Agriculture* 88, 1431-1441.
- Kliem K.E., Morgan R., Humphries D.J., Shingfield K.J. and Givens D.I. (2008) Effect of replacing grass silage with maize silage in the diet on bovine milk fatty acid composition. *Animal* 12, 1850-1858.
- Kraft J., Collomb M., Möckel P., Sieber R. and Jahreis G. (2003) Differences in CLA isomer distribution of cow's milk lipids. *Lipids* 38, 139-144.
- Kummeling I., Thijs C., Huber M., van de Vijver L.P.L., Snijders B.E.P., Penders J., Stelma F. and van Ree R. (2008) Consumption of organic foods and risk of atopic disease during the first 2 years of life in the Netherlands. *British Journal of Nutrition* 99, 598-605.
- Molkentin J. (2009) Authentication of organic milk using  $\delta^{13}C$  and the r-linolenic acid content of milk fat. *Journal of Agricultural Food Chemistry* 57, 785-790.
- Schweizerisches Lebensmittelhandbuch (2005) *Kapitel 62 Vitamine, Untersuchungsmethoden, 1.2.1 Bestimmung der Vitamine A und E mittels Umkehrphasen-HPLC*. Online database, <http://www.slmb.admin.ch/slmb/index.html>

## Effect of the reduction of indoor supplementation on grazing time and sheep milk quality

Mandaluniz N.<sup>1</sup> Barrón L.J.R.<sup>2</sup>, Amores G.<sup>2</sup>, Arranz J.<sup>1</sup>, Virto M.<sup>2</sup>, Abilleira J.E.<sup>2</sup>, Aldezabal A.<sup>2</sup>, Ruiz de Gordo J.C.<sup>2</sup>, Nájera A.I.<sup>2</sup>, Ruiz R.<sup>1</sup>, Albisu M.<sup>2</sup>, Pérez-Elortondo F.J.<sup>2</sup> and de Renobales M.<sup>2</sup>

<sup>1</sup> NEIKER-Tecnalia, Vitoria-Gasteiz, Spain.

<sup>2</sup> University of the Basque Country (UPV-EHU), Vitoria-Gasteiz, Spain

Corresponding author: nmandaluniz@neiker.net

### Abstract

During recent years there has been a significant research effort to modify milk composition in order to increase the concentration of healthy compounds as conjugated linoleic acids (CLA). According to these studies, grazing increases CLA content in the resulting milk. The objective of the current study was to evaluate the effect of the amount of indoor supplementation on grazing time and on the amount and quality of the resulting milk. The experiment was conducted with an experimental flock of Latxa dairy sheep during 4 weeks in spring 2008. Sheep were separated into 3 homogeneous groups of 12 sheep each and randomly assigned to different amounts of indoor alfalfa hay supplementation. According to the results, reducing indoor supplementation significantly increased pasture grazing while maintaining milk yield. The resulting milk of these groups showed healthier characteristics (higher content of CLA and higher antioxidant capacity).

Keywords: antioxidant capacity, dairy sheep, indoor supplementation, fatty acid profile, grazing time

### Introduction

In recent years consumers have become increasingly interested in foods containing compounds that provide health benefits (as conjugated linoleic acid isomers due to their positive biological activity: antiatherogenicity, anticarcinogenicity, etc.). Consequently, there has been a significant research effort to modify milk composition in order to increase the concentrations of these fatty acids. According to these studies, grazing increases the concentration of CLA in the resulting milk (Atti *et al.*, 2006; Jenkin *et al.*, 2006). Moreover, feed also has an important effect on the concentration of various compounds that exhibit antioxidant capacity (Havemose *et al.*, 2004).

In the Basque Country (northern Spain) Latxa dairy sheep production systems are based on part-time grazing during the spring milking period. Pasture feeding is supplemented with indoor forage (alfalfa and grass hay) and concentrate to meet production requirements. The main objective of the current study was to evaluate the effect of the amount of indoor supplementation (low, intermediate, high) on grazing time and on the quantity (milk yield) and quality (fatty acid profile and antioxidant capacity) of the resulting milk.

### Materials and methods

The experiment was conducted in an experimental flock of Latxa dairy sheep during 4 weeks in spring 2008 after one week of adaptation. Sheep were separated into 3 homogeneous groups of 12 sheep each and randomly assigned to 4 hours pasture access (at a polyphite pasture) and 3 different alfalfa hay supplements: 300 g d<sup>-1</sup> (Group 1), 600 g d<sup>-1</sup> (Group 2), and



900 g d<sup>-1</sup> (Group 3). A fourth group (Group 0) received 600 g d<sup>-1</sup> alfalfa hay and was not allowed to graze outdoors. All animals received 500 g d<sup>-1</sup> concentrate at milking.

Grazing time was visually monitored once a week. Whole milk was centrifuged to separate the cream, fat was extracted by the method of Folch *et al.* (1957) and fatty acids (FA) were methylated with sodium methoxide (Christie, 1982). Separation of fatty acid methyl esters was accomplished on a 100% dimethylpolysiloxane column using a Hewlett Packard Gas Chromatograph equipped with a split-splitless injector, flame ionization detector and autosampler. Quantification of fatty acids was done using nonanoic and heptadecanoic acids as internal standards added to the sample at the time of extraction. Finally, total antioxidant capacity in the sheep milk samples was measured by the spectrophotometric method of Re *et al.* (1999) as modified by Chen *et al.* (2003). Data were analysed considering as fixed effects alfalfa rate, week and initial values of each parameter as covariate.

## Results and discussion

According to the results, pasture ingestion made no differences ( $P > 0.05$ ) to milk yield or composition (Table 1), but the concentration of the c9t11 isomer in the resulting milk of Group 2 was over two-fold higher ( $P < 0.05$ ) than that of Group 0 (Table 2). The antioxidant capacity in the groups with highest grazing time (Groups 2 and 3) was also significantly higher than in the other groups (Table 2).

Table 1. Effect of grazing (0 vs. 4 hours pasture access per day) and amount of indoor alfalfa (low, middle, high) on milk yield, milk composition (% protein and fat) and grazing time.

Group	0	2	1	3
Amount of alfalfa	Middle	Middle	Low	High
Milk Yield (L d <sup>-1</sup> )	1.03 ± 0.22 <sup>a</sup>	1.32 ± 0.32 <sup>a</sup>	1.36 ± 0.35 <sup>a</sup>	1.46 ± 0.30 <sup>a</sup>
Protein (%)	5.05 ± 0.34 <sup>a</sup>	4.88 ± 0.45 <sup>a</sup>	5.05 ± 0.49 <sup>a</sup>	4.96 ± 0.47 <sup>a</sup>
Fat (%)	6.98 ± 0.89 <sup>a</sup>	6.12 ± 1.00 <sup>a</sup>	6.34 ± 1.12 <sup>a</sup>	6.30 ± 0.95 <sup>a</sup>
Grazing time (min (4 h) <sup>-1</sup> )	0	228 ± 8 <sup>a</sup>	224 ± 6 <sup>a</sup>	209 ± 14 <sup>b</sup>

Table 2. Effect of grazing and amount of indoor alfalfa on milk quality (fatty acid profile, atherogenicity index, and antioxidant capacity).

Group	0	2	1	3
Amount of alfalfa	Middle	Middle	Low	High
Total FA <sup>a</sup>	3509 ± 299 <sup>a</sup>	3716 ± 443 <sup>a</sup>	4415 ± 393 <sup>b</sup>	3929 ± 242 <sup>a</sup>
Unsaturated FA <sup>a</sup>	849 ± 113 <sup>a</sup>	917 ± 147 <sup>a</sup>	1186 ± 214 <sup>b</sup>	953 ± 100 <sup>a</sup>
CLA (isomer c9t11) <sup>a</sup>	15.88 ± 3.83 <sup>a</sup>	34.39 ± 8.44 <sup>c</sup>	50.25 ± 14.49 <sup>b</sup>	32.95 ± 10.32 <sup>c</sup>
short FA (C4-C10) <sup>a</sup>	1020 ± 69 <sup>a</sup>	1171 ± 129 <sup>c</sup>	1368 ± 64 <sup>b</sup>	1216 ± 150 <sup>c</sup>
medium FA (C12-C14) <sup>a</sup>	508 ± 38 <sup>a</sup>	522 ± 52 <sup>a</sup>	564 ± 12 <sup>b</sup>	555 ± 24 <sup>a,b</sup>
long FA (≥ C16) <sup>a</sup>	1980 ± 200 <sup>a</sup>	2023 ± 270 <sup>a</sup>	2482 ± 326 <sup>b</sup>	2156 ± 189 <sup>a,b</sup>
AI <sup>b</sup>	2.93 ± 0.32 <sup>a</sup>	2.69 ± 0.29 <sup>a,b</sup>	2.25 ± 0.40 <sup>b</sup>	2.72 ± 0.21 <sup>a</sup>
Antioxidant capacity <sup>c</sup>	2762 ± 109 <sup>a</sup>	2967 ± 112 <sup>b</sup>	3022 ± 234 <sup>b</sup>	2703 ± 120 <sup>a</sup>

<sup>a</sup> units: μmol g<sup>-1</sup> fat

<sup>b</sup> AI: Atherogenicity Index calculated according to the formula [C12:0 + (4 × C14:0) + C16:0] / total unsaturated FA (Ulbricht and Southgate, 1991)

<sup>c</sup>: antioxidant capacity units: μmol Trolox® equivalents/g protein

Focusing on the three grazing groups, grazing time increased significantly as indoor supplementation was reduced (Table 1). However, milk yield and quality for Groups 1 and 2 were not significantly different ( $P < 0.05$ ) from Group 3, which had higher alfalfa intake (Table 1). The resulting milk from the low indoor supplementation group (Group 1) had significantly higher amounts of CLA, lower AI (calculated as Ulbricht and Southgate, 1991) and higher antioxidant capacity (Table 2).

## Conclusion

These results show that there is the possibility to increase grazing by reducing indoor feeding, thus increasing the use of locally available resources, without compromising milk yield and quality. In conclusion, in this system no productive advantage is achieved by offering more than 600 g d<sup>-1</sup> alfalfa DM and this management could be interesting in areas with enough pasture availability due to its positive effects on the presence of CLA and unsaturated FA and higher antioxidant capacity in milk.

## Acknowledgements

Financial support was provided by the Spanish Instituto Nacional de Investigación y Tecnología Agraria y Alimentaria (INIA) RTA2006-00100-C02-01 and RTA2006-00100-C02-02.

## References

- Havemose M.S., Weisbjerg M.R., Bredie W.L.P. and Nielsen J.H. (2004) Influence of feeding different types of roughage on the oxidative stability of milk. *International Dairy Journal* 14, 563-570.
- Christie W.W. (1982) A simple procedure for rapid transmethylation of glycerolipids and cholesteryl esters. *Journal of Lipid Research* 23, 1072-1075.
- Folch J., Lees M. and Stanley G.H.S. (1957) A simple method for the isolation and purification of total lipids from animal tissues. *Journal of Biological Chemistry* 226, 497-509.
- Jenkins T.C. and McGuire M.A. (2006) Major advances in nutrition: impact on milk composition. *Journal of Dairy Science*. 89, 1302-1310.
- Atti N., Roussini H. and Othomane M.H. (2006) Milk production, milk fatty acid composition and conjugated linoleic acid (CLA) content in dairy ewes raised on feedlot or grazing pasture. *Livestock Science* 104, 121-127.
- Re R., Pellegrini N., Proteggente A., Pannala A., Yang C. and Rice-Evans C. (1999) Antioxidant capacity applying an improved ABTS radical cation decolorization assay. *Free Radical Biology and Medicine* 26, 1231-1237.
- Chen J., Lindmark-Mansson H., Gorton L. and Akesson B. (2003) Antioxidant capacity of bovine milk as assayed by spectrophotometric and amperometric methods. *International Dairy Journal* 19, 927-935.
- Ulbricht T.L.V. and Southgate D.A.T. (1991) Coronary heart disease: seven dietary factors. *Lancet* 338, 985-992.

## Ability of visible spectroscopy to authenticate pasture-fed lambs in three breeds

Prache S.<sup>1</sup>, Larue A.<sup>1</sup>, Ballet J.<sup>2</sup>, Jailler R.<sup>1</sup>, Coustet C.<sup>1</sup>, Teuma J.B.<sup>1</sup>, Pourrat J.<sup>1</sup> and Andueza D.<sup>1</sup>

<sup>1</sup>INRA, UR1213 Herbivores, Site de Theix, F-63122 St Genès-Champanelle

<sup>2</sup>INRA, UE1296 Monts d'Auvergne, Le Roc, F-63210 Orcival

Corresponding author: sophie.prache@clermont.inra.fr

### Abstract

The development of rapid analytical methods for diet authentication and quality assessments in animal products is under active investigation. We assessed the ability of visible spectroscopy to distinguish pasture-fed (P) from stall concentrate-fed (S) lamb carcasses using a large database totalling 1054 (418 P and 636 S) male lambs from three sheep breeds, i.e. 148 P and 258 S Romane breed, 102 P and 92 S Ile-de-France breed, and 168 P and 286 S Limousine breed lambs. The reflectance spectrum of perirenal fat was measured 24 h *post-mortem* at wavelengths between 400 and 700 nm using a portable spectrophotometer. We quantified light absorption by carotenoids in the 450-510 nm area (method 1, M1) and performed a multivariate analysis over the full set of reflectance data (method 2, M2). Using M1, the proportion of correctly-classified S lambs was 100%, 95.8% and 93.5% in Romane, Limousine and Ile-de-France breeds, respectively, while the proportion of correctly-classified P lambs was 87.2%, 81.5% and 66.7% in Romane, Limousine and Ile-de-France breeds, respectively. Using M2, the proportion of correctly-classified S lambs was 99.6%, 99.6% and 97.9% in Romane, Limousine and Ile-de-France breeds, respectively, while the proportion of correctly-classified P lambs was 89.9%, 85.7% and 92.2% in Romane, Limousine and Ile-de-France breeds, respectively.

Keywords: diet authentication, lamb, meat, pasture-feeding, tracer techniques, visible spectroscopy

### Introduction

The sensory and nutritional properties of meat differ between pasture-fed and grain-fed animals. Furthermore, consumers are demanding information on the diet fed to food animals. It is therefore important to be able to discriminate between products obtained in different production systems, in particular pasture-feeding vs. stall-feeding (Prache *et al.*, 2007; Prache 2007). This study used a large database of three sheep breeds to evaluate the ability of two portable spectroscopy methods to discriminate pasture-fed (P) from stall-fed (S) lamb carcasses. Method 1 quantifies light absorption in the 450-510 nm band of the visible reflectance spectrum, as proposed by Prache and Theriez (1999) who demonstrated the utility of carotenoid pigments in discriminating P from S lamb carcasses, and method two uses the overall optical data of the visible reflectance spectrum, as proposed by Dian *et al.* (2007) who suggested the implication of other compounds absorbing light in the visible region.

### Materials and methods

A total of 1054 (418 P and 636 S) male lambs were used over 5 years. The breed-feed breakdown was 148 P and 258 S Romane (ROM), 102 P and 92 S Ile-de-France (IDF), and 168 P and 286 S Limousine (LIM) lambs. P lambs grazed pastures that were maintained at a leafy stage and offered *ad libitum*; they received no diet supplementation at pasture. S lambs

were fed in stalls on an *ad libitum* diet of commercial concentrate and hay until slaughter. The reflectance spectrum was measured on perirenal fat at wavelengths between 400 and 700 nm, with optical data readings taken every 10 nm using a portable MINOLTA CM-2002 spectrophotometer (D65 illuminant, observer angle 10°). Measurements were made in triplicate, at 24 h *post mortem*.

In method 1 (M1), fat reflectance spectrum data were used at wavelengths between 450 and 510 nm to calculate an index quantifying light absorption by in-fat carotenoid pigments. The reflectance spectrum data ( $R_i$ ) between 510 and 450 nm were translated ( $TR_i$ ) to make the reflectance value at 510 nm equal zero. On the translated spectrum, the integral value ( $I_{450-510}$ ) was calculated as follows:  $I_{450-510} = [(TR_{450}/2) + TR_{460} + TR_{470} + TR_{480} + TR_{490} + TR_{500} + (TR_{510}/2)] \times 10$ .

The integral value was averaged over the three measurements. Since mean integral values were all negative, we now use the absolute value of the mean integral (AVMI). Variance in AVMI was stabilized using a logarithmic transformation, and then subjected to ANOVA to test the effects of breed, feeding treatment and their interaction. Linear discriminant analysis was performed on AVMI, followed by a cross-validation procedure to classify the fat samples according to feeding treatment, using Minitab software v.13 (Minitab Inc., Paris).

In method 2 (M2), a multivariate analysis was performed over the full set of fat reflectance data. The raw reflectance spectra of perirenal fat representing the two feeding treatments were submitted to discriminant analysis using a partial least squares discriminant analysis (PLS-DA). In a prior step, principal component analysis was performed and the mean reflectance spectrum from each feeding treatment was ranked according to Mahalanobis distance (H) to the average reflectance spectrum in order to detect outlier samples ( $H > 3$ ). No outliers were found. The models were tested by a cross-validation procedure.

The proportion of correctly classified carcasses was analysed using the CATMOD procedure of the SAS software suite via a three-factor model (feeding treatment: P vs. S; discrimination method used in the fat: M1 vs. M2; and breed: ROM vs. LIM vs. IDF).

## Results and discussion

There was an interaction between breed and feeding treatment on AVMI ( $P < 0.001$ ). In all breeds, AVMI was higher in P lambs than S lambs ( $P < 0.001$ ). For a given feeding treatment, AVMI differed between breeds for both P ( $P < 0.001$ ) and S lambs ( $P < 0.001$ ), with all pairwise comparisons being statistically significant. AVMI averaged 355, 290 and 267 in ROM, LIM and IDF pasture-fed lambs, and 131, 137 and 169 in ROM, LIM and IDF stall concentrate-fed lambs. The threshold of the linear discriminant analysis performed on AVMI was 245, 213 and 221 units in ROM, LIM and IDF lambs, respectively. The proportion of S lambs with an AVMI greater than this threshold was 0%, 4.2% and 6.5% in ROM, LIM and IDF lambs, respectively, and the proportion of P lambs with an AVMI lower than or equal to this threshold was 12.8%, 18.5% and 33.3% in ROM, LIM and IDF lambs, respectively (Table 1). This threshold cut-off thus correctly classified 95.3%, 90.5% and 79.4% ROM, LIM and IDF lambs, respectively. The reliability of method 1 proved therefore variable across breeds. When pooling all the data for the three breeds, the threshold of the linear discriminant analysis was 224 units. The proportion of S lambs with an AVMI over this threshold was 2.7%, whereas the proportion of P lambs with a AVMI lower than or equal to this threshold was 20.6%. This threshold cut-off thus correctly classified 90.2% of the 1054 lambs.

The PLS-DA analysis performed in M2 correctly classified 99.6% and 89.9% of the S and P ROM lambs (mean: 96.1%), 99.6% and 85.7% of the S and P LIM lambs (mean: 94.5%), and 97.9% and 92.2% of the S and P IDF lambs (mean: 94.8%) (Table 1). The discriminatory ability of M2 was fairly comparable across the three breeds. When pooling all the data for the

three breeds, the PLS-DA analysis was able to correctly classify 99.1% and 86.1% of the 636 S and 418 P lambs (mean: 93.9%).

There was an interaction between breed, feeding treatment and method on the proportion of correctly classified carcasses ( $P < 0.01$ ). In ROM lambs, there were no significant differences between methods in the proportions of correctly-classified P carcasses (87.2% vs. 89.9% for M1 and M2,  $P = 0.39$ ) or S carcasses (100.0% and 99.6% for M1 and M2 respectively,  $P = 0.31$ ). In LIM lambs, there were no significant differences between methods in the proportion of correctly-classified P carcasses (81.5% vs. 85.7% for M1 and M2,  $P = 0.25$ ), whereas the proportion of correctly-classified S carcasses was lower using M1 than M2 (95.8% vs. 99.6% for M1 and M2,  $P < 0.001$ ). In IDF lambs, there were no significant differences between methods in the proportion of correctly-classified S carcasses (93.5% vs. 97.9% for M1 and M2,  $P = 0.15$ ), whereas the proportion of correctly-classified P carcasses was much higher when using M2 than M1 (66.7% vs. 92.2% for M1 and M2,  $P < 0.001$ ).

Table 1. Number of lambs and proportion of correctly classified pasture-fed and stall-fed lambs using two perirenal fat reflectance methods (Method 1: index quantifying light absorption by in-fat carotenoid pigments between 450 and 510 nm; Method 2: multivariate analysis performed over the full set of reflectance data between 400 and 700 nm)

Feeding treatment	Romane		Limousine		Ile de France	
	Stall	Pasture	Stall	Pasture	Stall	Pasture
Number of lambs	258	148	286	168	92	102
Method 1	100.0	87.2	95.8	81.5	93.5	66.7
Method 2	99.6	89.9	99.6	85.7	97.9	92.2

## Conclusion

Measuring the optical properties of animal tissues online at the slaughterhouse using a portable spectrophotometer is of interest for the development of on-the-spot methods for diet authentication in animal products. Measuring the reflectance spectrum of perirenal fat between 400 and 700 nm correctly classified from 97.9% to 99.6% of stall concentrate-fed lambs and from 85.7% to 92.2% of pasture-fed lambs, depending on sheep breed. Using the full range of reflectance data between 400 and 700 nm generally increased the reliability of the discrimination compared with only quantifying light absorption between 450 and 510 nm. This confirms the likely implication in the discrimination of various compounds absorbing light in the visible region.

## References

- Dian P.H.M., Andueza D., Barbosa C.P., Amoureux S., Jestin M., Carvalho P.C.F., Prado I.N. and Prache S. (2007) Methodological developments in the use of visible reflectance spectroscopy for discriminating pasture-fed from concentrate-fed lamb carcasses. *Animal* 1(8), 1198-1208.
- Prache S. (2007) Developing a diet authentication system from the composition of milk and meat in sheep: a review. *Journal of Agricultural Science, Cambridge* 145 (5), 435-444.
- Prache S. and Theriez M. (1999) Traceability of lamb production systems: carotenoids in plasma and adipose tissue. *Animal Science* 69, 29-36.
- Prache S., Priolo A., Jailler R., Dubroeuq H., Micol D. and Martin B. (2002) Traceability of grass-feeding by quantifying the signature of carotenoid pigments in herbivore meat, milk and cheese. In: Durand J.L., Emile J.C., Huyghe C. and Lemaire G. (eds.), *Multi-Function Grasslands: Quality Forages, Animal Products and Landscapes* 7, 592-593.
- Prache S., Martin B., Nozière P., Engel E., Besle J.M., Ferlay A., Micol D., Cornu A., Cassar-Malek I. and Andueza D. (2007) Authentification de l'alimentation des ruminants à partir de la composition de leurs tissus et produits. *INRA Productions Animales* 20(4), 295-308.

## Seasonal variation of fatty acid in milk of intensive and extensive dairy systems in Northern Italy

Revello Chion A.<sup>1</sup>, Battelli G.<sup>2</sup>, Giaccone D.<sup>3</sup>, Peiretti P.G.<sup>4</sup>, Tabacco E.<sup>1</sup> and Borreani G.<sup>1</sup>  
<sup>1</sup>*Dep. Agronomia, Selvicoltura e Gestione del Territorio, University of Turin, Grugliasco (TO), Italy*

<sup>2</sup>*Istituto di Scienze delle Produzioni Alimentari, CNR, Milano, Italy*

<sup>3</sup>*Associazione Regionale Allevatori Piemonte, Torino, Italy*

<sup>4</sup>*Istituto di Scienze delle Produzioni Alimentari, CNR, Grugliasco (TO), Italy*

Corresponding author: andrea.revellochion@unito.it

### Abstract

The effect of dairy farm management practices (intensive or extensive) on the fatty acid (FA) profile of milk transformed in Protected Designation of Origin (PDO) ‘Raschera’ cheese have been studied over two years. The intensive farms adopted diets based on corn silage, with a high concentrate to forage ratio, whereas the cow diets on the extensive farms were based on hay in the winter season, and on grazing in summer. The milk from the pastures presented the highest contents of human health FA, i.e. conjugated linoleic acid (CLA) and  $\alpha$ -linolenic acid. Furthermore, the extensive production systems allowed milk to be produced with higher odd- and branched-chain FA (OBCFA) content than intensive farms. Therefore, different FA profiles could be used to confer added value to dairy products from extensive systems and to justify their higher prices.

Keywords: forage, milk, fatty acid composition, dairy system, intensive, extensive

### Introduction

Most of the milk produced in both intensive and extensive dairy systems in Northern Italy is transformed into traditional PDO cheeses. Intensive farms normally breed high milk producing cows that are fed maize silage and concentrate based diets throughout the year. Extensive farms breed local-breed cows, and the diets are based on conserved meadow forages during winter and pasture during summer. Several researches have shown that farm management affects the chemical and sensorial dairy product characteristics, including FA composition (Butler *et al.*, 2008), with the diet composition having the most influence. Short and medium chain FA (4 to 14 carbons) occur almost exclusively from *de novo* synthesis, whereas long chain FA (>16 carbons) are derived from the uptake of circulating lipids of diet origin and body fat mobilization (Bauman and Griinari, 2003). Fresh herbage based diets allow milk to be obtained with high FA content that are beneficial to human health (e.g. CLA, polyunsaturated FA (PUFA), and branched-chain FA (OBCFA)), whereas beneficial FA decrease to a great extent in milk from cows fed corn silage and high amounts of concentrate. The aim of this research was to evaluate the effects of diet management in intensive and extensive dairy farm systems on the FA profile of milk destined for ‘Raschera’ PDO cheese.

### Materials and methods

Four dairy farms (2 intensive and 2 extensive) have been studied over different seasons and over two years. The management and production parameters, including the diet of milking cows were recorded for each farm. The intensive and extensive farms breed Holstein and Piemontese dairy cows, respectively. During both winter and summer seasons the diet components and milk were sampled three times (every 60 days) on the same sampling dates.

The diet component samples were freeze dried and ground. Milk samples were taken from the stirred bulk tank of each farm after two milkings, then centrifuged and cream was extracted. The ground diet component and milk cream samples were analysed for the FA methyl esters by gas chromatography. The milk FA profiles were subjected to ANOVA using GLM of the SPSS software (v 16.0), considering the fixed effect ‘production system’ and ‘season’, and their interaction.

Table 1. Percentage composition and fatty acid profile of cow diets during winter and summer seasons in intensive and extensive production systems

	Production systems			
	Intensive		Extensive	
	Winter	Summer	Winter	Summer
Diet composition (% DMI)				
Pasture	0	0	0	100.0
Maize silage	35.5	33.4	35.5	0
Hay	12.8	8.3	61.6	0
Concentrates	51.7	58.3	2.9	0
FA diet composition (g kg <sup>-1</sup> DM)				
C16:0	3.72	2.36	1.53	3.51
C18:0	0.56	0.62	0.26	0.54
C18:1 <i>c</i> 9	4.48	4.41	1.46	1.97
C18:2 <i>c</i> 9 <i>c</i> 12	10.77	8.87	3.88	5.51
C18:3 <i>c</i> 9 <i>c</i> 12 <i>c</i> 15	1.26	3.54	2.67	12.79
Total FA	22.49	21.42	12.02	32.29

## Results and discussion

The intensive farms had similar cow diets throughout all the seasons (Table 1), with higher concentrates than 50% of dry matter (DM) intake. The extensive diets were based on hay in winter and exclusively on pasture in summer. The winter and summer intensive diets contained similar amounts of total FA in DM, with a mean value of around 22 g kg<sup>-1</sup>, whereas the extensive diets contained a lower amount of total FA in DM in winter (12 g kg<sup>-1</sup>) than in the summer season (32 g kg<sup>-1</sup>). The summer extensive diets, based on pasture, contained the highest value of  $\alpha$ -linolenic acid (C18:3 *c*9 *c*12 *c*15), which, with linoleic acid, is the main precursor of the wide range of unsaturated FA isomers present in the milk. The FA profile of the milk was significantly affected by the production systems adopted on the farms, by seasons and by their interaction (Table 2). Milk from extensive farms produced in summer season presented the highest CLA,  $\alpha$ -linolenic acid, monounsaturated FA (MUFA) and PUFA contents, and the lowest values of saturated FA (SFA). The production systems seemed to have a direct influence on the milk content of many OBCFA (C15:0+C17:0, C17:0i, C17:1, C19:1), which have been reported to be positive for human health (Vlaeminck *et al.*, 2006). Further, OBCFA could be used to discriminate different animal diets (Engel *et al.*, 2007). Increasing the forage percentage in the cow diets resulted in an increase in the amount of OBCFA in the milk. The OBCFA occur in trace levels in most plants and are mainly present in the membrane lipid of cellulolytic bacteria of the rumen (Vlaeminck *et al.*, 2006). The proportion of hay and pasture utilised in extensive farms in cow diets leads to milk with a higher OBCFA content than milk of intensive farms.

## Conclusions

Extensive production systems with high forage contribution from meadows and pastures in the diet of dairy cows offers the opportunity of producing milk destined for typical PDO cheese with a high FA content that is beneficial for human health. Furthermore, different OBCFA contents, linked to forage percentages in dairy cow diets, could be used to trace the



different origins of milk and confer an added value to dairy products from extensive systems.

Table 2. Partial fatty acid profile of milk (g (100 g)<sup>-1</sup> fatty acids) produced in intensive and extensive farms during winter and summer seasons

Fatty acids	Production systems				SEM	Effect		
	Intensive		Extensive			P	S	PxS
	Winter	Summer	Winter	Summer				
C16:0	27.26	28.33	26.89	22.09	0.772	***	**	**
C16:1	1.75	1.86	1.75	1.68	0.036	ns	ns	Ns
C17:0i	0.40	0.39	0.70	0.64	0.041	***	ns	Ns
C17:0a	0.12	0.31	0.14	0.55	0.069	ns	**	Ns
C17:0	0.49	0.53	1.04	1.21	0.099	***	ns	Ns
C17:1	0.17	0.27	0.44	0.52	0.044	***	ns	Ns
C18:0	10.30	10.62	10.54	12.27	0.355	ns	ns	Ns
C18:1 c9	25.56	24.89	23.13	25.95	0.690	ns	ns	Ns
C18:1 t11	1.70	1.56	0.66	3.41	0.390	ns	ns	***
C18:2 c9 c12	3.36	2.77	1.59	2.21	0.193	***	ns	**
C18:2 c9 t11 CLA	0.82	0.63	0.85	1.87	0.156	***	**	***
C18:3 c9 c12 c15	0.30	0.39	0.67	1.56	0.154	***	***	***
C19:1	0.11	0.08	0.22	0.17	0.019	**	ns	Ns
Short chain	6.81	7.06	7.51	6.37	0.239	ns	ns	Ns
Medium chain	19.16	18.47	22.32	17.23	0.709	ns	**	Ns
Long chain	74.03	74.47	70.17	76.40	0.914	ns	ns	Ns
C14i+C16i	0.20	0.27	0.77	0.64	0.069	***	ns	**
C15+C17	1.60	1.57	2.66	2.80	0.179	***	ns	Ns
SFA	64.18	64.75	68.69	59.76	1.078	ns	**	**
MUFA	31.19	31.29	27.94	33.98	0.787	ns	*	*
PUFA	4.63	3.96	3.36	6.26	0.337	ns	***	***

P = production systems of farms; S = seasons; ns = not significant; \* =  $P < 0.05$ ; \*\* =  $P < 0.01$ ; \*\*\* =  $P < 0.001$ ; SEM = standard error of the mean.

## Acknowledgements

The research was funded by the Regione Piemonte Project: ‘Qualità degli alimenti, gestione degli animali e tecnologia di caseificazione: esempio di filiera produttiva di alcuni formaggi DOP tipici piemontesi in zona montana’. All the authors contributed equally to this paper.

## References

- Bauman D.E. and Griinari J.M. (2003) Nutritional regulation of milk fat synthesis. *Annual Review of Nutrition* 23, 203-227.
- Butler G., Nielsen J.H., Slots T., Seal C., Eyre M.D., Sanderson R. and Leifert C. (2008) Fatty acid and fat-soluble antioxidant concentrations in milk from high- and low-input conventional and organic systems: seasonal variation. *Journal of the Science of Food and Agriculture* 88, 1431-1441.
- Engel E., Ferlay A., Cornu A., Chilliard Y., Agabriel C., Bielicki G., and Martin B. (2007) Relevance of isotopic and molecular biomarkers for the authentication of milk according to production zone and type of feeding of the cow. *Journal of Agricultural and Food Chemistry* 55, 9099-9108.
- Vlaeminck B., Fievez V., Cabrita A.R.J., Fonseca A.J.M. and Dewhurst R.J. (2006) Factors affecting odd- and branched-chain fatty acids in milk: a review. *Animal Feed Science and Technology* 131, 389-417.

# Composition and fatty acids profile of bovine milk after supplementation with barley and cottonseed

Roca-Fernández A.I.<sup>1</sup>, González-Rodríguez A.<sup>1</sup>, Vázquez-Yañez O.P.<sup>1</sup> and Fernández-Casado J.A.<sup>2</sup>

<sup>1</sup>Agrarian Research Centre of Mabegondo. PO Box 10, 15080, A Coruña, Spain

<sup>2</sup>Agrarian and Fitopathologic Laboratory of Galicia. PO Box 365, 15640, A Coruña, Spain

Corresponding author: anairf@ciam.es

## Abstract

The objective of this study was to investigate the effect of supplementation with oilseeds (C, cottonseed) compared to concentrate with cereal grains (B, barley) on milk composition and fatty acids (FA) profile of Holstein-Friesian dairy cows in an indoor feeding regime. Three groups of twelve cows at the end of lactation (mean calving date 19 February) were studied over ten weeks during autumn. Two groups were supplemented with cottonseed at two levels: (C5), 5 and (C7), 7 kg cow<sup>-1</sup> d<sup>-1</sup> DM and one group was supplemented with barley (B7) at 7 kg cow<sup>-1</sup> d<sup>-1</sup> DM. Milk yield was significantly higher at the high level of supplementation (C7, 16.9 and B7, 17.4 kg cow<sup>-1</sup> day<sup>-1</sup>) compared to the low level (C5, 14.6 kg cow<sup>-1</sup> d<sup>-1</sup>). Milk protein was significantly lower in cotton treatments (C5, 32.9 and C7, 31.9 g kg<sup>-1</sup>) than in barley (B7, 34.4 g kg<sup>-1</sup>). There were no differences between treatments for milk fat. Medium chain FA showed a tendency to be higher with barley supplementation, whereas long chain FA were higher with cottonseed supplementation. The lowest ratio of saturated to unsaturated FA was observed in C7. Polyunsaturated FA and linoleic acid were significantly higher in C7. There were no differences between treatments for conjugated linoleic acid (CLA).

Key words: dairy cow, milk fat, oilseeds, linoleic acid, rumen biohydrogenation

## Introduction

The diet of ruminant animals has previously showed a significant effect on conjugated linoleic acid (CLA) levels in milk fat (Khanal and Olson, 2004). Feeding 18-carbon unsaturated fat supplements, which can undergo a certain degree of rumen biohydrogenation, helps to increase the CLA content in milk (Lock and Bauman, 2004). Lipid substrates that have been added to the ruminant diet and proven to be successful for enhancing the CLA content include whole or processed oilseeds which are rich in long chain polyunsaturated fatty acids (PUFA), such as linoleic (cottonseed) or linolenic (linseed) acid (Chilliard *et al.*, 2006). The effect of supplementation with oilseeds (cottonseed) compared to cereal grains (barley) at two levels of concentrate was studied in order to establish its influence on milk composition and FA profile of dairy cows in an indoor feeding regime during autumn.

## Materials and methods

**Experimental design, animals and feeding regime.** The study was conducted at the Agrarian Research Centre of Mabegondo, A Coruña, Spain (43°15'N; 81° 18' W) during 70 days in autumn, using an indoor feeding regime. Thirty-six primiparous and multiparous Holstein-Friesian dairy cows (mean calving date 19 February and milking 200 days) were balanced according to milk yield and calving date and were randomly assigned to one of three treatments: two supplemented with oilseeds, cottonseed (C), at two levels (C5, 5 and C7, 7 kg DM cow<sup>-1</sup> d<sup>-1</sup>) and one with cereal grains, barley (B7) at 7 kg DM cow<sup>-1</sup> d<sup>-1</sup>. A total mixed

ration (TMR) with a silage proportion of 50% grass and 50% maize (33% DM) was offered to animals with 16 kg cow<sup>-1</sup> d<sup>-1</sup> DM in C5 and 15 kg cow<sup>-1</sup> d<sup>-1</sup> DM in C7 and B7.

**Measurements, sampling and analysis.** Daily milk yields (MY) were registered and weekly milk protein, fat and milk urea content were determined. Individual body weight (BW) and body condition score (BCS) of each animal were recorded twice a month. Weekly milk FA profile was determined by gas chromatography of milk samples collected from fifteen dairy cows. Short (SCFA, C4:0 to C10:0), medium (MCFA, C12:0 to C16:0) and long chain fatty acids (LCFA, C18:0 to C18:3) and, the ratio between saturated (SFA, C4:0 to C18:0) and unsaturated fatty acids (UFA, C18:1 to C18:3) were determined. The proportions of monounsaturated (MUFA, C18:1) and polyunsaturated (PUFA, C18:2 to C18:3) of the total unsaturated fatty acids detected in fatty acids methyl esters (FAME) were also calculated.

**Statistical analysis.** A data analysis was performed using the statistical program SPSS version 15.0 by Tukey's multiple comparison test. Significant differences were declared at  $P < 0.05$ .

## Results and discussion

Body weight was significantly ( $P < 0.05$ ) higher in B7 than in C5 (Table 1). No significant differences were found between treatments for body condition score. Milk yield was significantly higher at the high level of supplementation with both concentrates (C7, 16.9 and B7, 17.4 kg cow<sup>-1</sup> d<sup>-1</sup>), without any significant differences between cottonseed and barley. This is in contrast to results from other studies with dairy cows that showed an increase on milk yield by fat supplementation (DePeters and Cant, 1992). Milk protein was significantly lower in cotton treatments than in barley. This result agrees with Beaulieu and Palmquist (1995) because feeding fat supplements to dairy cows usually decreases milk true protein of ruminants. Milk fat and milk urea content were lower with cottonseed supplementation compared to barley.

Table 1. Effect of feeding cottonseed or barley on body weight, body condition score, milk yield and milk composition of Holstein-Friesian cows in an indoor feeding regime.

Treatments <sup>1</sup>	Cottonseed		Barley	SEM <sup>2</sup>	P-values <sup>3</sup>		
	C5	C7	B7		C5 vs. C7	C5 vs. B7	C7 vs. B7
BW (kg)	567	598	605	14	NS	*	NS
BCS (1-5)	2.8	2.8	2.9	0.1	NS	NS	NS
MY (kg cow <sup>-1</sup> d <sup>-1</sup> )	14.6	16.9	17.4	0.8	*	**	NS
Milk protein (g kg <sup>-1</sup> )	32.9	31.9	34.4	0.6	NS	*	***
Milk fat (g kg <sup>-1</sup> )	41.4	41.6	43.6	1.1	NS	NS	NS
Milk urea content (mg kg <sup>-1</sup> )	123	129	136	18	NS	NS	NS

<sup>1</sup>Cottonseed (C5, 5 kg cow<sup>-1</sup> day<sup>-1</sup> DM and C7, 7 kg cow<sup>-1</sup> day<sup>-1</sup> DM) and Barley (B7, 7 kg cow<sup>-1</sup> day<sup>-1</sup> DM).

<sup>2</sup>SEM: Standard Error of the Mean; <sup>3</sup>Effect: NS, Not significant differences; \*  $P < 0.05$ ; \*\*  $P < 0.01$ ; \*\*\*  $P < 0.001$ .

The medium chain fatty acids (MCFA) showed a tendency to be lower with cottonseed (C5 and C7) compared to barley (B7) (Table 2). The contrary tendency was found in the long chain fatty acids (LCFA), with the highest values with cottonseed and the lowest with barley. The lowest ratio SFA/UFA was observed in C7 (3.5), with the highest levels of UFA (20.6 ± 0.6 g (100 g)<sup>-1</sup> of FAME) and MUFA (18.0 ± 0.8 g (100 g)<sup>-1</sup> of FAME). The levels of PUFA and linolenic acid were significantly higher in C7 compared to B7 ( $P < 0.05$ ) and C5 ( $P < 0.001$ ).

The short and medium chain FA mainly have a mammary-gland origin, in contrast to the long chain FA which are principally of a dietary origin. Feeding oilseeds rich in the LCFA may exert an inhibitory effect on the MCFA in the mammary gland. Clapperton and Banks (1985), attributed 80% of this inhibitory action of supplemental fat to the increase of the absorption of

the LCFA, while Hansen and Knudsen (1987) attributed this result mainly to the increase of the C18:1 isomers concentrations, and this could have happened in the treatment C7 in the present study as a consequence of a increased ruminal biohydrogenation activity of C18:2. A tendency to increase the CLA content in milk fat was found at the high level of cottonseed in the C7 treatment.

Table 2. Effect of feeding cottonseed or barley on fatty acids contents (g (100 g)<sup>-1</sup> of FAME) in milk fat of Holstein-Friesian dairy cows in an indoor feeding regime.

Treatments <sup>1</sup>	Cottonseed		Barley	SEM <sup>2</sup>	P-values <sup>3</sup>		
	C5	C7	B7		C5 vs. C7	C5 vs. B7	C7 vs. B7
SCFA	17.9	16.6	16.4	1.9	NS	NS	NS
MCFA	46.4	46.6	47.6	1.1	NS	NS	NS
LCFA	27.2	29.0	26.4	1.3	NS	NS	NS
Ratio SFA/UFA	3.7	3.5	3.6	0.2	NS	NS	NS
MUFA	17.3	18.0	17.3	0.8	NS	NS	NS
PUFA	2.20	2.63	2.38	0.10	***	NS	*
Linoleic acid, C18:2	1.96	2.37	2.11	0.09	***	NS	*
CLA, C18:2 cis-9-trans-11	0.35	0.40	0.37	0.02	NS	NS	NS

<sup>1</sup>Cottonseed (C5, 5 kg cow<sup>-1</sup> day<sup>-1</sup> DM and C7, 7 kg cow<sup>-1</sup> d<sup>-1</sup> DM) and Barley (B7, 7 kg cow<sup>-1</sup> day<sup>-1</sup> DM).

<sup>2</sup>SEM: Standard Error of the Mean;

<sup>3</sup>Effect: NS, Not significant differences; \* P < 0.05; \*\* P < 0.01; \*\*\* P < 0.001.

## Conclusions

Using cottonseeds for feeding dairy cows showed a tendency to decrease the medium chain fatty acids and increase the long chain fatty acids. Polyunsaturated fatty acids and linoleic acid were significantly higher at the same level of concentrate DM (7 kg cow<sup>-1</sup> d<sup>-1</sup>), with a tendency to increase the conjugated linoleic acid in the cottonseed supplemented treatment than in the barley supplemented treatment.

## Acknowledgements

To INIA by their financially supported, under the research project RTA2005-00204-00-00.

## References

- Beaulieu A.D. and Palmquist D.L. (1995) Differential effects of high fat diets on fatty acid composition in milk of Jersey and Holstein cows. *Journal of Dairy Science* 78, 1336-1344.
- Clapperton J.L. and Banks W. (1985) Factors affecting the yield of milk and its constituents, particularly fatty acids, when dairy cows consume diets containing added fat. *Journal of the Science of Food and Agriculture* 36 1205.
- Chilliard Y., Rouel J., Ferlay A., Bernard L., Gaborit P., Raynal-Ljutovac K., Lauret A. and Leroux C. (2006) Optimising goat milk and cheese fatty acid composition. In: Williams C. and Buttriss J. (eds.) *Improving the fat content of foods*, Woodhead Publishing Limited, Cambridge, UK, pp. 281-312.
- DePeters E.J. and Cant J.P. (1992) Nutritional factors influencing the nitrogen composition of bovine milk: A review. *Journal of Dairy Science* 75, 2043-2070.
- Hansen H.O. and Knudsen J. (1987) Effect of exogenous long chain fatty acids on individual fatty acid synthesis by dispersed ruminant mammary gland cells. *Journal of Dairy Science* 70, 1350-1354.
- Khanal R.C. and Olson K.C. (2004) Factors affecting conjugated linoleic acid (CLA) content in milk, meat, and egg: A Review. *Pakistan Journal of Nutrition* 3, 82-98.
- Lock A.L. and Bauman D.E. (2004) Modifying milk fat composition of dairy cows to enhance fatty acids beneficial to human health. *Lipid* 39, 1197-1206.

# Influence of French dairy feeding systems on cow milk fatty acid composition

Rouillé B.<sup>1</sup> and Montourcy M.<sup>2</sup>

<sup>1</sup>*Institut de l'Élevage, Monvoisin, BP 85225, 35652 LE RHEU Cedex, France*

<sup>2</sup>*ENITA Bordeaux, 1 Cours du Général De Gaulle, CS 40201, 33175 GRADIGNAN Cedex, France*

Corresponding author: benoit.rouille@inst-elevage.asso.fr

## Abstract

The aim of this study was to assess the impact of diet composition on the fatty acid (FA) composition of dairy cow milk in some French feeding systems. Seventeen farms from six regions were selected. Milk samples and a description of the diet were collected in five periods between May 2008 and February 2009 (May, July, September, January and February). Four feeding systems were identified. The grass-based system presented the best average milk composition over a year ( $P < 0.05$ ). Seven types of diets were also statistically different ( $P < 0.05$ ). The results showed strong correlations between the proportion of grazed grass in the diet and (i) polyunsaturated FA (PUFA) and mono-unsaturated FA (MUFA) (increase), (ii) saturated FA (SFA) and omega-6/omega-3 ratio (decrease). According to their FA composition, the results showed a strong correlation between the milk fatty acid profile and the diet. Grass-based diets produce milks with better nutritional profiles. This was particularly obvious for pasture-based diets.

Keywords: dairy cow, milk fatty acids, feeding systems, diets, France

## Introduction

The diversity of milk fatty acids (FA) presents a high degree of interest in milk fat and human nutritional issues. However, milk fat does not have a good reputation in human nutrition due to its relative richness in saturated FA (SFA). However, increased mono-unsaturated FA (MUFA), polyunsaturated FA (PUFA) and decreased omega-6/omega-3 ratio ( $< 5$ ) are goals to improve milk quality according to nutritionists. The diet of dairy cows is an efficient, fast and reversible way to modify milk composition. Nutritional and sensorial qualities of milk depend on this composition. Effects of different forages and concentrates are now well known (Couvreur *et al.*, 2006; Chilliard *et al.*, 2008).

As actions to improve milk fatty acid composition are well established, the main issue is to develop feeding systems and diets that lead to an adapted and stable milk composition over the year. The succession of different diets consumed by the same herd during a whole year also needs to be investigated. The goal of this study is to characterize some French diets and feeding systems producing cow milk over a year.

## Materials and methods

From May 2008 to February 2009, five samples of milk (0.15 L per sample) were taken from 17 farms, leading to a pool of 85 samples. The farms were chosen to vary in feeding system and to be typical, although they do not cover the whole diversity of French systems. They were located in mountains areas (6), in lowland areas with grass dominance (5) and in lowland areas with maize dominance (6). Each sample was coupled with a description of the diet. Frozen samples ( $-20$  °C) were analysed in a laboratory using a complete gas-chromatography method leading to the separation of fifty-eight fatty acids

(ISO14156/FIL172, ISO15886/FIL182 and ISO15885/FIL184). Data from diet surveys were verified and corrected if necessary using herds, forages and concentrates characteristics. The pasture intake was estimated from the information given by the farmers, the intake of forages and concentrates. Statistical analysis on feeding systems and diets were made with a principal component analysis (PCA) method using SPAD software.

The 17 farms were statistically separated into four feeding-system groups: maize silage (S-MS), maize silage and grass (S-MSG), maize silage and by-products (S-MSBP) and grass (S-G).

The 85 diets were statistically classified into seven groups: maize silage (D-MS), maize silage and hay (D-MSH), maize silage and grass silage (D-MSG), maize silage and pasture (D-MSP), hay (D-H), grass silage (D-GS) and pasture (D-P).

## Results and discussion

The average milk composition concerning FA for the four feeding systems (Table 1) clearly showed that milk from the S-G group differed from the three others: it was richer in PUFA and *trans* FA. The omega-6/omega-3 ratio was lower for this group and more stable over the year (ratio between 2 and 3 during the year) which is positive for human nutrition.

Table 1. Influence of annual feeding systems on milk fatty acid composition for maize silage system (S-MS), maize silage and grass system (S-MSG), maize silage and by-products system (S-MSBP) and grass system (S-G).

Feeding system		S-MS	S-MSG	S-MSBP	S-G
Number of farms		5	3	3	6
Average diet composition over a year	Pasture (%)	8.6	14.9	16.7	35.3
	Maize silage (%)	51.5	33.1	41.5	3.5
	Grass silage (%)	6.0	17.3	0.8	10.2
	Hay (%)	7.7	9.5	3.8	29.6
	By-products (%)	0.2	0.8	12.5	0.4
	Concentrates (%)	26.1	24.4	24.7	21.0
	Milk fatty acid composition				
SFA (%)		69.6	69.0	70.5	67.9
MUFA (%)		26.5	27.0	25.4	27.0
PUFA (%)		3.02 <sup>b</sup>	3.12 <sup>b</sup>	3.38 <sup>ab</sup>	3.97 <sup>a</sup>
<i>Trans</i> FA (%)		3.27 <sup>b</sup>	3.33 <sup>ab</sup>	3.22 <sup>b</sup>	4.89 <sup>a</sup>
Omega-6/omega-3		5.74 <sup>b</sup>	4.97 <sup>b</sup>	6.69 <sup>b</sup>	2.38 <sup>a</sup>
CLA <i>c9t11</i> (%)		0.56 <sup>b</sup>	0.63 <sup>b</sup>	0.59 <sup>b</sup>	1.21 <sup>a</sup>

<sup>a-b</sup>: statistically different  $P < 0.05$

Average percentages of SFA and MUFA did not differ among the four groups. The percentage of rumenic acid, which is a conjugated linoleic acid (CLA *c9t11*), reached 1.21% in S-G versus 0.56%, 0.63% and 0.59% for S-MS, S-MSG and S-MSBP, respectively. This fatty acid is specific to ruminant products and seems to have a positive effect on human health.

The fatty acid composition of the seven different diets is shown in Table 2. SFA percentage was higher when the diet contained maize silage and decreased with the incorporation of grass, except for D-H. D-P showed the strongest effect regarding SFA. MUFA and PUFA increased when the percentage of grass was increasing in the diet, and the effect was also stronger with the use of pasture instead of preserved grass (silage or hay). D-H group presented a particular composition with a high percentage of SFA and a low omega-6/omega-3 ratio, which is specific to these kinds of diets (Collomb *et al.*, 2008). The percentage of CLA *c9t11* varied from 0.49% for D-MS to 1.72% for D-P. Therefore, pasture is the most efficient forage to improve milk fatty acid composition.

Table 2. Influence on milk fatty acid composition of maize silage diet (D-MS), maize silage and hay diet (D-MSH), maize silage and grass silage diet (D-MSGs), maize silage and pasture diet (D-MSP), hay diet (D-H), grass silage diet (D-GS) and pasture diet (D-P).

Diet	D-MS	D-MSH	D-MSGs	D-MSP	D-H	D-GS	D-P
Number of samples	17	12	9	14	9	8	16
Pasture (%)	0.1	5.6	4.0	37.9	0.0	1.5	68.8
Maize silage (%)	60.3	46.7	45.0	29.7	0.0	9.0	2.0
Grass silage (%)	3.2	0.8	21.1	1.7	0.0	53.6	1.4
Hay (%)	4.7	15.2	4.9	3.2	77.6	8.2	10.2
By-products (%)	4.3	3.3	0.0	6.6	0.0	1.4	0.0
Concentrates (%)	27.4	28.3	25.1	20.9	22.4	26.3	17.6
SFA (%)	72.3 <sup>d</sup>	69.7 <sup>cd</sup>	69.1 <sup>bc</sup>	67.3 <sup>b</sup>	71.6 <sup>d</sup>	70.8 <sup>cd</sup>	64.2 <sup>a</sup>
MUFA (%)	23.9 <sup>c</sup>	26.5 <sup>cd</sup>	26.7 <sup>bc</sup>	28.4 <sup>ab</sup>	24.1 <sup>dc</sup>	25.1 <sup>cde</sup>	29.9 <sup>a</sup>
PUFA (%)	2.97 <sup>c</sup>	3.03 <sup>c</sup>	3.25 <sup>bc</sup>	3.36 <sup>b</sup>	3.33 <sup>b</sup>	3.11 <sup>c</sup>	4.62 <sup>a</sup>
Trans FA (%)	2.84 <sup>d</sup>	3.05 <sup>cd</sup>	3.54 <sup>bc</sup>	3.87 <sup>b</sup>	2.71 <sup>d</sup>	2.83 <sup>d</sup>	6.80 <sup>a</sup>
Omega-6/omega-3	7.64 <sup>c</sup>	6.68 <sup>c</sup>	4.15 <sup>b</sup>	4.30 <sup>b</sup>	2.40 <sup>a</sup>	3.43 <sup>b</sup>	2.20 <sup>a</sup>
CLA <i>c9t11</i> (%)	0.49 <sup>d</sup>	0.53 <sup>d</sup>	0.59 <sup>c</sup>	0.75 <sup>b</sup>	0.65 <sup>c</sup>	0.61 <sup>c</sup>	1.72 <sup>a</sup>

<sup>a-c</sup>: statistically different  $P < 0.05$

These results clearly show that milk produced from grass-based diets, and especially from pasture-based diets, contained more health promoting FA than milk from maize silage-based diets. Variations in fatty acid composition over the year were also significant due to the succession of different diets at different periods. Results concerning diets explained the average differences existing between feeding systems over the year.

## Conclusion

This study shows the large diversity of milk fatty acid composition in France. It also underlines efficient, fast and reversible diet solutions to improve milk in terms of health-promoting FA. It is the first step for an association between technical advices and an eventual remuneration on milk fatty acid composition.

## References

- Chilliard Y., Bauchart D., Lessire M., Schmidely P. and Mouro J. (2008) Qualité des produits : modulation par l'alimentation des animaux de la composition en acides gras du lait et de la viande. *INRA Productions Animales* 21 (1), 95-106.
- Collomb M., Bisig W., Bütikofer U., Sieber R., Bregy M. and Etter L. (2008) Seasonal variation in the fatty acid composition of milk supplied to dairies in the mountain regions of Switzerland. *Dairy Science Technology* 88, 631-647.
- Couvreur S., Hurtaud C., Lopez C., Delaby L. and Peyraud J.L. (2006) The linear relationship between the proportion of fresh grass in the cow diet, milk fatty acid composition and butter properties. *Journal of Dairy Science* 89, 1956-1969.



# Seasonal variation in the fatty acid composition of cow milk in the mountain regions of the Czech Republic

Frelich J.<sup>1</sup>, Šlachta M.<sup>1</sup>, Hanuš O.<sup>2</sup>, Špička J.<sup>1</sup>, Samková E.<sup>1</sup> and Kobes M.<sup>1</sup>

<sup>1</sup> University of South Bohemia, Faculty of Agriculture, České Budějovice, Czech Republic

<sup>2</sup> Research Institute for Cattle Breeding, Ltd., Rapotín, Czech Republic

Corresponding author: slachta@zf.jcu.cz

## Abstract

The fatty acid composition of milk produced by cows during the grazing season (May-October) and during the period of winter silage feeding (November-April) was examined on three mountain farms in the Czech Republic. There was a higher proportion of long-chain and unsaturated fatty acids in milk from pastured cows than from the indoor-fed cows ( $P < 0.01$ ). Also the content of conjugated linoleic acid (CLA) was higher in the pasture period (on average 1.1%;  $P < 0.01$ ) than in the indoor period (on average 0.7%;  $P < 0.01$ ). The milk produced during the grazing season thus contained fat with a more beneficial composition, in relation to consumer health, than during the winter silage feeding.

Keywords: fatty acids, CLA, Czech Fleckvieh, Holstein, cattle, pasture

## Introduction

Seasonal grazing of dairy cows is traditionally applied in mountain regions in the Czech Republic. Grazing increases the proportion of unsaturated fatty acids (FA) in cow milk fat at the expense of saturated FA (Dewhurst *et al.*, 2006; Elgersma *et al.*, 2006). Although the consumption of saturated fat, mainly of C12:0, C14:0 and C16:0 FA, is associated with cardiovascular diseases, the unsaturated FA are regarded as beneficial for human health (Parodi, 2004). The intake of fresh grass also increases the content of conjugated linoleic acid (CLA), which has been proven to be a biologically active compound with anticarcinogenic and other health-beneficial effects in animal models (Ip *et al.*, 2003). The modification of milk fat composition by grazing is thus a cheap measure with positive impacts on consumers' health. The aim of this study was to examine the effect of seasonal grazing of cows reared on Czech mountain farms on the FA profile of the milk produced.

## Material and methods

Three dairy farms located at an altitude of 575, 793 and 730 meters above sea level (farm 1, 2, 3, respectively) were selected. The herd on farm 1 consisted of Czech Fleckvieh and Holstein cows with an average milk yield of 5529 and 6673 kg per standard (305-days) lactation. On farm 2 and 3, the Czech Fleckvieh cows were reared with an average milk production of 6601 and 5319 kg per standard lactation. The calving occurred continuously throughout the year. The herbage (grazed and cut) formed the majority of the feed ration in the pasture period (May-October). The vegetation of pastures appertained to the *Lolium-Cynosuretum* association (Frelich *et al.*, 2006). The fresh-cut herbage was offered to cows in the stalls during the milking twice a day. In the indoor period (November-April), cows were fed grass silage prepared from the pasture vegetation cut in late May and June. The grain concentrates were added to feed rations throughout the year in amounts of 1-10 kg (farm 1) or 4-8 kg (farms 2, 3) per cow each day according to the current milk production of each particular cow. In the pasture period, the cows were also supplemented with 2 kg of hay, 2 kg of rapeseed and 1 kg of wheat pollard per cow per day on farm 1, and by 10 kg of brewery draff per cow, per day,

on farm 3. Bulk milk was collected once a month, four samples in the indoor period (March, April and November 2007, February 2008) and five samples in the pasture period (May, June, July, August and September 2007). Fatty acids were determined by a gas-chromatographic method (GLC) using a Varian 3800 apparatus (Varian Techtron, USA; Column Omegawax 250, 30m). Fatty acids in isolated fat were re-esterified to their methyl esters by methanolic solution of potassium hydroxide. The identification of fatty acid methyl esters was carried out using the analytical standards (Supelco, USA). A two-way ANOVA with the factors farm and period of milk sampling collection was used for statistical analysis.

Table 1. Milk fatty acid composition (g per 100 g total fatty acids) in bulk milk samples from three farms and in two feeding periods.

Fatty acid	Farm			Period		P		
	1	2	3	Indoor	Pasture	Farm	Season	F*S
C14:0	10.5	9.8	9.5	10.7	9.2	0.275	0.006	0.671
C16:0	30.5a	26.9b	26.9b	30.7	25.4	0.007	<0.001	0.025
C18:0	10.9a	12.5b	12.5b	11.1	12.9	0.012	<0.001	0.028
9-cis 18:1	19.7	23.0	23.0	20.5	23.3	0.022	0.011	0.191
CLA	0.8	0.9	1.1	0.7	1.1	0.029	0.001	0.452
C4 – C11	8.2	7.7	7.6	7.7	8.0	0.260	0.898	0.968
C12 – C16	48.7a	43.5ab	43.2b	48.9	41.3	0.030	<0.001	0.195
C17 – C24	41.8a	47.5ab	47.9b	42.3	49.2	0.022	0.001	0.234
SAFA	67.5a	63.4ab	63.1b	67.2	62.2	0.029	0.001	0.453
MUFA	27.0a	30.8ab	31.1b	27.6	31.7	0.023	0.002	0.363
PUFA	4.2	4.5	4.5	4.2	4.7	0.288	0.004	0.425

SAFA – saturated fatty acids; MUFA – monounsaturated fatty acids; PUFA – polyunsaturated fatty acids;

<sup>a,b</sup> Different superscripts indicate differences between farms (differences within rows);

P – level of statistical significance; F\*S interaction between farm and season effects.

## Results and discussion

The content of the most important FA in the samples are given in Table 1. The palmitic (C16:0), oleic (9-cis C18:1), stearic (C18:0) and myristic acids (C14:0) were the most abundant. The content of long-chain (>C16), mono- and polyunsaturated FA in the milk fat was higher in the pasture period (49%, 32% and 5%, respectively) than in the indoor period (42%, 28% and 4%, respectively;  $P < 0.01$ ). The content of conjugated linoleic acid (CLA) was also higher in the pasture period (1.1%) than in the indoor period (0.74%;  $P < 0.01$ ). These results agree with other studies, in which the intake of fresh grass increased the content of long-chain, unsaturated FA and CLA in cow milk fat when compared with the feeding of conserved forage (e.g. Collomb *et al.*, 2002; Bargo *et al.*, 2006).

## Conclusion

The seasonal alternation between the grass-silage based diet and the fresh-herbage based diet was identified as an important factor affecting the fat composition of cows' milk on Czech low-input mountain farms. The ratio of unsaturated : saturated fatty acids, and the content of CLA in milk fat, were higher in the pasture period (May-October) than in the indoor period (November-April). A more valuable milk fat composition, in terms of its implications for consumer health, was produced during the pasture period than in the period of indoor silage feeding.

## Acknowledgement

This work was supported by the research project of Ministry of Education, Youth and Sports of the Czech Republic, No. MSM 6007665806, and by the Ministry of Agriculture of the Czech Republic, No. NAZV QH 81210 and NAZV QH 81280.

## References

- Bargo F., Delahoy J.E., Schroeder G.F., Baumgard L.H. and Muller L.D. (2006) Supplementing total mixed rations with pasture increase the content of conjugated linoleic acid in milk. *Animal Feed Science and Technology* 131, 226-240.
- Collomb M., Bütikofer U., Sieber R., Jeangros B. and Bosset J. O. (2002) Composition of fatty acids in cow's milk fat produced in the lowlands, mountains and highlands of Switzerland using high-resolution gas chromatography. *International Dairy Journal* 12, 649-659.
- Dewhurst R.J., Shingfield K.J., Lee M.R.F. and Scollan N.D. (2006) Increasing the concentrations of beneficial polyunsaturated fatty acids in milk produced by dairy cows in high-forage systems. *Animal Feed Science and Technology* 131, 168-206.
- Elgersma A., Tamminga S. and Ellen G. (2006) Modifying milk composition through forage. *Animal Feed Science and Technology* 131, 207-225.
- Frelich J., Pecharová E., Klímeš F., Šlächta M., Hakrová P. and Zdražil V. (2006) Landscape management by means of cattle pasturage in the submountain areas of the Czech Republic. *Ekológia (Bratislava)* 25, Suppl. 3, 116-124.
- Ip M.M., Masso-Welch P.A. and Ip C. (2003) Prevention of mammary cancer with conjugated linoleic acid: role of the stroma and the epithelium. *Journal of Mammary Gland Biology and Neoplasia* 8, 103-118.
- Parodi P.W. (2004) Milk fat in human nutrition. *Australian Journal of Dairy Technology* 59, 3-59.

# Diversity of vascular plants and ground beetles (Coleoptera: Carabidae) in mountain cattle pastures

Šlachta M., Frelich J., Tonka T., Hakrová P. and Sýkorová Z.

University of South Bohemia, Faculty of Agriculture, Studentská 13, CZ-37005 České Budějovice, Czech Republic.

Corresponding author: slachta@zf.jcu.cz

## Abstract

The diversity of vascular plants and ground beetles (carabids) was examined in pastures of three dairy farms (575-793 m above sea level) in the Czech Republic. The pastures were grazed in rotation in 3-4 cycles from May to October. On each farm, two pasture sites were monitored. The botanical 16 m<sup>2</sup> scans were taken three times a year in two consecutive years and carabid beetles were sampled during two sampling seasons by pitfall trapping. No significant differences in the community alpha diversity (Shannon diversity index, H') and the evenness (Shannon equitability index, E) were found between the farms, the sites within farms, and the years in any of the examined organismal groups (hierarchical ANOVA, site nested in farm,  $P > 0.05$ ). Pasture swards belonged to the *Lolio-Cynosuretum* association. In total, 28 to 47 species of vascular plants and 17 to 30 species of ground beetles were recorded. Carabid communities were dominated mainly by *Poecilus versicolor*.

Keywords: pasture, cattle, diversity, vascular plants, ground beetles, *Poecilus versicolor*

## Introduction

In the mountain areas of the Czech Republic, cattle feeding has traditionally relied on forages from permanent grasslands. The Czech Fleckvieh and the Holstein have been the two main dairy breeds reared on the farms. They have been seasonally grazed or they have been permanently confined in stalls and fed with a conserved forage. Since 1990, beef cattle husbandry has expanded in the Czech Republic and the number of suckler cows increased from about 20000 in 1990 to 163000 in 2008 (Kohoutek *et al.*, 2009), which was accompanied by the transformation of a substantial part of meadows or arable land to pastures. The aim of this study was to examine the diversity of vascular plants and ground beetles in the long-term used cattle pastures at the local and regional scales (on a farm and between the farms).

## Material and methods

The examination was conducted on three dairy farms in the south of the Czech Republic. The farms were located at an altitude of 575 m a.s.l. (farm 1), 793 m a.s.l. (farm 2) and 730 m a.s.l. (farm 3). The maximum distance between the farms (farm 1 – farm 3) was about 100 km. The prevailing soils are cambisols, mean annual precipitations are 600-800 mm and the mean annual temperature is 6-7 °C. The seasonal grazing of approximately 100 cows of Czech Fleckvieh and Holstein breeds (farm 1) or Czech Fleckvieh breed only (farms 2, 3) has been practised on those farms for about fifteen years. In some cases, cattle grazing was applied for more than forty years without interruption. The grazing started in May and finished in October. The pastures were grazed in rotation in 3-4 cycles.

The abundance of vascular plant species was measured as the percentual contribution of the species to total plant coverage at stands of 16 m<sup>2</sup> area (Moravec, 1994). A line of five permanent stands in fifty-meters distance was established at two pasture sites on each farm.

The species abundance was measured in May, July and September in 2006 and 2007. The Shannon index of diversity ( $H'$ ) and Shannon equitability index ( $E$ ) (Magurran, 1988) were calculated for each site on the basis of the sum of species abundance in botanical scans in each year. The ground beetles were collected in five or three pitfall traps (first or second year of sampling) at two pasture sites on each farm. The traps were located in a line with five-meter distances under the fencing between the pasture fields, and 10% formalin was used as a preserving fluid. The Shannon diversity index ( $H'$ ), Shannon equitability index ( $E$ ) and species dominance were calculated from the material collected in traps at a particular site in each year. The differences between  $H'$  and  $E$  were evaluated by the hierarchical ANOVA with factors of farm, site (nested in farm) and year.

Table 1. Mean values of Shannon index of diversity ( $H'$ ) and evenness ( $E$ ) on the farms, the range of number of species ( $S$ ) at the sites in two years of examination ( $n = 4$  for each farm).

		Farm 1	Farm 2	Farm 3	ANOVA		
					Farm	Site (Farm)	Season
Plants	S	28 – 40	30 – 47	31 – 40			
	$H'$ (Mean)	0.99	0.96	1.00	$P > 0.05$	$P > 0.05$	$P > 0.05$
	$E$ (Mean)	0.65	0.61	0.66	$P > 0.05$	$P > 0.05$	$P > 0.05$
Carabids	S	21 – 26	17 – 24	19 – 30			
	$H'$ (Mean)	0.85	0.88	0.95	$P > 0.05$	$P > 0.05$	$P > 0.05$
	$E$ (Mean)	0.62	0.69	0.70	$P > 0.05$	$P > 0.05$	$P > 0.05$

Table 2. The list of carabid species with 20% dominance or higher at some of the sites and year. The relative species dominance (%) at the site is given in the table.

Species	Farm 1		Farm 2				Farm 3					
	Site 1		Site 2		Site 1		Site 2		Site 1		Site 2	
	2006	2008	2006	2008	2006	2008	2006	2008	2006	2008	2006	2008
<i>P. versicolor</i>	58	42	34	31	18	27	34	39	29	40	51	26
<i>Pt. melanarius</i>	8	20	7	2	9	19	4	18	13	10	4	17
<i>N. brevicollis</i>	3	2	< 1	0	38	31	4	17	1	2	0	0
<i>C. scheidleri</i>	2	20	20	8	0	0	0	0	0	0	0	0
<i>C. cancellatus</i>	0	0	0	0	0	0	0	0	1	16	1	20
<i>Cal. fuscipes</i>	1	3	7	24	0	0	0	0	5	6	1	3

*P.* – *Poecilus*, *Pt.* – *Pterostichus*, *N.* – *Nebria*, *C.* – *Carabus*, *Cal.* – *Calathus*.

## Results and discussion

In total, 93 species of vascular plants were identified in the botanical scans on three farms (57, 69 and 49 species on farms 1, 2 and 3, respectively). The species composition of the swards appertained to the *Lolio-Cynosuretum* association (Chytrý, 2007). The most dominant species were *Lolium perenne*, *Festuca rubra*, *Poa pratensis*, *Dactylis glomerata*, *Agrostis capillaris*, *Trifolium repens*, *Taraxacum sect. Ruderalia* (respectively up to 30, 26, 16, 13, 23, 13, 12% average dominance at a site in a particular year). The diversity and the evenness did not differ significantly between the farms or sites, nor between years ( $P > 0.05$ ; Table 1). In total, 66 carabid species were found in the pitfall traps during two years of observation (45, 35 and 43 species on farms 1, 2 and 3, respectively). Only 16 species were common to all the farms, 25 species were found on two farms and 25 species just on one of the farms. At a regional scale, the most dominant species was *Poecilus versicolor*, which formed 18-58% of the total numbers of carabids collected at a site in a particular year (Table 2). The other dominant species on all the farms was *Pterostichus melanarius* (2-20%). Only four other species were present in 20% or higher dominance at the sites: *Carabus scheidleri* and *Calathus fuscipes* on farm 1, *Nebria brevicollis* on farm 2 and *Carabus cancellatus* on farm 3. The diversity and

the evenness did not differ significantly between the farms, sites or between years ( $P > 0.05$ ; Table 1).

The results revealed similar values of the community characteristics of vascular plants and carabids in comparably managed pastures. The site-to-site variation in the species composition, however, was remarkable. The tendency to a higher abundance of *Rumex obtusifolius* was observed on farm 3 for example, whereas *Lotus corniculatus*, *Prunella vulgaris*, *Leontodon autumnalis*, *Plantago lanceolata*, *Veronica chamaedrys* and *Trifolium pratense* were more abundant on farm 1. In carabids, the community was characterised by two eurytopic species of *Poecilus versicolor* and *Pterostichus melanarius* on all the farms. The microclimatic conditions strongly determine the species composition of carabid communities. In the study executed near Kiel in Germany (Hoernes and Irmeler, 2004), *N. brevicollis*, *P. melanarius* and *P. versicolor* were identified as typical species for the community associated with mineral soils and relatively dry organic soils (mean water content 36%). The soil parameters of grasslands had a higher influence on spatial distribution of the carabid species than the agricultural use. In our study, the mean soil moisture was 15%, 18% and 7% on farm 1, 2 and 3, respectively, and the mean pH was between 5.2 and 6.5 (measurements from July 2006). A similar composition of carabid communities was found also in extensive pastures in Bílé Karpaty Mountains in the east of the Czech Republic (unpublished data) where the most dominant species was *P.versicolor* and the other abundant species were *Calathus fuscipes* and *Pseudoophonus rufipes*.

## Conclusion

The results indicated the similar diversity and the evenness of vascular plant communities and the carabid communities in the pastures with comparable grazing conditions. The swards were dominated by species typical of a *Lolio-Cynosuretum* association. The most dominant carabid species at the regional scale were *Poecilus versicolor* and *Pterostichus melanarius*.

## Acknowledgement

This work was supported by the research project of Ministry of Education, Youth and Sports of the Czech Republic, No. MSM 6007665806.

## References

- Chytrý M. (2007) *Vegetation of the Czech Republic 1, Grassland and heathland vegetation*. Academia, Prague, 528 pp.
- Hoernes U. and Irmeler U. (2004) Räumliche Verteilung epigäischer Carabiden in einer halboffenen Weidelandschaft in Abhängigkeit von Nutzung und Standortparametern. *Faunistisch-ökologische Mitteilungen Supplement* 31, 57-104.
- Kohoutek A., Kvapilík J., Cagaš B., Hrabě F. and Pozdíšek J. (2009) Selected indicators of productive and extraproductional management of grasslands in the Czech Republic. *Grassland Science in Europe* 14, 11-24.
- Moravec J. (1994) *Phytocenology*. Academia, Prague, pp. 403.

## The maturity stage of the grass affects milk fatty acids of cows grazing a mountain grassland.

Tornambé G.<sup>1,3</sup>, Martin B.<sup>1</sup>, Pradel P.<sup>2</sup>, Di Grigoli A.<sup>3</sup>, Bonanno A.<sup>3</sup>, Chilliard Y.<sup>1</sup> and Ferlay A.<sup>1</sup>

<sup>1</sup>INRA, UR1213 Herbivores, 63122 Saint Genès Champanelle, France

<sup>2</sup>INRA, UE Monts d'Auvergne, 15190 Marcenat, France

<sup>3</sup>Università degli Studi di Palermo, Dipartimento SENFIMIZO, I-90128 Palermo, Italy

Corresponding author: gtornambe@unipa.it

### Abstract

We aimed to quantify the effect of the growth stage of a mountain grassland pasture on the fatty acid (FA) composition of grass and milk. In June (growth) and October (regrowth), a mountain pasture was continuously grazed by six dairy cows in a strip grazing system. During June, the grass C18:3 $n$ -3 content decreased while C16:0,  $c$ 9-C18:1 and C18:2 $n$ -6 content increased. During October, the grass FA composition was similar to that observed in the first part of June. During June, milk saturated FA (SFA) content increased while the sum of the *trans* FA and polyunsaturated FA (PUFA) content decreased, mainly due to the decrease in C18:3 $n$ -3 and  $c$ 9 $t$ 11-CLA percentages. At the start of October, milk content of PUFA, total *trans* FA,  $t$ 11-C18:1,  $c$ 9 $t$ 11-CLA and C18:3 $n$ -3 was higher than that at the start of June when the grass was still in its vegetative stage. For these FA, the content strongly decreased between the two samplings in October. The variability observed in milk FA composition during one month was high for  $c$ 9 $t$ 11-CLA, C18:3 $n$ -3,  $t$ 11-C18:1 and C16:0

Key words: milk fatty acids, grazing, grass maturity stage, cows, grassland

### Introduction

The content of monounsaturated (MUFA) and polyunsaturated fatty acids (PUFA), conjugated linolenic acid (CLA) and  $\omega$ 3 fatty acids (FA), all well known for their putative positive action on human health, increase in milk when cows are grazing (Ferlay *et al.*, 2006). Nevertheless, even for cows only fed pasture, a considerable variability is often reported (Ferlay *et al.*, 2008). It could be partly explained by the botanical composition of the grassland (Dewhurst *et al.*, 2006) and also by the growing stage (Ferlay *et al.*, 2006). The aim of this experiment was to quantify the effect of the growing stage from one mountain grassland pasture on the grass and milk FA composition.

### Material and methods

A 1.4-ha mountain grassland pasture (1100 m a.s.l.) at the INRA experimental farm of Marcenat (Cantal, France) was examined from 31 May to 1 July (first growth), and again from 1 October to 7 October (regrowth). This pasture was strip grazed by six dairy cows (107 days in milk) at a stocking rate of 75 and 150 m<sup>2</sup> cow<sup>-1</sup> day<sup>-1</sup> in June and in October, respectively. The strip limits were moved forward every 2 d. Twice a week grass samples were collected to estimate the biomass, the contribution of monocotyledons and dicotyledons, dry matter (DM), total nitrogen (TN), energy content UFL (unité fourragère lait, 1 UFL = net energy content of 1 kg air-dried barley for milk production = 7.1 kJ) and FA composition. Once a week, the development stages of three key plants (*Dactylis glomerata*, *Meum athamanticum* and *Achillea millefolium*) were noted. During June the cows received 2.3 kg day<sup>-1</sup> cow<sup>-1</sup> of concentrate. During October the animals were only fed pasture. Individual milk



production was measured at each milking and milk fat and protein content were determined at four consecutive milkings each week. Individual milk samples from morning and evening milkings for the six cows were collected twice a week. The FA in lyophilized milk and grass were methylated and the FA methyl esters were injected into a GC with a flame ionization detector for FA determination (Ferlay *et al.*, 2006). Milk FA data were analysed using the MIXED procedure of the SAS software V 9.1, while considering the sampling date (11 dates) as main effect and the animal as random effect.

Period		First growth			Regrowth
		I	II	III	IV
Poaceae in dry matter	%	83	78	72	78
Dicotyledons in dry matter	%	17	22	28	22
Biomass dry matter	t ha <sup>-1</sup>	2.3	1.9	1.9	0.8
UFL in dry matter	UFL kg <sup>-1</sup>	0.90	0.82	0.80	0.95
Total nitrogen in dry matter	%	14.0	12.0	11.2	16.7
C16:0 in total FA	0.01 g (100g) <sup>-1</sup>	16.0	17.9	18.1	17.4
c9-C18:1 in total FA	0.01 g (100g) <sup>-1</sup>	2.7	3.6	5.3	3.3
C18:2n-6 in total FA	0.01 g (100g) <sup>-1</sup>	15.8	16.5	19.2	15.9
C18:3n-3 in total FA	0.01 g (100g) <sup>-1</sup>	57.8	51.6	46.4	53.8

Table 1. Composition, chemical characteristics and fatty acid profile of grass in June (first growth) and October (regrowth).

Period, I = average of 1<sup>st</sup>, 2<sup>nd</sup> and 3<sup>rd</sup> samplings; II = average of 4<sup>th</sup>, 5<sup>th</sup> and 6<sup>th</sup> sampling; III = average of

7<sup>th</sup>, 8<sup>th</sup> and 9<sup>th</sup> samplings; IV = average of 10<sup>th</sup> and 11<sup>th</sup> sampling.

## Results and discussion

Forty-six plant species were identified in the grassland: 14 *poaceae* (44% of total DM weight) and 32 dicotyledons (56% of total DM weight). The botanical composition of the grass is detailed in Tornambe *et al.* (2008). During June, the phenological stage of *D. glomerata* evolved from boot to mature stage while *M. athamanticum* passed from flowering to seed formation stage. *A. millefolium* was at leafy stage at 31 May, and then increased its proportion of flowers during June. From the beginning to the end of June (Periods I to III), the proportion of dicotyledon plants increased from 17% to 28% DM (Table 1) and crude protein and organic matter digestibility decreased by 19% and 9% respectively. During October, the DM biomass was 0.8 t ha<sup>-1</sup>, and the proportion of dicotyledons was 22% of DM (Table 1).

During June, the content of linolenic acid (C18:3n-3) in grass decreased (- 4 g per 100 g total FA) while the stearic (C16:0), the oleic (c9-C18:1), and the linoleic (C18:2n-6) acid content increased by 1.0, 2.6 and 3.4 g per 100 g total FA, respectively (Table 1) as already reported by Dewhurst *et al.* (2006). During October, the grass FA composition was similar to that observed in the first part of June (Table 1).

During June the milk yield and protein content decreased dramatically (Fig. 1), because of the progressive decline of the nutritional value of the grazed grass whereas the milk fat content increased from 33.7 to 36.4 g kg<sup>-1</sup> (data not shown). In October, the low milk yield (11.4 kg day<sup>-1</sup>) and high milk fat and protein content (47.2 and 37.4 g kg<sup>-1</sup>, respectively) can be explained partly by the progression of the lactation stage of the cows (+ 3 months).

During June the increase in the milk SFA content (from 57 to 60 g per 100 g total FA) was mainly due to the important increase in C16:0 content. In parallel, the PUFA content decreased (Fig. 1) as C18:3n-3 (-0.3 g per 100 g of total FA) and c9t11-CLA content (- 0.7 g per 100 g total FA). The decrease in milk C18:3n-3 and *trans* FA resulting in part from ruminal biohydrogenation of C18:3n-3 content (Fig. 1) was concomitant with the decrease in grass C18:3n-3 content (Chilliard *et al.*, 2007). At the start of October, the milk content of PUFA, total *trans* FA, vaccenic acid (t11-C18:1), c9t11-CLA and C18:3n-3 was higher than that at the start of June when the grass was still vegetative. The strong decrease in these FA content between the two samplings of October could be explained by the low availability of

the grass and/or changes in the grass FA composition observed during this short period (Dewhurst *et al.*, 2006; Ferlay *et al.*, 2006). Milk fat *c9*-C18:1 content was high despite the fact that the grass was poor in *c9*-C18:1 (Table 1). The increased milk fat *c9*-C18:1 content in October could result from higher C18:3*n*-3 intake, stearic acid absorption after ruminal biohydrogenation of C18:3*n*-3, and  $\Delta$ -9 desaturation (Chilliard *et al.*, 2007). Thus, the variability observed in milk FA composition during one month in our study was high especially for *c9* $\mu$ 11-CLA; C18:3*n*-3;  $\mu$ 11-C18:1 and C16:0, likely because of changes in the botanical composition of this grassland pasture and the maturing of the grass.

Figure 1. Change of milk yield (circles), milk protein content (triangles) and milk FA composition ( $\text{g (100g)}^{-1}$  total FA) from 3<sup>rd</sup> to 30<sup>th</sup> of June and from 3<sup>rd</sup> to 7<sup>th</sup> of October. The effect of the sampling date is significant ( $P < 0.01$ ) for all the milk characteristics reported. The vertical bars represent the SE of each mean.

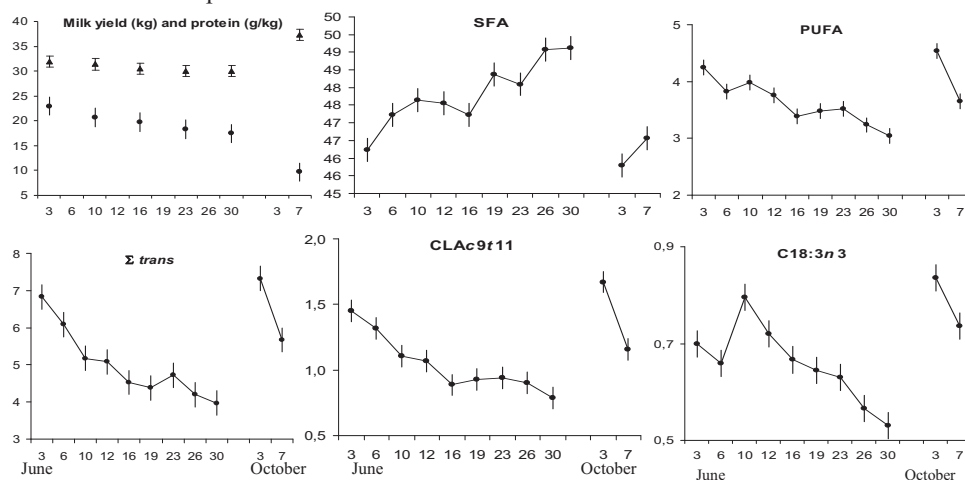

## Conclusion

These results underline the marked variability of the milk FA composition during a grazing period even when cows grazed the same grassland. Our results clearly show that all the milks from pasture differ regarding their FA profile. The best nutritional quality of the milks was observed when cows were grazing vegetative grass from the early growth or regrowth stages.

## References

- Chilliard Y., Glasser F., Ferlay A., Bernard L., Rouel J. and Doreau M. (2007) Diet, rumen biohydrogenation, and nutritional quality of cow and goat milk fat. *European Journal of Lipid Science and Technology* 109, 828-855.
- Dewhurst R.J., Shingfield K.J., Lee M.R.F. and Scollan N.D. (2006) Increasing the concentrations of beneficial polyunsaturated fatty acids in milk produced by dairy cows in high-forage systems. *Animal Feed Science and Technology* 131, 168-206.
- Ferlay A., Martin B., Pradel P., Coulon J.-B. and Chilliard Y. (2006) Influence of grass-based diets on milk fatty acid composition and milk lipolytic system in Tarentaise and Montbeliarde cow breeds. *Journal of Dairy Science* 89, 4026-4041.
- Ferlay A., Agabriel C., Sibra C., Journal C., Martin B. and Chilliard Y. (2008) Tanker milk variability of fatty acids according to farm feeding and husbandry practices in a French semi-mountain area. *Dairy Science and Technology* 88, 193-215.
- Tornambé G., Cornu A., Verdier-Metz I., Pradel P., Kondjoyan N., Figueredo G., Hulin S. and Martin B. (2008) Addition of pasture plant essential oil in milk: its influence on milk and cheese chemical and sensory properties. *Journal of Dairy Science* 91, 58-69.

## Fatty acid composition of different grassland species

Wyss U. and Collomb M.

Agroscope Liebefeld-Posieux Research Station ALP, 1725 Posieux, Switzerland

Corresponding author: ueli.wyss@alp.admin.ch

### Abstract

The fatty acids composition of eight grassland species was investigated. Forage of the first growth and the third regrowth (second regrowth for one species) was harvested at three different dates. The samples were freeze-dried and the fatty acids were determined by gas chromatography. The nutrient contents were also analysed. In the grasses and the legumes the sum of the fatty acids, and also the different fatty acids, decreased with age, especially in the forage of the first growth. The highest sums of the fatty acids were detected in the legumes and the herb *Taraxacum officinale*. The  $\alpha$ -linolenic acid (C 18:3 c9c12c15) was the most dominant fatty acid. In young plants its proportion was over 60%. An exception was found in *T. officinale* of the first growth. Here the total fatty acids decreased from the first to the second cutting date and then increased to the third cutting date, because higher amounts of linoleic acid (C 18:2 c9c12) were produced in the older forage.

Keywords: grasses, legumes, cutting date, fatty acids,  $\alpha$ -linolenic acid, linoleic acid

### Introduction

Grasses, legumes and other herbs are an important part of diet of ruminants, and as such, they are an important source of poly-unsaturated fatty acids, despite their low lipid concentration. Sources of variation in the fatty acid composition are plant species, growth stage, temperature and light intensity (Hawke, 1973). There are several fatty acids in plants, of which the most important are  $\alpha$ -linolenic acid, linoleic acid and palmitic acid (Bauchart *et al.*, 1984).

The objective of this study was to investigate the influence of different grassland species, which were cut at different dates in the first growth as well as in a regrowth, on fatty acid composition.

### Materials and methods

The fatty acid composition of the grasses *Lolium multiflorum*, *Dactylis glomerata*, *Phleum pratense* and *Alopecurus pratensis*, and the legumes *Trifolium repens*, *Trifolium pratense* and *Medicago sativa*, as well as the herb *Taraxacum officinale* was investigated. All species were grown in Posieux (altitude 650 m a.s.l.).

Forage of the grasses and the legumes of the first growth and also the third regrowth was harvested at three different dates from the same plot. For *Taraxacum officinale* forage of the first growth and second regrowth was used. A part of the plots was cut every two weeks to provide forage samples differing in age. The samples were freeze-dried and the fatty acids were determined by gas chromatography (Alves *et al.*, 2008). In addition, a part of the sample was dried at 60 °C, milled, and analysed for crude ash, crude protein, crude fibre and sugar contents.

Results for fatty acid concentrations were analysed by analysis of variance. Correlations between nutrient contents and fatty acid concentrations were calculated.

## Results and discussion

In the first growth, the values of the sum of total fatty acids and of  $\alpha$ -linolenic acid, linoleic acid and palmitic acid were significant between the different species and cutting dates (Table 1). The highest fatty acid concentrations were found in the young forage of the first growth. Bauchart *et al.* (1984) also found the highest fatty acid concentrations in early May. Furthermore, our results confirm the results of Dewhurst *et al.* (2001), who found that the age of the forage influences the fatty acids in the forage. The highest values of  $\alpha$ -linolenic acid were found in legumes, especially in *Trifolium repens*, and in the herb *Taraxacum officinale*. In young plants their proportion was over 60%. An exception was *T. officinale*. Here the total fatty acids decreased from the first to the second cutting date and then increased to the third cutting date of the first growth, because high amounts of linoleic acid were produced in the older forage. It is supposed that the white sap in the *T. officinale* is responsible for this development.

In the third regrowth (second regrowth for *T. officinale*), the fatty acid composition between the different species and cutting dates also differed (Table 2). As expected, the contents of the regrowths were not higher than in the first growth. According to Van Rast *et al.* (2009) plants in the generative stage have higher FA concentration than in the reproductive stage.

Table 1. Fatty acid concentrations in dry matter of eight species and three cutting dates of the first growth ( $\text{g kg}^{-1}$ )

Species	Cutting date	C16:0	C18:2 c9,c12	C18:3 c9c12c15	Sum of fatty acids
<i>Lolium multiflorum</i>	28.04.	3.4	3.1	17.0	28.0
	12.05.	3.1	3.1	11.8	21.8
	26.05.	2.6	2.9	6.7	15.1
<i>Dactylis glomerata</i>	28.04.	3.9	4.6	20.4	34.5
	12.05.	3.0	3.8	12.3	22.9
	26.05.	2.5	3.2	9.0	18.4
<i>Phleum pratense</i>	28.04.	3.7	5.1	17.7	31.9
	12.05.	3.0	4.3	11.4	23.1
	26.05.	2.4	3.3	7.7	17.5
<i>Alopecurus pratensis</i>	28.04.	3.9	5.8	18.8	34.1
	12.05.	2.9	4.3	11.8	23.0
	26.05.	2.4	5.0	7.5	19.0
<i>Trifolium repens</i>	28.04.	5.6	7.3	27.6	48.0
	12.05.	5.1	6.3	24.6	43.7
	26.05.	4.9	6.1	19.4	37.4
<i>Trifolium pratense</i>	28.04.	4.7	7.1	21.0	38.9
	12.05.	4.1	5.9	16.2	31.7
	26.05.	3.5	4.9	12.6	25.5
<i>Medicago sativa</i>	28.04.	5.3	6.9	19.7	37.7
	12.05.	4.6	5.8	15.9	31.5
	26.05.	3.8	4.7	11.6	24.4
<i>Taraxacum officinale</i>	15.04.	5.4	7.8	22.7	42.2
	28.04.	5.1	7.9	14.7	33.0
	12.05.	5.8	23.7	8.8	50.0
Species (S)		***	***	***	***
Cutting date (D)		***	***	***	***
Interaction SxD		***	***	***	***

\*\*\*  $P < 0.001$

The crude fibre content correlated negatively with the sum of the fatty acids ( $r = -0.76$ ), C16:0 ( $r = -0.75$ ), C18:2 ( $r = -0.40$ ) and C18:3 ( $r = -0.71$ ). In contrast, the crude protein content and the sum of the fatty acids ( $r = 0.78$ ), C16:0 ( $r = 0.74$ ), C18:2 ( $r = 0.23$ ) and C18:3 ( $r = 0.86$ ) correlated positively.

Table 2. Fatty acid concentrations in dry matter of eight species and three cutting dates of the third regrowth respectively second regrowth for *T. officinale* (g kg<sup>-1</sup>)

Species	Cutting date	C16:0	C18:2 c9,c12	C18:3 c9c12c15	Sum of fatty acids
<i>Lolium multiflorum</i>	24.08.	3.3	3.9	13.9	25.8
	07.09.	2.9	3.6	11.0	21.9
	21.09.	3.7	4.3	11.4	26.2
<i>Dactylis glomerata</i>	24.08.	3.3	3.7	16.2	29.2
	07.09.	2.6	3.1	11.5	22.0
	21.09.	2.6	3.8	11.9	22.9
<i>Phleum pratense</i>	24.08.	3.3	4.5	13.6	28.4
	07.09.	2.7	4.4	10.6	24.5
	21.09.	2.7	4.0	10.6	24.7
<i>Alopecurus pratensis</i>	24.08.	2.9	4.1	12.7	25.3
	07.09.	2.8	3.9	13.2	24.6
	21.09.	2.9	3.5	12.6	24.5
<i>Trifolium repens</i>	24.08.	4.7	5.9	21.6	39.8
	07.09.	4.1	5.9	19.7	36.9
	21.09.	3.9	5.8	17.4	34.4
<i>Trifolium pratense</i>	24.08.	3.7	5.7	14.0	28.9
	07.09.	3.2	5.1	12.6	26.4
	21.09.	2.9	5.0	10.9	24.3
<i>Medicago sativa</i>	24.08.	4.5	5.2	17.0	32.6
	07.09.	3.9	4.8	15.4	29.6
	21.09.	3.6	4.6	15.0	28.4
<i>Taraxacum officinale</i>	24.06	4.9	7.1	21.1	39.2
	08.07.	4.6	6.2	17.5	33.6
	22.07.	4.3	6.0	14.9	30.1
Species (S)		***	***	***	***
Cutting date (D)		***	***	***	***
Interaction SxD		***	***	***	***

\*\*\*  $P < 0.001$

## Conclusions

- The fatty acid concentrations differ between plant species. Legumes, especially *Trifolium repens*, have more fatty acids than grasses.
- An important factor for the fatty acid composition is the age of the forage.
- $\alpha$ -linolenic acid is the dominant fatty acid in grass.
- An exception was *T. officinale*. For this species, high amounts of linoleic acid were produced in the older forage of the first growth.

## References

- Alves S.P., Cabrita A.R.J., Fonseca A.J.M. and Bessa R.J.B. (2008) Improved method for fatty acid analysis in herbage based on direct transesterification followed by solid-phase extraction. *Journal of Chromatography* 1209, 212-219.
- Bauchart D., Verite R. and Remond B. (1984) Long-chain fatty acid digestion in lactating cows fed fresh grass from spring to autumn. *Canadian Journal of Animal Science* 64 (Suppl.), 330-331.
- Dewhurst R.J., Scollan N.D., Youell S.J., Tweed J.K.S. and Humphreys M.O. (2001) Influence of species, cutting date and cutting interval on the fatty acid composition of grasses. *Grass and Forage Science* 56, 68-74.
- Hawke J.C. (1973) Lipids. In: Butler G.W. and Bailey R.W. (eds.) *Chemistry and Biochemistry of Herbage*, London Academic Press, pp. 213-263.
- Van Ranst G., Fievez V., Vandewalle M., De Riek J. and Van Bockstaele E. (2009) Influence of herbage species, cultivar and cutting date on fatty acid composition of herbage and lipid metabolism during ensiling. *Grass and Forage Science* 64, 196-207.

## Seasonal variation in fatty acid contents of cow milk from indoor and pasture-based feeding

Wyss U.<sup>1</sup>, Collomb M.<sup>1</sup>, Frey H.J.<sup>2</sup> and Hofstetter P.<sup>3</sup>

<sup>1</sup>Agroscope Liebefeld-Posieux Research Station ALP, Posieux, Switzerland

<sup>2</sup>Hohenrain Agricultural Education and Extension Centre, Hohenrain, Switzerland

<sup>3</sup>Schüpfheim Agricultural Education and Extension Centre, Schüpfheim, Switzerland

Corresponding author: ueli.wyss@alp.admin.ch

### Abstract

The objective of this study was to compare the fatty acid contents in two systems of milk production. One system was pasture-based (P) with the calving season between February and April and with a restricted concentrate supplementation of 290 kg cow<sup>-1</sup> y<sup>-1</sup>. The second system used indoor feeding (I) with a mixed ration of grass and maize silage as well as a supplementation of concentrates (1135 kg cow<sup>-1</sup> y<sup>-1</sup>). The calving season was mainly between June and September. In 2008 and 2009, every month tank milk samples were taken and the fatty acid composition in the milk fat was analysed. The milk production was 5800 kg cow<sup>-1</sup> y<sup>-1</sup> in system P and 8400 kg cow<sup>-1</sup> y<sup>-1</sup> in system I. The milk of system P had less saturated and more unsaturated fatty acids in comparison to I. The conjugated linoleic acid in fat increased continuously from spring to autumn to 2.5 g (100 g)<sup>-1</sup> in system P while it amounted 0.5 g (100 g)<sup>-1</sup> during the whole year in system I. Differences were also found in the omega-3 acid content. In system P the contents were always higher than in I.

Keywords: pasture-based system, indoor feeding system, fatty acid content, omega-3

### Introduction

Bovine milk contains a large number of fatty acids (FA), some of which may be of potential benefit to human health, including polyunsaturated FA as omega-3 and conjugated linoleic acids (CLA). Many factors affect the FA composition of bovine milk. Compared with total mixed rations, pasture-based diets resulted in higher concentrations of unsaturated long-chain FA and CLA in milk (Kelly *et al.*, 1998; White *et al.*, 2001). The objectives of this study were to determine the effects of two different feeding systems on the FA composition in the milk and to investigate the development of the different FA during the year.

### Materials and methods

Two systems of milk production were compared on 13 ha each in Hohenrain (altitude 620 m a.s.l.). One system was pasture-based (P) with the calving season between February and April; 27 cows in 2008 and 28 cows in 2009 belonged to this system. The concentrate feed was restricted to 290 kg cow<sup>-1</sup> y<sup>-1</sup>. The pasture period started on 17 March in 2008 and 18 March in 2009, at first only during the day and then day and night. The pasture period lasted until 11 November in 2008 and 18 November in 2009. The second system used indoor feeding (I) with a mixed ration of grass and maize silage as well as a supplementation of concentrates of 1135 kg cow<sup>-1</sup> y<sup>-1</sup>. The calving season was mainly between June and September. This herd consisted of 25 cows in 2008 and 24 cows in 2009. Every month, tank milk samples were taken and the FA in the milk fat were analysed according to Collomb and Bühler (2000).

## Results and discussion

In system P the average milk production was  $5800 \text{ kg cow}^{-1} \text{ y}^{-1}$ . The indoor feeding system yielded a higher milk production of  $8400 \text{ kg cow}^{-1} \text{ y}^{-1}$ . Due to the seasonal calving period the average milk production per cow decreased in system P continuously. In system I, with the calving period over the whole year but with an accumulation between June and September, the average milk production was more stable, with a little increase at the end of summer (Figure 1). In system P the average milk fat content decreased first and then increased towards the end of lactation. In system I the milk fat content of the tank milk samples was higher than in system P with less seasonal variation (Figure 2).

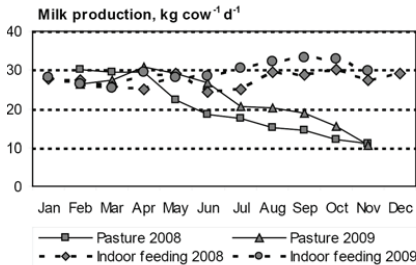

Figure 1. Evolution of the average milk production

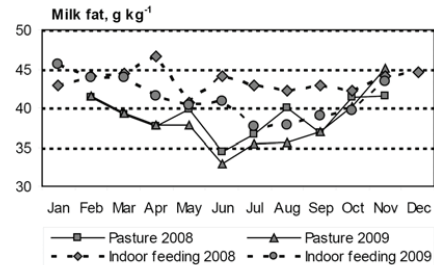

Figure 2. Evolution of the milk fat content

The milk of system P had less saturated and more mono- and poly-unsaturated FA in comparison to I, especially from April to October when the cows were on the pasture day and night (Figures 3 to 5).

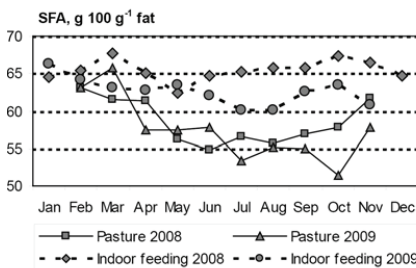

Figure 3. Evolution of the saturated fatty acids (SFA)

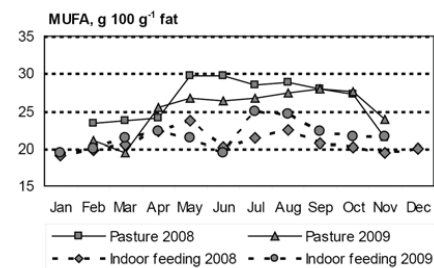

Figure 4. Evolution of the mono-unsaturated fatty acids (MUFA)

In system P the conjugated linoleic acid (CLA) increased continuously until September to a maximum of  $2.5 \text{ g (100 g)}^{-1} \text{ fat}$  with both years being very similar (Figure 6). In system I, the CLA content in fat amounted  $0.5 \text{ g (100 g)}^{-1}$  during the whole year. The CLA contents from system P as well as the development during the grazing season were similar to the results obtained by Collomb *et al.* (2008) from milk from mountain regions in Switzerland. The omega-3 FA also increased during the grazing season in system P in both years (Figure 7). In system I the values were lower than in system P and varied little. The omega-6 FA was not influenced by the grazing season (Figure 8). The omega-6 contents of the system I were higher in comparison to system P.



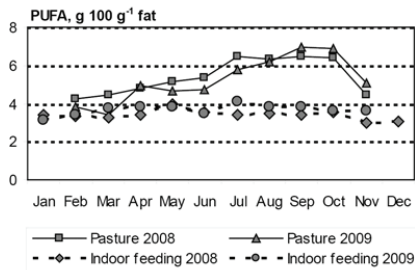

Figure 5. Evolution of the conjugated acids (PUFA)

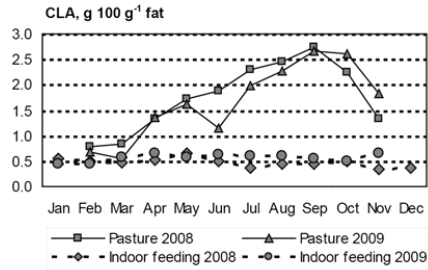

Figure 6. Evolution of the poly-unsaturated fatty linoleic acids (CLA)

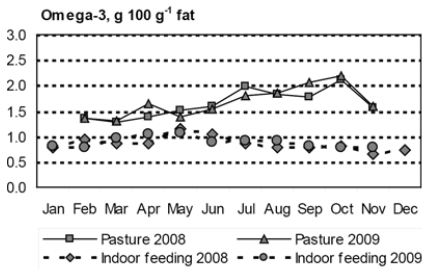

Figure 7. Evolution of the Omega-3 fatty acids

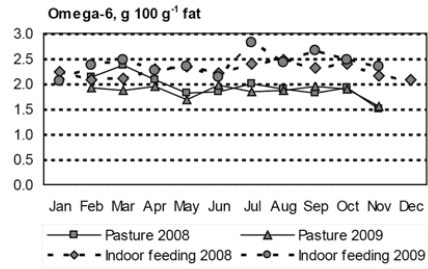

Figure 8. Evolution of the Omega-6 fatty acids

## Conclusions

- Milk of grazing cows had less saturated and more mono- and poly-unsaturated FA than milk from cows fed conserved forage and a higher supplementation of concentrates.
- Milk from grazing cows had higher amounts of CLA and omega-3 FA in comparison to milk from cows fed conserved forage and a higher supplementation of concentrates.
- CLA and omega-3 FAs increased during the grazing season from March to September.

## References

- Collomb M. and Bühler T. (2000) Analyse de la composition en acides gras de la graisse de lait. I. Optimisation et validation d'une méthode générale à haute résolution. *Mitteilungen aus Lebensmitteluntersuchung und Hygiene* 91, 306-332.
- Collomb M., Bisig W., Bütikofer U., Sieber R., Bregy M. and Etter L. (2008) Seasonal variation in the fatty acid composition of milk supplied to dairies in the mountain regions of Switzerland. *Dairy Science Technology* 88, 631-647.
- Kelly M.L., Kolver E.S., Bauman D.E., van Amburgh M.E. and Muller L.D. (1998) Effect of intake of pasture on concentrations of conjugated linoleic acid in milk of lactating cows. *Journal of Dairy Science* 81, 1630-1636.
- White S.L., Bertrand J.A., Wade M.R., Washburn S.P., Green J.T. and Jenkins T.C. (2001) Comparison of fatty acid content of milk from Jersey and Holstein cows consuming pasture or total mixed ration. *Journal of Dairy Science* 84, 2295-2301.

# Session 4

## Grassland ecosystem services



## Balancing trade-offs in ecosystem functions and services in grassland management

Sanderson M.A.<sup>1</sup> and Wätzold F.<sup>2</sup>

<sup>1</sup>USDA-ARS, Pasture Systems and Watershed Management Research Unit, University Park, PA, 16802 USA

<sup>2</sup>Ernst-Moritz-Arndt University of Greifswald Department of Law and Economics and Institute for Botany and Landscape Ecology Grimmer Str. 88, 17487 Greifswald, Germany

Corresponding author: matt.sanderson@ars.usda.gov

### Abstract

Managed grasslands are increasingly expected to provide ecosystem services beyond the traditional provision of forage and livestock products. Grassland systems can provide ecosystem services such as soil conservation, water quality protection, biodiversity conservation, medicinal plants, pleasing landscapes, soil carbon storage, and greenhouse gas mitigation. These benefits sometimes are accepted uncritically and the potential trade-offs among ecosystem functions or services are not recognized. For example, greenhouse gas emissions from intensive pasture-based livestock systems can be as large as or larger than losses from confinement systems because of N emissions from dung and urine of grazing animals. Some of the new ecosystem services, such as cellulosic biofuels from forages, may compete with traditional provisioning services. Thus, innovative management is critical to realizing the various ecosystem services from managed grasslands. In this context it is important that management measures are cost-effective to mitigate trade-offs between agricultural production and the provision of other ecosystem services. We illustrate this point by introducing an ecological-economic modelling procedure to design cost-effective payments for species conservation measures in grasslands.

Keywords: ecosystem services, ecological-economic modelling; multifunctionality, species conservation

### Introduction

Managed grasslands have long been recognized for multiple services such as soil conservation, water quality protection, biodiversity conservation, pleasing aesthetics, among many others, in addition to their traditional role as providers of forage and livestock products. These multiple services are now recognized in the concepts of ecosystem functions and ecosystem services. Ecosystem functions are the “habitat, biological, or system properties or processes of ecosystems”, whereas ecosystem goods and services include the “benefits humans derive, directly or indirectly, from ecosystem functions” (Costanza *et al.*, 1997). Ecosystem goods and services may be placed into four broad categories of provisioning, supporting, regulating, and cultural services (Millennium Ecosystem Assessment, 2005). These services often are discussed in the context of multifunctionality, which refers to the joint production of agricultural goods and other ecosystem services (Jordan *et al.*, 2007). Social pressures, environmental concerns, and regulations continue to challenge farmers to grapple with managing grasslands for multiple ecosystem services. Not all services may be realized at once; hence a critical challenge is to identify and accurately assess trade-offs among desired services. A trade-off may be defined as “a balancing of factors all of which are not attainable at the same time” (Merriam-Webster online dictionary; [www.merriam-webster.com/](http://www.merriam-webster.com/)). For example, maintaining acceptable wildlife habitat on grassland farms may compromise the quantity and quality of forage needed for economic livestock production. To

mitigate trade-offs in grassland it is important that policies to support the provision of ecosystem services are cost-effective, in other words, ecosystem services are provided for a minimum loss of agricultural production.

We start this paper with a presentation of the economic concept of the transformation curve which may be used to analyse trade-offs in grasslands. Then, we present two classical examples of trade-offs in grassland agriculture to illustrate the concept and consider recent examples of trade-offs from current complex situations facing society, agriculture, and the environment. We continue with the introduction of an ecological-economic modelling procedure to illustrate how cost-effective policies to mitigate trade-offs between conservation and agricultural returns in grasslands may be designed, and end with brief conclusions.

**Trade-offs in grassland management from an economic point of view**

Trade-offs in grassland management can be illustrated with the economic concept of the transformation curve (in the literature also referred to as production possibility frontier or efficiency frontier). For example, assume a (grassland) economy can produce only two bundles of goods – dairy products and biodiversity. Assume further that all production factors in the example economy are being used for the production of these goods. The transformation curve (Fig. 1) now shows all possible combinations of these goods that can be produced with the production factors and given technology if the factors are employed efficiently. Though often a concave shape of the transformation curve is assumed, it can also be a straight line or a convex curve depending on the specific characteristics of the production processes.

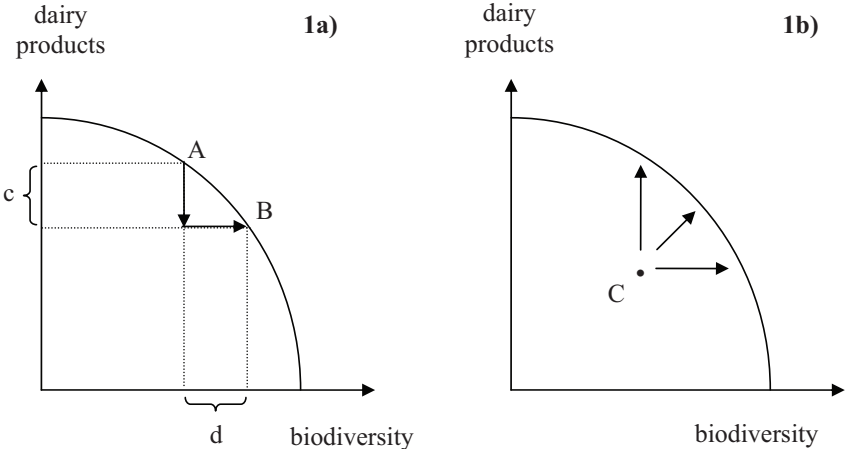

Figure 1. Transformation curves illustrating trade-off possibilities.

One key advantage of a transformation curve is that it shows trade-offs: The example economy may produce a combination of dairy products and biodiversity as represented by point A (Fig. 1a). Then it shows how much a society has to give up in terms of dairy products (the amount c) to get a certain amount (here d) more biodiversity (assuming that biodiversity can be measured somehow) – with the new combination of dairy products and biodiversity by the point B.

Another key advantage is that an empirical estimation of the transformation curve including an estimation of the current allocation of production factors and the resulting production of the two goods can detect possible improvements in terms of cost-effectiveness (in the literature also referred to as efficiency). Consider Fig. 1b with point C representing the current

production output which is not cost-effective. A reallocation of production factors may lead to a situation where more is produced from biodiversity or from dairy products or from both goods. Fig. 1b illustrates that if the production factors are not allocated efficiently a trade-off related to the production of two goods does not have to occur. More of one good can be produced without reducing the production of the other good. This shows the importance of designing cost-effective policies for grassland management (see Wätzold and Schwerdtner, 2005 for a general analysis on cost-effectiveness in biodiversity conservation).

The transformation curve can be used as a framework to analyse real-world trade-offs in grassland management, which to our knowledge has not yet been done and would be an area of further research. To illustrate the potential of the transformation curve approach consider a study by Polasky *et al.*, 2008 who investigate trade-offs between biodiversity conservation and economic value production depending on land use in the Willamette River basin in Oregon, USA. Polasky *et al.* use economic models to predict economic return of major land use activities (agriculture, managed forestry, rural residential use, and conservation) and a biological model to predict land use pattern's ability to support viable populations of a large set of species. With input from these models they estimate a transformation curve in order to assess the costs of species conservation in terms of foregone economic value production (Fig. 1a). They also find that the actual land use pattern in the Willamette Basin is represented by a point inside the transformation curve (Fig. 1b), i.e. that it is not cost-effective. According to their estimate the potential for improvement is substantial (e.g. by re-arranging land use patterns the existing level of species conservation could be achieved with a higher economic return of \$10 bio.) illustrating the usefulness of the transformation curve concept to support land management.

### **Examples of trade-offs in grassland agriculture**

Several functional characteristics of managed grasslands contribute to ecosystem services of benefit to humans. These include tangible products such as high quality forage and intangibles such as the aesthetics of grassland landscapes. Associated with the benefits are potential environmental or economic trade-offs. Each trade-off varies in space and time and has differing degrees of reversibility (Rodriguez *et al.*, 2006). In this section we discuss examples of trade-offs among ecosystem functions and services from managed grasslands.

#### *Forage quantity-quality and stocking rate-livestock productivity trade-offs*

Two examples of trade-offs in grassland production familiar to farmers and agronomists include the trade-off between forage yield and forage quality in hay and silage systems and between stocking rate and animal productivity in grazing systems. In the yield-quality trade-off, as forage yield increases forage quality generally decreases because of greater plant maturity. If the farmer's goal is to maximize forage yield then he or she must consider the trade-off in livestock production with reduced forage quality. This decision making process depends on the kind and production class of livestock to be fed. If the farmer is feeding livestock with a low plane of nutrition (e.g., beef brood cows) then forage quality may be sacrificed to obtain economic supplies of forage. However, if the farmer is feeding highly productive livestock, such as dairy cows, then forage quality becomes paramount and a significant trade-off in yield may be acceptable. In other words, the farmer must assess the value of the ecosystem service (in this instance production of quality forage) within the context of the service (i.e., within the context of the livestock production system).

The considerations become more complex when analysing trade-offs between stocking rate or stocking density and grazing animal performance in grazing systems. Liveweight gain per animal is maximized at relatively low stocking rates, whereas gain per hectare reaches a maximum at a higher stocking rate. Maximizing individual animal performance requires a

trade-off in land area production and inefficient utilization of the forage resource. Maximizing animal production per unit land area may cause degradation of the grazing land resource and reduce the sustainability of the system. Thus, the decision making process regarding trade-offs in this instance requires that the farmer considers not only production economics but also the health and sustainability of the resource.

The trade-offs in these two examples can be evaluated in a production economic framework that balances feed costs and livestock economic returns. The scope and scale of the trade-offs are relatively small and limited to individual fields, pastures, and herds within the specific farm. The time scales are short, typically less than a year and the trade-offs can be easily reversible. Next, we consider more complicated examples that include forces and constituents external to the farm and farmer.

#### *Trade-offs associated with carbon storage and greenhouse gas mitigation*

Perennial grassland systems generally accumulate soil organic matter and may reduce CO<sub>2</sub> emissions, a valuable ecosystem service. This potential to sequester C can be influenced by management such as defoliation frequency, stocking level, plant species selection, age of the stand, and soil fertility (Schnabel *et al.*, 2001). In the U.S., it has been estimated that improved grassland management could increase the quantity of C sequestered in soil by 10 to 34 Tg yr<sup>-1</sup> (Follett *et al.*, 2001). Recent research, however, indicates that temperate grassland in the U.S. may not be as effective in mitigating CO<sub>2</sub> emissions as expected. Carbon flux monitoring of pastures in Pennsylvania showed that mature (> 40 years old) pastures were substantial C sinks for a short time in April and May and a C source for the remainder of the year at typical forage utilization levels (Skinner, 2008), which is consistent with other research (e.g., Gianelle *et al.*, 2004; Ammann *et al.*, 2007). A study of nine European grasslands showed wide variation in net annual C accumulation, ranging from a loss of 2.66 Mg ha<sup>-1</sup> yr<sup>-1</sup> to a net gain of 4.62 Mg ha<sup>-1</sup> yr<sup>-1</sup> (Soussana *et al.*, 2007). Mature grasslands frequently show no net annual C uptake when all sources and sinks are taken into account (Suyker and Verma, 2001; Gianelle *et al.*, 2004). Delaying forage harvest by cutting or grazing as late as possible during spring could maximize the C sink; however, that would involve an economic trade-off in forage quality and animal performance (Skinner 2008). The current market for C credits in the U.S. would not favour this trade-off.

New tools based on whole-farm simulation models can be used to compare the carbon balance of grassland systems. Carbon footprint estimates with simulation models suggest that summer pasture combined with winter confinement had lower GHG emissions than either full confinement or year-round pasture-based dairies (Sedorovich, 2008). Year-round pasture had lower CO<sub>2</sub> emissions than confinement dairies, but had greater N<sub>2</sub>O emissions (Fig. 2). The pasture-based systems, however, had lower net economic returns compared with a full confinement system, which suggests that management recommendations resulting in the lowest GHG emission may require trade-offs in farm profitability. The transformation curve concept described above could be used to quantify such trade-offs which might be useful for analysing at what market price for carbon credits which type of grassland management is appropriate.

Implementing improved grassland management could enable C sequestration to continue for 25 to 50 years until a new equilibrium soil C content would be reached, after which time the improved grasslands would no longer serve as C sinks (Follett *et al.*, 2001). Adopting management practices to increase C sequestration often increases emissions of other GHGs, such as N<sub>2</sub>O and CH<sub>4</sub>, a trade-off that could counter up to 50% of the climate change mitigation potential from increased C sequestration (Hopkins and Del Prado, 2007). Grassland systems research at the Karkendamm farm in northern Germany documented that CO<sub>2</sub> emissions from cutting and grazing management systems were proportional to energy



use (Kelm *et al.*, 2004). Thus, increasing C sequestration by improving or intensifying (e.g., through additional energy inputs) grassland management could be short term at best, and may require careful management to ensure that grasslands actually provide the ecosystem service.

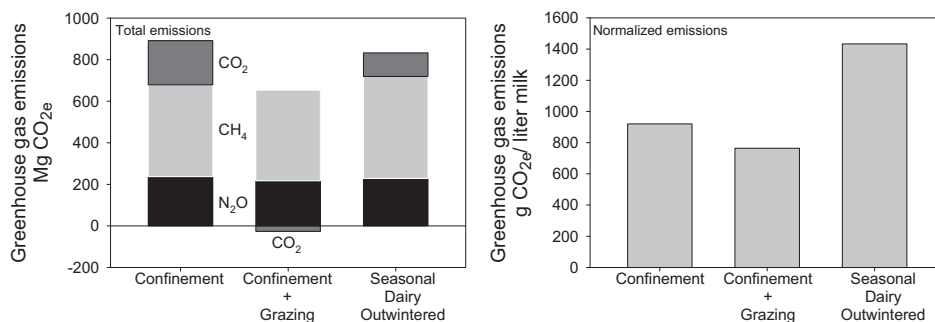

Figure 2. Total greenhouse gas emissions from three representative dairy farming systems (left panel) and emissions normalized per kg of milk production (right panel). Year-round confinement dairy, milk production level = 9700 L cow<sup>-1</sup> yr<sup>-1</sup>; Confinement+Grazing, Confinement in winter, grazed April to October, 8200 9700 L cow<sup>-1</sup> yr<sup>-1</sup>; Seasonal Dairy, year-round grazing, wintered outdoors; 9700 L cow<sup>-1</sup> yr<sup>-1</sup>. Data are model simulations from the Integrated Farming Systems model based on representative farms in the Northeast U.S. Source: Sedorovich (2008).

#### *Bioenergy production and trade-off implications for managed grasslands*

Grasslands may provide renewable feedstock for biofuel production as a future ecosystem service. Feedstocks could include perennial grasses, such as switchgrass (*Panicum virgatum* L) and Miscanthus (*Miscanthus x giganteus*), grown as dedicated energy crops (Sanderson and Adler, 2008) and the use of abandoned or marginal seminatural grasslands (Wachendorf *et al.*, 2009).

In the U.S., national goals for renewable energy call for an annual biomass supply of 907 Tg yr<sup>-1</sup> (1 billion tons; Perlack *et al.* 2005). Significant changes in land use would be required to meet these goals. Estimates are that 22.3 10<sup>6</sup> ha of the 181.4 10<sup>6</sup> ha of U.S. cropland would be needed to produce perennial biomass feedstock. Land for biomass feedstock was proposed to come from cropland pasture, set aside land in the Conservation Reserve Program, and reallocation of existing cropland. These estimates were based on several assumptions including a 50% increase in grain yields, technology to recover 75% of all annual crop residues, and average annual perennial cropland biomass yields of 12 Mg ha<sup>-1</sup> yr<sup>-1</sup>.

The projections for bioenergy cropping and associated land use changes in 2030 have significant ramifications for future forage-livestock production systems in the U.S. For example, the assumptions for increased crop yields and new technologies are likely optimistic, which means that more land area will be required to produce the targeted biomass than anticipated. Similarly, if less cropland was converted to perennial energy crops, then the production of perennial energy crops could be forced to more marginal lands. In the Chesapeake Bay region of the U.S., scenarios of replacing up to 0.4 10<sup>6</sup> ha of pasture and hayland with switchgrass for bioenergy have been proposed (Chesapeake Bay Commission, 2007). This would also force forage-livestock production to other regions or cause greater intensification of confined livestock production and result in dramatic social and economic trade-offs. The loss of the forage-livestock industry would change the socio-economic structure of rural communities in the watershed because small grassland-based farms would go out of business, which would have cascading effects on businesses that provide support

services. Greater intensification of livestock production in confined operations could lead to environmental damage from nutrient contamination of surface and ground waters.

Significant land use change from converting grasslands to bioenergy production as a result of biofuels targets have raised concerns about environmental consequences in the European Union (Taube *et al.*, 2007; Peeters, 2008; Haughton *et al.*, 2009). In the U.S., projections of expanded ethanol and biodiesel production indicate large reductions in pastureland (De La Torre Ugarte *et al.*, 2007). A global analysis of bioenergy production suggested that shifting livestock production from pasture to confinement feeding would reduce land needs for agriculture (Smeets *et al.*, 2006). If these projections are realized, there will be tremendous pressures on hay, forage, and pastureland in the future. The expanding need for biomass production would probably force forage and grazing land production to more marginal lands with the attendant social and economic trade-offs in the fabric and sustainability of rural communities (DeFries *et al.*, 2004).

### **Ecological-economic modeling and design of cost-effective policies to mitigate trade-offs**

One possibility to mitigate trade-offs in grasslands is to design policies in a way that they are cost-effective. However, this may not be trivial because depending on the trade-offs it may require integration of knowledge from various disciplines within an optimization framework (Wätzold *et al.*, 2006). We illustrate this point by presenting an ecological-economic modelling procedure that combines ecological and economic knowledge in an optimisation framework and that is able to determine cost-effective management measures for species protection in grasslands. The ecological-economic modelling procedure is based on Johst *et al.* (2002) and described in Drechsler *et al.* (2007b). It is developed by means of a case study: the design of management measures to conserve the endangered Great Blue butterfly (*Maculinea teleius*) which is protected by the EU Habitats Directive. Butterfly conservation measures reduce the profits of farmers, and, following the common approach in European agricultural policy, they have to be compensated for their profit losses. Cost-effectiveness here is defined that for a given budget for compensation payments the positive impact on the butterfly population is maximised. The development of the modelling procedure is based on a four-step approach which is described in Wätzold and Drechsler (2006) and briefly summarised here.

#### *1. Identifying causes for the endangerment of the species*

The Great Blue butterfly needs meadows with a certain type of vegetation. In particular, host plants on which eggs of the butterfly can be deposited (*Sanguisorba spp.*) need to be present and vegetation for ants necessary for the development of butterfly larvae (*Myrmica spp.*). Mowing is important for the development of the butterfly as when and how often a meadow is mowed determines the presence of the host plants and the ants. It is further important that mowing should not take place when the butterflies deposit their eggs on the host plants. With agricultural intensification mowing in an area has become synchronised: in Germany typically meadows are mowed twice a year with the first cut at the end of May and the second cut mid of July. This is the reason why the butterfly is highly endangered today as the second cut falls into the eclosion period of the butterflies.

#### *2. Developing alternative management options and assessing their ecological effects*

Drechsler *et al.* (2007b) systematically developed possible alternative mowing options to identify the cost-effective mowing regimes. They considered 112 different mowing regimes taking into account (1) that mowing could take place every year or every second year, (2) 14 different dates of the first cut and (3) four alternatives possibilities for the second cut including the possibility of no second cut. An ecological model that simulates the life cycle of

the butterflies and the butterflies' movement in the landscape was used to estimate the impacts of the alternative mowing regimes on the regional survival of the butterflies.

3. Assessing the costs of the different mowing regimes

The costs of different mowing regimes for each meadow were assessed. The costs depend – among a variety of factors – on the altitude of the meadow, the quality and humidity of soil, as well as the size and the shape of the meadow (Bergmann, 2004).

4. Combining the results from steps 2 and 3 in an optimisation procedure

The results of the ecological model (step 2) and the cost assessment (step 3) feed into an optimisation procedure to identify the cost-effective mowing regime (Fig. 2) – the mowing regime that leads to maximum butterfly survival (here measured as the number of meadows occupied by the butterfly after twenty model years) for a given budget – and the compensation payments to be offered to farmers for implementing the cost-effective mowing regime.

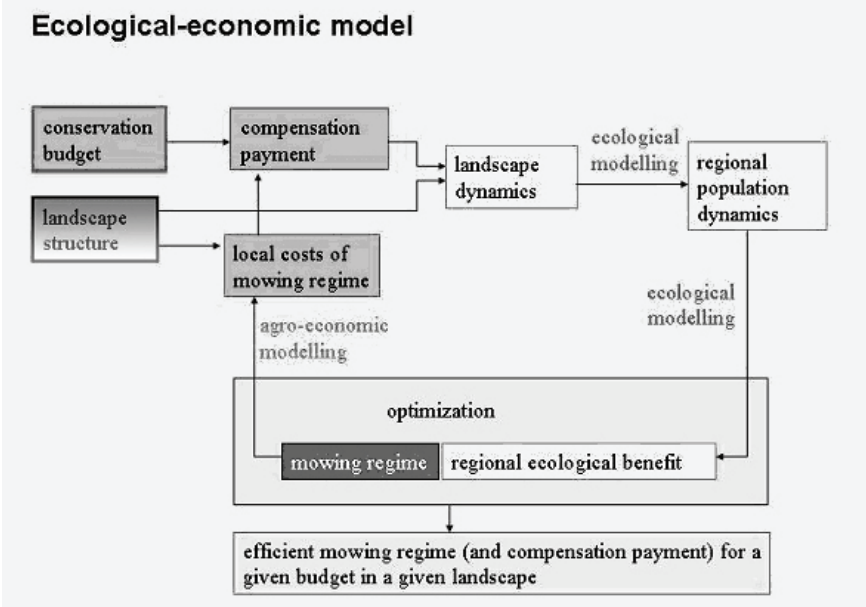

Figure 3. Overview of the ecological-economic modelling procedure. Source: Drechsler and Wätzold (2006, 383).

The functioning of the modelling procedure is illustrated in Fig. 3. Consider as a starting point one of the 112 mowing regimes (dark grey box in Fig. 3). The costs of implementing the mowing regime on each meadow in the region (local costs) are determined by the agro-economic cost assessment. Costs are influenced by the meadow's geographic parameters which are determined by the landscape structure. Costs are one factor that determines the compensation payment offered to the farmer to adopt the selected mowing regime. Farmers who own meadows on which the costs are below the payment adopt the selected mowing regime, other meadows are mowed conventionally. The conservation budget is the second factor that influences the size of the payment because with a rising budget higher compensation can be paid and more meadows can be mowed according to the selected mowing regime. In the region there are now meadows with the selected mowing regime and meadows mowed conventionally leading to a spatio-temporally structured landscape on which

the dynamics of the butterfly population is modelled. In a next step, the ecological model assesses the survival probability of the butterfly population in this landscape. The described sequence of steps is carried out for each of the 112 mowing regimes for a given conservation budget and the mowing regime with the highest butterfly survival probability is identified as the cost-effective mowing regime. For example, for a budget of €10000, the cost-effective mowing regime is one where every year the first cut is at the end of May and the second cut four weeks later.

Referring to the transformation curve introduced earlier: The ecological-economic modelling procedure is able to identify all points on a transformation curve which shows the efficient combinations of the two goods “agricultural production” and “Great Blue conservation.” These combinations can be achieved by one (or several) of the 112 mowing regimes that is cost-effective. Without *cost-effective* conservation, butterfly protection would be represented by a point on the left of the transformation curve with such points standing for mowing regimes that are not cost-effective. Butterfly protection would be more expensive in terms of foregone agricultural production and, hence, trade-offs between agricultural production and conservation would be more severe.

The modelling procedure forms the basis for a software tool for *Maculinea* conservation which can be downloaded free of charge from the internet ([www.macman.ufz.de/tool](http://www.macman.ufz.de/tool)). The software consists of a descriptive part and a simulation tool and is described by Ulbrich *et al.* (2008). For the region of Landau, Germany, the user can chose a conservation budget and a mowing regime and simulate the ecological outcome of that selection. The user can identify the cost-effective mowing regime by comparing the ecological benefits of a given budget for various mowing regimes. The tool also provides the corresponding compensation payments for the various budgets. A current project aims to extent this software in various ways. The new software shall be able to determine cost-effective grassland measures for all relevant endangered species (see Drechsler *et al.* (2007a) for first steps in this direction) for a large spatial scale (the German Federal States of Saxony and Schleswig-Holstein) and be easily adaptive to changing ecological and economic circumstances (see for more information the project-website [http://page.mi.fu-berlin.de/sturm/SokoBio/soko\\_bio\\_main\\_eng.html](http://page.mi.fu-berlin.de/sturm/SokoBio/soko_bio_main_eng.html)).

## Conclusions

Grassland agricultural systems have a number of environmental benefits, including soil conservation, improved nutrient cycling, and provision of wildlife habitat. Grassland systems could provide a range of newly-emerging services, including C sequestration and biofuels production. But it must be remembered that as with most agricultural production systems there are trade-offs between achieving production levels necessary to meet the farmer’s economic sustainability, while at the same time satisfying the demands of an expanding population that wants to eat meat and drink milk, and maintaining the integrity of the agroecosystem. Intensifying production on grassland systems, even modestly, can result in nutrient losses, GHG emissions, and soil degradation. Increasing agricultural bioenergy production by simply appropriating grasslands will further squeeze and marginalize forage-livestock producers. Any new recommendations or formulations of new policies, programmes, or payment systems to encourage grassland farming must acknowledge and understand these trade-offs. Designing cost-effective policies is an important way to mitigate trade-offs and efficiently use resources.

## References

Adler P.R., Del Grosso S.J. and Parton W.J. (2007) Life cycle assessment of net greenhouse gas flux for bioenergy cropping systems. *Ecological Applications* 17, 675–691.

- Ammann C., Fecharad C.R., Leifeld J., Neftel A. and Fuhrer J. (2007) The carbon budget of newly established temperate grassland depends on management intensity. *Agriculture, Ecosystems, and Environment* 121, 5-20.
- Bergmann H. (2004) *Berechnung von Kosten für Maßnahmen zum Schutz von gefährdeten Maculinea-Arten*, UFZ-Diskussionspapier 2/2004, 61 pp. (<http://www.ufz.de/index.php?de=2301>).
- Boody G., Vondracek B., Andow D.A., KinKrinke M., Westra J., Zimmerman J. and Welle P. (2005) Multifunctional agriculture in the United States. *Bioscience* 55, 27-38.
- Brauman K.A., Daily G.C., Ka'eo T. and Mooney H.A. (2007) The nature and value of ecosystem services: an overview highlighting hydrologic services. *Annual Review of Environmental Research* 32, 67-98.
- Chesapeake Bay Commission (2007) *Biofuels and the Bay*. <http://www.chesbay.state.va.us/Publications/BiofuelsAndTheBay1.pdf>.
- Costanza R., d'Arge R., de Groot R., Farber S., Grasso M., Hannon B., Limburg K., Naeem S., O'Neill R.V., Paruelo J., Raskin R.G., Sutton P. and van den Belt M. (1997) The value of the world's ecosystem services and natural capital. *Nature* 387, 253-260.
- DeFries R.S., Foley J.A. and Asner G.P. (2004) Land-use choices: balancing human needs and ecosystem function. *Frontiers in Ecology and Environment* 2, 249-257.
- De La Torre Ugarte D.G., English B.C. and Jensen K. (2007) Sixty billion gallons by 2030: Economic and agricultural impacts of ethanol and biodiesel expansion. *American Journal of Agricultural Economics* 89, 1290-1295.
- Drechsler M., Johst K., Ohl C. and Wätzold F. (2007a) Designing cost-effective payments for conservation measures to generate spatiotemporal habitat heterogeneity. *Conservation Biology* 21 (6), 1475-1486.
- Drechsler M., Wätzold F., Johst K., Bergmann H. and Settele J. (2007b) A model-based approach for designing cost-effective compensation payments for conservation of endangered species in real landscapes. *Biological Conservation* 140, 174-186.
- Follett R.F., Kimble J.M. and Lal R. (2001) *The Potential of U.S. Grazing Lands to Sequester Carbon and Mitigate the Greenhouse Effect*, CRC Lewis Publishers, Boca Raton, FL, 442 pp.
- Gianelle D., Zorer R., Marcolla B., Cescatti A. and Vescovo L. (2004) Carbon flux measurements in a mountain grassland in the Italian Alps. *Grassland Science in Europe* 9, 157-159.
- Haughton A.J., Bond A.J., Lovett A.A., Dockerty T., Sunnenberg G., Clark S.J., Bohan D.A., Sage R.B., Mallott M.D., Mallott V.E., Cunningham M.D., Riche A.B., Shield I.F., Finch J.W., Turner M.M. and Karp A. (2009) A novel, integrated approach to assessing social, economic and environmental implications of changing rural land use: a case study of perennial biomass crops. *Journal of Applied Ecology* 46, 315-322.
- Hopkins A. and Del Prado A. (2007) Implications of climate change for grassland in Europe: impacts, adaptations and mitigation options: a review. *Grass and Forage Science* 62, 118-126.
- Johst K., Drechsler M., Wätzold F. (2002) An ecological-economic modelling procedure to design compensation payments for the efficient spatio-temporal allocation of species protection measures. *Ecological Economics* 41, 37-49.
- Jordan N., Boody G., Broussard W., Glover J.D., Keeney D., McCown B.H., McIsaac G., Mueller M., Murray H., Neal J., Pansing C., Turner R.E., Warner K. and Wyse D. (2007) Sustainable development of the bio-economy. *Science* 316, 1570-1571.
- Kelm M., Wachendorf M., Trott H., Volkens K. and Taube F. (2004) Performance and environmental effects of forage production on sandy soils. III. Energy efficiency in forage production from grassland and maize for silage. *Grass and Forage Science* 59, 69-79.
- Millennium Ecosystem Assessment. (2005). *Ecosystems and human well-being: Synthesis*. Island Press, Washington, D.C. USA.
- Peeters A. (2008) Challenges for grasslands, grassland-based systems, and their production potential in Europe. *Grassland Science in Europe* 13, 9-24.
- Perlack R.D., Wright L.L., Turhollow A.F., Graham R.L., Stokes B. and Erbach D.C. (2005) *Biomass as a feedstock for a bioenergy and bioproducts industry: The technical feasibility of a billion-ton annual supply*. A joint study sponsored by the U.S. Department of Energy and the U.S. Department of Agriculture [online] [www1.eere.energy.gov/biomass/publications.html](http://www1.eere.energy.gov/biomass/publications.html).
- Polasky S., Nelson E., Camm J., Csuti B., Fackler P., Lonsdorf E., Montgomery C., White D., Arthur J., Garber-Yonts B., Haight R., Kagan J., Starfield A. and Tobalske C. (2008) Where to put things? Spatial land management to sustain biodiversity and economic returns. *Biological Conservation* 1505-1524.
- Rodriguez J.P., Beard T.D., Bennett E.M., Cumming G.S., Cork S.J., Agard J., Dobson A.P. and Peterson G.D. (2006) Trade-offs across space, time, and ecosystem services. *Ecology and Society* [online] [www.ecologyandsociety.org/vol11/iss1/art28/](http://www.ecologyandsociety.org/vol11/iss1/art28/)
- Sanderson M.A. and Adler P.R. (2008) Perennial forages as second generation bioenergy crops. *International Journal of Molecular Science* 9, 768-788.

- Schnabel R.R., Franzluebbers A.J., Stout W.L., Sanderson M.A. and Stuedeman J.A. (2001) Pasture management effects on soil carbon sequestration. In: Follett R.F., Kimble J.M., and Lal R. (eds.) *Potential of U.S. Grazing Lands to Sequester Carbon*, CRC Lewis Publishers, Boca Raton, FL, pp.291-322.
- Sedorovich D.M. (2008) *Greenhouse gas emissions from agroecosystems: simulating management effects on dairy farm emissions*. Ph.D. dissertation, Pennsylvania State University, University Park, Pennsylvania.
- Skinner R.H. (2008) High biomass removal limits carbon sequestration of mature temperate pastures. *Journal of Environmental Quality* 37, 1319-1326.
- Smeets E.M.W., Faaij A.P.C., Lewandowski I.M. and Turkenburg W.C. (2006) A bottom-up assessment and review of global bio-energy potentials to 2050. *Progress in Energy and Combustion Science* 33, 56-106.
- Smith P, Marino D., Cai Z., Gwary D. Janzen J., Kumar P., McCarl B., Ogle S., O'Mara F., Rice C., Scholer B. and Sirotenko O. (2007) Agriculture. In: Metz B., Davidson O.R., Bosch P.R., Dave, R. and Meyer L.A. (eds.) *Climate Change 2007: Mitigation. Contribution of working group III to the fourth assessment report of the Intergovernmental Panel on Climate Change*, Cambridge Univ. Press, U.K. pp. 497-540.
- Soussana J.-F., Allard V., Pilegaard K., Ambus P., Ammann C., Campbell C., Ceschia E., Clifton-Brown J., Czobel S., Domingues R., Flechard C., Fuhrer J., Hensen A., Horvath L., Jones M., Kasper G., Martin C., Nagy Z., Neftel A., Sutton M., Tuba Z. and Valentini R. (2007) Full accounting of the greenhouse gas (CO<sub>2</sub>, N<sub>2</sub>O and CH<sub>4</sub>) budget of nine European grassland sites. *Agriculture, Ecosystems, and the Environment* 121, 121-134.
- Suyker A.E. and Verma S.B. (2001) Year-round observations of the net ecosystem exchange of carbon dioxide in a native tallgrass prairie. *Global Change Biology* 7, 279-289.
- Taube F., Herrmann A. and Pötsch E.M. (2007) What are the consequences of producing energy crops in the European Union for grassland renovation and new forage production systems? *Grassland Science in Europe* 12, 445-453.
- Ulbrich K., Drechsler M., Wätzold F., Johst K. and Settele J. (2008) A software tool for designing cost-effective compensation payments for conservation measures. *Environmental Modelling and Software* 23, 122-123.
- Wachendorf M., Richter F., Fricke T., Graß R. and Neff P. (2009) Utilization of semi-natural grassland through integrated generation of solid fuel and biogas from biomass. I. Effects of hydrothermal conditioning and mechanical dehydration on mass flows of organic and mineral plant compounds, and nutrient balances. *Grass and Forage Science* 64, 132-143.
- Wätzold F. and Drechsler M. (2006) Policy instruments for environmental and natural resource management: economic perspective and integration of knowledge from natural sciences. In: Jiarong G., Veste M., Baoping S. and Beyschlag W. (eds.) *Restoration and stability of ecosystem in arid and semi-arid areas*, Science press, Beijing, pp. 377-387.
- Wätzold F. and Schwerdtner K. (2005) Why be wasteful when preserving a valuable resource? A review article on the cost-effectiveness of European conservation policy. *Biological Conservation* 123, 327-338.
- Wätzold F., Drechsler M., Armstrong C.W., Baumgärtner S., Grimm V., Huth A., Perrings C., Possingham H.P., Shogren J.F., Skonhofs A., Verboom-Vasiljev J. and Wissel C. (2006) Ecological-economic modeling for biodiversity management: Potential, pitfalls, prospects. *Conservation Biology* 20, 1034-1041.



## Ecosystem services and functions of biodiversity in grasslands

Weigelt A.<sup>1</sup>, Vogel A.<sup>2</sup> and Scherer-Lorenzen M.<sup>3</sup>

<sup>1</sup>*Institute of Biology I, University of Leipzig, D-04103 Leipzig, Germany*

<sup>2</sup>*Institute of Ecology, University of Jena, D-07743 Jena, Germany*

<sup>3</sup>*Faculty of Biology – Geobotany, University of Freiburg, D-79104 Freiburg, Germany*

Corresponding author: alexandra.weigelt@uni-leipzig.de

### Abstract

The Millennium Ecosystem Assessment (2005) concluded that the global decline in biological diversity will compromise the delivery of important ecosystem services and thus have an effect on human well-being. Our goal is to test this statement for the biome of temperate grasslands. We seek evidence from experimental studies demonstrating a positive or negative effect of grassland biodiversity on ecosystem functions and services. We find that even though the effect of biodiversity on the four categories of ecosystem services – provisioning, regulating, supporting and cultural – are very differently reflected in scientific literature, there is a large database supporting that biodiversity, and especially functional composition, is an important driver of ecosystem functioning in temperate grassland systems.

Keywords: ecosystem services, biodiversity, ecosystem functioning, Jena-Experiment

### Introduction

There is growing agreement that the long-term stability of terrestrial landscapes that provide ecosystem services will be increased by the conservation of existing biodiversity (Collins and Qualset, 1999; Kates and Parris, 2003). Accordingly, the Millennium Ecosystem Assessment (MEA, 2005) stated that biological diversity plays a critical role in underpinning ecosystem services and that the ongoing reduction in biodiversity will have large impacts on ecosystem processes and, thus, human well-being. However, the benefits that biodiversity provides to people have not been well reflected in decision-making and resource management (MEA, 2005).

Grasslands are the most widespread biome on earth and they provide many important goods and ecosystem services (Gibson, 2009). This, together with their good accessibility, their easy manipulation and their comparatively fast built up of a stable community from seeds, made grasslands the ideal target for experimental and observational biodiversity-ecosystem functioning research. Balvanera *et al.* (2006) reviewed 446 biodiversity studies, 78% of which targeted terrestrial ecosystems and 75% thereof studied grasslands. Dividing ecosystem services into the four main categories proposed by the MEA (2005) – provisioning, regulating, supporting and cultural – we seek to explicitly link these services to studies of temperate grassland ecosystem functioning. We will focus on the results of the largest grassland biodiversity experiment in Europe, the Jena-Experiment, and will support these findings with other recent studies in grassland research.

### Results and discussion

Experimental evidence directly supporting the positive effect of biodiversity on temperate grassland services is best for categories of supporting and regulating services which are mostly indirectly affected through the biodiversity-ecosystem functioning relationship (Fig. 1, Balvanera *et al.*, 2006; Diaz *et al.*, 2006). Of these, the positive effect of biodiversity on aboveground primary productivity is by far the best studied relationship, while the fact that the positive biodiversity-productivity relationship equally holds under fertilized conditions



over several years has only been studied in the Jena-Experiment (Fig. 2, Weigelt *et al.*, 2009) and the COST Action (Kirwan *et al.*, 2007).

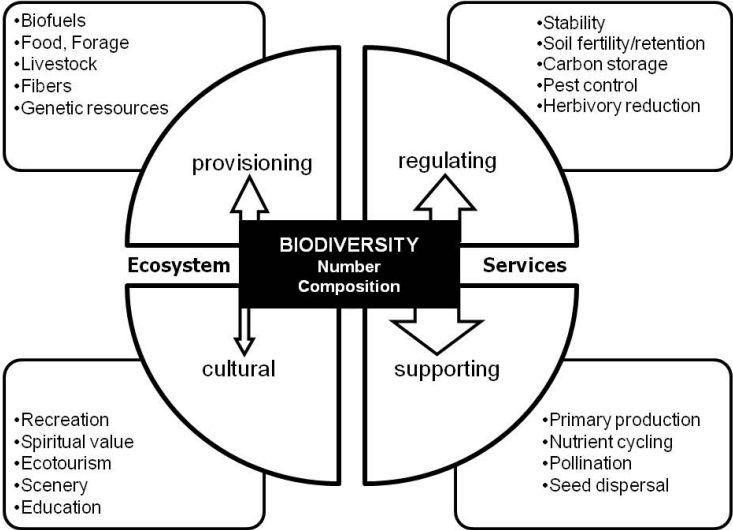

Fig. 1: Schematic summary of potentially important services in grassland ecosystems which might be affected by biodiversity. The width of arrows gives a rough indication of the number of studies available in each field.

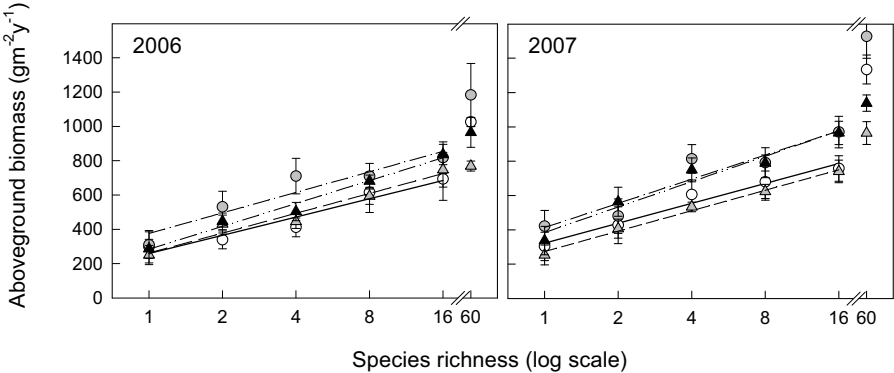

Fig. 2: Aboveground biomass in 2006 (left) and 2007 (right). Means ( $\pm$  SE) for species richness are given for four treatments combining mowing frequency (M2=mowing twice, M4= mowing four times) with N fertilization (F0= no fertilizer, F100= 100 kg ha<sup>-1</sup>a<sup>-1</sup>, F200= 200 kg ha<sup>-1</sup>a<sup>-1</sup>). M2F0: open circle, solid line; M2F100: grey circle, dash-dotted line, M4F100: grey triangle, dashed line, M4F200: black triangle, dash-double dotted line. The 60 species mixtures (60) were not included in the linear regressions which were all significant ( $P < 0.05$ , see Weigelt *et al.*, 2009 for experimental details).

The diversity effect on the stability of grassland communities also received much attention but shows variable results within and between different aspects of stability, e.g. resistance or resilience (Tilman *et al.*, 2006; Roscher *et al.*, 2009). Some of the directly affected

provisioning services are also well represented in the scientific literature as e.g. the effect of biodiversity on biofuel production (Tilman *et al.*, 2006; Hill *et al.*, 2009). However, there is hardly any published evidence on biodiversity and cultural services of temperate grasslands. Irrespective of the category of ecosystem services, it is generally important to separate between different aspects of biodiversity: functional composition and here predominantly the presence of legumes often revealed a higher importance than species richness *per se* on ecosystem functioning in temperate grasslands (Marquard *et al.*, 2009).

Overall, the biological diversity in temperate grasslands, both in terms of functional diversity and species richness, does play a critical role in maintaining ecosystem functioning and ecosystem services and its ongoing reduction will most likely affect human well-being. For permanent grasslands, highly diverse communities composed of species with complementary traits could provide an agro-economic and ecological option for sustainable and productive grassland use. Developing mixtures composed of such complementary species that remain stable even under intensive use or changing climatic conditions will be an important research goal for the future.

## References

- Balvanera P., Pfisterer A.B., Buchmann N. *et al.* (2006) Quantifying the evidence for biodiversity effects on ecosystem functioning and services. *Ecology Letters* 9 (10), 1146-1156.
- Collins W.W. and Qualset C.O. (1999) *Biodiversity in Agroecosystems*. CRC Press, Boca Raton, FL.
- Díaz S., Fargione J., Stuart Chapin F. III, Tilman D. (2006) Biodiversity loss threatens human well-being. *PLoS Biol* 4(8): e277. DOI: 10.1371/journal.pbio.0040277.
- Gibson D.J. (2009) *Grasses and Grassland Ecology*. Oxford University Press, Oxford, New York.
- Hill J., Polaskya S., Nelson E. *et al.* (2009) Climate change and health costs of air emissions from biofuels and gasoline. *PNAS* 106(6), 2077-2082.
- Kates R.W. and Parris T.M. (2003) Long-term trends and a sustainability transition. *Proceedings of the National Academy of Sciences of the USA* 100, 8062-8067.
- Kirwan L., Lüscher A., Sebastia M.T. *et al.* (2007). Evenness drives consistent diversity effects in intensive grassland systems across 28 European sites. *Journal of Ecology* 95, 530-539.
- Marquard E., Weigelt A., Temperton V. *et al.* (2009) Plant species richness and functional composition drive overyielding in a six-year grassland experiment. *Ecology* 90(12), 3290-3302.
- Millennium Ecosystem Assessment (2005) *Ecosystems and Human Well-being*. Biodiversity Synthesis Report. Island Press, Washington, DC.
- Roscher C. Beßler H., Oelmann Y. *et al.* (2009) Resources, recruitment limitation and invader species identity determine pattern of spontaneous invasion in experimental grasslands. *Journal of Ecology* 97, 32-47.
- Tilman D., Hill J. and Lehmann C. (2006) Carbon-negative biofuels from low-input high-diversity grassland biomass. *Science* 314, 1598-1600.
- Tilman D., Reich P.B. and Knops J.M.H. (2006) Biodiversity and ecosystem stability in a decade-long grassland experiment. *Nature* 441(1), 629-632.
- Weigelt A, Weisser W.W., Buchmann N. and Scherer-Lorenzen M. (2009) Biodiversity and multifunctional agriculture: equal productivity in high-diversity low-input and low-diversity high-input grasslands. *Biogeosciences* 6, 1695-1706.



## **Session 4.1**

### **Balancing tradeoffs between functions**

*Editor: Johannes Isselstein*

# Plant functional strategies from 13 co-occurring grass species explain the productivity and abundance in productive grasslands

Pontes L. da S., Maire V., Gross N., Proulx R., Louault F., Carrère P. and Soussana J.F.  
INRA UR874 UREP, Grassland Ecosystem Research, F-63100 Clermont-Ferrand, France  
Corresponding author: Vincent.Maire@clermont.inra.fr

## Abstract

How plant functional strategies are translated into species abundance in a community is a key question for the estimation of ecosystem functioning along environmental gradients. We address this question using 13 widespread grass species co-occurring in semi-natural mesic grasslands of central France. Plant functional strategies were identified using a principal component analysis (PCA) on 28 plant traits measured for this species pool. We found that the main functional strategy that explains species productivity in monoculture was linked to a plant stature PCA axis. However, applied to six-species mixtures, the plant stature axis alone did not explain species abundances in these communities. Two additional functional axes were needed, particularly for grass mixtures under strong N limitation and high cutting frequency: the first described a trade-off between the acquisition of  $\text{NO}_3^-$  and  $\text{NH}_4^+$  and the second a trade-off between nitrogen (N) acquisition and conservation strategies.

Keywords: plant functional traits, axis of specialization, community functioning, trade-off

## Introduction

One way to identify plant functional strategies is to establish major axes of plant specialization in life history and resources acquisition. Plant functional traits (PFT) have been proposed as useful tools to achieve this goal, as they may reflect species adaptation to the local environment. Moreover, trade-offs among traits are likely to translate into differences in species performance/abundance. Despite some recent theoretical progress (Suding *et al.*, 2008), there are few empirical studies which have investigated how trades-offs translate into species abundance and species response to environmental factors. Here, we investigated i) the trades-offs among 28 PFTs, which may explain species performance (biomass production in monoculture and abundance in mixture) of 13 co-occurring grasses from managed grasslands; ii) and how these trades-offs translate into response to environmental (here land use) change.

## Materials and methods

In a two-year experiment (2003-2004), 28 vegetative root and shoot PFTs of 13 species (cf. species and traits list in Fig. 1), reflecting the morphology, phenology, physiology and chemical composition of 13 co-occurring grass species, were measured in field monocultures under low disturbance and low N stress levels (the  $\text{C}^+\text{N}^+$  treatment, 3 cuts  $\text{yr}^{-1}$ , 360  $\text{kg ha}^{-1} \text{yr}^{-1}$  N) (see methods in Pontes *et al.*, 2007). Three different mixtures of six species were randomly established: 1) *Dg*, *Fa*, *Fr*, *Lp*, *Pp*, *Cynosurus cristatus* (*Cc*); 2) *Ap*, *Ao*, *Ae*, *Er*, *Hl*, *Tf*; 3) *Ae*, *Dg*, *Er*, *Fa*, *Fr*, *Hl*. Productivity in monoculture and species abundance in mixtures were measured under four management conditions (crossing between 3 and 6 cuts  $\text{yr}^{-1}$  and 120 and 360  $\text{kg ha}^{-1} \text{yr}^{-1}$  N), one of them being the treatment where plant traits were measured. The experimental design comprised 192 plots in a complete randomized block design with three replicates. PCA was done using the 28 PFTs of the 13 grass species. The PCA was rotated to match the first axis with the vegetative plant height, which had the strongest component weight in the unrotated PCA. The scores of each species on the first four PCA axes were used

in separate multiple regressions to explain the monoculture productivities and species abundance in six-species mixtures, subjected to four management conditions.

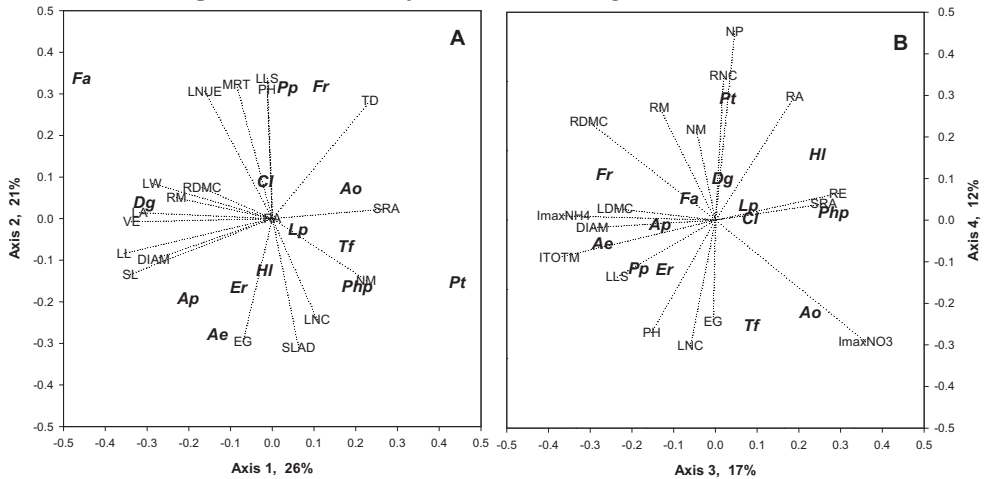

Figure 1. The first four axes (A axes 1 and 2; B axes 3 and 4) in a PCA of a trait-species matrix including 13 co-occurring grass species and 28 plant traits. On each figure, only traits with a component weight higher than 0.2 were represented. Species: *Alopecurus pratensis* (Ap), *Anthoxanthum odoratum* (Ao), *Arrhenatherum elatius* (Ae), *Dactylis glomerata* (Dg), *Elytrigia repens* (Er), *Festuca arundinacea* (Fa), *Festuca rubra* (Fr), *Holcus lanatus* (Hl), *Lolium perenne* (Lp), *Phleum pratense* (Php), *Poa pratensis* (Pp), *Poa trivialis* (Pt) and *Trisetum flavescens* (Tf). Abbreviation of traits: Earliness of growth (EG), root diameter (DIAM), root maximal uptake capacities for  $\text{NH}_4^+$  (ImaxNH4), for  $\text{NO}_3^-$  (ImaxNO3) and for both ions (ITOTM), leaf lamina area (LA), leaf dry matter content (LDMC), leaf length (LL), leaf lifespan (LLS), leaf lamina N content (LNC), leaf N use efficiency (LNUE), leaf lamina water (LW), mean N residence time (MRTN), numbers of growing (NG), and mature (NM) leaves, shoot N productivity (NP), phyllochron (PH), root area per soil volume (RA), root dry matter content (RDMC), leaf N resorption rate (RE), root mass per soil volume (RM), root N content (RNC), ratio between SL and LL (SL/LL), sheath length (SL), specific leaf area (SLA), specific root area (SRA), tiller density (TD), vegetative plant height (VE).

## Results and discussion

The four first axes of the PCA (Fig. 1) accounted for 76% of the variance. These four axes corresponded to well-known functional specialization axes: i) the first axis accounted for 30% of the total variance and opposed vegetative plant height (VE) and specific root area (SRA). It was interpreted as a plant stature axis (Ackerly 2004); ii) the second axis (18%), opposed the earliness of plant growth onset (EG) to leaf lifespan (LLS), reflecting the trade-off between plant growth precocity and longevity during the vegetation period (Aerts and Chapin 2000); iii) the third axis (16%), opposed the root uptake capacity for  $\text{NO}_3^-$  vs  $\text{NH}_4^+$ , reflecting the trade-off between the investments in root  $\text{NO}_3^-/\text{NH}_4^+$  transporters (Maire *et al.* 2009); iv) the fourth PCA axis (11%), opposed the leaf N content (LNC) and the shoot N productivity (NP), and was interpreted as the N acquisition/conservation trade-off (Aerts and Chapin 2000).

In multiple regression analyses, the four PCA axes together explained significantly both species productivity in monoculture ( $R^2 = 0.80$ ;  $P < 0.001$ ) and species abundance in three different six-grass mixtures ( $R^2 = 0.66$ ;  $P < 0.001$ ) (Table 1). However, the variance explained by each axis was strongly dependent on the species richness (i.e., monoculture or mixture) and on the management condition. Although species' productivity in monoculture was well

explained by the first PCA axis (84% of the total variance), species' abundance in mixtures was significantly ( $P < 0.001$ ) dependent on the first, third and fourth axes (40%, 41% and 19% of the total variance, respectively). For all treatments in monocultures, the first PCA axis explained a large part of the total variance in productivity. In addition, the axes 2 and 3 significantly contributed to the explained variance in regressions (between 11% in  $CN^+$  and 21% in  $C^+N^+$  treatments, together). Finally, the additional contribution of PCA axes 4 was never significant. For mixtures, the weight of axis 1 to explain the total variance in species abundance was strongly decreased, except for the  $CN^+$  treatment. On the contrary, the weights of axes 3 (up to 57%) and 4 (up to 26%) were strongly increased. Interestingly, this shift of functional strategy was particularly strong for treatments with N limitation (N).

Table 1. Multiple regressions between species coordinates on the first four PCA components of the 13 grass species monocultures and: i) their productivity in monocultures; ii) their abundances in three mixtures including different six species combinations. These analyses were conducted for the four management treatments (crossing between 3 and 6 cuts  $yr^{-1}$  and 120 and 360  $kg\ ha^{-1}\ yr^{-1}\ N$ ), which were applied to cultures. Coefficient value, 0-100% rescaled value of explained variance and significance of each independent variable (PCA axes) are given, as well as error term ( $\epsilon$ ) and determination coefficient ( $R^2$ ) for full regression.

Culture	Treat.	Axis 1		Axis 2		Axis 3		Axis 4		$\epsilon$	$R^2$
		Value	Vari.	Value	Vari.	Value	Vari.	Value	Vari.		
Mono	C-N+	-1.16	87.2***	0.34	4.1*	0.42	6.8*	0.25	1.9 <sup>ns</sup>	9.95***	78.4***
Mono	C+N-	-0.55	83.2***	-0.01	0.6 <sup>ns</sup>	0.27	14.8*	0.10	1.4 <sup>ns</sup>	6.73***	55.8***
Mono	C-N-	-0.90	78.3***	0.37	7.7**	0.41	9.6*	0.32	4.4 <sup>o</sup>	8.26***	72.1***
Mono	C+N+	-0.75	77.2***	0.27	5.2*	0.43	16.2**	0.14	1.4 <sup>ns</sup>	8.95***	69.7***
Mixture	C-N+	-4.92	66.7***	-0.84	1.1 <sup>ns</sup>	2.94	19.3**	4.24	12.9*	14.6***	59.4***
Mixture	C+N-	-2.57	23.7*	0.26	0.4 <sup>ns</sup>	5.13	55.6***	5.28	20.3***	18.2***	62.9***
Mixture	C-N-	-2.87	29.6*	-0.88	1.0 <sup>ns</sup>	4.46	43.5***	6.02	25.9***	17.8***	59.2***
Mixture	C+N+	-3.53	40.9***	0.72	1.9 <sup>ns</sup>	4.37	42.9***	4.28	14.3**	16.6***	66.9***

<sup>o</sup>,  $P < 0.1$ ; \*,  $P < 0.05$ ; \*\*,  $P < 0.01$ ; \*\*\*,  $P < 0.001$ ; ns, not significant.

## Conclusion

This study highlights a direct way of explaining species productivity in monocultures and species abundance in grass mixtures, from four fundamental plant trades-offs. Further, we also highlight the particular  $NO_3^-/NH_4^+$  trade-off, which was previously never taken account of in the literature despite its significant role for both, productivity in monoculture and species abundance in mixtures in our system. Finally, the complementarity between different trades-offs shown here opens new perspectives to estimate the abundance patterns of natural communities and their change in response to environmental changes. Other traits, such as reproductive traits, other-than-N-nutrients traits or traits related to grazing could be helpful to explore further the drivers of species association in semi natural grasslands.

## References

- Ackerly D. (2004) Functional strategies of chaparral shrubs in relation to seasonal water deficit and disturbance. *Ecological Monographs* 74, 25-44.
- Aerts R. and Chapin F.S. (2000) The mineral nutrition of wild plants revisited: A re-evaluation of processes and patterns. *Advances in Ecological Research* 30, 1-67.
- Maire V., Gross N., Pontes L. da S. and Soussana J.F. (2009) Trade-off between root N acquisition and shoot N utilization across 13 co-occurring pasture grass species. *Functional Ecology* 23, 668-679.
- Pontes L. da S., Soussana J.F., Louault F., Andueza D. and Carrere P. (2007) Leaf traits affect the above-ground productivity and quality of pasture grasses. *Functional Ecology* 21, 844-853.
- Suding K.N., Lavorel S., Chapin F.S. et al. (2008) Scaling environmental change through the community-level: a trait-based response-and-effect framework for plants. *Global Change Biology* 14, 1125-1140.



# Distinct response of two wet grassland communities to different management regimes

Čop J., Eler K. and Vidrih M.

University of Ljubljana, Biotechnical Faculty, SI-1000 Ljubljana, Slovenia

Corresponding author: jure.cop@bf.uni-lj.si

## Abstract

Vegetation characteristics of an Arrhenatherion grassland (Experiment 1) and a Molinion grassland (Experiment 2), both located in the Ljubljana marsh of Slovenia, were evaluated 11 years after exposure to cutting and fertilizer treatments. The responses of both grasslands were compared with respect to shifts in species composition and to changes in species diversity and functional group composition. Each experiment represented a randomized split-plot design with three cutting frequencies as main plots and four fertilizer applications as sub-plots (four replicates). In total 96 vegetation relevés were made in 2009. The cutting treatments affected only plant diversity in Experiment 2 whereas each fertilizer application reduced species richness compared to the unfertilized control in both experiments. These applications also decreased the plant diversity in Experiment 1. The species composition of the Arrhenatherion grassland showed a weaker response to the treatments than that of the Molinion grassland. Shifts of vegetation composition occurred mostly due to fertilizer treatments, but the differences in species composition among PK and two NPK treatments were small. The treatment effects on the functional groups were more pronounced in the Arrhenatherion grassland where a larger increase of legumes was also observed.

Keywords: wet grassland, cutting regime, fertilizer application, plant diversity, vegetation composition

## Introduction

Intensification of grassland management through defoliation frequency and fertilizer application results in a shift in plant community composition (e.g. Hopkins and Holz, 2006) and usually in a decrease of plant species richness and diversity (e.g. Zechmeister *et al.*, 2003). In habitats with low soil nutrient availability, however, richness and diversity can be positively affected by moderate intensification. Therefore, implications of the grassland management for ecosystem functioning are huge, but they are also site- and management-specific. In this sense grassland management is often an issue of scientific investigations throughout Europe and beyond. The aim of this study was to determine the long-term effects of cutting and fertilizer treatments on vegetation characteristics of two wet grassland communities, and to compare the responses of both communities to these treatments with respect to their ecological and agronomical values.

## Materials and methods

Two field experiments in a split-plot design with four replicates per treatment were set up in the Ljubljana marsh (45°58' N, 14°28' E, 295 m a.s.l.) in spring 1999. In Experiment 1, assigned to an Arrhenatherion grassland, the main-plot cutting treatments were two cuts with a delayed first cut, three cuts and four cuts during the growing season of each year. In Experiment 2, assigned to a Molinion grassland, the cutting treatments were two cuts with a delayed first cut, two cuts with a traditional harvest time, and three cuts. The four sub-plot fertilizer treatments were an unfertilized control, application of phosphorus and potassium

(PK) fertilizer, application of nitrogen (N) and PK fertilizer to the first cut only (N<sub>1</sub>PK) and application of PK plus N applied to each of two, three or four cuts (N<sub>c</sub>PK). For experimental details and sites characteristics, see Čop *et al.* (2009). The data presented here were obtained from the experiments in spring 2009 after eleven years of exposure to the cutting and fertilizer treatments. Vegetation relevés using the Braun-Blanquet cover-abundance scale were made on 96 plots, with plots sizes of 4 × 2.5 m<sup>2</sup> in Experiment 1 and 4 × 2 m<sup>2</sup> in Experiment 2. Plots by species matrices with abundance values of the relevés were subjected to detrended correspondence analysis to determine shifts in community composition for each experiment separately. The compositional data approach was used to analyse functional type composition (grasses, legumes, forbs). For other analyses the split-plot ANOVA was used.

## Results and discussion

Plant species richness was affected only by the fertilizer treatments ( $P < 0.001$ ) in both experiments where each fertilizer application reduced richness compared to the unfertilized control. Average richness with standard deviation for the fertilized plots versus the control was  $27.8 \pm 3.0$  vs.  $33.9 \pm 2.8$  in Experiment 1 and  $25.7 \pm 4.4$  vs.  $31.3 \pm 2.6$  in Experiment 2. Plant diversity (measured as Shannon-Wiener index) was negatively affected by the fertilizer treatments ( $P < 0.001$ ) only in Experiment 1 whereas it was positively affected by the cutting treatments ( $P < 0.049$ ) in Experiment 2. Average diversity for the fertilized plots versus the control was  $1.5 \pm 0.3$  vs.  $2.0 \pm 0.2$  (Experiment 1) and average diversity for the delayed two-cuts versus the three-cuts plots was  $1.3 \pm 0.3$  vs.  $1.5 \pm 0.3$  (Experiment 2). Due to low level of nutrients in the experimental soils and the moderate intensification mimicked in this study the reduction of richness and diversity was relatively weak. On the basis of the humped-back model of Al-Mufti *et al.* (1977) such responses are expected.

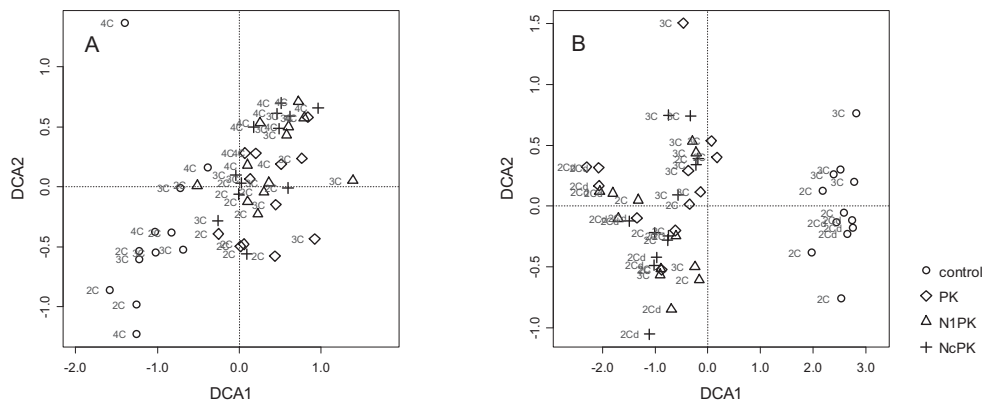

Figure 1: Ordination of the vegetation samples of (A) the Arrhenatherion grassland (Experiment 1) and (B) the Molinion grassland (Experiment 2) in first two axes of detrended correspondence analysis. The relevés were made in spring 2009 after 11 years of treatment,  $N = 2 \times 48$ . Symbols and labels denote the fertilizer and cutting treatments, respectively.

As for the richness, the fertilizer application was a major factor influencing the vegetation composition in both experiments (Fig. 1). However, magnitude of response of the community composition was larger in Experiment 2. As shown in Fig. 1 both communities responded quite differently to the fertilizer application and even showed different trajectories during the treatment period (data not included). However, the response did not differ significantly between the types or amounts of fertilizer added. The cutting regime appeared to be of

secondary importance, especially in Experiment 1. In Experiment 2, there was some perceivable influence of cutting regime. Under each fertilizer application, the three-cuts treatment promoted grass species while delayed cutting promoted competitive forbs.

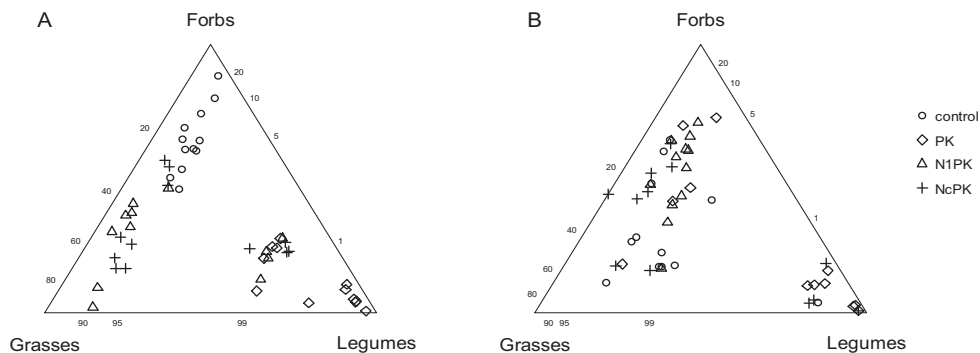

Figure 2: Ternary graph of functional group composition of the vegetation samples of (A) the Arrhenatherion grassland (Experiment 1) and (B) the Molinion grassland (Experiment 2). The relevés were made in spring 2009 after 11 years of treatment,  $N = 2 \times 48$ . Symbols denote the fertilizer treatments. Note the distorted (centred) graph axes.

Fertilizer addition caused more significant shifts in functional group composition in the Experiment 1 (Fig. 2) which is contrary to the response with respect to community composition. Increased proportion of legumes under the PK treatment and grasses under both NPK treatments, as found in Experiment 1, is in agreement with other similar studies. In Experiment 2, such development of the vegetation was disturbed by *Filipendula ulmaria* which encroached in all fertilized plots early in the treatment period but decreased in the three-cut treatment later. However, the proportions of legumes were rather low in both experiments indicating their low competitive ability for light in high vegetation.

## Conclusion

On the basis of vegetation composition, moderate management intensification of semi-natural wet grasslands, included in this study, will likely improve their production value for domestic animals at the reasonable expense of plant species richness and diversity. But such intensification may alter vegetation composition completely, as it was in the case with Molinion grassland in Experiment 2, indicating that major ecological and agricultural deterioration may be the consequence of inappropriate management.

## References

- Al-Mufti M.M., Sydes C.L., Furness S.B., Grime J.P. and Band S.R. (1977) A quantitative analysis of shoot phenology and dominance in herbaceous vegetation. *Journal of Ecology* 65, 759-791.
- Čop J., Vidrih M. and Hacin J. (2009) Influence of cutting regime and fertilizer application on the botanical composition, yield and nutritive value of herbage of wet grasslands in Central Europe. *Grass and Forage Science* 64, 454-465.
- Hopkins A. and Holz B. (2006) Grassland for agriculture and nature conservation: production, quality and multifunctionality. *Agronomy Research* 4, 3-20.
- Zechmeister H.G., Schmitzberger I., Steurer B., Peterseil J. and Wrba T. (2003) The influence of land-use practices and economics on plant species richness in meadows. *Biological Conservation* 114, 165-177.

# Regulation of meadow saffron (*Colchicum autumnale* L.) in extensively managed grasslands

Jung L.S.<sup>1\*</sup>, Winter S.<sup>2\*</sup>, Kriechbaum M.<sup>2</sup>, Eckstein R.L.<sup>1</sup>, Donath T.W.<sup>1</sup> and Otte A.<sup>1</sup>

<sup>1</sup>Department of Landscape Ecology and Resource Management, Justus-Liebig-University Giessen, Heinrich-Buff-Ring 26–32, D-35392 Giessen, Germany

<sup>2</sup>Institute of Integrative Nature Conservation Research, University of Natural Resources and Applied Life Sciences Vienna, Gregor-Mendel-Str. 33, A-1180 Vienna, Austria

\*contributed equally

Corresponding authors: Linda.Jung@umwelt.uni-giessen.de; Silvia.Winter@boku.ac.at

## Abstract

During the last years, the toxic grassland species *Colchicum autumnale* has reached critical population densities in extensively managed grasslands of Austria and Germany. As farmers have problems to feed or sell their hay, there is a risk of intensification or abandonment. Extensive management is essential for conserving species-rich grasslands and their ecosystem services. Our objective was to develop management strategies to regulate *C. autumnale* without affecting species richness. In 2008 we established permanent plots (1 m<sup>2</sup>) in seven Austrian and eight German *C. autumnale* populations. In each country, we conducted one of four (five) different mowing treatments per plot and recorded every individual of *C. autumnale*. For data analysis via a matrix population model, plants were categorized into five life stages. First results show that an early cut in April/May had the strongest effect on population growth rate ( $\lambda$ ). The population growth rate of the control treatment was about 1, i.e. population equilibrium, whereas the other treatments reduced  $\lambda$  significantly below 1, indicating population decline. Differences in  $\lambda$  between control and other treatments were mainly the result of growth reduction and increased regression.

Keywords: *Colchicum autumnale*, extensive management, matrix population models, lifetable response experiment (LTRE)

## Introduction

During the last years, the toxic grassland species *Colchicum autumnale* has reached critical population densities in extensively managed grasslands of Austria and Germany. As farmers have problems to feed or sell their hay, there is a risk of intensification or abandonment. However, extensive management is essential for the conservation of species-rich grasslands and their important ecosystem services (Dierschke and Briemle, 2002). Therefore, our objective was to develop suitable measures to reduce the size of *C. autumnale* populations without significantly affecting species diversity. In this study, we compared the effect of seven different mowing regimes on population dynamics of *C. autumnale* in Austria and Germany. We hypothesized that the earlier the mowing date and the more intensive the mowing regime, the more negative is its effect on the *C. autumnale* population. To evaluate treatment effects on population dynamics and population growth rate, matrix population models (Caswell, 2001) were applied.

## Material and methods

In 2008 we established 16–20 permanent plots (1 m<sup>2</sup> each plus a buffer zone of at least 0.5 m) in seven Austrian and eight German *C. autumnale* populations (in three regions of each country). Investigated grasslands were extensively managed, i.e. not fertilised and mown once

or twice a year. *C. autumnale* density per plot without seedlings ranged from 11 to 63 (average: 34) and 6 to 147 (average: 49) plants per m<sup>2</sup> in Germany and Austria, respectively. In each country, every plot (including the buffer zone) was subject to one of four different mowing treatments (Table 1). Treatments were replicated four times in Germany and five times in Austria. In one region in Germany, a fifth treatment was applied.

Table 1. Overview of mowing treatments in Austria and Germany

Treatment no.	Mowing treatment	Austria (A)	Germany (G)
1A, 1G	June, September (Control)	x	x
2G	Mid-May		x
3A, 3G	Mid-May, June	x	x
4G	Mid-May, June, September		x
5G	April, Mid-May		x (in one region only)
6A	Beginning of May, June	x	
7A	June, repeated flower-removal in autumn	x	

We recorded every individual of *C. autumnale* per plot and assigned it to one of five life stages (Fig. 1). Transition matrices and population growth rates ( $\lambda$ ) were calculated for each treatment and country. Fecundity was determined by dividing the number of generative plants by the number of seedlings in the following year. We established a 95% confidence interval for  $\lambda$  of each matrix by bootstrapping the data (10000 iterations). The contribution of different demographic processes to the difference in  $\lambda$  between each treatment and the control (Caswell, 2001) was quantified by a life-table response experiment (LTRE).

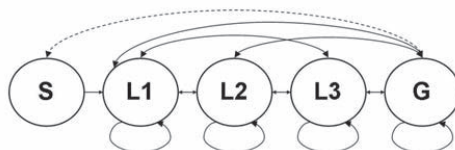

Figure 1. Life cycle graph of *Colchicum autumnale* (S seedling, L1-L3 vegetative plant with one, two and three or more leaves, G generative plant with capsules). Arrows indicate possible transitions between stages, the dashed line represents fecundity.

## Results and discussion

All treatments except the control resulted in a reduced  $\lambda$  (Fig. 2A). While the results of the treatments 2G, 3A, 3G, 4G, 6A and 7A (Table 1) were similar in spite of their different mowing regime, treatment 5G resulted in a markedly lower  $\lambda$ . Treatment 5G had also the largest effect on  $\lambda$  when compared to the other treatments within the same single region. In general, controls had population growth rates of around 1, indicating population equilibrium. LTRE analyses revealed that differences in population growth rate between controls and treatments were mainly due to growth reduction, but also to an increase in regression (Fig. 2B). Of all treatments, regression was highest in treatment 5G, which was also the only treatment where stasis was strongly affected. Effects on growth and on regression increased within the Austrian treatments in the order 7A, 3A, 6A. Stasis was positive in the early mown treatment 6A due to the strong contribution of L1 plants staying in their stage. They were possibly less affected by mowing than the other stages due to their smaller size. Differences in  $\lambda$  between the treatments can be explained with the life cycle of the species. Each year, the plant's corm is replaced by a new corm, which starts storing nutrients with leaf emergence in late April. Until then, the old corm provides nutrients and gradually becomes depleted (Frankova *et al.*, 2003). Thus, an early leaf removal in mid-April or early May reduces the nutrient reserves of *C. autumnale* more dramatically than a later cut. Accordingly, the smallest  $\lambda$  in our study resulted from the earliest mowing treatments, i.e. 5G and 6A.

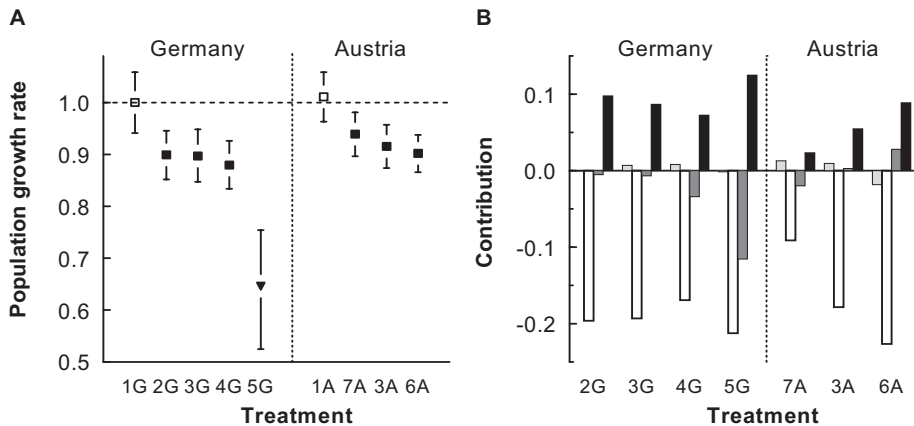

Figure 2: (A) Mean population growth rates ( $\lambda$ ) with their confidence intervals of *Colchicum* populations under different treatments (cf. Table 1). Treatment 5G (triangle) was only carried out within one region (three populations), open squares denote controls, broken horizontal line indicates stable population growth ( $\lambda = 1$ ). (B) Contribution of different demographic processes to  $\lambda$  from a life table response experiment. Light gray bars denote fecundity, open bars growth, dark gray bars stasis, and black bars regression.

The much stronger effect of treatment 5G on  $\lambda$  compared to 6A may have two reasons: (1) the second cut in May in treatment 5G resulted in a suppression of photosynthesis and nutrient storage, as regrown plant tissue was removed. (2) Leaf removal in April could have a larger effect on plant performance than in May, when the plant has possibly already stored nutrients in the corm. The similar results of the treatments 2G-4G despite different mowing intensity are due to the fact that leaves did not regrow after the cut in May, and thus plants were not additionally affected by the cut in June. In summary, the early cut treatments showed the best results (cf. Wehsarg, 1929). The next years will show which treatments exert consistent effects on *Colchicum* and result in sufficiently reduced population densities without affecting total plant diversity.

### Acknowledgements

We thank the Deutsche Bundesstiftung Umwelt (Ref. no. 25073-33/0), the Federal Ministry of Agriculture, Forestry, Environment and Water Management, Jubiläumsfonds der Österreichischen Nationalbank, and Österreichische Bundesforste for financial support, the farmers, and all people who helped during the project.

### References

- Caswell H. (2001) *Matrix population models*, Sinauer Associates, Inc. Publishers, Sunderland, Massachusetts, 722 pp.
- Dierschke H. and Briemle G. (2002) *Kulturgrasland: Wiesen, Weiden und verwandte Staudenfluren*, Eugen Ulmer, Stuttgart (Hohenheim), 239 pp.
- Franková L., Komjáthyová H., Bóka K., Gašparíková O. and Pšenák M. (2003) Biochemical and physiological aspects of developmental cycle of *Colchicum autumnale* L. *Biologia Plantarum* 47, 509-516.
- Wehsarg O. (1929) *Die Verbreitung und Bekämpfung der Ackerunkräuter in Deutschland. Einzelunkräuter. Ihr Vorkommen und ihre Verbreitung. Herbstzeitlose und Weißer Germer*. Deutsche Landwirtschafts-Gesellschaft, Berlin, 126 pp.

## Winter resistance of pasture weeds *Rumex obtusifolius* L. and *R. crispus* L.

Křišťálová V.<sup>1</sup>, Hejzman M.<sup>1,2</sup> and Červená K.<sup>1</sup>

<sup>1</sup>Department of Ecology, Faculty of Environmental Sciences, Czech University of Life Sciences, Kamýčká 129, CZ-165 21 Prague 6 - Suchbát, Czech Republic

<sup>2</sup>Crop Research Institute, Drnovská 507, CZ-161 06 Prague 6 - Ruzyně, Czech Republic

Corresponding author: vkostalova@gmail.com

### Abstract

*Rumex obtusifolius* L. is a problematic widespread weed species of permanent grasslands in many European countries. After severe winters, retreat of *R. obtusifolius* from infested grasslands was recorded several times by Czech farmers. The aim of this study was to investigate winter resistance of *R. obtusifolius* L. compared with *R. crispus* L. In spring 2008, a pot experiment with ten fertilizer treatments (combination of N, P and K application) was established and both *Rumex* species were seeded. The plants in pots were exposed to winter conditions without any protection. During the experiment, the lowest measured temperature -13.2 °C was recorded on 3 January 2009. Winter survival over all levels of nutrient availability was 18% and 100% for *R. obtusifolius* and *R. crispus*, respectively. No survival of *R. obtusifolius* was recorded in the K treatment and survival was higher than 30% in NP and NPK treatments. In the case of *R. crispus*, no mortality was recorded. *R. obtusifolius* flowered in all treatments during the first season, while *R. crispus* started to flower in the second season after over-wintering. Retreat of *R. obtusifolius* from infested grasslands after severe winters can be connected with low winter resistance of this species.

Keywords: curled and broad-leaved docks, nitrogen, phosphorus and potassium, winter mortality and resistance, pot experiment, nitrophilous species

### Introduction

*Rumex crispus* L. (curled dock) and *R. obtusifolius* L. (broad-leaved dock) are perennial species native to temperate Europe (Cavers and Harper, 1964) but nowadays they are cosmopolitan and troublesome weeds worldwide, especially on arable land and on temperate grasslands and the prognosis is for increasing infestation in the future (Zaller, 2004). The combination of the effective generative reproduction by well viable and germinable seeds together with the clonal reproduction makes the control of both docks extremely difficult (Hopkins *et al.*, 2002). Many studies about *Rumex* species were focused on its ecology (Hatcher *et al.*, 1997) and on methods for regulating its uncontrolled spread, e.g. timing of the first flowering, seed production, establishment of seedlings, but whether the species are monocarpic or polycarpic still remains unclear, as well as their longevity and the effect of nutrient availability on winter resistance. Unlike in Britain and the rest of Europe, the plants of *R. crispus* in most North American populations require over-wintering before flowering can occur (Bond *et al.*, 2007). According to Cavers and Harper (1964), *R. obtusifolius*, but especially *R. crispus*, have a tendency to die after seed production. Martinkova *et al.* (2009) marked *R. obtusifolius* as perennial, even though half of the plants died within the first four years. It was determined that N, P, and K nutrient level contained in the plant can influence the frost-resistance (Jönsson *et al.*, 2004). *Rumex obtusifolius* seems to be a short-lived plant while *R. crispus* can be marked as short or long-lived without the tendency to die after producing an inflorescence. The aim of this study was to explore whether winter survival or winter mortality differ between the two species, and whether these are affected by different N, P and K availability.



## Material and methods

In May 2008, a factorial pot experiment was established in an open air vegetation hall of the Crop Research Institute in Prague-Ruzyně (Czech Republic, 50° 5' 7.574" N, 14° 18' 13.286" E). The investigated factors were species (two levels: *Rumex crispus* and *R. obtusifolius*) and nutrient availability (ten levels: Control, N<sub>1</sub>, N<sub>2</sub>, P<sub>1</sub>, P<sub>2</sub>, K, N<sub>1</sub>P<sub>1</sub>, N<sub>1</sub>P<sub>1</sub>K, N<sub>2</sub>P<sub>1</sub>K, N<sub>2</sub>P<sub>2</sub>K; one application: N<sub>1</sub> = 150 kg ha<sup>-1</sup> N, N<sub>2</sub> = 300 kg ha<sup>-1</sup> N, P<sub>1</sub> = 40 kg ha<sup>-1</sup> P, P<sub>2</sub> = 80 kg ha<sup>-1</sup> P, K = 100 kg ha<sup>-1</sup> K) leading to 20 treatments altogether. Each treatment was replicated five times, i.e. five pots, (Fig.1). The pots were filled with clay soil of low PN availability. Three plants were grown in each pot under optimal watering conditions for growth. Pots were fertilized two times per vegetation season on 12 May and 20 July 2008 using the following fertilizers: saltpetre ammonium with lime (N), super phosphate (P) and potash salt (K). At the study site, the mean annual temperature was 8.2 °C and mean annual precipitation was 422 mm. The mean temperature from June to September 2008 (main vegetation season) was 17.6 °C and from December 2008 to March 2009 (winter season) was 2.4 °C, but with 72 days with temperature below 0 °C. During the experiment, the lowest measured temperature (-13.2 °C) was recorded on 3 January 2009. The pot volume was 30 l and the pot surface area was 1963 cm<sup>2</sup> (pot diameter 50 cm). The plants were not cut during the vegetation season or \*in the autumn. Pots were not protected by covering or insulated from frost (the soil was completely frozen) and were exposed to normal weather conditions during the winter. The number of plants surviving the winter was counted on 1 April 2009. All analysis was done using factorial ANOVA.

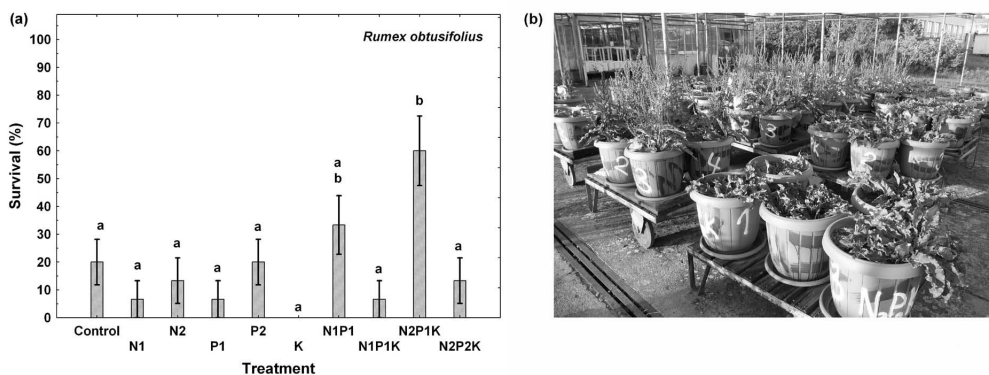

Figure 1: (a) The effect of the treatment on over-wintering of *R. obtusifolius*. Error bars represent standard error of the mean (SE). Using Tukey post-hoc test, treatments with the same letter were not significantly different. (b) Photograph of the pot experiment taken in September 2008. Flowering *R. obtusifolius* highly contrast with rosettes of *R. crispus*.

## Results

Winter survival (over-wintering) was significantly affected by species ( $F = 1009$ ,  $P < 0.001$ ), treatment ( $F = 5$ ,  $P < 0.001$ ) and by species and treatment interaction. Mean winter survival over all levels of nutrient availability was 18% and 100% for *R. obtusifolius* and *R. crispus*, respectively (Fig. 1a). There was no survival of *R. obtusifolius* in K treatment, and more than 30% survival in N<sub>1</sub>P<sub>1</sub> and N<sub>2</sub> P<sub>1</sub>K treatments. Furthermore there was no difference in over-wintering between the sterile and the fertile plants. In the case of *R. crispus* no mortality was recorded in any treatment. An interesting result was that *R. obtusifolius* flowered in all

treatments during the first seeding season while *R. crispus* started to flower in the second season after over-wintering.

## Discussion

According to Cavers and Harper (1964) both species of dock have a tendency to be monocarpic and to die after producing seeds. This is supported by the observation of almost no over-wintering of *R. obtusifolius* after it had flowered. It seems that the main reason for low over-wintering in the pot experiment was the low resistance of adult plants of *R. obtusifolius* to the frost as pots were exposed to winter conditions without any protection. On the other hand, *R. crispus* possessed substantially higher cold resistance as no winter mortality was recorded. The low frost resistance of *R. obtusifolius* probably explains its high retreat after severe winters recorded in the field experiments by Hongo (1989) or Martinkova *et al.* (2009). Furthermore, high mortality of *R. obtusifolius* after severe winters was recorded by many farmers in the Czech Republic. According to Bond *et al.* (2007), plants of *R. crispus* in most North American populations require over-wintering before flowering can occur, unlike populations in Britain and the rest of Europe. It seems that *R. crispus*, in contrast to *R. obtusifolius*, requires a cold period and a sufficient amount of carbohydrates to induce stem elongation and flowering. The results of this study indicate that at least in some populations of *R. crispus* in the Czech Republic, no flowering can occur in the seeding year under all levels of nutrient availability. On the other hand *R. obtusifolius* can flower in the seeding year. Over-wintering of *R. obtusifolius* was only marginally affected, while over-wintering of *R. crispus* was not at all affected by N, P and K availability. It will be the subject to further investigation which factors influence docks longevity and their over-wintering.

## Acknowledgements

The research was funded by the Ministry of Agriculture of the Czech Republic by project NAZV 72217.

## References

- Cavers P.B. and Harper J.L. (1964) Biological flora of the British Isles. *Rumex obtusifolius* L. and *R. crispus* L., *Journal of Ecology* 52, 737–766.
- Bond W., Davies G. and Turner R.J. (2007) *The biology and non-chemical control of broad-leaved dock (Rumex obtusifolius L.) and curled dock (R. crispus L.)*. HDRA, Coventry, UK.
- Hatcher P.E., Paul N.D., Ayres P.G. and Whittaker J.B. (1997) Added soil nitrogen does not allow *Rumex obtusifolius* to escape the effects of insect-fungus interactions. *Journal of Applied Ecology* 34, 88–100.
- Hongo A. (1989) Survival and growth of seedlings of *Rumex obtusifolius* L. and *Rumex crispus* L. in newly sown grassland. *Weed Research* 29, 7–12.
- Hopkins A. and Johnson R.H. (2002) Effect of different manuring and defoliation patterns on broad-leaved dock (*Rumex obtusifolius*) in grassland. *Annals of Applied Biology* 140, 255–262.
- Jönsson A.M., Ingerslev M. and Raulund-Rasmussen K. (2004) Frost sensitivity and nutrient status in a fertilized Norway spruce stand in Denmark. *Forest Ecology and Management* 201, 199–209
- Martinkova Z., Honek A. and Pekar S. (2009) Survival of *Rumex obtusifolius* L. in unmanaged grassland. *Plant Ecology* 205, 105–111.
- Zaller J.G. (2004) Ecology and non-chemical control of *Rumex crispus* and *R. obtusifolius* (Polygonaceae): a review. *Weed Research* 44, 414–432.

# Evaluation of the agronomical and environmental relevance of the CAP measure ‘flowering grassland’

Plantureux S., Ney A. and Amiaud B.

*UMR Nancy Université - INRA Agronomie et Environnement, Nancy-Colmar, France*

Corresponding author: Sylvain.Plantureux@ensaia.inpl-nancy.fr

## Abstract

We aimed to evaluate an agri-environment measure called ‘flowering grassland’, devoted to biodiversity preservation in French grasslands. This measure is controlled by a short list of easily identifiable plants (indicators). Flora, agronomical and ecological value of a set of 671 grasslands of four French natural regional parks were studied. The indicators used for the control are mainly linked to the total species richness of the grasslands. Other aspects of the grassland value are less related to these indicators, including ecosystem services like preservation of patrimonial species or contribution to pollinator activity. Agronomical value of grasslands seems poorly linked to the short lists of plants. Finally, the methods used to construct plant lists were analysed. A wide range of lists was found among natural regional parks and it appears as a crucial step for the final result, the preservation of biodiversity.

Keywords: permanent grassland, biodiversity, agri-environment measure

## Introduction

Permanent grasslands are ecosystems with a potentially high vegetal and animal diversity. As these grasslands occupy almost 40% of the land used in the European Union, their management may be a powerful lever for the EU's internal policy on biodiversity protection. Agri-environment measures designed for biodiversity conservation in grassland have, historically, forced farmers to adapt their management, for instance by reducing fertilization or delaying harvest date. Since 2000, the MEKA programme in Baden-Wurtemberg (Germany) has introduced an agri-environment measure for grassland, to promote ‘species rich grasslands’. This is a new type of measure because farmers receive public subsidies only if they reach a target plant richness, but they are free to choose their practices. In MEKA programme, the result is controlled by the observation of four species, within a list of 28 species elaborated on phytosociological rules (Oppermann and Gujer, 2003). Similar measures were applied in other countries such as Switzerland. In France, this measure was more recently introduced by the Ministry of Agriculture, after a proposal coming from the federation of the natural regional parks (NRP). The measure is comparable to the German one, and is currently applied in some NRP, mainly in Natura 2000 areas. Our work is to assess the relevance of the measure in a mixed agronomical and environmental point of view. The first objective was to verify the relation between plant species richness observed in the grassland and the number of species used to control the measure. Moreover, we aimed to evaluate the impact of this measure on other biodiversity parameters, and on the agronomical value of the grassland.

## Materials and methods

The evaluation of the method was conducted in France in four natural regional parks (NRP), three of them in mountainous areas (Bauges, Haut-Jura and Ballons des Vosges) and a lowland NRP in the centre of the country (Brenne). The initial dataset was made up of 671 relevés of permanent grasslands, performed with a phytosociological methodology. As lists of

species retained for the control of the agri-environment measure (so called ‘control species’) were known for each NRP and habitat, it was possible to determine the number of ‘control species’ in each of the 671 relevés. This dataset was used to link the number of ‘control species’ with the following criteria of diversity: total plant species richness (R) and total plant oligotrophic species richness (RO), oligotrophy being evaluated with the Ellenberg nitrogen fertility index. For the other following criteria, the number of available data was lower (17 to 183): Rarity index was based on the mean value of a rarity coefficient of present species (Pervanchon *et al.*, 2005). Experts (group of scientists, farmers, advisers) evaluated the value of the vegetation for pollinators (pollinator index), and how long forage value was high enough for cattle requirement (qualitative appreciation so called ‘agronomical adaptability’, adapted from Meister *et al.* (1988)). Pastoral value was calculated as established by Daget *et al.* (1972), and forage dry matter yield was measured (hay biomass) or estimated in case of grazing (livestock unit x 13.5 kg day<sup>-1</sup>).

## Results and discussion

Main results are presented in Figure 1, where a selection of criteria is plotted against the number of ‘control species’.

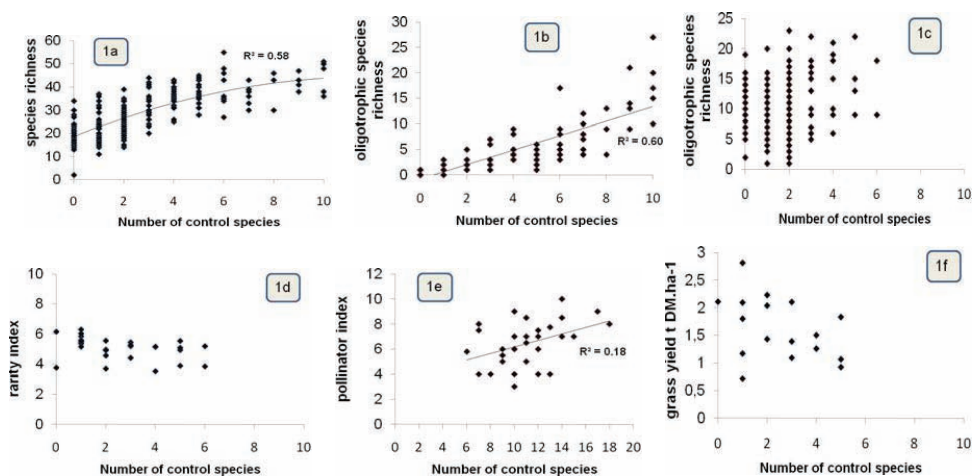

Figure 1 : Relation between the number of ‘control species’ and the total species richness (1a), oligotrophic species richness in Natural Regional Park of Haut-Jura (1b) and Ballons des Vosges (1c), rarity index (1d), pollinator index (1e) and mean grass annual yield estimated during 3 years (1f). Number of points depends on available data in Natural Regional Parks, and graphs associate data from several parks.

The number of control species (NCS) significantly increases with the total species richness (Fig. 1a), as previously demonstrated by Wittig *et al.* (2006) in a similar experiment in North-western Germany. A reduction of the slope for higher values of NCS was noticed. For a given NCS value, the variability of the species richness is relatively high ( $\pm 20$  species). Unlike the total species richness, the relation between NCS and the total number of oligotrophic species depends on the situations. In the NRP of Haut-Jura (Fig. 1b), a close and positive correlation appears between these two variables, although no relation can be highlighted in the NRP of Ballons des Vosges (Fig. 1c). Poor links were found between NCS and the two remaining diversity criteria: rarity index (Fig. 1d) and pollinator index (Fig. 1e). The relation between agronomical performances of grasslands and NCS was not significant, either for grass annual

yield (Fig. 1f) or other criteria not shown in this paper: pastoral value and agronomical adaptability. These yields obtained for unfertile grasslands (altitude >900 m) have to be confirmed for more productive ones. The close relation between species richness and the number of 'control species' (NCS) is logical, as the list of 'control species' was above set in order to evaluate this aspect of biodiversity. However, the variation in species richness for a given value of NCS, tested on 671 grasslands, demonstrated a poor precision. A possible explanation can be found in the design of the 'control species' list. Indeed, only one list of plants is used for several natural habitats, in order to simplify the control procedure in a region. Species richness is the most common diversity criteria in research works, but its ecological or agronomical significance is widely discussed. The number of oligotrophic species appears as interesting criteria in an ecological point of view. The opposite links observed in Fig. 1b and 1c were related to the methodology to build lists which differs between NRP (i.e. taking in account or not agronomical aspects by choosing forage productive species). Finally, the poor relationships between agronomic criteria and NCS must be carefully interpreted, due to the low number of data points, and the grasslands concerned by Fig. 1e (highland situations with forage annual DM yields above 3 t ha<sup>-1</sup>). Nevertheless, it is not surprising to observe this lack of link, as the list of 'control species' in many NRP, generally do not take into account forage production aspects. If confirmed by more data points, this fact could be positively interpreted, in the perspective of reaching a compromise between productivity and biodiversity.

## Conclusion

The number of 'control species' logically mainly indicates the total plant species richness of permanent grasslands. Unfortunately, it poorly shows other aspects of biodiversity. The methodology to build a list locally (i.e. in a specific natural regional park) clearly affects the significance of the observation of 'control species' in a grassland. Studies are currently conducted at the French national level (22 NRP) to precise and confirm the results of the present study and methodologies will be tested during a national flowering grassland competition.

## Aknowledgments

Funding for this project has been supplied by the French Ministry of Ecology (Research programme DIVA2 'MAE résultat'). In addition, data were provided by four Natural Regional Parks: Ballons des Vosges, Brenne, Haut-Jura, Massif des Bauges.

## References

- Daget P. and Poissonet J. (1972) Un procédé d'estimation de la valeur pastorale des pâturages. *Fourrages* 49, 31-39.
- Meister E. and Lehmann J. (1988) Nähr- und Mineralstoffgehalt von Wiesenkräutern aus verschiedenen Höhenlagen in Abhängigkeit vom Nutzungszeitpunkt. *Schweizerische Landw. Forschung* 27(2), 127-137.
- Oppermann R. and Gujer H. (2003) *Artenreiches Grünland bewerten und fördern – MEKA und ÖKV in der Praxis*, Stuttgart, Ulmer.
- Pervanchon F., Gairola C., Amiaud B. and Plantureux S. (2004) Species rarity, agricultural management and environmental factors in permanent grasslands. Land use systems in grassland dominated regions. *Grassland Science in Europe*, 9, 168-170.
- Wittig B., Richter gen. Kemmermann A., Zacharias D. (2006) An indicator species approach for result-orientated subsidies of ecological services in grasslands – A study in Northwestern Germany. *Biological Conservation* 133, 186-197.

# Pyrrolizidine alkaloid level in *Senecio jacobaea* and *Senecio erraticus* – the effect of plant organ and forage conservation

Berendonk C.<sup>1</sup>, Cerff D.<sup>2</sup>, Hünting K.<sup>1</sup>, Wiedenfeld H.<sup>3</sup>; Becerra J.<sup>3</sup> and Kuschak M.<sup>3</sup>

<sup>1</sup>North Rhine-Westphalia Chamber of Agriculture, Riswick house, D-47533 Kleve, Germany

<sup>2</sup>NABU-Naturschutzstation Kranenburg, D-47559 Kranenburg, Germany

<sup>3</sup>Pharmaceutical Institute, University of Bonn, D-53531 Bonn, Germany

Corresponding author: clara.berendonk@lwk.nrw.de

## Abstract

Tansy Ragwort (*Senecio jacobaea*, L.) is seriously spreading in the grassland of North Rhine-Westphalia, and in some regions the occurrence of Eastern Marsh Ragwort (*Senecio erraticus*, Bert.) is also increasing. As pyrrolizidine alkaloids (PA), which are the toxic ingredients in *Senecio* species, induce liver diseases it is recommended that *Senecio* species should not be fed to livestock. Our investigations analysed the amount of different PAs in different parts of *Senecio jacobaea* and *Senecio erraticus* during maturity. Moreover, the effects of varying methods of forage conservation such as ensiling or hay production were analysed. The two *Senecio* species differed in the patterns of PA composition but showed similar amounts of overall concentrations of PAs. The PA content was especially high in the blossom. The concentration of PAs in the plants decreased during forage conservation, especially by ensiling in later stages of maturity. The results indicated an interaction between plant age, PA concentration and PA stability. It is concluded that ensiling cannot be recommended as a reliable method to eliminate the risk of intoxication by feeding silage containing Tansy Ragwort or Eastern Marsh Ragwort. Also the decline of PAs by drying for hay is insufficient to use hay from these plants as forage.

Keywords: *Senecio jacobaea*, *S. erraticus*, PA-content, pyrrolizidine alkaloid, hay, silage

## Introduction

Tansy Ragwort (*Senecio jacobaea* L.) (TR) has received more and more interest during the last few years. This is because the species increasingly occurs on pastures and meadows. Similarly, Eastern Marsh Ragwort (*Senecio erraticus* Bert.) (EMR) seems to be becoming more widespread. Like all other *Senecio* species, TR and EMR contain pyrrolizidine alkaloids (PA), which are highly hepatotoxic. Many PAs are rated to be mutagenic and carcinogenic as well (Mattocks, 1968; Culvenor *et al.*, 1971). Several studies discuss the influence of growing conditions on the amount of PAs in the plants (Bosshard *et al.*, 2003), but there are no results concerning the amount of PAs under the growing conditions of North Rhine-Westphalia and the changes in the growing plant. Only few trials are reported regarding the stability of PAs in hay and silage. An interesting trial in Switzerland (Candrian *et al.*, 1984) documents that the PA content in hay from *Senecio alpinus* remained constant over months, while the PAs in silage were found to be destroyed to a great extent, when only the pure plants of *Senecio alpinus* without grass admixture were ensiled but that the degradation of PAs was of minor intensity in mixtures of grass with low rates of *Senecio*.

Hence, in this paper we tried to analyse the following aspects:

1. Change and amount of PAs in the different parts of TR.
2. Differences in the patterns of PA composition of TR and EMR during maturity.
3. Stability of PAs of TR and EMR in hay and silage.

The most important question is: Under which conditions can the PA content reliably be degraded?



## Materials and methods

Plant material of TR and EMR was collected at its original habitats in the Lower Rhine region in North Rhine-Westphalia, Germany, in 2008. It was separated according to plant organs (leaves, stems, flowers, complete plants) and maturity stage (rosette, pre-flowering, flowering). After separation 500 g fresh material of each sample were dried in a drying cabinet (60 °C) to prevent any decomposition of the PAs. Additionally, material of the whole plant was prepared for ensiling in preserving glass jars and dried for hay under field conditions, respectively. Each of these variants was tested with three repetitions. All different samples were analysed for PAs in the Pharmaceutical Institute, University of Bonn, using well-established methods by gaschromatography-massspectroscopy and comparison with authentic references (Wiedenfeld *et al.*, 1981).

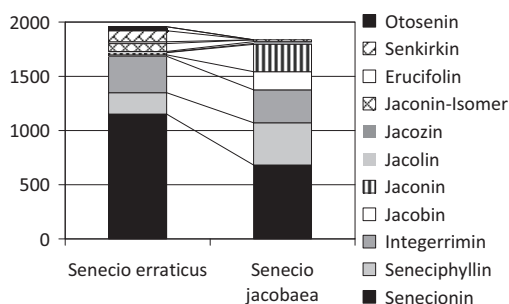

Figure 1: Dry matter content ( $\mu\text{g g}^{-1}$ ) of pyrrolizidine alkaloids in the complete plants of *S. erraticus* and *S. jacobaea* at full flowering.

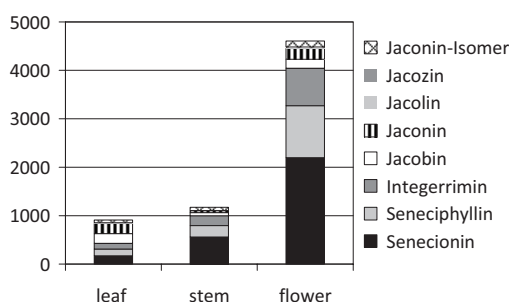

Figure 2: Dry matter content ( $\mu\text{g g}^{-1}$ ) of pyrrolizidine alkaloids in the different plant organs of *S. jacobaea*.

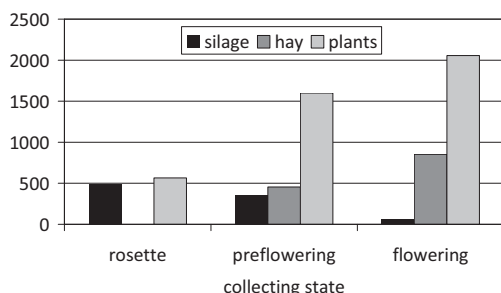

Figure 3: Total pyrrolizidine alkaloids dry matter content ( $\mu\text{g g}^{-1}$ ) in complete plants, hay and silage of *S. jacobaea*.

## Results and discussion

Ten PAs were identified in the plant material: senecionine, seneciphylline, integerrimine, jacobine, jaconine, jacozone, jacoline, erucifoline, senkirkinine, otosenine and an isomer (cis/trans) of jaconine (Fig. 1). The PAs senecionine, seneciphylline and integerrimine were



the major compounds in both species. Differences between both species resulted from a higher amount of jacobine, jaconine, jacozone, jacoline in TR whereas erucifoline, senkirkinine, otosenine was only found in EMR. Analysis of the separate plant organs (Fig. 2) confirmed results from Switzerland (Bosshard *et al.*, 2003) as far as PA concentration was highest in blossoms. Compared to those results, in our trials the concentration in blossoms was extremely high with  $4607 \mu\text{g g}^{-1}$  in DM which caused the strong increase of PA concentration of  $2057 \mu\text{g g}^{-1}$  in DM in the whole plant in flowering stage. As shown in Fig. 3 (PAs in TR) the decrease of the PA level in hay appeared to be only about 40%, which indicates that there was no general decomposition of PAs by hay production. As hay is generally produced in later stages of maturity, where highest concentration of PAs can be found, there is a serious risk of intoxication by hay containing TR or EMR. Such hay cannot be recommended as forage. On the other hand, we found a remarkable decrease of the PAs in silage. It can be assumed that during silage production an enzymatic decomposition of the alkaloids takes place. It is well established that PAs are hydrolysed by unspecific esterases which results in non-toxic necines and necic acids (Bull *et al.*, 1968; Culvenor *et al.*, 1976; Mattocks, 1986). Furthermore, we found that the level of decomposition in silage increased during the vegetation period (lowest content in silage produced in flowering state) which can be explained by the higher enzymatic activity in plants from this stage compared to that in young plants (rosette state). Similar results can be found in EMR. Although these results could encourage the conclusion that ensiling helps reducing the risk of poisoning by PAs, the minor effect in the early stage of plant development demands further examination to answer the question, by what circumstances PAs will be reliably destroyed. In this context it is interesting that Cadrian *et al.* (1984) found a much less complete reduction of PAs in silages with low concentrations of *Senecio alpinus* than within those with a high proportion. Thus it is necessary to study the interaction between the concentration of the PAs in *Senecio* plants and the proportion of *Senecio* plants in the silage on account of their effect on the enzymatic decomposition of the PAs. Unless these questions are answered ensiling cannot be recommended as a reliable method to eliminate the risk of intoxication by feeding silage containing TR or EMR.

## References

- Bosshard A., Joshi J., Lüscher A. and Schaffner U. (2003) Jakobs- und andere Kreuzkraut-Arten: eine Standortbestimmung. *Agrarforschung* 10, 231-235.
- Bull L.B., Culvenor C.C.J. and Dick A.T. (1968) *The pyrrolizidine alkaloids*. Amsterdam, North Holland Publishing Co.
- Candrian U., Lüthy J., Schmid P., Schlatter Ch. and Gallasz E. (1984) Stability of pyrrolizidine alkaloids in hay and silage. *Journal of Agricultural and Food Chemistry* 32, 935-937.
- Culvenor C.C.J., Edgar J.A., Smith L.W., Jago M.V. and Peterson J.E. (1971) Active metabolites in the chronic hepatotoxicity of pyrrolizidine alkaloids, including otonecine esters. *Nature New Biology* 229, 255-256.
- Culvenor C.C.J., Edgar J.A., Jago M.V., Outteridge A., Peterson J.E. and Smith L.W. (1976) Hepato- and pneumotoxicity of pyrrolizidine alkaloids and derivatives in relation to molecular structure. *Chemico-Biological Interaction* 12, 299-324.
- Mattocks A.R. (1968) Toxicity of pyrrolizidine alkaloids. *Nature (London)* 217, 723-728.
- Mattocks A.R. (1986) *Chemistry and toxicology of pyrrolizidine alkaloids*. Academic Express, London, New York, 393 pp.
- Wiedenfeld H., Pastewka U., Stengl P. and Röder E. (1981) On the gas-chromatographical determination of the pyrrolizidine alkaloids of some *Senecio* species. *Planta medica* 41, 124-128.

## Yield evolution from pastures on the Po Valley plain during the growing season

Da Ronch F. and Ziliotto U.

*Dipartimento di Agronomia ambientale e Produzioni vegetali dell'Università degli Studi di Padova, campus di Agripolis, viale dell'Università 16, 35020 Legnaro (PD), Italy.*

Corresponding author: flavio.daronch@unipd.it

### Abstract

In investigation on the development of herbage yield and herbage quality during the 2006 growing season of two non-irrigated pastures on the plain of the Po Valley in NE Italy is reported. The pastures differed in sward composition: one was composed almost exclusively of grasses and the other of a balanced mixture of grasses and legumes. Both pastures gave an uninterrupted yield for approximately 200 days. The pasture with the mixture of grasses and legumes provided a higher annual DM yield (8.1 vs. 6.7 Mg ha<sup>-1</sup>), which, in addition, was more evenly distributed over the growing season and had a higher forage quality.

Keywords: plain pastures, yield evolution, quantitative characteristics, qualitative characteristics, growing season

### Introduction

In the Po valley (northern Italy), the productive period of pastures lasts from April to October at most. As a result of the summer climate, which is characterized by mainly high temperatures and frequent water shortages, the yield of these crops varies greatly during the growing season and this complicates their utilization. In order to better understand yield formation and herbage quality of pastures under these conditions an experiment was set up with two pastures of different botanical composition. A rotational grazing management with a grazing cycle of 28 days was simulated by cutting. A major aim was to improve the basis for management decisions on such pastures, e.g. the grazing management and stocking rate. The results obtained are reported and discussed.

### Materials and methods

The trial was conducted on the farm 'Fattoria alle Origini' at Bovolenta (Padova, NE Italy). Annual average rainfall is *c.* 820 mm, and annual average temperature is 12.3 °C. The soils are loam or sandy-loam, with neutral or sub-alkaline reaction (pH 7.0-7.9) with low or average carbonate content (0.5-10.0%) and an organic matter content of 3.0-5.4%). In March 2006, two contiguous non-irrigated pastures were identified on the farm. At the start of the experiment, Pasture 1 (P1) was mainly composed of grasses (Poaceae, cover >80% of *Lolium multiflorum*, *Festuca arundinacea*, *Dactylis glomerata*, etc.) and Pasture 2 (P2) was composed of 50% grasses (the same species as P1) and 50% of legumes (fabaceae, *Medicago sativa* and *Trifolium pratense*). Apart from their different botanical composition, the pastures have the same environmental conditions. In each of the two pastures four experimental plots (Corrall and Fenlon, 1978) of 1 m x 5 m = 5 m<sup>2</sup> each were laid out in a randomized block design with two replications. From 14 April onwards, the plots were mown at 1-week intervals. Thereafter, they were cut at 28-day intervals for the rest of the growing season. The last sampling (the 30th) was on 2 November. At each cut, the yield from a sampling area of 0.8 m x 5 m = 4 m<sup>2</sup> was weighed and a 0.5 kg sample was kiln-dried to determine the dry matter (DM) content, then taken to a chemical laboratory for the determination (Martillotti *et*

*al.*, 1987) of the content of: crude protein (CP), lipids (L), ash, raw fibre (RF, Weende method), neutral detergent fibre (NDF), acid detergent fibre (ADF), and acid detergent lignin (ADL). Lastly, the *Unite Fourragere Lait* (UFL) content in the DM was calculated on the basis of values of the content of CP, L, NDF, ADF and ash (Graham, 1983; MAFF *et al.*, 1984; Sauvant *et al.*, 2004).

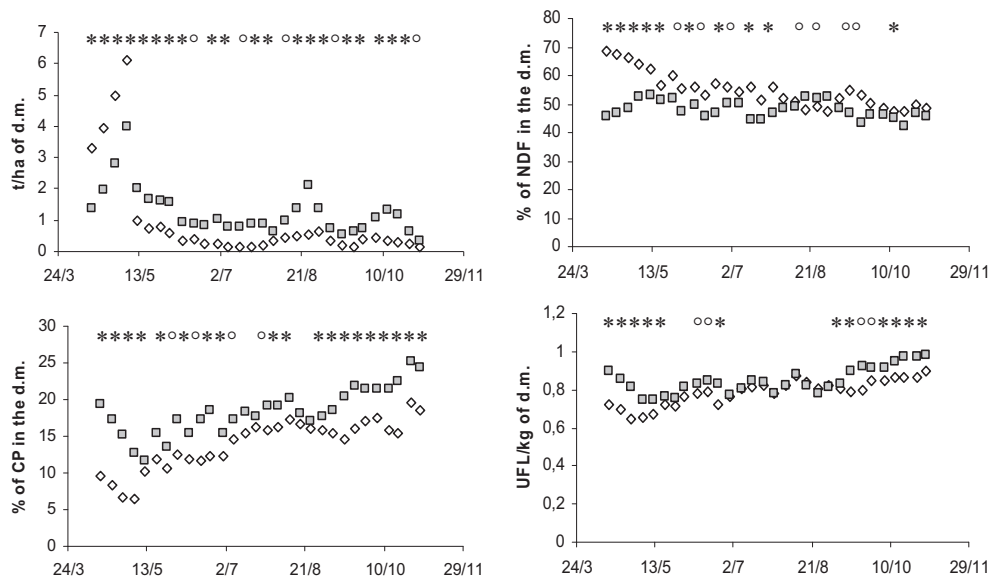

Figure 1 –Evolution of some yield characteristics of the 2 pastures during the growing season. White diamonds = P1 (grass dominated pasture); grey squares = P2 (pasture with balanced mixture of grasses and legumes).

\* = significant difference at  $P = 0.05$ ; ° = significant difference at  $P = 0.1$

## Results

The main results of the experiment are given in Fig. 1; further results are summarized in the text. During the first cycle of simulated grazing, the DM production gradually increased from 3.3 to 6.1  $\text{Mg ha}^{-1}$  in P1, and from 1.4 to 4.0  $\text{Mg ha}^{-1}$  in P2. In contrast, during the second cycle it diminished from 1.0 to 0.6 and from 2.0 to 1.6  $\text{Mg ha}^{-1}$  in P1 and P2, respectively. During the remaining period, the amount of DM provided by P1 was never more than 1  $\text{Mg ha}^{-1}$  and, on 11 occasions (out of a total of 22) it was less than 0.3  $\text{Mg ha}^{-1}$ . The phytomass from P2 at 15 cuts ranged between 0.65 and 1.09 and, in relation to the high rainfall in August (122 mm) and September (178 mm), was above 1.3  $\text{Mg ha}^{-1}$  on 4 occasions, and 2  $\text{Mg ha}^{-1}$  on one. The annual yield of the 4 plots, as ordered according to the date of the first cut, amounted respectively to 6.2, 6.0, 6.9 and 7.8  $\text{Mg ha}^{-1}$  of DM in P1 (average 6.7  $\text{Mg ha}^{-1}$ ) and 7.1, 7.0, 8.1 and 10.2  $\text{Mg ha}^{-1}$  in P2 (average 8.1  $\text{Mg ha}^{-1}$ ).

The CP content in the DM supplied during the first cycle of simulated grazing gradually dropped from 9.5% to 6.5% in P1 and from 19.3 to 13.8% in P2. It then gradually increased from 10.1 to 19.5% in P1, and from 11.6 to 25.2% in P2. In the yield provided by P1, the L content in the DM gradually increased from 2.1 at the first sampling to 4.3% on 28 July, and then oscillated between 3.2 and 4.3%. In the same period, this content was always between 2.8 and 4.2% in the phytomass of P2. Over the season, the NDF content in the DM of P1

more or less gradually diminished from 68.6% at the first cut to values of between 47.2 and 49.5% in the last twelve weeks. The results of P2 were lower (between 40.5 and 52.9%) and less variable. The ADF and crude fibre contents showed similar trends. In P1 the ADF content decreased during the growing season from around 40.0% to slightly less than 30.0%, and the crude fibre content from 29.1 to 18.4%. For P2 ADF values ranged from 37.5 to 29.1% and that of crude fibre from 27.5 to 17.0% but, in both cases, without any particular trend in the variation during the considered period. During the season, the ADL content in the DM provided by P1 was between 3.1 and 5.4%. For P2 the ADL content rose from 4.8 to 9.8% during the first 19 weeks, then ranged between 5.5 and 7.7%. The ash content values in the DM during the first cycle were between 8.9 and 9.9% in P1 and between 9.4 and 10.6% in P2. In the following cycles, they ranged instead between 10 and 12% in the former, and between 8 and 10% in the latter. The results of the calculation of the UFL content in the DM demonstrate that in both pastures a gradual reduction in this parameter during the first cycle was followed by a more or less gradual increase. In P1, the values of the first cycle were between 0.72 and 0.65 UFL kg<sup>-1</sup> of DM, while those of P2 decreased from 0.90 to 0.75. In the last weeks, the maximum values of P1 were between 0.85 and 0.90 and those of P2 ranged between 0.95 and 0.98 UFL kg<sup>-1</sup> of DM.

## Conclusions

The two types of pasture on the plain, managed without irrigation, can provide a yield for around 200 days per year. However, those containing a balanced mixture of grasses and legumes provide a higher DM yield (8.1 vs. 6.7 Mg ha<sup>-1</sup>), which is more evenly distributed during the growing season and characterized by higher forage quality.

## References

- Corrall A.J. and Fenlon J.S. (1978) A comparative method for describing the seasonal distribution of production from grasses. *Journal of Agricultural Science Cambridge* 91, 61-67.
- Graham N. McC. (1983) The energy value of livestock feeds: alternative expressions and their usefulness as feed characteristics. In: Robards G.E. and Packham R.G. (Eds.) *Feed information and animal production*. Commonwealth Agricultural Bureaux, Farnham Royal, UK, pp. 157-174.
- MAFF, DAFF, DANI (1984) *Energy allowances and feeding systems for ruminants*. Reference Book 433. HMSO, London, 85 pp.
- Martillotti F., Antongiovanni M., Rizzi L., Santi E. and Bittante G. (1987) *Quaderni metodologici*, CNR-IPRA, Roma, n. 8.
- Sauvant D., Chaupoutot P., Peyraud J.L., Meschy F. and Doreau B (2004) Nutritional values for ruminants. In: Sauvant D, Perez J.M. and Tran G. (Eds.) *Tables of composition and nutritional value of feed materials*. INRA Editions 43-51, pp. 260-261.

# Pasture characteristics on a Venetian prealps *malga* where the animals' diet is supplemented by concentrates

Da Ronch F. and Ziliotto U.

*Dipartimento di Agronomia ambientale e Produzioni vegetali dell'Università degli Studi di Padova, campus di Agripolis, viale dell'Università 16, 35020 Legnaro (PD), Italy*

Corresponding author: flavio.daronch@unipd.it

## Abstract

The botanical composition and soil characteristics were surveyed on *malga* pastures at the Asiago Plateau (NE Italy) where the animals' diet is supplemented by concentrates. In areas far away from the farm buildings, pastures are re-colonized by *Brachypodium rupestre* ssp. *coespitosum* and the adjacent woodland. Elsewhere the pasture has become rich in species with a high forage value, even if there are phenomena of degradation in the areas immediately surrounding the farmstead due to an excess of nitrophilous species. The content of the major soil nutrients increases progressively along a gradient from the higher elevated areas to the lower-lying areas where the cattle tend to linger.

Keywords: mountain pastures, alpine pasture management, evolution of biodiversity, plant community biodiversity, soil characteristics

## Introduction

In the Alps, the mountain pastures are traditionally exploited by moving the livestock to a seasonal farm known as *malga*, where formerly the domestic animals' diet came exclusively from grazing. However, in recent systems the diet is often supplemented by externally supplied feed to sustain livestock productivity. The aim of this investigation is to analyse the effects of this practice on the mountain pastures, the vegetation and soil characteristics.

## Materials and methods

The Asiago Plateau lies on the Veneto pre-Alps in the province of Vicenza. The *malga* 'Costalunga B' is situated to the south of Asiago, where it occupies 29.7 ha of the north-western slopes of Monte Ekar (lat. 45°51'40"N; long. 11°33'27"E). The land has a slope of 10-20 degrees and lies between 1150 m and 1225 m a.s.l. The farmstead buildings, including the milking stalls, are situated about mid-way. The annual stocking is 42 standard livestock units, the pasture is grazed by dairy cows mainly of the Friesian and Italian brown breeds. The grazing season normally lasts from 1 June to 30 September. During this period, each cow is given a daily ration, at milking time, of 7 kg of concentrates (composed of grain maize, soybean and maize flour), with the result that the animals graze less on the remote areas of the pasture. In 2007 a botanical survey was conducted. 20 relevés of 100 m<sup>2</sup> each were evenly distributed over the whole area and the vegetation was assessed according to the Braun-Blanquet method. Each plot was surveyed 4 times during the summer. The complete data set was subjected to a cluster analysis. The forage value of the individual plant communities was then calculated following the procedure proposed by Klapp *et al.* (1953).

## Results

The dendrogram resulting from the cluster analysis has demonstrated that the 20 surveyed pasture areas are referable to 4 different vegetation types, which can be paired according to their similarities (Table 1).

Table 1. Average cover of the main differential species of the four clusters

Differential species	Cluster							
	1		2		3		4	
	F	cover (%)	F	cover (%)	F	cover (%)	F	cover (%)
<i>Hippocrepis comosa</i> L.	V	2.7						
<i>Picea excelsa</i> (lam.) Link	V	3.1						
<i>Thymus serpyllum</i> L.	V	1.3						
<i>Anthyllis vulneraria</i> L.	IV	2.2						
<i>Dryopteris filix-mas</i> (L.) Schott.	IV	1.6						
<i>Helianthemum nummularium</i> (L.) Miller	IV	4.5						
<i>Brachypodium rupestre</i> (Host.) R.et S. ssp. caespitosum (Host) Scholz	V	23.4	II	4.2				
<i>Helleborus viridis</i> L.	V	2	II	0.4				
<i>Leontodon hispidus</i> L.	V	4.3	II	1.7	I	0.3	I	0.8
<i>Anthriscus sylvestris</i> (L.) Hoffm	V	4.7	III	3.3				
<i>Briza media</i> L.	IV	3.9	V	4.3				
<i>Carlina acaulis</i> L.	V	3.2	IV	3.2				
<i>Plantago media</i> L.	V	2.4	V	1.8			I	0.2
<i>Potentilla crantzii</i> (Crantz) Beck	V	2.8	V	3.1				
<i>Potentilla recta</i> L.	V	2.2	V	4.9				
<i>Rhinanthus minor</i> L.	V	8.5	V	8.6	I	0.4	I	0.1
<i>Rhinanthus alectorolophus</i> (Scop.) Pollich			V	5.1				
<i>Anthoxanthum odoratum</i> L.			IV	6.1				
<i>Carduus nutans</i> L.	II	0.2	III	2.5				
<i>Alchemilla vulgaris</i> L.			V	6.0	V	8.9	II	2.3
<i>Ranunculus acris</i> L.	II	0.6	V	4.5	V	5.2	III	2.1
<i>Trifolium pretense</i> L.	III	2.2	V	7.9	V	4.2	V	1.8
<i>Agrostis tenuis</i> Sibth.			III	1.2	V	11.0	I	0.3
<i>Poa trivialis</i> L.					V	1.9	I	0.2
<i>Stellaria graminea</i> L.			II	0.4	V	7.4	II	1.0
<i>Hypericum maculatum</i> Crantz			III	1.2	IV	3.2	I	0.3
<i>Dactylis glomerata</i> L.					IV	2.7	V	3.4
<i>Festuca pratensis</i> Hudson					V	12.8	V	4.2
<i>Poa pratensis</i> L.			I	0.2	V	8.7	V	3.0
<i>Urtica dioica</i> L.	II	0.6	I	0.7	III	2.0	V	25.1
<i>Lolium perenne</i> L.			I	0.9			IV	5.8
<i>Lamium album</i> L.							III	3.0
<i>Plantago major</i> L.							III	4.3
Total no. species per relevè		23.5±1.7		21.8±0.9		19.6±0.5		19.6±1.3

F = frequency: I from 0.1 to 20 %; II 21 – 40 %; III 41 to 60 %; IV 61 – 80 %; V 81 – 100 %.

The first pair includes clusters 1 and 2, formed by 4 and 6 surveys, respectively. The first cluster contains plots that are located at higher elevation of the *malga*, i.e. in pastures at the longest distance from the farmstead, whereas plots belonging to cluster 2 refer to pastures lying between the remote areas and the farmstead buildings. Both clusters differ from the other two clusters in various characteristic and differential species of the class *Festuco-Brometea* Br.-Bl. et Tx. 1943, some nemoral species typical of the alliance *Vaccinio-Piceion* Br.-Bl. 1939 or of the order *Fagetalia sylvaticae* Pawl. 1928, plus some species characteristic of poor pastures on neutral or alkaline substrates (order *Seslerietalia variae* Br.-Bl. in Br.-Bl. et Jenny 1926 em. Oberdorfer 1957) and on acid soils (alliance *Nardion* Br.-Bl. et Jenny 1926). Cluster 1 and 2 also contain various species characteristic of nutrient-rich pastures (class *Molinio-Arrhenatheretea* Tx. 1937) and a few nitrophilous species (class *Artemisietea vulgaris* Lohm., Prsg. et Tx. 1950). These nitrophilous species are more frequent in cluster 2 compared to the other clusters. Clusters 3 and 4 are formed by 5 plots each, respectively. In comparison with cluster 1 and 2, they both contain a larger number of characteristic and

differential species of the classes *Molinio-Arrhenatheretea* and *Artemisietea vulgaris*. A total of 76 species were identified in the 20 plots, with a limited average number of species per plot (Table 1). For cluster 1 this may be due to the frequent presence of *B. rupestre* (Da Ronch *et al.*, 2007) and, in the other three clusters, to the highly fertile soils that favour the growth of some competitive species. The chemical characteristics of the soils are shown in Table 2. In general, the content of the major soil nutrients increases from the remote areas at the higher altitude to those nearer the farmstead. The reason for this is that the cattle which are fed concentrates at milking time tend to remain in the vicinity when they graze. In contrast, the animals hardly visit the most distant pastures, so that these areas have been re-colonised by the woodland.

Table 2. Forage value and soil characteristics of the four clusters (in order of decreasing altitude), mean value and standard error. 3 samples for each cluster

Cluster	Forage value	Soil characteristics							
		Gravel content (%)	pH	Content in fine earth fraction					exch. K
				Org. Matter g (100 g) <sup>-1</sup>	Total N g (100 g) <sup>-1</sup>	Total P mg kg <sup>-1</sup>	Avail. P mg kg <sup>-1</sup>	Total K mg kg <sup>-1</sup>	
1	1.4±0.2	62±3	7.6±0.1	9.3±1.5	0.5±0.1	875±77	7.5±2.2	1295±135	180±44
2	2.0±0.3	39±3	5.8±0.1	11.7±1.8	0.6±0.1	1027±72	14.1±2.5	2268±149	414±36
3	3.1±0.4	30±3	7.0±0.1	11.3±1.6	0.6±0.1	1352±58	10.2±2.4	1440±27	122±23
4	4.4±0.4	31±4	6.3±0.1	12.6±0.6	0.7±0.1	1429±43	18.4±2.8	2558±157	457±45

## Conclusions

The analysed pastures have displayed the following phenomena that may, at least partly, be explained by the supplementing of the animals' diet with concentrates: 1) a re-colonisation by the woodland of the more distant or more impervious areas because they are less often or never used; 2) a reduction in the number of species forming the pastures; 3) an increase of the forage value in the pastures that are still used; 4) an increase in the content of the major soil nutrients on areas more frequently visited by the animals.

## References

- Da Ronch F., Macolino S. and Ziliotto U. (2007) Effects of different periods of abandonment on the features of the class *Festuco-Brometea* Br.-Bl. meadows in N-E Italy. *Grassland Science in Europe* 12, 548-551.
- Fischer M. and Wipf S. (2002) Effect of low-intensity grazing on species-rich vegetation of traditionally mown subalpine meadows. *Biological Conservation* 104, 1-11.
- Kampmann D., Herzog F., Jeanneret Ph., Konold W., Peter M., Walter T., Wildi O. and Lüscher A. (2008). Mountain grassland biodiversity: Impact of site conditions versus management type. *Journal for Nature Conservation* 16, 12-25.
- Klapp E., Boeker P., König F. and Stählin A. (1953) Wertzahlen der Grünlandpflanzen. *Das Grünland* 2/53, 38-40.
- Nösberger J., Messerli M. and Carlen Ch. (1998) Biodiversity in grassland. *Annales de Zootechnie* 47, 383-393.
- Peter M., Nyfeler D., Jeanneret Ph., Edwards P., Troxler J., and Lüscher A. (2004) Botanical composition of grassland in the Alps as an indicator for changes in management. *Grassland Science in Europe* 9, 299-301.
- Wildi O. and Orloci L. (1996) *Numerical Exploration of Community Patterns. A guide to the use of MULVA-5*. 2<sup>nd</sup> edition. SPB Academic Publishing.



# Speed of reduction of the specific biodiversity in abandoned meadows when they are re-colonized by woodland

Da Ronch F., Macolino S. and Ziliotto U.

*Dipartimento di Agronomia ambientale e Produzioni vegetali dell'Università degli Studi di Padova, campus di Agripolis, viale dell'Università 16, 35020 Legnaro (PD), Italy.*

Corresponding author: flavio.daronch@unipd.it

## Abstract

During the three-year period 2006-2008, the botanical composition and crown area projection of the woody component were surveyed on five meadows on the southern slopes of the Treviso pre-Alps that had been abandoned for different lengths of time (3-25 years). The results demonstrated that every 10 m<sup>2</sup> increase of the trees crown area projection corresponds to a loss of 8.1 species from the plant community, and that the crown area projection increases on average by 1.18 times of its initial value over a two-year period. On the basis of these results it has been estimated that, during the first 12 years after being abandoned, the reduction in the number of species forming the community remains limited, while it subsequently markedly increases, so that at 16 years after being abandoned the overall reduction is more than 38% of the initial value of the biodiversity of the meadow.

Keywords: mountain meadows, abandonment, crown area projection, specific biodiversity, reduction in biodiversity

## Introduction

During the last decades, many mountain areas that at one time were managed as meadows or pastures have been abandoned, or are only occasionally or partly utilized. Due to this change in management the grasslands that were present below the tree-line have, over a few decades, been re-colonized by the adjacent woodland, with substantial changes to both their specific and community biodiversity (Bischof, 1981; Tappeiner and Cernusca, 1993).

With the aim of contributing to the knowledge on the times taken for this woodland re-colonizing and its effects on the initial herbaceous community, the overall floral composition and crown area projection of the woody component of five meadows abandoned in the Treviso pre-Alps (NE Italy) were surveyed for three years. The following information was obtained: 1) the variation in the number of species in the meadow communities with the increase of the woody component; 2) the re-colonizing speed of the abandoned meadows by the woodland; 3) the speed of reduction of the specific biodiversity with the increase of the woody component. These results are reported and discussed below.

## Materials and methods

The five plant communities chosen for the study are meadows on the southern slopes of the Veneto pre-Alps (Treviso province). The meadows have been abandoned for between 3 and 25 years, and are thus composed of a number of species, the actual number being inversely proportional to the length of time the meadows have been abandoned (Da Ronch *et al.*, 2007). All plant communities are oligotrophic and belong to the alliance *Mesobromion* Br.-Bl. et Moor 38. The soils belong to the categories of Eutricambisols and Redzicleptosols overlaying calcaerous rocks. The local climate is characterized by an annual average temperature of 12.5 °C and annual rainfall of 1502 mm, which is distributed in a sub-equinoctial pattern with the main maximum in April (170 mm) and a secondary one in November (156 mm). The

woodlands surrounding these meadows are mainly composed of *Ostrya carpinifolia*, *Quercus pubescens*, *Fraxinus ornus*, *Robinia pseudoacacia*, *Corylus avellana* and *Rhamnus catharticus*.

In early 2006, two representative areas of 100 m<sup>2</sup> each were chosen in each of the five meadows. In the three years 2006-2008, a floral survey of the entire community was conducted on each of these areas using the Braun-Blanquet method. In order to record all the species present, the survey was done in June and repeated in September of each year. On the occasion of the survey in late summer of each year, the crown area projection of the woody plants was also measured with a 20 m metric tape.

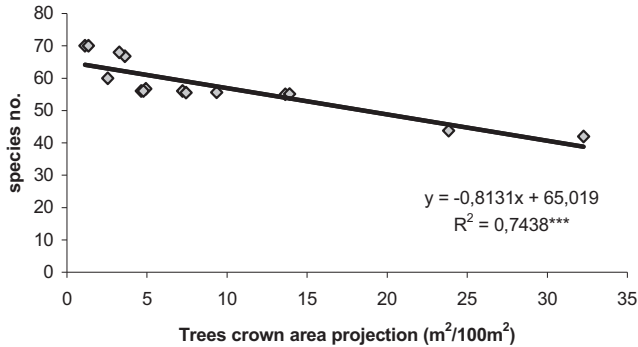

Figure 1. Relationship between the value of crown area projection and the number of species of abandoned meadow communities. Values measured in five meadows over the three-year study period.

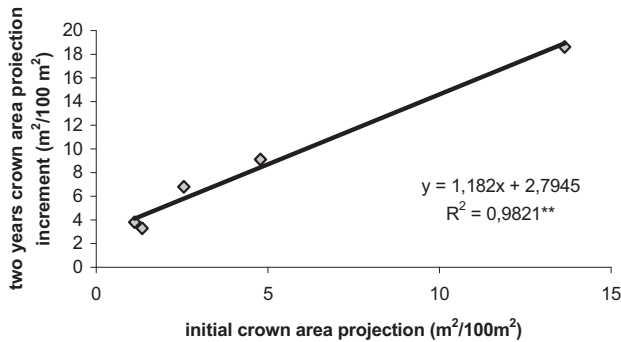

Figure 2. Relationship between the initial value (2006) of the crown area projection and its respective increment in the following two-year period. Values relative to the five studied meadows.

## Results

Over the three years, the number of plant species present on the 100 m<sup>2</sup> areas surveyed in the meadows varied from 42 to 70 and the crown area projection of the woody component growing in the same area was in the range of 1 and 32.5 m<sup>2</sup>. Crown area and plant species number were negatively correlated (Fig. 1). On average, for every 10 m<sup>2</sup> increase in crown area projection, i.e. equal to 10% of the surveyed area, there was a reduction of 8.1 units in the specific biodiversity. On the other hand, from the analysis of the values of crown area projection gathered in the three years (Fig. 2), it emerged that its increment over the first two

years was only slightly higher than the initial value ( $b=1.182$ ). Based on these results the rate at which the specific biodiversity of an abandoned meadow is reduced as a consequence of the re-colonization by the woodland was estimated. Therefore, a meadow community that was abandoned for 10 years and characterized by a crown area projection of  $3.2 \text{ m}^2/100 \text{ m}^2$  was hypothesized. Applying the above information to this hypothetical meadow, i.e. that the crown area projection slightly more than doubles in two years and that for every increase of  $10 \text{ m}^2$  there is a reduction of approximately 8.2 species, led to the results reported in Fig. 3. According to the model the species loss during the first eight years after abandonment is negligible. In subsequent years however, there is a reduction of 1.4, 3.0, 6.1 and 14.4 species in the 9<sup>th</sup>-10<sup>th</sup>, 11<sup>th</sup>-12<sup>th</sup>, 13<sup>th</sup>-14<sup>th</sup> and 15<sup>th</sup>-16<sup>th</sup> years, respectively. Therefore, the rate at which the number of species reduces over time is limited until about 12 years after being abandoned, after which it rapidly becomes substantial, so that by the 16<sup>th</sup> year 26.6 species have disappeared from the meadow.

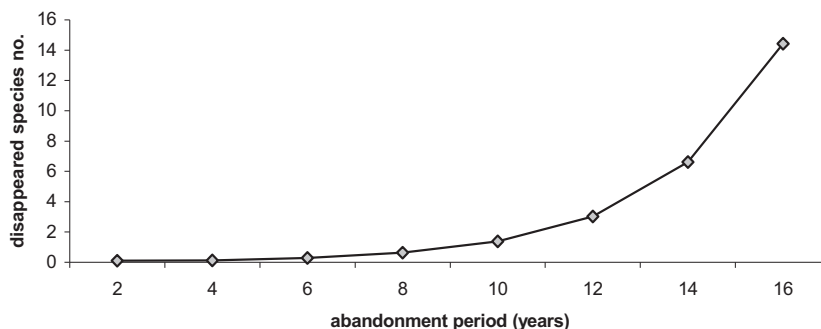

Figure 3. Number of species that disappear every two-year period after the meadow has been abandoned. Estimate made based on the two-yearly increment of crown area projection of the woody component.

## Conclusions

For the area where the study was conducted, abandonment of grassland and re-colonization by woody vegetation did not cause a considerable plant species loss during the first 12 years after abandonment. However, species loss strongly increased thereafter and already after 16 years, it amounts to around 27 species and thus to more than a third of those present initially. Consequently, if the meadow began to be re-exploited during the first 12 years after being abandoned, the composition of the plant community would still be very similar to the initial one. If, however, mowing is reintroduced later, the meadow community, irrespective of the presence of numerous woody plants, will rapidly be simplified. This is likely to affect herbage yield and the agronomic value of the swards.

## Reference

- Bischof N. (1981) Pflanzensoziologische Untersuchungen von Sukzessionen aus gemähten Magerrasen in der subalpinen Stufe der Zentralalpen. *Beitr. Geobot. Landesaufn. Schweiz* 60, 1-127
- Da Ronch F., Macolino S. and Ziliotto U. (2007) Effects of different periods of abandonment on the features of the class *Festuco-Brometea* Br.-Bl. meadows in N-E Italy. *Grassland Science in Europe* 12, 548-551.
- Tappeiner U. and Cernusca A. (1993) Alpine meadows and pastures after abandonment. Results of the Austrian MaB programme and the EC-STEP project INTEGRALP. *Pirineos* 141/142, 97-118.

## Effects of the management techniques on the specific and coenotic biodiversity in three meadows of the Venetian plain (NE Italy)

Da Ronch F., Bonifazzi B. and Ziliotto U.

*Dipartimento di Agronomia ambientale e Produzioni vegetali dell'Università degli Studi di Padova, Campus di Agripolis, viale dell'Università 16, 35020 Legnaro (PD) (Italy)*

Corresponding author: flavio.daronch@unipd.it

### Abstract

Results are presented from a botanical survey conducted in 2007, in plot trials on three irrigated permanent meadows of the northern Veneto plain, in order to study the effect of fertilization level and mowing frequency on the plant community and specific biodiversity. Neither of the two studied variables showed any consistent effect in modifying the number of plants of the meadow sward over a period three years differentiated management. However, the increase in mowing frequency produced marked variations in plant community composition, while there was no change with fertilization level.

Keywords: permanent meadows, biodiversity, fertilization, mowing frequency

### Introduction

Multi-annual and especially permanent forage crops can fulfil various landscape and environmental functions. These include also safeguarding both specific and plant community biodiversity. In order to study the effects of the agronomic practices most commonly adopted in the management of meadows on the plain on both types of biodiversity, plot trials were conducted on three permanent meadows of the Veneto plain over the three years 2005-2007. This paper reports results from the vegetation survey done in the third year.

### Materials and methods

On the Veneto plain (NE-Italy) permanent meadows are widespread between the rivers Brenta and Bacchiglione and are managed intensively including irrigation. The vegetation of the meadows mainly belongs to the association *Lolietum multiflori* Dietl and Lehman 1975. The swards can provide 4-5 harvests per year (Rodaro *et al.*, 1997 and 2000). In 2005, three meadows were identified in this area: (P1) in Carmignano di Brenta (province of Padova), 46 m a.s.l., loamy-clay soil, neutral pH, very high organic matter, total nitrogen, available phosphorus and potassium contents; (P2) in Gazzo Padovano (province of Padova), 36 m a.s.l., loamy soil, neutral pH, medium to high O.M., total N and available K contents and low available P content; (P3) in Bressanvido (province of Vicenza), 53 m a.s.l., silty-loam soil, neutral pH, very high O.M. and total N contents, medium available P and K contents. The average temperature is 13°C. The annual rainfall is 970-1045 mm. On each meadow, 9 treatments (3 fertilization levels x 3 mowing frequencies) were compared in a randomized-block experimental design, with 4 replications. Fertilization levels were: 1) equal to the amount removed with the herbage in the previous year (P1: 260, 73 and 293 kg ha<sup>-1</sup> per year of N, P<sub>2</sub>O<sub>5</sub> and K<sub>2</sub>; P2 and P3: 225, 63 and 253 kg ha<sup>-1</sup> per year); 2) one and a half of the amount of 1); 3) double of the amount of 1). Fertilization was supplied as manure distributed during late autumn, complemented with mineral fertilizers where necessary. Mowing frequencies were: 1) every 30 days, resulting in six cuts per year; 2) every 38 days, five cuts per year; and 3) every 50 days, four cuts per year. These frequencies were chosen to be able to take the first cut at the start of *Lolium multiflorum* ear emergence (first two weeks in May), and the last cut within the first two weeks of October in all treatments. In each of the three

years the botanical composition was measured immediately before the first cut. For the present paper, the results of the third year, 2007, were analysed. The species number (specific biodiversity) was subjected to an analysis of variance. The community biodiversity existing between the different treatments was analysed by a cluster analysis employing the software package *Mulva 5* (Wildi and Orloci, 1996), utilizing the Van der Maarel coefficient as function of similarity, and the minimum variance as classification algorithm.

Table 1. Number of species in 2007: results of Analysis of Variance (ANOVA).

Variable	Trials		
	P1	P2	P3
Cut frequency	ns	ns	*
Fertilization level	*	ns	Ns
Interaction cut fr. X fertilization lev.	ns	ns	Ns

\*= effect significant at  $P < 0.05$

Table 2. Cover (%) of plant species in 2007 at different cutting frequencies on average of the three fertilization levels.

Trials	P1									P2			P3					
										No. cuts per year								
Species	4			5			6			4			5			6		
<i>Lolium multiflorum</i> Lam	26.8	26.4	10.8	35.2	27.8	18.4	25.9	12.9	10.4									
<i>Ranunculus repens</i> L.	0.4	0.1	0.1	22.9	0.6	0.4	6.1	4.3	3.5									
<i>Echinochloa crus-galli</i> (L.) Beauv.	8.3	0.9	0.8	0.9	0.6	0.4	2.0	1.1	0.7									
<i>Convolvulus arvensis</i> L.	21.7	17.1	4.0				0.2	0.1	0.1									
<i>Trifolium pratense</i> L.	0.6	0.3	0.3				4.9	4.1	3.1									
<i>Ranunculus acris</i> L.	2.6	1.0	1.5	0.3	0.3		2.0	2.1	0.8									
<i>Achillea millefolium</i> L.							2.6	2.1	1.6									
<i>Centaurea jacea</i> L.							0.4	0.4	0.1									
<i>Trifolium repens</i> L.	9.8	14.8	19.7	10.5	10.7	15.7	6.8	14.6	14.5									
<i>Taraxacum officinale</i> Weber	7.2	10.5	15.0	4.8	12.0	15.8	18.7	22.9	24.4									
<i>Setaria viridis</i> (L.) Beauv.	11.4	12.8	14.2	15.4	22.1	28.6	5.4	7.1	12.8									
<i>Rumex obtusifolius</i> L.	7.3	7.2	11.5		0.1		2.2	2.2	2.4									
<i>Alopecurus utriculatus</i> (L.) Pers.				1.1	1.2	1.6	1.8	2.2	2.5									
<i>Rorippa sylvestris</i> (L.) Besser	0.4	0.3	1.2				0.1	0.1	0.1									
<i>Pimpinella major</i> (L.) Hudson							0.1	0.1	0.1									
<i>Poa trivialis</i> L.		0.6	1.5	7.5	7.1	8.2	3.5	3.6	3.0									
No. of other species	3	7	9	4	4	2	9	8	9									

## Results

The average number of species surveyed during 2007 was 16.2 in P1, 9.2 in P2 and 19.4 in P3. This is typical for a *Lolietum multiflori* of the region with species-poor swards and simple or even monotonous species composition. A significant treatment effect on the specific biodiversity was only found in two situations (Table 1). In P1, fertilization slightly changed the species number from 16.9 to 16.3 and 15.3 for fertilizer treatment 1, 2, and 3 respectively, with this effect being significant between treatments 1 and 3. In P3, the number of species was affected by cutting frequency with 18.7, 19 and 20.7 for 4, 5 and 6 cuts per year, respectively. Only the highest value significantly differed from the other two. The results of the cluster analysis showed that in all three trials only the variable 'mowing frequency' had a notable effect on the community composition (Fig. 1). However, this effect was of different intensity in the three meadows (Table 2). In P1 and P2, the frequent mowing resulted in a more or less accentuated variation compared to the less-frequent cutting treatments. In

contrast, in P3, it was the two most-frequent cutting treatments that led to a plant community which differed from the one relative to the 50-day interval. This analogous result may be due, at least partly, to the fact that the frequent cutting markedly reduced the cover of *L. multiflorum* (Bonifazzi *et al.*, 2008), thus allowing the other species to increase their cover (Storkey, 2006).

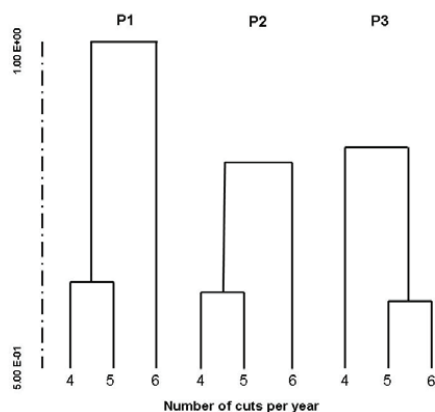

Figure 1: Dendrogram of the botanical survey.

## Conclusions

In the present study, mowing frequency and fertilization level did not consistently alter the number of plant species of irrigated permanent meadows on the plain during the first three years of differentiated management. While the fertilizer treatment also did not show any effect on the species composition, the cutting frequency markedly changed the composition with significant effects of the reduced cutting interval from 45-50 days to 30, in two of the three meadows, and to 30 and 38, in the third. Probably in the longer term these effects will become more relevant.

## References

- Bonifazzi B., Da Ronch F., Susan F. and Ziliotto U. (2008) Effects of cutting management on the floristic composition of two permanent Italian ryegrass (*Lolium multiflorum*) meadows. *Grassland Sciences in Europe* 13, 221-223.
- Rodaro P., Scotton M. and Gianelle D. (1998) Effects of management on botanical composition and production of permanent meadows intensively managed of the Veneto plain (Italy). *Grassland Science in Europe* 3, 187-190.
- Rodaro P., Scotton M. and Ziliotto U. (2000) Effetti delle caratteristiche stazionali e delle pratiche agronomiche su composizione floristica e produzione di alcuni prati del Veneto. *Rivista di Agronomia* 34, 435-451.
- Storkey J. (2006) A functional group approach to the management of UK arable weeds to support biological diversity. *Weed Research* 46, 513-522.
- Wildi O. and Orloci L. (1996) *Numerical Exploration of Community Patterns. A guide to the use of MULVA-5*. 2<sup>nd</sup> edition. SPB Academic Publishing.

# Construction of a simplified method based on the functional composition of the vegetation for characterizing the agricultural services provided by species-rich grasslands

Duru M., Cruz P., Jouany C. and Theau J.P.

UMR1248 INRA-ENSAT AGIR (Agrosystèmes et développement territorial), Chemin de Borde Rouge, BP 52627, 31326 Castanet Tolosan, France

Corresponding author: mduru@toulouse.inra.fr

## Abstract

Functional composition of species-rich grasslands, weighted leaf dry matter content-based (LDMC<sub>w</sub>), was previously successfully used for evaluating agricultural services they provided: plant productivity (P), dynamic of herbage production (T), and flexibility for management (F). However, these results were only based on measurements of plant traits for grass species because dicot species are usually numerous and tedious to recognize. Thus we wonder how to assess as simple as possible the three agricultural services, i.e. avoiding recognizing individually the dicots species, and only considering the LDMC for grass species. Based on the study of 24 grassland communities, we found that there were significant differences between the grass and dicotyledonous components co-existing within a plant community for T (earlier for dicots), but no significant effect for P. The presence of dicots species increased F. We concluded that recording the list and abundance of grass species and the abundance of dicots species as a whole allows assessing agricultural services provided by species-rich grasslands.

Keywords: plant diversity, leaf dry matter content, grass, dicotyledon

## Introduction

To evaluate services provided by species-rich grasslands, an approach is to use plant functional traits (Garnier *et al.*, 2007). Leaf dry matter content (LDMC) was successfully correlated with plant productivity and growth dynamics. Furthermore, the plant diversity, LDMC-based, determines the shape of the growth curve given flexibility for management when it was flattened (Ansquer *et al.*, 2009a). However, these results were only based on the grass component, and field measurement of plant traits is very time consuming. Thus we wonder how to assess by the simplest way possible the three agronomic services, using plant trait data base only for grass species and considering dicot species as a whole, avoiding recognizing them individually. This supposes that grass and dicots species co-existing within a plant community provide the same agronomic services or that differences between these two functional groups are predictable. Our observations have confirmed that there is a convergence within the plant community of productivity-related measured traits for grass and dicotyledonous species (Ansquer *et al.*, 2009b). Our objective is to examine whether the same was true for herbage productivity and growth dynamics, and, if not, to propose a method to take into account of the effect of the dicot component.

## Material and methods

An experiment set up in the central Pyrenees (650 m a.s.l.; 42°51'04N, 01°17'29"E) consisted of plots in grassland communities (8 in 2002, 18 in 2004) sampled on four livestock farms to cover a wide range of fertility and management (grazing, cutting). Two main grass functional types (PFT) defined on LDMC basis (Ansquer *et al.*, 2009) were used to distinguish plant



communities. Acquisitive PFT (1) have low LDMC: e.g. *Holcus lanatus* L., *Lolium perenne* L., *Dactylis glomerata* L.; companion dicots species being *Chaerophyllum aureum* L., *Ranunculus acris* L. Conservative PFT (2) having high LDMC: e.g. *Agrostis capillaris* L., *Festuca rubra* L.; companion dicots species (*Plantago lanceolata* L.). On this basis, there were 5 of the 8 plant communities in 2002 and 15 of the 18 in 2004 that were dominated by PFT1. The botanical composition was obtained by taking ten random samples of forage at the peak of growth, then sorting by species and weighing each fraction. Herbage yields were obtained by clipping 3 randomised subplots of 0.25 m<sup>2</sup> at 8 - 10 sampling dates from March to July in order to include the flowering time. On a sub-sample of herbage, grasses were separated from dicotyledons. The functional composition was defined through three indicators: (i) LDMCgw was calculated by weighting (w) the value of LDMC for each grass (g) species by its abundance. LDMC was taken from a database including only pure stands of grass species grown with non-limiting nitrogen; (ii) the functional diversity index (FD) represents how species abundance is spread along the trait axis (Mason, 2003); it is bounded between 0 and 1; (iii) the proportion of dicot species. Regression analysis was performed for determining the herbage growth dynamics: herbage growth rate, date at which the ceiling yield occurred and the relative variation of herbage mass around the peak (20 days beforehand and the variation of herbage mass around the peak in percent).

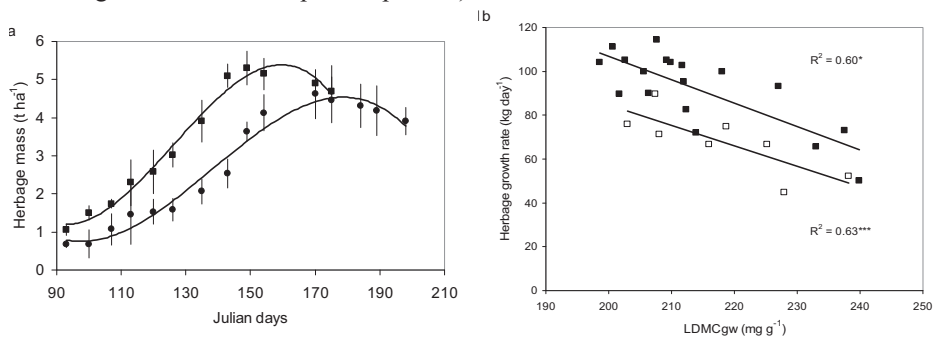

Figure 1. (a) Biomass accumulation for 2 grassland communities (2002) and adjusted third order polynomial equation for grassland type dominated by PFT1 (■) and 2 (●); vertical bars indicated standard errors calculated from 3 sub plots; (b) daily herbage growth rate in spring according to leaf dry matter content weighted by the grass species abundance in 2002 (□) and in 2004 (■); \*  $P < 0.05$ ; \*\*\*  $P < 0.001$

## Results

The dynamics of herbage accumulation over the spring growth depends on PFT for maximum values and dates (Fig. 1a). The herbage growth rate was negatively correlated to the LDMCgw ( $P < 0.001$ ) whatever the year (Fig. 1b). There was no effect of the proportion of grass ( $P = 0.16$ ) even though it varied from 28 to 88% between grassland fields. Dates of herbage peak varied from day 162 until day 202 for the grass component, and from day 140 until day 185 for the dicotyledonous component. These differences were observed irrespective of the grass PFT (Julian days, e.g. 162 vs. 174 for PF1 and 169 vs. 176 for PFT 2). The date at which herbage peak occurred was significantly correlated to LDMCgw (Fig. 2a), and it was later when considering only the grass component ( $P < 0.001$ ).

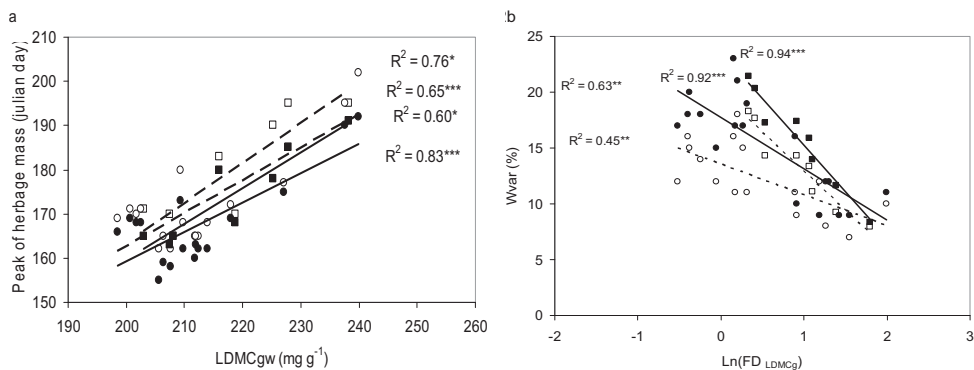

Figure 2. Date at which herbage peak occurred (a) and indicator of the growth curve shape (Wvar) (b) according to LDMCgw and  $\text{Ln}(\text{FD}_{\text{LDMCg}} \times 100)$  in 2002 (■, □) and in 2004 (●, ○) for whole herbage (full symbol) or the grass component (empty symbol); LDMCgw is leaf dry matter content weighted by the grass species abundance; FD is a functional diversity index established on LDMC basis; Wvar is the percentage of herbage mass 20 days before the peak in relation to peak; \*  $P < 0.05$ ; \*\*  $P < 0.001$ ;  $P < 0.001$

The percentage of herbage mass 20 days before the peak in relation to peak mass (Wvar) was significantly linearly negatively correlated to the logarithm of the functional diversity index whatever the year or component (grass or whole herbage), (Fig. 2b). Comparison of regressions between Wvar and  $\text{Ln}(\text{FD}_{\text{LDMCg}})$  for whole herbage and the grass component shows that there was a significant difference in the intercept ( $P < 0.001$  in 2002 and  $< 0.05$  in 2004). The presence of dicot species in the vegetation increased Wvar, leading to greater flexibility for harvest date; i.e. low variation in herbage yield over longer period of time.

## Discussion and conclusion

The results show the three agronomic services considered can be appropriately assessed by considering the abundance of the grass species for which LDMC is known, and the percentage of dicot species as a whole. This allows the assessment of agronomic services provided by permanent grasslands because relationships between LDMC and main plant features (e.g. flowering time, leaf lifespan) that have an effect upon agronomic properties are genetically fixed and are little dependant of environmental factors (Ansquer *et al.*, 2009). The weaker points rely on plant functional groups. The diversity of dicotyledonous species being great, it is necessary to verify whether the convergence and divergence with companion grass species exists elsewhere, as in the experiments reported here.

## References

- Ansquer P., Duru M., Theau J.P. and Cruz P. (2009) Functional traits as indicators of fodder provision over a short time scale in species-rich grasslands. *Annals of Botany* 103, 117-126.
- Garnier E., Lavorel S., Ansquer P. *et al* (2007) Assessing the effects of land-use change on plant traits, communities and ecosystem functioning in grasslands: a standardized methodology and lessons from an application to 11 European sites. *Annals of Botany* 99, 967-985.
- Mason W.H., MacGillivray K., Steel J.B. and Wilson J.B. (2003) An index of functional diversity. *Journal of Vegetation Science* 14, 571-578.

## Survival of *Rumex* seedlings under different management in upland grassland

Gaisler J., Pavlů V. and Pavlů L.

Crop Research Institute Prague, Department of Plant Ecology and Weed Sciences, Rolnická 6, CZ-460 01, Liberec, Czech Republic

Corresponding author: jan.gaisler@volny.cz

### Abstract

Survival of seedlings of *Rumex obtusifolius* and *R. crispus* was studied on upland grassland in the Jizera Mts. in the north of the Czech Republic from 2008 to 2009. The following treatments were applied: intensive grazing, extensive grazing, abandonment and cutting. Pre-cultivated seedlings were implanted into the sward in a factorial design with different micro-site conditions (gap – no gap, cowpat – no cowpat) in each treatment. The following variables of *Rumex* plants were measured: number of surviving plants, height of plants, number of leaves and size of plant base. Measurements were made three times per year (spring, summer and autumn). Due to the trampling effect the seedlings were more damaged on the intensively grazed plots than on extensively grazed ones. Seedlings of *R. crispus* were more susceptible to applied management than were *R. obtusifolius* seedlings. For the success of *Rumex* seedlings not only soil disturbance and nutrient availability but also grassland management are important.

Keywords: broad-leaved dock, weeds, grazing, cutting, cowpat, competition

### Introduction

Species of the genus *Rumex* are among the most troublesome weeds in meadows and pastures. *R. obtusifolius* and *R. crispus* are especially widespread on nutrient rich soils and disturbed swards. They produce seeds with long term persistence in the soil seed bank (Honěk and Martinková, 2002). The control of *Rumex* is very difficult in systems of organic farming. Chemical control methods are prohibited and biological ones are not simple to apply in practice. Generally, it seems to be necessary to develop and maintain optimal grassland management to prevent the infestation of *Rumex* by the creation of dense and competitive swards. For example the competition effect of *Lolium perenne* sward on *Rumex* seedlings was studied by Jeangros and Nösberger (1990). Our study focused on the conditions for seedling survival and consequent development of *R. obtusifolius* and *R. crispus* under different grassland management and micro-site conditions.

### Material and methods

The study was carried out on experimental mesic pasture in uplands of the Jizera Mts. from 2008-2009. Three-month old pre-cultivated seedlings of *Rumex obtusifolius* and *R. crispus* were implanted into the sward with the following managements: intensive grazing (IG = 2 LU (livestock unit) per ha), 1<sup>st</sup> cut and following intensive grazing (ICG), extensive grazing (EG = 1 LU ha<sup>-1</sup>), 1<sup>st</sup> cut and following extensive grazing (ECG), cutting twice per year with biomass removal (C) and abandonment (U). In June 2008 seedlings were implanted into each management treatment under different micro-site conditions in a factorial split plot design: gap (removed sward on area 15 cm x 15 cm) with cowpat GE, no gap with cowpat NGE, gap without cowpat GNE, no gap without cowpat NGNE. Cowpats (500 g) were placed onto gaps or sward surface. Six seedlings in four replications (i.e. 24 plants) for each combination of

factors were implanted for each *Rumex* species. We recorded number of surviving plants, number of leaves per plant, height of plant and base diameter. ANOVA (repeated measures) were used to analyse the data.

## Results and discussion

During the second year after seedling implantation a gradual decrease in the number of surviving plants of *R. crispus* and *R. obtusifolius* occurred. Higher mortality was found in *R. crispus* than in *R. obtusifolius*, especially on intensively grazed plots. Seedling survival was higher in plots with cowpats. The effect of nutrient enrichment through cowpats on seedling survival was slightly higher than the effect of soil disturbance. Percentage survival of the two species is shown in Fig. 1. In our study seedling mortality was lower than that reported by Martinková *et al.* (2009).

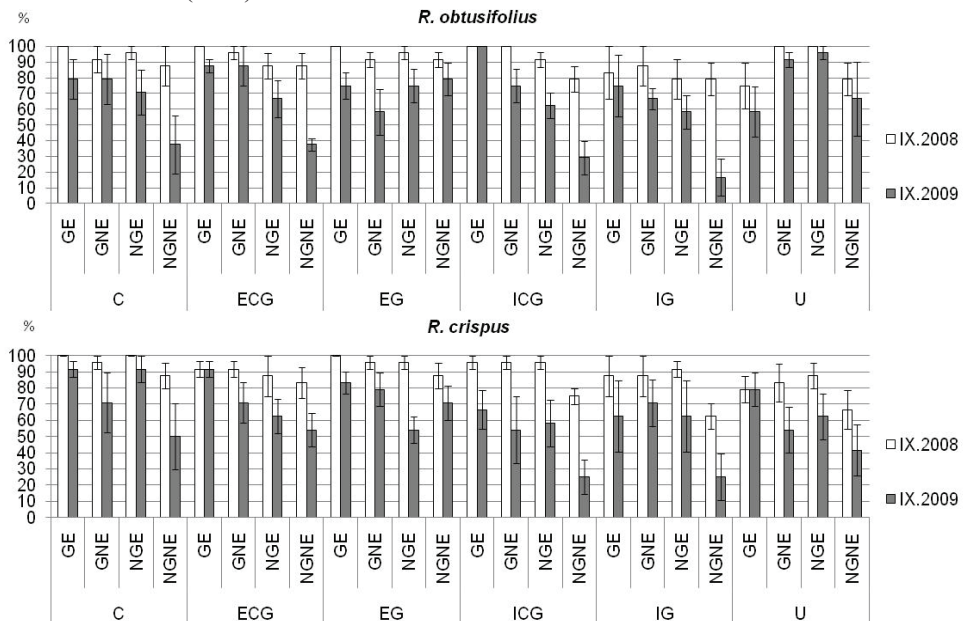

Figure 1. Percentage survival of *R. obtusifolius* and *R. crispus* in micro-sites at the end of seasons 2008 and 2009, G = gap, E = excrement, N = without, vertical bars give standard error.

Plant heights were significantly lower ( $P < 0.001$ ) on intensively grazed plots (IG, ICG), than on unmanaged or cut plots (Fig. 2). On the other hand, plants in the IG treatment had the highest number of leaves and the largest base diameter ( $P < 0.001$ ), i.e. these were strong plants but without inflorescences.

Generally, the weakest plants were recorded in all treatments without gaps and without cowpats. This is in line with other studies (e.g. Niggli *et al.*, 1993; Hatcher *et al.*, 1997; Hopkins and Johnson, 2002), which showed that a higher nutrient content in the soil increases the competitive ability of *Rumex* in the sward.

## Conclusion

Due to the trampling effect, *Rumex* seedlings on the intensively grazed plots were more damaged than on extensively grazed or cut treatments. The presence of gaps and/or cowpats significantly supported the probability of seedling survival.

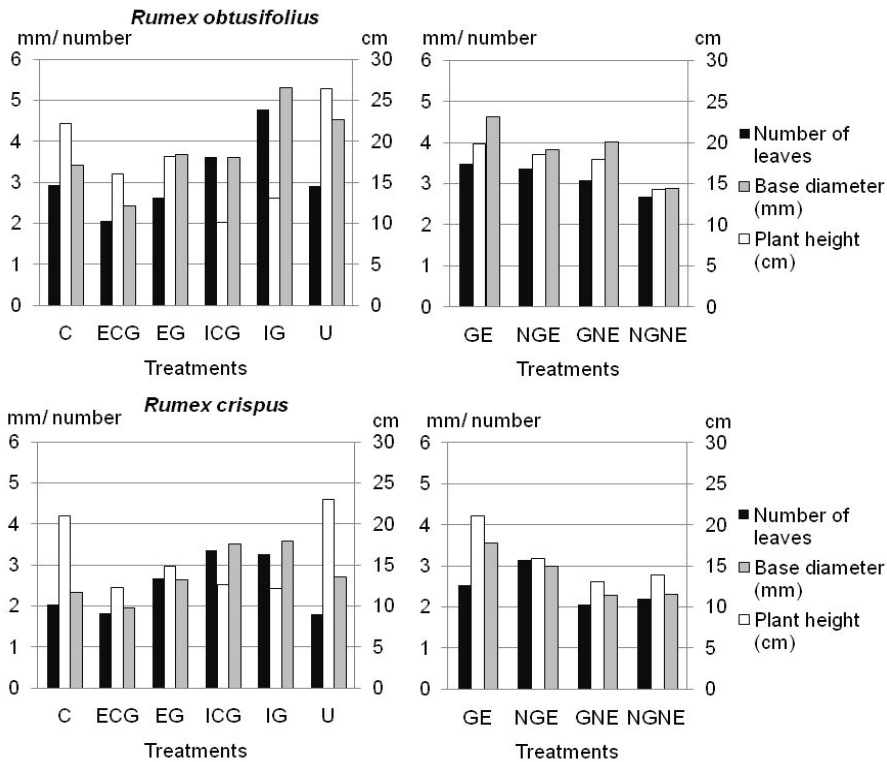

Figure 2. *R. obtusifolius* and *R. crispus* - plant height, number of leaves and mean base diameter after 15 months from plantation. G = gap, E = excrement, N = without.

### Acknowledgements

The study was supported by the Ministry of Agriculture of the Czech Republic – projects QH72217 and 0002700604.

### References

- Hatcher P.E., Paul N.D., Ayres P.G. and Whittaker J.B. (1997) Added soil nitrogen does not allow *Rumex obtusifolius* to escape the effects of insect-fungus interactions. *Journal of Applied Ecology* 34, 88–100.
- Honěk A. and Martínková Z. (2002) Effects of individual plant phenology on dormancy of *Rumex obtusifolius* seeds at dispersal. *Weed Research* 42, 148–155.
- Hopkins A. and Johnson R.H. (2002) Effect of different manuring and defoliation patterns on broad-leaved dock (*Rumex obtusifolius*) in grassland. *Annals of Applied Biology* 140, 255–262.
- Jeangros B. and Nösberger J. (1990) Effects of an established sward of *Lolium perenne* L. on the growth and development of *Rumex obtusifolius* L. seedlings. *Grass and Forage Science* 45, 1–7.
- Martínková Z., Honěk A., Pekár S. and Štrobach J. (2009) Survival of *Rumex obtusifolius* L. in an unmanaged grassland. *Plant Ecology* 205, 105–111.
- Niggli U., Nösberger J. and Lehmann J. (1993) Effects of nitrogen fertilization and cutting frequency on the competitive ability and the regrowth capacity of *Rumex obtusifolius* L. in several grass swards. *Weed Research* 33, 131–137.

## Increasing the milk quality with grazing feeding in humid Spain grassland

Gonzalez Rodriguez A.<sup>1</sup>, Roca-Fernandez A.I.<sup>1</sup>, Vazquez-Yañez O.<sup>1</sup> and Fernandez-Casado J.<sup>2</sup>

<sup>1</sup>Agrarian Research Centre of Mabegondo (CIAM), <sup>2</sup>Agrarian and Phytopathologic Laboratory (LAFIGA), <sup>1,2</sup>INGACAL. Xunta de Galicia PO Box 10, 15080, A Coruña, Spain.  
Corresponding author: antonio.gonzalez.rodriguez@xunta.es

### Abstract

The aim was to study the effect on milk fatty acids (FA) composition of three groups of cows with different proportion of grazing (zero, 12 hr and 24 hr) having silage and concentrate (6.5 kg cow<sup>-1</sup>) on the ration during the grazing season of sixty-one autumn-calving Holstein-Friesian dairy cows. Milk yield and quality, including the FA profile, were determined. Grazing 24-hr caused a significant decrease ( $P<0.05$ ) in the saturated (SFA) and a significant increase in the unsaturated (UFA) fatty acids. The conjugated linoleic acid (CLA) showed a significantly increase ( $P<0.05$ ) with grazing time, from 4.8, 8.4 and 11.7 g kg<sup>-1</sup> of FA in milk fat for the silage feeding, 12-hr or 24-hr grazing, respectively during the spring. Farmers from the humid part of Spain, producing milk from grazed grass, might get a benefit in milk price if FA composition of milk is taken into account in the dairy industry. We found that milk from grazing dairy cows had a higher proportion of unsaturated FA, and more polyunsaturated FA and CLA than milk from silage-fed cows, in the sustainable dairy systems proposed to reduce the intensiveness of milk production.

Keywords: dairy cow, milk composition, grazing time, CLA, silage feeding

### Introduction

Cows on pasture, grazing lush fresh grass at a high herbage allowance, produce milk with the highest concentrations of polyunsaturated fatty acids (PUFA) than cows feeding silage. These FA seem to reduce cardiovascular risks in humans (Elgersma *et al.*, 2004; Dewhurst *et al.*, 2006). The highest concentrations of ruminic acid and the beneficial unsaturated fatty acids (UFA) are mainly found in milk from countries like Ireland, New Zealand and Switzerland where the dairy production systems are based on long periods of pasture feeding. Moreover, Italian cheese produced from milk of cows grazing mountain pastures showed an average ruminic acid content of 16.7 g kg<sup>-1</sup> compared with 7.1 g kg<sup>-1</sup> in fat of cheese from barn-fed cows (Innocente *et al.*, 2002). The conjugated linoleic acid (CLA, C18:2 *cis*-9 *trans*-11) content varied from 12.4 to 27.8 g kg<sup>-1</sup> on 12 cows on pasture, and went down to 4.0-8.6 g kg<sup>-1</sup> after four days transition to a corn silage diet. As CLA concentrations are correlated with those of the beneficial UFA, they could be used as indicators of the FA composition in milk fat from ruminants feeding different regimes (Elgersma *et al.*, 2004). In general, the beneficial effects of CLA content now seems commonly accepted and the important role of grazing has to be considered for increasing the farmer's reliance on grass in order to improve milk quality at the farm level. In this paper, we present an attempt to assess the composition of milk FA levels, mainly the CLA content, in a sustainable dairy production system based on grazing as an alternative to intensive dairy systems based on silage feeding.

### Material and methods

A study was conducted during the grazing season with 61 autumn-calving Holstein-Friesian dairy cows from the experimental herd (mean calving date, 20 November 2007  $\pm$  17 d), at the Agrarian Research Centre of Mabegondo (CIAM). After calving, the cows were fed like the



first treatment, grazing when possible, autumn and early March, and supplemented throughout the trial with  $6.5 \text{ kg cow}^{-1} \text{ d}^{-1}$  of concentrate; then after peak of lactation ( $35 \text{ L cow}^{-1} \text{ d}^{-1}$ ) they were balanced and randomly assigned on 20 March to one of three treatments: (S24) Silage feeding,  $40 \text{ kg cow}^{-1} \text{ d}^{-1}$ , in stable 24 hours all lactation ( $n=11$ ); (G12) Rotational grazing 12 hours and silage supplementation,  $15 \text{ kg cow}^{-1} \text{ d}^{-1}$  ( $n=27$ ); (G24) Grazing 24 hours no silage for the whole lactation ( $n=23$ ). The silage was a 50% grass and maize mixture with 33% dry matter (DM). The lactation was divided into four periods for the study during the grazing season: 1-vegetative spring (April-May), 2-reproductive spring (May-July), 3-summer dry period (August), 4-autumn (September-October). Perennial ryegrass and white clover >4-year-old swards, low levels of legumes, were rotationally grazed individually by each group. Daily controls of milk production and weekly milk quality were examined in all cows, while the fatty acids profile and the CLA analysis was performed, sampling weekly 5 cows per treatment. The extraction of the milk fat was made for subsequent determination of FA profile by gas chromatography. The total amount of saturated fatty acids (SFA) was calculated as the sum of C4:0 to C18:0. Data analysis was performed using the statistical program SPSS-15.0 by Tukey's multiple comparison test.

## Results and discussion

The treatments were applied by housing the silage group all day (S24) and offering grass to both of the grazing groups, mid-day or all day (G12 and G24). After seven days of application of treatments, it was noticeable that there was a decrease in milk production according to the stage of lactation, more in the stable group (S24) than in both grazing groups (Figure 1-A).

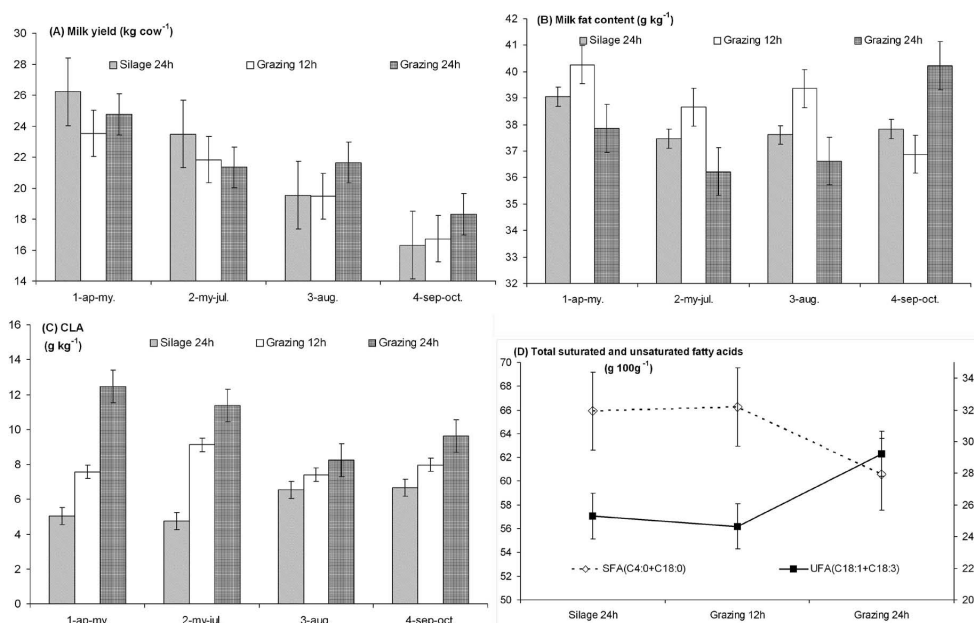

Figure 1. Milk yield (A), milk fat content (B), conjugated linoleic acid content (CLA) in milk fat (C) during four periods of lactation and proportion of saturated and unsaturated FA (D) of three herds at different grazing ratios (zero, 12 hr and 24 hr). Bars are mean standard error



Total milk production, with no differences between treatments, was 7700 kg cow<sup>-1</sup> with 2000 kg cow<sup>-1</sup> of concentrate. There were significant differences in milk fat of the groups (Figure 1-B). The herd with silage feeding and grazing mid day (G12) increased the fat content during the spring, while the group grazing all day (G24) increased it only in autumn. We found a high CLA content 13.3 g kg<sup>-1</sup> in milk fat in all groups before the treatments were applied. After that, from the first period of spring the levels of CLA in milk fat increased significantly ( $P<0.05$ ) when cows have grazing all day for all periods (G24) during the whole lactation, three times more in spring when quality grass is available to animals. The herd feeding silage (S24) reduces by a half the milk CLA content in relation to the herd grazing 12 hours (G12), with no relation to milk yield, in each period (Figure 1-C). These data were similar to the reviews reported by Precht and Molkentin (2000) and Jensen (2002) on FA profile, where average concentration of rumenic acid in bulk milk in most countries was 4-10 g kg<sup>-1</sup> of milk fat, and when cows are feeding at pasture its values are 2-3 times those during barn feeding. Total proportion of saturated fatty acids decreased significantly ( $P<0.05$ ) while unsaturated acids increased (Figure 1-D) when cows are fed with only fresh grass (G24). Similar results were reported by Gonzalez *et al.* (2009) also showing the benefits of grazing, with three times more CLA in milk fat with grazing cows compared with feeding silage in spring. A significant decline on short chain fatty acids (SCFA) such as caproic, caprylic and capric acids, in cows grazing 24-hr, and an increased on long chain fatty acids (LCFA) such as oleic and linoleic acids were also observed. The greatest differences in the milk levels of CLA between the three groups were also found during the grazing season in spring (from April to May) when grass is in a vegetative stage, tending to decrease at summer level with lower growth rate and lower quality sward. The differences in CLA content were lower in autumn than spring, and related more to the feeding regime than the similar milk yield in that period.

## Conclusions

The ingestion of fresh grass was a decisive factor for the CLA content in milk. Cows grazing grass 24 hours had a higher proportion of unsaturated fatty acids and more CLA in milk fat than cows fed on silage that showed an increased proportion of saturated fatty acids.

The fatty acids profile seems to show some seasonality during the grazing season. In spring, the levels of CLA were three times higher in milk from cows grazing grass all day than in cows feeding on silage, whereas in summer and in autumn these differences were reduced by half. Grazing proves to be a good tool to increase the added value of milk in sustainable dairy systems, if the fatty acids profile were to be taken into consideration by farmers and dairies.

## References

- Dewhurst R.J., Shingfield K.J., Lee M.R.F. and Scollan N.D. (2006) Increasing the concentrations of beneficial polyunsaturated fatty acids in milk produced by dairy cows in high-forage systems. *Animal Feed Science Technology* 131, 168-206.
- Elgersma A., Ellen G., Van der Horst H., Muuse B.G., Boer H. and Tamminga S. (2004) Quick changes in milk fat composition after transition from fresh grass to a silage diet and effects on consumer health benefits. *Animal Feed Science Technology* 117, 13-27.
- González-Rodríguez A., Vázquez-Yáñez O.P., Roca-Fernández A.I. and Fernández-Casado J.A. (2009) Contenido de ácido linoleico conjugado (CLA) en leche de vacuno en sistemas de producción en pastoreo en zonas húmedas. *XLVIII Reunión Científica de la SEEP*, Huesca, Spain, 519-526.
- Innocente N., Praturlon D. and Corradini C. (2002) Fatty acid profile of cheese produced with milk from cows grazing on mountain pastures, *Italian Journal Food Science* 14, 217-224.
- Jensen R.G. (2002) Invited review: the composition of bovine milk lipids. *Journal of Dairy Science* 85, 295-350.
- Precht D. and Molkentin J. (2000) Frequency distributions of conjugated linoleic acid and trans fatty acid contents in European bovine milk fats. *Milchwissenschaft* 55, 687-691.

# Grassland in Pays de Caux (France): balancing trade-off between livestock feeding and decreasing runoff

Faure J.<sup>1,3</sup>, Havet A.<sup>1,2</sup>, Remy B.<sup>1,2</sup> and Barrier C.<sup>2,1</sup>

<sup>1</sup>*INRA UMR 1048 SAD APT, 78 850 Thiverval-Grignon, France*

<sup>2</sup>*AgroParisTech UMR 1048 SAD APT, 78 850 Thiverval-Grignon, France*

<sup>3</sup>*present address: INRA- Agrocampus Ouest, UMR 1079 SENAH, 35 590 St Gilles, France*

Corresponding author: [alain.havet@grignon.inra.fr](mailto:alain.havet@grignon.inra.fr)

## Abstract

In mixed cropping-livestock farms, grassland fits both productive and environmental functions. Thus, in the Pays de Caux (Haute-Normandie, France), runoff might be mitigated by the presence of permanent or rotational grassland. The aim of our study was to assess how mixed crop-livestock farms, specifically breeding dairy or suckler cows, integrate grassland into their global functioning and to know the farmers' position about grass management. Livestock farms were surveyed and the collected data were analysed by multidimensional statistical analysis. Even though maize silage is the main fodder resource in this region now, we observed a large diversity of types in the more or less intensive uses of grassland. We identified two main strategies of grassland management. In the first type, farms combine grazed grassland and maize silage considered as forage security. In the second type, the farmers' choice of including cultivated grassland in crop rotations has both advantageous objectives: improving forage self-sufficiency (intensive use of grass for grazing or hay making) and decreasing the risk of runoff. Considering trade-offs between farm production and environmental benefit, the possibility to develop these sown pastures was assessed with quantitative indicators showing their impact on runoff level and providing economic results at farm scale.

Keywords: livestock farming, grassland strategy, cultivated grassland, rotational grassland, environmental function, runoff

## Introduction

In Pays de Caux (Haute-Normandie, France), runoff and erosion cause damage and affect farmers as well as the other people living in this area (e.g. houses are sometimes flooded and drinking water polluted). Much research has been carried out in soil science to understand the phenomenon of runoff and erosion. The Pays de Caux is strongly affected due to three main reasons: a high rate of impermeable built-up areas (Auzet, 1987), a low percentage of permanent vegetation, and a huge development of the share of land over the past few years at the expense of grasslands. Grasslands, however, possess some favourable properties to combat the risk of erosion: they raise water seepage, hold back land particles and slow the flow down (Martin, 1997). Whereas past dynamics have accentuated environmental risks, the question is now: how can livestock farmers manage grassland in order to decrease runoff while bovine production remains profitable? In this study, a survey was done on mixed cropping and livestock farms in the Pays de Caux to analyse management and general functioning (Capillon, 1993) of the farms in relation to erosion and runoff.

## Materials and methods

For the survey, 17 farms were selected that covered the range of mixed cropping and livestock farms in the Pays de Caux. Data were obtained on the farms during the vegetation period of

2009. The themes were: farmer’s objectives and strategic choices, means of production (workforce, equipment), combination of farm productions, social and economic environment. The diversity of livestock systems and grassland use is described by variables as the grazing period length, the percentage of permanent grassland area (PGA) and maize silage in the principal forage area (PFA), and the number of animals per hectare of PGA.

We observed interactions between main data on grassland use by employing a Principal Component Analysis. This method explains 57% of the variability of the farms sample. Taking also into account farmers’ point of view about grassland, we established a likely diagnosis of grassland area evolutions for their farms. We assessed environmental impacts using the DIAR (DIagnostic Agronomique du Ruissellement) application (Martin *et al.*, 2009) and economic results with the Olympe® software (Michaud and Bourgain, 2005).

**Results**

In the survey, we mostly identified mixed crop-livestock farms, specifically breeding dairy or suckler cows. Even if the farmer’s choice for grassland localization was largely influenced by the proximity to the cowshed and the sloping areas, our analysis (Capillon, 1993) underlined different strategies of grassland management. This paper focuses on two different forage systems (Fig. 1). The first type gives priority to the productive performances of livestock farming. Grassland areas are used mainly for grazing - the cheapest way to provide forage - and are in competition with maize silage areas which secure the forage production level. Moreover, farmers pointed out the difficulties of grassland management considered as a key constraint in their global strategy in order to organize pasture over time and space. A lack of regularity due to rainfall variability is not favourable to insure animal feeding. Due to this the preservation of the environmental functions is not guaranteed, because the contribution of grassland to the cropping plan might decrease. The second type uses sown grassland either for permanent use or as ley in a crop rotation, for grazing or hay making, associated with a low percentage of maize cropping for silage. Farmers’ choice is based on feeding quality, an earlier access to grass and a longer grazing period; thus improving forage self-sufficiency, even if farmers are aware of the need for more appropriate techniques and knowhow because of some risks in production regularity. The evolution trend in this strategy is consistent with maintaining the proportion of grassland and decreasing runoff. Their decisions integrate both agronomical and environmental concerns.

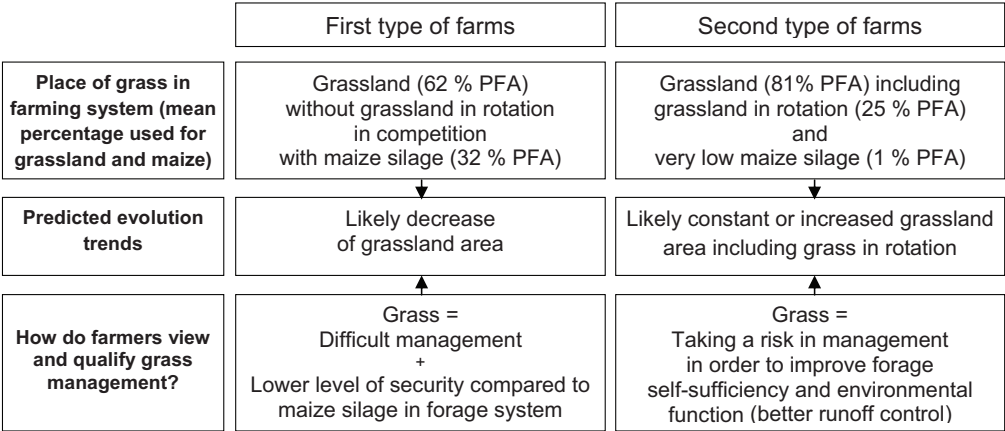

Figure 1. Two strategies of grassland management in Pays de Caux (PFA: principal forage area).

For this reason, we tested the economic feasibility of inserting rotational grassland, employing the Olympe® software, on a dairy farm of the first type. In this simulation, we used (i) Italian ryegrass (*Lolium multiflorum*) as a catch crop for production instead of mustard as an intermediate crop for green manure, and (ii) horse bean (*Vicia faba*) instead of some commercial crops, to achieve forage self-sufficiency and to increase pasture period. This simulation (Table 1) allows a 27% runoff decrease, a feeding cost cut (12 € per 1000 L) and a higher margin for the dairy unit (12 € per 1000 L).

Table 1. Economic results for introduction of Italian rye-grass as catch crop and horse bean.

		Initial state	Simulated year + 4
Margins (€)	Global	193007	194117
	Dairy unit	117335	123849
	Dairy unit / 1000 L	218	230
	Commercial crops	75672	70268
Feeding costs (€ per 1000 L)	Concentrates	73	42
	Fodder area	42	60
	Mustard	40	0
Intermediate crops costs (€ ha <sup>-1</sup> )	Italian rye-grass	0	82

Hypothesis: no changes for prices of milk and inputs

In the light of these environmental and economic indicators, such a forage system, including rotational grassland, can slightly increase the dairy margin and is a relevant balancing trade-off in order to preserve the grassland area for animal production and for runoff reduction.

## Discussion and conclusion

Farmers need technical advice on the integration of grasslands into a cropping plan because the management of such grass seems difficult to them, even if they have already adopted these techniques. Moreover, the context of high uncertainty for agricultural prices could lead farmers to improve forage self-sufficiency. According to this study, the development of grass inside cropping systems, and the perspective of cooperative associations between livestock farmers and crop growers, could bring greater environmental benefits in Pays de Caux. Nevertheless, the future of livestock farming and grasslands will mainly depend on the evolution of the roles given to farming in this region where agriculture is in competition for land with industry, tourism and urbanization.

## Acknowledgements

This work was carried out in the framework of the program 'Risque, Décision, Territoire' with the financial support of the French Ministry of ecology, energy, sustainable development and territory planning.

## References

- Auzet A.V. (1987) *L'érosion des sols par l'eau dans les régions de grande culture: Aspects agronomiques*. Centre d'études et de recherches éco-géographique (CEREG), 39 pp.
- Capillon A. (1993) Typologie des exploitations agricoles, contribution à l'étude régionale des problèmes techniques. Thèse INA P-G tome 1, 48 pp.
- Martin P. (1997) *Pratiques culturales, ruissellement et érosion diffuse sur les plateaux limoneux du nord ouest de l'Europe*. Thèse de doctorat, INA P-G, 184 p.
- Martin P., Ouvry J.F. and Bockstaller C. (2009) Adaptation of the curve number approach to runoff estimation for loamy soils over a growing season for winter wheat: comparison with the STREAM approach. *Land Degradation and Development* (in press).
- Michaud M. and Bourgain O. (2005) Evaluation du coût de mise en place de pratiques agricoles permettant de limiter le ruissellement érosif: l'exemple des exploitations sur le plateau du Neubourg. *Ingénieries* 43, 33-42.

## Secondary dry grassland management by frequent mowing in the Western-Cserhát, Hungary

Házi J.<sup>1</sup>, Bartha S.<sup>2</sup>, Szentes S.<sup>3</sup>, Malatinszky Á.<sup>1</sup> and Penksza K.<sup>1</sup>

<sup>1</sup> *Szent István University, Institute of Environmental and Landscape Management.*

*Department of Nature Conservation and Landscape Ecology, H-2103 Gödöllő, Hungary.*

<sup>2</sup> *Institute of Ecology and Botany of the Hungarian Academy of Sciences, H-2126 Vácrátót, Hungary.*

<sup>3</sup> *Szent István University, Department of Grassland Management, H-2103 Gödöllő, Hungary.*

Corresponding author: E-mail: hazijudit246@gmail.com

### Abstract

The effect of long-term mowing on the composition of secondary dry grasslands was studied in the Western Cserhát hills in Hungary. Our main aim was to develop an effective method which can facilitate the regeneration of grasslands. Here we report the results of a long-term mowing experiment designed to suppress the spread of *Calamagrostis epigeios*. In May 2001 we established permanent plots in the study area to understand if the dominant grass species of abandoned grassland fields can be suppressed by mowing. It was found that mowing was a useful management technique for modifying the botanical composition of the grassland to a composition that was better suited for agricultural use, in particular for grazing which could replace the costly and time-consuming hand-cutting. Mowing twice a year significantly affected the palatability of the herbage. Plant species richness and diversity increased continuously during the eight-year-long study.

Keywords: floristic composition, mowing, *Calamagrostis epigeios*, Shannon-diversity

### Introduction

Pastures were the traditional use for grasslands in the study area, as in other areas of in Hungary. The population of grazing livestock has dramatically reduced in the last twenty years, resulting in an increased shrub layer and grass species such as *Calamagrostis epigeios* spreading aggressively. This species is a tall growing, unpalatable grass which is not grazed by livestock. Grasslands infested by this grass are therefore not suitable for management as pastures. Creating and maintaining diverse grasslands remain a complex issue influenced by various abiotic and biotic factors. Frequent mowing was suggested as a potential management measure for improving and maintaining grassland biodiversity (Kramberger and Kaligarić, 2008). Other possibilities include grazing and burning (Ónodi *et al.*, 2008). Based on examples of studies in other countries, we have tried to introduce regular mowing to change the sward composition gradually and make it suitable for future grazing. Our main questions were as follows: Can the unpalatable *Calamagrostis epigeios* be suppressed by mowing? Are there possibilities to increase the diversity of sward by this?

### Materials and methods

The field experiment was conducted from 2001 to 2009 in a secondary dry grassland of the *Polygalo-Brachypodietum* plant community, near Vác in Northern Hungary (47° 47' 45" N, 19° 14' 13" E; 190 m a.s.l.). The study area is a vineyard that had been abandoned 30 to 35 years ago and used as a pasture thereafter. Due to the socio-economic changes between 1980 and 1990, grazing was terminated. The area represents a typical semi-natural, extensively managed hilly landscape. The area is 7.1 hectares with a north-eastern aspect and it is covered

by a mosaic of shrubby areas and open grasslands. We established an experiment with eight 3 m x 3 m plots, positioned randomly. The range of conditions of the observed environment was well represented by the eight plots. Vegetation data were monitored in 2 m x 2 m permanent quadrats, placed in the middle of each 3 m x 3 m plot. The treatment was mowing twice a year, in June and September of all years. As a control, eight unmanaged plots were established. Five and eight years after 2001 we sampled the plots in June, estimating the cover (as percent) of all plant species. Diversity changes were analysed using the Shannon-diversity (Pilou, 1975). The effects of mowing were tested using repeated-measure analyses of variance (ANOVA). For *post-hoc* test the TukeyHSD was used. Data were analysed by the R-statistical program (R Development Core Team, 2009).

## Results and discussion

At the start of the experiment (in May 2001) *Calamagrostis epigeios* was the dominant component of the forage with a cover of 64%, and the amount of legumes was 21%. The palatability index of the grassland was 1.6, according to evaluation method of Balázs (Balázs, 1960). After five years, i.e. by the spring of 2006, there was a considerable shift as *Calamagrostis epigeios* decreased to 17%; however, the cover of important legumes had not increased. By May 2009, the previously dominant *Calamagrostis epigeios* declined to 3% cover, which was at place seven in the dominance rank of the species. The most abundant species were legumes, e.g. *Dorycnium herbaceum* with 24%. The total cover of legumes was 37% in year 2009, which was significantly different from the value of 2001 ( $P < 0.001$ ). The palatability index of the grassland increased to 3.0. The average number of species was quite low compared to other grasslands in a good condition, which is 40-60 species per 4 m<sup>2</sup> (Bartha, 2007). At the beginning of the experiment the average number was 11.6 species per 4 m<sup>2</sup>. Species richness had increased with regular mowing to 25 species per 4 m<sup>2</sup> by June 2009. This change corresponds to findings in other studies (e.g. Kramberger and Kaligarić, 2008). The results of the repeated-measure analyses of variance (ANOVA) demonstrate that the mowing treatment was successful, with a significant ( $P < 0.001$ ) change of diversity. The TukeyHSD test (multiple comparison of means with 95% family-wise confidence) showed that only the 2001-2009 comparison was significant,  $P = 0.001$ . The *post-hoc* test showed a consistent trend of increase over time (Fig. 1).

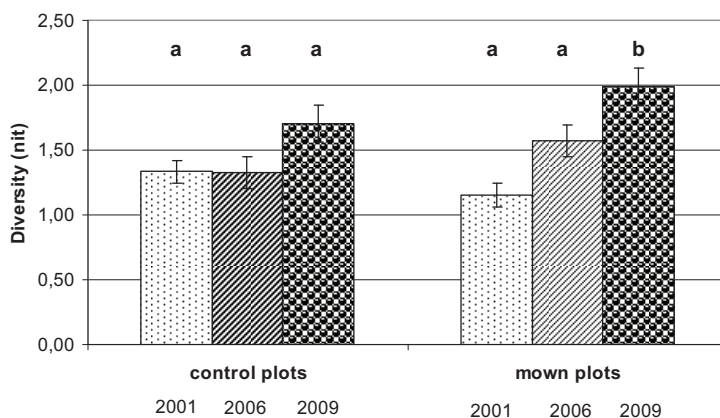

Figure 1. Shannon-diversity changes in the treated and control plots as a comparison of different years.

## Conclusions

We conclude that the five-year study was not long enough, as a significant difference was detected only over an eight-year time-scale. Mowing has significantly increased the palatability, the species richness and the diversity in the course of secondary succession. Therefore, mowing twice a year proved to be a successful management measure for controlling *Calamagrostis epigeios*. It also resulted in a sward composition that can provide herbage that is suitable for mowing as well as for grazing. The latter is particularly attractive as it could replace the costly and time-consuming hand-cutting.

## References

- Balázs F. (1960) Botanical and economical evaluation of grasslands. *Mezőgazdasági Kiadó, Keszthely* 8, 1-28.
- Bartha S. (2007) Composition, differentiation and dynamics in the forest steppe biome. In: Illyés E. and Bölöni J. (eds.): *Slope steppes, loess steppes and forest steppe meadows in Hungary*. Budapest, pp. 194-211.
- Kramberger B. and Kaligarić M. (2008) Semi-natural grasslands: the effect of cutting frequency on long-term changes of floristic composition. *Polish Journal of Ecology* 56, 33-43.
- Ónodi G., Kertész M., Botta-Dukát Z., and Altbäcker V. (2008) Grazing effects on vegetation composition and on spread of fire on open sand grasslands. *Arid Land Research and Management* 22, 273-285.
- Pielou E. C. (1975) *Ecological diversity*. Wiley, New York, 165pp.
- R Development Core Team (2009) *R: A language and environment for statistical computing*. R Foundation for Statistical Computing, Vienna, Austria. ISBN 3-900051-07-0, URL <http://www.R-project.org>.



# Agronomic characteristics of a lowland and a mountain hay meadow under different cutting regimes

Hofmann M., Kirschig J. and Riehl G.

Landesamt für Umwelt, Landwirtschaft und Geologie / Saxon State Agency for Environment, Agriculture and Geology, Christgruen 13, 08543 Poehl, Germany

Corresponding author: martina.hofmann@smul.sachsen.de

## Abstract

In this study, typical lowland hay meadows and mountain meadows are managed under agri-environmental scheme agreements according the time of the first cut and the cutting frequency as well as the nutrient management. Yield and forage quality under different agri-environmental schemes are compared to agronomic potential without management restrictions in these species-rich grasslands. Annual yields of dry matter obtained from species-rich grasslands managed under the restrictions to agri-environment schemes ranged from 51% to about 94% of the production that can be achieved under conventional management of these grasslands. Annual net energy lactation yields were 10-55% below those under conventional management for these grasslands, particularly in the very late first-cut treatment. These semi-natural grasslands, with low net energy content of the late-cut forage, will be difficult to integrate into livestock feeding systems.

Keywords: species rich grassland, agri-environment schemes, forage quality, dry matter yield

## Introduction

Agriculturally unimproved, species-rich grasslands can support a wide range of indigenous species of plants, invertebrates and birds, and thus have high nature conservation value. The future maintenance of these species-rich grasslands strongly depends upon continued extensive management. Whether grazed or cut, the herbage has to be usable as a feed for ruminant livestock (Tallowin and Jefferson, 1999) otherwise these grasslands will be increasingly marginalized or abandoned by farmers, even if a premium is paid. The objective of this paper is therefore to examine the range in productivity and forage quality of herbage harvested under management agreements of agri-environmental scheme and to assess the yield and net energy lactation loss compared to grassland managed without restrictions.

## Materials and methods

In 2008, three experiments were established to evaluate the current agri-environmental measures in grassland in Saxony, Germany. The agriculturally 'improved grassland' is located on grassland with an agronomic potential (phytosociological alliance: *Cynosurion cristati*; 420 m a.s.l.), the 'lowland hay meadow' is a species-rich, typical lowland hay meadow (phytosociological alliance: *Ranunculus repens-Alopecurus pratensis-Arrhenatheretalia*; Habitat Code 6510 under FFH Directive; 395 m a.s.l.) and the 'mountain hay meadow' is a species-rich, typical mountain hay meadow (phytosociological alliance: *Festuca rubra-Agrostis capillaris-Arrhenatheretalia*; Habitat Code 6520 under FFH Directive, 731 m a.s.l.).

Before installation of the different treatments, the lowland and the mountain hay meadows had been managed extensively over decades, with low organic N-input and utilized by a three- or two-cut regime, respectively. Therefore, these grasslands can be expected to be in an equilibrium situation. The improved grassland was established five years ago and had been

reseeded regularly, and therefore a non-equilibrium situation can be expected. In 2008, five different treatments were applied. The effects of four different agri-environmental measures will be compared with a conventional management (Table 1).

Table 1: Management of the five different treatments.

Treatments	Management
Reduced N input	3 cuts $y^{-1}$ , organic N 100 kg $ha^{-1} y^{-1}$
N after first cut	2 cuts $y^{-1}$ , first cut after 15th June, inorganic N 60 kg $ha^{-1} y^{-1}$ but no N fertilizer before the first cut
Late first cut	first cut after 15th June, 2 cuts $y^{-1}$ , no N fertilizer
Very late first cut	first cut after 15th July, 2 cuts $y^{-1}$ , no N fertilizer
Conventional	grassland utilized more or less intensively - at the lowland sites: 4 cuts $year^{-1}$ , inorganic N 180 kg $ha^{-1} y^{-1}$ , at the mountain site: 3 cuts $year^{-1}$ , inorganic N 100 kg $ha^{-1} y^{-1}$

Each treatment is replicated four times. In this paper the results of the first two years of an ongoing project will be shown. Herbage is harvested with a finger-bar mower at a cutting height of 5 cm on 24 m<sup>2</sup> plots and fresh weight is assessed immediately. Sub-samples are taken for assessment of DM content and forage quality. The dried material is analysed for forage quality. Net energy for lactation (NEL) content is calculated on the basis of acid detergent fibre concentration of organic matter, enzyme soluble organic matter, crude fat and crude ash using the regression equation of GfE (2008) for NEL concentration. In 2008, at the start of the project, the botanical composition was determined. In 2013, at the end of the project the development of vegetation under the different treatments will be assessed.

Table 2. Botanical characteristics of an improved grassland, a lowland hay meadow and a mountain hay meadow at the start of the experiments (mean of all treatments).

	Improved grassland	Lowland hay meadow	Mountain hay meadow
Species number/plot (24 m <sup>2</sup> )	14.2	20.3	24.8
Dominating species	<i>Festuca pratensis</i> , <i>Lolium perenne</i>	<i>Alopecurus pratensis</i> , <i>Festuca rubra</i> , <i>Holcus lanatus</i>	<i>Agrostis capillaris</i> , <i>Festuca rubra</i> , <i>Dactylis glomerata</i>
Percentage in dry matter			
- grasses	95.9	71.6	73.1
- legumes	1.2	1.0	5.6
- other forbs	1.7	27.2	19.4

## Results and discussion

Botanical characteristics as assessed at the start of the experiments varied between the three grasslands (Table 2). On average, across all treatments, annual dry matter yield was higher in the lowland hay meadow than the mountain hay meadow and highest in the improved grassland (Table 3). The impact of management agreements due to the agri-environment schemes on reduction of dry matter yield was more pronounced on the species-rich lowland hay meadow, with up to 49% yield reduction relative to the improved grassland, and with up to 39% yield reduction in each case compared to the conventional management. This might be caused, on the one hand, by the different management background and after-effects on the experimental sites with higher fertilizer inputs before start of the experiment and regular oversowing of ryegrass (*Lolium perenne*) and white clover (*Trifolium repens*) seeds on the improved grassland and, on the other hand, by the different vegetation composition. On the mountain hay meadow, the management restrictions had less impact on the dry matter yield and resulted in up to 17% reduction compared to the conventional management. Surprisingly,

on the mountain meadow the yields were even slightly higher in both treatments with delayed first cut compared to the lowland meadow.

The annual NEL output in the conventional treatments reached 64, 48 and 39 GJ ha<sup>-1</sup> in the improved grassland, lowland hay meadow and mountain hay meadow, respectively (Table 3). At all experimental sites, the reductions of annual energy output due to agri-environmental agreements were higher than the dry matter yield reduction. As expected, the forage quality (NEL in DM) in the first cut was highest in the conventional treatments with 6.3, 6.0 and 5.6 MJ kg<sup>-1</sup> in the improved grassland, lowland hay meadow and mountain hay meadow, respectively. The reduction in energy concentration due to the delayed cut was less pronounced in the lowland hay meadow compared to the improved grassland. Reasons for this might be the higher proportion of forbs in the species-rich sward and the fact that digestibility – and consequently energy value – of dicots falls more slowly than that of grasses. This forage harvested in the treatments with restrictions due to agri-environmental schemes is insufficient to meet the need of dairy cows during lactation, but with the exception of the forage harvested in the much delayed first cut would be sufficient for heifers or non-pregnant cows. Forage harvested later than mid June would also make hay made from this herbage unsuitable as a sole feed for highly productive animals, particularly as further losses in NEL value could be expected during hay making. In the second cut, the NEL concentration in DM of the treatments with a delayed first cut, reaches 5 MJ kg<sup>-1</sup> or higher. But as the second cut has only a proportion of less than 20 % of the total annual energy output in the delayed cut treatment, this effect is, from a nutritional point of view, quite small.

Table 3. Annual dry matter (DM) yield and energy yield (NEL) and concentration (means of 2008 und 2009) of an improved grassland, a lowland hay meadow and a mountain hay meadow under five different treatments.

Treatments	Improved grassland			Lowland hay meadow			Mountain hay meadow		
	DM yield (kg ha <sup>-1</sup> y <sup>-1</sup> )	NEL (GJ ha <sup>-1</sup> )	NEL in DM (MJ kg <sup>-1</sup> )	DM yield (kg ha <sup>-1</sup> y <sup>-1</sup> )	NEL (GJ ha <sup>-1</sup> )	NEL in DM (MJ kg <sup>-1</sup> )	DM yield (kg ha <sup>-1</sup> y <sup>-1</sup> )	NEL (GJ ha <sup>-1</sup> )	NEL in DM (MJ kg <sup>-1</sup> )
Reduced N-input	8744	49.7	5.5	7334	38.7	5.1	6425	36.4	5.5
N after first cut	8827	42.4	4.6	6069	29.9	5.1	6694	34.0	5.1
Late first cut	8060	39.4	4.8	4949	25.7	5.4	5620	32.1	5.1
Very late first cut	6511	31.3	4.3	4493	21.4	4.8	5606	27.4	4.8
Conventional	10717	63.7	6.3	8858	48.1	6.0	6730	38.6	5.6

## Conclusion

Yields of dry matter obtained from species-rich grasslands managed under agreements of agri-environment schemes ranged from 51% to about 94% of the production that can be expected under conventional management of these grasslands. The losses in annual energy output exceed 55% under some agreements. These losses can be compensated by a financial payment, provided for in the agri-environmental scheme of the European Union. However, even with the granting of a premium which would compensate the income loss, these forages must be able to be integrated into livestock feeding systems. This will be particularly difficult to achieve with the delayed cut forage harvested in July or later.

## References

- GfE (2008) New equations for predicting metabolisable energy of grass and maize products for ruminants. Committee for Requirement Standards of the Society of Nutrition Physiology. *Proceedings of the Society of Nutrition Physiology* 17, 191-198.
- Tallowin J.R.B. and Jefferson R.G. (1999) Hay production from lowland semi-natural grasslands: a review of implications for ruminant livestock systems. *Grass and Forage Science* 54, 99-115.

# The effect of different grazing systems on botanical composition, diversity and productivity of permanent pasture

Kobes M., Suchý K., Voženilková B. and Frelich J.

University of South Bohemia, Faculty of Agriculture, Dept of Plant Production and Agroecology, Czech Republic

Corresponding author: kobes@zf.jcu.cz

## Abstract

Two types of grazing systems are common in the Czech Republic: continuous grazing and rotational grazing with 2 – 4 grazing cycles from May to October. The effect of the two grazing systems on botanical composition, sward type, plant species diversity and production of a *Festuceto-Trisetetum* (*Cynosurion* alliance) pasture sward was examined at an altitude of 650 m a.s.l. from 2000 – 2008 in South Bohemia. A differentiation of *Festuceto-Trisetetum* to *Festuceto-Dactylidetum*, *Dactylideto-Agrostidetum* and *Poaetum* swards was observed for rotational and continuous grazing. Rotational grazing with a lower frequency (2 grazing cycles) increased the dominance of grasses, while the higher grazing frequency (4 grazing cycles) as well as continuous grazing increased the dominance of herbs. The highest species diversity (Simpson's index – D) was observed under rotational grazing with three grazing cycles ( $D > 12.80$ ). Higher biomass production ( $P < 0.01$ ) was recorded for rotational than for continuous grazing.

Keywords: pasture systems; continuous grazing; rotational grazing; botanical composition; species diversity; biomass production

## Introduction

Two types of grazing systems prevail in the use of grasslands for grazing in the Czech Republic – continuous grazing, and rotational grazing with 2 – 4 grazing cycles per year. The botanical composition of the pasture swards, the species richness, species diversity and productivity are affected by the grazing system and the intensity of grazing. Extensive grazing in a rotational system leads to a greater proportion of tall grass species, foliage area and crop yield as compared to continuous grazing with a high stocking rate. An optimal stocking rate and pasture exploitation increase the rate of non-climbing legumes (Klimeš *et al.*, 2006) and herbs with a high feeding value. A high intensity of pasture exploitation is associated with lower species diversity (Hofmann *et al.*, 2006). The sward species richness can increase with increasing altitude, where tall grasses (Pappas and Koukoura, 2006) and herbs represent stable parts of the communities. The aim of this study is to assess the effect of various grazing systems on the species richness, the diversity and productivity of the pasture sward.

## Material and methods

The influence of different pasture systems on species richness, species diversity and productivity was studied from 2000 – 2008 in a permanent pasture in the Šumava foothills (South Bohemia, Kaplice – Velký Chuchelec, 650 m a.s.l.). At the beginning of the study in 1999 the vegetation appertained to the *Cynosurion* alliance with dominant species of *Dactylis glomerata* L., *Trisetum flavescens* L. and *Festuca pratensis* Huds. The site was originally grazed by a rotational strip grazing system 2-3 times per year. Since 2000 three grazing systems have been applied: Rotational strip grazing with either 2, 3, or 4 grazing cycles per year (stocking rates 0.6, 1.2 and 1.8 LU ha<sup>-1</sup>), combined exploitation – mowing 1x and

grazing 1x, and continuous grazing throughout the grazing period (2.5 LU ha<sup>-1</sup>, May – October). The single plot area was 30 m<sup>2</sup> and each treatment had four replications (i.e. 120 m<sup>2</sup> per treatment). Fixed and mobile fences were used to arrange the rotational strip grazing and combined exploitation treatments. The area surrounding the strip rotational system was used for the continuous grazing treatment where the referring plots were located. A cattle herd of Charolais breed was used for the grazing trial. For the rotational strip grazing and the combined exploitation treatments several grazing animals were separated from the herd for the time of grazing on the plots. The botanical composition, the sward type, the number of species (species richness – S), species diversity (Simpson index – D;  $D = 1/\sum p_i^2$ ) and biomass (dry matter) production were measured in each grazing cycle before grazing. In continuously grazed plots herbage yield was measured by the use of enclosure cages (2 m<sup>2</sup>). Data were statistically analysed using ANOVA and LSD test for *post-hoc* comparison of mean values applying the STATISTICA software package.

Table 1. Experimental treatments (grazing system and intensity – number of grazing cycles) and total numbers of vascular plant species (S - alpha diversity, per 30 m<sup>2</sup>).

Variant of grazing	Year, total number of species (S)					
	2000	2002	2004	2006	2008	Mean <sub>00-08</sub>
Rotational strip, 2x	26	28	30	29	26	27.0 <sup>b</sup>
Rotational strip, 3x	26	26	24	29	25	26.0 <sup>b</sup>
Rotational strip, 4x	25	28	27	25	24	25.3 <sup>b</sup>
Continuous grazing	26	24	21	20	20	22.1 <sup>c</sup>
Mowing 1x + grazing 1x	27	32	29	28	28	29.2 <sup>a</sup>

Treatments: F = 16.59\*\*\*,  $P < 0.001$ ; Years: F = 1.08 ns,  $P > 0.05$

## Results and discussion

In response to the different pasture systems and grazing intensities, the sward composition developed from two stand associations originally (*Festuceto-Trisetum* and *Dactylidetum*) to three associations: *Festuceto-Dactylidetum* (rotational grazing 2x per year and mowing 1x + grazing 1x), *Dactylideto-Agrostidetum* (rotational grazing 3x) and *Poaetum* (rotational grazing 4x and continuous grazing). When a combined system of mowing and grazing was used as well as under lower grazing intensities (rotational grazing 2x per year), the swards contained tall, tussock forming/tall loosely clumped grasses (*Festuca pratensis*, *Dactylis glomerata*, *Trisetum flavescens*, *Phleum pratense* L.). Higher grazing intensity (rotational grazing 3x and 4x per year) and continuous grazing increased the abundance of *Lolium perenne* L., *Poa pratensis* L., *Agrostis capillaris* L. and of the herbs (*Plantago lanceolata* L., *Leontodon autumnale* L. and *Taraxacum* sect. *Ruderalia* Kirschner). The number of vascular plant species (S) increased under lower management intensities (mowing 1x + grazing 1x, rotational strip grazing 2x) but decreased under continuous grazing (Table 1). Simpson's index of species diversity was lower under continuous grazing ( $D = 10.3$ ; Table 2) than under rotational strip grazing. Preferred (more palatable) plant species and species non-resistant to trampling (*Trisetum flavescens*, *Agrostis stolonifera* L., *Ranunculus acris* L., *Lathyrus pratensis* L., *Vicia cracca* L. etc.) disappeared from the sward under continuous grazing. High management intensity favoured the development of short swards with a high proportion of herbs with leaf rosettes, whereas the lower intensity of pasture exploitation (rotational system 2x per year, combined system mowing and grazing) had a significantly higher biomass production ( $P < 0.01$ ) (Table 3). A higher species richness of non-fertilized pastures compared to unfertilized mown grasslands was also reported by Farruggia *et al.* (2008) in the French Massif Central. At stocking rates of 1.0 and 0.7 LU ha<sup>-1</sup> the authors found an increased potential for a medium-to-high species richness of the pasture swards.

Table 2. Simpson's index of species diversity (D) in relation to grazing treatment and time.

Grazing treatment	Simpson's index (D) in different years					
	2000	2002	2004	2006	2008	Mean <sub>00-08</sub>
Rotational strip, 2x	9.3	9.9	12.3	12.3	11.7	11.1 <sup>bc</sup>
Rotational strip, 3x	9.9	12.9	13.6	13.1	13.0	12.8 <sup>a</sup>
Rotational strip, 4x	9.9	10.3	13.7	11.6	11.8	11.4 <sup>b</sup>
Continuous grazing	9.2	11.9	11.8	10.5	9.1	10.3 <sup>c</sup>
Mowing 1x + grazing 1x	9.3	8.9	11.1	12.6	11.6	10.9 <sup>bc</sup>

Treatments:  $F = 8.02^{***}$ ,  $P < 0.001$ ; Years:  $F = 3.54^{**}$ ,  $P < 0.01$

Table 3. Dry matter production in relation to grazing treatment and time. Values indicated by the same character are not significantly different ( $P_{0.05}$ ).

Variant of Grazing	Dry matter yield (t ha <sup>-1</sup> ) in different years									
	00	01	02	03	04	05	06	07	08	$\bar{x}_{00-08}$
Rotational 2x	6.91	6.45	5.12	6.76	9.87	7.65	7.24	7.12	7.03	7.13 <sup>a</sup>
Rotational 3x	6.85	5.72	5.22	4.22	6.70	6.75	6.59	5.61	5.46	5.90 <sup>b</sup>
Rotational 4x	8.10	5.85	4.38	3.75	7.01	7.15	5.91	4.43	4.51	5.68 <sup>b</sup>
Continuous	6.91	5.65	4.45	3.81	7.20	6.61	5.98	4.21	3.98	5.42 <sup>b</sup>
Mow. 1x grazing 1x	7.72	7.04	5.66	6.37	9.09	7.99	10.11	8.56	8.43	7.89 <sup>a</sup>
Mean	7.30	6.14	4.97	4.98	7.97	7.23	7.17	5.99	5.88	6.40

Treatments:  $F = 12.35^{**}$ ,  $P < 0.01$ ; Years:  $F = 9.78^{***}$ ,  $P < 0.001$

## Conclusion

The results of this investigation confirm that rotational grazing with three grazing cycles per year proved to be a suitable pasture system to improve the species richness and diversity of *Lolio-Cynosuretum* grasslands under organic farming conditions in central Europe at altitudes of 450 – 800 m a.s.l. Considerably high values of species richness, together with a high biomass production, are achieved under exploitation combining mowing once a year with one cycle of grazing. In contrast, continuous grazing appeared to be a less suitable management system as it leads to decreased species richness and diversity, as well as decreased biomass production.

## Acknowledgements

This work was supported by Project No. MSM 6007665806, and by the the MZ CR, Project QH 81280.

## References

- Farrugia A., Dumont B., Jouven M., Baumont R. and Loiseau P. (2008) Specific and functional diversity of vegetation in three beef cattle farms of the French Massif Central. *Grassland Science in Europe* 13, 96-98.
- Hofmann M., Sahin N. and Isselstein J. (2006) The effect of grazing intensity across spatial scales of plant species richness. *Grassland Science in Europe* 11, 502-504.
- Klimeš F., Kobes M., Voženilková B., Květ J. and Suchý K. (2006) Influence of management on the representation of legumes in permanent grasslands. *Grassland Science in Europe* 11, 288-290.
- Pappas I. and Koukoura Z. (2006) Effects of grazing diversity along altitude gradient. *Grassland Science in Europe* 11, 673-675.

## The impact of *Deschampsia caespitosa* (L.) P. Beauv (tufted hairgrass) on the floristic composition of meadow communities

Kryszak A., Strychalska A., Kryszak J. and Klarzyńska A.

Poznań University of Life Sciences (PULS), Department of Grassland and Natural Landscape Sciences, Wojska Polskiego 38/42, 60-627 Poznań, Poland

Corresponding author: akryszak@up.poznan.pl

### Abstract

The impact of *Deschampsia caespitosa* (tufted hairgrass) on the floristic composition of meadow communities was investigated. Based on a phytosociological survey with some 2500 samples the relationship of the occurrence of tufted hairgrass with (1) the proportion of synanthropic species, including annuals (therophytes), (2) the number of plant species, and (3) the floristic diversity was analysed. The results revealed that increased proportions of tufted hairgrass in meadow swards were negatively related to the nature value (sward botanical composition, diversity) of the plant communities of the *Phragmitetea* class and *Molinietalia* order.

Key words: *Deschampsia caespitosa*, meadow communities, floristic diversity

### Introduction

Grasslands with a history of intensive management that have nowadays become extensified with infrequent defoliations and irregular maintenance measures often show considerable changes in their sward botanical composition. Such transformations can be attributed, in particular, to the occurrence of plant species that exert a strong competitive effect on other species. The competitive species increase their proportions in the sward at the expense of taxa of narrower ecological amplitude, leading to a dramatic impoverishment of the flora including a simplification of the phytocenotic structure (Bush and Barrett, 1993; Rejmánek, 2000; Kryszak *et al.*, 2009). An example of a species that exerts a negative impact on the sward botanical composition of meadow communities is *Deschampsia caespitosa* (tufted hairgrass). The objective of the present study was to evaluate the effect of the occurrence of tufted hairgrass in meadow communities on their floristic diversity and, related to this, on the nature value and agricultural value of the grasslands.

### Materials and methods

The behaviour of tufted hair-grass in meadow communities was analysed based on a comparison of long-term results of floristic investigations. Phytosociological surveys of plant communities were taken using the Braun-Blanquet method; botanical relevés were done on 75 to 100 m<sup>2</sup> plots. In total, some 2500 relevés were included in the analysis. They were divided into two equal groups differing in the percentage of *Deschampsia caespitosa* in the sward. Each group consisted of about 150 samples. The following attributes were analysed: the mean species number relevé, the share of synanthropic plants, and the proportion of plant life forms according to Raunkiaer. The impact of the *D. caespitosa* proportions on changes in the nature value and sward fodder value were determined on the basis of: (1) nature value index defined by Oświt (2000) and (2) fodder value score defined by Filipek (1973). In this method '10' refers to an exceptionally high nature value or high-quality fodder.



## Results

Results of the analysis show that an increased percentage of tufted hairgrass was found in the swards on less fertile grasslands. At the same time, together with changes in proportions of tufted hairgrass, changes were observed in the share of synanthropic species of meadow plants, particularly annuals, in meadow communities (Table 1).

Table 1. Characterization of the meadow plant communities including the occurrence of *Deschampsia caespitosa* (Dc).

Plant community	Cover of plants (%)	Share of Dc (%)	Number plant species/relevé	Plant species (%)		*H'
				Synanthropic	terophytes	
<i>Phalaridetum arundinaceae</i>	96.0	0.5	11.6	57.9	7.5	1.58
	75.5	26.5	19.0	73.1	11.5	1.83
<i>Glycerietum maximae</i>	98.3	0.1	7.4	46.7	7.0	1.55
	84.9	5.1	12.2	65.7	8.2	1.77
Mean for <i>Phragmitetea</i>	97.2	0.3	9.5	52.3	7.3	1.57
	80.2	15.8	15.6	69.4	9.9	1.80
<i>Alopecuretum pratensis</i>	95.0	0.2	29.0	59.0	12.5	3.72
	79.5	37.5	20.4	78.0	9.0	3.59
<i>Molinietum coeruleae</i>	92.4	0.5	32.2	56.7	3.8	1.66
	71.3	17.3	25.5	68.2	2.6	1.59
Community <i>Deschampsia caespitosa</i>	89.3	22.1	24.8	62.2	6.3	1.90
	63.0	61.4	19.1	86.7	4.2	1.32
Mean for <i>Molinietalia</i>	92.2	7.6	28.7	59.3	7.5	2.43
	71.3	38.7	21.7	77.6	3.9	2.17
<i>Lolio-Cynosuretum</i>	99.2	0.1	27.5	66.5	9.3	2.62
	90.0	9.6	20.3	78.1	7.1	1.38
<i>Arrhenatheretum elatioris</i>	97.8	0.5	30.2	61.8	7.5	2.84
	76.5	21.1	27.0	83.3	5.7	1.53
Community <i>Poa pratensis-Festuca rubra</i>	98.0	1.3	22.7	55.9	8.5	1.94
	81.9	12.9	17.6	76.1	3.8	1.61
Mean for <i>Arrhenatheretalia</i>	98.3	0.8	26.6	61.4	8.4	2.47
	82.8	14.5	21.6	79.2	5.5	1.51

\*H' – Shannon-Wiener's floristic diversity index

Most significant changes of the vegetation in relation to an increased occurrence of *D. caespitosa* were observed in the *Phragmitetea* class and the *Molinietalia* order. Proportions of synanthropic species in swards of these communities reached the level of about 30%. However, the presence of *Deschampsia caespitosa* in the swards of the *Phragmitetea* class communities was related to an increased floristic diversity. This was obviously due to plant species of wider ecological scale, regarding the moisture availability, which increasingly invaded the swards. On the other hand, increased proportions of *D. caespitosa* in the sward of the *Molinietalia* order communities were accompanied by a reduced (by about 15%) floristic diversity. This was obviously due to competitive exclusion of subdominant species by tufted hairgrass. Among these are taxa that are sometimes very rare, such as *Dactylorhiza sp.*, *Dianthus superbus*, *Iris sybirica*, *Cirsium rivulare*. As a consequence, the nature conservation value of the meadow communities is deteriorating. In addition, the increase of *Deschampsia caespitosa* also affects agriculturally valuable grasses that are displaced from the swards. This is causing a decrease in the fodder value, ranging from 14% for the *Phragmitetea* class communities up to 35% for the *Molinietalia* order communities (Table 2).

The success of *D. caespitosa* and the related changes in sward structure and botanical composition has been attributed to major changes of the soil conditions, such as soil moisture, the soil nutrient availability and the soil reaction (Tomaszewska and Wojciechowska, 2006; Kryszak *et al.*, 2009). In addition, Kryszak *et al.* (2007) state that, apart from site conditions,

the occurrence of *D. caespitosa* in the swards is also affected by improper and irregular utilisation. Such practices result in the withdrawal of many plant species from the swards, thereby leaving space for the expansion of tufted hairgrass and contributing to the reduction of the floristic diversity of meadow phytocenoses.

Table 2. Impact of the *Deschampsia caespitosa* (*Dc*) occurrence on sward nature and fodder values of selected meadow communities.

Plant community	Share <i>Dc</i> of the sward (%)	Nature value		Fodder value score (FVS)
		Index	Category	
<i>Phalaridetum arundinaceae</i>	0.5	3.8	large	6.4
	26.5	3.4	moderately large	5.9
<i>Glycerietum maximae</i>	0.1	3.6	large	4.3
	5.1	3.1	moderately large	3.3
Mean for <i>Phragmitetea</i>	0.3	3.7	large	5.3
	15.8	3.2	moderately large	4.6
<i>Alopecuretum pratensis</i>	0.2	2.8	average moderate	7.3
	37.5	2.5	moderately	4.7
<i>Molinietum coeruleae</i>	0.5	3.9	very large	5.1
	17.3	3.2	moderately large	3.0
Community <i>Deschampsia caespitosa</i>	22.1	2.0	small	4.6
	61.4	1.3	very small	3.3
Mean for <i>Molinietalia</i>	7.6	2.9	average moderate	5.7
	38.7	2.3	moderate	3.7
<i>Lolio-Cynosuretum</i>	0.1	2.5	moderate	7.1
	9.6	2.1	small	6.3
<i>Arrhenatheretum elatioris</i>	0.5	3.3	average large	7.0
	21.1	2.1	small	6.6
Community <i>Poa pratensis-Festuca rubra</i>	1.3	2.3	moderate	7.0
	12.9	1.7	average small	4.7
Mean for <i>Arrhenatheretalia</i>	0.8	2.7	average moderate	7.0
	14.5	2.0	small	5.9

## Conclusion

*Deschampsia caespitosa* is a good example of the effects of aggressive plant species invading meadow communities. Accompanied synanthropic species increase while subdominant species typical for these communities decrease and the floristic diversity is reduced.

## References

- Bush E. and Barrett S.C.H. (1993) Genetics of mine invasions by *Deschampsia caespitosa* (Poaceae). *Canadian Journal of Botany* 71, 1336-1348.
- Filipek M. (1973) Projekt klasyfikacji roślin łąkowych i pastwiskowych na podstawie liczb wartości użytkowej. *Postępy Nauk Rolniczych* 4, 59-68.
- Kryszak A., Kryszak J., Grynia M. and Czemko M. (2007) *Deschampsia caespitosa* (Poaceae) in the sward of meadow-pasture communities in the Wielkopolska. *Fragmenta Floristica et Geobotanica Polonica* 9, 73-82.
- Kryszak A., Kryszak J., Klarzyńska A. and Strychalska A. (2009) Influence of expansiveness of select plant species on floristic diversity of meadow communities. *Polish Journal of Environmental Studies* 18, (6), 1203-1210.
- Oświt J. (2000) *Metoda przyrodniczej waloryzacji mokradel i wyniki jej zastosowania na wybranych obiektach*. Wydawnictwo IMUZ. Materiały Informacyjne, 35 pp.
- Rejmánek M. (2000) Invasive plants: approaches and predictions. *Australian Ecology* 25, 497-506.
- Tomaszewska M. and Wojciechowska A. (2006) *Deschampsia caespitosa* (L.) P. BEAUV. as invasion species. *Proceedings of the 7<sup>th</sup> All-Polish Scientific Meeting 'Grass biology'*, W. Szafer Institute of Botany, Cracow, p. 26.

# Effect of cutting frequency of a meadow sward on the bulk density of a peat-muck soil

Kulik M.

*Department of Grassland and Landscape Forming, University of Life Sciences in Lublin, 20-950 Lublin, Poland*

Corresponding author: mariusz.kulik@up.lublin.pl

## Abstract

In recent years, grassland in Poland has been increasingly abandoned from agricultural use. This has been connected with a decrease in Poland's livestock density which, in consequence, has decreased the demand for forage from grasslands. Abandonment of meadows, in post-boggy habitats in particular, results in changes of plant species composition and in the physicochemical characteristics of the soil. Studies were carried out in 2006-2009 in a peatland complex in Sosnowica (the Wieprz-Krzna Canal area in eastern Poland). In 1964-1966, the fen had been drained and the reclaimed land was put to agricultural use. At present, the soils of this grassland complex belong to the muck soil type and peat-muck soil subtype (Mt II). The soil of utilized meadows was characterized by a lower bulk density in comparison with abandoned ones. The largest changes in the bulk density of soil were observed on abandoned grassland. Maintaining the utilization of meadows is an appropriate method of preventing the degradation of this ecosystem.

Keywords: bulk density, meadow use, peat-muck soil

## Introduction

Peatlands play a significant role in the regulation of greenhouse gas emissions and the global climate. The organic matter of peat is used in horticulture, floriculture and forestry as well as in agriculture. Unfortunately, in most regions of the world, peatlands have been irretrievably degraded. This unfavourable phenomenon has particularly affected post-boggy habitats that developed as a result of the drainage and cultivation of peatlands. Intensive agriculture has led to a number of effects including the lowering of the groundwater table, as well as changes in plant communities and the physicochemical properties of soil. Changes in organic soils caused by the mineralization process particularly affect the content of organic matter, water capacity and bulk density (Okruszko, 1976; Szuniewicz, 1994). Texture and structure of a soil are closely related to its bulk density. The soil structure can be modified by applying various soil management practices including aeration, tillage or drainage. The subsequent changes of the physical, chemical and hydraulic properties initiated by land amelioration for agricultural purposes are also intensified by grassland abandonment (Kulik *et al.*, 2007). The aim of the study reported in this paper was to determine the changes in the bulk density of peat-muck soil depending on the frequency or lack of meadow utilization in post-boggy habitats.

## Materials and methods

The study was carried out in 2006-2009 in a peatland area in Sosnowica (the Wieprz-Krzna Channel area in eastern Poland). In 1964-1966, the fen had been drained and the reclaimed land was put to agricultural use. At present, the soils of this grassland area mostly belong to the muck soil type and the peat-muck soil subtype (Mt II). This region extends over a wide area on both sides of the River Piwonia, along its middle course. It is part of Parczewskie Forests, a Natura 2000 site (Birds Directive). The bulk density of soil in the particular soil

layers (5-10 cm; 15-20 cm) and the differing frequencies of meadow utilization were determined (Table 1). Bulk density was measured in 4 replications by using a cylindrical steel core with a volume of 105 cm<sup>3</sup>. Samples were dried at 105°C. Results were analyzed statistically using Statistical Analysis System (SAS ver. 9.2) by means of Tukey's Honestly Significant Difference (HSD).

Table 1. Frequency of utilization and characteristics of the investigated meadows

Site no.	Frequency of utilization	Characteristics
0	A	degraded meadow with a predominance of <i>Deschampsia caespitosa</i> near the River Piwonia – abandoned for 13 years
	B	meadow with the succession of shrubby and arborescent vegetation of the genus <i>Salix</i> sp. and <i>Betula</i> sp.– abandoned for about 20 years
	C	meadow abandoned for 5 years, earlier used as a 2-cut meadow
1	A	without fertilization – used for 5 years, earlier used as a 2-cut meadow
	B	fertilization (N – 30; P – 26; K 75 kg ha <sup>-1</sup> yr <sup>-1</sup> ) – used for 5 years, earlier used as a 2-cut meadow
2	A	(N – 30; P – 26; K - 75 kg ha <sup>-1</sup> yr <sup>-1</sup> ) – used as a 2-cut meadow for over 25 years
	B	(N – 60; P – 26; K - 75 kg ha <sup>-1</sup> yr <sup>-1</sup> ) – used as a 2-cut meadow for over 25 years
3	A	(N – 60; P – 26; K - 75 kg ha <sup>-1</sup> yr <sup>-1</sup> ) – used for 5 years, earlier used as a 2-cut meadow
	B	(N – 90; P – 26; K - 75 kg ha <sup>-1</sup> yr <sup>-1</sup> ) – used for 5 years, earlier used as a 2-cut meadow

## Results and discussion

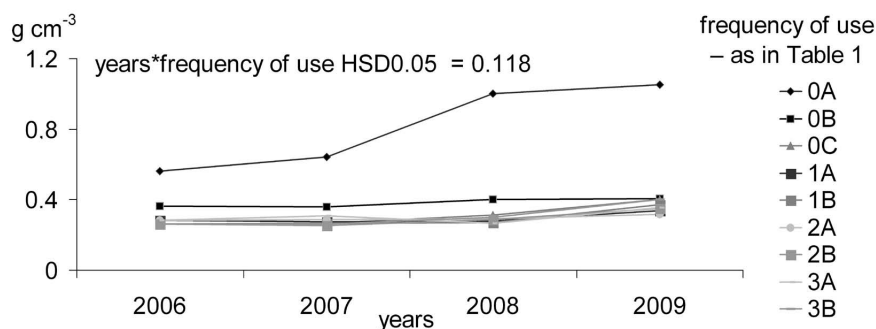

Figure 1. Bulk density of soil depending on frequency of utilization in 2006-2009

The results of this study indicate that the bulk density of peat-muck soil was increasing significantly over the consecutive years of the study. Compared to 2006 and 2007, the most significant differences in the soil were observed in 2008 and 2009 (Fig. 2). Great changes in bulk density in comparison with values averaged over years could be caused by lower precipitation (9-30%) as well as higher mean temperatures (15%) in 2007 and 2008. The increasing bulk density and disappearance of organic matter indicate the transformation of organic soils into mineral soil (Bieniek and Grabowski, 2007). The greatest changes were observed in the soil of the abandoned meadow (0A), which showed the highest bulk density of all treatments in 2009 (0.56 – 1.05 g cm<sup>-3</sup>; Fig. 1). Furthermore, a low groundwater level and indicator species of mineralization of organic matter such as *Linaria vulgaris* and *Urtica dioica* were observed in that meadow (Okruszko, 1976). The interaction between years and frequency of utilization was significant. Bulk density values of peat soils from various undisturbed and drained areas worldwide ranged from 0.04 to 0.4 g cm<sup>-3</sup> (Brandyk *et al.*, 2003). The soil of the meadow that remained abandoned for a long time was characterized by

a significantly higher bulk density (0A – 0.81; 0B – 0.38 g cm<sup>-3</sup>) in comparison with the other sites. The significantly lower values determined for the abandoned meadow (0B) in comparison to 0A might be caused by a higher groundwater table that limits bulk density increase. Maintaining the agricultural use of meadows is obviously an effective method to prevent the degradation that ecosystem (Warda, 2004; Kulik *et al.*, 2007).

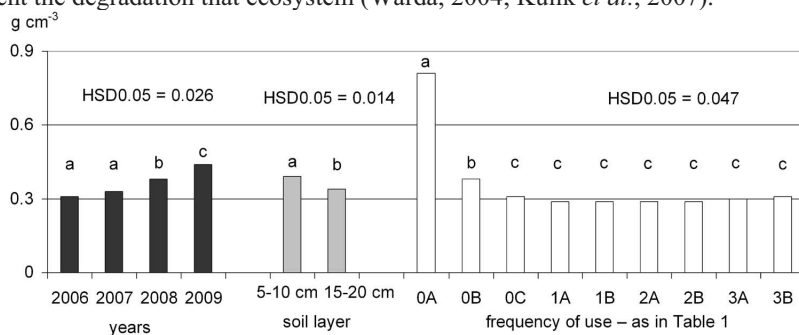

Figure 2. Mean bulk density (g cm<sup>-3</sup>) of soil depending on various factors under study

There were no significant differences among other methods of use but the lowest bulk density occurred in the soil of 1-cut and 2-cut meadows (Fig. 2). The soil layer at the depth of 5-10 cm was characterized by a significantly higher bulk density (0.39 g cm<sup>-3</sup>) than the deeper layer (0.34 g cm<sup>-3</sup>). The upper stratum of organic soils is characterized by a higher bulk density (Okruszko, 1976; Szuniewicz, 1994; Schwärzel *et al.*, 2002; Kulik *et al.*, 2007).

## Conclusion

The main conclusion of this study is that the maintenance of agricultural utilization of meadows is an appropriate method of preventing the degradation of the peat soil grasslands. The soil of irregularly used meadows is characterized by a lower bulk density in comparison with the soil of meadows abandoned from agricultural use for a long time. On abandoned grassland, the groundwater-table could be an important factor. The lowest value was observed in 1-cut and 2-cut meadows. These could be the best methods of using post-boggy habitats. The upper stratum of organic soils is characterized by a higher bulk density.

## Acknowledgements

This research is funded by a grant from the Polish Ministry of Science in 2007-2010

## References

- Bieniek A. and Grabowski K. (2007) The effects of mucky soil evolution in the outwash landscape as exemplified by the Gluch complex. *Soil Science Annual* 58, Issue 1-2, 5-11.
- Brandyk T., Szatyłowicz J., Oleszczuk R. and Gnatowski T. (2003) Water-related physical attributes of organic soils. In: Ilnicki P. (ed.) *Organic soils and peat materials for sustainable agriculture*, CRC Press LLC, pp.33-66.
- Kulik M., Baryła R. and Warda M. (2007) The effect of grassland utilisation way on physicochemical properties of peat–muck soils and species composition of sward. *Agronomy Research* 5 (2), 147-154.
- Okruszko H. (1976) The effect of the water melioration on organic soils in Poland. *Zeszyty Problemowe Postępów Nauk Rolniczych* 177, 159-204.
- Schwärzel K., Renger M., Sauerbrey R. and Wessolek G. (2002) Soil physical characteristics of peat soils. *Journal of Plant Nutrition and Soil Science* 165, 479-486.
- Szuniewicz J. (1994) Characteristics of prognostic soil-moisture complexes in terms of parameters of melioration system. *Biblioteczka Wiadomości IMUZ* 84, 35-57.
- Warda M. (2004) The effect of sward type on the content of organic matter in a peat-muck soil. *Grassland Science in Europe* 9, 151-153.

# Protecting Aquatic Warblers (*Acrocephalus paludicola*) through a landscape-scale solution for the management of fen peat meadows in Poland

Lachmann L.<sup>1,2</sup>, Marczakiewicz P.<sup>3,2</sup> and Grzywaczewski G.<sup>4</sup>

<sup>1</sup> Royal Society for the Protection of Birds (RSPB), The Lodge, SG19 2DL Sandy, Bedfordshire, United Kingdom

<sup>2</sup> Polish Society for the Protection of Birds (OTOP), Ul. Odrowąża 24, 05-270 Marki, Poland

<sup>3</sup> Biebrza National Park, Osowiec-Twierdza 8, 19-110 Goniądz, Poland

<sup>4</sup> Lublin University of Life Sciences, ul. Akademicka 13, 20-950 Lublin, Poland

Corresponding author: Lars.Lachmann@rspb.org.uk

## Abstract

The fen peatlands of the Biebrza Valley in Northeast-Poland hold 2500 singing males of Aquatic Warblers (*Acrocephalus paludicola*), equalling almost 20% of the world population of this globally threatened bird species. After traditional land use by hand-scything for hay ceased around 1970, successional overgrowth has become the main threat to this habitat, with over 15000 ha affected by 1999. A project funded by the EU LIFE Programme has now catalysed the implementation of a landscape-scale solution for the restoration and sustainable management of these fen peatlands, with almost 2300 ha under regular management by spring 2010. Purpose-built prototype mowing machinery with very low ground pressure and fast working speed is now used across the site. The national park has made 12500 ha of public land available for management under lease agreements that guarantee the benefit for biodiversity. A targeted Aquatic Warbler agri-environment package provides a financial incentive for local farmers and enterprises to take up the lease and implement the management measures. It is expected and there are clear indications that this management approach is benefiting the Aquatic Warbler population, but any final conclusions require additional years of monitoring and further analysis of existing data.

Keywords: Aquatic Warbler, Biebrza, fen mire, successional overgrowth, conservation management, agri-environment programme

## Conservation issue

The Biebrza Valley in Northeast-Poland presents one of the most pristine river ecosystems in Europe. Besides extensive wet forests, it holds c. 33500 ha of open habitats in its central parts, much of it near natural fen peatlands. These habitats are of highest international nature conservation importance. Amongst other key species, the fen peatlands hold around 2500 singing males of Aquatic Warblers (*Acrocephalus paludicola*), equalling almost 20% of the world population of this globally threatened bird species, Europe's rarest migratory songbird. Fens are naturally open habitats. Since at least 300 years, they have traditionally been used as hay meadows. Slight man-made changes to the hydrology of the valley, increased eutrophication through water and air combined with slow natural succession of the peatland lead to overgrowth with dense reeds and trees, especially birch (*Betula sp.*), willow (*Salix sp.*) and alder (*Alnus glutinosa*). This process was inhibited by the traditional extensive hand-scything, but became apparent as soon as this type of land use ceased around 1970. After earlier plans of full-scale drainage had been abandoned, eventually resulting in the creation of the Biebrza National Park in 1993, the successional overgrowth has become the main threat to this habitat. According to Matuszkiewicz (1999), over 15000 ha of open habitats were already subject to overgrowth by the end of the millennium. The establishment of the Biebrza



National Park in 1993 could not stop this negative development resulting in increased vegetation height and density.

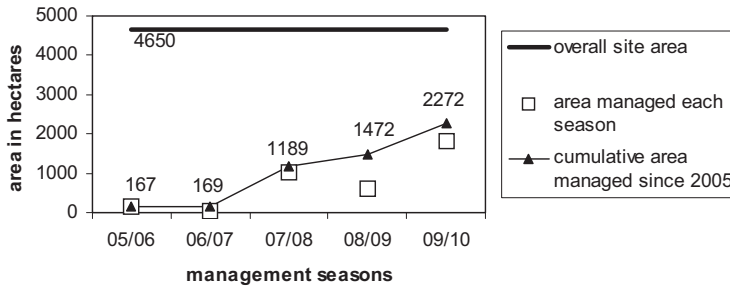

Figure 1. Area covered by conservation management for Aquatic Warblers at Bagno Ławki.

### Conservation approach

Since 2005, the Polish Society for the Protection of Birds (OTOP - BirdLife Poland) and partners, amongst them the Biebrza National Park, have been implementing a large-scale project funded by the EU LIFE Programme targeting the conservation of Aquatic Warblers and their fen mire habitats. This project has catalysed the implementation of a landscape-scale solution for the restoration and sustainable management of the peat meadows:

The plan to reintroduce mowing on several thousand hectares within the project facilitated the development and introduction of purpose-built prototype mowing machinery by a contractor of the project. The machine is an adapted alpine piste-basher on caterpillars, originally used for the preparation of ski runs, with very low ground pressure (30 g cm<sup>-2</sup>) and fast working speed (up to 10 ha day<sup>-1</sup>, including removal of biomass arisings). As it can be used also during high water levels and – in contrast to previously tested traditional tractors with twin-tires – does not destroy the delicate peat soil and vegetation, it is now used across the site.

In order to secure financial support beyond the project for large-scale habitat management, the project team worked with the government to develop a targeted Aquatic Warbler agri-environment package. Under this programme, users of land occupied by Aquatic Warblers receive an annual payment of 1370 PLN (c. 334 €) per hectare and year if they mow 50-70% each year (the unmown areas rotating each year) after 1 August and remove the arisings from the site. Similar packages are available for fen peatlands not currently holding the species, but with a typical vegetation indicating potential Aquatic Warbler habitat. The programme started in 2009 and is secured until 2013. To enable local farmers and enterprises to implement the necessary habitat management with the support of the agri-environment programmes, the national park has made public land available under lease agreements that guarantee the benefit for biodiversity. By the end of 2009, 4501 ha have been leased out, with contracts in preparation for further 8000 ha. In the near future, infrastructure will be put in place to allow for the energetic use of the biomass harvested, e.g. through the production of briquettes as alternative carbon-neutral fuel. The sale of these biomass products will contribute to the management costs in the future. The largest contiguous area of fen meadows in the Biebrza Valley is called Bagno Ławki (4650 ha). This is the focal area of the LIFE Project. Since 2005, the area of land managed each season at this site has increased, with substantial areas under management since 2007/08 (see Fig. 1), covering almost half the site in 2009/10.

### Conservation effect

In 2005 and from 2007-2009, we counted singing male Aquatic Warblers by walking transects through the total area of Bagno Ławki. Every day, multiple observers walked parallel transects simultaneously and noted singing males on a map. We covered the 4650 ha



with 30 parallel transects (counting areas) each year over a period of c. 40 days between late May and early July, and summed the number of singing males recorded during each transect count to estimate the overall total number. We recorded between 1280 and 1981 singing males in Bagno Ławki during the years 2005 and 2007-2009 (Table 1). This number does not provide an estimate of variability, but because the number of recorded males can vary by observer, weather, and singing activity of males, it is reasonable to assume that total numbers are subject to considerable variability. The raw count data reported here must therefore be interpreted with caution, and are not suitable for a final evaluation of the response of Aquatic Warblers to management. A more detailed analysis of the bird data is beyond the scope of the present manuscript and will be presented elsewhere. Because the exact location of each singing male was recorded, we were able to divide the total numbers into numbers for areas that received management at least once during that time period (1472 ha), and those areas that remained without management (3178 ha). On areas that were managed, we recorded between 756 and 846 singing males. We recorded between 742 and 1225 singing males in areas that were not managed (Table 1). During the last season (2009), after the first two years of large-scale management, we recorded a notable increase in the density of singing males in managed areas and a decrease in unmanaged areas, which is an indication for a shift of distribution of the birds towards the areas that received management.

year	2005	2007	2008	2009
unmanaged	1225	785	1026	742
Managed	756	495	595	846
Total	1981	1280	1621	1588

Table 1. Raw count data of singing male Aquatic Warblers on Bagno Ławki from 2005 to 2009, divided into areas that received management at least once during the five years (1472 ha), and

areas that did not receive any management (3178 ha).

## Discussion

We showed that it is technically and economically feasible to manage peat meadows in eastern Poland on a large scale. We expect that this management will be beneficial for the Aquatic Warbler population due to the species' known preference for intermediate vegetation height (Tanneberger *et al.*, 2008; Tanneberger *et al.*, 2010) and due to the observed return of singing males to areas after mowing management. To date, our count data do not enable us to draw any final conclusions as to whether the management has resulted in increased productivity or merely a distribution shift in Aquatic Warblers. The bird monitoring so far focused on the number of singing males. For the conservation of the species it is, however, critical that females also prefer these areas for breeding, and that the breeding productivity is higher at the managed sites. We will implement studies to determine the nest density and productivity of Aquatic Warblers in managed and unmanaged areas and their correspondence to the numbers of singing males to evaluate whether the management schemes that we describe in this paper are indeed beneficial for the long-term survival of the species.

## References

- Dyrz A. and Zdunek W. (1993) Breeding ecology of the Aquatic Warbler *Acrocephalus paludicola* on the Biebrza marshes, north-east Poland. *Ibis* 135, 181-189.
- Tanneberger F., Bellebaum J., Fartmann T., Haferland H.-J., Helmecke A., Jehle P., Just P. and Sadlik J. (2008) Rapid deterioration of Aquatic Warbler *Acrocephalus paludicola* habitats at the western margin of the breeding range. *Journal of Ornithology* 149, 105-115.
- Tanneberger F., Flade M., Preiksa Z. and Schroder B. (2010) Habitat selection of the globally threatened Aquatic Warbler *Acrocephalus paludicola* at the western margin of its breeding range and implications for management. *Ibis* 152, 347-358.
- Matuszkiewicz A.J., Głowacka I., Jakubowski W., Kamiński J., Myśliński G. and Sobczyński L. (1999) *Plan Ochrony BPN. Operat ochrony lądowych ekosystemów nieleśnych*. Maszynopis, BPN, Poland.

## Practices and motivations of farmers who sign contracts to preserve grassland biodiversity

Nettier B.<sup>1</sup>, Dobremez L.<sup>1</sup>, Orsini M.<sup>1</sup> and Fleury P.<sup>2</sup>

<sup>1</sup>Cemagref - G.I.S. Alpes-Jura, Domaine universitaire, BP 76, F-38402 Saint-Martin d'Hères

<sup>2</sup>Isara-Lyon - G.I.S. Alpes-Jura, 23 rue Baldassini, F-69364 Lyon cedex 07

Corresponding author: baptiste.nettier@cemagref.fr

### Abstract

The agri-environment measure 'Flowering meadows' aims to preserve the biodiversity of permanent grasslands. The measure is based on a list of specific plants that have to be maintained. It is an innovative measure as it is performance-indexed to ecological results, while farmers are left free to decide how to implement the measure. We aimed to identify and understand farmers' practices on contract-scheme grasslands, the roles these grasslands play in the forage system, and the reasons that prompted the farmers to sign the contract. We surveyed 21 farmers in two Regional Natural Parks in French mountain areas. Farmers establish a relationship between on-grassland biodiversity and organic manure management. The role of contract-scheme grasslands in the forage system varies greatly due to different farmers' strategies. Subsidies were a motivation, but the main driver is that farmers see the contract as a social recognition of their practices and skills.

Keywords: grassland, farming practices, biodiversity, agri-environment policies

### Introduction

The European Common Agricultural Policy has designed agri-environment measures (AEM) to preserve grassland biodiversity. Under the 'Flowering Meadows' AEM, farmers contractually agree to maintain a certain floristic diversity over a 5-year contract period. The floristic diversity is assessed as follows: a diagonal transect is drawn across the field and each third of the transect line has to contain at least four different species from a pre-established list (Opperman and Gujer, 2003). This is an innovative AEM, since it carries a performance obligation, whereas the other AEMs impose a set of practices (mowing dates, fertilization levels, etc.). In order to understand the changes that this new-format AEM can implement in farming systems, we conducted a study to detail farmers' practices on their contract-scheme grassland fields, the role given to these fields in the forage system, and the motivations prompting the farmers to sign the AEM contract.

### Materials and methods

We focused on farms in two French Regional Natural Parks ('PNR') that have implemented this AEM: the Massif des Bauges PNR (French Northern Alps) and the Haut-Jura PNR. Across these two PNR, a total of 77 farms signed contracts in 2008. We surveyed 21 of them, targeting a diverse panel, quite representative of these farming systems: 15 dairy cattle, three suckler cattle, two dairy goat, and one suckler sheep farming systems. Utilized farm areas vary from 10 to 180 hectares. We interviewed the farmers to characterize the technical and social factors driving their commitment to this AEM. First we focused on the technical organization of the farming system. Our aim was to capture and rebuild the farm functioning viewed from the forage management angle (Fleury *et al.*, 1996). For each field, we listed fertilization (dates, type, quantity), mowing (dates), and grazing practices (dates, number and type of animals). We then investigated the farmers' knowledge, attitudes and practices

(Dockès and Kling-Eveillard, 2005) about grassland management, biodiversity, and the AEM itself. The reasons for signing the AEM contract were characterized by studying the arguments of the farmers' justification (Boltanski and Thévenot, 1991).

**Results**

We cross-tabulated farm practices on contract-scheme grasslands against farmers' knowledge. Permanent grasslands occupied a large share of the farm area (77 - 100 %) of all the surveyed farms, and were essentially fertilized with organic manure. The farmers were all conscious of practices promoting broad floristic diversity. All considered fertilization as essential, and all felt nitrogen application had to be kept low. Overgrazing or early and repeated mowing are still considered unfavourable. The majority of the contract-scheme fields proved relatively unexposed to intensive fertilization or grazing and/or mowing pressure (Fig. 1).

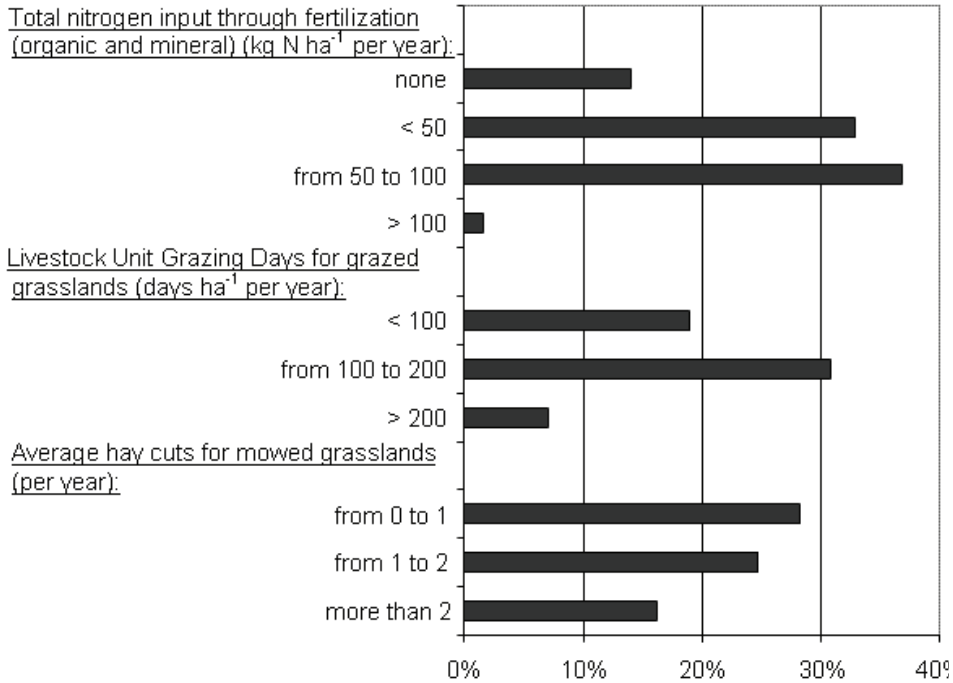

Figure 1: Percentage of the area of permanent grassland under AEM-scheme, for different practices (sum of the areas of 19 farms surveyed; data unreliable for 2 farms).

Farms committed between 4 and 87% of permanent grasslands to the AEM. This variability has several explanatory factors. First, the surveyed farms have different proportional shares of flowering meadows contributing to their forage systems. Furthermore, the performance obligation carries a certain degree of risk. Farmers understand that farming practices will influence floristic diversity for a number of years. They consequently only opt in fields that already housed the targeted flora, and which already have a long history of stable, unchanged practices. They underlined the uncertainty hanging over changes in vegetation composition if they changed practices. They also consider -rightly- that flora composition is dependent not just on farm practices but also exogenous factors (climate, pests) beyond the farmer's control. Their strategy in contending with these uncertainties has often been to only opt in fields more

likely to meet the AEM requirements. Most of the farmers told us '*I didn't take a risk*'. One farmer was circumspect about the attitude of some rare few intrepid farmers: '*I've seen some farmers committing fields that, for me, would have been off-limits*'. As things stand at present, the AEM acts more as a support to current non-intensive farm practices than any real incentive to change practices.

In order to characterize the farmers' motivations in joining the AEM contract, we have established the following typology based on farmers' arguments. Type 1 (2 farmers) characterizes farmers who committed solely on the basis of the subsidy bonus: the measure '*costs nothing*' and the performance obligation '*is less complicated than keeping a practices report book*'. Type 2 pools the majority of farmers (n=15): Although the subsidy was a factor, it was not the only reason - social recognition also weighed heavy in the balance: '*People get to recognize the work we do*'. The two farmers classed under type 3 underline only their environmental consciousness: '*Signing the AEM contract had nothing to do with grabbing some kind of subsidy. The aim is precisely to try and get the meadows with flowers, to rediscover these hidden treasures*'. Finally, the two farmers classed under type 4 have signed their contracts out of moral obligation, pushed by the technical advisor or by professional responsibilities.

## **Discussion and conclusion**

Farmers and researchers (Duru *et al.*, 2005) underline the influence of cutting date and fertilization practices in shaping floristic diversity. Farmers' experience is that species-rich grassland is more flexible to manage ('*grassland that stays green for longer*') and is often assigned specific functions within the forage system (such as '*last hay [mowed]*'). It follows that, while farm practices shape vegetation type, the vegetation type present in turn shapes how grassland is used. The 'flowering meadows' AEM creates the conditions for maintaining relatively extensive grasslands offering a degree of biodiversity. The study reveals various farmers' attitudes to the AEM and its performance obligation: some see it as a welcome windfall gain, while for most it represents another step towards gaining broader social recognition that their practices are well-founded. Thévenet *et al.* (2006) had previously captured this concern. The performance obligation and its degree of uncertainty branch directly back to the farmers' judgement and behaviour responses to risk and uncertainty. It is essential to integrate these dimensions when building such AEMs.

## **Acknowledgements**

This work was carried out with the financial support of the French Ministry in charge of environment (DIVA2 research program).

## **References**

- Boltanski L. and Thévenot L. (1991) *De la justification. Les économies de la grandeur*, Gallimard, Paris, 483 pp.
- Dockès A.C. and Kling-Eveillard F. (2005) Les éleveurs de bovins nous parlent de leur métier et de leurs animaux, *Fourrages* 184, 513-532.
- Duru M., Tallowin J. and Cruz P. (2005) Functional diversity in low-input grassland farming systems: characterisation, effect and management. *Agronomy Research* 3, 125-138.
- Fleury P., Dubeuf B. and Jeannin B. (1996) Forage management in dairy farms: a methodological approach. *Agricultural Systems* 52, 199-212.
- Oppermann R. and Gujer H. (2003). *Artenreiches Grünland bewerten und fördern -MEKA und ÖQV in der Praxis*, Ulmer, Stuttgart, 199 pp.
- Thévenet C., Dobremez L., Fleury P. and Larrère R. (2006) Insertion de contrats de préservation de la biodiversité dans les exploitations agricoles des Alpes du Nord. *Fourrages* 188, 495-510.

## Phenolic compounds in sustainable grassland production: availability of nitrogen to plants

Oreja A., San Emeterio L., Villanueva E. and Canals R.M.

Dpto. Producción Agraria, Universidad Pública de Navarra, Arrosadia s/n 31006 Navarra, Spain.

Corresponding author: amaia.oreja@unavarra.es

### Abstract

The establishment of productive pastures with a low input of nitrogen fertilization is a primary focus in sustainable grassland production. *Lolium* spp. encompasses a genus of valuable forage grasses. Several species of *Lolium* contain phenolic compounds, which may have a role on the allelopathic potential of the species. We undertook a field trial to ascertain 1) whether phenols present in *Lolium* were able to depress the activity of soil nitrifying populations, thus decreasing the availability of nitrate to plants, and 2) whether the addition of other easily usable sugar was able to modulate this effect. Twenty-four hours after substrate additions (phenols and/or glucose at different concentrations) N microbial biomass remained constant, whereas nitrifying activity decreased significantly with high glucose addition, suggesting ammonium starvation, and eclipsing the tendency of phenols to restrain populations of nitrifiers.

Keywords: *Lolium* spp, phenolic acids, glucose, nitrifiers, N cycling, sustainable grassland

### Introduction

Phenolic compounds are aromatic alcohols widely distributed in plants. These secondary metabolites have been related to various ecological functions. They may attract pollinators, act as signalling molecules between plants and symbiotic or pathogenic organisms, and confer a protective role against biotic and abiotic stresses and disturbances (Hutzler, 1998). Phenols released by plants to the environment may also have a role as allelochemicals, affecting negatively the development of neighbouring plants, as well as the activity of soil microbial populations, such as those related to the nitrogen (N) cycle (Castells, 2008).

In grassland science, *Lolium* spp. encompasses the most precious forage genus, with taxa adapted to temperate and semi-arid environments. *Lolium* grasses are competitive, productive and nutritious, with high soluble sugar contents. Previous research has demonstrated that species of this genus have allelopathic potential. Phenols in *Lolium rigidum* may be responsible for the negative effects observed in the early growth of species such as *Dactylis glomerata* (San Emeterio *et al.*, 2004), and even for autotoxic phenomena (Canals *et al.*, 2005).

The establishment of productive pastures with a low external N input is a primary focus in sustainable grassland production. Since *Lolium* species are valuable candidates for the establishment of sustainable pastures, we were interested in estimating the effects that may play 1) its high sugar concentration (e.g. released via roots exudates) and 2) its phenolic content, both sources of energy for the soil microbiota related to the N cycle. For that purpose, we undertook a field trial in order to ascertain 1) whether phenols present in *L. rigidum* were able to depress the activity of nitrifying populations, thus decreasing the availability of nitrate to plants, and 2) whether the addition of an easily usable sugar was able to modulate the effect of phenols.

## Materials and methods

We established a field trial in Arazuri (northern Spain, 42°48'N-1°43'W), on an agricultural land with a clay-loamy soil, low total nitrogen contents (0.18%), and higher contents of nitrate than ammonium ( $0.64 \mu\text{g g}^{-1} \text{N-NH}_4^+$  and  $23.91 \mu\text{g g}^{-1} \text{N-NO}_3^-$ ). The experiment was set up in autumn 2008. We buried to the level of the soil surface 48 PVC cylinders (9 cm diameter and 10 cm high) in a completely randomized design with six replicates. Soil contained within each cylinder was placed in a plastic bag and sprayed with 10 mL of the following 8 solutions: ferulic and coumaric acids (50:50; total phenols  $97.4 \mu\text{g per g soil}$ , PHE); fractionated leachate of *L. rigidum* (leachate was fractionated into phenolic and non-phenolic fractions by solid-phase extraction using a C18 Extra-sep column to retain phenols, total phenols  $0.35 \mu\text{g per g soil}$ , FL); unfractionated leachate of *L. rigidum* (total phenols  $2.88 \mu\text{g per g soil}$ , UL); high glucose ( $1.95 \text{ mg C per g soil}$ , HG), low glucose ( $19.5 \mu\text{g C per g soil}$ , LG), high glucose with phenols (PHG); low glucose with phenols (PLG) and a control of distilled water (CON). After spraying, bags with soil were re-buried into the field and incubated for 24 hours. After this period we measured in the field soil respiration rates (EGM-4 CO<sub>2</sub> Gas Analyzer and SRC-1 Soil Respiration Chamber), and analysed in the laboratory the N microbial biomass (chloroform fumigation and direct extraction technique) and the nitrification potential (shaken soil-slurry method). Data were normally distributed and were analysed using one-way ANOVA (SPSS 16.0).

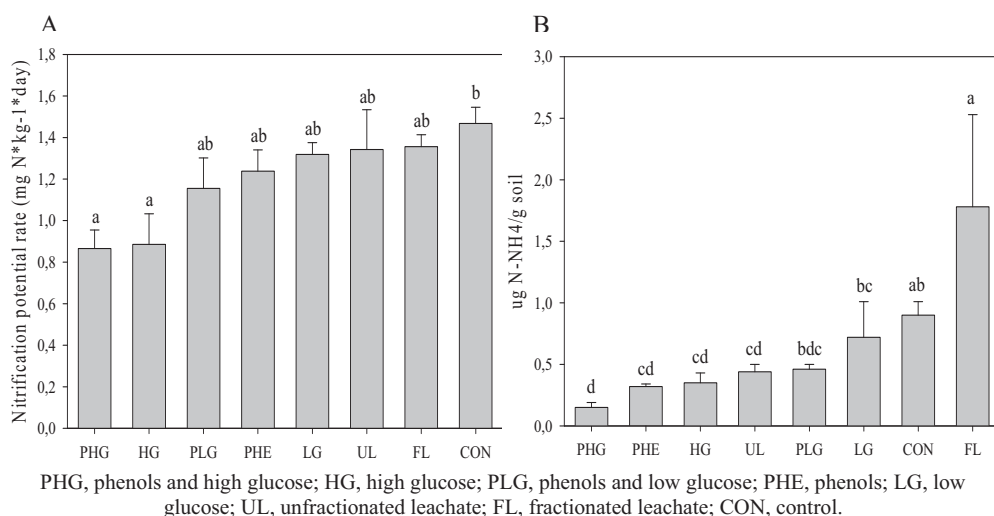

Figure 1. Nitrification potential (A) and  $\text{N-NH}_4^+$  content (B) of soils amended with different types and concentrations of phenolic compounds and glucose. Different letters mean significant differences.  $F=3.516$ ,  $P=0.005$ , Fig 1A;  $F = 2.255$ ,  $P = 0.058$ , Fig 1B.

## Results and discussion

Glucose is a readily available supply of C (Blagodatskaya *et al.*, 2007) more easily assimilated by micro-organisms than other C sources (Pue *et al.*, 1995). C input, and glucose additions in particular, influenced soil microbial activities but did not change the size of the microbial biomass (determined as N microbial biomass). Respiration rates increased when high glucose as a simple solution or associated with phenols were applied ( $3.90$  and  $4.09$  respectively, versus  $1.58 \text{ g CO}_2 \text{ per m}^2 \text{ per hr}$  for control soils;  $F = 2.255$ ,  $P=0.058$ ), and

nitrification potential significantly declined in high glucose treatments and, to a lesser extent, in phenolic treatments ( $F=3.516$ ;  $P=0.005$ , Fig 1A). High glucose, phenolic and unfractionated leachate inputs significantly decreased soil  $N-NH_4^+$  contents ( $F=6.405$ ,  $P<0.001$ , Fig 1B). These data suggested that  $NH_4^+$  immobilisation might be restraining the development of nitrifying populations. The lack of response of the nitrifying potential to the phenol inputs (PHE, UL), even though ammonium contents did significantly decreased in those treatments, might be explained by the lower rate of microbial activity.

Castells (2008) described a decrease in soil N availability after phenolic additions, and Blum *et al.* (2000) reported an increase in the populations of phenolic-utilizing bacteria (PAU) as a response to a phenolic supply. Our field results indicate that an excess of energy, when N constrained, depress nitrifying populations rapidly (1-day incubation), and may promote a shift towards microbial populations not-related to the N-cycle.

## Conclusions

Nitrifying activity is significantly constrained by  $N-NH_4^+$  starvation caused by a high availability of carbon sources, mostly coming from rapidly usable glucose, and to a lesser extent, from phenols. Results are noticeable in the field 24 hours after carbon additions. Despite readily usable carbon enhancing microbial activity, the activity of nitrifiers depends on ammonium pools. We suggest that other different microbial species, as PAU, might take advantage in this short time lapse, causing the decline of nitrifying populations.

The lack of information on total phenolic contents in soils under a *Lolium* cover makes it difficult to extrapolate the results to field conditions. Soils under a culture of *Sorghum bicolor* (a grass with a lower phenolic content than *Lolium*,  $2.8 \text{ mg g}^{-1}$  vs.  $9.5 \text{ mg g}^{-1}$ ) had a total phenolic content of  $6.7 \text{ } \mu\text{g per g soil}$ . We were well above this level in the phenolic treatment reported here ( $97.4 \text{ } \mu\text{g per g soil}$ ), and below it in the unfractionated leachate ( $2.8 \text{ } \mu\text{g per g soil}$ ). The significant decrease in the soil  $N-NH_4^+$  content after applying the unfractionated leachate led us to suggest that the mechanism occurs in the field and that it may be especially important at the micro-site, soil rhizosphere level.

## References

- Blagodatskaya E. V., Blagodatsky S. A., Anderson T. H. and Kuzyakov Y. (2007) Priming effects in Chernozem induced by glucose and N in relation to microbial growth strategies. *Applied Soil Ecology* 37, 95-105.
- Blum U., Staman K. L., Flint L. J. and Shafer F. R. (2000) Induction and/or selection of phenolic acid-utilizing bulk-soil and rhizosphere bacteria and their influence on phenolic acid phytotoxicity. *Journal of Chemical Ecology* 26, 2059-2078.
- Canals R. M., San Emeterio L. and Peralta J. (2005) Autotoxicity. In: *Lolium rigidum*: Analyzing the role of chemical mediated interactions in annual plant populations. *Journal of Theoretical Biology* 235, 402-407.
- Castells E. (2008) Indirect effects of phenolics on plant performance by altering nitrogen cycling: another mechanism of plant-plant negative interactions. pp. 137-156. In: Zeng R.S. and Luo S.M. (eds.) *Allelopathy in Sustainable Agriculture and Forestry. International Symposium on Allelopathy Research and application*, Springer, New York.
- Hutzler P., Fischbach R., Heller W., Jungblut T.P., Reuber S., Schmitz R., Veit M., Weissenböck G. and Schnitzler J.P. (1998) Tissue localization of phenolic compounds in plants by confocal laser scanning microscope. *Journal of Experimental Botany* 49, 953-965.
- Pue K. J., Blum U. and Gerig T. M. (1995) Mechanism by which noninhibitory concentrations of glucose increase inhibitory activity of p-coumaric acid on morning-glory seedling biomass accumulation. *Journal of Chemical Ecology* 21, 833-847.
- San Emeterio L., Arroyo A. and Canals R. M. (2004) Allelopathic potential of *Lolium rigidum* Gaud. on the early growth of three associated pasture species. *Grass and Forage Science* 59, 107-112.



## Could the grassland production costs be an argument for biodiversity?

Orth D., Begon M. and Sabatier J.

*UMR Metafort – VetAgroSup Campus Agronomique de Clermont,*

*89, avenue de l'Europe BP35 63370 Lempdes, France*

Corresponding author: orth@enitac.fr

### Abstract

In order to find economic arguments in favour of maintaining species-rich grasslands a study was carried out on grassland production costs. The aim was to test whether these costs were decreasing with higher biodiversity, as agricultural practices were supposed to be more extensive. A set of 29 permanent grasslands (14 mown, 15 grazed only) located in Auvergne (central France) were analysed using information on grassland management, yield and floristic diversity. The production costs were estimated through agricultural practices and divided into mechanisation and input costs. Results showed globally no obvious link between production costs per hectare and biodiversity level for grazed or mown grasslands. However, when considering the intensification degree of the practices, we noticed that the most extensive grazed pastures had a higher biodiversity level than the intensive one and the lowest cost per hectare and per tonne of dry matter.

Keywords : biodiversity, production cost, permanent grassland management

### Introduction

Grassland biodiversity is nowadays an important stake which is included in many agri-environmental policies. Supplies are often given to maintain species-rich grasslands as the more extensive practices required are given to be less interesting for fodder production. Many research programmes are also going on to find out positive arguments in favour of species-rich grasslands, like quality of the products (meat, milk, cheese) or animal health (Farruggia *et al.*, 2008). In this work we wanted to test whether economic arguments, different from supplies, could be proposed to the farmers in order to motivate them to maintain biodiversity. The study focused on the permanent grassland production costs. The hypothesis was that these costs should be lower for species-rich grasslands as the agricultural practices should be less intensive. The links between production costs, biodiversity and the intensification level of the practices were therefore studied. This text presents the first results obtained for a sample of mown and grazed grasslands.

### Materials and methods

We worked on 29 permanent grasslands (14 mown and 15 grazed only) selected among a set of data obtained in 2008 in a research project studying grassland biodiversity in the Saint Nectaire cheese Protected Denominated Origin Area (Auvergne, France). It is an average mountain area (1000 m a.s.l) with mainly natural grassland. The plots were chosen in order to get different biodiversity levels and reliable and complete data on agricultural practices. The grasslands' floristic diversity was assessed using a simplified method based on indicators such as number of different species (no botanical recognition), colours, and flowers' forms (Orth *et al.*, 2008). Each plot obtained a diversity mark between 1 (low) and 5 (high) with reference to Auvergne's grasslands biodiversity potential. The management of the plots was obtained through farm surveys and was manually classified into 3 levels of intensification considering mineral and organic fertilisation, stocking rate, number and period of cuttings and grassland upkeep. The yield of the harvested grass (mown meadows) was given by the farmers. To

estimate the grazed grass yield we used the stocking rate of the plot considering that a cow of 600 kg eats 14 kg d<sup>-1</sup> dry matter (DM). The production costs were divided into mechanisation and input costs due to fodder production, grazing management and grassland maintenance (Table 1). Each single cost came from a set of references used by the Agricultural Extension and Development Services (Réseaux d'élevage Auvergne-Lozère, 2008) except for the costs mineral fertilizers which were provided by a private trader. Total production costs were calculated per hectare (ha) and per tonne DM.

Table 1. Data used for the estimation of production costs.

	Input costs (€ ha <sup>-1</sup> y <sup>-1</sup> )	Mechanisation costs (€ ha <sup>-1</sup> y <sup>-1</sup> )
Mineral fertiliser	14 to 63 € per 100 kg fertiliser	6
Organic fertiliser		35
Harrowing		6
Refusals' cutting		23
Fences setting up and maintenance	5	5
Grazing management		15
First hay cutting *	4.3 to 6.3**	162
Second hay cutting*	4.3 to 6.3**	123
Wrapped bales *	47 to 63**	211

\* all included from cutting to transport ; \*\*cost depending on the yield (number of bales)

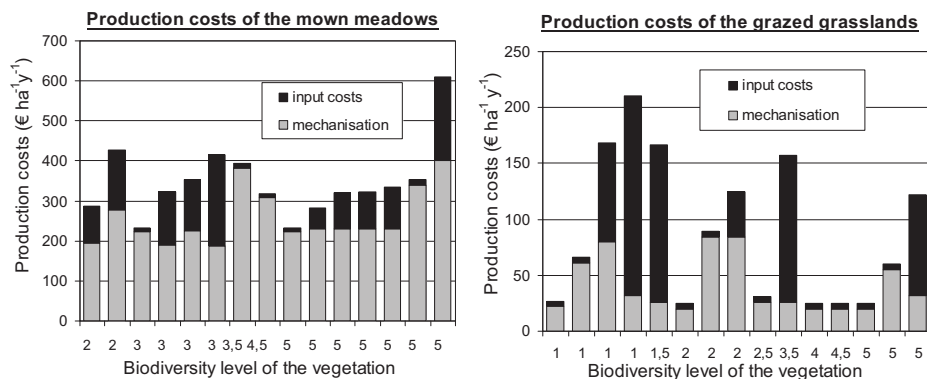

Figure 1. Production costs (€ ha<sup>-1</sup> y<sup>-1</sup>) and biodiversity levels of the mown and grazed grasslands. Biodiversity levels from 1 (low) to 5 (high).

Table 2. Production costs, biodiversity and level of intensification.

Intensification level	Number of plots	Biodiversity level (1 low to 5 high)	DM yield (t ha <sup>-1</sup> )	Production costs € ha <sup>-1</sup>	Production costs € t <sup>-1</sup>
<b>MOWN MEADOWS</b>					
Extensive	4	3.2	5.3	280.8	54.1
Medium	4	5	6.7	302.5	46.2
Intensive	6	3.8	6.8	409.5	65.9
<i>Variance analysis</i>		ns	ns	<i>P</i> = 0.05	ns
<b>GRAZED MEADOWS</b>					
Extensive	5	3.3	2.4	25.4	9.4
Medium	4	3.2	5.1	93.5	30.5
Intensive	6	1.4	9.3	158.7	17.5
<i>Variance analysis</i>		ns	<i>P</i> = 0.0	<i>P</i> = 0.0	ns

ns : not significant test, *P* : *P* value of the variance analysis

## Results and discussion

The production costs were very different for mown and grazed grasslands, with an average value of 342 and 88 € ha<sup>-1</sup> y<sup>-1</sup>, respectively. Mown meadows had much higher mechanisation costs (262 against 40 € ha<sup>-1</sup> y<sup>-1</sup>) and input costs (80 against 48 € ha<sup>-1</sup> y<sup>-1</sup>). Figure 1 shows that mechanisation was always the main expense for these meadows, and that input costs could vary because some plots receive only organic fertilizers. For the grazed grasslands, the input costs which are only mineral fertilisers were sometimes the main expenses and were responsible for the highest cost differences among the pastures. No obvious link between production costs per ha and biodiversity level was found (Fig. 1). The correlation coefficient was near 0 for the mown plots and -0.37 for the grazed grasslands but not significant. Figure 1 also shows that most of the expensive pastures had a low or medium biodiversity level except one with high biodiversity due to soil heterogeneity. When considering the intensification level of the practices (Table 2) we found that the production costs per ha for both kinds of grasslands increased significantly with intensification. This is expected as we built our classes on the intensity of fertilisation and grassland use. Although differences were not significant we noticed for the mown meadows an advantage for the medium intensive plots which had the highest diversity, the same yield as the intensive ones and the lowest production cost per DM tonne. The surprisingly low diversity of the extensive mown meadows was due to the history of some of the plots, as our sample included two summer mountain pastures that had been turned into mown grassland more than 15 years ago where the vegetation was obviously not yet stabilized. The results for grazed grasslands were as expected, and showed a lower diversity level for the intensive pastures and a significant higher yield which led to medium production costs per DM tonne. Extensive and medium grazed grasslands both had an average biodiversity level, but costs per ha and per DM tonne were lower for the extensive plots despite of a very low yield. These results should, however, be balanced by plot location as more extensive practices often occur on the more distant plots, so mechanisation costs were perhaps under evaluated. A larger number of plots is also needed to verify these first results.

## Conclusion

The hypothesis of lower production costs for more diversified meadows related to extensive practices was not validated for mown meadows and partially for grazed pastures. Low costs could be an argument for extensive grazing but the main question remains the link between extensive management and high biodiversity.

## References

- Farrugia A., Martin B., Baumont R., Prache S., Doreau M., Hoste H. and Durand D. (2008) Quels intérêts de la diversité floristique des prairies permanentes pour les ruminants et les produits laitiers? *INRA Productions Animales* 21(2), 181-200.
- Orth D., Balay C., Bonafos A., Deleglise C. and Loiseau P. (2008) Proposition d'une démarche simple pour évaluer la diversité floristique d'une prairie permanente, *Fourrages* 194, 233-252.
- Réseaux d'élevage Auvergne-Lozère (2008) *Coût des fourrages 2007*, 27 pp.

# Multidimensional scaling for describing the risks for grasslands ecosystems located in the Polish Landscape Parks

Paderewski J.<sup>1</sup> and Sienkiewicz-Paderewska D.<sup>2</sup>

<sup>1</sup>*Department of Experimental Design and Bioinformatics*

<sup>2</sup>*Department of Agronomy*

*Warsaw University of Life Sciences, 02-776 Warsaw, Nowoursynowska 159, Poland*

Corresponding author: jakub.paderewski@omega.sggw.waw.pl

## Abstract

The identification of factors that might be harmful for grasslands is important concerning the protection of their nature values. Based on questionnaires that were sent to all landscape parks in Poland, the most dangerous factors for grasslands were listed. Some of the threats occurred together. Multidimensional scaling was used to describe similarities among landscape parks in terms of the perceived threats. Parks located close to each other on the multidimensional scaling graph were grouped into five blocks. Based on this chart, we have found a few distinctive threats to the groups of parks: cessation of grassland management, secondary succession, problems with the enforcement of regulations and development of infrastructure.

Keywords: environmental protection, cessation of grassland utilization

## Introduction

Identification and elimination of the factors that might endanger grassland ecosystems are the most important tasks concerning the maintenance and protection of grassland biodiversity. Based on questionnaires that were sent to the managements of all landscape parks in Poland (Sienkiewicz-Paderewska and Stypiński, 2009) in 2005, the most threatening factors were listed. The present work describes similarities between the analysed parks with respect to the selected threats using the multidimensional scaling analysis.

## Material and methods

A questionnaire was sent to the persons in charge of all landscape parks in Poland, which amounted to 127 in 2005. The respondents were asked about threats that may be harmful to grasslands located in each park and mark them either as '1' if it was occurring in the park, and '0' if not. They could choose among 30 given possibilities and also could add other ones (Table 1). The questionnaire was completed by 95% of the parks' managers. The Euclidean distance between landscape parks was computed. The data were analysed as the complete inquiries with missing values. The (metric) multidimensional scaling (Kruskal and Wish, 1978, Seok, 2009), known as principal coordinate analysis (PCoA), was used to describe similarities between landscape parks in terms of the perceived threats. The 'sammon' procedure in R language (R Development Core Team, 2009) was used for a multidimensional scaling analysis. The initial value of distance was not allowed to be '0', but sometimes it was (some of the park managers indicated identical positions), so the initial distances were random noised with a very low value (taken from a normal distribution with mean 0 and variance 0.01). As the result is not deterministic (the noise was added), the computation was repeated 2000 times and the best results (those with the lowest value of stress function) were chosen.

## Results

We have found a few threats that were obviously typical for the parks, which are indicated by the close location of the referring items in the chart: cessation of grassland management (1 in Fig 1.), secondary succession (2), infrastructure building (3) and urbanization building (4). In this way, the parks were allocated to 5 groups.

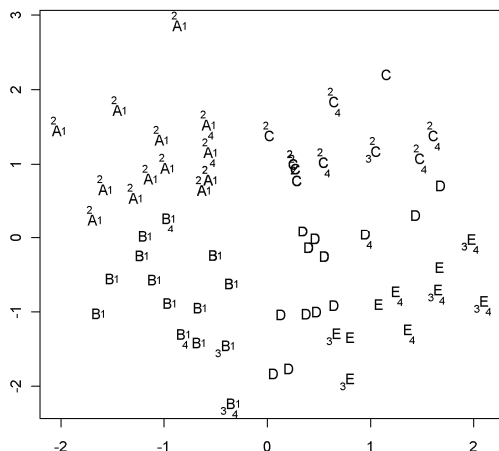

Figure 1. Multidimensional distance plot of Euclidean distance for the vector of threats in landscape parks and the 5 groups of parks connected to the groups with distinctive threats. A, B, C, D, E are groups of the landscape parks similar in term of the perceived threats. The distinctive threats are: (1) cessation of grassland management, (2) secondary succession, (3) infrastructure building, and (4) urbanization building.

The presented groups were associated with the following factors that differed among parks (Table 1): Group A- Cessation of grassland management connected to secondary succession, B- Cessation of grassland management but not connected to secondary succession, C- Secondary succession not connected to cessation of grassland management, E- Infrastructure development, D- Other threats.

## Discussion

Based on Table 1, we described the relations between threats in landscape parks, i.e. we identified the threats typical for the different groups of parks. In group A (cessation of grassland management connected to secondary succession), a clearly higher proportion of the following threats was observed: conversion into arable land, afforestation, soil drainage, lack of fertilization (this threat was only found here), low livestock stocking rates (only here), unprofitability of grassland production, insufficient staff level (almost exclusively here). Hence, these risks may occur together. In group B (cessation of grassland management but not connected to secondary succession) proportion of early cutting was higher. This effect was found in only 2% of the parks of group B. In group C (secondary succession not connected to cessation of grassland management), afforestation, secondary marshy processes and tourist building had a clearly higher proportion. In group D, a higher proportion of burning, difficulties in agreement with local government and limited decision rights of the park management were observed. This could be interpreted as problems with the enforcement of regulations by the parks managers. Group E (tourist building and infrastructure building) is characterized by a higher proportion of conversion into arable land, afforestation, soil drainage, mechanization of grassland farming (only here), burning, poaching (usually marked in this group), dams building, urbanization building (usually marked in this group), unrestricted buying out of land, inappropriate waste management, financial difficulties.

## Conclusion

A multidimensional scaling graph of the similarity among parks enables us to indicate threats that are typical for the group of Parks. Moreover, it may be a possibility of finding the threats that occur together. Summing up: factors that are harmful to grasslands do not exist independently which should be taken into account for conservation aims.

Table 1. The proportion of threats in the groups of Polish landscape parks

Group of Parks	A	B	C	D	E	Particularly vulnerable group <sup>a</sup>		
Cessation of grassland management (mowing/grazing)	100%	100%	0%	0%	0%	A	B	
Conversion into arable land	19%	2%	11%	8%	18%	A		E
Afforestation	19%	5%	17%	3%	18%	A	C	E
Inappropriate forest management	0%	0%	0%	0%	0%			
Soil drainage	25%	12%	11%	8%	27%	A		E
Secondary marshy processes	6%	2%	11%	0%	0%	A	C	
Increasing in number of cuttings per year	6%	0%	6%	3%	0%	A	C	
Early cutting	0%	2%	0%	0%	0%		B	
Late cutting	0%	0%	0%	0%	0%			
Mechanization of grassland farming	0%	0%	0%	0%	9%			E
Lack of fertilization	6%	0%	0%	0%	0%	A		
High fertilizer input	6%	0%	6%	3%	0%	A	C	
High stocking rate	6%	0%	6%	3%	0%	A	C	
Low livestock rate	19%	0%	0%	0%	0%	A		
Burning	6%	10%	11%	17%	27%			D E
Poaching	0%	2%	0%	3%	9%			E
Secondary succession	100%	0%	94%	0%	0%	A	C	
Unprofitability of grassland production	25%	2%	17%	6%	9%	A	C	
Dams building	6%	2%	6%	0%	9%	A	C	E
Tourist building	13%	7%	28%	6%	55%		C	E
Infrastructure building	0%	5%	6%	0%	55%			E
Urbanization building	6%	2%	0%	3%	36%			E
Unrestricted buying out of land	6%	5%	0%	3%	18%			E
Inappropriate waste management	0%	0%	6%	0%	9%		C	E
Nearness to pollutants emitters	0%	0%	0%	0%	0%			
Difficulties in execution of regulations	6%	0%	6%	0%	0%	A	C	
Difficulties in agreement with local government	0%	0%	0%	3%	0%			D
Financial difficulties	0%	0%	0%	3%	9%			E
Limited decision rights of the park management	6%	0%	6%	6%	0%	A	C	D
Insufficient staff level	13%	0%	0%	3%	0%	A		

<sup>a</sup> The threat is typical of the group of Parks

## References

- Kruskal J.B. and Wish M. (1978) *Multidimensional Scaling*. Sage University Paper series on Quantitative Applications in the Social Sciences 07-011, Sage Publications, Beverly Hills and London, 93 pp.
- R Development Core Team (2009) *R: A language and environment for statistical computing*. R Foundation for Statistical Computing, Vienna, Austria. ISBN 3-900051-07-0, URL <http://www.R-project.org>.
- Sienkiewicz-Paderewska D. and Stypiński P. (2009) Permanent grasslands in the Polish Landscape Parks. Part I. The state and the threats. *Grassland Science in Poland* 12, 165-176.
- Seok S. (2009) Item validation of online postsecondary courses: rating the proximity between similarity and dissimilarity among item pairs (Validation study series I: multidimensional scaling). *Educational Technology Research and Development* 57 (5), 665-684.

# Changes in plant C-S-R strategy after 10 years of different management of a mountain hay meadow

Pavlu L., Pavlu V. and Gaisler J.

*Crop Research Institute Prague, Department of Plant Ecology and Weed Science, Grassland Research Station, Rolnická 6, CZ-46011, Liberec, Czech Republic,*

Corresponding author: lpavlu@vurv.cz

## Abstract

The aim of this study was to identify changes in plant C-S-R strategy in a mountain hay meadow (*Polygono-Trisetion*) when management ceases. Five permanent paired plots in a once-yearly mown (M) and an abandoned (U) meadow were established in 1999. The changes in C-S-R strategy were calculated by means of C, S, R values (ranged from 0 to 1) weighted with cover of each species and the sum of calculated C-S-R strategies was 1 for each plot. C strategy was the most successful strategy with means of 0.64 and 0.67 for M and U treatment respectively. In contrast, R strategists had the lowest values with means of 0.14 and 0.11 for M and U treatment respectively. S strategy was indifferent to management with a value of 0.22. The proportion of herbs with C and S strategy was significantly higher on U than on M treatment, whereas the proportion of graminoids with C-S-R strategy was higher in M treatment than in U. Detailed evaluation of plant C-S-R strategy according to the main botanical groups can give different results when all plants are analysed together. No matter how infertile, mountain hay meadows are fairly stable systems and despite long term different management the changes of botanical composition and C-S-R were slight and they are still in process.

Keywords: Mowing, abandonment, grassland, plant species composition, diversity

## Introduction

Grassland changes and dynamics may be studied from different viewpoints, e.g. species diversity, community, plant traits (Ryser *et al.*, 1995; Myklestad and Saetersdal, 2004; Eler *et al.*, 2005). An alternative way of evaluating management activities on meadows is to observe the responses of groups of species according to the C-S-R plant strategy scheme proposed by Grime *et al.* (1988). This C-S-R scheme is built on the assertion that three major determinants of vegetation exist, namely competition (C), stress (S) and disturbance (R). Evaluating the proportions of the C-S-R model may reveal the state of the meadow in relation to the intensity of management well before there are any apparent changes in habitat physiognomy (Huhta, 2001). The aim of this study was to compare development of C-S-R strategy under long term mowing and abandonment of the mountain hay meadow.

## Material and methods

The experiment was carried out in a mountain hay meadow in the Bukovec Nature Reserve in the NW of the Jizera Mts., Czech Republic. The altitude of the study site is 910 m, the average annual precipitation is 1500 mm and the mean annual temperature is 4.5 °C. The bedrock in Jizera Mts. consists mainly of granite, but in the study site patches of basalt also occur. Soil attributes were: pH<sub>KCl</sub>: 4.4, available P content 5 mg kg<sup>-1</sup>, available K content 198 mg kg<sup>-1</sup> and available Mg content 300 mg kg<sup>-1</sup>. According to phytosociological nomenclature (Moravec *et al.*, 1995) the vegetation of the experimental site was classified as *Polygono-Trisetion*. The experiment was established in 1999. The treatments were: mowing once a year



with removal of biomass in mid July (M) and unmanaged control (U). The vegetation was monitored in five pairs of permanent 5 m x 5 m plots annually before cutting at the same phenological stage in mid July. The cover of all vascular plant species on each plot was recorded using a percentage scale. Nomenclature followed Kubát *et al.* (2002). The C-S-R signature (Grime *et al.*, 1988) for each plot was calculated by means of C, S, R values weighted with cover of each species present in the individual plot (Hunt *et al.*, 2004). The sum of calculated C-S-R strategies was 1 for each plot. Repeated ANOVA measures were used to evaluate C-S-R strategies.

Table 1. Results of repeated measures ANOVA of C-S-R strategy.

Strategy	Effects					
	Time		Treatment		Time x Treatment	
	F-ratio	P-value	F-ratio	P-value	F-ratio	P-value
C – herbs	0.80	0.635	103.00	<0.001	0.64	0.018
C – graminoids	2.10	0.036	135.10	<0.001	5.60	<0.001
S – herbs	6.18	<0.001	29.79	<0.001	1.96	0.047
S – graminoids	4.66	<0.001	52.22	<0.001	2.13	0.030
R – herbs	4.69	<0.001	0.03	0.875	0.99	0.455
R – graminoids	6.40	<0.001	113.70	<0.001	5.90	<0.001
C – total	2.47	0.012	3.07	0.083	0.49	0.893
S – total	3.15	0.002	3.23	0.076	1.12	0.360
R – total	1.16	0.327	26.76	<0.001	0.56	0.844

## Results and discussion

The proportion of herbs (e.g. *Cirsium heterophyllum*, *Geranium sylvaticum*, *Hypericum maculatum*) was significantly higher in U treatment than in M. On the other hand the proportion of graminoids (e.g. *Agrostis capillaris*, *Festuca rubra*, *Anthoxanthum odoratum*, *Briza media*) was significantly higher on M plots than on U plots. C strategy was the most successful strategy with means of 0.64 and 0.67 for M and U treatment, respectively, whereas R strategists had the lowest values with means of 0.14 and 0.11 for M and U treatment, respectively. S strategy was indifferent to management with a value of 0.22. The cover of all plant species (graminoids and herbs) with C and S strategy was higher (not significant) on abandoned plots whereas the cover of all plant species with R strategy was higher on cut plots (Table 1). However it should be noted that the cover of R strategists is low in the study plots.

Total C-S-R strategy was influenced by the proportional representation of herbs and graminoids (the cover of herbs in both treatments was approximately twice as high as graminoids). However, if the response of C-S-R strategy to mowing is calculated for herbs and graminoids separately the results will differ. The proportion of herbs with C and S strategy was significantly higher in U treatment than in M whereas the proportion of graminoids with C-S-R strategy was higher on mown plots than on abandoned ones (Fig. 1). Only the cover of herbs with R strategy was similar on both treatments. Similarly, Moog *et al.* (2005) observed that competitive species were particularly favoured by succession although in our study plots only C strategy-herbs preferred abandonment, unlike C strategy-graminoids.

## Conclusions

A detailed evaluation of the plant C-S-R strategy according to the main botanical groups can give different results compared to an analysis that includes all species. No matter how infertile, upland hay meadows are fairly stable systems and despite long term different

management the changes of botanical composition and C-S-R were only slight and still in process after a period of ten years of differentiated management.

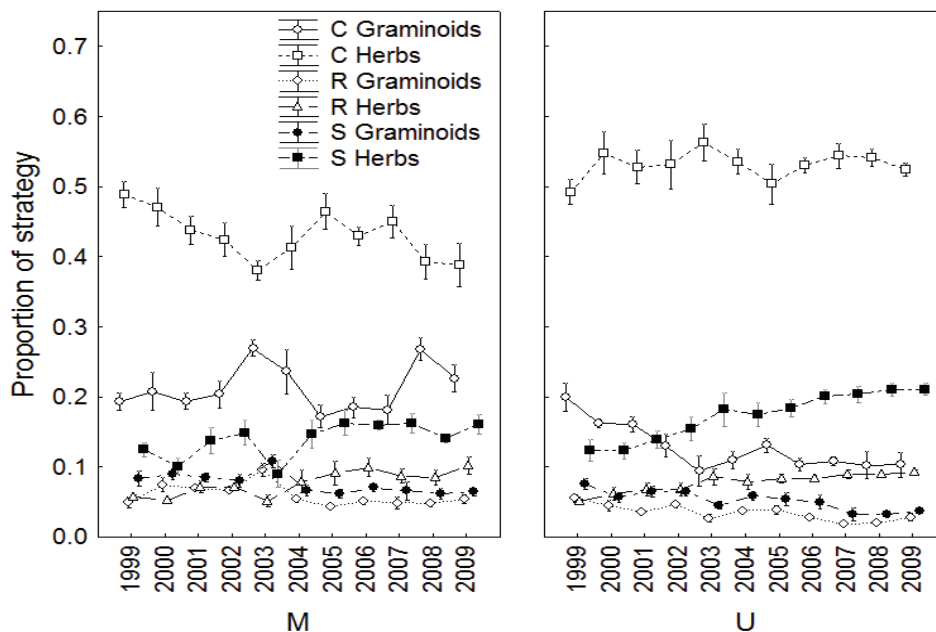

Figure 1. C-S-R signature of the vegetation during the study years 1999-2009. Error bars represent standard error of the mean.

### Acknowledgements

This study was supported by the Ministry of Agriculture (grant no. 0002700604) and Ministry of Environment CR (grant no. SP/2D3/179/07).

### References

- Eler K., Vidrih M. and Batič F. (2005) Vegetation characteristics in relation to different management regimes of calcareous grassland: A functional analysis using plant traits. *Phyton-Annales Rei Botanicae* 45, 417-426.
- Grime J.P., Hodgson J.G. and Hunt R. (1988) *Comparative Plant Ecology a Functional Approach to Common British species*. Unwin Hyman, London, UK, 742 pp.
- Huhta A.P. (2001) *Restorative mowing on semi-natural grasslands: community-level changes and species-level responses*. Doctoral thesis. Department of Biology, University of Oulu, Oulu.
- Hunt R., Hodgson J.G., Thompson K., Bungener P., Dunnett N.P. and Askew A.P. (2004) A new practical tool for deriving a functional signature for herbaceous vegetation. *Applied Vegetation Science* 7, 163-170.
- Kubát K., Hrouda L., Chrtek J. jun., Kaplan Z., Kirschner J. and Štěpánek J. (eds.) (2002) *Key to the flora of the Czech Republic*. Academia, Praha, CZ, 928 pp. (in Czech).
- Moog D., Kahmen S. and Poschold P. (2005) Application of CSR- and LHS- strategies for the distinction of differently managed grasslands. *Basic and Applied Ecology* 6, 133-143.
- Moravec J. (ed.) (1995) *Red list of plant communities of the Czech Republic and their endangerment*. Severočeskou přírodou, Litoměřice, CZ, 206 pp. (in Czech).
- Myklestad A. and Saetersdal M. (2004) The importance of traditional meadow management techniques for conservation of vascular plant species richness in Norway. *Biological Conservation* 118, 133-139.
- Ryser P., Langenauer R. and Gigon A. (1995) Species richness and vegetation structure in a limestone grassland after 15 years management with 6 biomass removal regimes. *Folia Geobotanica et Phytotaxonomica* 30, 157-167.

## Incidence of *Epichloë festucae* in *Festuca rubra* plants of natural grasslands and presence of double-stranded RNA fungal viruses

Petisco C., García-Ciudad A., Vázquez-de-Aldana B.R., García-Criado B. and Zabalgoageazcoa I.

*Instituto de Recursos Naturales y Agrobiología, IRNASA-CSIC; Apdo. 257; 37071*

*Salamanca; Spain*

Corresponding author: cristina.petisco@irnasa.csic.es

### Abstract

In natural grasslands of western Spain, *Festuca rubra* is frequently infected by *Epichloë festucae* and this association is considered as a mutualistic symbiosis. Viruses appear to be common in fungi and are often associated with symptomless infections. This study focused on three objectives: i) to examine the infection frequency of *E. festucae* in populations of *F. rubra*, ii) to identify the presence of two known viruses, EfV1 and EfV2, in *E. festucae* strains, and iii) to determine if there are differences in the chemical composition of *E. festucae* strains infected and non infected by viruses. A total of 161 plants of *F. rubra* were collected in natural grasslands at six locations. The infection frequency by *E. festucae* in these populations of *F. rubra* ranged from 24% to 87% (average 59%); 57% of the endophytic isolates were infected by viruses. EfV2 infections and coinfections by EfV1 and EfV2 were common in isolates from the different locations and only one isolate of the 93 analysed was infected only by EfV1. No significant differences were found among virus-infected and virus-free *E. festucae* isolates with respect to their chemical composition.

Keywords: Viruses, fungal endophytes, *Epichloë festucae*, *Festuca rubra*, grasslands

### Introduction

In semi-arid grasslands of western Spain, *Festuca rubra* is a very common species and *Epichloë festucae* infection rates are high in these ecosystems (Zabalgoageazcoa *et al.*, 1999). In populations of *F. rubra* infected by *E. festucae*, most plants are asymptomatic and produce infected seeds, but a few plants develop choking stromata in all or some of their flowering stems (Schardl *et al.*, 2004). Endophytic fungi can be mutualistic in some cases, for example *F. rubra* plants infected by the endophyte *E. festucae* are more resistant to several species of insect herbivores, and have a better appearance and survival rates under stressful conditions than uninfected plants. As a consequence the improvement of *F. rubra* cultivars with *Epichloë* endophytes is important in turfgrass breeding programmes (Brilman, 2005). While viruses of plants have long been recognized as important components of plant biosystems, viruses of fungi have been largely ignored (Pearson *et al.*, 2009). The associations between fungal viruses and their hosts are similar to plant-endophyte associations, so many of the known fungal viruses cause no obvious symptoms (Pearson *et al.*, 2009). Fungal virus genomes are commonly composed of double-stranded RNA (dsRNA). The presence of two dsRNA viruses with genomes of 5.2 (EfV1) and 3.2 kilo-base pairs (kbp) (EfV2) was previously described in *E. festucae* (Zabalgoageazcoa *et al.*, 1998). EfV1 is a member of the family *Totiviridae* and of the genus *Victorivirus* (Romo *et al.*, 2007). The purpose of the present investigation was: i) to determine the frequency of infection by the endophyte *E. festucae* in *F. rubra* plants in wild populations from grasslands of western Spain, ii) to estimate the incidence of infection by EfV1 and EfV2 in *E. festucae*, and iii) to test whether nutrient contents differ between virus-infected and virus-free *E. festucae* isolates.

## Materials and methods

A total of 161 plants of *F. rubra* were collected in natural semi-arid grasslands of the province of Salamanca (Spain) at six dispersed locations (Table 1). Infection by *E. festucae* was verified by isolation of the fungus from plant stems and leaf sheaths previously disinfected with a solution of 20% bleach. The stem pieces were placed on Petri plates containing potato dextrose agar (PDA) and were incubated at 24 °C in the dark for 10 - 15 days. Ninety-three isolates were identified as *E. festucae* based on the descriptions given by Leuchtman *et al.* (1994). To produce enough mycelium for RNA extraction, the 93 isolates of *E. festucae* were grown on top of cellophane disks in PDA plates. The mycelium obtained was freeze-dried and ground in a coffee grinder. DsRNA was purified from 0.5 - 1 g of mycelium by means of the CF-11 cellulose chromatography method described by Morris *et al.* (1983). The nucleic acids purified by chromatography were resolved by electrophoresis in 1% agarose gels. Double-stranded RNA elements detected ranged from 5.2 (EfV1) to 3.2 kbp (EfV2) size. The nutrient content (N, C, Ca, Cu, Fe, K, Mg, Mn, Na, P, S and Zn) of virus-infected and virus-free isolates was determined by chemical analyses using the ICP method (Inductively Coupled Plasma). Differences between means were tested with a Student's t test.

Table 1 Incidence of infections: *E. festucae* in plants of *F. rubra* and mycoviruses in *E. festucae* isolates.

Location	Plant infection		Virus infection	
	N° of plants	% plants infected	N° of isolates	% isolates infected
Berrocal	34	59	20	50
Los Valles	21	81	17	82
Servández	25	44	11	64
Llen	24	87	21	19
Membribe	28	61	17	53
Valeros	29	24	7	71
Mean	27	59	15	57

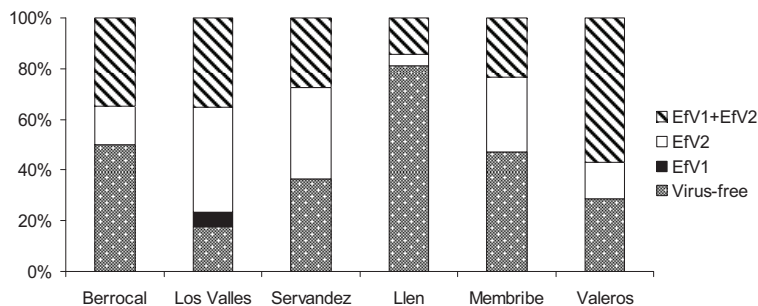

Figure 1. Frequency of EfV1 and EfV2 virus infections (%) in *E. festucae* populations.

## Results and discussion

In the six populations studied we found an average of 59% of *F. rubra* plants that were infected by *E. festucae*. The infection frequencies ranged from 24% to 87% (Table 1). The observed infection frequency was slightly lower than that reported by Zabalgoeazcoa *et al.* (1999) which was 70%. However, the results suggest that the association between *F. rubra* and the endophyte *E. festucae* is a common event in grasslands of western Spain. It has been reported that differences in infection frequency between habitats are associated with environmental variables (Wäli *et al.*, 2007). The incidence of virus infection was relatively

high among *E. festucae* isolates (mean value = 57%). The percentage of isolates infected ranged from 19% to 82% (Table 1). EfV2 and co-infections by EfV1 and EfV2 were common in isolates from most locations. Only one infected isolate, found in Los Valles, contained only the virus EfV1 (Fig. 1). Mixed infections by different mycoviruses have been reported in *E. festucae* (Romo *et al.*, 2007). Statistical analysis did not detect significant differences ( $P > 0.05$ ) in the chemical composition of infected and uninfected isolates (data not shown). Most known fungal viruses seem to be asymptomatic in their hosts, but recently a case where a virus which infects a fungal endophyte confers thermal resistance to the host plant of the virus-infected endophyte has been reported (Marquez *et al.*, 2007). In our particular case the effect of the *Epichloë* viruses upon their host fungus and plant host is yet under study.

## Conclusions

The results of this survey suggest relatively high levels of infection in *F. rubra* plants by *E. festucae* and in *E. festucae* isolates by mycoviruses. No significant effect of virus infection on the nutrient content of the *E. festucae* isolates was found.

## Acknowledgements

This work was supported by the project AGL2008-01159AGR of Spanish Ministry of Science and Technology and FEDER.

## References

- Brilman L.A. (2005) Endophytes in turfgrass cultivars. In: Roberts C.A., West C.P. and Spiers D.E. (eds.) *Neotyphodium in Cool Season Grasses*. Blackwell Publishing, Ames, USA, pp. 341-349.
- Leuchtman A., Schardl C.L. and Siegel M.R. (1994) Sexual compatibility and taxonomy of a new species of *Epichloë* symbiotic with fine fescue grasses. *Mycologia* 86, 802-812.
- Marquez L.M., Redman R.S., Rodríguez R.J. and Roossinck M.J. (2007) A virus in a fungus in a plant: three-way symbiosis required for thermal tolerance. *Science* 315, 513-515.
- Morris T.J., Dodds J.A., Hillman B., Jordan R.L., Lommel S.E. and Tamak S.E. (1983) Viral specific dsRNA: diagnostic value for plant virus disease identification. *Plant Molecular Biology Reports* 1, 27-30.
- Pearson M.N., Beever R.E., Boine B. and Arthur K. (2009) Mycoviruses of filamentous fungi and their relevance to plant pathology. *Molecular Plant Pathology* 10, 115-128.
- Romo M, Leuchtman A., Garcia B. and Zabalgoceazcoa I. (2007) A totivirus infecting the mutualistic fungal endophyte *Epichloë festucae*. *Virus Research* 124, 38-43.
- Schardl C.L., Leuchtman A. and Spiering M.J. (2004) Symbioses of grasses with seedborne fungal endophytes. *Annual Review of Plant Biology* 55, 315-340.
- Wäli P.R., Ahlholm J.U., Helander M. and Saikkonen K. (2007) Occurrence and genetic structure of the systemic grass endophyte *Epichloë festucae* in fine fescue populations. *Microbial Ecology* 53, 20-29.
- Zabalgoceazcoa I., Benito E.P., Garcia Ciudad A., Garcia Criado, B. and Eslava A.P. (1998) Double-stranded RNA and virus-like particles in the grass endophyte *Epichloë festucae*. *Mycological Research* 102, 914-918.
- Zabalgoceazcoa I., Vázquez de Aldana B.R., García Criado B. and García Ciudad A. (1999) The infection of *Festuca rubra* by the fungal endophyte *Epichloë festucae* in Mediterranean permanent grasslands. *Grass and Forage Science* 54, 91-95.

## **e-FLORA-sys, a website tool to evaluate the agronomical and environmental value of grasslands**

Plantureux S. and Amiaud B.

*UMR Nancy Université - INRA Agronomie et Environnement, Nancy-Colmar, France*

Corresponding author: Sylvain.Plantureux@ensaia.inpl-nancy.fr

### **Abstract**

e-FLORA-sys is a free website tool (<http://eflorasys.inpl-nancy.fr/>), designed by Nancy University and INRA, in order to provide a research and decision-making tool. The system is based on databases describing features of most European grassland species (ecological indices, plant traits, productivity, and forage quality), floristic composition, agricultural practices, soil and climate characteristics, and vegetation associations. From this information, the system calculates numerous indices to evaluate the agronomical and ecological value and management of grasslands. For instance, indices of forage productivity or grassland value for pollinator insects are provided by e-Floras-sys. Users can freely record their own observations (botanical relevés, agricultural practices, etc.), which are protected by a login device. One of the key goals of e-FLORA-sys is to produce real time and useful information to decision makers and scientists concerned with the management or the understanding of grasslands.

Keywords: permanent grassland, software, evaluation, plant traits

### **Introduction**

Over the last decades, evaluating and managing forage production and environmental aspects (biodiversity, water quality, etc) simultaneously in permanent grasslands has become a key question in agriculture. Perennial grasslands occupy almost 40% of the land used by the European Union. Despite this importance, the functioning of these grassland ecosystems remains only partially understood, and farmers and their advisers are still waiting for relevant tools to manage grasslands. Therefore, there is a need for research works that link, on the one hand, management, soil and climate, and grassland flora and, on the other hand, forage production (grass quantity, forage quality, seasonality of production, resistance to climate change, etc.) and environmental services (protection of biodiversity, carbon sequestration, landscape preservation etc.). This research must lead to decision-making tools being available for farmers. The purpose of e-FLORA-sys is to contribute to these goals, providing an easily accessible tool for grassland researchers, farmers and their advisers. In comparison with existing systems that are botanically, environmentally or agronomically oriented, the ambition of the system is to provide elements to understand and manage permanent grassland from a mixed agronomical and environmental point of view. There are numerous available computer applications (programs or websites) for the description of species (i.e. LEDA plant traits base), or for ecological data processing such as CANOCO, PC-ORD and SYNTAX compared by Gilliam *et al.* (2003). e-FLORA-sys does not aim to replace these tools but to provide a complementary tool at the interface of agronomy and the ecology of permanent grassland. A first and simpler version named 'FLORA-sys' was set up in 1995 (Plantureux, 1996).

### **System structure**

e-FLORA-sys is a free website tool based on a relational database management system (MySQL). The system has been developed with CakePHP, a development framework for PHP. Database structure can be modified by administrators to improve the system (i.e. introduce new criteria). It is available in English and French languages, but species names are also translated into German (German and Spanish versions soon). Everyone can access the

system, but an authentication (login and password) is needed to fully use all the features of e-FLORA-sys. This guarantees the confidentiality of data entered by users (i.e. botanical relevés). All the calculations are performed and data stored on a central machine, but users can export in various formats (txt, pdf, csv) input data and calculation results.

There are twelve tables managed by the system (Fig. 1):

The species table contains information on plants (currently 3000 species) found in most European grasslands, including some tree species sometimes found in abandoned or very extensive situations. For each species, the information concerns the following criteria (more than 100 variables per species): identification (translations and synonyms), agronomical value (potential production level, quality for cattle, sheep, goats and horses), patrimony value (rarity, inscription on red lists), reaction to abiotic factors (soil and climate) and agricultural practices (i.e. adaptation to frequent cutting or trampling) including Ellenberg indices, biological and ecological characteristics (aerial part, root and diaspore morphology, germination, reproduction and dispersion, life traits, classification in typologies like Raunkier types).

The Relevé table includes the floristic composition observed on a station, and all the calculations, graphs and texts generated by the system for an agronomical and an ecological diagnosis. Several methods of relevé are available. Each relevé is linked to a station (station table) which is itself linked to three tables describing the climate (temperature, precipitation and radiation), the soil (physical and chemical parameters) and the agricultural practices (fertilization, grazing and forage harvesting management, other practices). The ‘plant associations and typology’ table enables the users to link the relevés to record known types of grassland vegetation or European habitats. Relevés can be gathered in projects, in order to study grasslands of a particular region, to compare evolution in time, or to focus on a specific aspect (i.e. effect of nitrogen fertilization amount). Pictures of species and grasslands can be stored in a table. The access to information is controlled by a system of user rights defined in the table of ‘people and rights’. A dictionary allows a full translation of all technical and software command terms in English and French (German and Spanish in progress). Finally, a table describing decision rules mobilized to produce the agronomical and ecological interpretation, and to predict floristic composition (see Flora-predict description below).

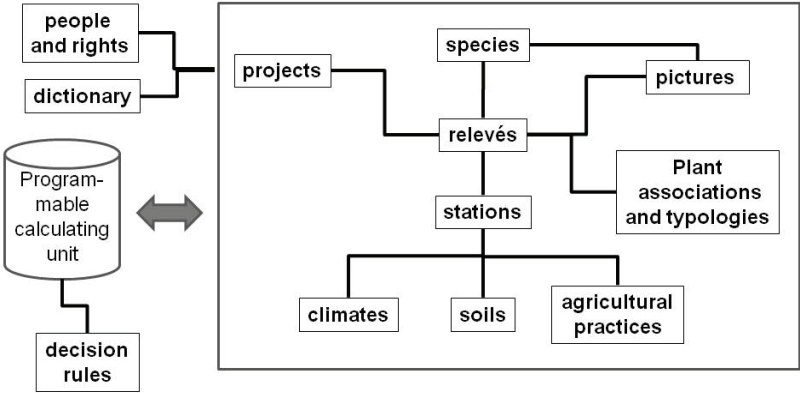

Figure 1: General e-FLORA-sys database organisation - Tables with the main links

**Applications for research and decision making**

*Data management and collection:* For those who collect various data on grassland and biotic and abiotic factors influencing vegetation, e-FLORA-sys is a secure and a comprehensive



solution. It allows the users to record data in order to perform studies over long time periods or studies on metabases (almost 10000 relevés currently in the database). This can be very useful for researchers, for example to set or to improve the precision of response curves or ecological profiles of species. For decision makers, it can be used as a frame of reference on grassland types and agronomical and ecological values.

*Calculation of indices:* These indices can be sorted in four categories : 1) Ellenberg or similar dominance in sward, and evaluating the state of vegetation, soil or agricultural practices (i.e. soil nitrogen fertility, soil moisture, trampling level, etc ), 2) diversity indices : species richness, Shannon indices, Red List plants counting, 3) agronomical indices such as pastoral value or mean forage quality, and 4) (under construction) indicators evaluating agri-environmental services like preservation of pollinator activity, habitat conservation, aromatic quality of the forage for cheese production, landscape aesthetic value, etc.

*Plant species richness prediction (FLORA-predict):* FLORA-predict is a mechanistic model built by Amiaud *et al.* (2005) in order to predict the floristic composition of a grassland from agricultural practices, soil and climate conditions and biogeographical area. Model output is a probability of presence of species. In e-FLORA-sys, this model can be used either to validate the hypotheses and the formulae of FLORA-predict or improve them (research objective), or to test scenario of changing agricultural practices (decision making objective).

*Evaluation of agronomical and ecological value:* This evaluation is mainly based on the calculation of indicators. For instance, the nitrogen indicator designed by Pervanchon *et al.* (2005) will assess environmental risks due to nitrogen management. Although the main purpose of this evaluation is decision making, research applications can be found.

*Research tool:* A key feature of e-FLORA-sys is the possibility to modify decision rules, calculation formulae and database structures without rewriting the program instructions. This parameterization allows an evaluation of new hypotheses, calculations and interpretation methods. Researchers elsewhere are thus invited to suggest improvements. Moreover, the broad range of relevés recorded in the database can be used in research programmes, for instance to set ecological profiles of species. e-FLORA-sys is currently implemented to test whether plant life traits can predict agronomic and environmental performances of a French network of 200 grasslands along an intensification and a climate gradient.

## Conclusion

e-FLORA-sys is already providing key information on agronomical and environmental values for scientists and decision makers. The system was built to allow continuous improvements by its designers, but also by the scientific and technical community. It appears as a tool for sharing knowledge and data on permanent grassland.

## References

- Amiaud B., Pervanchon F. and Plantureux S. (2005) An expert model for predicting species richness in grasslands: Flora-predict. In: Proceedings of the 13th International Occasional Symposium of the European Grassland-Federation 2005, Tartu Estonia, *Grassland Science in Europe* 10, 103-106.
- Gilliam F.S. and Saunders N.E. (2003) Making more sense of the order: A review of Canoco for Windows 4.5, PC-ORD version 4 and SYN-TAX 2000. *Journal of Vegetation Science* 14, 297-304.
- Pervanchon F., Bockstaller C., Amiaud B., Peigné J., Bernard P.Y., Vertes F., Fiorelli J.L. and Plantureux S. (2005) A novel indicator of environmental risks due to nitrogen management on grasslands. *Agriculture Ecosystems and Environment* 105 (1-2), 1-16
- Plantureux S. (1996) FLORA-sys: a software for the data management and the interpretation of botanical composition of permanent pastures. *Acta Botanica Gallica* 143(4-5): 403-410.

# Effects of extensive year-round grazing on breeding bird communities in Northern Germany

Ruf M.<sup>1</sup>, Neumann H.<sup>2</sup> and Reck H.<sup>3</sup>

<sup>1</sup>*Institute of Geography, Christian-Albrechts-Universität zu Kiel, D-24118 Kiel, Germany*

<sup>2</sup>*Institute of Crop Science and Plant Breeding, Christian-Albrechts-Universität zu Kiel, D-24118 Kiel, also: Deutscher Verband für Landschaftspflege e.V., D-24220 Flintbek, Germany*

<sup>3</sup>*Ecology Centre, Christian-Albrechts-Universität zu Kiel, D-24118 Kiel, Germany*

Corresponding author: MRuf@gmx.de

## Abstract

The effects of extensive year-round grazing on breeding bird communities have rarely been investigated so far. For this purpose, territory mapping of birds was carried out on ten sites in the federal state of Schleswig-Holstein in Northern Germany in 2009. Grazing areas were characterised by low stocking rates (0.3 to 0.6 livestock units per hectare) as well as by abandonment of fertilisation, herbicides and tillage operations. For every grazing area, a similar conventionally used agricultural site was selected for reference purposes (paired sampling design: resemblance to area size, landscape structure and former agricultural management of the grazing sites). 43 breeding bird species were registered on the study sites, 38 of them on the grazing areas and 23 on the reference sites. Total abundance of breeding pairs and diversity (species density, Shannon index) were significantly higher on the grazing sites compared to the reference areas. Species density as well as total abundance of threatened bird species also achieved higher values in the year-round grazing sites. Both species and breeding bird density of ground nesting bird species were significantly higher in the grazing areas. Significant effects on the abundance of single bird species could be detected for Tree Pipit (*Anthus trivialis*) and Skylark (*Alauda arvensis*), which both reached higher abundances in the grazing sites. Results indicate that establishment of extensive year-round grazing systems can make a positive contribution to the protection of (threatened) bird species.

Keywords: grassland, conservation, biodiversity, fauna

## Introduction

Extensive year-round grazing systems with low stocking rates and abandonment of fertilisation and tillage operations have been established as a cost-effective and practicable tool for grassland conservation in Germany (Riecken *et al.*, 2004; Bunzel-Drüke *et al.*, 2008). However, the effects of the system on ecological communities, especially on fauna, have rarely been investigated. Our study aimed to answer the question of how breeding bird communities of year-round grazing conservation areas differ from those of conventionally managed agricultural reference sites. It was expected (as a hypothesis) that on the grazing areas species diversity, and also population density of single species, would be higher than on reference sites. Another question was whether species conservation issues (occurrence of threatened species) can be supported by the establishment of extensive year-round grazing.

## Materials and methods

Ten extensive year-round grazing areas in the eastern and central part of the federal state of Schleswig-Holstein in Northern Germany were chosen for investigations. Additionally, ten neighbouring conventionally used agricultural sites were selected for reference purposes. Grazing and reference sites were similar alike regarding topography, area sizes and (linear)

wood structures (paired sampling design). The size of study areas ranged between 10 and 40 hectares (mean: 22.6 hectares) and the density of linear wood structures varied between 20 and 150 metres per hectare (mean: 83.1 metres per hectare). Land use of the reference sites was similar to the former agricultural management of the grazing sites. Six of the reference sites were cultivated with arable crops; three of them were grassland (pasture, meadow) and one site was fallow land. Year-round grazing areas were managed for conservation purposes and were grazed with stocking rates of 0.3 to 0.6 livestock units per hectare. Eight sites were grazed by cattle and two sites were grazed by cattle and horses. Land use contracts included a ban on fertilisation, herbicides and tillage operations as well as an abandonment of extra-feeding of livestock (exception: times of need, e.g. continuing snowfalls in winter). Due to conservation measures for amphibians, seven grazing areas contained periodic or permanent waters (sizes ranging from 0.4 to 4.5 hectares), whereas on the reference sites there were no waters. Breeding bird populations were determined by territory mapping (Bibby *et al.*, 1995). In order to analyse breeding bird communities, several common ecological parameters were calculated (see results). Differences between year-round grazing and reference areas were analysed by two-sample t-tests as well as by sign tests of pairwise differences between grazing and reference sites (SAS 9.1.3, SAS Institute Inc.).

Table 1. Comparison of year-round grazing with reference sites (arithmetic means, t-tests, n = 10, df = 18, \*: significant for  $P < 0.05$ ).

Parameter	Grazing sites	Reference sites	t	$P >  t $
Species density (species per 10 ha)	5.27	1.38	-4.79	0.0001*
Shannon index	0.91	0.41	-4.89	0.0001*
Total abundance of all species (territories per 10 ha)	10.87	2.81	-4.96	0.0001*
Species density of threatened species (species per 10 ha)	1.62	0.55	-4.52	0.0003*
Total abundance of threatened species (territories per 10 ha)	4.10	1.06	-4.63	0.0002*

## Results and discussion

Altogether, 43 breeding bird species were recorded on the study sites. There were 38 species found on the grazing areas and 23 on the reference sites. Breeding bird communities of the grazing areas were dominated by the following species (presence (p) > 50 %): Wagtail (*Motacilla alba*) (p = 100 %), Tree Pipit (*Anthus trivialis*) (p = 90 %), Skylark (*Alauda arvensis*) (p = 80 %), Reed Bunting (*Emberiza schoeniclus*) (p = 70 %), Meadow Pipit (*Anthus pratensis*) (p = 60 %), Whinchat (*Saxicola rubetra*) (p = 50 %), Red-backed Shrike (*Lanius collurio*) (p = 50 %) and Mallard (*Anas platyrhynchos*) (p = 50 %). Differences in abundance could be detected for two species. Compared to the reference sites, Tree Pipit and Skylark reached higher abundances on the year-round grazing areas (sign-tests,  $P < 0.05$ ). Species diversity and total abundance of species was higher in the grazing areas compared to the reference sites (Table 1). Concerning threatened species (Knief *et al.*, in preparation), both species and breeding bird density also reached significantly higher values in the grazing areas. The guild of ground nesting birds showed a higher abundance and species diversity in the grazing areas compared to the reference sites (Table 2). In contrast, no differences between grazing and reference sites could be detected for the groups of bird species nesting in tall forbs or in shrubs and trees. In the grazing areas on average 19.1% of all territories belonged to water birds. The higher diversity and population density of bird species determined for extensive year-round grazing sites may be due to a more appropriate vegetation structure and a better food supply (abandonment of fertilisation, herbicides and tillage operations). Water bodies created on grazing sites influenced bird communities; however, extent was moderate. Our study did not include examination of breeding success, which is an important parameter

to evaluate agricultural land use systems. However, breeding losses caused by livestock on grazing sites should be low due to low stocking rates.

Table 2. Results of sign-tests carried out for different nesting guilds (differences between year-round grazing and reference sites, n = 10, \*: significant for  $P < 0.05$ ).

Nesting guild	Abundance (territories per ha)		Species density (species per ha)	
	M	$P >  M ^{\dagger}$	M	$P >  M ^{\dagger}$
Ground	4.5	0.0117*	5	0.0060*
Vegetation, tall forbs	2	0.5782	2	0.4376
Vegetation, shrubs	2.5	> 0.5782	2	> 0.4376

<sup>†</sup>incl. corrections after Bonferroni-Holm

## Conclusions

Results indicate that the establishment of extensive year-round grazing seems to be a reasonable tool to support species diversity and populations of (threatened) farmland bird species on a local to regional scale.

## References

- Bibby C.J., Burgess N.D. and Hill D.A. (1995) *Methoden der Feldornithologie: Bestandserfassung in der Praxis*. Neumann, Radebeul, Germany, 270 pp.
- Bunzel-Drüke M., Böhm C., Finck P., Kämmer G., Luick R., Reisinger E., Riecken U., Riedl J., Scharf M. and Zimball O. (2008) 'Wilde Weiden' – *Praxisleitfaden für Ganzjahresbeweidung in Naturschutz und Landschaftsentwicklung*. Arbeitsgemeinschaft Biologischer Umweltschutz im Kreis Soest e.V., Bad Sassendorf-Lohne, Germany. 215 pp.
- Knief W., Berndt R.K., Hälterlein B., Jeromin K., Kieckbusch J.J. and Koop B. (in preparation) Die Brutvögel Schleswig-Holsteins - Rote Liste, 5. Fassung. (pre-printed) In: Ministerium für Landwirtschaft, Umwelt und ländliche Räume des Landes Schleswig-Holstein (eds.) *Gemeinsam für Knoblauchkröte, Abendsegler and Co. – Artenhilfsprogramm Schleswig-Holstein 2008*. Kiel, Germany, pp. 25-30.
- Riecken U., Bunzel-Drüke M., Dierking U., Finck P., Härdtle W., Kämmer G., Reisinger E. and Sandkühler J. (2004) Perspektiven großflächiger Beweidungssysteme für den Naturschutz: 'Lüneburger Erklärung zu Weidelandschaften und Wildnisgebieten'. In: Finck P., Härdtle W., Redecker B. and Riecken U. (eds.) *Schriftenreihe für Landschaftspflege und Naturschutz 78*. Bundesamt für Naturschutz, Münster, Germany, pp. 527-539.

## Mechanical weeding of *Rumex obtusifolius* in grasslands

Strnad L.<sup>1</sup>, Hejzman M.<sup>1,2</sup>, Křišťálová V.<sup>1</sup> and Fričová K.<sup>1</sup>

<sup>1</sup>Department of Ecology, Faculty of Environmental Sciences, Czech University of Life Sciences, Kamýcká 129, CZ-165 21 Prague 6 - Suchbát, Czech Republic

<sup>2</sup>Crop Research Institute, Drnovská 507, CZ-161 06 Prague 6 - Ruzyně, Czech Republic

Corresponding author: strnad@fzp.czu.cz

### Abstract

In Europe, *Rumex obtusifolius* L. is a serious grassland weed, especially under the conditions of organic agriculture. The aims of this study were (1) to test the effectiveness of repeated mechanical weeding of *R. obtusifolius* plants from a permanent sward in the Czech Republic, where the plants were cut twice per year and dug out from 5 cm below the ground, and (2) to test the effect of nutrient availability on the effectiveness of mechanical weeding. In 2007, the manipulative experiment was established on permanent grassland infested by *R. obtusifolius* with the following fertiliser treatments: control, P, N, NP and NPK. Plants of *R. obtusifolius* were removed eight times during three vegetation seasons. No significant decrease in plant density of *R. obtusifolius* was recorded after the three vegetation seasons and the density was not significantly affected by fertiliser treatment. Mechanical weeding – digging the plants out from 5 cm below the ground – was not a sufficient method for the control of *R. obtusifolius* in infested fertilised grasslands, even when applied eight times during three vegetation seasons.

Keywords: nitrogen, phosphorus, potassium, fertiliser, weed control

### Introduction

Broad-leaved dock (*Rumex obtusifolius* L.) is a common and troublesome weed in temperate grasslands because of its high seed production, persistent soil seed bank and high regenerative ability from fragmented underground organs (Honěk and Martínková, 2002). For farmers, fear of a grassland infestation by *R. obtusifolius* is one of the most important obstacles preventing the switch from conventional to organic farming in many countries (Zaller, 2004). Whether digging the plants out from 5 cm below ground surface several times during the vegetation season is a sufficient enough method for the control of *R. obtusifolius* still remains unclear. Furthermore, one of the factors enabling the spread of *R. obtusifolius* into grasslands is the high nutrient availability, as *R. obtusifolius* is believed to be nitrophilous and its competitive ability in grass-dominated swards is substantially increased with high N availability in the soil (Hopkins and Johnson, 2002). The aim of this study, therefore, was to answer following questions: 1) is digging the plants out from 5 cm below the ground, repeated several times during three consecutive vegetation seasons, a sufficient enough method for *R. obtusifolius* control? 2) Is there any effect of N, P and K availability on the effectiveness of this mechanical weeding?

### Material and methods

The fertiliser experiment was set up near the village Mšec, 45 km northwest of Prague (50°12'24" N, 13°51'40" E). The study site is flat meadow with a mean annual precipitation and temperature of 550 mm and 8 °C, respectively. The experiment was established on a *Dactylis glomerata* and *Festuca arundinacea* meadow infested by *Rumex obtusifolius* in the summer of 2007, and was arranged in four completely randomized blocks, each with five fertiliser treatments (20 plots altogether): unfertilized control (C), application of P (P), N (N),

N and P (NP) and N, P and K (NPK). Total annual applications of N, P and K was 300 kg ha<sup>-1</sup> N, 80 kg ha<sup>-1</sup> P and 200 kg ha<sup>-1</sup> K in 2008 and 2009. The area of each individual monitoring plot was 4 m × 3 m. The plants were cut twice per year at the start of June and in late August in 2007 and 2008. Mechanical weeding of *R. obtusifolius* was performed manually (digging the plants out from 5 cm below the ground) eight times during the study period. The number of all *R. obtusifolius* plants (growing points, individual plants and seedlings together) was counted in each monitoring plot in the term of each mechanical weeding. The collected data were recalculated and expressed as plant density per 1 m<sup>2</sup> in all analyses.

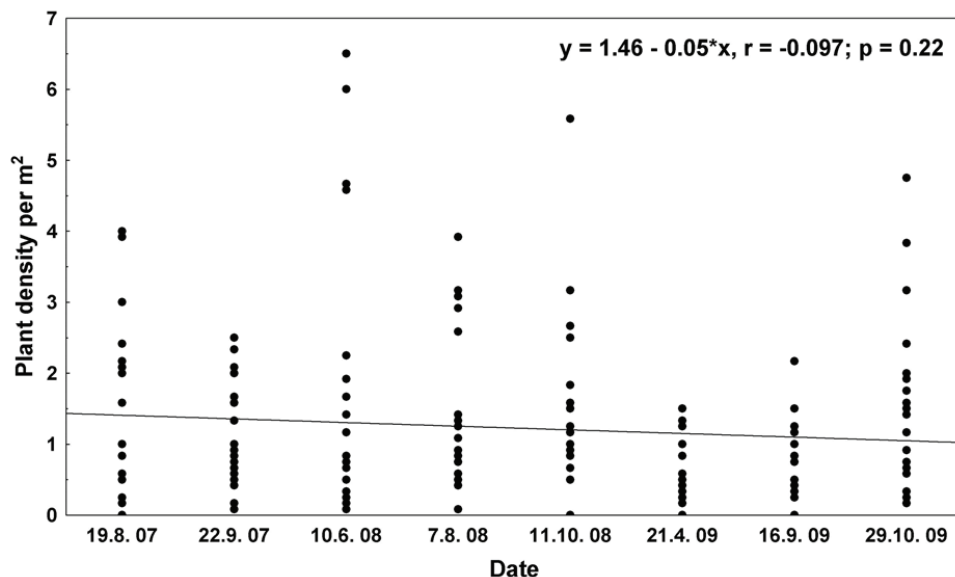

Figure 1 Plant density of *Rumex obtusifolius* as a function of sampling date.

## Results and discussion

The mean density of *R. obtusifolius* plants was 1.4 and 0.8 individuals per m<sup>2</sup> at the start and at the end of the experiment, respectively. Calculations of linear regression revealed no significant decrease in the density of *R. obtusifolius* during the experiment (Fig. 1). One-way ANOVA showed that the effect of the treatment was not significant on each individual sampling date. The main message of this paper is that no significant decrease in the density of *R. obtusifolius* was recorded after three seasons of digging the plants out from 5 cm below the soil surface. Furthermore, no significant effect of fertiliser treatment on the effectiveness of mechanical weeding indicated that regeneration of *R. obtusifolius* after digging out cannot be improved by an increase in N, P or K supply. The low effectiveness of mechanical weeding was caused by 1) a high regeneration of removed plants from underground organs, and in several cases by 2) recruitment of seedlings from the soil seed bank that was recorded in places where the sward was damaged by digging. The high regeneration (73%) of *R. obtusifolius* from underground organs of plants cut out from 5 cm below the soil surface was also reported by Dierauer (1993). On the other hand, Bond *et al.* (2007) recorded the regeneration of only 25% of plants cut at the same depth. A new finding by this study was that high regeneration of *R. obtusifolius* from underground organs of plants cut from 5 cm below the soil surface can be recorded even in the case of repeated weeding. Although mechanical weeding was not able to fully eradicate *R. obtusifolius* from the grassland, it was probably able to prevent its predominance over grasses, especially in treatments with N

application. An increase in the competitive ability of *R. obtusifolius* over grasses was frequently recorded in conditions of high N application rates (Hatcher *et al.*, 1997). The low effect of P and K application on the growth of *R. obtusifolius* can be explained by optimal P and K availability in the soil before the establishment of the experiment. The concentration of plant-available (Mehlich III) P was 152 mg kg<sup>-1</sup> and plant-available K was 267 mg kg<sup>-1</sup> in the upper 10 cm soil layer and these values are considered as optimal for crops with high P and K demands.

## Conclusion

Mechanical weeding – digging out of plants 5 cm below ground – is not a sufficient method for the control of *R. obtusifolius* in infested grasslands, even when applied eight times using a two to three cutting management scheme during the three vegetation seasons.

## Acknowledgements

This research was funded by the Ministry of Agriculture of the Czech Republic for project NAZV 72217.

## References

- Bond W., Davies G. and Turner R.J. (2007) The biology and non-chemical control of broad-leaved dock (*Rumex obtusifolius* L.) and curled dock (*R. crispus* L.). HDRA, Ryton Organic, Coventry, UK., 36 pp. (Online at <http://www.gardenorganic.org.uk/organicweeds/downloads/dock%20review.pdf>).
- Dierauer H.U. (1993) Efficiency of different non-chemical methods of controlling Broadleaf dock (*Rumex obtusifolius*). *Communications of the 4th International Conference I.F.O.A.M. - Non Chemical Weed Control*, Dijon, France, pp. 311–314.
- Hatcher P.E., Paul N.D., Ayres P.G. and Whittaker J.B. (1997) Added soil nitrogen does not allow *Rumex obtusifolius* to escape the effects of insect-fungus interactions. *Journal of Applied Ecology* 34, 88–100.
- Honěk A. and Martínková Z. (2002) Effects of individual plant phenology on dormancy of *Rumex obtusifolius* seeds at dispersal. *Weed Research* 42, 148–155.
- Hopkins A. and Johnson R.H. (2002) Effect of different manuring and defoliation patterns on broad-leaved dock (*Rumex obtusifolius*) in grassland. *Annals of Applied Biology* 140, 255–262.
- Zaller J.G. (2004) Ecology and non-chemical control of *Rumex crispus* and *R. obtusifolius* (*Polygonaceae*): a review. *Weed Research* 44, 414–432.



## Effect of different management on the yields, forage quality and botanical composition of permanent grassland

Štýbnarová M.<sup>1</sup>, Svozilová M.<sup>1</sup>, Hakl J.<sup>3</sup>, Karabcová H.<sup>2</sup>, Pozdíšek J.<sup>2</sup> and Otrhálková, P.<sup>2</sup>

<sup>1</sup>*Agriresearch Rapotín Ltd., Výzkumníků 267, 788 13 Vikýřovice, Czech Republic*

<sup>2</sup>*Research Institute for Cattle Breeding, Ltd., Výzkumníků 267, 788 13 Vikýřovice, Czech Republic*

<sup>3</sup>*Czech University of Life Sciences, Department of Forage Crops and Grassland Management, Kamýcká 129, 165 21 Prague 6-Suchbát, Czech Republic*

Corresponding author: marie.stybnarova@vuchs.cz

### Abstract

We investigated the effects of cutting frequency and fertilisation on the dry matter (DM) yield, forage quality and plant species composition of permanent grassland. A plot trial was set up in 2003 at Rapotín. Four levels of cutting frequency (4 cuts per year; 3 cuts per year; 2 cuts per year; 1 or 2 cuts per year) and four levels of fertilisation (no fertilisation, P<sub>30</sub>K<sub>60</sub>, N<sub>90</sub>P<sub>30</sub>K<sub>60</sub>, N<sub>180</sub>P<sub>30</sub>K<sub>60</sub>; pure nutrients) were applied from 2003-2008. The results showed that DM yield was significantly influenced by fertilisation and by intensity of use; the lowest DM yield was found with the 4-cut regime (6.10 t ha<sup>-1</sup>). Decreasing the cutting frequency reduced the energy value (NEL) to 4.64 MJ kg<sup>-1</sup> DM. The redundancy analyses showed that species composition was significantly influenced by intensity of use (9.5%) and time (8.5%).

Key words: grasslands, fertilisation, utilisation, yield, forage quality, species composition

### Introduction

Grassland management has a crucial effect on the production and quality of forage and, at the same time, animal performance. However, some excessive practices such as intensive grassland production and mineral fertilisers can lead to a serious degradation of the species diversity of grassland communities (Chapman, 2001). Klimeš *et al.* (2007) describe the positive ecological functions of grasslands that are associated with their botanical composition and the dynamics and quality of biomass production. For this reason, it is essential to use different approaches in order to be able to select the most appropriate method of grassland management and to observe all relevant aspects and consequences. The development of management practices that prevent degradation enables us to maintain the biodiversity of various ecosystems. The aim of this contribution is to evaluate how different strategies affect dry matter (DM) yield and forage quality in permanent grasslands on the basis of the grassland trials established under the conditions of the Czech Republic by simultaneous observation of species composition.

### Materials and methods

A trial was established in 2003 on permanent grassland sites in the locality Rapotín at an altitude 390-402 m a.s.l. Total annual rainfall is 693 mm and mean annual temperature is 7.2 °C. The experimental design was a randomised complete block in four replicates with the plot size 12.5 m<sup>2</sup>. The grassland vegetation on the experimental stands was classified as *Arrhenatherion*. Four levels of intensity of utilisation were used: intensive (1<sup>st</sup> cut by 15 May; 4 cuts per year at 45-day intervals); medium intensive (1<sup>st</sup> cut between 16 and 31 May, 3 cuts per year at 60-day intervals); low intensive (1<sup>st</sup> cut between 1 and 15 June, 2 cuts per year at 90-day intervals); and extensive (1<sup>st</sup> cut between 16 and 30 June, 1 or 2 cuts per year, second

cut after 90 days). Each utilisation treatment was divided into four levels of fertilisation: no fertilisation; N<sub>0</sub>P<sub>30</sub>K<sub>60</sub>; N<sub>90</sub>P<sub>30</sub>K<sub>60</sub>; N<sub>180</sub>P<sub>30</sub>K<sub>60</sub> (pure nutrients). The annual DM yield was measured for all plots. The samples of forages collected during 2003 - 2008 depending on the term of cut (264 samples in total) were analysed for the content of crude protein (CP), ether extract (EE), crude fibre (CF) and ash (A). The estimation of organic matter digestibility (OMD) was conducted using the modified *in vitro* method of Tilley and Terry (1963). The energy value was determined in terms of ME (metabolisable energy) and NEL (net energy of lactation). The botanical composition was estimated before the first cut by the projective dominance method. The results were statistically evaluated using a two-way ANOVA (effects of intensity of utilisation, fertilisation and their interaction) followed by the LSD test. However, interactions for all parameters under investigation were evaluated according to the model design (full factorial two-way ANOVA). Redundancy analyses were performed using the CANOCO for Windows v. 4.5 software.

Table 1 Dry matter (DM) yield and forage quality in DM at different grassland management (2003-2008).

Treatment	DM [t ha <sup>-1</sup> ]	CP [g kg <sup>-1</sup> ]	CF [g kg <sup>-1</sup> ]	EE [g kg <sup>-1</sup> ]	A [g kg <sup>-1</sup> ]	OMD [%]	ME [MJ kg <sup>-1</sup> ]	NEL [MJ kg <sup>-1</sup> ]
1A	4.68	146.8	240.0	32.8	109.2	67.7	9.31	5.46
1B	4.75	143.3	243.9	33.7	112.5	67.3	9.22	5.39
1C	6.93	157.8	236.8	33.4	110.1	67.2	9.22	5.39
1D	8.05	178.7	237.8	34.0	107.6	68.1	9.37	5.50
2A	4.85	127.0	257.6	31.4	109.3	65.8	8.96	5.22
2B	4.99	127.8	259.3	33.2	116.4	64.6	8.70	5.03
2C	6.87	140.7	258.9	33.1	118.4	66.2	8.94	5.20
2D	8.09	160.0	261.6	32.8	115.5	65.9	8.96	5.21
3A	5.00	106.7	286.0	27.7	93.1	61.5	8.44	4.85
3B	5.45	105.4	288.1	28.4	95.6	61.8	8.47	4.87
3C	7.69	120.7	298.9	27.6	93.9	61.3	8.42	4.83
3D	8.31	144.6	295.7	28.8	86.5	63.3	8.80	5.10
4A	5.15	99.4	304.3	26.4	93.4	60.1	8.24	4.70
4B	5.42	102.2	300.2	27.7	97.3	61.0	8.32	4.76
4C	7.76	115.8	308.4	28.2	96.2	59.1	7.98	4.52
4D	7.94	127.2	303.9	27.9	93.1	59.8	8.15	4.64
Mean	6.37	131.5	273.8	30.4	103.0	63.8	8.72	5.04
LSD <sub>0.05</sub>	0.68	10.9	12.7	1.3	4.9	1.5	0.21	0.15

Intensity of utilisation: 1 = intensive (4 cuts per year); 2 = medium intensive (3 cuts per year); 3 = low intensive (2 cuts per year); 4 = extensive (2-1 cut per year)

Fertilisation: A = no fertilisation; B = P<sub>30</sub>K<sub>60</sub>; C = N<sub>90</sub>P<sub>30</sub>K<sub>60</sub>; D = N<sub>180</sub>P<sub>30</sub>K<sub>60</sub> (pure nutrients)

## Results and discussion

The results for DM yield and forage quality are given in Table 1 (means of 2003-2008). Mixed effects of intensity × fertilisation were computed as not significant for all of parameters ( $P > 1.0$ ). The overall DM yield varied from 4.68 to 8.31 t ha<sup>-1</sup>, whereas the highest DM yield was achieved in treatment fertilised with the highest dose of nitrogen, in line with the results of other authors. Intensity of utilisation decreased the yield up to 4.68 t ha<sup>-1</sup>, especially when four cuts were taken, confirming the results of Gruber *et al.* (2000). The energy value (NEL) was also influenced by the grassland management, with some differences being significant. The highest energy content in DM (5.50 MJ kg<sup>-1</sup>) was found in the intensive utilisation by the fertilisation N<sub>180</sub>P<sub>30</sub>K<sub>60</sub>. The content of crude protein in DM significantly decreased with extensive utilisation up to 99.4 g kg<sup>-1</sup>. This qualitative parameter was also positively influenced mainly by nitrogen fertilisation at all treatments of intensity of utilisation. Organic matter digestibility (OMD) negatively correlated with the amount of crude fibre in the fodder.

The intensity of utilisation had especially significant effects on OMD, with decreasing intensity of utilisation reducing the OMD up to 59.1%.

Trends in species composition during 2003 – 2008 were calculated by redundancy analysis – RDA (Note: figure not presented in this paper). The inclusion of environmental variables (time, fertilisation, cutting regime) explained ca 22% of the variability in species composition. Species composition under our conditions was the most significantly influenced by intensity of utilisation (9.5%) and time (8.5%). However, it was confirmed that the level of fertilisation towards higher rates of nitrogen decreased the total number of species in vegetation, in line with the results of e.g. Veselá and Mrkvička (2005). The effect of the intensity of utilisation on the species diversity was significant only in unfertilised grasslands where the highest number of species was achieved for the extensively utilised treatment (20 species in mean of 2003-2008). It corresponds with the results of Šarapatka *et al.* (2005) who mention that intensive grassland utilisation leads to the suppression of the competitively weak species and, in consequence, to reduction in the species diversity. Furthermore, it was found that nitrogen fertilisation in combination with extensive utilisation increased the proportion of grasses in the vegetation (dominance of 86.3% for mean of 2003-2008). The main grass species that extended their dominance were *Elytrigia repens* and *Dactylis glomerata*. The highest mean proportion of legumes, particularly *Trifolium repens* (dominance of 14.3% for the mean of 2003-2008), was found in the intensively utilised treatment with N<sub>0</sub>P<sub>30</sub>K<sub>60</sub> fertilisation, which corresponds with findings of other authors (e.g. Hein *et al.*, 1999).

## Conclusion

On the basis of our results we can conclude that DM yield, forage quality and botanical composition of permanent grassland can be significantly influenced by management (fertilisation, exploitation). These findings are related to the conditions in the Czech Republic and they are important for the nutrition of cattle and for efficient grassland management.

## Acknowledgement

This work was supported by the Ministry of Education, Youth and Sports of the Czech Republic, Project No. MSM 2678846201 and LA 08041.

## References

- Chapman R. (2001) Recreated botanical diverse grassland. In: Tow P.G. and Lazenby A. (eds) *Competition and Succession in Pastures*, CAB International, Wallingford, UK, pp. 261-282.
- Gruber L., Steinwider A., Guggenberger T., Schauer A., Häusler J., Steinwender R. and Steiner B. (2000) Einfluss der Grünlandbewirtschaftung auf Ertrag, Futterwert, Milcherzeugung und Nährstoffausscheidung. 27. *Viehwirtschaftliche Fachtagung*, Bericht BAL Gumpenstein, 6.-8. Juni 2000, pp. 41-88.
- Hein V., Older H. and Papanastasis V.P. (1999) Management of natural meadows in Estonia. *Grassland Science in Europe* 4, 377-381.
- Klimeš F., Kolář L., Květ J., Opitz von Boberfeld W. and Laser H. (2007) Methodological aspects in the study of species richness, diversity and homotony of grass cover. *Plant, Soil and Environment* 53, 33-41.
- Šarapatka B., Hejduk S. and Čížková S. (2005): *Permanent grasslands in ecological agriculture*. PRO-BIO Svaz ekologických zemědělců, Šumperk. 24 pp.
- Tilley J.M.A. and Terry R.A. (1963) A two stage technique for the *in vitro* digestion of forage crops. *Journal of the British Grassland Society* 18, 104-111.
- Veselá M. and Mrkvička J. (2005) Changes in succession of plant species during long-term fertilization. In: Fuksa P. (ed.) *Současná aktuální témata pícninářství a trávníkářství*. ČZU, Prague, pp. 93-96.

## Fertilization as a factor of plant community change, higher productivity and water percolation on a mountain meadow

Szewczyk W. and Kasperczyk M.

*Department of Grassland Science, Agricultural University of Cracow, PL 31-120*

Corresponding author: w.szewczyk@ur.krakow.pl

### Abstract

Mountain grasslands serve multiple functions. They are not only the main source of forage in mountainous areas but also play an important environmental role. This study aimed at analysing the effects of fertilization on floristic changes, utilization value and rainwater retention in a mountain meadow. An experiment was performed from 2005-2007 comprising three fertilizer treatments (farmyard manure, mineral fertilizers, or combination of both) and a control treatment. On each plot lysimeters were dug into the soil. Mineral fertilization showed considerable effects on the floristic composition of the sward. It reduced the number of species in comparison to the control treatment, but provided the highest dry matter production. However, manure and combined fertilization reduced the amount of percolating water due to increased water consumption and higher density of the sward.

Keywords: mountain meadows, floristic composition, productivity, percolating water

### Introduction

Permanent grasslands, which serve both production and environmental purposes, are particularly important in mountainous areas. On many farms they are the only source of forage. Their major environmental functions are to prevent soil from erosion and to reduce rainwater run-off (Hejduk and Kasprzak, 2004). Low input agriculture in mountainous areas is characterized by the use of organic fertilizers on grasslands, which is rare in lowlands. With regard to the effectiveness of organic fertilizers and their impact on the plant species composition of meadows there are divergent opinions (Jankowski *et al.*, 2005; Kasperczyk and Kacorzyk, 2008). The purpose of this study was to determine the effects of different types of fertilizers on the productivity and environmental characteristics of a mountain meadow.

### Material and methods

The investigations were conducted in 2005-2007 on a mountain meadow (49°41' N, 20°92' E, alt. 640 m). The experimental field was located on a low-intensity, grazed grassland, on a brown, acid and nutrient-poor soil (pH=4.3, available P=8.0, K=56 and Mg=54 mg kg<sup>-1</sup>). Lysimeters collecting percolating water, 0.45 m deep and with a diameter of 50 cm, were used. The bottom 0.05 m was filled with gravel, to allow drainage toward the pipe and avoid clogging, and the upper 0.4 m of the lysimeters was filled with soil taken from the profile on site, including natural sod. Each lysimeter was connected to an external tank to measure percolating water output. Water measurements were done continuously from the middle of April to the end of September. Plot size was 18 m<sup>2</sup> (3 m × 6 m) and there were four replicates in a complete block design. The following four fertilization treatments were compared:

no fertilizers - control;

mineral fertilizers - P<sub>18</sub>K<sub>50</sub>N<sub>100</sub>;

farmyard manure - FYM 10 t ha<sup>-1</sup> (P<sub>14</sub>K<sub>55</sub>N<sub>69</sub>); and

combined fertilizers - FYM 10 t ha<sup>-1</sup> + P<sub>4</sub>N<sub>31</sub>.

Fertilizers were applied in each year of the study. In the mineral fertilizer treatment phosphorus (18 kg ha<sup>-1</sup>) and potassium (50 kg ha<sup>-1</sup>) were applied once in spring, whereas nitrogen fertilizer (100 kg ha<sup>-1</sup>) was split: 60 % of the whole amount for the spring growth and 40 % for the regrowth. Sheep manure was applied in spring. The meadow was mown twice in the summer and the botanical assessments were made before the first cut. Main effects were evaluated using one-way analyses of variance.

Table 1 Percentage of main species in the meadow sward at the start of experiment and after 3 years of different fertilization

Species	Initial state	Fertilization scheme			
		Control	P <sub>18</sub> K <sub>50</sub> N <sub>100</sub>	FYM 10 t ha <sup>-1</sup> (P <sub>14</sub> K <sub>55</sub> N <sub>69</sub> )	FYM 10 t ha <sup>-1</sup> +P <sub>4</sub> N <sub>31</sub>
<i>Festuca rubra</i>	27	40	10	15	13
<i>Agrostis capillaris</i>	12	17	2	8	6
<i>Cynosurus cristatus</i>	8	5	1	8	2
<i>Festuca pratensis</i>	6	1	40	17	25
<i>Poa pratensis</i>	6	2	10	10	13
<i>Anthoxanthum odoratum</i>	5	5	-	2	+
<i>Deschamsia caespitosa</i>	5	+	+	+	+
<i>Elytrigia repens</i>	1	+	17	2	5
<i>Trifolium repens</i>	6	7	-	10	3
<i>Lotus corniculatus</i>	1	2	-	4	+
<i>Alchemilla pastoralis</i>	5	5	4	8	8
<i>Taraxacum officinale</i>	4	4	3	7	7
<i>Achillea millefolium</i>	3	2	4	3	5
Others	11	10	9	6	13

Table 2 Dry matter yield [t ha<sup>-1</sup>] in relation to fertilization

Fertilization	2005	2006	2007	Mean
0 - Control	4.04	3.34	1.87	3.38
P <sub>18</sub> K <sub>50</sub> N <sub>100</sub>	9.02	6.88	4.58	6.83
FYM 10 t ha <sup>-1</sup> (P <sub>14</sub> K <sub>55</sub> N <sub>69</sub> )	7.62	5.12	4.37	5.70
FYM +P <sub>4</sub> N <sub>31</sub>	8.19	6.17	4.52	6.29
LSD <i>p</i> =0.05	0.63	0.61	0.54	0.59

Table 3 Amount of rainfall and percolating water [mm] in relation to fertilization

Item	Rainfall	Control	P <sub>18</sub> K <sub>50</sub> N <sub>100</sub>	FYM 10 t ha <sup>-1</sup> (P <sub>14</sub> K <sub>55</sub> N <sub>69</sub> )	FYM 10 t ha <sup>-1</sup> +P <sub>4</sub> N <sub>31</sub>	LSD <i>p</i> =0.05
2005	668	78.0	117.2	89.9	88.7	5.9
2006	739	85.0	150.6	100.6	82.7	8.7
2007	619	87.0	130.0	97.3	101.0	8.2
Average	675	83.3	132.6	95.9	90.8	7.6
Percol. coeff. [%]		12.4	19.7	14.2	13.5	-
Water consumption per DM [l kg <sup>-1</sup> ]		1741	794	1016	917	339

## Results and discussion

At the start of the study the meadow sward was dominated by grasses, mainly by *Festuca rubra* L. and *Agrostis capillaris* L. (Table 1). Both species accounted for approximately 40% of total production. Legumes were represented by *Trifolium repens* L. and *Lotus corniculatus* L., and together made up 7% of the dry matter yield. The group of other dicots included 10 species (among which *Alchemilla pastoralis* L., and *Taraxacum officinale* L. were the most frequent ones) accounted for approximately 25% of the yield. In the last year of the experiment significant changes in the plant species composition had occurred. In the control treatment the share of the dominant grasses increased from 39 to 57%. When mineral

fertilizers were applied, *Festuca pratensis* Huds., *Elytrigia repens* (L.) Desv. ex Nevski and *Poa pratensis* L. became the dominant species, and *Anthoxanthum odoratum* L. and legumes were completely lost. Organic manuring did not change the botanical composition of the sward compared to the initial state. Combined fertilization clearly increased the share of *Festuca pratensis* Huds., and *Poa pratensis* L. mainly at the expense of *Cynosurus cristatus* L. and *Trifolium repens* L., and to a minor degree also *Festuca rubra* L. and *Agrostis capillaris* L. The application of mineral fertilizers decreased the sod density. The highest yields of dry matter were obtained in the mineral fertilizer and the combined fertilizer treatment (Table 2). As compared to organic manuring, mineral and combined fertilization increased dry matter yield by 20 and 10%, respectively, and compared to the control treatment the yield was increased by 102 and 86%, respectively. The difference between the highest yield in the first year of the experiment and the lowest in the final year was, on average, 92%. The reason for the low yields in the final year was a lower amount of rainfall coupled with an uneven distribution during the growing season, especially in the regrowth. When analysing the productivity of 1 kg of PKN it was found that the highest increase in yield per 1 kg of PKN was obtained by using mineral fertilizer only, whereas organic manuring had the lowest efficiency. The average annual rainfall during the study ranged from 619 to 739 mm; the amount of water percolating through the soil profile was often not closely related to the precipitation (Table 3). It was found that the largest proportion of the percolating water was measured in the year with the smallest amount of rainfall. Most likely this was due to the uneven distribution of rainfall during the summer, and especially the occurrence of single heavy rains (Jagus and Twardy, 2004). Comparing the percolation coefficients it was found that the smallest values were found on the control plots and the largest in the mineral fertilizer treatment. Similar relations were calculated when compared the efficiency of water use.

## Conclusions

Beneficial effects of mineral fertilization on the yield of meadow swards should be seen also in terms of their environmental impact. Changes in species composition, water use and the density of the sod suggest that the application of manure or combined fertilizers have effects which influence the development of sustainable multispecies swards with an acceptable yield and a good ability to retain rainwater.

## References

- Hejduk S. and Kasprzak K. (2004) Advantages and risks of grassland stands from the viewpoint of flood occurrence. *Grassland Science in Europe* 9, 228-230.
- Jagus A. and Twardy S. (2004) The influence of cutting frequency of a mountain meadow on yield and chemical composition of percolating waters (Lysimeter studies). *Water – Environment – Rural Areas* 4/1, 125-137.
- Jankowski K., Ciepiela G.A., Jodełka J. and Kisielińska B. (2005) The changes in botanical composition of fallowed meadow sward under the influence of treated mineral and organic fertilizers (research note). *Grassland Science in Poland* 8, 255-262.
- Kasperczyk M. and Kacorzyk P. (2008) The effect of fertilization on the productivity of a mountain meadow. *Water-Environment-Rural Areas* t. 8 z.1 (22), 143-150.

# Minimum management intensity for maintaining and improving biodiversity of a mesotrophic semi-natural grassland

Tonn B. and Briemle G.

*Landwirtschaftliches Zentrum für Rinderhaltung, Grünlandwirtschaft, Milchwirtschaft, Wild und Fischerei Baden-Württemberg (LAZBW), 88326 Aulendorf, Germany*

Corresponding author: Bettina.Tonn@lazbw.bwl.de

## Abstract

Species-rich semi-natural grasslands traditionally used as hay meadows are threatened by both intensification and abandonment in many European regions. A minimum management is necessary to maintain or restore the biodiversity of grasslands that are no longer part of agricultural production systems. For economic reasons, it might be interesting to substitute cutting by mulching, and to reduce cutting or mulching frequency from two or three operations to just one operation per year. This may, however, have negative effects on plant biodiversity. An experiment was set up on a mesotrophic grassland in 1999 comparing cutting and mulching regimes at three management frequencies (one to three operations per year). Highest species numbers, and lowest dominance of most abundant species, were achieved by a management regime with two or three cuts, or by three mulching operations. The treatment with just one mulching operation in the middle of July yielded the least favourable results in these terms. The negative effects on vegetation appear to be related to a more intense covering with mulched biomass material. It therefore seems possible to maintain mesotrophic grassland sites by mulching, provided that more than just one operation per year takes place.

Keywords: semi-natural grasslands; biodiversity; conservation management; mulching

## Introduction

Semi-natural grasslands of intermediate environmental conditions traditionally used as hay meadows are threatened by either intensification or abandonment in many European regions. Their character as both valuable and threatened ecosystems has been recognised by their inclusion in Annex I of the European Habitats Directive as habitat types 6510 and 6520 (Lowland and Mountain Hay Meadows). A minimum intensity is needed to maintain characteristic species composition. As the production of hay from these meadows is limited by low economic viability and often by difficult terrain, low-cost management schemes that will preserve or restore the species composition need to be developed. The technique of mulching, where the grass is cut, shredded and left on the field, has been proposed as such an alternative. It has lower costs than haymaking and is independent of the possibility to use the hay in low-intensity husbandry systems. It is therefore particularly attractive for sites with a high abundance of toxic plants or incipient shrub succession. Mulching is, however, thought to negatively affect plant biodiversity by increasing nutrient levels and, above all, by covering vegetation with a layer of mulched biomass (Arens, 1976; Dierschke and Engels, 1991). Our hypothesis was that there is a significant interaction between management type (mulching or cutting) and management frequency. A higher mulching frequency results in a lower quantity of less lignified biomass after each mulching operation, leading to faster degradation of the plant litter and thus favouring less competitive plants. Therefore the effect of mulching is predicted to differ less from that of cutting at higher management frequencies.



## Material and methods

A field experiment was established in southwest Germany (47.772 °N, 9.497 °E; altitude: 580 m a.s.l., annual precipitation: 800 mm, mean daily temperature: 9 °C, soil: Luvisol) on a semi-natural grassland site. Trees had been planted in the early 1990s to establish a meadow orchard, but grassland management had been suspended after 1993. From 1999 onwards, six management treatments were assessed in a randomized block experiment with three replications: three cutting treatments (C1: one cut – middle of July; C2: two cuts – middle of July and middle of September, and C3: three cuts – end of May, middle of July and middle of September) were compared to three mulching treatments (M1, M2 and M3: one to three mulching operations, at the same dates as above). In the case of mulching, biomass was shredded and left on the field. At each cutting and mulching operation, samples were taken to assess biomass production. In the first year, the amount of remaining mulched biomass was assessed two, four and six weeks after each mulching operation. Vascular plant species were recorded on a 25 m<sup>2</sup> quadrat on each plot in the middle of May in eight years out of eleven experimental years. The abundance of each plant species was quantified by estimating its proportion of aboveground harvestable biomass following the method of Klapp and Stählin (Voigtländer and Voss, 1979). A rank/abundance plot was created for the 2009 species data by plotting species in sequence of their average abundance per treatment on the x axis against the value of their average abundance (measured as biomass percentage) on the y axis. Average yearly biomass production and vascular plant species number in 2009 were subjected to an analysis of variance using management form (cutting or mulching) and management frequency and their interaction as fixed effects, and replication as a random effect. Means were compared using Tukey's HSD.

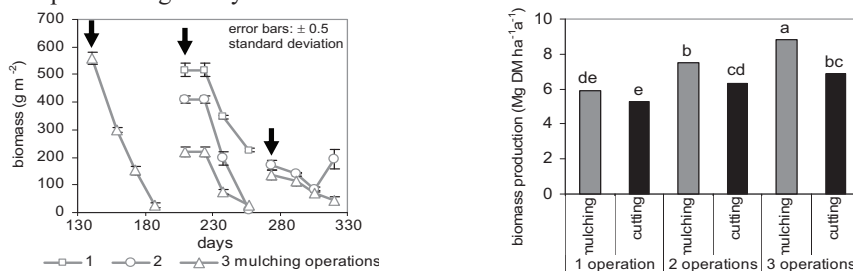

Figure 1: (a) Degradation of mulch layer: biomass at the times of mulching (arrows) and in the following six weeks.

(b) Average yearly biomass production 1999-2009. Different letters indicate significant differences at  $P < 0.05$ .

## Results and discussion

In the M2 and M3 treatments mulched biomass was quickly degraded during the summer months, with less than 30 g dry matter (DM) per m<sup>2</sup> remaining after six weeks (Fig. 1a). Degradation was slower after mulching in September, which may be attributed to lower activity of degraders due to lower temperatures. Under the M1 treatment, degradation was very slow. Over 40% of the mulched biomass still remained after six weeks. In addition, the second regrowth was left standing over winter in the M1 and C1 treatments, which may have lead to a lower degradation rate than in the M2 and M3 treatments, where it was left shredded on the ground. This, however, was not assessed in the experiment.

Biomass production was significantly higher under mulching than under cutting at two or three management operations per year ( $P < 0.05$ ; Fig. 1b), indicating a fertilizing effect of the nutrients returned in the mulched biomass. At only one yearly management operation, yields of the mulching treatment did not differ significantly from those of the cutting treatment.

Nutrients available from mineralisation and symbiotic N fixation apparently were sufficient to attain the yield potential of the sward in a single regrowth period.

Species number increased in all treatments when management was resumed after the five-year fallow period. The highest species numbers were attained under treatments C3, M3 and M2, where they were significantly higher than in treatment C1 ( $P < 0.05$ ), which had the lowest value (Fig. 2a). As the rank/abundance plot shows (Fig. 2b), the dominance of the most abundant species was lowest in the in the M3 and C3 treatments, and the highest in the M1 and C1 treatments. In these two treatments, the tall, perennial grass species *Arrhenatherum elatius* and *Dactylis glomerata* were dominant. These are species which may be expected to be competitive in a high sward before a late first cut and less hindered in their regrowth by a layer of plant litter than smaller or more planophile species.

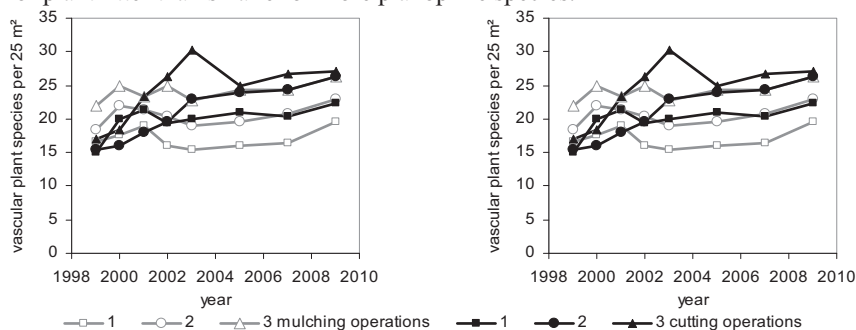

Figure 2: (a) Development of vascular plant species numbers.

(b) Rank-abundance plot of vascular plant species. Relative abundance of each species, expressed as biomass percentage, plotted against the rank of the species in terms of mean abundance in each treatment in 2009.

## Conclusion

Highest species numbers and lowest dominance of most abundant species were achieved by a management regime with two or three cuts, or three mulching operations. The treatment with just one mulching in the middle of July yielded the least favourable results in these terms. The negative effects on vegetation appear to be related to a more intense covering with mulched biomass. Middle of July was the date for the first cut in all except the M3 and C3 treatments, which is about one month later than the traditional local haymaking date. It is therefore possible that an effect of the 'date of first cut' overlaid the effect of mere management frequency, which should be tested in further experiments. The yield differences between cutting and mulching treatments at more than one operation per year suggest that cutting should be preferred to mulching where a decrease of trophic status is aimed at. In other cases, it seems possible to maintain mesotrophic grassland sites like Lowland and Mountain Hay Meadows by mulching, provided that more than just one operation per year takes place.

## References

- Arens R. (1976): Die Vegetationsentwicklung auf Brachflächen und Möglichkeiten ihrer Steuerung durch technische Maßnahmen. *Bayerisches Landwirtschaftliches Jahrbuch* 53, 732-738.
- Dierschke H. and Engels M. (1991) Response of a *Bromus erectus* grassland (Mesobromion) to abandonment and different cutting regimes. In: Esser G. and Overdieck D. (eds.) *Modern Ecology: Basic and Applied Aspects*. Elsevier, Amsterdam, The Netherlands, 844 pp.
- Voigtländer G. and Voss N. (1979) *Methoden der Grünlanduntersuchung und -bewertung. Grünland, Feldfutter, Rasen*. Ulmer, Stuttgart, Germany, 207 pp.



## **Session 4.2**

### **Functions of biodiversity**

*Editor: Nicole Wrage*

## Paths of nitrogen transfer from *Trifolium repens* to non-legume plants in unfertilised pastures

Auerswald K., Schäufele R. and Schnyder H.

Lehrstuhl für Grünlandlehre, Technische Universität München, D-85350 Freising

Corresponding author: auerswald@wzw.tum.de

### Abstract

Biological N fixation (BNF) is the main N input in unfertilised pastures and can provide transfer N to non-legume plants. This transfer can be coupled spatially or temporally to different degrees. In principle, three mechanisms are conceivable: (i) a direct transfer between living plants, (ii) a local but delayed transfer when non-legumes colonise a patch with decaying legume biomass, and (iii) a spatially diffuse transfer via the excreta of grazing animals. We analysed these mechanisms on 10 pastures grazed by suckler cows and offspring where BNF input was quantified over nine years. Modelled annual BNF yield varied between 1 and 225 kg ha<sup>-1</sup> yr<sup>-1</sup> (mean 30) between paddocks and years. Comparison of <sup>15</sup>N in non-legume plants growing in the immediate vicinity of white clover (*Trifolium repens*) and at large distance indicated negligible direct BNF-N transfer. <sup>15</sup>N analyses of non-legumes growing on legume patches of the previous year also indicated no significant delayed local transfer. Conversely, the <sup>15</sup>N of cattle correlated closely with the BNF input of the previous year. We conclude that BNF-N transfer occurred mainly via the excreta and was independent of the spatial distribution of legumes on the paddock.

Keywords: biological N fixation, excreta, 15-N, isotope, natural abundance, *Trifolium repens*

### Introduction

Nitrogen limits the productivity of most terrestrial ecosystems including non-fertilised grassland. In the latter, biological N fixation (BNF) is the main N input. Transfer of BNF-N to non-legume plants is important for sward productivity and composition and may occur via different mechanisms: (i) direct (spatio-temporally coupled) transfer between legumes and non-legumes, e.g. by mycorrhiza, leaching/interception or trampling, (ii) local but delayed transfer when non-legumes colonise a patch of decaying legumes, (iii) spatially diffuse transfer via grazing/excreta deposition by grazing animals. We studied these mechanisms by taking advantage of the isotopic contrast between BNF-N ( $\delta^{15}\text{N}$ : approx. -2‰) and soil N ( $\delta^{15}\text{N}$  approx. 4‰) and data from 10 pastures analysed over nine years.

### Materials and methods

The study was conducted from 1999 to 2007 on the Grünschaibe Grassland Research Station (near Munich, Germany). The experiment included five old pastures (>45 years old) and five young pastures established between 1998 and 1999 on former cropland. Young pastures were sown with a mixture of grass and white clover (*Trifolium repens*). All pastures were grazed by continuous-stocking with herds of either suckler cows or fattening steers during the entire vegetation period. Further details of the experiment and site are reported elsewhere (Schnyder *et al.*, 2006).

BNF was quantified using the model by Høgh-Jensen *et al.* (2004). The N content of *T. repens* was slightly higher (4.45%) than assumed in the model (4.30%), which is not considered in the following because the difference was smaller than the 95% interval of confidence (0.21%;  $n = 74$ ). Total biomass production was estimated from feed intake by the cattle on each pasture. Sward height was kept constant by adjusting stocking density. No

supplements were fed. Standing biomass of legumes (mainly *Trifolium repens*) was estimated visually by trained persons 2-3 times during the growing period on 40 permanent quadrats (1 m<sup>2</sup>, divided in 10 x 10 cm<sup>2</sup> squares) during nine years.

The direct transfer of BNF-N from legumes to non-legumes was estimated from <sup>15</sup>N analysis of *Lolium perenne* growing in immediate vicinity of *T. repens* and comparison with plants growing at large distance to it on the same pasture. Delayed local transfer of BNF-N from decaying clover residues was assessed by comparing  $\delta^{15}\text{N}$  of *L. perenne* growing on former clover patches (as determined in the previous year) and *L. perenne* on patches with no clover in the previous years. Diffuse transfer was assessed from the relationship between BNF yield (calculated following Høgh-Jensen *et al.*, 2004) and the  $\delta^{15}\text{N}$  of ingested feed-N, as reflected in <sup>15</sup>N of the tail switch hair of the grazing cattle (the  $\delta^{15}\text{N}$  of hair equals that of the diet plus a trophic level shift of 3.2‰; Männel *et al.*, 2007).

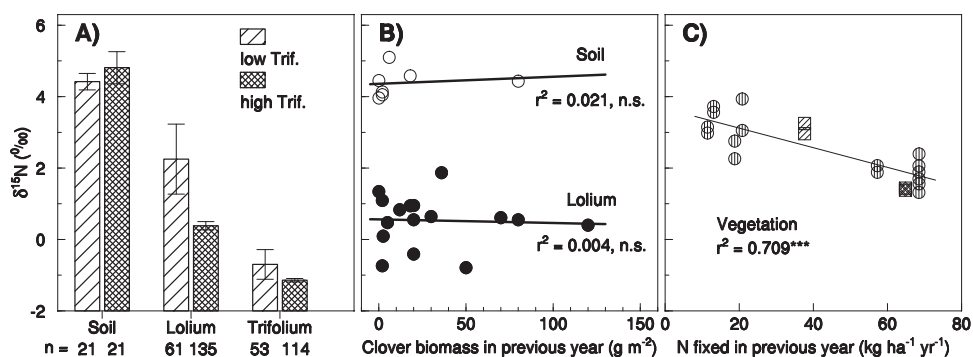

Fig. 1: A) Nitrogen isotopic composition of soil, *Lolium perenne* and *Trifolium repens* in two pastures with low and high *Trifolium repens* content in the previous years (error bars give 95% interval of confidence); B) Nitrogen isotopic composition in *Lolium perenne* and soil depending on the *Trifolium repens* biomass within the same 10x10 cm<sup>2</sup> square in the previous year; C) Nitrogen isotopic composition in bulk vegetation of ten pastures derived from cattle hair (two animals each) compared to biological N fixation in the previous year as calculated after Høgh-Jensen *et al.* (2004); square markers denote the two pastures in panel A).

## Results

The BNF varied greatly among pastures and years (total range: 1 – 225 kg ha<sup>-1</sup> yr<sup>-1</sup>). BNF was considerably smaller on old pastures (20 ± CI 5 kg ha<sup>-1</sup> yr<sup>-1</sup>; CI is the 95% interval of confidence) than on young pastures (54 ± CI 15 kg ha<sup>-1</sup> yr<sup>-1</sup>). On young pastures, it was especially high in year 1 after establishment (156 ± CI 49 kg ha<sup>-1</sup> yr<sup>-1</sup>). Thereafter, it decreased linearly ( $r^2 = 0.83$ , n = 30) until year 5 after stand establishment, when it became similar to that of old pastures. The  $\delta^{15}\text{N}$  of *L. perenne* on the high-clover pasture was 1.55‰ lower than on the low-clover pasture although the soils were similar and differed only by 0.35‰ (Fig. 1 A). This shows clearly that the BNF-N contributed significantly to N nutrition of the grass. However, *L. perenne* growing in close vicinity of *T. repens* and *L. perenne* at large distance from *T. repens* did not differ in <sup>15</sup>N in a high-clover pasture. The same was true on a low-clover pasture. The overall  $\delta$ -difference between *L. perenne* growing in close vicinity vs. at large distance to *T. repens* was 0.08‰ ± CI 0.03‰, indicating a negligible direct transfer of BNF-N. Comparing *L. perenne* growing in patches that were occupied by *T. repens* in the year before also did not indicate any transfer of BNF-N from mineralized dead *T. repens* biomass to *L. perenne* or to the soil at the same site (Fig. 1 B). In contrast, BNF-N yield of a

pasture was closely related to  $^{15}\text{N}$  of cattle hair in the following grazing season, indicating that BNF-N was ingested by the grazing animals and redistributed via excreta (Fig. 1 C). The  $^{15}\text{N}$  signal of forage was rapidly incorporated in hair: cattle had near-identical  $^{15}\text{N}$  in new hair growth during wintertime stall feeding when all animals were fed the same diet, but the composition started to change within one week after being put on pastures (data not shown).

## Discussion

The results indicate that direct plant-plant transfer of BNF-N between legumes and non-legumes was negligible and that most of the transfer occurred via the grazing cattle. Thus, N losses from living or mineralising dead *T. repens* plants must have been small in comparison with losses incurred by grazing. There are several mechanisms which underlie this result: (i) N concentration in live leaves of *T. repens* is high, (ii) the harvesting (i.e. grazing) efficiency of live leaf-biomass and -N of *T. repens* is high on pasture, (iii) N allocation to re-growing leaves of defoliated *T. repens* plants has a high priority (Corre *et al.*, 1996), (iv) our data show that losses of N from living *T. repens* other than those associated with grazing losses are small, and (v) N concentration in senesced decaying *T. repens* biomass is low because of mobilisation to other plant parts during senescence. All these mechanisms enhanced the flow of BNF-N from *T. repens* to the grazer and back to the pasture via excreta. These mechanisms explain why *L. perenne* on the high-clover pasture received a high proportion of BNF-derived transfer-N independently of its vicinity to *T. repens*. The mechanisms also explain why patches of decaying (N-poor) *T. repens* biomass provided a relatively unimportant source of transfer-N for *L. perenne* colonising the patch.

## Conclusions

Transfer of BNF-N occurred mainly via the excreta of grazing cattle. Conversely, the direct transfer between living plants or colonisation of decaying legume patches were unimportant paths for BNF-N transfer from *T. repens* to *L. perenne*. Together, these mechanisms enhance the redistribution and cycling of BNF-N in the pasture paddock, but limit the attractiveness of clover patches for colonisation by *L. perenne* and other non-legumes.

## References

- Høgh-Jensen H., Loges R., Jørgensen F.V., Vinther F.P. and Jensen E.S. (2004) An empirical model for quantification of symbiotic nitrogen fixation in grass-clover mixtures. *Agricultural Systems* 82, 181–194.
- Corre N., Bouchart V., Ourry A. and Boucaud J. (1996) Mobilization of nitrogen reserves during regrowth of defoliated *Trifolium repens* L. and identification of potential vegetative storage proteins. *Journal of Experimental Botany* 47, 1111–1118.
- Männel T.T., Auerswald K. and Schnyder H. (2007) Altitudinal gradients of grassland carbon and nitrogen isotope composition are recorded in the hair of grazers. *Global Ecology and Biogeography* 16, 583–592.
- Schnyder H., Schwertl M., Auerswald K. and Schäufele R. (2006) Hair of grazing cattle provides an integrated measure of the effects of site conditions and interannual weather variability on  $\delta^{13}\text{C}$  of temperate humid grassland. *Global Change Biology* 12, 1315–1329.



# Effect of mono- and mixed grazing of cattle and sheep on grassland diversity patterns

Seither M., Petersen U., Wrage N. and Isselstein J.

University of Goettingen, Department of Crop Sciences, Grassland Science, D-37075  
Goettingen

Corresponding author: mseithe@gwdg.de

## Abstract

Plant diversity is linked to a multitude of important ecosystem functions such as productivity. Intensive agricultural management results in a decrease of grassland diversity. In this study, the effect of different grazer species on the vegetation composition and diversity patterns of an extensively managed semi-natural grassland sward was investigated. The hypothesis was that grazing cattle and sheep affect vegetation composition and diversity patterns in different ways because of differences in forage selectivity. Mixed grazing should, therefore, lead to a greater evenness of the vegetation, which might be beneficial for the maintenance and enhancement of diverse grassland. The experimental site is a moderately species-rich *Lolio-Cynosuretum* in the Solling Uplands, Germany. The initial diversity of the grass sward was manipulated by the use of a herbicide, resulting in a low diversity sward compared to the untreated sward (control). Both diversity treatments were either grazed by sheep, by cattle or by both. The six combinations of plant diversity and grazing treatment were replicated three times in blocks that were grazed rotationally. Data on plant species diversity and botanical composition of three years were analysed. Grazing with cattle led to a significantly different vegetation composition than mono-grazing by sheep, which seemed to be related to differences in forage selectivity.

Keywords: phytodiversity, rotational grazing, German Simmental, Blackheaded sheep, Leine sheep

## Introduction

Diverse systems were found to be more productive (van Ruijven and Berendse, 2005), more stable against environmental disturbances (Dodd *et al.*, 2004) and might be important in the light of sustainability and stability in a changing environment. Diverse grasslands accomplish an important contribution to plant species diversity. Pasturing at a low stocking rate is a means of promoting and maintaining a diverse flora (Rook *et al.*, 2004). Grazing animal species differ in their foraging behaviour (Rook *et al.*, 2004). Therefore, the use of different grazing animal species - cattle and sheep alone or in combination - might help to achieve both optimal pasture utilization and maintenance of diversity.

## Materials and methods

The experimental site was established on a moderately species-rich *Lolio-Cynosuretum* on an old (16-20 years) grassland in the Solling Uplands, Germany. The soil type is a Pelosol with a clayey/silty loam texture. The site was formerly used as arable land. Before the start of the experiment, it was utilised as mown pasture (cattle or sheep grazing) for at least fifteen years. Thin cattle manure was regularly applied during that time. Two factors were manipulated: the botanical diversity and the species of grazers. Two diversity levels were established: an untreated control ('diverse treatment') and a treatment manipulated in autumn 2006 by the use of a herbicide against dicotyledonous plants resulting in a grass dominated 'grass treatment'. Both diversity treatments were either grazed by sheep, by cattle or by both. Animals were

assigned to the pastures according to sward productivity, ensuring an equal amount of livestock units on the plots (LU of 500 kg, 8-12 LU ha<sup>-1</sup>). Grazing animals were suckler cows and calves of the breed German Simmental, and ewes with lambs of Blackheaded and Leine sheep in comparable proportions. All treatments were replicated three times in rotationally grazed blocks, with the length of grazing period depending on the herbage on offer (14 days at the beginning of the grazing season to seven days towards the end). In spring 2007 to 2009, plant species and their yield estimates (Klapp and Stählin, 1936) were recorded on five permanent quadrats (1 m<sup>2</sup>) per plot, and species abundance in the 3 m x 3 m surrounding the quadrats. The experiment was conducted as a two-factorial block design with the fixed factors plant species diversity and grazing animal and the random factor block. Vegetation data were analysed using multivariate ordination techniques in Canoco (ter Braak and Šmilauer, 1997-2004). Univariate analyses of treatment effects were done with linear mixed models in R (R, version 2.7.2). Differences in yield proportions of functional groups (grasses, legumes, forbs) between variants and years were analysed with the Fisher exact test in R.

## Results and discussion

The vegetation composition in 2007 did not differ between diversity treatments before the start of grazing (PCA of presence/absence data; data not shown). From 2008 to 2009 there was a shift towards increasing proportions of legumes and forbs. Species numbers within the grass treatment increased steadily with time; in 2009, they were similar to those of the diverse treatment, but differed significantly among grazing treatments ( $P < 0.01$ ). The proportion of dicots increased significantly within all treatments from 2007 to 2009, except the co-grazed grass sward, where the proportion of grass did not fall below 98% in 2009. Within the grass treatment, the proportion of legumes increased to around 9 and 5% and that of forbs to 2 or 6% in the cattle- and sheep-grazed plots, respectively ( $P < 0.001$  and  $P < 0.01$ ). Within the diverse treatment, the yields of legumes and forbs particularly increased in mixed and cattle-grazed plots (by 4.1 and 28.6%, or 5.2 and 31.8% on average, respectively). Year, sward diversity and grazing by cattle or sheep led to significant differences in vegetation composition (partial RDA, spatial factors as covariables, 4999 Monte Carlo permutations: Year/Sward/Cattle  $P < 0.001$ , Sheep  $P < 0.05$ ); the vegetation of cattle-grazed and co-grazed plots was similar, but differed from that on sheep-grazed plots (Fig. 1). Some plant species responded similarly to sheep-, cattle- and mixed grazing. For example, the abundant species *Poa trivialis* and *Lolium perenne* decreased (mean yield of  $19.9 \pm 8.5$  and  $25.3 \pm 5.9\%$  in 2008, respectively). Other, lower yielding, species were differently favoured by the grazer species: *Taraxacum s. Ruderalia*, *Poa pratensis*, *Trifolium repens* and *Festuca pratensis* increased in cattle-grazed and mixed plots (Fig. 1), but decreased in sheep-grazed plots, whereas *Dactylis glomerata* increased in the latter only. These results suggest a greater selectivity by sheep, not only for high quality forage species, but also on the functional group level. This is in accordance with findings by Sebastià *et al.* (2008) and the hypothesis that mouth anatomy, body size and metabolic differences lead to higher selectivity by sheep compared to larger grazers (Rook *et al.*, 2004). Mixed grazing, however, led to plant community changes similar to those by cattle grazing. Sward diversity and grazing treatment had no significant effect on the evenness of vegetation, but the latter decreased significantly from 2008 to 2009 ( $P < 0.01$ ), which might be related to the increasing proportion of dicots.

## Conclusions

The results of the present experiment have indicated so far that grazing by cattle and co-grazing of cattle and sheep, compared to mono-grazing by sheep, might lead to appreciable differences of diversity patterns in a semi-natural grassland sward. Further long-term research

seems promising to elucidate the potential of mono- and co-grazing on low-input semi-natural grasslands to benefit diversity and productivity.

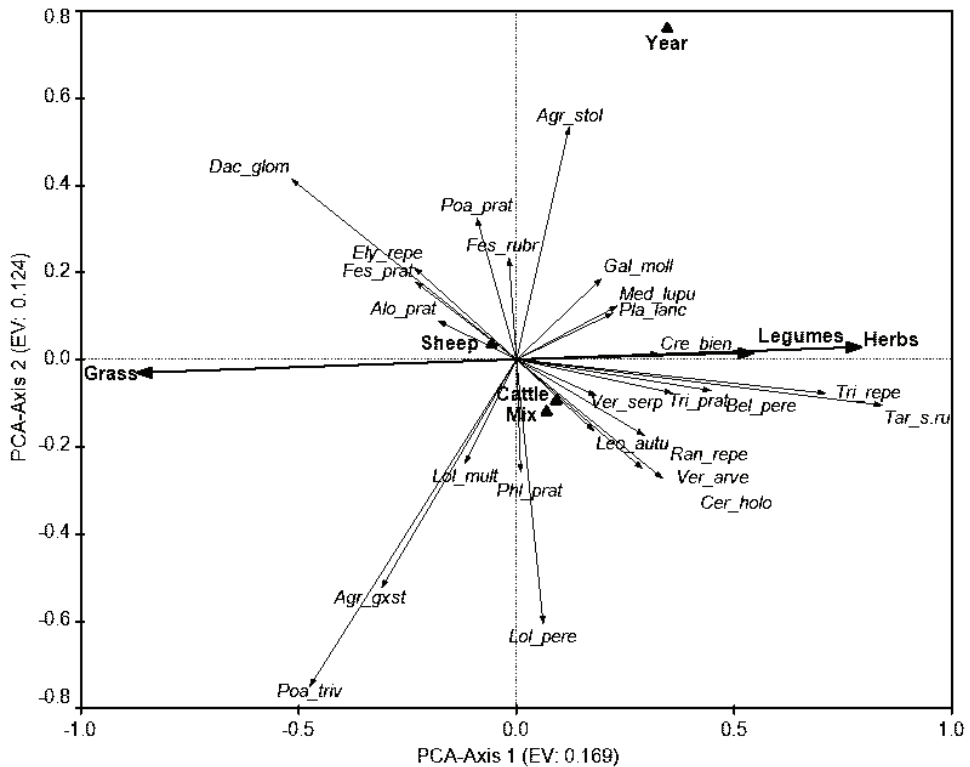

Figure 1: PCA diagram of the first and 2<sup>nd</sup> year after the start of the experiment (environmental variables: treatment factors and intrinsic variables; covariables: spatial factors. Only the most important intrinsic variables are displayed.). Axes 1 and 2 explain 16.9 and 12.4 % of the vegetation variance, respectively. Species within a fit range of 4-100 % are displayed in the species ordination. Species names are abbreviated with the 3+4 first letters. Grazing treatments are indicated as triangles, yield proportions of functional groups as arrows.

## References

- Dodd M.B., Barker D.J. and Wedderburn M.E. (2004) Plant diversity effects on herbage production and compositional changes in New Zealand hill country pastures. *Grass and Forage Science* 59, 29-40.
- Klapp E. and Stählin A. (1936) *Standorte, Pflanzengesellschaften und Leistung des Grünlandes*. Ulmer, Stuttgart.
- R (2008) R Version 2.7.2. *Foundation for Statistical Computing*.
- Rook A.J., Dumont B., Isselstein J., Osoro K., WallisDeVries M.F., Parente G. and Mills J. (2004) Matching type of livestock to desired biodiversity outcomes in pastures - a review. *Biological Conservation* 119, 137-150.
- Sebastià M.-T., de Bello F., Puig L. and Taull M. (2008) Grazing as a factor structuring grasslands in the Pyrenees. *Applied Vegetation Science* 11, 215-222.
- ter Braak C.J.F. and Šmilauer P. (1997-2004) Canoco for Windows Version 4.53. *Plant Research International*, Wageningen, Netherlands.
- van Ruijven J. and Berendse F. (2005) Diversity-productivity relationships: Initial effects, long-term patterns, and underlying mechanisms. *Proceedings of the National Academy of Sciences of the United States of America*, 102, 695-700.

## **Anecic earthworms and associated ecosystem services under pressure in a ley-arable crop rotation**

van Eekeren N.<sup>1</sup>, Bommelé L.<sup>2</sup>, Bokhorst J.<sup>1</sup>, Schouten A.J.<sup>3</sup>, Reheul D.<sup>2</sup> and Brussaard L.<sup>4</sup>

<sup>1</sup>*Louis Bolk Institute, Hoofdstraat 24, NL-3972 LA Driebergen, The Netherlands*

<sup>2</sup>*Ghent University, Coupure links 653, B-9000 Gent, Belgium*

<sup>3</sup>*National Institute for Public Health and the Environment, P.O. Box 1, NL-3720 BA Bilthoven, The Netherlands*

<sup>4</sup>*Wageningen University, P.O. Box 47, NL-6700 AA Wageningen, The Netherlands*

Corresponding author: n.vaneekeren@louisbol.nl

### **Abstract**

Earthworms in general, and anecic earthworms in particular, play a key role in the ecosystem service of water regulation. Earthworms were sampled over three years in a 36-year-old experiment. Permanent arable land was compared with permanent grassland and with a ley-arable crop rotation. In the first year of arable cropping in the rotation, the number of earthworms was already low and not different from continuous cropping. In the three-year grass ley, the abundance of earthworms returned to the level of permanent grassland in the second year. The restoration of earthworm biomass took a minimum of three years. However, the anecic species did not recover in the three-years of grass ley to the dominance they had in permanent grassland. The number of earthworm burrows was related to earthworm biomass and was highest in permanent grassland. Our data suggest that anecic earthworms are under pressure in a ley-arable crop rotation, which may have a negative impact on the ecosystem service of water regulation.

Keywords: climate change, ecological groups of earthworms, earthworm burrows, grassland, water regulation

### **Introduction**

The rainfall in the Netherlands has increased in the last 100 years by 18% and the number of days with more than 50 mm of rainfall has increased in the last 50 years from 5.4 to 9.0 (anonymous, RNMI; Boxel and Cammeraat, 1999). On the other hand, the length of drought periods in summer increases. Therefore, the ecosystem service of water regulation by soil biota becomes more important. Earthworms play a key role in water regulation: epigeic and endogeic earthworms increase water infiltration in the topsoil through their burrowing activity, while the deep, vertical burrows of anecic earthworms increase water infiltration and root growth (Logsdon and Linden, 1992; Bouché and Al-Addan, 1997; Edwards and Shipitalo, 1998). Recent legislative restrictions on the use of organic and artificial N fertilisers have brought attention back to crop rotations with grass and maize. A crop rotation of grass and maize can be sustainable in terms of efficient nutrient use (Nevens and Reheul, 2002; 2003). However, there is a lack of information on the effect of such a crop rotation on the abundance and ecological group composition of earthworms. In order to determine the long-term effects of a ley-arable crop rotation on earthworms in comparison with permanent grassland and continuous arable cropping, a 36-year-old experiment was sampled.

### **Materials and methods**

In 1966, a crop rotation experiment was established on a sandy loam soil at the experimental farm of Ghent University at Melle (50° 59'N, 03°49'E; 11 m above sea level) (Nevens and

Reheul, 2001; 2003). Four treatments were established in a complete randomised block design with four blocks:

PG: Permanent grassland since 1966;

TG: Temporary ley-arable crop rotation, started in 1966 with three years of grass ley followed by three years of arable land cropped with forage crops;

TA: Temporary arable crop-ley rotation. This treatment is comparable to TG but started in 1966 with three years of arable cropping followed by three years of grass ley;

PA: Permanent arable cropping since 1966.

In the first three years of the seventh rotation, earthworms were sampled in 2 blocks (20 cm x 20 cm x 20 cm) per plot on 30 October 2002, 7 October 2003 and 15 October 2004. Earthworms in the blocks were hand-sorted, counted, weighed and fixed in alcohol prior to identification. Adults were identified according to species. A distinction was made between (1) epigeic species (pigmented, living superficially in the litter layer), (2) endogeic species (living in burrows at approximately 10-15 cm depth) and (3) anecic species (relatively large worms, living in vertical burrows from which they collect dead organic matter) (Bouché, 1977). In 2004, the earthworm burrows ( $\phi > 2$  mm) were counted on horizontal surfaces (20 cm x 20 cm) at 10 cm and 20 cm depth. For further details see Van Eekeren *et al.* (2008).

The data were analysed with GENSTAT using a two-way ANOVA in randomised blocks with treatment (PG, TG, TA and PA) and year of sampling as factors.

## Results

The number of earthworms was highest in the PG treatment followed by the TG treatment (Table 1). The significant interaction of treatment and year is mainly due to the recovery in the number of earthworms in the TG treatment. In October 2003, the second year after the establishment of grass (TG) in the ley-arable crop rotation, the number of earthworms reached the same level as in the PG treatment. The body biomass of the earthworms in TG was significantly lower ( $P < 0.001$ ) than in PG, and therefore the recovery of the total biomass was not as spectacular as the total numbers. Even in October 2004, the final year of the three-year period of grass ley, the earthworm biomass in TG was different from PG: 96 g m<sup>-2</sup> compared to 163 g m<sup>-2</sup> ( $P = 0.002$ ). In total numbers and biomass, the TA plots resembled the PA plots. Numbers and especially biomass in the TA treatment already reached a low level in the first year of the rotation, suggesting a rapid decrease in earthworms after rotavating the grass ley.

Table 1. Earthworm numbers, biomass, species, functional groups and earthworm burrows in permanent grassland (PG), temporary grassland (TG), temporary arable land (TA) and permanent arable land (PA): averages from three consecutive years (2002-2004).

Earthworms	Units	Treatments				P-value	Year	Treat×year
		PG	TG	TA	PA		P-value	P-value
Total number	m <sup>-2</sup>	256 a	187 b	62 c	30 c	<0.001	NS	0.008
Body biomass	g <sup>-1</sup>	0.65 a	0.25 b	0.23 b	0.12 b	<0.001	0.033	NS
Total biomass	g m <sup>-2</sup>	166 a	52 b	14 bc	5 c	<0.001	NS	NS
Number species	(0.008 m) <sup>-3</sup>	2.0 a	1.3 b	0.5 c	0.2 c	<0.001	NS	<0.001
Epigeic adults	m <sup>-2</sup>	20 a	25 a	1 b	0 b	0.016	0.011	NS
Endogeic adults	m <sup>-2</sup>	46 ab	49 a	22 bc	7 cd	0.009	NS	0.031
Anecic adults	m <sup>-2</sup>	71 a	4 b	2 b	0 c	<0.001	NS	NS
Earthworm burrows*								
10 cm depth	m <sup>-2</sup>	388 a	238 b	106 c	6 d	<0.001	--	--
20 cm depth	m <sup>-2</sup>	356 a	206 b	100 c	6 d	<0.001	--	--

\* Earthworm burrows were counted in 2004 only

PG had the highest number of species and the arable treatments the lowest number. The interaction between treatment and year was mainly due to an increase of the number of species in the TG treatment from 2002 to 2003. Among the adult earthworms in the PG plots, the anecic species were dominant (52% anecic species). In TG and the arable treatments (TA and PA), the endogeic species were most common: 62%, 88% and 100%, respectively. The epigeic species were mainly found in the grass treatments. The number of earthworm burrows showed a clear decrease in the order PG > TG > TA > PA. The variation in the number of burrows at 10 cm depth, measured in October 2004, was explained by a regression model ( $R^2 = 0.93$ ) with treatment and earthworm biomass measured in 2004 as fitted terms.

## Discussion and conclusions

The number of earthworms in the PA treatment was as low as 12% of the number in the PG treatment. Edwards and Bohlen (1996) mention two reasons for a decreased number of earthworms, besides the mechanical damage and predation after cultivation: the loss of an insulating layer of vegetation and a decreased food supply. The small number of earthworms in the TA treatment six months after rotavating the grass ley suggests that the decrease in earthworm numbers in our experiment was rapid. In the ley phase of this experiment, earthworm biomass increased from 8 g m<sup>-2</sup> in the first year to 51 g m<sup>-2</sup> in the second year and to 96 g m<sup>-2</sup> in the third year. A more lasting difference between the PG treatment and the remaining ley-arable crop rotation treatments is the dominance of the anecic species in PG. The data suggest that especially anecic earthworms are under pressure in a ley-arable crop rotation, which may have a negative impact on the ecosystem service of water regulation.

## References

- Anonymous, Royal Netherlands Meteorological Institute, Risk analysis of heavy rain.
- Bouché M.B. (1977) Strategies lombriciennes. In: Lohm U. and Persson T. (Eds.) Soil organisms as components of ecosystems. *Ecological Bulletins* 25, 122-132.
- Bouché M.B. and Al-Addan F. (1997) Earthworms, water infiltration and soil stability: some new assessments. *Soil Biology and Biochemistry* 29, 441-452.
- Boxel J.H. and Cammeraat J. (1999) Een analyse van de neerslag in deze eeuw; Wordt Nederland steeds natter? *Meteorologica* 8 (1), 11-15.
- Edwards C.A. and Bohlen P.J. (1996) *Biology and Ecology of Earthworms*. 3<sup>rd</sup> edn., Chapman and Hall, London, 426 pp.
- Edwards W.M. and Shipitalo M.J. (1998) Consequences of earthworms in agricultural soils: aggregation and porosity. In: Edwards C.A. (Ed.), *Earthworm Ecology*. St Lucie Press, Boca Raton, FL, 147-161.
- Logsdon S.D. and Linden R.D. (1992) Interactions of earthworms with soil physical conditions influencing plant growth. *Soil Science* 154(4), 330-337.
- Nevens F. and Reheul D. (2001) Crop rotation versus monoculture; yield, N yield and ear fraction of silage maize at different levels of mineral N fertilization. *Netherlands Journal of Agricultural Science* 49, 405-425.
- Nevens F. and Reheul D. (2002) The nitrogen- and non-nitrogen-contribution effect of ploughed grass leys on the following arable forage crops: determination and optimum use. *European Journal of Agronomy* 16, 57-74.
- Nevens F. and Reheul D. (2003) Permanent grassland and 3-years leys alternating with 3 years of arable land: 31 years of comparison. *European Journal of Agronomy* 19, 77-90.
- Van Eekeren N., Bommelé L., Bloem J., Rutgers M., De Goede R., Reheul D. and Brussaard L. (2008) Soil biological quality after 36 years of ley-arable cropping, permanent grassland and permanent arable cropping. *Applied Soil Ecology* 40, 432-446.



# **Agronomically improved grass-legume mixtures: higher dry matter yields and more persistent legume proportions**

Suter D., Huguenin-Elie O., Nyfeler D. and Lüscher A.

*Agroscope Reckenholz-Tänikon Research Station ART, 8046 Zurich, Switzerland*

Corresponding author: daniel.suter@art.admin.ch

## **Abstract**

Since 1955, 'Swiss Standard Mixtures' (SSMIX) of grasses and legumes have been continuously improved, based on extensive experimentation in small plots and under practical conditions. These mixtures are labelled with a quality label of the Swiss Grassland Society (AGFF) and are highly accepted by Swiss seed companies and farmers. A multi-site grassland experiment across 33 European sites (COST852) with two grass and two legume species (one variety of each species) demonstrated strong yield benefits of four-species mixtures containing 30-70% legumes. The proportion of legumes in these mixtures, however, strongly decreased below the optimal range in the third year of the experiment. In a three-year field experiment, we compared the yield and the persistence of legume proportions in four different SSMIX with those of COST852 mixtures. The SSMIX surpassed the COST852 mixtures in yield and in persistence of legume proportion. We suggest that the higher number of species and/or varieties (2 legume species with 2 varieties of white clover and 4 to 5 grass species), as well as the partially different species and cultivars may be the main reasons for the observed differences. The long-term experience and knowledge gained from decades of mixture development have yielded an effective product.

Keywords: Swiss Standard Mixtures, COST 852, leys, multi-species mixtures

## **Introduction**

Grass-legume mixtures offer many benefits compared with grass monocultures (Peyraud *et al.*, 2009): they provide nitrogen to the plant-soil-system and thus reduce fertiliser costs, increase forage intake, and make it possible to extend the harvesting period without compromising forage quality. A multi-site grassland experiment across 33 European sites (COST852) with two grass and two legume species (one variety of each species) demonstrated strong yield benefits of four-species mixtures (Kirwan *et al.*, 2007; Lüscher *et al.*, 2008). This effect was most pronounced in mixtures containing 30-70% legumes (Nyfeler *et al.*, 2009). However, it was not possible to maintain such high percentages of legumes in the mixtures (Nyfeler *et al.*, 2009). Since 1955, 'Swiss Standard Mixtures' (SSMIX) of grasses and legumes have been developed based on extensive experimentation in small plots and under practical conditions. This includes testing the competitive ability of each individual variety (Suter *et al.*, 2008a). Most importantly, such mixtures are not exclusively developed for high yields but must fulfil many requirements, such as suitability for different types and intensities of management and conservation. The outcome of this continuous process of improvement is published every four years (Suter *et al.*, 2008b). In Switzerland, these standard mixtures are widely accepted by seed companies and farmers: about 90% of seeds for leys are sold as SSMIX. An important part of this success is the ideal knowledge-transfer from research to development, extension, industry and farmers, which is strongly supported by the Swiss Grassland Society (AGFF).

In a three-year field experiment we compared the yield and persistence of legume proportion in four SSMIX with the performance of the five most similar mixtures of COST852. The goal of this comparison was to test whether the advantages achieved by the best COST852



mixtures can also be achieved by grass-legume mixtures that are adapted to many requirements of practical agriculture, such as the SSMIX mixtures.

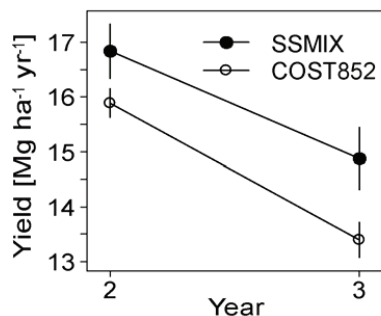

Figure 1. Annual yield of COST852 and SSMIX mixtures for the second and third experimental year (bars = 1 SE).

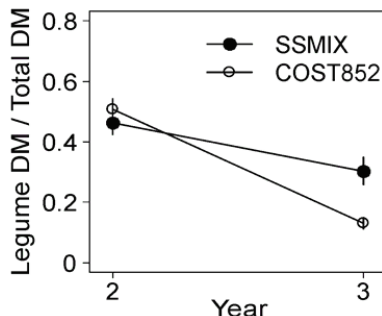

Figure 2. Legume proportion of total spring-DM (dry matter) yield of COST852 and SSMIX mixtures (bars = 1 SE).

## Materials and methods

Four typical representatives of SSMIX – types ‘240’, ‘310’, ‘330’ and ‘440’ (Suter *et al.*, 2008b) – were sown at the same time and in the same field as the COST852 mixtures. In the SSMIX, two legume species – *Trifolium pratense* L. and *Trifolium repens* L. – and 4 to 5 of the following grass species were used: *Lolium multiflorum* Lam. var. *italicum* Beck, *Lolium* × *boucheanum* Kunth, *Lolium perenne* L., *Dactylis glomerata* L., *Festuca pratensis* Hudson, *Festuca rubra* L., *Poa pratensis* L. and *Phleum pratense* L. *Trifolium repens* was represented by 2 varieties. In this article, we compare these SSMIX with five of the COST852 mixtures selected for similar initial legume proportion as the SSMIX. The COST852 mixtures were composed of one variety of each *L. perenne*, *D. glomerata*, *T. pratense* and *T. repens* and had an initial proportion in the seed mixture of 50% legumes. All mixtures were mowed five times per year and fertilised with 150 kg ha<sup>-1</sup> yr<sup>-1</sup> N. In both groups of mixtures, annual yield was measured during the second and the third years of the experiment. The legume proportion of the mixtures was recorded by manually separating plant samples from the spring harvest. Data was analysed by analysis of variance, testing ‘mixture type’ (SSMIX, COST852), ‘year’ (second, third) and ‘mixture type × year’ interaction effects.

## Results and discussion

Annual dry matter (DM) yield (Figure 1) of SSMIX (15.86 Mg ha<sup>-1</sup> yr<sup>-1</sup>) was significantly higher ( $P < 0.01$ ) than that of COST852 (14.64 Mg ha<sup>-1</sup> yr<sup>-1</sup>). This yield advantage was observed in each year examined (Mixture type × Year: *NS*). In all mixtures, a significant decrease ( $P < 0.001$ ) of annual DM yield from the second to the third year was observed.

Spring-harvest legume proportion decreased ( $P < 0.0001$ ) from 48% in the second to 22% in the third year (Figure 2). Although the legume proportion did not differ between the two mixture types in the second year, it differed greatly in the third year. This difference was due to a strong drop in legume proportion in the COST852 mixtures to 13%, while legume proportions of SSMIX remained at about 30% (Mixture type × Year;  $P < 0.001$ ).

For both DM yield and legume proportion, SSMIX were equal to or outperformed COST852 mixtures. In the third year, the legume proportion of COST852 mixtures dropped below the optimal legume proportion for biomass production found by Nyfeler *et al.* (2009), who showed that a reduction of legume percentage in the sward from 30% to 15% resulted in a

DM yield reduction of more than 2.5 Mg ha<sup>-1</sup> yr<sup>-1</sup> under the growth conditions of our experiment. The difference in legume proportion between the two groups of mixtures could, therefore, be a reason for the difference in yield in the third year. In the second year, however, SSMIX yielded more than the COST852 mixtures despite similar legume proportions. Nyfeler *et al.*, (2009) found a positive grass-grass and legume-legume interaction in yield, demonstrating that the mixing effect in grass-legume mixtures of more than two species is not only due to grass-legume interactions. Thus, the higher number of grass species in the SSMIX may have contributed to the higher yield of this group observed in the second year.

The legume proportion in the COST852 mixtures was dependent on the performance of just one variety per legume species. In contrast, SSMIX contained two different white clover varieties (a small and a medium leaved) and a more persistent ‘Swiss’ red-clover variety (Schubiger *et al.*, 2004). These two differences may have contributed to the far better persistence of legumes in the SSMIX. The more diverse composition of grass species in the SSMIX or the selection of a specific cultivar of the companion grasses (Suter *et al.*, 2007) may also have helped to maintain a greater legume proportion.

The SSMIX differ in several factors (species richness, species identities, cultivar identities, number of cultivars) from the COST852 mixtures. This makes it impossible to determine which factor or factors were responsible for the better performance of SSMIX observed. However, this study undoubtedly demonstrates that mixtures used in Swiss practice can achieve the same or even better performance as found in the COST852 experiment (Kirwan *et al.*, 2007; Lüscher *et al.*, 2008; Nyfeler *et al.*, 2009). Even though SSMIX have been developed not only for high yielding potential, but also to fulfil a wide range of requirements for practical use, they showed higher performance than the COST852 mixtures, which were designed for high-yield potential. This shows that the long-term experience and knowledge gained from decades of mixture development have yielded an effective product.

## Conclusion

We conclude that the higher number of species and/or varieties (2 legume species with 2 varieties of white clover and 4 to 5 grass species) and the long-term amelioration of ‘Swiss Standard Mixtures’ resulted in a better persistence of the legume proportion of the mixtures and in a higher yield potential than for mixtures based on only one variety of four species.

## References

- Kirwan L., Lüscher A., Sebastia M.T., Finn J.A., Collins R.P. *et al.* (2007) Evenness drives consistent diversity effects in an intensive grassland system across 28 European sites. *Journal of Ecology* 95, 530–539.
- Lüscher A., Finn J.A., Connolly J., Sebastia M.T., Collins R., Fothergill M., Porqueddu C., Brophy C., Huguenin-Elie O., Kirwan L., Nyfeler D. and Helgadóttir Á. (2008) Benefits of sward diversity for agricultural grasslands. *Biodiversity* 9, 29–32.
- Nyfeler D., Huguenin-Elie O., Suter M., Frossard E., Connolly J. and Lüscher A. (2009) Strong mixture effects among four species in fertilized agricultural grassland led to persistent and consistent transgressive overyielding. *Journal of Applied Ecology* 46, 683–691.
- Peyraud J.L., Le Gall A. and Lüscher A. (2009) Potential food production from forage legume-based systems in Europe: an overview. *Proceedings of International Conference, Forage legumes in temperate pasture-based systems, Cork, Ireland*, 1–22.
- Schubiger F.X., Alconz E., Streckeisen P. and Boller B. (2004) Resistenz von Rotklee gegen den südlichen Stengelbrenner. *Agrarforschung* 11, 168–173.
- Suter D., Briner H.U. and Lüscher A. (2007) Effect of *Lolium perenne* L. variety on the botanical composition of grass-clover mixtures. *Grassland Science in Europe* 12, 417–420.
- Suter D., Hirschi H.U., Briner H.U., Frick R., Jeangros B. and Bertossa M. (2008a) Liste der empfohlenen Sorten von Futterpflanzen 2009–2010. *Agrarforschung* 15 (10), 1–8.
- Suter D., Rosenberg E., Frick R. and Mosimann E. (2008b) Standardmischungen für den Futterbau: Revision 2009–2012. *Agrarforschung* 15 (10), 1–12.

## Grass root turn-over for improved soil hydrology to combat flooding

Humphreys M.W.<sup>1</sup>, Turner L.B.<sup>1</sup>, O'Donovan S.A.<sup>1</sup>, Macleod C.J.A.<sup>2</sup>, King I.P.<sup>1</sup>, Whalley W.R.<sup>3</sup> and Haygarth P.M.<sup>4</sup>

<sup>1</sup>*Institute of Biological, Environmental and Rural Sciences (IBERS), Aberystwyth University, Gogerddan, Aberystwyth, Ceredigion, Wales, UK SY23 3EB*

<sup>2</sup>*Rothamsted Research, North Wyke Research, Okehampton, UK, EX20 2SB*

<sup>3</sup>*Rothamsted Research, Department of Soil Science, Harpenden, UK, AL5 2JQ*

<sup>4</sup>*Lancaster Environment Centre, Lancaster University, Lancaster, UK, LA1 4YQ*

Corresponding author: mkh@aber.ac.uk

### Abstract

A *Lolium perenne* x *Festuca pratensis* cultivar demonstrates rapid and extensive root growth, in excess of either its parent species. Root turn-over at depth in the soil has a major effect on soil structure and porosity and thereby aids water retention and flood control improving water quality by mitigating against run-off of diffuse sediment and nutrients. Improved soil water retention together with increased root development at depth also improves access to scarce water resources and reduces impacts from drought stress when the water supply may be limited. We demonstrate heterosis between *Lolium* and *Festuca* gene sequences capable of providing grasslands with new multifunctional capabilities providing safeguards against flooding and improved food security with increased crop resilience to climate change. We identify QTL in *Festulolium* relevant to root growth and turn-over.

Key words: *Festulolium*, flood control, drought resistance, root growth, soil hydrology

### Introduction

Adaptation of agricultural land management to changes in climate is vital to food security. Runoff is a major component in the generation of flood events and is predicted to increase due to plant responses to raised CO<sub>2</sub>. In the UK, river catchments occur primarily in grassland locations. There is a need to breed forage grasses that deliver multiple benefits through increased levels of productivity whilst moderating fluxes of water, carbon, and key macronutrients (Macleod *et al.*, 2007). Although not as high in forage quality, new *Festulolium* hybrids provide many of the desirable traits of ryegrass (*Lolium*) species, but include also complementary characters from related fescue (*Festuca*) species to improve grass-crop resilience and persistency to combat climate change (Humphreys *et al.*, 2006). We hypothesise a heterosis effect whereby alleles for rapid growth in *L. perenne* in combination with alleles for enhanced rooting capabilities in *F. pratensis* lead to the initial development of extensive root systems followed by rapid root turn-over and death deep in the soil and consider that this impacts directly on the soil hydrology by improving soil water retention.

### Materials and methods

Four different *Lolium* and *Festuca* spp. and two *Festulolium* hybrid cultivars were established in North Wyke Research in 2006 in replicated 10 m x 3 m hydrologically-isolated plots, and rainfall and run-off measured at different soil depths over the course of 34 rainfall events in a subsequent two-year period at different times of the year (Gregory *et al.*, 2010). We report here a 4 replicated experiment at IBERS where the same six cultivars were grown over the same time period and managed using management practices identical to those employed at North Wyke. The cultivars were established in 1 m deep pipes lined with heavy-duty polythene and filled with JI No 2 potting compost as described by Turner *et al.* (2009). The

polythene sleeve was slid out of the pipe to enable non-destructive observations of the roots around the sides of the column of potting compost and measurements of root traits. Following a 6-month period of establishment, root measurements were taken in April and September 2007 and 2008. The column of compost was marked into 10 cm sections and root density scored for each section on a scale of 0 (no roots visible) to 4 (extremely dense rooting). Further traits were derived from these measurements; including root system depth, size, relative distribution through the soil column (root profile) and % root persistency. Root system size was the sum of scores for all the sections and root profile was the regression coefficient for a line fitted through the root scores from the lowest section with roots to the top section. Additional to the cultivars, a series of seven chromosome substitution lines (King *et al.*, 2002) and their parental genotypes were established and their root growth measured in an attempt to attribute root-growth QTL to their chromosome location. The chromosome substitution lines comprised 13 *L. perenne* chromosomes and one of seven alternative *F. pratensis* homoeologues together representing the entire *Festuca* genome. All statistical analyses were performed according to standard procedures with the menu-driven options available within GenStat® Version 11.1 (Payne *et al.*, 2008).

## Results and discussion

In comparisons at North Wyke taken over 34 rain run-off measurements during 2007-2008 at different times of the year, an IBERS bred *L. perenne* x *F. pratensis* amphiploid ( $2n = 4x = 28$ ) cultivar was significantly more effective ( $P < 0.001$ ) at soil water retention and reducing run-off than any of the other cultivars tested. These included the parental species *L. perenne* and *F. pratensis*. In summary, the field experiments found differences in (0-30 cm) run-off at the plot scale with the *L. perenne* cultivar giving 70% of rainfall as run-off, the *F. pratensis* cultivar 50 %, and the *Festulolium* cultivar 35 %.

At IBERS in a pipe experiment, root growth measurements of the same cultivars and a complete series of *L. perenne* x *F. pratensis* chromosome substitution lines and their parents managed in an identical way as the North Wyke field plots were obtained over the same time-lines. Convincing evidence was found, supported by soil cores taken from the North Wyke field trials, that the rapid growth and then turn-over of roots in the *Festulolium* hybrid was the major mechanism associated with the reduced run-off compared to either of the parent species. Over all measurements taken on all plant genotypes in spring and autumn 2007, there were significant differences in maximum root depth ( $P < 0.001$ ), overall root system size ( $P < 0.001$ ), root system profile ( $P < 0.001$ ), and root longevity ( $P < 0.009$ ). In screens undertaken at the same time in 2008, these significant differences were maintained for all four measurements. Specific to the *L. perenne* root profile in autumn 2008, which was a measure of root distribution at different soil depths, significant root growth was evident throughout the 1 m soil profile with 28% roots having died. At the same time in *F. pratensis*, root profile calculations indicated that roots were found primarily in the upper soil regions but had actually increased by 44%. The *Festulolium* cultivar had a contrasting root system profile with nearly half its root system concentrated within the uppermost 500 cm of soil and with 47% of roots having died, primarily in the deeper soil regions. The maximum root depth supported these conclusions with *L. perenne* roots found up to 940 mm soil depth, *F. pratensis* roots up to 735 mm, whilst the longest root in the *Festulolium* cultivar was only 604 mm. Root growth differences from spring 2007 until autumn 2008 are represented diagrammatically in Figure 1. Whilst soil samples taken from the North Wyke site concluded that changes to soil structure were likely due to physical rearrangement of soil particles by shrinkage and that this differed between grass species (Gregory *et al.*, 2010), evidence from the current root growth study was that the initial high root growth throughout the soil profile in the *Festulolium* cultivar compared to its parent species followed by subsequent significant

reduction of its roots at depth that left extensive areas of dead or decaying roots was the principal factor for change in soil structure and it was this that was primarily responsible for the increased soil water retention properties of the *Festulolium* hybrid compared to the parent species. The outcomes of this and related research at IBERS indicates heterosis effects between *Lolium* and *Festuca* alleles that contribute to an increased root growth in *Festulolium* hybrids. The root growth in the chromosome substitution lines supports this conclusion especially for chromosome 7, and to lesser extent chromosomes 2, 3, and 4. However, for substitution lines 4 and 7, the root growth was maintained over 2 years and extended throughout the 1 m soil column whilst the root growth of substitution lines 2 and 3 resembled more the *Festulolium* amphiploid cultivar with a rapid turn-over of roots leading to the death of roots at depth in the soil whilst root growth continued near the soil surface.

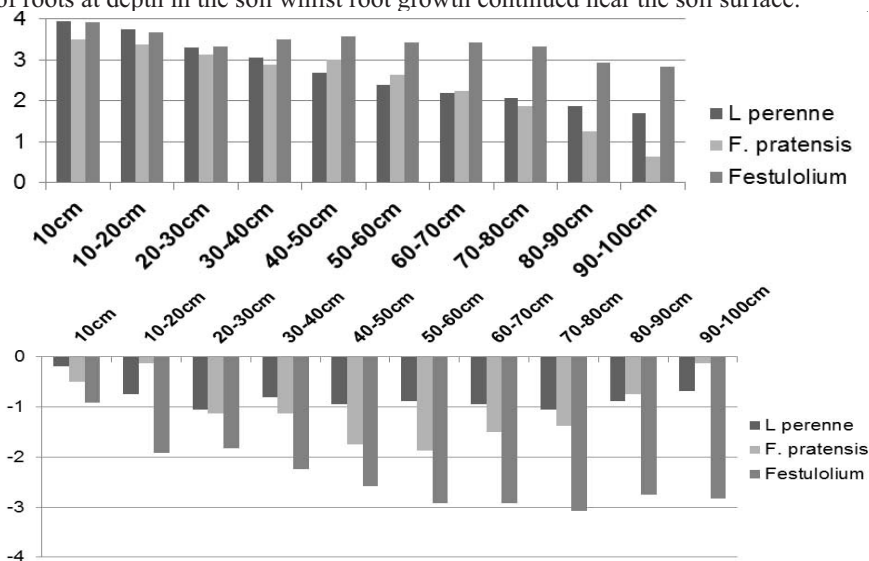

Figure 1 (top) Root system growth and distribution recorded 18 April 2007 following 6 months growth over 1 m soil depth in a *L. perenne*, *F. pratensis*, and *L. perenne* x *F. pratensis* cultivar (Scale: 0 = no roots) 4 = extensive root system). (bottom) Reduced root systems (compared to 1a) over 1 m soil depth recorded 17 September 2008 (Scale: 0 = no root reduction; -4 = all roots dead)

## References

- Humphreys M.W., Yadav R.S., Cairns A.J., Turner L.B., Humphreys J. and Skot L.(2006) A changing climate for grassland research. *New Phytologist* 169, 9-26.
- Gregory A.S., Webster C.W., Watts C.W., Whalley W.R., Macleod C.J.A., Joynes A., Papadopoulos A., Haygarth P.M., Binley A., Humphreys M.W., Turner L.B., Skot L. and Matthews G.P. (2010) The effect of different grass species, their hybrids and soil management on the hydraulic properties of shrinking soils. *Soil Science Society of America Journal* (in press).
- King J., Armstead I.P., Donnison I.S., Thomas H.M., Jones R.N., Kearsley M.J., Roberts L.A., Jones A., and King I.P. (2002) Physical and genetic mapping in the grasses *Lolium perenne*, and *Festuca pratensis*. *Genetics* 161, 315-324.
- Macleod C.J.A., Binley A., Clark L J., Hawkins S.L., Humphreys M.W., Turner L.B., Whalley W.R. and Haygarth P.M. (2007) Genetically modified hydrographs: what can grass genetics do for temperate catchment hydrology? *Hydrological Processes* 21 (16), 2217-2221.
- Payne R.W., Murray D.M., Harding S.A., Baird D.B. and Soutar D.M. (2008) *GenStat® for Windows® 11th Edition, Introduction*. Hemel Hempstead: VSN International.
- Turner L., Macleod K., Watts C., Whalley R., Binley A., Papadopoulos T., O'Donovan S., Haygarth P., King J., and Humphreys M. (2009) *Dissecting Festulolium chromosome 3 to locate rooting and drought resistance traits*. 28th Fodder Crops and Amenity Grasses Section of EUCARPIA, La Rochelle, France, 11-14 May 2009

## Habitat improvements with agronomic treatments for ungulates in an area of central Italy

Messeri A.<sup>1</sup>, Ponzetta M.<sup>2</sup>, Cervasio F.<sup>1</sup>, Crocetti C.<sup>2</sup>, Gori L.<sup>2</sup> and Argenti G.<sup>3</sup>

<sup>1</sup> CIRSeMAF, University of Florence, Via Maragliano 77, 50144 Firenze, Italy

<sup>2</sup> DiBA, University of Florence, Via delle Cascine 5, 50144 Firenze, Italy

<sup>3</sup> DiPSA, University of Florence, P.le delle Cascine 18, 50144 Firenze, Italy

Corresponding author: giovanni.argenti@unifi.it

### Abstract

Research was conducted to evaluate the effectiveness of different environmental improvements in order to recover areas encroached by *Pteridium aquilinum* for wildlife in Tuscany. The habitat improvements were represented by a simple cutting and a harrowing, followed by the sowing of a mixture of forage species. The two agronomical interventions were also compared with the surrounding natural areas that received no treatments. The results show a greater presence of forage species in the areas restored with agronomic managements, compared to the natural surfaces. Improved areas also presented a marked improvement in floristic richness and in biodiversity, as testified by the Shannon index.

Keywords: bracken, pastoral value, *Dactylis glomerata*, *Lolium perenne*, management

### Introduction

In recent years, in many European countries the abandonment of traditional agricultural practices has produced remarkable effects in marginal lands. This is causing deep changes in plant components and results in a marked increase in shrubs and woodland areas which replace open spaces. This leads to a significant decrease in floristic richness and biodiversity (Rook and Tallwin, 2003) particularly important within natural reserves, as open areas are essential for many wild animals. From this perspective, agronomical interventions can play an important role for environmental improvement. The recovery of forage resources in mountain areas is also important in view of the habitat management and to control the movements of wild ungulates, in order to reduce crop damages due to their presence in the cultivated areas. This paper reports on the effects of different methods of habitat improvements carried out in a protected area in central Italy to recover old pastures now encroached by intrusive species.

### Materials and methods

The study area is located within the Natural Reserve of Acquerino-Cantagallo (Tuscany, central Italy) in the northern Italian Apennines. Three open areas of different sizes were studied, which were once used as pasture and are now encroached upon, mainly by bracken fern (*Pteridium aquilinum* (L.) Kuhn) and forest species that have invaded the open areas from the edge of the surrounding woods. In the trial sites, two types of action were conducted in spring 2008 for environmental improvement: simple cutting and harrowing of the surface followed by the sowing of a mixture of two grasses (*Dactylis glomerata* L. and *Lolium perenne* L.). This management was proposed and realized by the administration of the Natural Reserve. In summer 2009, the botanical composition of improved areas was recorded using linear analysis (three replicates for each treatment) according to Daget and Poissonet (1971). Moreover, the improved areas were compared to nearby natural surfaces not subjected to any intervention, where the same botanical data were gathered. This analysis allowed the determination of the specific contribution (SC) of each species inside the studied vegetation.



From this it was possible to derive the pastoral value (PV) using the formula  $PV = \Sigma (SC_i \times SI_i) / 5$ , where  $SI$  is a specific index, variable from 0 to 5, which summarizes the forage value of each species in the pasture (Cavallero *et al.*, 2007). Biodiversity was also calculated using the floristic richness (R, i.e. the number of species occurring along each analysis) and the Shannon index  $H'$  (Magurran, 2004) to discriminate any ecological effect due to the different types of management. Results were analysed (SPSS, 2008) by type of management and subjected to a nonparametric test (Kolmogorov-Smirnov) because the data set had a non-normal distribution.

## Results and discussion

The number of grasses (sown and native) in the improved areas was higher than in natural areas (Figure 1, A), whereas the number of legumes differed from natural areas only in the sown sectors. Species of these botanical families are generally characterised by a good palatability by animals. The number of forbs was significantly lower under the sown treatment in comparison to natural areas. The analysis of the specific contributions (Figure 1, B) confirmed the increased presence of grasses and legumes in the improved areas compared to the natural ones, with no significant differences between the two types of management. Other botanical families were better represented in the unimproved areas, which were in general characterised by a high presence of forbs of low or no interest for animals, such as *Pteridium aquilinum*.

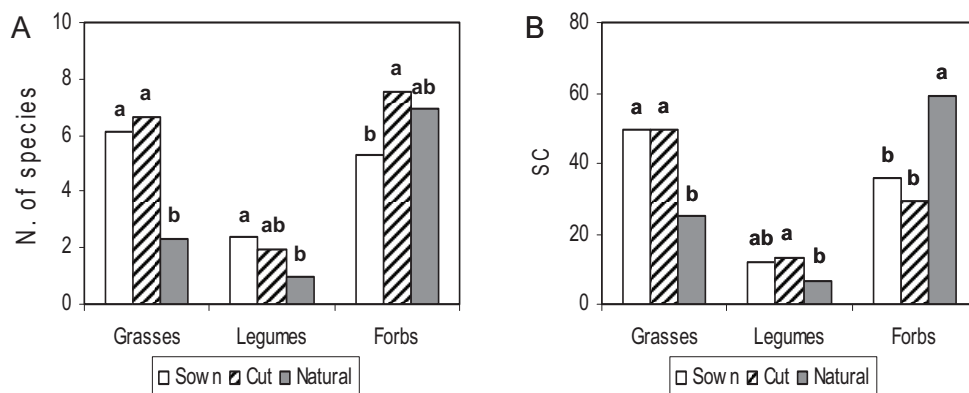

Figure 1. Number of species (A) and specific contribution (B) grouped for grasses, legumes and forbs for each studied treatment. Bars with the same letter are not significantly different (Kolmogorov-Smirnov test,  $P < 0.001$ )

Areas subjected to agronomical management were characterised by a higher pastoral value in comparison to surrounding natural areas, where a high occurrence of species of low pastoral interest affected this parameter significantly (Table 1). The intervention of sowing, compared to just mowing, produced the same effects in terms of improving the global characteristics of the pasture, as no significant differences were observed in terms of pastoral value in sown (31) and only cut areas (24). This result was attributable to the good initial emergence of the mixture species and to the recovery of natural species of a great forage importance that contributed significantly to raising the PV in the improved areas. Agronomic interventions affected significantly the floristic richness (R), as a larger number of species in sown (14 species) and in mown areas (16 species) was recorded in comparison to natural area, where an average of only 10 species was found. This may have been due to the high presence of



bracken fern (SC of 35.9 in natural areas), which may have suppressed the development of other species due to its intrusiveness and allelopathic characteristics. An increase in biodiversity can also be noted in improved areas, with no significant differences between sown and mowed areas in terms of Shannon index, since both methods seemed to favour a significant increase in the values of  $H'$  to the same extent in comparison to natural areas.

Table 1. Pastoral value (PV), floristic richness (R), Shannon index ( $H'$ ) and specific contribution of *Pteridium aquilinum* for each studied treatment. Values in the same row with the same letter are not significantly different (Kolmogorov-Smirnov test,  $P < 0.05$ )

Parameter	Sown	Treatment	
		Cut	Natural
PV	31 a	24 a	7 b
R	14 a	16 a	10 b
$H'$	2.3 a	2.3 a	1.7 b
SC <i>Pteridium aquilinum</i>	5.7 b	4.2 b	35.9 a

## Conclusions

The results demonstrated the efficiency of habitat improvements in the first years after agronomical interventions. The harrowing of the soil followed by the sowing of a good mixture of fodder species had a remarkable impact on the restoration of an open area but almost the same effects could be reached also with a simple cut of the existing biomass. The reduction of *Pteridium aquilinum* also produced ecological benefits, confirming what was found in other situations (Pakeman and Marrs, 1992; Ouden, 1994). Therefore, environmental improvement for wildlife is an important issue to recovery of encroached pastures, even if further research is necessary in order to evaluate the effects in the long run, as many studies highlighted the importance of follow up methods to increase the efficiency of the recovery operations over time after the initial bracken control (Petrov and Marrs, 2000).

## References

- Cavallero A., Aceto P., Gorlier A., Lombardi G., Lonati M., Martinasso B. and Tagliatori C. (2007) *I tipi pastorali delle Alpi Piemontesi*. Perdisa Ed., Bologna, I, pp. 467.
- Daget P. and Poissonet Y. (1971) Une méthode d'analyse phytologique des prairies. *Annales Agronomiques* 22, 5-41.
- Magurran A.E. (2004) *Measuring biological diversity*. Blackwell Publishing, Malden, USA, pp. 256.
- Ouden J. den (1994) Allelopathy in bracken in the Netherlands. In: Smith R.T. and Taylor J.A. (eds.) *Bracken: an Environmental Issue*. International Bracken Group, Leeds, UK, pp. 43-46.
- Pakeman R. J. and Marrs R.H. (1992) Bracken control vegetation restoration and land management. *Biological Conservation* 62, 101-114.
- Petrov P. and Marss R.H. (2000) Follow-up methods for bracken control following an initial glyphosate application: the use of weed wiping, cutting and reseeding. *Annals of Botany* 85, 31-35.
- Rook A.J. and Tallowin J.R.B. (2003) Grazing and pasture management for biodiversity benefit. *Animal Research* 52, 181-189.
- SPSS (2008) *SPSS Statistics 17.0*. Spss Inc.

# Plant communities and soil groups in mountain pastures of the Central Pyrenees

Ascaso J., Alcubilla M., Broca A. and Ferrer C.

*Department of Agriculture and Agricultural Economics, University of Zaragoza, E-50013 Zaragoza, Spain*

Corresponding author: jascaso@unizar.es

## Abstract

The type of ecosystem 'mountain pastures' in the Central Pyrenees is located at an altitude between 1400 and 2400 m a.s.l., and characterised by a distinct physiognomy, phytosociology and use as extensive pastures during summer time. To establish a sustainable use of these pasture areas, it is necessary to obtain a profound knowledge of these phytocoenoses and of the biotic and abiotic factors that govern them. The aim of this project was to determine the relationship between the vegetation units and the soils. The investigation was carried out in the Benasque Valley (Spanish Central Pyrenees). Five toposequences representing different lithological substrates and geomorphological characteristics of the area were selected. A total of 60 soil profiles was studied. Inventories of vegetation were done in the corresponding pastures and the vegetation units were established. The results indicate a great variability of plant communities (14 alliances, 24 associations) related to 12 soil groups. The abundance of well-developed soils (mostly eutric and dystric Cambisols) with high vegetation cover suggests that the use of these pastures has not led to significant ecosystem degradation.

Keywords: Benasque Valley, mountain grassland, plant associations, soil toposequences.

## Introduction

In the high mountain areas exists a type of ecosystem that is known as 'mountain pastures,' characterised by a distinct physiognomy (mainly grassland), phytosociology and the use as extensive pastures during summer. In the Central Pyrenees, this ecosystem is located at an altitude between 1400 and 2400 m a.s.l. To establish a rational and sustainable use of these pastures, it is necessary to obtain a profound knowledge of these phytocoenoses and of the factors that govern them, given that livestock is the basis of economic and social activity in these areas (Ascaso and Ferrer, 1993). The aim of this study was to determine the relationship between the plant communities and the soil in representative toposequences in the area.

## Materials and methods

The investigation was carried out in the Benasque Valley (Spanish Central Pyrenees), with an approximate area of 37000 ha, including 8700 ha of mountain pasture. We selected five toposequences representing different lithological substrates and geomorphological characteristics of the area. A total of 60 soil profiles were studied (Broca, 1992; Schad *et al.*, 1992), determining their morphological, chemical and physical properties and their classification (IUSS Working Group WRB, 2006). Inventories of vegetation were done in the corresponding pastures after the methods of the Zurich-Montpellier school of phytosociology (Braun-Blanquet, 1979) and the plant communities were established (Ascaso, 1992).

## Results and discussion

The relationships between 24 plant communities (14 alliances) and 12 soil groups identified in the five toposequences of mountain pastures (Benasque Valley) are shown in Table 1. The abundance of deep Cambisols with different physical and chemical properties was particularly striking. Vegetation and soil are intimately connected to the different environmental factors: altitude, steepness of terrain, lithology, and geomorphology. The range of phytocoenoses linked to different substrates, soil groups and topography, can be described as follows:

- a) Alpine and subalpine plant communities on calcareous substrates
  - The association *Festuco-Cirsietum glabri* is established on slope detrital sediments with deep slopes and low vegetation cover on Calcaric Regosols. In areas with greater substratum stability, high snow accumulation and rainwater retention, phytocoenoses of *Elyno-Oxytropidetum halleri* on Eutric Cambisols are present. When the snow persistence is lower, there is an increased solifluction and cryoturbation and a reduced water retention, the phytocoenoses *Saponario-Festucetum gautieri* and *Seslerio-Festucetum gautieri* with xerophytic species on Calcaric Regosols and Eutric Cambisols are found.
  - In areas of less altitude and relief shapes with higher water retention, species from *Mesobromion* of the association *Teucri-Astragaletum Catalaunici* on Calcaric Regosols and Eutric Cambisols were established.
  - Finally, the persistence of more or less dense forests of *Pinus uncinata* results in the phytocoenosis of *Pulsatillo-Pinetum uncinatae* on Eutric Regosols and Eutric Cambisols.
- b) Subalpine and mountain plant communities on calcareous substrates
  - In areas of less altitude on heterogeneous substrates containing limestone, stable relief shape, gentle slopes and 100% plant cover, *Euphrasio-Plantaginietum mediae*, *Phyteumo-Festucetum nigrescentis* and *Genistello-Agrostidetum capillaris* on Eutric Cambisols appear.
  - In sites where livestock dwells, species such as *Chenopodium bonus-henricus*, *Cirsium eriophorum* and *Rumex pseudoalpinus* coexist with plants from *Mesobromion*, originating phytocoenosis of *Rumicion pseudoalpini* on Eutric Cambisols.
- c) Alpine and subalpine plant communities on siliceous substrates
  - Within *Caricetalia curvulae*, the phytocoenoses *Selino-Nardetum*, *Alchemillo-Nardetum strictae* and *Ranunculo-Festucetum eskiae* are present in sites with less slope and 100% plant cover. The soils belong to the groups Gleysols, Stagnosols, Cambisols, and Podzols.
  - In zones with deeper slopes and less plant cover, *Hieracio-Festucetum paniculatae* in subalpine level and *Carici-Festucetum eskiae* in alpine level on Dystric Cambisols are found.
  - In areas exposed to the wind with little snow accumulation, communities with sparse vegetation of *Arenario-Festucetum yvesii* and *Hieracio-Festucetum airoidis vaccinietosum microphylli* are established on Eutric Leptosols, Eutric Cambisols and Dystric Cambisols.
  - In areas with shrubs and trees, *Vaccinio-Piceetalia* communities with plants of *Caricetalia curvulae* appear. On southern exposed slopes, *Arctostaphylo-Pinetum uncinatae* on Humic Cambisols are present. With increased snow accumulation, the existing communities are *Saxifrago-Rhododendretum* on Dystric Cambisols and Dystric Leptosols.
- d) Bog plant communities
  - In relief positions that accumulate water from the surrounding slopes, communities of *Caricetum nigrae* and *Caricetum davallianae* on Umbric and Mollic Gleysols are established.

Table 1. Relationships between vegetation and soils in mountain pastures (Spanish Central Pyrenees). The numbers indicate the distribution of the 60 soil profiles / plant associations.

PLANT COMMUNITIES		SOIL GROUPS											
ALLIANCE	ASSOCIATION	Leptosols, Dystric	Leptosols, Eutric	Gleysols, Mollic	Gleysols, Umbric	Gleysols, Eutric	Podzols, Umbric	Stagnosols, Dystric	Cambisols, Humic	Cambisols, Dystric	Cambisols, Eutric	Regosols, Calcaric	Regosols, Eutric
<i>Iberidion spathulatae</i>	<i>Festuco-Cirsietum glabri</i>											2	
<i>Mesobromion</i>	<i>Genistello-Agrostidetum capillaris</i>											3	
	<i>Phyteumo-Festucetum nigrescentis</i>											1	
	<i>Euphrasio-Plantagnetum mediae</i>											6	
	<i>Teucrio-Astragaletum catalaunici</i>											1	2
<i>Rumicion pseudoalpini</i>	<i>Rumici-Chenopodietum pseudoalpini</i>											1	
<i>Polygono-Trisetion</i>	<i>Alchemillo-Trollietum</i>										1	1	
<i>Festucion gautieri</i>	<i>Saponario-Festucetum gautieri</i>												1
	<i>Seslerio-Festucetum gautieri</i>												2
<i>Elynion medioeuropaeum</i>	<i>Elyno-Oxytropidetum halleri</i>												2
<i>Nardion strictae</i>	<i>Selino-Nardetum</i>					1							1
	<i>Alchemillo-Nardetum strictae</i>							1				2	2
	<i>Alchemillo-Nardetum bellardiochloetosum</i>												2
	<i>Alchemillo-Nardetum festucetosum eskiae</i>												2
	<i>Ranunculo-Festucetum eskiae</i>							1					2
<i>Festucion eskiae</i>	<i>Carici-Festucetum eskiae</i>												4
	<i>Hieracio-Festucetum paniculatae</i>												2
<i>Festucion airoidis</i>	<i>Arenario-Festucetum yvesii</i>		1										1
	<i>Hieracio-Festucetum airoidis vacciniotosum microphylli</i>												3
<i>Caricion nigrae</i>	<i>Caricetum nigrae</i>					1							
<i>Caricion davallianae</i>	<i>Caricetum davallianae</i>					2							
<i>Rhododendro-Vaccinion</i>	<i>Saxifrago-Rhododendretum</i>	1											1
<i>Juniperion nanae</i>	<i>Arctostaphylo-Pinetum uncinatae</i>								1				
<i>Seslerio-Pinenion</i>	<i>Pulsatillo-Pinetum uncinatae</i>											3	1

## Conclusion

The results show a great diversity of plant communities (14 alliances, 24 associations) in mountain pastures of the Benasque Valley (Central Pyrenees) related to 12 soil groups. Vegetation and soil are intimately connected to the altitude, steepness of terrain, lithology, and geomorphology. The abundance of well-developed soils (mostly eutric and dystric Cambisols) with high vegetation cover suggests that the use of these pastures has not led to significant ecosystem degradation.

## References

- Ascaso J. (1992) *Estudio fitocenológico y valoración de los pastos de puerto del Valle de Benasque (Pirineo Oscense)*. Tesis doctoral, University of Zaragoza, Spain, 409 pp.
- Ascaso J. and Ferrer C. (1993) Valoración agronómica de los pastos de puerto del Valle de Benasque (Pirineo de Huesca). Clasificación, valor forrajero y carga ganadera. *Pastos* 23, 99-127.
- Braun-Blanquet J. (1979) *Fitosociología. Bases para el estudio de las comunidades vegetales*. Blume, Madrid.
- Broca A. (1993) *Caracterización química y físico-química de suelos de pastos del Pirineo Aragonés (Valle de Benasque)*. Tesis doctoral, University of Zaragoza, Spain, 389 pp.
- IUSS Working Group WRB (2006) World reference base for soil resources 2006, *World Soil Resources Reports* No. 103, FAO, Roma, 128 pp.
- Schad P., Makeschin F., Rehfuess K.E., Ascaso J. and Alcubilla M. (1992) Bodenformen und Bodenabtrag in den Hochlagen der Axialen Pyrenäen. *Zeitschrift für Pflanzenernährung und Bodenkunde* 155, 87-93.

## Quality of food products from species-rich alpine pastures

Bele B.<sup>1</sup>, Østerlie M.<sup>2</sup> and Norderhaug A.<sup>1</sup>

<sup>1</sup>Norwegian Institute for Agricultural and Environmental Research (Bioforsk), the Grassland and Landscape Division, NO -7500 Stjørdal, Norway

<sup>2</sup>Sør-Trøndelag University College, Department of Food Technology, NO-7004 Trondheim, Norway

Corresponding author: bolette.bele@bioforsk.no

### Abstract

Alpine pastures have been created by extensive and long term farming practices, and their maintenance and biodiversity is dependent on livestock grazing. In an interdisciplinary project in the Norwegian mountains, we focus on local food production and 'added values' such as beautiful landscapes, biodiversity, special food quality and flavour. Possible connections between species-rich alpine pastures and food quality are documented by several methods, including product analysis, fodder analysis and by recording landscape patterns and vegetation types. Three local products (sour cream, brown whey goat's cheese and lamb chops) were analysed for fatty acids and antioxidants. Industrially produced milk products and meat from animals fed on different types of pastures, mostly less species-rich, or silage and supplementary concentrates were used as references. The results show that local products based on species-rich alpine pastures contain more  $\alpha$ -linolenic acid, conjugated linolenic acid (CLA), carotenoids and polyphenols than the reference products. Milk products and lamb produced on species-rich alpine pastures are in other words of special quality. Maintenance of beautiful landscapes and biodiversity by grazing as well as special food quality and flavour may be defined as 'added values' to local food production.

Keywords: biodiversity, landscape, added values, fatty acids, antioxidants, sensory value

### Introduction

Food quality labels linked to landscape, climate and geographical origin are favourable tools for rural development. The French word 'terroir' meaning the sense of place and cultural traditions is therefore successfully used in the marketing of local food. Many consumers require high ethical standards in the food production and are willing to pay more for products that involve benefits for the landscape. Documentation of this kind of 'added values' is crucial. Unsaturated fatty acids and antioxidants such as carotenoids and polyphenols are considered important nutraceuticals and may provide many health benefits. Carotenoids and polyphenols are examples of direct plant biomarkers, while fatty acids are indirect markers (Prache *et al.*, 2005). The objectives of this project were to investigate the links between food quality and sustainable use of biodiversity and to document biomarkers and possible 'terroir-effects' that may give added values to the products and thereby a better price in the market.

### Materials and methods

The study was carried out in two representative summer farming areas, in Nord-Trøndelag and Sør-Trøndelag Counties, Central Norway in 2008-2009. Subalpine/alpine pastures are the main fodder source during the summer farming period. The local food investigated was sour cream, brown goat cheese, and lamb chops from twin ewes. The reference products were industrially produced sour cream (Tine), industrially produced brown goat cheese (Tine) and a local brown goat cheese (D) based on milk from several farmers in Nord-Trøndelag County. All reference products are based on different types of pastures, mostly less species-rich, or

silage and supplementary concentrates. Two mountainous summer farms (A and B) from Sør-Trøndelag took part in the sour cream study and one summerfarm (C) from Sør-Trøndelag took part in the brown goat cheese study. One farm in Sør-Trøndelag and one farm in Nord-Trøndelag took part in the lamb study. Lamb chops from twin ewes slaughtered directly after the grazing season were investigated. The reference products were lamb chops from twin ewes supplementary fed with silage and concentrates for nine weeks after the grazing season. Vegetation types and species richness in pastures were recorded and classified. Mixed pasture samples were taken by cutting quadrats (10 cm x 10 cm) in grazed areas. Food products and pasture samples were analysed for composition and content of a range of fatty acids, carotenoids and of total polyphenols. Sensory preference tests of the lamb chops were performed. Lipids and water soluble bioactive substances were extracted as described by Bligh and Dyer (1959). Fatty acid methyl esters (FAME) were analysed by gas chromatography and carotenoids by high pressure liquid chromatography. Total polyphenol content was estimated colourimetrically using the Folin-Ciocalteu method. Sensory analyses were performed by a paired comparison test according to ISO-standard 5495.

## Results and discussion

Alpine pastures have been created by extensive and long-term farming practices and their maintenance and biodiversity is dependent on livestock grazing (Norderhaug *et al.*, 1999). In the study area a mosaic of such still-grazed, species-rich vegetation types, as open grasslands, intermediate and rich mires, birch woodlands and mountain heathland were recorded.

Table 1. Amount of  $\alpha$ -linolenic acid, carotenoids and polyphenols in pastures and corresponding sour creams (means of four replicates with standard deviation).

Analysis	Production place/product	Summer farm A in Sør-Trøndelag/product A	Summer farm B in Sør-Trøndelag/product B	Tine/ Industrial reference
Pasture	% $\alpha$ -Linolenic acid	56.7 $\pm$ 1.9a	56.0 $\pm$ 2.4a	x
	Carotenoids mg (100 g) <sup>-1</sup>	60.3 $\pm$ 0.20a	114.3 $\pm$ 0.0b	x
	Polyphenols GAE (100 g) <sup>-1</sup>	604.6 $\pm$ 52.2a	704.5 $\pm$ 76.6a	x
Sour cream	% $\alpha$ -Linolenic acid	0.60 $\pm$ 0.02a	0.90 $\pm$ 0.01b	0.70 $\pm$ 0.02c
	Carotenoids mg (100 g) <sup>-1</sup>	0.12 $\pm$ 0.01b	0.20 $\pm$ 0.07a	0.12 $\pm$ 0.05b
	Polyphenols GAE (100 g) <sup>-1</sup>	7.1 $\pm$ 0.3b	14.9 $\pm$ 0.5a	4.3 $\pm$ 0.4c

Means with different letters indicate differences ( $P < 0.05$ ) between columns

GAE = mg gallic acid equivalents 100 g<sup>-1</sup>

FW = Fresh weight

x = Pasture was not available for analysis

Table 1 shows that the two summer farms in Sør-Trøndelag County (A and B) had the same amount of  $\alpha$ -linolenic acid (C18:3) in the pasture samples. In spite of that, the sour cream from B had significantly more polyunsaturated fatty acid. An explanation may be that summer farm B has both the modern dairy cattle breed Norwegian red (NR) and old breeds, while summer farm A just has NR cattle. The analyses also showed that the higher the content of carotenoids and polyphenols in the pasture vegetation, the more was found in the sour cream. Correlation factors were 1.000 and 0.950, respectively. The correlation factor for  $\alpha$ -linolenic acid in the pasture samples and sour cream was not so high (0.539). This may be explained by the fact that fatty acids are indirect plant biomarkers and therefore dependent also on breed etc. Figure 1 shows that the amount of  $\alpha$ -linolenic acid and CLA in brown goat cheese from

summer farm C, reference farm D and Tine were significantly different ( $P < 0.05$ ). The goat cheese from summer farm C contained significantly more of both  $\alpha$ -linolenic acid and CLA than the cheeses from reference farmers D and Tine. Summer farm C had almost the same amount of  $\alpha$ -linolenic acid in the pastures as summer farm B.

More  $\alpha$ -linolenic acid was found in the meat from lambs that had grazed on alpine pastures than from those fed with concentrates. The 'alpine lambs' were preferred ( $P < 0.05$  and  $P < 0.30$ , respectively) in the consumer sensory test (60 assessors).

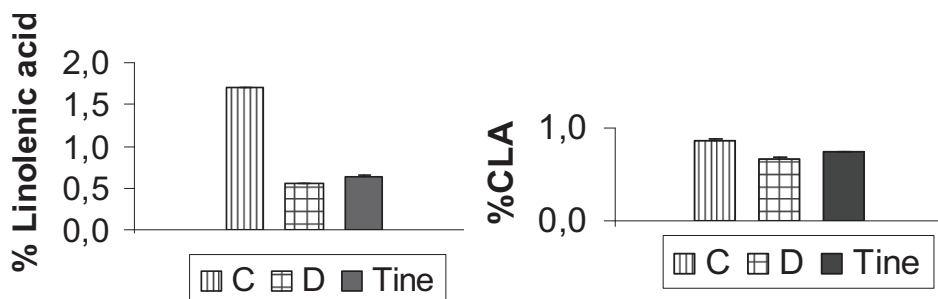

Figure 1. Amount (means of four replicates with standard deviation) of  $\alpha$ -linolenic acid and CLA (% of total fatty acids) in brown goat cheese, product C (from summer farm C in Sør-Trøndelag), reference product D (from reference farmers D in Nord-Trøndelag) and product from Tine (industrial reference).

## Conclusion

Species rich alpine pastures were maintained in the study area by grazing. Compared to corresponding industrial products, higher levels of beneficial components were found in sour cream and brown goat cheese produced on these species-rich alpine pastures. The flavour of meat from ewes grazing on alpine pastures was preferred when compared to meat from ewes supplementary fed with silage and concentrates after the grazing season. Documentation of connections between plant biomarkers in the pastures and food products as well as special flavour makes it possible to use the term 'terroir' in the marketing of food products from the summer farms.

## References

- Bligh E.G. and Dyer W.J. (1959) A rapid method of total lipid extraction and purification. *Canadian Journal of Biochemistry and Physiology* 37, 911-117.
- Norderhaug A., Austad I., Hauge L. and Kvamme M. (eds.) (1999) *Skjotselsboka for kulturlandskap og gamle norske kulturmarker*. Landbruksforlaget, Oslo, 252 pp.
- Prache S., Cornu A., Berdagué J.L. and Priolo A. (2005) Traceability of animal feeding diet in the meat and milk of small ruminants. *Small Ruminant Research* 59, 157-168.



# Halting the loss of biodiversity: Endemic vascular plants in grasslands of Europe

Bruchmann I. and Hobohm C.

*University of Flensburg, Biology, D-24943 Flensburg, Germany*

Corresponding author: ines.bruchmann@uni-flensburg.de

## Abstract

About 6200 vascular plant taxa are confined to Europe. As underlined in the Convention on Biological Diversity or in subsequent regional strategies, Europe has a particular responsibility to protect those species that are restricted to its boundaries. However, little is known about the distribution patterns of European endemics. Which habitats are rich in endemics and should therefore be given conservation priority? And are there endemic plants associated with European grassland ecosystems?

We evaluated European floras in order to obtain data on ecological affinities and habitat preferences. We assigned endemic taxa to one or more of eight predefined habitat categories, e.g. habitats of rocks and scree, forest ecosystems, grasslands, and others.

At least 1320 endemic plants inhabit grasslands. Of these, 352 taxa are restricted entirely to natural or semi-natural grasslands. Although grassland covers only a very small portion of Europe, this habitat type contains the second largest number of endemics and exceeds e.g. woodland ecosystems by far. Our analysis confirms the particular importance of grassland in species conservation but, nevertheless, this habitat type is strongly endangered by a creeping loss of quantity and quality. Therefore, it is imperative that action be taken in the area of grassland management and conservation.

Keywords: Convention on Biological Diversity (CBD), conservation priority, cultural landscapes, EU Habitats Directive, habitat loss

## Introduction

In 1992, with the agreement on the Convention on Biological Diversity, the importance of the biodiversity challenge was universally acknowledged (United Nations, 1992). In the following world summit, the parties declared that their goal was 'to achieve by 2010 a significant reduction in the current rate of biodiversity loss at the global, regional, and national level' (United Nations, 2002). In the 6th Environmental Action Programme the EU itself has set the objective to halt the biodiversity decline, which in turn requires its member states to corroborate this goal within their National Strategies on Biodiversity ([www.cbd.int/reports](http://www.cbd.int/reports)).

As the European Plant Conservation Strategy (Planta Europa, 2002) stresses, conservation action must be targeted at those plants and habitats that are most in need, which means that rare species or vulnerable habitats should be given conservation priority. Generally, species with a restricted distribution range are said to be more vulnerable to extinction than widespread species (Kruckeberg and Rabinowitz, 1985). According to the IUCN, about 50% of Europe's plant endemics are considered to be in danger of extinction (Planta Europa, 2002), so there is an urgent need to concentrate conservation action on endemics and the inhabited habitats. However, despite the fact that Europe's flora is probably the best studied in the world, we do not know much about the concrete distribution patterns of many of the endemics. With our study we aim to answer the questions: 1) which European habitats are rich in endemics and should therefore be given conservation priority, and 2) how many endemics are associated with grassland ecosystems?

## Methods

We evaluated European floras and floristic monographs in order to obtain data on endemic taxa, their distribution and ecological affinities or habitat preferences (detailed reference list of evaluated literature in Hobohm, 2008). Our study area covers Europe as defined in Fontaine *et al.* (2007) and our appreciation of the term ‘endemic’ follows the original definition dating back to de Candolle (1820).

Being well aware of the difficulties and biases that result from the different habitat terminologies in the various European languages, or from different national regulations and standards of classification, we decided to use eight habitat categories that correspond well with those defined by the European Habitats Directive (European Commission DG Environment, 2007). We distinguish rocky habitats and screes; grassland ecosystems; scrubs and heaths; forests; coastal and saline habitats; urban and other man-made habitats; inland water bodies; and mires (including bogs, fens, swamps). As far as possible, we assigned the endemic taxa to predefined habitat categories.

As Mucina and Rutherford (2006) state, the ‘term grassland is one of the most used, misused and abused terms of vegetation ecology’ (also Gibson, 2009). Indeed, the term is often used as a generic term, irrespective of the huge variety of defining environmental parameters, the different patterns of floristic or plant functional compositions. We define grassland as habitat dominated by herbs and grasses with shrub or tree cover of less than 15%. This includes natural grasslands (e.g. steppe, alpine meadow) and semi-natural grasslands, e.g. pastures and meadows (including all different types of dry to wet, nutrient poor to nutrient rich, extensively to intensively grazed or mowed).

## Results

To date, our database comprises about 6200 endemic species and subspecies. Only about three quarters of the listed plants are assigned to one or more of the predefined habitats as much current data on distribution, ecology, altitude range, etc. are still insufficient.

The large majority of endemics inhabit rocky habitats (2772), followed by grasslands (1320), shrub and heath habitats (1125), and forests (773). Lower rates were found for coastal/saline habitats (449), man-made habitats (413), inland waterbodies (265), and finally mires, bogs and fens, which are inhabited by only about 102 endemics.

Of the 1320 endemics occurring in grasslands, 352 taxa are absolutely restricted to this habitat type. However, it should be emphasised that most of these inhabit more than one European region (Median = 3). Large numbers of grassland endemics are found in the following regions: Italy (537), countries of former Yugoslavia (516), France (503), Austria (428), Spain (376), Switzerland (358), Germany (320), Romania (309), Czech Republic and Slovakia (292), Bulgaria (269).

## Discussion

Although grassland vegetation covers less than 10% of Europe’s area (White *et al.*, 2000), this habitat type contains the second largest number of endemics and exceeds e.g. woodland ecosystems by far. The reason why grassland endemics receive only little attention in conservation management may originate from the fact that many of these plants are spread over more than one European region, and are thus not ‘local’ endemics. However, this does not necessarily imply that these endemics are widely distributed. As a result of the fragmentation of Europe’s once wide grassland landscapes, the population areas are often disconnected and decreasing in size. Further, the grasslands suffer a creeping loss of biodiversity features because of fertilisation, land abandonment or the transformation of grassland into cropland (European Environment Agency, 2007). The first systematic

assessment of Europe's most vulnerable habitat types and species (under the Habitats Directive) has already shown that grasslands in particular have an unfavourable conservation status. This is ascribed to changes, throughout Europe, from the traditional extensive agricultural land-use patterns towards intensive agricultural usage (Commission of the European Communities, 2009).

## Conclusion

Our analysis confirms (1) the equal importance of Europe's natural and cultural landscapes, and (2) highlights the importance of grasslands in terms of endemic species richness. Europe's grassland is characterised by a high species diversity in general (Briemle, 2003; Hobohm and Bruchmann, 2009) and harbours the second largest number of European endemics. We are convinced that decision-makers in the field of nature conservation must be encouraged to pay more attention to the richness of Europe's undervalued natural and semi-natural grasslands. Given the current adverse conservation status of many grasslands, it is vital that grassland species and their habitats be given conservation priority.

## References

- Briemle G. (2003) Artenreiches Grünland- von der Naturkunde zur landwirtschaftlichen Praxis. In: Oppermann R. and Gujer H. (eds.) *Artenreiches Grünland*, Ulmer, Stuttgart, pp. 15-26.
- Commission of the European Communities (2009) *Composite report on the conservation status of habitat types and species as required under Article 17 of the habitats directive*, Brussels, 17 pp.
- De Candolle A. (1820) *Essai elementaire de geographie botanique. Dictionnaire des sciences naturelles*, Flevrault, Strasbourg, pp. 1-64.
- European Commission DG Environment (2007) *Interpretation manual of European Union habitats - EUR 27*, Brussels, 144 pp.
- European Environment Agency (2007) *Europe's environment: The fourth assessment*. EEA-Publications Office, Copenhagen, 452 pp.
- Fontaine B., Bouchet P., Van Achterberg K., Alonso-Zarazaga M. et al. (2007) The European Union's 2010 target: Putting rare species in focus. *Biological Conservation* 139, 167-185.
- Gibson D. (2009) *Grasses and Grassland Ecology*. Oxford University Press, Oxford, 305 pp.
- Hobohm C. (2008) Endemische Gefäßpflanzen in Europa. *Tuexenia* 28, 7-22.
- Hobohm C. and Bruchmann I. (2009) Endemische Gefäßpflanzen und ihre Habitate in Europa: Plädoyer für den Schutz der Grasland-Ökosysteme. *Berichte der Reinhold-Tüxen-Gesellschaft* 21, 142-161.
- Kruckeberg A. and Rabinowitz D. (1985) Biological aspects of endemism in higher plants. *Annual Review of Ecology and Systematics* 16, 447-479.
- Mucina L. and Rutherford M. (eds.) (2006) *The vegetation of South Africa, Lesotho and Swaziland*. South African National Biodiversity Institute, Pretoria, 807 pp.
- Planta Europa (2002) *European plant conservation strategy*. London, 40 pp.
- United Nations (1992) *Convention on Biological Diversity*, 26 pp.
- United Nations (2002) *Plan of Implementation of the World Summit on Sustainable Development*, New York, 88 pp.
- White R., Murray S. and Rohwedder, M. (2000) *The Pilot Analysis of Global Ecosystems: Grassland Ecosystems*. World Resources Institute, Washington D.C., 89 pp.

# Diversity of weed spectrum in grasses grown for seed in the Czech Republic

Cagaš B.<sup>1</sup>, Macháč J.<sup>2</sup>, Frydrych J.<sup>1</sup> and Macháč R.<sup>1</sup>

<sup>1</sup>OSEVA PRO Ltd., Grassland Research Station Rožnov-Zubří, CZ-756 54 Zubří, Czech Republic

<sup>2</sup>Association of Grass and Clover Seed Growers, CZ-756 54, Czech Republic

Corresponding author: cagas@oseva.cz

## Abstract

Growing grasses for seed has almost a 100-year tradition in the Czech Republic and the area, an integral part of grasslands, now occupies 18 000 ha. In the years 1999-2008, the occurrence of weeds was monitored for 19 different grass species during the growing season on an area of 2000 – 4500 ha at several locations in the country. The continuously occurring weed species can be divided into three groups: (1) species whose occurrence was recorded in 15-70% of the areas under study (*Elytrigia repens*, undesirable cultivated grasses, *Rumex* spp., *Matricaria* spp., *Tripleurospermum* spp., *Cirsium arvense*, *Apera spica venti*, wild *Poa* species); (2) species occurring in 5-15% of areas (*Viola tricolor*, *Avena fatua*, *Myosotis arvensis*, *Chenopodium* spp., *Echinochloa crus-galli*); and (3) species occurring in less than 5% of the localities under study (*Galeopsis* spp., *Capsella bursa-pastoris*, *Lamium* spp. etc.). A stable trend in occurrence was evident in *Elytrigia repens*, whereas a downward trend was recorded in *Matricaria* spp. and *Tripleurospermum* spp. A further increasing tendency in occurrence is expected in *Echinochloa crus-galli* and *Viola tricolor*.

Key words: invasive weeds, occurrence, expected tendency

## Introduction

The areas of grasses grown for seed which are an integral part of grassland fluctuated in the Czech Republic in the years 1999 – 2008 from 12 000 to 18 000 ha. Grass seed production is an interesting branch of domestic plant production. Even though the Czech Republic is one of Europe's largest seed producers viewed from the aspect of seed growing areas, yields are not high enough. One of the factors markedly affecting the level and quality of seed yield is an enormous occurrence of weeds in these stands. The objective of the study was to evaluate the diversity of the weed spectrum in grass seed stands and to show the trend in its development.

## Material and methods

Data on the occurrence of the weed spectrum come from the inspectors' reports of the Central Institute for Supervising and Testing in Agriculture on stands at the time of vegetation (May-July). Throughout the monitoring period (1999-2008), about 500 samples were taken each year to estimate the incidence of weeds. The investigation of weed occurrence in seed stands was conducted on 2000 – 4500 hectares in 19 cultivated grass species located in different regions of the Czech Republic. The data of two typical weeds (*Elytrigia repens*, *Matricaria* and *Tripleurospermum* complex) and two invasive weeds (*Echinochloa crus-galli*, *Viola tricolor*) were processed by regression analysis in the Statgraphics program version XV.

## Results and discussion

The monocotyledonous and dicotyledonous weeds that were found in grasses grown for seed at the time of vegetation in the years 1999 – 2008 are given in Table 1. The grass weeds that occurred on more than 15% of localities throughout the ten years of observations were

*Elytrigia repens*, cultural but undesirable grasses, *Apera spica-venti*, uncultivated *Poa* species and volunteer cereals. Other important monocotyledonous weeds persistently occurring on more than 8% of the areas under observation were *Avena fatua* and *Echinochloa crus-galli*. The most frequently occurring dicotyledonous weeds were species of the genera *Rumex*, *Matricaria* spp., *Tripleurospermum* spp., *Cirsium arvense*, *Viola tricolor* and species of the genus *Galium*.

The data from long-term observations of the occurrence of weed species in the stand shows that this spectrum has not markedly changed in the last ten years. The statistical analysis of occurrence of some important weeds brought some interesting facts. The incidence of *Elytrigia repens* decreased in the monitored period, but according to the calculated equation (Figure 1), its incidence has remained lately at a high level ( $y = 0.2538x^2 - 4.3717x + 82.063$ ,  $R^2 = 0.666$ ,  $y =$  weed incidence (%),  $x (1-10) =$  the years 1999-2008). This is not a desirable result as *Elytrigia repens* is one of the main factors reducing yield and quality of grass seeds and it is a reservoir of ergot (*Claviceps purpurea*) in nature (Cagaš *et al.*, 2006). An interesting finding is the expanding occurrence of warm-loving *Echinochloa crus-galli* in the early stage of grass stands in recent years (Table 1). It may suggest an increase in air temperatures over the growing season. The incidence of *Echinochloa crus-galli* has an increasing tendency and further spreading should be expected ( $y = 0.2754x^2 - 1.1019x + 4.2783$ ,  $R^2 = 0.665$ , Figure 1). Similarly, the recently increasing occurrence of *Viola tricolor* was investigated ( $y = 0.3485x^2 - 3.2024x + 15.807$ ,  $R^2 = 0.605$ , Figure 1). On the other hand, a decrease of incidence of *Matricaria* and *Tripleurospermum* species, which belong to the most contemporary common and invasive weeds (Peterka and Stach, 2007), was observed: ( $y = 0.2159x^2 - 4.0538x + 45.323$ ,  $R^2 = 0.639$ ; Figure 1). Differences in the occurrence of weeds in particular years may be caused by many factors: predominantly by a different spectrum of cultivated grass species, soil and climatic conditions and by different management practices (fertilising, crop protection).

Long-term monitoring of the weed spectrum in grasses grown for seed should not only signal the level of cultural methods and point out the absence of components in the portfolio of registered herbicides. It should give an overview of weed diversity in special perennial crops and also warn against spreading of new and non-traditional invasive species, the existence of resistant populations in some weeds and indicate the problems which aggressive weed species may cause in organic seed production and grasslands in general.

Table 1. Occurrence of some important weeds in grasses grown for seed at the time of vegetation in the Czech Republic (as %) in the years 1999 - 2008

Species	Year of observation										Mean
	1999	2000	2001	2002	2003	2004	2005	2006	2007	2008	
<i>Elytrigia repens</i>	79.4	78.6	65.1	64.2	67.3	66.2	65.0	68.7	62.9	60.5	67.8
undesirable grasses	53.6	57.8	56.5	60.0	63.8	44.7	41.3	21.6	39.7	43.5	48.3
<i>Poa</i> spp (wild species)	36.0	35.8	15.1	23.4	25.2	21.6	48.0	13.6	13.4	26.2	25.8
<i>Apera spica-venti</i>	34.5	33.6	16.9	15.7	23.8	17.9	29.6	25.8	18.7	16.8	23.3
volunteer cereals	21.8	19.6	5.8	2.8	10.2	12.6	9.8	14.7	16.5	9.6	12.3
<i>Avena fatua</i>	11.3	11.2	0.7	5.9	10.6	11.2	22.1	20.2	22.5	17.4	13.3
<i>Echinochloa crus-galli</i>	5.6	5.8	0.0	0.1	3.7	4.2	15.5	20.9	16.9	15.5	8.8
<i>Rumex</i> spp.	38.2	36.8	60.4	78	43.4	31.6	38.9	54.6	37.6	42.8	46.2
<i>Matricaria</i> spp.,	41.8	43.6	29.6	26.6	32.9	30.0	28.1	32.3	23.6	24.9	31.3
<i>Tripleurospermum</i> spp.											
<i>Cirsium arvense</i>	35.3	36.4	40.2	30.6	39.7	0.0	18.2	25.0	20.1	27.6	27.3
<i>Galium</i> spp.	16.2	14.8	18.3	15.2	5.5	8.8	12.5	9.3	7.0	9.7	11.7
<i>Viola tricolor</i>	12.6	13.4	10.1	3.9	6.7	9.3	12.6	17.0	13.2	17.3	11.6
<i>Myosotis arvensis</i>	5.8	4.3	11.9	6.0	1.4	4.2	5.6	6.4	2.7	3.5	5.2
<i>Chenopodium</i> spp.	3.2	4.3	0.9	2.4	9.4	5.4	9.7	11.5	11.5	9.7	6.8

%...area (expressed as a percentage) where the weed was recorded

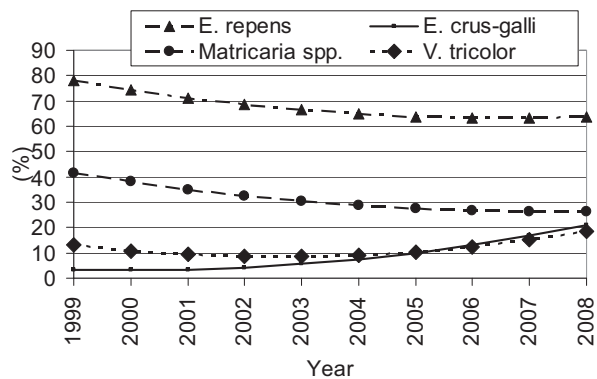

Figure 1. Regression curves of incidence (in %) of selected weeds (x = 1-10)

### Conclusions

The spectrum of important weeds in grasses grown for seed has been relatively stable in the last years. An exception is an increased occurrence of *Echinochloa crus-galli* and *Viola tricolor*. Further observations are required.

### References

- Cagaš B., Macháč J., Frydrych J. and Macháč R. (2006) Occurrence of Biotic Harmful Agents in Czech Grass Seed Production (1995 – 2004). *Plant Protection Science* 42, 58 – 65.
- Peterka J. and Stach J. (2007) Plevelé – nežádoucí společenstva v porostech kulturních rostlin v minulém a současném období. *Nové AGRO*, 2/2007, 22 – 23.

## Multi-species mixtures - new perspectives on models and mechanisms

Connolly J.<sup>1</sup>, Bell T.<sup>2</sup>, Brophy C.<sup>3</sup>, Carnus T.<sup>1,4</sup>, Finn J.<sup>4</sup>, Kirwan L.<sup>5</sup>, Luscher A.<sup>6</sup>, Sebastia M.T.<sup>7</sup> and Weigelt A.<sup>8</sup>

<sup>1</sup>School of Mathematical Sciences, UCD, Ireland, <sup>2</sup>Dept of Zoology, University of Oxford, UK, <sup>3</sup>Dept of Mathematics, NUIM, Ireland, <sup>4</sup>Johnstown Castle, Teagasc, Wexford, Ireland,

<sup>5</sup>Dept of Mathematics WIT, Waterford, Ireland, <sup>6</sup>Agroscope ART, Zurich, Switzerland,

<sup>7</sup>CTFC, Solsona, Spain, <sup>8</sup>Institute of Biology, University of Leipzig, Germany

Corresponding author: john.connolly@ucd.ie

### Abstract

The delivery of essential ecosystem functions (primary productivity, maintenance of soil fertility, resistance to weed invasion etc.) may be compromised by global declines in biodiversity. There is still controversy about the description of, and mechanisms behind, Biodiversity-Ecosystem Function (BEF) relationships. The Diversity-Interactions model quantified BEF relationships in terms of all the pairwise interactions between the species in a community. The model gives the contribution of two species ( $i$  and  $j$ ) to the functional response in a community as  $\delta_{ij}P_iP_j$ , where  $\delta_{ij}$  reflects the potential of the two species to contribute to the response and its actual contribution depends also on  $P_i$  and  $P_j$ , the initial relative abundance of the two species in the community. This model and variants fitted well to a wide range of functional responses (biomass production, respiration) from several, but not all, experiments that examined a wide range of organisms (plants, microorganisms) and levels of species richness (1 to 72 species). A modified version introduces a more complex effect of pairwise interaction. The properties of this more flexible model and its implications for BEF relationships are discussed, particularly in the context of grass-clover contributions to sward functions.

Keywords: Diversity-Interactions model, BEF relationship, species richness.

### Introduction

Increasing biodiversity can positively influence ecosystem functioning in natural grassland systems (e.g. Hooper *et al.*, 2005, Cardinale *et al.*, 2007). Explanations for this positive biodiversity-ecosystem function (BEF) relationship centre on complementary species interactions due to niche partitioning and facilitation (e.g. Hector *et al.*, 1999; Tilman, 1999) and selection effects (Loreau and Hector, 2001). Recently, models of BEF have been proposed (Kirwan *et al.*, 2007; Kirwan *et al.*, 2009) that characterise the functional response for a community as due largely to an identity effect (the expectation of response based on the monoculture performance of species in a community) and a diversity effect (DE), which is the sum of the effects of all the pairwise interactions between species in a community. The contribution of each pair of species depends on their relative abundances and their propensity to interact. This approach has been used in understanding the BEF relationship in a 33-site study of mixtures of four agronomic species (Kirwan *et al.*, 2007; Lüscher *et al.*, 2008) and in an analysis of effects within two of these sites (Frankow-Lindberg *et al.*, 2009; Nyfeler *et al.*, 2009). BEF modelling seeks 1: to provide a simple summary that captures most of the structure of the data, 2: to provide insight into the mechanisms driving the diversity effect.



## Materials and methods

*Diversity-Function model based on two-species interactions:* Suppose that the species pool contains  $s$  species from which communities of various levels of richness may be constructed. If the average and particular diversity effects depend only on pairwise species interactions, the following provides a simple description of the functional response ( $y$ ) in a  $t$ -species community ( $t \leq s$ ).  $P_i$  and  $P_j$  are the sown proportions of the  $i$ th and  $j$ th species in the community ( $= 0$  if the species is not in the community) and  $M$  is the overall initial abundance.

$$y = \sum_{i=1}^s \beta_i P_i + \gamma M + \sum_{i < j}^s \delta_{ij} (P_i P_j) + \varepsilon \quad [1]$$

In several cases examined, this model fitted well but did not explain all the variation among community responses other than that due to variation between replicate communities. An alternative was examined in which the term  $(P_i P_j)$  was replaced by  $(P_i P_j)^\theta$  where  $\theta$  was estimated by profile likelihood (Pawitan, 2001).

*Datasets:* Two data sets were used. (1) Total stand biomass from a Jena dataset: Standardised protocols were used to establish experimental assemblages of grassland species (grasses and forbs) that varied in species richness from 1, 2, 3, 4, 6 to 9 (Roscher *et al.*, 2004). Plots were established in summer 2002. Aboveground plant biomass production was measured for each plot. In total, the experiment comprised 206 plots and 100 different plant assemblages (9 monocultures and 36, 24, 18, 12 and 1 mixtures with 2, 3, 4, 6 and 9 species, respectively, replicated at least twice). For each assemblage, all species present were equally represented at sowing. (2) A field experiment was established in autumn 2006 at Johnstown Castle research centre, Ireland. Plant species were two grasses (G1: *Lolium perenne* and G2: *Phleum pratense*) and two legumes (L1: *Trifolium pratense* and L2: *Trifolium repens*). The design consisted of 4 monocultures, all 6 binary mixtures and various four-species mixtures; dominated in turn by each species (88:4:4:4); dominated in turn by each species at a lower percentage of the dominant, (70:10:10:10); six mixtures co-dominated by each pair of species (40:40:10:10) and four mixture with species equally represented (25:25:25:25). The design was repeated at two levels of overall initial abundance (low being 60% of high). All plots received a baseline 45 kg ha<sup>-1</sup> yr<sup>-1</sup> N in two applications and were harvested 3 times in 2007. Total aboveground biomass for 2007 was analysed. Model 1 and the alternative were fitted to aboveground biomass for the two datasets. In addition, a null model was fitted that included assemblage as a factor (1 degree of freedom for each assemblage) in addition to overall abundance for dataset (2). The total number of plots was 56. There was no replication and residual error was variation around the fitted model.

## Results

For the Jena data, model [1] with 48 coefficients (9 identity, 36 pairwise and 3 block) gave a residual Mean Square (RMS) lower than that of the null model (102 coefficients, 100 for assemblages and 3 for block) and so fitted better than it (Table 1). Adding the coefficient  $\theta$  (estimate 0.95) further reduced the RMS but not significantly ( $P = 0.213$ ). For Johnstown Castle data model [1] with 11 coefficients (4 identity, 6 pairwise and 1 total abundance) gave a higher RMS than the null model (NS) with 25 coefficients (24 for communities and 1 for overall abundance). Adding  $\theta$  (estimate 0.43) reduced the RMS ( $P = 0.038$ ) and gave the lowest RMS of the three models.

Table 1: Details of model fitting for two datasets.

Model	Model	Resid df	Resid ss	Resid ms	Comparison of models	P value
Jena						
1	Null Model	103	1618167	15710		
2	Model [1]	158	2408032	15241	2 vs 1	0.638
3	Model [1] Theta 0.95	157	2383403	15085	3 vs 2	0.213
Johnstown Castle						
1	Null Model	30	105.44	3.515		
2	Model [1]	45	168.28	3.739	2 vs 1	0.306
3	Model [1] Theta 0.43	45	151.8	3.373	3 vs 2	0.038

## Discussion and conclusion

The extra coefficient improved model fit only for the Johnstown Castle data. This coefficient is related to the way in which pairs of species interact, has implications for the rate at which the BEF relationship increases with increasing richness and provides a unifying description that includes many of the empirical BEF relationships that have been proposed. More experience with this model is required.

## References

- Cardinale B.J., Wright J.P., Cadotte M.W., Carroll I.T., Hector A., Srivastava D.S., Loreau M. and Weis J.J. (2007) Impacts of plant diversity on biomass production increase through time because of species complementarity. *Proceedings of the National Academy of Sciences of the United States of America* 104, 18123-18128.
- Frankow-Lindberg B.E., Brophy C., Collins R.P. and Connolly J. (2009) Biodiversity effects on yield and unsown species invasion in a temperate forage ecosystem. *Annals of Botany* 103, 913-921.
- Hector A., Schmid B., Beierkuhnlein C., Caldeira M.C. *et al.* (1999) Plant diversity and productivity experiments in European grasslands. *Science* 286, 1123-1127.
- Hooper D.U., Chapin F.S., Ewel J.J., Hector A., Inchausti P., Lavorel S., Lawton J.H. *et al.* (2005) Effects of biodiversity on ecosystem functioning: A consensus of current knowledge. *Ecological Monographs* 75, 3-35.
- Kirwan L., Lüscher A., Sebastia M.T., Finn J.A. and Collins R.P. *et al.* (2007) Evenness drives consistent diversity effects in intensive grassland systems across 28 European sites. *Journal of Ecology* 95, 530-539.
- Loreau M. and Hector A. (2001) Partitioning selection and complementarity in biodiversity experiments. *Nature* 412, 72-76.
- Lüscher A., Finn J.A., Connolly J., Sebastia M.T., Collins R.P., Fothergill M., Porqueddu C., Brophy C., Huguenin-Elie O., Kirwan L., Nyfeler D., Helgadottir A. (2008) (2008) Benefits of sward diversity for agricultural grasslands. *Biodiversity* 9, 29-32.
- Nyfeler D., Huguenin-Elie O., Suter M., Frossard E., Connolly J. and Lüscher A (2009) (2009) Strong mixture effects among four species in fertilized agricultural grassland led to persistent and consistent transgressive overyielding. *Journal of Applied Ecology* 46, 683-691.
- Pawitan Y. (2001) *In all Likelihood: Statistical Modelling and Inference Using Likelihood*. Clarendon Press, Oxford.
- Roscher C., Schumacher J., Baade J., Wilcke W. Gleixner G., Weisser W.W., Schmid B and Schulze E.D. (2004) The role of biodiversity for element cycling and trophic interactions: an experimental approach in a grassland community. *Basic and Applied Ecology* 5, 107-121.
- Tilman D. (1999) The ecological consequences of changes in biodiversity: A search for general principles. *Ecology* 80, 1455-1474.

# Study of the earthworm population (*Lumbricus terrestris*) in grassland differing in management

Daugėlienė N., Žekonienė V., Bartkevičius E. and Gavenauskas A.

Lithuanian University of Agriculture, Ecological Department, Studentų 11, Akademija, LT-53361, Kaunas district, Lithuania

Corresponding author: ndaugelen@takas.lt

## Abstract

This study summarises the occurrence of the earthworm *Lumbricus terrestris* in differently managed grassland. Experiments were conducted in four sward management systems: long-term sward of seven years of use, perennial grasses in the crop rotation kept for five, three and two years. The ploughed soil layer (13.5 m<sup>-2</sup>) had the lowest number of earthworms. The number of earthworms ranged from 0 to 28.8 m<sup>-2</sup> in the long-term sward, 5.0-20.0 m<sup>-2</sup> in the sward used 5 years, 0-36.2 m<sup>-2</sup> in the sward used three years and 5.0-12.5 m<sup>-2</sup> in the sward used two years. The occurrence of earthworms was most markedly affected by the moisture content of freshly ploughed soil. A lesser effect was exerted by the soil undisturbed for three years. The effect of moisture in soil undisturbed for five years on the occurrence of earthworms was weak, and no effects were identified in the soil undisturbed for 18-24 years. Legumes had a positive effect on the occurrence of earthworms when the swards were used for three years (*Trifolium pratense*) and five years (*Trifolium repens*). It should be noted that in the sward of five years of use, *Lolium perenne* accounted for the largest share of grasses (34.9%).

Keywords: crop rotation, moisture, legume, long-term sward

## Introduction

Grasses and legumes are grown together worldwide to improve total herbage yield and the quality of forage. However, the causes of population oscillations of grasses and legumes are poorly understood. Especially in grasslands, earthworms are among the most important detritivore animals functioning as ecosystem engineers, playing a key role in nutrient cycling and affecting plant nutrition and growth (Eisenhauer and Scheu, 2008). However, knowledge on effects of earthworms on plant growth has focused on crops, with most reported studies being for crop plants, particularly cereals, and pastures; very little is known on plant species in more natural communities (Scheu, 2003). Ploughing of established grassland increases earthworm populations, but continuous cultivation usually decreases them (Lee, 1985). Moreover, *Lumbricus terrestris* migrate in the soil into deeper layers (60-115 cm), especially in heavier-textured soils (Atlavinytė, 1960). We analysed earthworm populations in grassland under different management systems, of different age, soil moisture and plant species.

## Materials and methods

The soil of the long-term experimental site is a *Haplic-Luvisol (LVh)*, light loam on medium loam with a pH<sub>KCl</sub> of 5.7, topsoil available P of 76 mg kg<sup>-1</sup> and K of 245 mg kg<sup>-1</sup>. The soil's agrochemical properties (in the 0-20 cm soil layer) were determined using the following methods: pH<sub>KCl</sub> by electrometric method, phosphorus and potassium by AL method.

The trials were set up in a grassland used for 18 years, in which grasses prevailed (accounted for 70%). Experiments were conducted in four sward management systems: long-term sward of seven years of use, and perennial grasses in the crop rotation kept for five, three and two

years. The most frequent species were smooth-stalked meadow grass, cocksfoot, and meadow fescue. Legumes (white clover) accounted for 10% and forbs for 20-25%, of which the most frequent were dandelion, yarrow, autumn hawkbit and buttercup. Earthworm counts were done in 0.25 m<sup>2</sup> in the 0-20 cm soil layer. The number and mass of earthworms were then determined and recalculated into m<sup>-2</sup>. Macro-fauna was dug out in each plot post-harvesting (in autumn). The conditions during the vegetation period were described using the agrometeorological indicator – G. Selianinov hydromethermal coefficient (HTC) (Bukantis, Rimkus, 1997), which was calculated according to the following formula:  $HTC = \sum p / (0.1 \sum t)$ , where  $\sum p$  represents the sum of precipitation (mm) during the test period, when average daily air temperature is higher than 10 °C, and  $\sum t$  stands for the sum of active temperatures (°C) during the same period. Experimental data were statistically analysed using STAT-ENG according to Tarakanovas and Raudonius (2003).

## Results and discussion

After having ploughed an 18-year-old grassland sward, the number of earthworms in the soil was 13.5 m<sup>-2</sup>. In the soil of the long-term sward, the number of earthworms ranged from 0 – 28.8 m<sup>-2</sup>, in the sward of 5 years of use from 5.0 - 20.0 m<sup>-2</sup>, in the sward of 3 years of use from 0 - 36.2 m<sup>-2</sup> and in the sward of 2 years of use from 5.0 - 12.5 m<sup>-2</sup>. A curvilinear correlation was determined between the number of earthworms and HTC in the long-term sward ( $r=-0.59$ ); in the other swards there was no correlation between these two indicators over the whole growing season.

While estimating the effect of hydrothermal regime on the abundance of earthworms during separate months of the growing season, it was found that in the long-term sward there was a strong ( $r=0.797^*$ ) linear but negative correlation between earthworm number and HTC in July. In the short-term sward, moderately strong ( $r=-0.487$  and  $r=-0.566$ ) correlations were determined between the number of earthworms and HTC in July and August. When perennial grasses were kept in the crop rotation for three years, strong ( $r=0.798$  and  $r=0.963$ ) curvilinear correlations were also determined in June and August, i.e. with increasing HTC, the number of earthworms increased in the soil. In June – July, when the weather is dry, some of the earthworms die or migrate into deeper layers and are not active. In previous research, peak numbers in pasture reached 240 m<sup>-2</sup> (biomass 66 g m<sup>-2</sup>) during winter/spring, were reduced to very few individuals (13 m<sup>-2</sup>) by cultivation in late September, but increased to 578 m<sup>-2</sup> (biomass 62 g m<sup>-2</sup>) in the warm summer months under irrigation in a similar manner to a normal winter and spring period (June to October) (Smeaton *et al.*, 2003).

One of the factors determining the abundance of earthworm populations is soil moisture. The occurrence of earthworms was most markedly affected by the moisture content of freshly ploughed soil ( $r=-0.993$ ; standard error of estimate (SE):  $\pm 0.118$ ;  $y=15.286-0.245x$ ); a lesser effect was exerted by the soil undisturbed for three years ( $r=0.722$ ; SE:  $\pm 0.692$ ;  $y=17.509+0.116x$ ). The effect of the moisture of soil undisturbed for five years on the occurrence of earthworms was weak, and no effects were identified of the soil undisturbed for 18-24 years. Another factor that exerted an effect on the variation of earthworm population in the soil was the change in plant species composition in the course of years. The relationship between plant species composition and the earthworm number in separate years of use showed that there existed a strong linear or curvilinear but negative correlation between grasses and earthworm numbers (Table 1). Kreuzer *et al.* (2004) showed that the effect of earthworms is more pronounced in grasses than in legumes, suggesting that earthworm effects vary with plant functional groups. In our study, legumes had a positive effect on the occurrence of earthworms in the soil, when the swards were kept for three years (*Trifolium pratense*) and five years (*Trifolium repens*) of use. It should be noted that in the sward of five

years of use, *Lolium perenne* accounted for the largest share of grasses (34.9%). Wurst *et al.* (2005) suggested that earthworms enhance the competitive ability of *Lolium perenne* against *Trifolium repens* by increasing the supply of N for grasses.

Table 1. The effect of plant species composition on the occurrence of earthworms in the soil under the cover of swards of different age (SE: standard error of estimate)

Indication		Linear correlation		Linear regression		Coefficient of variation
Botanical composition	%	R	SE	intercept	slope	V %
Long-term grassland (7 years of use)						
Grasses	74,0	-0.845*	± 0.267	97.303	-1.156	9
Legumes	4,85	0.623	± 0.391	5.125	1.356	89
Forbs	21,1	0.653	± 0.378	-15.477	1.288	23
Grassland 5 years of use						
Grasses	79,9	-0.946*	± 0.187	69.149	-0.68	13
Legumes	10,1	0.817	± 0.333	9.248	0.548	111
Forbs	10,1	0.127	± 0.573	12.789	0.196	49
Grassland 3 years of use						
Grasses	38,9	-0.761	± 0.649	43.376	-0.612	58
Legumes	46,8	0.733	± 0.681	-2.813	0.479	60
Forbs	14,5	-0.562	± 0.827	47.551	-1.928	37

## Conclusions

The largest number of earthworms was found in the sward of 3 years of use. The lowest number of earthworms was found in the ploughed soil. In the soil of long-term grassland, the number of earthworms was 1.3-1.6 times higher than in the ploughed soil. The effect of soil moisture on earthworms was more pronounced in the ploughed soil. Grasses and legumes had a positive effect on the occurrence of earthworms in the soil.

## References

- Atlavinytė O. (1960) Dirvožemio ypatybių įtaka slikių paplitimui ir jų gausumui. *Lietuvos TSR Mokslų akademijos darbai*, serija C, T, 2, 55 – 63.
- Bukantis A. and Rimkus E. (1997) Lietuvos agroklimatinių išteklių kaita ir prognozės. *Lietuvos klimato ir dirvožemio potencialaus racionalaus naudojimo perspektyvos*, 5–11.
- Eisenhauer N. and Scheu S. (2008) Earthworms as drivers of the competition between grasses and legumes. *Soil Biology and Biochemistry* 40, 2650–2659.
- Kreuzer K., Bonkowski M., Langel R. and Scheu S. (2004) Decomposer animals (*Lumbricidae*, *Collembola*) and organic matter distribution affect the performance of *Lolium perenne* (Poaceae) and *Trifolium repens* (Fabaceae). *Soil Biology and Biochemistry* 36, 2005–2011.
- Wurst S., Langel R. and Scheu S. (2005) Do endogeic earthworms change plant competition? A microcosm study. *Plant and Soil* 271, 123–130.
- Lee K. E. (1985) *Earthworms their ecology, and relationships with soils and land use*. Academic press, 389 pp.
- Scheu S. (2003) Effects of earthworms on plant growth: patterns and perspectives. The 7 international symposium on earthworms. *Pedobiologia* vol. 47, 846–856.
- Smeaton T. C., Daly A. N. and Cranwell J. M. (2003) Earthworm population responses to cultivation and irrigation in a South Australian soil. *Pedobiologia* . 47, 379–385.
- Tarakanovas P., Raudonius S. (2003) *Statistinių duomenų apdorojimo programų paketas 'Selekcija'*, 56 pp.

## A method to assess the management of permanent grasslands at farm level

Duru M., Cruz P., Martin G. and Theau J.P.

UMR1248 INRA-ENSAT AGIR, BP 52627, 31326 Castanet Tolosan, France

Corresponding author: mduru@toulouse.inra.fr

### Abstract

In less-favoured areas, even if there are supports for conserving permanent grasslands, little is known about the agricultural services they can provide, especially at farm level. To assess such services, we propose a method based upon plant functional types (PFT). It was evaluated on eight beef and dairy farms in the Central Massif, 169 vegetation samplings in total. At land use type level (cutting area, area grazed by cow or heifer), we found that within- and between-field PFT diversity was highest for grassland vegetations mixing PFT having acquisitive (PFT<sub>acq</sub>) and conservative strategies for resource capture and use, respectively. At land use type level, a significant positive correlation was established between stocking rate and the percentage of PFT<sub>acq</sub> in the grasslands. In dairy farms during spring, similar milk production and turnout dates were observed whatever the proportion of PFT<sub>acq</sub>, but farms having the lowest proportion of PFT<sub>acq</sub> proceeded to topping on the meadows to compensate for later grass growth. The approach may be a relevant support for discussing management options.

Keywords: plant functional type, grazing, diversity

### Introduction

Policy makers are keen to encourage more sustainable livestock systems. In less-favoured areas, this can take the form of preserving plant diversity, e.g. through low-input farming systems. Such challenge calls for the development of a method for characterising and understanding the implications of diversity for farm management. Field-scale functional analysis of vegetation on the basis of plant traits allows evaluating objectively the agricultural services provided by permanent grasslands: dynamics of grass growth, nutritive value and flexibility for management. Grassland vegetation types (GVT) have been defined on the basis of the proportion of grass species having an acquisitive strategy for resource use (Duru *et al.*, 2010). Here, we examine if such a functional categorisation is appropriate for describing within- and between-field grassland diversity at land use type level (cutting vs. grazing), and for understanding the implications of diversity for management at the farm level.

### Material and methods

GVT were defined on the basis of LDMC<sub>gw</sub> (leaf dry matter content weighted by the abundance of grass species), leading to distinguish two functional types: acquisitive PFT (PFT<sub>acq</sub>) having low LDMC, and conservative PFT having high LDMC. For each grassland field, we calculated: (i) the proportion of PFT<sub>acq</sub> for assessing grassland productivity and the dynamics of grass growth along a growing cycle; (ii) within-field functional diversity (FD $\alpha$ ), the spreading of species abundance along a trait axis, was characterised by an index bounded between 0 and 1 ((Duru *et al.*, 2010); (iii) a Simpson index for characterising between-field diversity (FD $\beta$ ), considering six LDMC<sub>gw</sub> classes for calculating the proportion ( $\pi$ ) of grassland area of each LDMC<sub>gw</sub> class at land use type levels. Species richness was the number of species accounted on the fields of a land use type. The work was carried out in the French Central Massif. Focusing on the evaluation of the method, we chose to apply it on a limited number of farms (four dairy and four beef farms, Table 1). Before field observations, a survey consisted of recording information for mapping the farm and identifying farmer's

land use practices; then, botanical data were obtained from a simplified vegetation recording, 10 equidistant 40 cm quadrats along a transect on 169 grassland fields.

Table 1 Characterisation of dairy (D) and beef (B) farms for their structure and management

	D 1	D 2	D 3	D 4	B 1	B 2	B 3	B 4
Grassland area (ha)	54	58	77	69	105	70	115	160
Animal units (total) : AU	60	56	70	52	106	78	87	117
Animal units (cow)	39	38	48	35	70	55	60	80
Stocking rate (AU ha <sup>-1</sup> )	1.1	1.1	1	0.8	1	1.1	0.8	0.7
Cutting area / AU (ha)	0.4	0.45	0.44	0.43	0.37	0.4	0.41	0.36
Number of observed grasslands	17	23	20	21	26	20	21	24

## Results

At land use type level (cutting vs. grazing areas, respectively meadows and pastures), there were large differences in GVT (Figure 1a, x-axis). In general, percentage of PFT<sub>acq</sub> was higher for the cutting area. Expression of FD $\alpha$  according to GVT showed a significant parabolic relationship, with the highest diversity observed for GVT having PFT<sub>acq</sub> around 60% (Figure. 1a). The same was true for FD $\beta$ , except for farm B4 (Figure 1b). Species richness was linearly and significantly negatively correlated with GVT ( $r^2=0.50$ ;  $P<0.001$ ).

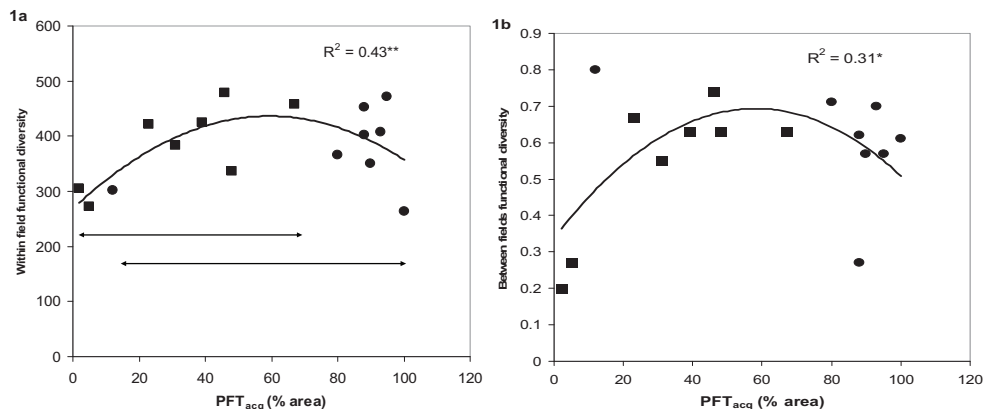

Figure 1. Relationship between within- (1a) and between-fields (1b) plant diversity according to PFT<sub>acq</sub> for grazing (■) and cutting (●) areas.

A significant correlation ( $P<0.01$ ) was found between percentage of land area with PFT<sub>acq</sub> and stocking rate for the grazing area (Figure 2a). When PFT<sub>acq</sub> of the grazing land increased from 0 to 100%, stocking rate increased by up to 2-fold. At land use type level, dairy farms had different patterns for the percentage of land area having PFT<sub>acq</sub> (Figure 2b). The GVT used by heifers were independent of those used by cows. For example, heifers grazed GVT with either a high (D1) or a low (D4) percentage of PFT<sub>acq</sub> whatever the GVT used by cows. Greater between-farms homogeneity was observed for GVT of the cutting area. Such a characterisation reveals that the same abundance of PFT<sub>acq</sub> at the farm level can hide large differences at land use type level. The farm-level ranking can correspond to large differences in management at land use type level, especially for cow and heifer grazing (Figure 2b). Within the grazing area, a low percentage of PFT<sub>acq</sub> and high FD $\beta$  was observed for low stocking and fertilisation rates (Table 2). FD $\alpha$  was highest for D2 in agreement with the whole dataset (Figure 1a). The duration of topping and mixed diet periods were positively and negatively related with the percentage of land area with PFT<sub>acq</sub> and FD $\beta$ , respectively (Table



2). On these farms, turnout dates were almost the same. Thus, adjustment of the duration of the topping and the mixed diet periods provided management flexibility to cope easily with the current conditions, especially weather. Similar milk production and concentrate consumption were reached with a wide variety of GVTs (Table 2).

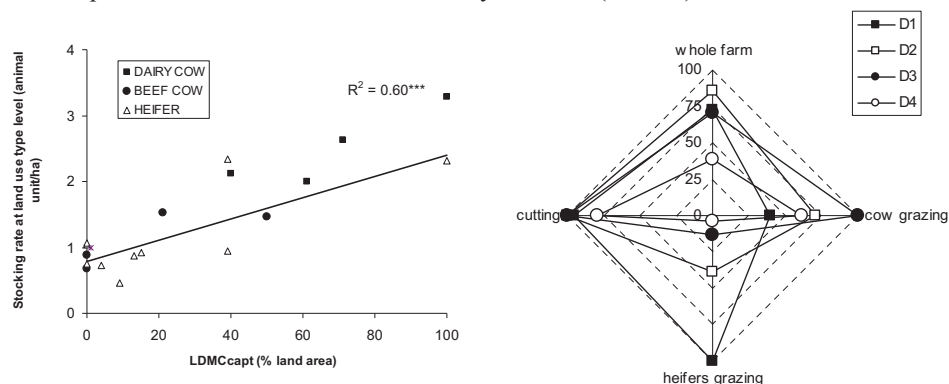

Figure 2. Relationship between the stocking rate and the percentage of grassland area having acquisitive GVT ( $LDMC_{acq}$ ) at land use type level (2a); radar diagram for dairy farms indicating the percentage of land area with acquisitive GVT for the three main land use types and the whole farm (2b)

Table 2. Detailed vegetation and spring management for three dairy cow farms.

		D1	D2	D3
Vegetation	GVT: $PFT_{acq}$ (% area)	40	71	100
	Within- ( $FD\alpha$ ) and between-field diversity ( $FD\beta$ )	272; 0.66	423; 0.63	355; 0.53
	Species richness	38	38	22
Management in spring	Stocking rate ( $cow\ ha^{-1}$ ) and N fertiliser ( $kg\ ha^{-1}$ )	2.12; 13	2.63; 29	3.29; 46
	Duration of topping (days)	40	25	10
	Duration of mixed diet (hay/grazing) (days)	27	20	7
Milk ( $kg\ year^{-1}\ cow^{-1}$ ) and concentrates ( $g\ l^{-1}$ )	4615; 259	5000; 285	4104; 244	

## Discussion and conclusion: managing biodiversity

Vegetation types encountered were mainly related to stocking rate, in such a way that contrasting GVT assemblages ( $FD\beta$ ) were observed at farm level depending on whether land was used for grazing or cutting and on management intensity. Highest  $FD\alpha$  was observed for intermediate management intensity. Recent reviews point out that habitat heterogeneity on several spatial scales (between farms, between fields, within-field) is beneficial to biodiversity, providing a diversity of organisms to exploit these habitats. We found that farmland management can take advantage of functional diversity, exploiting it within and between land use types. A same milk production target can be met by combining grazing on low productive grassland (low proportion of  $PFT_{acq}$ ) and on meadows for keeping early turnout dates. The use of our method shows that there is an opportunity to reconsider the balance between agricultural production and biodiversity management at farm level in addition to the usual larger spatial and temporal scales.

## References

Duru M., Cruz P., Jouany C. and Theau J.P. (2010) Construction of a simplified method based on the functional composition of the vegetation for characterizing the agronomic services provided by species-rich grasslands (*this volume*).

# **Influence of management and environmental factors on species composition and species richness in semi-arid rangeland in western Iran**

Faramarzi M.\*, Kesting S., Wrage N. and Isselstein J.

*Institute of Grassland Science, Department of Crop Sciences, University of Goettingen, Goettingen, Germany*

*\* current address: Natural Resources Group, Faculty of Agricultural Sciences, Ilam University, Ilam, Iran*

Corresponding author: mfarama@gwdg.de

## **Abstract**

A large proportion of rangeland in western Iran is in either fair or poor condition. The objective of this study was to analyse the main drivers of rangeland degradation and the vegetational changes that come along with it, and thereby identify mitigation options. A number of 43 main plots were sampled in four grazing areas using a stratified double sampling method. Soil and topographic variables, plant species richness and the distribution of species composition were determined. A measure of grazing intensity was obtained from livestock census data of the different grazing areas. For data analysis, parametric and non-parametric statistics as well as multivariate data analysis techniques were used. Of the measured environmental variables, altitude was the single one that showed a significant linear correlation with species richness. Furthermore, only the amount of K, the percentage cover of stones, and north-facing aspect were related with species composition. Grazing intensity as a management variable was negatively associated with species richness. The results indicated that past and present grazing intensity may have been an important factor influencing species richness and distribution of species composition in semi-arid rangeland in western Iran.

Keywords: grazing intensity, rangeland management, soil and topographic variables.

## **Introduction**

About 55% of the total land area of Iran is rangeland. Most rangeland is located in the arid and semi-arid regions. It is often intensively used and in rather poor condition (Mesdaghi, 1998; Badripour, 2004). The species composition and species richness of rangelands is controlled by both management practices such as grazing intensity (Abule, 2007) and environmental variables such as soil condition and topography (Dalle Tussie, 2004). In this study, we investigated the relationship between the factors grazing pressure, soil and topography, and species composition and species richness in a rangeland area of Kermanshah, western Iran.

## **Material and methods**

The study was conducted in four grazing areas (GAs) in the south-east of Kermanshah in Iran during the 2006 growing season. The livestock number of each grazing area (Livestock census, 2003) was used as a measure of grazing intensity. The grazing intensity of GA1, GA2, GA3, and GA4 was 0.57, 3.75, 2.88, and 0.82 animal units per ha, respectively. In Iran, an animal unit (AU) is defined as one sheep or goat of approximately 40 kg (Mesdaghi, 1998). The study area is grazed mostly by sheep, goats, and sometimes cattle, including both sedentary and migrating animals. A total of 43 sites were selected according to a stratified double sampling design based on the distribution of range classes distinguished by visual interpretation of satellite images (Thompson, 2002). There were 9, 9, 18 and 7 sites in GA1,

GA2, GA3, and GA4, respectively. On each site, two perpendicular transects of 60 m each were set up. Per 2-m section of each transect, the occurring plant species were determined (species richness) and their expansion (per species), as well as that of bare soil, stones and litter was recorded, resulting in 30 data sets per transect. Soil was sampled in two locations per site. These samples were analysed for available phosphorus (P), available potassium (K), organic carbon (OC), pH, and soil texture. The altitude per site was recorded by GPS (GARMIN; eTrex VISTA) and the slope aspect was determined. The results of the four GAs were compared using ANOVA followed by Tukey's HSD as a post-hoc test or the Kruskal–Wallis test followed by a post-hoc Mann-Whitney U-test for normally and non-normally distributed variables, respectively, using STATISTICA for Windows (Version 8.0) and SPSS (version 15). RDA was used for multivariate analysis using CANOCO for Windows (version 4.5).

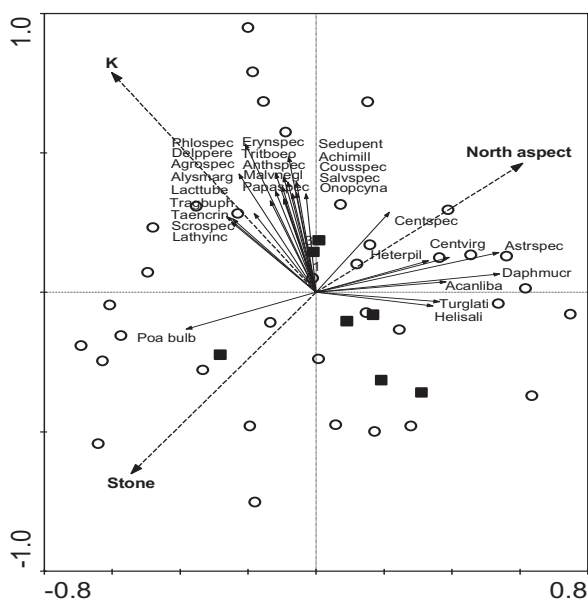

Figure 1: Ordination diagram based on RDA gradient analyses of species, samples, and measured variables in the study area. Only species with a fit better than 10% are presented to increase legibility.

## Results and discussion

In this study, we tested the hypothesis that grazing intensity and the measured explanatory soil and topographic variables influence species richness and species composition. Of all soil and topographic variables, only north-facing aspect, the percentage cover of stones and the amount of K were significantly related with the distribution of herbaceous and woody species (Figure 1). That these factors influence phytodiversity is known from the literature (Vogiatzakis *et al.*, 2003; Dalle Tussie, 2004; He *et al.*, 2007). However, other authors found that in addition, further environmental variables, e.g. the content of P, clay, silt, sand, pH and altitude also significantly influenced species composition (Dalle Tussie, 2004) and plant growth (Rezaei and Gilkes, 2005). It is surprising that in our study only so few measured variables showed correlations with species composition. Furthermore, of the measured soil and topographic variables, only altitude showed a significant linear correlation with species richness. However, altitude also explained just 16% of the variation in species richness. Therefore, the measured soil and topographic variables were not the main factors affecting vegetation composition and species richness.

Grazing intensity could not be included as a factor in the RDA, as the data were not available for each site. However, there are indications that grazing intensity was very important for vegetation composition and palatability. Thus, the ANOVA analysis indicated that the species richness of GA4 was larger than that of the other GAs, while there was no difference between GA4 and the others in soil and topographic variables (Table 1). However, GA4 had a lower grazing pressure than GA2 and GA3 (Table 1). This could have led to an increased species richness (e.g. Zhao *et al.*, 2007). GA1 also had a lower grazing pressure than the other GAs, but did not show higher species richness. Farmers in GA1 suggested that their rangelands had been subject to decades with heavy grazing, leading to degradation. This is in line with the dominance of spiny and poisonous *Astragalus* sp. and *Daphne mucronata* in this GA, which is a sign of overgrazing. Livestock owners avoid areas where these shrubs spread, leading to decreased grazing intensity.

## Conclusion

Of the measured environmental variables, only few showed a significant correlation with species richness or species composition. Grazing intensity may have had an important influence on plant diversity. Here, the occurrence of species indicating overgrazing in areas with presently low grazing pressure suggest that it is important to include past grazing management into analyses of plant diversity in semi-arid rangelands of Iran.

Table 1: Potentially important explanatory variables and species richness in the four grazing areas (GAs). Different superscript letters indicate significant differences ( $P < 0.05$ ) between GAs.

	GA1	GA2	GA3	GA4
Total livestock dependent on rangeland (AU/ha)	0.57	3.75	2.88	0.82
Extractable K ( $\mu\text{g g}^{-1}$ )	421 <sup>a</sup>	463 <sup>ab</sup>	531 <sup>b</sup>	456 <sup>ab</sup>
North-facing aspect (numeric)	0.89 <sup>a</sup>	0.22 <sup>b</sup>	0.44 <sup>ab</sup>	0.57 <sup>ab</sup>
Percentage cover of stones	12.7 <sup>a</sup>	33.9 <sup>b</sup>	20.8 <sup>ac</sup>	27.4 <sup>abc</sup>
Species richness	29.7 <sup>a</sup>	28.1 <sup>a</sup>	29.8 <sup>a</sup>	40.3 <sup>b</sup>

## References

- Abule E., Snyman H. A. and Smit G. N. (2007) Rangeland evaluation in the middle Awash valley of Ethiopia: I. Herbaceous vegetation cover. *Journal of Arid Environments* 70, 253-271.
- Badripour H. (2004) *Pasture/forage resource profiles of Iran*. Rangeland and Watershed Management Organization (FRWO) - Ministry of Jihad-e-Agriculture, Iran.
- Dalle Tussie G. (2004) *Vegetation ecology, rangeland condition and forage resources evaluation in the Borana lowlands, southern Oromia, Ethiopia*. Goettingen University, Goettingen, 258 pp.
- He M. Z., Zheng J. G., Li X. R. and Qian Y. L. (2007) Environmental factors affecting vegetation composition in the Alxa Plateau, China. *Journal of Arid Environments* 69, 473-489.
- Mesdaghi M. (1998) *Management of Iran's Rangelands* (In Persian), Imam Reza University, Mashhad, Iran.
- Rezaei S. A. and Gilkes R. J. (2005) The effects of landscape attributes and plant community on soil physical properties in rangelands. *Geoderma* 125, 145-154.
- Thompson S. K. (2002) *Sampling*. Second Edition, J. Wiley & Sons, New York, 400 pp.
- Vogiatzakis I. N., Griffiths G. H. and Mannion A. M. (2003) Environmental factors and vegetation composition, Lefka Ori Massif, Crete, S. Aegean. *Global Ecology and Biogeography* 12, 131-146.
- Zhao W. Y., Li J. L. and Qi J. G. (2007) Changes in vegetation diversity and structure in response to heavy grazing pressure in the northern Tianshan Mountains, China. *Journal of Arid Environments* 68, 465-479.

## Richness of unsown plant species in a sown ley crop

Frankow-Lindberg B.E.

Swedish University of Agricultural Sciences, Dept. of Crop Production Ecology, Box 7043, SE-750 07 Uppsala, Sweden

Corresponding author: bodil.frankow-lindberg@vpe.slu.se

### Abstract

A field trial was established in Svalöv, Sweden in June 2007. The experimental layout consisted of 48 communities following a simplex design, and the species used were timothy (*Phleum pratense* L.), perennial ryegrass (*Lolium perenne* L.), red clover (*Trifolium pratense* L.) and a deep-rooted forb: either chicory (*Cichorium intybus* L.) or lucerne (*Medicago sativa* L.). No harvest was taken in 2007, and no herbicide was applied. The plots were harvested regularly in 2008 and 2009. Emerging unsown species identity was identified in each plot four times each harvest year. They were classified into grasses, legumes, annual + biennial forbs and perennial forbs. At the end of the trial, a total of 54 unsown species had been recorded. Fewer unsown species emerged in mixtures of the species sown than in the pure stands of the species. However, pure stands of perennial ryegrass contained significantly fewer unsown species than the other pure stands.

Keywords: colonisation, diversity, forbs, grasses, legumes, unsown species

### Introduction

Increased community diversity and evenness of a sown ley crop have been found to generally reduce the abundance of unsown species in the harvested biomass (e.g. Frankow-Lindberg *et al.*, 2009). Less is known about the relationship between community diversity and the identity of the colonising species, but results reported by Hector *et al.* (2001) and Lanta and Lepš (2008) suggest that increasing community diversity results in fewer colonising species. Possible mechanisms for the diversity effect are the ‘sampling effect’ by which particular traits of a community member provides invasion resistance, or niche complementarity, which would result in a more complete utilisation of resources within the community, or a combination of both. It was hypothesised that a combination of sown species from several functional groups would i) decrease the number of unsown species that establish in a sown ley crop and ii) that the functional group identity of the sown ley crop would affect the functional group composition of the emerging unsown flora.

### Materials and methods

A field trial was established by drilling at Svalöv (56° 55'N, 13° 07'E, 55 m a.s.l.), Sweden in June 2007. The climate is cold-temperate with an annual mean temperature of 7.7°C and an annual precipitation averaging 700 mm. No herbicide was applied, and no harvest was taken in 2007. In the harvest years, 100 kg ha<sup>-1</sup> nitrogen per year was applied in split dressings. The experimental layout consisted of 48 communities following a simplex design, and the species used were timothy (T, cv. Ragnar), perennial ryegrass (PR, cv. Birger), red clover (RCL, cv. Vivi), and a deep-rooted forb: either chicory (C, cv. Puna), or lucerne (L, cv. Pondus). The seeding rates were 14.2 (T), 28.3 (PR), 26.1 (RCL), 8.4 (C) and 26.3 (L) kg ha<sup>-1</sup>, in the high density pure stands. Low density plots were sown at 50% of these rates. The experimental layout consisted of 48 communities. Thirty communities followed a simplex design with four pure stands (T, PR, RCL and C) and 11 mixtures of these four species sown at two densities. The 11 mixtures consisted of four mixtures dominated in turn by each species (sown

proportions were 85% of dominant and 5% of each other species), six mixtures dominated in turn by pairs of species (40% of each of the two species and 10% of the other two) and the centroid community (25% of each species). Eighteen communities had four pure stands (T, PR, RCL and L) at two densities and five mixtures of these four species sown at two densities (sown proportions were 85% of the dominant and 5% of each of the other species, plus the centroid community). Experimental communities were randomly assigned to 17 m<sup>2</sup> plots. The plots were harvested three times in 2008 and four times in 2009. In early March 2008, soil samples were collected from each plot and a screening of the species present as buried seeds was carried out in a greenhouse during the following seven months. Colonising species identity in the field was recorded by inspecting the area between the first and the third sown row along each plot (approximately 2.85 m<sup>2</sup>) at four times during each harvest year. Each inspection was carried out independently of previous inspections. All species that showed true leaves at the time of inspection were identified. The species identity was then used to classify the unsown species into annual and perennial grasses (GSP), annual and perennial legumes (LSP) and other forbs (classified into annuals + biennials (ABF) and perennials (PF)). Following the terminology of Lanta and Lepš (2008) all unsown species are referred to as ‘invaders’ irrespective of their origin. No plant was removed, so some plants were recorded several times, but the final list only included the cumulative number of species observed over the two years. A simple model was fitted to the numbers of unsown species within the functional groups defined above using data from all 48 plots in the analysis.

$$\text{Unsown species} = \beta_1 T + \beta_2 \text{PRG} + \beta_3 \text{RCL} + \beta_4 C + \beta_5 L + \beta_6 \text{DENS} + \beta_7 E * \text{TREAT} + \beta_8 E^2 * \text{TREAT} + \varepsilon$$

The coefficients  $\beta_1$  to  $\beta_5$  represent the pure stand responses. DENS is a variable indicating high or low seeding density, and TREAT is a variable indicating the identity of the deep-rooted forb. The diversity effect is estimated by an interaction term E (= (T\*PRG+T\*RCL+T\*TREAT+PRG\*RCL+PRG\*TREAT+RCL\*TREAT)\*8/3) which lies between 0 for a pure stand and 1 for a mixture in which the sown proportions of all species are equal (the centroid).  $\varepsilon$  is a random error term assumed to be normally and independently distributed with a mean of zero and constant variance. Differences between the respective coefficients were tested ( $\beta_1$  vs.  $\beta_2$  vs.  $\beta_3$  vs.  $\beta_4$  vs.  $\beta_5$ ), and the diversity coefficients ( $\beta_6$  and  $\beta_7$ ) were tested against zero. The significance of the diversity effect at the centroid was estimated.

## Results and discussion

Few unsown species were present at the first harvest, but species number increased over time. Out of a total of 54 colonising species identified, 17 were found in the soil seed bank. About half of the species recorded were annuals or biennials. Estimates of the coefficients for the respective component species (Table 1) showed that the most prominent effect was that a pure stand of perennial ryegrass is predicted to become colonised by significantly fewer annual and biennial species ( $P < 0.05$ ), but significantly more legume species ( $P < 0.05$ ) than pure stands of the other sown species. The latter was also true for a pure stand of timothy. More unsown grass species are predicted to colonise pure stands of the sown forbs ( $P < 0.05$ ). All sown swards are predicted to be colonised by perennial forb species to a similar extent. With only one exception, a diversity effect was significant for all unsown functional groups (Table 2), and this implies that mixtures of the sown species generally reduce colonisation by unsown species.

Table 1. Estimated cumulative unsown species numbers in the respective pure stands.

Parameter	GSP	LSP	ABF	PF	TCSP
Timothy - $\beta_1$	2.32 <sup>a</sup>	1.60 <sup>ac</sup>	14.69 <sup>acd</sup>	4.42 <sup>a</sup>	23.04 <sup>ade</sup>
Perennial ryegrass - $\beta_2$	1.93 <sup>a</sup>	2.12 <sup>a</sup>	7.56 <sup>b</sup>	3.76 <sup>a</sup>	15.38 <sup>b</sup>
Red clover - $\beta_3$	3.58 <sup>bd</sup>	0.46 <sup>bcd</sup>	13.28 <sup>c</sup>	3.31 <sup>b</sup>	20.64 <sup>c</sup>
Chicory - $\beta_4$	3.81 <sup>b</sup>	0.76 <sup>c</sup>	16.03 <sup>d</sup>	4.50 <sup>ab</sup>	25.09 <sup>d</sup>
Lucerne - $\beta_5$	3.41 <sup>d</sup>	0.25 <sup>d</sup>	13.50 <sup>c</sup>	3.41 <sup>ad</sup>	20.57 <sup>e</sup>

Numbers with different superscripts within each column are significantly different at  $P < 0.05$

Table 2. Estimated unsown species numbers in centroid mixtures

Mixture	GSP	LSP	ABF	PF	TCSP
Without diversity effect					
T+PRG+RCL+C	2.91	1.24	12.89	4.00	21.04
T+PRG+RCL+L	2.81	1.11	12.26	3.73	19.91
With diversity effect					
T+PRG+RCL+C	1.40 <sup>***</sup>	0.53 <sup>*</sup>	11.13 <sup>*</sup>	2.87 <sup>**</sup>	15.94 <sup>***</sup>
T+PRG+RCL+L	1.00 <sup>**</sup>	1.00 <sup>ns</sup>	7.00 <sup>***</sup>	2.00 <sup>*</sup>	11.00 <sup>***</sup>

\*  $P < 0.05$ , \*\*  $P < 0.01$ , \*\*\*  $P < 0.001$ , ns = not significant diversity effect

These results suggest that both the sampling effect, in this case the traits of perennial ryegrass, and the diversity effect were responsible for the resistance of the communities towards colonisation by unsown species. Complementarity in traits also appeared to play a role because more unsown legume species are predicted to colonise the sown grasses than the sown forbs, and unsown grass species are predicted to colonise the sown forbs more than the sown grass species. Among the sown forbs chicory differed from the legumes in becoming more colonised by unsown species. Traits of the most numerous group of invaders (annuals and biennials) were not represented in the sown community. The results support the view of Crawley *et al.* (1999) that both species richness and species identity will matter in determining the invasibility of a plant community.

It is concluded that both diversity and the identity of one of the species in the sown mixture had an impact on the number of unsown species and the functional composition of the unsown species flora that colonised the experimental plots.

## References

- Crawley M.J., Brown S.L., Heard M.S. and Edwards G.R. (1999) Invasion-resistance in experimental grassland communities: species richness or species identity? *Ecology Letters* 2, 140-148.
- Frankow-Lindberg B.E., Brophy C., Collins R.P. and Connolly, J. (2009) Biodiversity effects on yield and unsown species invasion in a temperate forage ecosystem. *Annals of Botany* 103, 913-921.
- Hector A., Dobson K., Minns A., Bazeley-White E. and Lawton J.H. (2001) Community diversity and invasion resistance: An experimental test in a grassland ecosystem and a review of comparable studies. *Ecological Research* 16, 819-831.
- Lanta V. and Lepš J. (2008) Effect of plant species richness on invasibility of experimental plant communities. *Plant Ecology* 198, 253-263.



# Carbon isotope composition ( $\delta^{13}\text{C}$ ) in *Dactylis glomerata* and its relationship with water use efficiency at plant and leaf level

Gulías J., Ribas-Carbó M., Moreno M.T., Conesa M.A. and Cifre J.

Research Group on Plant Biology under Mediterranean Conditions. University of the Balearic Islands. Crta. de Valldemossa Km. 7.5. 07122 Palma de Mallorca. Spain.

Corresponding author: dbajgl4@uib.es

## Abstract

The objective of the present work was to analyse the relationship between leaf carbon isotopic composition ( $\delta^{13}\text{C}$ ) and the water use efficiency (WUE) measured at plant and leaf level in three cultivars of *Dactylis glomerata*. Two irrigation treatments were applied: a) 100% of field capacity and b) progressive drought. Plant water use efficiency (produced biomass/consumed water), intrinsic water use efficiency (A/g, net photosynthesis/stomatal conductance) and carbon isotopic composition of different parts of the leaf blade were determined. The younger section of the leaves presented a slightly higher  $\delta^{13}\text{C}$  than the older section, probably as a consequence of the higher  $\text{CO}_2$  demand of the former. However, both the younger and the older section of the leaves showed similar regression coefficient between  $\delta^{13}\text{C}$  and intrinsic WUE. There were no differences in WUE estimation with respect to the sampled aerial biomass for  $\delta^{13}\text{C}$  analysis. The main conclusion was that  $\delta^{13}\text{C}$  did not appear to be a clear parameter to estimate either WUE or intrinsic WUE.

Keywords: carbon isotope discrimination, *Dactylis glomerata*, water stress, water use efficiency

## Introduction

Water use efficiency (WUE) of forage crops will be a main trait in the selection of new cultivars for Mediterranean areas where, in addition to the increase of water requirements, the scenarios for future climate change predict an increase in aridity (McCarthy *et al.*, 2001). Therefore, several attempts have been made to establish accurate and simple variables to estimate WUE in large selection field experiments. The relationship between leaf-level WUE, crop WUE and plant production has been found to be different depending on species and conditions (Condon *et al.*, 2004), increasing the difficulty of crop WUE estimation. Moreover, carbon re-translocation after cutting and leaf age variations in forage grasses can influence the relationship between  $\delta^{13}\text{C}$  and WUE.

The objective of the present work was to analyse the relationship between leaf carbon isotopic composition ( $\delta^{13}\text{C}$ ) and the water use efficiency (WUE) measured at plant and leaf level in three cultivars of *Dactylis glomerata*.

## Materials and methods

The experiment was carried out in a growth chamber, with environmental conditions fixed at 25 °C and 12 h photoperiod. Plants of *Dactylis glomerata* cv. Jana (Mediterranean non summer dormant), Kasbah (Mediterranean summer dormant) and Porto (Oceanic non summer dormant) were used. Seeds were sown in seed benches with horticultural substrate and seedlings were transplanted to 5 L pots (2 seedlings per pot) with a mix of horticultural substrate and a calcareous clay soil. The upper part of the substrate was covered with a 5 cm perlite layer to avoid direct evaporation. All pots were kept under field capacity until the beginning of the irrigation treatments. At the start of the experiment, four pots per cultivar

were fully cut to determine initial total biomass in order to be able to estimate WUE at plant level. Remaining pots were cut at 5 cm height and divided between two irrigation treatments: a) 100% of field capacity and b) progressive drought. Soil water regime was controlled by weighing each pot and restoring the soil water content specific to each treatment by irrigation every two-three days; the progressive drought treatment was imposed by a combination of deficit irrigation (80% of water lost) and no irrigation until a minimum of 30% of field capacity. At the end of the experiment, plant biomass was determined in each pot. Biomass production was calculated from the difference between total biomass at the end of the experiment and the biomass of the initially sampled plants. Five young developing leaves per pot were marked when the drought level was already established. Gas exchange measurements were taken on these leaves at days 27 and 47 after treatment imposition by using an infrared gas analyser (Li-Cor 6400, Li-Cor Inc., Nebraska, USA). Measuring conditions were fixed at 1000  $\mu\text{mol m}^{-2} \text{s}^{-1}$  of photons and 400 ppm of  $\text{CO}_2$ . Carbon isotope composition ( $\delta^{13}\text{C}$ ) was determined in the upper (older) half and in the bottom (younger) half of these leaves, and also in a sub-sample of the total final leaf biomass of each pot. All samples were oven dried for 48 h at 70 °C, grounded into powder and analysed with a continuous flow isotope ratio mass spectrometer (Thermo Delta Plus, Bremen, Germany).

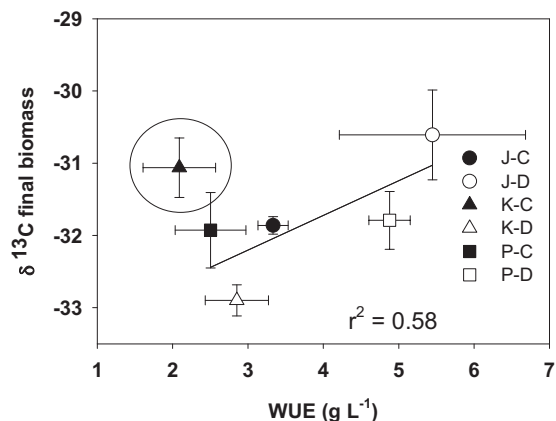

Figure 1. Relationship between isotopic composition of  $^{13}\text{C}$  ( $\delta^{13}\text{C}$ , ‰) in leaf final dry biomass and plant water use efficiency (WUE) (produced total biomass (g) / consumed water (L)). Values are means of 4 replicates  $\pm$  standard error. First letter refers to cv: J: Jana, K: Kasbah, P: Porto. Second letter refers to irrigation treatment: C: control, D: drought. The encircled point is out of the regression.

## Results and discussion

Soil water content of drought pots was between 25-35% of field capacity 25 days after treatment imposition in all three cultivars, and was sustained at this level until the end of the experiment (data not shown). Carbon isotope composition ( $\delta^{13}\text{C}$ ) was not different between treatments in cultivar Porto, and little differences were found in cultivars Jana and Kasbah (Figure 1). Moreover,  $\delta^{13}\text{C}$  of drought plants were lower than expected, suggesting that in spite of low soil water content under drought, plants underwent a mild drought stress. This could be due to both the environmental conditions of the growth chamber, with mild temperatures and vapour pressure deficit (VPD, between 1.6-2.1 KPa, which, however, is similar to that usually registered under field conditions during the active growth period in April), and to the specific ability of *D. glomerata* to cope with soil water stress. Nevertheless,

the importance of VPD variations, and not only soil water availability, is remarkable when comparing WUE data among experiments developed under different environmental conditions. WUE at plant level and  $\delta^{13}\text{C}$  were not highly correlated (Figure 1), although the regression was significant ( $P < 0.05$ ). Irrigated Kasbah plants were left out of this regression although they did not show a dormant status during the experiment.

The relationship between WUE at plant level and intrinsic WUE ( $A/g$ ) was not significant (data not shown). The younger section of the leaves presented a slightly higher  $\delta^{13}\text{C}$  than the older section (Figure 2), which could be a consequence of the higher  $\text{CO}_2$  demand of former, as the younger the tissue the higher its photosynthetic activity. Both the younger and the older sections of the leaves showed similar regression coefficients between  $\delta^{13}\text{C}$  and  $A/g_s$  (Figure 2). Moreover, there was no relation between  $\delta^{13}\text{C}$  of either young or old parts of the leaves and plant WUE (data not shown). In this sense, the precise sampling, i.e. only old parts or young parts, did not show any advantage in relation to the 'coarse' sampling, i.e. considering the whole leaf biomass, in order to estimate crop WUE.

As a main conclusion,  $\delta^{13}\text{C}$  did not appear to be a clear parameter to estimate neither WUE nor intrinsic WUE in the studied range of *Dactylis glomerata* genotypes.

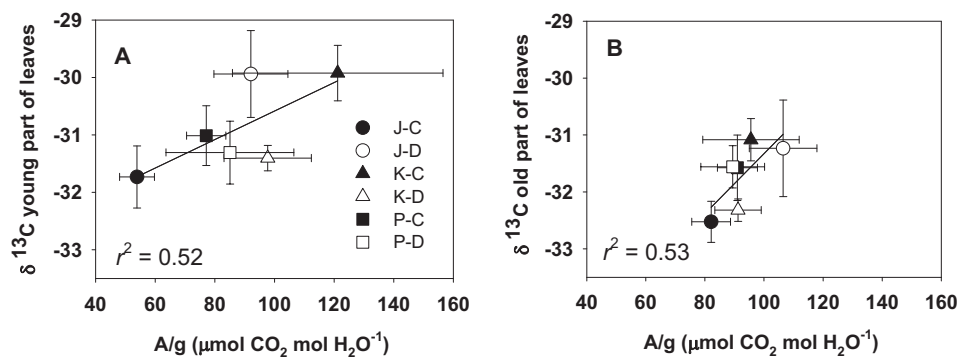

Figure 2. Relationship between A) isotopic composition of  $^{13}\text{C}$  ( $\delta^{13}\text{C}$ , ‰) in the younger part of marked leaves and intrinsic water use efficiency ( $A/g_s$ ) measured 27 days after treatments imposition; B)  $\delta^{13}\text{C}$  (‰) in the older part of marked leaves and  $A/g_s$  measured 47 days after treatments imposition. Values are means of 4 replicates  $\pm$  standard error. First letter refers to cv: J: Jana, K: Kasbah, P: Porto. Second letter refers to irrigation treatment: C: control, D: drought.

### Acknowledgements

This work has been developed with the financial support of EU, INCO-PERMED (PL509140) project, and of the Spanish Government (AGL2005-06297-CO2-01/AGR).

### References

- Condon A.G., Richards R.A., Rebetzke G.J. and Farquhar G.D. (2004) Breeding for water use efficiency. *Journal of Experimental Botany* 55, 2447-2460.
- McCarthy J.J., Canziani O.F., Leary N.A., Dokken D.J. and White K.S. (2001) *Climate change 2001: Impacts, adaptation and vulnerability*. Contributions of working group II to the third assessment report of the International Panel of Global Change. Cambridge University Press, Cambridge, UK, 1032 pp.

# Management strategies to increase botanical diversity at grassland with a history of intensive agricultural management

Hald A.B.<sup>1</sup> and Nielsen A.L.<sup>2</sup>

<sup>1</sup>National Environmental Research Institute (NERI), University of Aarhus, Frederiksborgvej 399, DK-4000 Roskilde, Denmark.

<sup>2</sup>Natlan, Agro Business Park, Niels Pedersens Allé 2, DK-8830 Tjele, Denmark

Corresponding author: abh@dmu.dk

## Abstract

To increase biodiversity on grassland after years of intensive agricultural management, different management strategies were established in 1997: continuous summer grazing with cattle, combinations of cutting and grazing, early and late cutting with two cuts, addition of potassium fertiliser and abandonment. Changes in biodiversity after 6 and 10 years with different management regimes are given as well as the effect on selected single species. Botanical biodiversity increased more under early cutting and two cuts than under extensive summer grazing. Abandonment for a few years resulted in establishment of some new species, and it was evaluated that small steppingstone areas of short time abandonment could be beneficial. The results indicate that a phased management with initial biomass/nutrient removal can facilitate an increase in botanical biodiversity.

Keywords: Abandonment, cutting, grazing, long-term monitoring

## Introduction

Agriculturally improved grasslands are dominated by cultural species and have a low botanical diversity. In Denmark, continuous cattle grazing is often used to obtain a more diverse vegetation of naturally occurring species, although other strategies could also have potential. The aim of this experiment was to examine the ability of different agricultural management strategies to increase the proportion of naturally occurring species but also to avoid a high proportion of species that we evaluate as problematic if they become dominant (*Juncus effusus* L., *Deschampsia caespitosa* L. Be., *Phalaris arundinacea* L.).

## Materials and methods

The experiment was established in 1997 on peat soil grasslands. Before 1955, the area was managed as permanent grassland; 1955-89 intensive agricultural management with grain and grassland management; 1990-96 no fertiliser, late cutting (after 15<sup>th</sup> July) followed by grazing, mainly sheep. The experimental management strategies were continuous cattle summer grazing (G), grazing following early cut (ECG) and late cut (LCG), early (ECC) and late (LCC) cutting with two cuts, addition of K-fertiliser (FCC) and abandonment (A) and laid out in three blocks. Production, N- and P-balances were described by Nielsen and Hald (2008). Number and abundance of species were analysed in June 1997, 2003 and 2007 within 11 m x 9 m, with five permanent extended Raunkiær circles (Böcher and Bentzon 1958). Giving points 1-4, for each species in four concentric circles, an abundance value of the species, was calculated, Sum of Points (PS). Species in the smallest circle, 0.001 m<sup>2</sup>, were given 4 points, and in the larger circles subsequently smaller points down to 1 point in the largest circle, 1 m<sup>2</sup>. Flowering shoots were analysed separately. The species were grouped and analysed as naturally occurring grasses, cultural (normally sown species) (*Festuca pratensis* Hudson, *F. rubra* L., *Lolium perenne* L., *Phleum pratense* L., *Poa pratensis* L., *Trifolium*

*repens* L.), and ‘other herbs’. A broad-leaved rosette species establishing from seeds (*Cirsium palustre* (L.) Scop.), moss (pleurocarpous) and some potentially dominant species were analysed separately. For the variables analysed, the plots did not differ significantly in 1997 (SAS GLM). The 1997 data were thus pooled for each block and used as reference level data in the statistical analyses. The hypothesis that management strategies do not over time change the variables describing biodiversity was analysed by comparing the values in 2003 and 2007 with the reference level in 1997 (GLM LSMEANS with option pdiff if the model was significant,  $n=21$ ,  $\alpha = 0.05$ ).

## Results and discussion

Following seven years of extensive management, the vegetation was still species poor in the 1997 reference year (‘Ref’) (Table 1). During the following 10 years of the experiment, in total 50 species were observed. The number of species increased, initially in abandoned (A), and later in early cut (ECC) (Table 1). Species abundance measured as PS generally increased, but only temporarily in A. Also the number of species generative in early June decreased in A after 10 years. The PS of generative species in early June 2007 had decreased in abandoned (A) and grazing (G) and increased in cutting followed by grazing (ECG and LCG). The decrease at abandonment may be explained by later flowering at this treatment. At grazing (G), the number of flowering species did not differ from the reference year, but the lower PS-value indicates that flowers are grazed.

Naturally occurring grasses increased temporarily in cutting combined with grazing (ECG, LCG). *D. caespitosa* with a low Ellenberg Nutrient value (EN=3) occurred sporadically in 1997, but increased in early and late cut with grazing (ECG and LCG) and in late cut (LCC). *J. effusus* (EN=4) also occurred at a very low level in 1997. After 10 years, the PS of this species had increased in early cut followed by grazing (ECG). *J. effusus* is a tufted species when uncut, but when cut the shoots grow more apart which may increase the PS-value. Removal of nutrients will benefit this species, and germination of seeds is promoted by the trampling and stratification action of the animals. *P. arundinacea* (EN=7) increased in abandoned and in fertilised treatments after 10 years, which may indicate nutrient mobilisation at abandonment. The cultural species generally decreased – but not in early cut (ECG, ECC). The number of ‘other herbs’ was low in 1997, but increased in abandoned and early cut (A, ECC). After 10 years, all other treatments were still low in number of ‘other herbs’. In 2003, the PS of ‘other herbs’ had increased in grazed (G, ECG, LCG) and early cut (ECC) treatments, but the increase at managements including grazing was not maintained after 10 years. Only the late cut (LCC) was consistently low in ‘other herbs’. *C. palustre* (EN=3), only occurred with a few rosettes in 1997. It established more or less in all treatments except at grazing (G) and late cut (LCC), but only well at abandonment. Grazing (G) may be too disturbed and the late cut too competitive for seedlings to establish. The establishment at the potassium-fertilised plots with cutting should be noted. The PS for light demanding moss was low in 1997, but generally increased.

In some cases the results after 6 and 10 years differ, i.e. some variables were not consistently increasing or decreasing, which indicates the importance of having long-term experiments (Hald and Vinther, 2000). Our results indicate that management of grassland with a history of intensive agriculture can include early and two cuts for nutrient removal (Nielsen and Hald, 2008) combined with an initial phase with small plots of abandonment (stepping-stone areas) for a few years only, to facilitate establishment of new species. Later in the process, management may change, e.g. to a late cut (promoting flowering and seeds) followed by grazing, which creates different niches. Strategically, variation in both space and time seems appropriate, i.e. a phased restoration strategy as emphasised by Pywell *et al.* (2007).

Table 1. The effect of management strategies on species groups and single species. The unit is number (N) or Sum of Point (PS) per 5 m<sup>2</sup>. Dark shading: Values differ from the reference year (Ref.), 1997 ( $\alpha = 0.05$ ). E: Cut 10<sup>th</sup> June. L: Cut 15<sup>th</sup> July.

	Ref. After 6 years of management (2003), n=21									After 10 years of management (2007), n=21								
		Graze	Cut	Cut	Cut	Cut	Fertil.	Aban			Graze	Cut	Cut	Cut	Cut	Fertil.	Aban	
1 <sup>st</sup> Treatm			E	L	E	L	Cut	L <sup>1</sup>	don			E	L	E	L	Cut	E <sup>1</sup>	don
2 <sup>nd</sup> Treatm		Graze			Cut	Cut	Cut		ment		Graze			Cut	Cut	Cut		ment
	'97	G	EC	LC	EC	LC	FC	A		G	EC	LC	EC	LC	FC	A		
			G	G	C	C				G	G	G	C	C				
Species	N	12.7	16.3	16.0	16.3	16.3	13.7	13.0	18.0	14.0	15.3	13.7	17.3	11.7	14.3	15.0		
Species	PS	81	119	132	135	117	105	94	106	95	115	106	114	107	112	86		
Generative	N	9.0	.	.	.	.	.	.	.	6.7	7.7	8.7	10.3	7.0	7.0	4.7		
Generative	PS	44	.	.	.	.	.	.	.	19	69	63	41	47	40	9.7		
Nat. grass. <sup>2</sup>	PS	34	46	55	58	28	43	49	27	39	48	45	25	42	40	13		
<i>D. caesp.</i>	PS	0.71	4.7	5.0	9.7	2.0	4.7	1.3	6.0	7.3	9.7	14.3	5.7	13.3	2.3	5.7		
<i>J. effusus</i>	PS	0.75	2.3	1.3	2.3	1.3	2.3	2.0	0	1.7	5.0	3.3	1.3	1.3	1.3	0		
<i>P. arundina</i> .	PS	7.1	6.0	7.7	3.7	11.0	9.3	9.7	4.3	9.0	3.0	6.0	13.3	9.3	17.3	13.7		
Cultural sp.	PS	26	22	21	22	25	15	9	12	12	20	7	23	12	13	5		
Other herbs	N	3.5	6.0	4.7	5.7	6.7	2.0	2.0	7.3	3.7	4.7	3.3	7.3	1.3	3.7	8.0		
Other herbs	PS	12	32	32	26	32	15	17	35	19	16	17	30	14	25	32		
<i>C. palustre</i>	PS	0.17	0	0	0.33	2.7	1.3	0.33	8.3	0	0.33	1.7	0.67	0	2.7	8.0		
Moss	PS	1.7	13	12	15	18	16	6.3	16	7.0	10	12	16	14	12	16		

1) Deep litter and late cut in 1997-2004, K-vinasse and early cut in 2005-2007. 2) Group of natural grasses is excl. *D. caespitosa* and *P. arundinacea*.

## Conclusion

In the 10 years with extensive cutting and grazing, the agriculturally improved and initially species-poor grassland showed an increase in the number of species and occurrence of other herbs if managed by early and two cuts. Abandoned plots had only initially increased numbers of species. These plots could function as stepping-stone areas for some new species, e.g. *C. palustre*. It is concluded that this grassland can be managed by early and two cuts and with small abandoned plots used for a few years, from where some established naturally occurring species can propagate further into the area, facilitated by nutrient removal by a cutting strategy. Continuous cattle grazing was not the best option.

## Acknowledgements

The Danish Food Industry Agency supported this study.

## References

- Böcher T.W. and Bentzon M.W. (1958) Density determination in plant communities. *Oikos* 9, 35-56.
- Hald A.B. and Vinther E. (2000) Restoration of a former species-rich-meadow in Denmark: response of 64 species to management. *Applied Vegetation Science* 3, 15-24.
- Nielsen A.L. and Hald A.B. (2008) Management strategies to restore agriculturally affected meadow on peat – biomass and N, P, K-balances. *Grassland Science in Europe* 13, 153-155.
- Pywell R.F., Bullock J.M., Tallwin J.B., Walker K.J., Warman E.A. and Masters G. (2007) Enhancing diversity of species-poor grassland: an experimental assessment of multiple constraints. *Journal of Applied Ecology* 44, 81-94.

## How can *Trifolium repens* patches simultaneously expand and persist?

Johansen L.

Norwegian Institute for Agricultural and Environmental Research, Grassland and Landscape Division, Kvithamar, N-7500 Stjørdal, Norway

Corresponding author: Line.Johansen@bioforsk.no

### Abstract

Simultaneously expanding and persistent *Trifolium repens* patches were studied in a nutrient-poor lawn that was frequently cut. *Trifolium repens* primary stolon growth strategies were analysed in relation to their location inside the patch, and according to patch size. It was hypothesised that different growth strategies inside a patch can explain a both persistent and expanding patch of *Trifolium repens*, and that growth strategies were different between patch sizes. The results indicated different growth strategies inside and at the border of patches. *Trifolium repens* stolons at the border were long, grew fast, had few lateral stolons and grew out of the patch, whereas stolons inside the patch were smaller, grew slowly, and had more lateral stolons and a wide range of growth directions. Growth strategies were not different between patch sizes. The directional growth and the high growth rate at the border will increase the patch size with time, whereas the growth strategy near the centre consolidates the patch in space and time, by placing ramets inside the patch. These growth strategies together in a patch result in *Trifolium repens* patches that are simultaneously persistent and on the increase. The results also indicate a division of labour among primary *Trifolium repens* stolons in a patch.

Keywords: Clonal growth, growth angles, growth strategies, patch dynamic.

### Introduction

The spatial distribution of clonal plants is affected by their vertical and horizontal growth pattern. Dependent on the horizontal growth, different spatial patterns of the ramets may arise and the patterns may change with time (Herben and Hara, 1977). *Trifolium repens* is known to aggregate in patches when growing together with different grass species (Kershaw, 1959; Cain *et al.*, 1995; Edwards *et al.*, 1996). For patches to maintain their original habitat and simultaneously increase in size, ramets or clonal fragments must both promote local persistence inside the patch and grow out of the patch into new habitats. The aim of the study was to quantify growth strategies that can explain simultaneously persistent and expanding *Trifolium repens* patches.

### Materials and methods

Six patches of *Trifolium repens* were selected from a lawn at the Norwegian Institute of Agricultural and Environmental Research, Grassland and Landscape Division, Kvithamar, Norway (63°26'N, 10°53'E, 30 m a.s.l.). The lawn had been sown in 1999 with a mixture of grass species. *Trifolium repens* plants had colonised the lawn since then and had established distinct patches that increased in size over the years. The lawn was cut twice a month from May until September, and no fertilizer was applied from 2003 to 2006. Two large (diameter, dm: 470 cm, 580 cm), two medium (dm: 340 cm, 260 cm) and two small (dm: 155 cm, 143 cm) sized patches were selected in 2006. Inside each patch, *Trifolium repens* primary stolons were randomly selected from the patch border, the centre, and between the border and centre (middle). The following variables were measured on each stolon: stolon survival, apical tip damage, stolon length (mm), stolon growth during 9 weeks (mm), growth direction (°),



number of and growth direction of rooted lateral stolons. Stolon length was from stolon base to the youngest open leaf. Growth angles were defined as the angle between the stolon growth direction and a reference line from the patch centre to the stolon apex (Sampaio *et al.*, 2004). Lateral stolons were measured only 15 cm behind the primary stolon apex in order to exclude lateral stolons growing in a different zone than the primary stolon. In total, 150 primary stolons were measured. The data was analysed with ANOVA, log-linear models and angular statistics.

## Results

Stolon length ( $df = 2$ ,  $F = 26.8$ ,  $P < 0.001$ ) and stolon growth during 9 weeks ( $df = 2$ ,  $F = 21.5$ ,  $P < 0.001$ ) differed among zone types, but not among patch size classes. Both length and growth were largest in the border zone (Figure 1). There was a difference in the presence of lateral stolons among zone types ( $df = 2$ ,  $F = 3.53$ ,  $P = 0.03$ ), with more primary stolons with lateral stolons in the centre and middle parts of the patch. There was no difference among patch size classes ( $df = 2$ ,  $F = 0.664$ ,  $P = 0.577$ ).

There were differences in the dispersion of growth angles, among combinations of zone types and patch size classes ( $df = 8$ ,  $H = 113.625$ ,  $P < 0.001$ ). In the middle zone, medium and large patches had a larger range of growth angles than in small patches. Small and medium size patches both had a small range of dispersion in the border zone compared with other zones.

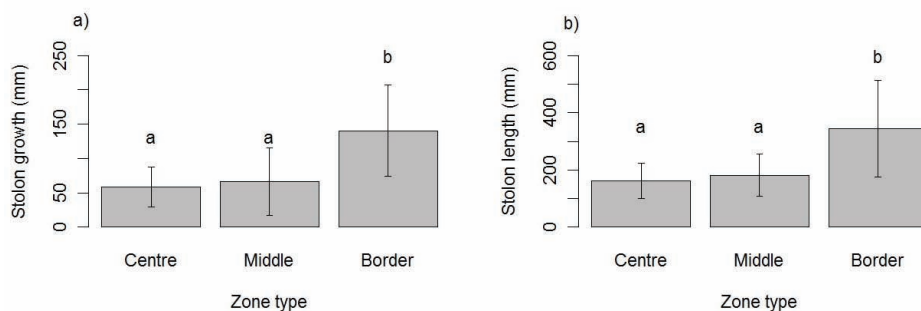

Figure 1. Mean and SD for a) stolon growth (mm) during 9 weeks and b) stolon length of *Trifolium repens* primary stolons in different patch zone types. Bars with different letters are significantly different ( $P > 0.05$ ).

## Discussion

Patches increase in size when fragments grow out of the patch into new habitats. However, expansion alone is not sufficient for patch persistence. If there is just expansion, the patch will become open in the centre and a ring form will develop (Wikberg and Svensson, 2003; Lanta *et al.*, 2008). Persistent patches may also depend upon fragments promoting local persistence (de Kroon and Schieving 1990), by placing ramets inside the patch. Thus, a patch that is simultaneously persistent and increasing may be predicted to have fragments with more than one growth strategy as demonstrated in this study. The results indicate two distinct growth strategies: (i) primary stolons on the patch border that are long, fast growing with few lateral stolons and that grow out of the patch, and (ii) primary stolons in the patch centre and middle zone that are shorter, grow more slowly and with more lateral stolons than the border, and that exhibit a wide range of growth directions. The combination of these two strategies is essential in a single *Trifolium repens* patch to maintain the patch in space and time, while at the same

time contributing to increase the patch size. The species in this way consolidates its dominance within patches and expands at the border. These results indicate a division of labour (Alpert and Stuefer, 1997) among *Trifolium repens* primary stolons in a patch, including two different growth strategies that result in expansion and consolidation of the patch.

*Trifolium repens* is often classified as a guerrilla species because of the considerably long internodes between ramets on a stolon (McLellan *et al.*, 1997). However, in this study the species had both a guerrilla and a phalanx growth form. Stolons localised on the border expressed a guerrilla growth form and an opportunistic strategy, whereas stolons near the patch centre had a phalanx growth form with a consolidating strategy. Hence, growth form and growth strategies can be altered according to environmental conditions.

## References

- Alpert P. and Stuefer J.F. (1997) Division of labour in clonal plants. In: De Kroon, H. and van Groenendael, J. (eds.) *The ecology and evolution of clonal plants*. Backhuys Publishers, Leiden, pp.137-154.
- Cain M.L., Pacala S.W., Silander J.A.J. and Fortin, M.J. (1995) Neighborhood models of clonal growth in the white clover *Trifolium repens*. *The American Naturalist* 145, 888-91.
- De Kroon H. and Schieving F. (1990) Resource partitioning in relation to clonal growth strategy. In: van Groenendael, J. and De Kroon, H. (eds.) *Clonal growth in plants: regulation and function*. SPB Academic Publishing, pp. 113-130.
- Edwards G.R., Parsons A.J., Newman J.A. and Wright I.A. (1996) The spatial pattern of vegetation in cut and grazed grass/white clover pastures. *Grass and Forage Science* 51, 219-231.
- Herben T. and Hara T. (1997) Competition and spatial dynamics of clonal plants. In: De Kroon H. and van Groenendael J. (eds.) *The ecology and evolution of clonal plants*. Backhuys Publishers, Leiden, pp 331-358.
- Kershaw K. (1959) An investigation of the structure of a grassland community. II. The pattern of *Dactylis glomerata*, *Lolium perenne* and *Trifolium repens*, III. Discussion and conclusions. *Journal of Ecology* 47, 31-53.
- Lanta V., Janecek S. and Dolezal J. (2008) Radial growth and ring formation process in clonal plant *Eriophorum angustifolium* on post-mined peatland in the Sumava Mts., Czech Republic. *Annales Botanici Fennici* 45, 44-54.
- McLellan A.J., Prati D., Kaltz O. and Schmid B. (1997) Structure and analysis of phenotypic and genetic variation in clonal plants. In: De Kroon, H. and van Groenendael, J. (eds.) *The ecology and evolution of clonal plants*. Backhuys Publishers, Leiden, pp. 185-210.
- Sampaio M.C., Araujo T.F., Scarano F.R. and Stuefer J.F. (2004) Directional growth of a clonal bromeliad species in response to spatial habitat heterogeneity. *Evolutionary Ecology* 18, 429-442.
- Wikberg S. and Svensson B.M. (2003) Ramet demography in a ring-forming clonal sedge. *Journal of Ecology* 91, 847-854.

# Restoration of species-rich grasslands: reduction in nutrient availability slightly improved forb species' establishment

Huguenin-Elie O.<sup>1</sup>, Stutz C.J.<sup>1</sup>, Gago R.<sup>2</sup> and Lüscher A.<sup>1</sup>

<sup>1</sup>Agroscope Reckenholz-Tänikon Research Station ART, 8046 Zurich, Switzerland

<sup>2</sup>AGFF, Swiss Grassland Society, 8046 Zurich, Switzerland

Corresponding author: olivier.huguenin@art.admin.ch

## Abstract

Restoring plant diversity of previously intensively used meadows has proven difficult even long after cessation of fertiliser application. Despite extensive management, forb species typical of semi-natural grasslands often fail to re-colonise such meadows. This may be due to the persistence of high nutrient availability in the soil or to seed limitation. In this experiment, the effects of nitrogen-, phosphorus-, and potassium-availability on the success of forb species' establishment in an existing sward was examined. We spread seeds of 27 different forb species and planted seedlings of *Leucanthemum vulgare* Lam. and *Salvia pratensis* L. in a long-term fertiliser experiment with large between-treatment differences in P- and/or K-availability in the soil and consequently, biomass production of the sward. The results support the hypothesis that low biomass productivity due to lower nutrient availability is favourable to the establishment of forb species typical of semi-natural meadows. Three years after sowing, only a small percentage of the sown species had more than a few individuals present and the number of surviving seedlings strongly decreased within three years after planting, even in the nutrient-poor treatments. These results show that restoration of plant diversity remains difficult even if nutrient availability has been successfully reduced.

Keywords: Diversity restoration, fertiliser, productivity, oversowing, hay meadow

## Introduction

The Swiss agri-environmental scheme solicits farmers to manage at least 7% of their land as an ecological compensation area (ECA) to promote farmland biodiversity. Three quarters of these ECAs are extensively managed hay meadows (SFOA, 2007). In the lowland, these are mainly de-intensified grasslands, which although extensively managed for a decade, often shelter a much lower number of species than the target for ECAs. This could be due to seed limitation (Tilman, 1997) and/or to high levels of nutrient availability (Suding *et al.*, 2005). We studied the effects of nutrient availability on the establishment of forb species in existing swards under the same defoliation regime by using a 14-year-old fertiliser experiment.

## Materials and methods

Different levels of mineral nitrogen (N), phosphorus (P) and potassium (K; Table 1) were applied, over 14 years, to a hay meadow of the *Arrhenatherion* alliance, mowed three times per year, with the first cut after June 15. The 10 m<sup>2</sup> plots were arranged in a randomised complete block design with 4 replicates. In spring 2005 and 2006, seeds of 27 forb species were oversown (broadcaster with roller) and three seedlings per plot of *Salvia pratensis* L. and *Leucanthemum vulgare* Lam. were planted in 2005. At this time, treatments differed in nutrient availability and, consequently, yield (Table 1). The relative species abundance differed between the treatments, but this was neither the case for the species composition nor for the number of forb species ( $P = 0.29$ ,  $cv = 10\%$ , data not shown). The presence of each species of vascular plants was recorded in 2008.

Table 1. Amount of nutrients applied in the treatments, gross dry matter yield, and soil P and K content (0-10 cm soil layer, extraction 1:2.5 CO<sub>2</sub>-saturated water) before sowing and planting the forb species (average of 2002 and 2005), and number of forb species in the swards in 2008.

Treat- ments	Applied nutrients (kg ha <sup>-1</sup> yr <sup>-1</sup> )			Annual yield (Mg ha <sup>-1</sup> )	P-CO <sub>2</sub> (mg kg <sup>-1</sup> )	K-CO <sub>2</sub> (mg kg <sup>-1</sup> )	# forb sp. <sup>a)</sup> per 10 m <sup>2</sup>	# new forbs <sup>b)</sup> per 10 m <sup>2</sup>
	N	P	K					
(NPK)0	0	0	0	5.0	0.66	4.8	27.8	5.5
(NPK)1	15	5.8	27.7	6.1	0.73	5.4	27.0	5.5
(NPK)2	30	11.6	55.3	7.1	0.89	4.7	24.8	3.3
(NPK)3	45	17.4	83	7.9	0.94	5.3	24.5	3.0
(NPK)4	60	23.2	110.7	7.9	0.87	6.3	23.5	2.5
N0	0	17.4	83.0	6.9	0.92	6.0	24.8	3.8
N1	15	"	"	7.1	0.80	6.0	24.3	3.5
N2	30	"	"	7.2	0.80	5.9	25.5	3.5
N4	60	"	"	7.9	0.84	4.9	22.8	2.0
P0	45	0	83.0	6.5	0.59	6.1	25.3	5.5
P1	"	5.8	"	6.8	0.68	5.9	25.5	4.5
P2	"	11.6	"	7.7	1.00	5.1	23.5	2.8
P4	"	23.2	"	7.9	0.97	5.3	23.5	2.5
K0	45	17.4	0	6.8	0.99	4.2	25.0	3.5
K1	"	"	27.7	7.0	0.91	4.5	24.0	2.5
K2	"	"	55.3	7.6	0.92	4.7	23.3	3.0
K4	"	"	110.7	7.5	0.86	6.3	23.0	3.0
<i>P</i> <sup>c)</sup>				0.001	0.009	0.001	0.046	0.051
SE				0.23	0.031	0.24	1.01	0.82

<sup>a)</sup> # forb sp. = number of forb species in the swards

<sup>b)</sup> # new forbs = number of new forb species, i.e. number of forb species that had established in the swards 3 years after being oversown, including 2 species that were present in the field at a frequency of less than 6%.

<sup>c)</sup> *P* for treatment effect in main effects ANOVA with treatment (17) and replicate (4) as categorical factors.

## Results and discussion

The number of forb species significantly differed between the fertiliser treatments three years after the first oversowing. The largest number of forb species was found in the treatment (NPK)0 and the lowest number in the treatments with high NPK application (Table 1), with a difference of up to 5 species per 10 m<sup>2</sup>. The number of forb species in the swards showed a linear relationship with above-ground productivity, with an average decrease of 1.6 forb species per supplementary tonne of dry mass yield (Figure 1). Eleven forb species of the oversown seed mixture that were absent from the whole experimental field prior to oversowing were found in the field three years after oversowing (Table 2) despite of the large biomass production of the swards. Furthermore, the frequency of two forb species included in the seed mixture (*Knautia arvensis* (L.) Coult. and *Tragopogon pratensis* L.), which, prior to oversowing were present in only 3 and 4 of the 68 plots, respectively, markedly increased after oversowing. Considering these 13 species as 'new forb species', new colonisation occurred in all treatments, with the largest number of 'new forb species' in treatments (NPK)0, (NPK)1 and P0 (Table 1). The treatment means for 'new forb species' were statistically just not significantly different but showed a significant negative linear relationship with above-ground productivity ( $P < 0.001$ ,  $b = -1.2$ ). Six of these species were found in less than 10% of the plots (Table 2), mostly with only one or two individuals per plot. These species might quickly die-off and their effective establishment in the sward should be re-evaluated in a few years. In all treatments, at least half of the planted *S. pratensis* and of *L. vulgare* seedlings disappeared between 2005 and 2008, with the largest number of surviving plants found in (NPK)0 and P0 ( $P = 0.014$ ; data not shown). It has been shown that the cessation or reduction

of fertilisation alone is often insufficient to achieve an increase in species richness in de-intensified grassland (reviewed by Marriott *et al.*, 2004), probably due to seed limitation. Our study indicates that nutrient availability is an important factor affecting the possibility of new colonisation when seeds of potentially new species are introduced into an existing grassland. This is in accordance with studies on the establishment of species-rich grasslands on vegetation-free soils (e.g. Pywell *et al.*, 2002).

Table 2: Frequency of the forb species that had established in the experimental field three years after being oversown.

Species	Frequency (%) <sup>a)</sup>
<i>Anthyllis vulneraria</i> L.	1.5
<i>Onobrychis viciifolia</i> Scop.	1.5
<i>Sanguisorba minor</i> Scop.	1.5
<i>Scabiosa columbaria</i> L.	2.9
<i>Carum carvi</i> L.	4.4
<i>Picris hieracioides</i> L.	8.8
<i>Pimpinella major</i> (L.) Huds.	13.2
<i>Salvia pratensis</i> L.	17.6
<i>Centaurea jacea</i> L.	29.4
<i>Tragopogon pratensis</i> L. <sup>b)</sup>	35.3
<i>Leontodon hispidus</i> L.	54.4
<i>Leucanthemum vulgare</i> Lam.	58.8
<i>Knautia arvensis</i> (L.) Coult. <sup>b)</sup>	66.2

<sup>a)</sup>Frequency = Number of plots with presence/Total number of plots.

<sup>b)</sup>Present in the sward before oversowing, but with a frequency of less than 6% (all other species were absent before oversowing).

## Conclusions

We conclude that colonisation of forb species in existing swards is more likely to occur when biomass production is limited by low nutrient availability. Nevertheless, the differences in the number of newly established species were small; indicating that restoration of diversity in existing swards remains difficult even when low nutrient availability limits above-ground productivity.

## References

- Marriott C.A., Fothergill M., Jeangros B., Scotton M. and Louault F. (2004) Long-term impacts of extensification of grassland management on biodiversity and productivity in upland areas. A review. *Agronomie* 24, 447-461.
- Pywell R.F., Bullock J.M., Hopkins A., Walker K.J., Sparks T.H., Burke M.J.W. and Peel S. (2002) Restoration of species-rich grassland on arable land: assessing the limiting processes using a multi-site experiment. *Journal of Applied Ecology* 39, 294-309.
- SFOA (Swiss Federal Office for Agriculture) (2007) *Rapport agricole*. Berne, Switzerland.
- Suding K.N., Collins S.L., Gough L., Clark C., Cleland E.E., Gross K.L., Milchunas D.G. and Pennings S. (2005) Functional- and abundance-based mechanisms explain diversity loss due to N fertilization. *Proceedings of the National Academy of Sciences of the United States of America* 102, 4387-4392.
- Tilman D. (1997) Community invasibility, recruitment limitation, and grassland biodiversity. *Ecology* 78, 81-92.

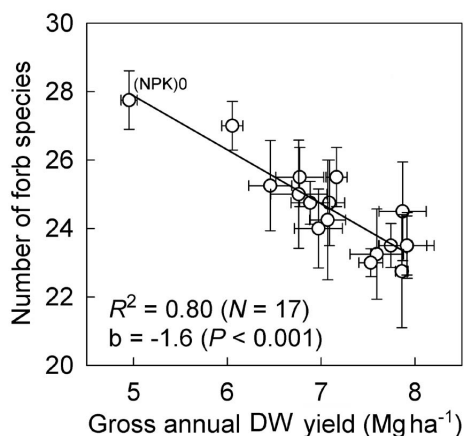

Figure 1. Relationship between above-ground productivity and number of forb species in the swards three year after oversowing. Shown are treatment means ( $N = 4$ )  $\pm$  SEM. (Without point (NPK)0:  $b = -1.7$ ,  $P < 0.001$ )

# Differences in plant species diversity between managed and abandoned semi-natural meadows

Kącki Z.

*Department of Biodiversity and Plant Cover Protection, Institute of Plant Biology, University of Wrocław, ul. Kanonia 6/8, 50-328 Wrocław, Poland*

Corresponding author: kackiz@biol.uni.wroc.pl

## Abstract

Differences in species diversity between abandoned and managed *Molinion* meadows were studied using 228 samples randomly collected from 60 meadows in southwestern Poland. The meadows were either currently managed, or had been abandoned for at least five years. Ecological diversity indices, Ellenberg indicators and the Disturbance Index (Z) were estimated. Differences between abandoned and managed meadows were identified, as were differences between the typical and atypical forms of *Molinion* meadows distinguished based on Z. The meadows differed in plant cover, total number of species, selected groups of species, and environmental condition as reflected by the Ellenberg indicators. Managed meadows had higher diversity and more species. Abandoned meadows and atypical forms had lower diversity, lower cover of species tolerant to mowing, and higher cover of woody plants, tall herbaceous plants and grasses.

Key words: management, disturbance index, changes, *Molinion*, Poland

## Introduction

Semi-natural meadows are endangered and are generally on the decline. This is especially true for *Molinion* meadows, which have long lost their economic significance and are disappearing due to neglect and abandonment. Meadows are very sensitive to changes in ecological conditions and land management practice (Zechmeister *et al.*, 2003). When a meadow is no longer mown, there are changes in species abundance and richness. Ecological indicators for individual species and functional groups in plant communities begin to change as soon as the meadow is abandoned. The aim of the present study was to examine differences in species diversity between abandoned and managed *Molinion* meadows. The effect of abandonment on species richness and on the abundance of particular species was estimated using the Disturbance Index (Z) and other indices of biodiversity.

## Materials and methods

The study was conducted on sixty meadows belonging to the *Molinion* meadow-complex in south-western Poland. The meadows selected were either currently managed, or had been abandoned for at least five years. 228 samples were collected from sites randomly chosen from maps. For each sample, a list of vascular species was drawn up. Relative cover abundance was recorded using the seven-point Braun-Blanquet scale (Westhoff and van den Maarel, 1978). All data were entered into the TURBOVEG database (Hennekens and Schaminée, 2001). The following indices were calculated for each sample: Richness, Shannon-Wiener Index, Evenness Index, Ellenberg indicators, and level of mowing tolerance (Klotz *et al.*, 2002). The mean number and cover of specific groups of species were then estimated. Finally, Z was used to determine differences in species composition between samples (Kącki and Michalska-Hejduk, 2010). Z is calculated as follows:  $Z = ((d/(1 + N)) + A + B^2)/C$ , where: d represents the sum of the mean percentage cover of each species

characteristic for the order and class to which the community belongs multiplied by the number of these species; N represents the sum of the mean percentage cover of each species characteristic for the alliance and association to which the community belongs multiplied by the number of these species; A represents the sum of the mean percentage cover of each accompanying species multiplied by the number of these species; B represents the sum of the mean percentage cover of each species indicative of changes in the plant community multiplied by the number of these species; and C represents the sum of the mean percentage cover of each species characteristic for the association, alliance, order and class to which the community belongs multiplied by the number of these species. In calculating variable B, species that were taken into consideration were species that are alien to meadow habitats, such as woody plants, kenophytes, *Calamagrostis epigejos* and *Nardus stricta*. Some species that are associated with meadow habitats were also taken into account, including the grass *Molinia caerulea*, and tall herbs such as like *Lysimachia vulgaris* and *Filipendula ulmaria*. In calculating variables d, N and C, species were divided into groups of characteristic species in accordance with the hierarchical order of the class *Molinio-Arrhenatheretea* (Oberdorfer, 1983). Other species were classified as accompanying species or as species indicative of change. Samples with Z between 0 and 1 are considered to be typical, whereas samples with greater values are considered to be atypical. Samples representing abandoned and managed meadows were compared using the unpaired groups method with the U Mann-Whitney test. Differences in diversity and species composition between the forms of *Molinion* meadows were evaluated using non-parametric analysis of variance with the Kruskal-Wallis test.

## Results and discussion

For grassland species, values for the diversity indices were significantly higher in managed meadows. Furthermore, differences in environmental conditions were also reflected in differing values of Ellenberg indices like soil reaction, light, temperature, and moisture (Table 1). Managed meadows had a higher overall number of species that were moderately and well tolerant to very tolerant to mowing.

Table 1. Characteristics of managed (M) and abandoned (A) *Molinion* meadows. Significant differences determined using the U Mann-Whitney test are marked at \*\*  $P < 0.01$ , \*  $P < 0.05$

	M	A		M	A	M
	Mean $\pm$ SE			Mean $\pm$ SE		vs A
Number of samples	68	160		68	160	
Disturbance Index (Z)	4.86	34.20	**	19.11	16.49	**
	$\pm 0.78$	$\pm 5.25$		$\pm 0.66$	$\pm 0.38$	
Richness	34.29	29.58	**	5.07	3.65	**
	$\pm 0.93$	$\pm 0.56$		$\pm 0.31$	$\pm 0.16$	
Shannon-Wiener	2.80	2.57	**	6.96	6.91	*
	$\pm 0.04$	$\pm 0.04$		$\pm 0.01$	$\pm 0.01$	
Evenness	0.79	0.76	*	5.50	5.41	**
	$\pm 0.01$	$\pm 0.01$		$\pm 0.02$	$\pm 0.02$	
Cover of <i>Molinia</i> species	60.97 $\pm$	50.74	**	6.38	5.89	**
	3.12	$\pm 2.00$		$\pm 0.07$	$\pm 0.06$	
Cover of <i>Molinio-Arrhenatheretea</i> species	109.59	90.41	**	6.26	6.46	*
	$\pm 2.56$	$\pm 2.53$		$\pm 0.07$	$\pm 0.05$	

Seven forms of *Molinia* meadows were distinguished based on Z: 1) the typical form; 2) atypical form with tall herbs; 3) atypical form with *M. caerulea*; 4) atypical form with *Solidago sp. div.* 5) atypical form with woody plants; 6) atypical form with *C. epigejos* and 7) atypical form with *N. stricta*. These forms were found in both managed and abandoned meadows, except for the atypical forms with *Solidago sp. div.*, woody plants and *N. stricta*,



which were found only in abandoned meadows. The atypical forms with *C. epigejos* and tall herbs were found much more often in abandoned meadows. The typical form was also found in abandoned meadows, especially in those meadows which were abandoned most recently. Based on the Ellenberg indicators, environment conditions did not vary greatly between the forms. Nutrients were higher in the form with woody plants ( $3.62 \pm 0.09$  SE) than in the typical form ( $3.97 \pm 0.06$  SE,  $P < 0.01$ ). On the other hand, they were lower in the form with *Nardus stricta* ( $3.15 \pm 0.08$  SE). Moisture was higher in the form with tall herbs ( $6.77 \pm 0.07$  SE) than in the typical form ( $3.05 \pm 0.09$  SE,  $P < 0.01$ ). Species diversity was highest in the typical form. On the other hand, the cover of woody plants was highest in the atypical forms. The cover of grasses and tall herbaceous plants was also higher in most of the atypical forms (Table 2).

Table. 2. Differences of mean ( $\pm$  SE) cover of selected groups of species and diversity indices between typical and atypical forms. Significant differences at  $P < 0.01$  using the Kruskal-Wallis test are followed by the same letter.

Meadow form	1 Typical	2 Tall herbs	3 <i>M. caerulea</i>	4 <i>Solidago sp. div.</i>	5 woody plants	6 <i>C. epigejos</i>	7 <i>N. stricta</i>
Percentage of samples from managed meadows	54	23	45	0	0	22	0
Disturbance Index (Z)	0.30 $\pm 0.04^{abcdef}$	11.75 $\pm 2.32^a$	13.61 $\pm 3.14^{bgh}$	35.98 $\pm 9.72^c$	40.05 $\pm 11.64^{dg}$	64.30 $\pm 18.64^{eh}$	69.29 $\pm 28.62^f$
Shannon-Wiener	2.98 $\pm 0.05^{abcde}$	2.76 $\pm 0.05$	2.49 $\pm 0.06^c$	2.49 $\pm 0.05^d$	2.56 $\pm 0.06^a$	2.61 $\pm 0.08^b$	2.48 $\pm 0.12^c$
Cover of:	0.90	2.01	0.95	1.24	14.38	4.71	2.40
Woody plants	$\pm 0.33^a$	$\pm 0.96$	$\pm 0.22^b$	$\pm 0.94$	$\pm 3.04^{ab}$	$\pm 2.74$	$\pm 1.07$
Tall herbs	6.06 $\pm 1.11^a$	24.11 $\pm 2.93^{abcde}$	5.46 $\pm 0.89^{bh}$	18.51 $\pm 3.95^{fghi}$	5.12 $\pm 1.14^{cf}$	3.92 $\pm 0.72^{dg}$	0.51 $\pm 0.01^{ei}$
Grasses	56.31 $\pm 2.95^a$	50.25 $\pm 2.72^{ce}$	67.88 $\pm 2.14^c$	65.51 $\pm 5.58$	56.87 $\pm 3.17^d$	62.76 $\pm 2.78^b$	89.52 $\pm 4.53^{abcd}$
Species intolerant to sensitive to mowing (1-3)	33.08 $\pm 2.82^{abcd}$	63.23 $\pm 3.30^{bf}$	68.40 $\pm 2.59^{\pm eg}$	51.86 $\pm 6.02$	59.95 $\pm 4.42^{ac}$	32.05 $\pm 3.19^{efgh}$	67.25 $\pm 4.02^{dh}$
Species well to very tolerant to mowing (7-9)	28.09 $\pm 2.47^{abcd}$	11.89 $\pm 2.24^c$	11.39 $\pm 1.46^d$	12.61 $\pm 2.89$	11.23 $\pm 2.30^a$	9.53 $\pm 1.75^b$	18.27 $\pm 4.79$

The cover of species that were well to very tolerant to mowing was highest in the typical form. However, the cover of species intolerant to sensitive to mowing was lower. In atypical forms, there was a higher share of *F. ulmaria*, *L. vulgaris*, *Solidago sp.*, and woody plants. These species are considered to be promoters of succession, and they appear during the earliest stages of succession in abandoned meadows (Falińska, 1998).

## References

- Falińska K. (1989) Plant population processes in the course of forest succession in abandoned meadows. II. Demography of succession promoters. *Acta Societatis Botanicorum Poloniae* 58, 467-491.
- Hennekens S. M. and Schaminée J.H.J. (2001) TURBOVEG, a comprehensive data base management system for vegetation data. *Journal of Vegetation Science* 12, 589-591.
- Kaçki Z. and Michalska-Hejduk D. (2010) Assessment of biodiversity in Molinia meadows in the Kampinoski National Park based on biocenotic indicators. *Polish Journal of Environmental Studies* 19, 351-362.
- Klotz S., Kühn I. and Durka W. (2002) Eine Datenbank mit biologisch-ökologischen Merkmalen zur Flora von Deutschland. *Schriftenreihe für Vegetationskunde* 38, 1-334.
- Oberdorfer E. (1983) *Süddeutsche Pflanzengesellschaften. Teil III.* – 2. Aufl. Gustav Fischer Verlag, Stuttgart, New York, 455 pp.
- Westhoff V. and van den Maarel E. (1978). The Braun-Blanquet approach. In: Whittaker R.H. (ed). *Classification of plant communities*. W. Junk, The Hague, pp. 289-399.
- Zechmeister H.G., Schmitzberger I., Steurer B., Peterseil J. and Wrška T. (2003). The influence of land-use practices and economics on plant species richness in meadows. *Biological Conservation* 114, 165-177.

# Diversity–ecosystem function relationship in mixed forage crops

Llurba R.<sup>1</sup>, Ribas A.<sup>1,2</sup>, Ventura D.<sup>1</sup>, Connolly J.<sup>3</sup> and Sebastià M.T.<sup>1,4</sup>

<sup>1</sup> Centre Tecnològic Forestal de Catalunya

<sup>2</sup> BABVE, Universitat Autònoma of Barcelona

<sup>3</sup> UCD, University College Dublin, School of Mathematical Sciences

<sup>4</sup> ETSEA-Universitat de Lleida

Corresponding author: rosa.llurba@ctfc.es

## Abstract

Monocultures and three species mixtures containing a grass (*Festuca arundinacea*), a legume (*Medicago sativa*) and a forb (*Cichorium intybus*) were sown in order to test the effects of diversity on forage swards. Yield, LAI (Leaf Area Index), leaching and stability indicators were determined as a function of sown species identity and diversity effects. Yield and LAI were higher in mixed swards than in monocultures. A diversity effect was found for both variables, with values in mixtures above that expected from the proportions of the sown species. There was a seasonal substitution of species dominance, thus maintaining overall total yield. As a result, mixtures showed higher stability than monocultures. On the other hand, we found a negative effect of total biomass on leaching, but this trend was not consistent across the 6 studied harvests.

Keywords: diversity effect, mixtures, *Cichorium intybus*, forage crops, LAI, leaching

## Introduction

In the current context of global change and energy scenarios it is essential to test agricultural strategies which may sustain agroecosystem function and derived goods and services. Mixed forage crops have been shown to provide enhanced ecosystem function (Kirwan *et al.* 2007; Nyfeler *et al.* 2009); nevertheless, their use is still relatively scarce, in part because of a lack of sward stability (Nyfeler *et al.*, 2009). The inclusion of forbs in the mixtures, such as chicory (*Cichorium intybus*), may affect species composition shifts and thus stability (Hogh-Jensen *et al.*, 2006). Further, a multifunctional approach is required to assess the tradeoffs of different societal demands that mixed forage crops may provide, including environmental issues. We manipulated sown diversity of forage swards to assess compositional (identity) and diversity (through the evenness component) effects on: 1) yield; 2) Leaf Area Index (LAI); 3) sward stability; and 4) leaching.

## Materials and methods

Monocultures and 3-species mixtures containing a grass (*Festuca arundinacea*), a legume (*Medicago sativa*) and a forb (*Cichorium intybus*) were sown following a *simplex* design (Kirwan *et al.*, 2007; 2009) in a semi-arid irrigated agricultural area in Catalonia. Mixtures included swards dominated by each of the components (80% sown proportion) and a centroid with an equal proportion of each of the sown species. This design was repeated at two densities, and replicated three times yielding a total of 42 plots measuring 12 x 12 m<sup>2</sup>. Total yield was determined through the harvesting of 9.36 m<sup>2</sup>; prior to that 0.5 x 0.5 m<sup>2</sup> samples were cut to 5 cm, separated into species, dried at 60 °C and weighed. LAI was measured using a ceptometer (AccuPAR, Decagon Devices). The solution leaching for the different diversity treatments was assessed using lysimeters consisting of 1 m<sup>3</sup> containers placed in each plot, which allowed the natural drainage of the soil solution across an isolated block of soil located on top of three layers of gravel and sand, with decreasing particle size. Leachate was collected

periodically so that the sum of several leaching assessments corresponded to plant development between two consecutive harvests. The response variables were modelled (GLM, SAS) as a linear function of initial sown species proportions ( $P_i$ ) and evenness ( $E$ ), thus allowing the separation of identity and diversity (evenness) effects (Kirwan *et al.* 2007; 2009). Evenness ( $E$ ) was given by the expression  $E = \frac{2S}{S-1} \sum_{i < j} P_i P_j$ , where  $S$  is the community

maximum plant species number and  $P_i P_j$  the species pairwise interactions. As no density effects were detected the models presented below are the average for the two density levels.

## Results and discussion

In general, yield was higher in mixtures than in monocultures (Figure 1A) with total annual yield (average for 2008 and 2009) being significantly higher in mixtures ( $P < 0.0001$ ). A diversity effect was found with values in mixtures above those expected from the proportions of the sown species (Figure 2A). This diversity effect increased with time, as found by Frankow *et al.* (2009), while the yield predicted from the monoculture performance decreased across the six studied harvests (Figure 1B); nevertheless, both identity and diversity effects decreased sharply in the last two harvests because of a water shortage. These results suggest a contribution of the species interactions to the stability of harvested biomass. Furthermore, we found a shift in the individual contribution of each species, or individual identity effects, across the six harvests, with a decrease in time of the chicory harvested biomass and an increase in the other two species, as reflected by the shift in the coefficients and the monoculture yields across the six harvests (Figure 1A). The same trends were found for LAI, with both yield and LAI showing predicted values above those expected from the monoculture performances (Figure 2A and 2B), due to the diversity effect.

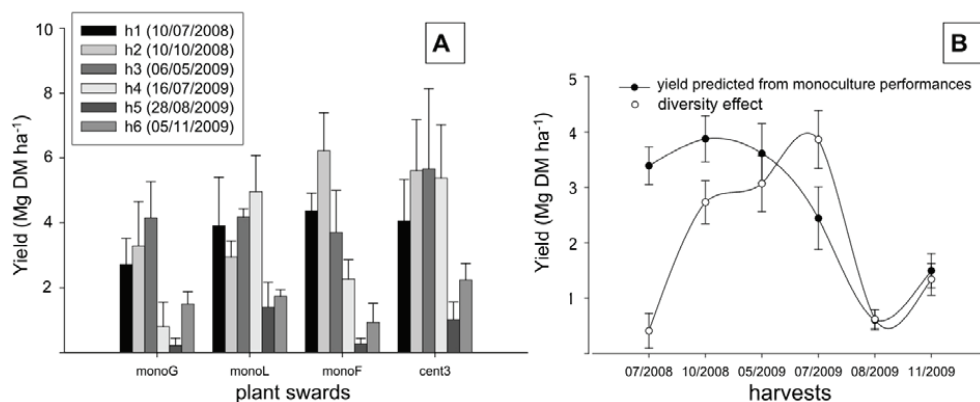

Figure 1. (A) Yield per harvest for each monoculture (monoG: *Festuca arundinacea*; monoL: *Medicago sativa*; monoF: *Cichorium intybus*) and the centroid mixture (cent3). (B) Yield per harvest predicted for the centroid from the monoculture performances and predicted diversity effect in

equation  $y = \sum_{i=1}^3 \beta_i P_i + \delta E$ . DM: dry matter.

The total harvested biomass in harvest 4 had a small but significant negative effect ( $P < 0.0001$ ) on the amount of solution leached since the previous harvest. Nevertheless, this trend was not found for the rest of the leachate associated to the biomass collected between two consecutive harvests. A water shortage in 2009 and the variability in total drainage in the lysimeters may have hampered the correct assessment of leaching dynamics that were associated with diversity. Indeed, we found no diversity effects on total leached solution.

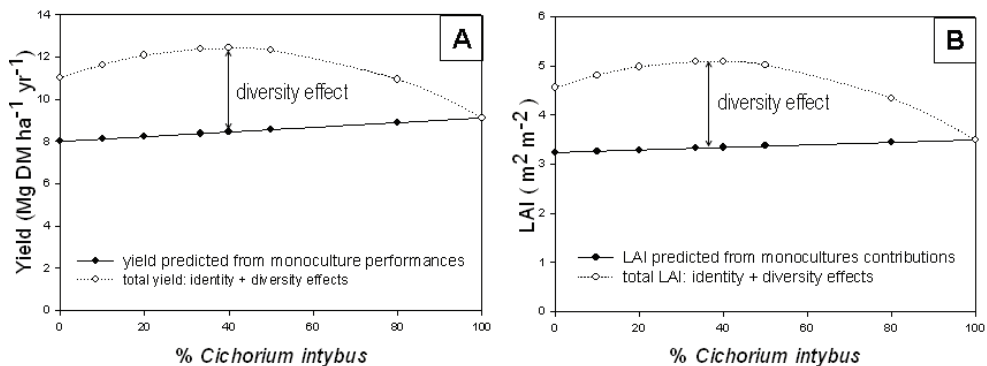

Figure 2. Annual yield (A) (mean from 2008 and 2009) and LAI (B) predicted for mixtures where the sown percentage of chicory is increased from 0 to 100% and the ratio among the other two sown species is held constant.

## Conclusions

Forage mixed crops have the potential to increase forage production and supply stability, through the shift in the contribution of their components across time. This agronomical advantage could be paralleled by a decrease in leaching, with a clear environmental interest.

## Acknowledgements

We thank Faustina, Teri, Laura, Josep and all the helpful hands that have made that project possible. This research project was supported by the Spanish Ministerio de Medio Ambiente.

## References

- Frankow-Lindberg B.E., Brophy C., Collins R.P. and Connolly J. (2009) Biodiversity effects on yield and unsown species invasion in a temperate forage ecosystem. *Annals of Botany* 103, 913-921.
- Høgh-Jensen H., Nielsen B. and Thamsborg S.M. (2006) Productivity and quality, competition and facilitation of chicory in grass/legume-based pastures under various nitrogen supply levels. *European Journal of Agronomy* 24, 257-256.
- Kirwan L., Lüscher A., Sebastia M.T., Finn J.A., Collins R.P., Porqueddu C., Helgadottir A., Baadshaug O.H., Brophy C., Coran C., Dalmanndóttir S., Delgado I., Elgersma A., Fothergill M., Frankow-Lindberg B.E., Golinski P., Grieu P., Gustavsson A.M., Höglind M., Huguenin-Elie O., Iliadis C., Jørgensen M., Kadziuliene Z., Karyotis T., Lunnan T., Malengier M., Maltoni S., Meyer V., Nyfeler D., Nykanen-Kurki P., Parente J., Smit H.J., Thumm U. and Connolly J. (2007) Evenness drives consistent diversity effects in an intensive grassland system across 28 European sites. *Journal of Ecology* 95, 530-539.
- Kirwan L., Connolly J., Finn J.A., Brophy C., Lüscher A., Nyfeler D. and Sebastia M.T. (2009) Diversity-interaction modelling - estimating contributions of species identities and interactions to ecosystem function. *Ecology* 90, 2032-2038.
- Nyfeler D., Huguenin-Elie O., Suter M., Frossard E., Connolly J. and Lüscher A. (2009) Strong mixture effects among four species in fertilized agricultural grassland led to persistent and consistent transgressive overyielding. *Journal of Applied Ecology* 46, 683-691.

## Plant strategies in relation to different grazing intensities

Ludvíková V.<sup>1</sup> and Pavlů V.<sup>1,2</sup>

<sup>1</sup> Faculty of Environmental Sciences, Czech University of Life Sciences Prague, Department of Ecology, CZ-165 21 Prague, Czech Republic

<sup>2</sup> Research Institute of Crop Production, Prague, Department of Plant Ecology and Weed Science, Grassland Research Station, CZ-460 11 Liberec, Czech Republic

Corresponding author: ludvikovavendula@fzp.czu.cz

### Abstract

The effect of grazing intensity on plant strategies (C-S-R signature) was studied on an experimental pasture in the Jizera Mts. (Czech Republic). The data collection took place during the vegetation seasons of 2003 - 2007 for two treatments: intensive grazing (IG) and extensive grazing (EG). Sward height was the main attribute for the analysis and the two following categories of sward patches were distinguished: i) heavily grazed (*H*): 0 - 5 cm and ii) rarely grazed (*R*): more than 10.5 cm. The S strategy occurred in all types of patches with the lowest value. The defoliation intensity had no effect on its abundance. In the *H* patches with higher disturbances, the R-components predominated, whereas the C strategy had the lowest value. For example, ruderals, like *Polygonum aviculare* or *Poa annua*, were present in those patches only. The C strategy had a higher proportion in the *R* patches. Although it has been shown that the IG treatment favours ruderal (R) strategy and EG treatment competitive (C) strategy, the results were affected by the abundance of different sward patches in treatments. Therefore, the rate of each C-S-R strategy was more dependent on the rate of different sward patches in treatments than by the grazing intensity itself.

Keywords: Heifers grazing, CSR strategy, sward height, sward patches, defoliation

### Introduction

Plant species exposed to similar selection pressure can respond variously depending on their life strategy. Knowledge about plant strategies may be important in analysing the distribution and the population dynamics of species and may be useful in predicting the consequences of changes under different management regimes (Grime *et al.*, 1988). Sward patches form in a pasture because of selective grazing (Bakker *et al.*, 1983; Willms *et al.*, 1988). Sward height may be an important predictor of species reaction to grazing (Diaz *et al.*, 2001) and can also be a key indicator of the presence of different life strategies. The objective of the research in this paper is to evaluate the effect of different intensities of cattle grazing on primary plant strategies (Grime, 1974).

### Material and methods

The study was carried out in an experimental pasture in the Jizera Mts., 10 km north of the city Liberec, Czech Republic. The average total annual precipitation in the region is 803 mm and the mean annual temperature is 7.2 °C. The altitude of the study site is 420 m above sea level. The pasture was continuously stocked with growing heifers. The treatments were: extensive grazing (EG) and intensive grazing (IG). The experiment was arranged in two completely randomised blocks. The paddock area for each EG and IG plot was approximately 0.35 ha. The stocking density in the different treatments was adapted to the target sward height of 10 cm (EG) or 5 cm (IG) and was maintained by varying the grazing area available for the treatment. The grazing season lasted from the beginning of May to the end of October.

The sward height and abundance of vascular plant species were collected in both treatments from two permanent line transects in each plot. Measurements were performed at 40 fixed points (subplots) along each line transect (2 treatments x 2 blocks x 2 transects x 40 fixed points = 320 subplots). The percentage abundance of vascular plant species and compressed sward height (Corell *et al.*, 2003) was estimated at fixed points in 700 cm<sup>2</sup> circles (diameter 30 cm). Different patch types were distinguished through sward height into the two following categories: a) heavily grazed patches (*H*) with heights from 0 to 5 cm and b) rarely grazed patches (*R*) with heights taller than 10.5 cm. Data were collected in years 2003, 2004, 2006 and 2007, in early summer (SE), late summer (SL) and in autumn (A). For every presented plant, a life strategy was assigned, and using a spreadsheet-based tool for calculating functional signatures within the context of the C-S-R life strategies (Hunt *et al.*, 2004), the distribution of C-S-R life strategies was established. Species nomenclature follows Kubát *et al.* (2002). ANOVA and post-hoc comparison using the Tukey HSD was used to evaluate the distribution of C-S-R life strategies in different patches.

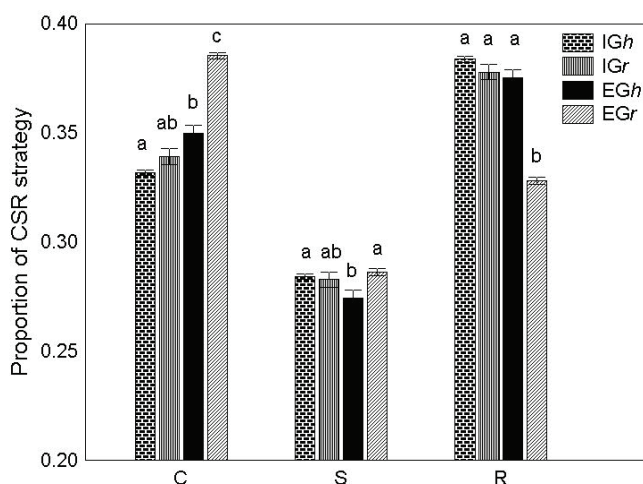

Figure 1. Weighted means of the CSR strategies in particular patches. Error bars represent the standard error of the mean (SE). The individual strategy with the same letter was not significantly different ( $P < 0.005$ ), Tukey HSD test. The abbreviations of the treatments and patch category interactions are given in Material and methods.

## Results and discussion

Different grazing intensities of cattle grazing affected the presence of plant species with different life strategies. A significant effect ( $P < 0.001$ ) of defoliation intensity on the presence of C and R strategists was found, but was non significant on the presence of S strategists. The interaction of the treatment and patches category was found to be a significant predictor of the distribution of plants with different life strategies under grazing ( $P < 0.001$ ). EGR patches had a different proportion of CSR from the others, C-strategy predominated there (Figure 1). These patches were not preferentially grazed by animals and the taller species with good light competition ability, like *Urtica dioica*, were dominant there. Conversely, R-strategy was significantly lowest in EGR patches, probably because of few sward disturbances. However, intensively defoliated patches (IGH, IGR, EGH) promoted R-strategy, which is typical for managed pastures (Ejarnæs and Bruun, 2000; Moog *et al.*, 2005). The lowest rate of C-strategy occurred in IGH patches, whereas R-strategy

predominated there. For example, ruderals like *Polygonum aviculare* or *Poa annua* were present in those patches only. In the IGR patches, the representation of C-strategy and of R-strategy changed year by year. Those patches arose predominantly on places with faeces, which were not stable (Pavlů, pers. comm.). The results have shown that the IG treatment favours a ruderal strategy, and EG treatment a competitive strategy. It should be noted that the proportion of C-S-R strategy in the particular sward patches was relatively stable during the study years.

## Conclusion

Although it has been shown that the IG treatment favours a ruderal strategy and EG treatment a competitive strategy, the results were affected by the abundance of different sward patches in treatments. Therefore, the rate of each C-S-R strategy was more dependent on the rate of different sward patches in treatments than by grazing intensity itself.

## Acknowledgements

This study was supported by the Ministry of Agriculture (grant no. 0002700604) and the Ministry of Environment (grant no. SP/2D3/179/07).

## References

- Bakker J.P., de Leeuw W. and van Wieren S.E. (1983) Micro-patterns in grassland vegetation created and sustained by sheep grazing. *Vegetatio* 55, 153-161.
- Correl O., Isselstein J. and Pavlů V. (2003) Studying spatial and temporal dynamics of sward structure at low stocking densities: the use of an extended rising-plate-meter method. *Grass Forage Science* 58, 450-454.
- Diaz S., Noy-Meir and Cabido M. (2001) Can grazing of herbaceous plants be predicted from simple vegetative traits? *Journal of Applied Ecology* 38, 457-508
- Ejrnæs R. and Bruun H.H. (2000) Gradient analysis of dry grassland vegetation in Denmark. *Journal of Vegetation Science* 11, 573-584.
- Grime J.P. (1974) Vegetation classification by reference to strategies. *Nature* 250, 26-31.
- Grime J.P., Hodgson J.G. and Hunt R. (1988) *Comparative plant ecology: a functional approach to common British species*, Unwin Hyman Ltd, London, UK, 742 pp.
- Hunt R., Hodgson J.G., Thompson K., Bungener P., Dunnett N.P. and Askew A.P. (2004) A new practical tool for deriving a functional signature for herbaceous vegetation. *Applied Vegetation Science* 7, 163-170.
- Kubát K., Hroudá L., Chrtek J., Kaplan Z., Kirschner J. and Štěpánek J. (eds.) (2002) *Klíč ke květeně České republiky*, Academia, Praha, CZ, 928 pp.
- Moog D., Kahmen S. and Poschlod P. (2005) Application of CSR- and LHS-strategies for the distinction of differently managed grasslands. *Basic and Applied Ecology* 6, 133-143.
- Willms W.D., Dormaar J.F. and Schaalje G.B. (1988) Stability of grazed patches on rough fescue grasslands. *Journal of Range Management* 41, 503-508.



# Grass-legume mixtures can fix more N<sub>2</sub> from the atmosphere than legume pure stands

Lüscher A.<sup>1</sup>, Nyfeler D.<sup>1</sup>, Suter M.<sup>1,2</sup>, Suter D.<sup>1</sup> and Huguenin-Elie O.<sup>1</sup>

<sup>1</sup>Agroscope Reckenholz-Tänikon Research Station ART, CH-8046 Zurich, Switzerland

<sup>2</sup>Institute of Integrative Biology, ETH Zurich, CH-8092 Zurich, Switzerland

Corresponding author: andreas.luescher@art.admin.ch

## Abstract

A multi-site grassland experiment across 33 European sites (COST 852) demonstrated transgressive overyielding of grass-legume mixtures (biomass yield of the mixture was higher than that of the best monoculture) under agronomic management. To get insight into mechanisms driving such mixing effects, we studied N-resource use of grass-legume mixtures over a wide range of legume percentages in the sward (0-100%). We found interspecific interactions stimulating acquisition of N from symbiotic sources to be most important. Interspecific interactions stimulating acquisition of N from non-symbiotic sources were also evident. Furthermore, transformation of acquired N into biomass was more efficient in well balanced mixtures as compared to legume pure stands. We conclude that the largest benefit of mixing grasses and legumes in terms of biomass and N-yield are achieved with about 40-60% legumes in the sward.

Keywords: facilitation, <sup>15</sup>N, N-transfer, symbiotic N<sub>2</sub>-fixation, overyielding

## Introduction

Substitution of mineral fertiliser N by an improved exploitation of symbiotic N<sub>2</sub>-fixation in agricultural grasslands would be an important contribution to sustainable and resource-efficient agriculture. While symbiotic N<sub>2</sub>-fixation from photosynthetic carbon is 'greenhouse gas neutral', an equivalent of greenhouse gas emissions of 3.3 and 8.6 kg CO<sub>2</sub> is calculated by the database ecoinvent data v2.1 (Ecoinvent Centre, 2008) per kg of urea-N and ammonium-nitrate-N respectively for production and transport. Despite the high potential to symbiotically fix N<sub>2</sub> (Zanetti *et al.*, 1997), the range of legume percentage in grass-legume mixtures for which symbiotic N<sub>2</sub>-fixation is maximised remains unclear.

In intensively managed swards strong benefits of mixing grasses and legumes were achieved in a pan-European experiment over 33 sites in 17 countries (Kirwan *et al.*, 2007; Lüscher *et al.*, 2008). In contrast to many diversity experiments (Cardinale *et al.*, 2007), mixing effects in this multi-site experiment even led to transgressive overyielding; that is, biomass yield of the mixture was higher than that of the highest yielding monoculture (Trenbath, 1974). The mechanisms responsible for these mixing effects have not been investigated so far.

## Materials and methods

Monocultures and grass-legume mixtures with the four most important agronomic species for intensive grassland in temperate climate were established in a field experiment as described in detail in Nyfeler *et al.* (2009). The experiment was designed to study interactions among the two functional groups 'grasses' (represented by *Lolium perenne* L. and *Dactylis glomerata* L.) and 'legumes' (*Trifolium pratense* L. and *Trifolium repens* L.). This was achieved by a wide range of grass and legume percentages in the sward (0%, 7%, 20%, 50%, 80%, 93% and 100% at sowing). The twenty-one different mixtures and the four different monocultures were established in two overall sowing densities.

$^{15}\text{N}$ -technology quantified N derived from symbiotic sources ( $N_{\text{sym}}$ ) as described in detail in Zanetti *et al.* (1997).  $N_{\text{sym}}$  comprises legume-N derived from symbiotic  $\text{N}_2$ -fixation and grass-N derived from apparent N-transfer. The influence of the sward's legume percentage on  $N_{\text{sym}}$  measured in the 50 plots of the experiment was evaluated by multiple linear regression. There was no replication; estimation was based on regression methods and inference was based on the residual variation around the regression model fitted (Kirwan *et al.*, 2009).

## Results and discussion

Symbiotic  $\text{N}_2$ -fixation was the main source of N for grass-legume mixtures across a wide range of legume percentages in both years. Yield of  $N_{\text{sym}}$  harvested with the entire sward reached values of  $305 \text{ kg ha}^{-1} \text{ yr}^{-1}$  N in year one (Figure 1) and  $284 \text{ kg ha}^{-1} \text{ yr}^{-1}$  N in year two, thus agreeing with results from earlier studies under comparable conditions (e.g. Zanetti *et al.*, 1997). These high amounts of  $N_{\text{sym}}$  yield demonstrate that additional input of  $N_{\text{sym}}$  is an important component of diversity effects in grass-legume mixtures as compared to pure grass stands. This can be considered as a key example of niche differentiation for N between grasses (only N-uptake from soil) and legumes (access to  $\text{N}_2$  from the atmosphere), resulting in the overall niche of the mixture being broadened by  $N_{\text{sym}}$  compared to pure grass stands.

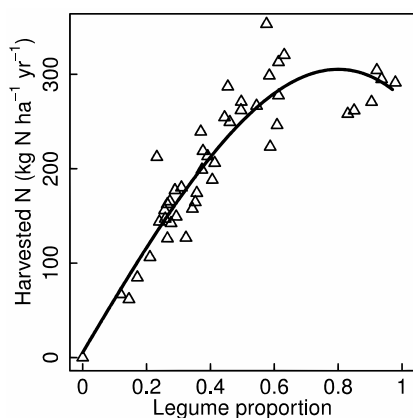

Figure 1: Effect of legume proportion in the swards on the amount of nitrogen yield derived from symbiotic  $\text{N}_2$ -fixation ( $N_{\text{sym}}$ ) harvested with the entire sward.

Surprisingly, strong stimulatory interspecific interactions (mixing effects) resulted in  $N_{\text{sym}}$  yield being maximised not in pure legume stands, but in mixtures with a legume percentage of 80% in year one (Figure 1) and 61% in year two. These maximal amounts of  $N_{\text{sym}}$  tended to be higher by 24 and 44  $\text{kg ha}^{-1} \text{ yr}^{-1}$  N than  $N_{\text{sym}}$  harvested from the pure legume stands, indicating transgressive overyielding of  $N_{\text{sym}}$ . These stimulatory effects were so strong that a legume percentage in the mixture of only 66% in year one and 37% in year two was sufficient to attain the same amount of  $N_{\text{sym}}$  as in pure legume stands. A more detailed analysis (not shown here) revealed that two processes were responsible for these stimulatory effects of mixtures on  $N_{\text{sym}}$ . First, an increasing percentage of grasses in mixtures stimulated the percentage of symbiotically fixed  $\text{N}_2$  in the legume plants by up to 94%. Second, an increased grass percentage in the sward increased the amount of

apparent N-transfer of formerly symbiotically fixed  $\text{N}_2$  from the legumes to the grasses to up to  $45 \text{ kg ha}^{-1} \text{ yr}^{-1}$ . The concurrent increase of the symbiotic  $\text{N}_2$ -fixing activity of the legumes with increasing grass percentage fits well with the conceptual model that legumes regulate their symbiotic  $\text{N}_2$ -fixation to close the gap between their N-demand for growth and N-availability of non-symbiotic N-sources (Hartwig, 1998). Although symbiotic  $\text{N}_2$ -fixation takes place exclusively within the legume plants' root nodule, there are important stimulatory feedback mechanisms exerted by the accompanying grasses leading to an increased  $\text{N}_2$ -fixing activity of the legumes.

This study shows that the positive effects of mixing grasses and legumes on biomass production found in the same experiment (Nyfeler *et al.*, 2009) do not solely rely on the direct effect of symbiotic  $\text{N}_2$ -fixation (expected from the proportional contribution of symbiotically fixed  $\text{N}_2$  of the legume pure stand). They mainly rely on stimulatory interspecific interactions

on symbiotic N<sub>2</sub>-fixation leading to mixtures with optimal legume percentage yielding more N<sub>sym</sub> than legume pure stands.

Further results of this study (not shown here) revealed that other stimulatory interspecific interactions (mixing effects) were evident resulting in better exploitation of mineral N in the soil by the mixtures as compared to monocultures. Also these non-symbiotic stimulatory interspecific interactions lead to increased N-acquisition in the mixture. Finally, results on N-concentration in the harvested plant material (not shown here) demonstrated that swards with a legume percentage below 50-70% show a more efficient transformation of acquired N into biomass than legume dominated mixtures or legume pure stands. Thus, mixed swards also achieved positive effects on transformation of acquired N into biomass.

## Conclusions

We conclude that the largest benefit of mixing grasses and legumes in terms of biomass yield can be achieved with about 40-60% legumes in the swards because these swards not only benefit from a stimulation of symbiotic N<sub>2</sub>-fixation but also from a stimulated uptake of N from non-symbiotic sources and from an efficient transformation of acquired N into biomass.

## Acknowledgements

The project was supported by the Swiss State Secretariat for Education and Research.

## References

- Cardinale B.J., Wrigh J.P., Cadotte M.W., Carroll I.T., Hector A., Srivastava D.S., Loreau M. and Weis J.J. (2007) Impacts of plant diversity on biomass production increase through time because of species complementarity. *Proceedings of the National Academy of Sciences* 104, 18123-18128.
- Ecoinvent Centre (2008) *Ecoinvent data – The life cycle inventory data*, V2.1. Swiss centre for life cycle inventories, Dübendorf, ISBN 3-905594-38-2. Available at [www.ecoinvent.org](http://www.ecoinvent.org).
- Hartwig U.A. (1998) The regulation of symbiotic N<sub>2</sub> fixation: a conceptual model of N feedback from the ecosystem to the gene expression level. *Perspectives in Plant Ecology, Evolution and Systematics* 1, 92-120.
- Kirwan L., Connolly J., Finn J.A., Brophy C., Lüscher A., Nyfeler D. and Sebastià M.T. (2009) Diversity-interaction modelling: estimating contributions of species identities and interactions to ecosystem function. *Ecology* 90, 2032-2038.
- Kirwan L., Lüscher A., Sebastià M.T., Finn J.A., Collins R.P., Porqueddu C., Helgadóttir Á., Baadshaug O.H., Brophy C., Coran C., Dalmannsdóttir S., Delgado I., Elgersma A., Fothergill M., Frankow-Lindberg B.E., Golinski P., Grieu P., Gustavsson A.M., Höglind M., Huguenin-Elie O., Iliadis C., Jørgensen M., Kadžiulienė Ž., Karyotis T., Lunnan T., Malengier M., Maltoni S., Meyer V., Nyfeler D., Nykanen-Kurki P., Parente J., Smit H.J., Thumm U. and Connolly J. (2007) Evenness drives consistent diversity effects in an intensive grassland system across 28 European sites. *Journal of Ecology* 95, 530-539.
- Lüscher A., Finn J.A., Connolly J., Sebastià M.T., Collins R., Fothergill M., Porqueddu C., Brophy C., Huguenin-Elie O., Kirwan L., Nyfeler D. and Helgadóttir Á. (2008) Benefits of sward diversity for agricultural grasslands. *Biodiversity* 9, 29-32.
- Nyfeler D., Huguenin-Elie O., Suter M., Frossard E., Connolly J. and Lüscher A. (2009) Strong mixture effects among four species in fertilized agricultural grassland led to persistent and consistent transgressive overyielding. *Journal of Applied Ecology* 46, 683-691.
- Trenbath B.R. (1974) Biomass productivity of mixtures. *Advances in Agronomy* 26, 177-210.
- Zanetti S., Hartwig U.A., van Kessel C., Lüscher A., Hebeisen T., Frehner M., Fischer B.U., Hendrey G.R., Blum H. and Nösberger, J. (1997) Does nitrogen nutrition restrict the CO<sub>2</sub> response of fertile grassland lacking legumes? *Oecologia* 112, 17-25.

# The effect of manipulated plant species diversity of semi-natural permanent grassland on forage production and quality

Petersen U., Isselstein J. and Wrage N.

*University of Goettingen, Institute of Grassland Science, Department of Crop Sciences  
Von-Siebold-Str. 8, D-37075 Goettingen*

Corresponding author: Ute.Petersen@agr.uni-goettingen.de

## Abstract

So far, most experiments investigating environmental as well as agricultural benefits of plant diversity in grassland have dealt with sown grassland, whereas permanent grassland has been poorly examined. In the Grassland Management Project (GRASSMAN) in the Solling Uplands (Germany), the biodiversity of permanent grassland has been manipulated by herbicides to obtain either pure grass swards or swards with relatively high amounts of forbs and legumes, on top of untreated control swards. These swards were subjected to different management intensities, regulated by both the cutting regime and the nutrient supply. The aim of this study was to compare the forage quality in terms of crude protein and fibre content as well as the yield of the different swards. Furthermore, the role of species richness as well as that of functional biodiversity, that is to say the distribution of the functional groups, for yield formation was examined. Neither the species composition of the sward nor its functional diversity influenced the yield in this experiment. The swards rich in legumes and forbs tended to have a better quality than the control and grass-rich swards.

Keywords: yield, biodiversity, nutritive value, ecosystem services

## Introduction

Since the times of Darwin there have been discussions about the relationship between biodiversity and productivity of grassland. As Sanderson *et al.* (2004) summarise, there have been numerous field trials on this topic – mainly with sown, artificial grass swards. Permanent grasslands have mostly been analysed in surveys, not in manipulative experiments. As a new approach, we used permanent grassland as a starting point and manipulated its functional and species diversity by application of selective herbicides. The resulting sward types were subjected to different management treatments to analyse their performance in terms of forage yield and quality.

## Material and methods

The Grassland management (GRASSMAN) experiment was established in 2008 on an extensively grazed, nutrient-poor *Lolium-Cynosuretum* grassland in the Solling Uplands near Silberborn. It is a three factorial experiment, comprising the factors sward (untreated control sward (Co), Dicot reduced (Dic -) and Monocot reduced (Mon -)), fertilisation (no (x) and 180/30/100 kg ha<sup>-1</sup> NPK (NPK)) and utilisation (one (1) and three cuts (3) per year). This resulted in twelve treatments – the three sward types each with four different management intensities. The experiment was set up as a Latin Square with six replications. Herbage was harvested with a Haldrup® forage combine harvester, the harvest dates were in mid-May, mid-July and end of September 2009. For forage quality analysis, mixed herbage samples per plot were dried, ground and analysed by near-infrared-spectroscopy (NIRS). Species richness and the distribution of functional groups was monitored in vegetation relevés and by hand sorting of representative samples taken at harvest.

The statistical analyses were conducted with R (version 2.10.0). Linear contrasts and linear models were used to compare the means of the measured parameters. To take into account the spatial variability of the experimental area, the rows and columns of the Latin Square were included into the models as fixed effects. To obtain homogeneous variances and normal distribution of the residuals, the data was square-root (yield) or arcsine transformed (% data of forage components).

## Results and discussion

The twelve treatments resulted in widely spread annual yields, ranging from 55 dt ha<sup>-1</sup> (Mon - 3x) up to 122 dt ha<sup>-1</sup> in the Co 3\_NPK treatment. In none of the four management types were there significant differences in yield between the three sward types (Figure 1), although they did show significantly different proportions of the functional groups grasses, forbs and legumes (data not shown).

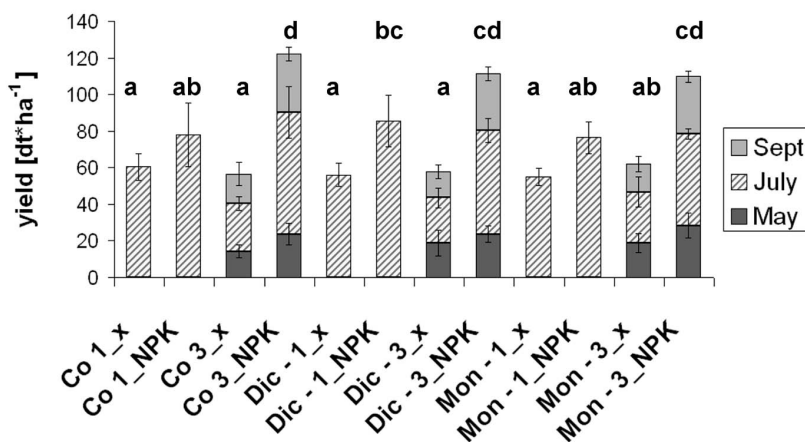

Figure 1. Sum of DM yields 2009 according to treatments (for explanations of treatment abbreviations, please refer to the text). Annual means denoted by the same letters are not different according to Tukey's mean separation ( $P < 0.05$ ).

The main factor influencing the yields was the fertilisation (Table 1), which also interacted with the cutting frequency. The factor sward, containing the three sward types, only accounted for less than 1% of the total variance of the yield. A relation between species number (on average 13-19 per 9 m<sup>2</sup>) and total annual yield could not be established. This could be due to the fact that the range of species richness was relatively narrow. As Deak *et al.* (2007) point out, rather than the species number, the species identity is important for yield and quality, which was not part of this investigation.

Table 1. Importance of the experimental factors in explaining the differences in annual yield 2009 (square root transformed). ANOVA including spatial effects.

Factors	df	Sum Sq	Mean Sq	F value	P (>F)	% Var expl.
Row	5	2.5	0.5	1.043	0.402	0.42
Column	5	4.081	0.816	1.702	0.149	0.69
Sward	2	0.286	0.143	0.298	0.7435	0.12
Nutrients	1	87.427	87.427	182.357	<0.001	74.25
Utilisation	1	15.481	15.481	32.291	<0.001	13.15
Nutrients x Utilisation	1	12.893	12.893	26.893	<0.001	10.95

In contrast to yield, the forage quality was influenced by sward composition (Table 2). As for the crude protein (CP) content, at the third cut, the swards rich in legumes and forbs (Mon-) still contained larger amounts of CP than the other swards. As expected, CP was significantly increased by fertiliser application. In July, CP contents were smaller and acid detergent fibre (ADF) contents larger ( $P < 0.001$ ) in swards cut once compared to those cut three times (Table 2). In September, the Dic - swards contained significantly larger amounts of ADF than the other swards. The neutral detergent fibre (NDF) contents were relatively high in all of the swards, ranging from 475 g kg<sup>-1</sup> in the Mon - 3\_NPK swards up to 680 g kg<sup>-1</sup> in the mature Dic - 1\_x swards (data not shown). Owing to the relatively high fibre content of the herbage, the digestibility and energy content is likely to be low and not to be recommended to feed highly performing ruminants (Henning *et al.*, 1999).

Table 2. Means and SD of forage nutritive value parameters (in g kg<sup>-1</sup> DM) influenced by the different treatments of the experiment. For explanations of the treatment abbreviations, please refer to the text. \* indicate significant differences from the reference level (Co3\_x or Co1\_x), (\* $P < 0.05$ , \*\* $P < 0.01$ , \*\*\* $P < 0.001$ ).

Treatment	CP			ADF		
	May 2009	July 2009	Sept 2009	May 2009	July 2009	Sept 2009
Co3x	166 ± 13.1	114 ± 9.1	147 ± 1.0	270 ± 6.3	333 ± 7.2	291 ± 1.4
Co3NPK	232 ± 12.4***	155 ± 13.3***	135 ± 0.6*	252 ± 6.3*	337 ± 11	307 ± 1.7**
Dic-3x	158 ± 7.2	107 ± 10.8	134 ± 0.9**	271 ± 10.3	337 ± 6.6	303 ± 1.5*
Dic-3NPK	225 ± 12.7***	163 ± 15.4***	135 ± 0.8*	251 ± 9.7*	328 ± 13	310 ± 1.4**
Mon-3x	171 ± 15.8	128 ± 10.7***	151 ± 0.8	277 ± 10.4	336 ± 11	295 ± 1.3
Mon-3NPK	218 ± 16.3***	177 ± 14.9***	151 ± 1.1*	253 ± 8.8*	316 ± 9.4**	299 ± 1.7**
Co1x		91 ± 9.0			360 ± 6.6	
Co1NPK		159 ± 14.5***			352 ± 15.9*	
Dic-1x		99 ± 8.1			366 ± 9.5	
Dic-1NPK		145 ± 11.2***			362 ± 14.1	
Mon-1x		98 ± 10.9			380 ± 12.7*	
Mon-1NPK		157 ± 7.2***			360 ± 13.3*	

## Conclusions

In the present investigation on permanent grassland, neither the species number nor the sward composition had any influences on the DM yield. It might be possible to gain better relations between these parameters if the actual proportions of functional groups were used as continuous variables. The quality of the forage was dependent on the sward type, although fertilisation and herbage age induced more pronounced changes in quality.

## References

- Deak A., Hall M.H., Sanderson M.A. and Archibald D.D. (2007) Production and nutritive value of grazed simple and complex forage mixtures. *Agronomy Journal* 99, 814-821.
- Henning J., Lacefield G.D. and Ameral-Phillips D. (1999) *Interpreting forage quality reports*. Online electronic publication via Agricultural Communications Service, University of Kentucky, ID 101.
- Sanderson M.A., Skinner R.H., Barker D.J., Edwards G.R., Tracey B.F. and Wedin D.A. (2004) Plant species diversity and Management of Temperate Forage and Grazing Land Ecosystems. *Crop Science* 44, 1132-1144.



# Manipulating species richness of permanent grasslands - a new approach to biodiversity experiments

Petersen U.<sup>1</sup>, Wrage N.<sup>1</sup>, Köhler L.<sup>2</sup>, Leuschner C.<sup>2</sup> and Isselstein J.<sup>1</sup>

<sup>1</sup>University of Goettingen, Institute of Grassland Science, Department of Crop Sciences, von-Siebold-Str. 8, D-37075 Goettingen, Germany

<sup>2</sup>University of Goettingen, Albrecht-von-Haller-Institute of Plant Science, Department of Ecology and Ecosystem Research, Untere Karspüle 2, D-37073 Goettingen, Germany

Corresponding author: Ute.Petersen@agr.uni-goettingen.de

## Abstract

The relationship between biodiversity and ecosystem services of grasslands has received increasing attention in recent years. While most of the research has so far been focussing on artificial grasslands, only few studies have examined semi-natural systems such as managed permanent grasslands. The Grassland Management Project (GRASSMAN) in Silberborn (Solling Uplands, Germany), implemented in 2008, tries to fill this gap of knowledge. Instead of sowing new grassland with different levels of species richness, permanent grassland has been manipulated by application of herbicides against a) dicots and b) monocots to alter the species richness and to obtain a new distribution of the functional groups. The resulting swards were subjected to different management intensities in terms of cutting regime and fertilisation. The combination of treatments, especially the herbicide application, led to a broad variety of grass swards. They differed significantly in species numbers, evenness and composition of functional groups.

Keywords: species number, meadow, herbicides, monocots, dicots, functional diversity

## Introduction

During the last two decades, biodiversity research has received increasing attention. Although many studies focussed on the role of biodiversity in grassland ecosystems, a great proportion of them were either surveys or experiments with sown, artificial grassland. There have been few analyses of grasslands in agricultural systems (Sanderson *et al.*, 2004). A new approach to biodiversity experiments would be to start with a long established grass sward and manipulate its species richness and proportions of functional groups (grass, forbs, legumes) by the application of selective herbicides. The reactions of the resulting swards to different management intensities could then be analysed. The grassland management project (GRASSMAN) of the University of Goettingen was set up following this new approach.

## Material and methods

The experiment was established in 2008 on permanent, extensively grazed grassland (nutrient-poor *Lolium - Cynosuretum*) in the Solling Uplands near Silberborn. To obtain three different levels of species richness, namely the control (the untreated original sward (Co)), dicot reduced (Dic-) and monocot reduced (Mon-) sward, herbicides against dicots (Fluoroxypyr+Triclopyr 3 l ha<sup>-1</sup> + *Duplosan KV* (Mecoprop-P 3 l ha<sup>-1</sup>)) and monocots (*Select 240 EC* by Stähler (Clethodim 0.5 l ha<sup>-1</sup>)) were applied each on a third of the experimental plots. The three sward types received a combination of two different cutting regimes (cut once (1) or three times (3) per year) and two fertilisation levels (no fertilisation (x) or 180/30/100 kg ha<sup>-1</sup> NPK (NPK)). This resulted in twelve separate treatments. The experimental layout is a Latin square design with six replications.



For sward monitoring, the initial sward composition of June 2008 was compared with the manipulated swards (May and August 2009) by means of vegetation relevés with estimation of proportional yield for each species according to Klapp/Stählin (1936). The means of measured parameters and influence of treatments were compared by Kruskal-Wallis test, linear models and linear contrasts (R version 2.10.0). Visual correlations between variables of the ordination diagram (Canoco for Windows version 4.5) were tested for significance by linear regression and, in case of correlations between species and environmental variables, by T-value biplots ( $\alpha = 5\%$ ) implemented in Canoco. To take into account the spatial variability of the experimental area, the rows and columns of the Latin Square were included into the models as fixed effects. To obtain homoscedacity and normal distribution of the residuals, all data in % scale were arcsine transformed.

## Results and discussion

We managed to achieve a wide spread of several vegetation parameters among sward and management treatments. This variation was mainly due to the herbicide application (Table 1). On average, the species numbers in the swards ranged from 13 per 9 m<sup>2</sup> in the Dic- plots up to 17 in the Mon- plots, with all grass rich plots apart from Dic- 3 NPK having significantly ( $P < 0.05$ ) less species than the control sward (Co 1 x, data not shown). As for the evenness, highest values were found in plots of the Mon- treatments and both manipulated swards were significantly different from the control sward ( $P < 0.05$ , data not shown). These differences were due to the sward manipulation as well as fertilisation and cutting frequency (Table 1). The proportions of functional groups showed a broad range with grass contents in the sward ranging from 40% (Mon- plots) up to more than 90% (Dic- plots) and legume contents between 13 and 0%. Unlike the grass proportions, the legume contents were not only influenced by the sward treatment, but also by the utilisation ( $P < 0.05$ , data not shown).

Table 1. Influence of treatment factors on selected vegetation parameters in August 2009. ANOVA table including the proportion of variance explained by one factor, spatial effects and interactions between factors. For factor descriptions, please refer to text.

Factor	Species per 9 m <sup>2</sup>		Shannon-Evenness in % ( $H_{\max}/H_s \cdot 100$ )		% of grass in sward	
	%Var expl.	$P (>F)$	%Var expl.	$P (>F)$	%Var expl.	$P (>F)$
Row	3.28	0.06	1.05	0.512	0.38	0.583
Column	13.45	<0.001***	3.17	0.036*	0.03	0.81
Sward	46.92	<0.001***	43.7	<0.001***	96.84	<0.001***
Nutrients	5.35	0.059	9.9	0.006**	0.52	0.313
Utilisation	20.27	<0.001***	13.41	0.002**	0.59	0.285
Sward x Nutrients	1.97	0.263	1.66	0.264	0.41	0.447
Sward x Utilisation	0.19	0.875	12.35	<0.001***	0.17	0.714
Nutrients x Utilisation	2.5	0.193	1.37	0.292	0	0.952
Sward x Nutrients x Utilisation	4.63	0.048*	12.18	<0.001***	0.56	0.335

The main gradient explaining the variation within the vegetation originates in the different proportions of functional groups within the swards (Figure 1). Compared with the Co swards, it was most notably *Ranunculus repens*, *Rumex acetosa*, *Trifolium repens* and *Achillea millefolium* that increased significantly in yield proportions in the Mon- plots, mainly at the cost of *Agrostis capillaris*, *Dactylis glomerata* and *Poa pratensis* agg.. However, *Festuca rubra* did not show any preferences regarding the sward type, but was instead more common on all non-fertilised plots. This also applied to *Veronica chamaedrys*, which was scarce in the high, dense vegetation of the fertilised plots. Species richness and Shannon diversity were correlated with forb and legume contents. Evenness was largest in the low growing

unfertilised Co and Mon- plots that were cut three times. This was probably due to the better light climate as described by Hautier *et al.* (2009), which allowed smaller species like *Ranunculus repens* and *Trifolium repens* (significantly higher proportions in plots cut three times) or *Veronica chamaedrys* to gain more space.

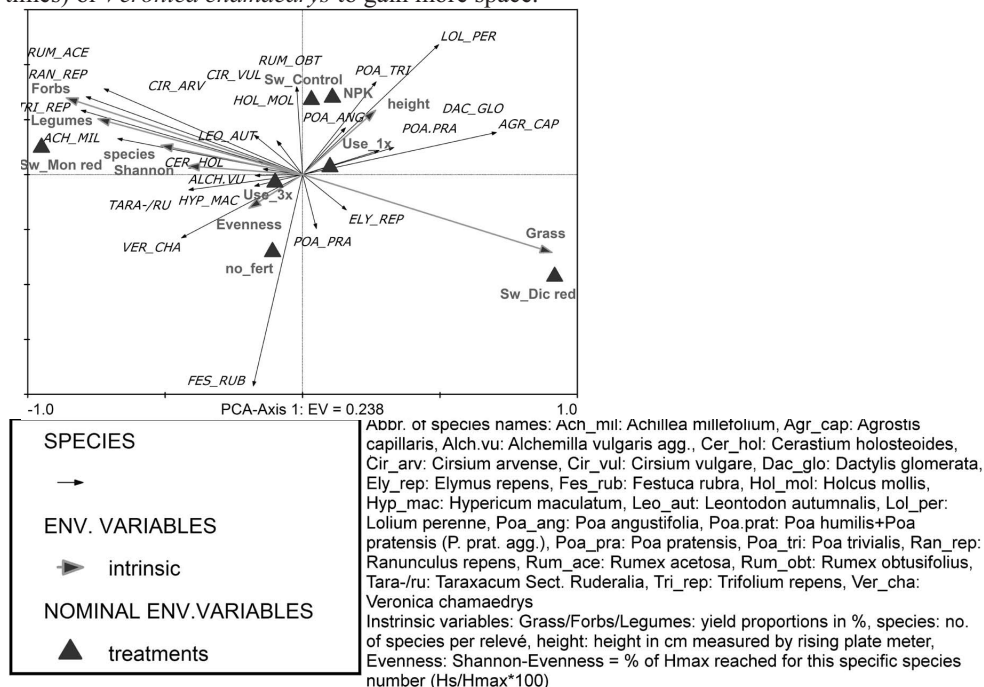

Figure 1. Ordination diagram based on partial PCA (log transformed; environmental influences (row, column, date) as covariables) with species, treatment and intrinsic variables, August 2009. Included are species with a fit of >2%. All treatments explain significant ( $P < 0.05$ ) conditional proportions of variance as analysed by Monte Carlo permutation tests.

The experimental factors increased the  $\beta$ -diversity (average standard deviation of species turnover given by DCA, data not shown) of the experimental area from 1.4 SD (June 2008) to 2.18 SD in August 2009.

### Conclusion

The application of herbicides is a useful tool for creating a broad variety of grass swards without completely disrupting the permanent grassland ecosystem. The effects, following spraying, of the high input of dead biomass on nutrient cycles still have to be analysed. Careful monitoring is required to control how long these different swards will last.

### References

Hautier Y., Niklaus P.A. and Hector A. (2009) Competition for light causes plant biodiversity loss after eutrophication. *Science* 324, 636-638.  
 Klapp E. and Stählin A. (1936) *Standorte, Pflanzengesellschaften und Leistung des Grünlandes*. Ulmer, Stuttgart. 122 pp.  
 Sanderson M.A., Skinner R.H., Barker D.J., Edwards G.R., Tracey B.F. and Wedin D.A. (2004) Plant species diversity and management of temperate forage and grazing land ecosystems. *Crop Science* 44, 1132-1144.

## Diversity and stability in experimental grassland communities

Picasso V.D.<sup>1</sup>, Brummer E.C.<sup>2</sup> and Liebman M.<sup>3</sup>

<sup>1</sup>*Facultad de Agronomía, Univ. de la República, Garzón 780, Montevideo, Uruguay*

<sup>2</sup>*Dep. of Crop and Soil Sciences, Univ. of Georgia, Athens, GA, 30602, USA*

<sup>3</sup>*Dep. of Agronomy, Iowa State Univ., Ames, IA, 50011, USA*

Corresponding author: vpicasso@gmail.com

### Abstract

The relationship between diversity and stability in grasslands is an historical issue of debate in ecology. Here we build on plant breeding concepts of crop yield stability to test the hypotheses that multi-species grasslands were more stable across environments than monocultures, and that stability increased linearly with species richness. We assembled eight perennial grassland species in fifty different experimental communities ('entries') ranging from monocultures to six-species mixtures, in a randomised complete block design with three replications per entry, at two locations in Iowa, USA. We split the plots into two harvest management systems, and collected total biomass yield data over three years. Each of the twelve combinations of location, harvest management, and year was defined as a unique 'environment'. The mean yield of all entries in each environment was defined as the environment mean. For each entry, the means of the three replications in each environment were regressed against the environment means. Entries with four and six species were more stable across environments than the highest yielding monoculture measured as deviations of the regression. Consistency (yields parallel to the environment potential) and reliability (deviation from the expected yield) increased linearly with species richness.

Keywords: Regression, environment, constancy, consistency, reliability, variability

### Introduction

Stability is a main goal in grasslands managed for productivity and ecosystem services. A long standing issue in ecology is the debate about the relationship between diversity and stability (McCann, 2000). Stability has many dimensions that are not necessarily correlated: variability of production, resistance to perturbation, resilience, and robustness, among others (Loreau *et al.*, 2001). In this paper, we use the plant breeding concept of yield stability over a range of environments (Finlay and Wilkinson, 1963; Bernardo, 2002), and define constancy, consistency, and reliability as three relevant dimensions of yield stability across environments. We test the hypotheses that multi species grasslands were more stable than monocultures, and that stability increased linearly with species richness in this experiment.

### Materials and methods

Fifty plant communities (i.e., 'entries') were assembled from seeds of eight perennial grassland species: *Medicago sativa* L., *Trifolium repens* L., *Desmanthus illinoensis* (Michx.) MacM. ex B.L. Robins. & Fern., *Dactylis glomerata* L., *Thinopyrum intermedium* (Host) Barkworth & D.R. Dewey, *Panicum virgatum* L., *Tripsacum dactyloides* (L.) L. and *Helianthus maximiliani* Schrad. A replacement design was used, where all monocultures were included, as well as mixtures with varying richness: nineteen entries of two species, thirteen entries of three species, seven entries of four species, and six entries of three species (for the complete list see Picasso *et al.*, 2008). Seeding density of each species was reduced proportionately to the number of species in each plot. Each entry was replicated three times in a randomised complete blocks design at two locations in Iowa, USA. Seeds were drilled into

4 m by 3 m plots and each plot was split in half to sub-plots that were allocated to either a multiple (two to three times per year) or a single (late autumn) machine harvest management system during three years. Relative abundance of species was measured by clipping two 0.09 m<sup>2</sup> quadrats per plot. Yield refers to biomass of seeded species without weeds.

For stability analyses, we followed the plant breeding concepts of yield stability over a range of environments (Finlay and Wilkinson, 1963) which is novel in ecological literature. Each of the twelve combinations of location, harvest management, and year was defined as a unique ‘environment’. The mean yield across all entries in each environment was defined as the ‘environment mean’. For each entry, the means of the three replications in each environment were regressed against the environment means. Linear regression coefficients ( $b_I$ ) and root mean squared errors of the regression (RMSE) were calculated for each entry. The  $b_I$  represented the amount of yield change along the environmental gradient and RMSE represented the variability of yields and the fit to the linear model. Three stability dimensions were considered (modified from Bernardo, 2002): ‘constancy’ (type I) occurs when  $b_I = 0$ , thus yields are the same in all environments; ‘consistency’ (type II) occurs when  $b_I = 1$ , thus yields are parallel to the mean of the environments; and ‘reliability’ (type III) occurs with lower RMSE. To test the hypotheses that  $b_I = 0$  (constancy) and  $b_I = 1$  (consistency), confidence intervals were constructed with alpha = 0.05 for each entry. We defined a measure for consistency:  $ST_{II} = |b_I - 1|$ , where lower values of  $ST_{II}$  indicate higher consistency. To test the hypotheses that consistency and reliability increased with richness, the means of  $ST_{II}$  and RMSE across richness levels were regressed against species richness.

## Results and discussion

Monocultures and mixtures showed a wide range of  $b_I$  and RMSE (Figure 1 shows four examples). *M. sativa* monoculture had the highest  $b_I$  ( $2.4 \pm 1.3$ ), which was greater than one ( $P < 0.1$ ), and this monoculture had yields above average in high productivity environments.

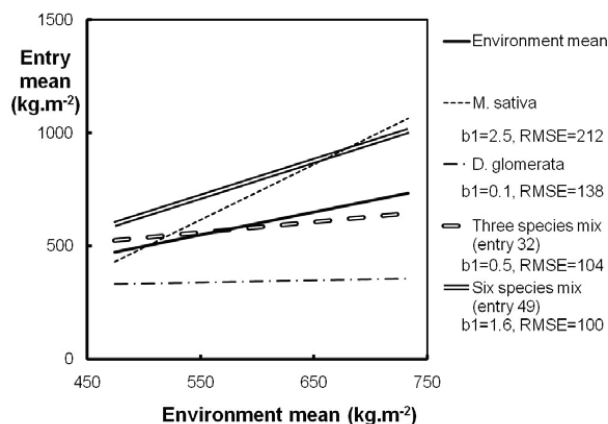

Figure 1. Linear regressions of the entry means by environment against the environment means for two monocultures (*M. sativa* and *D. glomerata*) and two mixtures (three species mix of *T. repens* - *D. glomerata* - *T. intermedium*, and six species mix of *M. sativa* - *T. repens* - *D. glomerata* - *T. intermedium* - *P. virgatum* - *T. dactyloides*). Linear coefficients ( $b_I$ ) and RMSE are shown.

Monocultures (e.g., *D. glomerata*) and mixtures with  $b_I = 0$  had, in general, low yields across environments. Therefore, constancy (type I stability, or lack of variability in yields) was

associated with low yields, and therefore it is not a desirable stability criteria for agricultural situations. *T. intermedium*, among other entries, had  $b_I$  not different from one, indicating that these entries had yields parallel to the environment mean (high consistency).

All mixtures with four and six species had higher reliability (type III stability) than the two highest yielding monocultures (*M. sativa* and *T. intermedium*). The regressions of  $ST_{II}$  and RMSE vs. richness were significant at  $P < 0.05$ , had negative slopes, and high  $R^2$  values (Figure 2), so consistency and reliability increased linearly with species richness in our experiment.

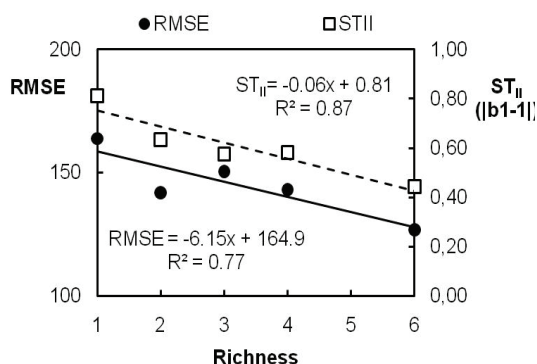

Figure 2. Regressions for mean values (across richness levels) of consistency ( $ST_{II}$ , dotted line) and reliability (RMSE, solid line) vs. species richness. Equations and  $R^2$  are shown.

## Conclusions

Consistency (yields parallel to the environment potential) and reliability (deviation from the expected yield) are useful dimensions of stability for productive situations, and were positively and linearly correlated with species richness in our experiment. This regression approach may enhance the interpretation of other biodiversity experiments across environments.

## Acknowledgements

Funding from Iowa State University, Fulbright Commission, NCR-SARE, and The Land Institute, KS. We thank Dr. Wrage and two anonymous reviewers for helpful comments on this manuscript.

## References

- Bernardo R. (2002) *Breeding for quantitative traits in plants*. - Stemma Press.
- McCann K.S. (2000) The diversity-stability debate. *Nature* 405, 228-233.
- Loreau M., Downing A., Emmerson M., Gonzalez A., Hughes J., Inchausti P., Joshi J., Norberg J., and Sala O. (2001) A new look at the relationship between diversity and stability. In: Loreau M., Naeem S. and Inchausti P. (eds.) *Biodiversity and Ecosystem Function. Synthesis and Perspectives*. Oxford. pp. 79-91.
- Finlay K. and Wilkinson G. (1963) The analysis of adaptation in a plant-breeding programme. *Australian Journal of Agricultural Research* 14, 742-754.
- Picasso V., Brummer E.C., Liebman M., Dixon P.M., Wilsey B.J. (2008) Crop species diversity affects productivity and weed suppression in perennial polycultures under two management strategies. *Crop Science* 48, 331-342.

# <sup>15</sup>Nitrogen uptake from shallow- versus deep-rooted plants in multi-species and monoculture grassland

Pirhofer-Walzl K.<sup>1</sup>, Høgh-Jensen H.<sup>2</sup>, Rasmussen J.<sup>3</sup>, Rasmussen J.<sup>1</sup>, Søegaard K.<sup>3</sup> and Eriksen J.<sup>3</sup>

<sup>1</sup>*Department of Agriculture and Ecology, Faculty of Life Sciences, University of Copenhagen, Højbakkegaard Allé 9, 2630 Taastrup, Denmark*

<sup>2</sup>*National Environmental Research Institute, Department of Policy Analysis, Aarhus University, Frederiksborgvej 399, 4000 Roskilde, Denmark*

<sup>3</sup>*Department of Agroecology and Environment, Research Centre Foulum, Aarhus University, Blichers Allé, 8830 Tjele, Denmark*

Corresponding author: kpw@life.ku.dk

## Abstract

Only a few studies have explored the importance of functional diversity in temperate agricultural grasslands in relation to nitrogen (N) uptake. This study investigates the consequence of growing deep-rooted plants together with grass-clover mixtures in terms of N uptake efficiency from deep soil layers. The objective was to compare the N uptake of the shallow-rooted grassland species *Lolium perenne* and *Trifolium repens*; and the deep-rooted species *Cichorium intybus* and *Medicago sativa* in monocultures and mixtures. We hypothesized that growing deep-rooted plant species in mixture with shallow-rooted species increases the N uptake from deep soil layers partly through competition. A <sup>15</sup>N tracer study was carried out with <sup>15</sup>N enriched ammonium sulphate placed at three different soil depths (40, 80 and 120 cm). To recover <sup>15</sup>N, above-ground plant biomass was harvested after 10 days. We described the decline of <sup>15</sup>N uptake with depth by using an exponential decay function. The studied plant communities showed the same relative decline in <sup>15</sup>N uptake by increasing soil depths, but different capacities in total <sup>15</sup>N uptake. Monoculture *L. perenne* foraged less <sup>15</sup>N at all depths compared to the other four plant communities. The relative <sup>15</sup>N uptake of individual plant species grown in mixture decreased more strongly with depth than in monoculture. Thus, both findings rejected our hypothesis.

Keywords: plant diversity, *Lolium perenne*, *Trifolium repens*, *Cichorium intybus*, *Medicago sativa*

## Introduction

Perennial grassland systems are widely managed as grass monocultures or two-species mixtures in temperate climates, where grass monocultures especially require high nitrogen inputs. In a number of studies grassland diversity has been examined in terms of nitrogen supply from legumes. Less well examined has been plant diversity in perennial grassland based on different root depths. Multi-species grasslands with plants differing in the rooting system could increase the nitrogen-use efficiency of the whole plant community by complementary nutrient uptake. In this field experiment, we investigated the importance of functional diversity in relation to active rooting depth by measuring the N uptake at different depths (40, 80 and 120 cm). The N uptake of the shallow-rooted *Lolium perenne* (perennial ryegrass) and *Trifolium repens* (white clover) and the deep-rooted *Cichorium intybus* (chicory) and *Medicago sativa* (lucerne) was compared in monocultures and mixtures. We hypothesized that the N uptake from deep soil layers could increase by growing deep-rooted species in mixture with shallow-rooted species and that competition increases the N uptake from deep soil layers in multi-species mixtures.



## Materials and methods

Five grassland plant communities were grown in four replicated plots at the Research Farm of Copenhagen University in Denmark from September 2007 to October 2009 (Table 1). The plots were cut four times in both growing seasons, when dry matter yield and botanical composition were determined. On 8 June 2009, 25 days after the first cut, ammonium sulphate, enriched with the heavy nitrogen isotope  $^{15}\text{N}$  (99.5 atom %), was placed at depths of 40, 80 and 120 cm ( $156.25 \text{ mg m}^{-2} \text{ }^{15}\text{N}$ ). A tracer application as solution and in five evenly distributed holes facilitated an even spreading of the tracer. Measured  $^{15}\text{N}$  enrichments in the above-ground plant biomass were corrected for background  $^{15}\text{N}$  levels from untreated plant communities next to the treated plots and normalized for the respective above-ground plant biomass to finally receive the amount of  $^{15}\text{N}$  taken up ( $\text{mg m}^{-2}$ ). Regression analysis was used to analyse how  $^{15}\text{N}$  uptake was influenced by depth in different plant communities and how competition influenced the relative decline of  $^{15}\text{N}$  uptake by depth.

## Results and discussion

All plant communities showed relatively high productivity on the 2<sup>nd</sup> cut in 2009, shortly after the  $^{15}\text{N}$  placement study was conducted. The botanical composition was similar for individual plant species in the mixtures at the 1<sup>st</sup> and 2<sup>nd</sup> cut 2009, respectively (Table 1).

Table 1. Plant community, mean yield and mean botanical composition in 2009. Values are means  $\pm$  SE. Different lowercase letters show significant difference determined by Tukey HSD test at  $P=0.05$ .

Plant community	Dry matter yield ( $\text{kg ha}^{-1}$ )				Botanical composition (% of dry matter)			
	1 <sup>st</sup>	2 <sup>nd</sup>	3 <sup>rd</sup>	4 <sup>th</sup>	1 <sup>st</sup>	2 <sup>nd</sup>	3 <sup>rd</sup>	4 <sup>th</sup>
<i>L. perenne</i>	600 <sup>a</sup>	1038 <sup>a</sup>	197 <sup>a</sup>	103 <sup>a</sup>				
<i>C. intybus</i>	1975 <sup>bd</sup>	2810 <sup>b</sup>	1397 <sup>bd</sup>	1231 <sup>b</sup>				
<i>M. sativa</i>	3998 <sup>c</sup>	3510 <sup>c</sup>	2960 <sup>c</sup>	2510 <sup>c</sup>				
<i>T. repens</i>					47.9	53.8	68.1	57.9
<i>L. perenne</i>	1762 <sup>d</sup>	3452 <sup>c</sup>	862 <sup>ab</sup>	741 <sup>b</sup>	52.1	46.2	31.9	42.1
<i>M. sativa</i>					22.1	23.0	53.6	61.1
<i>C. intybus</i>	2367 <sup>bd</sup>	3575 <sup>c</sup>	2121 <sup>ed</sup>	2050 <sup>c</sup>	33.0	38.5	34.4	30.3
<i>T. repens</i>					23.1	23.9	8.6	5.6
<i>L. perenne</i>					21.8	14.6	3.5	3.1

Ten days after  $^{15}\text{N}$  placement, a general  $^{15}\text{N}$  recovery between 0.004 and 1.107% was measured, which lies in the lower range compared with other studies (Kristensen and Thorup-Kristensen 2004; Felten *et al.*, 2009). All plant communities (Table 1) showed the same relative decline in  $^{15}\text{N}$  uptake with increasing soil depth ( $P=0.353$ ; Fig 1a) and there was no significant difference in total  $^{15}\text{N}$  uptake among plant communities, except that monoculture *L. perenne* showed lower  $^{15}\text{N}$  uptake than the rest. Thus, there was no indication of increased N uptake from deep soil layers in plant communities including deep-rooted species. The observed means of  $^{15}\text{N}$  uptake in the four-species and two-species plant community appeared to be higher in 40 cm depth than in the monocultures, but the difference was not significant ( $P>0.05$ ). The two legumes, *M. sativa* and *T. repens*, could have influenced the N cycle in the plant communities, enhancing the growth of both the legumes and non-legumes (Rasmussen *et al.*, 2007). Felten *et al.* (2009) concluded from a field experiment on natural grassland that a high soil N pool in communities including legumes can make it unnecessary for deep-rooted plant species to explore N resources in deeper soil layers. The slopes of the exponential decay functions were used to compare the  $^{15}\text{N}$  uptake with increasing depth of individual plant species grown in monoculture or in a four-species mixture. The N uptake decreased relatively



stronger when plant species were grown in mixtures compared to monocultures ( $P < 0.0001$ , Fig 1b).

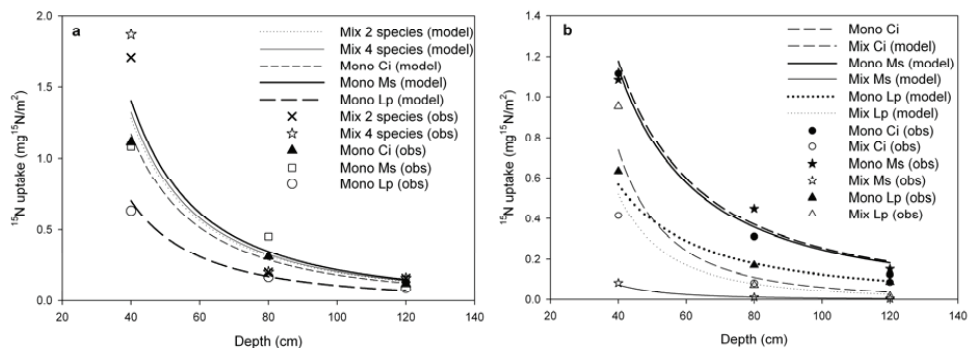

Fig 1. Observed values and predicted curves from regression analysis describing the  $^{15}\text{N}$  uptake in above-ground plant tissue 10 days after  $^{15}\text{N}$  placement relative to: a) depth and plant communities, and b) depth and whether plant species were grown in mono- or mixed plant communities. Mono= Monoculture, Mix= Mixture, Lp= *L. perenne*, Ms= *M. sativa*, Ci=*C. intybus*, obs= observed values and model= predicted curve.

When competing in the mixture, the deep-rooted *M. sativa* could forage nitrogen in deep soil layers, but instead, our finding indicates that *M. sativa* invests in atmospheric nitrogen fixation. Furthermore, the legumes in the mixtures could have donated atmospheric nitrogen to neighbouring plants (Rasmussen *et al.*, 2007) and thus, measurements of  $^{15}\text{N}$  uptake in plant communities with legumes could have been biased. N uptake from deep soil layers can also change throughout the growing season, as Veresoglou and Fitter (1984) showed on five co-existing grasses. Additional studies at different periods in the growing season can give a more detailed picture on the N uptake from deep soil layers throughout the growing season.

## Conclusion

During a single period of 10 days, it was not possible to show an increase in N uptake by increasing depth when growing deep-rooted species (*M. sativa* and *C. intybus*) in mixture with shallow-rooted species (*T. repens* and *L. perenne*), and there was no increase in N uptake from deep soil layers when plant species were grown in a competitive multi-species mixture. The study could not support the hypothesis that the deep-rooted species, *M. sativa* and *C. intybus* are relatively more efficient in N uptake in deep soil layers and that they add a new 'deepness' function to communities with shallow roots.

## References

- Felten von S., Hector A., Buchmann N., Niklaus P.A., Schmid B. and Scherer-Lorenzen M. (2009) Belowground nitrogen partitioning in experimental grassland plant communities of varying species richness. *Ecology* 90, 5, 1389–1399.
- Kristensen H.L. and Thorup-Kristensen K. (2004) Uptake of  $^{15}\text{N}$  labeled nitrate by root systems of sweet corn, carrot and white cabbage from 0.2–2.5 meters depth. *Plant and Soil* 265, 93–100.
- Rasmussen J., Eriksen J., Jensen E. S., Esbensen K. H. and Høgh-Jensen H. (2007) In situ carbon and nitrogen dynamics in ryegrass-clover mixtures: Transfers, deposition and leaching. *Soil Biology and Biochemistry* 39, 804–815.
- Veresoglou D.S. and Fitter H. (1984) Spatial and temporal pattern of growth and nutrient uptake of five co-existing grasses. *Journal of Ecology* 72, 259–272.

# Use of species number, Shannon index and Sorensen index for the evaluation of biodiversity in different types of pasture

Pornaro C., Munari N. and Ziliotto U.

*Dipartimento di Agronomia Ambientale e Produzioni Vegetali, Università degli Studi di Padova, Campus di Agripolis, Viale dell'Università 16, 35020 Legnaro (Padova), Italy*

Corresponding author: cristina.pornaro@unipd.it

## Abstract

Many of the indices that are normally used to analyse biodiversity are based only on the number of species present in the plant communities. However, they are very often not useful for studying how the community as a whole evolves. In this paper, two of these indices (species number and Shannon index) are compared with a qualitative analysis obtained with the matrix of the Sorensen index. The evaluation was conducted on two pastures in different stages of succession. The first type showed three levels of vegetation change, from pasture to complete re-colonisation by the adjacent woodland; the second was characterised by a gradual evolution of *Nardus stricta* grassland. During 2009, a floral survey was done on twenty-six plots, in both locations. The results of these surveys were used to calculate the number of species present, the Shannon index and Sorensen index. Because of the high plant community complexity, the species number and Shannon index were inadequate for a full understanding of the pasture ecosystem. At the first location, the qualitative analysis confirmed the discontinuity of the succession. In the second, the percentage of degradation with the biodiversity was highlighted, which pointed out qualitative variations in the composition.

Keywords: specific biodiversity, Shannon Index, Sorensen Index, ecosystem biodiversity.

## Introduction

Grasslands are useful for the conservation of biodiversity and they also play an important role in the overall protection of the environment (Starczewski *et al.*, 2009). Quantification of the specific biodiversity is given by the number of species that compose the individual plant communities, but this does not account for the relationship between species within these communities (Peet, 1974). Therefore, although this number allows a comparison to be made between particular botanical situations that have evolved over time or in space, it is unable to point out differences in the composition of plant communities (Botta-Dukát, 2005). In order to make these evaluations, two specific aspects of the plant communities have to be known: the number of species and the relationship between the individuals that represent these species (Shannon index). The aim of this study was to analyse the usefulness and role of three indices (species number, Shannon index and Sorensen index matrix) in the development of the evolution of biodiversity in different forage plant communities.

## Materials and methods

Two survey areas with different stages of pasture succession were chosen for the study. In the first location, Prà della Casara (Trento, NE Italy), the pasture had been partially re-colonised by woodland, with three stages being easily identifiable: pasture without any trees (group P), pasture with *Larix decidua* trees (group PA) and an area completely reforested by *Larix decidua* and *Picea abies* (group B). The other location on the Asiago Upland (Vicenza, NE Italy), a mountain grassland, presented a gradual evolution towards pasture dominated by *Nardus stricta* L. During 2009, twenty-six plots of 100 m<sup>2</sup> were selected in each location, in

which the species and their percentage cover (method proposed by Braun-Blanquet) were recorded. The results were used to calculate the species richness (S), the Shannon index (ShI; Peet, 1974), and Sorensen similarity index (SoI; Sorensen, 1948) of all the combinations between the surveys for the construction of an index matrix. The statistical analysis was performed with ANOVA and comparison of means with the SNK test.

## Results and discussion

For the first location (Figure 1), different results were expected for each of the three situations. In general, S ranged from 4 to 36 species, but the averages of the surveys were 27, 24 and 11 for groups P, PA and B, respectively. A comparison between these means pointed out that there were only significant differences ( $P<0.01$ ) between groups P and PA, on the one side, and group B on the other. Instead, the values of ShI highlighted significant differences ( $P<0.01$ ) between the mean values of all three groups: the average of group P was 2.69, that of group PA 1.93 and group B 1.09. At the second location, the values of S and ShI decreased with a rectilinear trend with the increase in the *N. stricta* cover value ( $P<0.01$ ,  $R^2=0.61$  and  $R^2=0.74$ , respectively). In particular, passing from the *N. stricta* cover of 10% in sample 1 to that of 90% in sample 26, the value of S diminished by 60% (passing from 55 to 22), and that of ShI by 59% (from 3.9 to 1.6). The surveyed plots in this pasture were also subdivided into three groups utilising the SoI matrix. The first of these groups was formed by surveys with a low *N. stricta* cover (group L: cover  $<50\%$ ); the second by those with average cover (group M: cover from 50 to 80%) and the third by those with dense cover (group H: cover  $>80\%$ ). Regarding these groups (Figure 2), the average number of species present in the various surveys was 51 in group L, 36 in group M and 24 in group H, with significant differences between these averages ( $P<0.05$ ). The average value of ShI was 3.42, 2.66 and 1.64 for groups L, M and H, respectively and the differences between the averages of the three groups were highly significant ( $P<0.01$ ). The analysis of the matrix of the SoI for the two studied locations pointed out very distinct differences between them (Figure 3). In the first location, in the presence of the three very different situations there was, as expected, a clear subdivision into three groups. In the second location, although the subdivision between groups was not as clear, two levels of changes of SoI could be identified that were most probably linked to the changes in the botanical composition of the pasture and, in particular, to the variation in the cover of *N. stricta*. In addition, a comparison between the averages of SoI of the three groups performed with SNK demonstrated significant differences ( $P<0.05$ ) between them.

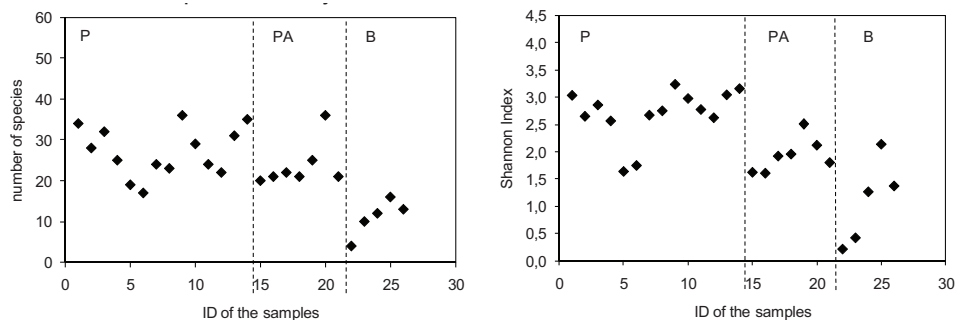

Figure 1: Specific biodiversity (left) and heterogeneity index (right) trends for site Prà della Casara. Group P: pasture without any trees; group PA: pasture with *Larix decidua* trees; group B: area reforested by *Larix decidua* and *Picea abies*.

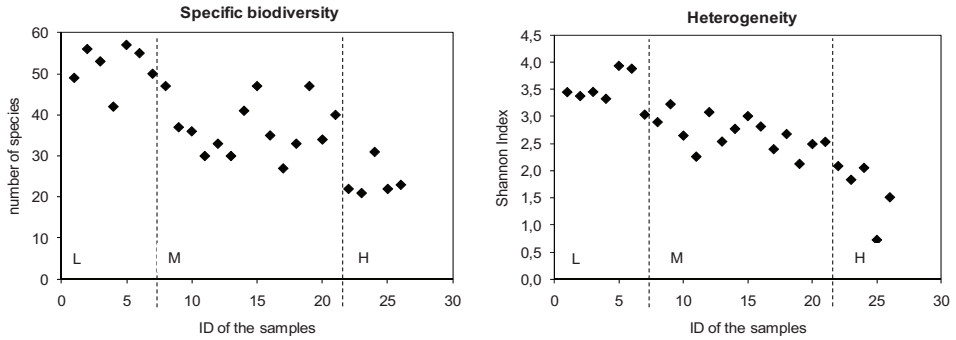

Figure 2. Specific biodiversity (left) and heterogeneity index (right) trends for site Malga Longara. Cover of *N. stricta*: group L <50%; group M 50 to 80%; group H >80%.

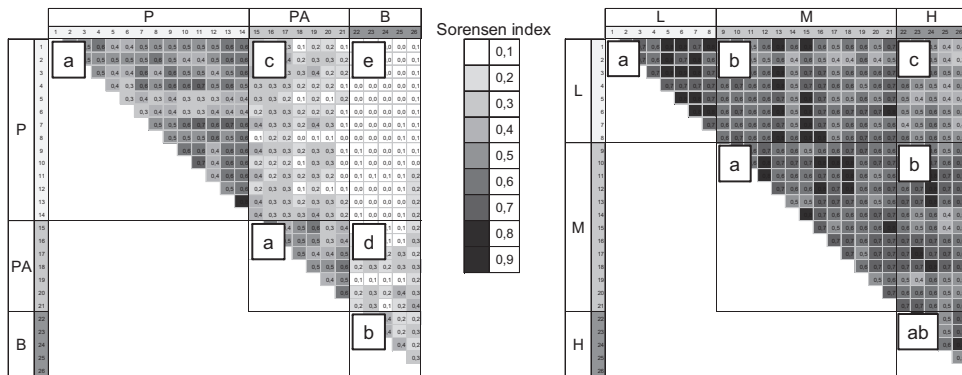

Figure 3. Sorensen index matrix for the locations Prà della Casara, left, and Malga Longara, right. The greyscale shows degree of similarity and underlines Sorensen index value in the matrices. The axes show the ID numbers. Different letters indicate significant differences between groups (SNK test).

## Conclusions

The number of species present in the individual stages of succession of forage plant communities was not always useful for differentiating between these stages. On the contrary, the values of the Shannon index were particularly useful in differentiating among various successional stages in both situations examined. Lastly, the Sorensen index was very effective in distinguishing the successional stages when they clearly differed, but not when the change was gradual. It therefore seems that for a complete analysis of succession it would be useful to evaluate the results of all three indices simultaneously.

## References

- Botta-Dukát Z. (2005) Rao's quadratic entropy as a measure of functional diversity based on multiple traits. *Journal of Vegetation Science* 16, 533-540
- Peet R.K. (1974) The measurement of species diversity. *Annual review of Ecology and Systematics* 5, 285-307.
- Sorensen T. (1948) A method of establishing groups of equal amplitude in plant sociology based on similarity of species content and its application to analyses of the vegetation. *K. Dan. Vidensk. Selsk. Biol. Skr.* 5, 1-34
- Starczewski K., Affek-Starczewska A. and Jankowski K. (2009) Non-marketable functions of grasslands. In: Cagas B., Machac R. and Nedelnik J (Eds) *Grassland Science in Europe* 14, 37-45 (15<sup>th</sup> European Grassland Federation Symposium 2009, Czech Republic).

# Influence of afforestation on forage value and plant diversity in the Mediterranean

Susan F., Pornaro C., Migliorini S. and Ziliotto U.

*Dipartimento di Agronomia Ambientale e Produzioni Vegetali, Università degli Studi di Padova, Campus di Agripolis, Viale dell'Università 16, 35020 Legnaro (Padova), Italy*

Corresponding author: cristina.pornaro@unipd.it

## Abstract

In this study, we examined the influence of afforestation on diversity and forage value of herbal layer in comparison with neighbouring grassland sites. Nine woods differing in plantation year (1992, 2000 and 2004, respectively) were studied in Caorle, NE Italy, in order to evaluate the temporal development of the herbaceous component. Botanical surveys of herbaceous species were performed both inside each wood and in neighbouring grassland areas that were cut regularly 2-3 times per year. The results indicated a general decrease in species numbers passing from recently established (1 to 3 years old) to older woods, that were characterised by 60-70% and 30-40% of arboreal and shrubby cover values, respectively; at the same time, the forage value remained relatively constant. In contrast, on the grassland sites the total number of species was maintained or increased, at the same time improving the grassland forage value. The forage quality results showed that in the first years after wood constitution, the qualitative characteristics of herbaceous components were almost similar in both situations; in the following years, however, the phytomass from grassland strips was characterised by higher quality compared to the herb layer of the woods.

Keywords: grassland strips, environmental restoration, hydrophilic woods, specific biodiversity, forage value, forage quality.

## Introduction

For several years, the Common Agricultural Policy (CAP) has been promoting the creation of hedges and woods, especially in intensively cultivated areas, where significant environmental impacts are mostly expected. These interventions can fulfil several important functions connected to environment and landscape management, for instance the conservation of specific biodiversity (Starczewski *et al.*, 2009) and the protection and feeding of wild fauna. The aims of this work were to study how, in the first stages of development, woods created in intensively cultivated areas may affect flora biodiversity and its forage value. Moreover, we wanted to evaluate if these two aspects may be improved by the association with grassland strips located outside the woods. Therefore, herbaceous and arboreal components of three hydrophilic woods differing in age were analysed together with regularly cut herbaceous strips located outside the woods.

## Materials and methods

The present work was carried out in the Vallevicchia Agricultural Farm (municipality of Caorle, Venice Province, NE of Italy) along the island in the Adriatic Sea (45°37'33"N, 12°56'39"E). The average altitude is about 0 m a.s.l. The study area, which is 900 hectares wide, is characterised by an annual average temperature of 12.6 °C and a mean annual rainfall of 854 mm, distributed following a sub-equinoctial course.

The study site was initially characterised by the presence of marshy soils, in connection with agricultural but unproductive areas, and it was subjected to remediation during the 1950s. In

the last decades, Vallevecchia Farm was acquired by Region of Veneto, and is now maintained by Veneto Agricoltura. In addition, in the last twenty years in Vallevecchia farm many restoration interventions have been realised, with the constitution of humid areas, phytodepuration basins and the plantation of hedges and hydrophilic woods. Woods have been created in different years and, in particular, during 1992 (14 ha), 2000 (35 ha) and 2004 (15 ha). In all cases native species were used, such as *Alnus glutinosa*, *Fraxinus angustifolia*, *Populus alba*, *Quercus pedunculata*, *Acer campestre* and *Quercus ilex*. In all cases, planting interventions were carried out in three different sites of the farm, planting each seedling 2 m apart from the others, along parallel and sinusoidal lines, with 3.5 m of offset distance. During 2005 and 2007, per wood of different age, three sample areas were selected (9 sample areas as a whole), so that they were as far as possible one from the other. Beside this, three neighbouring grassland surfaces were chosen for each plantation, with each strip subjected to 2-3 cuts per year; grasslands surfaces were of the same age as the woods and were re-colonised by spontaneous species. In all 18 sites, 3 sample plots of 100 m<sup>2</sup> were selected and localised with GPS in each year. The cover estimation of vascular plants was performed during the climatically critical season (summer) following the Braun-Blanquet approach (Westhoff and Van der Maarel, 1978). According to this method, all species and their relative abundance values expressed in per cent were recorded. Besides, total arboreal and shrubby cover values were estimated. Number of species was analysed in each plot in order to describe specific biodiversity. The forage value was calculated on the basis of Stahlin (1970) and Klapp (1971) forage indices. In each plot, a phytomass survey was realised in the herbaceous layer. In each survey, the following steps were followed: 1) visual estimation of bare ground; 2) cutting of the herbaceous phytomass in a sub-plot of 50 cm<sup>2</sup>; 3) weighing of the collected phytomass; 4) conservation of a phytomass sample characterised by a weight of about 0.5 kg. All samples were firstly dried in order to calculate dry matter (DM); subsequently, dry matter crude protein (CP, Kjeldahl method), neutral detergent fibre (NDF) and acid detergent fibre (ADF) were measured. All datasets were subjected to one-way analysis of variance (ANOVA).

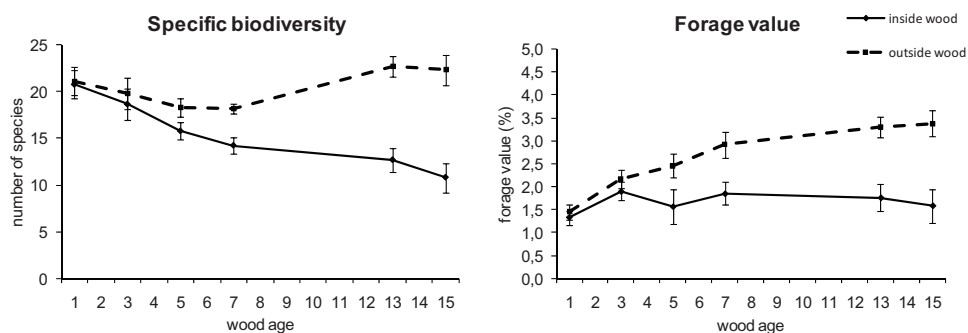

Figure 1. Specific biodiversity (i.e. number of species) and forage values measured inside (solid line) and outside (dotted line) woods. Bars indicate standard errors.

## Results and discussion

The results concerning wood cover values underlined an increase of shrubby species, passing from zero to 30-40% cover values in the first fifteen years after plantation. A similar trend was observed also in the case of arboreal species that moved from zero to 60-70% cover values, leading, at the end of the period, to a complete wood covering of the study area.

When the number of species was considered, a different trend was observed inside and outside the wood areas, respectively (Figure 1). It was possible to notice an annual

progressive reduction of specific biodiversity inside the wood area, so that after 15 years the total biodiversity amounted to 50% of the initial values; outside the wood areas, instead, specific biodiversity initially decreased, but then it progressively increased so that after 15 years it was almost twice that inside the wood areas. Forage value (FV) of the herbaceous layer of wood slightly increased, passing from the time of transplanting to 5-7 year-old woods; subsequently, considering 15-year-old woods, FV values remain rather stable. For herbaceous strips placed outside the wood area, FV increased gradually with time.

When forage quality was considered (Table 1), it was observed that in the first years after wood establishment, differences between arboreal sites and neighbouring grasslands were not significant. When oldest situations were analysed, the forage quality of grasslands strips was significantly ( $P<0.05$ ) higher than wood samples.

Table 1. Evolution of forage values inside and outside wood, measured during summer. Mean and standard error of 9 replicate samples; abbreviations see text.

wood age	Inside wood					
	1	3	5	7	13	15
Herbaceous cover (%)	58.33±2.04	70.56±2.69	74.89±6.70	69.44±7.33	56.11±9.08	43.00±7.17
DM (Mg ha <sup>-1</sup> )	0.80±0.14	0.82±0.02	0.94±0.17	0.78±0.17	0.72±0.27	0.64±0.14
CP (%)	13.40±1.22	12.80±0.61	8.80±0.43	9.60±0.51	8.99±0.46	8.21±0.44
NDF (%)	50.12±2.83	46.00±3.21	62.00±2.52	63.00±1.90	69.75±0.96	67.50±1.69
ADF (%)	32.93±1.51	29.90±1.01	39.30±0.87	40.30±0.88	42.31±0.78	39.50±0.54
wood age	Outside wood					
	1	3	5	7	13	15
Herbaceous cover (%)	56.00±2.06	73.50±2.57	85.00±2.82	93.89±2.17	90.00±3.06	87.78±2.65
DM (Mg ha <sup>-1</sup> )	0.80±0.14	0.87±0.03	1.14±0.15	1.21±0.15	1.41±0.21	1.35±0.17
CP (%)	14.06±1.32	13.95±0.71	10.54±0.67	11.90±0.32	12.67±1.57	13.05±0.52
NDF (%)	48.85±3.06	48.19±3.32	56.00±2.95	51.56±3.06	55.00±2.07	54.78±3.71
ADF (%)	31.45±1.30	28.31±1.01	36.94±1.16	35.00±1.76	33.50±2.35	33.15±1.25

## Conclusions

During the first 13-15 years of development of hydrophilic woods, the herbaceous component undergoes a reduction of the number of species, accompanied by the decrease or the maintaining of forage value. In contrast, the analysis performed on the grassland external areas indicated an increase in specific biodiversity, together with a clear improvement in forage value. In addition, inside wood sites, forage yield values gradually decreased compared with that of the grassland plots, together with a worsening in forage quality. In conclusion, it is advisable, when recovery interventions with hedges and woods are planned, to realise also herbaceous and regularly managed strips in the surrounding areas, in order to assess the improving of the site-specific biodiversity. Also, this resulted in a useful tool to provide higher yield values and forage quality that can be exploited by wild local fauna that takes shelter in these restoration interventions.

## References

- Klapp E. (1971) *Wiesen und Weiden*. 4. Auflage. Verlag Paul Parey, Berlin und Hamburg, 620 pp.
- Stählin A. (1970) *Gütezahlen von Pflanzenarten in frischem Grundfutter*. DLG Verlag, Frankfurt.
- Starczewski K., Affek-Starczewska A. and Jankowski K. (2009) Non-marketable functions of grasslands. In: Cagas B., Machac R. and Nedelnik J (eds.) *Grassland Science in Europe 14*, 37-45 (15<sup>th</sup> European Grassland Federation Symposium 2009, Czech Republic).
- Westhoff V. and Van der Maarel E. (1978) The Braun-Blanquet approach. In: Whittaker R.H. (ed.) *Classification of plant communities*. The Hague, Junk, pp. 124-399.



# Changes in biodiversity composition and soil nutrient content with management in a Pyrenean grassland community

Ribas A.<sup>1,2</sup>, Llurba R.<sup>1</sup>, Ventura D.<sup>1</sup>, Hodge A.<sup>3</sup> and Sebastià M.-T.<sup>1,4</sup>

<sup>1</sup> Centre Tecnològic Forestal de Catalunya, Cra. de Sant Llorenç km 2, 25280 Solsona

<sup>2</sup> BABVE, Universitat Autònoma de Barcelona, 08193 Bellaterra

<sup>3</sup> Department of Biology, University of York

<sup>4</sup> ETSEA-Universitat de Lleida, 25198 Lleida

Corresponding author: angela.ribas@ctfc.es

## Abstract

We investigated the influence of livestock type on vegetation and biogeochemical cycling in grasslands with the objective of describing differences between agropastoral systems experiencing different managements from a trophic perspective. We sampled grassland plots in the Pyrenees of which four were grazed by sheep and four by cattle. We defined three patch types, based on the specific and functional plant composition: Legume-dominated (mostly by *Lotus corniculatus*); Grass-dominated (mainly by either *Festuca nigrescens* or *Nardus stricta*); and Forb-diverse (with *Myosotis sylvatica* and a diversity of other species). We sampled both above- and below-ground to obtain information about vegetation, roots (including mycorrhiza colonization) and soil nutrients. The above- and belowground plant biomass depended upon functional components of the patch and on grazing management. Plant allocation to green and dead matter changed between management types. Further, differences in grassland vegetation composition between cattle- and sheep-grazed areas found in previous studies were also confirmed. Higher P and NO<sub>3</sub> concentrations in cattle-grazed areas suggest eutrophication under this management, linked with lower mycorrhizal colonisation. Our results therefore confirm patterns in previous studies and provide a deeper insight into the mechanisms of biotic differentiation and biogeochemical processes associated with differences in grazing management.

Keywords: above-belowground system, carbon and nitrogen concentrations, functional diversity, land use changes, mycorrhizal colonization, patch scale.

## Introduction

Management regime of pastures influences soil C storage and, as has been observed previously, this effect can take place due to changes in plant species composition (Reeder and Schuman, 2002; Sebastià *et al.*, 2008) in addition to other factors. Studies suggest that changes in the pastoral management, such as grazing pressure, determine changes in the vegetation and functional groups' distribution of plants with specific attributes (de Bello *et al.*, 2005), which leads to variations in carbon distribution among soil compartments (Casals *et al.*, 2004). In addition, faecal-N incorporation associated with grazing has a recognized role in nutrient dynamics within the system (Bardgett *et al.*, 1998). Further, changes in herbivory may have an effect through two different processes mediated by the plant community, namely: 1) through changes in the plant community composition which in turn will affect the quality and quantity of the litter incorporated into the soil, as previously mentioned; and 2) through plant physiological changes associated with herbivory, including changes in C allocation patterns (Bardgett *et al.*, 1998). In this context, we wished to investigate how changes in herbivory behaviour may affect grassland ecosystems and the possible mechanisms associated with these changes, including interactions between the above- and

below-ground compartments and the subsequent impact upon nutrient cycles, by comparing grasslands under different management regimes.

## Material and methods

Eight plots were established in two neighbouring but differently managed grassland areas in the Pyrenees (1860-1950 m a.s.l.; 1°58' E, 42°19' N): four plots were grazed by sheep and four were grazed by cattle. Stocking rates were equivalent and the grasslands were pastured during summer. In each one of these plots we defined different patches based on specific and functional characterization of the plant community. Three types of patches were defined: 1) patches dominated by legume species (L), in particular by *Lotus corniculatus*; 2) patches dominated by grass species (G), including *Avenula pratensis*, *Agrostis capillaris*, *Festuca nigrescens*, *Koeleria macrantha*, *Poa bulbosa*, *Deschampsia flexuosa* or *Nardus stricta*; and 3) diverse patches (D), characterized by the presence *Myosotis sylvatica* ssp *alpestris*, in combination with other forbs, grass and legume species. At the patch scale, we sampled both above- and below-ground to obtain information about vegetation, roots, mycorrhizal colonisation and soil nutrients. Three neighbouring 5 x 5 cm core probes were introduced in the soil, in every patch dominated by each one of the species in each plot, and the first 10 cm of belowground material were collected. Aboveground biomass was determined in each of the three cores. In addition, one core was used to determine belowground biomass at 0-5 cm and 5-10 cm depth, the second core was used to analyze soil nutrient content and the third core was transported to the University of York for assessment of percentage of arbuscular mycorrhiza colonization (%RLC).

A split-plot model analysis was used to test for differences between treatments, including plot, management as main plot and patch type, representing Plant Functional type (PFT), as factors in the model. Detrended correspondence analysis (DCA) was used to compare vegetation characteristics among the patches.

## Results and discussion

Grass-dominated patches showed the highest differentiation between grazing managements, as found by Sebastià *et al.* (2008), with *Nardus stricta* and *Deschampsia flexuosa* showing a higher contribution in sheep grazed areas. Above- and below-ground responses of plant biomass depended upon functional components of the patches and on grazing management. Plant allocation to green and dead matter changed between the cattle and sheep grazing regimes (Figure 1). Statistically significant responses were found for aboveground biomass (Management x Plant Functional Type (PFT)  $P = 0.03$ ). There was a tendency for soil carbon concentration to be higher in cattle grazed (mean value  $12.5 \pm 0.49$ ) than in sheep grazed areas ( $10.1 \pm 0.49$ ,  $P = 0.06$ ). Similar results were found in carbon organic content. In addition, N ( $1.02 \pm 0.04$  vs.  $0.86 \pm 0.04$ ) and P content ( $21.4 \pm 1.8$  vs.  $12.3 \pm 1.8$ ) also tended to be higher in cattle-grazed than in sheep grazed areas. Grasses from sheep grazed areas showed a tendency to be more heavily colonized by arbuscular mycorrhizae than grasses from cattle-grazed areas ( $47.8 \pm 8.2$  vs.  $24.7 \pm 8.2$ ). This tendency was not found for other patch types.

The differences found in plant biomass allocation between managements and the tendency towards eutrophication in cattle-grazed grasslands, with higher P and  $\text{NO}_3$  concentrations, in addition to the lower mycorrhizal colonisation in those areas, suggest that ecophysiological processes are acting at the patch scale. The divergence in vegetation between the two differently managed areas found in this study (notably the increased proportion of *Nardus stricta* in the sheep-grazed grasslands), agree with those previously reported by Sebastià *et al.* (2008) at a larger sampling scale.

## Conclusions

These results therefore suggest that current changes in the Pyrenees such as the replacement of sheep- by cattle-grazing, could drive important changes in plant community structure and nutrient cycling in these grassland ecosystems.

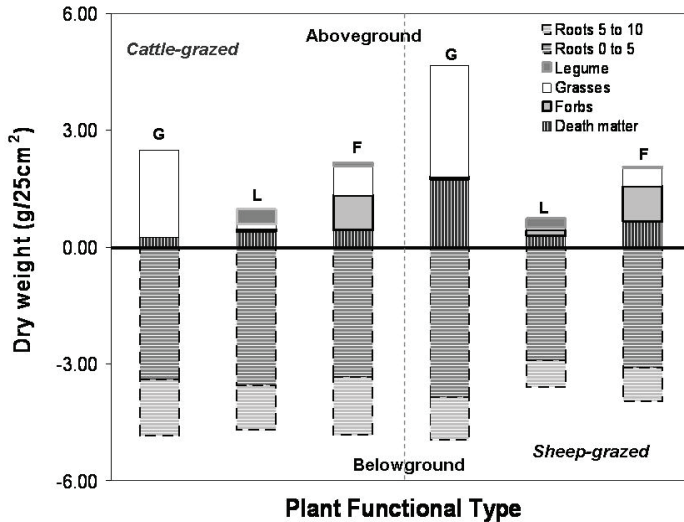

Figure 1. Plant biomass allocation per functional component, plant functional type (G=grasses, L=legume, and D=diverse) and management. These values correspond to biomass obtained from cores.

## Acknowledgements

This work was supported by the CARBOAGROPAS (CGL2006-13555-C03-01/BOS) and the OBAMA (CGL2009-13425-C02-01 /BOS) projects from the Spanish Ministry of Education and Science, and Consolider-Ingenio Montes SD2008-00040.

## References

- Bardgett R.D., Wardle D.A. and Yeates G.W. (1998) Linking above-ground and below-ground interactions: how plant responses to foliar herbivory influence soil organisms. *Soil Biology and Biochemistry* 30, 1867-1878.
- Casals P., Garcia-Pausas J., Romanyà J., Camarero L.L., Sanz M.J. and Sebastià M.T. (2004) Effects of livestock management on carbon stocks and fluxes in grassland ecosystems in the Pyrenees. *Grassland Sciences in Europe* 9, 136-138.
- de Bello F., Leps J. and Sebastià M.-T. (2005) Predictive value of plant traits to grazing along a climatic gradient in the Mediterranean. *Journal of Applied Ecology* 42, 824-833.
- Reeder J.D. and Schuman G.E. (2002) Influence of livestock grazing on C in semi-arid mixed-grass and short-grass rangelands. *Environmental Pollution* 116, 457-463.
- Sebastià M.T., de Bello F., Puig L. and Tauli M. (2008) Grazing as a factor structuring grasslands in the Pyrenees. *Applied Vegetation Science* 11(2), 215-222.

# Effects of arbuscular mycorrhizal symbiosis on growth and N<sub>2</sub> fixation of *Trifolium alexandrinum* under late drought stress conditions

Saia S., Ruisi P., Amato G. and Giambalvo D.

*Dipartimento di Agronomia Ambientale e Territoriale, Università degli Studi di Palermo, 90128 Palermo, Italy*

Corresponding author: sergiosaia@unipa.it

## Abstract

Several experiments, mostly carried out under controlled conditions, have shown that arbuscular mycorrhizal (AM) symbiosis enhances nutrient uptake and improves drought tolerance of host plants. The present research, carried out in a typical Mediterranean environment, evaluated the effect of AM symbiosis on berseem clover (*Trifolium alexandrinum* L.) grown in the field under both late drought stress and well-watered conditions. The crop was subjected to repeated defoliation. N<sub>2</sub> fixation was estimated using the <sup>15</sup>N dilution method and using ryegrass (*Lolium multiflorum* var. Westervoldicum) as the reference crop. In late drought conditions, AM symbiosis resulted in a significant increase in biomass yield, total N uptake, total amount of N fixed, and proportion of N derived from the atmosphere. The results suggest that AM symbiosis could play a key role in alleviating the stress effects of late drought on berseem forage production in the field.

Keywords: Berseem, Forage production, N uptake, Mediterranean environment

## Introduction

Arbuscular mycorrhizal (AM) symbiosis involves mutually beneficial associations between plants and soil-borne fungi of the phylum *Glomeromycota*. These associations improve plant growth and nutrient uptake (Garg *et al.*, 2006). Several pot studies have shown the beneficial effects of AM symbiosis on plants grown in water-stressed conditions, even though in other research the effects were absent or negative (Augé, 2001). However, limited information is available on the effects of AM symbiosis on crop drought tolerance under field conditions. In many Mediterranean areas, spring rainfall is scarce, which stresses plants and limits crop productivity. In such environments, AM symbiosis could play an important role in alleviating the effects of drought on crop yield and quality.

The aim of this field experiment was to determine the effect of AM symbiosis on forage yield, quality, and biological N<sub>2</sub> fixation of berseem (*Trifolium alexandrinum* L.) grown under both late drought stress and well-watered conditions.

## Materials and methods

The research was carried out in 2007–2008 in a typical semi-arid Mediterranean area (37°33'N – 13°30'E, 170 m a.s.l.) on a Vertic Haploxerept soil. The long-term mean annual rainfall in this area is ~550 mm. There were two treatments: 1) soil moisture regime: rainfed or well-watered, and 2) crop mycorrhization: AM inoculation (+AM) or AM suppression (–AM). Minimal rainfall occurred during the spring (61 mm, 55% below long-term average), resulting in late drought stress conditions for crops in the rainfed treatments. Well-watered crops received sprinkle irrigation (total of 90 mm, starting at 116 days after sowing [DAS]). AM suppression was achieved by spraying plots with systemic fungicides once per month starting from sowing. Benomyl, Fenpropimorph, and Carbendazim were applied at 10, 5, and 5 mg m<sup>-2</sup> a.i., respectively. These fungicides are capable of suppressing AM symbiosis

without affecting plant growth (Kjøller and Rosendahl, 2000). AM inoculation involved the application of a commercial AM inoculum (pure spores of *Glomus intraradices* and *G. mosseae*; 2000 spores g<sup>-1</sup>) at a rate of 12 g per kg of seed.

A split-plot experimental design with four replicates was used, with soil moisture regime as the main plot and crop mycorrhization as the sub-plot. Sub-plots were 36 m<sup>2</sup>. Berseem (cv. Lilibeo) was hand-sown on 3 January 2008 at 1200 seed m<sup>-2</sup> in rows 25 cm apart. Weeds were removed by hand.

Plots were cut at 5 cm stubble height at 76 (first cut), 116 (second cut), and 144 (third cut) DAS. Root samples were collected at 55 and 144 DAS, and AM root colonization was measured according to Phillips and Hayman (1970) and Giovannetti and Mosse (1980). The <sup>15</sup>N isotope dilution technique was used to estimate N<sub>2</sub> fixation by berseem, using annual ryegrass as the reference crop (ryegrass received the same treatments as berseem). At 116 DAS (second cut), <sup>15</sup>N-labelled fertiliser ([NH<sub>4</sub>]<sub>2</sub>SO<sub>4</sub> with an isotopic composition of 10 atom% <sup>15</sup>N) was applied in liquid form at a rate of 8 kg ha<sup>-1</sup> N to a 2.25 m<sup>2</sup> microplot in the middle of each plot.

At each cut, one sample area per plot was harvested both above and below ground by removing the top 20 cm of soil. Plants were separated into taproots, residual leaves and stems (below cutting height), removed leaves, and stems and heads (above cutting height).

The fresh weight of each sample was determined, and the leaf area of the residual and removed leaves was immediately measured on a 10 g subsample. Each subsample was oven dried and weighed. At 144 DAS (third cut), biomass samples were analysed for total N and <sup>15</sup>N enrichment. The percentage of berseem N derived from N<sub>2</sub> fixation (%Ndfa) was calculated according to Fried and Middleboe (1977). One-way ANOVA was performed separately by cut according to the experimental design.

## Results and discussion

AM infection at 55 DAS was significantly lower in the –AM than the +AM treatment (7.0 and 32.4%, respectively; *P* < 0.001). At 76 DAS (first cut), root dry matter (DM) yield, aboveground biomass (both removed and residual), and respective Leaf Area Indices (LAIs) were significantly higher in the +AM than the –AM treatment, whereas at 116 DAS (second cut) no significant effects of mycorrhization treatment were observed (Table 1).

Table 1. Characteristics of berseem at first and second cut by crop mycorrhization (–AM = AM suppression; +AM = AM inoculation).

		First cut		Second cut			
		–AM	+AM	–AM	+AM		
Aboveground removed biomass DM	g m <sup>-2</sup>	113	136	**	393	410	ns
Leaf Area Index		2.51	2.87	*	4.62	4.97	ns
% leaves		74.7	68.2	**	40.6	41.5	ns
Aboveground residual biomass DM	g m <sup>-2</sup>	46	51	*	155	158	ns
Leaf Area Index		0.44	0.51	*	1.31	1.33	ns
% leaves		32.2	32.8	ns	28.6	28.5	ns
Taproot biomass DM	g m <sup>-2</sup>	35	41	*	36	36	ns

\*, \*\*, significant at the 0.05 and 0.01 levels, respectively; ns, not significant

At 144 DAS (third cut), AM infection was very low in the –AM treatments irrespective of soil moisture regime. In contrast, infection was significantly higher in the drought-stressed than in well-watered crops in the +AM treatments. At third cut, +AM resulted in a significantly higher aboveground DM yield (+13%) and total N uptake (+11%) in drought-stressed conditions than in well-watered ones (Table 2). This result is consistent with the findings of pot studies (e.g. Azcón *et al.*, 1988). Al-Karaki *et al.* (2004) observed a beneficial effect of

increased AM infection on yield and quality of field-grown wheat in both drought-stressed and well-watered conditions. In the present research, Ndfa (as both a percentage of total N uptake and the amount of N fixed) was significantly higher in well-watered than in drought-stressed conditions. A higher Ndfa was observed for +AM than -AM only in the drought-stressed conditions; also, Porcel *et al.* (2003) found that N<sub>2</sub>ase activity increased more in AM than non-AM soybeans in a controlled environment and that this increase was more evident under drought-stressed conditions.

In conclusion, the results, although based on a 1-year experiment only, suggest that AM symbiosis may help alleviate the effects of late drought stress on berseem forage production grown in semiarid areas.

Table 2. Characteristics of berseem at third cut by soil moisture regime (W) and crop mycorrhization (M).

		Drought stress		Well-watered		Significance		
		-AM	+AM	-AM	+AM	W	M	W×M
AM infection	%	8.9	66.0	8.5	52.4	*	***	**
Aboveground biomass DM	g m <sup>-2</sup>	501	567	667	657	*	*	**
Leaf Area Index		1.99	2.12	3.98	4.22	***	ns	ns
% leaves		22.1	22.1	20.6	18.8	*	*	*
N concentration in DM	g kg <sup>-1</sup>	24.6	24.2	25.4	24.6	ns	ns	ns
N uptake	g m <sup>-2</sup>	12.32	13.68	16.92	16.18	*	ns	*
Root biomass DM	g m <sup>-2</sup>	38.7	40.5	40.2	38.1	ns	ns	ns
N concentration in DM	g kg <sup>-1</sup>	17.8	17.6	17.7	17.5	ns	ns	ns
N uptake	g m <sup>-2</sup>	0.69	0.71	0.71	0.67	ns	ns	ns
Ndfa	%	40.4	52.9	50.3	52.7	*	ns	*
	g m <sup>-2</sup>	5.2	7.6	8.9	8.9	*	*	*

-AM = AM suppression; +AM = AM inoculation;

\*, \*\*, \*\*\*, significant at the 0.05, 0.01, and 0.001 levels, respectively; ns, not significant

## Acknowledgments

This study was funded by Regione Siciliana – Project SI.CO.BIO.S.

## References

- Al-Karaki G., McMichael B. and Zak J. (2004) Field response of wheat to arbuscular mycorrhizal fungi and drought stress. *Mycorrhiza* 14, 263-269.
- Augé R.M. (2001) Water relations, drought and vesicular-arbuscular mycorrhizal symbiosis. *Mycorrhiza* 11, 3-42.
- Azcón R., El-Atrash F. and Barea J.M. (1988) Influence of mycorrhiza versus soluble phosphate on growth, nodulation, and N<sub>2</sub> fixation (<sup>15</sup>N) in alfalfa under different levels of water potential. *Biology and Fertility of Soils* 7, 28-31.
- Fried M. and Middleboe V. (1977) Measurement of amount of nitrogen fixed by a legume crop. *Plant and Soil* 47, 713-715.
- Garg N., Geetanjali and Kaur A. (2006) Arbuscular mycorrhiza: Nutritional aspects. *Archives of Agronomy and Soil Science* 52, 593-606.
- Giovannetti M. and Mosse B. (1980) An evaluation of techniques for measuring vesicular-arbuscular mycorrhizal infection roots. *New Phytologist* 84, 489-500.
- Kjøller R. and Rosendahl S. (2000) Effects of fungicides on arbuscular mycorrhizal fungi: differential responses in alkaline phosphatase activity of external and internal hyphae. *Biology and Fertility of Soils* 31, 361-365.
- Phillips J.M. and Hayman D.S. (1970) Improved procedure for clearing roots and staining parasitic and vesicular-arbuscular fungi for rapid assessment of infection. *Transactions of the British Mycological Society* 55, 158-161.
- Porcel R., Barea J.M. and Ruiz-Lozano J.M. (2003) Antioxidant activities in mycorrhizal soybean plants under drought stress and their possible relationship to the process of nodule senescence. *New Phytologist* 157, 135-143.



# Plant functional trait expression in the Rengen Grassland Experiment

Schellberg J.<sup>1</sup>, Brüne K.<sup>1</sup> and Hejcman M.<sup>2,3</sup>

<sup>1</sup>University of Bonn, Institute of Crop Science and Resource Conservation, Katzenburgweg 5, D 53115 Bonn, Germany

<sup>2</sup>Department of Ecology, Faculty of Environmental Sciences, Czech University of Life Sciences, Kamýcká 129, CZ-16521 Praha 6 – Suchbátka, Czech Republic

<sup>3</sup>Crop Research Institute, Drnovská 507, CZ-161 06 Prague 6 - Ruzyně, Czech Republic

Corresponding author: j.schellberg@uni-bonn.de

## Abstract

Plant functional trait expression has been investigated in the Rengen Grassland Experiment (RGE). Six fertiliser treatments have been present in the RGE since 1941: unfertilised control, Ca, CaN, CaNP and CaNPK with K in two forms. Categorical traits of communities were determined throughout four consecutive years. Cluster analysis identified distinct clusters: (i) control, (ii) Ca, (iii) CaN and (vi) the remaining treatments with CaNP or CaNPK application. Redundancy analysis (RDA) revealed high similarity of categorical traits in treatments with CaNP and CaNPK application, but a distinct differentiation to CaN, Ca and control. Categorical traits varied such that one can identify trait-based plant strategy of adaptation in response to soil nutrient content.

Keywords: species-rich meadow, long-term fertiliser application, RDA, community plant functional trait expression

## Introduction

It is common knowledge that grassland undergoes permanent change in floristic composition along with variation in amount and type of fertiliser applied, regime of defoliation either by cutting or grazing as well as trampling or shaping. Any treatment that influences growth and development of individual plants within the community inevitably leads to a shift in floristic composition. The functionalities behind such a shift are rarely understood. The concept of plant functional traits (PFT) helps to better understand plant community response to management. The major advantage is that PFTs can explain ecosystem processes and functioning much better than can the evaluation of simple floristic composition (Diaz *et al.*, 2001). Further, the PFT approach allows improving our understanding of competitive ability. Competition is seen as the driving force of vegetation dynamics and it strongly interferes with environmental and management gradients given for particular grassland. Further, the PFT approach also allows the development of a logical hierarchical system of vegetation performances and scaling up functionalities from plant and habitat to ecosystem. Diaz and Cabido (2001) describe the role of plant functional diversity in the interpretation of ecosystem processes and include a list of relevant experiments and a glossary of terms. In the present study, we aimed to better understand the mechanisms behind floristic diversification as induced by long-term fertiliser application in the RGE based on the PFT approach. In the present approach we considered response traits that we derived from a database. The key question was whether fertiliser treatments in the RGE created different sets of PFT and whether the expression of traits of the communities can explain the functions behind competitive ability of species involved.



## Material and methods

The RGE was set up in 1941. Description of location, climate, experimental site, fertilizer application and soil nutrient content is given in Hejcman *et al.* (2007) and Schellberg *et al.* (1999). In brief, the experiment consists of six treatments arranged in a complete randomised block with five replicates of each, including an unfertilised control and treatments receiving Ca, CaN, CaNP, CaNPKCl and CaNPK<sub>2</sub>SO<sub>4</sub> at rates of 715-936 kg ha<sup>-1</sup> y<sup>-1</sup> Ca, 100 kg ha<sup>-1</sup> y<sup>-1</sup> N, 35 kg ha<sup>-1</sup> y<sup>-1</sup> P, 133 kg ha<sup>-1</sup> y<sup>-1</sup> K, and 67 – 90 kg Mg ha<sup>-1</sup> y<sup>-1</sup>. Individual plot size is 3 × 5 m<sup>2</sup>. Two cuts are taken annually, in the first half of July and in October. A detailed phytosociological classification of the treatments is given in Chytrý *et al.* (2008). From LEDA traitbase (Kleyer *et al.*, 2008) and the BIOLFLOR database (Klotz *et al.*, 2002), a total of 58 categorical trait attributes (PFTA) out of 14 PFTs of all recorded species were selected except for tree seedlings and undefined species of *Taraxacum* and *Hieracium*. Percentage cover of species exhibiting the respective PFTA was summed up for each plot and then averaged across five replicates within each treatment. This procedure was repeated based on plant cover data from 2005 to 2008 each obtained immediately before the first cut in July, thus leading to a matrix containing numerical values for treatments and years. Categorical trait attributes of individual species were then transformed into numerical values (community plant functional trait expressions, CPFTE) for each of these attributes. A series of redundancy analyses (RDA) in the CANOCO for Windows 4.5 program (ter Braak and Šmilauer, 2002) has been performed based on mean values of CPFTE defined as species in RDA analyses.

## Results

CPFTE derived from the data bases varied significantly between fertiliser treatments in that rhizome-pleiocorm, rosette plant species and hemiparasitic adaptations (NA2) displayed the highest cover in the fertilised control. Some more traits were assembled in these treatments such as strict monocarpic biennials and poly-annuals (LL) (Figure 1). In contrast, some CPFTE were frequently found in plots fertilised with N (runner-like rhizome VP3, simple and palmate leaf form LF10, stress-tolerators/ruderals strategy type ST7). Finally, six CPFTE (shoot tuber VP15, tuft SO7, persistent green leaves LP4, competitor strategy types ST1, competitors/stress-tolerators ST3 and competitors/stress-tolerators/ruderals ST4) indicated an effect of CaNP or CaNPK fertiliser application. The results of the RDA clearly indicate that nutrients have been the driving force for trait combination. The hierarchical cluster analysis revealed clear separation of most experimental treatments with respect to combination of CPFTE (data not shown). Four collectives could be identified. Without exception, plots without P could be separated from plots with P fertiliser. Further, control plots created an independent cluster as well as plots receiving either Ca or CaN.

## Discussion and conclusions

The inter-correlation of categorical traits in the RGE gives an indication on what trait combination succeeds under soil nutrient states generated by the respective fertiliser treatment. Combinations of CPFTE derived from the entire floristic composition and trait data base can also be interpreted as ‘plant community strategy’. With respect to categorical traits, the adaptability of the community to environmental conditions is based on either promotion or suppression of plant species exhibiting particular traits. This does not imply that plants share the same traits but that their traits can be complementary with respect to resource use and niche colonisation. It is therefore not surprising that, in this study, there were no two species exhibiting the same combination of categorical traits. From a comparison of floristic composition in the RGE as presented by Hejcman *et al.* (2007) with trait combination, it follows that species exhibiting similar traits and comparable competitive ability (i.e. refer to

the same plant functional type) have been able to colonise the same niches. From the present study we conclude that vegetation change driven by long-term fertiliser application can be explained by a combination of categorical plant functional traits of the community. The significance of the ‘trait-based approach’ has not yet asserted itself in agricultural sciences in general, although it brings about considerable informative value for type and intensity of grassland for land-use.

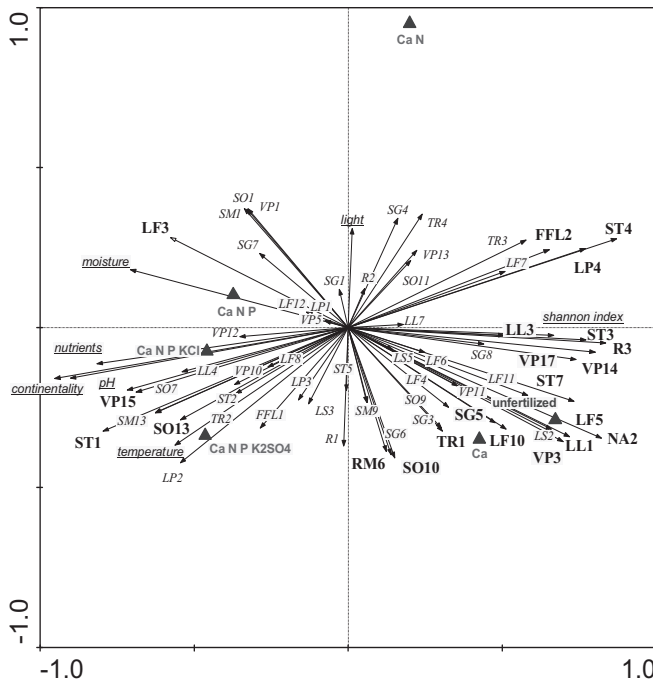

Figure 1. Ordination diagram displaying plant functional trait attributes and Ellenberg indicator values in relation to fertilizer application treatments as a result of the RDA in the Rengen Grassland Experiment. Traits exhibiting significant differences among treatments A to F ( $P < 0.05$ ) are in bold. For a description of abbreviations, please refer to text.

## References

- Chytrý M., Hejcman M., Hennekens S. M. and Schellberg J. (2009) Changes in vegetation types and Ellenberg indicator values after 65 years of fertilizer application in the Rengen Grassland Experiment, Germany. *Applied Vegetation Science* 12, 167–176.
- Diaz S. and Cabido M. (2001) Vive la difference. Plant functional diversity matters to ecosystem processes. *Trends in Ecology and Evolution* 16, 646–655.
- Diaz S., Noy-Meir I. and Cabido M. (2001) Can grazing response of herbaceous plants be predicted from simple vegetative traits? *Journal of Applied Ecology* 38, 497–508.
- Hejcman M., Klaudivová M., Schellberg J. and Honsová D. (2007) The Rengen Grassland Experiment: plant species composition after 64 years of fertilizer application. *Agriculture, Ecosystems and Environment* 122, 259–266.
- Kleyer M., Bekker R.M., Knevel I.C., Bakker J.P., Thompson K., Sonnenschein M., Poschold P., van Groenendael J.M., Klimes L., Klimesová J. *et al.* (2008) The LEDA Traitbase: a database of plant life-history traits of North West Europe. *Journal of Ecology* 96, 1266–1274
- Klotz S., Kühn I. and Durka W. (2002) BIOLFLOR – Eine Datenbank mit biologisch-ökologischen Merkmalen zur Flora von Deutschland. *Schriftenreihe für Vegetationskunde* 38, Bundesamt für Naturschutz, Germany, Bonn-Bad Godesberg.
- Schellberg J., Möseler B.M., Kühbauch W. and Rademacher I.F. (1999) Long-term effects of fertilizer on soil nutrient concentration, yield, forage quality and floristic composition of a hay meadow in the Eifel mountains, Germany. *Grass and Forage Science* 54, 195–207.
- Ter Braak C.F.J. and Smlauer P. (2002) *CANOCO reference manual and CANODRAW for Windows user guide. Software for canonical community ordination* (version 4.5) Ithaka, NY, USA. Microcomputer Power.

# Long-term effects of large-scale, moderate grazing on the vegetation of a river valley

Schrautzer J.<sup>1</sup>, Jensen K.<sup>2</sup>, Breuer V.<sup>1</sup> and Breuer M.<sup>1</sup>

<sup>1</sup>Ecology Centre, University of Kiel, D-24098 Kiel, Germany

<sup>2</sup>Biozentrum Klein Flottbek, University of Hamburg, D-22609 Hamburg, Germany

Corresponding author: jschrautzer@ecology.uni-kiel.de

## Abstract

In this study we present results of large-scale, moderate cattle grazing. We are concerned with long-term (1999-2009) effects on the structure and dynamics of vegetation in three pastures with distinct land use histories. Our investigations were carried out in a typical northern German river valley. The results showed that species richness depends on livestock unit, forage quality of the vegetation, and on previous land use. Both in fen areas and on mineral slopes, species richness increased in cases where the previous land use was termed either 'abandoned' or 'high-density grazing'. In fen areas with previously moderately used, species-diverse grasslands, species richness decreased when adjacent mineral slopes provided good forage quality for grazing, and when livestock unit was less than 0.75 cattle ha<sup>-1</sup> a<sup>-1</sup>. We conclude that large-scale grazing is an appropriate alternative to more costly nature conservation measures in grasslands. However, in order to avoid pasture abandonment in isolated species-rich wet grasslands, additional measures, such as mowing or temporary fencing, should be considered.

Keywords: Grassland restoration, species richness, grazing management, livestock density, secondary succession

## Introduction

Semi-natural, dry and wet grassland ecosystems have declined in number during recent decades throughout Europe due to both intensification and abandonment of traditional land use. Concepts aiming at the maintenance and restoration of these ecosystems comprise measures such as improving abiotic site conditions (e.g. re-wetting), mowing (1-2 cuts/year) and grazing with low stocking densities. In principle, these practices are applied to achieve restoration goals such as maintenance of endangered plant species of early stages of succession. Target species of later successional stages, however, are not considered in these concepts. A further disadvantage is that their implementation is often too costly. A relatively new management alternative is moderate grazing on large areas. Its target is the achievement of a mosaic of different successional stages, providing appropriate habitats for species of early successional stages, as well as for characteristic species of late successional stages (Olf *et al.*, 1999). Desirable examples of this concept are large pastures with an age-long tradition of moderate grazing, exhibiting high biodiversity. Little is known, however, about the long-term effects of large-scale, moderate grazing in previously intensively used cultural landscapes. It is at this point that the present study fills a gap. In a river valley, we investigated changes in the vegetation structure from 2000 until 2009 in three pastures that differ according to land use history and grazing regime. In detail we try to answer the following questions:

- How do the grazing regime and the land use history affect species richness?
- How do target species develop in the investigated pastures?
- What conclusions can be drawn from the results for the management of large pastures?

## Materials and methods

The project area (Eidertal) is located 15 km southeast of Kiel in the Pleistocene region of Schleswig-Holstein. It is a typical river valley in northwestern Germany with varying types of fen ecosystems in the lowlands, and mineral soils on the adjacent lateral slopes. At the start of a nature conservation project in 1999, the fens were covered mainly with species-poor, intensively used or abandoned wet grasslands and the mineral slopes were dominated by intensively used mesic grasslands. In contrast, species-rich mesotrophic grasslands occurred only on small, isolated sites. Within the scope of the conservation project many small pastures and abandoned fields were combined to a few bigger pastures with both mineral and fen soils. The characteristics of the investigated pastures were as follows:

P 1 (38 ha): Fen soils 57% (species-rich wet grasslands, recent history: low-density grazing), mineral (loamy) soils 43% (species-poor mesic grasslands, recent history: high-density grazing), grazing regime: summer grazing (May to October), grazing pressure (heifers, Holstein cows): 1.5 cattle ha<sup>-1</sup> in 2000-2004 (livestock units [LU = 500 kg]: 0.75 LU ha<sup>-1</sup> a<sup>-1</sup>), 1.0 cattle ha<sup>-1</sup> in 2005-2009 (0.5 LU ha<sup>-1</sup> a<sup>-1</sup>).

P 2 (36 ha): Fen soils 59% (species-poor abandoned wet meadows, recent history: 9 years of abandonment), mineral (loamy) soils 41% (species-poor mesic grassland, recent history: 5 years of abandonment), grazing regime: summer grazing, grazing pressure 1.1 cattle (heifers) ha<sup>-1</sup> in 2000-2004, 0.6 LU ha<sup>-1</sup>, year-round grazing since 2005, no supplementary fodder supply in winter, grazing pressure 0.1 cattle (Galloways) ha<sup>-1</sup> in 2005 and 0.5 cattle ha<sup>-1</sup> in the following years (0.1 and 0.5 LU ha<sup>-1</sup> a<sup>-1</sup>, respectively).

P 3 (31 ha), fen soils 47% (species-poor wet grasslands, recent history: high-density grazing), mineral (sandy) soils 53% (species-poor and -rich mesic grasslands, recent history: abandoned (5 years) fields and grasslands with high-density grazing), grazing regime: summer grazing, suckler cow herd, grazing pressure 1.5 cattle ha<sup>-1</sup> in 2002-2009 (0.75 LU ha<sup>-1</sup> a<sup>-1</sup>).

The experimental design consists of plots, each 625 m<sup>2</sup> in size (P 1 = 10, P 2 = 12, P 3 = 10 plots), arranged along transects from the mineral slopes to the fen area. These plots were subdivided into 5 sub-plots (4 at the edges, 1 in the centre) of 25 m<sup>2</sup> area each. Species composition and grazing intensity (coverage of grazed vegetation in %) of the plots were recorded each year at the end of August. Livestock unit per year was calculated by adjusting grazing pressure to grazing period in days. Differences in species number among years were analysed with ANOVA, followed by pairwise comparisons (Tukey's HSD).

## Results and discussion

Species richness on mineral soils was initially highest in P 3 (Fig. 1). This was due to the coexistence of weed species and grassland species. Furthermore, species indicative of low nutrient availability in sandy soils were also present. During the investigation period, species richness increased significantly on the mineral soils of all pastures, caused probably by the impoverishment of the soils and the grazing-induced development of gaps for the establishment of new species. Impoverishment was indicated by the increase of mesotrophic grassland species and a continuous decrease of ruderals such as *Cirsium arvense* and *Urtica dioica*. Species richness on fen soils was initially highest in P 1 where species-rich wet meadows were dominating. During the first five years, species richness remained more or less constant at these sites despite low grazing intensities. Continuously low grazing intensities during the following years, however, resulted in a decline of species richness, caused mainly by the decrease of mesic grassland species, and the significant increase of tall sedges such as *Carex acutiformis* and ruderal species (cf. Schrautzer *et al.*, 2004). In addition, endangered target species such as *Carex echinata* and *Valeriana dioica* began to suffer from reduced light

availability. In P 2, species diversity on fen soils increased during the first five years of moderate grazing. This was due to the creation of gaps in the previously abandoned wet grasslands. After conversion from summer into year-round grazing, which was accompanied by a decrease of the livestock unit particularly in the first year after conversion due to the reorganisation of the livestock by the farmer, the number of species declined rapidly to initial values, and stands were again dominated by tall sedges and herbs. Diversity of the previously intensively used wet grasslands on P 3 continuously increased.

## Conclusions

From the standpoint of biodiversity, we conclude that large-scale, moderate grazing in river valleys with dry and wet grasslands is an appropriate alternative to conventional grazing conservation measures. However, grazing pressure must be adjusted to the forage quality and supply of the pastures, these depending to a high degree on the previous land use. A stocking rate lower than 0.75 cattle ha<sup>-1</sup> a<sup>-1</sup> bears the risk of abandonment of pasture and the consequent extinction of endangered, light-demanding species. Measures to solve this problem are to increase the grazing pressure, to elongate the grazing period and to occasionally mow or fence sites containing endangered species.

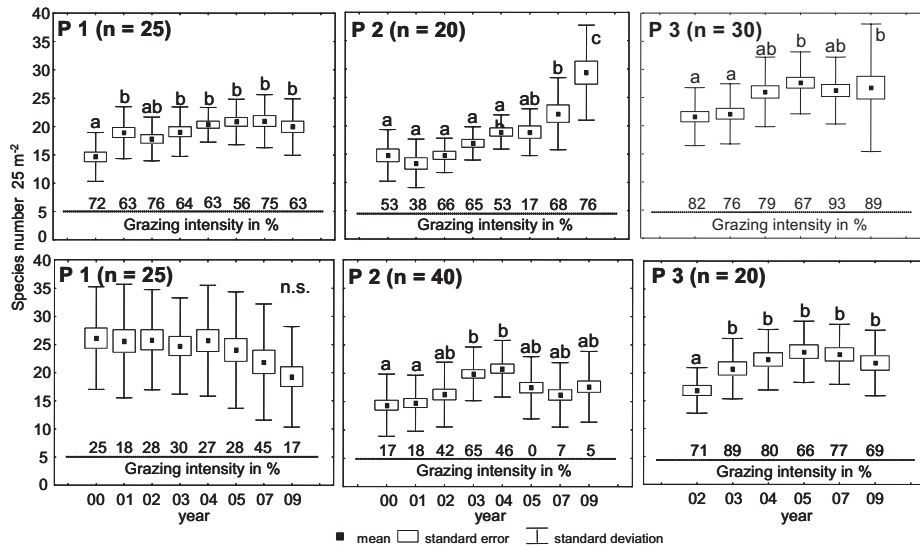

Figure 1. Development of species diversity from 2000 to 2009 (plot size: 25 m<sup>2</sup>) in the investigated pastures. Upper row: mineral soils, lower row: fen soils. ANOVA: Letters denote significant differences ( $P < 0.01$ ) according to Tukey's HSD.

## References

- Olf H., Vera F.W.M., Bokdam J., Bakker E.S., Gleichman J.M., de Maeyer K. and Smit R. (1999) Shifting mosaics in grazed woodlands driven by the alteration of plant facilitation and competition. *Plant Biology* 1, 127-137.
- Schrautzer J., Irmeler U., Jensen K., Nötzold R. and Holsten B. (2004) Auswirkungen großflächiger Beweidung auf die Lebensgemeinschaften eines nordwestdeutschen Flusstales. *Schriftenreihe für Landschaftspflege und Naturschutz*, 78, 39-61.

## Assessing the environmental qualities of permanent grassland

Hasund K.P.<sup>1</sup>, Holgersson T.<sup>2</sup>, Norell B.<sup>1</sup> and Ståhlberg D.<sup>1</sup>

<sup>1</sup> Swedish Board of Agriculture, S-55182 Jönköping, Sweden

<sup>2</sup> Jönköping International Business School, S-55111 Jönköping, Sweden

Corresponding author: Knut.Per.Hasund@Jordbruksverket.se

### Abstract

A current issue is whether it is possible to evaluate the environmental qualities of individual meadows and pastures based solely on information about some of their attributes. The question is: would biologists make concordant evaluations and, if so, which attributes would be relevant. The aim of this study was to investigate the possibility of developing a model that can classify grassland by environmental values based on survey data. The reason is the policy demand to prioritise measures for preserving the environmental qualities of grassland cost-effectively. A questionnaire was used in which 40 grassland-biology experts classified 50 semi-natural grassland objects into value deciles based on survey data. The grassland objects were randomly spread across Sweden, and described by eight attributes. The study indicates that: (i) domestic experts in biodiversity conservation are quite concordant in assessing semi-natural grasslands; (ii) it is possible to quantitatively assess the general environmental quality of a grassland object by means of a simple, linear prediction model, and less than 10 carefully selected variables suffice to characterise a grassland object in a condensed but balanced way; and (iii) 'number of positive indicator species' is the variable the experts most heavily relied upon in their assessments of grassland environmental qualities.

Keywords: biodiversity, environmental attributes, evaluation, semi-natural pastures, traditionally mowed meadows

### Introduction

The Swedish Parliament requires that permanent grasslands be managed in a way that preserves their environmental values. There is also a demand to prioritise agri-environmental payments and conservation measures to the most valuable objects. It was previously not possible to judge the development or status of grassland at the macro level, since there were no all-encompassing surveys of their environmental qualities. The task is complicated because grasslands are heterogeneous and their biodiversity is determined by a complex set of dynamically changing variables. Permanent grasslands are very important for Swedish biodiversity, but their area, and in many locations also their quality, has declined strongly. In 2009, there were just 10000 ha of traditional hay meadows and 500000 ha of permanent pastures. Of these, 300000 ha were semi-natural (never fertilised or ploughed) compared to many millions of hectares in the 19th century. As a result of the decrease and the fragmentation, more than 1600 of their species are now red-listed (SSIC, 2005).

The database TUVa was created in 2005 based on the national Meadow and Pastureland Survey, containing information about the 50000 grassland objects (300000 ha) assessed as the most environmentally valuable (SBA, 2005a; 2005b). TUVa describes each grassland object by a set of attributes estimated by a common survey method. The evaluation of environmental qualities of grassland depends on who evaluates, and the person's preferences or value criteria. In this study, biologists with long experience of preservation work made the evaluations. It may be interesting since they are usually the ones who make such evaluations in the policy implementation. Our aims were: (i) to investigate whether biology experts make



concordant evaluations of the environmental values of grassland based on survey data; and (ii) if so, whether it is possible to formulate a model of attributes that are determinant for the evaluation; and (iii) to estimate the significance of the attributes; see SBA (2008) about the method and the results.

## Methods

The biologists were asked to rank in a questionnaire specified grassland objects into deciles based on their environmental values (including biodiversity but excluding cultural heritage). Each of the 50 objects was described by eight attributes (see below). Data on the attributes were taken from the TUVVA database (SBA, 2010). The experts hence based their evaluations solely on written information about these attributes. All experts were quite familiar with TUVVA and ought to have a good idea about what kind of object the various attributes represent. The first step of the project was that a small expert group selected variables from TUVVA. Then, various sets of attributes and three different evaluation methods were tested. After this pilot study the survey instrument was established, and the questionnaire sent to experts recommended by the County Administrative Boards. Totally 40 out of 77 appointed experts replied in accordance with the guidelines. The individual rankings of the experts were weighed into an average rank using principal component analysis (an ‘average expert’).

## Results and discussion

(i) Biologists agree. The experts were remarkably concordant in their evaluations of the grassland objects, even though they made their evaluations independently of one another. It should be emphasized in this context that it is a complex task to make an environmental classification of 50 pastures or meadows on a ten-point scale (where 1 is highest rank). For most objects, the experts’ classifications fell within an interval of three deciles. Paired comparisons between all experts resulted in strong, statistically significant relations with correlation coefficients ( $r$ ) in the interval 0.7 – 0.9 ( $r = 1$ : perfect correlation).

(ii) The study supports the hypothesis that the environmental qualities of a grassland object can be evaluated by using a model based on no more than eight explanatory variables in order to obtain the same evaluation that a biology expert would have made using the same information. A linear multiple regression analysis showed that it is possible to formulate a prediction model that weights the various attributes’ relative importance to the classification of an object. The model showed a strong correlation between the weighed importance of the given attributes and the average classifications made of each grassland object ( $y$ ). The model had an  $R^2$ -value of 0.92. The model also allows calculations of how the value of an object changes when the value of one of the attributes changes.

(iii) Some attributes were assessed as more important for the environmental value of grassland. The estimated model is described by the equation

$$\hat{y}_i = 8.11 - 0.12x_{1i} - 1.48x_{2i} - 0.89x_{3i} - 0.26x_{4i} - 0.01x_{5i} + 2.46x_{6i} + 0.81x_{7i} + 0.14x_{8i}$$

where  $i$  represents grassland object N°  $i$ , and  $x_1$  = area of the object (ha),  $x_2$  = percentage of the object’s total area classified according to Natura 2000 habitat types,  $x_3$  = pasture/meadow,  $x_4$  = number of positive indicator species (vascular plants) of the object,  $x_5$  = number of valuable (individual) trees,  $x_6$  = share affected by fertilisers or biocides,  $x_7$  = percentage of the object’s area covered by tree canopies, and  $x_8$  = percentage of the object’s area covered by bushes. Almost without exception, the experts assigned importance to only five of these attributes when classifying the grassland objects. The correlation between these five attributes and the average classification of the objects was unambiguous with high statistical significance. The attribute assigned the largest weight was ‘Number of positive indicator



species' (positive impact; note that rank 1 is better than rank 10, explaining the negative sign of the parameter) followed by 'Share of area consisting of nature type according to Natura 2000' (positive). The third most important attribute was 'Share of object treated by fertilisers or biocides' (negative impact). Large areas were valued higher than small areas, and traditional hay meadows higher than pastures. Other attributes: number of valuable trees, density of bushes (bush index), and tree canopy coverage (tree index) – had no clear significance as regards how the experts classified the objects. The VIF values were all below 2.2, indicating that there was no problem of multicollinearity.

Even though the results were unambiguous, they should be interpreted bearing in mind the limits of the method. It is not certain that the experts would have made the same evaluation after field inspections. Furthermore, there is no objective measure of the biological value of grassland, the study merely shows that the experts agreed and were consistent in their evaluations (using this model design). New knowledge might for instance result in a different classification in the future. The model is valid only in the observed range of 0.4 – 15 ha (covering 90% of Swedish grassland objects), and estimates only linear connections between the variables and the total evaluation. It is, however, likely that there are some non-linear effects between the variables  $x_7$  and  $x_8$ , cover by trees and bushes. This was tested, but because of complexity, no better model could be developed. The selection of variables may be criticised on the basis that they do not take into account 1) cultural heritage qualities, 2) the regional or landscape context, and that 3) there was no differentiation between various nature types (according to Natura 2000), and 4) they place too much emphasis on vascular plants. Including more variables and objects would provide more information, but it would also make the task more complex. More than 80% of the experts believed that eight attributes were a manageable number in relation to the number of objects (50). Half of the experts believed that the number of attributes was enough to reflect reality, but 40% believed it was insufficient.

## Conclusions

Our prediction model can be used to consistently evaluate the environmental values of a large number of environmental objects based on the attributes mentioned and obtaining the same result as would an experienced expert. This would have been almost impossible by inspections in the field. The model is already being used for such purposes in one county. In spite of the specific shortcomings of the method, the high degree of concordance between the experts shows that the evaluations in preservation work are based on fact. In addition, the possibility of quantifying ecological qualities based on established criteria may contribute to increased confidence in the evaluations and decisions that the authorities have to make, not least when distributing agri-environmental payments. The results show that conditions are good for further development of evaluation tools for nature preservation to be used in planning and decision-making at various levels. The strength of the model is that it provides a uniform, reliable and transparent method of assessing the environmental values of grassland.

## References

- SBA, Swedish Board of Agriculture (2005a) *Ängs- och betesmarksinventeringen*. Report 2005:1, Jönköping.
- SBA, Swedish Board of Agriculture (2005b) *Ängs- och betesmarksinventeringen – inventeringsmetod*. Report 2005:2, Jönköping, 63 pp.
- SBA, Swedish Board of Agriculture (2008) *Värdering av betesmarker*. Report 2008:26, Jönköping. 76 pp.
- SBA, Swedish Board of Agriculture (2010) *Ängs- och betesmarksinventeringen 2002 – 2004. Databasen TUVÅ2*, Jönköping <http://www.jordbruksverket.se/TUVA> .
- SSIC, Swedish Species Information Centre (2005) *Rödlistade växter i Sverige 2005*, Swedish Red Data Book of Plants 2005, Uppsala.

## Roots and earthworms under grass, clover and a grass-clover mixture

van Eekeren N.<sup>1</sup>, Bokhorst J.<sup>2</sup> and Brussaard L.<sup>3</sup>

<sup>1</sup>Louis Bolk Institute, Hoofdstraat 24, NL-3972 LA Driebergen, The Netherlands

<sup>2</sup>Wageningen University, P.O. Box 47, NL-6700 AA Wageningen, The Netherlands

Corresponding author: n.vaneeekeren@louisbolk.nl

### Abstract

We investigated the root biomass, the abundance of earthworms and a selection of soil physical parameters in white clover, grass-clover and grass. The treatment with clover-only had a lower root biomass, a lower C/N ratio of the roots, a higher abundance of earthworms, a higher number of earthworm burrows, a lower penetration resistance at the 20-30 cm soil layer and a lower proportion of crumbs in the soil, than the other treatments. This confirms evidence in the literature that pure clover stimulates the ecosystem services of water regulation, but is less conducive to soil structure maintenance. However, the grass-clover mixture did not differ significantly from the grass treatments, but differed from clover-only in a higher percentage of soil crumbs. We infer that when clover is introduced in grassland to reduce the reliance on inorganic fertiliser, the mixture of grass and clover maintains the positive impact of grass roots on soil structure. However, it only may show a positive effect of clover-only on water regulation with a higher clover percentage in the dry matter.

Keywords: ecosystem services, water regulation, soil structure, soil quality, white clover

### Introduction

Important ecosystem services for grassland are soil structure maintenance and water regulation. For these services, roots and earthworms play an important role. When sustainable grassland systems are developed, it is important to know which effect management measures have on roots, earthworms and the functioning of the soil-plant system. One of the management measures is the introduction of white clover (*Trifolium repens*). It is well documented that the root density of white clover is considerably lower than that of grass (Evans, 1977), which could have an impact on soil structure (Robinson and Jacques, 1958). On the other hand, Sears (1950) and Van Eekeren *et al.* (2005) found a higher earthworm biomass in a grass-clover mixture than in grass-only swards. Earthworms are known for their positive effect on soil structure and water regulation (Clements *et al.*, 1991). Altogether, this would suggest that with the introduction of white clover in grassland, soil structure could deteriorate, while water regulation could improve. We conducted a field experiment (1) to measure the effect of white clover on root biomass and abundance of earthworms, and (2) to explore the relevance of changes for the ecosystem services of soil structure maintenance and water regulation.

### Methods

The experiment was established in spring 2004 on a free-draining sandy loam soil. Four treatments were established in a completely randomised block design of six blocks: Grass with 150 kg inorganic N fertiliser per ha (GN1), Grass without N fertiliser (GN0), Grass-clover without N fertiliser (GCN0) and Clover without N fertiliser (CN0). For further details see Van Eekeren *et al.* (2009).

On 16 December 2005 soil samples were taken. Root biomass was determined in three soil cores (0-10 cm,  $\varnothing$  8.5 cm) per plot. Earthworms were hand-sorted, counted and weighed in two blocks (20 cm x 20 cm x 20 cm) per plot. Earthworm burrows ( $\varnothing >2$  mm) were counted

on horizontal surfaces (20 cm x 20 cm) at 10 cm and 20 cm depth. Bulk density was measured in the 5-10 cm layer below the soil surface, in three ring samples containing 100 cm<sup>3</sup> of soil. Penetration resistance was measured with a penetrometer with a cone diameter of 2 cm<sup>2</sup> and a 60° apex angle. Soil structure was determined in 1 block (20 cm x 20 cm x 20 cm) per plot by visual observation into crumbs, sub-angular blocky elements and angular blocky elements. The treatment effects were tested with a one-way ANOVA, using the GENSTAT statistical software.

## Results

CN0 had significantly lower grass root biomass and significantly higher clover root biomass than the other treatments (Table 1). The C/N ratio in the total root biomass was lowest for CN0 and highest for GN0. GN1 and GCN0 were intermediate. Earthworm abundance was significantly higher in CN0 than in the other treatments (Table 1).

Table 1. Root biomass, earthworm abundance, earthworm burrow number and soil structure in grass with inorganic N fertiliser (GN1), grass without N fertiliser (GN0), grass-clover without N fertiliser (GCN0) and clover without N fertiliser (CN0).

Parameter	Unit	Treatments				P-value
		GN1	GN0	GCN0	CN0	
<i>Root biomass 0-10 cm</i>						
Grass	g m <sup>-2</sup> AFDM	169a	217a	177a	12b	<0.001
Clover	g m <sup>-2</sup> AFDM	0c	1c	16b	62a	<0.001
Total	g m <sup>-2</sup> AFDM	169a	218a	193a	73b	<0.001
C/N		21.0b	26.3a	21.3b	14.2c	<0.001
<i>Earthworms</i>						
Total number	n m <sup>-2</sup>	322b	326b	359b	480a	0.002
Total biomass	g m <sup>-2</sup>	82b	76b	110ab	135a	0.009
<i>Earthworm burrows</i>						
10 cm depth	n m <sup>-2</sup>	58b	67b	138b	225a	0.002
20 cm depth	n m <sup>-2</sup>	50ab	8b	113a	121a	0.023
<i>Bulk density</i>	g cm <sup>-3</sup>	1.47	1.42	1.49	1.47	NS
<i>Penetration resistance</i>						
0-10 cm	mPa	1.48	1.44	1.46	1.39	NS
10-20 cm	mPa	1.46	1.45	1.40	1.34	NS
20-30 cm	mPa	2.51a	2.39ab	2.45ab	2.13b	0.036
<i>Soil structure 0-10 cm</i>						
Crumb	%	39bc	53a	50ab	32c	0.006
Sub-angular	%	13	9	12	5	NS
Angular	%	47b	38b	38b	62a	0.009

\* AFDM = Ash Free Dry Matter

Earthworm numbers and biomass were negatively correlated with the C/N ratio of the root biomass ( $r = -0.59$ ,  $P = 0.002$  and  $r = -0.52$ ,  $P = 0.01$ , respectively). The number of earthworm burrows at 10 cm depth was significantly higher in CN0 than in the other treatments. The number of burrows at 10 cm and 20 cm depth was positively correlated with the earthworm biomass ( $r = +0.50$ ,  $P = 0.012$  and  $r = +0.49$ ,  $P = 0.015$ , respectively). Bulk density was not significantly different between the treatments. The penetration resistance in all soil layers was lower in CN0 than in GN1, but this was only statistically significant in the soil layer at 20-30 cm depth. The penetration resistance at 20-30 cm was negatively correlated with earthworm biomass ( $r = -0.47$ ,  $P = 0.02$ ). The proportion of crumbs was significantly higher in GN0 than CN0 (Table 1). GN1 and GCN0 took an intermediate position.

## Discussion and conclusions

In line with other research (Robinson and Jacques, 1958; Evans, 1977), the root biomass in CN0 was less than in grass-only. However, GCN0 had the same root biomass as grass-only. Although soil structure (measured as proportion of crumbs) was only correlated with clover root biomass and not with grass or total root biomass, the soil structure followed the pattern of root biomass. Since the grass root mass and the soil structure in the GCN0 were comparable to the grass-only treatments, we suggest that the soil structure of clover mixed with grass is maintained at the same level. The earthworm biomass was higher (70%) in CN0 than in GN1 and GN0, with GCN0 in an intermediate position. Sears (1950) and Van Eekeren *et al.* (2005) found a higher earthworm biomass in a grass-clover mixture than in grass-only swards. Thus, introduction of clover in a grass sward results in higher earthworm population densities. Water regulation is an ecosystem service in grasslands greatly influenced by earthworms (Bouché and Al-Addan, 1997) and earthworm burrows (Edwards and Shipitalo, 1998). In our experiment, the numbers of earthworm burrows at 10 and 20 cm depth were highest in CN0. Furthermore, CN0 showed the lowest penetration resistance at 20-30 cm, suggesting improved water infiltration. These data are consistent with results of Mytton *et al.* (1993), who found that white clover-only drained more rapidly than grass-only, and the mixture of grass-clover (> 50% clover in the DM) took an intermediate position. In our research, the mixture of grass-clover (GCN0), with 26% clover in the DM, showed a higher number of earthworm burrows and a lower penetration resistance than grass-only with fertilisation (GN1), but differences were not significant. This suggests that a positive effect of clover on water infiltration was not apparent in our grass-clover mixture. With a higher clover percentage in the dry matter this might be different.

## References

- Bouché M.B. and Al-Addan F. (1997) Earthworms, water infiltration and soil stability: some new assessments. *Soil Biology and Biochemistry* 29, 441-452.
- Clements R.O., Murray P.J. and Sturdy R.G. (1991) The impact of 20 years' absence of earthworms and three levels of N fertilizers on a grassland environment. *Agriculture Ecosystems and Environment* 36, 75-85.
- Edwards W.M. and Shipitalo M.J. (1998) Consequences of earthworms in agricultural soils: aggregation and porosity. In: Edwards C.A. (Eds.) *Earthworm Ecology*. St Lucie Press, Boca Raton, FL, 147-161.
- Evans P.S. (1977) Comparative root morphology of some pasture grasses and clovers. *New Zealand Journal of Agricultural Research* 20, 331-335.
- Mytton L.R., Cresswell A. and Colbourn P. (1993) Improvement in soil structure associated with white clover. *Grass and Forage Science* 48, 84-90.
- Robinson G.S. and Jacques W.A. (1958) Root development in some common New Zealand pasture plants: Effect of pure sowings of some grasses and clovers on the structure of a Tokomaru silt loam. *New Zealand Journal of Agricultural Research* 1, 199-216.
- Sears P.D. (1950) Soil fertility and pasture growth. *Journal of the British Grassland Society* 5, 267-280.
- Van Eekeren N., Smeding F.W., De Vries F.T. and Bloem J. (2005) Analysis of the soil food web structure under grass and grass-clover. In: Wachendorf M., Helgadóttir A., Parente G. (Eds.), *Sward dynamic, N-flows and forage utilisation in legume-based systems, Proceedings of the 2<sup>nd</sup> COST 852 workshop in Grado*, pp. 37-40.
- Van Eekeren N., van Liere D., de Vries F., Rutgers M., de Goede R. and Brussaard L. (2009) A mixture of grass and clover combines the positive effects of both plant species on selected soil biota. *Applied Soil Ecology* 42, 254-263.

# <sup>13</sup>Carbon allocated to the leaf growth zone of *Poa pratensis* reflects soil water and vapour pressure deficit

Auerswald K., Landinger C., Wittmer M. and Schnyder H.

Lehrstuhl für Grünlandlehre, Technische Universität München, D-85350 Freising

Corresponding author: wittmer@wzw.tum.de

## Abstract

Leaf expansion is extremely sensitive to water stress caused by a shortage of soil water content or a high vapour pressure deficit. Both parameters also influence stomatal opening, which affects the discrimination of the heavier carbon isotope (<sup>13</sup>C) during photosynthesis. Thus, photosynthates reflect the water status of the leaf by their <sup>13</sup>C content and this signal is incorporated in the leaf growth zone. This mechanism was elaborated by analysing the <sup>13</sup>C content of the leaf growth zone of *Poa pratensis* sampled at eleven sites with different soil organic carbon and at three different times (early spring to mid summer) during the growing period to cover wide ranges in soil water content (15-500 mm for 1 m depth) and vapour pressure deficit (0.5-2 kPa). Discrimination varied by about 5‰. This variation and hence stomatal opening of *P. pratensis* was mainly determined by vapour pressure deficit and less by the soil water content. A large vapour pressure deficit, however, only occurred during times of low soil water content. The combined effect of both influences was described best by the ratio of vapour pressure deficit and the logarithm of soil water content. Analysis of <sup>13</sup>C in the leaf growth zone offers an elegant way to record stomatal opening as influenced by water stress with high temporal resolution.

Keywords: 13-C, isotope, natural abundance, discrimination, Kentucky bluegrass

## Introduction

Water stress is recorded in the isotopic composition of the assimilates as it affects stomatal opening, which in turn modifies discrimination ( $\Delta$ ) of the heavier <sup>13</sup>C because of the coupling of water vapour loss and CO<sub>2</sub> assimilation through the stomata. Schnyder *et al.* (2006) have shown that differences in water availability lead to an isotopic signal that is transferred from herbage to grazer tissues. A much finer spatio-temporal resolution, and hence more direct insight into the effects of water stress, should be possible by analysis of the carbon isotope composition ( $\delta^{13}\text{C}$ ) of the leaf growth zone (LGZ), which is fed by recent assimilates and hence records water stress within the rooting area of a plant at a daily resolution.

Water stress, in principle, results from two drivers: the soil water content (SWC) and the water vapour deficit (VPD) of the atmosphere. The  $\delta^{13}\text{C}$  of the LGZ could allow quantification of the contribution of each driver to actual water stress in natural conditions. A major constraint in analysing this relation, however, results from the poorly defined root zone, which gradually fades out into the unrooted subsoil and thus only allows quantifying SWC by assuming the construct of an “effective” root depth. This difficulty in the quantification of the SWC is reduced where root depth is defined by a discontinuity between a fine-grained, shallow, well-rooted soil over permeable but unrooted coarse sediment.

Here, we tested the hypothesis that the LGZ is a high-resolution recorder of water stress. We use this to quantify the influence of VPD and SWC within a wide range of water stress in natural conditions. To do this, we took advantage of fully drained peat soils overlaying gravel, which provided a wide range of rooting depths that are well defined due to a sharp discontinuity between peat and gravel. Other soil properties and grazing conditions were similar.

## Material and methods

The investigations were carried out on the Grünschaige Grassland Research Station (48°23'N 11°50'E, 435 m a.s.l.) situated at the north end of the Munich Gravel Plain, Germany. The leaf growth zone (lower half between the last nodium and the ligule) of *Poa pratensis* was sampled three times (early spring to mid summer) at 10-11 sites differing in soil water capacity to cover wide ranges in SWC and VPD. Volumetric SWC was determined by taking soil cores of the peat soil. The soils were well above the groundwater table during sampling. Plant available water was modelled following Allen *et al.* (1998) and yielded  $r^2 = 0.8$  with SWC. Both were largely determined by soil depth, which varied from 5 to 95 cm. VPD was taken from a meteorological station in 3 km distance. The  $\delta^{13}\text{C}$  of the LGZ was measured and  $\Delta$  was calculated by taking into account the seasonal variation of  $\delta^{13}\text{C}$  in air  $\text{CO}_2$ . The calculations followed Wittmer *et al.* (2008).

## Results

The air temperature at the time of sampling varied between 10 and 25 °C, VPD varied between 0.5 and 1.2 kPa. SWC varied between 15 and 500 mm between sites and dates while plant available water differed between 10 and >200 mm. The  $\Delta$  varied by about 5 ‰.  $\Delta$  strongly decreased with increasing VPD (Fig. 1A) and it increased with increasing SWC (Fig. 1B). The influence of SWC was sub-proportional (logarithmic), indicating that an increase in water supply had a stronger effect if the initial SWC was low than on an initially wet soil. Furthermore, the influence of SWC seemed to be smaller ( $r^2 = 0.18$ ,  $P < 0.05$ ) than that of VPD ( $r^2 = 0.48$ ,  $P < 0.001$ ) and the regression was shifted between dates. Combining both counteracting influences in a ratio VPD/lg(SWC) then explained 58% of the variation (root mean squared error: 1.25 ‰) between samples (Fig. 1C). More importantly, the regression for the individual dates did not deviate from the overall regression, indicating that VPD/lg(SWC) fully accounted for the spatio-temporal variation of  $\Delta$ .

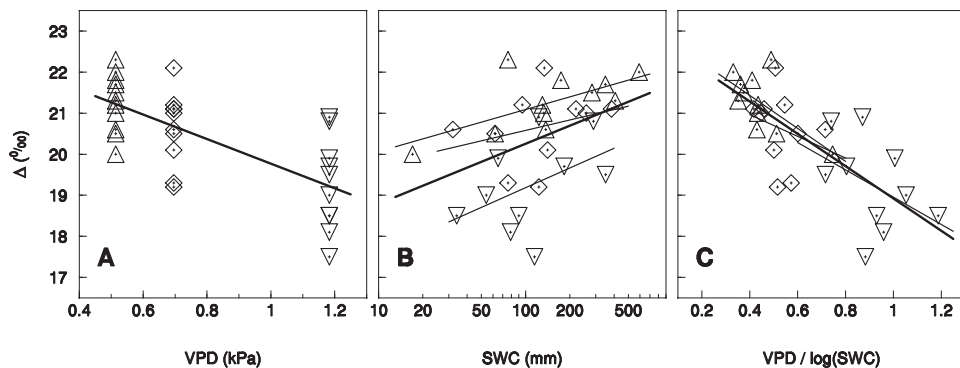

Fig. 1. Influence of vapour pressure deficit (VPD) (A), soil water content (SWC) (B) and the ratio of VPD and the logarithm of SWC (C) on  $^{13}\text{C}$  discrimination ( $\Delta$ ) as recorded in the leaf growth zone. (Upright triangles = April, diamonds = May, downward triangles = July; thick line = overall regression; thin lines = monthly regressions)

## Discussion

The  $\delta^{13}\text{C}$  of the LGZ sensitively recorded differences in water availability (SWC) and water demand (VPD), confirming that internal  $\text{CO}_2$  concentration was strongly influenced by both parameters. The influence of VPD differences between dates seemed to be more pronounced

than that of SWC, although VPD differed only by a factor of three, while SWC differed by two orders of magnitude. However, a high VPD was generally associated with a low SWC. The seasonal trend of VPD hence also included some seasonal variation in SWC. Both influences were thus not fully separated in natural conditions.

This also implied that sites of low water storage capacity profited from nearby soils of high storage capacity, which caused VPD to be lower than would be the case if only soils of low storage capacity were present. The influence of soil water availability on stomatal opening, discrimination and water use efficiency thus not only depended on the soil properties in the rooting zone of a particular plant but also on soil properties on a larger scale, which is large enough to influence VPD substantially.

In consequence, the influence of SWC must become more important on a larger spatial scale, which integrates over the mosaic of soils, and on a larger temporal scale, because daily fluctuations in VPD level out while the effects of the slowly changing SWC accumulate. This agrees with the finding by Schnyder *et al.* (2006) that the variation in discrimination between pastures and between years was closely related to the variation in SWC on the examined scale.

Interestingly, the response of  $\Delta$  towards SWC (either when tested alone or as ratio VPD/lg(SWC)) did not differ with VPD. This indicates that the influence of SWC is independent from the influence of VPD, although at low VPD usually also the range in SWC is smaller than at high VPD (the standard deviation of SWC was 175 mm at VPD = 0.5 kPa, while it was 105 mm at VPD = 1.2 kPa).

## Conclusions

The LGZ records stomatal opening as influenced by water stress with high temporal resolution. In this study, VPD had a stronger effect on this signal than SWC.

## References

- Allen G.A., Pereira L.S., Raes D. and Smith M. (1998) *Crop Evapotranspiration – Guidelines for Computing Crop Water Requirements*. FAO Irrigation and Drainage Paper 56, 293 pp.
- Schnyder H., Schwertl M., Auerswald K. and Schäufele R. (2006) Hair of grazing cattle provides an integrated measure of the effects of site conditions and interannual weather variability on  $\delta^{13}\text{C}$  of temperate humid grassland. *Global Change Biology* 12, 1315–1329.
- Wittmer M.H.O.M., Auerswald K., Tungalag R., Bai Y.F., Schäufele R. and Schnyder H. (2008) Carbon isotope discrimination of C3 vegetation in Central Asian Grassland as related to long-term and short-term precipitation patterns. *Biogeosciences* 5, 913-924.



# Influence of drought stress and fertilisation on carbon isotopes as indicators of water use of grassland differing in diversity

Wrage N., Gauckler L., Steep E., Küchenmeister F., Küchenmeister K. and Isselstein J.  
*University of Goettingen, Department of Crop Sciences, Grassland Science*  
Corresponding author: nwrage@gwdg.de

## Abstract

Plant diversity in grassland may influence the water use of a sward due to complementary use of the rooting zone. An indicator of the water use of C<sub>3</sub> plants is their natural abundance of the carbon isotope <sup>13</sup>C. Without water stress, plants may fractionate more against <sup>13</sup>C than with water stress, leading to a stronger depletion of <sup>13</sup>C in plant material. We have used this principle to investigate the water use of grassland differing in diversity. In old grassland, diversity was altered three years before this experiment by applying a herbicide against dicots in half of the plots. On sub-plots, different combinations of rainout shelters (yes-no) and N fertilisation (0 or 90 kg ha<sup>-1</sup>) were established. Differences between drought treatments were clearly reflected in <sup>13</sup>C values. N fertilisation led to a further enrichment in <sup>13</sup>C, especially in unsheltered conditions. This could be explained by increased biomass production, which might have led to higher water use, and enhanced CO<sub>2</sub> fixation capacity. Unexpectedly, plant diversity did not have a significant influence on the isotopic composition. This was perhaps due to the occurrence of the deep-rooted *Taraxacum* sp. on all plots and the similar species numbers in herbicide-treated and -untreated plots.

Keywords: rainout shelter, nitrogen, dicot, biomass production, <sup>13</sup>C, stable isotope

## Introduction

Climate change will likely increase the occurrence of droughts (IPCC, 2007). To enable sufficiently large production, agricultural management needs to become efficient not only in terms of nutrients and energy, but also in water use. Plant diversity has been suggested to influence the water use of a sward. Different rooting depths of coexisting species increased the water use of more diverse grassland systems (Caldeira *et al.*, 2001). So far, experiments testing for the relationship between phytodiversity and water stress have been conducted on experimental grassland under conditions not readily comparable to agricultural situations. Here, we carried out an experiment on an old grassland sward where diversity was altered by herbicide application. As one indicator of water use, carbon isotopes were measured in plant material. When sufficient water is available and the stomata are wide-open, CO<sub>2</sub> can exchange rapidly between ambient air and the leaf internal spaces. For a given photosynthetic capacity, this effect causes a strong <sup>13</sup>CO<sub>2</sub> discrimination (meaning <sup>13</sup>C depletion) in photosynthesis. The reverse occurs under drought, leading to a relative enrichment of <sup>13</sup>C in plant biomass. We hypothesised that diverse grassland would suffer less from drought stress, leading to larger biomass production and depleted <sup>13</sup>C values compared to less diverse grassland. N fertilisation should aggravate drought conditions, thus increasing the observed effects.

## Material and methods

The experiment was carried out in 2009 at the experimental farm of the University of Goettingen at Relliehausen on grassland that was at least 14 years old. In September 2006, main plots differing in diversity were established by treating half of them with herbicides against dicots (n = 4). We combined sub-plots with or without rainout shelters and with or

without N fertilisation on each main plot, giving four different sub-plots per main plot. Rainout-shelters were installed for five weeks from the beginning of May. N fertilisation was with 90 kg ha<sup>-1</sup> (calcium ammonium nitrate) one week before installation of the shelters.

As a measure of phytodiversity, the yield percentage of main species was estimated three weeks after establishment of the shelters. Aboveground biomass was harvested two weeks later, dried (60 °C), weighed, milled, and samples measured for <sup>13</sup>C on an isotope ratio mass spectrometer. We analysed bulk samples, as earlier measurements gave no significant differences in δ<sup>13</sup>C between functional groups on these plots. Isotopic values are given as δ<sup>13</sup>C values:

$$\delta^{13}\text{C} [\text{‰}] = \left( \frac{^{13}\text{C}/^{12}\text{C}_{\text{sa}}}{^{13}\text{C}/^{12}\text{C}_{\text{std}}} - 1 \right) \times 1000, \text{ where sa} = \text{sample and std} = \text{standard (V-PDB)}.$$

At the time of harvest, soil samples were taken of the top 10 cm to measure gravimetric water content.

Differences between treatments were analysed with ANOVA according to a hierarchical design with diversity on the main plot and drought stress and fertilisation on sub-plots (R, α = 0.05). Correlations were analysed with Pearson's correlation coefficient (Statistica 9.0).

## Results

The yield percentage of main dicots was larger on diverse than on herbicide-treated plots (average 21% vs. 3%, Table 1). Irrespective of the herbicide treatment, the dicot biomass was mainly composed of *Taraxacum sp.* The most abundant species were *Phleum pratense*, *Dactylis glomerata* and *Festuca arundinacea*. Species numbers were similar on both diversity treatments (Table 1).

The rainout shelters led to a significant decrease of the water content in the top 10 cm of soil at the end of the sheltering period (Table 1; 11% vs. 18% and 10% vs. 20% in unfertilised diverse and non-diverse plots, respectively). Fertilisation only significantly reduced the water content on fertilised, unsheltered plots compared to unfertilised, unsheltered plots (15% vs. 18% and 17% vs. 20% for diverse and non diverse plots, respectively). Diversity did not have a significant influence on the water content in the top 10 cm, although there was a trend to lower water content on diverse, unsheltered plots compared to herbicide-treated, unsheltered plots (Table 1).

Table 1: Main results of the experiment. Diversity was manipulated by herbicide treatment against dicots. Drought stress was applied by installation of rainout shelters for five weeks. N fertilisation was carried out on subplots with or without 90 kg ha<sup>-1</sup>. Shown are means (n = 4). The first two parameters are shown for species with a percentage cover larger than 2%.

	diverse				non diverse			
	unsheltered		sheltered		unsheltered		sheltered	
	0 N	90 N	0 N	90 N	0 N	90 N	0 N	90 N
Number main species	8.0	8.0	7.0	7.3	6.3	7.0	6.0	6.8
Yield percentage main dicots [%]	24.5	17.8	31.3	8.8	1.5	4.5	2.3	2.3
Water content 0-10 cm [%]	17.8	15.0	10.7	10.2	19.8	17.0	9.8	9.4
Biomass [g/m <sup>2</sup> ]	451.4	581.5	288.4	458.3	437.4	565.1	360.5	434.7
δ <sup>13</sup> C [‰]	-28.1	-27.7	-27.4	-26.2	-28.2	-27.8	-27.4	-26.6

The biomass production was not significantly influenced by plant diversity (Table 1). It was, however, significantly larger on unsheltered, fertilised relative to unfertilised plots (573 vs. 444 g m<sup>-2</sup>) and smaller on sheltered, unfertilised plots (325 g m<sup>-2</sup>). The biomass production on sheltered, fertilised plots did not differ significantly from that on the other treatments (447 g m<sup>-2</sup>).

Plant diversity did also not affect <sup>13</sup>C values significantly (Table 1). Biomass on sheltered

plots was significantly less depleted in  $^{13}\text{C}$  than that on unsheltered plots. N fertilisation led to a significant further enrichment of  $^{13}\text{C}$ .

There was a significant correlation between soil water content in the top 10 cm and the  $\delta^{13}\text{C}$  values of the vegetation ( $P < 0.05$ ;  $r = -0.612$ ). However, there was no significant correlation between biomass production and soil water content, while percentage cover and soil water content ( $P < 0.05$ ,  $r = 0.475$ ) as well as percentage cover and biomass production ( $P < 0.05$ ,  $r = 0.644$ ) revealed significant correlations.

## Discussion

Unexpectedly, phytodiversity had no significant effect on water content in the top 10 cm of soil, biomass production, or the  $^{13}\text{C}$  value as an indicator of water use. This could have been due to the occurrence of *Taraxacum sp.* on all plots. With its deep roots, this species could have allowed a complementary use of the soil resources, including water, also on the herbicide-treated plots. However, as its yield percentage was much lower on herbicide-treated than -untreated plots, the missing effect of phytodiversity could also be due to the comparable number of species in both diversity treatments (Table 1).

N fertilisation increased biomass production as expected on rainfed plots. At the same time, soil water content decreased and  $\delta^{13}\text{C}$  increased. Probably, the increased biomass led to a larger use of water (indicated by the correlation between percentage cover and soil water content), in turn increasing water stress for the plants, leading to the observed  $^{13}\text{C}$  values. Furthermore, an increase in Rubisco and thus  $\text{CO}_2$  fixation capacity following N fertilisation could have caused the increased  $\delta^{13}\text{C}$ . A similar effect of fertilisation on biomass production and soil water was missing under rain-sheltered conditions. Here, the reduced water content, which was not affected further by fertilisation, probably limited a significant increase in biomass production. However, there was a trend towards a larger biomass production, influencing  $^{13}\text{C}$  values.

## Conclusions

We did not find indications for increased productivity or improved water use with higher phytodiversity in this old grassland system, perhaps due to the similar species numbers and the occurrence of deep-rooted *Taraxacum sp.* on all plots. Therefore, the experiment should be repeated in grassland showing larger differences in plant composition before conclusions are drawn concerning the importance of biodiversity in old grassland with respect to water stress. N fertilisation was shown to increase water stress of grassland vegetation, probably due to enhanced biomass production and  $\text{CO}_2$  fixation capacity.

## References

- Caldeira M.C., Ryel R.J., Lawton J.H., and Pereira J.S. (2001) Mechanisms of positive biodiversity-production relationships: insights provided by  $\delta^{13}\text{C}$  analysis in experimental Mediterranean grassland plots, *Ecology Letters*, 4, 439-443.
- IPCC (2007) *Climate Change 2007: Synthesis Report*. Contribution of Working Groups I, II and III to the Fourth Assessment Report of the Intergovernmental Panel on Climate Change IPCC, Geneva, Switzerland.

# Session 5

## Pastoral/grazing systems



# Producing milk from grazing to reconcile economic and environmental performances

Peyraud J.L.<sup>1,2</sup>, Van den Pol-van Dasselaar A.<sup>3</sup>, Dillon P.<sup>4</sup> and Delaby L.<sup>1,2</sup>

<sup>1</sup> INRA, UMR 1080 Production du lait, F-35590 St Gilles

<sup>2</sup> Agrocampus Ouest, UMR 1080 Production du lait, F-35590 St Gilles

<sup>3</sup> Wageningen UR Livestock Research, P.O. Box 65, 8200 AB Lelystad, the Netherlands

<sup>4</sup> TEAGASC, Moorepark Dairy production research Centre, Fermoy. Co. Cork

Corresponding author: jean-louis.peyraud@rennes.inra.fr

## Abstract

Several reports, directives, regulations and initiatives challenge high-input dairy systems at the environmental level. At the same time the dairy sector has to adapt to a greater volatility of prices and to the projected increase in energy and fertiliser prices. In this new context, it should be considered whether the model of development based on intensification, often in connection with the reduction in the use of grazing, is always well adapted. Dairy systems that maximise grass utilisation appear to be highly competitive and the various roles of grassland in providing regulating and supporting services are now widely recognized. Thus grassland should form the basis of more sustainable dairy systems in the future, provided technical innovations are produced to improve the efficiency of grassland-based dairy systems. Innovations in forage production, innovations in characteristics of the cows and management of lactations, as well as innovations in the management of the system have potential for increasing economic and environmental performances of grassland-based systems. The more systematic use of legume forages in multi-species swards makes it possible to reduce the consumption of mineral N, to reduce the carbon footprint of the dairy system, to regularize the forage production over the year and to increase the nutritional quality of the forages. It clearly appears that intensive selection for milk based on high concentrate diets has generally resulted in genotypes that are not well suited for systems maximising forage utilisation. In these systems there needs to be a special focus to address fertility, survival and other functional traits such as mastitis resistance, although high genetic merit for milk should be maintained to produce efficient responses to concentrate supply. Finally, extending the grazing season with early turnout or late grazing, and tactical use of grazing in association with conserved forages in large herds, offers many opportunities to reduce the requirement of expensive conserved forage and to reduce the utilisation of purchased feeds. All these potential sources of progress are discussed.

## 1. Introduction

High milk prices have encouraged dairying systems using high inputs of chemical fertilizers, concentrate feeds and mechanised methods for silage production at the expense of grazing. The use of grazing for milk production has decreased considerably over the last 30 years (Bourgeois, 2002) and the number of cows which are kept indoors for all or part of the herbage growing season has increased considerably in many European countries (Van den Pol-van Dasselaar *et al.*, 2008). These tendencies were largely reinforced by the convenience of managing dairy herds indoors particularly with cows calving in autumn and fed with maize silage, whereas dairy farmers have many difficulties to organize the feeding programme of grazing dairy herds in time and space from an unstable feed resource. For forty years the selection of dairy cows has been almost exclusively oriented toward genetic potential for milk production. Today, high genetic merit Holstein cows are able to produce more than 10000 kg milk per lactation in high-input farming systems but can not produce such an amount of milk

from grazing alone. This has largely contributed to reduce the use of grazing, especially in countries in the North of Europe. More recently, the increasing use of automated milking systems also makes grazing more difficult, although the combination of grazing and milking robot is possible (Wiktorsson and Spöndly, 2002). Increased herd size may be another reason for the decreasing of grazing, at least for countries in the North of Europe where pressure for land use and stocking rate are high.

The context has gradually changed since the early 1990s primarily with the emergence of environmental regulation considering water quality in a first step (the Nitrate Directive, the Water framework Directive) and the agri-environmental measures will become gradually more restrictive and will define new priorities. Apart from nitrate, ruminant production systems are also considered to be responsible for the emission of large quantities of greenhouse gases (FAO, 2006; Steinfeld *et al.*, 2006). More recently the projected fall or instability of price of milk and the projected price increase of non-renewable energy and mineral fertilizers will reinforce the necessity to engage a new era of development. This new context offers new opportunities for dairying systems based on grasslands and grazing. Indeed, grazing is not only a relatively cheap source of feed for ruminants but grasslands are increasingly recognised for their contributions to the conservation of biodiversity, regulation of physical and chemical fluxes in ecosystems, the mitigation of pollution, and especially carbon sequestration which might partly counteract methane emissions from ruminants, and also the protection of soils (MEA, 2005). Additionally, grassland-based systems promote a clean, animal welfare-friendly image for ruminant production, and open landscapes with grazing ruminants are highly appreciated by the public. The objective of this paper is to review existing knowledge for developing productive, efficient and environmentally friendly dairying systems based on grazing and grassland utilisation and using level of inputs as low as possible.

## **2. Improved grassland utilisation can increase sustainability of dairying systems**

### **2.1. Grassland utilisation has many assets to combine economic and environmental performances**

The comparisons made at the world level show that dairying systems maximising grassland utilisation appear to be highly competitive. A study of international competitiveness (Fig. 1) shows that the total cost of production is negatively related to the proportion of grass in the cow's diet (Dillon *et al.*, 2008). This cost is therefore 50 to 60% higher in Denmark and in The Netherlands than in Ireland, whereas France and UK are intermediate. For similar climatic conditions grazing is still more economically attractive than indoor-feeding systems. Models indicate that in Ireland early grazing will generate an increased profitability of € 2.70 per cow and day for each extra day at grass, through higher animal performance and lower feed costs (Kennedy *et al.*, 2005). Similarly in the Netherlands, the more grass the cows eat at pasture the larger is the farmer's income. Only in situations with more than 10 cows ha<sup>-1</sup> grazing surface is indoor feeding more profitable than grazing (Van den Pol *et al.*, 2010).

Using life cycle assessment, Basset-Mens *et al.* (2005) have shown that global warming potential per kg milk is 30 to 80% lower in the New Zealand dairying systems, which rely essentially on permanent white clover-grass pastures grazed all around the year than in conventional intensive dairying systems encountered in Sweden and in southern Germany (0.72 vs. 1.2 kg kg<sup>-1</sup> CO<sub>2</sub> eq per milk) which rely mainly on conserved forages and high amount of concentrates. Organic dairy Swedish systems and extensive dairying systems in Germany are intermediate (1.0 kg kg<sup>-1</sup> CO<sub>2</sub> eq per milk). It is also noticeable that total consumption of non-renewable energy is reduced in grassland-based systems. This might confer a decisive advantage to these systems in the case of high price of energy in the future.



In the study of Basset-Mens *et al.* (2005), total consumption of energy is two times less in New Zealand systems than in intensive European dairy systems. Le Gall *et al.* (2009) have calculated that energy consumption to produce one kg of milk decreases from 5.0 MJ for intensive dairy farms in Netherlands to 4.0 for French farms using maize silage and fertilised grasses pastures to 3.1, and to 1.4 for Irish systems based on fertilized ryegrass pastures and 1.4 for NZ farms. Increasing the proportion of grassland in arable land linearly decreases the utilisation of pesticides as shown in the European project Greendairy (Raison *et al.*, 2008).

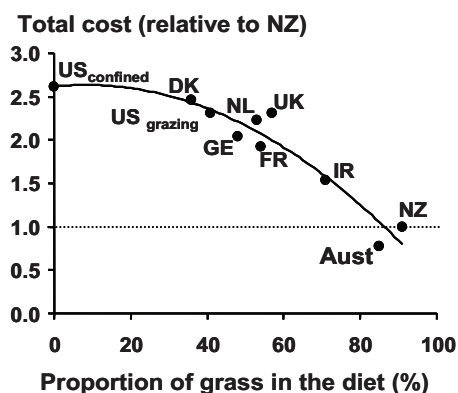

Figure 1. Total cost (expressed relative to New Zealand costs) of milk production according to the proportion of grass in the annual diets of the cows (adapted from Dillon *et al.*, 2008)

## 2.2 Technical innovations are required to enhance the sustainability and competitiveness of grassland based dairying systems

Dry matter (DM) intake and milk yield of grazing dairy cows are limited compared to conserved forage-based diets (Kolver and Muller, 1998). High genetic merit cows are able to eat more grass and the marginal increase of daily intake with genetic merit for milk covers approximately two-thirds of the additional energy requirements associated with the increase in milk potential (Peyraud *et al.*, 2004). Consequently, a grassland-based system prevents high genetic merit cows from fully expressing their milk potential despite high amounts of concentrate being provided. However, several trials have shown that relatively high milk production (i.e. 7400 kg per lactation) is achievable with high genetic merit cows in grassland-based systems with only 350 kg of concentrate (Buckley *et al.*, 2000; Kennedy *et al.*, 2002; Horan *et al.*, 2005; Delaby *et al.*, 2010) at least under areas well suited for giving high yields of grass over a prolonged grazing season. Herbage allowance is one of the primary factors influencing herbage intake (Peyraud *et al.*, 2004) and high herbage allowance is required to achieve maximum intake and milk yield per cow. The implication is that grazing systems designed to maximise individual animal performance are inefficient in utilisation per ha. To solve the dilemma of a high herbage intake per cow versus high utilisation of herbage per ha, sward structures and grassland management allowing the maintenance of a high intake together with a low residual sward height must be determined.

There is a large variation both between and within countries in the grass-growth season and expected yield and the contribution of pasture to the total energy supply should vary, but in all cases grazed forage must be at the maximum to reduce the cost. The length of the grass-growing season varies from about 5 months in the north Europe to up to 11 months. Grass grows regularly from the spring to autumn in the western part of Europe (UK, Irish Republic, Normandy in France). The most favourable regions with humid summers have a DM yield potential of 15000 kg ha<sup>-1</sup> and of 20000 kg ha<sup>-1</sup> milk (Holmes, 1980; Delaby and Peyraud,

1998). In other regions the grass growth curves are usually characterised by having a summer drought during most of the years, which obliges farmers to house their animals, or a cold spring; these limitations reduce the grazing season to 4 or 5 months and DM yield to 5000 or 6000 kg ha<sup>-1</sup>. Grazing also suffers from the difficulties of management. The feed resource is not stable during the season and there is large inter-annual growth curve variability. Therefore, animal performances may be variable and this is not well accepted by farmers. The use of on/off grazing that means combination between restricted access time to pasture and indoors feeding should be investigated to increase grassland utilisation and reduce variability of animal performances, even for systems having a very high stocking rate and short grass-growing season.

The relative importance of the multiple functions provided to society by grasslands varies depending on regional contexts, grassland type and type of management. It is not well known how well the different grassland management systems and their localisations perform in delivering ecosystem services. In particular, the role of grazing on regulation of N flows is questionable. It is well established that much higher amounts of N are leached from grazed pastures than from cut pastures, mainly because of animal-N depositions as direct returns on the field (Decau *et al.*, 1997; Wachendorf *et al.*, 2004). Under highly fertilized pure-grass pastures relatively large amounts of nitrate may be leached and there may be relatively large emissions of nitrous oxide (N<sub>2</sub>O). Losses of N<sub>2</sub>O-N up to 29 kg ha<sup>-1</sup> yr<sup>-1</sup> have been reported on Irish grassland receiving 390 kg ha<sup>-1</sup> yr<sup>-1</sup> N (Hyde *et al.*, 2006). Estimates of N leached from grazed pastures vary widely. Summarizing data from New Zealand, France and Denmark, Ledgard *et al.* (2009) have shown that nitrate-N leached remains below 50 kg ha<sup>-1</sup> yr<sup>-1</sup> so long as total mineral N inputs are lower than 300 kg ha<sup>-1</sup> yr<sup>-1</sup>. In Europe, many dairy production systems are to a large extent based on ley-arable rotations that are characterized by three phases: pasture, ploughing out and subsequent arable cropping (Vertès *et al.*, 2007). These systems present more important risks of nitrate leaching than the systems based on permanent grassland as shown in the European project Greendairy (Raison *et al.*, 2008) and they require a great technical control to reduce the nitrate losses to the minimum. The release of accumulated soil N following pasture cultivation often exceeds 100 kg ha<sup>-1</sup> (Vertès *et al.*, 2007; Eriksen *et al.*, 2008).

### **3. Multi species swards with forage legumes (MSS) should form the basis of more sustainable dairy systems**

Difficulties in maintaining well-balanced mixtures and the tendency to lose key species in multi species swards (MSS) (Guckert and Hay, 2001) contribute to the prevalence in temperate grasslands of grass monocultures, with associated significant inputs of synthetic fertilisers. Yet legumes can have an important contribution in sustainable ruminant production systems in the future. They potentially allow the reduction of inputs of purchased mineral N and concentrate N, considering their ability to use atmospheric N for producing home grown proteins and their high nutritional value.

#### **3.1. Multi species swards increase productivity compared to pure grass pastures**

A pan-European experiment was carried out at 28 sites in 17 countries across Europe. At each site, the two most important forage grasses and the two most important forage legumes were tested and the management of the swards followed local recommendations for best agricultural practice. Monocultures and mixtures of the four species were managed at the same cutting frequency and the same fertilizer inputs. The results (Fig. 2) showed strong benefits of grass-clover mixtures containing four species as compared to these species sown in monoculture (Kirwan *et al.* 2007; Lüscher *et al.*, 2008) for all sites. There was even

significant transgressive over-yielding for most of the mixtures (higher yield than best monoculture yield). For the mid-European and north-European sites, all the mixtures yielded more than the best monoculture. This occurred even though mixtures were sown with widely varying species proportions (from 10 to 70% for each species). This result persisted over the 3 years of the experiment, with transgressive over-yielding being 6%, 20% and 16% in years 1, 2 and 3 respectively.

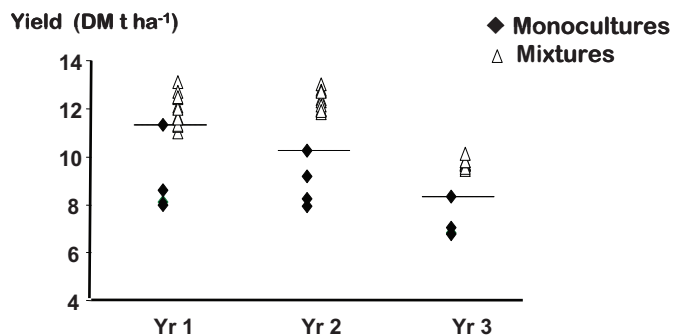

Figure 2. Total dry matter (DM) yield across sites of four monocultures (♦; horizontal dotted lines indicate the maximum) and 11 grass-legume mixtures with strongly varying species proportions (Δ) for harvest year 1 to 3 (adapted from Kirwan *et al.*, 2007).

Yield benefits of grass-clover mixtures are equivalent to 150-350 kg ha<sup>-1</sup> fertilizer N. Comparing the yield of heavily N-fertilised grass swards with the yield of moderately fertilised grass-clover mixtures illustrates the potential N fertiliser savings associated with grass-clover mixtures. At the Swiss site in Zurich, additional plots were sown alongside the pan-European experiment to investigate the effect of three N fertiliser levels (50, 150 and 450 kg ha<sup>-1</sup> yr<sup>-1</sup> (Nyfeler *et al.*, 2009). Grass-clover mixtures fertilised with 50 or 150 kg ha<sup>-1</sup> yr<sup>-1</sup> N attained yields in the range of the heavily fertilised (450 kg ha<sup>-1</sup> yr<sup>-1</sup> N) monocultures of the highly productive grass, with clover percentage in the mixture ranging from 30 to 80%. To define more precisely the potential of the grass-clover mixtures compared to pure grass stands for the different soil and climatic conditions encountered in the west part of France, more than 400 fields on commercial farms were monitored for several years (Institut de l'Élevage, 2004). The study confirms that the productivity of mixed pastures is directly related to the contribution of clover. The DM production of grass-clover mixtures increases by 7.2 to 7.9 and 9.2 t ha<sup>-1</sup> for clover contributions of, respectively, less than 20%, 20-40% and 40-60% in summer. On good and deep soils and with a sufficient water supply in summer, mixed pastures produce almost as much DM as the pure grasses pastures receiving 200 to 250 kg ha<sup>-1</sup> (9.6 vs. 9.8 t ha<sup>-1</sup>). In dry conditions, grass-clover mixtures produce less than pure stands because the reduction or cessation of growth during summer does not make it possible to compensate for the latespring start of production of mixed pasture.

Using grass-clover mixtures also offers the possibility to extend the herbage growth season. Characteristic within-season growth patterns favour the grasses in spring, during reproductive growth, and the legumes in summer when temperatures are high (Lüscher *et al.*, 2005). Thus the production of mixed pastures is generally shifted about the summer. At the opposite, a major objective of grass breeders is to increase the length of the growing season of ryegrass, and increased productivity of new ryegrass variety is mainly due to slightly longer growth period and there is no indication that any limit has been reached from continuous selection (Wilson, 1993).

### 3.2. Multi-species swards can sustain high animal performances

At grazing, herbage intake is higher on grass-clover mixtures than on pure stands. In the studies conducted in Rennes (Ribeiro Filho *et al.*, 2003; 2005), mixed pastures steadily increased DM intake and milk yield (on average 1.5 kg d<sup>-1</sup>) whatever the level of herbage allowance. Besides the positive effect of legumes on voluntary intake, which is well established (INRA, 1989), it is also probable that leaves of legumes are more favourable for prehension than stems and sheaths of grasses. Thus Ribeiro-Filho *et al.* (2003) have reported that higher intake on white clover-grass pastures is mediated through a higher rate of intake on mixed pastures compared to pure perennial ryegrass pastures. One of the most decisive advantages of white clover is that the rate of decline of nutritional quality throughout the plant-ageing process is far less than for grasses (Peyraud, 1993; Dewhurst *et al.*, 2009). At grazing, the difference in DM intake between pure grass pastures and grass-clover mixtures increases with increasing age of the regrowth. Ribeiro-Filho *et al.* (2003) showed that herbage DM intake declines by 2.0 kg d<sup>-1</sup> on pure ryegrass pastures compared to 0.8 kg d<sup>-1</sup> on mixed pastures. This makes mixed pastures easier to manage than pure grass pastures. Age of regrowth can be increased without adverse effect on quality.

Increasing the content of white clover in pasture has increased milk yield by 1-3 kg per cow per day in several short-term trials conducted at similar herbage allowance (Philips and James, 1998; Ribeiro Filho *et al.*, 2003). The difference increases with clover content and reaches a maximum when white clover content averages 50-60% (Harris *et al.*, 1998). As a consequence of higher energy intake, milk protein content tends to increase on mixed pastures.

### 3.3. Multi-species swards have potential for reducing negative effects of intensive dairying systems on the environment

Forage legumes have potential for reducing nitrate leaching to some extent. This was well illustrated by Ledgard *et al.* (1999, Table 1) who measured the N inputs and outputs and N flows over three years in a trial involving three dairy farmlets (i.e. the herd and the experimental area required to feed the herd). The results clearly indicate that, from an environmental point of view, the intensively managed grass-clover mixtures are relatively efficient in terms of conversion of N inputs from N<sub>2</sub> fixation into milk, and in reducing N surplus at the field level. N in milk averaged 45% of N inputs for the 0 N farmlet compared with a value of only 22% for 400 N farmlet. Ledgard *et al.* (1999) have also quantified the different routes of N surplus. Leaching of nitrate-N was minimal for the 0 N farmlet and increased very rapidly with the level of fertilisation. Losses of N by denitrification remained small but were reduced on white clover-grass pastures. Nonetheless, it might be expected that N-nitrate leaching, and thus eutrophication potential, would rise with increasing legume content and thus level of N<sub>2</sub> fixation per hectare. Loiseau *et al.* (2001) have reported higher leaching losses from lysimeters when swards were sown with pure white clover (28 to 140 kg ha<sup>-1</sup>), whereas the losses from ryegrass-white clover swards were lower than 20 kg ha<sup>-1</sup> over the 6 years of the experiment. Similarly, in the study of Ledgard *et al.* (1999), the amount of nitrate-N leached varied greatly (20 to 74 kg ha<sup>-1</sup>) in the ryegrass-white clover paddocks and these variations are linked to the N<sub>2</sub> fixation by white clover. On ley-arable rotations, ploughing grass-clover mixtures can release large quantities of N, and fertilizer-N on subsequent cereal crops must be reduced to a minimum (Ledgard *et al.*, 2009) to reduce the risk of nitrate-N leaching.

Ruminant livestock production systems relying on grass-clover mixture utilisation have potential for reducing the consumption of non-renewable energy. Energy efficiency, calculated as herbage net energy produced per MJ of non-renewable energy consumed is 3

times higher for white clover-grass pastures compared to fertilised grasses pastures (17.7 kJ NE vs. 5.7 kJ NE/MJ new renewable energy, NE calculating according to INRA 1989; Besnard *et al.*, 2006). In New Zealand conditions, Basset-Mens *et al.* (2009) have shown that energy consumption per kg milk is 59% lower on a farmlet receiving 0 kg ha<sup>-1</sup> mineral N than on a farmlet receiving 140 kg ha<sup>-1</sup> mineral N. It is also noticeable that Basset-Mens *et al.* (2005) have shown, using LCA analysis and IPCC emission coefficients, that total energy consumption per kg of milk is two times less in New Zealand systems, which rely essentially on permanent grass-clover mixtures, than in intensive European systems using large amounts of fertiliser-N and concentrates.

Using grass-clover mixtures also reduces total greenhouse gas emissions and global warming potential per kg milk. Using Life Cycle Analysis, Ledgard *et al.* (2009) have shown that total greenhouse gas emissions per kg milk were 10% lower for 0N farmlets than for 207 N farmlets. In Sweden, Cederberg and Mattson (2000) have showed lower greenhouse gas emissions in organic systems using grass-clover swards than in conventional systems. Global warming potential of N<sub>2</sub>O is very high (310 times higher than that of CO<sub>2</sub>). This raises the question of N<sub>2</sub>O emission factors for grass-clover mixtures compared to using N-fertilizer. Available data are very rare. It appears that emissions might be smaller for mixed sward (0.2 vs. 1.3% N; Corré and Kasper, 2002) but this should be confirmed by further experimentation.

Table 1. Annual N flows (kg yr<sup>-1</sup>) for 3 dairy farmlets varying in N fertilizer and white clover content (adapted from Ledgard *et al.* (2009))

Farmlet	A	B	C
N fertilization	0	200	400
Stocking rate (cows ha <sup>-1</sup> y <sup>-1</sup> )	3.3	3.3	3.3
Inputs			
Mineral fertilizer	0	215	413
N <sub>2</sub> fixation	174	117	40
Others	5	6	5
Outputs			
Milk and meat	80	95	98
Harvested forages	1	15	28
Transferred excreta <sup>1</sup>	57	78	84
N surplus	41	150	248
Denitrification	5	15	25
Volatilisation	16	38	61
Leaching	40	79	150

<sup>1</sup> Transfer of N from the paddock to the lanes and milking shed via cow excreta

#### 4. Appropriate cows for successful temperate grassland-based systems

Until very recently the Holstein cow has been selected almost exclusively in high-input farming systems, with milk production and cow conformation being the predominant breeding-goal traits. Today, the genetic merit for milk potential makes it possible to obtain high performances by using well managed grassland-based systems and low levels of concentrate. Several trials have shown that it is possible to reach 7000 kg of milk per lactation, or even more, with Holstein cows in compacted spring-calving systems while supplying less than 500 kg of concentrate (Kennedy *et al.*, 2002; Horan *et al.*, 2005; Delaby *et al.*, 2009b). However, it is now well established that cows selected solely on milk have poorer fertility performances. This negative effect observed on high-input systems might be exacerbated in low-input grassland-based systems. Therefore the improvement of genetic merit for milk production does not appear any more to be the unique objective. The question of the suitability of high genetic-merit cow (HGM cow) and the place of alternative breeds for grassland-based systems must be asked (Dillon *et al.*, 2006).

#### **4.1. Improvement of cow fertility is a key issue for efficient grassland-based dairying systems**

Several trials have compared cow genotypes in grassland-based systems. Most of the studies were conducted in Ireland (Dillon *et al.*, 2003; Horan *et al.*, 2005, 2006; McCarthy *et al.*, 2007) and in France (Delaby *et al.*, 2009b, 2010) under compacted spring-calving seasonal systems. These experiments have all shown that HGM cow always produce more milk even on low-input systems. But HGM cows were also characterized by degraded reproductive performances for all indicators of fertility traditionally monitored (intervals to first service, pregnancy rates, and no-return rates). In particular the rate of culling was strongly increased for HGM cows (Evans *et al.*, 2006). This is well illustrated by the experiment of Dillon *et al.* (2003) who compared the performance of high genetic merit cows (Dutch genetics), Irish Holstein with a lower genetic merit for milk, and French Montbeliarde and Normande over a 5-year period with 137 lactation per breed. The Dutch Holstein produced more milk but significantly more Dutch Holstein cows were not pregnant at the end of the reproductive period. Reproduction performances of Irish Holstein cows were intermediate and the best results were obtained with the dual-purpose breed. Finally, after 5 years of experimentation, only 20% of the Dutch cows survived compared to 50% for the dual-purpose breed.

The undesirable side effects of high genetic merit for milk on reproduction and survival do not seem to be counteracted by adjustment of the management. Several trials have been conducted to explore the cow genotype x system interactions. Concentrate supplementation (Kennedy *et al.*, 2003; Delaby *et al.*, 2010) or an offer of more abundant grass (Buckley *et al.*, 2000; Horan *et al.*, 2004) did not correct for genetically induced inferior fertility of HGM cows. The additional nutrients provided are used to produce additional milk with no effect on reproductive performance in HGM cows. Increasing the rate of involuntary culling results in inflated replacement costs and might eliminate part of the economic benefit that can be achieved from selection (Evans *et al.*, 2006). Increasing the rate of culling also implies a need to increase the number of dairy cows to produce the same amount of milk, as younger cows are present in the herd and that first lactating cows produce less than adult animals. We have simulated that increasing the replacement rate from 20 to 35% in a herd of 100 cows will require an extra of 4 cows to produce the same amount of milk. This will increase the requirements of forage and thus of grassland area and will increase the emissions to the environment. Younger cows are also less efficient in their ability to convert forage into milk because intake capacity increases with the rank of lactation (Faverdin *et al.*, 2007).

It should be noted that infertility problems are less acute when compact calving is not required. This is the case when high quality forages are available all around the year, for example when maize silage can be used in periods of low or nil grass growth. In these situations the production of one calf per cow per year is not an absolute objective, and other lactation management can be considered. Lengthening of lactations, with a desired delayed first artificial insemination, offers several advantages such as reducing the non-productive periods and limiting the inherent risks associated to the beginning of lactation. This is not yet a common practice although 90000 lactations were recently recorded in Brittany, with 11200 kg milk over 440 days (Trou *et al.*, 2009). However, this strategy requires cows having a high persistency of lactation and success at first service, and low embryonic mortality still remains a key objective even if first service is voluntarily delayed.

#### **4.2. The ideal cow should be able to quickly adjust her level of production to the economical conditions**

Although grassland-based systems prevent HGM cows from fully expressing their milk potential, this does not remove the need for having animals of good milk potential especially



in a context of fluctuating prices to adjust the level of production to the current situation. In periods of high milk prices (as it was the case in 2008) it could be efficient to produce more milk by increasing the supply of concentrate. A good genetic potential for milk production guarantees an efficient milk response (about 1 kg of milk per kg of concentrate; Peyraud and Delaby, 2004). Horan *et al.* (2006) and McCarthy *et al.* (2007) have shown that compared to high-production North American cows, NZ cows have a much higher pregnancy rate: only 7% of NZ cows were not pregnant at the end of the breeding period compared to 26% of the HGM cows, but NZ cows have also low response to supplementation. The milk response to concentrate was 0.4 for NZ cows compared to 1.1 for HGM cows.

The objective would be in the long term to have animals expressing their ability to produce milk primarily by a good persistency of the lactation and with a moderate peak of lactation. This will limit the energy deficit and associated pathological troubles at the beginning of lactation while making lactation management on grassland easier. In the future, genomic selection will make it possible to select on the persistency of lactation, something that is not possible with the traditional methods of selection.

#### **4.3. Are others breed more sustainable than Holstein cows to maximise grassland utilisation?**

In theory the most efficient animal is that which produces the maximum of milk per kg of live weight, because the needs for maintenance are then diluted in a higher level production thus giving theoretical advantage to small animals. Several studies have reported that Jersey cows were more efficient at converting grass DM into milk solids than Holstein cows. Grainger and Goddard (2004) reported that production efficiency is 6% higher in Jersey than in Holstein cows. More recently, Prendiville *et al.* (2009) reported that Jersey are 11% more efficient than Holstein-Friesian cows. However, it is noticeable in this study that the Holstein-Friesian cows weighed only 500 kg, which is far lower than the weight of Holstein used in France and in the North of Europe (650 to 700 kg). Large cows produce generally much more milk than small ones. This means that at herd level more Jersey cows are required to produce the same amount of milk than a Holstein herd, and the advantage of small cows might be rather limited in practice. However, Thomet and Kunz (2008) support that the smaller cows are more effective in terms of production per hectare because they make it possible to increase the stocking rate. In their simulation, the dairy production increases by 6% with the smaller cows for the same stocking rate expressed in live weight per ha.

It is also advisable to reconsider the interest of the dual-purpose dairy breeds which have better milk composition and beef merit compared to Holstein cows. These breeds make it possible to produce 6000-7000 kg of milk per lactation mainly from grassland with very low amount of concentrates. Pregnancy rates were higher with Normande cows than with Holstein cows (Dillon *et al.* 2003; Delaby *et al.*, 2010) thus ensuring a limit of the culling rate for infertility problems and the replacement costs in seasonal compact calving systems. Moreover, dual-purpose breeds ensure a greater stability because of the double source of income (milk and meat). The economic comparisons of various systems does not show a clear advantage for specialised milk production systems compared to systems using a dual-purpose breed producing milk and meat (Evans *et al.*, 2004; Delaby and Pavie, 2008), at least in a fixed milk quota scenario.



## **5. Grassland and herd management for improving the proportion of milk produced from grazed forages**

### **5.1. Increasing stocking rate to produce more milk per hectare**

In most countries of Europe, pressure on land use is high and maximising milk yield per unit area is more than just a challenge to maximise profitability per hectare (Dillon *et al.*, 2008). In experimental herds, annual production of 15000 kg ha<sup>-1</sup> milk from grass, with less than 500 kg of concentrate, have been reported (Horan *et al.*, 2005). Stocking rate, defined as the number of animals per unit area of land during the grazing season, has been recognized for a long time as the most important factor governing milk output per unit area of pasture (Mott, 1960). A recent meta analysis including 131 comparisons of stocking rate concluded that an increase in stocking rate of one cow ha<sup>-1</sup> resulted in an increase in milk yield of 1650 kg ha<sup>-1</sup> (i.e. 20%) and milk solids of 113 kg ha<sup>-1</sup> while milk yield per cow decreased by 1.3 kg d<sup>-1</sup> and milk protein content by 0.5 g kg<sup>-1</sup> (McCarthy *et al.*, 2010).

The effects of feeding supplement on cow performance were reviewed by Peyraud and Delaby (2001). Efficient response of one kg of milk to one kg concentrate is now currently reached when the amount of concentrate per cow does not exceed 6 kg d<sup>-1</sup>. Moreover, the efficiency of supplementation at grazing appears to be closely related to energy balance of the cows, and it increases when pasture intake is restricted through increased stocking rate, with economic returns depending of the concentrate to milk price ratios and most often positive. Therefore, feeding concentrate can be a very efficient tool to maintain a high stocking rate and thus good sward management, which allows the control of post-grazing sward height while achieving high milk yield per cow and per hectare with high economic returns.

### **5.2. Extending the grazing season to consume more grass while increasing cow performance**

There is considerable opportunity to extend the grazing season, thereby reducing costs associated with indoor feeding systems. Given the high feeding value of grass relative to conserved forages, there is interest to extend the grazing season as much as possible. In many situations moderate grass growth occurs in early spring and herbage growth in late autumn is almost entirely lost through senescence and grass death during winter if not grazed. Experiments have been conducted from mid February to mid April in Ireland (Dillon and Crosse, 1994; Kennedy *et al.*, 2005), in Northern Ireland (Sayers and Mayne, 2001) with grass silage fed indoors, and in Brittany (O'Donovan *et al.*, 2004) with maize silage fed indoors. These experiments have all showed that access to grass for a few hours per day increased milk yield by 1 to 3 kg and reduced silage intake by 4 to 6 kg per day thus reducing the amount of conserved forage to be harvested and distributed. In the study of Kennedy *et al.* (2005) it is noticeable that early turnout of spring-calving cows to pasture in the early postpartum period resulted in a slight improvement of milk yield and milk protein content when compared to housed indoor cows fed with a TMR ration (44% grass silage). Extending the grazing season may also occur in autumn as shown by Mayne and Laidlaw (1995). The effective use of late autumn grass as part of the diet of dairy cows was further confirmed under Brittany conditions (Chenais and Le Roux, 1996). Cows having access to grazing during daylight (6 h d<sup>-1</sup>) produced 1 kg d<sup>-1</sup> more milk and consumed 5.1 kg d<sup>-1</sup> less maize silage than cows fully housed. Obviously, during these transition periods daily grazing time and stocking rate should be adjusted according to the climatic conditions and soil types to avoid poaching and to limit the risk of nitrate leaching. The influence of extending the grazing season on N-nitrate leaching will be investigated during the FP7-EU-project MULTISWARD (Peyraud *et al.*, 2009).

Besides the positive effect on cow performances during the period of part time grazing, early spring grazing has a positive effect on herbage quality in subsequent rotations. Early grazed swards contained a high proportion of green leaf, a lower proportion of grass stems and senescent material and are more digestible (O'Donovan *et al.* 2004; Kennedy *et al.*, 2006). Moreover, grass growth during the subsequent rotations was not affected by early grazing although pre-grazing sward height was lower and almost all grass that has been produced is grazed thus making the system very efficient (Table 2). Finally, early grazing in spring avoids large accumulations of herbage which can be difficult to graze and increases ease of grazing management for subsequent rotations.

Table 2. Effect of the date at turnout on the sward production and animal performance in spring grazing (from April to end of June) (adapted from O'Donovan *et al.*, 2004)

Date of first grazing	Early February	Late March
Sward height, 30 <sup>th</sup> March (cm)	5.5	10.0
Herbage DM growth (kg ha <sup>-1</sup> d <sup>-1</sup> )	66	66
Pregrazing sward height (cm) <sup>1</sup>	11.8	15.2
Milk (kg d <sup>-1</sup> )	23.2	22.1
Herbage disappeared (kg d <sup>-1</sup> ) <sup>2</sup>	15.6	15.9
Herbage utilisation (% of growth)	100	85

<sup>1</sup> When cows enter to a new paddock

<sup>2</sup> Calculated as (H pregrazing – H postgrazing) x sward bulk density

### 5.3. Part time grazing to maintain grassland utilisation for large herds

Grazing becomes more complicated with increasing herd size. It is not the size of the herd by itself which is the most limiting factor because large herds (up to 400 cows or more) are grazing in England and in New Zealand. The difficulties rise from the increased area that is needed around the milking parlour for grazing. This is occurring in many regions or countries in Europe, especially in the most intensive dairying areas. In these situations where stocking rates are high, the time at pasture can be restricted to a few hours per day to maintain grazed forage in the diets. Part time grazing combined with restricted indoor feeding should be considered as an interesting alternative to reduce the amount of conserved forages which are always expensive to produce, and to keep as much as possible of the fresh forage for producing milk. Allowing the cows to graze for some hours per day can also improve the welfare of cows (Sairanen *et al.*, 2006).

When time at pasture is restricted, cows increase the proportion of time spent grazing and the pasture intake rate to partially compensate for the reduction of time at pasture. Large increase in rate of intake (more than 25%) were reported when access time decreased from 8-9 h to 4-5 h d<sup>-1</sup> (Kristensen *et al.*, 2007; Pérez-Ramirez *et al.*, 2008, 2009) However, these adaptations are insufficient to compensate for the large reduction of time at pasture. Some studies have shown that restricted grazing time to 4 h per day does not allow dairy cows to maintain milk production and herbage intake, in spite of a high rate of supplementation (Kristensen *et al.*, 2007). An experiment was recently conducted at Rennes (Delaby *et al.*, 2010) which examined the response curves to increasing levels of maize silage fed as a supplement to cows having access to pasture either 4 h (between morning milking and midday) or 8 h a day (between morning and evening milking) (Table 3). When the access time was restricted to 4h, 15 kg of maize silage were required to achieve high animal performances. When the access time was 8h, the response reached a plateau for 10 kg of maize silage. Feeding only 5 kg of maize silage did not allow the maintaining of animal performances. These results clearly show that the amount of supplementary forage must be adjusted to the access time. The level of supplementation will be chosen in order to maximise milk yield per cow or to maximise pasture utilisation.

Table3. Effect of the supply of maize silage on dairy cow's performances having a restricted access to pasture for grazing

Daily access time to grazing (h) Offered maize silage DM (kg d <sup>-1</sup> )	4			8		
	5	10	15	5	10	15
Maize silage DM intake (kg d <sup>-1</sup> )	5.8	11.2	15.5	5.8	11.1	14.4
Milk (kg d <sup>-1</sup> )	22.4	24.7	26.5	23.1	25.7	26.4
Fat content (g kg <sup>-1</sup> )	38.2	37.8	37.8	38.7	37.1	37.8
Protein content (g kg <sup>-1</sup> )	27.8	28.7	29.8	28.9	29.1	29.7

## 6. Conclusion

In the future, dairy systems should be more environmentally sound, economically viable and productive. Grassland with its multifunctional roles provides a good basis for developing more sustainable production systems in the long term. This paper shows there is quite considerable scope to improve the performances of dairy systems based on grassland. Forage legumes in multi-species swards will undoubtedly constitute one of the pillars for the development of future dairy systems with high environmental and economic performances. Selection of functional traits for more robust cows and adaptations of lactation and system management will constitute the other pillars. The FP7 funded European project MULTISWARD (Peyraud *et al.*, 2009) will conceive, evaluate and promote sustainable ruminant production systems based on the use of grasslands with a high level of multi-functionality in order to optimize the provision of environmental goods and biodiversity preservation, on one hand, and on the other, economic efficiency. To enhance the competitiveness and multi-functionality of grassland-based dairying systems, MULTISWARD will assess and optimize the roles and performances of multi-species swards and will design and evaluate innovations in grazing and animal management according to the possible ways of progress described in this paper. MULTISWARD will also identify and analyse the effects of several socio-economic and policy scenarios on the future of grassland.

## 7. References

- Basset-Mens C., Ledgard S. and Carran A. (2005) First life cycle assessment of milk production from new Zealand dairy farm systems. [www.anzsee.org/anzsee2005papers/Basset-Mens\\_LCA\\_NZ\\_milk\\_production.pdf](http://www.anzsee.org/anzsee2005papers/Basset-Mens_LCA_NZ_milk_production.pdf)
- Basset-Mens C., Ledgard S. and Boyes M. (2009) Eco-efficiency of intensification scenarios for milk production in New Zealand. *Journal of Ecological Economics* 68, 1615-1625.
- Besnard A., Montargès-Lellahi A. and Hardy A. (2006) Systèmes de culture et nutrition azotée. Effets sur les émissions de GES et le bilan énergétique. *Fourrages* 187, 311-320.
- Bourgeois L. (2002) Common agricultural policy and grasslands: the case study of France. *Grassland Science in Europe* 7, 5-15.
- Buckley F., Dillon P., Rath M. and Veerkamp R.F. (2000) The relationship between genetic merit for yield and live weight condition score, and energy balance of spring calving Holstein Friesian dairy cows on grass based systems on milk production. *Journal of Dairy Science* 83, 1878-1886.
- Cederberg C. and Mattsson B. (2000) Life cycle assessment of milk production – a comparison of conventional and organic farming. *Journal of Cleaner Production* 8, 49-60.
- Chenais F. and Le Roux M. (1996) Réduction de la part de maïs dans les systèmes d'alimentation des vaches laitières. Résultats expérimentaux obtenus en Bretagne. *Document EDE-Chambre d'Agriculture de Bretagne*, Rennes, 12-15.
- Corré, W.J. and Kasper, G.J. 2002. Beperking van lachgasemissie door gebruik klaver in grasland. *Alterra Rapport* 560: 4–30.
- Decau, M.L., Delaby, L. and Roche, B. (1997) Azotpât: une description quantifiée des flux annuels d'azote en prairie pâturée par les vaches laitières. II- Les flux du système sol-plante. *Fourrages* 151, 313-330
- Delaby L., Delagarde R. and Peyraud J.L. (2009a) Which level of supplementation for limited access time grazing dairy cows? *Rencontre Recherches Ruminants* 16, 50.
- Delaby L., Faverdin P., Michel G., Disenhaus C. and Peyraud J.L. (2009b) Effect of feeding strategies on performances and their evolution during lactation of Holstein and Normande dairy cows. *Animal* 3, 891-905.
- Delaby L., Horan B., O'Donovan M., Gallard Y. and Peyraud J.L. (2010) Are high genetic merit dairy cows compatible with low input grazing systems? *Grassland Science in Europe*, 15 (this volume).

- Delaby L. and Pavié J. (2008) Consequences of different feeding strategies and feeding systems on the dairy farm economical performances in a context of fluctuating prices. *Rencontres Recherches Ruminants* 15, 135-138.
- Delaby L. and Peyraud J.L. (1998) Effet d'une réduction simultanée de la fertilisation azotée et du chargement sur les performances des vaches laitières et la valorisation du pâturage. *Annales de Zootechnie* 47, 17-39
- Dewhurst R.J., Delaby L., Moloney A., Boland T. and Lewis E. (2009) Nutritive value of forage legumes used for grazing and silage. *Irish Journal of Agriculture and Food Research* 91, 51-70.
- Dillon P., Berry D.P., Evans R.D., Buckley F. and Horan B. (2006) Consequences of genetic selection for increased milk production in European seasonal pasture based systems of milk production. *Livestock Production Science* 99, 141-158.
- Dillon P. and Crosse S. (1994) Summer milk production. The role of grazed grass. *Irish Grassland and Animal Production Association Journal* 28, 23-25.
- Dillon P., Hennessy T., Shalloo L., Thorne F., and Horan B. (2008) Future outlook for the Irish dairy industry: a study of international competitiveness, influence of international trade reform and requirement for change. *International Journal of Dairy Technology* 61, 16-29.
- Dillon P., Snijders S., Buckley F., Harris B., O'Connor P. and Mee J.F. (2003) A comparison of different dairy cow breeds on a seasonal grass-grazed system of milk production. 2. Reproduction and survival. *Livestock Production Science*, 83, 35-42.
- Eriksen J., Askegaard M. and Soegaard K. (2008) Residual effect and nitrate leaching in grass-arable rotation: Effect of grassland proportion, sward type and fertilizer history. *Soil Use and Management* 24, 373-382.
- Evans R.D., Dillon P., Shalloo L., Wallace M. and Garrick D.J. (2004) An economic comparison of dual-purpose and Holstein Friesian cow breeds in a seasonal grass-based system under different milk production scenarios. *Irish Journal of Agricultural and Food Research* 43: 1-16.
- Evans R., Wallace M., Shalloo L., Garrick D. and Dillon P. (2006) Financial implications of recent declines in reproduction and survival of Holstein-Friesian cows in spring-calving Irish dairy herds. *Agricultural Systems* 89, 165-183.
- FAO (2006) *Livestock's Long Shadow, Environmental issues and options*. United Nations Food and Agriculture Organisation, Rome, 390 pp.
- Faverdin P., Delagarde R., Delaby L. and Meschy F. (2007) Alimentation des vaches laitières. In: *Alimentation des bovins, ovins, caprins*. Editions QUAE, Paris, 23-55.
- Grainger C. and Goddard M.E. (2004) A review of the effects of dairy breed on feed conversion efficiency – An opportunity lost? *Animal Production in Australia* 25, 77-80.
- Guckert A. and Hay R.K.M. (2001) The overwintering, spring growth, and yield in mixed species swards of white clover in Europe. *Annals of Botany* 88, 667-668.
- Harris S.L., Auld M.J., Clark D.A. and Jansen E.B.L. (1998) Effect of white clover content in the diet on herbage intake, milk production and milk composition of New Zealand dairy cows housed indoors. *Journal of Dairy Research* 65, 389-400.
- Horan B., Mee J.F., Rath M., O'Connor P., Dillon P., 2004. The effect of strain of Holstein-Friesian cow and feed system on reproductive performance in seasonal-calving milk production systems. *Animal Science* 79, 453-468
- Horan B., Dillon P., Faverdin P., Delaby L., Buckley F. and Rath M. (2005) The interaction of strain of Holstein-Friesian cow and pasture based feed system for milk production, bodyweight and body condition score. *Journal Dairy Science* 88, 1231-1243.
- Horan B., Faverdin Ph., Delaby L., Rath M. and Dillon P. (2006) The effect of strain of Holstein-Friesian dairy cow and pasture-based system on grass intake and milk production. *Animal Science* 82, 435-444.
- Holmes W. (1980) Grazing management. In: Holmes W. (ed). *Grass: its production and utilization*, 1<sup>st</sup> edn. Oxford, UK: Blackwell Scientific Publications, pp. 125-173.
- Hyde B.P., Hawkins M.J., Fanning A.F., Nooman D., Ryan M., O'Toole P. and Carton O.T. (2006) Nitrous oxide emissions from a fertilized and grazed grassland in the south east of Ireland. *Nutrient Cycling in Agroecosystems* 75, 187-200.
- Le Gall A. and Guernion J.M. (2004) Associations graminées – Trèfle blanc, Le pâturage gagnant. Collection Synthèses. Institut de l'Élevage publications, Paris, 64 pp.
- INRA (1989) *Ruminant Nutrition: Recommended allowances and feed tables*. Eds. Jarrige R. and Libbey J., Institut National de la Recherche Agronomique (Paris) Eurotext (Paris-London-Rome) pp. 33-48.
- Kennedy J., Dillon P., Faverdin P., Delaby L., Buckley F. and Rath M. (2002) The influence of cow genetic merit for milk production on response to level of concentrate supplementation in a grass-based system. *Animal Science* 75, 433-445.
- Kennedy J., Dillon P., Faverdin P., Delaby L., Stackelum G. and Rath M. (2003) Effect of genetic merit and concentrate supplementation on grass intake and milk production with Holstein-Friesian dairy cows. *Journal of Dairy Science* 86, 246-251.

- Kennedy E., O'Donovan M., Murphy J.P., Delaby L. and O'Mara F. (2005) Effects of grass pasture and concentrate-based feeding systems for spring calving dairy cows in early spring on performances during lactation. *Grass and Forage Science* 60, 310-318.
- Kennedy E., O'Donovan M., Murphy J.P., O'Mara F. and Delaby L. (2006) The effect of initial spring grazing date and subsequent stocking rate on the grazing management, grass dry matter intake and milk production of dairy cows in summer. *Grass and Forage Science* 61, 375-384.
- Kirwan L., Lüscher A., Sebastià M.T., Finn J.A., Collins R.P., Porqueddu C., Helgadottir A., Baadshaug O.H., Brophy C., Coran C., Dalmannsdóttir S., Delgado I., Elgersma A., Fothergill M., Frankow-Lindberg B.E., Golinski P., Griep P., Gustavsson A.M., Höglind M., Huguenin-Elie O., Iliadis C., Jørgensen M., Kadziuliene Z., Karyotis T., Lunnan T., Malengier M., Maltoni S., Meyer V., Nyfeler D., Nykanen-Kurki P., Parente J., Smit H.J., Thumm U. and Connolly J. (2007) Evenness drives consistent diversity effects in an intensive grassland system across 28 European sites. *Journal of Ecology* 95, 530-539.
- Kolver E.S. and Muller L.D. (1998) Performance and nutrient intake of high producing Holstein cows consuming pasture or a total mixed ration. *Journal of Dairy Science* 81, 1403-1411.
- Kristensen T., Oudshoorn F., Munksgaard L. and Soegaard K. (2007) Effect of time at pasture combined with restricted indoor feeding on production and behaviour in dairy cows. *Animal* 1, 439-448.
- Ledgard S.F., Penno J.W. and Sprosen M.S. (1999) Nitrogen inputs and losses from clover/grass pastures grazed by dairy cows, as affected by nitrogen fertilizer application. *Journal of Agricultural Science* 132, 215-225.
- Ledgard S., Schils R., Eriksen J. and Luo J. (2009) Environmental impacts of grazed clover/grass pastures. *Irish Journal of Agricultural Research* 91, 91-107.
- Le Gall A., Bèguin E., Dollé J.B., Manneville V. and Pflimlin A. (2009) Nouveaux compromis techniques pour concilier efficacité économique et environnementale en élevage herbivore. *Fourrages* 198, 131-151.
- Loiseau P., Carrere P., Lafarge M., Delpy R. and Dublanche J. (2001) Effect of soil-N and urine-N on nitrate leaching under pure grass, pure clover and mixed grass/clover pastures. *European Journal of Agronomy* 14, 113-121.
- Lüscher A., Finn J.A., Connolly J., Sebastià M.T., Collins R., Fothergill M., Porqueddu C., Brophy C., Huguenin-Elie O., Kirwan L., Nyfeler D. and Helgadottir, A. (2008) Benefits of sward diversity for agricultural grasslands. *Biodiversity* 9, 29-32.
- Lüscher A., Fuhrer J. and Newton P.C.D. (2005) Global atmospheric change and its effect on managed grassland systems. In: McGilloway D.A. (eds) *Grassland: A global resource*, Wageningen Academic Press, Wageningen, pp. 251-264.
- McCarthy S., Horan B., Dillon P., O'Connor P., Rath M. and Shalloo L. (2007) Economic comparison of divergent strains of Holstein-Friesian cows in various pasture based production systems. *Journal of Dairy Science* 90, 1493-1505.
- Mayne C.S. and Laidlaw A.S. (1995) Extending the grazing season, a research review. In: Extending the Grazing Season, Discussion Meeting, *Proceedings of the British Grassland Society*, Reaseheath College, Nanwich, Cheshire, 31-35.
- McCarthy B., Delaby L., Pierce K.M., Journot F. and Horan B. (2010) Meta-analysis of the impact of stocking rate on the productivity of pasture-based milk production system. *Journal of Dairy Science*. In press.
- MEA (2005) Ecosystems and Human Well-being: Current State and Trends. Millennium Ecosystem Assessment Vol. 1, 901 p.
- Mott G.O. (1960) Grazing pressure and the measurement of pasture production. *Proceedings of the 8<sup>th</sup> International Grasslands Congress*, Reading, pp 606-611.
- Nyfeler D., Huguenin-Elie O., Suter M., Frossard E., Connolly J. and Lüscher A. (2009) Strong mixture effects among four species in fertilised agricultural grassland led to persistent and consistent transgressive overyielding. *Journal of Applied Ecology* 46, 683-691.
- O'Donovan M., Delaby L., Peyraud J.L. (2004) Effect of time of initial grazing date and subsequent stocking rate on pasture production and dairy cow performance. *Animal Research* 53, 489-502.
- Pérez-Ramirez E., Delagarde R. and Delaby, L. (2008) Herbage intake and behavioural adaptation of grazing dairy cows by restricting time at pasture under two feeding regimes. *Animal* 2, 1384-1392.
- Pérez-Ramirez E., Delagarde R.L. and Peyraud J.L. (2009) Restricting daily time at pasture at low and high herbage allowance: effects on herbage intake and behavioural adaptation of lactating dairy cows. *Journal of Dairy Science* 92, 3331-3340.
- Peyraud J.L. (1993) Comparaison de la digestion du trèfle blanc et des graminées prairiales chez la vache laitière. *Fourrages* 135, 465-473.
- Peyraud J.L. and Delaby L. (2001) Ideal concentrate feeds for grazing dairy cows – Response to concentrates in interaction with grazing management and grass quality. In: Garnsworthy P.G. and Wiseman J. (eds) *Recent Advances in Animal Nutrition*, University of Nottingham University Press, 203-220.



- Peyraud J.L., Mosquera-Losada R. and Delaby L. (2004) Challenges and tools to develop efficient dairy systems based on grazing: how to meet animal performances and grazing management. *Grassland Science in Europe* 9, 373-384.
- Peyraud J.L., Van den Pol-van Dasselaar A., Huguenin O., Dillon P., Peters A. and Huyghe C. (2009) MULTISWARD, Multi-species swards and multi scale strategies for multifunctional grassland-based ruminant production systems. *Seventh framework programme Food, Agriculture and Fisheries, Biotechnology*; 137pp.
- Philips C.J.C. and James, N.L. (1998) The effects of including white clover in perennial ryegrass pastures and the height of mixed pastures on the milk production, pasture selection and ingestive behaviour of dairy cows. *Animal Science* 67, 195-202.
- Prendiville R., Pierce K.M and Buckley F. (2009) An evaluation of production efficiencies among lactating Holstein-Friesian, Jersey, and Jersey x Holstein-Friesian cows at pasture. *Journal of Dairy Science* 92, 6176-6185.
- Raison C., Chambault H., Le Gall A. and Pflimlin A. (2008) Impact du système fourrager sur la qualité des eaux. Enseignements issus du projet Green Dairy. *Fourrages* 193, 3-18.
- Ribeiro-Filho H.M.N., Delagarde R. and Peyraud J.L. (2003) Inclusion of white clover in strip-grazed perennial ryegrass pastures: herbage intake and milk yield of dairy cows at different ages of pasture regrowth. *Animal Science* 77, 499-510.
- Ribeiro-Filho H.M.N., Delagarde R. and Peyraud J.L. (2005) Herbage intake and milk yield of dairy cows grazing perennial ryegrass pastures or white-clover/perennial rye grass pastures at low and medium herbage allowance. *Animal Feed Science and Technology* 119, 13-27.
- Sairanen A., Khalili H., Virkajärvi P. and Hakosalo J. (2006) Comparison of part time grazing and indoor silage feeding on milk production. *Agricultural and Food Science* 15, 280-292.
- Sayers H.J. and Mayne C.S. (2001) Effect of early turnout to grass in spring on dairy cows performance. *Grass and Forage Science* 56, 259-267.
- Steinfeld H., Wassenaar T. and Jutzi S. (2006) Livestock production systems in developing countries: status, drivers, trends. *Revue Scientifique et technique-office international des epizooties* 25, 505-516.
- Thomet P. and Kunz P. (2008) What type of cow do we need for grassland based milk production ? *Grassland Science in Europe* 13, 864-866.
- Trou G. and Piquemal B. (2009) Intervalles entre vêlage. Plus de 15 mois pour 90000 vaches bretonnes. *CAP Elevage* 40, 34-35.
- Van den Pol-van Dasselaar A., Vellinga T.V., Johansen A. and Kennedy E. (2008) To graze or not to graze, that's the question. *Grassland Science in Europe* 13, 706-716.
- Van den Pol-van Dasselaar A., De Haan M. and Philipsen A.P. (2010) Simulation of the effect of grass intake on the farmer's income. *Grassland Science in Europe* 15 (this volume).
- Vertès F., Hatch D., Velthof G., Taube F., Laurent F., Loiseau P. and Recous S. (2007) Short term and cumulative effect of grassland cultivation on nitrogen and carbon cycling in ley-arable rotations. *Grassland Science in Europe* 12, 227-246.
- Wachendorf M., Büchter M., Trott H. and Taube F. (2004) Performances and environmental effects of forage production on sandy soils. II. Impact of defoliation system and nitrogen input on nitrate leaching losses. *Grass and Forage Science* 59, 56-68.
- Wiktorsson H. and Spöndly E. (2002) Grazing: an animal welfare issue for automatic milking farms. In: *The First North American Conference*, Wageningen Academic Publishers, Wageningen, The Netherlands, VI32-VI45.
- Wilson D. (1993) Breeding grasses and legumes for an extended grazing season. In: *The Place for Grass in Land Use Systems*. British Grassland Society, December 1993, pp 93-104.

## Environmental impacts of grazed pastures

Eriksen J.<sup>1</sup>, Ledgard S.<sup>2</sup>, Luo J.<sup>2</sup>, Schils R.<sup>3</sup> and Rasmussen J.<sup>1</sup>

<sup>1</sup>*Department of Agroecology and Environment, University of Aarhus, PO Box 50, Tjele, Denmark*

<sup>2</sup>*AgResearch Ltd., Ruakura Research Centre, Private Bag 3123, Hamilton, New Zealand*

<sup>3</sup>*ALTERRA, Wageningen-UR, PO Box 47, 6700 AA Wageningen, The Netherlands*

Corresponding author: Jorgen.Eriksen@agrsci.dk

### Abstract

Large nitrogen (N) surplus and return of excreta-N in localised patches at high N rates in intensively grazed pasture systems markedly increases the risk of N losses to waterways and the atmosphere. Here are described the main routes of N input to grazed pastures, losses via N leaching, methane (CH<sub>4</sub>) and nitrous oxide (N<sub>2</sub>O) emissions. Furthermore, farm N budgets and N-use efficiency in relation to management strategies that can be applied to reduce N losses are discussed. Nitrate leaching increases exponentially with increased inputs and is closely related to urine patches, which also influence the leaching of dissolved organic N. High N<sub>2</sub>O emission rates in grazed pastures are related to fertiliser-N or N in excreta combined with compaction by animal treading. Grazing may considerably reduce CH<sub>4</sub> emissions compared to indoor housing of cows. Pastures are occasionally cultivated due to sward deterioration followed by a rapid and extended period of N mineralization, contributing to an increased potential for losses. Good management of the pasture (e.g. reduced fertiliser input and reduced length of grazing) and of the mixed crop rotation during both the grassland and the arable phase (e.g. delayed ploughing time and a catch-crop strategy) can considerably reduce the negative environmental impact of grazing. It is important to consider the whole farm system when evaluating environmental impact, in particular for greenhouse gases since the pasture may serve as a source of N<sub>2</sub>O and indirectly of CH<sub>4</sub>, but also as a sink of CO<sub>2</sub> influenced by management practices on the farm.

Keywords: Clover/grass pastures, grazing, nitrogen losses, pasture management

### Introduction

Grazing animals have profound effects on pastoral systems, including nutrient removal by grazing and redistribution through excreta. Generally, in grazed pastures the conversion of consumed N into product is low and a substantial quantity of N (>70%) is recycled through the direct deposition of animal excreta. This low N utilization by grazing animals reflects the relatively high concentrations of N required for metabolic functions and optimum growth of plants compared to that needed by the grazing ruminant for amino acid and protein synthesis (Haynes and Williams, 1993). Increasing the N concentration in grass, such as by increasing the rate of N fertiliser application, can result in a substantial N surplus (i.e. N inputs minus N outputs in products). For example, N surpluses of 150 to 250 kg ha<sup>-1</sup> yr<sup>-1</sup> occur in highly productive dairy farm systems in the Netherlands and northern Germany (Rotz *et al.*, 2005). Increasing the N concentration of the diet generally increases the excretion of urinary N in both absolute terms and as a percentage of the total N excreted. There is an exponential relationship between N intake and N excretion in urine, and Scholefield *et al.* (1991) predicted that about 80% of N intake is excreted in urine with a dietary N concentration of 4% N. Grazing cattle return N in urine patches at rates of up to about 1000 kg ha<sup>-1</sup>, which is far in excess of plant requirements (Haynes and Williams, 1993). Urine N is in highly mineralisable forms compared to dung N, and within 3-5 days is rapidly converted to plant-available N in



soil. This can result in inorganic soil N under urine patches up to 10 times greater than under dung patches, and more than 30 times greater than areas unaffected by excreta (Afzal and Adams, 1992).

The large N surplus and return of excreta-N in localised patches at high N rates in intensively grazed pasture systems markedly increases the risk of N losses to waterways and the atmosphere. The excretal returns, particularly urinary N, from grazed animals are typically the major sources of N lost from grazed pastures. The primary transformations leading to N losses are ammonia (NH<sub>3</sub>) volatilisation, nitrification and denitrification (Bolan *et al.*, 2004). Leaching losses of NO<sub>3</sub> to waterways and emissions of NH<sub>3</sub> and N<sub>2</sub>O to the atmosphere from grazed pastures have significant environmental implications (Oenema *et al.*, 1997; Di and Cameron, 2002).

In grazed pastures, animal treading damage during grazing under wet soil conditions limits pasture growth and reduces soil infiltration rates (Drewry *et al.*, 2008). Animal treading of pasture can also increase soil bulk density and consequently cause an increase in mechanical impedance to root penetration and a reduction in aeration and/or an increase in waterlogging of soil. This will have a negative effect on legume growth, productivity, and N<sub>2</sub> fixation in pasture (Menneer *et al.*, 2004). In addition, the treading damage also increases the risk of run-off losses of other nutrients, such as P, from grazed pastures (Monaghan *et al.*, 2005).

Pastures are permanent or occasionally cultivated due to sward deterioration. As a consequence of the substantial N surplus and the soil N build-up, the cultivation of grazed grassland is followed by a rapid and extended period of N mineralization, which may also contribute significantly to an increased potential for losses.

The objectives of the present review are to describe the main routes of N input to farming systems with grazed pastures, to quantify environmentally harmful losses from these systems via NO<sub>3</sub> leaching, atmospheric CH<sub>4</sub> and N<sub>2</sub>O losses, and to discuss farm N budgets and N use efficiency in relation to management strategies that can be applied to reduce N losses.

## **Nitrogen leaching**

### *Permanent pastures*

Research on grazed systems indicates that NO<sub>3</sub> leaching increases exponentially with increased N input (Figure 1). This is mostly associated with an increase in dry matter (DM) production, N uptake and recycling in animal excreta resulting in a corresponding increase in leaching losses from urine patches (Ledgard, 2001). Various studies have also shown the much greater importance of urine N, compared to fertiliser N, in contributing to NO<sub>3</sub> leaching (because of the much larger specific rate of N application in urine); urine typically contributes 70-90% of total N lost through leaching (Monaghan *et al.*, 2007).

Many permanent pastures include legumes, particularly white clover in temperate pastures, to supply N from clover N<sub>2</sub> fixation for long term production (Ledgard, 2001). The N concentration of pasture exceeds that required by grazing animals, and furthermore white clover has higher digestible protein N and lower soluble carbohydrate concentrations than perennial ryegrass (e.g., Vinther and Jensen, 2000; Wilkins and Jones, 2000). This can result in poor utilisation of clover-protein, increased urinary N output and consequently greater risk of environmental N pollution (Weller and Jones, 2002). For example, Wilkins and Jones (2000) measured a greater proportion of N intake by cattle partitioned to urine-N output with a white clover diet than with a ryegrass-based diet. However, the clover-N feedback mechanism, whereby N<sub>2</sub> fixation decreases with high N inputs, acts to enhance N efficiency. In areas where N inputs from excreta occur there will be low associated input from N<sub>2</sub> fixation.

Fertiliser N is generally used efficiently by pastures for plant growth but it enhances pasture N uptake and grass N concentrations, thereby increasing both N excretion in urine and the risk

of environmental loss. Estimates of N leached from managed pastures vary widely, ranging from about 5 to 200 kg ha<sup>-1</sup> yr<sup>-1</sup>, due to many factors including differences in N input, N output in excreta, soil drainage and animal type (e.g. Monaghan *et al.*, 2007).

Eriksen *et al.* (2004) observed higher leaching N losses from grazed N-fertilised ryegrass pasture (on average 47 kg ha<sup>-1</sup> yr<sup>-1</sup>) than from grazed non-N-fertilised clover-ryegrass pasture (on average 24 kg ha<sup>-1</sup> yr<sup>-1</sup>). Over time, the losses from the clover-ryegrass pasture decreased due to a reduction in N<sub>2</sub> fixation together with a reduction in DM production which in turn led to a lower grazing intensity and lower rate of recycling of animal excreta. The research summary of N leaching from grazed pastures in Figure 1 shows overlap of N leaching values estimated from pastures with or without clover at similar N inputs. However, in long-term grass-clover pastures, N inputs from N<sub>2</sub> fixation are usually less than about 200 kg ha<sup>-1</sup> yr<sup>-1</sup> thereby limiting maximum N leaching from non-N-fertilised clover-grass pastures, whereas N fertiliser may be used at much higher annual rates of application, with potential for high N losses.

One of the options to mitigate NO<sub>3</sub> losses is to reduce the length of the grazing season. A NO<sub>3</sub> leaching model of Vellinga *et al.* (2001) was used to exemplify the effect of grazing season length on NO<sub>3</sub> losses (Figure 2). Under full grazing, i.e. 20 hours a day from 15 April to 15 October, the NO<sub>3</sub> concentration is 69 mg l<sup>-1</sup>. In this experiment, the best strategy to reduce NO<sub>3</sub> losses was to shorten the end of the grazing season in the autumn. For example, NO<sub>3</sub> concentration was reduced to 59 mg l<sup>-1</sup> by ending grazing on the 15 September, and the Nitrate Directive target was achieved by ending grazing around 15 August. However, some farmers especially in mainland Europe choose to start grazing their herds later in the spring/summer and do not turn out cows until after the whole grassland area has been cut for silage. Farmers follow this strategy to ensure that high quality silage can be harvested. From an environmental viewpoint this strategy is less efficient than shortening the end of the grazing season as delaying turnout from 15 February to 15 March only reduces NO<sub>3</sub> concentration to 66 mg l<sup>-1</sup>.

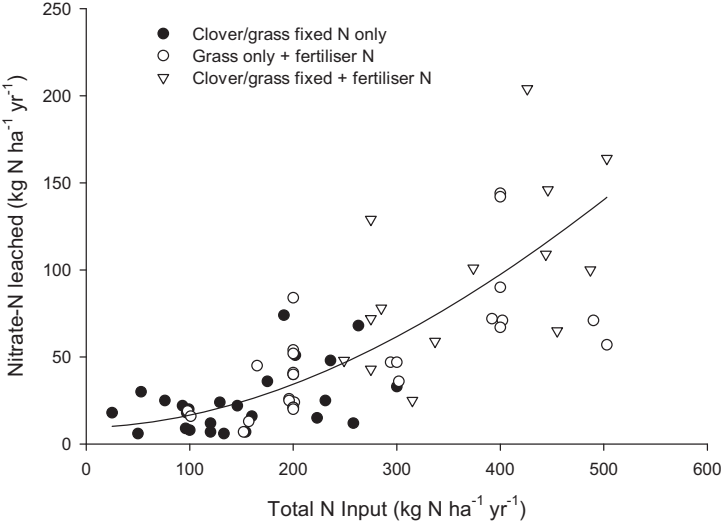

Figure 1. Nitrate leaching from grazed pasture systems as affected by total N input. Data are a summary of studies from NZ, France, UK and Denmark. The line of best fit is an exponential function obtained by fitting the data on the log scale. Updated from Ledgard (2001).

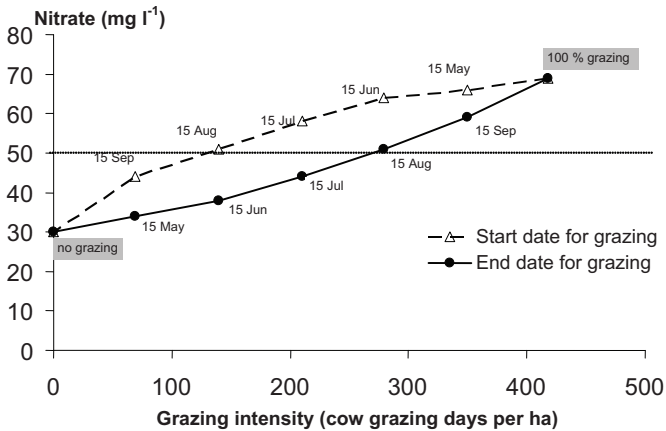

Figure 2. The effect of the length of the grazing season on NO<sub>3</sub> leaching. The upper line represents the starting dates of the grazing season, while the lower line represents the end dates of the grazing season. The modeled dairy farm has 80 cows, with a milk production of 8000 kg cow<sup>-1</sup>, on 35 ha of grassland on sandy soil, fertilised with 250 kg ha<sup>-1</sup> N.

#### Pastures in crop rotation

Dairy production systems in parts of Europe are based on ley-arable rotations (Vertés *et al.*, 2007) that are characterised by three phases: pasture, ploughing out, and subsequent arable cropping (Watson *et al.*, 2005). Generally, the ploughing-out phase carries the highest risk of NO<sub>3</sub> leaching as N accumulated in the soil during the ley phase is released upon cultivation. However, in every phase there are options to reduce NO<sub>3</sub> leaching.

Table 1 shows N budgets for temporary pastures as influenced by different sward types and uses, and that the N surplus is considerable for pasture grazed by dairy cows with high feed-N (Eriksen, 2001). However, in the early pasture phase NO<sub>3</sub> leaching losses are usually low as much N can be accumulated in the sward, but over time the N loss depends on the equilibrium between inputs and the soil organic N pool. This equilibrium is not reached within the first years of the clover pasture (Johnston *et al.*, 1994) and also takes longer to be reached in grass-clover compared to grass-only swards due to the self-regulatory nature of legumes. Even though NO<sub>3</sub> leaching losses in young swards are much less than indicated by the surplus of the N budgets, losses occur depending on management of the defoliation system and N input. In terms of leaching, cutting-only systems are the most advantageous (Wachendorf *et al.*, 2004) but a management system that combines cutting and grazing is preferable to a pure grazing system. The dual advantage is in less recycling of animal excreta and a lower N surplus because of herbage removal, both leading to less NO<sub>3</sub> leaching. In a Danish experiment, grazing with spring application of cattle slurry showed NO<sub>3</sub> losses dramatically higher than other managements (Figure 3, Eriksen *et al.*, unpublished) but excluding the use of slurry under grazing management, or alternatively using combinations of cutting and grazing, reduced NO<sub>3</sub> leaching considerable to an average level of approximately 30 kg ha<sup>-1</sup> NO<sub>3</sub>-N. This was close to, and not statistically different from, the leaching under cutting.

The release of N following grassland cultivation is often substantial in the first year, with N fertilizer replacement values often exceeding 100 kg ha<sup>-1</sup> (Eriksen *et al.*, 2008), but with relatively little effect of both grassland management and age, even in situations with huge differences in N input during the grass phase (Eriksen, 2001; Hansen *et al.*, 2005). It has been demonstrated that mineralisation of N following grassland cultivation is a two-stage process with a rapid mineralisation over the first 160-230 days followed by a second phase with mineralisation rates 2-7 times lower than in the first phase (Vertes *et al.*, 2007). However, it is

recognised that grass-rich crop rotations are more beneficial to soil fertility than arable rotations and although differences in the initial residual value between grasslands of different age or management often seem small, the accumulated effect can be considerable over the years. It is well known that cultivation of permanent pasture has an impact on soil C and N dynamics for decades (Springob *et al.*, 2001), but it has also been shown that even grasslands of 2 to 8 years of age may affect the availability of soil N for some time (Eriksen *et al.*, 2008). Delayed ploughing in late winter or spring can reduce NO<sub>3</sub> leaching, especially on sandy soils and where rainfall occurs early in the autumn or winter (Djurhuus and Olsen, 1997). However, this must be set against possible lower yields of spring versus winter crops. It has also been shown that rotary cultivation of grass swards prior to ploughing can result in faster N availability and better synchrony between N mineralization and plant uptake (Eriksen and Jensen, 2001).

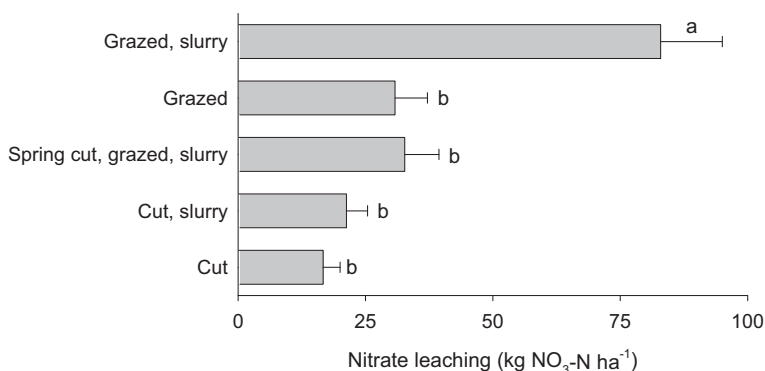

Figure 3. Nitrate leaching from grass-clover pastures with different management. In grazed grass-clover slurry was injected in the spring (100 kg ha<sup>-1</sup> cattle slurry total-N), in cut-only grass-clover an additional injection of slurry was made following a spring harvest of herbage. Bars with the same letter indicate no significant difference ( $P>0.05$ )

Table 1. Annual N budget of six pasture management systems (kg ha<sup>-1</sup> yr<sup>-1</sup>). Data are mean of production years 1-3 (Eriksen, 2001).

	Ryegrass-only			Clover-ryegrass		
	cut	grazed low N <sup>1</sup>	grazed high N <sup>1</sup>	cut	grazed low N <sup>1</sup>	grazed high N <sup>1</sup>
<b>N-Input</b>						
Fertilizer	300	300	300	0	0	0
N <sub>2</sub> -fixation	0	0	0	300	258	266
Animal manure	0	222	320	0	240	326
<b>N-Output</b>						
Herbage yield	287	240	292	288	271	342
Balance	13	282	328	12	227	250

<sup>1</sup> Grazed low and high N refers to grazing by dairy cow with 140 and 310 g d<sup>-1</sup> N in supplements, respectively.

The release of large quantities of N from grass-clover residues means that fertiliser-N use on subsequent cereal crops can be reduced, or even eliminated, in the first following crop. Catch crops are useful during winters in the arable phase of the crop rotation to reduce NO<sub>3</sub> leaching, by removing soil mineral N from the soil profile before winter drainage occurs. An example is given in Figure 4, where two grass-clover swards were ploughed on coarse sandy soil in Denmark. Perennial ryegrass as a catch crop reduced NO<sub>3</sub> leaching by 66-88% compared to bare soil, and in the treatment with barley harvested green and followed by Italian ryegrass it was reduced by more than 90% to less than 10 kg ha<sup>-1</sup> yr<sup>-1</sup> NO<sub>3</sub>-N.

A key objective in designing grass-arable crop rotations is to optimise the grass phase, i.e. the number of grassland cultivations in relation to the length of the grass phase. For the individual farmer this depends on the requirement for feed and access to grazing. The common motivation for grassland cultivation is yield loss due to sward deterioration caused by e.g. compaction from wheel traffic and invasion of less productive natural grasses (Hoving and Boer, 2004), but also the maintenance or increase of soil fertility and nutrient utilisation play a role.

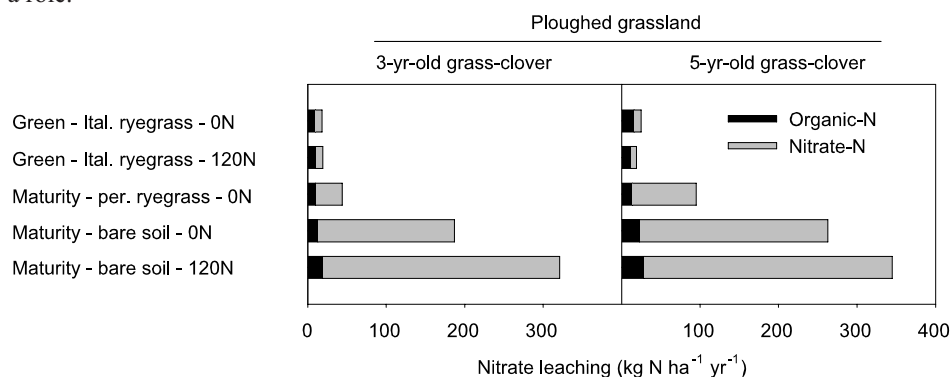

Figure 4. Leaching of  $\text{NO}_3$  and dissolved organic nitrogen after spring cultivation of 3 or 5 year old grassland followed by 1) barley harvested green with Italian ryegrass undersown; 2) barley harvested at maturity with perennial ryegrass undersown; and 3) barley harvested at maturity without catch crop. From: Hansen *et al.* (2007).

#### *Leaching of dissolved organic N*

Leaching of N from cultivated soils occurs mainly in  $\text{NO}_3$  form, but leaching of dissolved organic N (DON) has recently received increasing attention. Urine patches by cows have been indicated to influence leaching of DON as a consequence of the increase in soil solution pH following urea hydrolysis leading to increased solubility of soil organic matter (Wachendorf *et al.*, 2005; Van Kessel *et al.*, 2009). Rasmussen *et al.* (2008) reported a total N leaching of  $10 \text{ kg ha}^{-1}$  from cut grass-clover with DON accounting for 15% of the total loss, and Wachendorf *et al.* (2005) reported a total N leaching of  $30 \text{ kg N ha}^{-1}$  from a grazed pasture with DON accounting for one-third of total N. Nitrogen leaching in both experiments was estimated on the basis of soil solution sampled with suction cups/plates. Other studies reporting much higher DON proportion of the total dissolvable N are most often based on soil extractions (e.g. Jones and Willet, 2006) mobilizing disproportional high amounts of DON. The trend often found in studies of the contribution of DON to total N leaching is that the amount of DON lost is relatively constant, whereas changes in total N losses occur due to changes in the leaching of  $\text{NO}_3$  (Vinther *et al.*, 2006; Rasmussen *et al.*, 2008).

#### **Nitrous oxide and methane emissions**

Eckard *et al.* (2003) noted that denitrification losses were highest in winter when soil moisture was highest. Very high  $\text{N}_2\text{O}$  emission rates have been observed in grazed pastures (e.g., de Klein *et al.*, 2006; Luo *et al.*, 2008b; 2008c) when wet soils become compacted by animal treading. Treading causes anaerobic conditions and animal excreta provides abundant N and C. Thus, high  $\text{N}_2\text{O}$  emission rates can occur on wet soils soon after N fertilisation or grazing.

Reported  $\text{N}_2\text{O}$  emission rates from soils under clover-grass pasture grazed by dairy cows in New Zealand and Australia range from 6 to  $11 \text{ kg ha}^{-1} \text{ yr}^{-1} \text{ N}_2\text{O-N}$  (Dalal *et al.*, 2003; Luo *et*

*al.*, 2008a). At comparable levels of production it is likely that the N<sub>2</sub>O emissions resulting from N-cycling of animal excreta will be similar for both clover-grass and grass pasture. However, because grass pasture requires inputs of N fertiliser, this type of pasture will have additional fertiliser-specific losses. For example, losses of up to 29 kg ha<sup>-1</sup> yr<sup>-1</sup> N<sub>2</sub>O-N have been measured in grass pastures in Ireland that received N fertiliser application at a rate of 390 kg ha<sup>-1</sup> yr<sup>-1</sup> (Hyde *et al.*, 2006). Ryden (1983) reported N losses of 1.3 kg ha<sup>-1</sup> yr<sup>-1</sup> for grass pasture that did not receive N fertiliser inputs and of 11 kg ha<sup>-1</sup> yr<sup>-1</sup> after N fertilisation at a rate of 250 kg ha<sup>-1</sup> yr<sup>-1</sup>. In an Australian study (Eckard *et al.*, 2003), N losses from total denitrification were significantly less from unfertilised clover/ryegrass pasture than from the same pasture receiving 200 kg ha<sup>-1</sup> yr<sup>-1</sup> N (as either ammonium nitrate or urea), at 6 kg ha<sup>-1</sup> yr<sup>-1</sup> without N fertiliser and 15 and 13 kg ha<sup>-1</sup> yr<sup>-1</sup>, respectively, for the two N fertilisers. Similar denitrification losses have been reported by other workers on clover-grass pastures in New Zealand. For example, Ruz-Jerez *et al.* (1994) reported annual losses of 3.4 kg ha<sup>-1</sup> from grass-clover swards compared to 19.3 kg ha<sup>-1</sup> after application of 400 kg ha<sup>-1</sup> yr<sup>-1</sup> of N fertiliser, and Ledgard *et al.* (1999) reported total denitrification losses of 3-7 kg ha<sup>-1</sup> yr<sup>-1</sup> without added N compared to 10-25 kg ha<sup>-1</sup> yr<sup>-1</sup> after application of 200 kg ha<sup>-1</sup> yr<sup>-1</sup> as N fertiliser. Much higher denitrification losses were measured from N-fertilised pasture in Northern Ireland at up to 154 kg ha<sup>-1</sup> yr<sup>-1</sup> after application of 500 kg ha<sup>-1</sup> yr<sup>-1</sup> as N fertiliser (Watson *et al.*, 1992).

Methane emission from animal excreta occurs under strictly anaerobic conditions in slurry stores and is expected to be negligible during grazing. Thus, by lowering the quantity of slurry stored especially during summer when emissions are highest (Sommer *et al.*, 2009) grazing systems may considerably reduce methane emissions compared to indoor housing of cows. Methane emissions from enteric digestion of pasture by grazing ruminants are large (e.g., Clark, 2001). The main determinant of methane emissions is the amount of feed consumed by the ruminant animal and it is likely to be similar for perennial ryegrass and white clover-ryegrass pastures. However, other temperate forage legumes such as *Lotus corniculatus* and *Hedysarum* that contain compounds such as condensed tannins can lead to a reduction in methane emissions on a per unit DM of intake (Woodward *et al.*, 2001; Ramirez-Restrepo and Barry, 2005). They also have the potential to reduce N leaching and N<sub>2</sub>O emissions by increasing the relative N excretion in faeces compared to urine (Carulla *et al.*, 2005), thereby reducing the amount of urine-N with high risk of N loss.

### **Farm N budgets and N use efficiency**

The previous two sections referred to measurements from plots or paddocks with pasture but there is also a need to consider the whole farm and account for effects of nutrients in external inputs such as brought-in feed and within-farm transfers such as from farm dairy effluent or stored slurry. The magnitude of N input to grazed farm systems is generally the main factor determining the N surplus and therefore the potential for N losses. For example, Ledgard *et al.* (1999) found that a three-fold increase in total N inputs to intensively grazed dairy pastures in NZ resulted in a four-fold increase in N surplus, a four- to five-fold increase in gaseous and leaching losses, and a halving of the N use efficiency (Table 2). A summary of dairy farm systems across Western Europe (Bossuet *et al.*, 2006) showed an even wider range in the quantity and form of N inputs, N outputs, and N surplus, with denitrification being generally higher overall and N leaching lower than in the New Zealand study. A three-year comparison between fertiliser-N and clover-N dairy systems using ryegrass-based pasture was carried out by Schils *et al.* (2000a, 2000b). The farm systems had the same number of cows but more land was used in the clover system due to lower pasture production (Table 3). An intensive monitoring programme was carried out, with measurements including forage production and quality, feed intake and milk production. Biological N<sub>2</sub> fixation was calculated

from clover contents and clover-grass yields. Nitrate concentration in drain water was measured on a weekly basis, while GHG emissions were calculated using IPCC emission factors (Schils *et al.*, 2005). The N surplus per ha was higher for the N-fertilised system, but this was mainly related to the higher milk production per ha. There was no significant difference in the calculated N leaching between the systems when expressed as N leached per kg milk. There was a trend for N leaching it to be 25% higher from the clover system than from the N-fertilised system. Calculated N<sub>2</sub>O emissions (direct and indirect) were lower on the clover system, both per ha and per kg milk, mainly due to the much lower use of fertiliser-N.

Table 2. N inputs and outputs from intensive dairy farm systems in NZ receiving N fertiliser at 0 or 410 kg N ha<sup>-1</sup> yr<sup>-1</sup> (Ledgard *et al.*, 1999 and unpublished data). Bracketed values are range in N flows measured over 5 years. Data are compared with that from a range of farm systems in Western Europe (Bossuet *et al.*, 2006).

	0 N (NZ)	410 N (NZ)	EU farms
<b>N Inputs (kg ha<sup>-1</sup> yr<sup>-1</sup>):</b>			
Clover N <sub>2</sub> fixation + atm. dep.	170 (90-220)	50 (25-135)	6-133
Fertiliser N	0	410	0-262
Manure N (imported)	0	0	0-22
Purchased feed	0	41	6-489
<b>N Outputs (kg ha<sup>-1</sup> yr<sup>-1</sup>):</b>			
Milk + meat	78 (68-83)	114 (90-135)	20-127
Transfer of excreta to lanes/sheds	53 (41-63)	77 (72-91)	
Denitrification	5 (3-7)	25 (13-34)	10-41
Ammonia volatilisation	15 (15-17)	68 (47-78)	18-81
Leaching	30 (12-74)	130 (109-147)	16-63
Immobilisation of fertiliser N		70 (60-84)	
N balance (kg N ha <sup>-1</sup> yr <sup>-1</sup> ):	-11 (-74 to +47)	7 (-11 to +24)	
Farm N surplus (kg N ha <sup>-1</sup> yr <sup>-1</sup> ):	92	387	70-463
(N input – N output in product)			
N use efficiency (product-N/input-N)	46%	23%	22-36%

### Importance of managing whole systems

Intensively grazed pasture systems markedly increase the risk of N losses to waterways and the atmosphere. Traditionally, N losses are expected to increase with the age of the sward due to the likely loss of excess N when maximum accumulation has been reached. This picture of increasing N losses with sward age, and comparatively huge losses following cultivation, may well describe the situation on many farms, but it is not an inherent property of grassland and grass-arable rotations. Good pasture management (e.g. reduced fertiliser input and reduced length of grazing) and in the mixed crop rotation both during the grassland and the arable phase (e.g. delayed ploughing time and a catch crop strategy) can considerably reduce negative environmental impact of grazing.

Although there are environmental consequences of grazing, pollution swapping can occur with, e.g., housing and cutting only systems, due to transport and storage of feed – all of which require energy often from non-renewable sources. Therefore, when evaluating environmental impact it is necessary to examine the whole farming system. In particular, for greenhouse gases since pasture may serve as a source of N<sub>2</sub>O and indirectly of CH<sub>4</sub>, but also as a sink of CO<sub>2</sub> influenced by management practices on the farm. Furthermore, indirect emissions in other ecosystems from losses of N via NO<sub>3</sub> leaching and NH<sub>3</sub> volatilisation should be accounted for.



Table 3. Characteristics of fertiliser-N and clover-N dairy farm systems in the study undertaken by Schils *et al.* (2000 a,b).

	Fertiliser-N	Clover-N
Cows (number)	59	59
Area (ha)	34	41
Milk production FPCM <sup>a</sup> (kg ha <sup>-1</sup> )	13884	12053
Fertiliser N (kg ha <sup>-1</sup> yr <sup>-1</sup> )	208	17
Manure effective N (kg ha <sup>-1</sup> yr <sup>-1</sup> )	67	52
Clover fixed N (kg ha <sup>-1</sup> yr <sup>-1</sup> )	0	176
Grazing system (h d <sup>-1</sup> )	24	24
N input (kg ha <sup>-1</sup> yr <sup>-1</sup> )	333	279
N output (kg ha <sup>-1</sup> yr <sup>-1</sup> )	80	69
N surplus (kg ha <sup>-1</sup> yr <sup>-1</sup> )	253	212
Nitrate N leaching (kg ha <sup>-1</sup> yr <sup>-1</sup> )	20	22
Nitrous oxide N (kg ha <sup>-1</sup> yr <sup>-1</sup> )	9.4	6.6
GHG total CO <sub>2</sub> -equiv (kg ha <sup>-1</sup> )	16065	12198
Nitrate leaching (kg per 1000 kg milk)	1.4	1.8
Nitrous oxide (kg per 1000 kg milk)	0.7	0.5
GHG total (kg CO <sub>2</sub> -equiv per kg milk)	1.2	1.0

a) Fat and protein corrected milk

## References

- Afzal M. and Adams W.A. (1992) Heterogeneity of soil mineral nitrogen in pasture grazed by cattle. *Soil Science Society of America Journal* 56, 1160-1166.
- Bossuet I., Chambaut H., le Gall A. and Raison C. (2006) Study of the distribution of nitrogen surplus in experimental dairy farms of the Atlantic area. Dairy Systems and Environment in the Atlantic Area. *Proceedings of the Final Seminar of the Green Dairy Project*, 13-14 December 2006, Institute of de l'Elevage, Rennes, France, pp. 67-95.
- Bolan N.S., Saggarr S., Luo J., Bhandral R. and Singh J. (2004) Gaseous emissions of nitrogen from grazed pastures: processes, measurements and modelling, environmental implications, and mitigation. *Advances in Agronomy* 84, 37-120.
- Carulla J.E., Kreuzer M., Machmuller A. and Hess H.D. (2005) Supplementation of Acacia mearnsli tannins decreases methanogenesis and urinary nitrogen in forage-fed sheep. *Australian Journal of Agricultural Research* 56, 961-970.
- Clark H. (2001) *Ruminant methane emissions: a review of methodology used for national inventory estimations*. A report for Ministry of Agriculture and Fisheries, Wellington, New Zealand.
- Dalal R.C., Wang W., Robertson G.P. and Parton W.J. (2003) Nitrous oxide emissions from Australian agricultural lands and mitigation options. *Australian Journal of Soil Research* 41, 165-195.
- de Klein C.A.M., Smith L.C. and Monaghan R.M. (2006) Restricted autumn grazing to reduce nitrous oxide emissions from dairy pastures in Southland, New Zealand. *Agriculture, Ecosystems and Environment* 112, 192-199.
- Di H. and Cameron K.C. (2002) The use of a nitrification inhibitor, dicyandiamide (DCD), to decrease nitrate leaching and nitrous oxide emissions in a simulated grazed and irrigated grassland. *Soil Use and Management* 18, 395-403.
- Djurhuus J. and Olsen P. (1997) Nitrate leaching after cut grass/clover leys as affected by time of ploughing. *Soil Use and Management* 13, 61-67.
- Drewry J.J., Cameron K.C. and Buchan G.D. (2008) Pasture yield and soil physical property responses to soil compaction from trading and grazing – a review. *Australian Journal of Soil Research* 46, 237-256.
- Eckard R.J., Chen D., White R.E. and Chapman D.F. (2003) Gaseous nitrogen loss from temperate perennial grass and clover dairy pastures in south-eastern Australia. *Australian Journal of Agricultural Research* 54, 561-570.
- Eriksen J. (2001) Nitrate leaching and growth of cereal crops following cultivation of contrasting temporary grasslands. *Journal of Agricultural Science, Cambridge* 136, 271-281.
- Eriksen J., Askegaard M. and Søegaard K. (2008) Residual effect and nitrate leaching in grass-arable rotations: Effect of grassland proportion, sward type and fertilizer history. *Soil Use and Management* 24, 373-382.

- Eriksen J. and Jensen L.S. (2001) Soil respiration, nitrogen mineralisation and uptake in barley following cultivation of grazed grasslands. *Biology and Fertility of Soils* 33, 139-145.
- Eriksen J., Vinther F.P. and Søegaard K. (2004) Nitrate leaching and N<sub>2</sub>-fixation in grasslands of different composition, age and management. *Journal of Agricultural Science, Cambridge* 142, 141-151.
- Hansen J.P., Eriksen J. and Jensen L.S. (2005) Residual nitrogen effect of a dairy crop rotation as influenced by grass-clover ley management, manure type and age. *Soil Use and Management* 21, 278-286.
- Hansen E.M., Eriksen J. and Vinther F.P. (2007) Catch crop strategy and nitrate leaching following a grazed grass-clover. *Soil Use and Management* 23, 348-358.
- Haynes R.J. and Williams P.H. (1993) Nutrient cycling and soil fertility in grazed pasture ecosystems. *Advances in Agronomy* 49, 119-199.
- Hoving I.E. and de Boer H.C. (2004) Farm management and economics – grassland renovation. In: Conijn J.G. and Taube F. (eds.) *Grassland Resowing and Grass-arable Crop Rotations*. Plant Research International, Wageningen, Report 80, pp. 67-70.
- Hyde B.P., Hawkins M.J., Fanning A.F., Noonan D., Ryan M., O'Toole P. and Carton O.T. (2006) Nitrous oxide emissions from a fertilized and grazed grassland in the south east of Ireland. *Nutrient Cycling in Agroecosystems* 75, 187-200.
- Johnston A.E., McEwen J., Lane P.W., Hewitt M.V., Poulton P.R. and Yeoman D.P. (1994) Effects of one to six year old ryegrass-clover leys on soil nitrogen and on the subsequent yields and fertilizer nitrogen requirements of the arable sequence winter wheat, potatoes, winter wheat, winter beans (*Vicia faba*) grown on a sandy loam soil. *Journal of Agricultural Science, Cambridge* 122, 73-89.
- Jones D.L. and Willet V.B. (2006) Experimental evaluation of methods to quantify dissolved organic nitrogen (DON) and dissolved organic carbon (DOC) in soil. *Soil Biology and Biochemistry* 35, 991-999
- Ledgard S.F. (2001) Nitrogen cycling in low input legume-based agriculture, with emphasis on legume/grass pastures. *Plant and Soil* 228, 43-59.
- Ledgard S.F., Penno J.W. and Sprosen M.S. (1999) Nitrogen inputs and losses from clover/grass pastures grazed by dairy cows, as affected by nitrogen fertiliser application. *Journal of Agricultural Science, Cambridge* 132, 215-225.
- Luo J., Ledgard S.F., de Klein C.A.M., Lindsey S.B. and Kear M. (2008a) Effects of dairy farming intensification on nitrous oxide emissions. *Plant and Soil* 309, 227-237.
- Luo J., Ledgard S.F. and Lindsey S.B. (2008b) A test of a winter farm management option for mitigating nitrous oxide emissions from a dairy farm. *Soil Use and Management* 24, 121-130.
- Luo J., Saggart S., Bhandral R., Bolan N., Ledgard S., Lindsey S. and Sun W. (2008c) Effects of irrigating dairy-grazed grassland with farm dairy effluent on nitrous oxide emissions. *Plant and Soil* 309, 119-130.
- Menneer J.C., Ledgard S.F., McLay C.D.A. and Silvester W.B. (2004) The impact of grazing animals on N<sub>2</sub> fixation in legume-based pastures and management options for improvement. *Advances in Agronomy* 83, 181-241.
- Monaghan R.M., Paton R.J., Smith L.C., Drewry J.J. and Littlejohn R.P. (2005) The impacts of nitrogen fertilisation and increased stocking rate on pasture yield, soil physical condition and nutrient losses in drainage from a cattle-grazed pasture. *New Zealand Journal of Agricultural Research* 48, 227-240.
- Monaghan R.M., Hedley M.J., Di H.J., McDowell R.W., Cameron K.C. and Ledgard S.F. (2007) Nutrient management in New Zealand pastures – recent developments and future issues. *New Zealand Journal of Agricultural Research* 50, 181-201.
- Oenema O., Velthof G.L., Yamulki S. and Jarvis S.C. (1997) Nitrous oxide emissions from grazed grassland. *Soil Use and Management* 13, 288-295.
- Ramirez-Restrepo C.A. and Barry T.N. (2005) Alternative temperate forages containing secondary compounds for improving sustainable productivity in grazing ruminants. *Animal Feed Science and Technology* 120, 179-201.
- Rasmussen J., Gjettermann B., Eriksen J., Jensen E.S. and Høgh-Jensen H. (2008) Fate of 15N and 14C from labelled plant material: Recovery in perennial ryegrass-clover mixtures and in pore water of the sward. *Soil Biology and Biochemistry* 40, 3031-3039
- Rotz C.A., Taube F., Russelle M.P., Oenema J., Sanderson M.A. and Wachendorf M. (2005). Whole-farm perspectives of nutrient flows in grassland agriculture. *Crop Science* 45, 2139-2159.
- Ruz-Jerez B.E., White R.E. and Ball P.R. (1994). Long-term measurement of denitrification in three contrasting pastures grazed by sheep. *Soil Biology and Biochemistry* 26, 29-39.
- Ryden J.C. (1983) Denitrification loss from a grassland soil in the field receiving different rates of nitrogen as ammonium nitrate. *Journal of Soil Science* 34, 355-365.
- Schils R.L.M., Boxem T.J., Sikkema K. and Andre G. (2000a) The performance of a white clover based dairy system in comparison with a grass/fertiliser-N system. I. Botanical composition and sward utilisation. *Netherlands Journal of Agricultural Science* 48, 291-303.

- Schils R.L.M., Boxem T.J., Jagtenberg C.J. and Verboon M.C. (2000b) The performance of a white clover based dairy system in comparison with a grass/fertiliser-N system. II. Animal production, economics and environment. *Netherlands Journal of Agricultural Science* 48, 305-318.
- Schils R.L.M., Verhagen A., Aarts H.F.M. and Šebek L.B.J. (2005) A farm level approach to define successful mitigation strategies for GHG emissions from ruminant livestock systems. *Nutrient Cycling in Agroecosystems* 71, 163-175.
- Scholefield D., Lockyer D.R., Whitehead D.C. and Tyson K.C. (1991) A model to predict transformations and losses of nitrogen in UK pastures grazed by beef cattle. *Plant and Soil* 132, 165-177.
- Sommer S., Olesen J.E., Petersen S.O., Weisbjerg M., Valli L., Rohde L. and Béline F. (2009) Region-specific assessment of greenhouse gas mitigation with different manure management strategies in four agroecological zones. *Global Change Biology* 15, 2825-2837.
- Springob G., Brinkmann S., Engel N., Kirchmann H. and Böttcher J. (2001) Organic C levels of Ap horizons in North German Pleistocene sands as influenced by climate, texture, and history of land-use. *Journal of Plant Nutrition and Soil Science* 164, 681-690.
- Vellinga T. V., Van der Putten A. H. J. and Mooij M. (2001). Grassland management and nitrate leaching, a model approach. *Netherlands Journal of Agricultural Science* 49, 229-253.
- Van Kessel C., Clough T. and van Groeningen J.W. (2009) Dissolved organic nitrogen: An overlooked pathway of nitrogen loss from agricultural systems. *Journal of Environmental Quality* 38, 393-401.
- Vertés F., Hatch D., Velthof G., Taube F., Laurent F., Loiseau P. and Recous S. (2007) Short-term and cumulative effects of grassland cultivation on nitrogen and carbon cycling in ley-arable rotations. *Grassland Science in Europe* 12, 227-246.
- Vinther F.P. and Jensen E.S. (2000) Estimating legume N<sub>2</sub> fixation in grass-clover mixtures of a grazed organic cropping system using two <sup>15</sup>N methods. *Agriculture, Ecosystems and Environment* 78, 139-147.
- Vinther F.P., Hansen E.M. and Eriksen J. (2006) Leaching of soil organic carbon and nitrogen in sandy soils after cultivating grass-clover swards. *Biology and Fertility of Soils* 43, 12-19.
- Wachendorf M., Büchter M., Trott H. and Taube F. (2004) Performance and environmental effects of forage production on sandy soils. II. Impact of defoliation system and nitrogen input on nitrate leaching losses. *Grass and Forage Science* 59, 56-68.
- Wachendorf C., Taube F. and Wachendorf M. (2005) Nitrogen leaching from N-15 labelled cow urine and dung applied to grassland on a sandy soil. *Nutrient Cycling in Agroecosystems* 73, 89-100
- Watson C.J., Jordan C., Taggart P.J., Laidlaw A.S., Garrett M.K. and Steen R.W. (1992) The leaky N-cycle on grazed grassland. *Aspects of Applied Biology* 30, 215-223.
- Watson C.A., Öborn I., Eriksen J. and Edwards A.C. (2005) Perspectives on nutrient management in mixed farming systems. *Soil Use and Management* 21, 132-140.
- Weller R.F. and Jones E.L. (2002) An overview of the role and potential of forage production on lowland organic livestock farms. *Proceedings of the UK Organic Research 2002 Conference*, Aberystwyth, UK, pp. 81-84.
- Wilkins R.J. and Jones R. (2000) Alternative home-grown protein sources for ruminants in the United Kingdom. *Animal Feed Science and Technology* 85, 23-32.
- Woodward S.L., Waghorn G.C., Ulyatt M.J. and Lassey K.R. (2001) Early indications that feeding lotus will reduce methane emissions from ruminants. *Proceedings of the New Zealand Society of Animal Production* 61, 23-26.

## **Session 5.1**

### **Pasture management and production**

*Editor: Jürgen Schellberg*

## Utilisation of cut and grazed fields is linked to their geographical characteristics in mountainous bovine systems

Garcia-Launay F.<sup>1</sup>, Sibra C.<sup>2,3</sup>, Molénat H.<sup>2,3</sup>, Agabriel C.<sup>2,3</sup> and Brunshwig G.<sup>2,3</sup>

<sup>1</sup>INRA, UR1213 Herbivores, Theix, F-63122 Saint-Genès-Champanelle, France

<sup>2</sup>Clermont Université, VetAgro Sup, UR 2008.03.102, EPR, BP 10448, F-63000 Clermont-Ferrand, France

<sup>3</sup>INRA, USC 2005, F-63370 Lempdes, France

Corresponding author: florence.garcia@clermont.inra.fr

### Abstract

The impact of geographical characteristics on the utilization of cut and grazed fields was investigated on 72 farms in Massif Central (France) managing milked cows with their calves. Principal component and hierarchical cluster analyses were performed on 679 cut and grazed fields. Relationships between the classes obtained and the slope, area, distance to farmstead and elevation of the field were established through linear mixed models. The population was separated into six utilisation classes characterized by different types of sequences: one grazing before cutting, early cutting before grazing, late cutting before grazing, grazing cutting and grazing sequence, two cuttings before grazing, and one unspecialised sequence of cutting and grazing. The fields grazed before cutting are larger and closer to the farmstead than the fields cut before grazing. Elevation is involved in the orientation between early and late cutting. The fields grazed twice have a low distance to farmstead that is consistent with two periods of grazing. Although field utilisation is strongly driven by its geography, farmers have the possibility to adapt their conducting on fields with characteristics suitable for several utilisations. These results will help to model the forage system functioning and to adapt on-farm advice to the fields' characteristics.

Keywords: cutting, grazing, cattle, field geographical characteristics, Salers breed

### Introduction

Forage management in mountainous grass-based livestock systems depends on the general farm objectives, inter-year variation of grass growth but also on the geographic characteristics of the grassland fields (Fleury *et al.*, 1996). Some authors have investigated how farmers allocate the utilisation of fields according to distance to the cowshed, field elevation or slope in dairy systems (Brunshwig *et al.*, 2006; Andrieu *et al.*, 2007) and have even proposed a discrimination tree of grassland use opportunities in grass-based bovine systems (Martin *et al.*, 2009). In these studies, definition and categorisation of field management practices were made *a priori* from farmer formalisation and expert knowledge. A better understanding of the relationships between field geographical characteristics and field utilisation, in both dairy and suckler systems, is particularly needed in the context of increasing farm area in mountainous territories where field geographical characteristics are highly variable. Our objective was to identify the relationships between field geographical characteristics and field utilisation in mountainous grass-based livestock systems. This paper focuses on cut and grazed fields.

### Materials and methods

We carried out surveys in 2005 on 72 farms utilising the traditional Salers livestock system (43 ± 19.8 cows, 78 ± 33.5 ha with 95% as permanent grasslands) located in the mountainous area of the Massif Central, France. This system manages Salers milked cows that

simultaneously suckle their calf. Each field was characterized by the farmer: detailed cutting and grazing schedule, area, distance to farmstead, slope, and elevation. We divided the grazing season into 4 periods: Period 1, from turnout to 22 May (topping period); Period 2, from 23 May to 5 August (spring grazing or cutting); Period 3, from 6 August to 21 September (summer grass utilisation); Period 4, from 22 September to housing (autumn grazing). First utilisation, either cutting or grazing, was characterized by its precocity relative to the theoretical date of the beginning of ear emergence according to elevation. Data analyses were conducted with the field as the statistical unit ( $n = 1586$ ). General field groups were first identified and compared: cut only ( $n = 113$ ), grazed only ( $n = 794$ ), cut and grazed ( $n = 679$ ). Principal component analysis (PCA) was applied using SPAD software on cut and grazed fields using date of first cutting, number of cuttings and the starting and ending dates for utilisation. The resulting factors were subjected to a hierarchical cluster analysis. The utilisation classes obtained were verified by means of a linear mixed model. The effects of the utilisation classes on the geographical characteristics were tested with linear mixed models including the farm as a random factor. We report the results obtained on the cut and grazed fields in the following section.

Table 1. Description of the 6 utilisation classes

	GC ( $n = 25$ )	eCG ( $n = 158$ )	ICG ( $n = 139$ )	uCG ( $n = 98$ )	GCG ( $n = 179$ )	CCG ( $n = 80$ )
<i>Dates (calendar days)</i>						
First utilisation	111 d	158 b	188 a	142 c	109 d	155 b
End of utilisation	188 d	315 a	305 b	266 c	316 a	306 b
First cutting	183 ab	163 c	188 a	176 b	187 a	159 c
<i>Difference between date of first utilisation and theoretical date of ear emergence (days)</i>						
	-40 d	11 b	37 a	-6 c	-39 d	7 b
<i>Intensity of grazing (% of the total grazing season)</i>						
Period 1	92 a	0 d	0 d	10 c	32 b	1 d
Period 3	1 c	14 b	14 b	44 a	10 b	2 c
Period 4	0 f	74 c	85 b	16 e	45 d	95 a
<i>Geographical characteristics</i>						
Area (ha)	3.2 ab	3.0 b	3.1 b	2.7 b	4.5 a	3.2 b
Distance to farmstead (km)	0.6 ab	1.3 ab	2.2 a	2.0 a	0.8 b	2.4 a
Elevation (m)	905 a	860 b	892 a	857 b	875 ab	863 ab
Slope (% of field area)	9.1 ab	11.3 ab	2.4 b	9.9 ab	13.6 a	9.0 ab

## Results and discussion

Comparison of the general field groups showed that cut and grazed fields were closer to the farmstead ( $1.6 \pm 0.53$  km) than the grazed only fields ( $2.6 \pm 0.52$  km) and the cut only fields ( $3.0 \pm 0.76$  km). They occupied an area ( $3.2 \pm 0.22$  ha) greater than cut only fields ( $1.5 \pm 0.44$  ha) and smaller than grazed only fields ( $4.2 \pm 0.21$  ha). The percentage of area with slope on cut and grazed fields (8.6%) was lower than on grazed-only fields (42.7%). For cut and grazed fields, the PCA explained 82% of the variability with three factors. The date of first cutting is opposite to the number of cuttings, along the first axis. The starting and ending dates for utilisation are linked according to the second factor and opposite on the third axis. The population was separated into six classes (Table 1) labelled according to their sequence of utilisation: GC for grazing before cutting, eCG for early cutting before grazing, ICG for late cutting before grazing, uCG for unspecialised sequence, GCG for grazing, cutting and grazing, and CCG for two cuttings before grazing. Here a sequence corresponds to a succession of grazing and cutting utilisations during the grazing season, e.g. GCG. GC fields were subjected to early grazing in Period 1 followed by one cutting in P2 and their utilisation ended early. They presented the earliest starting and ending dates of utilisation (111 and 188

calendar days,  $P < 0.05$ ) and the highest (92%,  $P < 0.05$ ) proportion of grazing in Period 1. Cutting occurred earlier in eCG than in ICG (11 days and 37 days respectively after the theoretical date of the beginning of ear emergence,  $P < 0.05$ ), which resulted in a longer season of utilisation in eCG (+ 40 days). In Class uCG, we observed several sequences that always ended with a CG succession. Indeed, grazing occurred mainly in Period 3 (44%) and first utilisation occurred at an early growth stage (6 days before the theoretical date of the beginning of ear emergence). On the GCG fields the date of first cutting (187 calendar days) was later than the date of first utilisation (109 calendar days) which meant that first utilisation was grazing. This is consistent with the distribution of grazing in periods 1 (32%) and 4 (45%). On CCG fields, first cutting occurred early during the season (7 days after the theoretical date of the beginning of ear emergence) and grazing was concentrated in Period 4 (95%). Fields grazed in first utilisation (GC and GCG) were early grazed, about 40 days before the theoretical date of ear emergence. The earlier cut fields (eCG and CCG) were always cut after the theoretical date of the beginning of ear emergence (from 7 to 11 days after). These two observations suggest that, for the first cycle of grass growth, farmers are more careful with grass quality for grazing and with grass quantity for cutting. This was consistent with the studied system based on a hardy breed with moderate milk production. Fields with grazing and cutting sequences (GC and GCG) were larger and closer (Table 1) than fields of classes with cutting and grazing sequences (eCG, ICG and CCG). The fields of the GCG class presented a low distance to farmstead that is consistent with two periods of grazing. Their percentage of slope was the highest observed (13.6%) in relation with their main utilisation through grazing. The fields of GC class were located at a high elevation, which could explain why they were not grazed after cutting. The fields of eCG were situated at a lower elevation than the fields ICG with late cutting.

## Conclusions

Combinations of geographical characteristics appear as strong determinants of the grassland fields' utilisation in mountainous livestock systems. However, different types of utilisation are observed on fields with similar characteristics. This suggests that on fields suitable for several utilisations, farmers could adapt their conduct according to the forage production of the year. These results will help to model the interactions between forage production and feeding requirements of the herd to adapt on-farm advice to the fields' characteristics.

## References

- Andrieu N., Josien E. and Duru M. (2007) Relationships between diversity of grassland vegetation, field characteristics and land use managements practices assessed at the farm level. *Agriculture, Ecosystems and Environment* 120, 359-369.
- Brunschwig G., Josien E. and Bernhard C. (2006) Contraintes géographiques et modes d'utilisation des parcelles en élevage bovin laitier et allaitant. *Fourrages* 185, 83-95.
- Fleury P., Dubeuf B. and Jeanin B. (1996) Forage management in dairy farms: a methodological approach. *Agricultural Systems* 52 (2/3), 199-212.
- Martin G., Hossard L., Theau JP., Therond O., Josien E., Cruz P., Rellier JP., Martin-Clouaire R. and Duru M. (2009) Characterizing potential flexibility in grassland use. Application to the French Aubrac area. *Agronomy for Sustainable Development* 29 (2), 381-389.



# Grazing behaviour and intake of two Holstein cow types in a pasture-based production system

Schori F. and Münger A.

*Agroscope Liebefeld-Posieux Research Station ALP, CH-1725 Posieux, Switzerland*

Corresponding author: fredy.schori@alp.admin.ch

## Abstract

Cow types adapted to forage-based production systems are of particular interest for organic milk production. The objective of the present study was to compare grass intake and grazing behaviour of New Zealand genetics Holstein cows ( $H_{NZ}$ ) ( $n = 11$ ) with farm-bred 'Swiss' Holstein cows ( $H_{CH}$ ) ( $n = 11$ ). The comparison was realised in a pasture-based production system with a short late winter/early spring calving season, under organic conditions. Intake of cows was estimated individually 4 times during 2 grazing seasons using the n-alkane marker technique. Simultaneously, selected cows were equipped with behaviour recorders to collect grazing behaviour data. Motion sensors monitored activity and position status. Grass dry matter intake (GDMI) and total DM intake (TDMI) of  $H_{NZ}$  were significantly lower than  $H_{CH}$ , but per unit of metabolic body weight no differences were found. Energy-corrected milk yield per unit of TDMI shows no significant differences between the two cow types. The  $H_{NZ}$  spent more time ruminating, had a higher number of mastications during rumination, but no differences occurred related to eating and idling time. Fewer bites and more mastications during eating were found for  $H_{NZ}$ . The latter tended to stand less and lie more.

Keywords: Grazing behaviour, intake, dairy cow type, pasture, organic farming

## Introduction

Cow types adapted to forage-based, especially pasture-based production systems are of particular interest for organic milk production. Evidence of genotype x environment interaction exists (Kolover *et al.*, 2002; Horan *et al.*, 2005). Furthermore, McCarthy *et al.* (2007) found differences in grazing behaviour between Holstein genetic strains. It seems that some cow breeds or strains fit better into pasture-based production systems with low concentrate supplementation than others. In a comprehensive project including several partners (Swiss College of Agriculture; farmer organisation 'Milk from Pasture', Swissgenetics, Vetsuisse Faculty University of Zurich, University of Veterinary Medicine Vienna and Agroscope) the aptitude of  $H_{NZ}$  to produce milk in a pasture-based production system with a short calving season late winter/early spring were studied. Grazing behaviour, intake and feed efficiency of  $H_{NZ}$  complying with organic guidelines, and with a seasonal calving pattern, are presented in this paper. As comparison  $H_{CH}$  are used.

## Materials and methods

The study was conducted at the organic farm 'L'Abbaye' in Sorens, Switzerland, (46° 39.767' N, 7° 3.143' E, 824 m a.s.l.) from 2007 to 2008. Experimental groups consisted of cows with different genetic background, 11  $H_{NZ}$  and 11  $H_{CH}$ , which were in their first (2007) and second lactation (2008), and calved from February to mid April. All lactating cows on the farm, on average 73 animals, grazed together in a full time, rotational system with up to 18 paddocks, each approximately 2 ha. From mid-May to end September no forage supplements were offered. Over the first 105 days (2007) and 80 days of lactation (2008) an average of 405 kg and 316 kg concentrate  $cow^{-1}$  were eaten, respectively. Pre- (PREGSH) and post grazing

sward height (POGSH) was measured with a rising plate meter (Filip's folding plate pasture meter, Jenquip, NZ, 1 unit (U) corresponds to 0.5 cm).

Pasture intake was estimated twice in each grazing season, using the double marker method with n-alkanes (Mayes *et al.*, 1986). Five days before the first faecal samples were collected, alkane controlled-release capsules (Captec Ltd., Auckland, NZ) releasing Dotriacontane (C<sub>32</sub>) at a constant rate of 406 mg d<sup>-1</sup> (2007), resp. 402 mg d<sup>-1</sup> (2008) were administered into the rumen. Herbage and faecal samples were collected, shifted by 24 hours, each morning during 5 days. Simultaneously, twice 3 cows per type were equipped during 4 days with recorders (IGER Behaviour Recorder, Rutter *et al.*, 1997) to collect grazing behaviour data. Only in 2008, the cows' physical activity and position status were recorded with pedometers (IceTag, IceRobotics Ltd., Roslin, UK). For statistical analysis, a two-way univariate analysis of variance model was applied (Systat 12, Systat Inc., Chicago, USA) with the factors cow type and measurement period.

## Results and discussion

The average sward composition was 74% grasses, 12.5% clover and 13.5% herbs. Information about measurement date, PREGSH, POGSH and herbage quality are shown in Table 1. The cows had access to pasture during approximately 18 hours daily.

Table 1: Dates, PREGSH, POGSH and herbage quality

Year	2007			2008
	1	2	3	4
Measurement period				
Dates	10-21 June	26-30 August	25-29 May	17-21 August
PREGSH [U]	16.2	15.4	15.2	15.4
POGSH [U]	9.3	9.4	8.6	8.9
Crude protein in DM [g kg <sup>-1</sup> ]	148	175	172	164
Neutral detergent fibre in DM [g kg <sup>-1</sup> ]	458	437	426	427
Net energy for lactation in DM [MJ kg <sup>-1</sup> ]	5.9	6.1	6.1	6.0

Table 2: Herbage and total intake

Cow type	H <sub>CH</sub>				H <sub>NZ</sub>				SEE <sup>a</sup>	P		
	1	2	3	4	1	2	3	4		T <sup>b</sup>	P <sup>c</sup>	TxP <sup>d</sup>
Cows per treatment	10	11	10	9	10	11	10	9				
Days in milk	92	166	56	140	109	183	79	166	6	***	***	-
Energy-corrected milk [kg]	19.0	16.7	28.3	19.9	15.4	15.0	23.8	18.4	1.0	***	***	-
Live weight [kg]	580	592	621	628	475	493	518	538	13	***	***	-
Concentrate DM [kg]	2.0	0	3.0	0	0.3	0	1.7	0	0.3	**	***	*
Minerals DM [kg]	0.07	0	0.07	0	0.02	0	0.05	0	0.01	***	***	**
GDMI <sup>e</sup> [kg]	12.0	19.6	18.3	20.2	12.2	17.0	16.4	16.7	0.9	**	***	-
TDMI <sup>f</sup> [kg]	14.1	19.6	21.4	20.2	12.5	17.0	18.1	16.7	0.8	***	***	-
GDMI <sup>e</sup> [kg 100 kg BW <sup>-0.75</sup> ]	10.2	16.3	14.7	16.1	12.0	16.2	15.0	15.0	0.7	-	***	-
TDMI <sup>f</sup> [kg 100 kg BW <sup>-0.75</sup> ]	11.9	16.3	17.2	16.1	12.3	16.2	16.6	15.0	0.7	-	***	-
ECM <sup>g</sup> TDMI <sup>f</sup> [kg kg <sup>-1</sup> ]	1.36	0.88	1.33	0.99	1.24	0.89	1.34	1.13	0.07	-	***	-

Significant: <sup>t</sup>  $P < 0.10$ , \*  $P < 0.05$ , \*\*  $P < 0.01$ , \*\*\*  $P < 0.001$ ; <sup>a</sup>standard error of estimate, <sup>b</sup>cow type, <sup>c</sup>measurement period, <sup>d</sup>interaction cow type x measurement period, <sup>e</sup>grass dry matter intake, <sup>f</sup>total dry matter intake and <sup>g</sup>energy-corrected milk.

Table 2 contains information about lactation stage, milk yield, live weight and herbage as well as concentrate intake. The amount of concentrate eaten differed owing to slight differences in stage of lactation between the cow types. Thus, the grass intake during the first and third measurement period is difficult to interpret. For intake estimation the alkane pair C<sub>32</sub> and Tritriacontane was used, based on the results of Berry *et al.* (2000). Cow type had significant effects on GDMI and TDMI, which are related to body size. Neither intake per 100 kg metabolic body weight (BW<sup>0.75</sup>) nor milk yield per kg TDMI were different between the two

cow types. Similar results were obtained by Kolver *et al.* (2002) and McCarthy *et al.* (2007). The measurement period, and therefore stage of lactation, always had a significant influence on GDMI and TDMI. For intake measures no interactions were detected.

For H<sub>NZ</sub> a longer rumination time and a higher number of mastications during rumination were found, but no differences appeared related to eating and idling time (Table 3). Fewer prehension bites and more mastications during grazing were identified for H<sub>NZ</sub>. The latter tended to make more steps, to stand less and to lie more. McCarthy *et al.* (2007) noted no differences concerning the ruminating time per day. However, their NZ genetic strain had longer feeding times, and showed lower bite frequencies.

Table 3: Grazing behaviour and physical activity

Cow type Period	H <sub>CH</sub>				H <sub>NZ</sub>				SEE <sup>a</sup>	P		
	1	2	3	4	1	2	3	4		T <sup>b</sup>	P <sup>c</sup>	TxP <sup>d</sup>
Cows per treatment	6	6	6	5	6	6	6	5				
Ruminating time [min d <sup>-1</sup> ]	476	498	480	497	502	529	529	514	13	**	-	-
Grazing time [min d <sup>-1</sup> ]	602	584	612	572	602	558	599	555	18	-	*	-
Idling time [min d <sup>-1</sup> ]	362	358	348	372	336	353	311	371	20	-	-	-
No. ruminating mastication d <sup>-1</sup>	32925	34585	31808	33234	34682	35430	36764	34580	1325	*	-	-
No. of boli d <sup>-1</sup>	591	545	578	572	599	578	642	560	39	-	-	-
No ruminating mastication boli <sup>-1</sup>	57	66	57	60	60	62	58	63	5	-	-	-
No. prehension bites d <sup>-1</sup> (PB)	35833	38696	38634	37559	35019	33992	34520	29739	2190	**	-	-
No. grazing mastication d <sup>-1</sup> (GM)	6936	6776	7719	5401	8135	5657	10708	10989	1237	*	t	*
Total PB and GM d <sup>-1</sup>	42769	45472	46353	42960	43154	39649	45228	40728	1550	*	*	-
No. idling mastication d <sup>-1</sup>	1458	1751	1382	1328	1241	876	914	1536	296	t	-	-
T lying [min d <sup>-1</sup> ]			448	530			504	598	34	t	*	-
T standing & walking [min d <sup>-1</sup> ]			992	910			937	843	34	t	*	-
T walking [min d <sup>-1</sup> ]			338	363			378	385	25	-	-	-
No. steps d <sup>-1</sup>			3870	4200			4311	4607	211	t	-	-

Significant: t  $P < 0.10$ , \*  $P < 0.05$ , \*\*  $P < 0.01$ ; <sup>a</sup>standard error of estimate, <sup>b</sup>cow type, <sup>c</sup>measurement period, <sup>d</sup>interaction cow type x measurement period, <sup>e</sup>grass dry matter intake, <sup>f</sup>total dry matter intake and <sup>e</sup>energy-corrected milk.

## Conclusions

H<sub>NZ</sub> compared to H<sub>CH</sub> seems to behave slightly different while grazing, for example with longer rumination time and fewer prehension bites and more mastications during grazing, but differences in intake per BW<sup>0.75</sup> and feed efficiency did not occur. Differences in grazing behaviour might be of interest if specific dairy cow types could improve the utilisation of grown herbage.

## References

- Berry N.R., Scheeder R.L., Sutter F., Kröber T.F. and Kreuzer M. (2000) The accuracy of intake estimation based on the use of alkane controlled-released capsules and faeces grab sampling in cows. *Annales de Zootechnie* 49, 3-13.
- Horan B., Dillon P., Faverdin P., Delaby L., Buckley F. and Rath M. (2005) The interaction of strain of Holstein-Friesian cows and pasture-based feed systems on milk yield, body weight and body condition score. *Journal of Dairy Science* 88, 1231-1243.
- Kolver E.S., Roche J.R., De Veth M.J., Thorne P.L. and Napper A.R. (2002) Total mixed rations versus pasture diets: Evidence for a genotype x diet interaction in dairy cow performance. *Proceedings of the New Zealand Society of Animal Production* 62, 246-251.
- Mayes R.W., Lamb C.S. and Colgrove P.M. (1986) The use of dosed and herbage alkanes as markers for the determination of herbage intake. *The Journal of Agricultural Science* 107, 161-170.
- McCarthy S., Horan B., Rath M., Linnane M., O'Connor P. and Dillon P. (2007) The influence of strain of Holstein-Friesian dairy cow and pasture-based feeding system on grazing behaviour, intake and milk production. *Grass and Forage Science* 62, 13-26.
- Rutter S.M., Champion R.A. and Penning P.D. (1997) An automatic system to record foraging behaviour in free-ranging ruminants. *Applied Animal Behaviour Science* 54, 185-195.

## Comparison of methods to quantify bite rate in calves grazing winter oats with different structures

Nadin L.B.<sup>1,2</sup>, Sánchez Chopa F.<sup>1,2</sup>, Trindade J.K.<sup>3</sup>, Amaral G.<sup>3</sup>, Milano G.D.<sup>1</sup>, Moreno L.S.<sup>1</sup> and Gonda H.L.<sup>1</sup>

<sup>1</sup>*Facultad de Ciencias Veterinarias, Universidad Nacional del Centro de la Provincia de Buenos Aires, Argentina.*

<sup>2</sup>*Consejo Nacional de Investigaciones Científicas y Tecnológicas, Argentina.*

<sup>3</sup>*Faculdade de Agronomia, Universidad Federal do Rio Grande do Sul, Brazil.*

Corresponding author: lnadin@vet.unicen.edu.ar

### Abstract

To compare methods for the identification of bites: acoustic recorder (AR) and IGER behaviour recorder (IBR), 5-minute grazing sessions were registered for 9 Holstein-Friesian calves on winter oats (*Avena sativa*) with 3 different structures (surface height): tall (T; 50.4 ± 9.9 cm), medium (M; 25.3 ± 4.9 cm) and short (S; 13.9 ± 3.4 cm). The experiment lasted for 3 days, and each day 3 animals grazed on the 3 structures in a randomised sequence. Sound files were analysed aurally and IGER recordings by Graze 8.0. Data (bites per minute of eating time) were analysed as a completely randomised design by ANOVA. Bite rates were 40, 40 and 32 (RMSE = 6,  $P < 0.0001$ ) for O, AR and IBR, respectively. Within the structures, bite rates were T = 37, 37, 29 (RMSE = 8,  $P = 0.03$ ); M = 44, 43, 33 (RMSE = 5.1,  $P = 0.0002$ ) and S = 37, 38, 32 (RMSE = 4.7,  $P = 0.02$ ) for O, AR and IBR, respectively. The AR method provided accurate information of bite rate.

Keywords: calves, winter oats, behaviour recorder, acoustic recorder, sward structure, bite rate.

### Introduction

The requirement to measure the constituents of the ingestive behaviour by grazing ruminants has led to the development of various automatic devices. The IGER solid-state behaviour recorder (IBR; Rutter *et al.*, 1997) allows the recording of the jaw movements over a 24-h period and, through the analysis program GRAZE (Rutter, 2000), the quantification of biting and non-biting jaw movements, ruminative mastication movements, and the duration and temporal pattern of grazing and ruminating bouts. The algorithms used in GRAZE for the identification of bites have been validated and applied, in most cases, to recordings of dairy cattle grazing ryegrass pastures and in long term experiments using rotational or continuous stocking management (Gibb *et al.*, 1998; 2002; Rutter *et al.*, 2002; Orr *et al.*, 2005). However, in a different scenario of working with calves grazing tall swards on a daily strip grazing system, we have observed that IBR failed to identify correctly the bites (unpublished results). The acoustic technique (Demment *et al.*, 1992; Laca *et al.*, 1999) represents an interesting alternative to the IBR in the quantification of bites in grazing studies (Ungar *et al.*, 2006).

The objective of the present experiment was to compare two methods: acoustic recorder (AR) and IBR, for identifying biting jaw movements by calves grazing a pasture of winter oats (*Avena sativa*) with 3 different structures.

### Materials and methods

Nine Holstein-Friesian calves (138 ± 11 kg LW) were used in a 3-day experiment (3 calves

day<sup>-1</sup>). During the experiment, animals grazed a winter oats sward with 3 different structures (surface height): tall (T), medium (M) and short (S). Each day, one calf at the time was fitted with IBR and AR (with a microphone held in place on the forehead of the calf and connected to a digital recorder), and then was allowed to graze for 5 minutes on each of the 3 structures according to a random sequence. During the grazing sessions, the number of bites was registered simultaneously by 4 independent observers (O, control method), by IBR and AR methods. Each day, the structures were created leaving T unmodified, and cutting M and S to approximately 0.50 and 0.25 of T, respectively. Following measurements of sward surface height (SSH, n = 20) and herbage mass (n = 3), T, M and S plots were divided by electric fence into 3 sub-plots of 2 m × 0.75 m, each to be grazed by one calf. Herbage mass samples were separated manually in lamina and pseudostem.

The number of bites from IBR method was estimated by a trained operator using Graze 8.0 and from AR method was estimated aurally. Since the number of bites is a countable variable with a Poisson distribution, the bite rate was considered as the variable of analysis to be applicable to an ANOVA model with a three-way classification: methodology, sward structure and day. For estimating bite rate (number of bites eating time<sup>-1</sup>), eating time was obtained from IBR, excluding the periods of jaw inactivity > 3 seconds. Bite rate was analysed as a completely randomised design considering calves as independent replicates. As the observations were not normally distributed the variable bite rate was converted into natural logarithm. Infostat software was used for all statistical analyses. Mean comparison were done by Duncan's test.

Table 1: Sward characteristics: sward surface height (SSH, cm), herbage mass (g m<sup>-2</sup>) and lamina to pseudostem (L:PS) ratio and bite rate (bites min<sup>-1</sup>) in visual observation (O), acoustic recorder (AR) and IGER behaviour recorder (IBR) within tall (T), medium (M) and short (S) structures in Holstein-Friesian calves grazing a winter *Avena sativa* pasture.

Structure	Sward characteristics			Bite Rate				
	SSH	Herbage mass	L:PS	O	AR	IBR	RMSE	P
T	50.4 ± 9.9	550.4 ± 73.8	2.01 ± 0.24	37 <sup>a</sup>	37 <sup>a</sup>	29 <sup>b</sup>	8.0	0.03
M	25.3 ± 4.9	303.5 ± 84.3	1.02 ± 0.36	44 <sup>a</sup>	43 <sup>a</sup>	33 <sup>b</sup>	5.1	<0.01
S	13.9 ± 3.4	143.8 ± 42.6	0.28 ± 0.25	37 <sup>a</sup>	38 <sup>a</sup>	32 <sup>b</sup>	4.7	0.02

Within each structure, different superscripts indicate significant differences among treatments ( $P < 0.05$ ).

## Results and discussion

As the animals got used to human presence, the observers could stay within a range of 3 m from the animals during grazing sessions. This allowed the use of O method as a control for the number of bites. There were no significant differences in bite rate among the four observers ( $P = 0.48$ ).

Independently of the structures, bite rate showed no differences between O and AR. However, bite rate estimated by IBR was, in all cases, statistically lower than in AR by 21%, 23% and 16% for T, M and S, respectively. Ungar and Rutter (2006) also reported differences between bite rate estimated by IBR and AR methods in dairy cows grazing a clover sward. However, they observed higher bite rates estimated by IBR than AR. In spite of the differences, in both experiments AR appeared to be the most reliable method to estimate the number of bites. Potential advantages of AR include accurate counts of chewing and biting events and discrimination between compound jaw movements, manipulative jaw movements and bites (Laca *et al.*, 1999), and determination of dry matter intake of forages (Galli *et al.*, 2006).

In the present study, independently of the methodology, bite rate was higher in M (40) than T (34) and S (36), ( $P < 0.01$ ) probably associated with a few manipulative jaw movements.

## Conclusion

We may conclude that AR is a promising tool for identifying the biting jaw movements with accuracy. However, one disadvantage of AR is the lack of software for identifying and classifying the jaw movements of the sound files.

## References

- Demment M.W., Laca E.A., Seligman N.G. and Ungar E.D. (1992) Integrating sward structure and ingestive behavior to determine intake rate in cattle. *Final Scientific Report for BARD*. Project No. US, pp. 1329-1387.
- Galli J.R., Cangiano C.A., Demment M.W and Laca E.A. (2006) Acoustic monitoring of chewing and intake of fresh and dry forages in steers. *Animal Feed Science and Technology* 128, 14–30.
- Gibb M.J., Huckle C.A. and Nuthall R. (1998) Effect of time of day on grazing behaviour by lactating dairy cows. *Grass and Forage Science* 53, 41-46.
- Gibb M.J., Huckle C.A. and Nuthall R. (2002) Effects of level of concentrate supplementation on grazing behaviour and performance by lactating dairy cows grazing continuously stocked grass swards. *Animal Science* 74, 319-335.
- Laca E.A and Wallis De Vries M.F. (1999) Acoustic measurement of intake and grazing behaviour of cattle. *Grass and Forage Science* 55, 97-104.
- Orr R.J., Cook J.E., Young K.L., Champion R.A. and Rutter S.M. (2005) Intake characteristics of perennial ryegrass varieties when grazed by yearling beef cattle under rotational grazing management. *Grass and Forage Science* 60, 157–167.
- Rutter S.M., Champion R.A. and Penning P.D. (1997) An automatic system to record foraging behaviour in free-ranging ruminants. *Applied Animal Behaviour Science* 54, 185-195.
- Rutter S.M. (2000) Graze: a program to analyse recordings of the jaw movements of ruminants. *Behavioural Research Methods Instruments and Computers* 32, 86-92.
- Rutter S. M., Orr, R. J., Yarrow., N. H. and Champion R. A. (2002) Dietary preference of dairy cows grazing ryegrass and white clover. *Journal of Dairy Science* 87, 1317-1324
- Ungar E.D. and Rutter S.M. (2006) Classifying cattle jaw movements: Comparing IGER Behaviour Recorder and acoustic techniques. *Applied Animal Behaviour Science* 98, 11–27.

## **Increasing concentrate levels during the grazing season – effects on yield and behaviour of dairy cows**

Alvåsen K. and Spörndly E.

*Department of Animal Nutrition and Management, Swedish University of Agricultural Sciences, SE-750 07 Uppsala, Sweden*

Corresponding author: Karin.Alvasen@kv.slu.se

### **Abstract**

In a six-week grazing trial, 27 lactating dairy cows (Swedish Red Breed) were randomly assigned to five treatments with different concentrate levels in their diet: 20, 30, 40, 50 and 60% of each cow's energy requirement at the start of the study. The cows were fed their treatments twice daily together with 4 kg dry matter (DM) silage in the barn in connection with milking. The cows grazed together on 10.5 ha in a rotational grazing system with 6 paddocks. The average energy content and daily allowance of pasture was 10.8 MJ metabolisable energy per kg DM and 20 kg DM per cow. A 10% increase in the proportion of concentrates in the diet reduced grazing and rumination time by 4.1% ( $P < 0.001$ ) and 2.1% ( $P < 0.01$ ), respectively. With a 10% increase of the proportion of concentrate in the diet, milk yield increased by 1.5 kg ( $P < 0.001$ ). An increase in concentrates of 1 kg gave an average response in milk yield with 0.8 kg milk. The results indicate that feeding concentrates up to 60% of energy requirements during the pasture season is profitable when concentrate prices are below 0.8 of the payment for milk.

Keywords: Dairy cows, grazing behaviour, milk yield, concentrate levels

### **Introduction**

Feed costs are a major expense for dairy farmers. Pasture provides high quality feed at a low cost. However, supplementing grazing cows with concentrates has been shown to enhance milk yield (Bargo *et al.*, 2003; Stockdale, 2004). The objectives of this study were to quantify the response in milk yield to increased concentrate proportions and to record grazing-time and ruminating-time to evaluate the capacity of cows to compensate for a reduced concentrate ratio with an increased pasture intake.

### **Materials and methods**

The study was carried out at the Kungsängen Research Centre in Uppsala, Sweden during the summer of 2008 with an experimental period of six weeks. Twenty-seven lactating Swedish Red cows were blocked by parity, lactation number, days in milk and current milk yield. Cows were randomly assigned to five treatments with different concentrate levels in their diet: 20, 30, 40, 50 and 60% of each cow's energy requirement at the start of the experiment. Energy requirement was estimated with respect to weight and milk yield prior to the experiment according to Swedish standards (Spörndly, 2003). The average milk yield at the start of the experiment was 28 kg energy corrected milk (ECM) with the range of 18.8 - 39.6. Concentrate rations ranged between 3.2 - 12.6 kg cow<sup>-1</sup> d<sup>-1</sup>. All cows were milked twice daily at 6.30 and 15.00. The cows were fed their treatments along with 4 kg dry matter (DM) silage and 200 g minerals in the barn in connection with milking. Cows had free access to water and licking stone in the stable and on the pasture. Individual milk samples were collected one day (morning and evening) each week when milk yield was also recorded. Milk samples were



analysed for fat, protein and lactose content using infrared spectrophotometry (MilkoScan FT 120 Foss Electric, Hillerød, Denmark).

The 10.5 ha of permanent pasture was divided into six different paddocks, all dominated by meadow fescue (*Festuca pratensis* Huds.), smooth meadow grass (*Poa pratensis* L.) and white clover (*Trifolium repens* L.). The pasture was fertilised with 40 kg ha<sup>-1</sup> N prior to the study. The cows grazed together in a rotational grazing system and the average time for grazing a paddock was 4.2 ± 1.1 days. Pre- and post-grazing herbage mass were estimated using a Rising plate meter (4.7 kg m<sup>-2</sup>). A 30 x 30 cm frame was dispersed randomly over the grazing areas 20 - 25 times, wherein sward height was measured and all material inside the frame were cut to a height of 3 cm and collected. These samples were oven-dried at 60°C for 18 hours and weighed, then analysed for ash, neutral detergent fibre (NDF), crude protein (CP) and *in vitro* organic matter digestibility.

Grazing behaviour and ruminating time were measured for 3 cows in each treatment group using the IGER Behaviour Recorder, which records jaw movement (Rutter *et al.*, 1997; Rutter, 2000). The recorders were placed on cows after milking on the mornings that they were moved to a new paddock and were removed after 24 hours. Recorded data were analysed using GRAZE software (Rutter, 2000).

The following model was used to analyse time spent grazing (pasture and silage) and time spent ruminating according to the SAS GLM procedure:  $Y_i = \mu + \alpha_i + e_i$  where  $\mu$  = mean time,  $\alpha_i$  = treatment effect and  $e_i$  = residual effect.

Milk production data was analysed using the formula:  $Y_{ij} = \mu + \beta_1 X_{ij} + \alpha_i + \delta_j + e_{ij}$  where  $\mu$  = mean milk production,  $\beta_1 X_{ij}$  = effect of covariate,  $\alpha_i$  = treatment effect,  $\delta_j$  = block effect,  $e_i$  = residual effect.

## Results and discussion

The average energy content in DM of the pasture vegetation during the experiment was 10.8 MJ kg<sup>-1</sup>. The average CP content was 15.1% of DM and average NDF was 41.8% of DM. DM content was influenced by the weather prior to the sample-takings and ranged between 23 - 39%. An extended period of dry weather had led to pasture deficit towards the end of the experiment, consequently the experiment ended pre-maturely after 6 weeks instead of the planned 8 week experimental period.

Grazing time differed between the treatments. Cows that were given 20% concentrate grazed 40.3% of the time and cows given 60% concentrate grazed only 23.2% of the time (Fig. 1). This indicates that a lower concentrate proportion increases pasture intake. The highest ruminating time was recorded in treatment groups 30% and 40% (Fig. 1). Pasture DM allowance was never below 55 kg cow<sup>-1</sup> d<sup>-1</sup> (average 83 ± 14 kg cow<sup>-1</sup> d<sup>-1</sup>) as the recorders were used the first day in the paddocks after a period of pasture re-growth. The cows spent 25% of the recording time in the barn in connection with milking.

Milk yield increased with increasing concentrate proportions (Table 1). A separate analysis comparing the response of high and low yielders showed no interaction between yield and treatment group. Therefore, there was no significant difference in production response between high and low yielders to increased concentrate proportion.

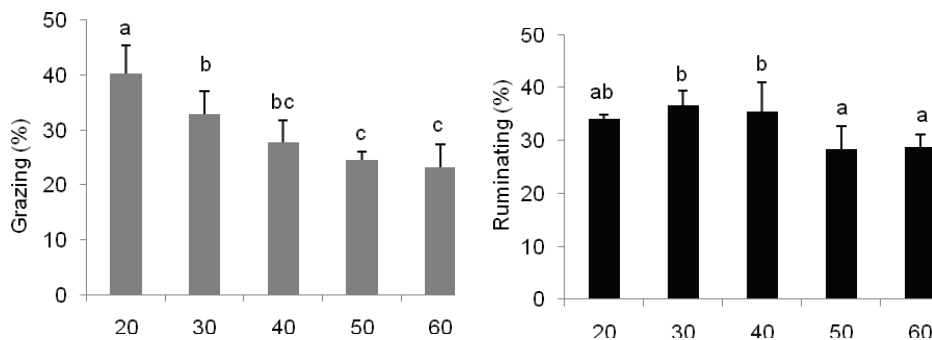

Figure 1. Grazing and ruminating behaviour (% of total time) from 24 h behaviour recording in five different treatment groups. Columns with different letters differ significantly ( $P < 0.05$ ).

Table 1. Average milk yield and Energy Corrected Milk (ECM) during the six week experiment. Mean  $\pm$  standard deviation. Values with different superscripts in the same column differ significantly ( $P < 0.05$ ).

Treatment	Milk (kg)	ECM (kg)
20%	21.1 <sup>a</sup> $\pm$ 0.9	22.8 <sup>a</sup> $\pm$ 1.1
30%	22.5 <sup>ab</sup> $\pm$ 1.2	23.2 <sup>ab</sup> $\pm$ 1.3
40%	24.3 <sup>b</sup> $\pm$ 1.0	25.3 <sup>abc</sup> $\pm$ 1.1
50%	25.3 <sup>bc</sup> $\pm$ 1.0	26.7 <sup>bc</sup> $\pm$ 1.2
60%	27.3 <sup>c</sup> $\pm$ 1.0	28.3 <sup>c</sup> $\pm$ 1.2

Milk yield increased by 1.5 kg when the proportion of concentrates was increased by 10%. A 1 kg increase in concentrate supplementation gave an average milk response with 0.8 kg at all production levels studied but milk composition was not significantly affected. Grazing time decreased with 4.1% and the time spent ruminating with 2.1% when the proportion of concentrates was increased by 10%.

## Conclusions

The results indicate that feeding concentrates up to 60% of energy requirements during the pasture season is profitable when concentrate prices are below 0.8 of the payment for milk.

## References

- Bargo F., Muller L.D., Kolver E.S. and Delahoy J.E. (2003) Invited Review: production and digestion of supplemented dairy cows on pasture. *Journal of Dairy Science* 86, 1-42.
- Rutter S.M. (2000) Graze: A program to analyse recordings of the jaw movements of ruminants. *Behaviour Research Methods, Instruments and Computers* 32 (1), 86-92.
- Rutter S.M., Champion R.A. and Penning P.D. (1997) An automatic system to record foraging behaviour in free-ranging ruminants. *Applied Animal Behaviour Science* 54, 185-195.
- Spörndly R. (2003) Fodertabeller för idisslare. Rapport 257, Department for Animal Nutrition and Management, Swedish University of Agriculture, Uppsala, 7-14. (In Swedish)
- Stockdale C.R. (2004) Effects of level of concentrates during early lactation on the yield and composition of milk from grazing dairy cows with varying body condition score at calving. *Australian Journal of Experimental Agriculture* 44, 1-9.

# The effect of sward *Lolium perenne* content and defoliation method on seasonal and total dry matter production

Creighton P.<sup>1,2</sup>, Kennedy E.<sup>1</sup>, Gilliland T.<sup>3</sup>, Boland T.M.<sup>2</sup> and O'Donovan M.<sup>1</sup>

<sup>1</sup>Teagasc Moorepark, Dairy Production Research Centre, Fermoy, Co. Cork, Ireland

<sup>2</sup>School of Agriculture, Food Science and Veterinary Medicine, University College Dublin, Belfield, Dublin 4, Ireland

<sup>3</sup>Agri-Food and Biosciences Institute, Crossnacreevy, Co Down, Northern Ireland

Corresponding author: Philip.Creighton@Teagasc.ie

## Abstract

Quantifying the production loss, as sward perennial ryegrass (*Lolium perenne* L.; PRG) content decreases is an important issue for grassland farmers. The evaluation of grass varieties in Ireland incorporates mechanical defoliation or simulated grazing (SG) methods and visual ground score (GS) estimates of the proportion of PRG in a sward. The objective of this study was to quantify the effect of i) sward PRG content and ii) defoliation method on seasonal and total dry matter (DM) production, as well as the effectiveness of GS estimates in predicting sward PRG content and DM production under an actual grazing management (AG). Plots were established in autumn 2007 incorporating three varieties of PRG, at five different seeding rates 5, 7.5, 12, 20 and 30 kg ha<sup>-1</sup> to establish swards with a PRG content of approximately 15%, 25%, 40%, 65% and 100%, under 2 defoliation managements SG and AG, replicated 3 times. Sward PRG proportion and defoliation method had a significant effect ( $P < 0.001$ ) on spring, summer and total DM production, increasing as sward PRG proportion increased, with the AG defoliation method having higher yields. GS was a useful indicator of sward PRG content and production potential. It can be concluded that swards with less than 65% PRG content are close to the reseeding threshold.

Keywords: *Lolium perenne*, dry matter production, defoliation method

## Introduction

It is widely accepted that perennial ryegrass (*Lolium perenne* L.; PRG) dominant swards are highly productive (Frame, 1991) and quantifying the production loss, as sward PRG content decreases is an important issue for grassland farmers. The seasonal distribution of sward production is influenced by sward species content. Haggard (1976), demonstrated the different seasonal pattern of growth of indigenous species, compared to PRG with indigenous species producing a higher proportion of their annual dry matter (DM) yield in the second half of the growing season. Such swards would be incapable of supporting early spring grazing production systems or forage conservation in late spring/early summer.

The evaluation of grass varieties in Ireland incorporates mechanical defoliation methods and visual ground score (GS) estimates of the proportion of PRG in a sward. The objective of this study was to quantify the effect of i) sward PRG content, and ii) defoliation method on seasonal and total DM production, as well as the effectiveness of GS estimates in predicting sward PRG content and DM production under actual animal grazing.

## Materials and methods

Ninety plots were established on free draining, acid brown earth soil with a sandy loam to loam texture in Autumn 2007. The study incorporated three varieties of PRG at five different seeding rates of 5, 7.5, 12, 20 and 30 kg ha<sup>-1</sup>, under 2 defoliation managements; i) a simulated

mechanical grazing management (SG), and ii) actual animal grazing by dairy cows (AG). Each variety was replicated three times at each seeding rate under the two defoliation managements (3 varieties x 5 seeding rates x 2 defoliation managements, replicated 3 times). The five seeding rates were used to establish swards with approximately 15%, 25%, 40%, 65% and 100% PRG content. *Agrostis* and *Poa* species made up the balance of sward contents. Plot size was 1.4 m x 5 m (7 m<sup>2</sup>) SG, and 2.8 m x 5 m (14 m<sup>2</sup>) AG. Plots were grazed nine times during their first full grazing season (February to October 2008). SG plots were harvested using a motor Agria mower (Etesia UK Ltd., Warwick, UK). The fresh weight of a 1.2 m x 5 m strip (>4 cm) was recorded and a sub-sample (100g) dried at 80 °C for 16 h to determine DM. Herbage DM yield (kg ha<sup>-1</sup>) was then calculated. The herbage yield for the AG plots was determined prior to each grazing by cutting a 0.25 m<sup>2</sup> sample (>4 cm) using a 0.5 m x 0.5 m quadrat and Gardena grass shears (Gardena, GmbH, Ulm Germany), with DM determined as described above. Tiller density was assessed in autumn 2008. Three turves (10 cm x 10 cm) were cut from each plot and dissected. From this, PRG tiller density and total tiller density per m<sup>2</sup> was calculated. All plots were ground scored (score 0-5, where 0 = no PRG present, 5 = 100% PRG present) based on the proportion of PRG present in the sward. SG plots received 350 kg nitrogen (N) per ha over the grazing season, with AG plots receiving 250 kg ha<sup>-1</sup> N, the difference accounting for the nitrogen recycling which would occur on the AG plots. All dung paths were removed from the AG plots after grazing. Data was analysed using PROC GLM in SAS (SAS, 2002).

## Results and discussion

Detailed results are presented in Table 1. Sward PRG proportion had no significant effect on PRG or total tiller density. Defoliation method approached significance ( $P < 0.07$ ) for PRG tillers/m<sup>2</sup> but had no effect on total tiller density. The proportion of PRG in the sward significantly effected DM yield in spring, summer and total DM yield ( $P < 0.001$ ). This demonstrates the importance of PRG content on the seasonality of grass growth and DM production potential. Defoliation method also had a significant effect ( $P < 0.001$ ) on spring, summer and total DM yields, with AG having higher yields. This difference may be due to higher levels of nutrient recycling taking place in the AG plots than was allowed for in the differing N application levels between the AG and SG plots. There was a significant interaction ( $P < 0.05$ ) between sward PRG proportion and defoliation method in spring, with AG swards consistently having a higher yield across all PRG proportions. Sward PRG proportion had a significant effect on GS, increasing for 15%, 25% and 40% swards, with no difference between 65% and 100% swards. This would suggest that visual GS estimates are a useful predictor of sward PRG content and DM production potential. Evidence to support this can be found in a study by Camlin and Stewart (1976) where visual assessments of sward cultivars were found to be highly and positively correlated with the yields of sown cultivars and to be highly and negatively correlated with the yields of unsown herbage species.

Table 1. Effect of sward perennial ryegrass content and defoliation method on tiller density, dry matter (DM) production and ground score

Sward PRG proportion	15%	25%	40%	65%	100%	Sig.	SG	AG	Sig.	SED	Inter
PRG Tillers (m <sup>-2</sup> )	4764	5258	5483	5058	5831	NS	5660	4898	<i>P</i> <0.07	422	NS
Total Tillers (m <sup>-2</sup> )	9322	8631	9383	7619	8314	NS	9054	8253	NS	572	NS
Spr. DM prod (kg ha <sup>-1</sup> )	364	447	538	822	910	<i>P</i> <0.001	333	899	<i>P</i> <0.001	56	<i>P</i> <0.05
Sum. DM prod (kg ha <sup>-1</sup> )	5832	6424	6457	6852	7414	<i>P</i> <0.001	6299	6893	<i>P</i> <0.001	169	NS
Aut. DM prod (kg ha <sup>-1</sup> )	3958	3903	4212	4269	4036	NS	4368	3783	<i>P</i> <0.001	102	NS
Total DM prod (kg ha <sup>-1</sup> )	10154	10774	11206	11943	12360	<i>P</i> <0.001	11000	11575	<i>P</i> <0.05	232	NS
Ground Score	1.89	2.34	2.91	3.72	3.71	<i>P</i> <0.001	2.89	2.94	NS	0.12	NS

SED = Standard error of the difference; PRG = Perennial ryegrass; Spr. = Spring; Sum. = Summer; Aut. = Autumn; NS = non significant

Inter = Interaction between sward perennial ryegrass content and defoliation method

SG = simulated mechanical grazing management; AG = actual animal grazing management

## Conclusion

The results of this study show that increasing the PRG proportion of swards significantly increased seasonal and total DM production of grass swards. Results suggest that swards with less than 65% PRG content are close to the reseeding threshold, particularly if spring DM production is important for the enterprise. Mechanical defoliation of swards compared with AG recorded lower DM yields, with this difference attributed to spring and summer DM production, however overall it appears to be reasonably reflective of AG systems. Visual GS estimates are a useful indicator of sward PRG content and production potential. It can also be concluded that sward response to applied nitrogen increases as PRG content increases as all swards received the same level of N fertiliser.

## Acknowledgements

The Department of Agriculture and Food Stimulus Fund (RSF 07 512) is acknowledged for its financial support.

## References

- Camlin M.S. and Stewart R.H. (1976) The assessment of persistence and its application to the evaluation of early perennial ryegrass cultivars. *Grass and Forage Science* 31(1), 1-6.
- Frame J. (1991) Herbage production and quality of a range of secondary grass species at five rates of fertilizer nitrogen application. *Grass and Forage Science* 46(2), 139-151.
- Haggar R.J. (1976) The seasonal productivity, quality and response to nitrogen of four indigenous grasses compared with *Lolium perenne*. *Grass and Forage Science* 31(4), 197-207.
- SAS Institute (2002) *Users Guide: Statistics*. SAS Inst., Cary, NC.

# The effect of organic management strategies on dairy production in clover-based grassland

Keogh B.<sup>1</sup>, Humphreys J.<sup>2</sup>, Phelan P.<sup>1,2</sup>, Necpalova M.<sup>1,2</sup>, Casey I.A.<sup>1</sup> and Fitzgerald E.<sup>1</sup>

<sup>1</sup>Department of Chemical & Life Sciences, Waterford Institute of Technology, Cork Road, Waterford, Ireland

<sup>2</sup>Moorepark Dairy Production Research Centre, Teagasc, Fermoy, Co. Cork, Ireland

Corresponding author: Bill.Keogh@teagasc.ie

## Abstract

In Ireland, there is a price premium for supplying 50% of annual organic milk production during the winter. However, profitability will only be realised through active cost reducing strategies by producers. In 2008/2009, this study examined the viability of supplying a large proportion (>50%) of the diet from grazed grass-clover (*Trifolium repens L.*) swards during the autumn and winter in order to substantially lower the cost of feed for organic winter milk production. Three systems of production compared had: (i) a mean calving date of 17 February, stocking density of 2.15 cows per ha, receiving 90 kg ha<sup>-1</sup> of annual fertilizer N input (Control); (ii) a mean calving date of 17 February, stocking density of 1.6 cows per ha, receiving no fertilizer N input (S-NFN) and (iii) a mean calving date of 16 April, stocking density of 1.6 cows/ha between calving and 1 September and stocking density of 1.2 cows/ha between 1 September and 18 February, receiving no fertilizer N input (W-NFN). There were 18 cows per system. There were no ( $P > 0.05$ ) differences between systems in production of milk yields and milk composition or live-weight and BCS during or at the end of lactation. The W-NFN system produced 48% of milk between 1 September and 18 February, suggesting a later calving date than 16 April is necessary to produce 50% of annual milk between September and March.

Keywords: Dairy cows, organic, milk production, white clover

## Introduction

In Ireland, there is a price premium if 50% of annual milk produced on organic farms is supplied during the autumn and winter (September to March). However, to ensure profitability, producers must actively follow strategies of cost reduction through the adoption of new technologies and improvement of production efficiencies (Rotz *et al.*, 2007). Organic systems of production operate at low stocking rates compared with conventional systems (Offermann and Nieberg, 2000). Low stocking rates offer the potential to extend the grazing season throughout the autumn, winter and early spring. Ireland's temperate climate is advantageous to milk production from clover-based swards over a long growing season (Humphreys *et al.*, 2008). Therefore the aim of the experiment was to examine the viability of supplying a large proportion (>50%) of the diet from grazed grass-clover swards during the autumn and winter in order to substantially lower the cost of feed for organic winter milk production.

## Materials and methods

This experiment was conducted in 2008/2009 at Moorepark Dairy Production Research Centre, Solohead Research Farm (52° 51'N, 08° 21'W; 95 m above sea level). The systems of production compared at the research farm had: (i) a mean calving date of 17 February, stocking density of 2.15 cows ha<sup>-1</sup>, receiving 90 kg ha<sup>-1</sup> of annual fertilizer nitrogen (N) input (Control); (ii) a mean calving date of 17 February, stocking density of 1.6 cows ha<sup>-1</sup>, receiving no fertilizer N input (S-NFN) and (iii) a mean calving date of 16 April, stocking density of 1.6

cows ha<sup>-1</sup> between calving and 1 September and a stocking density of 1.2 cows ha<sup>-1</sup> between 1 September and 18 February, receiving no fertilizer N input (W-NFN). Cows were turned out to pasture after calving and the number of days at pasture was recorded as 1 day when cows were outside both day and night and 0.5 when cows were outside only by day. There were 18 cows per system. Exceptionally high rainfall was recorded during the summer and autumn 2008 (28% above normal; 641 mm compared to 10-year average, 501 mm). The mean clover content of swards used in this experiment was 250 g kg<sup>-1</sup> of herbage dry matter (DM) in the previous growing season. Pasture was allocated to cows in a rotational grazing system and post-grazing heights, measured with a rising plate meter (Ashgrove Pastoral Products, Palmerston North, New Zealand), were used to determine when cows moved to the next section. Target post-grazing heights for Control and S-NFN systems were 50 mm (standard deviation std ± 0.45) from calving to dry off in early December while target post-grazing heights for W-NFN system were 50 mm (std ± 0.42) from calving to 31 August and 40 mm (std ± 0.41) from 1 September to dry-off in mid February. Milk yield per cow was recorded at each milking and the composition of milk from each cow was measured for a successive morning and evening milking once per week using a Milkoscan 203 (Foss Electric DK- 3400, Hillerød, Denmark). Body condition score (Edmonson *et al.*, 1989) and liveweight of cows was recorded once fortnightly. The liveweight was recorded using a weighing scales and the Winweigh software package (Trutest Limited, Auckland, New Zealand). Cows were divided into four main groups on the basis of lactation number (1, 2, 3 and ≥4) and then sub-divided into sub-groups of three on the basis of calving date. From within each sub-group one cow was randomly assigned to each herd. Herds were randomly assigned to each system. In a one factor experiment with 3 treatments, animal production data (milk production, milk composition, live-weight and body condition score (BCS)) were subjected to ANOVA using SAS. (2008). Milk yields and yields of fat, protein and lactose in the third entire week of lactation were used as covariates for the analysis of total milk yields and yields of fat, protein and lactose. Pre-calving live-weight and BCS were used as covariates when analysing live-weight and BCS.

## Results and discussion

There were no ( $P > 0.05$ ) detectable differences in production of milk, fat, protein or lactose, or in milk composition between the three systems (Table 1). These results are in agreement with Humphreys *et al.* (2008) and Schills *et al.* (2000) where no difference in milk output per cow from clover-based and fertiliser-based pasture were observed. In contrast, Ribeiro Filho *et al.* (2003) reported that white clover-based pasture with clover concentrations ( $> 420$  g kg<sup>-1</sup>) of live herbage DM, increased milk yield of grazing dairy cows relative to N-fertilized perennial ryegrass pasture. In the present experiment, the clover concentration of herbage was not sufficiently high to demonstrate improved milk production from grazing dairy cows. Finally, and of greater importance, is that 1.6 cows ha<sup>-1</sup> (W-NFN) on clover-based pasture produced over 10500 kg ha<sup>-1</sup> or over 800 kg of milk solids ha<sup>-1</sup> without fertiliser input relative to Control system. While W-NFN system consumed an extra 260 kg of concentrates relative to Control system, the price premium offered for organic winter milk in Ireland and zero fertiliser input has the potential to be a profitable system on Irish organic dairy farms. On W-NFN system, 48% of milk was produced between 1 September and 18 February, suggesting a later calving date than 16 April will be necessary to produce 50% of annual milk production between September and March. High rainfalls lead to difficult grazing conditions. Consequently cows in the Control system were housed in late October, approximately five weeks earlier than normal. Hence, the number of days at pasture for Control system was 220. Lower stocking densities on the NFN systems allowed cows to be kept outside for longer ( $P <$



0.001), although there was no ( $P > 0.05$ ) difference in days at pasture between the NFN systems (Table 1).

## Conclusion

Grazing clover-based swards during the autumn and winter had no adverse effects on milk production and milk composition. A long grazing season was possible with the late-calving W-NFN herd. However, a later calving date than 16 April is necessary to produce 50% of annual milk between September and March. The W-NFN system has potential to be a profitable system on Irish organic dairy farms.

Table 1. Production of milk, fat, protein and lactose, milk composition for 290 d lactation, the mean number of days that cows were at pasture, concentrates fed, mean cow live-weight during lactation, and body condition score (BCS; scale 1 to 5) during and at the end of lactation

	Control	S-NFN	W-NFN	s.e.m. <sup>1</sup>	<i>P</i> value
Milk (kg cow <sup>-1</sup> )	6371	6511	6605	182	NS <sup>2</sup>
Fat (kg cow <sup>-1</sup> )	274	282	273	18.8	NS
Protein (kg cow <sup>-1</sup> )	230	236	228	5.9	NS
Lactose (kg cow <sup>-1</sup> )	301	308	309	8.5	NS
Fat + Protein (kg cow <sup>-1</sup> )	504	518	502	13.0	NS
Fat (%)	4.31	4.34	4.18	0.096	NS
Protein (%)	3.62	3.63	3.48	0.050	NS
Lactose (%)	4.73	4.72	5.04	0.144	NS
Days at pasture (days cow <sup>-1</sup> )	220	234	231	1.7	<0.001
Concentrate fed (kg cow <sup>-1</sup> )	590	590	847	21.3	<0.001
Live-weight (kg cow <sup>-1</sup> )	602	594	590	9.2	NS
Mean BCS during lactation	3.00	3.03	2.97	0.039	NS
BCS at the end of lactation	3.02	2.97	2.89	0.068	NS

<sup>1</sup> s.e.m. ~ standard of the mean; <sup>2</sup> NS ~ not significant ( $P > 0.05$ )

## References

- Edmonson A.J., Lean I.J., Weaver L.D., Farver T. and Webster G. (1989) A body condition scoring chart for Holstein dairy cows. *Journal of Dairy Science* 72, 68–78.
- Humphreys J., O'Connell K. and Casey I.A. (2008) Nitrogen flows and balances in four grassland-based systems of dairy production on a clay-loam soil in a moist maritime climate. *Grass and Forage Science* 63, 467–480.
- Offermann F. and Nieberg H. (2000) *Organic Farming in Europe: Economics and Policy* 5, University of Hohenheim, Department of Farm Economics, Stuttgart, Germany, 220 pp.
- Ribeiro Filho H.M.N., Delagarde R. and Peyraud J.L. (2003) Inclusion of white clover in strip-grazed perennial ryegrass swards: herbage intake and milk yield of dairy cows at different ages of sward regrowth. *Animal Science* 77, 499–510.
- Rotz C.A., Kamphuis, G.H., Karsten H.D. and Weaver R.D. (2007) Organic dairy production systems in Pennsylvania: A case study evaluation. *Journal of Dairy Science* 90 (8), 3961–3979.
- Schills R.L.M., Boxem T.J., Jagtenberg C.J. and Verboon M.C. (2000) The performance of a white clover based dairy system in comparison with a grass/fertiliser-N system. II. Animal production, economics and environment. *Netherlands Journal of Agricultural Science* 48, 305–318.

# Feeding behaviour of sheep on shrubs (*Cytisus scoparius* L.) in response to contrasting herbaceous cover

Pontes L. da S.<sup>1</sup>, Magda D.<sup>1</sup>, Agreil C.<sup>2</sup> and Gleizes B.<sup>1</sup>

<sup>1</sup>INRA, UMR1248, Agrosystèmes et développement territorial, F-31326 Castanet-Tolosan, France.

<sup>2</sup>INRA, UR 0767 Ecodéveloppement, F-84914 Avignon Cedex9, France.

Corresponding author: laisepontes@iapar.br

## Abstract

Understanding the feeding behaviour of livestock faced with high plant diversity is a powerful tool available to managers to modify plant-herbivore interactions and achieve targeted shrub grazing levels. We addressed this issue by evaluating the role of herbaceous feed item diversity on browsing intensity of a targeted dominant shrub (broom, *Cytisus scoparius*). The effect of three herbaceous covers, which varied greatly in terms of green and dead material and of species phenological stages, on broom consumption, was compared by investigating the feeding behaviour of a flock of ewes over time and by monitoring the evolution of feed item availability and quality. We observed that different herbaceous covers influence the feeding choices of ewes, modifying their rate of consumption of broom. This confirms that factors other than the intrinsic properties of the dominant shrub (toxic contents, phenological stage, nutritive value, etc.) influence foraging choices. Therefore, managers can influence ewes' diet selection by modifying the herbaceous cover in order to stimulate the use of broom, amplifying the impact of browsing on the demography of this shrub population.

Keywords: bite, broom, feeding choices, grazing behaviour, shrub encroachment, shrubland

## Introduction

Shrubby rangelands in Europe are now considered to be valuable for ecological, landscape and agronomic reasons. A challenge is to increase the potential use of grazing to control dominant plant dynamics, especially of shrubby species, which includes maintaining them at density levels appropriate for both habitat conservation and forage production. However, few studies have focused on how to graze flocks on highly diversified plant communities, such as shrublands. Here we investigate the effects of management factors on selectivity in target dominant shrub plants, namely broom (*Cytisus scoparius*), through the manipulation of resource availability, i.e. abundance, size and quality feed in the heterogeneous vegetation community. We hypothesized that broom selection by ewes is influenced by the range of the feed items available, i.e. that factors other than the intrinsic properties of the dominant shrub (e.g. the presence of quinolizidine alkaloids in broom) influence the browsing habits.

## Materials and methods

We carried out a trial on heterogeneous vegetation, a natural broom shrubland located within a farm. In autumn 2008, 33 dry Tarasconnaise ewes, aged 18 months, grazed in turn three different paddocks ( $0.44 \pm 0.03$  ha), for approximately 10 days on each: P1, 100% of paddock area previously grazed in summer by horses; P2, 50% of paddock area previously grazed in summer by horses; and P3, paddock area non-grazed during the year, to build the range of feed items offered. We carried out this study in autumn so that mature broom twigs would be browsed, since repeated consumption of mature twigs can cause lasting or even irreversible effects on adult broom phenotypes (Cooper *et al.*, 2003). Every two days, flock activities were

observed for four 1-hr periods during daylight hours over the main grazing periods, using the scan sampling method (Altman, 1974). Every 10 minutes, ewes' intake was characterised using 12 bite categories, based on the mass (L, large bites; M, medium-sized bites; S, small bites; as described by Agreil *et al.*, 2005) combined with the nutritive value (A = 100% green leaves; B = 100% green tissue, i.e. leaves and stems; C = bites comprising less than 70% dry tissue; and D = more than 70% dry tissue) of the plant organs selected. Every two days in each paddock area, simulated bites were made on herbaceous cover by cutting out the selected portions of the plant with a knife (Agreil and Meuret, 2004) into 8 samples of 30x30 cm, distributed at random. Each bite was recorded and classified according its mass and the dry matter (DM) digestibility (by pepsin-cellulase method). A logistic regression analysis was performed, using the GLM procedure (quasi-binomial family) in R with R-Commander, to describe the changes in the ratio of the number of ewes browsing broom species and the number of ewes grazing each herbaceous bite category. Means were used for each paddock, each date and each period of flock activity observation ( $n = 64$ ).

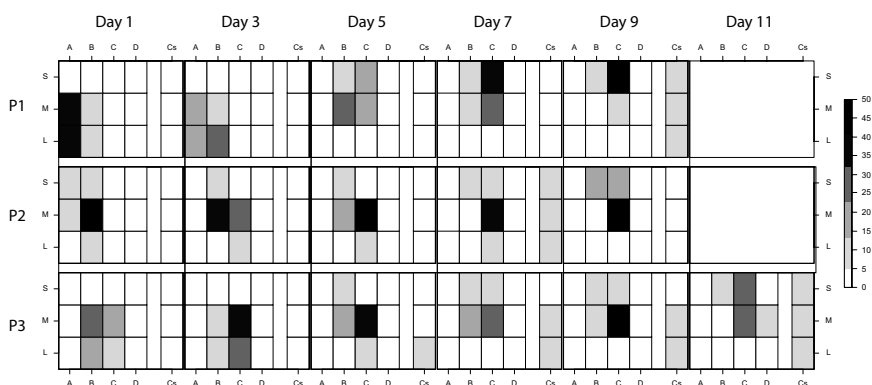

Figure 1. Percentage of ewes in each vegetation bite category for each sampling day (columns) and each paddock (lines). P1, 100% previously grazed paddock in summer; P2, 50% previously grazed paddock in summer; P3, not previously grazed paddock. Cs represents the *Cytisus scoparius* species. A, 100% green leaves; B, 100% green tissue (leaf and stem); C, bites comprising less than 70% dry tissue and D, bites comprising more than 70% dry tissue. L, large bites; M, medium-sized bites; S, small bites.

## Results and discussion

Each bite category weighed, on average:  $0.42 \pm 0.109$  g DM for large bites;  $0.16 \pm 0.051$  g DM for medium-sized bites; and  $0.05 \pm 0.026$  g DM for small bites. The digestibility was significantly different ( $P < 0.001$ ) between our four herbaceous quality categories (A =  $702 \pm 27.7$ ; B =  $634 \pm 46.2$ ; C =  $498 \pm 59.7$ ; D =  $385 \pm 50.7$  g kg<sup>-1</sup> DM). The digestibility for broom twigs was  $481 \pm 37.3$  g kg<sup>-1</sup>. At the start of a paddock use period, ewes took medium-large bites of higher-quality herbaceous cover (e.g. A<sub>L</sub>, A<sub>M</sub>, Fig. 1). When these categories became less available (data not shown), ewes consumed poorer quality herbage, such as C category, i.e. bites comprising dry tissue (e.g. from the first day in P3, which had lower availability of bites A and B, with higher nutritive value). Thereupon, broom plants offering larger bites became particularly attractive. Then, ewes gradually included larger bites of broom (from day 9 in P1, day 7 in P2 and day 5 in P3) and smaller and more nutritious bites of herbaceous plants (e.g. B<sub>S</sub>, Fig. 1), in order to maximize daily energy intake. A maximum of 26% of the flock browsing broom was observed on any given day. Hence, ewes have a threshold for this target shrubby species that they do not exceed during any paddock utilisation period. This

finding was interpreted as a mechanism to deal with post-ingestive consequences and complementary interactions between nutrients and toxins.

A negative relation was observed between the percentage of ewes taking large and medium-sized bites of highly digestible plant parts (i.e., A<sub>L</sub>, A<sub>M</sub>, B<sub>L</sub> and B<sub>M</sub> categories) and the percentage of ewes browsing broom (Table 1). Therefore, ewes integrated broom species in their diet differently and less abundantly when the bites offered by herbaceous cover were of high nutritive quality. For instance, later broom consumption by ewes was found in P1 (day 9, Fig. 1), which had 100% of its herbaceous cover previously grazed in summer, i.e. with a lower availability of mature herbaceous material, a reduced development of stems and spikes and higher leaf : stem ratio. From this moment, the herbaceous biomass in this paddock is scarce, with most of the ewes taking bites with DM masses of around 0.05 g bite<sup>-1</sup> (Fig. 1), which is probably inadequate to sustain intake rates through bite frequency. Hence, the grazing period in this paddock could not be extended, reducing the duration of broom consumption by ewes, and probably reducing the final broom browsing intensity. Unlike the situation in paddock P1, a tendency to browse broom target twigs occurred earlier when the herbaceous cover offer more bites with a poorer digestibility (particularly in P3). Consequently, more prolonged broom consumption was observed, probably because a satisfactory intake level of herbaceous cover could be maintained in order to provide a balanced mixture of nutrients, to allow for detoxification processes and to maintain animal performance.

The results supported our hypothesis that factors other than the intrinsic properties of dominant shrub species (e.g. the presence of secondary compounds) influence the browsing probability. Further, our study provides new qualitative indicators, encoded as bite categories, to describe the states of herbaceous cover that can trigger shrub consumption. More explicitly, in the absence of A<sub>L</sub>, A<sub>M</sub>, B<sub>L</sub> and B<sub>M</sub> bite categories (i.e. large and medium-sized bites in herbaceous cover with 100% of green tissues), ewes started to browse broom shrubs.

Bite category	Slope (SE)	P
A <sub>L</sub>	-0.093 (0.0404)	*
A <sub>M</sub>	-0.116 (0.0397)	**
A <sub>S</sub>	-0.090 (0.0667)	ns
B <sub>L</sub>	-0.100 (0.0287)	***
B <sub>M</sub>	-0.038 (0.0099)	***
B <sub>S</sub>	0.007 (0.0144)	ns
C <sub>L</sub>	-0.034 (0.0186)	ns
C <sub>M</sub>	0.005 (0.0065)	ns
C <sub>S</sub>	0.010 (0.0070)	ns
D <sub>L</sub>	0.402 (0.1381)	**
D <sub>M</sub>	0.102 (0.0283)	***
D <sub>S</sub>	0.172 (0.0738)	*

Table 1. Logistic regression statistics ( $n = 64$ ) for the relationship between the cohort of sheep browsing *Cytisus scoparius* and the cohort of sheep grazing each herbaceous bite category. For abbreviations, see Figure 1.

ns, not significant; \*,  $P < 0.05$ ; \*\*,  $P < 0.01$ ; \*\*\*,  $P < 0.001$ .

## Conclusion

We showed that target broom populations may be browsed by sheep in different ways depending on the herbaceous cover. Thus, we can manipulate diet selection to stimulate the consumption of broom by ewes, and probably to modify its demography.

## References

- Agreil C. and Meuret M. (2004) An improved method for quantifying intake rate and ingestive behaviour of ruminants in diverse and variable habitats using direct observation. *Small Ruminant Research* 54, 99-113.
- Altman J. (1974) Observational study of behaviour: sampling methods. *Behaviour* 9, 227-265.
- Cooper S., Owens M., Spalinger D. and Ginnett T. (2003) The architecture of shrubs after defoliation and the subsequent feeding behavior of browsers. *Oikos* 100, 387-396.

# Modelling the dynamics of biomass production and herbage quality of grasslands according to functional groups composition

Baumont R.<sup>1</sup>, Andueza D.<sup>1</sup>, Vuattoux J.<sup>1</sup>, Picard F.<sup>1</sup> and Michaud A.<sup>1</sup>

<sup>1</sup>INRA, UR1213 Herbivores, 63122 Saint-Genès Champanelle, France

Corresponding author: baumont@clermont.inra.fr

## Abstract

A model predicting the dynamics of herbage biomass, structure and digestibility in managed permanent grasslands (Jouven *et al.*, 2006a) was tested on data obtained over three successive vegetation cycles and two years from three contrasting grasslands: based on the classification given in Cruz *et al.* (2002), plot one (86% grasses) was dominated by functional group A species (*Lolium perenne*), plot two (68% grasses) was dominated by group B (*Dactylis glomerata*) and group b species (*Holcus mollis*), and plot three (only 39% grasses) was dominated by group b (*Agrostis capillaris*) and group C species (*Festuca rubra*). For the three types of grasslands, the precision of the simulation of biomass production was good for the first vegetation cycle but lower for the second and the third cycles. Digestibility was precisely simulated during the first cycle for grasslands one and two but was overestimated for plot three. It is concluded that model could be improved by better taking into account the seasonal modulation of growth, and by better knowledge of the herbage quality of species from functional groups b and C.

Keywords: permanent grassland, biomass production, digestibility, dynamic modelling

## Introduction

Permanent grasslands present a high level of among-grassland variability in biomass production and quality depending on species composition. The classification of grasses into functional groups according to functional traits was proposed to explain this variability (Cruz *et al.*, 2002). Jouven *et al.* (2006a) uses the functional groups composition based on this classification to parameterize type of grassland in a model that predicts the dynamics of herbage biomass, structure and digestibility according to management practices and climate. This study was conducted to investigate the ability of the model to predict the dynamics of contrasting grasslands.

## Materials and methods

Biomass production and herbage digestibility data were collected from an experiment set up over 2007 and 2008 at the INRA's Marcenat farm in an upland area of central France (45°15'N, 2°55'E; altitude 1135-1215 m) with a semi-continental climate (mean annual temperature: 6.1°C; mean annual rainfall: 1210 mm). The study investigated three contrasting grassland plots named Type A, B and C, respectively: plot one (86% grasses) was dominated by functional group A species (*Lolium perenne*), plot two (68% grasses) was dominated by group B (*Dactylis glomerata*) and group b species (*Holcus mollis*), and plot three (only 39% grasses) was dominated by group b (*Agrostis capillaris*) and group C species (*Festuca rubra*). On each of the grasslands, biomass was measured in the course of its accumulation, and herbage samples were collected in triplicate over 8 (2007) and 7 (2008) consecutive weeks from early May (1<sup>st</sup> vegetation cycle). The plots were then cut, and measurements were repeated from mid-July over 4 (2007) or 5 (2008) weeks (2<sup>nd</sup> vegetation cycle). After a second

cut, measurements were performed again over 6 (2007) and 7 (2008) weeks from the early September (3<sup>rd</sup> vegetation cycle).

The simulations were realized using the model developed by Jouven *et al.* (2006a) using grass functional groups composition as model inputs, together with the daily weather data recorded in Marcenat during 2007 and 2008. The simulations reproduced the cutting regime. For each of the grasslands, the functional groups composition determines a set of average functional traits used to run the model. The sward is subdivided into vegetative and reproductive compartments. Only above-ground growth is modelled, using a light-utilization efficiency approach modulated by a seasonal pattern of storage and mobilization of reserves. Plant ageing is driven by cumulative thermal time from 1 January and affects biomass flows and digestibility. To measure the precision of the model's predictions, the root mean squared deviation (RMSD) between observed and predicted values was computed, and the three additive MSD components described by Gauch *et al.* (2003) were calculated: squared bias (SB), which measures translation of observed:predicted from the 1:1 line; non-unity slope (NU), which measures rotation from the 1:1 line; and lack of correlation (LC), which measures dispersion.

Table 1. Statistical indicators of model performance: root mean-squared deviation (RMSD-value and % relative to the average observed value) and contribution of squared bias (SB), non-unity slope (NU) and lack of correlation (LC) to the mean squared deviation (MSD), for biomass ( $\text{t ha}^{-1}$  DM) and digestibility ( $\text{OMD g g}^{-1}$ ) predictions.

Variable	Grassland Type	Vegetation Cycle	No. of points compared	RMSD (value)	RMSD (%)	SB/MSD	NU/MSD	LC/MSD
Biomass DM ( $\text{t ha}^{-1}$ )	A	1 <sup>st</sup>	15	0.87	20	0.06	0.03	0.91
	A	2 <sup>nd</sup> and 3 <sup>rd</sup>	22	1.14	90	0.79	0.09	0.12
	B	1 <sup>st</sup>	15	1.06	32	0.30	0.02	0.68
	B	2 <sup>nd</sup> and 3 <sup>rd</sup>	22	0.45	56	0.50	0.06	0.44
	C	1 <sup>st</sup>	14	0.39	24	0.01	0.31	0.68
	C	2 <sup>nd</sup> and 3 <sup>rd</sup>	22	0.32	42	0.18	0.40	0.42
Digestibility ( $\text{g g}^{-1}$ )	A	1 <sup>st</sup> cycle	15	0.033	4.8	0.42	0.24	0.34
	A	2 <sup>nd</sup> and 3 <sup>rd</sup>	22	0.033	4.5	0.28	0.19	0.53
	B	1 <sup>st</sup>	15	0.032	4.7	0.20	0.10	0.70
	B	2 <sup>nd</sup> and 3 <sup>rd</sup>	22	0.049	6.8	0.08	0.43	0.49
	C	1 <sup>st</sup>	14	0.036	5.4	0.84	0.01	0.15
	C	2 <sup>nd</sup> and 3 <sup>rd</sup>	22	0.040	5.9	0.38	0.10	0.52

## Results and discussion

Predictions of biomass production were more precise for the 1<sup>st</sup> vegetation cycle than the 2<sup>nd</sup> and 3<sup>rd</sup> cycles (Table 1). The RMSD of biomass production prediction varied according to type of grassland between 20% and 32% of observed values for the 1<sup>st</sup> cycle, and the MSD was mainly explained by dispersion. These results are in the same range as the model precision reported by Jouven *et al.* (2006b). However, RMSD values were higher for the 2<sup>nd</sup> and 3<sup>rd</sup> cycles, and varied between 42% and 90% of observed values (Table 1). During the 2<sup>nd</sup> and 3<sup>rd</sup> cycles, biomass production was highly overestimated for type A grassland (Figure 1) and to a lesser extent type B grassland, whereas the model tended to underestimate production during the 1<sup>st</sup> vegetation cycle on these same grasslands. The empirical function used in the model to account for the modulation of growth by seasonal pattern of mobilization and storage of plant reserves needs to be better parameterized.

The precision of the prediction of digestibility was under 5% of the observed value for the 1<sup>st</sup> cycle on type A and B grasslands (Table 1), which is close to the values reported by Jouven *et al.* (2006b). However, the precision of the prediction was weaker for the 2<sup>nd</sup> and the 3<sup>rd</sup> cycles and there was a marked overestimation of digestibility for type C grasslands (Figure 1). This

could be explained by the fact that grasses represented only 39% of biomass in type C grassland. Increasing the data available on the digestibility of species from type C grassland should help improve the parameterization of the model.

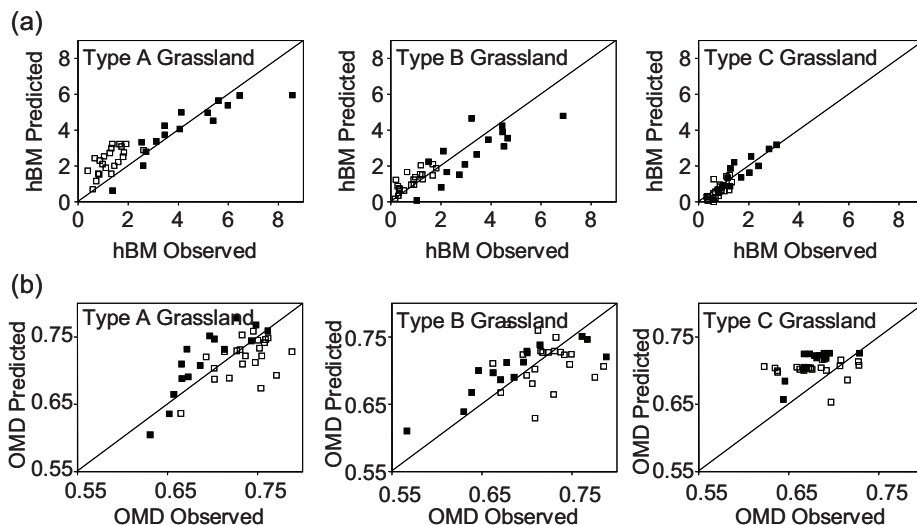

Figure 1. Comparison of observed and simulated (a) harvested dry matter biomass (hBM,  $\text{t ha}^{-1}$ ) and (b) organic matter digestibility (OMD,  $\text{g g}^{-1}$ ) for the three types (A, B and C) of grasslands. In each graph, full symbols (■) correspond to data on the 1<sup>st</sup> growth cycle and open symbols (□) correspond to data on 2<sup>nd</sup> and 3<sup>rd</sup> growth cycles.

## Conclusion

The model performs better for the first vegetation cycle than for the following cycles. The simulation of the dynamics of biomass production needs to better account for the seasonal modulation of growth. The simulation of digestibility for a wide range of grasslands needs better knowledge on the quality of species from functional groups b and c.

## Acknowledgments

The authors thank Anne Farruggia, Philippe Pradel and the technical staff at INRA Marcenat for their contributions in the designing and carrying out the grassland experiment.

## References

- Cruz P., Duru M., Therond O., Theau J.P., Ducourtieux C., Jouany C., Al Haj Khaled R. and Ansquer P. (2002) A new approach to the characterization of natural grasslands and their use value (in French). *Fourrages* 172, 335–354.
- Gauch H.G., Hwang G.J.T. and Fick G.W. (2003) Model evaluation by comparison of model-based predictions and measured values. *Agronomy Journal* 95, 1442–1446.
- Jouven M., Carrère P. and Baumont R. (2006a) A model predicting biomass, structure and quality dynamics in managed permanent grasslands: 1- Model description. *Grass and Forage Science* 61, 112–124.
- Jouven M., Carrère P. and Baumont R. (2006b) A model predicting biomass, structure and quality dynamics in managed permanent grasslands: 2- Model evaluation. *Grass and Forage Science* 61, 124–133.



# The quest for persistent green in outdoor chicken runs – an investigation on fourteen grassland species

Breitsameter L.<sup>1</sup>, Wrage N.<sup>2</sup> and Isselstein J.<sup>1,2</sup>

<sup>1</sup> The Research Centre for Agriculture and the Environment (ZLU), Grisebachstr. 6, D-37077 Goettingen

<sup>2</sup> Institute of Grassland Science, Department of Crop Sciences, University of Goettingen, von-Siebold-Str. 8, D-37075 Goettingen

Corresponding author: lbreits@uni-goettingen.de

## Abstract

In free-range chicken husbandry systems, the vegetation cover of the hen run is exposed to particularly high levels of stress. Sward deterioration is common, which entails environmental and animal health risks. Thus, specific agronomic strategies ensuring the preservation of an intact vegetation cover need to be developed for outdoor chicken runs.

Within the present field experiment, we investigated fourteen species of native grassland plants with regard to their suitability for greening chicken free-range areas. To this end, monocultures and a mixture of all species were grazed with chicken at three different stocking rates. The following parameters were analysed for each species: a) reduction of aboveground biomass caused by grazing and b) growth rates of aboveground biomass during rest periods. We identified significant ( $P < 0.001$ ) inter-specific differences in biomass removal by grazing with relative removal of original biomass ranging from 17 to 100% at the highest stocking rate. Stocking rate significantly ( $P < 0.001$ ) influenced post-grazing growth rates. Our results indicate that *Festuca arundinacea* potentially is the most eligible species for greening chicken outdoor runs, as in this species relative biomass removal by chickens is low and growth rates during recovery periods are largely unaffected by the previous grazing event.

Keywords: Poultry, free-range husbandry, grazing rest period, aboveground biomass removal, growth rates

## Introduction

In organic chicken husbandry, outdoor range areas are obligatory. However, in the most frequented parts of the hen run, the vegetation cover is exposed to high levels of stress due to the pecking and scratching activities of the birds. The resulting areas of bare soil show high rates of erosion and nitrogen leaching. Thus, specific agronomic strategies ensuring the preservation of an intact vegetation cover need to be developed for outdoor chicken runs. Within the present project, we tested fourteen native grassland species for their suitability for a sustainable greening of outdoor chicken runs.

## Material and methods

The investigated plant species and cultivars have been chosen on the basis of their strong grazing tolerance and their tolerance to cutting as characterized by indicator values in Dierschke and Briemle (2002) and in the descriptive list of cultivars (Bundessortenamt, 2006). The species chosen were (if no cultivar information is given, purchased wild seeds were used) *Achillea millefolium*, *Agrostis stolonifera* var. Barifera, *Deschampsia caespitosa*, *Elymus repens*, *Festuca arundinacea* var. Mustang, *Festuca rubra rubra* var. Rossinante,

*Festuca trichophylla* var. Barcrown, *Lolium perenne* var. Bargold, *Plantago major*, *Poa pratensis* var. Julius, *Poa supina* var. Supreme, *Ranunculus repens*, *Taraxacum officinale*, and *Trifolium repens* var. Rivendel. The species were established on the experimental site as monocultures and – in order to detect effects of species interaction – as a mixture comprising equal proportions of all fourteen species on plots of 8 m<sup>2</sup> (2 m x 4 m) in a randomized block design with three replications. All plots were split into four subplots of 2 m<sup>2</sup> (1 m x 2 m) which were exposed to three different stocking rates of laying hens of the breed ISA Warren brown (1. low: four chicken per m<sup>2</sup> for five hours; 2. medium: four chicken per m<sup>2</sup> for two times five hours; 3. high: four chicken per m<sup>2</sup> for three times five hours on consecutive days; 4. ungrazed control). All subplots of the same stocking rate level were grazed simultaneously; blocks were stocked successively in a rotational grazing scheme with rest periods of three weeks for each plot. Results for the second out of two grazing cycles are shown. Biomass removal during the stocking periods, and growth rates of aboveground biomass during the rest periods were quantified for each culture and each stocking rate. To this end, the sward height was measured at six spots within the subplots with a rising plate meter (Sahin Demirbag *et al.*, 2008) directly pre- and post-stocking, as well as three times during the rest period. Aboveground biomass for each subplot was calculated from sward height according to species-specific calibrations. The data were analysed in a two-way ANOVA and TukeyHSD test (95% confidence level) using the software package R ([www.r-project.org](http://www.r-project.org)). Data of relative biomass removal were arcsine square root transformed before analysis.

## Results and discussion

Relative aboveground biomass removal differed significantly ( $P < 0.001$ ) among the investigated species. At the high stocking rate, it exceeded 90% in *T. repens*, *T. officinale* and *E. repens*, while in contrast it did not reach 30% in *F. arundinacea*, *R. repens*, *P. supina*, *L. perenne* and *D. caespitosa* (Table 1). Stocking rate was a significant ( $P < 0.001$ ) explanatory factor for the growth rates during the following rest period. Growth rates in the grazed subplots were significantly higher than in the ungrazed control for *A. stolonifera*, *D. caespitosa*, *L. perenne* ( $P < 0.01$ ), *F. rubra rubra* and *P. pratensis* ( $P < 0.05$ ). For the other species, growth rates did not differ significantly among the treatments (Table 1).

In order to estimate the eligibility of species for greening outdoor chicken runs, we considered the specific values for both relative biomass removal and growth rates synoptically. Species with low biomass removal by chicken grazing particularly warrant further investigation, as these species are likely to need fewer resources to compensate for loss of photosynthetic tissue. Species that additionally do not show a significant decline in growth rates in post-stocking periods may prove to be tolerant to chicken grazing. Yet, species with post-stocking growth rates that are significantly higher than those of the ungrazed control may be prone to higher mortality in the course of repeated severe defoliation (Hazard, 2001). According to these criteria, we conclude that among the species tested within the present experiment, *Festuca arundinacea* is potentially most eligible for establishing poultry lawns.

Stocking rates within this experiment were devised as equal fractions of the maximum stocking allowance in order to create a gradient of grazing pressure exerted onto the swards. We recognize that this gradient may not be linear as we assume chicken interaction with the sward to be correlated with sward quality and thus to alter with increasing stocking rate. Clearly, further studies are necessary to supplement the existing results. A repeated assessment of plant productivity over a larger number of grazing cycles should be of particular importance. It should be accompanied by measurements of vegetation ground cover and belowground biomass. Studies of chicken behaviour should provide data for the quantification of animal-sward interactions. The synopsis of a larger range of variables

describing the grazing system should allow for a comprehensive analysis and a detailed evaluation of the tolerance of the investigated grassland species to chicken stocking.

Table 1. Relative aboveground biomass removal (RBR) at three stocking rates of laying hens and average growth rates (GR) during the following rest period in the ungrazed control and the grazed plots for the investigated species and cultivars in monoculture and in mixed plots. Significant differences in GR and RBR are indicated by lower and upper case letters, respectively. \*: no statistical analysis of RBR available due to missing data

Species and cultivar	Stocking rate level						
	ungrazed		low		medium		high
	GR	RBR	GR	RBR	GR	RBR	GR
<i>A. millefolium</i> *	1.37	0.51	1.67	0.45	1.71	0.63	0.87
<i>A. stolonifera</i> Barifera	2.50 <sup>a</sup>	0.26	5.40 <sup>ab</sup>	0.29	6.96 <sup>b</sup>	0.52	8.53 <sup>b</sup>
<i>D. caespitosa</i>	1.97 <sup>a</sup>	0.15 <sup>A</sup>	3.07 <sup>ab</sup>	0.22 <sup>B</sup>	4.31 <sup>b</sup>	0.27 <sup>C</sup>	4.39 <sup>b</sup>
<i>E. repens</i>	8.71	0.80	7.17	0.92	10.58	1	13.22
<i>F. arundinacea</i> Mustang	0.90	0.14	2.40	0.14	3.41	0.17	3.79
<i>F. rubra rubra</i> Rossinante	3.80 <sup>a</sup>	0.25	7.30 <sup>b</sup>	0.26	7.56 <sup>b</sup>	0.31	7.35 <sup>b</sup>
<i>F. trichophylla</i> Barcrown	6.54	0.42	9.00	0.43	8.68	0.60	10.20
<i>L. perenne</i> Bargold	1.78 <sup>a</sup>	0.18	3.39 <sup>ab</sup>	0.21	4.27 <sup>b</sup>	0.23	4.06 <sup>b</sup>
<i>P. major</i> *	0.23	0.27	1.75	0.39	0.80	0.50	0.35
<i>P. pratensis</i> Julius	3.06 <sup>a</sup>	0.63	7.48 <sup>ab</sup>	0.70	9.84 <sup>b</sup>	0.71	6.66 <sup>ab</sup>
<i>P. supina</i> Supreme	1.17	0.13	3.09	0.12	3.69	0.20	2.97
<i>R. repens</i>	0.54	0.13	0.68	0.15	0.57	0.18	0.63
<i>T. officinale</i>	5.50	0.98	7.17	1	8.20	1	7.56
<i>T. repens</i> Rivendel	8.49	0.64 <sup>A</sup>	3.78	0.80 <sup>B</sup>	1.48	0.91 <sup>C</sup>	1.52
Mixed seed	5.04	0.15 <sup>A</sup>	4.90	0.34 <sup>AB</sup>	5.25	0.37 <sup>B</sup>	5.21

## Conclusions

According to the existing results, we conclude that among the species tested, *Festuca arundinacea* is potentially the most eligible for establishing poultry lawns due to the small relative biomass removal by chicken and growth rates that are not significantly influenced by chicken grazing. We discern the need for further experiments to evaluate candidate species in the quest for persistent green in outdoor chicken runs.

## Acknowledgements

We thank the German Federal Agency for Food and Agriculture (BLE) for the funding of this project (06OE202). We furthermore thank the seed companies Barenbrug Holding BF, DLF TRIFOLIUM Deutschland GmbH, Feldsaaten Freudenberger GmbH&Co.KG, Innoseeds bv, and Saatzucht Steinbach GmbH for providing free samples of their cultivars for the experiments.

## References

- Bundessortenamt (Ed.) (2006) *Beschreibende Sortenliste Rasengräser*, Bundessortenamt, Hannover.
- Dierschke H. and Briemle G. (2002) *Kulturgrasland: Wiesen, Weiden und verwandte Staudenfluren*. Ulmer, Stuttgart, pp 239.
- Hazard L., Barker D.J. and Easton H.S. (2001) Morphogenetic adaption to defoliation and soil fertility in perennial ryegrass (*Lolium perenne*). *New Zealand Journal of Agricultural Research* 44, 1-12.
- Sahin Demirbag N., Röver K.-U., Wrage N., Hofmann M. and Isselstein J. (2008) Herbage growth rates on heterogeneous swards as influenced by sward-height classes. *Grass and Forage Science* 64, 12-18.

## Dietary selection of heifers in natural grasslands: effect of time of day and phenological stage

Carvalho P.C.F.<sup>1</sup>, Bremm C.<sup>1</sup>, Gibb M.J.<sup>2</sup>, Perez N.<sup>3</sup>, Fonseca L.<sup>1</sup> and Amaral G.A.<sup>1</sup>

<sup>1</sup> Grazing Ecology Research Group, Federal University of Rio Grande do Sul, Brazil

<sup>2</sup> Retired, Institute of Grassland and Environmental Research, North Wyke, UK

<sup>3</sup> Brazilian Agricultural Research Corporation (EMBRAPA), Brazil

Corresponding author: paulocfc@ufrgs.br

### Abstract

This study was conducted on a natural mosaic grassland of tall tussocks comprised mainly of *Eragrostis plana* Nees, and shorter inter-tussock areas comprised of prostrate grasses. The experimental paddocks were grazed by beef heifers and contained equal proportions of tussock and inter-tussock areas. Measurements were made at two times of day (during the first and the last grazing meals) replicated four times: twice spatially on paddocks and twice in time. The complete set of replicate measurements was conducted during two different tussock phenological stages: green reproductive (GR) and senescent reproductive (SR). Time of day had no effect on the proportions of grazing activity spent on the inter-tussock areas and tussocks. However, during GR stage the heifers spent more time grazing the reproductive tissues than the inter-tussock areas (66% vs. 34% of grazing activity, respectively). During SR stage virtually all grazing activity was concentrated on the inter-tussock areas (2% vs. 98% of grazing activity, respectively) and the heifers were able to increase mean bite mass and short-term intake rate.

Keywords: foraging behaviour, mixed diets, short-term intake rate, tussocks

### Introduction

Grazing ruminants exhibit dietary selection, availability (biomass or sward height) being the main constraint when they graze on short swards, whereas on taller swards the quality (nutrient content) is the major constraint, i.e. when forage is mature (Agreil *et al.*, 2006). Offering animals selection choices on pastures allows each animal to meet its needs for nutrients and to regulate its intake by selecting mixed diets (Provenza *et al.*, 2009). Within this context, studies have shown that grazing ruminants may increase consumption of grasses with higher fibre content in the afternoon to maintain rumen fill overnight (Rutter, *et al.*, 2000). The present experiment was designed to examine the effect of time of day at two phenological stages of tussocks on dietary selection by beef heifers in mosaic natural grassland in southern Brazil.

### Materials and methods

The measurements were made at two times of day (during the first and the last grazing meals) and the investigation comprised four replicates: two spatial replicates (paddocks) and two replicates in time (measurement dates). The complete set of replicate measurements was conducted during two different tussock phenological stages: green reproductive (GR) and senescent reproductive (SR).

The grazing paddocks contained equal proportions of shorter inter-tussock and taller tussock areas. The inter-tussocks areas were predominantly comprised of *Axonopus affinis*, *Paspalum nicorae*, *Paspalum notatum*, *Desmodium incanum*, *Andropogon lateralis*. Tussock vegetation was predominantly (>95%) *Eragrostis plana* Nees.

Paddocks were 368 m<sup>2</sup> and they were grazed between 08:00 and 09:30 hours in the morning and between 16:30 and 18:00 hours in the afternoon, by four crossbred beef heifers (Angus x Brahman). Measurements when tussocks were at the GR stage began in January 2009 with heifers aged 15 months and a mean weight of 198 ± 2.2 kg. At the SR stage of tussocks, the evaluation began in April 2009 with the same animals (226.5 ± 3.5 kg).

At 1-minute intervals during grazing activity, records were taken of whether the heifers were grazing on tussock or inter-tussock areas. The short-term intake rate was measured by weighing the heifers pre- and post-grazing, corrected for insensible weight losses. Grazing time and jaw movements were recorded using behaviour recorders (Rutter *et al.*, 1997).

The sward height was estimated by 150 pre- and post-grazing measurements using a sward stick. To determine the herbage mass six quadrats (0.5 m x 0.5 m; three in tussock and three in inter-tussock areas) by paddock were cut at ground level.

In all analyses the paddock group of four heifers was used as the experimental unit. A repeated-measures ANOVA with measurement dates as repeated effect was used to test for significant interactions between time of day and tussock phenological stage.

Table 1. Effect of time of day (TD, am vs. pm) and phenological stages of tussocks (PS, green reproductive vs. senescent reproductive) on sward structure and grazing behaviour in tussock and inter-tussock (IT) areas.

Phenological stage	Green reproductive				Senescent reproductive				<i>P</i> of PS effect
	am	pm	<i>P</i> of TD effect	Daily mean	am	pm	<i>P</i> of TD effect	Daily mean	
Sward characteristics									
Sward height of IT areas (cm)	11.7	11.0	0.129	11.4	11.0	10.7	0.146	10.8	0.388
Sward height of tussocks (cm)	39.8	40.1	0.392	40.1	42.2	41.9	0.923	42.0	0.264
HM of IT areas (Mg ha <sup>-1</sup> )	2.50	2.30	0.328	2.40	2.32	2.36	0.894	2.34	0.691
HM of tussocks (Mg ha <sup>-1</sup> )	14.1	14.7	0.639	14.41	15.7	14.9	0.707	15.29	0.497
Animal characteristics									
STIR (g min <sup>-1</sup> kg <sup>-1</sup> )	0.08	0.09	0.681	0.084	0.12	0.12	0.937	0.122	0.013
Bite mass (mg kg <sup>-1</sup> )	2.01	2.38	0.342	2.19	4.98	4.08	0.530	4.57	0.017
Bite rate (min <sup>-1</sup> )	41.2	40.5	0.879	40.9	40.8	37.4	0.617	38.4	0.025
Grazing IT areas (% of total)	27.8	40.0	0.484	33.5	97.9	98.4	0.840	98.1	0.003
Grazing tussocks (% of total)	72.2	60.0	0.484	66.5	2.1	1.6	0.840	1.9	0.003

HM = Herbage dry matter mass

STIR = Short-term dry matter intake rate per life weight

## Results and discussion

There were neither significant interactions ( $P > 0.10$ ) between time of day and tussock phenological stage, nor an effect ( $P > 0.10$ ) of time of day (morning vs. afternoon). At both phenological stages heifers showed similar diet selection strategies irrespective of the time of the day (Table 1).

During the GR stage, heifers spent more time grazing the reproductive tissues compared with the inter-tussock areas (67% vs. 34% of grazing activity, respectively). In contrast, during the SR stage, virtually all grazing activity was concentrated on the inter-tussock areas (2% vs. 98% of grazing activity, respectively). The sward height and herbage mass in the inter-tussock areas and tussocks were similar ( $P > 0.10$ ) between the phenological stages. Therefore, probably the change in diet selection was due to changes in chemical composition of the plant species (higher energy and a better carbon : nitrogen (C : N) ratio, in the earlier than in the later phenological stage). Rutter (2006) reported that ruminants adopt diet selection strategies to optimize their intake of nutrients, especially C and N.

During the SR stage, the greater concentration of grazing activity on the inter-tussock areas allowed heifers to increase their bite mass by 108% and, despite a reduction in bite rate, to increase short-term intake rate by 45%. During the GR stage, heifers selected a 'mixed' diet, (from inter-tussock areas and tussocks) compared with the SR stage, when they appear to abandon virtually all interest in the tussocks. Furthermore, bite rate was not adapted to compensate for a low bite mass and, as a result, short-term intake rate was lower than in the SR stage. Probably these smaller bites were due to the selection of green reproductive tissues from the tussocks, characterized by a smaller density and major spatial dispersion. In a mosaic vegetation, ruminants have to choose either small plant parts, which means small bite mass and highly nutritive bites, or large plant parts, which means bigger bite mass but poorer quality (Shipley *et al.*, 1999).

## Conclusion

The fact that heifers selected a mixed diet in GR stage may represent a good strategy of control of *Eragrostis plana* Nees in natural grasslands of southern Brazil. However, since bite mass and short-term intake were lower in GR than in SG stage, the use of animals with lower nutritional requirements should be considered.

## References

- Agreil C., Meuret M. and Fritz H. (2006) Adjustment of feeding choices and intake by a ruminant foraging in varied and variable environments: new insights from continuous bite monitoring. In: Bels V. (eds.) *Feeding in Domestic Vertebrates: from Structure to Behaviour*. CABI Publishing, Cambridge, pp. 302-325.
- Provenza F.D., Villalba J.J., Wiedmeier R.W., Lyman T., Owens J., Lisonbee L., Clemensen A., Welch K.D., Gardner D.R. and Lee S.T. (2009) Value of plant diversity for diet mixing and sequencing in herbivores. *Journal of Range Management* 31, 45-49.
- Rutter S.M. (2006) Diet preference for grass and legumes in free-ranging domestic sheep and cattle: Current theory and future application. *Applied Animal Behaviour Science* 97, 17-35.
- Rutter S.M., Champion R.A. and Penning P.D. (1997) An automatic system to record foraging behaviour in free-ranging ruminants. *Applied Animal Behaviour Science* 54, 185-195.
- Rutter S.M., Orr R.J. and Rook A.J. (2000) Dietary preference for grass and white clover in sheep and cattle: an overview. In: Rook A.J. and Penning P.D. (eds.) *Grazing Management: the principles and practice of grazing for profit and environmental gain, within temperate grassland systems*. British Grassland Society Occasional Symposium No. 34, pp. 73-78. Reading UK: British Grassland Society.
- Shipley L.A., Illius A.W., Danell K., Hobbs N.T. and Spalinger D.E. (1999) Predicting bite size selection of mammalian herbivores: a test of a general model of diet optimization. *Oikos* 84, 55-68.

# Intake choices of cattle and sheep grazing alone or together on grass swards differing in plant species diversity

Cuchillo H.M. and Isselstein J.

*Institute of Grassland Science, University of Goettingen, 37075 Goettingen, Germany*

Corresponding author: mcuchil@gwdg.de

## Abstract

The objective of this study was to evaluate the effect of either mono grazing of sheep and cattle or co-grazing, as well as the influence of sward botanical composition (either diverse swards or grass dominated swards) on intake choices of six forage species. The hypothesis was tested that intake choices of sheep and cattle are modified by the sward composition and the type of grazing. Jacobs' selection index was employed to quantify the proportion of a single target species preference in relation to its proportion to the sward composition. Results revealed distinct intake preferences of sheep and cattle; especially, sheep were more selective than cattle. To a lesser extent, the sward composition had an effect on intake preferences. Co-grazing facilitated a more homogeneous consumption of the main forage species. Co-grazing might have the potential to better maintain grassland biodiversity.

Keywords: biodiversity, grazing, intake preferences, animal behaviour

## Introduction

Grazing of grasslands is considered an effective measure to maintain and enhance biodiversity (Rook *et al.*, 2004). Research has shown that the type of grazing modifies the grazing behaviour, a main aspect being selective grazing (Fraser *et al.*, 2007). The extent of selective grazing is dependent on the sward structure and herbage availability. However, the botanical composition of the swards is also affecting intake behaviour of ruminants and efficiency of herbage utilization. Up to now, no information is available whether vegetation composition and the type of grazing interact in this respect. Deeper knowledge of this issue will make it clearer how plant diversity affects intake preferences. This could build the basis for improved pasture management aiming at the enhancement of production while maintaining diversity.

## Material and methods

A trial was carried out on mesotrophic permanent grassland in the Solling Uplands of Lower Saxony/Germany to identify intake choices of sheep and cattle grazing alone or together from May to September 2009 in a rotational grazing system. Eighteen (0.5 ha) paddocks divided into three blocks (A, B and C), arranged into six treatments were employed: LC = low diversity/cattle grazing; LS = low-diversity/sheep grazing; LCS = low-diversity/cattle and sheep co-grazing; HC = high diversity/cattle grazing; HS = high diversity/sheep grazing; HCS = high diversity/cattle and sheep co-grazing. Species diversity was manipulated by the use of herbicides three years prior to this investigation and resulted in grass-dominated swards (7 species per 9 m<sup>2</sup>) in contrast to untreated diverse swards with grasses, forbs and legumes (14 species per m<sup>2</sup>). Within each block, treatments were randomly allocated to the plots. The stocking density was 3000 kg of animal live weight per plot and rotation. The blocks were grazed sequentially. Animals were moved to the next block when the average compressed sward height was decreased from ~12 cm to ~6.5 cm. Measurements of intake choices of *Dactylis glomerata*, *Festuca pratensis*, *Lolium perenne*, *Phleum pratense*, *Taraxacum officinale*, and *Trifolium repens* were obtained seven times during the season, i.e. once per



block and rotation, as follows: The percentage of the six target species was visually assessed in five 0.5 m<sup>2</sup> subplots per plot immediately before and after a period of three days grazing on a plot. The target species were selected because they were the most abundant ones. Jacobs' selection index (Jacobs, 1974) was used to quantify the intake preference for single target species in relation to their proportion in the sward.  $Selection\ Index = c_i - a_i / c_i + a_i - 2c_i a_i$ ; where  $c_i$  = % forage in the diet and  $a_i$  = % forage in the pasture. Here,  $a_i$  was evaluated by the difference between the percentage mass of each species before and after three days of grazing. Data were transformed to have a Gaussian distribution by adding 1 and multiply by 0.5; then, values of forage selection ranged between -1.0 (entirely rejected) to +1.0 (exclusively preferred). Before further statistical analysis, the average percentage cover of target species was calculated per plot. Measurements of blocks and rotations were treated as repeated measurements. Results were analyzed with a Completely Random Variance Analysis in a 2 x 3 factorial arrangement. Comparison of the means with a significant difference ( $\alpha = 0.05$ ) was established by Tukey's test. All data was analyzed using the Proc Mixed procedure of SAS (2003).

Figure 1. Jacobs' selection index of dominant plant species grazed by cattle and sheep alone or together on grass swards differing in botanical composition (n = 7)

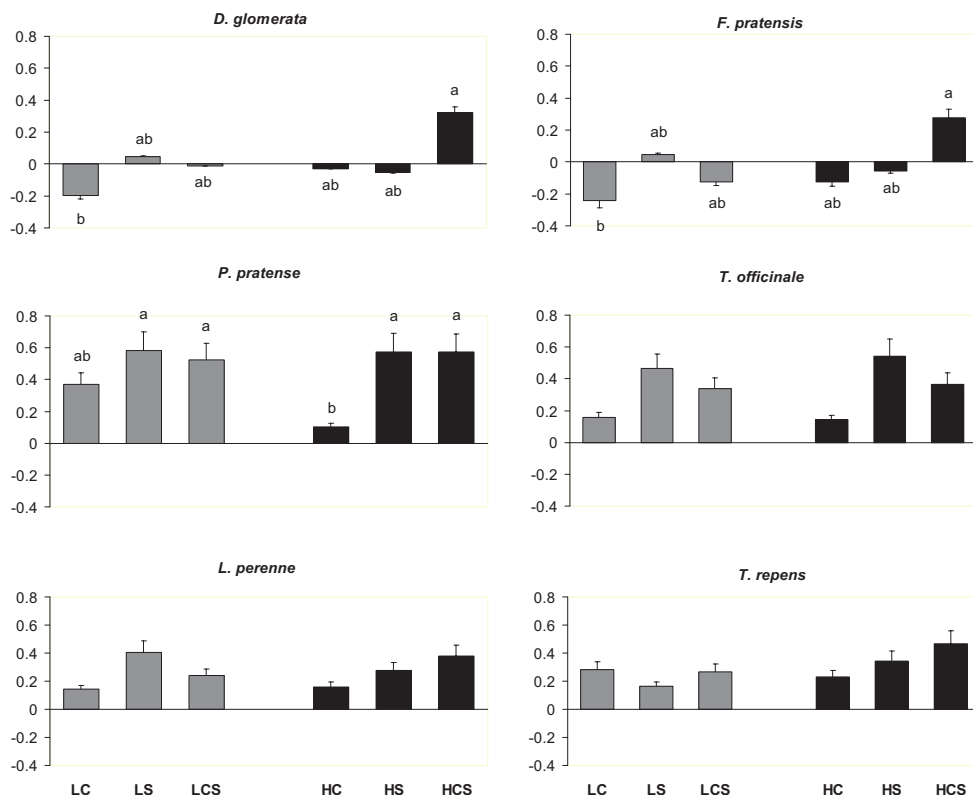

LC = low diversity/cattle grazing; LS = low-diversity/sheep grazing; LCS = low-diversity/cattle and sheep co-grazing; HC = high diversity/cattle grazing; HS = high diversity/sheep grazing; HCS = high diversity/ cattle and sheep co-grazing. <sup>a,b</sup> = Means with different letters indicate significant differences

## Results and discussion

We hypothesized that the interaction of grazing type (alone or together) as well as the sward composition would influence the intake preferences of cattle and sheep. Results indicate that timothy (*P. pratense*) was the most preferred forage species (Figure 1). *L. perenne*, *T. officinale* and *T. repens* were also highly preferred regardless of sward composition or type of grazing. In diverse co-grazed plots, cattle and sheep actively consumed *D. glomerata* and *F. pratensis* whilst these species were refused in the grass dominated sward ( $P < 0.05$ ). This result suggests that in the diverse swards, herbivores sought herbage with a higher fibre content, which may be due to the higher availability of the readily digestible white clover and dandelion. In addition, the herbivore species seem to interact with regard to their intake choice. Sheep seem to be more selective than cattle, i.e., a trend towards a higher consumption of *T. officinale* and *L. perenne* could be seen in sheep treatments, though this was not significant. On diverse swards, all species were grazed rather homogeneously on co-grazed pastures, which is in line with earlier findings (Fraser *et al.*, 2007). Such uniform consumption of species by mixed herds may bring positive benefits on sward biodiversity. Further research is necessary to confirm this finding and to explore the potential benefit for grassland management.

## Conclusions

The analysis of sward composition and the type of grazing on intake choices revealed differences between sheep and cattle; with sheep being more selective than cattle. To a lesser extent, the sward composition had effects on intake preferences. Co-grazing facilitated a more homogeneous consumption of the main forage species. Co-grazing might have the potential to better maintain grassland biodiversity.

## Acknowledgements

Cuchillo H.M was supported by a DAAD and DGRI-SEP grant.

## References

- Fraser M.D., Davies D.A., Vale J.E., Hirst W.M. and Wright I.A. (2007) Effects on animal performance and sward composition of mixed and sequential grazing of permanent pasture by cattle and sheep. *Livestock Science* 110, 251-266.
- Jacobs J. (1974) Quantitative measurement of food selection. *Oecologia* 14, 413-417.
- Rook A.J., Dumont B., Isselstein J., Osoro K., WallisDeVries M.F., Parente G. and Mills J. (2004) Matching type of livestock to desired biodiversity outcomes in pastures - a review. *Biological Conservation* 119, 137-150.
- SAS (2003) *Statistical Analysis System. User's Guide*. SAS. Institute Inc, Cary, North Carolina, USA, 120 pp.

## Relationship between herbaceous productivity and species richness in grazed areas on La Palma (Canary Islands)

de Nascimento L.<sup>1,2</sup>, Bermejo L.A.<sup>2</sup>, Saro I.<sup>2</sup>, Fernández-Lugo S.<sup>1</sup> and Mata J.<sup>2</sup>

<sup>1</sup>*Department of Ecology, Faculty of Biology, University of La Laguna, 38206 La Laguna, (Tenerife), Spain*

<sup>2</sup>*Department of Agricultural Engineering, Production and Economy, Technical School of Agricultural Engineering, University of La Laguna, 38201 La Laguna, (Tenerife), Spain*

Corresponding author: leadenas@gmail.com

### Abstract

Goat grazing in the Canary Islands is increasingly related to environmental policies, because it has to coexist with the natural protection of the territory. In order to correctly manage goat grazing and ensure its sustainability it is crucial to study its effect on the environment. After three years of monitoring in grazed areas of La Palma we try to observe whether the relationship between species richness and productivity shows different patterns due to the effect of grazing on vegetation. Biomass and richness of herbaceous plants were measured in grazed and non-grazed areas in the main ecosystems on the island. These communities differ in mean productivity and species richness ( $P < 0.01$ ). Three responses were detected, a) communities with no significant relationship between species richness and productivity in both grazed and non-grazed areas, b) communities with a significant and positive linear relationship only in non-grazed areas, and c) communities in which the relationship is significant in both areas but showing different patterns, linear and positive in grazed areas and unimodal in non-grazed areas ( $P < 0.01$ ). Managers should take into account the differences in the response of species richness to goat grazing depending on the type of vegetal community, as their productivity values are influencing the type of answer.

Keywords: goat grazing, herbaceous productivity, species richness, vegetal community

### Introduction

Grazing in La Palma is a traditional activity of important socioeconomic value; represented by the native goat breed 'Palmera' and the local cheese officially awarded a Designation of Origin. Currently, grazing has to coexist with the natural protection of the territory as 35% of the island's surface is included in the Canarian Network of Natural Protected Areas and the whole island was declared a Biosphere Reserve by UNESCO in 2002. Studies on the effect of grazing on La Palma ecosystems are scarce and recent initiatives promoted by the local Council aim at providing a basis for sustainable grazing management. Plant diversity is a common indicator to estimate grazing pressure on ecosystems, although its response might vary due to regional conditions and herbivore type (Olf and Ritchie, 1998), grazing intensity (Oba *et al.*, 2001) or grazing history (Milchunas *et al.*, 1988). The amount of herbaceous biomass as a result of climatic and soil conditions will differ among plant communities on the island. These differences in productivity combined with grazing, might cause a variety of responses in plant diversity (Osem *et al.*, 2002) modifying plant composition (Milchunas and Lauenroth, 1993). Here we study the relationship between diversity and productivity and the possible effect of grazing on this relation in various vegetal communities of La Palma.

### Material and methods

A total of 118 permanent points were randomly located in the communities studied (pastures,  $n = 31$ , shrubland,  $n = 31$ , and pine forest,  $n = 56$ ) spanning from 0-1800 m a.s.l. in the

southern region of La Palma, Canary Islands (28°35'N, 17°50'W). Half of the points were placed in grazing areas where the average stocking rate was 0.12 AU ha<sup>-1</sup>. Annual mean rainfall and temperature vary from pastures (250-1000 mm, 15-19 °C) to shrubland (50-300 mm, 19 °C) and pine forest (450 mm, 11-15 °C). Species richness and biomass were measured in the herbaceous stratum of each vegetation type during 2005-2007. Each point had fixed coordinates and was the origin of a 30 m transect where the number of species was measured using the point-quadrat intersect method (Daget and Poissonet, 1971). Productivity, in kg of dry matter (DM) per ha, was assessed by cutting aerial herbaceous biomass from three random plots of 1 m<sup>2</sup> located near each transect. Average productivity and species richness were compared among the three communities using the Kruskal-Wallis test and the non-parametric Tukey *posteriori* test ( $P < 0.01$ ). Differences due to grazing for both variables were contrasted using Mann-Whitney *U* test ( $P < 0.01$ ). Regression analysis between productivity and species richness was assessed using the curve estimation procedure.

## Results and discussion

Although the ecosystems studied might be considered semiarid sites with low productivity (< 2000 kg ha<sup>-1</sup>), pastures were significantly ( $P < 0.01$ ) more productive and diverse than shrubland and pine forest. According to the intermediate-disturbance hypothesis the relationship between diversity and biomass describes a unimodal pattern (Grime, 1973); this pattern could be modified by herbivores resulting in an increase or decrease of species richness (Oba *et al.*, 2001). This effect has been confirmed in the pine forest, where the significant unimodal curve of non-grazed areas changed in to a linear and positive relationship in grazed areas (Fig. 1, C). Although grazing did not affect species richness in this community, productivity was significantly increased ( $P < 0.01$ ) in grazed areas (Table 1). Therefore grazing might favour more productive herbaceous species.

Table 1. Mean productivity and species richness ( $\pm$  standard deviation) in grazed and non-grazed areas of each vegetation type. Significant differences due to grazing are shown in bold.

Vegetation type	DM productivity				species richness			
	kg ha <sup>-1</sup>		<i>U</i>	<i>P</i> value	number of species		<i>U</i>	<i>P</i> value
	(mean $\pm$ SD)				(mean $\pm$ SD)			
	Grazed	non-grazed			grazed	non-grazed		
Pastures	1729 $\pm$ 896	1360 $\pm$ 1318	78.0	0.104	14.0 $\pm$ 3.3	11.9 $\pm$ 5.9	93.5	0.311
Shrubland	675 $\pm$ 773	724 $\pm$ 801	115.5	0.952	7.3 $\pm$ 5.5	6.4 $\pm$ 5.5	109.5	0.763
Pine forest	518 $\pm$ 491	318 $\pm$ 614	213.5	<b>0.005</b>	7.1 $\pm$ 5.8	4.6 $\pm$ 6.0	231.0	0.011

Shrubland only showed a significant positive relationship ( $P < 0.01$ ) in non-grazed areas (Fig. 1, B). Low productive sites commonly present a positive linear relationship between species richness and biomass (Osem *et al.*, 2002), showing how species number rises with resources availability. In addition, in low productive sites, grazing increases diversity slightly or has no effect on it (Milchunas *et al.*, 1988; Osem *et al.*, 2002). However, we find no relationship in grazed shrubland (Fig 1, B), where shrubs could be buffering grazing effects on herbaceous species. Finally and despite having the highest productivity, pastures revealed no significant relationship (Fig. 1, A) in both grazed ( $P = 0.12$ ) and non-grazed areas ( $P = 0.52$ ). More productive communities under grazing, usually show a higher diversity, due to an increase in resources availability and a relaxation in the competition as a result of the reduction of dominant species (Milchunas *et al.*, 1988). These unexpected results for pastures could be explained with reference to productivity values being, in fact, the intermediate part of the

hump-shaped curve, where species richness is maximum and grazing pressure is having moderate effect on diversity (Grime, 1973; Oba *et al.*, 2001).

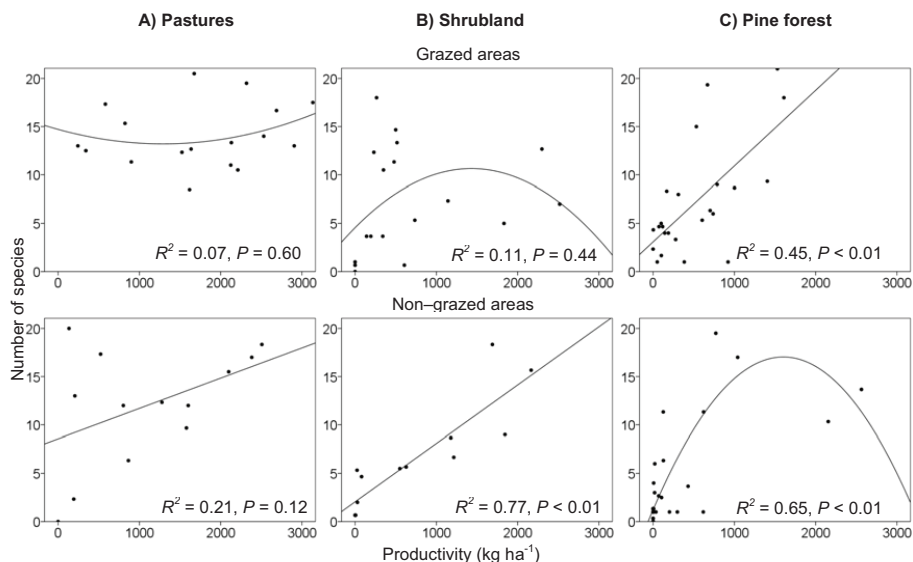

Figure 1. Relationship between productivity and number of pastures species, shrubland and pine forest in grazed and non-grazed areas.

## Conclusions

The effect of goat grazing on plant species richness in La Palma depends on the type of vegetal community and its productivity. These results should be taken into account when assessing the impact of grazing on each ecosystem.

## Acknowledgments

This project was funded by the Cabildo de La Palma. We thank the farmers and field assistants. S. Fernández-Lugo took part in this study through the FPU scholarship of the Spanish Ministry of Science and Innovation.

## References

- Dagget P. and Poissonet J. (1971) Une méthode d'analyse phytologique des prairies. Citres d'application. *Annales Agronomique* 22, 5-41.
- Grime J.P. (1973) Control of species density in herbaceous vegetation. *Journal of Environmental Management* 1, 151-167.
- Milchunas D.G., Sala O.E. and Lauenroth W.K. (1988) A generalized model of the effects of grazing by large herbivores on grassland community structure. *The American Naturalist* 132, 87-106.
- Milchunas D.G. and Lauenroth W.K. (1993) Quantitative effects of grazing on vegetation and soils over a global range of environments. *Ecological Monographs* 6, 327-366.
- Oba G., Veetas O.R. and Stenseth N.C. (2001) Relationships between biomass and plant species-richness in arid-zone grazing land. *Journal of Applied Ecology* 38, 836-845.
- Olf H. and Ritchie M.E. (1998) Effects of herbivores on grassland plant diversity. *Trends in Ecology and Evolution* 13, 261-265.
- Osem Y., Perevolotsky A. and Kigel J. (2002) Grazing effect on diversity of annual plant communities in a semiarid rangeland: interactions with small-scale spatial and temporal variation in primary productivity. *Journal of Ecology* 90, 936-946.

## Are high genetic merit dairy cows compatible with low input grazing systems?

Delaby L.<sup>1</sup>, Horan B.<sup>2</sup>, O'Donovan M.<sup>2</sup>, Gallard Y.<sup>3</sup> and Peyraud J.L.<sup>1</sup>

<sup>1</sup>INRA, AgroCampus Ouest, UMR 1080, Production du Lait, 35590 Saint Gilles, France

<sup>2</sup>Teagasc, Moorepark Dairy Production Research Centre, Fermoy, Co. Cork, Ireland

<sup>3</sup>INRA, Experimental farm, UE 326, Le Pin-au Haras, Borculo, 61310 Exmes, France

Corresponding author: luc.delaby@rennes.inra.fr

### Abstract

High genetic merit (HGM) dairy cows are often described as poorly adapted to low input grazing systems. To evaluate the ability of HGM cows to support varying levels of feed supply during lactation, a 5-year experiment comparing 4 feeding strategies took place at the INRA experimental farm based in Normandy. Cows received high and low levels of concentrate in early lactation during winter feeding time and 0 and 4 kg of concentrate per day during the grazing period resulting in four strategies : High-high, High-low, Low-high and Low-low levels of concentrate (i.e. 355, 736, 938 and 1300 kg per lactation). The dataset comprised 325 lactations of Holstein and Normande cows with milk genetic index varying between +396 and +3026 kg and +187 and +2149 kg, respectively. Within each breed, milk yield increased with increased supplementation. Within each breed, and irrespective of feeding strategy, the higher milk index animals achieved a higher level of milk, fat and protein production. While reproductive performance was significantly better for the Normande breed, within each breed, milk genetic index and feeding strategy had no effect on reproductive performance. It is concluded that HGM cows can be managed in low input grazing systems.

Keywords: dairy cow, genetic merit, low input system, milk yield, reproduction

### Introduction

During the last thirty years, the genetic potential for milk production of dairy cows in many European countries has increased more than 100 kg per year. Consequently, it is more and more difficult to feed high genetic merit (HGM) dairy cows according to their requirements. At grazing, where grass is rarely offered *ad libitum* and dry matter (DM) intake rate is limiting, this phenomenon is aggravated and the milk yield produced by the HGM dairy cow is always below the milk production potential, as illustrated by Kolver and Muller (1998). These authors observed a difference of 10 kg of milk per day between a total mixed ration and a grazed grass diet while these differences were later confirmed by Bargo *et al.* (2002). High genetic merit dairy cows are often described as poorly adapted to low input grazing-systems. The objective of this paper is to analyse the effect of genetic merit for milk yield on the milk production and reproductive performance of dairy cows managed according to different feeding strategies within a predominantly grazed grass system.

### Materials and methods

The experiment was carried out over 5 years at the INRA experimental farm of Le Pin-au-Haras in Normandy (France). Details on the design and management are reported by Delaby *et al.* (2009). Briefly, each year, 72 compact winter calving dairy cows of Holstein (Ho) and Normande (No) breeds were allocated to one of four feeding strategies (FS); High/high (Hh), High/low (Hl), Low/high (Lh) and Low/low (Ll) and organized as a 2 x 2 factorial design. In

winter for 100 days, early in lactation, the High feeding diet is composed of 65% maize silage, 5% hay and 30% concentrate and the Low feeding diet is composed of 45% first cut grass silage, 40% second cut wrapped big-bale silage and only 15% concentrate. At turnout, in April, and for the duration of the grazing season (210 days), half of each winter feeding group received 0 (low) or 4 (high) kg of concentrate. The high and low concentrate groups grazed separately but at the same stocking rate. Within each breed, the groups were balanced according to expected calving date, lactation number, genetic merit (GM) for milk, fat and protein content, body weight and body condition score. For each trait, the estimated genetic indices were evaluated with a BLUP animal model specially developed for this experiment by Larroque and Boichard (personal communication). The model included the sire and grandsire's genetic evaluation, the dam's performance over three lactations, the classical fixed environmental effects and the feeding treatment applied during each lactation. On average, milk genetic index varied between +396 and +3026 kg and +187 and +2149 kg for the Holstein and Normande breeds, respectively. The breeding season commenced on March 1 and was 3.5 months in duration. In March, the first artificial inseminations (AI) were performed after heat synchronisation resulting in 70% of first AI events with all others AI (first in April or May and consecutive AIs) resulting from natural heats.

Individual milk yield was measured daily while milk fat and protein contents were measured 6 times per week. Body condition score was evaluated monthly by two experienced assessors. All reproduction events (heat, AI, calving) and dates were recorded in a database. AI success and overall pregnancy rate (Prg - %) were calculated according to the subsequent calving event. Within each breed, three groups have been defined according to the genetic index for milk production. The average genetic potential values (numbers of cows) for the Low, Medium and High genetic merit groups were +1437 (53), +1939 (53) and +2444 (61) respectively for the Holstein breed and +980 (48), +1367 (54) and +1733 (56) respectively for the Normande breed. Milk production and body condition score data have been analysed with a general linear model integrating the effects of year (4df), breed (1df), parity (1df), feeding strategy (3df), genetic merit group (2df), various biologically meaningful interactions and data used to randomize as covariates (1df). The pregnancy rate to first or second AI and overall have been analysed using a logistic regression model including the effects of breed, parity, winter FS, GM group, heat synchronization and presence of health incident at calving.

## Results and discussion

The final analysis integrated 325 lactations, composed of 167 Holstein and 158 Normande cows while 295 (158 Ho and 137 No) cows were bred and used for the reproductive analysis. The four feeding strategies have been characterized by large differences in concentrate and total nutrient intake. Irrespective of the GM, the Holstein cows always produced more milk. For the two breeds, milk yield increased with the level of concentrate and genetic merit for milk production. Within the low input system without maize silage, the HGM cows produced the highest yield of milk, fat and protein. The same milk yield was obtained in the Low/low FS with HGM cows and in the High/high FS with LGM cows. Despite a large difference in nutrients supply pattern between HI and Lh FS, similar milk production was achieved. When the feeding level increased, the milk yield increased more than for the high than for the low genetic merit cows. Between the two extreme FS, the difference in response was 975 and 1,609 kg of milk for the LGM and HGM Holstein cows and 1048 and 1434 for the Normande cows. Although the interaction between FS and GM was not significant, this scale effect agrees with previously published results (Kennedy *et al.*, 2003; Horan *et al.*, 2005) and indicates that HGM cows better used the extra energy for milk production. Within the two breeds, the BCS losses were significantly greater for the HGM cows and the lowest FS with no adverse effect on the reproductive performance. Pregnancy rates were solely affected by



breed and were higher with the Normande cows (+10 %) and further confirm the Kennedy *et al.* (2003) and Horan *et al.* (2005) results. Early in lactation, the additional nutrients provided through the high FS are used to produce additional milk with no effect on reproductive performance.

Table 1: Effect of dairy cow breed, genetic merit for milk production and feeding strategy on milk production, body condition score change and reproductive performance.

Breed	Holstein				Normande				RSE	Significance		
	Low low	Low high	High low	High high	Low low	Low high	High Low	High high		Breed	Feed. Strat.	Gen. merit
Concentrate DM (kg)	359	954	724	1330	351	922	748	1267				
Total milk yield (kg)	6749	7670	7506	8214	5521	6215	6014	6739	638	0.001	0.001	0.001
Low GM	6265	6989	7130	7240	4971	5746	5385	6019				
Medium GM	6685	7331	7276	8496	5606	6231	6128	6777				
High GM	7295	8548	8253	8904	5987	6668	6528	7421				
BCS loss at nadir (pts)	-1.45	-1.20	-1.25	-1.05	-1.10	-0.85	-0.75	-0.55	0.48	0.001	0.001	0.001
Low GM	-1.30	-1.00	-1.15	-0.70	-1.00	-0.50	-0.40	-0.45				
Medium GM	-1.60	-1.45	-1.25	-1.15	-1.15	-0.85	-0.95	-0.70				
High GM	-1.40	-1.15	-1.35	-1.20	-1.25	-1.15	-0.90	-0.55				
Winter feeding	Low		High		Low		High					
1 <sup>st</sup> or 2 <sup>nd</sup> AI Prg (%)	62.0		53.2		77.5		66.7			0.009	0.112	0.797
Overall Prg (%)	73.4		74.7		88.7		81.8			0.014	0.652	0.306
Low GM <sup>(1)</sup>	52.0 / 60.0		46.1 / 76.9		83.3 / 94.4		68.4 / 79.0					
Medium GM	69.2 / 80.8		64.0 / 80.0		69.6 / 87.0		60.0 / 84.0					
High GM	64.3 / 78.6		50.0 / 67.9		80.0 / 86.7		72.7 / 81.8					

Prg % = pregnancy rate. (1) 1<sup>st</sup> or 2<sup>nd</sup> AI Prg (%) / Overall Prg (%)

## Conclusion

Within breed, cows with a high genetic merit for milk production and low concentrate input systems largely based on grazing do not seem mutually exclusive. HGM dairy cows remain as an efficient option to maximise the utilisation of high quality forages and respond to additional concentrate.

## References

- Bargo F., Muller L.D., Delahoy J.E. and Cassidy T.W. (2002) Performance of high producing dairy cows with three different feeding systems combining pasture or total mixed rations. *Journal of Dairy Science* 85, 2948-2963.
- Delaby L., Faverdin P., Michel G., Disenhaus C. and Peyraud J.L. (2009) Effect of different feeding strategies on lactation performance of Holstein and Normande dairy cows. *Animal* 3:6, 891-905.
- Horan B., Dillon P., Faverdin P., Delaby L., Buckley F. and Rath M. (2005) The interaction of strain of Holstein-Friesian cows and pasture-based systems on milk yield, body weight and body condition score. *Journal of Dairy Science* 88, 1231-1243.
- Kennedy J., Dillon P., Delaby L., Faverdin P., Stakelum G. and Rath M (2003). Effect of genetic merit and concentrate supplementation on grass intake and milk production with Holstein Friesian dairy cows. *Journal of Dairy Science* 86, 610-621.
- Kolver E.S. and Muller L.D. (1998) Performance and nutrient intake of high producing Holstein cows consuming pasture or a total mixed ration. *Journal of Dairy Science* 81, 1403-1411.

## Daily pattern of feeding activities of dairy cows in an 8-d rotational grazing system

Delagarde R.<sup>1</sup>, Peyraud J.L.<sup>1</sup> and Wade M.H.<sup>2</sup>

<sup>1</sup> INRA, UMR1080 INRA Agrocampus Ouest Production du Lait, F-35590 Saint-Gilles, France

<sup>2</sup> Univ Nacl Ctr Prov Buenos Aires, Fac Ciencias Vet, RA-7000 Tandil, Argentina

Corresponding author: remy.delagarde@rennes.inra.fr

### Abstract

The behavioural adaptation of dairy cows during the grazing down process was examined in an 8-d rotational grazing system. Eight cows were grazed in four 8-d paddocks of perennial ryegrass pasture without any supplements, at an average low pasture dry matter (DM) allowance of 25 kg cow<sup>-1</sup> d<sup>-1</sup> at ground level. On average, sward height measured with a platometer declined from 14.4 to 5.7 cm, extended height of free leaf lamina from 20.3 to 2.0 cm, 4%-corrected milk production from 22.6 to 17.2 kg, and herbage intake from 21.4 to 14.9 kg DM from d1 to d7-d8. Grazing and rumination times were lowest on d1, d2 and d8, and were slightly higher and stable from d3 to d7 (+41 and 25 min, respectively). Average pasture DM intake rate decreased from 37 g min<sup>-1</sup> on d1 to 26 g min<sup>-1</sup> on d7. Cows still maintained a high level of grazing activity until the end of the last day despite clear lower motivation to graze in the morning of d8. It is concluded that, despite the rapid and strong changes in sward canopy structure during the grazing down process, there was no 'rupture' in the behavioural strategy of the cows but rather a regular and continuous adaptation.

Keywords: rotational grazing, behaviour, intake, dairy cow, grazing down process

### Introduction

Simplified rotational grazing systems with long residency time per paddock (> 7 d) are characterized by large between-day variations of milk production (Hoden *et al.*, 1991). This is caused by a decline of pasture intake due to a considerable reduction in pasture availability and leaf to stem ratio from the first to the last day in each paddock. Milk production decline is related more to the height of free leaf lamina than to the total extended tiller height (Wade *et al.*, 1995). It can be hypothesized that cows strongly modify their grazing behaviour strategy when lamina height becomes limiting. The objective of this experiment was to examine the relationship between sward characteristics, pasture intake and feeding behaviour of lactating dairy cows during the grazing down process under an 8-d rotational grazing system.

### Materials and methods

This experiment was undertaken at the INRA experimental farm of Méjusseume (Brittany, France) on four paddocks of perennial ryegrass pastures, grazed by a herd of eight multiparous Prim'Holstein cows in late April-May (paddocks 1 and 2) and in June (paddocks 3 and 4) 2002. Cows were well adapted to grazing as they were turned out in March and supplementary feeding stopped 2 weeks prior the experiment. Before the experiment, the cows were 140 days in milk producing 29 kg of milk per day. During the experiment, cows were not supplemented and water was always available. The size of each paddock was calculated after measurement of pre-grazing pasture mass in order to offer an average low dry matter (DM) pasture allowance of 25 kg cow<sup>-1</sup> d<sup>-1</sup> at ground level over the 8-day residency

time. At least 3 days before starting grazing each experimental paddock, the cows strip-grazed perennial ryegrass pastures with a high daily pasture allowance to maximize pasture intake.

Pre-grazing pasture yield (d0) and chemical composition of offered pasture (d0 to d8) were determined by cutting at ground level. Pasture height was measured daily from 50 random measurements with an electronic platometer ( $30 \times 30 \text{ cm}^2$ ,  $4.5 \text{ kg m}^{-2}$ ). Extended tiller, sheath, and lamina (by difference) heights were measured daily with a ruler on 150 tillers.

Individual milk production was recorded daily. Daily pasture intake was determined at the herd level from d1 to d7 in each paddock from faecal OM output (ytterbium oxide dilution) and pasture OM digestibility (faecal CP and ADF concentrations) as described by Ribeiro Filho *et al.* (2005). All fresh dung pats were sampled from d3 to d9 and mixed before oven-drying and analyses. Grazing and rumination activities were recorded automatically using INRA portable APEC devices. Daily pasture DM intake rate was calculated by dividing daily pasture DM intake (OM intake/0.9) by daily grazing time.

Adjusted means for animal data were calculated on a daily and paddock basis through an ANAVAR including a cow effect. Daily data presented are averaged over the 4 paddocks.

## Results and discussion

Pre-grazing pasture DM mass averaged  $5.0 \text{ t ha}^{-1}$  at ground level and paddock size  $3250 \text{ m}^2$ . The total milk production decline from d1 to d8 was 26% (Table 1), which is higher than the typical 15% variation observed in a similar grazing system by Hoden *et al.* (1991). This is consistent with the low herbage allowance and the low post-grazing pasture height (36% of pre-grazing pasture height). Tiller and lamina height strongly decreased from d0 to d8. Sheath height started to decrease on d4 and defoliation depth of sheath represented half of the total defoliation depth on d8. As a consequence of the decreased leaf to stem ratio, pasture CP concentration (from  $142$  to  $105 \text{ g kg}^{-1}$ ) and OM digestibility (from  $0.719$  to  $0.658$ ) decreased regularly between d0 and d8. Between-day milk production variations can be related to the pasture characteristics one day before. Start of the milk production decline (d4-d5) occurred when sheath stratum began to be defoliated (d4). On this day, free leaf lamina height was around 6 cm, which is close to the results of Wade *et al.* (1995).

Pasture DM intake decreased regularly from  $21.4$  to  $14.9 \text{ kg}$  from d1 to d7, i.e. a 30% relative variation is in good agreement with the milk production decline. Grazing and rumination times were lowest on d1, d2 and d8, averaging 537 and 463 min, respectively (Table 1). Grazing and rumination times were higher from d3 to d7, averaging 578 and 488 min, respectively. The increase in grazing time on d3 may indicate the first difficulty in grazing, as supported by the regular decline of pasture DM intake rate from  $36.9 \text{ g min}^{-1}$  in d2 to  $25.9 \text{ g min}^{-1}$  in d7 (-30%). The regular decline of the number of grazing bouts and increase of the mean grazing bout duration also indicate progressive increasing difficulty in grazing during the grazing down process. Finally, there was a good temporal correlation between increased grazing time, decreasing pasture intake rate and the start of defoliation of sheath stratum (d3-d4), just before the milk production decline (d5). However, there was no 'rupture' in the grazing behavioural strategy of the cows, but rather a progressive and regular behavioural change. In contrast, the decreased grazing time on d8 could be considered as a 'rupture' in the behavioural strategy, when analysing the within-day pattern of grazing activity (Figure 1). On d8, cows clearly missed the first morning meal, showing a lack of motivation to start grazing with only 2 cm of free leaf lamina height, representing only 24% of tiller height. However, after 2-3 hours of inactivity (no replacement by ruminating time), and probably motivated by hunger, cows started grazing progressively. The afternoon and evening meals were as long as in the previous days. The daily pattern of rumination was similar from d1 to d8. Finally, total time spent masticating (grazing + rumination) increased regularly from 46 to  $71 \text{ min kg}^{-1} \text{ DM}$

intake between d1 and d7, which can be related to the increased pasture fibre concentration and probably increased time necessary for comminution and digestion of grass particles.

Table 1. Between-day variations of pasture height, milk production, pasture intake and feeding behaviour of dairy cows in an 8-d rotational grazing system

Variable	Day within paddock								
	1	2	3	4	5	6	7	8	9 <sup>a</sup>
Pasture height (cm)									
- Platometer	14.4	11.9	10.5	8.9	7.9	6.9	6.2	5.7	5.2
- Extended tiller	28.3	22.8	17.7	14.4	12.2	10.8	9.5	8.4	7.6
- Extended lamina	20.3	14.6	9.5	6.3	4.5	3.4	2.7	2.0	1.7
- Extended sheath	8.0	8.2	8.2	8.0	7.7	7.4	6.9	6.3	5.9
Performance data/cow									
4% FCM production (kg d <sup>-1</sup> )	22.6	23.2	23.1	22.7	21.2	19.6	18.4	17.2	
Pasture DM intake (kg d <sup>-1</sup> )	21.4	20.3	19.3	18.0	16.2	15.8	14.9	-	
Grazing time (min d <sup>-1</sup> )	529	534	583	568	575	570	595	547	
Rumination time (min d <sup>-1</sup> )	459	465	493	494	499	491	465	465	
Grazing bouts (bouts d <sup>-1</sup> )	9.1	7.8	7.1	7.1	6.4	6.6	6.5	6.0	
Mean grazing bout duration (min)	62	70	84	86	95	92	93	100	
Pasture DM intake rate (g min <sup>-1</sup> )	36.8	36.9	35.7	33.0	29.6	28.4	25.9	-	
Chewing index <sup>b</sup> (min kg <sup>-1</sup> )	46.7	49.8	56.1	59.9	67.4	68.3	72.4	-	

<sup>a</sup> post-grazing height; <sup>b</sup> chewing (grazing + rumination) time per kg dry matter intake

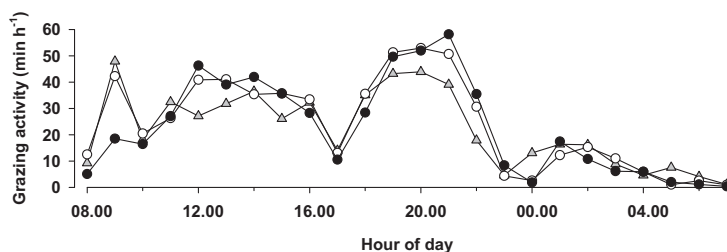

Figure 1. Within-day pattern of grazing activity of dairy cows in an 8-d rotational grazing system (grey triangle = mean of d1 and d2; white circle = mean of d3 to d7; black circle = d8)

## Conclusions

In an 8-d rotational grazing system with good quality pasture, modifications of grazing behaviour by dairy cows are regular and progressive during the grazing down process except on d8, when the low lamina availability clearly caused demotivation to start grazing in the morning. The initiation of milk production decline on d5 can thus be related to the change in sward canopy structure and energy intake, but not to a 'rupture' in the foraging strategy of the cows.

## References

- Hoden A., Peyraud J.L., Muller A., Delaby L. and Faverdin P. (1991) Simplified rotational grazing management of dairy cows: effects of rates of stocking and concentrate. *Journal of Agricultural Science, Cambridge* 116, 417-428.
- Ribeiro Filho H.M.N., Delagarde R. and Peyraud J.L. (2005) Herbage intake and milk yield of dairy cows grazing perennial ryegrass swards or white clover/perennial ryegrass swards at low- and medium-herbage allowances. *Animal Feed Science and Technology* 119, 13-27.
- Wade M.W., Peyraud J.L., Comerón E.A. and Lemaire G. (1995) The dynamics of daily milk production and sward height under paddock grazing conditions. *Annales de Zootechnie* 44 Suppl. 127.

## Tillering dynamics in *Brachiaria decumbens* pastures under continuous stocking

Santos M.E.R.<sup>1</sup>, Fonseca D.M.<sup>1</sup>, Nascimento Júnior D.<sup>1</sup>, Gomide C.A.M.<sup>2</sup>, Gomes V.M.<sup>1</sup> and Sbrissia A.F.<sup>3</sup>

<sup>1</sup>Universidade Federal de Viçosa, Departamento de Zootecnia, Viçosa, MG, Brazil.

<sup>2</sup>EMBRAPA/CNPGL, Juiz de Fora, MG, Brazil.

<sup>3</sup>Universidade do Estado de Santa Catarina - UDESC, Lages, SC- Brazil.

Corresponding author: domicilio@ufv.br

### Abstract

Two different strategies for managing *Brachiaria decumbens* under continuous stocking in the State of Minas Gerais, Brazil were evaluated. In one, the pasture was managed to maintain an average height of 15 cm in the winter and 25 cm in both the spring and the summer. In the other, pasture height was kept at an average of 25 cm during all the experiment. All pastures were managed at varying stocking rates with crossbred cattle weighing about 200 kg. A randomized block design and subdivided plots were used. Tiller emergence rate (TER) and tiller mortality rate (TMR) were lower in the winter and higher in the spring and summer. These results indicate a higher *B. decumbens* tiller turnover in the spring and the summer, resulting in more young tillers in the pasture. Lowering the pasture height to 15 cm in the winter increased the TER by 35% compared to 25 cm. On the other hand, the management strategies did not influence the TMR. Hence, to optimize the turnover of tillers in the pasture, *B. decumbens* should be managed, under continuous stocking, to have 15 cm in height in the winter and 25 cm in the spring and summer.

Keywords: *Brachiaria*, grazing, sward height, tiller

### Introduction

In Brazil, forage grasses of the genus *Brachiaria* are the most commonly used in the formation of pastures. The species *Brachiaria decumbens* is especially represented in the areas cultivated with pasture used to produce ruminants (Macedo, 2004). The key characteristics that justify the use of such forage are: suitable adaptation to the tropical soil and climate, high competitive capacity and large flexibility in its use and management. Most of the pasture systems in Brazil with *B. decumbens* are managed under continuous cattle grazing. Therefore, understanding the development and perpetuation of this forage managed under continuous stocking is important. For this purpose, the study of tillering dynamics throughout the seasons of the year and in pastures under different defoliation regimes is appropriate (Carvalho *et al.*, 2000). Knowledge on the demographic distribution patterns of *B. decumbens* tillers, in each season of the year, may aid the identification of more rational and efficient management actions regarding the pastures.

### Material and methods

From June 2008 to March 2009, two management strategies of a *B. Decumbens* pasture were evaluated at the Departamento de Zootecnia of the Universidade Federal de Viçosa located in the State of Minas Gerais, Brazil. The experimental site was located at 651 m altitude, 20°45' S and 42°51' W. Annual precipitation is approximately 1340 mm and the average relative humidity is 80%. Maximum and minimum temperatures are 22.1 °C and 15.0 °C, respectively. The experimental area was made up of eight plots (experimental units) of 0.3 ha. Pastures

were managed under continuous stocking and with variable cattle stocking rates. In one management strategy, *B. decumbens* pasture was maintained at 25 cm high during all the trial. In the other, the pasture was kept at an average of 15 cm high during the winter (July to September 2008), and at 25 cm from the beginning of winter until the summer (October 2008 to March 2009). The experiment was carried out using a randomized block design with four repetitions and subdivided plots. Both management strategies for the pasture correspond to the plots. The seasons of the year are the subplots. In each experimental unit, three 0.0625 m<sup>2</sup> areas representing the mean initial condition of the pasture were delimited with a 25 cm square shape metal frame painted in white. At the start of the evaluation, all tillers inside the frames were counted and marked with coloured plastic coated wire. Every 30 days, all tillers were recounted and new tillers were marked with a different wire colour. The collected data was used to calculate the tiller emergence rate and the tiller mortality rate, according to Carvalho *et al.* (2000). Data were analysed by variance analysis as repeated measures. Management strategies, season of the year and their interaction were fixed effect and blocks were considered random effects. Data regarding the management strategies of the pasture were compared using the F-test, while the ones regarding the seasons of the year the Tukey's test (10%).

## Results and discussion

The tiller emergence rate (TER) tended to be lower ( $P < 0.10$ ) in the winter than in the spring and summer (Table 1). The lower TER in the winter was due to the climatic conditions which were unfavourable to *B. decumbens* growth in this season which was characterized by lower temperatures, precipitation and sunshine duration. On the other hand, in the spring and summer, when the climatic conditions were favourable to the development of the pasture, the TER was higher ( $P < 0.10$ ). In comparison with the pastures managed to have 25 cm height, the lowering of the pasture to 15 cm in the winter increased the TER by 35% (Table 1). Lower pastures in the winter showed better turnover conditions during the winter itself and also in the following seasons (spring and summer). For lower canopies, the higher light incidence at the base of the plants stimulates tillering (Sackville Hamilton *et al.*, 1995), especially when the environmental conditions are favourable to the plant development, beginning in the spring. The tiller mortality rate (TMR) also tended to be influenced ( $P < 0.10$ ) by season of the year. Differing values from the spring, through summer and winter were observed. However, there was no effect of management strategies of the pasture on the TMR were not observed ( $P > 0.10$ ) (Table 1). The lower TMR in the winter may be an ecological strategy of *B. decumbens* to save nutrients since the absorption of nutrients by the plant, via mass flux and/or diffusion, is interfered with by the water deficit in the winter (Novaes and Smyth, 1999). Notwithstanding, the higher TMR in the spring coincides with the higher TER in this season, which indicates higher tiller turnover in the *B. decumbens* pasture in the spring. In the following season (summer), the TMR decreased, but the TER was still high, showing that the tiller turnover, which started in the spring, persisted in the summer. This pattern demonstrates that old tillers have little relative participation in *B. decumbens* pastures. In addition, the lowering to 15 cm high of *B. decumbens* pasture in the winter did not compromise the balance between the emergence and mortality of tiller, which was positive. Thus, management practices of the pasture should be optimized to allow the expression of the natural pattern of tiller turnover of *B. decumbens* under continuous stocking starting in the spring.

Table 1. Emergence and mortality rates (%) of the basal tiller of *Brachiaria decumbens* pastures managed under continuous stocking and fixed (25 cm) or variable (15-25 cm) height during the seasons of the year.

Pasture height (cm)	Seasons of the year			Mean
	Winter	Spring	Summer	
	Basal tiller emergence rate (%)			
25	3.0	35.9	37.3	25.4 <sup>b</sup>
15-25	6.5	51.0	45.3	34.2 <sup>a</sup>
Mean	4.7 <sup>b</sup>	43.5 <sup>a</sup>	41.3 <sup>a</sup>	
	Basal tiller mortality rate (%)			
25	3.4	21.6	17.3	14.1 <sup>a</sup>
15-25	6.1	20.7	12.8	13.2 <sup>a</sup>
Mean	4.7 <sup>c</sup>	21.2 <sup>a</sup>	15.1 <sup>b</sup>	

For each characteristic, means followed by the same letter in lowercase in the same line or in uppercase in the same column do not differ ( $P>0.10$ ).

## Conclusion

The renewal of *B. decumbens* tillers is low in the winter and intense in the spring and summer. The management of the *B. decumbens* pasture under continuous stocking should be seasonal, keeping the forage grasses at 15 cm high in the winter and 25 cm in the spring and summer in order to optimize the turnover in the spring.

## References

- Carvalho C.A.B., Silva S.C., Sbrissia A.F., Pinto L.F.M., Carnevalli R.A., Fagundes J.L. and Pedreira C.G.S. (2000) Demografia do perfilhamento e taxas de acúmulo de matéria seca em capim tifton 85 sob pastejo. *Scientia Agricola* 57, 591-600.
- Macedo N.C.M. (2004) Análise comparativa de recomendações de adubação em pastagens. In: Pedreira C.G.S., Moura J.C. and Faria V.P (eds.) *Simpósio sobre Manejo da Pastagem*, Escola Superior de Agricultura "Luiz de Queiroz", Piracicaba, SP, pp. 317-356.
- Novaes R.F. and Smyth T.J. (1999) *Fósforo em solo e em condições tropicais*, Universidade Federal de Viçosa, Viçosa, Brasil, 399pp.
- Sackville Hamilton N.R., Matthew C. and Lemaire G. (1995) In defence of the -3/2 boundary rule: a re-evaluation of self thinning concepts and status. *Annals of Botany* 76, 569-577.



## Selective grazing, patch stability and vegetation dynamics in a rotationally-grazed pasture

Dumont B.<sup>1</sup>, Carrère P.<sup>2</sup>, Rossignol N.<sup>1,2</sup>, Chadoeuf J.<sup>3</sup>, Farruggia A.<sup>1</sup>, Ginane C.<sup>1</sup> and Louault F.<sup>2</sup>

<sup>1</sup>INRA, UR1213 Herbivores, Theix, 63122 Saint-Genès-Champanelle, France

<sup>2</sup>INRA, UR874 Ecosystème Prairial, Crouël, 234 Avenue du Brézet, 63100 Clermont-Ferrand, France

<sup>3</sup>INRA, UR546 Biostatistique et Processus Spatiaux, Domaine Saint-Paul, Agroparc, 84914 Avignon Cedex 9, France

Corresponding author: bertrand.dumont@clermont.inra.fr

### Abstract

The lack of data on interactions between grazing intensity and livestock species makes it difficult to propose recommendations for the management of biodiversity and production in grassland ecosystems. A productive grassland area was therefore divided into 12 plots that were rotationally grazed by heifers at a high or a low stocking rate or by ewes at the same low stocking rate. Stocking rate appeared more important than grazer species in affecting the initial direction of community changes. Both heifers and ewes preferentially selected for bites containing legumes and forbs, and avoided reproductive grass. In lightly grazed plots, no significant effect of grazer species on sward botanical composition could be detected after four years of treatment application, though legumes were on average three-fold more abundant in plots grazed by heifers than plots grazed by ewes. Selective grazing on legumes and forbs, and avoidance of reproductive grass, can partly explain the stability of fine-scale grazing patterns in plots that were used by heifers. Cattle grazing would thus favour the creation of relatively stable open patches enabling prostrate forbs and legumes to compete with tall grasses. This could result in divergent vegetation dynamics within plots.

Keywords: Diet selection, Boolean model, stocking rate, cattle, sheep

### Introduction

The ‘Environment Research Observatory’ experiment on Agro-ecosystems, Biodiversity and Biogeochemical Cycles investigates the effects of grazing intensity and herbivore grazer species on plant functional group diversity in pastures evolving from the same initial biodiversity level, and the consequences on productivity and carbon sequestration. The experiment was set up on a grassland that had historically been submitted to intensive management schemes. Starting in 2005, established plots were used under a rotational grazing system and were either grazed by cattle at a high or a low stocking rate or by sheep at the same low stocking rate. Though dynamic equilibrium of soil-vegetation-herbivore interactions has not yet been reached, certain factors affecting the rate and direction of community change can bring about rapid responses in vegetation dynamics. Differences in selectivity between sheep and cattle can have a clear impact on vegetation dynamics (Grant *et al.*, 1996; Warren *et al.*, 2002), whereas under other conditions the difference in impact between the two species was minor compared with that of grazing intensity (Stewart and Pullin, 2008). This lack of data on interactions between livestock species and grazing intensity prompted us to assess vegetation composition response to three management regimes applied to the grassland plots.

## Materials and methods

Botanical composition was determined in May 2004, before the experiment started, by a point quadrat method with 160 points located along non-intersecting line transects across each plot. Grassland community structure was dominated by tall grasses (55-70% cover) such as *Festuca arundinacea*, *Alopecurus pratense*, *Elytrigia repens*, *Dactylis glomerata*. Other species included smaller grasses (*Poa* spp., *Lolium perenne*), forbs (*Taraxacum officinale*, *Achillea millefolium*, *Cerastium fontanum*) and legumes (*Trifolium repens*). From 2005, the plots were grazed with five rotations per year in mid-April, end of May, early July, September and November. Plots were either grazed by heifers at a high stocking rate (H+: 4 heifers grazing on 2200 m<sup>2</sup> plots, i.e. 1.3 LU ha<sup>-1</sup>, with 1 Livestock Unit = 600 kg live weight) or a low stocking rate (H-: 2 heifers per plot, i.e. 0.65 LU ha<sup>-1</sup>) or by ewes at the same low stocking rate (E-: 5 ewes grazing on 1100 m<sup>2</sup> plots). There were four replicates per grazing treatment. Botanical composition was determined again in 2006 and 2008. Direct observations were run on the vegetation items selected by the animals over the five rotations in 2006. Behaviour was measured by scan sampling the activity of all animals within each group at 5-min intervals, with one observation day (from 8 a.m. to 7 p.m.) per rotation. For each animal recorded as grazing, the observer moved as close to the animal as possible without disturbing it in order to record one selected bite. Bite types were defined according to botanical composition (grass, legume or forbs), height (tall or short, i.e. above or below a 7 cm threshold) and vegetation stage (vegetative, reproductive or dead). Data were analysed using a repeated statement to account for measurements made on the same plots over the successive rotations and/or years. Cover heterogeneity was surveyed at two spatial scales after the 3<sup>rd</sup> and 4<sup>th</sup> rotations of 2006 and 2007. Micro-heterogeneity (fine-scale) measurements were carried out in 1.6 x 0.8 m<sup>2</sup> grids with 128 10 x 10 cm<sup>2</sup> cells. In each cell, we recorded the cover fraction of vegetative grasses, reproductive grasses, legumes, forbs, bare soil and faeces, and the height of the dominant vegetation type. Macro-heterogeneity (large-scale) measurements were carried out on 500 m<sup>2</sup> areas comprised of eight 25 m-long parallel transects spaced at 2.5 m intervals. Height of dominant vegetation type was recorded every meter. For each treatment, six micro-heterogeneity grids and six macro-heterogeneity areas were randomly distributed between the four replicates. We modelled the mosaic of grazed and ungrazed patches within the pasture as a Boolean process. We used a Gaussian distribution to model sward height distribution in grazed areas, and a gamma distribution to model that in ungrazed areas. The model generated a map of probabilities of each point being grazed based on its height, and was validated by comparing empirical and simulated sward height distributions and semi-variograms. We used cross-variograms to assess the stability of grazing patterns between two dates, and the effect of local sward composition on patch stability.

## Results and discussion

There were no initial differences in botanical composition between grazing treatments; legumes and forbs covering an average of 5.9 and 30.5% of plot area. Stocking rate appeared more important than grazer species in affecting the initial direction of community changes. In 2008, legume abundance had become significantly higher in H+ plots compared with lightly grazed plots where competition for light was detrimental to *Trifolium repens* (H+: 22.9%, H-: 2.5%, E-: 0.9%,  $P < 0.001$ ). In the last two treatments, we were unable to detect any significant effect of herbivore species, although average legume abundance was three-fold higher in H- plots than E- plots. Forbs declined in all treatments between 2004 and 2008 ( $P < 0.001$ ). Over the first four years of the survey, forbs abundance was significantly higher in H+ compared with H- ( $P = 0.026$ ) and E-plots ( $P = 0.011$ ) without any additional effect of herbivore species ( $P = 0.82$ ). Heifers grazing at a high stocking rate showed a higher

proportional intake of both short grasses (19.9 vs. 7.6% of bites in 2006,  $P < 0.015$ ) and bites containing legumes (26.0 vs. 11.3%,  $P < 0.001$ ) than under H-. Ewes recorded the lowest consumption of short grasses and legumes (2.5 and 1.7%,  $P = 0.073$  and  $P < 0.001$  compared with H-). Animals averaged a 44.3% rate of bites containing forbs, which was greater than the proportion of forbs in the sward; on average 30.0% of plot cover in 2006. Reproductive grass patches only averaged 2.2% of bites made by the animal, while an average of 33% of sward surface remained taller than 20 cm when animals were turned out from plots. This selective grazing on legumes and forbs and avoidance of reproductive grass can partly explain the stability of grazing patterns. At the micro-heterogeneity scale, the model revealed in 2006 a strong stability of grazing patterns between the peak of biomass (3<sup>rd</sup> rotation) and the autumn (4<sup>th</sup> rotation; H+ and H-:  $P < 0.001$ ; E-:  $P < 0.05$ ). In lightly grazed plots, there was a positive link between the initial local abundance of legumes and forbs, and this stability of grazing patterns (H-:  $P < 0.05$ ; E-:  $P < 0.001$ ). At the macro-heterogeneity scale, patches were usually stable over the grazing season ( $P < 0.001$  for all treatments in 2006; H+:  $P < 0.001$ , H-:  $P < 0.05$  in 2007) with one exception for E- plots in 2007 ( $P = 0.68$ ). At this large scale, an inter-annual stability of grazing patterns was also detected at the time the peak of biomass occurred in H- plots ( $P < 0.05$ ), but in the autumn these lightly grazed plots showed 'fluctuating' patch boundaries. No inter-annual stability could be detected in E- plots (3<sup>rd</sup> rotation:  $P = 0.83$ ). In plots grazed by cattle, the initial local abundance of reproductive grasses was positively linked to the fine-scale stability of ungrazed patches between the 3<sup>rd</sup> and 4<sup>th</sup> rotations of 2006 (H+:  $P < 0.05$ ; H-:  $P = 0.089$ ). At the macro-heterogeneity scale, H+ plots showed a certain degree of inter-annual patch stability in the autumn ( $P < 0.001$ ). Repellent items (tussocks of unpalatable grasses, thistles, nettles, etc.) probably played an important role in this stability.

## Conclusion

The model reveals that selective grazing at a fine scale can create relatively stable patches within the pasture. Selection of legumes (*Trifolium repens*) and forbs such as *Taraxacum officinale* helped locally maintain relatively short cover heights, which in turn limited the negative effects exerted by competition for light on these small-sized species. While these species disappeared in productive pastures that were lightly grazed by sheep (Louault *et al.*, 2005), patch grazing by cattle contributed to locally maintain relatively short covers. Cattle grazing would thus favour the creation of relatively stable open patches enabling prostrate forbs and legumes to compete with tall grasses. In the long term, this could result in divergent vegetation dynamics within plots, and may lead to an effect of grazer species on sward botanical composition.

## References

- Grant S.A., Torvell L., Sim E.M., Small J.L. and Armstrong R.H. (1996) Controlled grazing studies on *Nardus* grassland: effects of between-tussock sward height and species of grazer on *Nardus* utilization and floristic composition in two fields of Scotland. *Journal of Applied Ecology* 33, 1053-1064.
- Louault F., Pillar V.D., Aufrère J., Garnier E. and Soussana J.-F. (2005) Plant traits and functional types in response to reduced disturbance in a semi-natural grassland. *Journal of Vegetation Science* 16, 151-160.
- Stewart G.B. and Pullin A.S. (2008) The relative importance of grazing stock type and grazing intensity for conservation of mesotrophic 'old meadow' pasture. *Journal for Nature Conservation* 16, 175-185.
- Warren J., Christal A. and Wilson F. (2002) Effects of sowing and management on vegetation succession during grassland habitat restoration. *Agriculture, Ecosystems and Environment* 93, 393-402.

## Balance between production and biodiversity in two upland dairy grazing systems

Farruggia A.<sup>1</sup>, Pomiès D.<sup>1</sup>, Bethier A.<sup>1</sup>, Troquier O.<sup>2</sup>, Le Bec G.<sup>2</sup>, Paccard P.<sup>3</sup>, Baumont B.<sup>4</sup> and Pradel P.<sup>2</sup>

<sup>1</sup>INRA, UR1213 Herbivores, F-63122 Saint-Genès-Champanelle, France

<sup>2</sup>INRA, UE 1296 des Monts-d'Auvergne, F-63210 Orcival, France

<sup>3</sup>Institut de l'Élevage, F-63170 Aubière, France

<sup>4</sup>EDE du Puy-de-Dôme, F-63170 Aubière, France

Corresponding author: anne.farruggia@clermont.inra.fr

### Abstract

More stringent requirements for PDO (protected designation of origin) cheese products and societal demands are encouraging farmers to promote grazing and favour biodiversity. Trials were conducted for two years in an upland region to compare animal performance, grass productivity and biodiversity in two dairy grazing systems: DIV<sup>-</sup>, managed with rotational grazing on former temporary grassland at a 'high' stocking rate (1.8 LU ha<sup>-1</sup>); and DIV<sup>+</sup>, managed with continuous grazing on diversified permanent grassland at a 'low' stocking rate (1.0 LU ha<sup>-1</sup>). Twelve cows per system were compared, with no concentrate supplementation. At the beginning of the grazing season, DIV<sup>+</sup> showed higher milk production than DIV<sup>-</sup> (+ 2.1 kg d<sup>-1</sup> per cow), due to a greater herbage allowance and better quality of grass selected by cows. Two months later an inversion of the milk production curves was observed, following the fall in grass nutritional value. From July to September, DIV<sup>-</sup> allowed a similar milk production to that of DIV<sup>+</sup> in 2008, and a higher production in 2009 (+ 1.5 kg d<sup>-1</sup> per cow). Animals' weight was not affected by the systems. Insect and flora biodiversity was greater in DIV<sup>+</sup>. This study supports that the two upland dairy systems have both advantages and limitations in the context of PDO cheese production.

Keywords: grazing system, dairy cows, milk production, grass nutritional value, biodiversity

### Introduction

For upland PDO (protected designation of origin) cheeses, an important part of the link between the product and its place of origin lies in the dairy herd's food intake. In the new specifications of most of these PDO cheeses, strong emphasis has been placed on grass and pasture. The objective is to consolidate their specific features, favour sustainable livestock farming and give consumers a more 'natural' image of the production system. These recent requirements need information on how best to balance the feeding systems used on these PDO dairy farms accordingly. As part of the 'Prairies AOC' research and development project, a trial was set up on an experimental farm of the National Agronomic Research Institute (INRA). Our purpose was to compare the zootechnical performance, grass productivity and pasture biodiversity of two grazing systems for dairy cows: (i) rotational grazing with a high stocking rate on previously temporary grassland displaying moderate biodiversity (DIV<sup>-</sup>), and (ii) continuous grazing with a low stocking rate on broadly diversified permanent grassland (DIV<sup>+</sup>).

### Materials and methods

The two grazing systems were set up from May to September in 2008 and 2009 on the INRA farm at Marcenat, located in the upland region of central France (altitude 1080 m, annual

rainfall 1100 mm, mean annual temperature 7.7 °C). Each year the trial was conducted with two groups of 12 Montbeliarde cows, paired before turning out to pasture. The grassland used for DIV- was a previously temporary grassland sown in 1998 (6.8 ha), divided into five plots for rotational grazing. It received annually 80 units per ha mineral nitrogen fertiliser. The permanent grassland DIV+ (12.5 ha) adjoined the DIV- grassland, and exhibited a broad diversity of flora. It had received no fertiliser for more than 30 years. Before the start of the trial two plots of DIV- were spring-grazed by a non-trial herd to initiate the rotational grazing. Three plots were used for grazing during the first rotations, thus offering 0.30 ha per cow. The other plots were mown early so as to be available for wider grazing during the summer (0.53 ha per cow on average). The changes of plot in DIV- were directed by the cows' level of milk production (Hodden *et al.*, 1991). Individual dairy production was recorded at each milking. Fat and protein content, and somatic cell count (SCC) of the milk were measured weekly. Cows' live weights and body condition scores (BCS) were recorded every month. In 2008, crude protein concentration (CP) of faeces was measured in each group in three periods to give an indicator of grass digestibility. The accumulation of biomass was measured each year every fifteen days during the first vegetation cycle on closed areas set up on the two pastures. In 2009, on DIV-, grass height was measured using a rising plate meter on the cows' entry to and exit from each plot to estimate the quantities of grass offered. Dry matter cellulase digestibility (DMcd) and CP of the grass offered was measured from squares in each pasture. In 2009 botanical surveys were carried out in mid-July on squares of area 1 m<sup>2</sup>. Insect capture in nets was carried out three times on fixed lines. They were then sorted by order. The Shannon index was used to quantify the diversity of vegetation and insects. The statistical analyses were performed using SAS software for repeated measurements (Proc Mixed) except for botanical data.

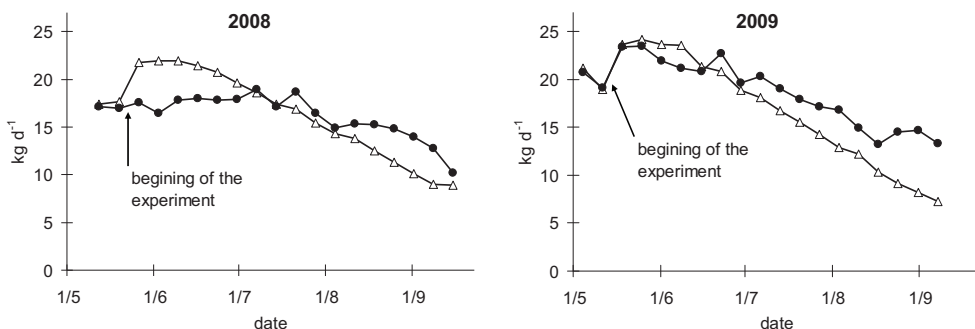

Figure 1. Milk production by week ( $\text{kg d}^{-1}$ ) of cows from DIV+ ( $\Delta$ ) and DIV- ( $\bullet$ ) systems during 2008 and 2009 pasture seasons.

## Results and discussion

The milk production per cow in the DIV- group was equivalent to that of the DIV+ group in 2008 ( $-0.2 \text{ kg d}^{-1}$ , NS) and greater in 2009 ( $+ 1.5 \text{ kg d}^{-1}$ ,  $P < 0.10$ ). On going out to pasture, the production of the DIV+ cows increased strongly ( $+ 4.5 \text{ kg d}^{-1}$  on average in both years, Figure 1) whereas a rise occurred only in 2009 for DIV- ( $+ 4.3 \text{ kg d}^{-1}$ ). During the first part of the trial, the DIV+ cows produced more than the DIV- cows ( $+ 3.1 \text{ kg d}^{-1}$  in 49 d in 2008,  $+ 1.0 \text{ kg d}^{-1}$  in 28 d in 2009), but in early July the performance per group was reversed, with a better persistence in DIV-. The DIV+ group had a higher milk fat content ( $P < 0.05$  in 2009), lower protein content ( $P < 0.05$  in 2008) and the same SCC. Lastly, the time course of weight and BCS was not statistically different between the two groups. Forage production per hectare for DIV- was on average 69 % higher than for DIV+, allowing hay to be stored (2.0 and 7.6 t

DM in 2008 and 2009 respectively). However, grass ran short in mid-August in DIV-, requiring 9 days of pasture in a plot outside the trial (2008) and provision of hay for 6 days (2009). In 2009, the average quantities of grass offered in DIV- were estimated at 31.2 kg DM d<sup>-1</sup> per cow. In both years, throughout the season the DIV- grassland showed significantly higher values of DMcd and CP than DIV+ ( $P < 0.001$ ). Analysis of CP in faeces (2008) showed a reversal similar to that observed for milk production. At the beginning of the season the DIV+ cows had significantly higher levels (+ 24 g kg<sup>-1</sup> DM), whereas by mid-July there was a significant difference of + 30g kg<sup>-1</sup> DM in favour of DIV-. The DIV- system thus ensured a good level of milk production (2.2 times higher per hectare than DIV+) and of protein content. However, the quantity of grass offered by DIV- most probably restricted ingestion, even though good grass quality was maintained. This may explain the better initial performance of the DIV+ cows, which had abundant high quality grass, given the surface area offered. The different results recorded between the nutritional value of the grass offered and the CP of faeces from DIV+ cows may arise from the ability of the cows to select the best grass in the sward. The reversal of dairy performance between the two systems in July may be linked to a marked fall in the quality of the grass in DIV+ due to the maturity of the cover (-36 % in CP and -21 % in DMcd on average between animals turn out to pasture and biomass peak). The better results for DIV- at the beginning of grazing in 2009 compared with 2008 may be due to the forward management of rotational grazing, with spring grazing and early exit of cows, enabling them to graze a better quality grass in the first rotations. In addition, the DIV+ grassland presented double the number of plant species per quadrat than DIV- (23.9 vs. 12.2,  $P < 0.001$ ) and the Shannon index was higher ( $P < 0.001$ ). The number of insects captured per line was not different between the grasslands, but the Shannon index was higher in DIV+ ( $P < 0.01$ ). Grassland DIV+ thus displayed a greater biodiversity.

## Conclusion

This study provides evidence to support discussion in the cheese industry of the balance to be set between production and biodiversity in upland dairy systems. Continuous grazing with a low stocking rate on diversified grassland gives good milk performance on putting out to pasture and is compatible with a high level of biodiversity. Rotational grazing on fertile grassland allows stable high milk production per hectare and hay stocks. However, its more complex management requires forward planning and can cause grass shortages in summer. This type of grazing also needs more inputs, is less conducive to biodiversity, and causes discontinuities in production when the cows change plots that can be detrimental to farm cheesemaking.

## Acknowledgements

This work was funded by the French Ministry of Agriculture and Fisheries through a project managed by the Pôle Fromager AOC Massif Central.

## References

Hodden A., Peyraud J.L., Muller A., Delaby L. and Faverdin P. (1991) Simplified rotational grazing management of dairy cows: effects of rates of stocking and concentrate. *Journal of Agricultural Science, Cambridge* 116, 417-428.



## Long term performance of an artificial pasture vegetation under Mediterranean conditions in Turkey

Geren H., Avcioglu R., Soya H., Kir B., Demiroglu G. and Kavut Y.T.

Ege University, Faculty of Agriculture, Dept. of Field Crops, 35100, Izmir, Turkey

Corresponding author: hakan.geren@ege.edu.tr

### Abstract

A study on artificial pasture was conducted during 2002-09 in the experimental field of a private farm at Aydin, Turkey, which was under typical Mediterranean climatic conditions. Some promising legumes in this environment (*Medicago sativa*, *Lotus corniculatus*, *Trifolium resupinatum*) and some grasses (*Bromus inermis*, *Dactylis glomerata*, *Festuca arundinacea*, *Arrhenatherum elatius*) as well as *Sanguisorba minor* were sown as a mixture. Stand yield characteristics and crop performances of sward were tested for 7 yrs under cattle grazing. The results indicated the adverse effects of Mediterranean climate and to some extent of grazing on the yield and cover characteristics of some mixture crop material, particularly *T. resupinatum*, *B. inermis* and *D. glomerata*. In contrast, *F. arundinacea*, *M. sativa*, *A. elatius* and *L. corniculatus* displayed higher contributions to total yield.

Key words: artificial pasture, Mediterranean climate, botanical composition, cover, yield

### Introduction

The most crucial challenge for the Turkish animal husbandry sector is to provide cheap and high quality roughage to farms. As the costs of roughage are generally 70% of expenditure in animal production, there is an urgent need to improve grasslands. Remembering the Mediterranean conditions of Western Turkey which allows favourable crop growth, it must be emphasized that any attempt to benefit from alternatives of new forage crop introductions is of vital significance (Genckan *et al.*, 1977). Artificial pasture (rotation pasture) establishments under field conditions in the area may be one of those attempts to promote roughage production (Avcioglu *et al.*, 2007). It should be also emphasized that the number of alternative warm or cool season grasses that are productive and persistent under the Mediterranean climate are quite limited compared to humid continental climates (Avcioglu, 1981). The objective of this study was to investigate a promising artificial pasture mixture and to test new crop cultivars under a grazing regime for long-term use in the region.

### Materials and methods

The experiment was carried out for seven years on a silty-sand loam soil (pH 7.1) in western Turkey (lat. 37°45'N, long. 27°24'E; 35 m a.s.l.). Soil properties (soluble salt 0.009%, organic matter 1.13%, total N 0.12%, available P 360 ppm, K 400 ppm, Ca 5400 ppm) indicated that there were no limiting factors in terms of soil properties to grow crops for herbage under grazing practices. Average annual temperature and precipitation data through experimental years (17.3, 17.9, 17.7, 17.9, 18.9, 18.9, 18.7 °C and 579, 392, 699, 745, 487, 427, 1072 mm, in 2003 to 2009 respectively) were generally in accordance with long term average values (17.1 °C and 633 mm), except in 2009. After conventional seed bed preparation, a mixture of *Medicago sativa* (10%, 3 kg ha<sup>-1</sup>), *Lotus corniculatus* (15%, 2.5 kg ha<sup>-1</sup>), *Trifolium resupinatum* (5%, 2 kg ha<sup>-1</sup>) and grasses: *Bromus inermis* (15%, 5 kg ha<sup>-1</sup>) *Festuca arundinacea* (25%, 5 kg ha<sup>-1</sup>) *Dactylis glomerata* (10%, 5 kg ha<sup>-1</sup>) *Arrhenatherum elatius* (15%, 6.5 kg ha<sup>-1</sup>) and *Sanguisorba minor* (5%, 1 kg ha<sup>-1</sup>) were sown on a 7 ha



lowland field in 15 cm row spacing on 21 November 2002. A total of 200 kg ha<sup>-1</sup> NPK fertilizer was applied prior to sowing in early spring of each year. The experimental design was randomised plots (100 × 100m) with 4 replicates. Irrigation was applied regularly based on soil tensiometer measurements. Pasture plots were grazed by dairy cattle for a week during each harvest period. Data were collected from beneath 2 portable cages sized 2 × 1 m<sup>2</sup> in each plot. Botanical composition data were collected 3 times a year (April, July, October) prior to grazing. Cover rates were assessed using quadrat (1 m<sup>2</sup>) technique (Brown, 1963). Data indicating overall performances of material were statistically analysed and summarized in Table 1 and Table 2. In variation analysis, the least significant difference (LSD) test was performed.

## Results and discussion

Botanical composition data were highly variable in terms of legume, grass and weed components (Table 1). Long term (7 yr) performance of experimental crops indicated increased rates of *Ms* and *Fa* in the swards, but decreasing rates of *Tr* and *Dg*, which is a grass well-known for its competitive ability (Lacefield *et al.*, 2003). Another striking point was the steady increase of weed infestation throughout the experimental years. Warda and Krywiec (2002) and Kadziulis and Kadziuliene (2002) revealed that indigenous species are strong competitive crops and an acceptable rate of existence is unavoidable. *Ae* and *Sm* maintained reasonable percentages in botanical composition.

Table 1: Botanical compositions (%) in different years

Crops	2003	2004	2005	2006	2007	2008	2009	Mean
<i>M. sativa</i> (Ms)	12.2	13.8	15.7	17.2	23.7	18.4	18.6	17.1
<i>L. corniculatus</i> (Lc)	8.6	11.0	9.6	13.3	8.7	9.2	11.8	10.3
<i>T. resupinatum</i> (Tr)	14.2	10.8	4.3	1.1	0.0	0.0	0.0	4.3
<i>B. inermis</i> (Bi)	8.1	7.6	9.2	8.8	6.9	10.1	5.6	8.0
<i>D. glomerata</i> (Dg)	18.3	13.9	11.4	7.6	5.1	3.8	1.1	8.7
<i>A. elatius</i> (Ae)	12.3	11.5	9.7	11.1	9.4	11.2	11.1	10.9
<i>F. arundinaceae</i> (Fa)	16.7	21.1	23.8	24.4	26.6	28.7	30.7	24.6
<i>S. minor</i> (Sm)	7.1	6.6	8.4	5.3	6.4	6.2	6.7	6.7
Natives-weed (W)	2.5	3.7	7.9	11.2	13.2	12.4	14.4	9.3
LSD (0.05)	Year : ns, Crops : 0.7, Year x Crops : 1.9							

There were significant differences among total dry matter (DM) yield of experimental years (Table 2). Sward total DM yields increased until 2006 and decreased in the following years (2007-2009). DM yield data also confirmed that *Ms* and *Fa* performed far better than other crops in the sward. These results may be attributed to the well-known adaptive capacity of none-hardy *Ms* cultivar and heat resistant *Fa* crops to Mediterranean conditions (Hall *et al.*, 2009). Further, *Lc* and *Ae*, with satisfactory and sustainable DM yields in the course of experimental years, also performed better than *Tr* and *Dg*. The latter species are known as being susceptible to high atmospheric heat, light intensity and low air moisture, which are the essential characteristics of Mediterranean environments (Hall *et al.*, 2009). Our results confirmed related information given by Lacefield *et al.* (2003) and Deak *et al.* (2007). Existing as an indigenous species in the region, *Sm* cultivar maintained a reasonable performance in sward whereas weeds invaded the gaps left by disappearing individuals of *Tr*, *Bi* and *Dg* (Søegaard, 2002). The results of the long-term cover tests in the experiment supported the approach pointing out the promising performances of the sward through the contributions provided particularly by *Fa*, *Ms*, *Ae* and *Lc* in the mixture. General cover rates decreased in succeeding years, mainly because of weed infestation (Table 2). In addition to

Mediterranean ecological impacts, it is obvious that grazing has to some extent adverse effect on pasture crops, and thinning in the swards is expected. Although there were increasing weed infestation and decreasing cover rates, better yield performances were generally recorded during the experimental years. The general performance of the mixture was quite sustainable and suggested that the sward could be utilized economically for another couple of years.

Table 2: Dry matter yield and cover traits of mixtures crops in succeeding years

	DM yield (kg ha <sup>-1</sup> )								Total cover (%)							
	2003	2004	2005	2006	2007	2008	2009	Mean	2003	2004	2005	2006	2007	2008	2009	Mean
Ms	875	1190	2210	2470	3005	2490	2145	2055	17	19	14	17	20	17	15	17
Lc	645	950	1325	1665	1165	1200	1430	1197	6	11	7	13	8	9	11	9
Tr	1005	640	350	45	0	0	0	291	14	8	3	2	0	0	0	4
Bi	415	395	970	860	635	955	385	659	6	5	10	7	5	6	4	6
Dg	960	1080	1255	810	510	370	85	724	15	10	8	6	3	3	1	6
Ae	680	995	1040	1410	940	1305	965	1048	11	8	10	10	7	9	10	9
Fa	1198	1534	3888	4119	3698	4272	3746	3208	17	19	21	23	22	24	25	22
Sm	351	615	915	505	875	568	82	559	6	5	9	4	6	4	4	5
W	219	390	835	1380	1305	1230	1610	996	4	2	7	12	11	9	12	8
Σ	6348	7789	12788	13264	12133	12390	10448		96	88	90	93	84	79	83	
LSD (.05)→	Year: 36 Crops: 41 Year x Crops: 108								Year: 0.6 Crops: 0.7 Year x Crops: 1.9							

## Conclusion

We concluded that *M. sativa* and *F. arundinacea* were the permanent and most successful legume and grass crops in the mixture, with respect to botanical composition throughout the experimental years. With respect to DM yield and cover characteristics, these same components of the mixture also performed well and have been evaluated as recommendable for all similar Mediterranean environments. It was also suggested that as both *L. corniculatus* and *A. elatius* exhibited stable and sustainable DM yield and cover contribution to overall performances of the sward, these species should be included in this type of Mediterranean pasture mixture. The general performances of *T. resupinatum*, *B. inermis* and *D. glomerata* in the mixture proved that more attention should be paid to consider these forage crops in mixtures and indicated the necessity for further investigations.

## References

- Avcioğlu R. (1981) Investigations on the effect of sowing technique, rate of mixture and grazing or cutting on some characteristics of *Lotus corniculatus*, *Bromus inermis* and *Dactylis glomerata* mixtures. Ege University Fac. of Agriculture, Dept. of Field Crops, (Asc. Prof. Thesis)
- Avcioğlu R., Geren H., Demiroğlu G., Kir B. and Soya H. (2007) *Structural change of an artificial pasture vegetation under Mediterranean conditions in Izmir/Turkey*. In: 14<sup>th</sup> EGF Symposium, Book of Abstracts, p36.
- Brown D. (1963) *Methods of surveying and measuring vegetation*, Commonwealth Agric. Bureau, England.
- Deak A., Hall M.H., Sanderson M.A. and Archibald D.D. (2007) Production and nutritive value of grazed simple and complex mixtures. *Agronomy Journal* 98, 814–821.
- Gençkan M.S., Avcioğlu R., Soya H. and Atanasıu N. (1977) Forschungsbeiträge zur rationellen Erzeugung von Futter im Ege-Gebiet, Ergebnisse der Agrarforschung in der Universitätspartnerschaft Gießen-Izmir, *Justus Liebig Univ. Gießen Symposium* 10, pp.205-217.
- Hall M.H., Dillon J.M., Undersander D.J., Wood T.M., Holman P.W., Min D.H., Leep R.H., Lacefield G.D., Kadziulis L. and Kadziulienė Z. (2002) Efficiency of different legume/grass swards under pasture management and in field crop rotation. *Grassland Science in Europe* 7, 320-321.
- Kunelius H.T., Peterson P R. and Ehlke N.J. (2009) Ecogeographic factors affecting inflorescence emergence of cool-season forage grasses. *Crop Science* 49, 1109-1115.
- Lacefield G.D., Henning J.C. and Phillips T.D. (2003) *Orchardgrass*, Coop. Ext. Serv, Univ. of Kentucky
- Søgaard K. (2002) The effect of grazing management on botanical composition and herbage quality on field level. *Grassland Science in Europe* 7, 162-163.
- Warda M. and Krywić D. (2002) The effect of sward botanical composition on the pasture utilization. *Grassland Science in Europe* 7, 176-177.

# The effect of nitrogen on yield and composition of grass clover swards at three sites in Ireland: a comparison of six commonly grown species

Gilliland T.J.<sup>1</sup>, Farrell A.D.<sup>2</sup>, McGilloway D.<sup>3</sup> and Grogan D.<sup>3</sup>

<sup>1</sup>Agri-Food Biosciences Institute, Crossnacreevy, Belfast, UK

<sup>2</sup>Department of Life Sciences, University of the West Indies, Trinidad and Tobago

<sup>3</sup>Department of Agriculture, Fisheries and Food, Backweston, Kildare, Ireland

Corresponding author: trevor.gilliland@afbini.gov.uk

## Abstract

With the trend to reduce nitrogen (N) use in grassland systems it is apt to reappraise the performance of different forage grasses. Here, we compare the performance of the most widely grown species, perennial ryegrass, to that of four alternative species at three different N levels. Over three years, cocksfoot, meadow fescue, tall fescue, Timothy, diploid and tetraploid perennial ryegrass, were grown along with a companion white clover at three sites across Ireland. Plants were grown at three N levels: high (420 kg ha<sup>-1</sup> N), medium (210 kg ha<sup>-1</sup> N) and low (105 kg ha<sup>-1</sup> N), in a randomised block design. Differences between sites were significant, with the two more northerly sites showing a large increase in clover in low N plots, such that clover typically accounted for more than 50% of the yield by year three. Timothy and tall fescue showed potential to out yield perennial ryegrass, particularly at low and medium N. Although the results are strictly limited to the cultivars tested, the consistently high yields from Timothy and tall fescue at low and medium N suggest they are worthy of further investigation. However, care must be taken in marginal sites where the combination of limited N and poor growing conditions can result in the over abundance of clover.

Keywords: Grassland, nitrogen, yield, grass species, clover, nitrogen use efficiency.

## Introduction

Reducing N use in grassland systems has implications for the choice of grass species used by growers and breeders. Currently, Irish grasslands are populated with varieties bred to produce high yields under optimum N. Such swards are largely dominated by perennial ryegrass grown in association with clover. As N levels are reduced it is uncertain whether this will remain the most productive system. Variation in N use efficiency has been found both within and between forage grass species, highlighting the potential for improved yield in reduced N systems (Sollenberger *et al.*, 1984; Berlinger and Gastal, 2000; Wilkins *et al.*, 2000). The aim of this study is to compare the yield and persistence of six commonly grown perennial grasses at three N levels.

## Material and methods

From 2006 to 2009, six forage grasses, cocksfoot (*Dactylis glomerata* L., Donata), meadow fescue (*Festuca pratensis* Huds., Pradel), tall fescue (*Festuca arundinacea* Schreb., Barolex), Timothy (*Phleum pratense* L., Dolina), diploid (2x) perennial ryegrass (*Lolium perenne* L., Portstewart) and tetraploid (4x) perennial ryegrass (*Lolium perenne* L., Navan), were grown along with a companion white clover (*Trifolium repens* L., Chieftain; sown at 0.5 g m<sup>2</sup>) at three locations in Ireland. The sites broadly followed a latitudinal gradient (Table 1). Plants were grown at three N levels: high, medium and low (420, 210 and 105 kg ha<sup>-1</sup> N). Trial plots measured 1.5 m x 7 m and were replicated three times within each treatment in a randomised block design. Each treatment was managed to maximise dry matter yield, with a target of 10

cuts per season. Plot fresh weight was determined by harvesting the entire plot to a stubble height of 5 cm using a plot harvester (Haldrup, Logstor, Denmark). A random subsample of c. 250 g was taken from each plot for dry weight determination after oven drying at 80 °C for 16 h. Botanical composition was also determined for two cuts each year by taking a subsample from each plot during the June-August cuts. N content of the harvested grass was measured in botanically separated samples from selected harvests (data not shown). Plot yields and clover content were compared using multifactor analysis of variance (general treatment structure in randomise blocks: year, site, species and treatment) (Genstat 8; VSN International Ltd., Hemel Hempstead, UK).

Table 1. Description of the three experimental sites.

Code	Location	Elevation	Description
North	Crossnacreevy, Co Down 54° 32' N, 05° 52' W	390'	Exposed poorly drained site on medium loam soil, pH 6.0
Central	Backweston, Co Kildare 52° 26' N, 06° 30' W	50'	Open average draining site on clay loam soil, pH 6.4
South	Moorepark, Co Cork 52° 09' N, 08° 13' W	100'	Sheltered well drained site on medium loam soil, pH 6.8

## Results and discussion

Multifactor analysis of variance for plot yield and clover content showed all factors and all two-level interactions to be highly significant, with the exception of site x species for clover content.

For yield, the majority of the site and year variation was due to a year on year increase at the North site and a year on year decrease at the Central site (data not shown). At 420 kg ha<sup>-1</sup> N the high N treatment is close to the level required to maximize yield in perennial ryegrass (Whitehead, 1995). Table 2 shows the total yield for all species for the three sites averaged over the three years. There was a clear positive association between N and yield for all grass species tested, although variation between sites was apparent. At high N tetraploid perennial ryegrass, Timothy and tall fescue were the highest yielding plots, with all three yielding significantly more than diploid perennial ryegrass. At low and medium N the tetraploid perennial ryegrass showed a marked reduction in productivity with yields falling below that of diploid perennial ryegrass. Timothy and tall fescue plots maintained relatively high yields at low and medium N, yielding significantly more than diploid or tetraploid perennial ryegrass. Clover content increased year on year at the Central and North sites, but declined at the South site where clover content was negligible by the second year (data not shown). In general there is a negative association between N application and clover content in grass swards (Frame *et al.*, 1998). This was apparent in the Central and North sites, with clover content in the low N plots averaging 34 and 53% respectively, compared to 4 and 7% at high N (Table 2). The high content of clover at low N in the Central and North sites shows the extent to which grass growth was restricted under these conditions. However, in the South site where clover content was negligible plot yields were similar or higher than at the other sites even at low N. This suggests that the clover out-competed the grasses in the Central and North sites causing the sward to deteriorate over time. Diploid perennial ryegrass appeared the least able to compete against clover at the lower N levels, suggesting that its compatibility with clover can be a disadvantage under certain conditions.

Table 2. Average yield (dry matter, t ha<sup>-1</sup> y<sup>-1</sup>) and clover content (%) over three years, of six grass clover swards at three nitrogen levels grown at three locations (see Table 1). Different letters indicate significant differences, Tukey's post-hoc test for species x treatment ( $P < 0.05$ ).

	Low N				Medium N				High N			
	South		Central North		South		Central North		South		Central North	
	site mean				site mean				site mean			
	dry matter t ha <sup>-1</sup> y <sup>-1</sup>				dry matter t ha <sup>-1</sup> y <sup>-1</sup>				dry matter t ha <sup>-1</sup> y <sup>-1</sup>			
Ryegrass (4x)	8.6	7.5	8.2	8.1 <sup>a</sup>	10.0	10.3	9.4	9.9 <sup>c</sup>	12.6	12.1	14.1	12.9 <sup>ij</sup>
Ryegrass (2x)	9.1	7.4	8.5	8.3 <sup>a</sup>	10.6	10.2	9.9	10.2 <sup>cd</sup>	12.1	10.5	12.9	11.8 <sup>gh</sup>
Cocksfoot	10.3	6.8	8.2	8.4 <sup>a</sup>	12.5	10.4	9.0	10.6 <sup>de</sup>	15.0	10.6	11.2	12.3 <sup>hi</sup>
M. Fescue	8.9	7.6	9.1	8.5 <sup>ab</sup>	10.2	10.5	9.6	10.1 <sup>cd</sup>	12.1	10.5	12.8	11.8 <sup>gh</sup>
T. Fescue	10.1	8.3	9.0	9.1 <sup>b</sup>	11.8	11.7	9.6	11.0 <sup>ef</sup>	14.3	11.9	13.4	13.2 <sup>j</sup>
Timothy	10.7	7.8	9.2	9.2 <sup>b</sup>	12.6	10.9	10.9	11.5 <sup>fg</sup>	14.2	10.3	13.8	12.7 <sup>ij</sup>
	Clover content (%)				Clover content (%)				Clover content (%)			
Ryegrass (4x)	6	31	49	29 <sup>wx</sup>	2	20	26	16 <sup>v</sup>	0	3	5	3 <sup>t</sup>
Ryegrass (2x)	22	40	62	41 <sup>z</sup>	2	35	37	25 <sup>w</sup>	0	5	7	4 <sup>tu</sup>
Cocksfoot	1	27	46	25 <sup>w</sup>	0	16	32	16 <sup>v</sup>	0	1	6	2 <sup>t</sup>
M. Fescue	15	37	54	35 <sup>y</sup>	7	23	31	20 <sup>v</sup>	2	7	6	5 <sup>tu</sup>
T. Fescue	3	35	57	32 <sup>xy</sup>	2	21	26	17 <sup>v</sup>	0	2	8	3 <sup>t</sup>
Timothy	8	35	49	31 <sup>x</sup>	4	21	34	20 <sup>v</sup>	3	7	13	8 <sup>u</sup>

## Conclusion

As expected, N reduced plot yields and increased clover content for all of the species tested (Whitehead, 1995; Frame *et al.*, 1998). Although the results are strictly limited to the cultivars tested, they suggest underlying differences between species. In the South site, where clover content was negligible, Timothy and tall fescue offered a yield benefit compared to perennial ryegrass particularly under reduced N. For the more exposed Central and North sites the low N plots showed an over-dominance of clover. Timothy and tall fescue plots remained high yielding, but selecting for high persistence of grasses may be the priority in low N systems.

## References

- Belanger G. and Gastal F. (2000) Nitrogen utilization by forage grass. *Canadian Journal of Plant Science* 80, 11-20.
- Frame J., Charlton J.F.L. and Laidlaw A.S. (1998) *Temperate Forage Legumes*. CAB Int., Wallingford, UK.
- Sollenerger L.E., Templeton W.C. and Hill R.R. (1984) Orchardgrass and perennial ryegrass with applied nitrogen and in mixtures with legumes 1. Total dry matter and nitrogen yields. *Grass and Forage Science* 39, 255-262
- Whitehead D.C. (1995) *Grassland Nitrogen*. CAB International, Wallingford, UK.
- Wilkins P.W., Allen D.K. and Mytton L.R. (2000) Differences in the nitrogen use efficiency of perennial ryegrass varieties under simulated rotational grazing and their effects on nitrogen recovery and herbage nitrogen content. *Grass and Forage Science* 55, 69-76.

## Evaluation of leaf tensile strength of selected grass genotypes

Goliński P., Golińska B. and Zajac M.

Poznan University of Life Sciences (PULS), Department of Grassland and Natural Landscape Sciences, Wojska Polskiego 38/42, 60-627 Poznań, Poland

Corresponding author: pgolinsk@au.poznan.pl

### Abstract

The objective of this work was to evaluate leaf tensile strength of selected pasture grass species and cultivars. The investigations were carried out in 2008-2009 on plant material obtained from two cultivar testing experiments, in which *Dactylis glomerata* (10 cultivars), *Festuca arundinacea* (10 cvs), *Festuca pratensis* (15 cvs), *Lolium perenne* (16 2x and 15 4x cvs) and *Phleum pratense* (10 cvs) were analysed. Leaf tensile strength was estimated on fully developed leaf blades using a prototype testing stand for measuring tensile strength of biological material designed on the basis of a sub-assemblies of the Höttinger Baldwin Messtechnik (HBM) Company. The dry matter weight and size of leaves were also determined. Leaf tensile strength of investigated species ranged from 3.64 N (*Lolium perenne* 2x) to 22.16 N (*Dactylis glomerata*). The differentiation of cultivars within species was also high and statistically significant. The obtained results help to better understand the impact of plant functional traits on forage intake.

Keywords: cultivar, grass, leaf tensile strength, pasture

### Introduction

Many factors affect dry matter (DM) intake by grazing animals. One of them is strength, in which animals, particularly cattle, tear off sward bites. The leaf tensile strength influences bite mass, biting rate, sward preference and energy used by pasturing animals (MacAdam and Mayland, 2003). Grass leaves are dominant in pasture swards and, therefore, investigations associated with leaf tensile strength are crucial for the determination of the total energy expenditure to ingest fodder. Grass genotype variability in this regard makes possible the appropriate selection of breeding materials with the aim of improving pasture cultivars (Rogalski and Kozłowski, 1981). The objective of this work was to evaluate leaf tensile strength of selected pasture grass species and cultivars.

### Materials and methods

The leaf tensile strength of selected grass species and cultivars was evaluated during the 2008 and 2009 growing seasons at the Brody Experimental Station of PULS (52° 26' N, 16° 18' E). Plant material originated from two cultivar testing experiments established in 2007 and 2008 on an Albic Luvisols soil (pH<sub>KCl</sub> – 5.8, N<sub>t</sub> – 0.72%, P – 0.083 mg g<sup>-1</sup>, K – 0.125 mg g<sup>-1</sup>, Mg – 0.063 mg g<sup>-1</sup>) in randomized complete block designs (r = 3) on 10 m<sup>2</sup> (1m × 10 m) plots, in which *Dactylis glomerata* – Dg (10 cultivars), *Festuca arundinacea* – Fa (10 cvs), *Festuca pratensis* – Fp (15 cvs), *Lolium perenne* – Lp (16 2x and 15 4x cvs) and *Phleum pratense* – Php (10 cvs) were examined. Every year the following rates of fertiliser were applied: N – 120 kg ha<sup>-1</sup>, P – 26.2 kg ha<sup>-1</sup>, K - 83 kg ha<sup>-1</sup> and 3-4 regrowth periods were harvested. The annual mean temperature and total precipitation for 2008 and 2009 was 10.3 and 9.3 °C, and 795, 628 mm, respectively. From each regrowth and each plot, 30 fully developed grass leaves were randomly collected from plants in the vegetative growth stage (about 20 cm height). Leaf tensile strength was estimated on leaf blades on the day of sampling using prototype testing stand for measuring tensile strength of biological material designed on the



basis of subassemblies (tensiometric sensors of appropriate nominal ranges, special measuring amplifiers with analogue/digital converters) of the Höttinger Baldwin Messtechnik (HBM) Company (Goliński, 2009). The dry matter weight and size of leaves were also determined. The data were analysed by ANOVA. Tests of the main effects were performed by F-tests. Means were separated by the LSD and were declared at  $P < 0.05$ .

## Results and discussion

Results on the tensile strength of grass leaves confirm considerable differences between species (Table 1). When mean values for the entire period of investigations are compared, 2x genotypes of *Lp* were characterised by the lowest leaf tensile strength. The force required to break leaf blades of *Fp* was 19.8% higher than *Lp* 2x. On the other hand, the force needed to break leaves of *Php* and 4x genotypes of *Lp* was 42.6% and 59.3% higher, respectively when compared with the *Lp* 2x. The highest leaf tensile strength, however, was observed in *Fa* and *Dg* which, in comparison with that of 2x *Lp* genotypes, was found to be, respectively, almost 3 and 5 times higher. It is also worth emphasising the very small coefficients of variation recorded for grass species characterised by the highest leaf tensile strength, i.e. 4.5% for *Dg* and 6.1% for *Fa* in contrast to a much higher variation coefficient in the case of *Lp* 2x (15.4%). This was most certainly associated with the higher number of *Lp* 2x genotypes examined and their greater variability with respect to one another than *Dg* and *Fa*. It should also be added here that, following the performed statistical analysis, the existence of significant differences between genotypes was proved in all analysed grass species.

In addition, cultivars within individual species were also characterised by considerable variations in leaf tensile strength. The greatest variability amounting to, respectively, 220.0% and 201.7% was recorded in the case of 2x and 4x *Lp* genotypes, whereas *Fp* (129.1%), *Dg* (77.8%) and *Fa* (44.5%) cultivars varied between one another much less in this regard. The lowest leaf tensile strength variability (26.0%) was registered in the *Php* cultivars.

Table 1. Leaf tensile strength of grasses in total investigation period

Species	Mean (N)	Coefficient of variation (%)	Cultivar means (N)		LSD <sub>0.05</sub> for cultivars based on plot error
			Minimum	Maximum	
<i>Dactylis glomerata</i>	22.16	4.5	16.57	29.46	0.876
<i>Festuca arundinacea</i>	14.50	6.1	11.41	16.49	0.723
<i>Festuca pratensis</i>	4.36	12.2	2.78	6.37	0.324
<i>Lolium perenne</i> 2x	3.64	15.4	1.60	5.12	0.574
<i>Lolium perenne</i> 4x	5.80	14.5	2.95	8.90	0.866
<i>Phleum pratense</i>	5.19	14.5	4.65	5.86	0.554

Pasture grasses differ with regard to their morphological structure and that is why it is interesting to investigate leaf tensile strength with reference to selected biological features (Zhang *et al.*, 2004). Rogalski and Kozłowski (1981) reported a correlation between leaf tensile strength and length and width of leaves. Data shown in Table 2 confirm that *Fp* genotypes were characterised by the lowest leaf tensile strength when calculated per leaf weight unit. With regard to the 1 g of dry matter, the leaf tensile strength of that species was 42.2% smaller in comparison with *Php* and 70.4% smaller in comparison with the 2x *Lp* genotypes. The highest leaf tensile strength was observed in the leaves of *Dg*. It was 4.3 times greater compared to *Fp*, 2 times greater than in *Php* and 57% higher in comparison with the 2x *Lp* genotypes, particularly suitable for pastures. These results differ significantly from those reported by Rogalski and Kozłowski (1981) who found that leaf tensile strength of *Dg* cultivars was only 19.6% higher in comparison with *Php* cultivars. Undoubtedly, such considerable differences in the present results must have been caused by a different set of



cultivars subjected to analyses as well as measurement accuracy resulting from technical advances in measuring equipment. In the past, tensile strength investigations were conducted with the aid of simple devices operating on the principle of dynamometers (Evans, 1967; Rogalski and Kozłowski, 1981). With regard to the 1 mm leaf blade width, the lowest leaf tensile strength was registered in the *Php* and *Fp* cultivars, and the highest was in *Dg*.

Table 2. Leaf tensile strength of grasses in regard to leaf weight and width

Species	Leaf blade weight		Leaf blade width (mm)	Leaf tensile strength		
	FM (g)	DM (g)		N g <sup>-1</sup> FM	N g <sup>-1</sup> DM	N mm <sup>-1</sup> of leaf blade width
	<i>Dactylis glomerata</i>	1.15	0.33	8.0	19.30	67.98
<i>Festuca arundinacea</i>	0.76	0.26	7.3	19.00	55.13	1.99
<i>Festuca pratensis</i>	1.48	0.34	5.1	2.95	12.82	0.85
<i>Lolium perenne</i> 2x	0.36	0.08	3.4	10.20	43.33	1.07
<i>Lolium perenne</i> 4x	0.61	0.15	4.6	9.51	39.46	1.26
<i>Phleum pratense</i>	0.86	0.23	6.2	6.03	22.18	0.84

FM – fresh matter; DM – dry matter

## Conclusions

Intraspecific differences in leaf tensile strength in each of the analysed grass species were statistically significant. Performance of precise tensile strength measurements of leaf blades could be a helpful tool in the breeding for creation of improved pasture grass cultivars and selection of appropriate components in seed mixtures. The obtained results help to better understand the impact of plant functional traits on forage intake.

## References

- Evans P.S. (1967) Leaf strength studies of pastures grasses: I. Apparatus, techniques and some factors affecting leaf strength. *Journal of Agricultural Science, Cambridge* 69, 171-174.
- Goliński P. (2009) Investigations on tensile strength of plant material using a modern measuring stand. *Grassland Science in Poland* 12, 47-59.
- MacAdam J.W. and Mayland H.F. (2003) The relationship of leaf strength to cattle preference in tall fescue cultivars. *Agronomy Journal* 95, 414-419.
- Rogalski M. and Kozłowski S. (1981) Work expenditure on leaves and stems tensile strength as characteristic of grasses varieties. *Cultivar Testing Bulletin* 9, (13-14), 117-123.
- Zhang J.M., Hongo A. and Akimoto M. (2004) Physical strength and its relation to leaf anatomical characteristics of nine forage grasses. *Australian Journal of Botany* 52 (6), 799-804.

# Performance of *Lolium perenne* with *Trifolium repens*, and spontaneous grasses with *Trifolium repens*, in Azores

Gomes A.

Universidade dos Açores (UAç), 9700-851 Terra-Chã, Portugal

Corresponding author: agomes@uac.pt

## Abstract

A three-year experiment was conducted in the interior of Terceira Island, Azores, at 400 meters of altitude, to evaluate yield and quality of the herbage of a seeded pasture of *Lolium perenne* and *Trifolium repens* (LPxTR) and of a pasture of spontaneous species and introduced *Trifolium repens* (SPxTR), both harvested at four-week intervals. The average LPxTR pasture dry matter (DM) productions were 6368, 6671, 7340, 7960 kg ha<sup>-1</sup> y<sup>-1</sup> and the average SPxTR DM productions were 5176, 5266, 6887, 7038 kg ha<sup>-1</sup> y<sup>-1</sup> for respectively 0, 100, 200 and 300 kg ha<sup>-1</sup> y<sup>-1</sup> N. Increasing nitrogen fertilisation increased yield in either pasture only in the first two years of the study but not in the third. Nitrogen fertilization never significantly increased yields in summer, increased yields in two springs and increased yields in only one winter (the driest). The two pastures had a similar pattern of dry matter production. For both pastures the highest fibre concentrations were in summer and the lowest crude protein concentrations were in the spring. In the management of a *L. perenne* x *T. repens* pasture care should be taken to avoid infestation by spontaneous grasses as this decreases pasture yield, especially under summer drought and low N rates.

Keywords: *L. perenne*, permanent, nitrogen, yield, quality

## Introduction

In the mid altitudes of the Azores Islands there are two types of pastures, seeded pastures of *Lolium perenne* L. generally associated with *Trifolium repens* L., and permanent pastures of spontaneous species, where *Poa trivialis* L., *Holcus lanatus* L. and *Agrostis castellana* L. are the most common grasses and *Trifolium repens* L. (white clover) and *Lotus pedunculatus* Cav. are generally present. In the permanent pastures, dairy cattle generally graze in the flat land and heifers and beef cattle graze in the hills and mountains. The composition of the permanent pastures varies with the frequency of grazing and soil fertility. Nowadays most permanent pastures are in soils with medium to high phosphorus and potassium levels. If stocking rate is low during spring and summer (extensive system) generally *H. lanatus* is the most frequent species and *L. pedunculatus* is present as well. If the stocking rate is higher (semi-intensive system), *P. trivialis* is the most frequent species and white clover is generally present in various amounts.

The intention of this work was to measure, under the same management, the yield and the quality of the herbage produced by a seeded pasture of *L. perenne* and *T. repens* and to compare it with the yield and the quality of the herbage produced by a permanent pasture of spontaneous species with the introduction of a more productive white clover variety.

## Materials and methods

This experiment was conducted during three years at the University Experimental Farm, in the interior of Terceira Island, latitude 38° 39' N; longitude 27° 05' W; altitude 390 m, a.s.l.). After the harvest of maize in October, the *L. perenne* (cv. Vigor) and *T. repens* (cv. Olwen) were seeded, at the rate of 25 and 6 kg ha<sup>-1</sup>, respectively. In an adjacent area only *T. repens*

(cv. Olwen) was seeded at a rate of 6 kg ha<sup>-1</sup>. Both areas were grazed during one year by dairy cows in a rotational system (common in Azores) and developed a dense stand. In the area seeded with *L. perenne* and *T. repens* (LPxTR) *L. perenne* was almost the only grass present in the pasture. In the area seeded only with *T. repens* by far the most frequent grass was *P. trivialis* (>80%) although small amounts of *P. annua*, *H. lanatus* and *A. castellana* were present. This last pasture (SPxTR) was very similar in its floristic composition to the permanent pastures of that area (under semi-intensive management) except for the greater presence of white clover. In each pasture a single factor experiment in a randomized complete block design (r = 3) was established with four nitrogen rates (0, 100, 200 and 300 kg ha<sup>-1</sup> y<sup>-1</sup>). Dry matter yields were determined at 4-wk intervals for a total of 13 harvests per year. In the experimental site the soil was a sandy loam with a pH of 5.2, average levels of phosphorus and low levels of potassium, calcium and magnesium. Every year 50 kg ha<sup>-1</sup> P (superphosphate 18%) and 300 kg ha<sup>-1</sup> K (potassium sulphate) were applied to both pasture areas. Nitrogen (NH<sub>4</sub>NO<sub>3</sub> with 27% N) was applied after each harvest in 13 equal doses.

## Results and discussion

The three-year average annual DM yields for 0, 100, 200 and 300 kg ha<sup>-1</sup> y<sup>-1</sup> N (N0, N100, N200 and N300) were respectively 6368, 6671, 7340 and 7960 kg ha<sup>-1</sup> y<sup>-1</sup> for the *L. perenne* and *T. repens* pasture and 5176, 5266, 6887 and 7038 kg ha<sup>-1</sup> y<sup>-1</sup> for the spontaneous species and *T. repens* pasture. The average yields of the spontaneous-species pasture were 23% lower for N0, 27% for N100, 7% for N200 and 13% for N300. Haggar (1971) reported that under comparable conditions the DM yield from pure swards of *P. trivialis* at Aberystwyth (Wales) and Hurley (SE England) were 22 to 34% lower than that from *L. perenne* and, that under optimal growing conditions (irrigation and high levels of N), the yield difference between the two species was reduced. Increasing nitrogen fertilisation increased yield in either pasture only in the first two years of the study but not in the third (Table 1). Nitrogen fertilization never significantly increased yields in summer, increased yields in two springs and increased yields in only one winter (the driest). Equations describing the relationship between average response in pasture DM yield (kg ha<sup>-1</sup> y<sup>-1</sup>) to N fertilization rate (kg ha<sup>-1</sup> year<sup>-1</sup>) are:

For LPxTR, yield<sub>pasture</sub> = 6268 + 5.44\* N<sub>rate</sub>, R<sup>2</sup> = 0.66, P < 0.001

For SPxTR, yield<sub>pasture</sub> = 4994 + 7.46\* N<sub>rate</sub>, R<sup>2</sup> = 0.48, P < 0.01

Table 1. Total dry matter yield (kg ha<sup>-1</sup> y<sup>-1</sup>) from 13 harvests per year of the *Lolium perenne* x *Trifolium repens* pasture and of the spontaneous grasses x *Trifolium repens* pasture, in the three years of the study.

Nitrogen (kg ha <sup>-1</sup> y <sup>-1</sup> )	<i>Lolium perenne</i> x <i>Trifolium repens</i>			Spontaneous grasses x <i>Trifolium repens</i>		
	1 <sup>st</sup> year	2 <sup>nd</sup> year	3 <sup>rd</sup> year	1 <sup>st</sup> year	2 <sup>nd</sup> year	3 <sup>rd</sup> year
0	5125 <sup>c</sup>	5598 <sup>b</sup>	8382 <sup>a</sup>	4191 <sup>b</sup>	3612 <sup>b</sup>	7724 <sup>a</sup>
100	6119 <sup>bc</sup>	5410 <sup>b</sup>	8483 <sup>a</sup>	4587 <sup>b</sup>	3969 <sup>b</sup>	7243 <sup>a</sup>
200	7233 <sup>ab</sup>	6101 <sup>ab</sup>	8684 <sup>a</sup>	7573 <sup>a</sup>	5319 <sup>a</sup>	7769 <sup>a</sup>
300	8710 <sup>a</sup>	6928 <sup>a</sup>	8240 <sup>a</sup>	7608 <sup>a</sup>	6217 <sup>a</sup>	7289 <sup>a</sup>
SE	471	319	854	1342	379	1020

Different letters within a column indicate differences between yield at P < 0.05

In the LPxTR pasture by far the greatest impact of the nitrogen fertilization was at 29 March, which greatly increased the yield at the harvest on 21 April. In the rest of the year the effects of the nitrogen fertilization were low. In the SPxTR the impact of the nitrogen fertilization was lower in April but was slightly better than in the LPxTR pasture until the 11<sup>th</sup> of August. As Vartha (1965) and Haggar (1976) we also found a similar pattern of dry matter production for *L. perenne* and *P. trivialis*. White clover production was high from early July to the end of

October (when temperatures were higher) and very low in winter and early spring, when it almost disappeared from the pastures.

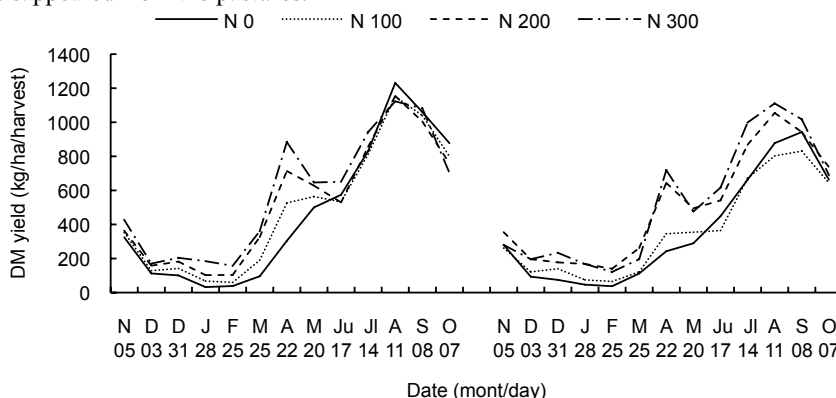

Figure 1. Three year average DM yields of the thirteen harvests done per year in the *Lolium perenne* x *Trifolium repens* pasture (left) and spontaneous grasses x *Trifolium repens* pasture (right).

The average NDF, ADF, ADL and lignin ( $\text{g kg}^{-1}$  DM) were respectively 576, 280, 58 and 32 in the LPxTR and 597, 278, 57 and 26 in the SPxTR. Average crude protein concentration in DM ( $\text{g kg}^{-1}$ ) were 248 for the LPxTR pasture and 254 for the ESPxTR pasture. In spring and summer the NDF and ADF were higher in the SPxTR pasture. For both pastures the highest fibre concentrations were in summer and the lowest crude protein concentrations were in the spring, results similar to the ones obtained by Pontes *et al.*, 2007.

## Conclusions

Under the same management, permanent pastures where the main components are *P. trivialis* and *T. repens* have the same pattern of growth as pastures seeded with *L. perenne* and *Trifolium repens* but are less productive, especially under summer drought and low N rates. The nutritive value of a spontaneous grasses and *T. repens* pasture is lower in spring and summer, due to its higher fibre content. In the management of a *L. perenne* x *T. repens* pasture care should be taken to avoid infestation by spontaneous grasses as this decreases pasture yield.

## References

- Haggar R.J. (1971) The significance and control of *Poa trivialis* in ryegrass pastures. *Journal of the British Grassland Society* 26, 117-121.
- Haggar R.J. (1976) The seasonal productivity, quality and response to nitrogen of four indigenous grasses compared with *Lolium perenne*. *Journal of the British Grassland Society* 31, 197-207.
- Pontes L.S., Carrère P., Andueza D., Louault F. and Soussana J.F. (2007) Seasonal productivity and nutritive value of temperate grasses found in semi-natural pastures in Europe: responses to cutting frequency and N supply. *Grass and Forage Science* 62, 485-496.
- Vartha E.W. (1965) Of what significance is the presence of *Poa trivialis* in ryegrass pastures? *Proceedings of the New Zealand Grassland Association*, Whangarei, 102-111.

# Comparison of methods for estimating forage mass in grazing systems of the south Brazilian Pampas

Grün A.<sup>1</sup>, Gierus M.<sup>1</sup>, Carvalho P.F.C.<sup>2</sup>, Pinto C. E.<sup>2</sup> and Brambilla D.<sup>2</sup>

<sup>1</sup> *Grass and Forage Science/Organic Agriculture, Institute for Crop Science and Plant Breeding, Christian Albrecht University Kiel, D-24118 Kiel, Germany*

<sup>2</sup> *Forage Plants and Agrometeorology Dept., Federal University Rio Grande do Sul, 91501-970 Porto Alegre, Brazil*

Corresponding author: mgierus@email.uni-kiel.de

## Abstract

We evaluated two different methods of indirect forage mass estimate on two large-scale grazing experiments in the south Brazilian Pampas. HFRO Sward stick (SW) and Rising Plate meter (RPM) forage mass estimates were compared to the forage mass obtained with representative cutting samples in two experiments varying in grazing intensity and fertilization level. The investigations indicated a clear linearity between SW, RPM and the forage mass. However, there was a high variation between measurements. The sward structure was influenced by the presence of tall grasses, which belongs to the less frequently grazed areas in the paddock. Although the SW performed marginally better than the RPM, the latter had a limited application in swards or sward areas with taller species (> 25 cm). In conclusion, with  $R^2=0.92$  (CV=27.1; RMSE=840.1) for SW and  $R^2=0.88$  (CV=32.9; RMSE=1017.1) for RPM, both methods were applicable for different grazing intensities of the complex natural grassland in the subtropics.

Keywords: indirect forage mass estimate, natural grassland, subtropics, sward height, sward density, sward structure

## Introduction

The subtropical Pampas in South Brazil belongs to the large natural grassland of South America. The Pampas has a wide diversity of native forage species. The biomass productivity is characterized by a high variability in space and time linked to soil fertility and precipitation amount and distribution. The vegetation is currently in disclimax, reflecting the grazing management (Nabinger *et al.*, 2000). A reliable estimate of forage mass is essential to adjust adequately the grazing pressure, avoiding overgrazing and to preserve this ecosystem as the base of cattle feeding by a sustainable increase of productivity and decrease of deficient management, labour and costs. Due to their practical efficiency and adequate accuracy, forage mass estimates would be achievable if non-destructive methods described by Mannetje (2000) and Frame (1993) could be adopted in complex natural grassland production systems like the Pampas. The objective of this investigation was to determine and to compare the accuracy and the application of sward height (cm) measured using the HFRO Sward stick (SW), and compressed sward height (cm) using the Rising Platometer (RPM), as forage mass estimates for conditions that differ to those reported in the literature for homogenous swards and temperate climates.

## Material and Methods

Data for the present study were obtained from two grazing experiments: extensive and intensive managed pastures of natural grassland grazed by cattle (EMP and IMP, respectively). The experiments were located in Eldorado do Sul in the experimental station

belonging to the Universidade Federal do Rio Grande do Sul (UFRGS, Brazil), 46 m a.s.l. with Podsol and Plinthosol dominant soils. The climate is subtropical humid (Cfa, according to the classification of Köppen), with an average yearly temperature of 19.3°C and 1400 mm of average precipitation. The vegetation period is about 220 days, mainly from September until May.

The EMP is a long term grazing experiment managed with four different grazing intensities (4 kg, 8 kg, 12 kg and 16 kg dry matter (DM) of forage mass per 100 kg live weight) established as a randomised block design with two field replications. Due to a higher proportion of seldom-grazed areas observed in paddocks with the lower grazing intensity, two types of grazed layers were designated in each paddock as follows: inferior layer for the frequently grazed areas within the paddock, and superior layer for the seldom-grazed areas within the paddock. On the IMP the grazing intensity was maintained at 12 kg DM forage mass per 100 kg live weight by adjusting the number of young cattle in periods of 28 days from August 2008 onwards ('put and take method'). The experiment was a randomised block design with three N fertilisation treatments (0, 100, 200 kg ha<sup>-1</sup>) and overseeded with a C3 grass (*Lolium multiflorum*) in the winter months (May to August).

HFRO Sward stick (SW) and Rising Plate Meter (RPM, Grasstec, Charleville, Co. Cork, Ireland; metal plate: 32 cm x 32 cm, 456.2 g) were used for sward height determination. The average DM forage mass of samples were obtained by hand clipping of 50 cm x 50 cm squares above ground level. The five dominant species within the measurement points were determined in subsamples of the clipped forage samples. All samples were dried for 72 h at 65 °C until constant weight. Eight measurement points per paddock were sampled at the beginning of September in EMP, and three measurement points inside and outside of enclosure cages within each replication were sampled after sward height measurement in IMP in October.

Regression analysis was performed using the DM forage mass obtained by hand clipping and the sward height obtained with SW and RPM under the different experimental conditions in EMP and IMP.

## Results and discussion

The grazing intensity and management influenced the botanical composition in both experiments. The botanical composition in turn influenced the sward structure and consequently the sward height and DM forage mass. Despite the strong heterogeneous sward structure, both instruments showed a linear relationship with forage mass. With  $R^2=0.92$  (CV=27.1; RMSE=840.1) for SW and  $R^2=0.88$  (CV=32.9; RMSE=1017.1) for RPM, the SW performed marginally better than the RPM which had a limited application in swards with taller tussock grasses (>25 cm). As these taller grasses appeared mainly in the less frequently grazed area in the paddock, it is questionable if they are relevant for the forage mass estimates under practical conditions. However, the agile RPM required less physical effort and more measurements could be performed in the same time over a larger area as observed by Silva *et al.* (2003).

The sward DM density was, as expected, higher for the RPM (433 kg cm<sup>-1</sup>) compared to the SW (263 kg cm<sup>-1</sup>), as shown in Figure 1. The coefficient of variation is quite high as a result of the inclusion of the inferior and superior layer in the forage mass estimates. Even though it shows that, for large scale grazing systems with complex sward structure, indirect methods are applicable to estimate forage mass and the development of sustainable grazing concepts.

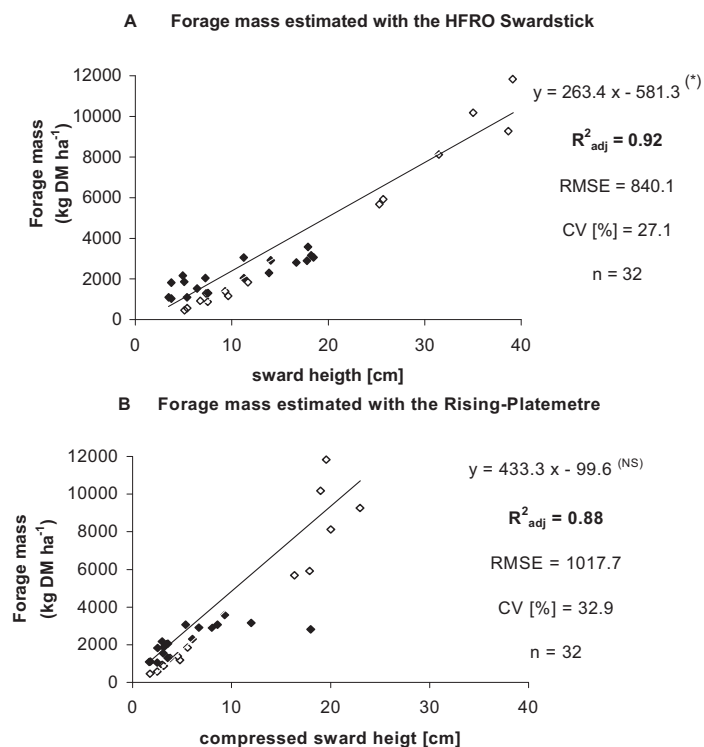

Figure 1. Forage dry matter mass estimates [kg ha<sup>-1</sup>] using HFRO Swardstick (A) and Rising Plate meter (B) for extensive  $\diamond$  and intensive  $\blacklozenge$  natural grassland of the Pampas in South Brazil, including superior and inferior grazing layers; statistical analysis with SAS 9.1; Statistical significance ( $P < 0.05$ ) for the intercept with tendency to zero (significant\*)

## Conclusion

Forage mass estimates using indirect methods are applicable for the subtropical natural grassland of the Pampas. Taller grasses limit the use of the Rising Plate meter. Due to sward structure as a result of moderate grazing intensity, forage mass estimates should be performed in the inferior layer, which represents the frequently grazed area in the paddock.

## References

- Frame J. (1993) Herbage mass. In: Davies *et al.* (eds.) *Sward measurement Handbook*. 2<sup>nd</sup> Edition, British Grassland Society, Reading, UK, 3, 39-68.
- Mannetje L.'t (2000) Measuring Biomass of Grassland Vegetation. In: Mannetje L.'t, Jones R.M. (eds.) (2000) *Field and Laboratory Methods for Grassland and Animal Production Research*. CABI Publishing, Wallingford, UK, 151-177.
- Nabinger C., Moraes A. de and Maraschin G.E. (2000) Campos in Southern Brazil. In: Lemaire G., Hodgson J., Moraes A. de, Nabinger C. and Carvalho P.C. de F. (eds.) CAB International 2000. *Grassland Ecophysiology and Grazing Ecology* 18, CABI Publishing, Wallingford, UK, 355-376.
- Silva S.C. da and Cunha W.F. da (2003) Métodos indiretos para estimar a massa de forragem em pasto de *Cynodon ssp.*. *Pesquisa Agropecuária Brasileira* 38, 981-989.



## Post-grazing height and productivity of white clover-based systems of dairy production

Humphreys J.<sup>1</sup>, Keogh B.<sup>2</sup>, Phelan P.<sup>1,2</sup> and Casey I.A.<sup>2</sup>

<sup>1</sup>Moorepark Dairy Production Research Centre, Teagasc, Fermoy, Co. Cork, Ireland.

<sup>2</sup>Department of Chemical and Life Sciences, Waterford Institute of Technology, Cork Road, Waterford, Ireland.

Corresponding author: James.Humphreys@teagasc.ie

### Abstract

The objective was to examine the impact of post-grazing height (PGH) on annual herbage production and milk production by spring-calving dairy cows grazing grass-clover (*Trifolium repens* L.) swards under rotational grazing management throughout three consecutive grazing seasons (2007 to 2009) at Solohead Research Farm (52° 51' N, 08° 21' W). There were three treatments involving PGH of 6, 5 and 4 cm, each maintained throughout the grazing season (mid-February to mid-November). Each treatment was stocked at 2.1 cows per ha, with an average of 21 cows per treatment each year. Herbage dry matter (DM) yields [mean (s.e.) Mg ha<sup>-1</sup>] increased ( $P < 0.05$ ) with lower PGH from 9.92 to 11.22 (0.255). There were no differences in the clover content of herbage DM; 195 (14.8) g kg<sup>-1</sup> or in clover stolon DM mass; 542 (40.6) kg ha<sup>-1</sup>. There were no differences in yields (kg cow<sup>-1</sup>) of milk; 6177 (94.2), fat; 263 (4.5), protein; 222 (3.3) or lactose; 287 (4.5) between the PGH treatments. There were no differences in cow live-weight or body condition score. A PGH of 4 cm substantially increased herbage DM yields with no significant impact on dairy cow performance.

Keywords: White clover, post grazing height, dairy production

### Introduction

Cutting grass-clover (*Trifolium repens* L.) swards to 4 cm above ground level increased clover yield by 0.30 to 0.35 and combined grass and clover yield by 0.16 to 0.20 compared with higher cutting heights (Frame and Boyd, 1987; Acuña and Wilman, 1993; Schils and Sikkema, 1999). However, with dairy cows, grazing to 4 cm is not recommended because it has been found to depress intake of herbage, milk yield and composition (Mayne *et al.*, 1987; Maher *et al.*, 2003). The objective was to evaluate the impacts of post-grazing height (PGH) on annual herbage production, clover content of swards, stolon abundance and milk production from cows grazing grass-clover swards over three consecutive years (2007-2009).

### Materials and methods

The experiment was conducted at Solohead Research Farm; latitude 52° 51' N, longitude 08° 21' W. The soil had clay loam soil texture; 0.25 sand and 0.42 clay in the upper 20 cm. Drainage was impeded, contributing to waterlogged conditions under high rainfall. Annual rainfall was 996, 1228 and 1296 mm in 2007, 2008 and 2009 respectively, compared with the 10-year average of 1019 mm. Perennial ryegrass (*Lolium perenne* L.) was the predominant component of swards. Two-thirds of swards had clover contents averaging 0.27 of herbage dry matter (DM) in 2006. The remaining one-third contained 0.065 clover in herbage DM. Clover seed was over-sown into this area in May 2007. Thereafter, approximately 0.2 of the area of each treatment was over-seeded with white clover seed each year to maintain sward clover contents. Swards were rotationally grazed by spring-calving dairy cows with calving dates ranging between late January and late April. Lactating cows were turned out to pasture

approximately three days after calving and remained at pasture until mid-November each year depending on pasture supply and the suitability of ground conditions for grazing. There were three treatments involving three target PGH of 6, 5 and 4 cm, each maintained throughout the grazing season. Post-grazing heights were measured twice per day using a rising plate-meter. Achieving the target PGH determined when cows were moved to new pasture. This final PGH was recorded. Each treatment received annual mineral fertilizer N input of 90 kg ha<sup>-1</sup>, applied between February and April each year, and was stocked at 2.1 cows per ha. There was an average of 21 cows per treatment each year. Each spring, cows were divided into four main groups on the basis of lactation number (1, 2, 3 and ≥4) and then sub-divided into sub-groups of three on the basis of calving date. From within each sub-group one cow was randomly assigned to each herd. Herds were randomly assigned to treatment each spring.

Milk yield per cow was recorded at each milking and the composition of milk from each cow was measured for a successive morning and evening milking once per week. Solids-corrected milk yield was calculated using the equation of Tyrell and Reid (1965). The live-weight of cows was recorded each week. Body condition score (Edmonson *et al.*, 1989) of each cow was recorded once fortnightly. The length of the grazing season was measured in terms of days at pasture where one day was defined as when all the cows per treatment were out day and night and one-half day when cows were out only by day.

Herbage was sampled immediately before grazing by cutting four strips, each 5 m long and 0.55 m wide, using a lawn-mower. Prior to harvesting herbage for silage, herbage was harvested from four strips (5.0 m × 1.1 m) using an Agria auto-scythe. On each occasion the herbage harvested was bulked and weighed to determine herbage mass. A sub-sample was dried to determine DM content. Intake of grazed pasture DM by the cows was calculated by the difference between net energy (NE) intake from silage and concentrate DM and that needed to meet the NE requirements for milk production, maintenance and body weight change using methodology described by Humphreys *et al.* (2008). The proportion of white clover in the herbage of each paddock was determined during April, June and September each year. Clover stolon mass was measured in February, May, August and November using methodology described by Humphreys *et al.* (2008).

## Results and discussion

Mean (s.d.) PGH were 5.89 (0.45), 5.05 (0.36) and 4.16 (0.41) cm (n = 392) during the experiment. Mean calving date was 21 February and mean (s.e.) lactation length was 290 (1.6) days. There were no ( $P > 0.05$ ) differences in production of milk, fat, protein or lactose between the PGH treatments (Table 1). Likewise there were no differences in live-weight or BCS during or at the end of lactation. Mean concentrate input was 551 (6.3) kg cow<sup>-1</sup> and was not different between PGH treatments. There was no interaction between PGH and year for any of the above variables. Herbage DM production increased ( $P < 0.05$ ) from 9.92 to 11.22 (0.255) Mg ha<sup>-1</sup> and the length of the grazing season increased ( $P < 0.001$ ) with lower PGH (Table 1). Clover herbage DM yields, the clover content of herbage DM and clover stolon DM mass were not significantly affected by PGH. In contrast to previous research (Mayne *et al.*, 1987; Maher *et al.*, 2003), the lower PGH in the present experiment did not significantly impact dairy cow performance. A reason for this was that cows were turned out to pasture in early spring and the PGH was maintained throughout three consecutive grazing seasons, whereas the above experiments were of relatively short duration (9 to 17 weeks). The 4 cm PGH increased herbage production by 0.13 compared with the 6 cm PGH, which is similar to that found in cutting experiments outlined above. However, the lower PGH did not significantly increase clover herbage yield or the clover content of herbage in contrast to the above experiments and in a cutting experiment conducted at Solohead in 2008 and 2009 (Phelan *et al.*, 2010). The differences between cutting and grazing experiments can be partly

attributed to white clover being relatively vulnerable to damage under grazing (Menneer *et al.*, 2005).

Table 1. Production of milk, solids-corrected milk (SCM), fat, protein and lactose, milk composition, mean cow live-weight and body condition score (BCS; scale 1 to 5) at the end of lactation, the mean number of days that individual cows were at pasture, herbage dry matter (DM) production, clover content of herbage DM and clover stolon mass (means of three years).

	Post grazing height			P value	sem
	6 cm	5 cm	4 cm		
Milk (kg cow <sup>-1</sup> )	6270	6159	6102	NS*	94.2
SCM (kg cow <sup>-1</sup> )	6222	6073	6036	NS	93.0
Fat (kg cow <sup>-1</sup> )	268	260	261	NS	4.5
Protein (kg cow <sup>-1</sup> )	227	221	218	NS	3.3
Lactose (kg cow <sup>-1</sup> )	291	286	284	NS	4.5
Live-weight at end of lactation (kg cow <sup>-1</sup> )	625	635	622	NS	6.49
BCS at end lactation	2.98	3.02	2.93	NS	0.029
Mean number of days at pasture per cow	225	234	237	<0.001	0.9
Grass herbage DM production (Mg ha <sup>-1</sup> )	8.06	8.39	8.89	<0.05	0.150
Clover herbage DM production (Mg ha <sup>-1</sup> )	1.87	1.90	2.33	NS	0.164
Clover content of herbage DM (g kg <sup>-1</sup> )	190	186	209	NS	14.8
Clover stolon DM mass (kg ha <sup>-1</sup> )	514	548	564	NS	40.6

\*NS, not significant ( $P > 0.05$ )

## Conclusions

A PGH of 4 cm substantially increased herbage DM yields with no significant impact on dairy cow performance in years with above-average annual rainfall and when grazing conditions were often less than ideal. A PGH of 4 cm is recommended for grass-clover swards grazed by cows with intermediate genetic potential for milk production.

## References

- Acuña P.G.H. and Wilman D. (1993) Effects of cutting height on the productivity and composition of perennial ryegrass-white clover swards. *Journal of Agricultural Science, Cambridge* 121, 29-37.
- Edmonson A.J., Lean I.J., Weaver L.D., Farver T. and Webster G. (1989) A body condition scoring chart for Holstein dairy cows. *Journal of Dairy Science* 72, 68-78.
- Frame I. and Boyd A.G. (1987) The effect of fertilizer nitrogen rate, white clover variety and closeness of cutting on herbage productivity from perennial ryegrass/white clover swards. *Grass and Forage Science* 42, 35-96.
- Humphreys J., O'Connell K. and Casey I.A. (2008) Nitrogen flows and balances in four grassland-based systems of dairy production on a clay-loam soil in a moist maritime climate. *Grass and Forage Science* 63, 467-480.
- Maher J., Stakelum G. and Rath M. (2003) Effect of daily herbage allowance on the performance of spring-calving dairy cows. *Irish Journal of Agricultural and Food Research* 42, 229-241.
- Mayne C.S., Newberry R.D., Woodcock S.C.F. and Wilkins R.J. (1987) Effect of grazing severity on grass utilization and milk production of rotationally grazed dairy cows. *Grass and Forage Science* 42, 59-72.
- Menneer J.C., Ledgard S.F., McLay C.D.A. and Silvester W.B. (2005) The effects of treading by dairy cows during wet soil conditions on white clover productivity, growth and morphology in a white clover-perennial ryegrass pasture. *Grass and Forage Science* 60, 46-58.
- Phelan P., Keogh B., Casey I.A., Fitzgerald E. and Humphreys J. (2010) Cutting height and interval in autumn and annual herbage production from a grass-white clover sward. *Grassland Science in Europe* 15 (this issue).
- Schils R.L.M. and Sikkema K. (1999) The effect of cutting height and management system on the performance of a grass/clover sward. In: Frame, J. (ed.) *Developments in White Clover*. FAO REUR technical series no. 29.
- Tyrell H.F. and Reid J.T. (1965) Prediction of the energy value of cows' milk. *Journal of Dairy Science* 48, 1215-1233.

# Growth and quality of multispecies pastures harvested at a fixed sward height

Johansen A.

Norwegian Institute for Agricultural and Environmental Research, Grassland and Landscape Division, Kvithamar, 7500 Stjørdal, Norway

Corresponding author: astrid.johansen@bioforsk.no

## Abstract

Two multispecies swards in Central Norway were repeatedly cut as soon as they reached 15 cm sward height in order to simulate rotational grazing. From early May to early September swards were cut nine (2007) or seven (2008, 2009) times at a stubble height of 7 cm. Despite challenging overwintering conditions, 'Ryegrass' (*Lolium perenne* and *Trifolium repens*) yielded no less than 'Winterhardy' in which *Festuca pratensis*, *Phleum pratense* and *Poa pratensis* were the dominating grass species in mixture with *Trifolium repens*. The quality of 'Ryegrass' as analysed by NIRS was higher than that of 'Winterhardy'. However, differences between mixtures were less than those between cuts. Early spring growths were low in NDF and high in water soluble carbohydrates (WSC) and digestible dry matter. Cuts later in the growing season were lower in WSC and less digestible, whereas from July to September, higher in crude protein due to high contents of *Trifolium repens*.

Key words: digestibility, fibre, grazing, grass, protein, white clover, yield

## Introduction

Which species/mixtures provide the highest yield and pasture quality? Is good management (i.e. frequent/regular cuts) enough to maintain a high nutritive quality throughout the grazing season? Is it necessary to use different concentrate formulas in different parts of the grazing season? These are among many frequently asked questions by Norwegian dairy farmers. In Norway, dairy cows are typically supplied with 4-6 kg compound feeds at pasture to counterbalance deficiencies or imbalances in nutrient and/or energy supply from the pasture. The fields are most commonly established by seed mixtures of timothy (*Phleum pratense*), meadow fescue (*Festuca pratensis*) and smooth meadow grass (*Poa pratensis*) and sometimes clover. However, the growing zone for perennial ryegrass (*Lolium perenne*) has expanded, and white clover (*Trifolium perenne*) is now more frequently included in seed mixtures. There is a paucity of data on growth patterns, yield potentials and nutritive value of intensive managed pastures under Norwegian conditions. The aim of the present study was to gain knowledge in these matters to be able to answer some of the questions raised.

## Material and methods

A block experiment with three replicates of two commercial seed mixtures was established on a silt loam in Stjørdal, Norway (63°N, 10°E, 28 m.a.s.l.) in 2006. The plots (10.5 m<sup>2</sup>) were repeatedly cut with a reciprocating mower at a stubble height of 7 cm from 1 May until 15 September as soon as the sward had reached a pre-grazing height of 14-16 cm, as measured with a rising plate meter. Thus, cutting dates were not necessarily the same for the two mixtures. The mixture 'Winterhardy' was established from SPIRE Beite Vintersterk (Felleskjøpet Agri, Trondheim, Norway) in which timothy, meadow fescue and smooth meadow grass contributed 32%, 25% and 25% of the total seed weight, respectively and white clover contributed with 8%. The remaining 10% were made up of red fescue (*Festuca rubra*)

and common bent (*Agrostis capillaris*). The mixture ‘Ryegrass’ was established from SPIRE Surför Pluss (same producer as above) in which six varieties of perennial ryegrass were included. Before seeding 10% (by seed weight) white clover (var. ‘Milkanova’) was added. A total of 180 kg N ha<sup>-1</sup> year<sup>-1</sup> was applied from a compound fertilizer (NPK 21-4-10). The botanical composition was subjectively estimated before cutting. Nutritive value and clover content were determined in dry yield samples by near infrared reflectance spectroscopy (NIRS). The data from each single year were subjected to mixed model analyses. The models included mixture (fixed), month (fixed and repeated, quality parameters only) and block (random). All data were balanced. LS-means are presented, followed by the common standard errors obtained within treatment (mixtures and months) by using the SAS MIXED procedure.

## Results and discussion

Despite challenging overwintering conditions, including periods with permanent ice cover, dry matter yield (DMY) of ‘Ryegrass’ was no less than that of ‘Winterhardy’ for the overall period (Table 1). Within year, the number of cuts taken did not differ between mixtures. However, in 2008 and 2009 the growth rate of ‘Ryegrass’ tended to be slower in the spring and more rapid in the autumn than ‘Winterhardy’ (results not shown).

Table 1. Dry matter yield (kg ha<sup>-1</sup>) in three consecutive years of management.

Year	No of cuts	‘Winterhardy’	‘Ryegrass’	Std. error
2007	9	5930	6537*	18
2008	7	7378*	6734	36
2009	7	7018	6881	80

\*: significant ( $P < 0.05$ ) differences between mixtures within year.

Initially, meadow fescue and timothy were the dominating grass species of ‘Winterhardy’, however, gradually exchanged by smooth meadow grass (results not shown). White clover (WC) constituted less than 6% of the DMY in ‘Ryegrass’ in 2007, and as much as 30% in 2009 (Table 2). In ‘Winterhardy’ the average content of WC varied from 22 to 33% on yearly basis. The results indicate that WC may contribute significantly to DMY in frequent cut/grazed swards, even when relatively high amounts of N-fertilizer are applied. Furthermore, WC seems less competitive in newly established mixtures with ryegrass compared to mixtures with ‘traditional’ grass species at relatively high N-fertilizing level.

‘Ryegrass’ was more digestible, contained more water-soluble carbohydrates (WSC) and less NDF compared to ‘Winterhardy’ (Table 2). However, differences in quality between cuts/months were more pronounced than differences between mixtures. The first cuts (May) were low in NDF, high in WSC and moderately high in crude protein (CP). The NDF fraction was highly and rapidly degradable (results not shown) and DM digestibility high. With such quality, high herbage intakes (HI) would have been expected, but also low feed utilization, high N-losses and low milk fat. Such negative effects may be avoided by use of supplemental feeds high in slowly degradable fibre and low in rumen degradable CP. However, CP contents were found to be even higher in the late part of the season, caused by high WC contents. Similar dynamics of WC in Norwegian grass/WC pastures has previous been reported by Höglind *et al.* (2005) and Johansen and Höglind (2008). Based on these results, supplements low in CP should probably be required throughout the season for animals grazing grass/clover-swards. Contribution of WC seemed to have major impacts also on Ca and WSC contents. Low growth rates causing relatively old/mature plant stems and leaves at the target sward height may explain higher NDF and lower DMD in late compared to early cuts. Thus, it may be that HI potential is lower in the autumn compared to the spring. Experiments with

animals are needed to draw such conclusions as well as to conclude on ‘optimal’ concentrate formulas.

Table 2. Content (g kg<sup>-1</sup> in dry matter) of white clover (WC), crude protein (CP), water soluble carbohydrates (WSC), fibre (NDF), digestible dry matter (DMD) and Ca in herbage cut at 15 cm pre-grazing sward height in the second and third year of management.

	2008						2009					
	WC	CP	WSC	NDF	DMD	Ca	WC	CP	WSC	NDF	DMD	Ca
‘Winterhardy’	335	201	134	408	787	7.8	245	182	172	413	811	6.0
‘Ryegrass’	245	192	176	388	817	7.0	301	187	196	361	844	6.6
Standard error	5	4	4	5	1	0.1	3	1	1	4	4	0.2
Level of sign.	***	**	***	**	***	***	***	*	***	***	***	*
May	54	184	261	371	868	4.4	98	176	285	355	884	3.8
June	338	159	160	431	797	7.3	270	166	198	403	827	6.1
July	359	197	130	401	780	8.5	389	178	150	395	793	7.4
August	361	228	107	390	791	7.9	334	217	105	394	806	7.9
September	338	214	119	397	775	8.8						
Standard error	6	6	6	1	1	0.2	5	2	2	4	5	0.2
Level of sign.	***	***	***	***	***	***	***	***	***	***	***	***

\*:  $P < 0.05$ , \*\*:  $P < 0.01$ , \*\*\*:  $P < 0.001$

## Conclusion

In the lowlands of Central Norway a perennial ryegrass/white clover grass seed mixture can be recommended for intensively managed pastures as an alternative to a seed mixture containing timothy, meadow fescue and smooth meadow grass.

## References

- Höglind M. and Johansen A. (2005) Herbage yields and cattle preferences for two new white clover cultivars from Norway. In: Frankow-Lindberg, B.E. et al (eds) *Adaptation and Management of Forage Legumes – Strategies for Improved Reliability in Mixed Swards.* ). *Proceedings of the 1<sup>st</sup> COST 852 workshop held in Ystad, Sweden 20-22 September 2004.* SLU Service, Uppsala, Sweden, 63-66.
- Johansen A. and Höglind M. (2007) Herbage intake, milk production and sward utilization of dairy cows grazing grass/white clover swards at low, medium and high allowances. *Acta Agriculturae Scandinavica, Section A – Animal Sciences*, 57 (3), 148-158.



# The use of grazing in intensive dairy production and assessment of farmers' attitude towards grazing

Kristensen T., Madsen M.L. and Noe E.

*Aarhus University, Faculty of Agricultural Sciences, Dept. of Agroecology and Environment, Blichers Allé 20, P.O. BOX 50, DK-8830 Tjele.*

Corresponding author: Troels.Kristensen@agrsci.dk

## Abstract

The intensification and specialization of dairy farming in Western Europe has decreased the use of grazing. This paper looks at the development based on information from a questionnaire which was sent to 800 Danish dairy farmers with more than 100 cows. Completed questionnaires were obtained for 396 farms, of which 347 were conventional and 49 organic certified. Of the conventional farms only 25% (n = 87) had grazing cows, while 62% (n = 215) of the farms had grazing heifers. The non-grazing - defined as farm without access to pasture for the cows - conventional farms had more cows and land than the grazing farms, and were also characterized by having a larger percentage using robot milking and change of ownership since year 2000, which, together with the largest increase in herd size since year 2000, illustrates that the trend from grazing to non-grazing indeed seems to be part of the ongoing intensification. Stocking rate was identical in the two groups, but in the non-grazing group fewer farms had the theoretical possibility of access to at least 0.3 ha per cow of arable land for grazing, and at these farms the cows had to cross more roads and walk further to get to the far end of the pasture.

Keywords: pasture, dairy cows, large herds, management

## Introduction

The intensification and specialization of dairy farming in Western Europe has increased the herd size and stimulated the development of production systems with a larger degree of automation of feeding and milking, which often has a negative impact on the use of grazing. The development of these systems is to large extent driven by the farmer's motivation and attitude towards farming. To get more information about the opportunities and obstacles for grazing, it is therefore relevant to explore the farmers' attitude and expectations in relation to the future use of grazing.

## Materials

A questionnaire was prepared based on input from a workshop with participants from extension, education and research within roughage production and grassland management and utilization. A representative sample of 800 herds with more than 100 dairy cows in 2008 was randomly selected from the total of 2349 herds in the central herd database (CHR) in Denmark. The group of farms with more than 100 cows represents 60% of the herds and more than 80% of the dairy cows. All information is based on data given by the farmer in the questionnaire. Grazing farms is farms with all or some of the lactating cows at pasture during summer or part of the summer. Completed questionnaires were handed in for 396 farms, of which 347 were conventional and 49 organic certified.



Table 1. Description of intensive Danish dairy farms with more than 100 cows classified after production method and the use of grazing for the cows during summer 2008.

Production system	Conventional		Organic
	Non grazing	Grazing	Grazing
Number of farms	258	85	49
Number of cows per farm	191 <sup>a</sup>	156 <sup>b</sup>	162 <sup>b</sup>
Stocking rate, cow per ha	1.22 <sup>a</sup>	1.28 <sup>a</sup>	0.89 <sup>b</sup>
Heifers grazing, % of farms	53 <sup>a</sup>	89 <sup>b</sup>	100 <sup>b</sup>
Automatic milking systems, % of farms	32 <sup>a</sup>	18 <sup>b</sup>	31 <sup>a</sup>
New owner since year 2000, % of farms	41	32	27
Increase in herd size since year 2000, %	71 <sup>a</sup>	59 <sup>ab</sup>	46 <sup>b</sup>
Access to 0.3 ha cow <sup>-1</sup> , % of farms	57 <sup>a</sup>	79 <sup>b</sup>	96 <sup>c</sup>
Distance to pasture, max, m	1340 <sup>a</sup>	860 <sup>b</sup>	925 <sup>a</sup>
Passage of road, no	0.90	0.65	0.75
Maize, % of land	36 <sup>a</sup>	33 <sup>a</sup>	9 <sup>b</sup>
Grassland, % of land	31 <sup>a</sup>	40 <sup>b</sup>	58 <sup>c</sup>
Pasture, % of DM intake summer period <sup>1)</sup>	0 <sup>a</sup>	23 <sup>b</sup>	40 <sup>c</sup>
Concentrate and cereals, % of DM intake summer period <sup>1)</sup>	35	31	32

<sup>abc</sup> Values with different superscripts are significantly different  $P < 0.05$

<sup>1)</sup> 1 May to 31 October

## Results and discussion

Grazing is part of the organic certification and therefore used on all organic farms. Of the conventional farms, only 25% ( $n = 87$ ) had grazing cows, while 62% ( $n = 215$ ) of the farms had grazing heifers. The largest herd size was 191 cows in the non-grazing group of the conventional farms compared to 156 cows in the group using grazing (Table 1). The non-grazing group was also characterized by having a larger proportion of farms using robot milking and farms having changed owner since year 2000. This, together with the largest increase in herd size since year 2000, illustrates that the trend from grazing to non-grazing indeed seems to be part of the ongoing intensification and development in the size of the dairy farms.

In the non-grazing group there were fewer farms compared to the grazing farms that would, in theory, have had access to at least 0.3 ha of arable land for grazing, and for these farms the cows had to cross more roads and walk further to get to the far end of the pasture. Although grazing is used on organic farms, this group of farms is quite different from the conventional groups of grazing farms, with a lower stocking rate and easier access to pasture.

The farmers on non-grazing farms, not surprisingly, were more likely to see grazing in a negative light than the other two farm groups. Establishment and maintenance of walkways was the major obstacle, followed by access to land, in accordance with the information in Table 1 that only 57% of the non-grazing farms has access to more than 0.3 ha of arable land per cow. About 50% of farmers, irrespective of system, agreed to some extent with the postulate that the use of grazing, compared to non-grazing, will reduce the milk yield (Table 2). With the non-grazing farms, many of the farmers believed that grazing would clearly reduce the milk yield, whereas the organic farmers has the opposite belief that grazing would not cause a reduced milk yield. Farmers on the organic and conventional grazing farms agreed to a large extent with the last more general postulate that grazing has a positive image, as did a large proportion of the farmers practising non-grazing systems.

Around 50% of the grazing farms expected to some degree that new technology, such as automatic measurement of the amount of herbage, intake and cow activity, will stimulate the use of grazing (Table 3). On non-grazing farms, 32% expected that environmental legislation would have a major negative impact on grazing, while 16% expected that concern about animal welfare would have a major positive impact.

Table 2. Dairy farmers' degree of agreement with three postulates about grazing compared with non-grazing, % farms within each system.

Postulate	System	Total	Partly	Disagree	Significance <sup>1</sup>
Grazing will reduce milk yield	Conventional non-grazing	42	49	7	***
	Conventional grazing	19	54	27	
	Organic	10	47	43	
Grazing will reduce health problems	Conventional non-grazing	9	37	52	***
	Conventional grazing	45	41	14	
	Organic	76	18	4	
Grazing is positive for the image of dairy farming	Conventional non-grazing	36	43	18	***
	Conventional grazing	81	17	2	
	Organic	92	8	0	

1) Chi-square test of random distribution

Table 3. Dairy farmers' expectations in terms of grazing in 10 years' time, % farms within each system.

	System	Major	Some	None	Significance <sup>1</sup>
New technology will stimulate grazing	Conventional non-grazing	2	23	59	***
	Conventional grazing	10	34	37	
	Organic	10	43	29	
Increasing demand for 'Grass-milk'	Conventional non-grazing	9	43	35	***
	Conventional grazing	16	55	11	
	Organic	53	41	2	
Environmental legislation will reduce grazing	Conventional non-grazing	32	40	11	***
	Conventional grazing	26	37	21	
	Organic	10	39	41	
Animal welfare regulation will stimulate grazing	Conventional non-grazing	16	41	26	***
	Conventional grazing	35	45	8	
	Organic	51	33	8	

1) Chi-square test of random distribution

## Conclusions

The development towards large, intensive dairy units is based on a strategy without the use of grazing, due to logistical problems but also due to the negative expectations of farmers for the productivity in a pasture-based system. Some farmers (typically organic producers) have shown that some obstacles such as combining robot milking with grazing can be overcome, which might give inspiration to the development of systems and management tools for the intensive dairy farms.

# Herbage productivity and quality of mountain grassland under different forage management systems

Leto J., Bošnjak K., Perčulija G., Kutnjak H. and Vranić M.

University of Zagreb Faculty of Agriculture, Svetošimunska 25 10000 Zagreb, Croatia

Corresponding author: jleto@agr.hr

## Abstract

Our objective was to evaluate the effects of 4 defoliation practices on productivity and quality of grassland. Treatments were cattle grazing followed by sheep grazing (CS); cattle grazing (2 rotations) followed by one hay cut, and then cattle grazing for the rest of season (CHC); two hay cuts (spring and autumn) and cattle rotational grazing between hay cuts (HCH); one hay cut (spring) followed by cattle rotational grazing at the rest of growing season (HC). Available herbage mass was similar between the treatments (mean 9.75 t ha<sup>-1</sup>,  $P > 0.05$ ). The greatest rejected herbage mass was under CHC (2.37 t ha<sup>-1</sup>), and the lowest under HCH (0.71 t ha<sup>-1</sup>). The highest crude protein content (CP) was under CHC and CS (mean 202 g kg<sup>-1</sup>), and the lowest under HCH (165 g kg<sup>-1</sup>). A significant treatment × year interaction for CP was found ( $P < 0.01$ ). Only HC had the similar CP in all investigated years (mean 184 g kg<sup>-1</sup>,  $P > 0.05$ ). Acid detergent fibre content was similar at all treatments and years (mean 312 g kg<sup>-1</sup>). There were no significant differences between treatments in neutral detergent fibre content (NDF) (mean 488 g kg<sup>-1</sup>), but there were differences between years ( $P < 0.01$ ).

Key words: grassland, cutting, grazing, productivity, quality

## Introduction

Major problems in exploitation of semi-natural grasslands in the Republic of Croatia are uncontrolled grazing and cutting at late grassland maturity stages. Exploitation of such grasslands is generally not systematically organized, which results in low yields, poor forage quality (Vranić *et al.*, 2004) and grassland degradation. Baker *et al.* (1988) and Prigge *et al.* (1999) found differences in hay yield and quality between different grassland management systems. Our objective was to evaluate the effects of 4 defoliation practices on the productivity and quality of semi-natural grasslands.

## Materials and methods

The experiment was conducted over a 3-year period (2004-006) at the Faculty of Agriculture, University of Zagreb experiment station on brown acid soil (at 650 m altitude). N fertilizers were applied at annual rates of 38 kg N ha<sup>-1</sup> in March and 3 equal rates of 24 kg ha<sup>-1</sup> N after the first three rotations/cuts. P and K were applied at annual rates of 47.6 kg ha<sup>-1</sup> P and 135.3 kg ha<sup>-1</sup> K in March. In spring of 2004 four blocks of mountain semi-natural grassland, each consisting of 0.2 ha plots, were each divided into four 0.05 ha subplots, and four management treatments were randomly assigned to each subplot. The treatments were cattle grazing followed by sheep grazing (CS); cattle grazing (2 rotations) followed by one hay cut and then cattle grazing for the rest of season (CHC); two hay cuts (spring and autumn) and cattle rotational grazing between hay cuts (HCH); and one hay cut (spring) followed by cattle rotational grazing at the rest of growing season (HC). Prior to hay harvest (early bloom of dominant grasses) or grazing, 15 randomly selected 0.3 m<sup>2</sup> areas per subplot were hand clipped to a 5 cm cutting height. The clipped herbage was dried in a forced-air oven at 60 °C for 48 h and weighed to determine available herbage mass (AHM). The same way, rejected

herbage mass (RHM) was estimated after each grazing cycle. Changes in botanical composition of AHM were determined in 2006 in comparison with average botanical composition in 2003. Subsamples were hand-separated into grasses, legumes and forbs, oven-dried for 48 h at 60 °C and weighed. The grazing regime was imposed when the mean sward height was 17-20 cm and continued until a post-grazing height of 5 cm was attained for all treatments except CS (cattle grazing 20-10 cm following sheep grazing 10-5 cm). Grazing was applied for a maximum of 48 hours with 10 Charolais heifers and 35 Charolais ewes plus lambs, depending on the herbage available. The composite sample of available herbage mass for each subplot was ground to pass a 1 mm screen. Components of forage quality were estimated as follows: CP (Kjeldahl method, AOAC, 1990), ADF and NDF (Van Soest *et al.*, 1991). All data were subjected to analysis of variance using the MIXED procedure of SAS (SAS Institute, 1997).

Table 1. Rejected herbage dry matter mass and crude protein content of available herbage

Treatments	Rejected DM t ha <sup>-1</sup>			CP g kg <sup>-1</sup>				
	2004	2005	2006	Mean	2004	2005	2006	Mean
CHC	3.51	2.23	1.37	2.37a	206.46	212.65	184.02	201.04a
CS	2.66	1.52	1.41	1.87ab	208.23	198.93	203.01	203.39a
HC	1.38	1.75	1.02	1.39b	186.08	186.25	179.4	183.91b
HCH	0.59	1.04	0.52	0.71c	171.89	169.2	153.4	164.83c
Mean	2.04a	1.64b	1.08c		193.16a	191.75a	179.96b	

The differences between the values with the same letters are statistically insignificant at  $P = 0.05$ .

Table 2. Botanical composition in 2003 and 2006 (% grasses-G, legumes-L, forbs-F in AHM)

Treatments	2003			2006			Mean		
	G	L	F	G	L	F	G	L	F
CHC	93.3	0.17	6.53	75.45ab	6.45	18.10	84.38	3.31 b	12.32
CS	86.16	1.10	12.74	72.35ab	9.06	18.58	79.26	5.08 b	15.66
HC	89.72	0.11	10.17	62.81b	19.04	18.15	76.26	9.58a	14.16
HCH	84.33	0.91	14.75	77.31a	9.17	13.52	80.82	5.04 b	14.14
Mean	88.38	0.57	11.05	71.98	10.93	17.09			

The differences between the values with the same letters are statistically insignificant at  $P = 0.05$ .

## Results and discussion

Management treatments did not differ in AHM ( $P > 0.05$ ) (mean 9.75 t ha<sup>-1</sup>) whereas Prigge *et al.* (1999) had found that early spring grazing (1<sup>st</sup> spring grazing followed by a hay cutting, then late autumn grazing and 2<sup>nd</sup> early spring grazing followed by two hay cuttings) reduced hay yield compared to two hay cuttings and one hay cutting (spring) plus late autumn grazing. Significant differences were determined in the average annual AHM ( $P < 0.05$ ). In 2005, 10.9% more AHM (10.19 t ha<sup>-1</sup>) was found than in 2006 (9.19 t ha<sup>-1</sup>), probably due to higher annual precipitation and more favourable distribution of precipitation over the growing season. Treatments differed significantly in RHM ( $P < 0.01$ ) (Table 1). Treatments involving spring cutting (HC and HCH) rendered significantly less RHM compared to treatments with spring grazing (CHC and CS). A significant treatment  $\times$  year interaction ( $P < 0.01$ ) for RHM was found (Table 1), which indicated that treatments responded differently under various growing seasons. Only RHM for HCH was similar in all years ( $P > 0.05$ ). Treatments differed significantly in CP content ( $P < 0.01$ ). The highest CP content was recorded for CHC and CS, and the lowest for HCH (Table 1). Average CP content was significantly higher ( $P < 0.01$ ) in the first two years compared to the third research year. A significant treatment  $\times$  year interaction was found for CP ( $P < 0.01$ ). In all treatments, except for HC (mean 184 g kg<sup>-1</sup>), significant changes in CP were determined in different years. Significant differences in CP between treatments were also recorded within individual years ( $P < 0.01$ ), with the lowest CP

in the HCH treatment. Similar ADF content was found in all treatments and all research years ( $P > 0.05$ ) and was, on average,  $312 \text{ g kg}^{-1}$ . No differences between treatments were recorded for the NDF content ( $P > 0.05$ ) (average  $488 \text{ g kg}^{-1}$ ), but there were differences in average annual NDF contents ( $P < 0.01$ ). The lowest NDF content was recorded in 2004 ( $471 \text{ g kg}^{-1}$ ); it was 5.1% lower than the average NDF contents in 2005 and 2006. Average grass content in 2006 was reduced by 18.6%; the proportion of forbs increased by 54.7%, and the legume content was many- times higher compared to the botanical composition in 2003 ( $P < 0.01$ ). The significant treatment  $\times$  year interaction ( $P < 0.05$ ) for grass content was in part due to the fact that all treatments had similar grass content in 2003, but in 2006 grass contents of treatments HC and HCH were significantly different. Changes of botanical composition probably did not cause the differences in CP content that were obtained between treatments. Greater CP content in the herbage for treatments that included spring grazing was probably caused by grazing at an earlier stage of grassland maturity compared to treatments with spring hay cuts. Obtained results partly confirm the results of Prigge *et al.* (1999), who determined better quality of forage in treatments with spring grazing compared to the treatment with spring cutting.

## Conclusion

The treatment with spring cutting, especially the combination of spring and autumn cutting for hay, resulted in the best grassland use efficiency, but also in smaller CP content compared to treatments involving grazing.

## References

- AOAC (1990) *Official Methods of the Association of Analytical Chemists*, 15th ed., Vol. 2. AOAC, Arlington, Virginia, USA.
- Baker M.J., Prigge E.C. and Bryan W.B. (1988) Herbage production from hayfields grazed by cattle in fall and spring. *Journal of Production Agriculture* 1, 275-279.
- Prigge E.C., Bryan W.B. and Goldman-Innis E.S. (1999) Early- and late-season grazing of orchardgrass and fescue hayfields overseeded with red clover. *Agronomy Journal* 91, 690-696.
- SAS Institute (1997) *SAS/STAT software: Changes and enhancements through release*, 6.12., Cary, NC.
- Van Soest P.J., Robertson J.B. and Lewis B.A. (1991) Method for dietary fiber, neutral detergent fiber and nonstarch polysaccharides in relation to animal nutrition. *Journal of Dairy Science* 74, 3583-3597.
- Vranić M., Knežević M., Perčulija G., Leto J., Bošnjak K. and Rupić I. (2004) Forage quality on family farms in Croatia 2. Hay quality on family farms. *Mljekarstvo* 54, 3, 187-194.

## The effect of pasture herbage mass on dairy cow ruminal pH

Lewis E.<sup>1</sup>, Coughlan F.<sup>1</sup>, O'Donovan M.<sup>1</sup> and Wims C.<sup>1,2</sup>

<sup>1</sup>Teagasc, Moorepark Dairy Production Research Centre, Fermoy, Co. Cork, Ireland

<sup>2</sup>School of Agriculture, Food Science & Veterinary Medicine, University College Dublin, Belfield, Dublin 4, Ireland

Corresponding author: eva.lewis@teagasc.ie

### Abstract

The objective of this study was to investigate the effects of different herbage mass treatments on dairy cow ruminal pH. A systems study with three separate farmlets was established. The three treatments were i) low herbage dry matter (DM) mass [LM] (1000 kg ha<sup>-1</sup>), ii) medium herbage DM mass [MM] (1600 kg ha<sup>-1</sup>), iii) high herbage DM mass [HM] (2200 kg ha<sup>-1</sup>). Six lactating rumen-cannulated dairy cows were arranged into two 3 x 3 Latin squares. Each period lasted two weeks. Ruminal pH was measured on days 10 and 11 of each period by means of an indwelling rumen pH probe connected to a datalogger, which recorded ruminal pH every 60 seconds. There was no difference in the average ruminal pH of dairy cows grazing grass of three different herbage masses (LM = 5.90, MM = 6.09, HM = 5.98) or on the amount of time during which ruminal pH was less than pH 5.5 (LM = 187, MM = 43, HM = 216 min d<sup>-1</sup>). Further work is needed to expand the limited data available on ruminal pH in grazing dairy cows and to explore the mechanisms by which the low ruminal pH values seen in grazing systems are attained without the expected problems of lameness and reduced milk fat concentration.

Keywords: ruminal pH, grass, herbage mass, dairy cow

### Introduction

In Ireland, a grass-based system of milk production is the lowest cost system and confers a competitive advantage for milk production relative to other European producers (Thorne and Fingleton, 2005). Hence, exploiting the capacity for milk production from grazed grass remains a key objective for profitability in Irish dairying. The management of grassland swards can further affect productivity as demonstrated by O'Donovan and Delaby (2008) who illustrated that swards with higher herbage mass reduced the feeding value of grass and the DMI of grass. Murphy *et al.* (2008) also found that high mid-season sward quality was associated with higher milk protein %. This illustrates the importance of maintaining high quality pasture. However, it is also suggested that grazing high quality pasture can lead to low ruminal pH (Gibbs *et al.*, 2007). Ruminal pH is affected by a number of (often inter-related) factors including feed intake, feed type and composition and rumen conditions (Bramley *et al.*, 2008). Ruminal pH is cited as an important factor related to milk fat %, fibre degradation, nutrient absorption and overall cow health and welfare (Kleen *et al.*, 2003). Little information is available on the ruminal pH of grazing dairy cows due to the complexity of measurement at pasture; most of the information derives from work done with high grain diets. Hence, the objective of the current study was to investigate the effects of three different herbage mass treatments on dairy cow ruminal pH.

### Materials and methods

A systems study with three separate farmlets was established on 100% perennial ryegrass (*Lolium perenne* L.) swards at the Teagasc Moorepark research farm. The three treatments were i) low herbage dry matter (DM) mass [LM] (1000 kg ha<sup>-1</sup>), ii) medium herbage mass

[MM] (1600 kg ha<sup>-1</sup>) and iii) high herbage mass [HM] (2200 kg ha<sup>-1</sup>). The treatments operated for the duration of the grazing season (Apr-Oct). The stocking rate (2.9 cows ha<sup>-1</sup>) and post-grazing sward heights (4 cm) were the same for all three treatments. Grass was allocated on a daily basis and no supplementary feed was offered. All cows were milked twice daily. Twenty intact spring-calved dairy cows were allocated to each treatment. In addition, six lactating rumen-cannulated dairy cows were arranged into two 3x3 Latin squares. Thus two rumen-cannulated cows were allocated to each treatment for one two-week period, then rotated to a new treatment for the next two-week period, and finally to their third treatment for the last two-week period. The results presented here pertain to the performance of the rumen-cannulated cows in the autumn part of the grazing season (Aug-Oct). Ruminal pH was measured on days 10 and 11 of each period by means of an indwelling rumen pH probe. The rumen pH probe utilised was an Ionode IJ44 pH probe (Ionode Pty Ltd., Australia). It was maintained immersed in one location at the bottom of the rumen by a 1.5 kg stainless steel weight (Flyco, Ireland). Data on ruminal pH were logged at 1-minute (min) intervals over the 48-hour period using a Delta Ohm HD 2105.2 datalogger (Delta Ohm S.r.l., Italy). The datalogger was housed in a MuPack backpack (Cassidy Covers, Ireland) which was a foam-filled canvas saddle. Each MuPack was mounted on the shoulders and secured using two elasticised girth straps crossing under the cow's brisket. The datalogger was connected to the pH probe via a 2 m cable passing through a modified cannula bung (Bar Diamond, Inc., USA). Average ruminal pH across the day was calculated, as was the amount of time spent below certain pH thresholds (see table). Milk yield and composition and body weight and body condition score were measured each week for the duration of the study. The data were analysed as a 3 x 3 Latin square using the mixed procedure (PROC MIXED) of SAS with herbage mass treatment, experimental period, square, cow and their interactions included in the model.

Table 1. The effect of grazing different pasture herbage masses on rumen pH in lactating dairy cows.

	LM	MM	HM	s.e.	Significance
Average ruminal pH	5.90	6.09	5.98	0.057	NS
Time spent at ruminal pH < 5.2 (min d <sup>-1</sup> )	37	0	52	37	NS
Time spent at ruminal pH < 5.5 (min d <sup>-1</sup> )	187	43	216	46	NS
Time spent at ruminal pH < 5.8 (min d <sup>-1</sup> )	518	288	360	62	NS

## Results and discussion

The six rumen-cannulated dairy cows in this current study were on average 259 days in milk (s.d. 62 days) at the start of the study. There was no effect of treatment on milk production performance (LM 11.6 kg, MM 11.8 kg, HM 11.6 kg, s.e. 0.71 kg,  $P > 0.05$ ). Milk composition was also not affected by treatment with milk fat concentration showing no evidence of being depressed on any treatment (LM 4.6%, MM 4.4%, HM 4.2%, s.e. 0.08%,  $P > 0.05$ ). There was no difference in the average ruminal pH of dairy cows when they grazed grass of three different herbage masses ( $P > 0.05$ , see table). In addition, no effect of treatment was found on the amount of time during which ruminal pH was less than pH 5.2, pH 5.5 or pH 5.8 ( $P > 0.05$ , see table). In comparison to data derived from lactating dairy cows on high grain diets, it appears that the ruminal pH of grazing dairy cows could be lower and the time they spend below certain thresholds greater. For example, Nocek *et al.* (2002) found that lactating dairy cows offered a total mixed ration diet spent 120 min d<sup>-1</sup> below pH 5.5, in comparison with up to > 200 min d<sup>-1</sup> in the current study. The data presented here agree with the low ruminal pH values suggested by Gibbs *et al.* (2007) who reported that grazing dairy cows in their study spent up to 20% of some trial periods at pH < 5.5. The



results here also suggest no detrimental effects on milk fat concentration of long periods of time spent at pH < 5.5. Unlike in high grain feeding scenarios where low ruminal pH is associated with depressed milk fat concentrations, impaired fibre digestibility and laminitis (Kleen *et al.*, 2003) the negative implications of low ruminal pH in grazing dairy cows are not as obvious (Kolver and de Veth, 2002). Kolver and de Veth (2002) speculated that this may be related to a number of factors including the fermentable nature of pasture carbohydrate, the fatty acid composition of pasture, the absence of starch in pasture and the low lactic acid production on pasture-based diets.

## Conclusions

In the current study, although recorded dairy cow ruminal pH was low, herbage mass did not have an effect on the levels. Further work is needed to expand on the very limited data available for grazing dairy cows, and to explore the mechanisms by which the low ruminal pH values seen in grazing systems are attained without the concomitant and expected problems in terms of lameness and milk fat concentration.

## Acknowledgements

The authors gratefully acknowledge the Dairy Levy Research Fund for financial support, the assistance of Theo Haezebrouck with sample collection and preparation, and the ongoing help and co-operation of John Paul Murphy and the Moorepark farm staff.

## References

- Bramley E., Lean I.J., Fulkerson W.J., Stevenson M.A., Rabiee A.R. and Costa N.D. (2008) The definition of acidosis in dairy herds predominantly fed on pasture and concentrates. *Journal of Dairy Science* 91, 308-321.
- Gibbs J., Laporte-Urbe J., Trotter C. and Noel J. (2007) Rumen function and lameness in pasture-based dairy cows of the South Island of New Zealand. *Journal of Dairy Science* 90 (Suppl. 1), 655 (Abstract).
- Kleen J.L., Hooijer G.A., Rehage J. and Noordhuizen J.P. (2003) Subacute ruminal acidosis (SARA): a review. *Journal of Veterinary Medicine Series* 50 (8), 406-414.
- Kolver E.S. and de Veth M.J. (2002) Prediction of ruminal pH from pasture-based diets. *Journal of Dairy Science* 85, 1255-1266.
- Murphy J.J., Kavanagh S., Patton J. and Maher J. (2008) Factors affecting mid season milk protein content. In: *Proceedings of the Teagasc National Dairy Conference*, Cork and Athlone, Ireland, 26-27 November, pg. 80-85.
- Nocek J.E., Allman J.G. and Kautz W.P. (2002) Evaluation of an indwelling ruminal probe methodology and effect of grain level on diurnal pH variation in dairy cattle. *Journal of Dairy Science* 85, 422-428.
- O'Donovan M. and Delaby L. (2008) Sward characteristics, dry matter intake and milk production performance is affected by timing of spring grazing and subsequent stocking rate. *Livestock Production Science* 115, 158-168.
- Thorne F. and Fingleton B. (2005) Irish dairy farming – can we compete. In: *Proceedings of the National Dairy Conference*, Wexford and Cavan, Ireland, 16-17 November, pp. 10-24.

## Patterns of sward height reduction in a tropical pasture grazed by dairy cows

Mezzalira J.C.<sup>1</sup>, Carvalho P.C.F.<sup>1</sup>, Amaral M.F.<sup>1</sup>, Bremm C.<sup>1</sup>, Da Trindade J.K.<sup>1</sup>, Gonçalves E.N.<sup>1</sup>, Martins R. S.<sup>2</sup> and Genro T.C.M.<sup>2</sup>

<sup>1</sup> *Grazing Ecology Research Group, Federal University of Rio Grande do Sul, Brazil.*

<sup>2</sup> *The Brazilian Agricultural Research Corporation (EMBRAPA), EMBRAPA South Animal Husbandry and Sheep, Brazil.*

Corresponding author: mezzalirajc@gmail.com

### Abstract

The aim of this experiment was to study the changes on sward height and herbage intake measured during grazing of dairy cows on a pearl millet (*Pennisetum glaucum* (L.) R. Br.) pasture under a rotational grazing system. The treatments (60-20; 60-10; 40-20; 40-10) consisted of the combination of two pre-grazing (60 and 40 cm) and two post-grazing (20 and 10 cm) sward heights. Measurements of sward height were made every 10 minutes along the grazing periods with 60 minutes duration. For the sward height reduction, treatment 60-10 seems to be the management strategy that most constrains the animals' grazing. Bite rate did not differ among treatments. The highest intake rate was observed in the treatment 60-20, which indicates that this management strategy is the best for dairy cows in a pearl millet pasture.

Key words: bite rate, *Pennisetum glaucum*, grazing strategies, sward structure

### Introduction

The dry matter intake (DMI) is considered to be the main constraint of animal production in pastures (Kertz *et al.*, 1991). To explain the typical low DMI associated with C<sub>4</sub> forage species, Silva and Carvalho (2005) have argued that the nutritive value of forage has been overestimated in the tropics/subtropics. According to these authors, the forage apprehension relationship to the ingestive behaviour could explain most of the herbage intake in these pastures.

It is important to understand how animals influence, and are influenced by, pasture structural characteristics, and how those variables influence the herbage intake rate. Therefore, pastoral environments could be created for farmers who aim to not limit the animals' grazing strategies (Provenza and Launchbaugh, 1999) enhancing their actions during the process of searching and selecting pastures (Carvalho *et al.*, 2001).

The aim of this experiment was to study the changes on sward height and herbage intake measured during grazing of dairy cows on a pearl millet (*Pennisetum glaucum* (L.) R. Br.) pasture under a rotational grazing system.

### Materials and methods

The study was conducted at the EMBRAPA South Animal Husbandry and Sheep, Bagé, RS, Brazil. The pearl millet pastures (*Pennisetum glaucum* (L.) R. Br.) were established in January 2008, in a no-till system. Measurements began in March 2008 and the paddocks were grazed by four Holstein cows with mean weight of 450 ± 20 kg.

The treatments (60-20; 60-10; 40-20 and 40-10) consisted of combinations between two pre-grazing (60 and 40 cm) and two post-grazing (20 and 10 cm) sward heights. The experimental design was a randomized block with four replicates (two in space and two in time). The

grazing time during the day (morning and afternoon) was blocked. The paddocks size of each treatment calculated for the grazing period did not exceed 60 minutes.

The sward height was estimated by 30 measurements using a sward stick before and after grazing and in intervals of ten minutes to characterize the sward height reduction during the grazing period.

The short-term intake rate was determined by measuring pre- and post-grazing weight of cows corrected for insensible weight losses. The dry matter (DM) intake rate (IR) per metabolic weight (MW) ( $\text{g kg}^{-0.75} \text{min}^{-1}$ ) was calculated by the following formula:  $\text{IR} = [(\text{DMIR MW}^{-1}) \text{ET}^{-1}]$ , where: IR is intake rate, DMIR is dry matter intake rate (g of DM per animal), ET is the eating time excluding the periods of the inactivity  $> 3 \text{ s.}$ , and MW is the metabolic weight = (live weight) $^{0.75}$ . The bite mass ( $\text{mg bite}^{-1} \text{kg}^{-0.75} \text{MW min}^{-1}$ ) was calculated by the following formula:  $\text{BM} = (\text{IR } 1000^{-1} \text{BR}^{-1})$ , where BM is bite mass and BR is bite rate ( $\text{min}^{-1}$ ).

Recordings were analysed using the GRAZE™ Software (Ultra Sound Advice, UK; Rutter, 2000) to determine total time spent grazing (G; included biting and non-biting jaw movements and intra meal intervals  $< 5 \text{ min}$ ).

Bite rate represented the ratio between number of bites and bite rate. Bite mass was calculated by the ratio between short-term intake rate and bite rate. Paddock groups of four cows were used as the experimental unit. A repeated-measures ANOVA with measurement dates as repeated effect was used, as well as regression analysis using the SAS® Software.

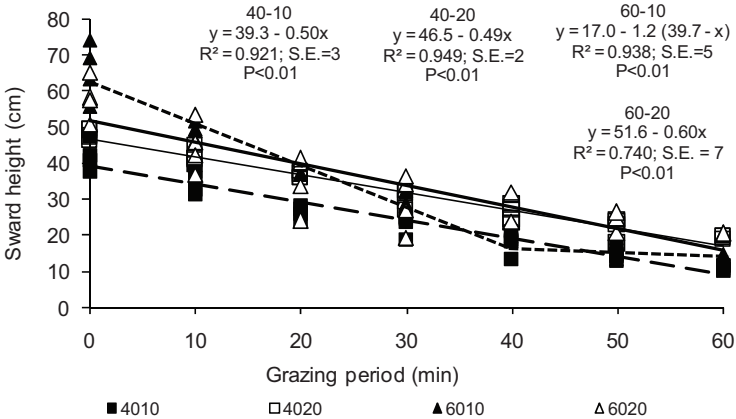

Figure 1: Sward height (cm) throughout the grazing period in pastures of *Pennisetum glaucum* (L.) R. Br. grazed by dairy cows under rotational stocking strategies (treatments: 60-20 (Δ), 60-10 (▲), 40-20 (◻) and 40-10 (■))

**Results and discussion**

The sward height reduction during the grazing period is shown in Figure 1. The treatments 40-10, 40-20 and 60-20 presented similar decreasing rate ( $\text{cm min}^{-1}$ ) during the grazing period. On the other hand, in the treatment 60-10 the animals reduced the sward height during the first 39.7 minutes of grazing in a high decreasing rate ( $1.2 \text{ cm min}^{-1}$ ). From this period to the end of all grazing time the sward height remained constant at 17 cm. This result indicates the important constraints to grazing created by this management strategy.

Bite rate did not differ among treatments and was observed to be 39 bites  $\text{min}^{-1}$ . Bite mass exhibited higher values in treatments with 20 cm post-grazing sward height ( $12.9 \text{ mg bite}^{-1} \text{kg}^{-0.75} \text{min}^{-1}$ ) than at 10 cm post-grazing sward height treatments ( $11.4 \text{ mg bite}^{-1} \text{kg}^{-0.75} \text{min}^{-1}$ ).

The treatment 60-20 presented higher short-term DM intake rate ( $0.53 \text{ g kg}^{-0.75} \text{ min}^{-1}$ ) as compared to the other treatments ( $0.42 \text{ g kg}^{-0.75} \text{ min}^{-1}$ ).

These results clearly indicate how grassland management strategy can influence animal response in a rotational system and how these contrasting structures interfere with herbage intake (Carvalho *et al.*, 2009). It is expected that animals will obtain high intake rates at highest initial sward height.

## Conclusion

Lower post-grazing structures can constrain animals' intake. For dairy cows grazing pearl millet the best sward height seems to be 60-20 cm for pre- and post-grazing strategy, respectively.

## References

- Carvalho P.C.F., Trindade J.K., Mezzalira J.C., Poli C.H.E.C., Nabinger C., Genro T.C.M. and Gonda H.L. (2009) From the bite to precision grazing: understanding the plant-animal interface to exploit the multi-functionality of grasslands. *Brazilian Journal of Animal Science* 38, 109-122.
- Carvalho P.C.F., Ribeiro Filho H.M.N., Poli C.H.E.C., Moraes A. and Delagarde R. (2001) Importância da estrutura da pastagem na ingestão e seleção de dietas pelo animal em pastejo. In: *Reunião anual da sociedade brasileira de zootecnia*, 38, Piracicaba. A produção animal na visão dos brasileiros. Piracicaba 1, 853-871.
- Kertz A.F., Reutzel L.F. and Thomson O.M. (1991) Dry matter intake from parturition to midlactation. *Journal of Dairy Science* 74, 2290-2295.
- Provenza F.D. and Launchbaugh K.L. (1999) Foraging at the edge of chaos. In: Launchbaugh K.L., Mosley J.C. and Sanders K.D. (ed.) *Grazing Behaviour and Wildlife*. University of Idaho, pp.1-12.
- Rutter S.M. (2000) A program to analyze recordings of the jaw movements of ruminants. *Behaviour Research Methods, Instruments and Computers* 32, 86-92.
- Silva S.C. and Carvalho P.C.F. (2005) Foraging behaviour and herbage intake in the favourable tropics/sub-tropics. In: McGilloway D.A. (ed.) *Grassland: a global resource*. Wageningen Academic Publishers, pp.81-95.

## Beef fattening on grazed leys: interest of tall fescue

Mosimann E.<sup>1</sup>, Schmied R.<sup>2</sup> and Thomet P.<sup>2</sup>

<sup>1</sup>Research Station Agroscope Changins-Wädenswil (ACW), CH-1260 Nyon, Switzerland

<sup>2</sup>Swiss College of Agriculture (SHL), CH-3052 Zollikofen, Switzerland

Corresponding author: eric.mosimann@acw.admin.ch

### Abstract

Experiments were conducted at four sites from 2007 to 2009 comparing two grass-clover mixtures (dominant grass: M1 perennial ryegrass; M2 tall fescue) grazed by young cattle. During the first two years, annual DM yield exceeded 12 t y<sup>-1</sup>. Under dryer conditions, in 2009, M2 grew better than M1. Sward height and organic matter digestibility of both mixtures were similar, resulting in comparable animal performance. Tall fescue was shown to be a promising component for creation of pastures in dry conditions.

Keywords: grass-clover mixtures, grazing, *Festuca arundinacea*, meat production

### Introduction

Many holders of small dairy herds seek diversification. Beef fattening on grazed grass-clover mixtures presents advantages, such as utilisation of existing infrastructures, positive effect of leys on soil fertility, enjoyment of having cattle and complementary income. The new Swiss tall fescue (*Festuca arundinacea* Schreb.) variety Belfine, which has soft leaves, should be appropriate for grazing under dry conditions. This assumption justified the following experiment which aimed to assess its use in a grass-clover mixture grazed by young cattle and to compare it with a mixture of perennial ryegrass (*Lolium perenne* L.) and white clover.

### Materials and methods

Trials were conducted on four farms: Sugiez (430 m a.s.l.), Chevroux (480 m a.s.l.), Moudon (560 m a.s.l.) and St-Urbain (520 m a.s.l.). The first three farms are situated in a relative dry region with less than 1000 mm y<sup>-1</sup> rainfall. The experiment was able to be carried out in 2007 on each site; in 2008 on the first three ones, and in 2009 it could be maintained only in Moudon. In summer 2006, two grass-clover mixtures were sown side by side on 1.2 to 1.5 ha paddocks. Their main grass component was perennial ryegrass for M1 and tall fescue cv. Belfine for M2.

Twenty young cattle from diverse breeds were distributed evenly according to their weight on both mixtures. The carrying capacity was then kept to the same level on both paddocks. Continuous grazing was managed by cutting a part of the surface in spring time and removing the heavier animals during summer. N fertilisation was 4 x 30 kg ha<sup>-1</sup> y<sup>-1</sup>. Vegetation was monitored with the following measurements:

- On the whole grazed area: botanical composition (Daget and Poissonet, 1969) and grass height (plate pasture meter Jenquip®).
- On two fenced plots inside each paddock, alternatively cut every two weeks: grass growth (Corrall and Fenlon, 1977) and organic matter digestibility (Scehovic, 1991).

### Results and discussion

At the beginning of the trial in Sugiez, M2 grasses did not establish, but tall fescue could be successfully over-sown in March 2007. With this exception, the botanical composition was well balanced (Fig. 1). White clover proportion ranged between 20% and 40%, considered as

adequate for grazing (Pflimlin, 1993). Tall fescue covered approximately half of the biomass of M2 grasses, in good balance with the ryegrass.

The linear regression with 125 pairs of measurement gives equal sward heights in paddocks M1 and M2 ( $R^2 = 0.84$ ). A classification per period (Table 1) indicates that M2 had a higher grass cover in autumn than M1. Considered as an optimal forage ability (Thomet *et al.*, 2004), 3.5 to 5 cm plate pasture height was generally exceeded, leading to grazing control difficulties and to fodder losses. In Moudon, a high grazing pressure in spring and drought in summer 2009 explain the opposite tendency, with a lack of fodder. These observations on the whole grazed area were confirmed by yield measurement on small fenced plots.

Due to regular rainfall, the annual dry matter (DM) production of both mixtures was high in 2007 and 2008 (Table 2). Pastures exceeding  $12 \text{ t ha}^{-1} \text{ y}^{-1}$  of DM are considered as the most productive in Switzerland. Yield decrease during the years was more important for M1 than for M2, indicating that tall fescue fits for long duration leys. The growth dynamic followed the usual tendency with a peak in spring and a depression in summer (Table 2). In summer, growth DM rates higher than  $60 \text{ kg ha}^{-1} \text{ d}^{-1}$  confirm the good yielding-capacity of grass-legumes mixtures and correspond to the best pasture production on the Swiss lowland. Results from 2009 in Moudon show that M2 offers promising perspectives in dry conditions.

The organic matter digestibility analysed in 2007-2008 was similar for both mixtures (Table 2). Considering these values and the grass height results, it can be concluded that palatability of M2, i.e. tall fescue, was comparable with that of M1.

Results of the monthly weighing of the animals confirmed that the mixture type did not influence their performance. In spite of low weight gains ( $760 \text{ g d}^{-1}$  on average), a productivity of 1200 kg of meat per hectare was reached, generating gross margins higher than those of wheat.

Table 1. Grass height measured with a plate pasture meter in three sites (cm)

Grazing Period	Sugiez		Chevroux				Moudon							
	2007		2008		2007		2008		2007		2008		2009	
	M1	M2	M1	M2	M1	M2	M1	M2	M1	M2	M1	M2	M1	M2
Turnout	*	*	7.3	6.4	5.9	6.8	6.1	5.6	8.6	7.4	4.8	5.7	4.0	5.0
Spring	6.7	6.6	7.0	6.9	7.9	8.0	8.0	8.1	9.9	8.6	8.6	8.5	4.3	4.9
Summer	5.2	5.5	4.1	4.7	5.0	5.1	4.6	4.2	8.5	7.8	5.5	5.0	4.5	4.8
Autumn	3.1	3.4	2.6	3.3	4.0	3.9	3.4	3.6	5.7	6.2	3.9	3.9	2.8	3.1

\* no measurement

Table 2. Fodder production of grass-clover mixtures M1 and M2 at four sites

Site	Sugiez		Chevroux		Moudon		St-Urban			
	M1	M2	M1	M2	M1	M2	M1	M2		
Grass-clover mixture matter yield ( $\text{t ha}^{-1} \text{ y}^{-1}$ )	2007		13.4	11.7	13.7	13.5	14.5	14.4	15.9	15.7
	2008		10.2	12.2	12.9	13.3	13.4	14.3	*	*
	2009		*	*	*	*	9.2	10.7	*	*
Daily dry matter grass growth ( $\text{kg ha}^{-1} \text{ d}^{-1}$ )	Spring 2007		97	82	81	69	82	72	87	91
	Summer 2007		65	66	73	79	68	72	66	67
	Spring 2008		97	110	97	104	90	98	*	*
	Summer 2008		35	51	73	64	59	68	*	*
	Spring 2009		*	*	*	*	67	85	*	*
	Summer 2009		*	*	*	*	37	44	*	*
Organic matter digestibility (%)	Spring 2007		82	83	81	82	81	80	77	78
	Summer 2007		77	79	77	77	74	75	78	78
	Spring 2008		80	79	82	79	80	80	*	*
	Summer 2008		79	78	79	76	79	81	*	*

\* no measurement

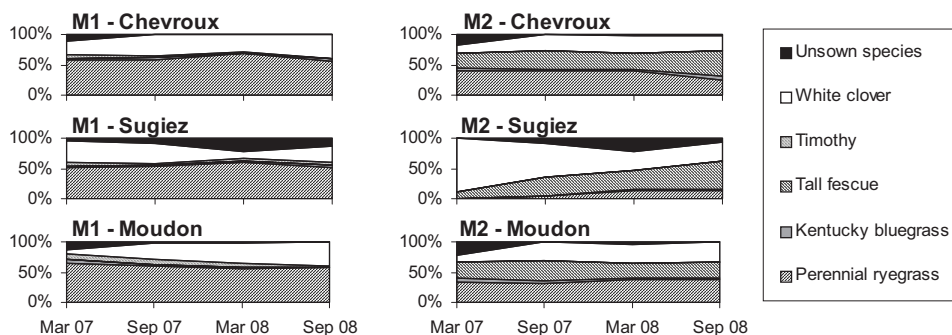

Figure 1. Botanical composition (%) of mixtures M1 and M2 in three sites in 2007 and 2008

## Conclusion

Tall fescue cv. Belfine is appropriate as a component in grass-clover mixtures for grazing. In comparison with perennial ryegrass, it has the following advantages: higher yielding capacity in summer, and better persistence over three years. No differences in terms of the digestibility of organic matter and the cattle intake could be observed.

## References

- Corral A.J. and Fenlon J.S. (1977) A comparative method for describing the seasonal distribution of production from grasses. *Journal of Agricultural Sciences, Cambridge* 91, 61-67.
- Daget P. and Poissonet J. (1969) Analyse phytologique des prairies. *CNRS Montpellier* 48, 67 pp.
- Pflimlin A. (1993) Conduite et utilisation des associations graminées-trèfle blanc. *Fourrages* 135, 407-428.
- Scehovic J. (1991) Considérations sur la composition chimique dans l'évaluation de la qualité des fourrages des prairies naturelles. *Revue suisse d'Agriculture* 23 (5), 305-310.
- Thomet P., Blättler T., Aeby P. and Mosimann E. (2004) Pâturage des vaches laitières: conduite de la pâture – objectifs et contrôle. *Information ADCF*, 2 pp.



# The effects of the nitrification inhibitor dicyandiamide (DCD) on herbage production when applied at different times and rates in the autumn and spring

O'Connor P.J.<sup>1,2</sup>, Hennessy D.<sup>1</sup>, O'Donovan M.<sup>1</sup> and Lynch B.<sup>2</sup>

<sup>1</sup>Teagasc, Moorepark Dairy Production Research Centre, Fermoy, Co. Cork, Ireland

<sup>2</sup>UCD School of Agriculture, Food Science and Veterinary Medicine, Belfield, Dublin 4, Ireland

Corresponding author: Patrick.OConnor@teagasc.ie

## Abstract

Nitrification inhibitors have been proposed as management tools to reduce nitrate (NO<sub>3</sub><sup>-</sup>) leaching and denitrification, as well as increasing the availability of nitrogen (N) for the growing sward (Serna *et al.*, 1995). The objective of this experiment was to observe the effects, if any, of DCD on herbage production when applied at different times and rates in the autumn and winter. A randomised block design experiment with three replicates of each treatment was conducted at two sites - Moorepark (MPK) and Ballydague (BD). The soils were: (1) a free-draining acid brown earth of sandy loam to loam in texture at MPK, and (2) a moderate to heavy brown earth of sandy loam texture with evidence of an iron pan at BD. Swards were predominantly perennial ryegrass. Annual precipitation was 1052 mm in 2008 and 1293 mm in 2009. The factors that were tested in this experiment were as follows: urine application, fertiliser application, DCD rate and time application. Annual herbage production was significantly increased at both sites when fertiliser was applied ( $P < 0.001$ ). There was a significant effect ( $P < 0.01$ ) of urine application on annual herbage production at MPK and for the November treatment only at BD. There was no significant effect of DCD rate or application time on annual herbage production at either site.

Keywords: herbage mass, nitrification inhibitor, urine patch

## Introduction

Nitrification inhibitors such as dicyandiamide (DCD) have been shown to reduce NO<sub>3</sub><sup>-</sup> leaching and nitrous oxide (N<sub>2</sub>O) emissions (Moir *et al.*, 2007). A study by Di and Cameron (2002) has shown that DCD can potentially increase spring herbage production by up to 33%. Dicyandiamide slows the conversion of ammonium (NH<sub>4</sub><sup>+</sup>) to nitrate (NO<sub>3</sub><sup>-</sup>) in the soil by interfering with *Nitrosomonas* bacteria, which are responsible for the first step in the nitrification process (Serna *et al.*, 1995). By slowing the conversion of NH<sub>4</sub><sup>+</sup> to NO<sub>3</sub><sup>-</sup>, the loss of N from the soil is reduced. Nitrate is readily taken up by growing plants, but if there is a surplus of NO<sub>3</sub><sup>-</sup> available (e.g. when plant growth slows in winter or under urine patches) it is likely to be lost through leaching. Dicyandiamide is most effective at reducing nitrification at low temperatures (e.g. in winter), and so when nitrification occurs in spring after a period of inhibition, the availability of N can potentially result in increased herbage production. Urine patches account for 25% of paddock surface and provide a substantial source of N to grazing swards (1000 kg ha<sup>-1</sup> N). In Ireland, fertiliser N is applied at rates between 170 and 250 kg ha<sup>-1</sup> to grazed swards and dairy animals deposit urine on these swards. The objective of this experiment was to examine the effect of DCD rate and time of application on herbage production in spring and annually on swards receiving 0 or 350 kg ha<sup>-1</sup> N with and without urine application.

## Materials and methods

The experiment was undertaken at Teagasc Moorepark Dairy Production Research Centre, Fermoy, Co. Cork on two contrasting soil types. The soils were: (1) a free-draining acid brown earth, of sandy loam to loam in texture, at Moorepark (MPK), and (2) a moderate to heavy brown earth of sandy loam texture with evidence of an iron pan, at Ballydague (BD). Swards at both sites were predominately perennial ryegrass (PRG; *Lolium perenne*). The swards were divided into 168 plots. The plots were 5 m x 1.5 m at MPK and 5 m x 1 m at BD. The experiment had a 2 x 2 x 2 x 3 x 2 factorial arrangement plus 8 controls. Treatments were as follows: two annual fertiliser levels (0 or 350 kg ha<sup>-1</sup> N); two urine rates (0 or 1000 kg ha<sup>-1</sup> N); two timings of DCD application immediately after urine application or immediately after urine application and 90 days later; three times of urine application (September, October, November); two rates of DCD (5 or 10 kg ha<sup>-1</sup>). The 8 controls were a zero control, fertiliser only control, urine applied in September, October, November with zero DCD and 0 or 350 kg ha<sup>-1</sup> N. Treatments were replicated 3 times at each site. The treatments were applied in autumn/winter 2008 and measurements were undertaken in 2009. Simulated dairy cow urine was applied at a rate of 1000 kg ha<sup>-1</sup> N as a single deposition using 10 litre watering cans with rose caps. Dicyandiamide was applied at rates of 5 and 10 kg ha<sup>-1</sup> to designated plots within 24 hours of urine application as a fine particle suspension (FPS) using a walk behind motor operated sprayer. Ninety days following the first application DCD, 5 or 10 kg ha<sup>-1</sup> was again applied to half the plots that initially received DCD at those rates. Fertiliser N was applied to half the plots in the form of calcium ammonium nitrate (CAN) at a rate of 350 kg ha<sup>-1</sup> year<sup>-1</sup> N. Fertiliser was applied in mid-January and following defoliation from March to mid-September. Herbage was harvested every 4 weeks from February to November to simulate typical grazing practice using an Agria mower at MPK and using a lawnmower at BD. Cut herbage was weighed and a sub-sample (100 g) was dried at 40 °C for 48 hours to determine dry matter (DM) yield. Data were analysed using PROC MIXED in SAS. Data for each site were analysed separately. The fixed effects included fertiliser, urine, DCD rate and time of DCD application. The dependent variable examined was herbage yield.

## Results and discussion

Average annual herbage DM production was 10514 kg ha<sup>-1</sup> at MPK and 6081 kg ha<sup>-1</sup> at BD. There was no significant effect of DCD on spring or annual herbage production at either site (Table 1). Urine application increased herbage mass at MPK compared to when no urine was applied. Average annual herbage DM production was increased by 2014 kg ha<sup>-1</sup> when urine was applied at MPK and 639 kg ha<sup>-1</sup> at BD compared to when no urine was applied. Applying urine in September, October and November increased herbage production by proportions of 0.12, 0.20 and 0.20, respectively, compared to when no urine was applied in MPK. In MPK, applying urine in November significantly ( $P < 0.001$ ) increased annual herbage mass compared to applying urine in September (Table 2). Urine application significantly increased herbage mass in November at BD compared to when no urine was applied. Fertiliser N significantly increased herbage production ( $P < 0.001$ ) at both sites. Average annual herbage DM production was increased by 5677 kg ha<sup>-1</sup> when fertiliser was applied compared to when it was not applied at MPK, and by 2136 kg ha<sup>-1</sup>, when fertiliser was applied at BD compared to when it was not applied.

It is not clear why the DCD did not have an effect on herbage production. However, high rainfall during autumn and winter 2008/2009 (89.9, 113.2, 65.6, 50.1, 193.7, and 15.6 mm in September, October, November, December, January and February respectively) may have washed the DCD and N beyond the rooting zone. The DCD may still have been effective in inhibiting the conversion of NH<sub>4</sub><sup>+</sup> to NO<sub>3</sub><sup>-</sup> but the N was not available for herbage production.

## Conclusion

Urine application and fertiliser application both increased herbage production at both sites. The application of DCD at the times examined was not effective in increasing herbage production.

Table 1. The effect of DCD applied at two rates (5 or 10 kg ha<sup>-1</sup>) in September, October or November and in September, October and November with a second application 90 days later (September +90, October +90 or November +90) plus zero DCD control for September, October and November on mean annual herbage DM production (kg ha<sup>-1</sup>) in 2009 at Moorepark and Ballydague.

	Moorepark				Ballydague			
	0	5	10	Sig	0	5	10	Sig
September	10591	9981	10125	n.s	5405	6555	5690	n.s
October	9653	10304	10646	n.s	5265	5106	5561	n.s
November	10875	11314	10763	n.s	6352	6240	6495	n.s
September + 90	10591	9969	10466	n.s	5405	6256	6060	n.s
October + 90	9653	10597	10674	n.s	5265	6561	5684	n.s
November + 90	10875	10910	11103	n.s	6352	6598	6508	n.s
s.e.m.	23.92				12.73			

s.e.m. = standard error of the mean

n.s. = Non significant

Table 2. The effect of urine application on mean annual herbage DM mass (kg ha<sup>-1</sup>) in 2009 at Moorepark and Ballydague when applied or not applied in September, October or November.

	Moorepark			Ballydague		
	Urine	No Urine	Sig	Urine	No Urine	Sig
September	10783	9439	**	6357	5805	n.s
October	11583	9218	**	5731	5596	n.s
November	11851	9519	**	6934	5705	**
s.e.m.	23.79			12.63		

s.e.m. = standard error of the mean

n.s. = Non significant

\*\* =  $P < 0.01$

## References

- Di H.J. and K.C. Cameron (2002) The use of a nitrification inhibitor, dicyandiamide (DCD), to decrease nitrate leaching and nitrous oxide emissions in simulated grazed and irrigated grassland. *Soil Use and Management* 18(4), 395-403.
- Moir J.L., Cameron K.C and Di H.J. (2007) Effects of the nitrification inhibitor dicyandiamide on soil mineral N, pasture yield, nutrient uptake and pasture quality in a grazed pasture system. *Soil Use and Management* 23(2), 111-120.
- Serna M., Legaz F. and Primo-Millo E. (1995) Improvement of the N fertilizer efficiency with dicyandiamide (DCD) in citrus trees. *Nutrient Cycling in Agroecosystems* 43, 137-142.

# Substitution rate and milk response to maize silage supplementation of dairy cows grazing low-mass pastures

Pérez-Prieto L.A.<sup>1</sup>, Peyraud J.L.<sup>1</sup> and Delagarde R.<sup>1</sup>

<sup>1</sup>INRA, UMR1080 INRA Agrocampus Ouest Production du lait, F-35590 Saint-Gilles, France

Corresponding author: Lucio.perez@rennes.inra.fr

## Abstract

When extending the grazing season into autumn, the grazing of low-mass pastures is almost inevitable, potentially limiting pasture availability and animal performance. An experiment was carried out to determine the substitution rate and the milk response to maize silage (zero vs. 8 kg d<sup>-1</sup> of dry matter (DM) of a mixture of 7/1 of maize silage and soyabean meal) of dairy cows grazing low-mass swards at two pasture allowances (low = 18 vs. high = 30 kg cow<sup>-1</sup> d<sup>-1</sup> DM above 2.5 cm). Twelve multiparous Holstein cows in late lactation, producing 18 kg FCM at the beginning of the experiment, were used in a 4 × 4 Latin square design during four 14-d periods. Pregrazing pasture DM mass, platometer height and OMD of the pasture were 1780 kg ha<sup>-1</sup>, 6.3 cm and 0.62, respectively. Maize silage supplementation decreased pasture DM intake by 4.0 and 5.8 kg d<sup>-1</sup> at low and high pasture allowance, respectively (substitution rate: 0.51 vs. 0.75). Milk response averaged + 0.67 kg of milk per kg of supplement, whatever the pasture allowance was. The low substitution rate combined with the high milk response suggests that energy intake from pasture was restricted. This restriction seems more related to the low quality than to the low mass of the pasture.

Keywords: dairy cow, grazing, pasture intake, low-mass pasture, substitution rate

## Introduction

In dairy systems, it is widely accepted that grazed pasture reduces feed costs. One way to increase grazed pasture in the annual diet of dairy cows is the extension of the grazing season e.g. in autumn. Pasture growth during this period is generally low and grazing low-mass pastures with forage supplementation is usually done. In strip-grazing systems, milk response (0.4 – 1.0 kg kg<sup>-1</sup> DM of forage) and the level of substitution between pasture and forage (0.2 – 0.8) are globally known in medium- to high-mass pastures (Stockdale, 2000; Morrison and Patterson, 2007; Burke *et al.*, 2008). However, this information is virtually non-existent for cows grazing low-mass pastures. The objective of the present study was to determine the effect of pasture allowance (PA) and of maize silage supplementation on pasture intake of strip-grazing dairy cows when grazing low-mass pastures in autumn.

## Materials and methods

Two pasture allowances (low = 18 vs. high = 30 kg cow<sup>-1</sup> d<sup>-1</sup> DM above 2.5 cm) and 2 supplementation levels (zero vs. 8 kg d<sup>-1</sup> DM) were compared in a 2 × 2 factorial design. The supplement (6.85 MJ NE<sub>L</sub> and 116 g CP per kg DM) was a 7/1-mixture on DM basis of maize silage and soyabean meal and was individually offered to the cows everyday after the a.m. milking (between 7:30 h and 9:00 h). Twelve multiparous Holstein-Friesian dairy cows were used in a 4 × 4 Latin square design during 4 successive periods of 14 days in September and October 2008. The cows were allocated into 4 groups according to their pre-experimental characteristics (230 days in milk, 18 kg FCM, bodyweight 593 kg) measured in a pre-experimental period of 3 weeks. During this period, the cows grazed non experimental pasture day and night and the supplementation, i.e. 5 kg DM of maize silage, 3 kg DM of grass silage

and 2.7 kg DM of concentrate was reduced gradually to 4.5 kg DM of maize silage and 0.5 kg DM of soyabean meal. The experiment was carried out on perennial ryegrass (*Lolium perenne* L.) paddocks working in a strip-grazing system. Individual pasture intake (PI) was estimated with the *n*-alkanes technique, using the ratio of pasture C<sub>33</sub> (tritriacontane) to dosed C<sub>32</sub>. Each cow was dosed twice daily before milking with 450 mg of C<sub>32</sub>. Faeces were sampled twice daily the last five days of each period. Hand-plucked pasture samples representative of that grazed (selected pasture) were collected for chemical analysis. Pre-grazing pasture mass and chemical composition was determined by cutting quadrates at 2.5 cm above ground level. Organic matter digestibility (OMD) was calculated according to INRA (2007) from pepsin-cellulase digestibility. Pre- and post-grazing platometer pasture height was daily measured.

## Results

Pre-grazing pasture DM mass averaged 1780 kg ha<sup>-1</sup> above 2.5 cm and platometer height was 6.3 cm. Dry conditions before and during the experiment restricted pasture growth and strongly reduced pasture quality (639 g NDF, 115 g CP, 5.15 MJ NE<sub>L</sub> kg<sup>-1</sup> DM and 0.62 OMD). Post-grazing sward height increased with both increasing PA and supplementation ( $P < 0.01$ ; Table 1). On average, selected pasture was more digestible than the pre-grazing pasture (0.67 vs. 0.62 OMD). Supplementation reduced PI at both PA, the reduction being less important at low than at high PA (-4.0 vs. -5.8 kg d<sup>-1</sup> DM, interaction PA × S,  $P < 0.01$ ; Table 1). Substitution rate (SR) was therefore numerically lower at low than at high PA averaging 0.51 and 0.75, respectively. Pasture intake increased by 0.11 kg per kg increase in PA for unsupplemented cows and was not significantly affected by PA for supplemented cows. On average, net energy supply increased by 45% with supplementation and by 8% from low to high PA. Daily milk production averaged 13.5 kg and increased by 0.1 kg kg<sup>-1</sup> PA ( $P < 0.01$ ). Milk response to maize silage supplementation did not vary between low and high PA and averaged 0.67 kg milk per kg DM of supplement ( $P < 0.001$ ). Milk fat concentration averaged 43.9 g kg<sup>-1</sup> and did not vary between treatments. Milk protein concentration increased by 0.2 g kg<sup>-1</sup> per kg DM supplement ( $P < 0.05$ ) and was not affected by PA.

Table 1. Effect of pasture allowance (PA) and supplementation (S) on post-grazing pasture height, organic matter digestibility (OMD) of selected pasture, intake, energy supply and milk production and composition.

Supplementation (S) DM, kg	Low PA		High PA		s.d.	Significance		
	0	8	0	8		PA	S	PA×S
Post-grazing pasture height, cm	4.1	4.5	4.7	5.0	0.20	<.001	0.002	0.420
OMD of selected pasture	0.64	0.66	0.66	0.70	0.016	0.009	0.005	0.249
Pasture DM intake, kg	11.6	7.6	13.1	7.3	1.15	0.070	<.001	0.016
Total DM intake, kg	11.6	15.4	13.1	15.0	1.20	0.114	<.001	0.012
NE <sub>L</sub> supply, MJ	59.5	93.2	70.2	94.8	5.97	0.002	<.001	0.015
Milk production, kg	10.1	15.5	11.7	16.6	1.57	0.006	<.001	0.563
Milk fat concentration, g kg <sup>-1</sup>	43.3	45.4	43.0	43.9	3.36	0.353	0.141	0.539
Milk protein concentration, g kg <sup>-1</sup>	33.8	35.2	33.6	35.0	1.76	0.669	0.013	0.984

## Discussion

In the present study, the SR increased from low to high PA (0.51 vs. 0.75). This effect of PA on SR has been reported for other types of pasture and/or supplement (Stockdale, 2000). The average substitution, i.e. 0.63, was comparable to that previously reported by Morrison and Patterson (2007) for maize silage supplementation at similar PA, although the high supplementation level (DM 8 kg d<sup>-1</sup>) and the late stage of lactation are two factors normally recognized for increasing SR (Faverdin *et al.*, 1991). This response might be related to the

very limited supply of  $NE_L$ . Unsupplemented cows at low and high PA satisfied only 65 and 76% of their theoretical energy requirements calculated from the pre-experimental milk production, respectively. Therefore, the  $NE_L$  balance of the cows probably reduced SR (INRA, 2007). The low PI recorded in unsupplemented treatments seems to be more related to the low quality than to the low-mass of the pasture, the combined effect of the two factors not being excluded. In fact, in our trial, the post-grazing pasture height in unsupplemented treatments suggests that the low pasture mass was not the primary factor reducing PI. Previous studies have demonstrated the ability of cows to graze below 4 cm, particularly when pre-grazing pasture height is low (< 10 cm). On the other hand, the OMD of selected pasture averaged 0.67, a level previously reported as restricting PI of grazing dairy cows. According to INRA (2007), when OMD decrease from 0.80 to 0.67, pasture intake is reduced by 12% and energy intake by 35%. Accordingly, there was a high probability that the presence of poorly digestible material in the lower strata strongly reduced PI because of the low digestibility *per se*. Its combination with the increasing difficulty for grazing lower strata may also have reduced cows' motivation to keep on grazing.

The marginal response of 0.67 kg milk per kg DM of supplement was high when compared to forage supplementation studies with no restriction of PA but was typical of low PA i.e. 20 – 25 kg  $cow^{-1} d^{-1}$  DM (> 0 cm). In fact, the greatest marginal responses in milk production from feeding supplements to grazing dairy cows occur when cows are underfed on pasture alone (Burke *et al.*, 2008). Consequently, the milk response was expected to be lower at high PA due to the higher PI and higher SR. Nevertheless, the high milk response recorded here seems to be the consequence of the low pasture quality that decreased energy intake.

## Conclusions

On low-mass and low quality pasture, the PA had little effect on PI, forage supplementation being essential to increase total intake. Under these conditions, maize silage supplementation should be combined with a high protein concentrate such as soyabean meal to balance the total ration. The low substitution rate and the high milk response seemed to be related to the low pasture quality (low energy intake) rather than to the low-mass of the pasture.

## Acknowledgements

The financial support of both the CONICYT (Chile) and the French Embassy in Chile in the form of the first author's PhD scholarship are gratefully acknowledged. This research was partly financed by the 'Programme PSDR GO', Project 'Laitop'.

## References

- Burke F., O'Donovan M.A., Murphy J.J., O'Mara F.P. and Mulligan F.J. (2008) Effect of pasture allowance and supplementation with maize silage and concentrates differing in crude protein concentration on milk production and nitrogen excretion by dairy cows. *Livestock Science* 114, 325-335.
- Faverdin P., Dulphy J.P., Coulon J.B., Vérité R., Garel J.P., Rouel J. and Marquis B. (1991) Substitution of roughage by concentrates for dairy cows. *Livestock Production Science* 27, 137-156.
- Institut National de la Recherche Agronomique (2007) *Alimentation des bovins, ovins et caprins*. Editions Quae, Versailles, France, 307 pp.
- Morrison S.J. and Patterson D.C. (2007) The effects of offering a range of forage and concentrate supplements on milk production and dry matter intake of grazing dairy cows. *Grass and Forage Science* 62, 332-345.
- Stockdale C.R. (2000) Levels of pasture substitution when concentrates are fed to grazing dairy cows in northern Victoria. *Australian Journal of Experimental Agriculture* 40, 913-921.



# Impacts of autumn cutting height and interval on annual productivity of a white clover-grass sward.

Phelan P.<sup>1,2</sup>, Keogh B.<sup>2</sup>, Casey I.A.<sup>2</sup>, Fitzgerald E.<sup>2</sup> and Humphreys J.<sup>1</sup>

<sup>1</sup>Moorepark Dairy Production Research Centre, Teagasc, Fermoy, Co. Cork, Ireland

<sup>2</sup>Department of Chemical and Life Sciences, Waterford Institute of Technology, Ireland

Corresponding author: paul.p.phelan@teagasc.ie

## Abstract

This experiment measured the effects of autumn cutting interval and cutting height on annual herbage production and persistence of a white clover (*Trifolium repens* L.) and predominantly perennial ryegrass (*Lolium perenne* L.) sward in Ireland. The experiment involved four cutting intervals (21, 42, 56 or 84 days) and four cutting heights (approximately 2.7, 3.6, 5.4 or 6.0 cm above ground level). Plots were laid out in a randomized complete block design with five replications. Treatments were imposed from July to December 2008. From March to June 2009 all plots were harvested at an interval of 28 days and a cutting height of 4.5 cm. Grass yield, clover yield and clover stolon mass were measured using standard protocols. There was no ( $P > 0.05$ ) interaction between cutting interval and cutting height for any of the variables measured. Highest ( $P < 0.001$ ) herbage and clover yields were associated with the 42-day interval and with the two lower cutting heights. Lowest grass yield and lowest stolon mass were associated with the 21-day interval ( $P < 0.001$ ). A 42-day interval with a low cutting height (2.7 to 3.6 cm) in autumn gave the most desirable results in terms of herbage yield and stolon mass in the following spring and summer.

Keywords: *Trifolium repens*, autumn, cutting interval, cutting height

## Introduction

White clover is an important component in many grazing systems, particularly organic ones, and successful overwintering of the clover is essential to its success (Davies, 2001). Temperate, maritime climates such as Ireland usually have mild winters which present a challenge to maintaining the clover component as clover growth rate is depressed more at 5–10° C than that of grass (Davies, 2001). Autumn management of rotationally grazed grassland in temperate regions usually involves increasing the intervals between grazing in order to build up the herbage mass available and thereby extend the grazing season into winter. However, Laidlaw *et al.* (1992) has shown that high herbage mass in a mild winter can result in shading of clover leaves by the grass canopy. Low defoliation heights are associated with increased white clover contents in mixed swards (Acuña and Wilman, 1993) and this may enhance clover's ability to overwinter. The objective of this experiment was to investigate the effect of various autumn defoliation intervals combined with various defoliation heights, on annual herbage production and clover stolon mass of a white clover-grass sward over winter.

## Materials and methods

This experiment was conducted on a permanent clover-grass sward at Solohead Research Farm, Tipperary, Ireland (52°51'N, 08°21'W, 95 m above sea level). Site characteristics are described by Humphreys *et al.* (2008). The experimental treatments were four cutting intervals (every 21, 42, 56 or 84 days) and four cutting heights (approximately 2.7, 3.6, 5.4 or 6.0 cm above ground level) imposed between 1 July and 16 December 2008. The plots (8 m × 2 m) were laid out in a randomized complete block design with a factorial arrangement of



treatments and five replications. From the following 3 March to 1 July 2009 all plots were harvested every 28 days at a common cutting height of 4.5 cm. Herbage was harvested using a Honda® HRH-536 lawn-mower (Toss Bryan, Fermoy, Ireland). The area received no fertilizer N but fertilizer P and K were applied to replace that removed in herbage. Herbage dry matter (DM) yields, clover content of herbage and clover stolon DM mass (per unit area) were measured throughout the experiment. Results were analysed using PROC MIXED in SAS® (SAS, 2006). Sampling date was included as a repeated measure for stolon mass. All possible interactions were examined.

## Results and discussion

There was no ( $P > 0.05$ ) interaction between cutting interval and cutting height for any of the variables measured. The 42-day intervals had the highest ( $P < 0.001$ ) clover and overall herbage yield. The 21-day intervals had the lowest ( $P < 0.001$ ) grass yield. Therefore the 42-day intervals achieved the best balance between yield of both species; clover yield declined with longer cutting intervals and grass yield declined with the shorter one (Figure 1a). Total herbage yield and clover yield increased ( $P < 0.001$ ) with the two lower cutting heights (2.7 and 3.6 cm) whilst grass yield was unaffected by cutting height. Therefore the increase in herbage yield achieved with the lower cutting heights was due to the response of clover to cutting height (Figure 1b).

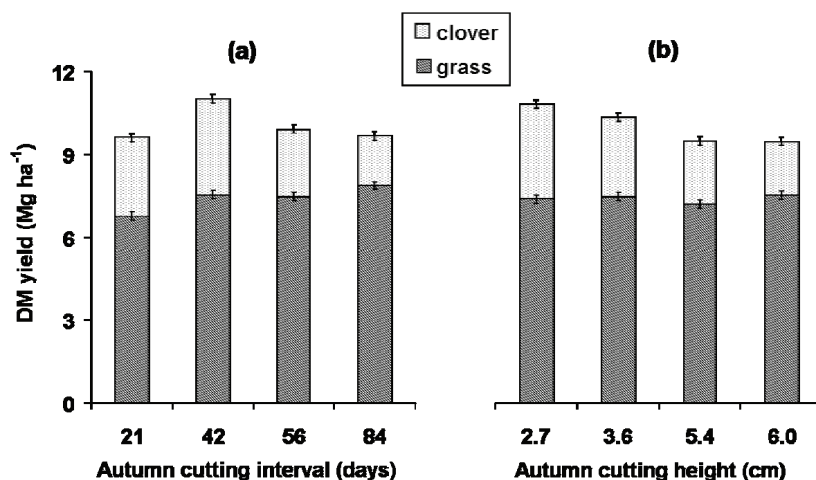

Figure 1. Mean clover and grass dry matter (DM) yield ( $\text{Mg ha}^{-1}$ ) produced between 1 July 2008 and 1 July 2009 for (a) autumn cutting intervals and (b) autumn cutting heights. The term ‘autumn’ refers to the period from 1 July 2008 to 16 December 2008. Error bars are the standard error of the mean.

Stolon mass was affected by ( $P < 0.001$ ) interactions between sampling date and cutting interval and between sampling date and cutting height. The impact of sampling date followed typical seasonal changes, stolon mass being highest in autumn and lowest in spring/early summer. The 21-day cutting intervals reduced ( $P < 0.001$ ) stolon mass throughout the experimental period compared with the other intervals (Figure 2a). This is similar to findings by Lüscher *et al.* (2001) that frequent defoliation of the clover plants can have a stronger negative impact on stolon mass over winter than that caused by competition from grass. Autumn cutting height only had an effect ( $P < 0.05$ ) at the final sampling date in July 2009, when higher stolon mass was associated with the two lower cutting heights (Figure 2b).

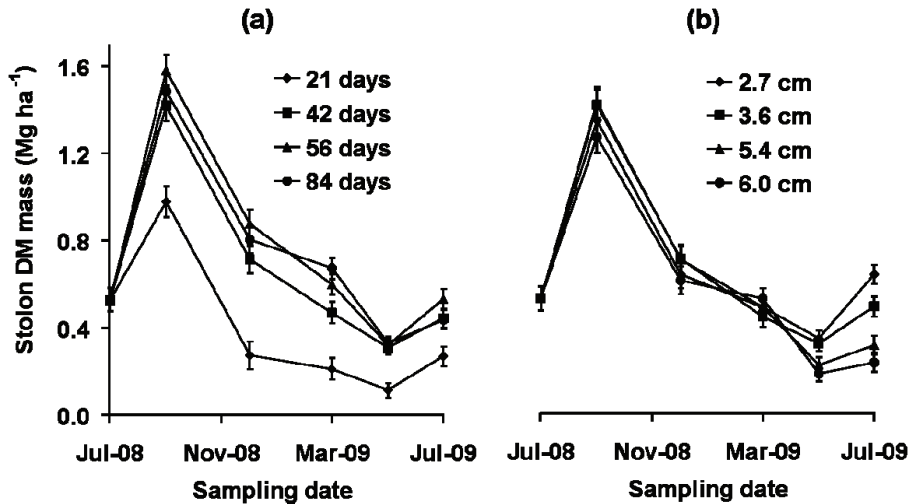

Figure 2. Changes in mean white clover stolon dry matter (DM) mass ( $\text{Mg ha}^{-1}$ ) between 1 July 2008 and 1 July 2009 for (a) autumn cutting intervals (b) autumn cutting heights. The term 'autumn' refers to the period from 1 July 2008 to 16 December 2008. Error bars are the standard error of the mean.

## Conclusion

Cutting every 42 days in autumn, combined with a low defoliation height (2.7 to 3.6 cm) gave the most desirable outcome in terms of herbage yield, clover yield and stolon mass in the following spring and summer. Short (21 day) intervals between defoliations should be avoided during the autumn because of the negative impact on grass yield and clover stolon mass. This suggests that the common practice in temperate regions of increasing the intervals between grazing in autumn is conducive to successful clover management once an interval of 42 days is not exceeded. Further analyses, including herbage nutritive value and N-fixation, are currently being conducted.

## References

- Acuña P.G.H. and Wilman D. (1993) Effects of cutting height on the productivity and composition of perennial ryegrass-white clover swards. *Journal of Agricultural Science, Cambridge* 121, 29-37.
- Davies A. (2001) Competition between grasses and legumes in established pastures. In: P.G. Tow and A. Lazenby (eds.) *Competition and Succession in Pastures*. CAB, 63-83.
- Humphreys J., Casey I.A., Darmody P., O'Connell K., Fenton O. and Watson C.J. (2008) Quantities of mineral N in soil and concentrations of nitrate-N in groundwater in four grassland-based systems of dairy production on a clay-loam soil in a moist temperate climate. *Grass and Forage Science* 63, 481-494.
- Laidlaw A.S., Teuber N.G. and Withers J.A. (1992) Out-of-season management of grass/clover swards to manipulate clover content. *Grass and Forage Science* 47(3), 220-229.
- Lüscher A., Stäheli B., Braun R. and Nösberger J. (2001) Leaf area, competition with grass, and clover cultivar: Key factors to successful overwintering and fast regrowth of white clover (*Trifolium repens* L.) in spring. *Annals of Botany* 88(4, Part 2), 725-735.
- SAS (2006) Version 9.1. SAS Institute, Cary, NC, USA.

# Productivity and floristic diversity of a continuous grazing system on short swards in mountainous regions of Austria

Poetsch E.M., Resch R., Haeusler J. and Steinwidder A.

*Agricultural Research and Education Centre (AREC) Raumberg-Gumpenstein, A-8952  
Irdning, Austria*

Corresponding author: erich.poetsch@raumberg-gumpenstein.at

## Abstract

Austrian farmers cast major doubts on a successful implementation of a continuous grazing system on short swards due to the assumption it may cause high ecological and mechanical stress on grassland. Productivity, forage quality and botanical composition of a continuous grazing system have therefore been investigated for a period of six years on a mountainous site in Central Austria. Growth rate, digestibility of organic matter, energy concentration and content of crude nutrients were analysed, as well as the botanical development of the swards. Even under unfavourable climatic conditions, in mountainous areas continuous grazing on short swards resulted in high yields and excellent forage quality without any negative botanical impact on the grassland ecosystem during the observation period. The results suggest that this grazing system can be recommended for practice in Austria.

Keywords: Pasture, dairy cows, simulated grazing, forage quality, crude protein

## Introduction

Grassland and dairy farming in mountainous regions have to meet serious challenges due to natural disadvantages in climate and site conditions. Low productivity, high costs of forage conservation for a long winter feeding period and expensive special mechanisation are the main drivers of new and cost-effective farming strategies. Grazing has long been a traditional part of grassland management and dairy farming in mountainous regions. After a longer period of increasing indoor feeding, nowadays there is recurrence of grazing stimulated by both cost pressure and rising demands for animal welfare (Steinwidder *et al.*, 2008). Continuous grazing on short swards is seen as an intensive system that imposes mechanical and ecological stresses on grassland. Austrian farmers cast major doubts on a successful implementation of this grazing system, which is already well established in New Zealand and is nowadays being introduced in some European countries.

## Materials and methods

From 2004 to 2009, experiments with continuous grazing on short swards were conducted at the Agricultural Research and Education Centre Raumberg-Gumpenstein, which is located in the production area 'Hochalpen'. This mountainous site is characterized by a low annual temperature of 6.8 °C, an annual precipitation of 1030 mm and an average yearly period of permanent snow cover of nearly 100 days. The field experiment was carried out on two pastures with a herd of dairy cows. The size of the grazing area was adjusted depending on the actual yield growth rate, aiming at a high proportion of grazed forage in the total feed ration. Yields were estimated using (i) a plate pasture meter, (ii) a yard stick and (iii) simulated grazing plots which were yearly relocated and cut at a growing height of approximately 10 to 12 cm. Forage was analysed for DOM, energy concentration and crude nutrients, and the botanical composition of the pasture was observed periodically by plant surveys.

**Results and discussion**

The yield growth curves for six vegetation periods presented in Figure 1 originate from the simulated grazing plots of the experiment which were cut 7 to 9 times per year. The shape indicates significant differences in both the curve progression and in the daily growth rate, for which the maximum was achieved in 2007 with 76 kg ha<sup>-1</sup> day<sup>-1</sup> DM. Depending on the yield, stocking rate on pasture had to be adjusted several times during the vegetation period. In all years, a clear yield decrease occurred within the vegetation period which was mainly caused by high temperatures and low precipitation. Such situations require a flexible grazing management to provide the animals with a sufficient amount of forage by enlarging the pasture area. The total DM yield varied between 6.95 and 9.3 t ha<sup>-1</sup> y<sup>-1</sup>, which can be regarded as sufficient and within a normal oscillation of grassland productivity in mountainous regions of Austria. In addition to exact yield measurements, the growth height - as an important indicator of pasture productivity in practice - was recorded by the plate pasture meter and by a yard stick. There was a significant relationship between the measured DM yield and the results of the plate pasture meter at the 99% confidence level (left part of Fig.2). The correlation coefficient equals 0.73, indicating a moderately strong relationship between the variables. The same significant relationship but with a lower R<sup>2</sup> of 0.49 occurred between the measured DM yield and the results of the yard stick measurement (right part of Fig. 2).

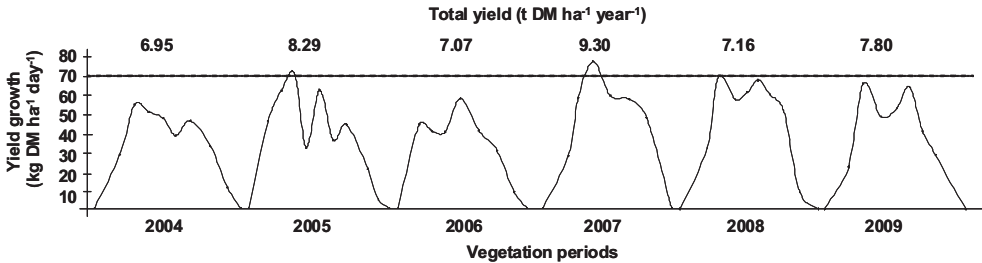

Figure 1. Dry matter yield curves and total yield amount in the short sward grazing experiment at AREC Raumberg-Gumpenstein during six vegetation periods (2004-2009)

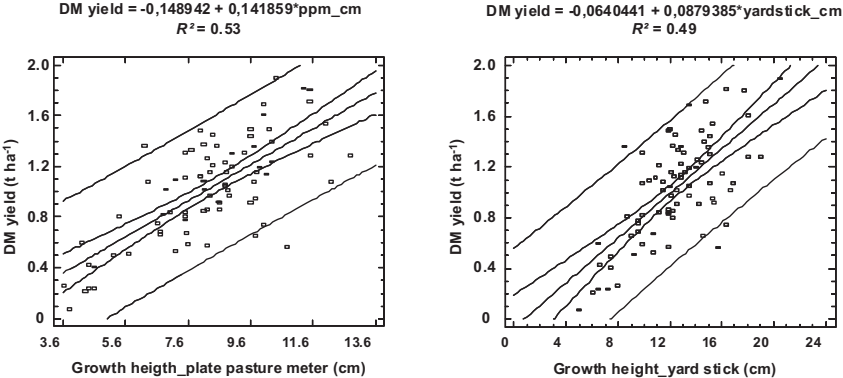

Figure 2. Relationship between yield productivity measured in simulated grazing plots and different measurements of growth height in the short sward grazing experiment at AREC Raumberg-Gumpenstein (2004-2009)

Table 1. Forage quality of short sward pastures and of simulated grazing areas (average data of 2004-2009)

	DM % in FM	Crude protein	Crude fibre % in DM	Crude ash	DOM %	NEL in DM MJ kg <sup>-1</sup>
Short sward grazing (n = 80)	15.6 <sup>a</sup>	20.8 <sup>a</sup>	20.4 <sup>a</sup>	10.5 <sup>a</sup>	74.7 <sup>a</sup>	6.25 <sup>a</sup>
Simulated grazing (n = 82)	14.5 <sup>b</sup>	22.0 <sup>b</sup>	19.3 <sup>b</sup>	11.0 <sup>a</sup>	75.3 <sup>a</sup>	6.30 <sup>a</sup>

The relationship between the growth height measurement with the plate pasture meter and the yard stick was strong ( $R^2=0.83$ ) with a correlation coefficient of 0.91. Both methods can therefore be used in practice to estimate the yield without any complex analysis to adjust the size of the pasture area to the actual growth rate. The forage quality of both systems tested in the project was high with a low content of crude fibre indicating an early date of utilisation (Table 1). This corresponds with a high average concentration of protein, which in practice has to be seriously considered in terms of milk urea content. The digestibility of organic matter reached more than 74%, resulting in an NEL concentration in the DM of about 6.3 MJ kg<sup>-1</sup>, and this is an excellent basis for high milk performance (Poetsch *et al.*, 2006). High forage quality from pastures helps to reduce the amount of concentrates in the feed ration and is therefore an essential part of a low-input farming strategy.

On all tested plots the projective coverage of the vegetation reached the maximum of 100% at the end of the observation period. The number of different species ranged between 21 and 26, indicating a significant lower floristic diversity compared with extensively used grassland types in Austria (Bohner *et al.*, 2002). The proportion of grasses has increased up to 60%, of which *Lolium perenne* and *Poa pratensis* were the dominating species but also *Festuca pratensis* and *Dactylis glomerata* contributed to the vegetation. *Poa trivialis*, which is an undesirable and widespread grass species, only occurred on some plots and at negligible proportions. Other weeds also played only a subsidiary role.

## Conclusion

The findings of the presented experiment indicate that even under unfavourable climatic conditions in mountainous areas continuous grazing on short swards can result in high yields and excellent forage quality without any negative botanical impact on the grassland ecosystem. The data and findings obtained from the simulated grazing system were quite consistent with those of the real grazed areas.

## References

- Bohner A., Sobotik M. and Poetsch E.M. (2002) The species richness of the Austrian grassland and the importance of grassland management for biodiversity. EGF-Meeting 2002, La Rochelle (France), *Grassland Science in Europe* 7, 766-767.
- Poetsch E.M., Resch R., Schaumberger A. and Buchgraber K. (2006) Effect of different management systems on quality parameters of forage from mountainous grassland. EGF Meeting 2006, Badajoz (Spain), *Grassland Science in Europe* 11, 484-486.
- Steinwider A., Starz W., Podstatzky L., Kirner L., Poetsch E.M., Pfister R. and Gallnboeck M. (2009) Ergebnisse zur saisonalen Low-Input Vollweidehaltung von Milchkühen im österreichischen Berggebiet. *Beiträge zur 10. Wissenschaftstagung Ökologischer Landbau*, Zürich, 11-13 February 2009, Tagungsband 2, 62-65.

# Voluntary intake of forages from permanent grasslands with different quality in suckler cows

Pozdíšek J.<sup>1</sup>, Látal O.<sup>1</sup> and Štýbnarová M.<sup>2</sup>

<sup>1</sup>*Agriresearch Rapotin Ltd., Výzkumníků 267, 788 13 Vikýřovice, Czech Republic*

<sup>2</sup>*Research Institute for Cattle Breeding, Ltd., Výzkumníků 267, 788 13 Vikýřovice, Czech Republic*

Corresponding author: jan.pozdisek@vuchs.cz

## Abstract

Objectively determined voluntary intake of forage from permanent grasslands is necessary for ensuring both the required intake of nutrients by different cattle categories and for appropriate grassland management. This paper presents the results on voluntary intake of high dry matter-content silages made from the second cuts of permanent grasslands. Grasslands were managed as follows: fertilised treatments (N<sub>90</sub>P<sub>30</sub>K<sub>60</sub>; pure nutrients), intensive utilisation (4 cuts per year), medium intensive utilisation (3 cuts per year), low intensive utilisation (2 cuts per year); and unfertilised treatment, extensive utilisation (2 cuts per year). The experiment was conducted on 6 suckler cows at the Research Institute for Cattle Breeding, Ltd. using feeding troughs (Comp. Insentec). Voluntary dry matter (DM) intake was influenced by intensity of grassland management increasing intensity of use increased the voluntary dry matter intake. The average DM intake for the particular treatments ranged from 15.2 to 23.9 g kg<sup>-1</sup> live weight (LW). A significant decrease in DM intake in connection with increasing content of crude fibre in forage was also found. It is important to continue studies with different cattle categories fed on permanent grassland.

Key words: voluntary intake, crude fibre, neutral detergent fibre, utilization

## Introduction

In the Czech Republic, an expansion of the permanent grassland areas is expected. In this situation it is necessary to identify the most suitable methods of grassland management for the future. A good knowledge of voluntary dry matter intake of forage from grassland by various cattle categories is important for rational grassland management by means of cattle breeding. This paper presents the findings of a study of voluntary dry matter intake of silages made from the fodder from permanent grasslands with the higher content of dry matter on the basis of four feeding trials, conducted from December 2008 to March 2009, with suckler cows.

## Material and methods

The study was conducted within the framework of the experiment that was established in 2008 on permanent grassland sites in the locality of Rapotin (elevation 390–402 m a.s.l.; total annual rainfall 693 mm; mean annual temperature 7.2 °C). The experimental grasslands were managed with four intensities of utilisation: intensive (area 3.5 ha, 4 cuts per year - first cut on 15 May followed by cuts at 45 d intervals); medium intensive (area 2.5 ha, 3 cuts per year - first on 30 May followed by cuts at 60 d intervals); low intensive (area 0.8 ha, 2 cuts per year - first on 15<sup>th</sup> June, next cut after 90 d), and extensive (area 1.6 ha, 2 cuts per year - first on 15 June and next cut after 90 days). Each utilisation treatment was fertilised with mineral fertilisers (N<sub>90</sub>P<sub>30</sub>K<sub>60</sub>; pure nutrients - model stocking rate: 1 LU ha<sup>-1</sup>) except for the extensive utilisation treatment. Before each cut, the botanical composition and vegetation stage of the grassland were evaluated. The dominant species in the swards were *Dactylis glomerata*, *Poa*

*pratensis*, *Lolium perenne*, *Trifolium repens* and *Taraxacum sect. Ruderalia*. The grass silage was made by cutting grass and leaving it to dry naturally in the field, after which the dry matter content was about 37%. After the wilting the mowed fodder was compressed to round bales (5 wrap layers) using a baling press with chopping equipment. The fermentation process lasted 3 months for ensuring an optimal silage quality. The feeding trials were conducted using the silages made from the second cuts of all the grassland utilisation treatments. The trials used 6 cows (700-750 kg L.W.); these were crossbreeds of Czech Fleckvieh with meat breeds from a suckler cow rearing system using the equipment (RIC Insentec B.V.). Four feeding trials lasted from December 2008 to March 2009. Each trial was divided into the habit-forming period (one week) and the testing period (three weeks). The animals were offered grass silage *ad libitum*. Analyses of crude protein (CP), crude fibre (CF), neutral detergent fibre (NDF) and acid detergent fibre (ADF) in samples grass silage were carried out by the Czech State Standard (CSS) 46 7092 'Method for Feed Testing'.

The *in vitro* organic matter digestibility (OMD) was determined by the method of Tilley and Terry (1963) modified according Resch (1991). The NEL (net energy of lactation), PDIE (ingested digestive protein allowed by energy), PDIN (ingested digestive protein allowed by nitrogen) was predicted by means of the regression equation for organic matter digestibility (Pozdíšek *et al.*, 2001) and by means of the equations described by Petrikovič *et al.* (2000). For evaluation of the nutritive value in system NE, PDI is officially used in the Czech Republic. This system corresponds with the INRA system (Jarrige *et al.*, 1989).

The data were processed descriptive statistics and General Linear Models with fixed effects of cows, method of utilization and between effect (day in test) and its interactions with fixed effects using the SAS® 2007 software package. *Post-hoc* analysis was performed by using Tukey's HSD test. The level of significance was set at  $P < 0.05$ .

## Results and discussion

Voluntary dry matter intake of the ensiled forage obtained from the second cuts of grasslands ranged from 15.2 to 23.9 g kg<sup>-1</sup> LW (Table 1). There was a tendency for increased dry matter intake in connection with increasing intensity of grassland management and decreasing content of crude fibre in the forage. Our findings are in agreement with Gruber *et al.* (2000), who investigated a similar issue in dairy cows. Compared to our results, they found a higher level of voluntary dry matter intake (19.9 – 27.6 g kg<sup>-1</sup> LW). Pozdíšek *et al.* (1998) mention that dry matter intake of intensively managed grasses conserved by freezing was 24.3 to 30.7 g kg<sup>-1</sup> LW for heifers of 300 kg LW. These findings indicate that both quality of feed and animal have effects on the variability of dry matter intake.

Table 1. Nutrient content and voluntary dry matter intake of silages by different grassland management

T	CP	CF	ADF	NDF	OMD	NEL	PDIN	PDIE	PDIN/PDIE	VI*	SD*
	g kg <sup>-1</sup>					MJ	g kg <sup>-1</sup>			g kg <sup>-1</sup>	
1	151.7	242.0	325.0	448.6	717.9	5.71	96.8	88.5	1.09	23.9	3.6
2	116.1	262.1	323.7	483.6	686.0	5.43	75.0	82.6	0.91	20.4	3.0
3	110.0	282.9	408.5	573.9	686.1	5.15	70.9	78.8	0.90	16.3	3.4
4	105.2	358.6	418.6	608.1	582.0	4.45	67.2	72.6	0.92	15.2	2.8

T- (treatment - type of utilisation): 1 – Intensive, 2 - Medium intensive, 3 - Low intensive, 4 - Extensive  
 VI\* (voluntary dry matter intake); SD\* - standard deviation (\*for mean of whole treatment and group of the 6 cows)

According to Jarrige *et al.* (1989), the optimal forage quality for cattle nutrition is when the PDIN/PDIE ratio approximates a value of 1. If this presumption is satisfied, animals have the



minimum requirements for supplements. From this viewpoint, the most suitable PDIN/PDIE ratio (1.09) was discovered to be the intensive method of grassland use in our case. *Post-hoc* analysis confirmed highly significant differences in voluntary dry matter intake between intensive and low intensive ( $P < 0.001$ ) and extensive utilisation ( $P < 0.001$ ). Significant differences were also found between medium intensive utilisation and low intensive ( $P < 0.05$ ) and extensive utilisation ( $P < 0.05$ ).

The treatments of the grassland management had the significant effects on the quality of the tested silages. As many authors mention (e.g. Gruber *et al.*, 2000) the forage quality is closely related to the voluntary dry matter intake. On the basis of our trials we have found the negative correlation ( $r = -0.972$ ) between the content of NDF and the dry matter intake (regression equation:  $y = 45.347 - 0.05x$ ). Furthermore, a positive relation was found between the voluntary dry matter intake and the content of crude protein ( $y = 0.1698x - 1.5803$ ;  $r = 0.931$ ) and between the voluntary dry matter intake and the content of NEL ( $y = 3.4497e^{0.3253x}$ ;  $r = 0.881$ ). The increase of the intensity of utilisation has the positive influence on the increase of the dry matter intake. From this viewpoint, on the basis of our results we can consider the four-cut regime of grassland utilisation to be optimal.

## Conclusions

It is possible to influence the quantity and quality of fodder by means of grassland management, i.e. through the number of cuts and fertilisation. Voluntary dry matter intake in cattle is influenced by intensity of grassland management. Further study of the voluntary intake by different cattle categories fed on grasslands is needed.

## Acknowledgements

This work was supported by the Ministry of Education, Youth and Sports of the Czech Republic, Project No. MSM 2678846201, and by the Ministry of Agriculture of the Czech Republic, Project QH 81280.

## References

- Gruber L., Steinwider A., Guggenberger T., Schauer A., Häusler J., Steinwender R. and Steiner B. (2000) Einfluss der Grünlandbewirtschaftung auf Ertrag, Futterwert, Milcherzeugung und Nährstoffausscheidung. In: Eckhart A. *et al.* (eds.) *Management von Hochleistungskühen, Grünlandwirtschaft und Milchproduktion, Biologische Wirtschaftsweise*. BAL Gumpenstein, Austria, pp. 41-88.
- Jarrige R. (1989) *Ruminant nutrition*. Paris-London-Rome: John Libbey Eurotext, 389 pp.
- Petrikovič P., Sommer A., Čerešňáková Z., Svetlanská M., Chrenková M., Chrastinová L., Poláčiková M., Bencová E. and Dolešová P. (2000) *The feed nutritive value*, part I. VÚZV, Nitra, Slovak Republic, 134 pp.
- Pozdíšek J. and Kohoutek A. (1998) Voluntary intake of fresh forage of selected grass species conserved by freezing in cattle. *Czech Journal Animal Science* 43 (8), 349-354.
- Pozdíšek J., Kohoutek A., Jakešová H., Nerušil P. and Schuplerová-Němcová P. (2001) Changes of the nutritive value in the chosen species and grass and clover varieties during vegetation. *Cattle Research* 43, 2, 9-14.
- Resch R. (1991) In vitro – Verdaulichkeitsuntersuchung nach Tilley und Terry, 1963. *Bericht über die Tagung der ALVA Fachgruppe Versuchswesen*. Innsbruck: 22-23 May 1991.
- Tilley J.M.A and Terry R.A. (1963) A two stage technique for the in vitro digestion of forage crops. *Journal of the British Grassland Society* 18, 104 – 111.

## Effect of two pre-grazing herbage masses and daily herbage allowances on perennial ryegrass sward characteristics

Roca-Fernández A. I.<sup>1</sup>, O'Donovan M.<sup>2</sup>, Curran J.<sup>2</sup> and González-Rodríguez A.<sup>1</sup>

<sup>1</sup>*Agrarian Research Centre of Mabegondo. INGACAL. PO Box 10, 15080, A Coruña, Spain*

<sup>2</sup>*Teagasc, Moorepark Dairy Production Research Centre, Fermoy, Co. Cork, Ireland*

Corresponding author: [anairf@ciam.es](mailto:anairf@ciam.es)

### Abstract

The aim of this study was to investigate the effect of two pre-grazing herbage masses (HM) and daily herbage allowances (DHA) on perennial ryegrass sward structure in the upper and lower sward horizon (> and <4cm). Sixty-four spring-calving Holstein Friesian dairy cows (24 primiparous and 40 multiparous) were balanced on calving date, lactation number, milk yield, body weight and body condition score, and randomly assigned to one of four grazing treatments (n=16) in a 2x2 factorial design. Animals were offered two levels of pre-grazing dry matter HM, low (L – 1600 kg ha<sup>-1</sup>) or high (H – 2400 kg ha<sup>-1</sup>) and two levels of dry matter DHA, low (L – 15 kg cow<sup>-1</sup> d<sup>-1</sup>) or high (H – 20 kg cow<sup>-1</sup> d<sup>-1</sup>). Thus the four treatments were LL, LH, HL and HH. The experiment was carried out from April to October. Pre- and post-grazing heights were measured and herbage utilization was calculated. Leaf, stem and dead proportions were determined. The results indicate that by maintaining 1600 kg ha<sup>-1</sup> and offering cows 15 kg cow<sup>-1</sup> d<sup>-1</sup> it is possible to achieve high herbage utilization and this will improve sward quality. These swards showed an increased leaf:stem ratio and lower dead proportion which is linked to higher nutritive value in the swards.

Key words: dairy cow, grazing, herbage utilization, leaf-to-stem ratio, sward quality

### Introduction

There is an increasing interest in grass based animal production systems worldwide as a result of lower prices for farm outputs and increased costs (Dillon *et al.*, 2002). Efficient exploitation of grass by grazing will require the development of grazing systems designed to maximise daily herbage intake per cow while simultaneously maintaining a large quantity of high quality pasture over the grazing season (McEvoy *et al.*, 2009). Daily grass intake will be maximised by adhering to important sward characteristics such as maintaining a high proportion of green leaf and low dead material within the grazing horizon and allocating an adequate daily allowance (O'Donovan and Delaby, 2008). The challenge for the future will be to develop swards through management and grass breeding that will maintain high DM intake, while at the same time result in low residual sward height (Hurley *et al.*, 2009). The objective of this research was to examine the effect of two pre-grazing herbage masses and two daily herbage allowances on perennial ryegrass sward structure across the grazing season.

### Materials and methods

The study was conducted at Moorepark Research Centre, Fermoy, Co. Cork, Ireland (50°7'N; 8°16'W) from 9 April to 31 October 2008. The soil type was a free draining, acid brown earth with a sandy loam-to-loam texture. The experimental area was a permanent grassland site consisting of a predominantly perennial ryegrass sward (*Lolium perenne* L.). The swards were on average 6 years old. A grass seed mixture of 3 late-heading diploid cultivars (Twystar, Cornwall and Gilford) was initially sown. No clover was present in the swards. The experiment was a Latin square randomized block design with a 2x2 factorial arrangement of

treatments. Two levels of pre-grazing dry matter HM (>4cm) were created: low (L – 1600 kg ha<sup>-1</sup>) or high (H – 1600 kg ha<sup>-1</sup>). Two levels of DHA were offered to cows: low (L – 15 kg DM cow/day) or high (H – 20 kg DM cow/day). The four grazing treatments were LL, LH, HL and HH. Fresh herbage was allocated daily. Two periods were examined (P1 and P2). Sixty-four Holstein-Friesian dairy cows (24 primiparous and 40 multiparous) were balanced on calving date (11 February; S.D. 23.9 d), lactation number (2.6; S.D. 1.74) and pre experimental milk yield (29.3; S.D. 4.78 kg), liveweight (513; S.D. 74.4 kg) and body condition score (2.96; S.D. 0.550). The animals were then randomly assigned to one of the four grazing treatments (n=16). No concentrate was offered during the experimental period. Pre-grazing HM was measured twice weekly on the DHA areas by defoliating two strips per paddock with an Agria autoscythe machine. Pre- and post-grazing heights were determined daily using an electronic plate meter. A 150 g sub-sample of grass was taken to derive the morphological composition of the swards and divided into two separately fractions, above and below 4.0 cm. Each individual layer was manually separated into leaf, stem and dead material. Each constituent was then weighed and dried overnight at 90 °C for DM determination. Proportions of leaf, stem and dead content were determined. Herbage utilization (>4cm) was calculated according to the method described by Delaby and Peyraud (1998). Data were analysed using PROC MIXED in SAS (2006). The variables included in the model were HM, DHA, interaction between HM and DHA and the pre-experimental variables where appropriate.

## Results and discussion

Pre-grazing dry matter HM was 1597 kg and 2389 kg ha<sup>-1</sup> for the low and high HM treatments respectively. Dry matter DHA was 14.8 and 19.6 kg cow<sup>-1</sup> d<sup>-1</sup> for the low and high DHA treatments respectively (Table 1). Pre-grazing height was significantly lower for the low HM treatments. There was an interaction for post-grazing height between HM and DHA. Mean stocking rates were 4.0 (LL), 3.85 (LH), 4.01 (HL) and 3.93 cows ha<sup>-1</sup> (HH). The low HM treatments completed 9 grazing rotations compared to 7 grazing rotations for the high HM treatments. There was an interaction for herbage utilization between HM and DHA, the HH treatment had significantly lower sward utilization than the LH treatment. The LL and HL treatments had the highest sward utilization. Leaf proportion was significantly higher and dead proportion was significantly lower (Table 2) in period 2 for the two low HM treatments in the upper sward horizon (>4 cm).

Table 1. Effect of two pre-grazing HM and two DHA on sward height and herbage utilization.

Herbage Mass (kg ha <sup>-1</sup> )	Low		High		SED	HM	DHA	HM*DHA
	Low	High	Low	High				
Allowance (kg cow <sup>-1</sup> d <sup>-1</sup> )	14.8 <sup>a</sup>	19.5 <sup>b</sup>	14.8 <sup>a</sup>	19.6 <sup>b</sup>	0.26	NS	***	NS
HM (kg ha <sup>-1</sup> )	1601 <sup>a</sup>	1593 <sup>a</sup>	2376 <sup>b</sup>	2403 <sup>b</sup>	168.7	***	NS	NS
DHA (kg cow <sup>-1</sup> d <sup>-1</sup> )	14.8 <sup>a</sup>	19.5 <sup>b</sup>	14.8 <sup>a</sup>	19.6 <sup>b</sup>	0.26	NS	***	NS
Pre-grazing height (cm)	11.9 <sup>a</sup>	11.5 <sup>a</sup>	14.4 <sup>b</sup>	14.3 <sup>b</sup>	0.68	***	NS	NS
Post-grazing height (cm)	4.2 <sup>a</sup>	4.7 <sup>b</sup>	4.2 <sup>a</sup>	5.2 <sup>c</sup>	0.16	***	***	***
Herbage utilization (%)	97.7 <sup>a</sup>	91.3 <sup>b</sup>	98.3 <sup>a</sup>	88.4 <sup>c</sup>	1.66	***	***	***

<sup>a-c</sup> Within a row means with different superscripts differ ( $P<0.05$ ). \*\*\*,  $P<0.001$ , \*\*,  $P<0.01$ , \*,  $P<0.05$ . NS = Not significant.

Table 2. Effect of two pre-grazing HM and two DHA on sward structure during the experiment in Period 1 (9 April – 20 July) and Period 2 (21 July – 31 October).

Herbage Mass (kg ha <sup>-1</sup> ) Allowance (kg cow <sup>-1</sup> d <sup>-1</sup> )	Low		High		SED	HM	DHA	HM*DHA
	Low	High	Low	High				
<b>Period 1</b>								
<b>Sward Horizon (&gt;40mm)</b>								
Leaf proportion	0.71	0.67	0.65	0.67	0.02	NS	NS	NS
Stem proportion	0.17	0.21	0.22	0.22	0.02	NS	NS	NS
Dead proportion	0.13	0.13	0.12	0.13	0.02	NS	NS	NS
<b>Sward Horizon (0-40mm)</b>								
Leaf proportion	0.18	0.15	0.17	0.13	0.03	NS	NS	NS
Stem proportion	0.33	0.32	0.34	0.36	0.04	NS	NS	NS
Dead proportion	0.50	0.53	0.49	0.51	0.02	NS	NS	NS
<b>Period 2</b>								
<b>Sward Horizon (&gt;40mm)</b>								
Leaf proportion	0.78 <sup>a</sup>	0.81 <sup>a</sup>	0.76 <sup>b</sup>	0.75 <sup>b</sup>	0.02	***	NS	NS
Stem proportion	0.12	0.11	0.12	0.11	0.02	NS	NS	NS
Dead proportion	0.10 <sup>a</sup>	0.09 <sup>a</sup>	0.13 <sup>b</sup>	0.14 <sup>b</sup>	0.02	***	NS	NS
<b>Sward Horizon (0-40mm)</b>								
Leaf proportion	0.30	0.30	0.24	0.27	0.03	NS	NS	NS
Stem proportion	0.41	0.39	0.42	0.43	0.02	NS	NS	NS
Dead proportion	0.29	0.32	0.34	0.30	0.02	NS	NS	NS

<sup>a,b</sup> Within a row means with different superscripts differ ( $P<0.05$ ). \*\*\*,  $P<0.001$ , \*\*,  $P<0.01$ , \*,  $P<0.05$ . NS = Not significant

## Conclusions

The results from this study show that maintaining 1600 kg ha<sup>-1</sup>, offering cows 15 kg cow<sup>-1</sup> d<sup>-1</sup> and achieving high utilization rates in the early season will improve sward quality and result in a sward of increased nutritive value in the mid-season compared to high HM swards.

## Acknowledgements

To INIA for their financial support and staff at TEAGASC Moorepark for their assistance.

## References

- Delaby L. and Peyraud J.L. (1998) Effect d'une reduction simultanée de la fertilisation azotée et du chargement sur les performances des vaches laitières et la valorisation du pâturage. *Annales of Zootechnia* 47, 17-39.
- Dillon P., Crosse S., O'Brien B. and Mayes R.W. (2002) The effect of forage type and level of concentrate supplementation on the performance of spring-calving dairy cows in early lactation. *Grass and Forage Science* 57, 212-223.
- Hurley G., O'Donovan M. and Gilliland T.J. (2009) Effect of spring defoliation pattern on the mid-season production and morphology of swards of perennial ryegrass cultivars of different maturity. *Grass and Forage Science* 64, 80-91.
- McEvoy M., O'Donovan M., Kennedy E., Murphy J.P., Delaby L. and Boland T.M. (2009) Effect of pregrazing herbage mass and pasture allowance on the lactation performance of Holstein-Friesian dairy cows. *Journal of Dairy Science* 92, 414-422.
- O'Donovan M. and Delaby L. (2008) Sward characteristics, grass dry matter intake and milk production performance is affected by timing of spring grazing and subsequent stocking rate. *Livestock Science* 115, 158-168.
- SAS®User's Guide. (2006) *Version 9.1: Statistics*. SAS Institute Inc., Cary NC, USA.

## Effect of entry time to a daily strip on daily weight gain and nitrogen balance

Sánchez Chopa F.<sup>1,2</sup>, Nadin L.B.<sup>1,2</sup>, Trindade J.K.<sup>3</sup>, Amaral G.<sup>3</sup> and Gonda H.L.<sup>1</sup>

<sup>1</sup> *Facultad de Ciencias Veterinarias, Universidad Nacional del Centro de la Provincia de Buenos Aires, Argentina*

<sup>2</sup> *Consejo Nacional de Investigaciones Científicas y Tecnológicas, Argentina*

<sup>3</sup> *Faculdade de Agronomia – Universidade Federal de Rio Grande do Sul, Brasil*

Corresponding author: fsanchez@vet.unicen.edu.ar

### Abstract

Twenty-four Holstein-Friesian male calves ( $132.9 \pm 6.3$  kg BW) divided in 3 blocks (8 animals block<sup>-1</sup>) grazing *Avena sativa*, were used to assess the effect of entry time to a daily strip on daily weight gain (DWG; 54 d). Nitrogen balance was estimated in animals from block 1 (n = 8). Animals had access to an individual daily grazing strip either at 8:30 (M) or at 14:30 (A). Herbage allowance on a dry matter basis was 4.5% of BW. Individual dry matter intake (DMI) and faecal output were estimated by the *n*-alkane technique. Pasture nitrogen content was lower and non-structural carbohydrates content was higher in A compared with M. Animals were weighed on days 1, 18 and 54 after a 48-hour fast. Data were analysed by ANOVA according to a complete block design. DMI and DWG were not affected by treatments ( $P > 0.05$ ). However, DWG was 21% higher in treatment A compared to M in blocks 2 and 3 ( $P < 0.03$ , n = 16) ( $0.790$  vs.  $0.650$  kg d<sup>-1</sup>). Nitrogen intake, N retention, N faecal excretion and N excreted in urine were not affected by treatments.

Keywords: Calves, weight gain, nitrogen balance, day-strip grazing, winter oat.

### Introduction

The chemical composition of grass changes during the day, having higher nutritional value for ruminants in the afternoon than in the morning (Delagarde *et al.*, 2000). The contents of dry matter (DM) and non-structural carbohydrates (NSC) are higher, while the contents of neutral detergent fibre (NDF) and crude protein (CP) are lower in the afternoon (Delagarde *et al.*, 2000). When managing animals in a one-day strip-grazing system, the access to a new grazing strip during the afternoon may improve the animal performance compared to a morning access (Gregorini *et al.*, 2006; Milano *et al.*, 2009). The use of winter oat pastures (*Avena sativa*) is widespread in Argentina for feeding growing ruminants and it has been reported to have high CP contents and also high CP/NSC ratios (Martínez *et al.*, 2005). This may result in high NH<sub>4</sub><sup>+</sup> concentrations in ruminal fluid, high urea concentrations in peripheral blood, increased N losses in urine and reduced efficiencies of N utilisation. Animal performance and nitrogen balance (NB) may be improved if animals are allowed to enter to a new grazing strip during the afternoon compared with the morning. The objective of the present work was to assess the effect of entry time on daily weight gain (DWG) and NB in calves on a winter oat pasture.

### Materials and methods

Twenty-four Holstein-Friesian male calves ( $132.9 \pm 6.3$  kg BW), grazing *Avena sativa*, were used in a 54-d experiment. After stratifying by initial BW in groups of two, animals were randomly assigned to one of two treatments, within treatments to one of three blocks (B; 4 animals per treatment and B) and within blocks to an individual grazing paddock, where they

were kept until the end of the experiment in daily strips. Blocks differed in herbage DM mass ( $5256 \pm 597$ ;  $2556 \pm 741$ ;  $2863 \pm 769$  kg ha<sup>-1</sup> for B1, B2 and B3, respectively). Treatments were: entry time to an ungrazed daily strip at 8:30 h (M) or at 14:30 h (A). Throughout the experiment, herbage allowance was kept at 4.5% BW taking into account both herbage mass (clipping to ground level 10 quadrats of 0.075 m<sup>2</sup> strip<sup>-1</sup> every 15 days) and BW. Lamina (L) to pseudostem (PS) ratios were estimated by manual separation of forage samples taken from B1 and B3. To estimate changes in chemical composition during the day, samples of forage from B1 and B3 taken at 8:30 and 14:30 h were separated into L and PS and each component was analysed for CP, NDF, NSC and *in vitro* digestibility.

DM intake (DMI) and diet composition (L to PS ratios) were estimated in B1 and B3 (n = 16) by the *n*-alkane technique. The animals were dosed twice a day for 10 days with cellulose pellets containing 140.66 and 146.00 mg pellet<sup>-1</sup> of C<sub>32</sub> in B1 and B3, respectively. The last 5 days of *n*-alkane dosage faecal grab samples were taken twice a day. Diet composition was estimated from *n*-alkane concentrations in L and PS. Nitrogen balance was performed in animals of B1 (n = 8; 4 animals per treatment). Nitrogen intake was estimated from the DMI and N content of L and PS at 8:30 and 14:30 h taking into account the main grazing events through the day. Ingestive behaviour was recorded for 24 h, twice on each animal, during the nutrient balance measurement period using IGER solid-state behaviour recorders. Nitrogen excretion in faeces and urine was estimated from the daily individual pool. Total collection of urine and faeces was performed using harnesses changed 3 times a day. The urine harnesses (bag-shaped) were made of PVC. Inside the harness there was a paper-bag containing a cotton pad impregnated with gel (sodium polyacrylate) and a preserver (thymol) to absorb the urine. After changing harnesses, collected urine and faeces were weighed, homogenised and samples were taken and kept at -20 °C for further analysis. Before the N analysis, urine was recovered from the gel mass with a saturated sodium chloride solution. To estimate DWG (n = 24; B1, B2, B3), calves were weighed on d 1 and d 54 after a 48-h fast. Dry matter intake and BW data were analysed by ANOVA according to a complete randomised block design. Nitrogen balance was analysed by a *t* test.

Table 1. Height and lamina:pseudostem (L:PS) ratio, chemical composition, *in vitro* digestibility, energy content (ME), of *Avena sativa* grazed by Holstein-Friesian calves.

		B1		B3	
Height† (cm)		71.7 ± 13.4		39.9 ± 6.0	
L:PS ratio		1.22		2.45	
		8:30 h	14:30 h	8:30 h	14:30 h
Plant	DM (%)	12.9	12.4	10.8	11.7
	CP (%)	21.2	18	14.1	13.6
Lamina	NDF (%)	50.5	46.7	44.1	39.2
	NSC (%)	9.2	12.2	17.0	23.8
	<i>in vitro</i> digestibility (%)	85.8	86.9	89.8	90.4
	ME in DM (MJ kg <sup>-1</sup> )	12.96	13.13	13.55	13.63
Pseudostem	CP (%)	13.6	8.6	7.4	6.7
	NDF (%)	51.4	55.3	43.9	43.8
	NSC (%)	14.2	16.9	24.3	30.7
	<i>in vitro</i> digestibility (%)	82.8	80	85.3	84.5
	ME in DM (MJ kg <sup>-1</sup> )	12.51	12.09	12.89	12.76

† extended lamina height.

## Results and discussion

Table 1 shows chemical composition, *in vitro* digestibility, sward characteristics and energy content of L and PS of B1 and B3. There were no statistical differences ( $P > 0.05$ ) in DMI between treatments. DMI in B1 was  $4.99 \pm 0.98$  and  $4.97 \pm 0.56$  kg d<sup>-1</sup> and in B3 was  $4.71 \pm$

0.19 and  $4.66 \pm 0.53 \text{ kg d}^{-1}$  for M and A, respectively. Entry time did not statistically affect DWG ( $P > 0.05$ ) ( $M = 730 \pm 190$  and  $A = 790 \pm 140 \text{ g d}^{-1}$ ). However, in B2 and B3 animals on treatment A had a numerically higher DWG (21 %;  $790$  vs.  $650 \text{ g d}^{-1}$ ) than animals on M. The lack of treatment effect in B1 was probably due to a higher herbage mass in B1 than in B2 and B3. Daily weight gain was, on average,  $840$ ,  $810$  and  $630 \text{ g d}^{-1}$ , for B1, B3 and B2, respectively. Data for N intake, N excretion in faeces and urine and N retention are shown in Table 2. There were no statistical differences ( $P > 0.05$ ) between treatments in N intake, N faecal excretion, N urine excretion or N retention.

Table 2. Nitrogen balance (N intake, faecal and urinary N excretion and N retention) per (body weight)<sup>-0.75</sup> in Holstein-Friesian calves grazing winter oats on individual daily strips with different entry time: 8:30 (M) or 14:30 h (A).

		Treatments		$S^{2\dagger}$	$P$
		M	A		
N Balance ( $\text{g kg}^{-0.75} \text{ d}^{-1}$ )	<i>Intake</i>	3.03	2.67	0.26	0.37
	<i>Faeces</i>	0.67	0.74	0.02	0.55
	<i>Urine</i>	1.64	1.56	0.05	0.61
	<i>Retained</i>	0.71	0.38	0.16	0.29

$\dagger S^2$  = Pooled variance.

## Conclusions

The entry time to a daily strip did not affect either DMI or DWG. However, in B2 and B3, animals on treatment A had a numerically higher DWG (21%) than animals on M. The N balance was not different between treatments in line with no differences in DWG in B1.

## References

- Delagarde R., Peyraud J.L., Delaby L. and Faverdin P. (2000) Vertical distribution of biomass, chemical composition and pepsin-cellulase digestibility in a perennial ryegrass sward: interaction with moth of year, regrowth age and time of day. *Animal Feed Science and Technology* 84, 49-68.
- Gregorini P., Eirin M., Refi R., Ursino M., Ansin O. and Gunter S.A. (2006) Timing of herbage allocation in strip grazing: effects on grazing pattern and performance of beef steers. *Journal of Animal Science* 84, 1943-1950.
- Martínez M.F., Arelovich H.M., Laborde H.E., Correa M., Wehrhahne L. and Loyola J. (2005) Evaluation of *Avena sativa* cultivars. 2. Chemical composition of the forage dry matter. *Revista Argentina de Producción Animal* 25 (S1), 164-165.
- Milano G.D., Sánchez Chopra F., Nadin L.B. and Gonda H.L. (2008) Previous nutrition and entry time to pasture affect weight gain and grazing behaviour in steers. *Grassland Science in Europe* 13, 831-833.



# Suitability of grass species on equine pasture: water soluble carbohydrates and grass preferences by horses

Särkijärvi S.<sup>1</sup>, Niemeläinen O.<sup>2</sup>, Sormunen-Cristian R.<sup>2</sup> and Saastamoinen M.<sup>1</sup>

<sup>1</sup>MTT Agrifood Research Finland, Opistontie 10 A 1, FI-32100 Ypäjä, Finland

<sup>2</sup>MTT Agrifood Research Finland, FI-31600, Jokioinen, Finland

Corresponding author: susanna.sarkijarvi@mtt.fi

## Abstract

Suitability of timothy (T; *Phleum pratense* L.), meadow fescue (MF; *Festuca pratensis* L.) and tall fescue (TF; *F. arundinacea* Schreb.) and of T-MF, T-TF and TF-Kentucky bluegrass (KB; *Poa pratensis* L.) mixtures for equine pasture was studied. Total area of 240 m x 240 m was divided into three equal paddocks. Each had the six treatments randomized in four blocks. Paddocks were grazed rotationally for 10 – 14 days with ten Finnhorse mares in May-August 2008. Water soluble carbohydrates (WSC) content of grass was measured and behaviour observations of grass preferences were made. WSC content in dry matter averaged 238 g kg<sup>-1</sup> on 14 May and 74 g kg<sup>-1</sup> on 26 August. In spring, T had significantly higher ( $P < 0.001$ ) and TF had lower ( $P < 0.05$ ) WSC content compared to other grasses. Based on grazing behaviour, the mares preferred TF-KB over other grasses ( $P < 0.001$ ). T, TF and T-TF were preferred secondly and were not statistically different. MF was the least preferred. Low WSC content and good preference by horses makes TF an interesting option into horse pastures.

Keywords: grass, grazing, horse, preference, pasture, water soluble carbohydrates

## Introduction

Pasture is the most important and natural feed for horses in summer. Grazing promotes the welfare and health of horses and is economical and labour saving. Properly managed pasture can cover about 25% of annual energy and protein demands of horses in Finnish conditions. However, horse grazing is usually very extensive and it could be intensified. Information on suitability of different plant species on horse pasture is scarce. High content of carbohydrates can cause metabolic problems like laminitis (Watts, 2005). Tall fescue is highly productive and persistent grass species for Finnish conditions (Niemeläinen *et al.*, 2001). It has gained popularity in cattle feeding, but little is known about its applicability for horse pasture. The aim of this experiment was to compare suitability of tall fescue with commonly used grass species in equine pastures. We hypothesized that tall fescue may have lower water soluble carbohydrates (WSC) content and preference by horses. In this paper, results on grazing preference by horses and WSC concentration during grazing season are presented.

## Materials and methods

Six pasture treatments: timothy (T; *Phleum pratense* L.), meadow fescue (MF; *Festuca pratensis* L.), tall fescue (TF; *F. arundinacea* Schreb.) and T-MF, T-TF and TF-Kentucky bluegrass (KB; *Poa pratensis* L.) mixtures were established in 2005 in an even field by sowing 240 m long and 10 m wide treatments in four horizontal blocks. Treatments were randomized into each block, resulting in 24 grass strips in the total pasture area of 240 m x 240 m. The area was vertically divided into three paddocks of 70 m x 240 m.

Ten Finnhorse mares grazed on the pasture from 15 May to 24 September. Mares grazed on the first two paddocks for ten days, after that each paddock was grazed for 14 days. Mares had previous experience on grazing and they had free choice to all the 24 treatments

simultaneously. Evaluation of grass preferences was based on visual grazing behaviour observations. Observations, i.e. the eating place of every horse, were recorded every five minutes, and were made right after paddock change for eight hours. All paddocks were topped in July. In total, nine grazing periods were carried out and each paddock was grazed three times. Herbage samples were taken from each plot with a Haldrup forage harvester before grazing. Stubble height was approximately 7 cm. WSC was analysed according to Somogyi (1945).

The dataset was analysed as completely randomized block design. Statistical analyses were carried out using the MIXED procedure of the SAS system (SAS 9.1). The response variable (Y) was analysed according to the following statistical model:  $Y_{ijkl} = \mu + replicate_i + treatment_j + replicate*treatment_k + paddock_l + replicate*paddock_m + treatment*paddock_n + \epsilon_{ijklmno}$ , where replicate, replicate\*paddock and replicate\*treatment were random effects. For statistical analysis the dataset was grouped as follows: grazing periods 1-3 (spring = 1<sup>st</sup> rotation for all 3 paddocks), 4-6 (summer = 2<sup>nd</sup> rotation) and 7-9 (late summer = 3<sup>rd</sup> rotation).

**Results and discussion**

WSC changed markedly during grazing (Fig. 1). All the species followed the same trend, but in different levels. WSC content in dry matter (DM) averaged 238 g kg<sup>-1</sup> on 14 May (period 1) and 74 g kg<sup>-1</sup> on 26 August (period 9). WSC content decreased during spring and summer, averaging 60 g kg<sup>-1</sup> at its lowest. In the beginning of late summer grazing, the WSC content rose to 93 g kg<sup>-1</sup>, probably due to regrowth after topping. Interestingly, from the end of June WSC content in almost every species stayed below 100 g kg<sup>-1</sup>, which is the safe upper limit for non-structural carbohydrates (WSC+starch) even for high-risk horses (Watts, 2005).

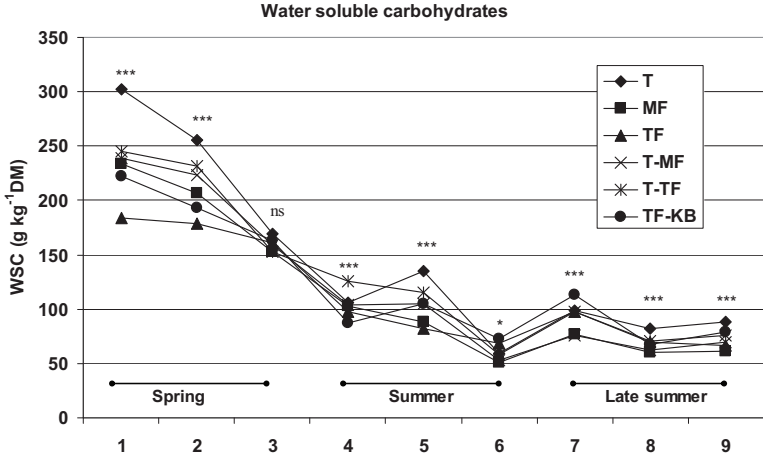

Figure 1. Water soluble carbohydrates in grass between 14 May and 26 August 2008. Samples (T = timothy, MF = meadow fescue, TF = tall fescue, KB = Kentucky bluegrass) were taken prior to grazing. Significance between species: \*\*\**P* < 0.001; \**P* < 0.05; ns = non-significant.

Between the species, there was a significant difference in WSC content. In spring grazing, T had significantly higher (*P* < 0.001) WSC content compared to other treatments and TF had lower WSC content than T, T-MF and T-TF (*P* < 0.001), MF (*P* < 0.01) and TF-KB (*P* < 0.05). In summer grazing, T had still higher WSC content compared to MF (*P* < 0.001), TF and T-MF (*P* < 0.01), TF-KB (*P* < 0.05) but not to T-TF. MF had the lowest WSC content. In

late summer grazing, there was significant difference between all species, except for T vs. TF-KB, MF vs. T-MF and TF vs. T-TF.

Horses preferred TF-KB. It represented nearly one-third of all the observations (Fig. 2). In statistical analyses the paddocks were used as replicates. TF-KB had, on average, 230 grazing observations, significantly more than the other species ( $P < 0.001$ ). According to the results, it was suggested that KB in the mixture increased grazing on the TF-KB treatment. T, TF and T-TF (137, 129 and 105, respectively) were secondly preferred and did not differ statistically. Minimum number of observations were on T-MF and MF (78 and 82, respectively), which were significantly less than those on TF-KB, T and TF.

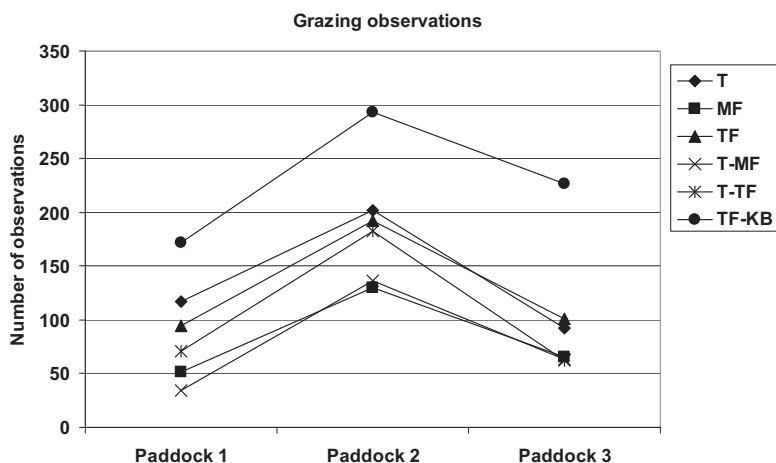

Figure 2. Preferences of different species/mixtures by horses. Numbers describe how often horses were recorded grazing on the species/mixtures within the observation period. (T = timothy, MF = meadow fescue, TF = tall fescue, KB = Kentucky bluegrass).

## Conclusion

WSC content of pasture grass varied between grazing periods and species/mixture treatments. The difference was pronounced in spring, when timothy had the highest and TF the lowest WSC content. High WSC content, especially with lush spring growth, can predispose horses to metabolic disorders. Since TF had low WSC content and good preference by horses, this makes TF a suitable option on horse pastures.

## References

- Niemeläinen O., Jauhiainen L. and Miettinen E. (2001) Yield profile of tall fescue (*Festuca arundinacea*) in comparison with meadow fescue (*F. pratensis*) in Finland. *Grass and Forage Science* 56, 249-258.
- Somogyi M. (1945) A new reagent for the determination of sugars. *The Journal of Biological Chemistry* 160, 61-68.
- Watts K. (2005) A review of unlikely sources of excess carbohydrate in equine diets. *Journal of Equine Veterinary Science* 25, 338-344.

# Potassium effect on pasture yield and its composition in management of an old permanent pasture

Sarunaite L. and Kadziuliene Z.

*Institute of Agriculture, Lithuanian Research Centre for Agriculture and Forestry, LT- 58344 Akademija, Kedainiai district, Lithuania*

Corresponding author: lina@lzi.lt

## Abstract

In pastures, potassium (K) can be one of the essential elements. An experiment was conducted over two periods (1961-1964 and 2005-2008) on a loamy *Endocalcari-Epihypogleyic Cambisol* cultivated soil, following the same experimental design. The focus was to estimate dry matter (DM) yield and botanical composition of the pasture in relation to different K rates. K rates influenced botanical composition in pastures and white clover (*Trifolium repens* L.) content decreased without the use of potassium. The annual DM yield was significantly affected by PK applications compared with the treatments without fertilizers. A regular application of PK in a long-term pasture sward makes it possible to maintain a good sward with a sufficient amount of legumes and a rather stable DM yield. In an older sward, the higher potassium rate exhibited a significant advantage over the lower rates.

Keywords: Potassium, dry matter yield, fertilisation, botanical composition, legume

## Introduction

Potassium is supposed to be one of the essential elements (Kayser and Isselstein, 2005), which has a weaker effect on increasing pasture productivity than nitrogen. However, K has a specific physiological role in plants. Plant species differ in K needs and have different abilities in their uptake of K. Nutrient cycling and the availability of K differ substantially between soils and depend on their mineralogical composition and fertilising strategy (Andersson *et al.*, 2007). Legumes have been shown to be more susceptible to K deficiency than grasses, and therefore potassium is very important for the legume growth and sustainability in mixed pasture swards (Høgh-Jensen and Pedersen, 2003). Greater plant species diversity can lead to increased plant productivity, with associated nutrient retention efficiency and ecosystem stability. However, increased productivity with species richness is not very simple and the essential component for productivity of the grassland community is legumes (Spehn *et al.*, 2002; Hopkins and Holz, 2006). The focus of this study was to estimate DM yield stability and botanical composition of the pasture in relation to the different long-term potassium fertilising.

## Materials and methods

The experiment has been carried out since 1961. The data presented in this paper cover two experimental periods: 1961-1964 and 2005-2008. The soil of the experimental site is loam-textured *Endocalcari-Epihypogleyic Cambisol*. Soil K and P concentrations ranged from 83-100 and 22-31 mg kg<sup>-1</sup>, during the first period of the experiment, respectively (Zimkus, 1995). During the second period of the experiment, soil K and P concentrations ranged from 76-112 and 77-98 mg kg<sup>-1</sup>, respectively. The experimental design included four replicates. The plot size was 33.3 m<sup>2</sup> (13.3 m x 2.5 m). Five different levels of K (0, 25, 50, 75 kg ha<sup>-1</sup>) in conjunction with P (0, 26 kg ha<sup>-1</sup>) fertilisation were applied to newly and long established swards. The pasture was fertilised with P (superphosphate) and K (potassium chloride)

according to the design of the experiment every spring before the start of pasture growth. The grazing season started in the middle of May and lasted until the beginning of October. Grazing intensity was 2-2.5 cows ha<sup>-1</sup> yr<sup>-1</sup>, and duration of the grazing season 150 days, 4 times per season. The pasture was grazed when the main species of the sward had reached an average height of 20-25 cm. Before each grazing, the dry matter (DM) was estimated. The cut herbage was immediately weighed, about 0.5 kg samples of the fresh herbage were taken to the laboratory for determination of DM and botanical composition. The samples for estimation of DM were dried in an oven at 105 °C until constant weight. DM yield was estimated on the basis of total dry matter amount per plot (20.8 m<sup>2</sup>) and calculated as DM yield in Mg ha<sup>-1</sup>. The botanical composition (legumes, grasses, forbs) of the samples was measured after separation. The concentration of potassium in the DM was estimated by flame spectrophotometry (Hanlon, 1998). The yield data were processed by statistical methods using ANOVA (Tarakanovas, 2002).

## Results and discussion

The botanical composition of old pasture swards depended on different climatic factors and K fertiliser rates. During the second experimental period the proportion of legumes in the herbage DM varied from 11.8% to 39.4% (data not shown) while the average for the period was 21.7–25.5% (Table 1). The legume content in the non-fertilised treatment ranged from 4.4% to 15.1% while the average for the period ranged between 9.6 and 14.2%.

However, during the first experimental period, the non-fertilised pasture swards had an average legume content of 20.2–23.0%, compared to the fertilized treatments with 26.6–28.2% legume content. The results indicate the relative importance of K to legume sustainability and that legume content decreased without the use of potassium. Høgh-Jensen (2003) reported that low soil K availability can reduce legume growth. During the experimental periods the content of forbs mostly varied irrespective of whether potassium fertiliser was applied or not. The proportion of grasses decreased and was exacerbated in the treatments with potassium fertilisation.

Table 1. The influence of P and K fertilisation on botanical composition, dry matter yield and K concentration in herbage dry matter of the pasture

Treatments	Average of 1961-1964				Average of 2005-2008				
	Legume %	Grass %	Forbs %	Yield Mg ha <sup>-1</sup>	Legume %	Grass %	Forbs %	Yield Mg ha <sup>-1</sup>	K, g ha <sup>-1</sup>
P <sub>0</sub> K <sub>0</sub>	20.2	73.4	6.5	4.46	9.6	51.4	39.0	4.13	22.8
P <sub>26</sub> K <sub>0</sub>	23.0	72.0	5.1	5.25	14.2	50.2	35.6	5.31	21.2
P <sub>26</sub> K <sub>25</sub>	26.6	68.9	4.5	5.45	21.7	47.2	31.1	5.75	23.5
P <sub>26</sub> K <sub>50</sub>	27.0	67.9	5.1	5.71	24.7	43.5	31.9	6.34	25.5
P <sub>26</sub> K <sub>75</sub>	28.2	67.3	4.6	5.73	25.5	41.5	33.1	6.21	29.6
P>0.005	1.68	1.20	1.23	0.460	2.52	2.91	3.22	0.325	2.00

In the second period of the experiment, the annual DM yield was significantly affected by P and K applications compared with the treatments without fertilisers. However, herbage production increasing in the treatment P<sub>26</sub>K<sub>75</sub> compared with P<sub>26</sub>K<sub>50</sub> was not significant. In previous stages (1961–1964) of this experiment the most efficient K fertiliser rates were found to be K<sub>25</sub> and K<sub>50</sub> (Zimkus, 1995; Gutauskas *et al.*, 2003). The differences between DM yield during the first and second period of the experiment across all treatments were not very marked. It would be difficult to state very clearly the influence of potassium fertilising based on the changes in DM yield over both periods of the experiment. The absence of large differences in production between P<sub>26</sub>K<sub>50</sub> and P<sub>26</sub>K<sub>75</sub> treatments in such long-term pasture use enables us to conclude that application of more than K<sub>50</sub> is not cost-effective. It should be

noted that the effect of potassium was very similar in newly established and long-term pasture swards. However, in the long-term sward the advantage of P<sub>26</sub>K<sub>50</sub> rate over P<sub>26</sub>K<sub>25</sub> was essential.

The concentration of potassium in the harvested herbage fluctuated slightly, and in most cases the highest content was found in herbage from the plots with P<sub>26</sub>K<sub>50</sub> and P<sub>26</sub>K<sub>75</sub> fertilisation rates. The lowest concentration of potassium was found under the P<sub>26</sub>K<sub>0</sub> fertilisation rate in the herbage, and this trend was observed during all recent experimental years. However, in almost all cases potassium content in herbage was normal.

## Conclusion

With a regular application of PK in a long-term pasture sward it is possible to maintain a good sward with a sufficient amount of legumes and a rather stable DM yield. In an older sward, the higher potassium rate (K<sub>50</sub>) exhibited a significant advantage over the smaller rates.

## References

- Andersson S., Simonsson M., Mattsson L., Edwards A.C. and Öborn I. (2007) Response of soil exchangeable and crop potassium concentrations to variable fertilizer and cropping regimes in long-term field experiments of different soil types. *Soil Use and Management* 23, 10-19.
- Hanlon E.A. (1998) Elemental determination by atomic absorption spectrophotometry. In: Kalra Y.P. (eds.) *Handbook of Reference Methods for Plant Analysis*. CRC Press, pp. 157-164.
- Høgh - Jensen H. (2003) The effect of potassium deficiency on growth and N<sub>2</sub>-fixation in *Trifolium repens*. *Physiologia Plantarum* 119, 440-449.
- Høgh-Jensen H. and Pedersen M.B. (2003) Morphological plasticity by crop plants and their potassium use efficiency. *Journal of Plant Nutrition* 26 (5), 969-984.
- Hopkins A. and Holz B. (2006) Grassland for agriculture and nature conservation: production, quality and multi-functionality. *Agronomy Research* 4(1), 3-20.
- Gutauskas J., Masauskiene A. and Slepetiene A. (2003) Long term investigation of different potassium fertilisation rates in pasture: variation of biomass, floristic composition and soil nutrient content. *Zemdirbyste-Agriculture* 84, 104-119. (In Lithuanian).
- Kayser M. and Isselstein J. (2005) Potassium cycling and losses in grassland systems: a review. *Grass and Forage Science* 60, 213-224.
- Spehn E.M., Scherer-Lorenzen M., Schmidt B., Hector A., Caldeira M.C., Dimitrakopoulos P.G., Finn J.A., Jumpponen A., O'Donovan G., Pereira J.S., Schulze E.-D., Troumbis A.Y. and Körner C. (2002) The role of legumes as a component of biodiversity in a cross-European study of grassland biomass nitrogen. *Oikos* 98, 205-218.
- Tarakanovas P. (2002). Data transformation of biological experiments using a computer program ANOVA. *Zemdirbyste-Agriculture* 77, 170-180. (In Lithuanian)
- Zimkus Z. (1995) Long-term potassium rate tests on pasture. *Zemdirbyste-Agriculture* 46, 39-42. (In Lithuanian).

# Morphological characteristics and tiller population density of aruana guineagrass subjected to frequencies and severities of grazing by sheep

Zanini G.D.<sup>1</sup>, Santos G.T.<sup>1</sup>, Padilha D.A.<sup>1</sup>, Cizinande S.<sup>1</sup>, Silva D.<sup>1</sup>, Borges J.A.S.<sup>1</sup>, Silva M.C.<sup>1</sup>, Freitas R.C.<sup>1</sup>, Arruda J.C.A.<sup>1</sup>, Almeida G.<sup>1</sup>, Nascimento-Junior D.<sup>2</sup>, Da Silva S.C.<sup>3</sup> and Sbrissia A.F.<sup>1</sup>

<sup>1</sup> Santa Catarina State University (UDESC), Av. Luiz de Camões, 2090, Lages, SC, Brazil

<sup>2</sup> Viçosa Federal University (UFV), Animal Science Department, Viçosa, MG, Brazil

<sup>3</sup> University of São Paulo (USP), Av. Pádua Dias, 11, Piracicaba, SP, Brazil

Corresponding author: sbrissia@cav.udesc.br

## Abstract

The objective of the experiment was to evaluate morphological characteristics and tiller population density of *Panicum maximum* cv Aruana subjected to frequencies and severities of grazing by sheep. Frequencies of grazing corresponded to interruption of regrowth at 95 and 98% of light interception (LI) by sward canopy, and severities corresponded to post-grazing heights of 10 and 15 cm. Treatments were assigned to experimental units (200 m<sup>2</sup> plots) according to a 2 x 2 factorial arrangement in a completely randomised design, with three replications. Measurements of morphological characteristics were performed on 20 randomly chosen tillers per plot. Grazing after the 95% LI condition resulted in significant stem elongation, particularly during autumn, causing difficulties to maintain the post-grazing target of 10 cm. The results indicate the importance of controlling sward conditions during regrowth, highlighting the importance of controlling grazing frequency as a means of minimising stem elongation and consequent reduction in nutritive value of the produced herbage. In this context, sward height is an effective and efficient field indicator to monitor the process.

Keywords: *Panicum maximum*, sward height, grazing management, pasture production

## Introduction

Recent evidence on management of tropical grasses has shown that the use of sward target-based grazing management strategies can result in significant increments in system productivity. Under those conditions, grazing frequency corresponded to levels of canopy light interception (LI) during regrowth on swards subjected to rotational stocking management. The results indicated the possibility of combining high dry matter production with high nutritive value of the produced herbage (Da Silva *et al.*, 2009). The studies on tropical grasses were mainly based on *Panicum maximum* cultivars and demonstrated that grazing over 95% LI resulted in high senescence and stem elongation, deteriorating sward structure and nutritive value of the herbage. Aruana guineagrass is a small-sized (30-50 cm) tropical grass relative to other cultivars of the same genus (*Panicum*) and is very suitable for the sheep industry in tropical zones (Bianchini *et al.*, 1999). There are few studies about its morphology and responses to grazing. The aim of this experiment was to evaluate some morphological characteristics and tiller population density of *Panicum maximum* cv Aruana subjected to frequencies and severities of grazing by sheep.

## Materials and methods

The experiment was carried out in Lages, state of Santa Catarina, Brazil (27°52' S, 51°18' W and 930 m above sea level), on a *Panicum maximum* cv. Aruana pasture (aruana guineagrass).



Treatments corresponded to the factorial arrangement of two pre-grazing conditions (95 and 98% LI) and two post-grazing heights (10 or 15 cm), and were allocated to experimental units (200 m<sup>2</sup> paddocks) according to a completely randomised design, with three replications. Sheep grazing started in November 2008 using the mob grazing method described by Gildersleeve *et al.* (1987). The number of animals used was dimensioned to allow a grazing period no longer than 12 h (grazing during day time only). Measurements started in January 2009 and were performed until May 2009. Monitoring of canopy light interception was performed using a canopy analyser LP-80 (Decagon Devices, USA). Readings (five at ground level and one above sward canopy) were taken at post-grazing condition twice a week on six sampling areas per paddock (representative of the average sward condition at the time of sampling - visual assessment of height and herbage mass). Measurements of sward height were made concomitantly to measurements of LI using a sward stick. A total of 60 readings were taken consistently along pre-defined trajectories in each paddock throughout the experimental period. Measurements of leaf senescence and stem elongation were performed on 20 randomly chosen tillers per paddock. Tiller population density was estimated using three frames of 0.00625 m<sup>2</sup> per paddock. Data were analysed as repeated measures using the Mixed Procedure of SAS<sup>®</sup> (Statistical Analysis System). The reported means are least square means ("LSMEANS"), and the comparisons made with "PDIF" based on a Student t test and at 5% significance level.

## Results and discussion

Pre-grazing sward height corresponded to approximately 30 and 40 cm for 95 and 98% LI, respectively (average of 5 and 3 grazing cycles, respectively). Despite post-grazing height being a control variable, targets could not be maintained when grazing was carried out at 98% LI, especially with 10 cm post-grazing height (Table 1).

Table 1. Pre and post-grazing heights in aruana guineagrass subjected to different frequencies and severities of defoliation by sheep

Post-grazing height (cm)	Light interception (%)		Mean	SEM*
	95	98		
10	32.0	44.0	38.0	1.38
15	31.0	38.0	35.0	
Mean	31.5 <sup>b</sup>	41.0 <sup>a</sup>		
	Post-grazing sward surface height (cm)			
10	12.5 <sup>c</sup>	18.1 <sup>a</sup>	15.2	0.65
15	16.3 <sup>b</sup>	19.3 <sup>a</sup>	17.8	
Mean	14.4	19.0		

\* Standard error of the mean – means followed by the same lowercase letter in lines (or interaction) are not different ( $P>0.05$ )

Stem elongation rates were approximately 4 times greater on swards grazed at 98% LI relative to those managed at 95% LI. Leaf senescence was 4 times greater as well on swards managed at 98% LI (Table 2). Swards managed at 95% LI showed larger tiller population density than those managed at 100% LI, the same happening to those grazed down to 15 relative to 10 cm. The highest rates of stem elongation and leaf senescence recorded on swards grazed at 98% LI highlights the importance of monitoring and controlling defoliation frequency. The findings of Korte *et al.* (1982) with perennial ryegrass, based on previous work of Brougham (1957), had already shown that at 95% LI the pastures presented a greater dry matter production with a higher proportion of leaves. Relative to leaves, stems have lower nutritive value and are avoided by animals.

Table 2. Stem elongation, leaf senescence and tiller population density in aruana guineagrass subjected to different frequencies and severities of defoliation by sheep

Post-grazing height (cm)	Light interception (%)		Mean	SEM*
	95	98		
	Stem elongation rate (cm tiller <sup>-1</sup> day <sup>-1</sup> )			
10	0.01 <sup>c</sup>	0.239 <sup>a</sup>	0.12	
15	0.10 <sup>b</sup>	0.206 <sup>a</sup>	0.15	0.0136
Mean	0.05	0.22		
	Leaf senescence rate (cm tiller <sup>-1</sup> day <sup>-1</sup> )			
10	0.16	0.29	0.23	
15	0.21	0.29	0.25	0.026
Mean	0.19 <sup>b</sup>	0.29 <sup>a</sup>		
	Tiller population density (tillers m <sup>-2</sup> )			
10	1341	963	1152 <sup>B</sup>	
15	1508	1146	1327 <sup>A</sup>	52.0
Mean	1425 <sup>a</sup>	1055 <sup>b</sup>		

\* Standard error of the mean - means followed by the same lowercase letter in lines (or interaction) and upper case in columns are not different ( $P > 0.05$ )

The difficulty experienced in having paddocks grazed down to post-grazing targets is a strong indication of that management difficulty, and is a result that corroborates the results of previous research using taller cultivars of *Panicum maximum* (Da Silva *et al.*, 2009). The present work shows that even a small-sized tropical grass like aruana guineagrass can exhibit significant stem elongation if not managed appropriately, and that sward height is an effective and efficient field indicator to monitor and control the grazing process.

## Conclusions

The observed correlation between LI and sward surface height suggest that aruana guineagrass should not be grazed higher than 30 cm at intermittent grazing. The interruption of growth at this point would prevent a higher stem elongation and senescence losses.

## Acknowledgements

To FAPESC (Fundação de Apoio à Pesquisa Científica e Tecnológica do Estado de Santa Catarina, Brazil) for funding of this research.

## References

- Bianchini D., Carriel J.M., Leinz F.F. and Rodrigues C.F.C. (1999) Viabilidade de doze capins tropicais para criação de ovinos. *Boletim de Indústria Animal* 56, 163-177.
- Brougham R.M. (1957) Interception of light by the foliage of pure and mixed stands of pasture plants. *Australian Journal of Agricultural Research* 9, 39-52.
- Da Silva S.C., Bueno A.A.O. and Carnevalli R.A. *et al.* (2009). Sward structural characteristics and herbage accumulation of *Panicum maximum* cv. Mombaça subjected to rotational stocking managements. *Scientia Agricola* 66 (1), 8-19.
- Gildersleeve R.R., Ocumpaugh W.R., Quesenberry K.H. and Moore J.E. (1987) Mob-grazing morphologically different *Aeschynomene* species. *Tropical Grasslands* 21, 123-132.
- Korte C.J., Watkin B.R. and Harris W. (1982) Use of residual leaf area index and light interception as criteria for spring-grazing management of ryegrass dominant pasture. *New Zealand Journal of Agricultural Research* 25, 309-319.

# Continuous grazing in comparison to cutting management on an organic meadow in the eastern Alps

Starz W.<sup>1</sup>, Steinwidder W.<sup>1</sup>, Pfister R.<sup>1</sup> and Rohrer H.<sup>1</sup>

*Agricultural Research and Education Centre (AREC), Institute of Organic Farming and Farm Animal Biodiversity, A-8952 Irtding, Austria*

Corresponding author: walter.starz@rauberg-gumpenstein.at

## Abstract

Continuous grazing is an appropriate pasture system for dairy cows in low input milk production systems like organic farming. Grazing increases for economic reasons and is also caused by regulations in organic farming. If a dairy farm converts a pasture-based system, cows will start grazing on a cutting-managed meadow. Due to the utilisation changing from cutting to grazing, a conversion of the botanical composition and the quantity and quality yield is expected. To document and assess such conversions, a three-year field trial was carried out on the organic grassland and dairy farm of the AREC Raumberg-Gumpenstein between 2007 and 2009. In this study, changes in the botanical composition were found. In contrast to botanical composition, no significant differences between below-ground biomass and quality yield (CP and NEL) could be detected, although the harvest sward yields of the grazing sward were significantly less than in the cutting variant in the trial years 2007 and 2008.

Keywords: plant species composition, below-ground, above-ground, biomass, organic farming

## Introduction

Continuous grazing is important for pasture-based systems and is of considerable interest for organic dairy farms with pasture in Austria. Practical knowledge of continuous grazing is low in the eastern part of the Alps. Some farmers have suggested that there is a lower yield under continuous grazing than in mown meadows. Investigations in Switzerland recorded pasture yields from 6276 kg (Schori, 2009) to 13470 kg (Thomet *et al.*, 2004) per year and ha, which is a comparable range to cutting yields under Austrian Alpine conditions. However, the harvested biomass yield is not the only important factor of a continuous grazing system. Change in plant species composition when converting a cutting meadow to continuous grazing, as well as below-ground biomass, are also important. The hypotheses of this study were that biomass yield will not differ between the two management systems and a change in species composition will take place.

## Materials and methods

In a three-year field trial, influences of grazing by dairy cows were measured regarding differences in plant composition, biomass production, and quality yield. The field trial was carried out on an organically managed continuous grazing area (680 m altitude, 7 °C average temperature, 1000 mm precipitation per year) as a block design with three replications. Before 2005 the area was used as a meadow and in 2005 the cutting plot was fenced to compare possible changes between the use as cutting meadow and pasture with continuous grazing. Changes in plant composition were measured in 2009, using area percent rating. To identify below-ground biomass, five soil cylinders (each measuring 0-10 cm in height and 6.2 cm in diameter) per variant and replication were sampled three times. Below-ground biomass was

separated from the soil by a root washer (water and pressure air mixes the samples, which are filtered by a riddle with a mesh width of 1000 µm). After washing, dry matter (DM) of the below-ground biomass was evaluated by drying in an oven at 105 °C for 48 hours. The DM of the harvested green biomass was assessed with the same method. Above-ground biomass was harvested with a motor mower at a cutting height of 7 cm from the cutting meadow as well as from the continuous grazing variant. This variant was harvested seven times per year at an average sward height of 15 cm. The sample cutting area on the continuous grazing variant was changed between two harvest times. One part of the continuous grazing variant was grazed 50% of the time by dairy cows and the other part was fenced in for harvesting the sward and to evaluate the DM production. Therefore, the effect of grazing was at least 50% on each continuous grazing variant area. The cutting meadow was harvested four times at the conventional cutting times with the motor mower. Crude protein (CP) contents were analysed with the Weender Analysis in the laboratory of AREC Raumberg-Gumpenstein. Regarding the MJ net energy (NEL), the calculation was based on a regression equation considering crude nutrients (GfE, 1998).

**Table 1. Listing of important parts and species of plant composition using area percent rating.**

Variant	Grass	Legumes	Herbs	<i>Lolium perenne</i>	<i>Poa trivialis</i>	<i>Trisetum flavescens</i>	<i>Dactylis glomerata</i>	<i>Poa pratensis</i>	<i>Trifolium repens</i>
	in %	in %	in %	in %	in %	in %	in %	in %	in %
Grazing	68 <sup>a</sup>	18 <sup>a</sup>	13 <sup>a</sup>	20 <sup>a</sup>	5 <sup>b</sup>	2 <sup>b</sup>	3 <sup>b</sup>	21 <sup>a</sup>	17 <sup>a</sup>
Cutting	78 <sup>a</sup>	8 <sup>b</sup>	12 <sup>a</sup>	11 <sup>b</sup>	18 <sup>a</sup>	12 <sup>a</sup>	11 <sup>a</sup>	7 <sup>b</sup>	7 <sup>b</sup>

Means with same letter are not significant different; T-test  $P > 0.05$

## Results and discussion

On examination of the botanical composition, a difference between grazing and cutting management of important species in Alpine permanent grassland could be measured (Table 1). Due to grazing, a significant lower coverage of bunch-type growth grasses like *Dactylis glomerata* and *Trisetum flavescens* on the grazing variant was found. Therefore, typical pasture plants like *Lolium perenne*, *Poa pratensis* and *Trifolium pratense* covered a significantly greater area on the grazed variant than on the cutting variant. This grazing effect on the botanical composition could also be detected in a trial in Switzerland (Thomet *et al.*, 2000). The below-ground biomass shows no significant difference between grazing and cutting at the three samplings. This result is interesting, considering the differences in the plant composition. At the first sampling in spring, the below-ground DM biomass ranged between 4792 kg ha<sup>-1</sup> in the cutting variant and 4289 kg ha<sup>-1</sup> in the grazing variant (Fig. 1). However, in a Swiss trial (Thomet *et al.*, 2000) 5525 kg ha<sup>-1</sup> (0-7.5 cm soil sampling depth) below-ground DM biomass at continuous grazing areas was found. One possible reason for the higher below-ground biomass in the Swiss trial could be the better climate condition in the Swiss midland (Schori, 2009) than in the eastern Alpine area. The harvested above-ground biomass showed a significantly lower yield in the grazing variant, but only in the trial years 2007 and 2008 (Fig. 2). In these yields, no technical harvesting losses (in practice, grassland management) were included. This is interesting in terms of the CP and NEL yields: both of these quality parameters showed no significant differences between grazing and cutting management. Similar yields on a pasture were measured in an organic trial in Switzerland (Schori, 2009). In the Swiss trial the highest DM yield from a pasture was measured in 2004, with 8439 kg DM ha<sup>-1</sup>, and the highest yield from the respective grazing variant of this trial reached 9381 kg DM ha<sup>-1</sup> (in 2007).

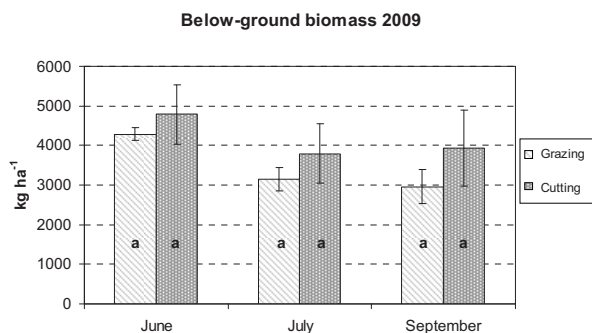

Figure 1. Illustration of below-ground biomass in vegetation year 2009. Means with same letter are not significant different; T-test  $P > 0.05$

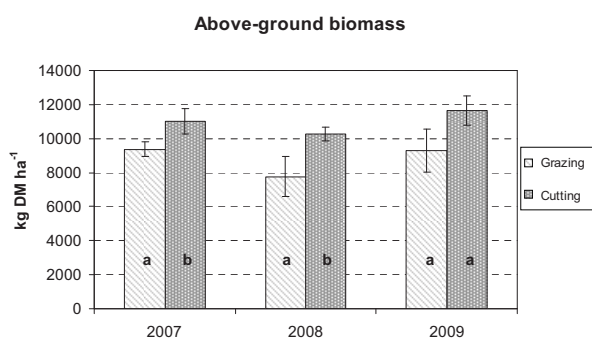

Figure 2. Dry matter yields of above-ground biomass in the three trial years. Means with same letter are not significant different; T-test  $P > 0.05$

## Conclusion

This field trial, carried out to evaluate the impact of continuous grazing in the eastern Alpine region, clearly showed changes in the botanical composition as a result of conversion from a cutting meadow to continuous grazing. However, the suggestions of farmers that there is a lower yield under continuous grazing could be disproved by the results of this trial. Continuous grazing can be a suitable pasture system for organic farms in eastern Alpine areas that have more favourable climate conditions.

## References

- GfE (1998) Gesellschaft für Ernährungsphysiologie: Formeln zur Schätzung des Gehaltes an Umsetzbarer Energie in Futtermitteln aus Aufwüchsen des Dauergrünlandes und Mais-Ganzpflanzen. *Proc. Soc. Nutr. Physiol.* 7, 141-150.
- Schori F. (2009) Weidebesatzstärken: Auswirkung auf Milchleistung und Grasqualität. *Agrarforschung* 16, 436-441.
- Thomet P., Hadorn M., Troxler J. and Koch B. (2000) Entwicklung von Raigras/Weißklee-Mischungen bei Kurzrasenweide. *Agrarforschung* 7, 218-223.
- Thomet P., Leuenberger S. and Blaettler T. (2004) Projekt Opti-Milch: Produktionspotenzial des Vollweidesystems. *Agrarforschung* 11, 336-341.

# Changing towards a seasonal low-input pastoral dairy production system in mountainous regions of Austria – results from pilot farms during reorganisation

Steinwider A.<sup>1</sup>, Starz W.<sup>1</sup>, Podstatzky L.<sup>1</sup>, Kirner L.<sup>2</sup>, Pötsch E.M.<sup>1</sup>, Pfister R.<sup>1</sup> and M. Gallnböck<sup>1</sup>

<sup>1</sup>Agricultural Research and Education Centre (AREC) Raumberg-Gumpenstein, A-8952 Irdning, Austria

<sup>2</sup>Federal Institute of Agricultural Economics, Marxergasse 2, A-1030 Wien, Austria

Corresponding author: andreas.steinwider@raumberg-gumpenstein.at

## Abstract

In order to obtain novel management and economic information on pastoral milk production in mountainous regions a research project with six pilot dairy farms (5 organic, 1 low input) was carried out in Austria. The farms were supervised during the reorganisation period aiming at a seasonal milk production system with a calving period in the winter-spring season. Within the observation period of three years a strict annual cycle in milk production and reproduction was only realised on two farms. An average pasture proportion of 42% (range 26 to 61%) of the total DM intake  $y^{-1}$  was realized. On four farms, which fed low amounts of supplementary feed during the grazing period, a pasture proportion of 50% of the total DM intake per year was realized in the last project year. With an input of only 470 kg  $cow^{-1} y^{-1}$  DM concentrate (8% of DM intake) a milk performance of 5542 kg with 4.02% fat and 3.34 % protein was achieved on those four farms. The results indicate that the full grazing strategy with seasonal calving is feasible for animal health reasons in Austria. Despite lower milk yield per cow, lower marginal costs per unit milk are possible under well managed grazing systems.

Keywords: grazing, dairy cows, seasonal milk production, alpine regions

## Introduction

Farms in regions with seasonal dairy production from pastoral systems achieve low production costs. Increasing costs of energy, supplementary feed and labour can also enhance the competitiveness of low-input grazing strategies in regions with disadvantaged pastoral conditions (Durgiai *et al.*, 2004). However, most of the milk produced in Austria is based on preserved pasture in combination with cereal grains as feedstuff (all year-round) with dairy cows bred for high daily milk yields. A research project was initiated by AREC Raumberg-Gumpenstein to provide novel management and economic information on seasonal low-input pastoral milk production in mountainous regions. Based on the experiences in Switzerland ('OPTI-Milch'-project; Durgiai *et al.*, 2004; Kohler *et al.*, 2004; Thomet *et al.*, 2004) dairy farms were supervised during the reorganisation period aiming at a seasonal milk production system on pastures.

## Materials and methods

In a research project six dairy farms (5 organic, 1 low input) in different mountainous regions of Austria were accompanied for three years (1 October 2004 to 30 September 2007) during the change-over to a seasonal low-input dairy production system based on pastures (Table 1). Every project farmer intended to maximise the proportion of fresh forage in the total yearly feed ration, and to minimise concentrate and supplementary feeding during the grazing

period. Another goal was to shift the calving period into the winter-spring season. Each farmer could define the speed and intensity of implementing the low-input strategy on his own responsibility, and the project team consulted and accompanied them and recorded the results and experiences. The pilot farmers had to keep daily records about the composition of the feed ration in the stable, input of concentrates, milk yield per herd, grazing management and about animal health and fertility parameters. Yearly feed intake and pasture proportion were calculated considering the energy content of the feedstuffs and the net energy requirements of the dairy cows for milk production, live weight change, maintenance (+15 % in grazing season) and pregnancy (GfE, 2001). Economically relevant data according to the Austrian federal extension programme (BMLFUW, 2004) were collected during the whole project period.

Table 1. Data of pilot farms (beginning of project)

pilot farm <sup>1</sup>	altitude (m a.s.l.)	Dairy cows (cows farm <sup>-1</sup> )	milk yield (kg cow <sup>-1</sup> y <sup>-1</sup> )	concentrate (kg cow <sup>-1</sup> y <sup>-1</sup> )
1	400	32	7300	1000
2	650	30	6800	700
3	1060	13	5000	800
4	700	30	7000	1200
5	700	14	6500	1100
6	550	14	6400	1200

<sup>1</sup>pilot farm 1 – 5: organic farm management

## Results and discussion

Within the observation period of three years a strict annual cycle in milk production and reproduction was only realised on farms 1 and 4. Depending on the farm specific conditions and the implementation level of the low-input strategy, an average pasture proportion of 42% (26 to 61%) related to the total DM intake per year could be determined. The duration of the grazing season varied between 155 and 215 days. Dry weather conditions in summer and fertility problems of cows resulted in higher amounts of supplementary feeds on two farms (farms 5 and 6). On the other four farms (farms 1-4) the average proportion of grazed pasture was 50% (41 to 61%) of the total dry matter intake per cow and year in the last project year. Under more favourable grazing conditions in Switzerland, Ireland, Australia and New Zealand pasture proportions between 60 and 90% are possible (Thomet *et al.*, 2004; Dillon, 2006). Despite the high standard deviation, the forage quality was high (6.3 MJ NEL and 21% crude protein kg<sup>-1</sup> DM). On farms 1-4 the concentrate input decreased to 470 kg DM (8% of DM intake) cow<sup>-1</sup> year<sup>-1</sup> during the total project period. The milk yield decreased from 6475 kg (3.94% fat; 3.38% protein) in the year 2003 to 5837 kg cow<sup>-1</sup> (4.06% fat; 3.33% protein) in 2007. Because of the enhancement of the number of dairy cows the milk production per farm increased by about 6-7%. Despite the lower milk yield the data based on a federal extension programme reveal lower marginal costs and higher production efficiency per unit milk for the four pilot farms in comparison to the average results of the organic and conventional farms (Table 2). The culling results, the incidence of diseases and disorders, the expenses for animal health and the conception rate contradict the claim that the full grazing strategy with seasonal calving is not possible for animal health reasons. During the adjustment of the calving season by delaying the insemination of inappropriate cows the average calving interval was extended to 415 days. On those farms where a strict seasonal milk production was implemented quickly an average calving interval of 379 days was achieved, but nevertheless these results still indicate repeated fertility problems of some cows.



Table 2: Results of pilot farms 1 – 4 in comparison to average results of organic and conventional farms of the federal extension programme (triennial means; BMLFUW, 2004)

	pilot farms 1–4 means (min-max)	federal extension programme (means)	
		organic farms	conventional farms
Cows per farm	29.1 (12.9-36.2)	22.5	24.0
Milk yield (kg cow <sup>-1</sup> )	5542 (5076-6263)	6320	6973
Milk fat (%)	4.02 (3.85-4.18)	4.16	4.28
Milk protein (%)	3.34 (3.25-3.40)	3.38	3.48
Grazed pasture (% of annual DM intake)	47 (41-54)	n.a.	n.a.
Concentrate (kg cow <sup>-1</sup> y <sup>-1</sup> ) <sup>1</sup>	581 (257-976)	1291	1787
Herd complementation (%)	23 (13-31)	32	34
Non return rate – 90 days (%)	73 (50-86)	64	61
Insemination rate (cow <sup>-1</sup> )	1.4 (1.3-1.5)	1.5	1.6
Calving interval (days cow <sup>-1</sup> )	419 (407-432)	393	394
Expenses for animal health (Euro cow <sup>-1</sup> y <sup>-1</sup> )	33.1 (18.3-40.3)	58.2	63.4
Marginal income (Euro cow <sup>-1</sup> y <sup>-1</sup> )	1640 (1310-1939)	1645	1720
Marginal income (Euro cent per kg milk)	29.4 (26.6-31.8)	25.9	24.6

<sup>1</sup>energy corrected (7.8 MJ NEL kg<sup>-1</sup> in concentrate)

## Conclusions

With optimal and site-specific seasonal grazing systems, a grazed pasture proportion of 45 to 60% (max. 65%) of the total dry matter intake of dairy cows seems to be attainable under disadvantaged mountainous conditions. Despite lower milk yield per cow, lower marginal costs per unit milk are possible under well managed grazing systems. Getting cows in calf within a short period is a big challenge in strict seasonal dairy programmes.

## References

- BMLFUW (Bundesministerium für Land- und Forstwirtschaft, Umwelt und Wasserwirtschaft) (2004) *Betriebszweigabrechnung neu für die Milchproduktion – Fibel zur Berechnung der direktkostenfreien Leistung*. BMLFUW Wien, 21 pp.
- Dillon P. (2006) Achieving high dry-matter intake from pasture with grazing dairy cow. In: Elgersma, A., Dijkstra J. and Tamminga S. (2006) *Fresh herbage for dairy cattle*, Springer-Verlag, 1-26.
- Durgiai B. and Müller R. (2004) Projekt Opti-Milch: Betriebswirtschaftliche Ergebnisse. *Agrarforschung* 11, 126-131.
- GfE (Gesellschaft für Ernährungsphysiologie) (2001) *Empfehlungen zur Energie- und Nährstoffversorgung der Milchkühe und Aufzuchttrinder*. DLG-Verlag Frankfurt am Main, 15-24.
- Kohler S., Blättler T., Wanner K., Schäublin H., Müller C. and Springer P. (2004) Projekt Opti-Milch: Gesundheit und Fruchtbarkeit der Kühe. *Agrarforschung* 11, 180-185.
- Thomet P., Leuenberger S. and Blättler T. (2004) Projekt Opti-Milch: Produktionspotential des Vollweidesystems. *Agrarforschung* 11, 336-341.

# Impact of grazing intensity on performance of sheep in the Inner Mongolian steppe, China

Müller K.<sup>1</sup>, Lin L.<sup>1</sup>, Glindemann T.<sup>1</sup>, Wang C.<sup>1a</sup>, Schiborra A.<sup>2b</sup>, Schönbach P.<sup>2</sup>, Wan H.W.<sup>2</sup>, Tas B.M.<sup>1c</sup>, Dickhöfer U.<sup>1</sup>, Gierus M.<sup>2</sup>, Taube F.<sup>2</sup> and Susenbeth A.<sup>1</sup>

<sup>1</sup>*Institute of Animal Nutrition and Physiology, Christian-Albrechts-University of Kiel, 24118 Kiel, Germany*

<sup>2</sup>*Institute of Crop Science and Plant Breeding, Christian-Albrechts-University of Kiel, 24118 Kiel, Germany*

<sup>a</sup>*Present address: College of Ecology and Environment, Inner Mongolia Agricultural University, Huhhot, China*

<sup>b</sup>*Present address: Institute of Animal Husbandry in the Tropics and Subtropics, Universities of Kassel and Göttingen, Witzenhausen, Germany*

<sup>c</sup>*Present address: Schothorst Feed Research B.V., Lelystad, The Netherlands*

Corresponding author: susenbeth@aninut.uni-kiel.de

## Abstract

In Inner Mongolia, China, grassland degradation due to overgrazing reduces grassland and animal productivity and leads to desertification with severe ecological and economical consequences. In 2005, 2006, and 2007, a grazing experiment was conducted in the Inner Mongolian steppe to analyse the effects of six different grazing intensities (GI) on quality of ingested herbage, feed intake and animal performance. Sheep were continuously kept on the plots throughout the grazing season (July – September). GI strongly influenced herbage mass and quality. However, digestibility of organic matter, feed intake, and live weight gain were not different between GIs. Feed intake as well as live weight gain per hectare increased with increasing GI. Hence, intensive grazing does not reduce performance of individual animals but increases productivity per area and therefore, income for farmers. However, in dry years a lack of herbage mass on offer on heavily grazed pastures may require the purchase of additional forage for animals at the end of the vegetation period or the untimely sale of animals. Long-term negative effects of high GIs on grassland productivity are likely.

Keywords: Sheep; Mongolia; grazing intensity; overgrazing; sedentarization

## Introduction

In the Inner Mongolian steppe, China, nomadic pastoralists traditionally moved through large catchment areas. Nowadays, livestock grazing is still an important component of the steppe agriculture; however, the recent sedentarization of sheep pastoralists has profoundly altered grassland use. While grazing pressure is high near farms, distant grassland is only used for haymaking and is not fertilized. Overgrazing as well as soil organic matter and nutrient depletion therefore caused a severe degradation of the natural grassland vegetation and may reduce grassland productivity and animal performance. They therefore threaten the long-term ecological and economic sustainability of this pastoral system. The objectives of this study were to determine the effects of different grazing intensities (GI) on the nutritional quality of ingested herbage and the feed intake and live weight gain (LWG) of grazing sheep.

## Materials and methods

A grazing experiment was conducted in the Xilin River Basin (116°42'E, 43°38'N; 1200 m a.s.l.) in July – September 2005, 2006, and 2007. Each year, about 132 sheep of the local fat-

tailed breed were kept in paddocks at six different GI defined by the following herbage allowance (HA) classes: >12 (GI1), 6-12 (GI2), 4.5-6 (GI3), 3-4.5 (GI4), 1.5- 3 (GI5), and <1.5 kg (GI 6) herbage dry matter per kg live weight. The number of animals was monthly adjusted to herbage mass. Paddocks had a size of 2 ha, with the exception of GI1, which comprised 4 ha to achieve a minimum number of six sheep per plot. Six animals per plot were chosen for repeated determination of digestibility of ingested organic matter (dOM) and daily organic matter intake (OMI) in the beginning of July, August, and September. dOM was determined using the crude protein (CP) concentration in faecal organic matter according to Wang *et al.* (2009). Faecal excretion was estimated using the external marker titanium dioxide (Glindemann *et al.*, 2009a). All sheep per plot were weighed on two consecutive days at the beginning of each month to determine daily LWG. Measurements were repeated in two paddocks per GI treatment. In 2006, GI 5 and 6 sheep had to be removed from the plots in the middle of August due to a lack of forage, and no weight data could be collected for the remaining GIs in September because of an early winter onset. Least squares means and standard errors were calculated using the Mixed Model Procedure offered by SAS version 9.1 (SAS, 2000). The Tukey test was applied to test for significant differences between GI treatments. Regression analyses were carried out to study the effect of HA on dOM, OMI, and LWG per sheep and per hectare.

## Results and discussion

dOM ranged between 0.565-0.580 and did not differ between GIs ( $P>0.05$ ), which complies with earlier findings that *in vitro*-digestibility of herbage on offer was not affected by GI (Glindemann *et al.*, 2009b). Since daily OMI (75-88 g kg<sup>-0.75</sup> live weight) was similar in animals grazing at different GIs ( $P > 0.05$ ; Fig. 1a), the sheep's daily LWG (82-103 g d<sup>-1</sup>) also did not differ between GI treatments ( $P > 0.05$ ). Results therefore suggest that sheep were able to compensate for decreasing HA. In contrast, total LWG of all sheep per hectare, and hence, income for farmers, decreased strongly with increasing HA ( $P<0.05$ ; Fig. 1b), which further substantiates the intensive grassland use by farmers.

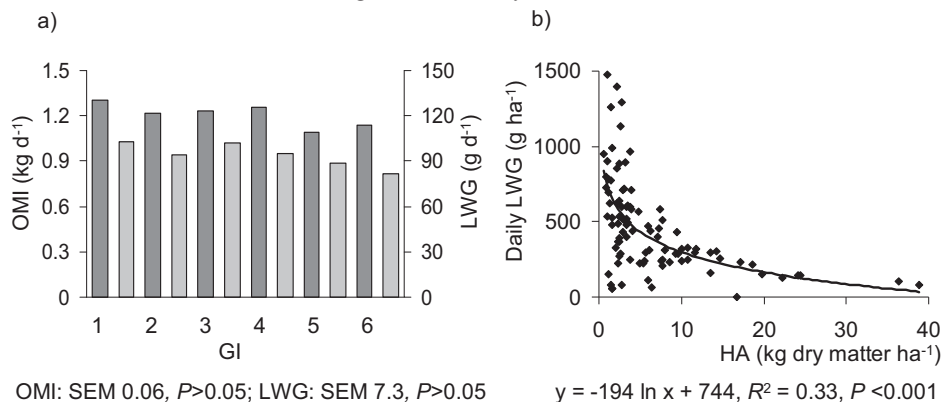

Figure 1. Daily organic matter intake (OMI, dark grey, primary axis) and total live weight gain (LWG, light grey, secondary axis) of sheep grazing at different grazing intensities (GI; a); and regressions between the herbage dry mass allowed (HA) and the total LWG of all sheep per hectare (b). For GI definitions see text. SEM standard error of the mean.

Nevertheless, many authors have stressed the severe effect of sheep grazing on grassland forage production and animal performance (Ackermann *et al.*, 2001; Animut *et al.*, 2005). Studies in the same area have shown that increasing GI reduces vegetation cover and herbage

mass (Schönbach, personal communication), indicating that negative long-term effects on grassland productivity are likely. While LWG of sheep in our study did not differ between GIs, Glindemann *et al.* (2009b) showed that in summer 2005, average daily LWG of sheep kept on the same experimental plots strongly decreased with increasing GI. Correspondingly, GI 5 and 6 sheep in our study had to be removed from the plots before the end of the grazing season in 2006 due to a lack of forage, whereas herbage on offer was sufficient in 2005 and 2007. Hence, the effect of GI on LWG of sheep may vary between years depending on the amount and distribution of rainfall.

## Conclusions

Intensive grazing does not reduce feed intake and performance of individual animals but increases output per area and, therefore, income for farmers. However, in dry years, a lack of herbage mass on offer on heavily grazed pastures requires the purchase of additional forage for animals at the end of the vegetation period or the untimely sale of animals and long-term negative effects of high GI on grassland productivity are likely. Recent changes in the steppe use towards intensive livestock grazing may therefore limit future grassland productivity and animal performance.

## Acknowledgements

The authors gratefully acknowledge the financial support by the Deutsche Forschungsgemeinschaft within the research group 536 'Matter fluxes in grassland of Inner Mongolia as influenced by stocking rate' - a Sino-German cooperation project.

## References

- Ackermann C.J., Purvis H.T., Horn G.W., Paisley S.I., Reuter R.R. and Bodine T.N. (2001) Performance of light vs heavy steers grazing plains old world bluestem at three stocking densities. *Journal of Animal Science* 79, 493-499.
- Animut G., Goetsch A.L., Aiken G.E., Puchala R., Detweiler G., Krehbiel C.R., Merkel R.C., Sahlü T., Dawson L.J., Johnson Z.B. and Gipson T.A. (2005) Performance and forage selectivity of sheep and goats co-grazing grass/forb pastures at three stocking rates. *Small Ruminant Research* 59, 203-215.
- Glindemann T., Tas B.M., Wang C.J., Alvers S. and Susenbeth A. (2009a) Evaluation of titanium dioxide as an inert marker for estimating fecal excretion in grazing sheep. *Animal Feed Science and Technology* 152, 186-197.
- Glindemann T., Wang C., Tas B.M., Schiborra A., Gierus M., Taube F. and Susenbeth A. (2009b) Impact of grazing intensity on herbage intake, composition, and digestibility and on live weight gain of sheep on the Inner Mongolian steppe. *Livestock Science* 124, 142-147.
- SAS (2000) *SAS/STAT User's guide*. Release 9.1 Edition. SAS Institute Inc. Cary, NC, USA.
- Wang C.J., Tas B.M., Glindemann T., Rave G., Schmidt L., Weissbach F. and Susenbeth A. (2009) Fecal crude protein content as an estimate for the digestibility of forage in grazing sheep. *Animal Feed Science and Technology* 149, 199-208.

## Efficiency of Swiss and New Zealand dairy breeds under grazing conditions on Swiss dairy farms

Thomet P.<sup>1</sup>, Piccand V.<sup>1</sup>, Schori F.<sup>2</sup>, Troxler J.<sup>3</sup>, Wanner M.<sup>4</sup> and Kunz P.<sup>1</sup>

<sup>1</sup>Swiss College of Agriculture (SHL), CH-3052 Zollikofen, Switzerland

<sup>2</sup>Agroscope Liebefeld-Posieux Research Station ALP, CH-1725 Posieux, Switzerland

<sup>3</sup>Institute for Animal Husbandry and Animal Welfare, University of Veterinary Medicine, A-1210 Vienna, Austria

<sup>4</sup>Institute of Animal Nutrition, Vetsuisse Faculty, University of Zurich, CH-8057 Zurich, Switzerland

Corresponding author: peter.thomet@bfh.ch

### Abstract

The objective of the study was to investigate over three years (2007 – 2009) the attributes of cows adapted to a pasture-based seasonal milk production system (New Zealand Holstein Friesian) under Swiss conditions and to compare them with Swiss breeds. For this purpose, pairs of Swiss (CH) and New Zealand (NZHF) cows were established (100 cows in total) with similar age and calving date on 15 commercial farms. Body weight (BW) in the first and second lactations were higher in CH cows than in NZHF cows (in 2007, 544 vs. 477 kg,  $P < 0.001$ ; in 2008, 578 vs. 517 kg,  $P < 0.001$ ). Milk yield was similar in CH and NZ cows for the initial two years but the milk of NZ cows had higher fat and protein content. The NZ cows produced more energy corrected milk (ECM) in the second lactation than the CH cows (6017 vs. 5470 kg,  $P < 0.001$ ). As a consequence, the efficiency (ECM per metabolic BW, kg kg<sup>-1</sup>) was higher in NZ than in CH cows in both years (2007, 49.7 vs. 44.2,  $P < 0.001$ ; 2008, 55.6 vs. 46.6,  $P < 0.001$ ). It is therefore concluded that New Zealand Holstein Friesians are more efficient in a pasture-based milk production system than Swiss breeds.

Key Words: Dairy cows, milk production, efficiency, pasture

### Introduction

An obligation of sustainable dairy production is the conversion of roughage to milk. This is especially valid for alpine areas where natural grassland is a key resource. However, in recent years, even in natural grassland areas like Switzerland, dairy-cattle breeding has become strongly orientated towards high annual yields per cow using increasing amounts of concentrates. Therefore, a lot of genetic material was imported from North America to improve the milk yield of Swiss breeds. However, there is strong evidence for interaction between the genotype of dairy cows and feeding systems (Horan *et al.*, 2005; Buckley *et al.*, 2007). Intensive selection for high annual milk yields on high concentrate diets has resulted in genotypes which are not suited to high forage systems and which need more daily energy intake. Kolver and Muller (1998) reported that the daily feed intake of grazing cows is lower than that of cows fed total mixed rations. As New Zealand Holstein Friesian (NZHF) have been selected for a system largely reliant on grazed pasture (>0.9 of the annual diet of cows) over a long time (Harris and Kolver, 2001) they could be more efficient than Swiss breeds (CH) in a pasture-based seasonal milk production system under Swiss conditions. To test this hypothesis, NZHF were compared with Swiss dairy cow breeds on commercial Swiss dairy farms.

## Material and Methods

The following results are part of a three-year study (2007 – 2009) including more aspects of the comparison between NZHF and Swiss dairy breeds. The present study was carried out in Switzerland in 2007 and 2008 on 15 commercial dairy farms with a pasture-based seasonal milk production system (60-65% of the annual diet). NZHF were sourced as pregnant heifers from Ireland. They were randomly distributed pre-partum among the project farms in January 2007. The Swiss animals were the cows present on the trial farms that were of similar age and expected calving date as the NZHF animals. The Swiss animals belonged to the three main Swiss breeds: Swiss Fleckvieh, Brown Swiss and Swiss Holstein Friesian. All groups of cows were representative (as per Breeding index) of the cows born the same year in their population of origin. The experimental cows were managed in the same way as the non-experimental cows on each farm. The composition of the annual DM intake was: 25-30% conserved forage (hay, grass silage, maize silage), on average 280 kg cow<sup>-1</sup> year<sup>-1</sup> concentrates and grazed grass. Cows were turned out to pasture by the end of March, and were grazing fulltime as soon as the pasture growth was sufficient to meet the herd feed demand. From that day conserved forage supplementation was stopped and only restarted in case of a temporary pasture deficit. Cows were weighed three times during lactation at fixed dates (Tru-Test weigh platform, Tru-Test, Palmerston North, NZ). Milk volume and composition (fat, protein, and lactose) were measured by monthly herd tests.

Efficiency of the cow genotype was defined as the relationship between energy corrected milk (ECM = kg milk × (0.38×fat% + 0.24×protein% + 0.816)/3.14) and metabolic body weight (BW<sup>0.75</sup>), with the BW as the average of the three measurements during lactation.

For comparison, pairs of NZHF and Swiss breeds (CHHF or FT or BV) were formed, by using the criteria calving date (max. 35 days difference), age and parity. Statistical analysis was made by a paired t-test using R statistical software (R Development Core Team, 2009).

## Results and discussion

The NZHF were smaller and lighter than the CH cows but produced similar amounts of milk during lactation (Table 1). Consequently, in the first and second lactations, the NZHF produced respectively 12% and 19% more energy corrected milk per kg BW<sup>0.75</sup> than the CH cows (Table 1, Figure 1).

Table 1. Calving age, lactation length, milk production and ECM efficiency per metabolic bodyweight of pairs of NZHF cows compared with Swiss breeds<sup>1</sup> on 15 dairy farms

	2007 first lactation			2008 second lactation		
	CH n = 44	NZ n = 44	P value	CH n = 46	NZ n = 46	P value
Age at calving (month)	25.5	23.8	< 0.0001	38.0	36.0	< 0.0001
Lactation length (d)	290	295	ns	284	287	Ns
Persistence <sup>2</sup> (%)	71.7	76.1	< 0.05	75.2	79.0	< 0.05
Energy corrected milk (kg cow <sup>-1</sup> )	4978	5061	ns	5470	6017	< 0.001
Bodyweight (BW, kg)	544	477	< 0.0001	578	517	< 0.0001
ECM efficiency (kg kg <sup>-0.75</sup> )	44.2	49.7	< 0.0001	46.6	55.6	< 0.0001
Energy efficiency <sup>3</sup>	0.52	0.55	< 0.0001	0.53	0.57	< 0.0001

<sup>1</sup> Brown Swiss, Swiss Fleckvieh and Swiss Holstein Friesian

<sup>2</sup> Relation between the production of days 1 to 100 to days 101 to 200 of the lactation

<sup>3</sup> Energy in the milk / calculated energy intake to cover the energy demand for lactation and the maintenance, pregnancy, body weight change and activity requirements

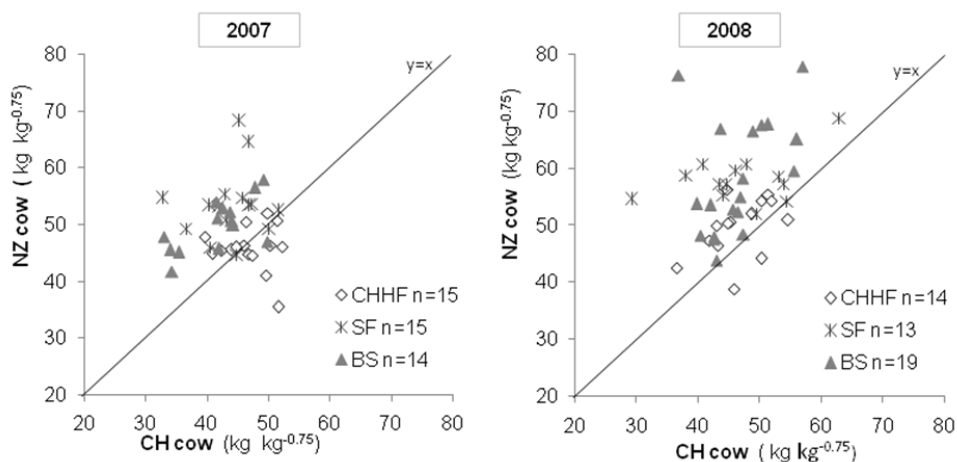

Figure 1. ECM efficiency per metabolic bodyweight of pairs of NZ Holstein Friesian dairy cows and Swiss breeds (BS = Brown Swiss, SF = Swiss Fleckvieh SF and CHHF = Swiss Holstein Friesian) on 15 Dairy farms

These results suggest that pasture-based milk production systems need other cow types than systems based on concentrates and conserved forage. The higher efficiency of the NZ cows could be due to a higher intake capacity at grazing. If these results are extrapolated over the feed conversion efficiency of an entire farm, the Swiss grassland farmer could improve net energy efficiency and productivity of milk production of about 10% from the grassland, regardless of breeding and raising costs. As in other enterprises, dairy production systems should aim at improving feed conversion efficiency, especially grazed grass which is the cheapest source of feed. With regard to milk production, which is resource-efficient and appropriate to the location, Swiss milk producers must ask themselves whether it is correct to raise the cow's annual milk production with the help of North American genetics. This would mean, on the one hand, feeding larger quantities of concentrates and, on the other hand, reducing the farm's own conserved forage and pasture conversion efficiency.

## Conclusion

In pasture-based seasonal milk production systems in Switzerland, where 60 to 65% of the diet was grazed pasture, the NZHF produced significantly more milk per kg metabolic body weight than local breeds.

## References

- Buckley F., Horan B., Lopez-Villalobos N. and Dillon P. (2007) Milk production efficiency of varying dairy cow genotypes under grazing conditions. In: National Dairy Alliance (Hrsg.). Dairy Science 2007, Meeting the challenges for Pasture-Based Dairying. *Proceedings of the 3<sup>rd</sup> Dairy Science Symposium*, Melbourne, pp. 74–83.
- Harris B.L. and Kolver E.S. (2001) Review of Holsteinization on intensive pastoral dairy farming in New Zealand. *Journal of Dairy Science* 84, 56–61.
- Horan B., Dillon P., Faverdin P., Delaby L., Buckley F. and Rath M. (2005) Strain of Holstein-Friesian by pasture-based feed system interaction for milk production, bodyweight and body condition score. *Journal of Dairy Science* 88, 1231–1243.
- Kolver E.S. and Muller L.D. (1998) Performance and nutrient intake of high producing holstein cows consuming pasture or a total mixed ration. *Journal of Dairy Science* 81, 1403–1411.



## Dry matter production of perennial ryegrass swards following poaching damage on a free-draining brown earth soil

Tuñon G.<sup>1,2</sup>, O'Donovan M.<sup>2</sup>, Hennessy D.<sup>2</sup>, Kemp P.<sup>1</sup>, Lopez Villalobos N.<sup>1</sup> and Kennedy E.<sup>2</sup>

<sup>1</sup> Massey University, Palmerston North, New Zealand

<sup>2</sup> Moorepark Research Centre, Fermoy, Ireland

Corresponding author: gonzalo.tunon@teagasc.ie

### Abstract

Poaching affects pasture production. This study investigated the effects of poaching on herbage production and tiller density of a perennial ryegrass sward on a free-draining brown earth soil. Twenty-four plots were established in a two-year-old perennial ryegrass (*Lolium perenne* L.) sward at Teagasc Moorepark Dairy Production Centre, Ireland. Four treatments were applied: i) Control (C), ii) Barely damaged (BR), iii) Intermediately damaged (ID), and iv) Badly damaged (BD). Forty-five cows were used to create the desired level of damage. Half of each plot was rolled four weeks after the treatments had been applied (12 March 2009). Once preceding, and five times subsequent to treatments being applied, herbage mass was estimated on each treatment plot. Tiller density was assessed once before and twice after the poaching event. Plots were fertilised with 30 kg nitrogen (N) per ha in the form of calcium ammonium nitrate (CAN) after each grazing. After poaching, the BD plots produced 691 kg dry matter (DM) per ha (30%) less than C plots. However, cumulative DM yields were not different between treatments (10383 kg ha<sup>-1</sup>) and tiller density was not affected by poaching or rolling. This study suggests that perennial ryegrass swards on a free-draining earth soil may overcome a single event of substantial treading damage in spring.

Keywords: Poaching, *Lolium*, herbage mass, rolling, free-draining earth soil

### Introduction

Dairy farmers must reduce production costs to cope with the imminent elimination of subsidies in Europe. Production costs can be strongly reduced when pasture utilisation is maximised – grazed herbage remains the cheapest feed for dairy cows (Holmes *et al.*, 2002; Shalloo *et al.*, 2004). Dillon *et al.* (2005) found a 2.5 Euro cent per litre reduction in production costs with every 10% increase of grass in the diet of the cow. Pasture utilisation can be maximised by extending the grazing season, allowing early turnout to pasture in early spring (Kennedy *et al.*, 2007). A limitation, however, is that grazing conditions during early spring and autumn may be difficult due to periodic levels of saturation when rainfall is high. More than 60 % of a representative sample of 1041 Irish dairy farmers included in a national survey responded that soil conditions were the most limiting factor to increasing the length of the grazing season into early spring (Creighton *et al.* in press). Poaching or treading damage is generally an issue when soil conditions are wet.

Wet soils or damaged soil structure can result in reduced pasture utilisation during grazing, reduced pasture regrowth subsequent to grazing and long term deterioration of the soil structure (Drewry and Paton, 2000). Previous studies examining the effects of poaching showed reduced pasture production of 20 to 40% and reduced pasture growth of 20 to 30% (Horne, 1987). The objective of this study was to quantify the effects of varying levels of poaching damage on the dry matter (DM) production and tiller density of a perennial ryegrass sward on a free-draining acid brown earth soil.

## Materials and methods

Twenty-four plots 5 m x 11 m (55 m<sup>2</sup>) were established in a two-year-old sward dominated by perennial ryegrass (*Lolium perenne* L.) at Teagasc Moorepark Dairy Production Centre, Ireland. Four treading damage treatments were applied: i) Control (C), ii) Barely damaged (BR), iii) Intermediately damaged (ID) and iv) Badly damaged (BD). Forty-five non-lactating dairy cows (average weight 550 kg) were used to achieve the desired levels of damage. Residency times were 0, 20, 40 and 120 minutes for C, BR, ID and BD, respectively. Half of each plot was rolled four weeks after the poaching treatments had been applied (12 March 2009) thereby creating 48 plots (2.5 m x 11 m). The site was then rotationally grazed by dairy cows until the end of the experiment. Once preceding, and five times subsequent to treatments being applied, herbage DM mass (kg ha<sup>-1</sup>) on each plot was estimated by harvesting a strip of 10 m x 1.2 m using a motor Agria mower (Etesia UK Ltd., Warwick, UK). The fresh weight of the harvested material was recorded and a sub-sample (100 g) was dried at 40 °C for 48 h, and DM% obtained. Herbage mass was then calculated. Tiller density was assessed once before and on two occasions after the poaching event. Three sections of turf (10 cm x 10 cm) were selected randomly from each plot, cut to a depth of >30 mm and dissected. The species of each tiller were identified and counted. All plots were fertilised with 30 kg nitrogen (N)/ha in the form of calcium ammonium nitrate (CAN) after each grazing. Hoof depth was measured with a ruler on 20 random hoof marks in each plot. Surface roughness was measured using a 7.57 m chain placed on the soil surface following the contours of the poached soil. The chain length reduction was an estimate of the roughness of the surface (Saleh, 1994). Differences between mean values were tested for significance by ANOVA, with level of poaching and rolling as factors in a randomised complete block design with rolling as a split plot.

## Results and discussion

Poaching affected herbage mass on the first harvest after treatment imposition but there was no difference in cumulative DM yields. After the imposition of treatments, herbage mass was significantly reduced for the BD treatment (Table 1). Neither the cumulative DM yields to the end of August, nor tiller density, were different between treatments. Equally, rolling did not have an effect on tiller density, pre- and post-grazing heights or herbage production. Average depth of hoof prints were 3.57, 4.83 and 5.83 cm deep ( $P < 0.001$ ) for BR, ID and BD, respectively. Surface roughness, expressed as a percentage of chain reduction, was 2.52, 6.17, 8.37 and 12.73 % ( $P < 0.001$ ) C, BR, ID and BD, respectively. Surface roughness was greater in areas that had not been rolled (5.89%) compared to areas that had been rolled (2.97%;  $P < 0.001$ ). Previous studies have reported reduced pasture production following a single intensive poaching event (Drewry *et al.*, 2008). However, in those studies, the soil type was silt loam or clay. Conversely, in the present study, the soil type was a free-draining, acid brown earth with sandy-to-loam texture, the composition being 70% acid brown earth, 15% grey brown podzolics and 15% gley (Gardiner and Radford, 1980). Herbage on this soil may be more resilient to damage than herbage on soils with higher clay content. Hence, the lack of treatment effect in the present study may have been due to soil texture.

Table 1. Dry matter (DM) yield and perennial ryegrass tiller density (TD) of the four treatments Control (C), Barely damaged (BR), Intermediately damaged (ID) and Badly damaged (BD), and for the two sub-treatments Rolled (R) and Not rolled (NR).

	Grazing	C	BR	ID	BD	<i>P</i> value	R	NR	<i>P</i>	SED
DM yield (kg ha <sup>-1</sup> )	1	2304 <sup>ab</sup>	2402 <sup>a</sup>	2095 <sup>b</sup>	1620 <sup>c</sup>	<0.001	2042	2169	n.s.	153.7
	2	1215	1320	1369	1351	n.s.	1309	1319	n.s.	56.6
	3	2192	2332	2472	2509	n.s.	2361	2392	n.s.	123.3
	4	1488 <sup>a</sup>	1558 <sup>a</sup>	1587 <sup>ab</sup>	1706 <sup>b</sup>	0.0432	1564	1606	n.s.	69.2
	5	2038	1983	2156	2145	n.s.	2086	2075	n.s.	121.1
TD (m <sup>-2</sup> )	1	7985	8276	8050	8106	n.s.	8126	8082	n.s.	734.9
	2	7700	7498	7485	7817	n.s.	7646	7604	n.s.	712.4

SED = Standard error of the difference; <sup>abc</sup> values in the same row not sharing a common superscript are significantly different; PRG=Perennial rye grass.

## Conclusion

This study indicates that perennial ryegrass swards on sandy-to-loam soils overcome a single event of substantial treading damage in spring. A similar experiment is being repeated in a heavier textured soil.

## References

- Dillon P., Roche J.R., Shalloo L. and Horan B. (2005) Optimising financial return from grazing in temperate pastures. In: Murphy J.J. (ed.) *Utilisation of Grazed Grass in Temperate Animal Systems (Satellite workshop of the XXth International Grassland Congress, Cork 2005)*. Wageningen Academic Publishers, the Netherlands, pp. 131 - 148.
- Drewry J.J. and Paton R.J. (2000) Effects of cattle treading and natural amelioration on soil physical properties and pasture under dairy farming in Southland, New Zealand. *New Zealand Journal of Agricultural Research* 43, 377 - 386
- Gardiner M.J. and Radford T. (1980) Soil associations of Ireland and their land use Potential In: National Soil Survey of Ireland (ed.) *Explanatory Bulletin to Soil Map of Ireland*.
- Holmes C.W., Wilson G.F., McKenzie D.D.S., Flux D.S., Brookes I.M. and Davey A.W.F. (2002) *Milk Production from Pasture*. Butterworks of New Zealand Ltd., Wellington, New Zealand.
- Horne D.J. (1987) Soil water and unsafe grazing days on the Tokomaru silt loam in the winter of 1986 Massey University. *Dairyfarming Annual*, pp. 131 - 133.
- Kennedy E., O'Donovan M., Murphy J.P., Delaby L. and O'Mara F.P. (2007) Effect of spring grazing date and stocking rate on sward characteristics and dairy cow production during midlactation. *Journal of Dairy Science* 90, 2035 - 2046
- Saleh A. (1994) Measuring and predicting ridge-orientation effect on soil surface roughness. *Journal of Soil Science Society of America* 58, 1228 - 1230.
- Shalloo L., Dillon P., Rath M. and Wallace M. (2004) Description and validation of the Moorepark Dairy System Model. *Journal of Dairy Science* 87, 1945 - 1959.

# The grazing selectivity of Konik horses on grasslands located in Biebrza National Park

Chodkiewicz A. and Stypiński P.

University of Life Science, Faculty of Agriculture and Biology, Warsaw

Corresponding author: anna\_wiercioch@poczta.onet.pl

## Abstract

The aim of the study was to evaluate grazing preferences of Polish primitive horses (Koniks) grazing on peatlands in Biebrza National Park in Northeastern Poland. The studies were carried out in three periods (spring, early and late summer) for which the selectivity ratio was calculated on the basis of grazing time and percentage of grazing horses on the specific grassland area. During the vegetative season the highest percent of grazing horses was observed in sedge community with *Carex nigra*. Communities *Molinia caerulea* and willow-birch thicket were grazed mostly in spring. In June, Koniks grazed on swards dominated by *Agrostis canina* and swards dominated by *C. nigra*, *M. caerulea* and *Potentilla erecta*. In August thicket and sedges were used more. The changing values of selectivity ratio, representing different levels of palatability of communities during the vegetative season, show that communities of *P. anserina* and *M. caerulea* are mostly exploited in spring, whereas during summer Koniks choose *C. nigra*, *M. caerulea* and *P. erecta*. A positive effect of horse grazing on grassland stability was also observed during the study.

Key words: koniks, grazing selectivity, wetlands, biodiversity

## Introduction

Northeastern European wetlands require proper management tools in order to protect and maintain grassland biodiversity. On peatlands, communities with *Molinia caerulea*, which typically have a rich composition of species, are particularly valuable. Although animals are becoming popular tools for use in conservation of the natural environment, there is still not enough knowledge about introduction of herbivores into wetlands. Primitive breeds that are well-suited for difficult environmental conditions, such as Polish primitive horses (Koniks), descendents of tarpan, are very useful in extensive grazing. Free-ranging horses are faced with spatial and temporal heterogeneity during the vegetative season. Height and palatability of the sward can influence their choice of communities (Naujeck *et al.*, 2004). Relatively little is known about plant communities selected by Koniks during grazing (Cosyns *et al.*, 2001). There is also not enough knowledge about the influence of horses on botanical composition. Therefore the aim of the study was to evaluate grazing preferences of Polish primitive horses (Koniks) grazing on peatlands in Biebrza National Park.

## Materials and methods

Field research was conducted in Biebrza National Park (BPN) in north-eastern Poland in 2009. The habitat for Koniks in the Middle Basin of BPN was created in 2004 and now contains 210 hectares of which about 40 hectares are grasslands. Within this grassland area about 30 hectares are dominated by *M. caerulea*. A herd of about 30 adult Koniks live in natural surroundings and are supplemented with hay during winter which is harvested from the grassland. Direct visual observations were carried out every two months for three periods: April (beginning of vegetation), late June (the stem elongation of grasses) and the end of August (regrowth of the sward after cutting). In each period, Koniks were observed during six

days in two three-hour time ranges: in the morning before noon and after 3 p.m. The place of grazing and number of eating horses were noted at 5-minute intervals during observation. Each plant community was characterized by visual estimation of botanical composition and sward cover. The area of the grassland communities chosen by horses was also measured by GPS (Garmin eTrex Venture HC). The average percentage of grazing horses was calculated for each period of observation taking into consideration the number of grazing horses and time of making observation. Comparative grazing intensity (CGI) was calculated according to Hunter (Rogalski 1982 cit. in Griffiths 1970):

$$CGI = \frac{\text{average percent of grazing horses}}{\text{percentage of grazed area relative to the whole refuge}} \times 100$$

In order to demonstrate seasonal differences, the environmental average was excluded by subtracting average CGI unit for whole vegetative season from month CGI average. The data were analysed by using Principal Component Analysis (PCA) in Statgraphics Plus 4.1 in order to visualize multivariate data on two-dimensional plot (results shown in Fig. 1).

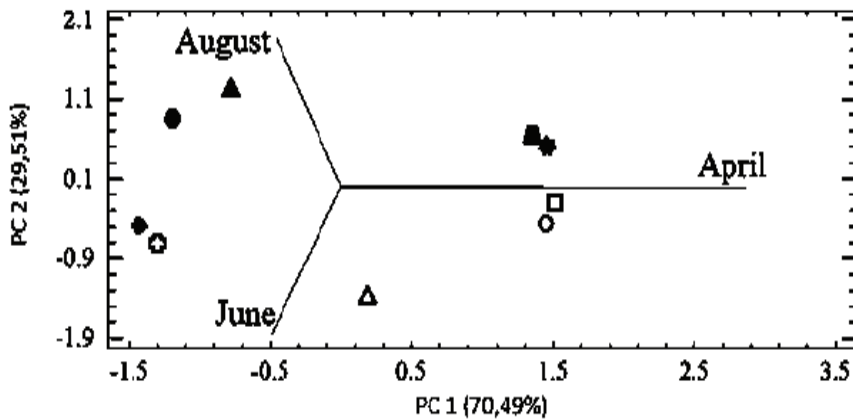

Figure 1. Principal component analysis (PCA) biplot for CGI unit for three phenological period. The communities that are father along the positive direction of vector (month) tend to be more selected by horses at this time.

▲ sedges *C.nigra* ○ willow-birch thicket ▲ *F.ulmaria*, *C.arvensis* ◆ *A.canina* □ *M.caerulea*  
 ○ *C.nigra*, *M.caerulea*, *P.erecta* ● midforest grasslands △ *P.anserina* ● forest and other

## Results and discussion

During the vegetative season the highest percentage of grazing horses was observed in sedges with *Carex nigra* (Table 1). In spring, communities dominated by *M.caerulea* are most important for Koniks as indicated by high values of percentage of grazing horses and CGI. Horses usually choose the most numerous species in communities on pastures and, according to Duncan (1983), horses prefer areas with high quality food. *M.caerulea* is known as a harmful grass for animals but is eaten by horses in spring and summer (Taylor *et al.* 2001). Selection of this species by Koniks in spring also suggests a palatability preference for it. Whereas in June and August, Koniks grazed on *Agrostis canina* and *C.nigra*, *M.caerulea* and *Potentilla erecta* (Table1), during late summer they also fed more on the community with *Filipendulia ulmaria* and *Cirium sp.* (Fig.1). A higher percentage of grazing horses and high value of CGI unit for these two areas in August are probably connected with cutting grass in a significant part of the refuge. Koniks tend to choose uncut communities with higher vegetation (Naujeck *et al.* 2004). Willow-birch thicket, sedge communities and forest are

evenly grazed in each period; however, they are preferred more in April than during other parts of the vegetative season (Fig. 1). Grazing of horses on *Potentilla anserina* and on willow-birch thicket situated on mineral soils is connected with using these areas as a place of resting, especially in spring and early summer when the water table is high. Potentially small communities, such as *M. caerulea* and *P. anserina*, are threatened by eutrophication and simplification of species composition as a result of overgrazing in spring and early summer.

Table 1. Average percent of grazing horses in different communities and comparative grazing intensity unit (CGI) for communities

Plant communities	Area* (%)	Grazing horses (%)			CGI**				
		April	June	August	Av.***	April	June	August	Av.***
Sedges <i>Carex nigra</i>	7.45	37.37	25.43	31.03	31.28	501	341	416	419
Willow-birch thicket	13.29	13.47	11.88	11.10	12.15	101	89	83	91
<i>Filipendulia ulmaria</i> , <i>Cirsium arvensis</i>	0.15	0.00	0.37	11.77	4.05	0	243	7631	2625
<i>Agrostis canina</i>	1.61	2.37	17.52	12.11	10.67	146	1086	750	661
<i>Molinia caerulea</i>	0.27	12.58	2.02	0.23	4.94	4602	739	83	1808
<i>Carex nigra</i> , <i>Molinia caerulea</i>	2.58	0.00	23.70	11.30	11.67	0	919	438	452
<i>Potentilla erecta</i>									
Midforest grasslands	0.14	0.00	1.85	4.67	2.17	0	1362	3444	1602
<i>Potentilla anserina</i>	0.77	8.25	10.80	4.25	7.77	1072	1405	553	1010
Forest and others	73.74	25.98	6.42	13.53	15.31	35	8	18	20

\* area of the community references to the whole refuge \*\* Abstract number; the highest value of CGI shows the more preferred community \*\*\* average of whole vegetative season

## Conclusions

Koniks change their grazing preference during the vegetative season, and they choose even small communities provided that they contain preferred species. Further research, including digestibility of species, is needed in order to verify if Koniks have significant influence on grassland situated in the refuge and if their feeding needs are fulfilled.

## Acknowledgements

The work was supported by Ministry of Education of Poland. Project number: 0884/B/P01/2009/37

## References

- Cosyns E., Degezelle T., Demeulenaere E. and Hoffman M. (2001) Feeding ecology of Konik horses and donkeys in Belgian coastal dunes and its implications for nature management. *Belgian Journal of Zoology* 131 (Supplement 2), 111-118.
- Duncan P. (1983) Determinants of the use of habitat by horses in Mediterranean Wetland. *The Journal of Animal Ecology* 52, 93-109.
- Naujeck A., Hill J. and Gibb M.J. (2004) Influence of sward height on diet selection by horses. *Applied Animal Behaviour Science* 90, 49-63.
- Rogalski M. (1982) Testing the palatability of pasture sward for horses on the basis of comparative grazing intensity unit. *Roczniki Akademii Rolniczej w Poznaniu* 138, 85-92.
- Taylor K., Rowland A.P., Jones H.E. (2001) *Molinia caerulea* (L.) Moench. *Journal of Ecology* 89, 126-144.

## **Session 5.2**

### **Environmental benefits and risks**

*Editor: Friedhelm Taube*



## The contribution of grass and clover root turnover to N leaching

Rasmussen J.<sup>1</sup>, Helgadóttir Á.<sup>2</sup>, Frankow-Lindberg B.<sup>3</sup>, Loges R.<sup>4</sup>, and Eriksen J.<sup>1</sup>

<sup>1</sup> Dept. of Agroecology and Environment, Faculty of Agricultural Sciences, Aarhus University, Denmark

<sup>2</sup> Faculty of Land and Animal Resources, Agricultural University of Iceland, Reykjavik, Iceland

<sup>3</sup> Dept. of Crop Production Ecology, Swedish University of Agricultural Sciences, Uppsala, Sweden

<sup>4</sup> Dept. of Crop Science and Plant Breeding, Christian-Albrechts-University, Kiel, Germany

Corresponding author: Jim.Rasmussen@agrsci.dk

### Abstract

Sources of inorganic and organic N leaching from grass-clover mixtures at field sites in Denmark, Germany and Iceland were investigated. Grass or clover was labelled with <sup>15</sup>N-urea four times (autumn 2007, spring, summer and autumn 2008) prior to the leaching season in autumn and winter 2008. Soil water was sampled at 30 cm depth and analysed for <sup>15</sup>N-enrichment of dissolved inorganic N (DIN) and dissolved organic N (DON). Most <sup>15</sup>N was recovered in DON for both labelled grass and clover at all sites. At the Danish site, grass and clover contributed more to the DON pool than the DIN, whereas the opposite was observed at the German and Icelandic sites. The results show that both clover and grass contribute directly to N leaching from the root zone in mixtures, and that clover contribution is higher than grass. Furthermore, the present study indicates that roots active in the growth season prior to the drainage period contribute more to N leaching than roots active in the growth season the previous year, which is consistent with estimates of root longevity at the three sites.

Keywords: DIN, DON, clover, grass, leaching

### Introduction

Leaching of nitrogen (N) from agricultural land largely depends on soil N status, crop choice, management practice, and climatic conditions. Legumes like clover constitute the main N input in many low-input agricultural systems (Lampkin, 2002), supplying both companion and following crops with this often-limiting nutrient (Høgh-Jensen, 2006). There is increasing interest in the sources of N being leached from grass-clover swards. DON has been identified as an important proportion of the total N loss (Jones *et al.*, 2004). The environmental impact of dissolved inorganic N (DIN) leaching is well described, but the fate of DON is not well understood. Characterisation of DON composition and sources are essential when evaluating management strategies to reduce the environmental impact of agricultural systems. The aim of the present study was i) to identify the sources of DON and DIN leaching from grass-clover swards under different soil, climatic and management regimes, ii) to determine the distribution of N between DON and DIN, and iii) to relate these findings to grass and clover root turnover.

### Materials and methods

Similar field experiments were conducted at three locations on (1) a sandy soil (7.7% clay, 1.6% organic carbon (C)) at Foulumgård Experimental Station, Viborg, Denmark, (2) a more clayey soil (10.1% clay, 1.3% organic C) at Lindhof Experimental Station, Kiel, Germany, and (3) an organic soil (18% clay, 8.4% organic C) at Korpa Experimental Station, Reykjavik, Iceland. Grass or clover were leaf-labelled with <sup>15</sup>N-urea (Høgh-Jensen and Schjoering, 2000)

within small PVC cylinders ( $\varnothing$  10 cm), inserted 2 cm into the soil in existing grass-clover swards. Leaf-labelling was done in new plots four times from autumn 2007 to autumn 2008. Soil water was sampled using Teflon suction cups installed at 30 cm depth beneath the PVC cylinders in winter 2008, to determine the total N concentration and the  $^{15}\text{N}$ -enrichment of the DIN and total dissolved N (TDN) (Rasmussen *et al.*, 2008). In early spring 2009, root samples were taken from the labelled species in the PVC cylinders to measure the  $^{15}\text{N}$ -enrichment.

## Results and discussion

At all three locations both leaf-labelled grass and clover were sources of  $^{15}\text{N}$  in soil water samples. DON constituted the largest part of the total N sampled with the exception of one sampling at the Danish site in February (Table 1). The proportion of DON is higher than found in previous studies in cultivated soil with deeper sampling (1 m) (Vinther *et al.*, 2006), which can be explained by the sampling of soil water just beneath the ploughed layer.

The presence of  $^{15}\text{N}$  in DON showed a marked difference between the sites (Table 1). In Denmark, the proportion of  $^{15}\text{N}$ -DON of total  $^{15}\text{N}$  was always higher than the proportion of DON of total N. This strongly indicates that labelled plants contributed more to the DON pool than to the DIN pool in the sampled soil water. The opposite was true for the field sites in Germany and Iceland where the proportion of  $^{15}\text{N}$ -DON of total  $^{15}\text{N}$  was less than or equal to the proportion of DON of total N, i.e. labelled plants contributed more to the DIN pool, and thus more DON originated from other sources. From the present experiment we cannot deduce the determining factor of this difference (e.g. climate or soil conditions), but we suggest that soil texture could play a role in the retention and mobility of DON in the upper soil layers with less retention in sandy soil compared to clayey and organic soils.

Table 1. DON proportion of total N and  $^{15}\text{N}$ -DON of total- $^{15}\text{N}$  in soil water samples from Denmark, Germany, and Iceland.

Site	Sampling date	DON of total N	$^{15}\text{N}$ -DON of total $^{15}\text{N}$	Replicates
Denmark	Dec. 2008	$0.79 \pm 0.01$	$0.86 \pm 0.01$	15
	Feb. 2009	$0.34 \pm 0.01$	$0.63 \pm 0.01$	16
	April 2009	$0.70 \pm 0.01$	$0.81 \pm 0.01$	17
Germany	Dec. 2008	$0.82 \pm 0.01$	$0.82 \pm 0.01$	14
	Feb. 2009	$0.81 \pm 0.01$	$0.71 \pm 0.01$	13
	April 2009	$0.94 \pm 0.00$	$0.86 \pm 0.01$	6
Iceland	Jan. 2009	$0.96 \pm 0.00$	$0.90 \pm 0.00$	6

The presence of  $^{15}\text{N}$  in both DIN and DON was related to the time since leaf-labelling. In the example given in Figure 1, it can be seen that  $^{15}\text{N}$  in DIN for both labelled grass and clover decreased with time since labelling (lowest for the plots labelled 14 months before soil water sampling). The opposite trends were found for DON with  $^{15}\text{N}$  contents increasing with time since labelling, except for labelled clover in the plots labelled 14 months before soil water sampling. Comparing across field sites and between sampling times at the individual field sites gives a less clear picture of the contribution of labelled grass and clover to  $^{15}\text{N}$  in DIN and DON. However, it is clear that grass and clover labelled in the growth season prior to soil water sampling contributed in all cases to both DIN and DON. The  $^{15}\text{N}$ -enrichment remaining in the roots from labelled grass or clover sampled after the leaching season in Denmark and Germany showed that clover roots had survived less than a year, whereas grass roots seemed to survive longer. In Iceland, the trend, although less clear, was that both clover and grass roots survived longer compared to Denmark and Germany.

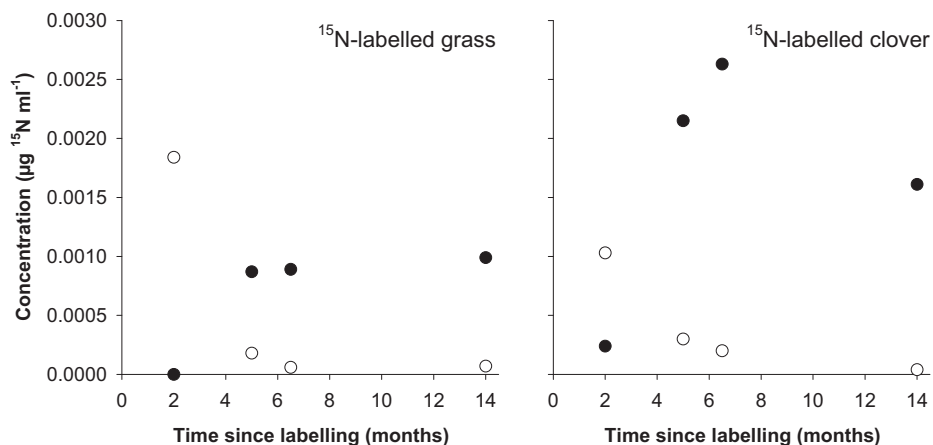

Figure 1. <sup>15</sup>N in DIN (○) and DON (●) from leaf-labelled grass and clover at the December 2008 soil water sampling in Denmark as related to the time since labelling. The number of replicates on each data point varies from 1 to 3.

## Conclusion

The present experiment showed a direct contribution from both grass and clover roots to leaching of DIN and DON at 30 cm. DON was the dominant N form in all sites and the presence of <sup>15</sup>N in this pool was consistent with the presence of <sup>15</sup>N in the roots after the leaching season.

## Acknowledgements

We thank Margit Schacht for proof reading the manuscript. This study was financially supported by the Danish Research Council for Technology and Production Sciences (project no. 274-07-0211).

## References

- Høgh-Jensen H. and Schjoerring J. K. (2000) Below-ground nitrogen transfer between different grassland species: Direct quantification by N-15 leaf feeding compared with indirect dilution of soil N-15. *Plant and Soil* 227, 171-183.
- Høgh-Jensen H. (2006) The nitrogen transfer between plants: An important but difficult flux to quantify. *Plant and Soil* 282, 1-5.
- Jones D. L., Shannon D., Murphy D. V. and Farrar J. (2004) Role of dissolved organic nitrogen (DON) in soil N cycling in grassland soils. *Soil Biology and Biochemistry* 36, 749-756.
- Lampkin N. (2002) *Organic Farming*. Old Pond Publishing, Ipswich, UK.
- Rasmussen J., Gjetterman B., Eriksen J., Jensen E.S. and Høgh-Jensen H. (2008) Fate of <sup>15</sup>N and <sup>14</sup>C from labelled plant material: Recovery in perennial ryegrass-clover mixtures and in pore water of the sward. *Soil Biology and Biochemistry* 40, 3031-3039.
- Vinther F. P., Hansen E. M. and Eriksen J. (2006) Leaching of soil organic carbon and nitrogen in sandy soils after cultivating grass-clover swards. *Biology and Fertility of Soils* 43, 12-19.

# Winter grazing of grass-clover swards grown as green manure under the maritime climatic conditions of Northern Germany

Loges R., Westphal D. and Taube F.

*Institute of Crop Science and Plant Breeding - Grass and Forage Science/ Organic Agriculture, Christian-Albrechts-University, D-24118 Kiel, Germany*

Corresponding author: rloges@email.uni-kiel.de

## Abstract

The aim of the study was to investigate if winter grazing is an alternative to mulching or harvesting grass-clover grown as green manure in organic farming, taking into account both N-leaching and pre-crop value to following arable crop. Against this background, yield and forage quality of three different legume species (*Trifolium repens*, *Trifolium pratense*, *Medicago sativa*), grown in binary mixtures with two grass species (*Lolium perenne*, *Festuca arundinacea*) on a loamy sand under the maritime climatic conditions of Northern Germany, respectively, had been examined before grazing the third growth in autumn or winter. Nitrate leaching losses during winter and yield of the following spring wheat have been recorded.

Yield and forage quality of the sward were not significantly influenced by grass species while the interaction of legume species and grazing date had a high impact. Mulching the last growth and autumn grazing led to higher N-leaching than late winter grazing.

Winter grazing promises to be an interesting alternative to mulching or autumn grazing of grass-clover, because of a decreased risk of N leaching and the absence of negative effects on the following spring wheat.

Keywords: Winter grazing, *Lolium perenne*, *Festuca arundinacea*, clover, N-leaching

## Introduction

Management factors such as defoliation system and seed mixture influence yield, nitrogen (N) management and N leaching of grass-clover fields (Wachendorf *et al.*, 2004, Dreymann 2005). In comparison to harvesting and feeding grass-clover as silage, winter grazing is less cost intensive but tends to higher N losses (Jakob, 2003, Buchgraber *et al.*, 2006). Grazing during winter can cause pasture damage, which is of minor relevance for older grass-clover grown on arable land that will be ploughed in the following spring. The aim of the study is to show if winter grazing is an alternative to mulching or harvesting grass-clover swards grown as green manure, taking into account both N-leaching and the pre-crop value to a following arable crop.

## Materials and methods

The current study is based on a multifactorial experiment carried out from 2005 to 2007 on the organic Farm 'Hof Ritzerau' (53:39:47N; 10:34:02E) in Northern Germany on an organically managed loamy sand soil under maritime temperate climatic conditions (8.5 °C; 750 mm precipitation annually). Yield and forage quality of three different legume species (white clover (*Trifolium repens*), red clover (*Trifolium pratense*), alfalfa (*Medicago sativa*)), grown in binary mixtures with two grass species (perennial ryegrass (*Lolium perenne*), tall fescue (*Festuca arundinacea*)), respectively, had been examined before sheep grazing the third growth in autumn or winter. Nitrate leaching losses during winter and yield of the following spring wheat have been recorded and compared to data gathered in grass-clover plots grown for silage (3 cuts) and green manure (3 x mulched) respectively. The experiment was laid out in a split-plot design with three field replicates. Yields were calculated from hand

sampling of 2 x 0.25 m<sup>2</sup> before the plots were grazed by sheep. The harvested material was oven-dried at 58°C to constant weight. Forage quality parameters were determined using near infrared spectroscopy (NIRS). Plot size was 12 x 24 m. Grazing was performed with 46 ewes grazing the six seed mixtures of one replication as a paddock for 3 days. In winter (November-March), nitrate leaching was measured using ceramic suction cups installed at 75 cm depth. All plots were ploughed and sown to spring wheat in late March 2006 and 2007, respectively. Spring wheat yield was harvested by a plot combine harvester. Kernel crude protein content was determined by NIRS. All NIRS calibrations are based on laboratory analysis of samples from the present experiment. Data were statistically analysed using the mixed procedure of SAS. Using a different field in each year, weather effects cannot be separated sufficiently from soil effects, therefore the basis for ANOVA were means of the two experimental years. The Students t-test ( $P < 0.05$ ) was used for comparison of means.

Table 1. Factors and factor levels included in the experiment.

Factor	Factor level
1. Grass species	1.1 Perennial ryegrass / <i>Lolium perenne</i> (PR) 1.2 Tall fescue / <i>Festuca arundinacea</i> (TF)
2. Legume species	2.1 White clover / <i>Trifolium repens</i> (WC) 2.2 Red clover / <i>Trifolium pratense</i> (RC) 2.3 Alfalfa / <i>Medicago sativa</i> (A)
3. Defoliation system	3.1 3 x cut for silage 3.2 3 x mulched for green manure 3.3 2 x cut for silage + grazing at the end of October (Oct.) 3.4 2 x cut for silage + grazing at the end of December (Dec.) 3.5 2 x cut for silage + grazing at the end of January (Jan.)
4. Experimental period	4.1 2005-2006 4.2 2006-2007

## Results and discussion

The influence of legume species and grazing date on yield and forage quality of the last growth of different grass-clover mixtures is shown in Table 2. Yield and forage quality of the total sward was not significantly influenced by grass species while the interaction of legume species and grazing date had a high impact on yield and quality of the swards. Before grazing

Table 2. Influence of legume species and grazing date on yield, legume content and content of crude protein and metabolisable energy of the last growth of grass-clover (averaged over 2 experimental periods 2005-06 and 2006-07 and 2 companion grasses).

Parameter	White Clover grazed in		Red Clover grazed in		Alfalfa grazed in	
	Oct.	Jan.	Oct.	Jan.	Oct.	Jan.
DM Yield [t ha <sup>-1</sup> ]	1.99 <sup>abB*</sup>	1.54 <sup>aA</sup>	3.36 <sup>aA</sup>	2.16 <sup>bA</sup>	4.49 <sup>aA</sup>	2.53 <sup>bA</sup>
Legume content in DM [%]	32.5 <sup>aB</sup>	0.9 <sup>bB</sup>	79.0 <sup>aA</sup>	66.2 <sup>bA</sup>	92.3 <sup>aA</sup>	83.0 <sup>aA</sup>
Crude protein cont. in DM [%]	17.9 <sup>aB</sup>	16.5 <sup>aA</sup>	22.6 <sup>aA</sup>	12.7 <sup>bB</sup>	24.2 <sup>aA</sup>	13.5 <sup>bB</sup>
Energy cont. in DM [MJ kg <sup>-1</sup> ]	11.1 <sup>aA</sup>	10.0 <sup>bA</sup>	10.6 <sup>aAB</sup>	7.2 <sup>bB</sup>	10.1 <sup>aB</sup>	5.8 <sup>bC</sup>

\* Means with different lower case letters indicate significant differences between grazing dates within a legume species, means with different upper case letters indicate significant differences between legume species within a grazing date ( $P < 0.05$ ).

In October, swards with white clover had shown lower yields and due to lower legume contents, also lower crude protein (CP) concentrations but higher contents of metabolisable energy (ME) compared with swards with alfalfa or red clover. Comparing the two grazing dates October and January, it became apparent that losses of leaf material from the legume plants during winter led to high losses of CP-concentration in swards with alfalfa or red clover. For all legume species, losses of sward ME concentrations occurred during winter. Before grazing in January the ME concentrations in DM of swards with alfalfa or red clover

had not met the nutritional requirements for cattle of 10 MJ kg<sup>-1</sup> (GfE 2001). Mulching the last growth and autumn grazing led to higher nitrate losses than late winter grazing (Table 3). After ploughing the grass-clover in March, no effect of grass-clover management on yield of the succeeding spring wheat was observed. Compared to cutting for silage or autumn grazing, grazing in January led to higher N availability resulting in higher grain crude protein contents in spring wheat. Regression analyses (data not presented) showed that a delay in winter grazing led to lower leaching losses and higher N uptake in the succeeding spring wheat crop.

Table 3. Nitrate-N leaching during winter (November-March), grain yield and kernel crude protein (CP) content of succeeding spring wheat as affected by grass-clover management (averaged over two experimental periods 2005-2006 and 2006-2007, 6 seed mixtures and 3 replicates).

Parameter	3 x cut	3 x mulched	2 x cut + grazed in October	2 x cut + grazed in December	2 x cut + grazed in January
Nitrate-N-leaching [kg ha <sup>-1</sup> ]	13.53 <sup>ab</sup>	17.53 <sup>a*</sup>	18.94 <sup>a</sup>	12.99 <sup>ab</sup>	10.82 <sup>b</sup>
Grain DM yield [t ha <sup>-1</sup> ]	32.70	33.13	32.14	34.74	33.68
Kernel CP content in DM [%]	13.84 <sup>b</sup>	14.05 <sup>ab</sup>	13.75 <sup>b</sup>	13.96 <sup>ab</sup>	14.25 <sup>a</sup>

\* Means with the same letters within a row are not significantly different ( $P < 0.05$ ).

## Conclusions

For all-arable farms, because of a decreased risk of nitrate leaching and the absence of negative effects on the following spring crop, winter grazing by sheep is an economically interesting alternative to mulching of grass-clover. Winter grazing on arable grass-clover, which will be ploughed in spring, also represents an alternative to winter grazing of wet permanent grassland which usually is accompanied by irreversible trampling damages to sensitive swards as well as very high nutrient leaching losses.

## References

- Buchgraber K., Pötsch E. M., Bohner A., Ofner E., Gasteiner J. and Hausleitner A. (2006) *Ganzjährige Tierhaltung im Freiland-Problemfelder und Lösungsansätze*. 12. Alpenländisches Expertenforum, Gumpenstein, Austria, 19–24 (in German).
- Dreyman S. (2005) *N-Haushalt unterschiedlich bewirtschafteter Rotklee-Bestände und deren Bedeutung für die Folgefrucht Weizen im Ökologischen Landbau*. Ph.D. Thesis, University of Kiel, Germany (in German, with English summary).
- GfE. (2001) *Empfehlungen zur Energie- und Nährstoffversorgung der Milchkühe und Aufzuchttrinder*. Deutsche Landw.-Ges, Frankfurt, Germany (in German).
- Jakob M. (2003). *Ökonomische Analyse extensiver Verfahren der Mutterkuh- und Schafhaltung auf der Basis von Plankostenleistungsrechnungen*. Ph.D. Thesis, University of Giessen, Germany (in German, with English summary).
- Wachendorf M., Büchter M., Trott H. and Taube F. (2004) Performance and environmental effects of forage production on sandy soils. II. Impact of defoliation system and nitrogen input on nitrate leaching losses. *Grass and Forage Science* 59, 56-68.

# Nitrogen excretions in dairy cows on a rotational grazing system: effects of fertilization type, days in the paddock and time period.

Dufresne I., Robaye V., Istasse L. and Hornick J.-L.

*Nutrition Unit, Veterinary Medicine Faculty, Liège University, B-4000 Liège, Belgium*

Corresponding author: Isabelle.Dufresne@ulg.ac.be

## Abstract

The present study aims to quantify nitrogen (N) excretions in dairy cows on a rotational grazing system with different types of fertilization (mineral N, slurry and compost) after 3 or 5 days in the paddock and during two different periods in June and September. Individual samples of faeces and urine were collected to assess N excretions from cows in the paddocks. The urea content in milk from the tank or from the individual cows was also measured. N intake was higher on day 3 compared to day 5 (465 vs. 425 g d<sup>-1</sup>,  $P < 0.001$ ) and in September as compared to June (488 vs. 400 g d<sup>-1</sup>,  $P < 0.001$ ) but was not influenced by the fertilization type. The amount of excreted urinary N was significantly higher in the mineral N group than in the two other groups (272 vs. 226 g d<sup>-1</sup>;  $P < 0.001$ ). The N excretion in faeces and urine decreased with days (92 vs. 84 g d<sup>-1</sup>,  $P < 0.01$ ; 256 vs. 228 g d<sup>-1</sup>,  $P < 0.001$  respectively for days 3 and 5). Urinary N excretion was lower in June than in September (181 vs. 302 g d<sup>-1</sup>,  $P < 0.001$ ) while the N excretion in the faeces was higher (96 vs. 80 g d<sup>-1</sup>,  $P < 0.01$ ).

Keywords : Nitrogen, dairy cows, grazing, urine

## Introduction

In pastures composed of different grasses and white clover, nitrogen (N) intake generally exceeds animal requirements and the N surplus is excreted in the faeces and urine. In order to reduce pollution, the European Community aims to limit these N losses but the calculation of amounts can nowadays vary between countries. Fertilization with manures can lead to low N efficiency and N losses owing to N emissions (Stevens and Laughlin, 1997). The present study aims to investigate the effects of three fertilisation types (slurry, compost or mineral N), two different periods of grazing (June or September) and different days (day 3 or day 5) in the paddock on the N excretions in rotationally grazing dairy cows. The days were studied as a control of the measured parameters in the same paddock in which the grass composition changed.

## Materials and methods

Three grazed paddocks were used in this experiment. The first grazed paddock was fertilized with mineral N fertilizer, the second with pig slurry and the third with cattle compost. The paddocks were grazed for the fourth and the second times in the rotation, respectively in September and in June of the following year. The total inputs of N by fertilisation were 78 and 56 kg ha<sup>-1</sup> in the mineral N paddock, 105 and 69 kg ha<sup>-1</sup> in the slurry paddock, 105 and 78 kg ha<sup>-1</sup> in the compost paddock, in September and in June respectively. Mineral N and slurry were applied after each grazing, and cattle compost in spring. The measurements were obtained from a herd which comprised 35 Friesian Holstein cows in late lactation in the September trial, and 15 Friesian Holstein cows in mid-lactation from a herd of 40 cows were used in the June trial. Their days in milk were 254 ± 72 days in September and 164 ± 93 days in June. In the week prior to the trials, mean daily milk yield was 14.9 ± 4.7 kg d<sup>-1</sup> in September and 18.5 ± 3.7 kg d<sup>-1</sup> in June. The cows received 1 kg dry sugar beet pulp per day



in the milking parlour distributed with a handling distributor. N contents were determined in grass, urine and faeces, and urea was determined in the milk. Two grass samples were taken at each time. Tank milk samples were taken at each milking in order to determine N and urea contents. A sample of urine (vulval stimulation) was taken on the paddock between 9 h and 10 h a.m. on days 3 and 5 from 35 cows in September and from 15 cows in June. The cows were removed from their grazed paddock to the barn located at 300 meters just for the time of the sample collection. Samples were divided into two parts; one was analysed for creatinin the day of the collection and the other was frozen at -20 °C. At the same time, a faeces sample was taken from each cow by manual collection in the rectum. In June, on collection days, individual milk was sampled at the morning and evening milkings and aliquoted as an individual day sample. The N intake was assessed on the basis of the energy requirement of the cows calculated by the UFL system (INRA, 1980). Grass dry matter intake (DMI) was calculated by dividing the energy provided by grass and grass energy content. N intake was calculated as the sum of N concentrate intake and N grass intake. Urinary creatinin was used to estimate the daily urinary volumes. The insoluble ash contents determined in grass, dry sugar beet pulp and faeces were used to estimate the faeces output (on the basis that the insoluble ash intake is equivalent to the insoluble ash excreted in faeces, since insoluble ash is indigestible). The N faeces output was calculated by multiplying N content in faeces by faeces output. Milk N output was calculated as the milk protein yield/6.38. N retention was calculated as N intake – (Milk N+Faecal N+ Urinary N). The data were analysed with a mixed model (PROC MIXED, SAS, 1999) allowing the inclusion of an autocorrelation between successive measurements made on the same animal within a treatment. The effects of the treatments, the collection days, the month, the interaction between the treatments and collection days, the interaction between treatments and month and the interaction between month and collection days were taken into account in the model.

## Results and discussion

Milk urea concentration considered as an indicator of N excretion, was at 248 mg l<sup>-1</sup> in June and 393 mg l<sup>-1</sup> in September (Table 1). According to de Brabander *et al.* (1999), the milk urea concentration is deemed satisfactory between 175 and 300 mg l<sup>-1</sup>. The September values were too high, compared to these recommended values. The significantly higher N intake at day 3 compared with day 5, and in September compared with June, were the results of a higher N intake at day 3 and in September. Milk N excretion was not influenced by the fertilizer treatment, the day on the paddock or the time period. Mean faecal N excretion was within values reported by Leonardi *et al.* (2003) and was higher on day 3 than on day 5 and in June than in September. With mineral N fertilizer, the increased urinary N excretion and increased urinary N proportion in N excretion have to be related to the higher milk-urea content. It should be noted that with compost, the urinary N excretion was lower along with lower N content in urine and lower milk urea content. A more complete chemical analysis of grass with the different fractions of N could explain these results. Fertilization with mineral N could lead to higher nitrate concentrations in the sward, as compared with fertilization with manure. Dieguez *et al.* (2001) reported higher nitrate content in grass fertilized with mineral N as compared to no fertilization and observed also an increase in urea in blood and milk. The significantly higher urinary N excretion at collection day 3 and in September can be associated with the higher N intake. The urinary N excretion relative to DM intake decreased sharply from 12 g kg<sup>-1</sup> in June to 22 g kg<sup>-1</sup> in September. It should be noted that the urinary N proportion in N excretion was much higher in September than in June, indicating that the N grass content in September was too high. The very high urinary N excretion, the high milk urea level and the low efficiency in N utilisation in milk in September indicate that the crude protein intake at 230 g kg<sup>-1</sup> DM content lead to an N intake that was too high for cows with

low production. Such high crude protein is not appropriate for cattle. Usual recommendations for dairy cows fed with a forage diet are about 16-18% crude protein (NRC, 2001). With a grass crude protein content at 167 g kg<sup>-1</sup> DM in June, the N excretion, the milk urea content and the efficiency in N utilisation in milk was improved.

## Conclusion

N excretion by grazing dairy cows was comprised mainly of urinary N. High N intake leads to high N excretion and there can be an excess of N in the sward especially at the end of the grazing season. At this time, to improve milk production at grazing, it should be recommended to give an energy supplement, and not an N supplement as is made in practice.

Table 1. Grass nitrogen content, milk urea content, nitrogen balance and partition with grazing dairy cows

	Treatment			Day		Month		SEM
	MinN	S	C	3	5	June	Sept.	
Grass CP in DM (g kg <sup>-1</sup> )	200	202	194	210 <sup>a</sup>	186 <sup>a</sup>	167 <sup>a</sup>	230 <sup>b</sup>	3.8
Milk yield (kg d <sup>-1</sup> )	16.5	17.2	17.0	17.2	16.7	18.7	15.1	0.4
June milk urea (mg l <sup>-1</sup> )	277 <sup>a</sup>	240 <sup>b</sup>	227 <sup>b</sup>	254	242			6.7
Sept.milk urea (mg l <sup>-1</sup> )	425	375	380	383	403			
N intake (g d <sup>-1</sup> )	448	449	436	465 <sup>a</sup>	425 <sup>b</sup>	400 <sup>a</sup>	488 <sup>b</sup>	7.1
Milk N excr. (g d <sup>-1</sup> )	88	93	93	93	90	93	89	2.4
Faecal N excr. (g d <sup>-1</sup> )	81 <sup>a</sup>	94 <sup>b</sup>	89 <sup>ab</sup>	92 <sup>a</sup>	84 <sup>b</sup>	96 <sup>a</sup>	80 <sup>b</sup>	2.0
Ur. N excr. (g d <sup>-1</sup> )	272 <sup>a</sup>	235 <sup>a</sup>	217 <sup>c</sup>	256 <sup>a</sup>	228 <sup>b</sup>	181 <sup>a</sup>	302 <sup>b</sup>	5.1
Total N excr. (g d <sup>-1</sup> )	353 <sup>a</sup>	329 <sup>b</sup>	306 <sup>b</sup>	347 <sup>a</sup>	312 <sup>b</sup>	276 <sup>a</sup>	382 <sup>b</sup>	5.9
Retention N (g d <sup>-1</sup> )	4.31 <sup>a</sup>	32.4 <sup>b</sup>	29.3 <sup>b</sup>	26.3	17.8	31.2	12.8	7.6
Ur. N/N excr. (%)	74.4 <sup>a</sup>	70.8 <sup>b</sup>	70.8 <sup>b</sup>	72.3	71.6	65.4 <sup>a</sup>	78.6 <sup>b</sup>	0.5

For a similar parameter (fertilisation treatment, day or month) means with different superscripts differ significantly ( $P < 0.05$ )

CP: crude protein. MinN: mineral nitrogen. S: slurry. C.: compost. Sept.: September. excr.: excretion. Ur.: urinary

## References

- De Brabander D., Vanacker J., Botterman S., De Boever J. and Boucqué C.V. (1999) *Invloedsfactoren op het melkureumgehalte. Informatienamiddag: een doelbewuste melkveevoeding - goed voor de boer, het dier en het milieu.* Ministerie van Middenstand en Landbouw, Department Dierenvoeding en Veehouderij, Gent, Belgium.
- Dieguez Camerón F., Hornick J.L., de Behr V., Istasse L. and Dufrasne I. (2001) Incidences phytotechniques et zootechniques d'une réduction ou d'une suppression de la fertilisation azotée sur des prairies pâturées par des vaches laitières. *Animal Research* 50, 299-314.
- INRA (1980) *Alimentation des Ruminants*. R. Jarrige (eds.), 621 pp.
- Leonardi C., Stevenson M. and Armentano L.E. (2003) Effect of two levels of crude protein and methionine supplementation on performance on dairy cows. *Journal of Dairy Science* 86, 4033-4042.
- NRC (2001) *Nutrient Requirements of Dairy Cattle*, 7<sup>th</sup> revised edition, National academic press, 381 pp.
- Stevens R.J. and Laughlin R. J. (1997) The impact of cattle slurries and their management on ammonia and nitrous oxide emissions from grassland. In: Jarvis S.C. and Pain B.P. (eds.) *Gaseous Nitrogen Emissions from Grasslands*, CAB International; Wallingford, UK, pp. 233-256.

## Water quality and the environmental use of livestock ponds

Canals R.M.<sup>1</sup>, Ferrer V.<sup>2</sup>, San Emeterio<sup>1</sup> L., Iriarte<sup>2</sup> A. and Villanueva E.<sup>1</sup>

<sup>1</sup>Dpto. de Producción Agraria, UPNA, Campus Arrosadia s/n 31006 Pamplona, Spain.

<sup>2</sup>BELARDI Consultoria, C/Batondoa 3 entreplanta B, Burlada. Spain.

Corresponding author: rmcans@unavarra.es

### Abstract

Many pastoral systems in Europe are included in protected areas. Management decisions in these ecosystems prioritize environmental concerns over stockbreeding objectives. The design and management of livestock ponds for wildlife is an example. This issue was examined in the Urbasa-Andia Natural Park, a 16100 ha mountain rangeland grazed by over 11700 livestock units. The effect of constructive traits of different ponds on the physicochemical and bacteriological quality of the water during the grazing period was evaluated, the amphibian populations living there were identified, and the interaction between wildlife conservation purposes and livestock production requirements was evaluated.

Key words: artificial ponds, water quality, wetlands, amphibians, grazing livestock.

### Introduction

Continental freshwater, natural or artificial, may contribute significantly to biodiversity conservation purposes. In regions transformed by human activity or where natural wetlands are scarce, artificial ponds created for stockbreeding purposes are alternative habitats for wildlife such as migratory birds, wild mammals and amphibians (Knutson *et al.*, 2004). Although the ecological interest of artificial ponds is supported by a growing body of publications, the literature does not address the potential negative trade-offs that may occur with stockbreeding objectives. Animal welfare and product traceability may be greatly affected by the quality of the water supply.

In the EU, no specific legislation regulates water quality for livestock. Contrary to intensive stockbreeding systems, where water is supplied by the general distribution network, in extensive systems water is usually derived from natural, less-monitored sources, and may remain stagnant in inadequate reservoirs during long periods. This problem occurs in the Urbasa-Andia Natural Park, a karstic mountain range of great environmental value and grazing use, located south of the Western Pyrenees (950 m a.s.l.). Since surface streams are scarce, water for livestock is supplied by artificial ponds which, in recent years, have acquired a singular environmental relevance. Nowadays, managers advocate the construction of naturalised ponds that satisfy the requirements of an emblematic amphibian, the alpine newt (*Triturus alpestris*), which is well distributed over central and eastern Europe but threatened in the Iberian Peninsula. The aim of this research is to examine the conflicts that may occur when managing water for this dual use. In particular, the effect of pond construction features on the quality of the water supply is examined, as are the potential effects on both livestock and amphibians.

### Materials and methods

In the Park, 45 livestock ponds have been catalogued. For this study, 7 ponds that traced the constructive changes which have occurred over the last decades, from very simple (small, unfenced, unsealed) to more sophisticated reservoirs (deep, fenced, sealed) were selected (Table 1). Ponds were sampled in April/early May 2009, before livestock accessed the

rangeland, and in late July/early August, which coincided with the middle of the grazing period. Overall, 13 water samples were collected, refrigerated and analysed within 24 hours. Thirteen water quality variables were determined: colour and odour, particulate matter (turbidity and conductivity), pH, inorganic nitrogen (nitrate, nitrite and ammonium), organic matter (oxidability), faecal indicator bacteria (total coliforms and enterococci) and the enteric pathogens *Clostridium perfringens* and *Escherichia coli*. Information on the occurrence of aquatic life (amphibian, crustacean and fish) had been compiled by Gosà *et al.* (2004) and Cárcamo (2008). We performed bivariate correlations among all variables using SPSS 16.0.

Table 1. Construction features and characteristics of the seven sampled ponds.

Pond	Iusiar	Mármol	Bekosare	Olaberri	M. Alsasua	Bardoitza	R. Urbasa
Construction year	2005	1998	<1950	<1950	<1950	<1950	<1950
Pond fencing	G-B wire	G-B wire	B. wire	B. wire	St. wall	No	No
Pond sealing	Bentonite	Plastic	No	No	No	No	No
Water collection	Spr./rain	Rain/run.	Rain/spr.	Rain/run./spr.	Aquif/rain	Rain/run.	Rain
Pond surface (m <sup>2</sup> )	1000	540	1950	260	1200	825	875
Average depth (cm)	>200	>200	>130	>130	>130	60	30
Permanent water body	Yes	Yes	Yes	Yes	Yes	Yes	No
Number of troughs/pond	1	1	1	1	2	0	0
Floating vegetation (%)	0	0	<5	0	<25	0	0
Submerged veg. (%)	<25	>75*	<25	>75*	>75	25-75	<25
Pond edge herbs (%)	>75	>75	>75	<25	<25	>75	>75
Pond edge shrubs (%)	<25	<25	<25	>75	>75	<25	<25
Surrounding community	Shrubland	Beech	Clearing	Beech	Grassland	Grassland	Grassland
Fish occurrence	0	0	0	1	0	0	0
Crustacean occurrence	0	0	1	0	0	0	0
Amphibian richness <sup>(1)</sup>	6	6	1	5	6	6	1
<i>T. alpestris</i> occurrence	1	1	0	1	1	1	0

G-B, Grid-barbed; B, Barbed; St, Stones; Spr, Spring; run, runoff; Aquif, Aquifer;

(1) Amphibians present are *Triturus helveticus*, *T. alpestris*, *T. mamoratus*, *Rana temporaria*, *R. perezi*, *Alytes obstetricans*, *Hyla arborea* and *Salamandra salamandra*.

## Results and discussion

Water quality declined during the grazing period in the open ponds due to the wading of animals. The chemical and microbiological quality of the water was significantly affected (Table 2). Prior to grazing, water quality in the unfenced ponds was similar to that of fenced ponds; however, two months later the microbiological charge of the unfenced pond Bardoitza increased, and it displayed the highest turbidity, conductivity, oxidability and N content. Water degradation was caused by faecal and urine excrements of livestock having access to the pond and, to a lesser extent, by the lack of a surrounding vegetative strip.

In the open pond Bardoitza, N contents in summer were far below the guidelines for safe livestock consumption (<44 mg NO<sub>3</sub> per L); however, the voluntary intake of water would probably be affected by the degraded water, hence negatively influencing the animal consumption of solids (Lardner *et al.*, 2005). N compounds are known to have strong negative effects on amphibian survival (Knutson *et al.*, 2004). In the summer sampling we did not find a significant relationship between N and amphibian richness ( $R^2 = 0.252$  for ammonium and  $R^2 = 0.247$  for nitrate, n.s.). In fact, Bardoitza pond, which displayed the highest N content, supported a richness of amphibians similar to that of fenced ponds. These results led us to formulate the following hypotheses: 1) the early larval stages of amphibians, very sensitive to N pollution (Shinn *et al.*, 2008), occur before the loss of water quality, 2) different species of amphibians more resistant to pollution developed and 3) other pond characteristics were more decisive for amphibian survival. In this sense, the temporary nature of the water body, and the

presence of predators, such as crustaceans, might explain the lower occurrence of amphibians in R.Urbasa and Bekosare, respectively.

Table 2. Chemical and microbiological quality of the water in ponds in the spring and summer samplings.

Pond	Ilusiar		Mármol		Bekosare		Olaberri		Majadas		Bardoitza		R. Urbasa
	Spr	Sum	Spr	Sum	Spr	Sum	Spr	Sum	Spr	Sum	Spr	Sum	Spr
Chemical variables:													
pH	7.9	8.2	7.2	7.9	7.7	8.2	7.9	7.5	7.4	7.5	8.4	7.7	8.1
Colour (mg l <sup>-1</sup> Pt)	<5	7	6	8	6	<5	13	28	24	25	16	80	7
Turbidity (UNF)	2.3	19.4	7.1	4.3	18.8	18.7	2.9	8	1	1.2	6.1	71	32.1
Conductivity (µS cm <sup>-1</sup> )	236	166	40	48	177	198	194	201	206	252	130	395	216
O <sub>2</sub> demand (mg l <sup>-1</sup> )	1.9	9.9	4.8	5.5	3.5	3.5	5.6	9.9	9.8	8.2	6.2	20.9	6.3
Nitrates (mg l <sup>-1</sup> )	<0.4	0.4	<0.4	<0.4	<0.4	<0.4	<0.4	0.6	0.4	<0.4	<0.4	1.5	<0.4
Amonium (mg l <sup>-1</sup> )	<0.05	<0.05	<0.05	<0.05	<0.05	<0.05	<0.05	<0.05	<0.05	0.16	<0.05	5.58	0.71
Microbial variables:													
TC (NMP (100 ml) <sup>-1</sup> )	1553	24200	260	750	816	310	47	3260	219	24200	5	24200	26
EC (UFC (100 ml) <sup>-1</sup> )	<10	15	<1	15	<10	<10	<10	15	<1	144	<10	179	<10
<i>E. coli</i> (UFC (100 ml) <sup>-1</sup> )	<10	179	<1	<10	<10	<10	<10	15	<1	2182	<10	6581	<10
<i>C. perf.</i> (UFC (100 ml) <sup>-1</sup> )	<1	<1	50	<1	<1	10	<1	10	<1	<1	<1	30	30

Spr, Spring; Sum, Summer; TC, Total Coliforms; EC, Enterococci;

In contrast to chemical pollution, preventing livestock access to ponds did not fully eliminate the risk of microbial degradation. *E. coli* and *C. perfringens*, two typical enteric bacteria of mammals, were found in some fenced ponds, which indicated that the faecal microbial charge came from wildlife, presumably small-size mammals (e.g. squirrels, voles) and birds (migratory and prey birds). These enteric pathogens, harmless for amphibians, may largely affect livestock health and welfare, and are unsafe for humans consuming their raw products.

## Conclusions

The quality of the water during the grazing season is largely affected by the wading of animals in open ponds. The chemical and microbiological degradation of the water may be more negative to livestock than to some amphibian populations.

## References

- Cárcamo S. (2008) Estudio faunístico. In: Canals, R. M. et al. *Proyecto de ordenación de los recursos pascícolas forestales de Sierras de Urbasa y e Andia*. Scio de Medio Ambiente, Gobierno de Navarra, Pamplona.
- Gosá A., Sarasola V. and Cárcamo S.(2004) *Bases para la gestión de las poblaciones de anfibios de los L.I.Cs de la Sierra de Aralar, Urbasa y Andia*. Viveros y Repoblaciones de Navarra, Pamplona.
- Knutson M. G., Richardson W. B. and Reineke D. M. (2004) Agricultural ponds support amphibian populations. *Ecological Applications*. 14, 669-684.
- Lardner H.A., Kirychuk B.D. and Braul L. (2005) The effect of water quality on cattle performance on pasture. *Australian Journal of Agricultural Research* 56, 97-104.
- Shinn C., Marco A. and Serrano L. (2008) Inter- and intra-specific variation on sensitivity of larval amphibians to nitrite. *Chemosphere* 71, 507-514.

## Residual effects of cutting and grazing on grass-clover growth

Eriksen, J., Søgaard K. and Askegaard M.

*Department of Agroecology and Environment, University of Aarhus, PO Box 50, 8830 Tjele, Denmark*

Corresponding author: Jorgen.Eriksen@agrsci.dk

### Abstract

The residual effect of cutting and grazing during the growing season was investigated in the spring and summer growth in an organic crop rotation with 1-4 year-old grass-clover mixtures of white clover (*Trifolium repens* L.) and perennial ryegrass (*Lolium perenne* L.) either with or without red clover (*Trifolium pratense* L.) and with and without slurry. The white clover mixtures had significantly higher yields in spring and summer in swards that were previously grazed compared to previously cut swards, when slurry was applied. The percentage of white clover in spring was considerably reduced by previous grazing and this caused the yield response of slurry application to be highest following grazing. A similar effect on the clover content was not found in the summer growth. With the inclusion of red clover in the sward the effect of previous management on spring yield disappeared. Red clover was very abundant under the cutting regime, while the contents were declining under grazing.

Keywords: cutting, fertiliser response, grazing, red clover, residual effects, white clover

### Introduction

Grass-clover production is affected by grazing animals through the recycling of nitrogen (N) in animal excreta. This immediately affects the growth and N<sub>2</sub>-fixation of the clover (Rotz *et al.*, 2005), but may also have some effects on pasture production in the longer term. Grazing also imposes animal treading and more frequent defoliation, and different clover species have different abilities to survive under grazing conditions (Brummer and Moore, 2005). This experiment investigated the residual effect of grazing on sward production, composition and response to nitrogen fertilisation in perennial ryegrass-white clover mixtures alone or with inclusion of red clover.

### Materials and methods

The experiment was carried out in a grass-arable crop rotation (barley/grass-clover; 4 years of grass-clover; barley/catch crop) at Foulum Research Centre. In spring, grass-clover was undersown in a spring barley (*Hordeum vulgare* L.) cover crop. The seed mixture (sown at 26 kg ha<sup>-1</sup>) was either 15% white clover and 85% perennial ryegrass (five leys in total) or 4% red clover, 14% white clover and 82% perennial ryegrass (three leys in total). Five grassland treatments were imposed in each grass-clover ley between 2006 and 2009. The treatments were:

- 1) Grazing regime with cattle slurry application in spring (100 kg ha<sup>-1</sup> total-N);
- 2) Grazing regime without slurry application;
- 3) One cut with cattle slurry application in spring (100 kg ha<sup>-1</sup> total-N) followed by grazing;
- 4) Cutting regime (4 cuts) with cattle slurry application (200 kg total-N ha<sup>-1</sup>, half in spring and half after 1<sup>st</sup> cut); and
- 5) Cutting regime (4 cuts) without slurry application.

Grazing plots were grazed continuously by heifers. Effects of previous ley management were investigated by harvesting with a Haldrup plot-harvester; 18 m<sup>2</sup> in cut plots. In grazed plots, cuts were made in temporarily fenced off subplots (6 or 12 m<sup>2</sup>) and the rest period was the



same as for the cutting regime in spring growth and 2<sup>nd</sup> regrowth. Botanical composition, dry matter (DM) yield and N content were determined as described by Søegaard (2009). Results were processed by analysis of variance (GLM) applying the Least Significant Difference (LSD) test using the SAS software.

Table 1. Dry matter (DM) yield, clover proportion and N concentration of herbage in spring and summer growth following different management in the previous and the year of harvest. Same letters within variable and species mixture indicate no significant differences ( $P>0.05$ ).

		Spring growth			Summer growth		
		DM yield (t ha <sup>-1</sup> )	Clover (% of DM)	N (% of DM)	DM yield (t ha <sup>-1</sup> )	Clover (% of DM)	N (% of DM)
Ryegrass/white clover							
– Slurry	Cutting	3.8c	21a	2.1a	2.4ab	58a	3.3a
	Grazing	3.9c	11b	1.7b	2.4ab	54a	3.4a
+ Slurry	Cutting	4.8b	13b	2.1a	2.2b	34b	3.0b
	Grazing	5.4a	4c	1.8b	2.7a	34b	3.2a
Ryegrass/white and red clover							
– Slurry	Cutting	5.0b	52a	2.7	2.3b	76a	3.6
	Grazing	4.9b	23c	2.1	2.9a	57b	3.3
+ Slurry	Cutting	5.6a	31b	2.5	2.5b	70a	3.7
	Grazing	5.9a	16d	2.1	3.0a	51b	3.6

## Results and discussion

In swards with white clover mixtures, previous grazing compared to cutting significantly increased DM yields where slurry was applied (Table 1) in both spring and summer. Previous grazing significantly reduced the white clover content in the spring cut, both with and without slurry, whereas there was no effect later in the season. Similar reductions in clover content in spring growth were not found on farms with dairy cow grazing (Søegaard, 2009), which could be due to a tighter grazing by heifers in this experiment. Usually the N concentration in herbage is greatly influenced by clover content. Taking this into consideration, the N concentrations in herbage in the previously grazed plots were relatively higher than in the previously cut plots, probably due to the higher N supply from recycling of urine and faeces in the grazed plots. With the inclusion of red clover in the sward the effect of previous management on spring yield disappeared. However, in the summer growth, previous grazing increased yields compared with cutting. Including red clover in the sward increased the total clover content of the sward, and both in spring and summer previous grazing reduced the red clover content significantly.

The species dynamics in the multi-species mixture sward (Fig. 1) may explain the responses to the management. Red clover was very abundant under the cutting regime, while the contents were declining with grazing, whereas the proportion of white clover was positively influenced by grazing. It appears that the high red clover proportion during summer growth under cutting conditions was not able to compensate for the positive residual effect of grazing on grass yield probably caused by N excretion, increased tiller density and more stems as observed in the pasture. The experiment also had a treatment with a spring cut prior to grazing and the results (not shown) were not significantly different ( $P>0.05$ ) from the results under whole-season grazed management.

The yield response of fertiliser (100 kg ha<sup>-1</sup> total-N in cattle slurry) of the sward to the spring cut decreased from 37% to 27% in the white clover mix, going from previous grazing to previous cutting, and similarly from 20% to 13% in the red and white clover mix. Others have found the N response of grazed pure grass swards (Lantinga *et al.*, 1999) and perennial ryegrass-white clover mixtures (Søegaard, 2009) to be lower than that of cut swards, probably due to N excretion by cattle in the grazed sward. In this experiment the residual effect was



determined by making a cut in a fenced-off part of the grazed plot. Under similar conditions, with a longer rest period than normally occurs during grazing, the higher yield and N response under grazing compared to cutting has also been found on farms (Søegaard, 2009) and it indicates a higher growth potential in grazed swards. The reduction in clover content caused by N application probably contributed to a significant N response in perennial ryegrass in the grazed sward.

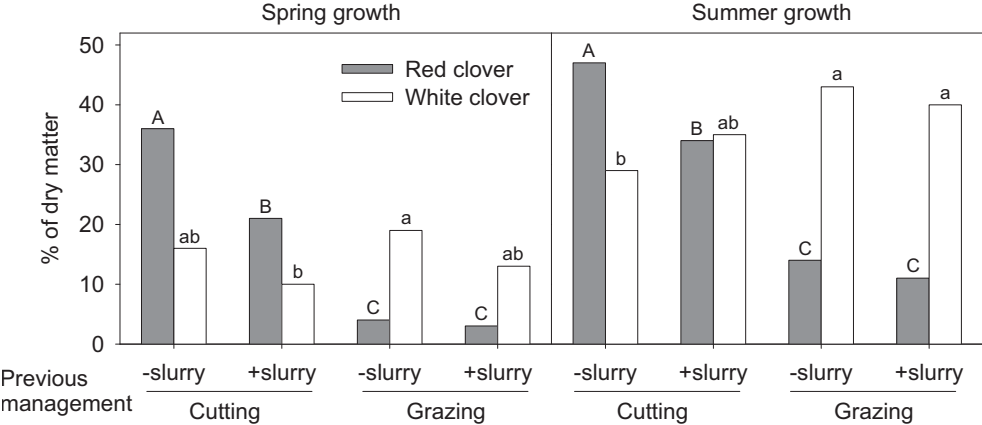

Figure 1. Proportion of red and white clover in a mixture of perennial ryegrass, white and red clover subject to previous grazing and cutting, with and without slurry. Same letter within growth period and species indicate no significant difference ( $P > 0.05$ ).

**Conclusions**

The experiment showed profound residual effects of management on white clover-perennial ryegrass swards both with and without red clover. These effects can be utilised in farm management for improving yield and fertilizer response.

**References**

Brummer E.C. and Moore K.J. (2000) Persistence of perennial cool-season grass and legume cultivars under continuous grazing by beef cattle. *Agronomy Journal* 92, 466-471.

Lantinga E.A., Deenen P.J.A.G. and van Keulen H. (1999) Herbage and animal production responses to fertilizer nitrogen in perennial ryegrass swards. II. Rotational grazing and cutting. *Netherlands Journal of Agricultural Sciences* 47, 243-261.

Rotz C.A., Taube F., Russelle M.P., Oenema J., Sanderson M.A. and Wachendorf M. (2005) Whole-farm perspectives of nutrient flows in grassland agriculture. *Crop Science* 45, 2139-2159.

Søegaard K. (2009) Nitrogen fertilization of grass/clover swards under cutting or grazing by dairy cows. *Acta Agriculturae Scandinavica Section B – Soil and Plant Science* 59, 139-150.

# How does stocking rate influence biodiversity in a hill-range pasture continuously grazed by horses?

Fleurance G.<sup>1,2</sup>, Dumont B.<sup>2</sup> and Farruggia A.<sup>2</sup>

<sup>1</sup>*Institut français du cheval et de l'équitation, 19230 Arnac-Pompadour, France*

<sup>2</sup>*INRA, UR1213 Herbivores, Theix, 63122 Saint-Genès-Champanelle, France*

Corresponding author : [gfleuran@clermont.inra.fr](mailto:gfleuran@clermont.inra.fr)

## Abstract

Reduction of grazing intensity is assumed to favour biodiversity as a result of increased pasture heterogeneity, but there is a clear lack of data on the impact of grazing horses at different stocking rates. Over a 4-year study, we therefore recorded the species richness and abundance of vascular plants (25 fixed 50 cm × 50 cm quadrats per plot), ground beetles (18 pitfall traps per plot) and grasshoppers (three fixed 50 m long transects per plot) in a mesophile grassland that was continuously grazed by horses at either 1.8 or 1.1 LU ha<sup>-1</sup>. Average number of plant species per plot (n = 28) was not affected by stocking rate, but the creation of relatively stable short patches by horses enabled legumes to compete with tall grasses. Consequently, legume abundance increased from an average of 0.042 to 0.157 of plot area at the high stocking rate, while remaining stable around 0.082 in moderately grazed plots (SR×year:  $P = 0.024$ ). Higher structural heterogeneity in these last plots led to favour ground-beetle and grasshopper populations, especially those species associated with tall swards. Reduction in stocking rate did not affect horse performance per ha.

Keywords: stocking rate, horse, biodiversity, vascular plants, ground beetles, grasshoppers

## Introduction

Semi-natural grasslands are recognized as important sources of biodiversity in Europe. Appropriate grazing management is thus essential for preserving biological diversity in these ecosystems. Several authors have reported that moderate stocking rates help to maintain high levels of biodiversity as a result of increased pasture heterogeneity. Selective defoliation by herbivores is the main driver of pasture heterogeneity. Among livestock species, horses play an increasing role in the management of grasslands and they are known to create and maintain short patches within a matrix of tall swards. Our study was carried out during 4 years to explore the effects of continuously grazing horses at a high or a moderate stocking rate on both animal performance and the diversity of vascular plants, ground beetles and grasshoppers in a mesophile grassland of central France.

## Materials and methods

The species richness and abundance of plants, ground beetles (Carabidae) and grasshoppers (Orthoptera) were recorded from 2006 to 2009 in six 2.7 ha plots of a mesophile grassland (430 m a.s.l.) that were continuously grazed from April to November by either five or three 3-year-old horses (French Saddle and Anglo-Arab geldings and mares, 1.8 and 1.1 LU ha<sup>-1</sup>; 1 LU = 600 kg live weight). Each stocking rate treatment was replicated three times in a randomized block design. Horses of the two treatments were removed from their pastures from the end of July to early September each year to prevent animals being limited in their intake in highly grazed plots. The liveweight changes of horses were obtained from weighing three horses on each plot when the animals entered and left their pastures. To evaluate botanical diversity, percentage cover of all plant species was estimated in June 2006 and 2009

in 25 fixed 50 cm × 50 cm quadrats per plot. Ground beetles were sampled each year in June with 18 pitfall traps per plot. Adult grasshoppers were counted in two periods between 13 July and 29 September each year, along three fixed transects (50 m × 2 m) in each plot.

Data were analysed at the plot scale. A mixed ANOVA model was used with repeated measures to take into account the dependence of data between years. Stocking rate (SR) and year were considered as fixed factors and block as a random factor. The interaction SR × year was never significant and thus removed from the model. For grasshoppers, significant interactions between period and year led us to consider separately the two recording periods. Abundance data for ground beetles and grasshoppers were analysed in relation to habitat affinity: i.e. short grassland (<10 cm) or tall grassland (>10 cm).

## Results and discussion

The average daily liveweight gain per animal was not influenced by the treatment between April and the end of July (on average 430 g animal<sup>-1</sup> d<sup>-1</sup>) but was significantly higher in the moderately grazed plots during the second part of the grazing season (on average 362 and 140 g animal<sup>-1</sup> d<sup>-1</sup> at the moderate and at the high SR respectively,  $P = 0.017$ ). Reduction in stocking rate did not affect the horse performance per ha (on average 617 g ha<sup>-1</sup> d<sup>-1</sup> from April to July and 331 g ha<sup>-1</sup> d<sup>-1</sup> from September to November). Species richness of vascular plants (on average 28 species per plot) was not affected by SR over this 4-year study. This confirms that species abundance usually changes more rapidly than species number (Louault *et al.*, 2005; Scimone *et al.*, 2007): the creation of relatively stable short patches by horses (Putman *et al.*, 1987; Ménard *et al.*, 2002) enabled legumes to compete with tall grasses. Consequently, legume abundance increased under the high SR from an average of 0.042 to 0.157 of plot area, while it remained stable around 0.082 in moderately grazed plots (SR × year:  $P = 0.024$ ). Four years after the two stocking rates had been applied, we were unable to detect any significant effects on grass and forb abundances, although grasses decreased from an average of 0.675 to 0.551 of plot cover at the high SR. Species richness and abundance of insects varied strongly between years mainly because of variable precipitations (Tables 1 and 2). SR did not significantly affect species richness, but a beneficial effect of the reduction in grazing intensity was observed on ground beetle abundance ( $P = 0.06$ ), especially for those species associated with tall swards ( $P < 0.05$ ; Table 1). Similarly, grasshoppers associated with tall grasslands were more abundant in moderately grazed plots at the end of July (Table 2). These results are consistent with observations made by Wallis de Vries *et al.* (2007) and Dumont *et al.* (2009) and confirm the usually positive influence of extensification on grasshopper populations. This could reflect a greater number of ecological niches and a higher availability of food resources in moderately grazed pastures, but also a more favourable microclimate and lower levels of disturbance from livestock.

Table 1 Species richness and abundance of Carabidae (log N individuals per plot) under the two stocking rate treatments (Moderate, 1.1 LU ha<sup>-1</sup>; High, 1.8 LU ha<sup>-1</sup>).

	Stocking rate		s.e.	<i>P</i>	Year				s.e.	<i>P</i>
	Moderate	High			2006	2007	2008	2009		
Species richness	22.4	21.2	0.03	NS	28.3 <sup>a</sup>	18.7 <sup>c</sup>	16.7 <sup>c</sup>	23.5 <sup>b</sup>	0.02	***
Log N individuals	2.13	2.03	0.04	†	2.18 <sup>a</sup>	2.17 <sup>a</sup>	1.87 <sup>b</sup>	2.10 <sup>a</sup>	0.06	***
Short grassland	0.81	0.84	0.13	NS	1.13 <sup>a</sup>	0.96 <sup>a,b</sup>	0.49 <sup>c</sup>	0.71 <sup>b,c</sup>	0.18	*
Tall grassland	1.83	1.72	0.04	*	1.75	1.82	1.66	1.86	0.09	NS

NS, not significant; †  $P < 0.1$ , \*  $P < 0.05$ , \*\*  $P < 0.01$ , \*\*\*  $P < 0.001$

For each row, mean values with different superscripts are significantly different at  $P < 0.05$ .

Abundance of wide ranging generalist ground beetles and of species for which habitat affinity is undetermined (44.3% of the total number of individuals) was not affected by SR.

Table 2 Species richness and abundance of grasshoppers (log (N+1) individuals per plot) under the two stocking rate treatments (Moderate, 1.1 LU ha<sup>-1</sup>; High, 1.8 LU ha<sup>-1</sup>).

End of July	Stocking rate		s.e.	P	Year				s.e.	P
	Moderate	High			2006	2007	2008	2009		
Species richness	8.6	7.7	0.04	NS	10.7 <sup>a</sup>	5.8 <sup>c</sup>	8.7 <sup>b</sup>	7.3 <sup>b,c</sup>	0.04	***
Log N+1 individuals	1.79	1.75	0.04	NS	2.30 <sup>a</sup>	0.96 <sup>c</sup>	2.00 <sup>b</sup>	1.81 <sup>b</sup>	0.09	***
Short grassland	0.86	1.09	0.17	NS	1.64 <sup>a</sup>	0.56 <sup>c</sup>	0.96 <sup>b</sup>	0.73 <sup>b,c</sup>	0.21	***
Tall grassland	1.73	1.56	0.07	*	2.18 <sup>a</sup>	0.69 <sup>c</sup>	1.94 <sup>b</sup>	1.76 <sup>b</sup>	0.10	***

September	Stocking rate		s.e.	P	Year				s.e.	P
	Moderate	High			2006	2007	2008	2009		
Species richness	6.8	6.4	0.97	NS	9.7 <sup>a</sup>	2.8 <sup>c</sup>	8.2 <sup>a</sup>	5.7 <sup>b</sup>	0.91	***
Log N+1 individuals	1.39	1.33	0.08	NS	2.03 <sup>a</sup>	0.55 <sup>d</sup>	1.71 <sup>b</sup>	1.16 <sup>c</sup>	0.12	***
Short grassland	1.04	1.09	0.11	NS	1.82 <sup>a</sup>	0.32 <sup>c</sup>	1.15 <sup>b</sup>	0.97 <sup>b</sup>	0.17	***
Tall grassland	1.11	0.92	0.12	NS	1.57 <sup>a</sup>	0.35 <sup>b</sup>	1.50 <sup>a</sup>	0.67 <sup>b</sup>	0.16	***

NS, not significant; †  $P < 0.1$ , \*  $P < 0.05$ , \*\*  $P < 0.01$ , \*\*\*  $P < 0.001$

For each row, mean values with different superscripts are significantly different at  $P < 0.05$ .

## Conclusions

Over the four years of measurements, the selective grazing of short patches by horses led to an increase of legume abundance in heavily grazed plots. The moderate grazing intensity did not affect the species richness of vascular plants but benefited ground beetle and grasshopper populations, without affecting horse performance per ha. Further research is needed to evaluate the effects of stocking rate over a longer period. Moreover, a fine scale analysis at the patch level would improve our understanding of those processes driving the diversity of plants and insects in heterogeneous grasslands.

## Acknowledgements

This study was funded by Les Haras Nationaux. The authors thank N. Edouard, L. Lanore, F. Decuq, B. Calmont, E. Boitier and the staff of the experimental farm of Les Haras Nationaux for their help with measurements.

## References

- Dumont B., Farruggia A., Garel J.-P., Bachelard P., Boitier E. and Frain M. (2009) How does grazing intensity influence the diversity of plants and insects in a species-rich upland grassland on basalt soils? *Grass and Forage Science* 64, 92-105.
- Louault F., Pillar V.D., Aufrère J., Garnier E. and Soussana J.F. (2005) Plant traits and functional types in response to reduced disturbance in a semi-natural grassland. *Journal of Vegetation Science* 16, 151-160.
- Ménard C., Duncan P., Fleurance G., Georges J.Y. and Lila M. (2002) Comparative foraging and nutrition of horses and cattle in European wetlands. *Journal of Applied Ecology* 39, 120-133.
- Putman R.J., Pratt R.M., Ekins J.R. and Edwards P.J. (1987) Food and feeding behaviour of cattle and ponies in the New Forest, Hampshire. *Journal of Applied Ecology* 24, 369-380.
- Scimone M., Rook A.J., Garel J.P. and Sahin N. (2007) Effects of livestock breed and grazing intensity on grazing systems: 3. Effects on diversity of vegetation. *Grass and Forage Science* 62, 172-184.
- Wallis de Vries M.F., Parkinson A.E., Dulphy J.P., Sayer M. and Diana E. (2007) Effects of livestock breed and grazing intensity on biodiversity and production in grazing systems. 4. Effects on animal diversity. *Grass and Forage Science* 62, 185-197.

# Silage maize in crop rotations with different grass mixtures – N balances and N leaching

Kalmlage T.<sup>1</sup>, Kayser M.<sup>1</sup> and Isselstein J.<sup>2</sup>

<sup>1</sup>Georg-August-University Goettingen, Department of Crop Sciences - Grassland Science  
Location Vechta, D-39377 Vechta

<sup>2</sup>Georg-August-University Goettingen, Department of Crop Sciences - Grassland Science, D-37075 Goettingen

Corresponding author: manfred.kayser@agr.uni-goettingen.de

## Abstract

The cultivation of maize in Germany is expanding due to its use as fodder or corn and increases in biogas production based on renewables. The biogas boom helped to make maize the most cultivated crop in the federal state of Lower Saxony in 2007. A further increase in maize production is, however, viewed with criticism, because it affects the landscape and its biodiversity and might pose a risk to groundwater protection. For future developments maize needs to be integrated in economically and ecologically sound crop rotations.

We tested the effect of different grass mixtures, with and without clover, reduced or moderate N supply, on yield and N leaching of corn as a follower crop in a 3-year field experiment on sandy soils. The yield of silage maize is an important factor in evaluating the suitability of such crops within a rotation, as is the amount of N leaching for the environmental impact of the whole system. We found that integrating maize in crop rotations with a reduced N input has the potential to achieve satisfying DM yields of 160 dt ha<sup>-1</sup> combined with lower risks of N leaching losses (60 kg ha<sup>-1</sup> versus 123 kg ha<sup>-1</sup> with high N input).

Keywords: Silage maize, crop rotation, N leaching, maize yields

## Introduction

Maize often leaves large amounts of residual soil mineral nitrogen after harvest (Schweiger *et al.*, 1989). This can cause high pollution of groundwater by nitrate leaching (Bobe *et al.*, 2003; Kelm *et al.*, 2007). The integration of maize in crop rotation systems with grass can contribute positively to ground water protection (Bobe *et al.*, 2004). The aim of this study was to test the hypothesis that maize in crop rotations with different grass mixtures and moderate N supply can have yields comparable to fertilized maize but with a significantly reduced N leaching risk.

## Materials and methods

The study sites were located in the county of Cloppenburg in northwest Germany (52°52'N, 7°54'E). Site I, a loamy sand, was a Plaggic Anthrosol. The soil of site II is a sandy to loamy sand turning to pure sand 0.7 m below the surface. In September 2005, on both sites, four grass mixtures with and without clover were established in three replications. Each plot was 96 m<sup>2</sup> in size. The experimental design with crop rotation and N fertilisation is given in Table 1.

The dry matter (DM) yield was determined at the respective harvest dates and subsequently analysed for total N content with near infrared spectroscopy (NIRS). A permanent vacuum-controlled suction cup system with four cups per plot at a depth of 0.75 m was installed to take samples of drainage water in winter. Nitrate leaching losses were calculated as a product

of the nitrate concentration and the amount of water percolating through the profile during a given time using the water balance model 'Simpel - Version 2' (Hörmann, 1998). Analysis of variance (ANOVA) was carried out using the STATISTICA software package (Version 9). Normality in data was usually achieved by logarithmic transformation. To simplify interpretation of the results, arithmetic means are presented together with the results of the Student-Newman-Keuls (SNK) post hoc test.

Table 1. Experimental design with crop rotation and fertilisation.

	Low N input	High N input	Low N input	High N input
Seeding in	Grass mixture A		Grass mixture B	
autumn 2005	35 kg ha <sup>-1</sup> with 6% white clover	35 kg ha <sup>-1</sup> no clover	45 kg ha <sup>-1</sup> with 29% red clover	45 kg ha <sup>-1</sup> no clover
1. year (2006)	0 kg ha <sup>-1</sup> N	280 kg ha <sup>-1</sup> N	0 kg ha <sup>-1</sup> N	360 kg ha <sup>-1</sup> N
2. year (2007)	see above	see above	Break up and cultivation of silage maize	
			23 kg N ha <sup>-1</sup> †	180 kg ha <sup>-1</sup> N
3. year (2008)	Break up and cultivation of silage maize		Silage maize	
	23 kg ha <sup>-1</sup> N †	180 kg ha <sup>-1</sup> N	23 kg ha <sup>-1</sup> N †	180 kg ha <sup>-1</sup> N

†side dressing

## Results and discussion

The intensively fertilised grass plots had significantly larger DM and N yields than the non-fertilised clover grass mixtures. In 2006 and 2007, site and N fertilisation had a significant effect on DM and N yield in grass mixture A with and without white clover, but not on N leaching. In 2006 the grass mixture B, on the other hand, showed significant effects of site and N fertilisation on yields and N leaching. In this year the grass mixture B without clover and an N supply of 360 kg ha<sup>-1</sup> was obviously over-fertilised, due to the summer dryness, so that the N leaching from 44 to 71 kg ha<sup>-1</sup> under the fertilised grass mixture B turned out to be higher than expected (versus 6.0 to 8.4 kg ha<sup>-1</sup> under the fertilised grass mixture A). In the first year of maize cultivation after grassland break up, DM yields for moderately (N23) and highly fertilised crop rotation parts were similar (Figure 1).

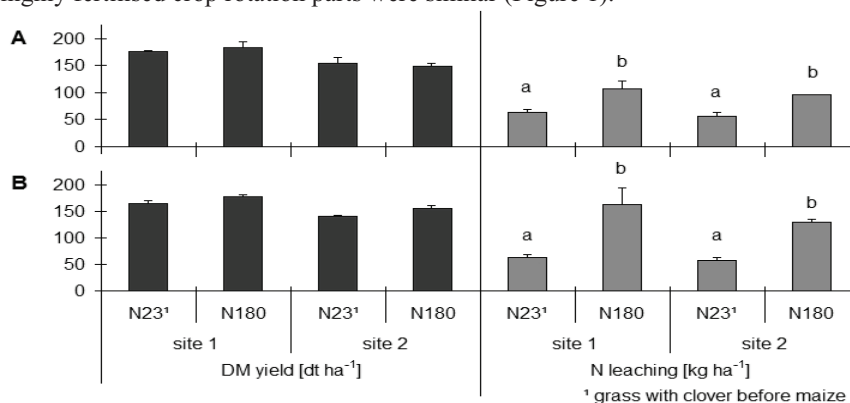

Figure 1. Maize DM yield and calculated N leaching losses (Oct-April); (A) in the first year after grass mixture A in 2008, and (B) after a grass mixture B in 2007; different letters indicate significant differences at  $P = 0.05$  (SNK test), error bars are standard errors of the mean; averaged over three replications.

The N fertilisation had no significant effect on DM and N yield, but had an effect on N leaching losses. The N leaching losses in the highly fertilised crop rotation parts were significantly higher. In different experiments on sandy soils, the N leaching of maize in

monoculture ranged from 63 to 110 kg ha<sup>-1</sup> (Schweiger *et al.*, 1989; Bobe *et al.*, 2003; Kayser *et al.*, 2008). In our crop rotation system with moderate N supply, satisfying DM and N yields coupled with reduced N leaching (60 kg ha<sup>-1</sup>) were achieved in the first growing season after spring break up of one- or two-year old grassland. In the second year, maize after grass mixture B (grass-maize-maize) significantly smaller DM and N yields were determined in the moderately fertilised crop rotation part. The intensively fertilised plots had the largest N yields (Table 2) when accumulated over the three-year crop rotation. This effect mainly resulted from the large N yields of the fertilised grass mixtures (without clover). The moderately fertilised grass-maize crop rotation parts had negative nitrogen balances (Table 2), meaning that nitrogen had been provided mainly by non-quantified mineralisation processes. The higher N surplus in the intensively fertilised crop rotation parts led to larger N leaching losses, particularly with higher maize proportion in the crop rotation.

Table 2. Cumulated N yield, simplified N balances (N fertilisation – N yield) and cumulated N leaching over 3 years crop rotation with different grass mixtures with maize as follower crop; averaged over three repetitions with standard errors of mean (SEM N yield = SEM simplified N balance).

	N (kg ha <sup>-1</sup> )							
	Grass mixture A (2y) – maize (1y)				Grass mixture B (1y) – maize 2(y)			
	site 1		site 2		site 1		site 2	
N input	low	high	low	high	low	high	low	high
N fertilisation	23 <sup>1</sup>	740	23 <sup>1</sup>	740	45 <sup>1</sup>	720	45 <sup>1</sup>	720
Cumulated N yield	658±16	782±32	350±10	653±26	487±6.7	684±14	417±14	556±13
Simplified N balance	-635	-42	-327	87	-442	36	-372	164
Cumulated N leaching	84±7.7	116±13	67±5.7	108±3.5	113±13	297±24	109±6.3	241±24

<sup>1</sup>grass with clover before maize

## Conclusions

During the grass phase, dry matter and nitrogen yields of the highly fertilised grasses without clover were superior to the grass-clover mixtures with no mineral N input. The results show that after the breakup of 1 to 2-year-old grass the nitrogen fertilisation to maize as a follower crop can be significantly reduced in the first year, with no losses in DM and N yield. The mineralisation after ploughing of short-term grassland on sandy soils obviously provides sufficient nitrogen. This allows integrating maize in crop rotations with reduced N input to achieve satisfying yields combined with a much reduced risk of elevated N leaching losses and groundwater pollution. However, unadjusted N fertilisation in these situations, especially on former permanent grassland soils, would lead to an excess supply of N and thus to potentially higher nitrate leaching.

## References

- Bobe J., Wachendorf M., Büchter M. and Taube F. (2003) Vergleich der Nitratkonzentrationen im Grund- und Sickerwasser bei variiertem Düngungsintensität im Dauergrünland und in einer Maismonokultur – Erste Ergebnisse. *Mitteilungen der Gesellschaft für Pflanzenbauwissenschaften* 15, 190-193.
- Bobe J., Wachendorf M., Büchter M. and Taube F. (2004) Nitrate leaching losses under crop rotation. *Grassland Science in Europe* 9, 346-348.
- Hörmann G. (1998) Speichermodelle zum Bodenwasserhaushalt – Simpel Version 2, Kiel. [http://www.hydrology.uni-kiel.de:9673/Hydrology/Members/schorsch/Simpel/index\\_html/view](http://www.hydrology.uni-kiel.de:9673/Hydrology/Members/schorsch/Simpel/index_html/view).
- Kayser M., Seidel K., Müller J. and Isselstein J. (2008) The effect of grassland renovation and break up on nitrogen losses. *Grassland Science in Europe* 13, 123-125.
- Kelm M., Taube F., Hüwing H., Kemper N. and Neumann H. (2007) *Ergebnisse des Projektes COMPASS*, 2. Auflage, Kiel.
- Schweiger P., Brinkele V. and Traub R. (1989) Nitrat im Grundwasser. *Agrar- und Umweltforschung in Baden-Württemberg* 20, Stuttgart (Hohenheim).



# Soil nitrogen, phosphorus and potassium contents on a dairy cattle pasture

Kryszak J. and Musiał M.

Poznan University of Life Sciences, Department of Grassland and Natural Landscape Sciences, Wojska Polskiego 28, 60-637 Poznan, Poland

Corresponding author: kryszak@up.poznan.pl

## Summary

On a pasture for dairy cattle (mean annual milk yield of approximately 9000 kg), that has been utilised continuously for over 50 years, the sward utilisation intensity, the date of sampling and the depth of sample collection significantly affected the soil nutrient status. From spring to autumn, the soil mineral nitrogen increased, predominantly in the form of nitrate. In summer and autumn, the highest quantities of mineral nitrogen (111 to 174 kg ha<sup>-1</sup>), predominantly as ammonium, were determined at 31–60 cm depth in the grazed paddocks. Phosphorus and potassium contents were low and not subjected to clear fluctuations in relation to the method of utilisation and the date or depth of soil sample collection. Mean contents of phosphorus ranged from 113 to 171 mg kg<sup>-1</sup> of soil and the highest quantities were found to occur on grazed plots.

Key words: nitrogen, phosphorus and potassium, pasture, dairy cows

## Introduction

Apart from production and economic objectives, agriculture should also fulfil ecological functions by limiting on-farm nutrient losses (Watson and Wachendorf, 2008). Highly effective feeding technologies applied in milk production can lead to a surplus of fertiliser components at the farm level. According to Sapek and Walczuk (2009), excretion of 115-180 kg nitrogen (N) and 22-24 kg phosphorus (P) per cow, which is typical for an annual milk production of 9000 l, poses a serious problem for good management of these elements. During pasturing, surplus nutrients are excreted by animals in the form of urine and faeces and returned to the soil. In particular, on peat-muck soils, frequent in areas included in the Natura 2000 programme (Pietrzak, 2004), the mineralisation process of organic matter leads to rapid release of mineral nitrogen in amounts frequently exceeding plant requirements. Consequently, nitrates are leached from the soil profile contaminating ground and surface waters (Ten Berge, 2002; Seidel *et al.* 2004). Monitoring nutrient balances of pastures for dairy cattle is required to improve their environmental function regarding water quality preservation. The objective of this research was to determine the effect of sward utilisation on the availability of N, P and K in pasture soils.

## Material and methods

Investigations were carried out at the Brody Experimental Station on a pasture (total area 40 ha) established in 1957 with a sward of *Poa pratensis*, *Lolium perenne* and *Trifolium repens*, grazed in a fertilised-paddock system grazed by approximately 190 Holstein/Friesian cows. During the growing season (early spring, summer and late autumn), soil samples were collected on a 4 ha paddock at four levels of the soil profile, i.e. 0-10, 11-30, 31-60 and 61-90 cm. The samples were taken from 3 specific areas (5 m x 5 m in 4 replications): a grazed area, a cut area (no animals) and a place where cows usually gathered (at the gate area with a very small cover of plants – especially *Polygonum aviculare*). Concentrations of soil mineral nitrogen (N<sub>min</sub>), i.e. nitrate (NH<sub>3</sub><sup>-</sup>) and ammonium (NH<sub>4</sub><sup>+</sup>), were determined in the solution of

0.01 M calcium chloride followed by the colorimetric method with the assistance of a FIAstar 5000 flow autoanalyser (Houba *et al.*, 1996). Available forms of P and K were determined by the Egner-Riehm colorimetric method (DL).

## Results and discussion

The analyses confirmed a higher concentration of  $\text{NH}_3^-$  (from 31 to 186 kg ha<sup>-1</sup>) compared to  $\text{NH}_4^+$  (from 1.5 to 61.2 kg ha<sup>-1</sup>). Particularly low concentrations of  $\text{NH}_4^+$ -N were determined in the top soil layer, i.e. 0-10 cm, at all sampling dates, especially in spring. Over time and with a peak in autumn, at all sampling locations elevated concentrations of N were recorded, predominantly in the form of  $\text{NH}_3^-$ .

Differences in the chemical elements were also due to the method of pasture utilisation, the date of sampling and the sampling depth (Table 1).

Table 1. The influence of utilisation of dairy cows pastures on nitrogen (N) content in the soil (kg ha<sup>-1</sup>)

Season	Soil profile (cm)				Total
	0-10	11-30	31-60	61-90	
	<b>Cutting</b>				
Spring	36.3	79.4	91.2	36.3	291.9
Summer	32.6	43.4	124.1	32.6	249.7
Autumn	41.9	80.3	140.8	41.9	361.1
	<b>Grazing</b>				
Spring	78.4	53.7	110.8	68.9	311.8
Summer	91.6	117.3	128.6	90.9	428.4
Autumn	96.2	144.3	173.8	116.7	531.0
	<b>At the gate*</b>				
Spring	47.5	67.0	82.1	85.6	282.2
Summer	83.7	123.5	138.1	145.5	490.8
Autumn	52.9	122.8	217.2	157.0	549.9

\* Not utilised: no mowing or grazing

The analysis of soil  $N_{\min}$  in the upper soil layer (0-30 cm) enabled us to assume that appropriate amounts of  $N_{\min}$  are available to allow yields sufficient for grazing animals without additional fertilisation. Mean N contents were about 42% lower on the cutting plots compared to the grazed paddocks.

During the growing season,  $N_{\min}$  accumulated below the reach of the plant root system. The highest amounts of  $N_{\min}$  (from 111 to 174 kg ha<sup>-1</sup>), predominantly in the form of  $\text{NH}_4^+$ , were determined during summer and autumn under grazing at the depth of 31-60 cm as well as below 60 cm, suggesting N could pass through to ground waters if  $\text{NH}_4^+$  is nitrified. Pastures were fertilised only in early spring with small doses of mineral fertilisers (100 kg ammonium sulphate per ha). The main part of available N results from mineralisation of soil organic matter and animal excrements. Cows fed with grazed grass containing lucerne and high-energy concentrates excrete considerable amounts of N, P and K in urine and faeces (Sapek and Walczuk, 2009).

The high and low amounts of soil P and K, respectively, can be attributed to the irregular application of P and K fertilisers during the last years (Table 2).

Table 2. Mean content of phosphorus (P) and potassium (K) in the organic soil of the dairy cow pasture

Utilisation	Soil profile (cm)			
	0-10	11-30	30-60	60-90
	P (mg kg <sup>-1</sup> of soil)			
Cutting	116	141	156	154
Grazing	151	166	171	168
At the gate*	149	128	150	113
	K (mg kg <sup>-1</sup> of soil)			
Cutting	41	36	36	43
Grazing	48	38	31	36
At the gate*	660	570	350	200

\* Area not used, absence of mowing and grazing

Mean P content was between 113 to 171 mg kg<sup>-1</sup> soil, with the highest contents determined on grazed paddocks. Similar differences were observed in soil K contents on cut and grazed plots, ranging from 31 to 48 mg kg<sup>-1</sup> soil.

The pasture surface near the gate is exposed to point contamination with N and, particularly, K compounds. This is the area where cows gather waiting to be driven back to the cow house and it is lacking vegetation cover. At the gate area, K contents were 660 and 570 mg K kg<sup>-1</sup> soil at depths of 0-10 and 11-30 cm, respectively.

## Conclusion

The results obtained in this study confirmed the need to monitor soil fertility. Carrying out N, P and K balances will improve utilisation efficiency of these nutrients and will reduce possible negative impacts on the environment caused by the biogenic infiltration into surface and ground waters. It is concluded that management strategies such as mixed systems (cutting/grazing) should be developed in order to avoid hot spots of nutrient accumulation in the soil.

## References

- Ten Berge H.F.M., van der Meer H.G., Carlier L., Baan Hofman T. and Neeteson J.J. (2002) Limits to nitrogen use on grassland. *Environmental Pollution* 118 (2), 225-238.
- Pietrzak S. (2004) N and P budget in selected dairy farm in view of changes in Polish agriculture. *Water-Environment-Rural Areas* 4, 1(10): 159-176 [In Polish with English summary].
- Sapek A. and Walczuk T. (2009) Nitrate balance in the diet of dairy cows. *Water-Environment-Rural Areas* 9, 1(25): 99-110 [In Polish with English summary].
- Seidel K., Kayser M. and Isselstein J. (2004) Nitrate leaching from reseeded grassland: The effect of the season, technique of removal and former N fertilization. *Grassland Science in Europe* 9, 349-351.
- Watson C.A. and Wachendorf M. (2008) Sustainable nutrient management for organic farming systems. *Grassland Science in Europe* 13, 519-528.
- Houba W.J.G., Lexmond Th.M., Novozamsky I. and van der Lee J.J. (1996) State of the art and future developments in soil analysis for bioavailability assessment. *The Science of the Total Environment* 178, 21-28.

# Shortcut strategies to improve plant species richness after years of intensive management in moist grassland

Nielsen A.L. and Hald A.B.

Natlan, Agro Business Park, Niels Pedersens Allé 2, DK-8830 Tjele, Denmark

Corresponding author: lisbeth.nielsen@agropark.dk

## Abstract

In Denmark new wetland areas are established with the aim of reducing the nutrient load to the aquatic environment, and at some sites former lakes are re-established. They will attract people to enjoy the local amenity values. However, the grasslands around the lakes may need careful management to improve plant species richness after years of intensive agriculture. Therefore we imposed different shortcut restoration treatments to examine if improvement in the species richness could be optimised by initial nutrient removal or immobilisation. The three restoration treatments were: de-turfing, deep ploughing, and rough sawdust mulched into the topsoil, and these were compared with more usual grassland management strategies: two cuts and three cuts per year. The most efficient treatment in terms of nutrient reduction was topsoil removal, as assessed in the lowest Ellenberg-N index of the vegetation after this treatment. Sawdust mulch had only a very short-time effect, and in the following years it showed a faster increase in available nutrients than expected, resulting in the highest Ellenberg-N index. Removal of nutrients by cutting-only treatments gave intermediate responses, slower than the de-turfing treatment.

Keywords: De-turfing, deep ploughing, sawdust, cutting, nutrient removal, restoration

## Introduction

As the residual soil fertility is a major challenge when trying to increase species richness in former intensive agricultural land, it is useful to make initial steps to counteract this problem. It may be de-turfing or a relatively deep ploughing to get less fertile soil to the surface. Another way is to add rough sawdust to reduce plant available nitrogen in the initial restoration process. Cutting is usually used to remove nutrients from such sites, and it is efficient compared to grazing (Hald *et al.*, 2003). In current agri-environment schemes swards cannot be cut before late June and often only two cuts are possible. In order to reduce competitive sown grassland species and increase different broadleaved species, a strategy with an early first cut may be more appropriate, using a three-cut strategy with first cut in the middle of May. Our aim was to compare the ability of five different management regimes to reduce nutrient levels and restore biodiversity in former intensively managed grassland.

## Materials and methods

In autumn 2004 the pumps removing water from a low-land area were stopped and a shallow lake re-established at Rødding, in the central part of Jutland. Our experiment was established in autumn 2005 on the sandy and freely drained loam, 3 m from the lake. In 2005 the topsoil (0-20 cm) contained 3.2% organic matter; C to N-ratio 10.1; extractable P 45 kg P ha<sup>-1</sup> and extractable K 97 kg K ha<sup>-1</sup>. Restoration treatments were: cut early, first cut in the middle of May, three cuts (T1); cut late, first cut at end of June, two cuts (T2); de-turfing by the removal of the upper 5-10 cm of soil in autumn 2005, cut as 'T2' in the following years (T3); ploughing to a depth of 30-40 cm and smoothing of the soil surface by a seedbed combined harrow, in autumn 2005, then cut as 'T2' (T4); addition of rough sawdust at 70 t ha<sup>-1</sup>,

followed by two times mulching in autumn 2005, then cut as 'T2' (T5). The managements were applied to plots of 12 m x 6 m in three blocks. At cutting in 2008 and 2009, the biomass from the centre of the plots (2 m x 10 m) was weighed and representative samples taken for analyses and botanical composition on a dry matter (DM) basis. Analyses of N, P and K of the biomass removed were used to calculate the yearly N-, P- and K-balance.

## Results and discussion

Results are given as the average of the third and fourth year of management. The DM production figures showed that de-turfing resulted in the lowest biomass and thereby more space for different plant species (Table 1), while sawdust treatment had the highest plant production. The N-balance showed that the initial immobilisation of N by sawdust mulching seemed to be reversed after 2 years. The strategy with three cuts had also a lower biomass than the sawdust treatment. At this stage of the restoration process, de-turfing resulted in a lower removal of N in biomass than the treatment with sawdust addition. In the 2 cuts strategy, removal of 48 kg N per ha was low compared to a similar sward on organic soil rich in N, which resulted in a N removal of 132 kg ha<sup>-1</sup> (Nielsen and Hald, 2008). Apart from de-turfing, the other strategies removed 10-12 kg ha<sup>-1</sup> P in the biomass, whereas K removal varied more, with the highest value in the sawdust treatment and the lowest in de-turfing.

Table 1. Total yearly production and NPK-removal in different management regimes on permanent grassland. The treatments were established in autumn 2005. Results are average of 2008 and 2009, the third and fourth year with the different types of management.

	Cut early	Cut late	De-turfing 2005	Ploughing <sup>1)</sup> 2005	Sawdust, mulch. 2005	LSD
	3 cut	2 cut	2 cut	2 cut	2 cut	
DM, t ha <sup>-1</sup> y <sup>-1</sup>	4.2 <sup>bc</sup>	5.2 <sup>ab</sup>	3.2 <sup>c</sup>	5.7 <sup>ab</sup>	6.0 <sup>a</sup>	1.5
N-balance, kg ha <sup>-1</sup> y <sup>-1</sup>	-56 <sup>ab</sup>	-48 <sup>ab</sup>	-40 <sup>b</sup>	-55 <sup>ab</sup>	-62 <sup>a</sup>	19
P-balance, kg ha <sup>-1</sup> y <sup>-1</sup>	-10 <sup>a</sup>	-10 <sup>a</sup>	-5 <sup>b</sup>	-11 <sup>a</sup>	-12 <sup>a</sup>	2.7
K-balance, kg ha <sup>-1</sup> y <sup>-1</sup>	-51 <sup>b</sup>	-53 <sup>b</sup>	-33 <sup>c</sup>	-57 <sup>ab</sup>	-70 <sup>a</sup>	16

1) Ploughing to at depth of 30-40 cm and smoothing of the soil surface by a seedbed combined harrow.

In September 2005 the sward was mainly dominated by *Lolium perenne* L., *Poa pratensis* L. and *Taraxacum* sp. The botanical composition, in % on a DM-basis as an average of 2008 and 2009, is shown in Table 2. The data are grouped in sown, cultural grasses, here *L. perenne*, *Festuca rubra* L., *P. pratensis*, *P. trivialis* L. and *F. pratensis* Hudson; natural grasses, mainly *Holcus lanatus* L. and *Elytrigia repens* (L.) Nevski; rushes, mainly *Juncus effusus* L.; white clover; other herbs, mainly *Rumex acetocella* L. and *Taraxacum* sp.; and dead material. As an average of the third and fourth year of the management regimes, the proportion of cultivated grasses were lower in the treatments 'de-turfing' and 'deep ploughing' compared to the 3 other treatments. The proportion of natural grasses was especially high after ploughing, with about half of the biomass comprised of *E. repens*, a species observed mainly in this treatment. Rushes occurred more after de-turfing than after sawdust application and 'cut early' strategy. Percentage of white clover was high in de-turfed plots, where other broadleaved herbs had to compete with this N accumulating cultural species. Other herbs occurred to a higher degree in 'cut early' compared to 'sawdust' plots. Proportion of dead material varied between 11% (3 cuts) and about 24% (all '2-cuts' treatments) of the total biomass.

Ellenberg-N index was calculated from the values of the individual species in the sample, weighted by percentage on DM basis (Table 2). Treatments differed clearly with sawdust at the higher end and de-turfing at the lower end. This means that topsoil removal has resulted in space for species with lower Ellenberg-N value, and was therefore a good basis to obtain higher botanical diversity. There may still be some competition to deal with for the different

broad-leaved species, regarding the high amounts of clover as well as rush, especially *J. effusus*. Early addition of seeds to de-turfed plots could be an effective way to increase the amount of other herbs (Pywell *et al.*, 2007), e.g. from an appropriate nearby donor site.

Table 2. Botanical composition in percent on DM basis (average of late June 2008 and 2009). This is the first cut for all treatments except the early cut strategy, where it is the second cut.

	Cut early	Cut late	De-turfing	Ploughing <sup>1)</sup>	Sawdust, mulch. 2005	LSD
	3 cut	2 cut	2005	2005	2 cut	
Cultural grass	48.3 <sup>a</sup>	49.6 <sup>a</sup>	18.2 <sup>b</sup>	26.0 <sup>b</sup>	54.8 <sup>a</sup>	15.1
Natural grass	14.0 <sup>ab</sup>	6.2 <sup>b</sup>	10.2 <sup>b</sup>	19.5 <sup>a</sup>	14.8 <sup>ab</sup>	9.2
Rush	5.3 <sup>b</sup>	7.3 <sup>ab</sup>	23.3 <sup>a</sup>	18.1 <sup>ab</sup>	2.3 <sup>b</sup>	16.7
White clover	1.0 <sup>b</sup>	0.4 <sup>b</sup>	11.2 <sup>a</sup>	0.3 <sup>b</sup>	0.5 <sup>b</sup>	1.5
Other herbs	20.1 <sup>a</sup>	12.5 <sup>ab</sup>	18.5 <sup>ab</sup>	16.1 <sup>ab</sup>	7.6 <sup>b</sup>	12.2
Dead material	11.3 <sup>b</sup>	23.8 <sup>a</sup>	18.6 <sup>ab</sup>	19.9 <sup>ab</sup>	19.9 <sup>ab</sup>	9.7
Ellenberg-N <sup>2)</sup>	5.4 <sup>ab</sup>	5.4 <sup>ab</sup>	4.7 <sup>c</sup>	5.2 <sup>bc</sup>	5.9 <sup>a</sup>	0.6

1) See table 1. 2) Ellenberg-N value, weighted by percentage on DM-basis of individual species in the sample.

## Conclusion

De-turfing of small sub-plots is relevant as a restoration strategy. Here new species with low Ellenberg-N value will have an opportunity to establish and spread further to the surrounding area. However, the effect may be improved by adding seeds from a local donor site just after the disturbance. Deep ploughing can be used with good results including low biomass of clover. Both treatments resulted in development of rushes. The sawdust strategy was the least successful, with the lowest percentage of other herbs and the highest EN. The response of plant diversity was slower following removal of nutrients using only a cutting strategy than by the de-turfing strategy. However, the early-cut strategy resulted in a high percentage of other herbs and a relatively low amount of rush, especially *J. effusus*.

## Acknowledgements

The Danish Food Industry Agency supported this study.

## References

- Hald A.B., Hoffmann C.C. and Nielsen A.L. (2003) Ekstensiv afgræsning af ferske enge. DIAS, 91, 191 pp.
- Nielsen A.L. and Hald A.B. (2008) Management strategies to restore agriculturally affected meadow on peat – biomass and N, P, K-balances. *Grassland Science in Europe* 13, 153-155.
- Pywell R.F., Bullock J.M., Tallowin J.B., Walker K.J., Warman E.A. and Masters G. (2007) Enhancing diversity of species-poor grassland: an experimental assessment of multiple constraints. *Journal of Applied Ecology* 44, 81-94.

# Cattle grazing on Swedish semi-natural pastures – how behaviour affects nutrient transport in the grazing area

Pelve M.E.<sup>1</sup>, Glimskär A.<sup>2</sup> and Spörndly E.<sup>1</sup>

<sup>1</sup>Department of Animal Nutrition and Management, the Swedish University of Agricultural Sciences, Kungsängen Research Centre, Kungsängens gård, S-753 23 Uppsala, Sweden

<sup>2</sup>Department of Ecology, the Swedish University of Agricultural Sciences, Box 7044, S-750 07 Uppsala, Sweden

Corresponding author: Maja.Pelve@huv.slu.se

## Abstract

The objective of this study was to examine the grazing behaviour of cattle on semi-natural pastures and how cattle behaviour relates to their urination and defaecation patterns. The research was carried out in nine semi-natural pastures, grazed by cattle of different breeds. On each site, different vegetation types were identified and mapped: dry, mesic, wet, shaded and previously fertilised. Three adult female cattle were followed for 24 hours. Every five minutes, an observer noted the behaviour of the animals (grazing/lying down/other) and which vegetation type the animal grazed. Continuous recordings were also taken of the time and location of defaecation and urination, using a hand-held GPS device.

Location preference for urination and defaecation followed cattle preferences for grazing and rest location. The vegetation types differed significantly with regard to all nutrient-content measurements except crude protein. Previously fertilised areas had vegetation with the highest nutritive content and were also grazed most often by the cattle. No evidence could be seen that cattle chose to defaecate or urinate in locations other than where they were grazing.

Keywords: Grazing behaviour, cattle, nutrient transport, semi-natural grassland

## Introduction

The layout of the Swedish agrarian landscape is generally patchy and heterogeneous with many small pastures (Blom, 2009). This heterogeneity complicates management routines. To establish a larger, more rational production unit it is often necessary to merge a number of smaller pastures. In this process, farmers may need to include previously fertilised areas (such as leys or older fields), thickets, or sparsely wooded areas in the new pasture. Such rationalisation has been discussed among Swedish conservationists, who are concerned that this may result in the transport of nutrients from the previously fertilised areas to the *bona fide* semi-natural or natural parts of the pasture. Hypothetically, animals would preferentially graze previously fertilised areas and then rest preferentially on semi-natural parts of the pasture. Since most animals defaecate and urinate after longer periods of rest (Aland *et al.*, 2002), a disproportionately large nutrient load would be placed on semi-natural parts and thus disturb the flora there. Therefore, the main objective of this study was to examine the selection of grazing locations by cattle on heterogeneous semi-natural pastures and the location of urination and defaecation in relation to grazing and resting behaviour.

## Materials and methods

The research was carried out in early June to late August 2008 in nine privately owned pasture sites in eastern central Sweden, all of which were chosen for their heterogeneity. Five different vegetation types were identified: dry, mesic, wet, shaded and previously fertilised.



The pastures were mapped and the areas of the different vegetation types within them were determined.

The pastures were grazed by commercial herds of either non-lactating dairy cows, or suckler cows with calves. Three adult females in each herd were selected as focal animals. Behaviour observations were performed over a 24 h period at each site, recording one of three possible events every five minutes: grazing, lying down, or any other behaviour. If the cow was grazing, the observer also recorded which vegetation type. Continuous observations were made using a hand-held global positioning system (GPS) device each time a focal animal defaecated or urinated.

In connection with behavioural observations on a site, the vegetation was sampled for chemical analysis of nutrient content. Three sampling plots of 1x1 m were placed randomly in each vegetation type and all grasses and forbs in the plot were cut. Chemical analysis for dry matter (DM), ash, crude protein (CP) and neutral detergent fibre (NDF) were performed using conventional methods. Metabolisable energy (ME) was determined by *in vitro* digestion as described by Lindgren (1979).

Statistical analysis was performed in SAS 9.1 using three procedures; GENMOD (behavioural data), GLM (nutrient content of vegetation), and CORR (correlation between resting, grazing and urination/defaecation behaviour). The relative preference (RP) for different vegetation types was calculated by the method described by van Dyne and Heady (1965). Relative preference is defined as the ratio between percent behaviour recordings in a vegetation type and the percentage of the total pasture area that the vegetation type represents. An RP value > 1 indicates preference and an RP value < 1 indicates avoidance of a vegetation type for the specified behaviour.

## Results and discussion

There was overall significance in nutrient content between vegetation types ( $P < 0.001$ ) for all nutritional parameters except CP, which only showed pairwise significance between dry and previously fertilised vegetation (Table 1). Vegetation in previously fertilised areas had the highest nutritive content and the cows also spent most of their time grazing these areas. It follows that the cows mainly selected vegetation with the highest nutritive content.

Table 1. Herbage dry matter mass and nutrient content in dry matter of vegetation found in dry, mesic, wet, shaded and previously fertilised areas. Least square means with standard error in brackets. Different letters within a column indicate significant difference ( $P < 0.05$ ).

	Herbage mass [kg ha <sup>-1</sup> ]	Crude protein [g kg <sup>-1</sup> ]	NDF [g kg <sup>-1</sup> ]	Ash [g kg <sup>-1</sup> ]	Energy [MJ kg <sup>-1</sup> ]
Dry	226 <sup>a</sup> (± 86)	116 <sup>b</sup> (± 5)	471 <sup>a</sup> (± 12)	72 <sup>d</sup> (± 3)	9.4 <sup>ab</sup> (± 0.2)
Mesic	458 <sup>bc</sup> (± 79)	122 <sup>ab</sup> (± 5)	471 <sup>a</sup> (± 11)	85 <sup>abc</sup> (± 3)	9.6 <sup>a</sup> (± 0.1)
Wet	1364 <sup>d</sup> (± 127)	127 <sup>ab</sup> (± 8)	536 <sup>b</sup> (± 18)	93 <sup>a</sup> (± 4)	8.2 <sup>c</sup> (± 0.2)
Shaded	358 <sup>ab</sup> (± 79)	124 <sup>ab</sup> (± 5)	509 <sup>b</sup> (± 11)	81 <sup>b</sup> (± 3)	9.0 <sup>b</sup> (± 0.1)
Previously fertilised	594 <sup>c</sup> (± 79)	131 <sup>a</sup> (± 5)	455 <sup>a</sup> (± 11)	91 <sup>ac</sup> (± 3)	9.7 <sup>a</sup> (± 0.1)

The relative preference for different vegetation types was significantly different among vegetation types ( $P < 0.0001$ ) and among sites ( $P < 0.01$ ). The relative preference for grazing on previously fertilised vegetation was high. The relative preference for urination and defaecation location also differed significantly between vegetation types ( $P = 0.001$ ). Most urinations and defaecations occurred in previously fertilised areas (Figure 1). The correlation between both grazing and resting location preferences and resting and urination/defaecation location preferences was highly significant ( $P = 0.0001$  and  $P < 0.0001$ , respectively).

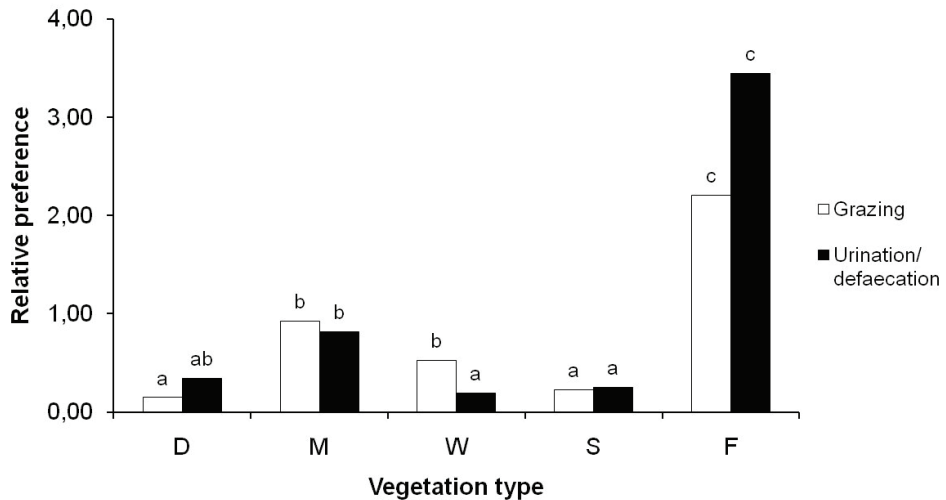

Figure 1. The relative preference (RP) for grazing and urination/defaecation behaviour recorded on different vegetation types (D = dry; M = mesic; W = wet; S = shaded; F = previously fertilised) on sites one to nine. Least square means of 27 focal animals over a 24 h period. Different lowercase letters between bars of the same colour indicate significant difference ( $P < 0.05$ ) between areas with regard to location of grazing (white bars) and for location of urination/defaecation (black bars).

## Conclusions

No evidence was found that cattle chose to defaecate or urinate in locations other than where they chose to graze, and cattle preferentially grazed previously fertilised areas. The present findings do not support the theory that nutrients would be transported from nutrient rich parts onto semi-natural parts of a pasture through the behaviour of cattle. Therefore, the inclusion of previously fertilised areas when making larger pastures may not be as detrimental to biodiversity as previously feared.

## References

- Aland A., Lidfors L. and Ekesbo I. (2002) Diurnal distribution of dairy cow defaecation and urination. *Applied Animal Behaviour Science* 78, 43-54.
- Blom S. (ed) (2009) *Utveckling av ängs- och betesmarker – igår, idag och imorgon*. Swedish Board of Agriculture, Report 2009:10. Jönköping. (In Swedish)
- Lindgren E. (1979) *Vallfodrets näringsvärde bestämt in vivo och med olika laboratoriemetoder*. Rapport 45. Department of Animal Nutrition and Management, Swedish University of Agricultural Sciences, Uppsala, Sweden. 66 p. (In Swedish with English summary)
- Van Dyne G.M. and Heady H.F. (1965) Botanical composition of sheep and cattle diets on a mature annual range. *Hilgardia* 36, 465-492.

# Nitrogen and potassium leaching from grassland soil depending on applied fertilizer type and rate and sward botanical composition

Raave H., Kauer K., Noormets M., Selge A. and Viiralt R.

*Estonian University of Life Sciences, Institute of Agricultural and Environmental Sciences  
Kreutzwaldi 1a, 51014, Tartu, Estonia*

Corresponding author: henn.raave@emu.ee

## Abstract

In Estonia annual precipitation exceeds evaporation so there is a need to implement fertilization practices that minimize nutrient leaching. The objective of the present research was to study nitrogen (N) and potassium (K) leaching from three grassland swards in relation to fertilizer type and application rate. The experiment was 3x3x6 factorial design with three replicates, conducted in plastic mini-lysimeters (0.01 m<sup>3</sup>) filled with loamy sand soil. We tested effects of (1) sward type (three-species grass mixture, grass mixture with white clover, grass mixture with lucerne); (2) fertilizer type (mineral fertilizer, cattle slurry and sewage sludge); and (3) mineral fertilizer at six application rates (N<sub>0</sub>P<sub>0</sub>K<sub>0</sub>, N<sub>0</sub>P<sub>30</sub>K<sub>60</sub>, N<sub>0</sub>P<sub>60</sub>K<sub>120</sub>, N<sub>60</sub>P<sub>30</sub>K<sub>60</sub>, N<sub>120</sub>P<sub>60</sub>K<sub>120</sub>, N<sub>180</sub>P<sub>60</sub>K<sub>120</sub> kg ha<sup>-1</sup>). Organic manures were applied in quantities corresponding to nitrogen rates equivalent to 60, 120 and 180 kg ha<sup>-1</sup>.

Initial results indicate that the lowest leaching losses during the growing season (May to end of October) were from a grass-white clover mixture, while the highest were recorded under a grass-only sward. Amounts of N and K leached depended on water drainage and sward yield. Effects of type of fertilizer and the applied N rate on nutrient leaching were weak.

Key words: leaching, fertilization, slurry, sewage sludge, grassland

## Introduction

Crop fertilization is a major cause of groundwater pollution. Granstedt (1992) argued that organic manures are more environmentally friendly than mineral fertilizers. However, some studies (Bergström and Goulding, 2005; Torstensson *et al.*, 2006) show that the uptake of nutrients by plants and nitrogen mineralization from organic matter of manures are only weakly synchronized. Nutrients are released to the soil when plants do not need them, and this increases the likelihood of nutrient leaching. The objective of the present research was to compare nitrogen (N) and potassium (K) leaching from different types of grassland swards receiving organic manure and mineral fertilizers, and also to test the hypothesis that higher rates of N and K leaching occur in grassland fertilized with organic manure than with mineral fertilizers.

## Materials and methods

The experiment was carried out during the 2008 growing season at the Eerika Experimental Station, Estonian University of Life Sciences (58°23'32" N, 26°41'31" E). The experiment used plastic mini-lysimeters (surface area 0.07 m<sup>2</sup>; volume 0.01 m<sup>3</sup>) installed in July 2007. The lysimeters were filled with a loamy sand soil (sand 64%, silt 29%, clay 7%; specific surface area of soil 30.6 m<sup>2</sup> g<sup>-1</sup>), and then dug into the ground so that soil surface of the lysimeters were at the same level as the surrounding soil. At the beginning of the experiment the soil organic matter (OM) was 17-19 g kg<sup>-1</sup>, total N content was 1.1 g kg<sup>-1</sup>, available P was 94-102 mg kg<sup>-1</sup> and K was 165-180 mg kg<sup>-1</sup> dry matter soil. The experiment was 3x3x6 factorial design with three replicates. We tested the effects of (1) sward type (grass mixture

including timothy (*Phleum pratense*), perennial ryegrass (*Lolium perenne*) and smooth meadow-grass (*Poa pratensis*); grasses with white clover (*Trifolium repens*) mixture; and grasses with lucerne (*Medicago sativa*) mixture), (2) fertilizer type (mineral fertilizer, cattle slurry and sewage sludge) and (3) mineral fertilizer application rate, in kg ha<sup>-1</sup> (Control (N<sub>0</sub>P<sub>0</sub>K<sub>0</sub>), N<sub>0</sub>P<sub>30</sub>K<sub>60</sub>, N<sub>0</sub>P<sub>60</sub>K<sub>120</sub>, N<sub>60</sub> P<sub>30</sub>K<sub>60</sub>, N<sub>120</sub>P<sub>60</sub>K<sub>120</sub>, N<sub>180</sub>P<sub>60</sub>K<sub>120</sub>). Organic manures were applied in quantities according the nitrogen rates of 60 kg, 120 kg and 180 kg ha<sup>-1</sup> and the application rate was calculated based on NH<sub>4</sub> content. All manures and mineral fertilizers were applied to the plots in one to three split applications, depending on the N rate, as follows: (1) 1 week after grass started to grow in spring, (2) in June/July (after second cut) and (3) in August (after third cut). During the experiment amounts of leached water, total N and K content in the water on a monthly basis, and herbage yield harvested five times in growing season were measured. The N and K content in the leachate were measured using a VarioMax CNS elemental analyzer and a flame photometer, respectively. ANOVA was used to test the effect of sward type and fertilization and Fisher's LSD test to distinguish means. All calculations were carried out using the statistical package Statistica 8 (StatSoft.Inc ).

## Results

The effect of the type of fertilizer applied on N and K leaching was weak (Table 1), with only two treatments (N<sub>0</sub>P<sub>30</sub>K<sub>60</sub>, N<sub>0</sub>P<sub>60</sub>K<sub>120</sub>) increasing significantly the K leaching from two sward types: the grass mixture ( $F_{(4,38)} = 2.7, P < 0.05$ ) and the grass-lucerne mixture ( $F_{(4,39)} = 3.4, P < 0.05$ ). N leaching did not vary significantly with either the type of fertilizer applied or the N rate ( $P > 0.05$ ), for any sward type.

Sward botanical composition influenced N leaching ( $F_{(2,16)} = 13.4, P < 0.01$ ) and K leaching ( $F_{(2,16)} = 62.9, P < 0.01$ ). The lowest amounts of N leaching ( $1628 \pm 108 \text{ mg m}^{-2}$ ) and K leaching ( $816 \pm 61 \text{ mg m}^{-2}$ ) came from the grass-white clover mixture, for all fertilization treatments (control included), while the highest amounts of N leaching ( $2513 \pm 132 \text{ mg m}^{-2}$ ) and K leaching ( $2909 \pm 166 \text{ mg m}^{-2}$ ) were recorded from the sward with the grass mixture.

Table 1. Nitrogen and potassium leaching from grassland swards from May to the end of October (mean  $\pm$  SE)

Sward	Control	Fertilizer			
		Mineral		Slurry <sup>3</sup>	Sewage <sup>3</sup> sludge
		P K <sup>1</sup>	NPK <sup>2</sup>		
Nitrogen mg m <sup>-2</sup>					
Grasses	3034 $\pm$ 99 <sup>a A 4</sup>	2995 $\pm$ 140 <sup>a A</sup>	2338 $\pm$ 243 <sup>a A</sup>	2552 $\pm$ 343 <sup>a A</sup>	2544 $\pm$ 287 <sup>a A</sup>
Grasses + white clover	1900 $\pm$ 168 <sup>a B</sup>	1555 $\pm$ 125 <sup>a B</sup>	1458 $\pm$ 220 <sup>a B</sup>	1810 $\pm$ 320 <sup>a A</sup>	1675 $\pm$ 220 <sup>a B</sup>
Grasses + lucerne	2412 $\pm$ 170 <sup>a B</sup>	2644 $\pm$ 145 <sup>a A</sup>	1947 $\pm$ 287 <sup>a AB</sup>	2164 $\pm$ 300 <sup>a A</sup>	1806 $\pm$ 298 <sup>a AB</sup>
Potassium mg m <sup>-2</sup>					
Grasses	3690 $\pm$ 144 <sup>ab A</sup>	4256 $\pm$ 241 <sup>b A</sup>	2614 $\pm$ 273 <sup>a A</sup>	2846 $\pm$ 373 <sup>a A</sup>	2933 $\pm$ 384 <sup>a A</sup>
Grasses + white clover	1147 $\pm$ 163 <sup>a B</sup>	944 $\pm$ 149 <sup>a B</sup>	692 $\pm$ 117 <sup>a B</sup>	833 $\pm$ 155 <sup>a B</sup>	656 $\pm$ 99 <sup>a C</sup>
Grasses + lucerne	3157 $\pm$ 265 <sup>ab A</sup>	3618 $\pm$ 336 <sup>b A</sup>	2337 $\pm$ 361 <sup>a A</sup>	2089 $\pm$ 325 <sup>a A</sup>	1809 $\pm$ 324 <sup>a B</sup>

<sup>1</sup>Mean of treatments N<sub>0</sub>P<sub>30</sub>K<sub>60</sub>, N<sub>0</sub>P<sub>60</sub>K<sub>120</sub>

<sup>2</sup>Mean of treatments N<sub>60</sub> P<sub>30</sub>K<sub>60</sub>, N<sub>120</sub>P<sub>60</sub>K<sub>120</sub>, N<sub>180</sub>P<sub>60</sub>K<sub>120</sub> kg ha<sup>-1</sup>

<sup>3</sup>Mean of treatments N<sub>60-180</sub> kg ha<sup>-1</sup>

<sup>4</sup> The values with different letters in the same line and capital letters in the same column are significantly different ( $P < 0.05$ )

The amounts of leachate from the grasses-lucerne mixture were  $2106 \pm 124 \text{ mg m}^{-2}$  N and  $2286 \pm 166 \text{ mg m}^{-2}$  K.

There was a positive relationship between N and K leaching ( $r = 0.84, P < 0.05$ ) and between both elements and the water drainage ( $r = 0.53, P < 0.05$  for N;  $r = 0.69 P < 0.05$  for K) but a

negative relationship with the sward herbage yields ( $r = -0.38$ ,  $P < 0.05$  for N,  $r = -0.62$ ,  $P < 0.05$  for K).

The amounts of leached water, percolated through 30 cm soil layer during the growing season depending on fertilization were between 88 and 110 l m<sup>-2</sup> for grasses-white clover mixture, 128 and 140 l m<sup>-2</sup> for grasses-lucerne mixture and 147 and 164 l m<sup>-2</sup> for grasses. The quantity of leached water depended on sward herbage yield ( $r = -0.71$ ,  $P < 0.05$ ), indicating that the sward yield is one of the most important factors influencing nutrient leaching during the growing season, through nutrient and water uptake.

## Discussion

Our results showed that plant nutrient leaching during the growing season depends mainly on the quantity of water that passed through the sward and this is consistent with Jarvis *et al.* (1989). Increments in the N application rate up to 180 kg ha<sup>-1</sup> y<sup>-1</sup> resulted in a small decrease in leaching ( $P > 0.05$ ) because water uptake by plants and herbage yield both increased. In general, in the first year we did not find significant relationships between fertilization and the quantity of leached N. The amount of N leaching in the control treatment was similar to the fertilized treatments, or even slightly higher.

## Conclusion

Initial results of our study did not support our hypothesis that organic manure treatments cause larger quantities of N and K to leach than mineral fertilizers. Leaching of N and K during the growing season depended almost solely on the yield of the sward, which was correlated positively to the quantity of leached water.

## Acknowledgements

The study was supported by Estonian Ministry of Agriculture (contract no 3.4-23/22)

## References

- Granstedt A., (1992) Case studies on the flow and supply of nitrogen in alternative farming in Sweden. I. Skilleby- Farm 1981–1987. *Biological Agriculture and Horticulture* 9, 15–63.
- Bergström L. and Goulding K. (2005) Perspectives and challenges in the future use of plant nutrients in tilled and mixed agricultural systems. *Ambio* 34, 283-287.
- Jarvis S.C., Barraclough D., Unwin R.J. and Royle S.M. (1989). Nitrate leaching from grazed grassland and after straw incorporation in arable soils. In: Germon J.C. (ed) *Management systems to reduce impact of nitrates*, Elsevier, London, UK, pp. 110–125.
- Torstensson G., Aronsson H. and Bergström L. (2006) Nutrient use efficiencies and leaching of organic and conventional cropping systems in Sweden. *Agronomy Journal* 98, 603-615.

# Behaviour of two cow genotypes within a low input grazing system and a high input total confinement system

Roca-Fernández A.I.<sup>1</sup>, Ferris C.P.<sup>2</sup>, Vance E.R.<sup>2</sup> and González-Rodríguez A.<sup>1</sup>

<sup>1</sup>*Agrarian Research Centre of Mabegondo. Abegondo, A Coruña, PO Box 10, 15080, Spain*

<sup>2</sup>*Agri-Food and Biosciences Institute, Hillsborough, Co. Down BT26 6DR, United Kingdom*

Corresponding author: [anairf@ciam.es](mailto:anairf@ciam.es)

## Abstract

Forty Holstein-Friesian dairy cows (H) and 40 Jersey x Holstein-Friesian crossbred dairy cows (Jx) were randomly allocated to one of two milk production systems (a low input grazing system or a high input total confinement system) in a 2 x 2 factorial design experiment. On three occasions during a six-week period, each group was observed at 20-min intervals, between 16:00-22:00 h and 07:00-14:00 h. The 'behaviour' of each cow was recorded, as follows: feeding/grazing, lying, or standing (including walking and drinking, but not feeding/grazing) and, in addition, ruminating or non-ruminating. Average milk yields (kg day<sup>-1</sup>) over the six-week period were 14.8 (H) and 14.8 (Jx) for the grazing system, and 28.0 (H) and 23.3 (Jx) for the confinement system. There were significant differences between the three observation periods for time spent lying ( $P < 0.001$ ), feeding ( $P < 0.05$ ) and ruminating ( $P < 0.001$ ), while time spent standing did not differ between observation periods. Breed had no significant effect on any of the behaviours recorded ( $P > 0.05$ ). Cows on the grazing system spent significantly ( $P < 0.001$ ) more time grazing, than those on the confinement system spent eating. Cows on the confinement system spent significantly more time lying, standing and ruminating ( $P < 0.001$ ) than did those on the grazing system.

Key words: dairy cows, grazing, confinement, behaviour

## Introduction

Dairy systems in Europe range from low input grazing systems to high input total confinement systems. As total confinement systems become increasingly common, there is increasing interest in the impact of these systems on cow performance, health, welfare and behaviour. To date, the impact of these systems on cow behaviour has not been extensively examined. Thus we aim to compare the behaviour of two cow genotypes when managed within either a low input grazing system, or a high input total confinement system.

## Materials and methods

This study was conducted at AFBI Hillsborough, and involved eighty mid-lactation spring-calving dairy cows (20 primiparous and 60 multiparous), 40 Holstein-Friesian (H) and 40 Jersey x Holstein-Friesian crossbreds (Jx). Cows were managed on one of two milk production systems (a low input grazing system or a high input total confinement system) in a 2 (cow genotype) x 2 (milk production system) factorial design experiment. Cows on the total confinement system were offered a complete diet containing equal proportions of concentrate and grass silage (DM basis), with the two genotypes penned separately. Each genotype accessed its food via a series of six Calan gates, with fresh food offered at 11:00 h. Within the grazing system, the two genotypes grazed separately within rotational paddock grazing systems, with fresh herbage offered daily at 16:00 h. These cows were supplemented with 1.0 kg concentrate per cow and day in late summer. Cows did not have access to food during

milking (05:00-07:00 h and 14:00-16:00 h). In addition, cows on the total confinement system did not have access to food between 09:00 and 10:00 h.

*Measurements:* Milk yields were recorded daily and milk fat and protein determined weekly. Cow live weights and body condition scores were measured weekly. On three occasions during a six-week period (27 July – 4 September), each herd was observed at 20-min intervals between 16:00 – 22:00 h and, 07:00 – 14:00 h. The behaviour of each cow was recorded, as follows: feeding/grazing, lying, or standing (the latter included walking and drinking, but not feeding/grazing). Ruminating or non-ruminating was also recorded. The total time that each cow spent in each of these activities was calculated for each observation period. Data were analysed as a 2 x 2 factorial design, with repeated measures (period), using REML Genstat.

## Results and discussion

Mean pre- and post-grazing sward heights were 10.3 and 6.1 cm (Holstein-Friesian) and 10.0 and 5.9 cm (Jersey crossbreds), respectively, while herbage grazed had a mean crude protein and ME content in DM of 193 g kg<sup>-1</sup> and 11.5 MJ kg<sup>-1</sup>, respectively. Average milk yields (kg day<sup>-1</sup>) were significantly ( $P < 0.001$ ) lower in the grazing system, with differences ( $P < 0.001$ ) between breeds in the confinement system (Table 1). An interaction between breed and system was observed for milk yield. Jersey had a significantly higher milk fat ( $P < 0.01$ ) and milk protein ( $P < 0.05$ ) content than Holstein. Jersey were lighter ( $P < 0.001$ ) than Holstein, while cows on the confinement system were heavier ( $P < 0.001$ ) than those on the grazing system. Body condition score was lower ( $P < 0.001$ ) for cows on the grazing system than confinement system and, Jersey showed a significantly ( $P < 0.001$ ) higher value than Holstein. An interaction between breed and system was also found for body condition score.

Table 1. Effect of cow genotype and milk production system on cow performance.

Item <sup>1</sup>	Grazing		Confinement		Breed		System		Interaction <sup>2</sup>	
	H	Jx	H	Jx	SE	Sig	SE	Sig	SE	Sig
Milk yield (kg day <sup>-1</sup> )	14.8	14.8	28.0	23.3	0.32	***	0.32	***	0.45	***
Milk fat (g kg <sup>-1</sup> )	45.0	49.1	43.8	48.0	0.96	**	0.96	NS	1.35	NS
Milk protein (g kg <sup>-1</sup> )	35.4	37.5	35.9	37.7	0.59	*	0.59	NS	0.83	NS
Live weight (kg)	510	453	594	535	4.2	***	4.2	***	5.9	NS
Body condition score	2.25	2.27	2.56	2.78	0.02	***	0.02	***	0.03	***

<sup>1</sup>H, Holstein-Friesian; Jx, Jersey x Holstein-Friesian crossbred; SE= Standard error; <sup>2</sup>Interaction, Breed x System; Sig= Significance; \*\*\*,  $P < 0.001$ ; \*\*,  $P < 0.01$ ; \*,  $P < 0.05$ ; NS= Not significant

Time spent lying, feeding and ruminating differed between periods, while time spent standing did not differ (Table 2). None of the behaviours recorded were affected by cow genotype ( $P > 0.05$ ). Cows on the confinement systems spent more time standing and ruminating ( $P < 0.001$ ) compared to those on the grazing system, while the latter spent more time grazing than those on the housing system spent feeding ( $P < 0.001$ ).

Although data presented in Figure 1 (where each point represents mean data for the three observations each hour across the three recording periods) can not be analysed statistically, a number of interesting trends can be identified: with both genotypes the main grazing bouts occurred after each milking, with the evening bout appearing to be more prolonged. The percentage of cows feeding indoors remained relatively constant throughout the day, except for the period prior to fresh feed being offered. However, the number of animals feeding at any one time was limited by access to Calan gates. The main lying period with the grazing cows was after morning grazing bout was finished (09:00 – 11:00 h), while the main lying period with the confined cows was during the period immediately after morning milking.



Table 2. Effect of cow genotype and milk production system on cow behaviour.

Behaviour <sup>1</sup>	Period	Grazing		Confinement		Period		Breed		System		Interaction <sup>2</sup>	
		H	Jx	H	Jx	SE	Sig	SE	Sig	SE	Sig	SE	Sig
Lying	1	144	162	409	442								
	2	214	212	407	383								
	3	302	240	412	413								
	1-3	220	205	409	413	25	***	23	NS	23	***	24	**
Standing	1	117	116	250	209								
	2	96	62	230	253								
	3	55	67	235	242								
	1-3	89	82	238	235	25	NS	23	NS	23	***	24	**
Feeding/ Grazing	1	560	547	170	172								
	2	506	544	180	181								
	3	465	514	176	164								
	1-3	510	535	175	172	17	**	16	NS	16	***	17	N S
Ruminating	1	114	150	223	257								
	2	121	117	256	240								
	3	237	184	251	157								
	1-3	140	142	239	249	16	***	15	NS	15	***	16	N S

<sup>1</sup>H, Holstein-Friesian; Jx, Jersey x Holstein-Friesian crossbred; SE = Standard error; <sup>2</sup>Interaction, Period x Breed x System; Sig= Significance; \*\*\*,  $P < 0.001$ ; \*\*,  $P < 0.01$ ; \*,  $P < 0.05$ ; NS = Not significant differences

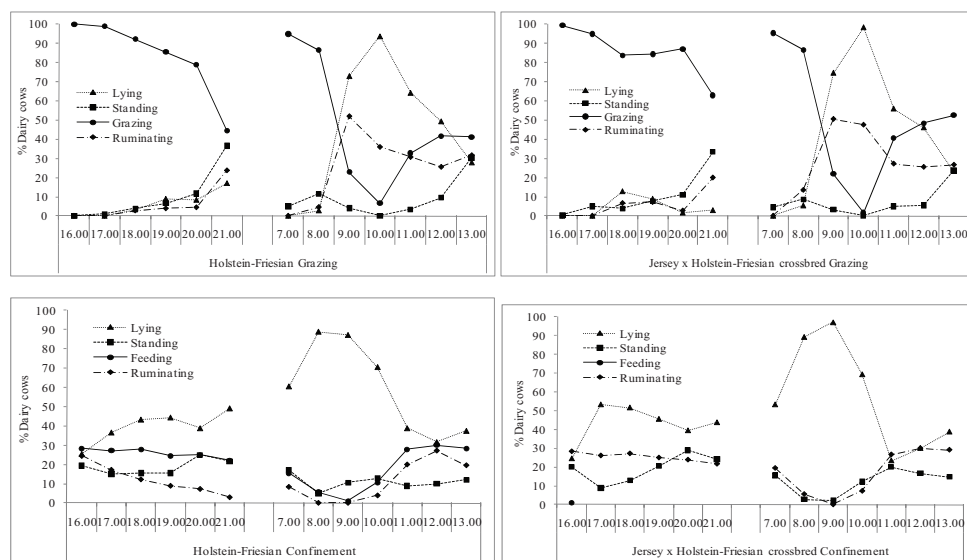

Figure 1. Percentage of cows within each group involved in a range of activities.

## Conclusions

Cows within the grazing system and confinement system behaved differently. Most of these differences likely result from the fact that grazing cows need more time to meet their dry matter intake requirements compared to cows on indoor diets. From these behavioural differences it is not possible to say if the welfare of cows between the two systems differed.

## Acknowledgements

To INIA for their financial support and the staff at AFBI Hillsborough for their assistance.

# Effect of Scottish Highland cattle grazing on plant communities with *Phalaris arundinacea*

Rogalski M. and Pławska-Olejniczak J.

Department of Ecology and Environmental Protection, University of Szczecin, PL - 71-415 Szczecin, Poland

Corresponding author: rogma@univ.szczecin.pl

## Abstract

Reed canary grass (*Phalaris arundinacea* L.) communities constitute a substantial percentage of grasslands by the Szczecin Lagoon. These multi-hectare meadows situated on organic soils have been partly included under protective actions related to the Habitat and Bird Directives. To protect these habitats, one method is to carry out extensive grazing. This was performed in 2005-2009 and results of its effects are presented in this paper. Within singled-out study areas dominated by *Phalaris arundinacea* up to 75% (A) and 50% (B) a year-round grazing of Scottish Highland cattle was carried out with a livestock density equal to 0.3 LU ha<sup>-1</sup>. A strong reduction in the percentage of reed canary grass was observed in both areas affected by grazing, with 30% in A and 18% in B after 2 and 4 years respectively. It was first replaced by other grasses as well as herbs and weeds. The percentage of legumes, amounting initially to 1%, increased to 8-9% after 5 years of pasture use. There was a clear improvement in plant species richness during the study period. Grazing showed a favourable effect in natural amenities of these meadows and such a system can be a useful method of active protection on moist grassland habitats.

Keywords: extensive grazing, cattle, natural value, *Phalaris arundinacea*

## Introduction

The introduction of extensive forms of pasture management is one of the methods of protecting and restoring naturally valuable grassland communities (Hopkins and Holz, 2005). It aims to improve floristic diversity as well as prevention of unfavourable transformations within phytocoenoses, in particular with respect to areas under the Natura 2000 nature protection programme (Stypiński and Sienkiewicz-Paderewska, 2007). Reed canary grass (*Phalaris arundinacea*) beds situated by the Szczecin Lagoon, among others areas, are of concern, and in 2002 continuous grazing of Scottish Highland cattle was introduced in part of these areas (Musielak *et al.*, 2006). The vegetation dynamics induced by extensive grazing was studied during five years (2005-2009) and results are presented here.

## Materials and methods

Experiments were carried out on two separated areas which differed in terms of the proportion of reed canary grass: 75% (area A) and 50% (area B). Both were continuously grazed by Scottish Highland cattle (0.3 LU ha<sup>-1</sup>) during five years. Each year, botanical composition of the swards was evaluated along five permanent transects, 150 m long each, in spring, summer and autumn, applying a phytosociological (Braun-Blanquet, 1932) and estimation methods (Mannetje, 2001). The natural values of the communities were determined on the basis of floristic composition (Oświt, 2000). Furthermore, plant samples were collected (Rhodes and Collins, 1993), to determine the distribution of reed canary grass and companion plants in the sward horizon.

Table 1. Effect of grazing on botanical composition and natural value of two examined *Phalaris arundinacea* communities (Szczecin Lagoon, Poland)

Community	A			B		
	2005	2007	2009	2005	2007	2009
Year	2005	2007	2009	2005	2007	2009
Share (in %) of <i>Phalaris arundinacea</i>	75%	30%	30%	50%	22%	18%
Total number of taxa	25	51	56	25	62	53
Number of other grasses	6	12	13	7	17	18
Share (in %) of other grasses	14%	51%	45%	13%	55%	59%
Number of herbs and weeds	15	35	39	13	40	31
Share (in %) of herbs and weeds	10%	16%	17%	34%	15%	14%
Number of legumes	3	3	3	4	4	3
Share (in %) legumes	1%	3%	8%	3%	8%	9%
Index of amenity value	2.07	3.53	3.53	3.11	3.69	3.78
Natural value	low	High	high	moderate high	high	high

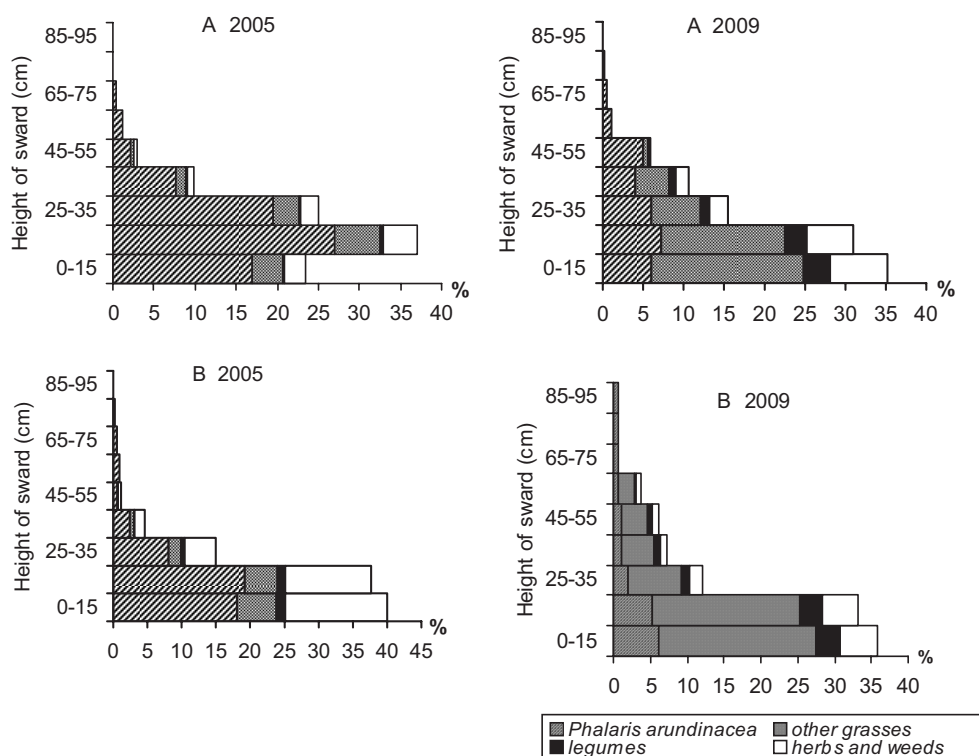

Figure 1. Distribution of canary reed grass and accompanying species in the horizons of sward (in % of dry matter).

## Results and discussion

A clear reduction of the percentage of reed canary grass occurred with time in the grazed areas, decreasing to 30% in area A and 18% in area B. It was replaced by other species of vascular plants, whose numbers increased two-fold. The presence of other grass species in the sward deserves special attention: in the last year they contributed over 50% of the crop. The grazing was favourable for the development of *Poa pratensis*, *Holcus lanatus*, *Agrostis*

*stolonifera* and *Trifolium repens*. The natural value of these communities was also improved (Table 1). The positive effect of grazing on the species richness and natural values of abandoned meadows under Western Pomerania conditions have also been confirmed in other research work, carried out in the area examined (Pławska-Olejniczak and Żywiczka, 2009). Efforts are also being made to increase biodiversity and in the improvement of the habitat conditions and in the value of plant cover. Grazing animals induced changes in the distribution of above-ground biomass in the sward. In successive years, a decrease in the biomass of reed canary grass occurred in lower sward horizons and its place was taken up by other species (Fig. 1). Changes limiting the contribution of tall grasses and favourably affecting the development of short plants are obviously due to selective grazing (Strodthoff and Isselstein, 2001). It is one of the reasons that grazing is one of the important tools for connecting grassland farming with nature conservation (Hopkins and Holz, 2005, Isselstein *et al.*, 2005).

## Conclusions

Evident decreases in the proportion of *Phalaris arundinacea* in response to cattle grazing in the studied conditions suggests that grazing animals could be used as a management factor for limiting the proportion of this grass species.

## References

- Braun-Blanquet J. (1932) *Plant sociology*. McGraw Hill, London, UK, 439 pp.
- Hopkins A. and Holz B. (2005) Grassland for agriculture and nature conservation: production, quality and multifunctionality. *Grassland Science in Europe* 10, 15-29.
- Isselstein J., Jeangros B. and Pavlu V. (2005) Agronomic aspects of extensive grassland farming and biodiversity management. *Grassland Science in Europe* 10, 211-220.
- 't Mannetje L. (2001) Methods for estimating botanical composition, species diversity and dry matter yields. *Grassland Science in Europe* 6, 311-323.
- Musielak D., Milek E. and Rogalski M. (2006) Grazing animals as an element of natural landscape of Western Pomerania. In: J.Tarasiuk i J.Kępczyński. (eds) *Człowiek i środowisko przyrodnicze Pomorza Zachodniego*. Print Group, Szczecin, Poland, pp. 261-265.
- Oświt J. (2000) *Metoda przyrodniczej waloryzacji mokradel i wyniki jej zastosowania na wybranych obiektach*. Instytut Melioracji i Użytków Zielonych, IMUZ Falenty, Poland, 35 pp.
- Pławska-Olejniczak J. and Żywiczka A. (2009) The effect of Polish Koniks and Scottish Highland Cattle grazing on the vascular flora of extensively used Skoszewskie Meadows. *Grassland Science in Poland* 12, 131-140.
- Rhodes I. and Collins R.P. (1993) Canopy Structure. In: Davies A., Baker R.D., Grant S.A. and Laidlaw A.S. (eds) *Sward measurement handbook*. British Grassland Society, Reading, UK, pp. 139-156.
- Strodthoff J. and Isselstein J. (2001) The effect of selective grazing on the spatial distribution of herbage and the liveweight gain of cattle grazing a peat soil pasture. *Grassland Science in Europe* 6, 320-323.
- Stypiński P. and Sienkiewicz-Paderewska D. (2007) The protection and conservation of grassland in the Polish Landscape Parks. *Grassland Science in Europe* 12, 520-523.

# Nitrogen balances for three strains of dairy cows and contrasting intensive grassland systems

Ryan W.<sup>2</sup>, Hennessy D.<sup>1</sup>, Boland T.<sup>2</sup> and Shalloo L.<sup>1</sup>

<sup>1</sup>Grassland Research Department, Animal and Grassland Research and Innovation Centre, Teagasc, Moorepark, Fermoy, Co. Cork, Ireland

<sup>2</sup>UCD School of Agriculture, Food Science and Veterinary Medicine, Belfield, Dublin 4, Ireland.

Corresponding author: deirdre.hennessy@teagasc.ie

## Abstract

In recent years nitrogen (N) use efficiency has become increasingly important because of economical and environmental concerns, combined with EU policy such as the Water Framework Directive. A Nitrogen balance model, at the cow level, has been developed to assess N use efficiency, N surpluses and N losses from spring-calving grass-based dairy production systems. The model was linked with the Moorepark Dairy Systems Model (MDSM; Shalloo *et al.*, 2005). Data from a 5-year study undertaken at Moorepark were used to evaluate the N-use efficiency of contrasting spring-calving dairy systems. The study consisted of 3 divergent strains of Holstein-Friesian cows: high-production North American (HP), high-durability North American (HD) and New Zealand (NZ), managed across a variety of Irish pasture-based production systems. As replacement rate increased, the total N input per cow increased – 170 kg cow<sup>-1</sup> for NZ strain (0.18 replacement rate), 184 kg cow<sup>-1</sup> for HD strain (0.25 replacement rate) and 200 kg cow<sup>-1</sup> for HP strain (0.37 replacement rate). The N surplus per cow was greater for the HD and HP strains (141 and 157 kg cow<sup>-1</sup>, respectively) than for the NZ strain (129 kg cow<sup>-1</sup>).

Keywords: Nitrogen, dairy production, N use efficiency, grassland, animal strains

## Introduction

Grassland based livestock production systems in Ireland and in other temperate regions have a competitive economic advantage compared with confinement systems due to the use of grazed grass as a feed source (Dillon *et al.*, 2005). In Ireland, intensive grass-based milk production systems generally rely on inputs of nitrogen (N) in the form of chemical fertiliser to produce sufficient herbage, and strategic concentrate supplementation to sustain milk output per cow and per ha at economically viable levels. Achieving the optimum balance between profitable agriculture and environmental protection is challenging. When production is maximised and output is near equilibrium, all further N inputs are lost to the environment (Rotz *et al.*, 2005). The objective of this study was to develop, evaluate and validate an annual dairy cow N balance model based on a range of Irish grass-based dairy production systems.

## Materials and methods

The model was developed in Microsoft Office Excel 2003® and is in monthly stages from 1st January to 31st December. The model was developed as a cow N balance. The annual N balance is the sum of all annual N inputs less outputs in the form of agricultural products. Imported N was in the form of fertiliser, feed stuffs and livestock (in the form of replacements or purchased animals) and N outputs were N leaving the system in products (milk, meat, exported feed and exported manure). The data used to validate the model were from a 5-year

study undertaken at Curtins Research Farm, Moorepark Dairy Production Research Centre, Fermoy, Co. Cork, Ireland (Horan *et al.*, 2004; McCarthy *et al.*, 2007). Briefly, the study consisted of three divergent strains of Holstein-Friesian (HF) dairy cows: high-production North American (HP), high-durability North American (HD) and New Zealand (NZ), managed across three pasture-based production systems: the Moorepark Blueprint system (MP), a high concentrate input system (HC) and a high stocking rate system (HS). The MP system was designed to achieve high output from grass, had an overall stocking rate of 2.47 cows ha<sup>-1</sup>, N fertilizer input of 290 kg ha<sup>-1</sup> (117.4 kg cow<sup>-1</sup>) and 325 kg cow<sup>-1</sup> concentrate in early lactation, with the remainder of the lactation diet composed of grazed grass. The HC system had a similar overall stocking rate and N input to the MP feed system and 1445 kg cow<sup>-1</sup> concentrate were fed. The HS system had similar concentrate and N fertiliser input to the MP system and had an overall stocking rate of 2.74 cow ha<sup>-1</sup>. The land base (40 ha), grazing season length and housing periods were similar for all treatments. Two scenarios were investigated: Scenario 1 (S1) investigated the N utilisation, N use efficiency and N losses of the contrasting dairy production systems, excluding the N required to rear replacement animals for the production system (from birth to first calving). Scenario two (S2) was similar but included the N required to rear replacement animals for the production system.

Table 1. Annual N balance per cow for nine dairy production systems when N required to rear replacement heifers was not included in the budget (S1) and when replacement animals are included (S2).

Production system	HS <sup>‡</sup>			HC <sup>‡</sup>			MP <sup>‡</sup>		
	HP <sup>‡</sup>	HD <sup>‡</sup>	NZ <sup>‡</sup>	HP <sup>‡</sup>	HD <sup>‡</sup>	NZ <sup>‡</sup>	HP <sup>‡</sup>	HD <sup>‡</sup>	NZ <sup>‡</sup>
Grazed pasture N intake (kg cow <sup>-1</sup> )	110	112	112	99	102	93	111	114	115
Silage N intake (kg cow <sup>-1</sup> )	26	24	23	23	22	20	26	24	23
Concentrate N intake (kg cow <sup>-1</sup> )	7	7	7	31	30	30	7	7	7
Dairy cow replacement N (kg cow <sup>-1</sup> )	4	2	3	3	2	2	4	3	2
Total N inputs S1 (kg cow <sup>-1</sup> )	147	145	145	156	156	145	148	148	147
Heifer N intake pasture (kg cow <sup>-1</sup> )	34	23	16	34	23	16	34	23	16
Heifer N intake silage (kg cow <sup>-1</sup> )	10	7	5	10	7	5	10	7	5
Heifer N intake concentrate (kg cow <sup>-1</sup> )	6	4	3	6	4	3	6	4	3
Total N input S2 (kg cow <sup>-1</sup> )	197	179	169	206	190	169	198	182	171
Milk N output (kg cow <sup>-1</sup> )	35	36	35	42	42	38	36	37	36
Calf N output (kg cow <sup>-1</sup> )	1	1	1	1	1	1	1	1	1
Cull cow N output (kg cow <sup>-1</sup> )	5	3	3	5	4	3	5	4	3
Total N output S1 and S2 (kg cow <sup>-1</sup> )	41	40	39	48	47	42	42	42	40
N surplus S1 (kg cow <sup>-1</sup> )	106	105	106	108	109	103	106	106	107
N use efficiency S1	0.28	0.28	0.27	0.31	0.30	0.30	0.28	0.28	0.27
N surplus S2 (kg cow <sup>-1</sup> )	156	139	130	158	143	127	156	140	131
N use efficiency S2	0.21	0.22	0.23	0.23	0.25	0.25	0.21	0.23	0.23

<sup>‡</sup>Pasture-based production systems – Moorepark (MP), high concentrate (HC) and high stocking rate (HS).

<sup>‡</sup>Divergent strains of Holstein-Friesian cows – high-production North American (HP), high-durability North American (HD), New Zealand (NZ).

## Results and discussion

The quantity of N imported in the form of concentrate varied between treatments, ranging from 7 kg cow<sup>-1</sup> for HS and MP treatments to 30 kg cow<sup>-1</sup> for HC treatments (Table 1). Total N input per cow in S1 ranged from 145 kg cow<sup>-1</sup> for NZHS up to 156 kg cow<sup>-1</sup> for HDHC and HPHC (Table 1). When the N required to rear replacement heifers is included in the balance, the N input increases by proportions of approximately 0.25, 0.18 and 0.13 for the HP, HD and NZ strains, respectively (Table 1) due to the higher replacement rate required for HD and HP strains compared to NZ. The fertility of the NZ strain is superior to the HP and HD strains across a variety of grass based systems (McCarthy *et al.*, 2007). The quantity of N utilised in

the form of grazed pasture, silage and concentrate used to rear replacement heifers in S2 was 24, 34 and 50 kg ha<sup>-1</sup> for the NZ, HD and HP genetic strains, respectively, explained by the increasing replacement rate.

Milk production was the primary source of exported N. Nitrogen exported in milk was 35, 36 and 41 kg cow<sup>-1</sup> for HS, MP and HC treatments, respectively (Table 1). The increase in replacement rate had a positive effect on the quantity of N exported in the form of meat (Table 1). The overall quantity of N exported in the form of product ranged from 39 to 48 kg cow<sup>-1</sup> (Table 1).

The mean N surplus per cow in S1 was similar across treatments with a mean of 106 kg cow<sup>-1</sup> (s.d. = 2.21) (Table 1). However, when the N required to rear a replacement heifer is included in the N balance, as in S2, it becomes clear that there is an effect of strain of animal on N surplus due to the different replacement rates required to maintain the dairy production system (Table 1). The mean N surplus was 129, 141 and 157 kg cow<sup>-1</sup> for the NZ, HD and HP strains, respectively. Differences in N surplus in S2 also result in differences in N use efficiency (Table 1). Nitrogen use efficiency was greatest for the NZ strain (0.24) and least for the HP strain (0.21) across production systems.

## Conclusion

Exported milk was the greatest source of N output. Replacement rate within genetic strain had a large effect on N surplus and N-use efficiency per cow. Regardless of production system, HP animals had the least efficient N utilisation rates per cow when the whole system (including the rearing of replacement animals) was evaluated. The results demonstrate the importance of including the rearing of replacement heifers in the N balance as they contribute to N inputs, N surplus and N use efficiency.

## Acknowledgement

Funding for this project was provided under the National Development Plan, through the Research Development Fund, administered by the Department of Agriculture, Fisheries and Food, Ireland, RSF05201.

## References

- Horan B., Mee J.F., Rath M., O'Connor P. and Dillon P. (2004) The effect of strain of Holstein-Friesian cow and feed system on reproductive performance in seasonal-calving milk production systems. *Animal Science* 79, 453-467.
- McCarthy S., Horan B., Dillon P., O'Connor P., Rath M. and Shalloo L. (2007) An economic comparison of three divergent strains of Holstein-Friesian dairy cows in various pasture-based milk production systems. *Journal of Dairy Science* 90, 1493-1505.
- Rotz C.A., Taube F., Russell M.P., Oenema J., Sanderson M.P. and Wachendorf M. (2005) Whole-farm perspectives of nutrient flows in agriculture. *Crop Science* 45, 2139-2159.
- Dillon P., Roche J.R., Shalloo L. and Horan B. (2005) Optimising financial return from grazing in temperate pastures. In: Murphy J.J. (ed.) *Utilisation of Grazed Grass in Temperate Animal Systems (Satellite workshop of the XXth International Grassland Congress, Cork 2005)*. Wageningen Academic Publishers, the Netherlands, pp. 131-147.



# Flows of nitrogen and phosphorus on large dairy farms with different grazing systems – a model study

Salomon E.<sup>1</sup>, Spörndly E.<sup>2</sup>, Sundberg M.<sup>1</sup> and Wahlund L.<sup>1</sup>

<sup>1</sup> JTI Swedish Institute of Agricultural and Environmental Engineering, P.O. Box 7033, SE-750 07 Uppsala, Sweden

<sup>2</sup> Swedish University of Agricultural Sciences, Department of Animal Nutrition and Management, SE-753 23 Uppsala, Sweden

Corresponding author: eva.salomon@jti.se

## Abstract

This study describes and calculates flows of nitrogen (N) and phosphorus (P) on theoretical 300-cow dairy farms with four different grazing systems and investigates potential risks for negative environmental impacts regarding N and P losses. The systems were: 1) Indoor - cows indoors all year around; 2) Pasture for exercise - cows have access to permanent pasture just outside the house 6 hours a day for 3 months; 3 and 4) Pasture-based milk production - cows graze for 4 months and have access to pasture for 8 hours during the day (3) or for 18 hours during the day and night (4). Point loads of N and P were highest on cattle walkways to grazing areas. Total ammonia (NH<sub>3</sub>) losses at farm level decreased from 10.1 t y<sup>-1</sup> in system 1 to 7.4 t y<sup>-1</sup> in system 4. The N surplus at field level was larger in systems 3 and 4 (18 and 33 kg ha<sup>-1</sup> respectively) than in systems 1 and 2 (9 kg ha<sup>-1</sup>). By hypothetically including the fertiliser effect of urine-N on herbage production, it was possible to reduce the quantity of chemical N fertiliser required.

Keywords: pasture, grazing systems, dairy cows, nutrient flow, nitrogen, phosphorus

## Introduction

A grazing system for dairy cows has the advantages of being beneficial to animal health and welfare (Mannetje, 2000). However, problems can arise with increasing herd size, such as decreased herbage allowance, larger areas of trampled ground and longer distances between pasture and cow house. It can also become more difficult to direct/control the flows of nitrogen (N) and phosphorus (P) on the farm (Schröder *et al.*, 2003), leading to an increase in pasture areas with a nutrient surplus. The objectives of this project were to describe and calculate flows of N and P on 300-cow dairy farms with different grazing systems, and to identify potential risks for negative environmental impacts regarding N and P losses.

## Materials and methods

Based on Swedish conditions, input and output calculations were established for four theoretical farms with different grazing systems, each with a 300 cow herd and an average annual production of 9900 kg cow<sup>-1</sup> energy-corrected milk (ECM). All farms were assumed to produce sufficient silage, spring barley and straw, with concentrates purchased to supplement the home-grown feeds.

The four farms represented the following systems:

- 1) Indoor - dairy cows are indoors all year around and have no access to pasture.
- 2) Pasture for exercise - dairy cows have access to permanent pasture just outside their house 6 hours a day for 3 months of the grazing period. The pasture has low herbage production.
- 3 and 4) Pasture-based milk production - dairy cows graze for 4 months of the year and a large proportion of forage intake is through grazing. The grazing areas are partly permanent

pasture and partly forage ley after first harvest. Cattle walkways connect the cow house with the pasture areas. In system 3, cows have access to 8 hours of day-time grazing, i.e. between morning and evening milking. Cows in system 4 have access to pasture all day and night, except for the two 3 h periods needed for milking. The total length of cattle walkways used during one season in these two systems were 2.6 and 2.7 km, respectively.

Feed rations were optimised for protein content and balanced to cover cow requirements in terms of energy, amino acids absorbed in the small intestine, calcium and phosphorus (Spörndly, 2003). The amounts of N and P produced in faeces and urine were calculated as the difference between cow intake through feed and the amounts allocated to body growth, pregnancy and lactation (Gustafson, 2000).

Of the total amount of N in manure, N losses from NH<sub>3</sub> emissions were assumed to be 7% in the cow house, 3.5% during storage and 7.5% for manure deposited on pastures. Ammonia losses from spreading cattle slurry on bare soil in spring were set at 15% of the manure NH<sub>3</sub>-N content, while the corresponding figure when slurry was applied to leys after first cut was 50% (STANK in MIND, 2005).

As much as possible of the stored manure was assumed to be applied to spring barley, and the remainder to leys after first cut. In systems 2, 3 and 4, deposition of fresh faeces and urine was assumed to be proportional to the time the cows stayed in each area (house, pasture, ley, cattle walkway). When additional N in the form of chemical N was needed, the amount was calculated from the crop requirement and expected yield (SJV, 2007).

## Results and discussion

With increasing time of grazing, total ammonia emissions on farm level decreased (Table 1). The main reason for this was that with smaller amounts of stored manure total NH<sub>3</sub> emissions during spreading of cattle slurry decreased.

Table 1. Calculated total losses of nitrogen as ammonia emissions, t y<sup>-1</sup>

	System 1	System 2	System 3	System 4
Cow house	2.6	2.4	2.3	1.9
Manure storage	1.2	1.1	1.1	0.9
Cattle slurry spreading	6.4	5.8	5.2	3.8
Pasture <sup>1</sup> /exercise area	-	0.2	0.3	0.7
Total	10.1	9.5	8.9	7.4

<sup>1</sup> Including cattle walkways

Point loads of N and P proved to be very high on the cattle walkways (Table 2). Even though these constructions only represents a small part of total farm area (in this study 0.5%), biological/technical solutions that can reduce, collect or absorb faeces and urine is interesting.

Table 2. Loads of N and P from faeces and urine on cattle walkways, kg ha<sup>-1</sup> year<sup>-1</sup>

	N		P	
	System 3	System 4	System 3	System 4
Load, kg ha <sup>-1</sup> y <sup>-1</sup>	198	418	24	48

The total N requirements by the pasture was covered by chemical N fertilisers in the basic scenario, resulting in a larger N surplus at field level and a higher potential risk of N losses in systems 3 and 4 (Table 3). The effect of including the fertiliser effect of urine-N and thereby decrease the amount of chemical N fertilisers was investigated in a sensitivity analysis. In this analysis, all urine-N was hypothetically assumed to be available for plants, except for a loss of 12.5% from ammonia emissions (Petersen *et al.*, 1998). This would decrease the N-surplus at field level considerably in the pasture systems 3 and 4 (Table 3).

For P, the net inflow was close to balance in all systems (Table 3). Apart from the cattle walkways in systems 3 and 4, the only area with a net surplus of P was the pasture for exercise in system 2, which had a surplus of 13 kg ha<sup>-1</sup> y<sup>-1</sup>. Other factors permitting, a possibility to reduce this P accumulation is to include the pasture in a crop rotation.

Table 3. Net inflow of N and P at field level, kg ha<sup>-1</sup> y<sup>-1</sup>

	System 1	System 2	System 3	System 4
N, field level (basic scenario)	9	9	18	33
N, field level (urine-N included)	9	9	10	17
P, field level	-1.4	-1.5	-1.7	-1,7

## Conclusions

At farm level, total losses of N as ammonia emissions decreased as the time cows spent on pasture increased. At field level, net inflow of N was higher in the pasture systems with herbage production than in the indoor system and the system with pasture for exercise, indicating higher risk of N losses. However, N inflow through chemical N fertilisers can be reduced by consider the fertiliser effect of urine-N deposited on pasture. Technical/biological solutions need to be developed to reduce point loads of N and P on cattle walkways.

## Acknowledgements

Financial support for this study was provided by the Swedish Board of Agriculture.

## References

- Gustafson G.M. (2000) Partitioning of nutrient and trace elements in feed among milk, faeces and urine by lactating dairy cows. *Acta agriculturae Scandinavica*, Sect. A 50, 111-120.
- Mannetje L.'t. (2000) The importance of grazing in temperate grasslands. In: Rook A.J. and Penning P.D. (eds.) *Grazing management, British Grassland Society, Occasional symposium no. 34*, 3-13.
- Petersen S.O., Sommer S.G., Aaes O. and Søegaard K. (1998) Ammonia losses from urine and dung of grazing cattle: effect of N intake. *Atmospheric Environment* 32, 295-300.
- Schröder J.J., Aarts H.F.M., ten Berge H.F.M., van Keulen H. and Neeteson J.J. (2003) An evaluation of whole-farm nitrogen balances and related indices for efficient nitrogen use. *European Journal of Agronomy* 20, 33-44.
- SJV (2007) *Riktlinjer för gödning och kalkning 2008 (Guidelines for Fertilising and Liming 2008)*. Report 2007:22. Swedish Board of Agriculture, Jönköping. (In Swedish.)
- Spörndly R. (ed.) (2003) *Fodertabeller för idisslare (Feed Tables for Ruminants 2003)*. Report 257, Dept. of Anim. Nutr. and Management, Swedish University of Agricultural Sciences, Uppsala. (In Swedish.)
- STANK in MIND (2005) *Calculation Program Version 1.06*. Swedish Board of Agriculture, Jönköping. (In Swedish.)

# **Addendum**

## **Session 4.1**



# Concepts for nutrient management in nature conservation areas on organic soils

Müller J.<sup>1</sup>, Kayser M.<sup>2</sup> and Belting H.<sup>3</sup>

<sup>1</sup>*Institute f. Management of Rural Areas, University of Rostock, D-18059 Rostock, Germany*

<sup>2</sup>*Department of Crop Sciences, University of Göttingen, D-37075 Göttingen, Germany*

<sup>3</sup>*Nature Conservation Group, Lower Saxony Service of Water, Coast and Nature Protection, D-49448 Hüde, Germany*

Corresponding author: juergen.mueller3@uni-rostock.de

## Abstract

Concepts of nutrient management that rely on actual nutrient fluxes are rarely available for the practice of nature conservation management. Especially protected grassland sites on low peat soils show different trophic levels depending on soil status and management, which in turn has an effect not only on botanical composition and feed quality, but also on the abundance of soil fauna as a feed source for meadow birds. Although nitrogen is not a limiting factor on low moor soils, levels of available potassium can decrease drastically within a short period of time under a cutting regime. Based on these considerations and experimental data, we propose a concept for nutrient management that takes into account nutrient offtake rather than soil nutrient status alone. This would imply that controlled nutrient input should be allowed if required, and, generally, that concepts should be allowed to take precedence over inflexible restrictions.

Keywords: low peat soil, meadow bird conservation, trophic levels, grassland management

## Introduction

Lowland fens in Germany fulfil a range of ecological functions in the landscape context and were predominantly used as grasslands (Kratz and Pfadenhauer, 2001). This holds true for the nature conservation area 'Dümmer' in northwest Germany, which has great importance for meadow bird breeding on a European scale. The extensive agricultural use is supposed to provide a habitat for nesting meadow birds and consider soil protection, since nutrient input via fertilisation is forbidden. Typically there is a call for complete de-eutrophication. Grasslands exhibit different trophic levels, which in turn have an effect not only on botanical composition (Janssens *et al.*, 1998) and feed quality for herbivores, but also on the abundance of soil fauna as a feed source for meadow birds (Altenburg and Wymenga, 1998). In order to create a reasonable concept for nutrient management for grassland on lowland fens, we intended to identify the main drivers for the different trophic levels of grassland soils and their effects on the biotic and agricultural resources.

## Methods and materials

Our investigation area was a part of the Dümmer-lowlands located in northwest Germany. The 180 ha were divided into 54 management units according to the field use pattern. In 1999 we started to collect data on the characteristics of grassland use to investigate the soil conditions and the situation of flora and avifauna over an 8-year period. This included peat layer thickness and ground water levels. Soil nutrients P and K (double lactate extraction method, DL) were analysed from representative topsoil samples (0-10 cm). Evaluation of the agricultural suitability of above ground biomass was based on yield recording, weighing livestock and in-vitro-digestibility analyses of hay and silages. To estimate the habitat quality

for meadow birds, we characterised the sward structure and determined invertebrate-biomass of the topsoil using eclector traps.

## Results and discussion

The highest levels of available K and P in the topsoil were found in grazed grasslands while cut grassland had smaller nutrient contents. When fields are grazed most of the nutrients are returned via excrements to the soil-plant cycle and even a long-term use with no fertiliser input does not necessarily or will only slowly lead to a poor nutrient status. With increasing peat layer thickness, the concentrations of P increased while K did not seem to be affected.

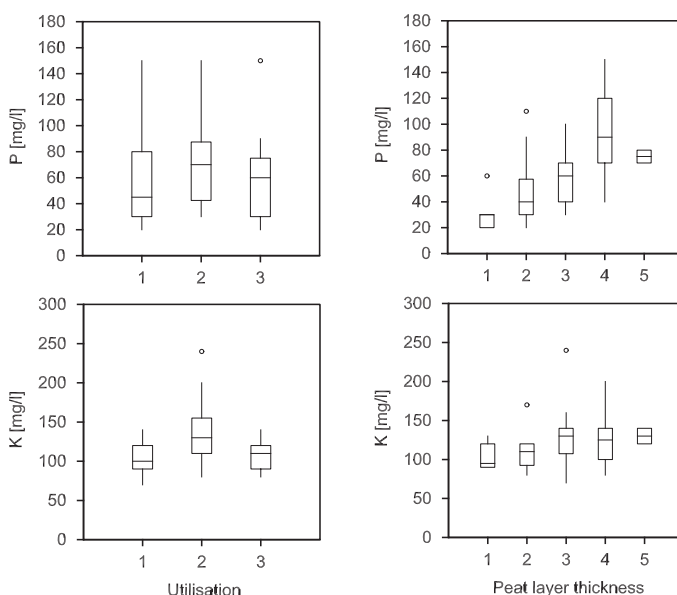

Figure 1: Effect of grassland utilisation (left) and peat layer thickness (right) on nutrient concentrations in the topsoil (0-10 cm); boxplots, the box spans the interquartile range (25-75% quartile) with the line indicating the median, whiskers extent to the minimum and maximum restricted to 1.5 of the interquartile range, individual outliers are plotted as an open dot; utilisation: 1 = cutting 2 = grazing 3 = cut/grazing; peat layer thickness: 1 = 20-30 cm, 2 = 30-40, cm, 3 = 40-50 cm, 4 = 50-60 cm, 5 = 60-70 cm.

The duration of flood irrigation during winter and spring was the main factor controlling the invertebrate populations. Without flooding an intermediate invertebrate-biomass of nearly 350 mg below 0.25 m<sup>2</sup> sward area was detected in the topsoil. Short flooding reduces it to nearly 200 mg, long term flooding to 100 mg biomass.

But effects of soil trophic levels were also partly significant (Fig. 2). The amount of potential feed sources for meadow birds were markedly reduced at low pH values (< 4.7) and at a poor K status of the topsoil ( $K_{DL} < 50 \text{ mg kg}^{-1}$ ).

The pH but especially K deficiency were limiting the agronomical use and yields, and were often accompanied by a dominance of *Deschampsia cespitosa* as a grass of minor forage value. On the other hand, plant available P concentrations were not affecting the agronomical value of the fields as long as  $P_{DL}$  did not drop below 2 mg P (100 ml)<sup>-1</sup> soil and nutrient content of the vegetation do not fall below a critical value (Müller, 2001). Above a value of 6



mg P (100 ml)<sup>-1</sup>, reductions in phytodiversity might occur (Janssens *et al.*, 1998). As fields with a peat layer thickness of more than 50 cm regularly go beyond this value in our investigation area, restitution of historically biodiverse grass swards on wetlands would be difficult to achieve.

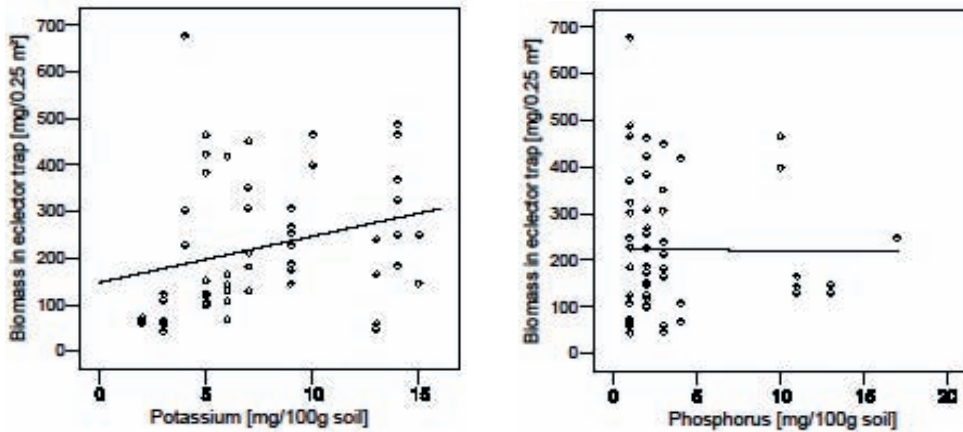

Figure 2: Relationship between plant available potassium (left;  $r_s = 0.44$ ;  $P = 0.001$ ) and phosphorus (right;  $r_s = 0.08$ ;  $P > 0.05$ ) and invertebrate-biomass, which describes the potential feed source for meadow birds.

## Conclusions

Providing a good potential feed source for meadow birds while maintaining a good agronomical field utilisation are not necessarily conflicting aims. This finding offers perspectives for an efficient management of meadow bird protection in extensive grassland, which are used by farmers.

Despite the geogenic determined differences in nutrient status of lowland fen soil, the trophic level and the sustainability of it can be controlled, at least partly, by choosing the management and utilisation of grasslands either as grazed or cut or a mixture of both. The K flux can be seen as a very important control variable as K is closely related to the biomass yield on low moor sites (Käding, 1996) and parameters of biotop/habitat quality, and is influenced in the short-term. K fertilisers that are permitted in organic agriculture might be applied when K levels decrease so much that the extent of potential feed sources for meadow birds are affected.

## References

- Altenburg W. and Wymenga E. (1998) Onderzoek naar de achteruitgang van Weidevogels in het Natuurreservaat De Gouden Bodem. *A&W-rapport* 170, Veenwouden.
- Janssens F., Peeters A., Tallowin J.R.B., Bakker J.B., Bekker R.M., Fillat F. and Oomes M.J.M. (1998) Relationship between soil chemical factors and grassland diversity. *Plant and Soil* 202, 69-78
- Kratz R. and Pfadenhauer J. (2001) *Ökosystemmanagement für Niedermoore*, Verlag Eugen Ulmer, Stuttgart, Germany
- Käding H. (1996) Auswirkungen variiertener Kaliumdüngung auf Niedermoorgrünland. *Archives of Agronomy and Soil Science* 40, 205-215
- Müller J. (2001) Concept of nutrient management in preserve grassland areas. *Land Use and Development* 42, 284-287



# Index of Authors



—A—

Abilleira.....	607
Abrahamse.....	586
Acar.....	323
Acosta.....	554
Acuña.....	326, 347
Adamovica.....	187
Adamovics.....	187
Adler.....	425, 446
Agabriel.....	449, 892
Agreil.....	910
Ahvenjärvi.....	467, 470
Akbarlou.....	190
Alberti.....	60
Albisu.....	607
Albizu.....	244
Alcubilla.....	770
Aldezabal.....	607
Alibegovic-Grbic.....	160
Almeida.....	1006
Alvåsen.....	901
Amanullah.....	353
Amaral.....	428, 482, 898, 919, 973, 997
Amato.....	223, 842
Amiaud.....	666, 732
Amores.....	607
Andersen.....	362
Andreasen.....	33
Andresen.....	33
Andueza.....	449, 452, 610, 913
Argenti.....	265, 767
Arnesson.....	524
Arranz.....	607
Arriaga.....	39
Arruda.....	1006
Artetxe.....	54
Ascaso.....	770
Asci.....	323
Askegaard.....	1040
Assis.....	461, 464
Audebert.....	494
Auerswald.....	752, 857
Aufrière.....	452, 485
Avcioglu.....	943
Ayan.....	323

—B—

Baadshaug.....	42
Baars.....	604

Bakken.....	455
Balezentiene.....	45, 193
Ballet.....	610
Bande-Castro.....	196
Barrier.....	693
Barrón.....	607
Bartha.....	696
Bartkevičius.....	785
Basaran.....	323
Basso.....	458, 461, 464
Batič.....	60
Battelli.....	613
Baumont.....	440, 452, 485, 913, 940
Bayat.....	467, 470
Becerra.....	669
Begon.....	720
Bélanger.....	473
Bele.....	773
Bell.....	782
Belting.....	1075
Bender.....	199
Berendonk.....	669
Berg.....	592
Bermejo.....	925
Bernardes.....	428, 458, 482
Berone.....	48
Bertrand.....	473
Besga.....	244
Bethier.....	940
Bezdrob.....	160
Biewer.....	163
Blanco.....	39
Bleizgys.....	45
Bochtis.....	443
Bockor.....	488
Bodner.....	536, 539
Boguhn.....	437
Bokhorst.....	758, 854
Boland.....	578, 904, 1067
Bolaños-Aguilar.....	494
Bolger.....	247
Boller.....	149
Bommelé.....	758
Bonanno.....	628
Bonifazzi.....	681
Borawska-Jarmułowicz.....	359
Borges.....	1006
Borreani.....	202, 613
Bortolazzo.....	476

Bošnjak.....	967
Boubaker.....	184
Brambilla.....	955
Branco.....	509
Breitsameter.....	916
Breland.....	365
Bremm.....	214, 919, 973
Brereton.....	63
Breuer.....	848
Briemle.....	747
Broca.....	770
Brophy.....	782
Bruchmann.....	776
Brummer.....	827
Brüne.....	845
Brunschwig.....	892
Brussaard.....	758, 854
Bühle.....	205, 208
Bulang.....	437
Burns.....	479

—C—

Cagaš.....	779
Campos.....	557
Canals.....	717, 1037
Carnus.....	782
Carrère.....	654, 937
Carvalho.....	214, 919, 955, 973
Casado.....	554
Casey.....	907, 958, 985
Castonguay.....	473
Cavallero.....	595
Cerff.....	669
Cervasio.....	265, 767
Červená.....	663
Chadoeuf.....	937
Chauveau-Duriot.....	589
Chilliard.....	589, 628
Chion.....	202
Chodkiewicz.....	1024
Cifre.....	797
Civic.....	160
Cizinande.....	1006
Claupein.....	307
Cloppet.....	75
Collins.....	51
Collomb.....	422, 631, 634
Cone.....	491
Conesa.....	797
Connolly.....	782, 812

Constant.....	449
Conte.....	214
Čop.....	657
Coppa.....	449, 595, 598
Cortés-Mora.....	338
Coughlan.....	247, 970
Coustet.....	610
Creighton.....	904
Crocetti.....	265, 767
Cruz.....	684, 788
Cuchillo.....	922
Cugno.....	595
Curran.....	994
Czarnecki.....	341

—D—

D'Ottavio.....	106
Da Ronch.....	672, 675, 678, 681
Da Silva.....	332, 335, 1006
Da Trindade.....	973
Dabkevičius.....	304
Dahl.....	425
Daniel.....	527
Daugėlienė.....	785
de Haan.....	100, 112, 178
de la Roza-Delgado.....	601
de Miguel.....	554
de Nascimento.....	925
de Renobales.....	607
de Vlieghe.....	211
del Hierro.....	54
del Pozo.....	554
Delaby.....	485, 865, 928
Delagarde.....	931, 982
Delgado.....	329
Demdoun.....	329
Demiroglu.....	943
Detmann.....	332
Di Grigoli.....	628
Di Miceli.....	223
Dickhoefer.....	103
Dickhöfer.....	1015
Dieterich.....	57
Dijkstra.....	586
Dillon.....	865
Dittert.....	84, 301
Dittrich.....	488
Dobremez.....	714
Doležal.....	289
Donath.....	660

Donnison .....	208
Downey .....	401
Doyle .....	356
Drapeau .....	473
Dreyer .....	569
Dufrasne .....	217, 1034
Dumont .....	937, 1043
Dunne .....	401
Duru .....	684, 788

—E—

Eckstein .....	660
Eggers .....	488
Ehlert .....	271
Eik .....	592
Eilersen .....	524
Eilertsen .....	592
Eler .....	60, 657
Elgersma .....	491
Elizalde .....	554
Elsaesser .....	220
Emile .....	494
Eriksen .....	830, 880, 1028, 1040
Estavillo .....	66
Evers .....	100

—F—

Falchero .....	595
Faramarzi .....	791
Farrell .....	946
Farruggia .....	589, 598, 937, 940, 1043
Faure .....	693
Ferlan .....	60
Ferlay .....	589, 598, 628
Fernandez-Casado .....	616, 690
Fernández-Lugo .....	925
Ferreiro-Domínguez .....	250
Ferrer .....	770, 1037
Ferris .....	1061
Feuerstein .....	295
Fievez .....	586
Figl .....	536
Fiil .....	362
Finn .....	782
Finnan .....	57
Fitzgerald .....	63, 907, 985
Fleurance .....	1043
Fleury .....	714
Folkestad .....	256
Fonseca .....	919, 934

Frankow-Lindberg .....	51, 794, 1028
Freitas .....	1006
Frelich .....	622, 625, 702
French .....	247
Frenda .....	223
Frey .....	634
Fricke .....	163, 172, 232, 259, 262
Fričová .....	738
Frydrych .....	779
Fustec .....	338

—G—

Gago .....	806
Gaisler .....	687, 726
Gallard .....	928
Gallnböck .....	1012
Garbisu .....	244
García .....	482
García-Ciudad .....	368, 729
García-Criado .....	368, 729
García-Fernández .....	253
García-Launay .....	892
Garmo .....	425
Gauckler .....	860
Gavenauskas .....	785
Gawryluk .....	341
Genro .....	973
Geren .....	943
Gericke .....	166
Giaccone .....	613
Giambalvo .....	223, 842
Gibb .....	919
Gierus .....	87, 419, 488, 515, 521, 551 ..... 955, 1015
Gilliland .....	371, 479, 904, 946
Ginane .....	937
Gleizes .....	910
Glimskär .....	1055
Glindemann .....	1015
Goeritz .....	497
Golińska .....	949
Goliński .....	226, 949
Gomes .....	934, 952
Gómez-Sánchez .....	196
Gomide .....	934
Gonçalves .....	973
Gonda .....	898, 997
Gonzalez Rodriguez .....	690
González-Hernández .....	184
González-Murua .....	66



González-Rodríguez.....	616, 994, 1061
Göransson.....	320
Gori.....	767
Gorlier.....	595
Gottardi.....	536
Goulart.....	527
Graulet.....	589
Greef.....	295
Green.....	443
Grogan.....	946
Gross.....	654
Grün.....	955
Grzywaczewski.....	711
Gselman.....	241
Gulías.....	797

—H—

Haeusler.....	988
Hakl.....	741
Hakrová.....	625
Hald.....	800, 1052
Halling.....	175
Hansen-Møller.....	425
Hanuš.....	622
Harkot.....	341
Harrison.....	401
Hartmann.....	317, 344
Hartung.....	229
Hasund.....	851
Haugen.....	42
Haugland.....	592
Havet.....	693
Haygarth.....	764
Házi.....	696
Heikkilä.....	500, 503, 560
Heinsoo.....	208
Hejcman.....	663, 738, 845
Helander.....	524
Helgadóttir.....	51, 320, 1028
Hennessy.....	979, 1021, 1067
Henriksen.....	365
Hepp.....	57, 554
Hernández-Ortega.....	601
Herrmann.....	229, 268, 298, 301, 521, 551
Hersleth.....	592
Himstedt.....	232
Hobohm.....	776
Hochstrasser.....	57
Hodge.....	839
Hofmann.....	699

Hofstetter.....	109, 634
Høgh-Jensen.....	830
Holden.....	63
Holgersson.....	851
Holshof.....	112, 178
Hopkins.....	72
Höppner.....	295
Horan.....	928
Hornick.....	217, 1034
Huguenin-Elie.....	761, 806, 818
Huhtanen.....	379, 467, 470
Humphreys.....	764, 907, 958, 985
Hünting.....	669
Hyrkäs.....	572

—I—

Iacob.....	277
Ibarra.....	244
Iezzi.....	106
Ingwersen.....	295
Inostroza.....	326, 347
Iriarte.....	1037
Isermeyer.....	14
Isolahti.....	572
Isselstein.....	235, 755, 791, 821, 824, 860 916, 922, 1046
Istasse.....	217, 1034

—J—

Jaakkola.....	500, 503
Jacob.....	344
Jailler.....	610
Jankowska-Huflejt.....	581
Jankowski.....	238
Jankū.....	350
Jatkauskas.....	506, 575
Jensen.....	491, 566, 848
Jeske.....	533
Jobim.....	509
Jodełka.....	238
Johansen.....	455, 803, 961
Jokela.....	362
Jones.....	51
Jouany.....	684
Jung.....	660
Junges.....	557

—K—

Kaçki.....	809
Kadziuliene.....	304, 1003

Kage .....	166, 229, 268, 298, 301
Kalaji .....	359
Kaldmäe .....	530
Kalmlage .....	1046
Karabcová.....	741
Kärt.....	530
Kasal.....	536, 539, 542
Kasperczyk .....	744
Kauer .....	1058
Kavut .....	943
Kayser.....	235, 1046, 1075
Kemp .....	1021
Kennedy .....	314, 431, 904, 1021
Keogh .....	907, 958, 985
Kesting .....	791
King.....	512, 764
Kir.....	943
Kirner .....	1012
Kirschig .....	699
Kirwan.....	782
Klarzyńska.....	705
Klimas .....	45, 193
Kobes.....	622, 702
Köhler.....	824
Kohoutek .....	115
Kolczarek .....	238
Kölliker.....	149
Komárek .....	115
Koning.....	178
Korres .....	139
Kramberger.....	241
Krause.....	283
Krawutschke.....	419, 515
Kriechbaum.....	660
Křišťálová.....	663, 738
Kristensen.....	964
Krogh-Jensen.....	425
Kryszak.....	705, 1049
Küchenmeister.....	860
Kuikman.....	30, 81
Kulik.....	708
Kunz .....	1018
Kuschak .....	669
Kusche.....	604
Kutnjak .....	967
Kvapilík.....	115

—L—

Lachmann .....	711
Landinger .....	857

Lara .....	461
Larkham .....	127
Larue .....	610
Lassen .....	14
Látal .....	991
Latsch.....	169, 280
Lattanzi .....	3, 48
Lättemäe .....	518
Le Bec.....	940
Le Morvan .....	440
Le Roy .....	494
Ledgard.....	880
Lejeune .....	121
Lenssinck.....	178
Leto.....	967
Leuschner.....	824
Lewis.....	431, 479, 970
Liebman .....	827
Ligabue .....	476
Lin.....	87
Lind.....	592
Llurba.....	812, 839
Lobsiger .....	118
Loges.....	84, 497, 1028, 1031
Loiseau.....	589
Lombardi.....	449, 595
Lonati.....	595
Lopez Villalobos.....	1021
López-Díaz .....	434
López-Mosquera .....	196
Lösche.....	521, 551
Louault.....	654, 937
Lourenço .....	586
Ludvíková.....	815
Luesink .....	295
Luick .....	97
Luo.....	880
Luscher .....	782
Lüscher .....	94, 761, 806, 818
Lynch .....	356, 979

—M—

Macelli .....	265
Macháč.....	779
Machado .....	214
Macleod .....	764
Macolino.....	548, 678
Madsen.....	964
Magda .....	910
Maire.....	654

Malatinszky .....	696
Mandaluniz .....	607
Marczakiewicz .....	711
Marques .....	557
Martin .....	449, 589, 598, 628, 788
Martínez-Fernández .....	601
Martínez-Suller .....	39
Martins .....	973
Mastalerczuk .....	359
Mata .....	925
McEniry .....	512
McEvoy .....	314, 578
McGilloway .....	479, 946
Mendarte .....	244
Menéndez .....	66
Merino .....	39, 66
Meripöld .....	518
Mesdaghi .....	190
Messeri .....	265, 767
Mezzalira .....	973
Michaud .....	913
Miettinen .....	560
Miglietta .....	60
Migliorini .....	836
Mignon .....	121
Mikyska .....	289
Milano .....	898
Minder .....	265
Minogue .....	247
Misztal .....	69, 133
Moir .....	235
Molénat .....	892
Moloney .....	401
Monahan .....	401
Monsallier .....	598
Monteiro .....	332, 335
Montourcy .....	619
Morales-Almaráz .....	601
Moran .....	36
Moreau .....	75
Moreno .....	797, 898
Moreno Marcos .....	434
Mosimann .....	976
Mosquera-Losada .....	184, 250, 253
Mouhbi .....	184
Müller .....	57, 87, 416, 1015, 1075
Munari .....	833
Münger .....	422, 895
Muñoz .....	329
Murphy .....	139, 247, 431

Musiał .....	1049
Mut .....	323

—N—

Nadeau .....	524
Nadin .....	898, 997
Nájera .....	607
Nascimento .....	332
Nascimento .....	335
Nascimento Júnior .....	934
Nascimento-Junior .....	1006
Necpalova .....	907
Nesheim .....	181
Netland .....	256
Nettier .....	714
Neumann .....	735
Ney .....	666
Ni .....	166
Niderkorn .....	440
Nielsen .....	800, 1052
Niemeläinen .....	1000
Noe .....	964
Nogueira .....	458, 464
Noormets .....	1058
Norderhaug .....	773
Norell .....	851
Nørgaard .....	524
Nousiainen .....	379
Nussio .....	428, 482, 527
Nyfelner .....	761, 818

—O—

O'Connor .....	979
O'Donovan .....	314, 431, 479, 578, 764
.....	904, 928, 970, 979, 994, 1021
O'Kiely .....	356, 479, 512
Oenema .....	30, 271
Ohl .....	229
Oliveira .....	214, 509
Oliveira Júnior .....	488
Olt .....	530
Oreja .....	717
Orsini .....	714
Orth .....	720
Osterburg .....	14
Østerlie .....	773
Østrem .....	256
Otrhálková .....	741
Ots .....	530
Otte .....	660

Oudshoorn .....443  
 Oury .....338  
 Ovalle .....554

—P—

Paccard .....940  
 Pacchioli .....476  
 Pacholski .....166, 268, 301  
 Paderewski .....723  
 Padilha .....1006  
 Pageau .....473  
 Pakarinen .....362, 572  
 Panka .....533  
 Pavlů .....687, 726, 815  
 Peccatte .....485  
 Peeters .....72  
 Peiretti .....613  
 Pelletier .....473  
 Pelve .....1055  
 Pena .....332  
 Penksza .....696  
 Peratoner .....536, 539, 542  
 Perbandt .....205, 259, 262  
 Perčulija .....967  
 Peressotti .....60  
 Perez .....919  
 Pérez-Elortondo .....607  
 Pérez-Prieto .....982  
 Petersen .....755, 821, 824  
 Petisco .....368, 729  
 Petrović .....286  
 Peyraud .....485, 865, 928, 931, 982  
 Pfister .....1009, 1012  
 Phelan .....907, 958, 985  
 Philipsen .....100, 178  
 Piano .....202  
 Picard .....913  
 Picasso .....827  
 Piccand .....1018  
 Piergiovanni .....106  
 Pineau .....338  
 Pinto .....54, 66, 955  
 Pirhofer-Walzl .....830  
 Piva .....338  
 Plantureux .....666, 732  
 Pławska-Olejniczak .....1064  
 Podstatzky .....1012  
 Podvrsnik .....241  
 Poetsch .....988  
 Pomiès .....940

Pontes .....654, 910  
 Ponzetta .....265, 767  
 Popovici .....277, 310  
 Pornaro .....833, 836  
 Pötsch .....1012  
 Pourrat .....452, 610  
 Pozdíšek .....741, 991  
 Prache .....610  
 Pradel .....589, 598, 628, 940  
 Proulx .....654  
 Provan .....371

—Q—

Quakernack .....268  
 Quakernak .....301  
 Queiroz .....482

—R—

Raave .....1058  
 Rabier .....121  
 Ramos .....335  
 Randby .....545  
 Ranghino .....202  
 Rasmussen .....830, 880, 1028  
 Reck .....735  
 Reheul .....758  
 Reijneveld .....30, 271  
 Reis .....458, 461, 464  
 Remy .....693  
 Renaud .....338  
 Resch .....988  
 Revello Chion .....613  
 Réviron .....118  
 Ribas .....812, 839  
 Ribas-Carbó .....797  
 Richardson .....512  
 Richter .....172, 205, 274  
 Riehl .....699  
 Rigueiro-Rodríguez .....184, 250, 253  
 Rimi .....548  
 Rinne .....467, 470, 560  
 Rismondo .....106  
 Rivera .....347  
 Robaye .....217, 1034  
 Roca-Fernandez .....616, 690, 994, 1061  
 Rodehutsord .....437  
 Röder .....14  
 Rodhe .....175  
 Rodrigues .....332, 335, 461  
 Rogalski .....1064

Roggero .....	106
Rohrer .....	1009
Rolo Romero .....	434
Romo .....	368
Rosická .....	289
Rossignol .....	937
Roth .....	458, 464
Rouillé .....	619
Ruebesam .....	604
Ruf .....	735
Ruget .....	75
Ruisi .....	223, 842
Ruiz .....	607
Ruiz de Gordoa .....	607
Ryan .....	1067

—S—

Sá Neto .....	482
Saarijärvi .....	78
Saarisalo .....	500, 503
Saastamoinen .....	1000
Sabatier .....	720
Saghin .....	310
Saia .....	842
Sainz .....	196
Salama .....	521, 551
Salcedo .....	39
Salomon .....	1070
Samková .....	622
Samuil .....	277, 310
San Emeterio .....	717, 1037
Sánchez .....	326
Sánchez Chopa .....	898, 997
Sánchez-Jardón .....	554
Sanderson .....	639
Santanen .....	362
Santilocchi .....	106
Santos .....	509, 527, 934, 1006
Sargenti .....	106
Särkijärvi .....	1000
Saro .....	925
Sarunaite .....	1003
Sauter .....	169, 280
Savolainen .....	572
Sbrissia .....	332, 335, 934, 1006
Schäufele .....	752
Schaumberger .....	539
Schellberg .....	845
Schenck .....	416
Scherer-Lorenzen .....	649
Schiborra .....	1015
Schils .....	81, 880
Schlecht .....	103
Schmaler .....	283
Schmeer .....	84
Schmidt .....	401, 557
Schmied .....	976
Schnyder .....	48, 752, 857
Schönbach .....	87, 1015
Schori .....	895, 1018
Schoumans .....	271
Schouten .....	758
Schrautzer .....	848
Schrode .....	97
Schubiger .....	344
Sebastia .....	782, 812, 839
Šeda .....	289
Sehested .....	566
Seidel .....	235
Seither .....	755
Selge .....	1058
Senbayram .....	84, 301
Sepehry .....	190
Seppälä .....	470, 560
Seppänen .....	362
Shaloo .....	1067
Shingfield .....	379
Sibra .....	892
Sieling .....	229, 298
Sienkiewicz-Paderewska .....	723
Sierts .....	569
Silva .....	332, 1006
Silveira .....	332
Simić .....	286
Simončič .....	60
Singh .....	139
Skjelvåg .....	42
Skládanka .....	289
Skøt .....	51
Šlachta .....	622, 625
Slepetiene .....	292
Slepetys .....	292
Søegaard .....	563, 566, 830, 1040
Sokolović .....	286
Sölter .....	295
Songisepp .....	530
Sørensen .....	443
Sormunen-Cristian .....	1000
Sosnowski .....	238
Sousa .....	332, 335

Soussana .....654  
 Souverain .....75  
 Souza Júnior .....335  
 Soya .....943  
 Špička .....622  
 Spörndly .....901, 1055, 1070  
 Spychalski .....226  
 Ståhlberg .....851  
 Starz .....1009, 1012  
 Steep .....860  
 Steinshamm .....425, 446  
 Steinwidder .....988, 1009, 1012  
 Stilmant .....121  
 Stimpfl .....539, 542  
 Stoll .....118, 205  
 Straka .....350  
 Straková .....350  
 Stringi .....223  
 Strnad .....738  
 Struck .....344  
 Strychalska .....705  
 Stryhn .....33  
 Sturite .....365  
 Stutz .....806  
 Štýbnarová .....741, 991  
 Stypiński .....124, 1024  
 Suchý .....702  
 Südekum .....208, 379  
 Sundberg .....1070  
 Susan .....836  
 Susenbeth .....87, 1015  
 Sutcliffe .....127  
 Suter .....94, 761, 818  
 Svoboda .....298  
 Svozilová .....741  
 Sýkorová .....625  
 Synnes .....455  
 Szczepanek .....533  
 Szentes .....696  
 Szewczyk .....744

—T—

Tabacco .....202, 613  
 Taimisto .....500  
 Tamm .....199, 518  
 Tamminga .....586  
 Tas .....1015  
 Taube .....84, 87, 229, 268, 298, 301, 374  
 .....419, 515, 521, 551, 1015, 1031  
 Techow .....268, 301

Termorshuizen .....271  
 Teuma .....610  
 Thaysen .....515, 569  
 Theau .....684, 788  
 Theodoridou .....452  
 Thomet .....976, 1018  
 Thomsen .....569  
 Thuen .....425  
 Thumm .....90, 307  
 Tilvikiené .....304  
 Toledo Filho .....527  
 Tolkamp .....36  
 Tonka .....625  
 Tonn .....90, 307, 747  
 Topp .....36  
 Tornambé .....589, 628  
 Tremblay .....473  
 Trindade .....898, 997  
 Trobbiani .....106  
 Troquier .....940  
 Troxler .....1018  
 Tuñon .....1021  
 Turner .....764

—V—

Vae .....425  
 Van den Pol-van Dasselaar ... 100, 178, 865  
 Van der Hoek .....130  
 van Eekeren .....758, 854  
 Van Groenigen .....81  
 Vance .....1061  
 Vázquez-de-Aldana .....368, 729  
 Vazquez-Yañez .....616, 690  
 Velthof .....81  
 Ventura .....812, 839  
 Vicente .....601  
 Vidrih .....657  
 Viiralt .....1058  
 Vilela .....332  
 Villanueva .....717, 1037  
 Vintu .....277, 310  
 Virkajärvi .....78, 362, 572  
 Virto .....607  
 Vlaeminck .....586  
 Vodnik .....60  
 Vogel .....649  
 Voženílková .....702  
 Vranić .....967  
 Vrotniakiene .....506, 575  
 Vuattoux .....913

Vučković .....	286
<b>—W—</b>	
Wachendorf.....	163, 172, 205, 208, 232
.....	259, 262, 274
Wade.....	931
Wahlund.....	1070
Wallace.....	371
Wan .....	87, 1015
Wang .....	1015
Wanner .....	1018
Warner.....	491
Warpechowski.....	488
Wätzold .....	639
Weigelt .....	649, 782
Weiher .....	419, 515
Weiß .....	283
Werth.....	536, 539
Wesp.....	214
Westphal.....	1031

Whalley.....	764
Wiedenfeld.....	669
Wienforth.....	229, 298
Wims.....	314, 578, 970
Winter .....	660
Wittmer .....	857
Wrage.....	755, 791, 821, 824, 860, 916
Wreford.....	36
Wróbel .....	581
Wu.....	36
Wulfes.....	374
Wyss .....	118, 422, 631, 634

<b>—Z—</b>	
Zajac .....	226, 949
Zanini.....	1006
Zarzycki .....	69, 133
Žekonienė .....	785
Ziliotto ..	548, 672, 675, 678, 681, 833, 836
Zopollatto.....	527













EGF 2010  
Kiel Germany

ISBN 978-3-86944-021-7



9 783869 440217