



HAL
open science

Improving food sensory quality with and for elderly consumers

Claire Sulmont-Rossé, Ronan Symoneaux, Valérie Feyen, Isabelle Maître

► To cite this version:

Claire Sulmont-Rossé, Ronan Symoneaux, Valérie Feyen, Isabelle Maître. Improving food sensory quality with and for elderly consumers. *Methods in Consumer Research. Volume 2: Alternative Approaches and Special Applications*. 1st Edition, Elsevier, 478 p., 2018. hal-02791415

HAL Id: hal-02791415

<https://hal.inrae.fr/hal-02791415>

Submitted on 5 Jun 2020

HAL is a multi-disciplinary open access archive for the deposit and dissemination of scientific research documents, whether they are published or not. The documents may come from teaching and research institutions in France or abroad, or from public or private research centers.

L'archive ouverte pluridisciplinaire **HAL**, est destinée au dépôt et à la diffusion de documents scientifiques de niveau recherche, publiés ou non, émanant des établissements d'enseignement et de recherche français ou étrangers, des laboratoires publics ou privés.

Chapter 14

Improving Food Sensory Quality With and For Elderly Consumers

Claire Sulmont-Rossé¹, Ronan Symoneaux², Valérie Feyen¹,
Isabelle Maître²

¹Centre des Sciences du Goût et de l'Alimentation, CNRS, INRA, Univ. Bourgogne Franche-Comté, Dijon, France; ²Unité de Recherche GRAPPE, Univ. Bretagne Loire, Ecole Supérieure d'Agricultures (ESA), INRA, Angers Cedex, France

Chapter Outline

1. Introduction	356	5.2 The Elderly Population Is Characterized by a Large Interindividual Variability in Food Preferences	366
2. Learn—Qualitative Phase	357	5.3 Multidimensional Approaches Should Be Favored Rather Than Targeting One Sensory Dimension	367
3. Produce—Food Development Phase	358	5.4 Methodological Recommendations	368
4. Measure—Quantitative Phase	359	6. Conclusion	369
4.1 Method	359	7. Sources of Further Information	370
4.1.1 Participants	359	Acknowledgments	370
4.1.2 Food Products	360	References	370
4.1.3 Hedonic Rating	360		
4.1.4 Data Analysis	361		
4.2 Results	361		
4.2.1 General Overview	361		
4.2.2 Consumer Segmentation	363		
5. Discussion	365		
5.1 The Reverse Engineering Methodology, a Promising Strategy for Developing Food Products Targeting the Elderly	365		

1. INTRODUCTION

Within the context of an aging population, developing products that meet the specific needs of seniors while satisfying their sensory and hedonic expectations becomes a major challenge for the food industry as well as for society. As a result, it is highly important to use sensory assessment tools with elderly subjects “as their perceptions may not be interchangeable with those of adults who are under 60 years of age” (Murray, Delahunty, & Baxter, 2001).

Oral food consumption is by far the most important stage at which the sensory pleasure of a food can be perceived, appreciated, and accepted. It is widely acknowledged that aging is accompanied by a decline in the ability to perceive the taste and the odor of foods (Doty et al., 1984; Mojet, Christ-Hazelhof, & Heidema, 2001; Murphy, 1986) as well as by a deterioration in oral health such as tooth loss, decreased muscle strength, hyposalivation, and impaired swallowing induced by disease or drugs (Liu, Dion, Jurasic, Gibson, & Jones, 2012; Mioche, Bourdiol, & Peyron, 2004). However, beyond this overall effect of age, aging is accompanied by a large interindividual variability both for chemosensory abilities (Laureati, Pagliarini, & Calcinoni, 2008; Sulmont-Rosse et al., 2015) and for oral health (Vandenberghe-Descamps et al., 2016). Indeed, in addition to neurophysiological changes associated with the normal aging process, extrinsic factors may also have an impact on chemosensory and oral health decline, such as lifestyle factors, environmental factors, health, and medication. These factors, closely related to the life story of each individual, probably account for a large part of the variability observed in the elderly population (Mackay-Sim, Johnston, Owen, & Burne, 2006; Nordin, Almkvist, & Berglund, 2012; Sulmont-Rosse et al., 2015). To date, strategies to compensate for age-associated losses in chemosensory acuity have mainly explored flavor enhancement (i.e., deliberately adding flavor compounds to a food), providing mixed results (see Doets & Kremer, 2016; Song, Giacalone, Johansen, Frost, & Bredie, 2016; Sulmont-Rossé, Maître, & Issanchou, 2010 for a review). Strategies to improve nutrition in response to oral disorders consist in providing elderly people with “texture-modified” foods, in the form of chopped, blended, or pureed foods, which are often unattractive and not very palatable. Furthermore, food fortification (i.e., deliberately increasing the content of an essential nutrient in a food, so as to improve the nutritional quality of the food supply and provide a health benefit) is a common management approach for elderly people with reduced appetite. However, existing market solutions are mainly sweet oral nutritional supplements, for which liking and intake are often poor, because of unacceptable mouthfeel and flavor characteristics over full portion sizes (Methven et al., 2010).

Food industries and catering services have made efforts in recent years to improve food offerings dedicated to elderly people (in particular for texture-modified foods and fortified foods). However, to the best of our knowledge, the stakeholders seldom measure sensory expectations and preferences in elderly people through formal tests, and in particular in frail and dependent elderly

people, despite foods. At best, all quality of the a new product. However, such generation of elderly (1991) and older they depend (CI

In this chapter engineering product food according to people (case study a ready-to-eat oveal stew in w and a fortified fo engineering coming it based on developing new three phases, n produce (product measure (whether an iterative products on the market people was asked on the French n developed on the blanquette), one sert (high-protein opment phase). for each variant

2. LEARN—Q

Six focus groups participants living range 65–88 year potatoes, trout f texture-modified pork–prunes), an vanilla custard, t two high-protein items were available dishes and apple-fied custard). Each modified food, an

people, despite their being the main target for texture-modified and fortified foods. At best, catering services carry out a satisfaction survey on the overall quality of the food and service or they get feedback from their guests on a new product or a new recipe at the end of the meal in an informal manner. However, such practices suffer from social desirability bias: the present generation of elderly people has been educated not to complain about food (Doty, 1991) and older people are often reluctant to complain about a service on which they depend (CLCV, 2012).

In this chapter, we will describe a methodology following the reverse engineering principle that we have used to improve the sensory quality of food according to the sensory expectations and preferences of elderly people (case study). This methodology was applied to three types of dishes: a ready-to-eat dish from French familial cuisine (“*blanquette de veau*”—a veal stew in white sauce), a texture-modified food (pureed beef-carrots), and a fortified food (high-protein and energy-dense vanilla custard). Reverse engineering consists in extracting knowledge from an object and reproducing it based on the extracted information. In fact, Ries (2012) recommends developing new products according to a tailored management process in three phases, namely, *learn* (about consumers’ needs and expectations), *produce* (products that may fulfill consumers’ needs and expectations), and *measure* (whether products fit consumers’ needs and expectations), through an iterative process. This strategy aims at increasing the success of products on the market. In coherence with this method, first a panel of elderly people was asked to taste and provide feedback on food products available on the French market (*learn*: qualitative phase). Then, four variants were developed on the basis of qualitative results for one ready-to-eat dish (veal *blanquette*), one texture-modified food (pureed beef-carrots), and one dessert (high-protein and energy-dense vanilla custard) (*produce*: food development phase). Finally, a second panel of elderly people rated their liking for each variant on a scale (*measure*: quantitative phase).

2. LEARN—QUALITATIVE PHASE

Six focus groups (8 ± 2 elderly people in each) were carried out with 54 elderly participants living at home (21 men and 33 women; mean age 70.5 years; age range 65–88 years). For this first phase, three ready-to-eat dishes (omelet with potatoes, trout fillet with chives and rice, veal *blanquette* with rice), three texture-modified foods (pureed beef-carrots, pureed veal-endives, pureed pork-prunes), and six desserts (vanilla custard, high-protein and energy-dense vanilla custard, two high-protein, energy- and mineral-dense vanilla custards, two high-protein and energy-dense apple purees) were selected. All of these items were available on the French market (mass distribution for ready-to-eat dishes and apple puree; medical market for texture-modified foods and fortified custard). Each focus group was served one ready-to-eat dish, one texture-modified food, and two desserts so that each dish was assessed by two focus

TABLE 14.1 Food Products Tested During the Quantitative Phase

	Ready-to-Eat Food	Texture-Modified Food	Fortified Food
	Veal Blanquette	Pureed Beef-Carrots	High-Protein and Energy-Dense Vanilla Custard
Standard	Market product	Market product	Market product
Improved	+Tex	+Tex	+Tex
	Soft meat	Smother and less sticky texture	Fluid texture
Improved	+Tex+Tas	+Tas	+Tas
	Soft meat, taste improvement (salt, citrus acidity, pepper)	Enhancement of taste (salt, pepper)	Enhancement of sweetness
Improved	+Tex+Aro	+Tas+Aro	+Aro
	Soft meat, enhancement of gravy's aroma	Enhancement of saltiness and aroma	Improvement of vanilla aroma
Improved	+Hol	+Sep	+Hol
	Soft meat, whole mushrooms, crunchier mushrooms and carrots, taste improvement, enhancement of gravy's aroma	Pureed beef and pureed carrots presented side by side (not mixed altogether)	Fluid texture, improvement of vanilla aroma
Unpleasant	Without added salt	Without added salt	Pasty texture, low in sweetness, less aroma

For each type of food, the product set included the market product (standard), three variants improved in one or two sensory dimensions (texture, +Tex; taste, +Tas; aroma, +Aro), one variant improved in all the sensory characteristics of the product (+Hol), or by separating meat and vegetable purees for the texture-modified food (+Sep), and one a priori unpleasant variant.

4. MEASURE—QUANTITATIVE PHASE

4.1 Method

4.1.1 Participants

One hundred three elderly people living at home (44 men and 59 women; mean age 72 years; age range 65–82 years) and 63 elderly people living in a nursing home (8 men and 55 women; mean age 86 years; age range 67–98 years) were

recruited. The recruitment criteria were as follows: older than 65 years, no acute pathological episode at the time of the survey, no food allergies, no dysphagia, not on a doctor-prescribed diet, and scoring at least 20 on the Mini Mental State Examination (MMSE) (Folstein, Folstein, & Mchugh, 1975). The MMSE screens for cognitive impairment: scores greater than or equal to 26 points (of 30) indicate normal cognition. Below this, scores can indicate severe (≤ 15 points), moderate (16–19 points) or slight (20–25 points) cognitive impairment (Derouesné et al., 1999). Participants who self-reported a congenital anosmia or an anosmia due to head injury and participants who suffered from sinusitis or a severe respiratory infection at the moment of the survey were also excluded. An interview was carried out with each candidate to ensure that he or she met the inclusion criteria. The experimental protocol of the survey was approved by the French Ethics Committee for Research (CPP Est I, Dijon, No. 2011/16, AFSSAPS No. 2011-A00277-34). In accordance with the rules of ethics, all of the participants received written and oral information on the survey before signing a consent form.

4.1.2 Food Products

For each type of food (ready-to-eat dish, texture-modified food, fortified food), the product set included six variants (Table 14.1):

- the standard variant (Std) that was used in the qualitative phase (i.e., product available on the French market);
- the four variants that were developed from the proposals made by the focus groups;
- one a priori unpleasant variant (Unp). For the veal blanquette and the pureed beef and carrots, the unpleasant variants corresponded to the standard recipe without added salt (foods dedicated to people on a no-salt diet). For the custard, the unpleasant variant was obtained by making the texture thicker and decreasing the sweetness and the flavor of the standard recipe.

Unpleasant variants were added to control for positive bias often observed with elderly people, and in particular dependent elderly people (Maitre, Symoneaux, & Sulmont-Rossé, 2015). On average, elderly people tend to give higher liking scores than young people (Cordelle, Lange, & Schlich, 2004; D'Hauteville, Aurier, & Sirieix, 1997; Kälviäinen, Roininen, & Tuorila, 2003; Tuorila, Anderson, Martikainen, & Salovaara, 1998). This could be due to the fact that the present generation of elderly people has been educated not to complain about food (Doty, 1991). This could also be due to the fact that elderly people want to please the investigators, who are “taking care” of them during the sensory tests (this positive emotional context is even stronger in nursing homes, where sensory tests represent a disruption in the daily routine and an opportunity to “chat” with a “visitor”).

4.1.3 Hedonic Rating

Three sessions were carried out, one per food product. At each session, participants were served the six variants using a sequential monadic procedure. The

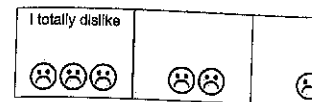

FIGURE 14.1 Hedonic scale c

products were presented in 1 design. The participants taste product on a 7-point categori was previously designed and Maitre et al., 2015).

Sessions were conducted i or in a meeting room at the r were carried out at lunch tim (participants were offered a d the afternoon collation for the were heated to the temperatur served: 60 g). Custard samples tion to be served: 125 g). Afte take a break and rinse their m with three-digit numbers.

4.1.4 Data Analysis

The hedonic scores were conv like”) to 6 (“I like a lot”). All STAT (1990). Analyses of varia linear model procedure of SAS means were computed for each analysis using the LSMEANS was conducted using SPAD soft (M) were associated with the st for significance was set at 5%.

4.2 Results

4.2.1 General Overview

An overview of the hedonic re: variant and per type of food. I to an ANOVA with *variant* and *fixed* factors and *participant* as was observed for the three foods beef-carrots, $F_{5,739} = 31.6, P < .0$ priori unpleasant variants were : three foods. For the veal blanqu obtained higher liking scores th.

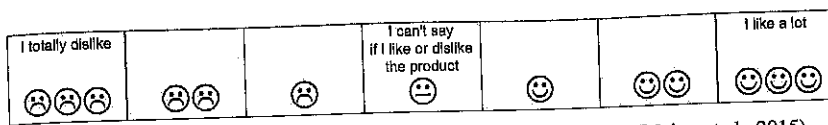

FIGURE 14.1 Hedonic scale designed for dependent elderly people (Maitre et al., 2015).

products were presented in the order determined by a Williams Latin square design. The participants tasted each product and evaluated their liking for the product on a 7-point categorical scale combining labels and pictograms, which was previously designed and validated for dependent elderly people (Fig. 14.1; Maitre et al., 2015).

Sessions were conducted in a sensory lab for the independent elderly people or in a meeting room at the nursing home for the dependent elderly. Sessions were carried out at lunch time for the veal blanquette and pureed beef-carrots (participants were offered a dairy product and a dessert before leaving) and at the afternoon collation for the custard. Veal blanquette and pureed beef-carrots were heated to the temperature of $68 \pm 2^\circ\text{C}$ before being served (portion to be served: 60 g). Custard samples were served at the temperature of $11 \pm 1^\circ\text{C}$ (portion to be served: 125 g). After each tasting, the participants were requested to take a break and rinse their mouth out with plain water. Samples were coded with three-digit numbers.

4.1.4 Data Analysis

The hedonic scores were converted into scores varying from 0 ("I totally dislike") to 6 ("I like a lot"). All statistical analyses were conducted using SAS/STAT (1990). Analyses of variance (ANOVA) were performed using the general linear model procedure of SAS/STAT (type III sum of squares). Least-squares means were computed for each factor and submitted to multiple comparison analysis using the LSMEANS option. The hierarchical cluster analysis (HCA) was conducted using SPAD software (7.4; COHERIS, Suresnes, France). Means (M) were associated with the standard error of the mean (SEM). The threshold for significance was set at 5%.

4.2 Results

4.2.1 General Overview

An overview of the hedonic results is given in Fig. 14.2, using box plots per variant and per type of food. For each food, hedonic scores were submitted to an ANOVA with *variant* and *category* (living at home; nursing home) as fixed factors and *participant* as the random factor. A significant *variant* effect was observed for the three foods (veal blanquette, $F_{5,765} = 22.0, P < .001$; pureed beef-carrots, $F_{5,739} = 31.6, P < .001$; vanilla custard, $F_{5,800} = 6.0, P < .001$). The a priori unpleasant variants were associated with the lowest liking scores for the three foods. For the veal blanquette, all the improved variants but +Tex+Aro obtained higher liking scores than the standard. No significant difference was

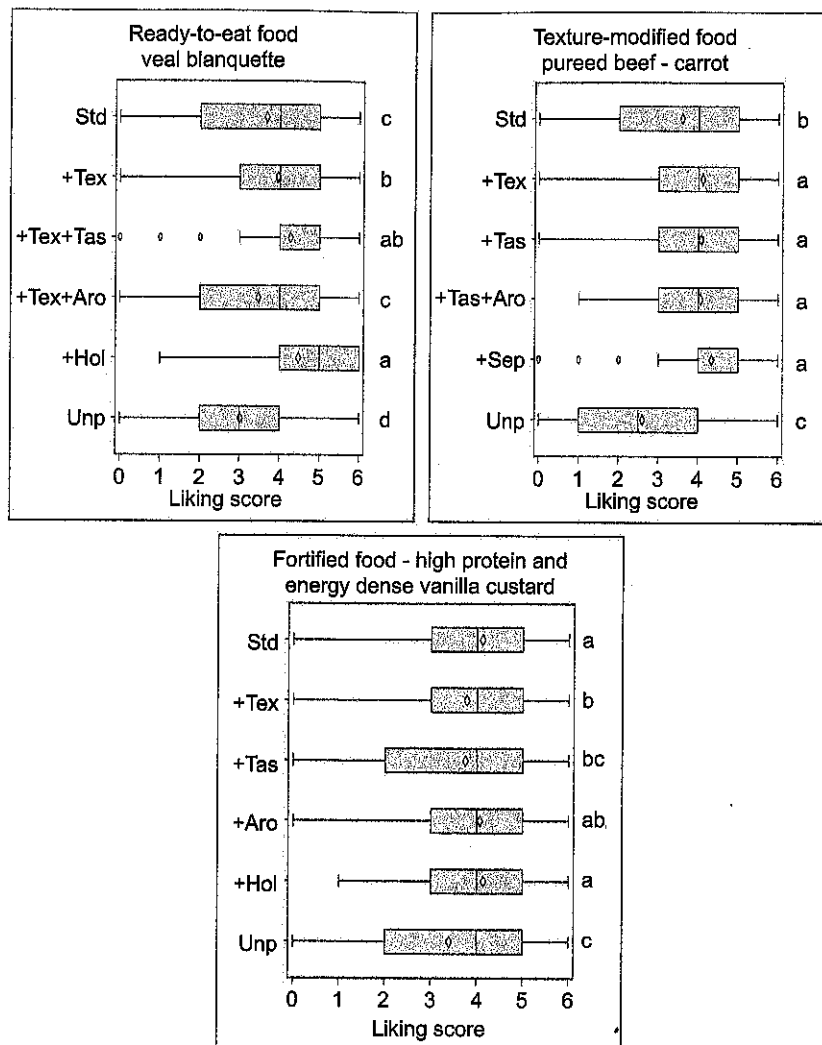

FIGURE 14.2 For each food, box-plot distributions of liking scores per variant are shown. The left and right of the box correspond to the 25th and 75th percentile, respectively. The vertical band and the diamond correspond to the median and the mean, respectively. The ends of the whiskers represent the lowest/highest data still within the 1.5 interquartile range. Any data not included between the whiskers are plotted as outliers with a dot. +Aro, aroma; +Hol, all sensory characteristics of the product; +Sep, meat and vegetable purees separated for the texture-modified food; Std, standard; +Tas, taste; +Tex, texture; Unp, unpleasant.

observed between the variant +Tex +Aro and the standard. For the pureed beef-carrots, all the improved variants obtained higher liking scores than the standard. No significant difference was observed between the improved variants. Finally, for the vanilla custard, the improved variants did not score higher than

TABLE 14.2 Food and Dependence Categories

Veal blanquette
Pureed beef-carrots
Vanilla custard

the standard. The va while the variants +

A significant $F(1,153) = 5.38; P < .05$ nor for the vanilla o people had higher li mous elderly people interaction was obse discrimination ability and participant as f decrease in the discr between the product (only a tendency for

4.2.2 Consumer S

As the box plot revea for each food were k-means consolidati dendrogram. As the interaction, all partic in a unique HCA. Th for veal blanquette, p of the clusters was a dent elderly people. 27%, and 45% of de pureed beef-carrots, of dependent people, ters 1, 2, and 3 includ ($\chi^2 = 1.44; P < .05$).

Regarding the ve preferred the variant

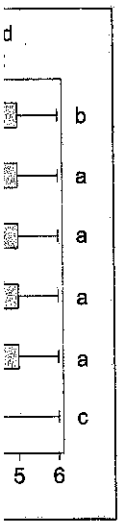

TABLE 14.2 *F* and *P* Values for the *Variant* Effect Per Product and per Dependence Category

	Independent Elderly People	Institutionalized Elderly People
Veal-blanquette	$F_{5,500}=15.91 (P<.001)$	$F_{5,265}=9.52 (P<.001)$
Pureed beef-carrots	$F_{5,450}=23.08 (P<.001)$	$F_{5,289}=11.23 (P<.001)$
Vanilla custard	$F_{5,505}=5.94 (P<.001)$	$F_{5,295}=1.95 (P=.08)$

the standard. The variants +Aro and +Hol were as appreciated as the standard, while the variants +Tex and +Tas were less appreciated than the standard.

A significant *category* effect was observed for the veal blanquette ($F_{1,153}=5.38; P<.05$), but not for the pureed beef-carrots ($F_{1,148}=0.08; P=.77$) nor for the vanilla custard ($F_{1,160}=1.25; P=.27$). On average, institutionalized people had higher liking for the blanquette ($M=4.0; SEM=0.08$) than autonomous elderly people ($M=3.7; SEM=0.06$). No significant *variant* × *category* interaction was observed. To further investigate the impact of dependence on discrimination ability, liking scores were submitted to an ANOVA with *variant* and *participant* as fixed factors per category (Table 14.2). Results showed a decrease in the discrimination level with dependency, but significant differences between the products were still observed for the institutionalized elderly people (only a tendency for the custard).

4.2.2 Consumer Segmentation

As the box plot revealed large between-subject variations, centered liking scores for each food were submitted to an HCA (Euclidean distance, Ward criteria, k-means consolidation), and the number of clusters was chosen based on the dendrogram. As the previous analysis did not reveal any *variant* × *category* interaction, all participants together (independent and dependent) were included in a unique HCA. The clustering analyses revealed three, four, and three clusters for veal blanquette, pureed beef-carrots, and vanilla custard, respectively. None of the clusters was associated with a significant higher percentage of dependent elderly people. For the veal blanquette, clusters 1, 2, and 3 included 32%, 27%, and 45% of dependent people, respectively ($\chi^2=4.41; P<.05$). For the pureed beef-carrots, clusters 1, 2, 3, and 4 included 44%, 36%, 38%, and 37% of dependent people, respectively ($\chi^2=0.51; P<.05$). And for the custard, clusters 1, 2, and 3 included 28%, 38%, and 41% of dependent people, respectively ($\chi^2=1.44; P<.05$).

Regarding the veal blanquette (Fig. 14.3), the three clusters significantly preferred the variant that was improved on all the sensory characteristics of

re shown. The
e vertical band
e whiskers rep-
cluded between
cteristics of the
; Std, standard;

pureed beef-
an the stan-
red variants.
higher than

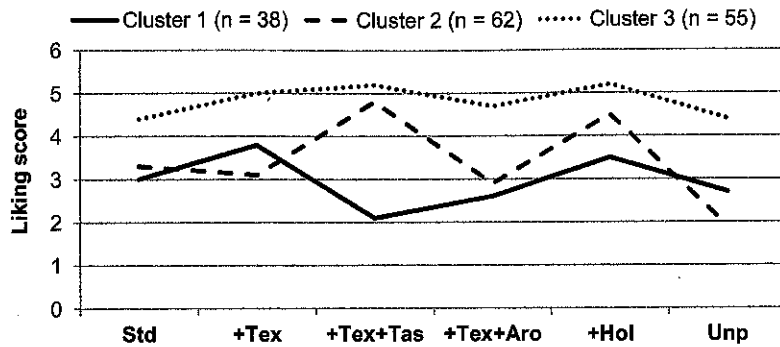

FIGURE 14.3 Ready-to-eat food: liking scores per cluster and per variant for the veal blanquette. Each cluster is associated with the number of participants belonging to that cluster (n). +Aro, aroma; +Hol, all sensory characteristics of the product; Std, standard; +Tas, taste; +Tex, texture; Unp, unpleasant.

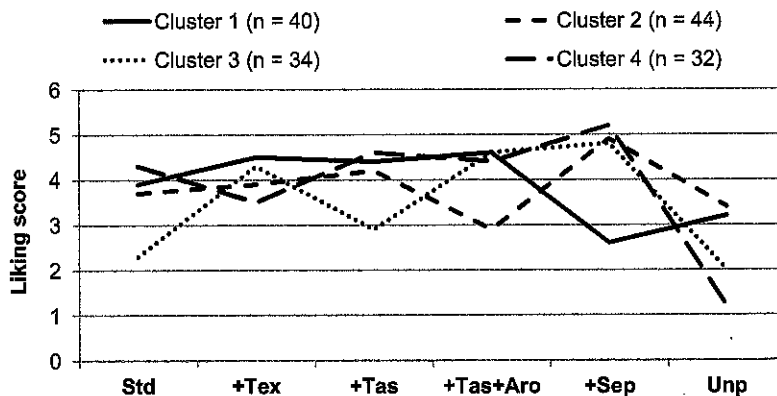

FIGURE 14.4 Texture-modified food: liking scores per cluster and per variant for the pureed beef-carrots. Each cluster is associated with the number of participants belonging to that cluster (n). +Aro, aroma; +Sep, meat and vegetable purees separated for the texture-modified food; Std, standard; +Tas, taste; +Tex, texture; Unp, unpleasant.

the product (+Hol) over the standard. The variant +Tex +Tas segmented cluster 1 from the two other clusters: this variant was the least liked variant in cluster 1, while it was equally liked compared to the variant +Hol in clusters 2 and 3. Clusters 2 and 3 mainly differed in the way they scored the variants: on average, cluster 3 gave higher liking scores than cluster 2 ($t=13.49$; $P<.001$), while they were less discriminant (cluster 3, $F_{\text{variant}}=8.01$; $P<.001$; cluster 2, $F_{\text{variant}}=37.68$; $P<.001$).

Regarding the pureed beef-carrots (Fig. 14.4), the variant with separated meat and vegetable purees (+Sep) segmented cluster 1 from the three other clusters: this variant was the least liked in cluster 1, while it was highly liked in the other clusters. For clusters 2 and 4, the separated variant was associated with the

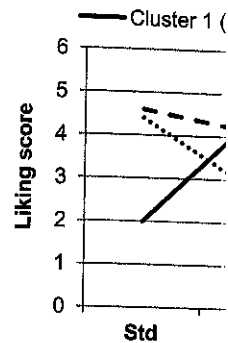

FIGURE 14.5 Fortified food: liking scores per cluster and per variant for the energy-dense vanilla custard. Each cluster is associated with the number of participants belonging to that cluster (n). +Aro, aroma; +Hol, all sensory characteristics of the product; +Tas, taste; +Tex, texture; Unp, unpleasant.

highest liking score. The standard and the variant +Tex +Tas were equally liked by cluster 1, while cluster 2 gave higher liking scores to the standard than to +Tex but not to +Tas. Cluster 3 gave higher liking scores to all the improved variants than to the standard, while cluster 4 gave higher liking scores to the standard than to +Tex but not to +Tas.

Regarding the fortified food (energy-dense vanilla custard), the variant +Tex +Tas segmented cluster 1 from the three other clusters: this variant was the least liked in cluster 1, while it was highly liked in the other clusters. For clusters 2 and 4, the separated variant was associated with the highest liking score. The standard and the variant +Tex +Tas were equally liked by cluster 1, while cluster 2 gave higher liking scores to the standard than to +Tex but not to +Tas. Cluster 3 gave higher liking scores to all the improved variants than to the standard, while cluster 4 gave higher liking scores to the standard than to +Tex but not to +Tas.

5. DISCUSSION

5.1 The Reverse Engineering Approach for Developing Food Products

As a first conclusion, the results of this study proved to be encouraging. The texture-modified food (pureed veal blanquette) and the texture-modified food (pureed beef-carrots) improved on the whole, with higher liking scores than the variant +Tex +Tas (Std). For the fortified food (energy-dense vanilla custard), the variant +Tex +Tas was

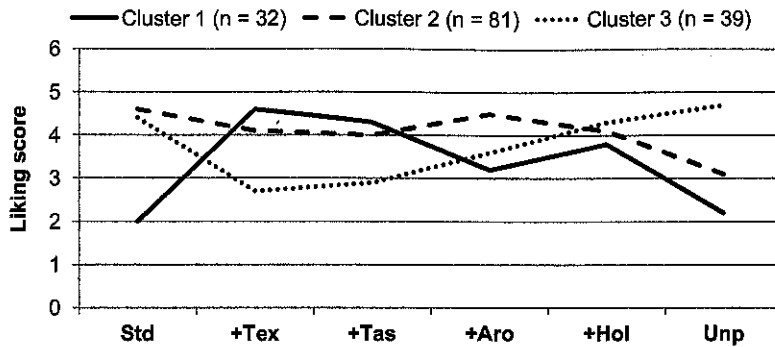

FIGURE 14.5 Fortified food: liking scores per cluster and per variant for the high-protein and energy-dense vanilla custard. Each cluster is associated with the number of participants belonging to that cluster (n). +Aro, aroma; +Hol, all sensory characteristics of the product; Std, standard; +Tas, taste; +Tex, texture; Unp, unpleasant.

highest liking score. Thus, both clusters gave similar liking scores to the standard and the variant +Tas. However, cluster 2 gave a similar liking score to the standard and to +Tex but disliked +Tas+Aro. Conversely, cluster 4 gave similar liking scores to the standard and +Tas+Aro but disliked +Tex. For cluster 3, all the improved variants obtained higher liking scores than the standard. The variant without added salt (Unp) was disliked by all the clusters, in particular cluster 4.

Regarding the fortified vanilla custard (Fig. 14.5), clusters were mainly segmented by the variants Std, Unp, +Tex, and +Tas. Indeed, cluster 1 gave the highest liking scores to +Tex and +Tas but disliked the Std and Unp variants. Conversely, cluster 3 gave the highest liking scores to the Std and Unp variants but disliked +Tex and +Tas. Interestingly, the variants Std, Unp, and +Tex differed on texture, with +Tex being fluid and the Std and Unp variants being thick. Consequently, cluster 1 seemed to favor fluid custard, while cluster 3 seemed to favor thick and not too sweet custard. Finally, cluster 2 preferred Std and +Aro over +Tex, +Sav, and Unp. This cluster may give more importance to variants' flavor than to texture.

5. DISCUSSION

5.1 The Reverse Engineering Methodology, a Promising Strategy for Developing Food Products Targeting the Elderly

As a first conclusion, the reverse engineering methodology followed up in this study proved to be efficient, at least for the ready-to-eat food (veal blanquette) and the texture-modified food (pureed beef-carrots). Indeed, the variants improved on the whole sensory dimension (+Hol) obtained higher liking scores than the variant available on the French market at the time of the study (Std). For the fortified vanilla custard, we did not observed any increase in

liking for the improved variant compared to the standard variant. This may be due to the difficulties encountered in reformulating this product, given that this product should comply with strict nutritional regulations to be acknowledged as an oral nutritional supplement and reimbursed for by French health insurance. Interestingly, a similar approach was used by den Uijl, Jager, Zandstra, de Graaf, and Kremer (2016) to develop two protein-enriched recipes for a traditional Dutch meat dish, a “cozy” recipe tailored to the expectations of senior consumers who eat mainly for coziness and social interaction (“cozy socializers”) and a “physical” recipe tailored to the expectations of senior consumers who eat mainly for nutrients and physical needs (“physical nutritioners”). As in the present experiment, den Uijl and colleagues carried out a qualitative phase with each senior consumer segment to determine their expectations, to further develop the two dishes (one per segment). Finally, they ran a home use test in which they consumed and assessed these two dishes. The results did not show any *segment* × *dish* interaction, meaning that the two senior consumer segments (cozy socializers and physical nutritioners) liked the “cozy” and the “physical” dishes equally. However, liking scores for both dishes were quite high (close to 80 on a 100-point rating scale), proving the efficiency of such methodology for reformulating traditional dishes to fit with the nutritional needs of the elderly population.

5.2 The Elderly Population Is Characterized by a Large Interindividual Variability in Food Preferences

As a second conclusion, this experiment highlighted a large interindividual variability in food preferences among the elderly population. Variability in food preferences is observed in all stages of life and elderly people do not escape the rule. Food preferences are affected by numerous factors, such as biological, physiological, psychological, and societal factors, which might account for this variability (Vabo & Hansen, 2014). As most of our food preferences are learned through experiences (Rozin & Vollmecke, 1986; Zellner, 1991), it may be assumed that increase in age goes along with an increased number of food experiences, which in turn leads to an increase in interindividual variability. In fact, family resemblance studies for individual food items have even demonstrated modest or no correlation between first-degree relatives (see, for instance, Birch, 1980; Rozin, 1991). Furthermore, Jilani, Intemann, Hebestreit, and Ahrens (2016) observed lower correlation between taste preferences of older siblings (>12 years of age) than between those of younger siblings (<12 years of age). Consequently, it may be assumed that variability in food preferences is higher in the elderly than in younger populations. Indeed, aging does not take the same toll on physiological processes, resulting in a large interindividual variability in perception, which may have an impact on food preferences. Furthermore, elderly people may have undergone more food experiences than younger people, just because of a longer life span. In view of this large variability in food preference, it is important to achieve a varied food supply in

response to the elderly and pureed carrots side participants, but 27% ($M=2.60$; $SEM=0.23$)

5.3 Multidimensional Than Targeting

Finally, strategies to c acuity have mainly exp compounds to a food). acceptability: several a food actually increases Van Staveren, 1996; G Tuorila, 2003; Kremer, 2008; Schiffman & W (1988) presented elder was not enhanced, whi different concentration. to taste each of the th average, 75% of the eld flavor enhancement sel & Kremer, 2016; Suln Warwick (1993) compa ate plain food versus wh that the addition of fla 30 foods. Mathey, Sieb daily dietary intake dec group who ate flavor-en Staveren, Kok, and de C enhancement did not le most of the studies that vor compounds and enh without exploring the e et al. (2003) and Bellis the enhanced foods usi taste and aroma enhanc in the present experime ended food liking. The the standard, but the ar the taste-enhanced cus was the variant that wa and texture) that got th dimensional approach wh Kremer, Holthuysen, &

response to the elderly population's needs. Interestingly, having pureed beef and pureed carrots side by side (and not mixed altogether) was valued by some participants, but 27% of the participants did not like this variant very much ($M=2.60$; $SEM=0.23$).

5.3 Multidimensional Approaches Should Be Favored Rather Than Targeting One Sensory Dimension

Finally, strategies to compensate for age-associated losses in chemosensory acuity have mainly explored flavor enhancement (i.e., deliberately adding flavor compounds to a food). Flavor enhancement has proved to be effective in food acceptability: several authors have observed that adding a flavor compound to a food actually increases liking scores among elderly people (De Jong, De Graaf, Van Staveren, 1996; Griep, Mets, & Massart, 1997; Koskinen, Kälviäinen, & Tuorila, 2003; Kremer, Bult, Mojet, & Kroeze, 2007a, 2007b; Laureati et al., 2008; Schiffman & Warwick, 1988). For instance, Schiffman and Warwick (1988) presented elderly participants with three food samples. One of these was not enhanced, while the other two were enhanced with the same flavor at different concentrations or with different flavors. The participants were asked to taste each of the three samples and to choose the one they preferred. On average, 75% of the elderly participants favored an enhanced sample. However, flavor enhancement seldom improves food intake in elderly people (see Doets & Kremer, 2016; Sulmont-Rossé et al., 2010, for a review). Schiffman and Warwick (1993) compared food intake of retirement home residents when they ate plain food versus when they ate flavor-enhanced foods. The results indicated that the addition of flavors significantly increased consumption of only 3 of 30 foods. Mathey, Siebelink, de Graaf, and van Staveren (2001) observed that daily dietary intake decreased in a control group, while it remained stable in a group who ate flavor-enhanced foods for 16 weeks. However, when Essed, van Staveren, Kok, and de Graaf (2007) replicated this study a few years later, flavor enhancement did not lead to a higher dietary intake. It should be noted that in most of the studies that have tested the effectiveness of flavor enhancement, flavor compounds and enhanced concentrations were chosen by the experimenters, without exploring the elderly subjects' expectations and preferences. Koskinen et al. (2003) and Bellisle et al. (1991) even chose the flavor concentrations for the enhanced foods using data collected from a young panel. However, even if taste and aroma enhancements have been drawn from the input of elderly people in the present experiment (qualitative phase), flavor enhancement seldom influenced food liking. The taste and aroma of enhanced purees were preferred to the standard, but the aroma-enhanced custard was as liked as the standard and the taste-enhanced custard was even less liked than the standard. In fact, it was the variant that was improved on three sensory dimensions (taste, aroma, and texture) that got the highest liking score. This pleads in favor of a multidimensional approach when developing food for the elderly population (see also Kremer, Holthuysen, & Boesveldt, 2014).

5.4 Methodological Recommendations

Running focus groups or hedonic ratings with elderly people requires some adjustments (see Methven, Jiménez-Pranteda, & Lawlor, 2016 for a review). Even within the framework of normal aging (with no pathology), age goes with slower cognitive and motor functions as well as with tiredness in people. Consequently, several precautions should be taken for them to feel comfortable in their taster role. Tests should be simplified and the workload during tasting sessions should be reduced (Maitre et al., 2015). Instructions and questionnaires should be easy to read (airy layout, large print, large scales) so as not to put seniors suffering from visual impairment in an awkward position. As many old people suffer from hearing impairment, it is recommended to give the instructions collectively, then to individually check that each participant understood well. Some elderly people may not be able to write (which frequently happens in nursing homes). In that case, an experimenter should take notes of the participant's answers without influencing him or her. As a rule of thumb, we serve no more than six different food products in a session with older people. It is also recommended to check that the total amount of food ingested does not exceed the size of a standard portion as elderly people often have digestion problems.

A high heterogeneity is seen among the elderly population, in particular in terms of sensory perception (Sulmont-Rosse et al., 2015), oral health status (Vandenberghe-Descamps et al., 2016), and cognitive functions (Alaphilippe & Bailly, 2013), three factors at the heart of food assessment. Consequently, recruiting a panel of healthy and autonomous elderly, i.e., a panel of subjects older than 75, presenting no pathology, taking no drugs, and with good sensory, masticatory, and cognitive aptitudes, is challenging. However, it is also difficult to recruit people with specific problems (such as people suffering from malnutrition or from dysphagia) as they are usually frail and dependent and therefore less willing to take part in this type of study and/or cognitively not capable of carrying out sensory tests. In fact, this can be seen as a limiting factor in applying the present methodology for the development of products meeting the specific needs and/or disabilities of elderly people (such as fortified food or texture-modified food). This study as well as a previous study (Maitre et al., 2015) revealed a decrease in the hedonic discrimination level with dependency, but product ranking was similar between independent elderly people and institutionalized elderly people. When searching in the PubMed and Web of Science databases to 2014, Methven et al. (2016) found 73 papers related to hedonic measures in older people. Over these 73 papers, 59 used a category hedonic liking scale and/or a visual analogue liking scale. Over these 59 papers, only 16 carried out hedonic measurement with both older people and elderly patients suffering from a specific disease (e.g., cancer patients, Alzheimer's disease) or a specific disability (e.g., olfactory dysfunction, dysphagia). In most of these studies, pleasantness did not differ between the elderly patients and the elderly controls. For instance, Stahlman et al. (2001) asked two groups of elderly

people with and types of pureed interaction on lik convenience sam to elderly people hedonic ratings c still too scarce to

Finally, a bias with elderly people elderly people gi 2004; D'Hautevil and dependent e elderly people (M present generation food (Doty, 1991) to please the inve sory tests. This pc where sensory tes tunity to "chat" wi make the responde to the products in ant in the product dependent people blanquette but not variants were asso these liking scores $M=3.01$, $SEM=0$. vanilla custard, M the fact that partici very unpleasant. B reluctant to use the

6. CONCLUSION

This chapter propos ciple to overcome the people's expectations to fit with elderly pe demonstrates that im consumers with inpu in the context of an elderly person's nutri ties and sensory pref as for society.

people with and without impaired swallowing to rate their liking for different types of pureed peach. They did not observe any *group* effect or *group* × *product* interaction on liking score. However, one should be cautious before recruiting a convenience sample of healthy elderly people to assess food products dedicated to elderly people with specific problems. In fact, studies that have compared the hedonic ratings of healthy elderly people with those of frail elderly people are still too scarce to support a definitive conclusion.

Finally, a bias toward the positive side of the scale was frequently observed with elderly people, and in particular dependent elderly people. On average, elderly people give higher liking scores than young people (Cordelle et al., 2004; D'Hauteville et al., 1997; Kälviäinen et al., 2003; Tuorila et al., 1998), and dependent elderly people give higher liking scores than independent elderly people (Maitre et al., 2015). This could be due to the fact that the present generation of elderly people has been educated not to complain about food (Doty, 1991). This could also be due to the fact that elderly people want to please the investigators, who are “taking care” of them during the sensory tests. This positive emotional context is even stronger in nursing homes, where sensory tests represent a disruption in the daily routine and an opportunity to “chat” with a “visitor”. In an attempt to prevent this bias, we tried to make the respondents comfortable with the idea of giving a low hedonic score to the products in the instructions. We also added an a priori unpleasant variant in the product series. These precautions were at least partly successful, as dependent people gave higher liking scores than autonomous people for the blanquette but not for the two other products. However, even if the unpleasant variants were associated with the lowest liking score for the three products, these liking scores were close to the middle of the scale (veal blanquette, $M=3.01$, $SEM=0.14$; pureed beef–carrots, $M=2.60$; $SEM=0.14$; fortified vanilla custard, $M=3.40$; $SEM=0.13$). Of course these scores might reflect the fact that participants did not perceive the a priori unpleasant variants as very unpleasant. But this might also reflect the fact that elderly people are reluctant to use the negative side of liking scales.

6. CONCLUSION

This chapter proposes a methodology following the reverse engineering principle to overcome the gap in the current food supply for food adapted to elderly people's expectations. Given the fact that experimental conditions were adapted to fit with elderly people's capacities and disabilities, the present experiment demonstrates that improving the sensory quality of foods dedicated to elderly consumers with input from elderly consumers is possible and efficient. In fact, in the context of an aging population, the development of products meeting an elderly person's nutritional needs while taking into account functional capacities and sensory preferences is a major challenge for the food industry as well as for society.

7. SOURCES OF FURTHER INFORMATION

- Maitre, I., Symoneaux, R., & Sulmont-Rossé, C. (2015). Sensory testing in new product development: Working with older people. In J. Delarue, B. Lawlor, & M. Rogeaux (Eds.), *Rapid sensory profiling techniques and related methods*. Cambridge, UK: Woodhead Publishing Limited.
- Methven, L., Jiménez-Pranteda, M. L., & Lawlor, B. J. (2016). Sensory and consumer science methods used with older adults: A review of current methods and recommendations for the future. *Food Quality and Preference*, 48, 333–344.

ACKNOWLEDGMENTS

This study is part of AUPALESENS—Improving the pleasure of elderly people for better ageing and to fight against malnutrition—funded by the French National Research Agency (ANR-09-ALIA-011-02). This work was also supported by grants from the Regional Council of Burgundy France (PARI Agral 1) and the European Funding for Regional Economical Development (FEDER). The authors thank Pauline De Facq, Françoise Durey, Christophe Laura Gimaret, Martin Anaïs Mesnier, Catherine Ouvrad, Corinne Patron, Isabelle Saillard, and Jérémy Tavarès for their help during the experiments; Sylvie Issanchou and Virginie Van Wymelbeke for providing advice; and D'Aucy, Nutrisens and Lactalis for the work they did on the recipes to provide the variants.

REFERENCES

- Alaphilippe, D., & Bailly, N. (2013). *Psychologie de l'adulte âgé*. De Boeck.
- Bellisle, F., Monneuse, M. O., Chabert, M., Larue-Achagiotis, C., Lanteaume, M. T., & Louis-Sylvestre, J. (1991). Monosodium glutamate as a palatability enhancer in the European diet. *Physiology & Behavior*, 49, 869–873.
- Birch, L. L. (1980). The relationship between children's food preferences and those of their parents. *Journal of Nutrition Education*, 12, 14–18.
- CLCV. (2012). *Enquête sur l'alimentation des personnes âgées*. <http://www.clcv.org/nos-enquetes/enquete-sur-l-alimentation-des-personnes-agees-02-02-2012.html>.
- Cordelle, S., Lange, C., & Schlich, P. (2004). On the consistency of liking scores: Insights from a study including 917 consumers from 10 to 80 years old. *Food Quality and Preference*, 15, 831–841.
- D'Hauteville, F., Aurier, P., & Sirieix, L. (1997). A sensory approach to consumers preferences for rice. In *First results of a European survey (France, Greece, Netherlands, Spain)*. *International symposium on rice quality*.
- De Jong, N., De Graaf, C., & Van Staveren, W. (1996). Effect of sucrose in breakfast items on pleasantness and food intake in the elderly. *Physiology & Behavior*, 60, 1453–1462.
- Derouesn , C., Poitreneau, J., Hugonot, L., Kalafat, M., Dubois, B., Laurent, B., et al. (1999). Mini-mental state examination (MMSE) a practical tool for evaluating cognitive status: The consensual French version. *Presse Medicale*, 28, 1141–1148.
- Doets, E. L., & Kremer, S. (2016). The silver sensory experience – A review of senior consumers' food perception, liking and intake. *Food Quality and Preference*, 48, 316–332.
- Doty, R. L. (1991). Olfactory system. In T. V. Getchell, R. L. Doty, L. M. Bartoshuk, & J. B. Snow (Eds.), *Smell and taste in health and disease*. New York: Raven Press.
- Doty, R. L., Shaman, P., Appelbaum, S. L., Giberson, R., Sikorski, L., & Rosenberg, L. (1984). Smell identification: Changes with age. *Science*, 226, 1441–1443.

- Bessed, N. H., van Staveren, W. (2015). Sensory enhancement on diet. *Food Quality and Preference*, 48, 29–36.
- Folstein, M., Folstein, S. (1999). The "Folstein" test of cognitive state of mind. *Journal of Clinical Gerontology and Preference*, 8, 1–10.
- Jilani, H. S., Intemann, T. (2015). Taste preference or diet? *Journal of Clinical Gerontology and Preference*, 8, 1–10.
- Kälviäinen, N., Roininen, L. (2015). Aroma on a yogurt-type. *Food Quality and Preference*, 14, 177–183.
- Koskinen, S., Kälviäinen, N. (2015). Pleasantness and intake. *Food Quality and Preference*, 48, 96–103.
- Kremer, S., Bult, J. H. F. (2015). Chemosensory losses. *Appetite*, 48, 96–103.
- Kremer, S., Bult, J. H. F. (2015). Relationship to pleasantness. *Appetite*, 48, 96–103.
- Kremer, S., Holthuysen, N. (2015). Independently living. *Appetite*, 38, 30–35.
- Laureati, M., Pagliarini, E. (2015). Improve the enjoyment. *Appetite*, 23, 234–250.
- Liu, B., Dion, M. R., Jura, G. (2015). Hypofunction in vulve. *Pathology and Oral Research*, 38, 30–35.
- Mackay-Sim, A., Johnston, J. (2015). Healthy population: Research. *Food Quality and Preference*, 15, 831–841.
- Maitre, I., Symoneaux, R. (2015). Working with older people: Sensory profiling techniques. *Food Quality and Preference*, 48, 333–344.
- Mathey, M. F., Siebelink, M. (2015). Food improves diet. *Journals of Gerontology*, 70, 1–10.
- Methven, L., Jiménez-Pranteda, M. L. (2016). Methods used with older adults. *Food Quality and Preference*, 48, 333–344.
- Methven, L., Rahelu, K., E. (2010). The effect of color of varied sweetness: Sensory. *Food Quality and Preference*, 23, 234–250.
- Mioche, L., Bourdiol, P., & (2015). Behaviour. *Nutrition Research*, 35, 1–10.

- Essed, N. H., van Staveren, W. A., Kok, F. J., & de Graaf, C. (2007). No effect of 16 weeks flavor enhancement on dietary intake and nutritional status of nursing home elderly. *Appetite*, *48*, 29–36.
- Folstein, M., Folstein, S., & McHugh, P. (1975). Mini-mental-state: A practical method for grading cognitive state of patients for the clinician. *Journal of Psychiatric Research*, *12*, 189–198.
- Griep, M. I., Mets, T. F., & Massart, D. L. (1997). Different effects of flavour amplification of nutrient dense foods on preference and consumption in young and elderly subjects. *Food Quality and Preference*, *8*, 151–156.
- Jilani, H. S., Intemann, T., Hebestreit, A., & Ahrens, W. (2016). Is there a familial aggregation of taste preference or do other correlates explain more? In *EUROSENSE: A sense of time* Dijon, France.
- Kälviäinen, N., Roininen, K., & Tuorila, H. (2003). The relative importance of texture, taste and aroma on a yogurt-type snack food preference in the young and the elderly. *Food Quality and Preference*, *14*, 177–186.
- Koskinen, S., Kälviäinen, N., & Tuorila, H. (2003). Flavor enhancement as a tool for increasing pleasantness and intake of a snack product among the elderly. *Appetite*, *41*, 87–96.
- Kremer, S., Bult, J. H. F., Mojet, J., & Kroeze, J. H. A. (2007). Compensation for age-associated chemosensory losses and its effect on the pleasantness of a custard dessert and a tomato drink. *Appetite*, *48*, 96–103.
- Kremer, S., Bult, J. H. F., Mojet, J., & Kroeze, J. H. A. (2007). Food perception with age and its relationship to pleasantness. *Chemical Senses*, *32*, 591–602.
- Kremer, S., Holthuysen, N., & Boesveldt, S. (2014). The influence of olfactory impairment in vital, independently living older persons on their eating behaviour and food liking. *Food Quality and Preference*, *38*, 30–39.
- Laureati, M., Pagliarini, E., & Calcinoni, O. (2008). Does the enhancement of chemosensory stimuli improve the enjoyment of food in institutionalized elderly people? *Journal of Sensory Studies*, *23*, 234–250.
- Liu, B., Dion, M. R., Jurasic, M. M., Gibson, G., & Jones, J. A. (2012). Xerostomia and salivary hypofunction in vulnerable elders: Prevalence and etiology. *Oral Surgery, Oral Medicine, Oral Pathology and Oral Radiology*, *114*, 52–60.
- Mackay-Sim, A., Johnston, A. N. B., Owen, C., & Burne, T. H. J. (2006). Olfactory ability in the healthy population: Reassessing presbyosmia. *Chemical Senses*, *31*, 763–771.
- Maitre, I., Symoneaux, R., & Sulmont-Rossé, C. (2015). Sensory testing in new product development: Working with older people. In J. Delarue, B. Lawlor, & M. Rogeaux (Eds.), *Rapid sensory profiling techniques and related methods*. Cambridge, UK: Woodhead Publishing Limited.
- Mathey, M. F., Siebelink, E., de Graaf, C., & van Staveren, W. A. (2001). Flavor enhancement of food improves dietary intake and nutritional status of elderly nursing home residents. *The Journals of Gerontology. Series A, Biological Sciences and Medical Sciences*, *56*, M200–M205.
- Methven, L., Jiménez-Pranteda, M. L., & Lawlor, B. J. (2016). Sensory and consumer science methods used with older adults: A review of current methods and recommendations for the future. *Food Quality and Preference*, *48*, 333–344.
- Methven, L., Rahelu, K., Economou, N., Kinneavy, L., Ladbrooke-Davis, L., Kennedy, O. B., et al. (2010). The effect of consumption volume on profile and liking of oral nutritional supplements of varied sweetness: Sequential profiling and boredom tests. *Food Quality and Preference*, *21*, 948–955.
- Mioche, L., Bourdiol, P., & Peyron, M.-A. (2004). Influence of age on mastication: Effects on eating behaviour. *Nutrition Research Review*, *17*, 43–54.

- Mojet, J., Christ-Hazelhof, E., & Heidema, J. (2001). Taste perception with age: Generic or specific losses in threshold sensitivity to the five basic tastes? *Chemical Senses*, 26, 845–860.
- Murphy, C. (1986). Taste and smell in the elderly. In M. L. Meiselman, & R. S. Rivlin (Eds.), *Clinical measurement of taste and smell*. New York: Macmillan.
- Murray, J. M., Delahunty, C. M., & Baxter, I. A. (2001). Descriptive sensory analysis: Past, present and future. *Food Research International*, 34, 461–471.
- Nordin, S., Almkvist, O., & Berglund, B. (2012). Is loss of odor sensitivity inevitable to the ageing individual? A study of “successfully aged” elderly. *Chemosensory Perception*, 5, 188–196.
- Ries, E. (2012). *Lean start-up: Adoptez l'Innovation continue*. Paris, France: Pearson.
- Rozin, P. (1991). Family resemblance in food and other domains: The family paradox and the role of parental congruence. *Appetite*, 16, 93–102.
- Rozin, P., & Vollmecke, T. A. (1986). Food likes and dislikes. *Annual Review of Nutrition*, 6, 433–456.
- Schiffman, S. S., & Warwick, Z. S. (1988). Flavor enhancement of foods for the elderly can reverse anorexia. *Neurobiology of Aging*, 9, 24–26.
- Schiffman, S. S., & Warwick, Z. S. (1993). Effect of flavor enhancement of foods for the elderly on nutritional status: Food intake, biochemical indices and anthropometric measures. *Physiology & Behavior*, 53, 395–402.
- Song, X., Giacalone, D., Johansen, S. M. B., Frost, M. B., & Bredie, W. L. P. (2016). Changes in olfactory perception related to aging and strategies for counteracting its influence on food preferences among older adults. *Trends in Food Science & Technology*, 53, 49–59.
- Stahlman, L. B., Garcia, J. M., Chambers, E., Smit, A. B., Hoag, L., & Chambers, D. H. (2001). Perceptual ratings for pureed and molded peaches for individuals with and without impaired swallowing. *Dysphagia*, 16, 254–262.
- Sulmont-Rosse, C., Maître, I., Amand, M., Symoneaux, R., van Wymelbeke, V., Caumon, E., et al. (2015). Evidence for different patterns of chemosensory alterations in the elderly population: Impact of age versus dependency. *Chemical Senses*, 40, 153–164.
- Sulmont-Rossé, C., Maître, I., & Issanchou, S. (2010). Âge, perception chimiosensorielle et préférences alimentaires. *Gérontologie et Société: Cahiers de la Fondation Nationale de Gérontologie*, 134, 87–106.
- Tuorila, H., Anderson, Å., Martikainen, A., & Salovaara, H. (1998). Effect of product formula, information and consumer characteristics on the acceptance of a new snack food. *Food Quality and Preference*, 9, 313–320.
- den Uijl, L. C., Jager, G., Zandstra, E. H., de Graaf, C., & Kremer, S. (2016). Silver protein meals: Applying mealtime functionality for tailoring protein-enriched meals to older consumer segments. In *EUROSENSE: A sense of time* Dijon, France.
- Vabo, M., & Hansen, H. (2014). The relationship between food preferences and food choice: A theoretical discussion. *International Journal of Business and Social Science*, 5, 145–157.
- Vandenbergh-Descamps, M., Labouré, H., Prot, A., Septier, C., Tournier, C., Feron, G., et al. (2016). Salivary flow decreases in healthy elderly people independently of dental status and drug intake. *Journal of Texture Studies*, 47, 353–360.
- Zellner, D. A. (1991). How foods get to be liked: Some general mechanisms and some special cases. In R. C. Bolles (Ed.), *The hedonics of taste*. Hillsdale, New Jersey: Lawrence Erlbaum Associates.

Chapter 15

Designing
Studies for
PopulationsHenriëtte L. de Kock,
University of Pretoria, Pretoria

Chapter Outline

1. Introduction
2. Characteristics of Consumers of Low Socioeconomic Status
3. Planning, Design, and Execution of Product Tests With Consumers of Low Socioeconomic Status
 - 3.1 Step 1: Identify the Research Question(s) That Need to Be Answered
 - 3.2 Step 2: Decide on the Objective(s) for the Consumer Test
 - 3.3 Step 3: Decide on the Conditions
 - 3.3.1 Test Participation
 - 3.3.2 Test Methodology

1. INTRODUCTION

Sensory and consumer science research is essential for the development of a prosperous, food-secure society. The development of food products for the benefit of consumers in low- and middle-income countries (Tuorila & Mäkelä, 2004; Tuorila & Hough, 2006; Sosa, M...

Methods in Consumer Research, Volume 1
Copyright © 2018 Elsevier Ltd. All rights reserved.